

ELECTRONICS

Australia

July, 1968

Incorporating RADIO, TELEVISION & HOBBIES

Vol. 30 No. 4



30c

ATOMIC FUEL ELEMENTS

Protecting projector lamps

Testing transistors

● Wide-band tuner

● Graphs, figures & hi-fi



NATIONAL

Sound Systems



Specialists in industrial sound equipment for every application

1. Sound System Control Desk.
2. Mobile Lecture Stand with self-contained P.A. system (Rostrum).
3. Electronic Chime.
4. Hi-Fi Speaker Box.
5. 'Sonoline' sound column for interior use.



6. 'Sonoline' sound column for exterior use.
7. AC/DC Wireless Microphone receiver/amplifier (solid state).
8. AC wireless microphone receiver/pre-amplifier.
9. AC professional wireless microphone receiver/pre-amplifier.
10. Super high quality 30W audio amplifier (hybrid).
11. Reflex Horn Speaker.
12. Multi-purpose 60W amplifier with tuner.
13. Multi-purpose 60W amplifier.
14. Cassette operated background music player/amplifier.
15. Loudhailer with detachable microphone.
16. Standard 30W P.A. Amplifier.
17. Battery powered microphone mixer/repeater (solid state).
18. Reflex horn speaker box for P.A. purpose.
19. Wall speaker box.
20. Loudhailer with inbuilt microphone.
21. General purpose microphone with stand.
22. Standard 10W amplifier with tuner.
23. Standard 10W amplifier.
24. Wall speaker box with volume control.
25. Portable battery operated P.A. unit.

26. Uni-directional studio microphone with stand.
27. Uni-directional ribbon microphone with stand.
28. 20W midjet amplifier (solid state.)
29. Quality Hi-Fi dynamic microphone with stand.
30. Flush mounted ceiling speaker.
31. Clip-on wireless microphone with transmitter.
32. Hand held wireless microphone with transmitter.
33. Standard Hi-Fi dynamic microphone with stand.

For further information, without obligation, send coupon to:

HACO DISTRIBUTING AGENCIES PTY. LIMITED
57/69 Anzac Parade, Kensington, N.S.W. 2033.

NAME

ADDRESS

ELECTRONICS Australia

Incorporating "RADIO, TELEVISION and HOBBIES"

ABC certified circulation in excess of 47,000.

Volume 30, No. 4

Editor:
NEVILLE WILLIAMS, M.I.R.E.E. (Aust.)
(VK2XV).

Assistant Editor:
PHILIP WATSON, A.M.I.R.E.E. (Aust.)
(VK2ZPW).

Technical Editor:
JAMIESON ROWE, B.A. (Syd.), B.Sc.
(Technology, N.S.W.), A.M.I.R.E.E.
(Aust.).

Technical Staff:
IAN POGSON (VK2AZN).
ANTHONY LEO (VK2ZHK).
HARRY TYLER.
JOHN HORSFIELD.
ROBERT FLYNN.
LEO SIMPSON.

Editorial Office:
12th Floor, 235-243 Jones Street,
Broadway, Sydney, Australia. Phone
2-0944, Ext. 2531, 2525-6-7.

Postal Address:
Box 2728, G.P.O., Sydney, 2001, Aus-
tralia.

Advertising:
SELWYN SAYERS, Mgr.
BILL SUMONS, Rep., Sydney.
Offices: 8th Floor, 235-243 Jones Street,
Broadway, Sydney, Australia. Phone
2-0944, Ext. 2531, 2509, 2943.
CLARRIE LEVY, Rep., Melbourne, 392,
Little Collins Street, 3000. Ph. 67-8131.

Circulation:
A. PARKER, Mgr.
Offices: 9th Floor, 235-243 Jones Street,
Broadway, Sydney, Australia. Phone
2-0944, Ext. 2595, 2509.

Subscription Rates—See back page.

Representation:
Melbourne—John Fairfax & Sons Ltd.,
392 Little Collins St., 3000. Ph. 67-8131
Brisbane—Sungravy Pty. Ltd. 78
Elizabeth Street, 4000. Ph. 2-6688.
Adelaide—John Fairfax & Sons Ltd.,
104 Currie Street, 5000. Ph. 51-3502.
Perth—Sungravy Pty. Ltd., 847 Hay
Street, 6000. Phone 23-4513.
Newcastle, N.S.W.—Associated News-
papers Ltd., 22 Bolton Street, 2300.
Phone 2-3696.
London—John Fairfax & Sons (Aust.)
Ltd., Reuter Building, 85 Fleet Street.
New York—"The Sydney Morning
Herald" Ltd., "Times Annex," 229 West
43rd Street.

Distribution:
Distributed in N.S.W. by Sungravy
Pty. Ltd., Jones St., Broadway, Sydney.
N.S.W.; in Victoria by Sungravy Pty.
Ltd., 392 Little Collins Street, Mel-
bourne; in South Australia by Sun-
gravy Pty. Ltd., 104 Currie Street,
Adelaide; in Western Australia by
Western Press; in Queensland by
Gordon and Gotch (Asia) Ltd.; in New
Zealand by Truth (N.Z.) Ltd.; in Tas-
mania by Davies Bros. Ltd., "Mercury,"
Hobart.

The microcircuit era



As recently as October last I referred in this column to the tremendous emphasis on integrated microcircuits, their virtual necessity in "sophisticated" electronic equipment and the inevitability of their spilling over into other functions presently performed by discrete components. I concluded with the sentence "microcircuits are destined to dominate electronics . . . We may as well move over now!"

Everything that I have read and seen in the intervening months has confirmed this prediction. Samples of new switching and linear microcircuits have been arriving regularly at our laboratory for "inspection and test," with the obvious thought that we may ultimately be able to use them in practical constructional projects. In most cases the suppliers are willing to sell them in large numbers or in small and, even at this early stage, the "one-off" price is attractive when compared with the cost of the equivalent discrete components—if, in fact, there is a practical equivalent.

The idea of buying prefabricated "black boxes" and connecting wires to them has long been viewed with suspicion by "old-time" engineers and hobbyists alike and the opinion has often been expressed that, when microcircuits come in one door, electronics as a hobby will go out the other.

In fact, there is good reason to believe that the reverse may happen. Just as the era passed when people made their own B-batteries and their own mica condensers, just as valves have gradually given way to transistors, so discrete components look like giving way to integrated circuits—units capable of being designed into equipment which previously would have been beyond the reach of hobbyists or anyone else operating on a small scale.

The square-wave generator and the pulse generator described last year, and an audio gating unit featured in the April issue, are examples of test equipment, which is quite straightforward when built around integrated circuits, but scarcely practical otherwise. In other fields, only lack of time is now delaying the description of hi-fi control units and amplifiers in which ICs will eliminate much of the rat's-nest wiring that has characterised solid-state amplifiers to date.

As a hobby, electronics is certainly maturing but it is far from being senile.

W. N. Williams

July, 1968

P.O. Recorded Voice Services ..	8	Basic Broadcast Tuner	63	Trade Reviews and Releases ..	114
Isaac Newton Optical Telescope	12	The Serviceman	73	Technical Publications	125
Designing Lenses by Computer	15	Solar and Sidereal Time	77	Amateur Band News and Notes	133
U.S. Army's MARS Network ..	17	Forum	81	Listening Around the World ..	145
Festival Records' Expansion ..	18	Reader Built It	87	Answers to Correspondents ...	151
Electronic "Nurses"	21	Audio Topics—Equipment per- formance figures	89	Classified Advertisements	159
Review—Navigation in Fog ...	23	Classical Reviews	96	Subscription Form	160
Review—Improved Schottky Diodes	25	Documentary Records	101	Advertisers' Index	160
Review—Computer Banking System	27	Variety Fare	103	Errata and Notes	101
Scientific and Industrial News .	29				
Wide-band AM Tuner Design ..	37				
Parameter Spreads and FET Amps.	43				
Projection Lamp Protector ...	47				
Testing Diodes, Transistors ...	52				

COVER PICTURE: Britain justly claims to lead the world in the application of atomic energy to power generation. Manufactured at the Springfields works of the U.K. Atomic Energy Authority, the pellets pictured are destined for use in a steam generating heavy water reactor. They are referred to as S.G.H.W. pellets.

NEW INSTROL HI-FI EQUIPMENT

INSTROL Model T-101 Fully Transistorised WIDE BAND TUNER

A high quality hi-fi tuner designed to operate in conjunction with all makes of solid state amplifiers.

- Wide band 530 to 1600KHz.
- Tuning Meter. ● Efficient noise Filter. ● R.F. Stage. ● Built-in AC Power Supply. ● Major Stations, all States clearly marked on large illuminated scale. ● Available in smart metal box or in teak cabinet. ● Available as Amp/Tuner combination, with the Instrol 20-20 and 10-10 Amplifiers, in attractive Teak cabinet as illustrated below, or less cabinet for panel mounting.



INSTROL MODEL 20-20 STEREO AMPLIFIER

Solid state, 20 Watts per channel max. power (10w R.M.S.), 30 to 20,000 Hz—less than 1½% harmonic distortion, suits ceramic and magnetic pickups — packed with features.



INSTROL MODEL 10-10 STEREO AMPLIFIER

10 watts per channel (5w R.M.S.), ideal for ceramic and crystal pickups. High quality at low cost.



PRICE DETAILS:

T101 TUNER (in Metal Case)	\$72.00
(\$6.00 extra for Teak Case.)	
20-20 AMP' (in Teak Case)	\$99.00
10-10 AMP' (in Teak Case)	\$58.00
Combined 20-20-T101 in Teak Case	\$176.00
Combined 10-10-T101 in Teak Case	\$135.00

NEW INSTROL CABINET DESIGNS . . . "Series one thousand" PRE CUT KITS or BUILT & POLISHED



PRE-CUT KITS, including absolutely everything. Smooth sanded mortised panels, precision cut doors ready for insertion of handles and hinges, perspex, nails, screws, speaker grille cloth. Innerbond acoustic wadding, full building instructions, etc., etc. Call or send postage stamp for fully illustrated leaflet.

Modern . . . dignified cabinet settings which breathe quality. Modular in design, they will compact to form a sweeping uniform 3-piece setting or may be attractively spread for musical effect.
Speaker Enclosure Model .. 1001
Two Section Cabinet Model 1002
Three Section Cabinet Model 1003

All compartments will suit large players and amplifiers. Pull-out drawers with nylon bearings on heavy duty metal slides. Drawer fronts finished in perspex to give full player and tape recorder visibility. Clean, smooth-fitting doors with recessed wooden handles. Model 1003 also provides for tape deck or recorder with storage for tapes in addition to record storage. Speaker enclosure Model 1001, an acoustically designed vented enclosure to suit all types and sizes of speakers and networks features a directionally sloping front panel.

Yes, we carry a range of imported loudspeakers, players, amplifiers and tape recorders. Please state your requirements and we will gladly quote. All well-known brands stocked.

- INSTROL
- PLAYMASTER
- FISHER
- ROLAND
- TRIO
- SANSUI
- WHARFEDALE
- GOODMAN'S
- SHURE
- A.D.C.
- DECCA
- LABCRAFT
- ALL BALANCE
- DUAL
- ELAC
- GARRARD
- SONY
- BRENNELL
- MINICONICS
- AKAI
- TEMPO
- LEAK
- QUAD

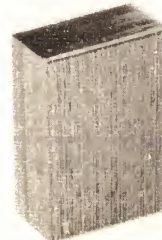
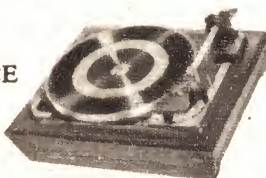

Easy to Assemble

INSTROL CABINET KITS

MAKE YOUR OWN HI-FI FURNITURE FOR LITTLE MORE THAN HALF THE COST

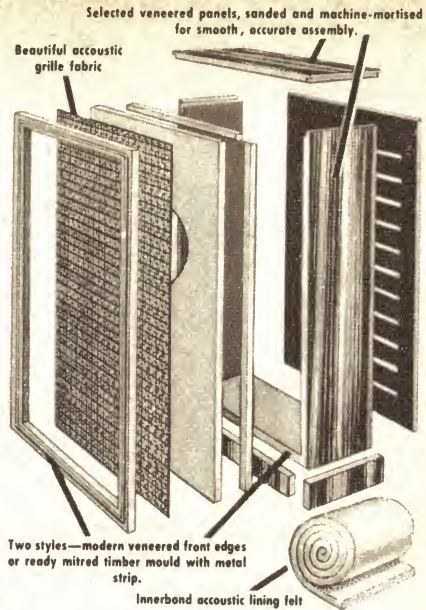

So easy, a child can manage it. The Instrol way—a new simplified method of assembly. A hammer, screwdriver, few hours of your time, and you can make for yourself a complete high quality hi-fi cabinet setting, fully professional in appearance.



FREE
INSTROL
CABINET
CATALOGUE

Post coupon, call, or phone for free fully illustrated Instrol hi-fi cabinet brochure. It includes full specifications and down to earth price details of all Instrol cabinet designs. (If writing please include postage stamp.)

Each kit is complete with all necessary timber parts, plus nails, screws, full, easy to follow instructions, and where necessary, ready mitred and grooved timber mould with metal insert. Speaker enclosure kits are complete with acoustic Innerbond lining felt, and acoustic grille cloth. Equipment cabinet kits include hinges, knobs, catches, sliding stays, castors, slides, leg sets, etc. All timber parts are precision cut, fit together smoothly. Panels are best quality veneered in selected Teak or Queensland Maple. Instrol cabinet designs will cater for virtually any make of speaker player amplifier, and tapedeck. If required, all designs are available ready built and polished, but it's highly economical and much more fun to make your own.



BROADWAY ELECTRONICS (SALES)
PTY. LTD.

32 GLEBE PT. ROAD, GLEBE, N.S.W.
Telephone 68-1171. Only 100 yards from Broadway.
OPEN SATURDAY MORNINGS.

Send Coupon for **FREE CATALOGUE**.
(Please enclose postage stamp.)

NAME

ADDRESS

.....

.....

Instrol Hi-Fi Instrol Cabinets

SCOPE



IN SOLDERING IRONS



**VOTED FIRST BY A
HOST OF SATISFIED
USERS.**

**Far ahead
in design,
for speed
and economy
of operation...**

SCOPE

the world famous irons, have a solid carbon heating element that gives heat right at the copper tips, plus longer worry-free service—no wire wound element to suddenly burn out.

SCOPE

offers greater economy, they consume current only whilst in use. Low maintenance costs. A spare tip and two carbon heating elements are supplied with the irons. Both Deluxe and Miniscope are presented in reusable Plastic Pouch-Packs. Ideal for neat storage and easy portability.



Scope and Miniscope both operate on voltages from 2.5V to 6.3V A.C. or D.C. or from 240V A.C. Mains through a "National" scope transformer. Fitted with 6ft. 3 core flex and 3 pin mains plug only \$7.65

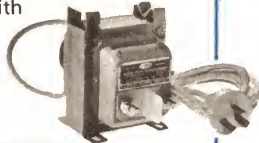

SCOPE

AVAILABLE FROM ALL MAJOR ELECTRICAL WHOLESALERS AND HARDWARE STORES — THE FULL GUARANTEE APPLIES ONLY WHEN THE IRON IS USED WITH THE APPROVED 'SCOPE' TRANSFORMER. MANUFACTURED BY NATRONICS PTY. LTD.

AUSTRALIAN & OVERSEAS AGENTS:

IRH COMPONENTS PTY. LIMITED

THE CRESCENT, KINGSGROVE. 2208. N.S.W. 50 0111

VICTORIA:
I. R. H. GROUP SALES VICTORIA
202 Bell Street, PRESTON. 480 1211

S. AUSTRALIA: COLLETT & CANT PTY.
103 Halifax Street, ADELAIDE.

N.Z.: H. W. CLARKE (N.Z.) LIMITED
42-46 Cable Street,
WELLINGTON, C.3

TASMANIA: W. P. MARTIN PTY. LTD.
202 Argyle Street, HOBART.

W. AUSTRALIA: I. W. HOLMAN & CO.
249 James Street, PERTH

N.Z.: H. W. CLARKE (N.Z.) LIMITED
10 Teed St., New Market,
AUCKLAND, S.E.1

QUEENSLAND: K. H. DORE & SONS
505-507 Boundary Street, BRISBANE

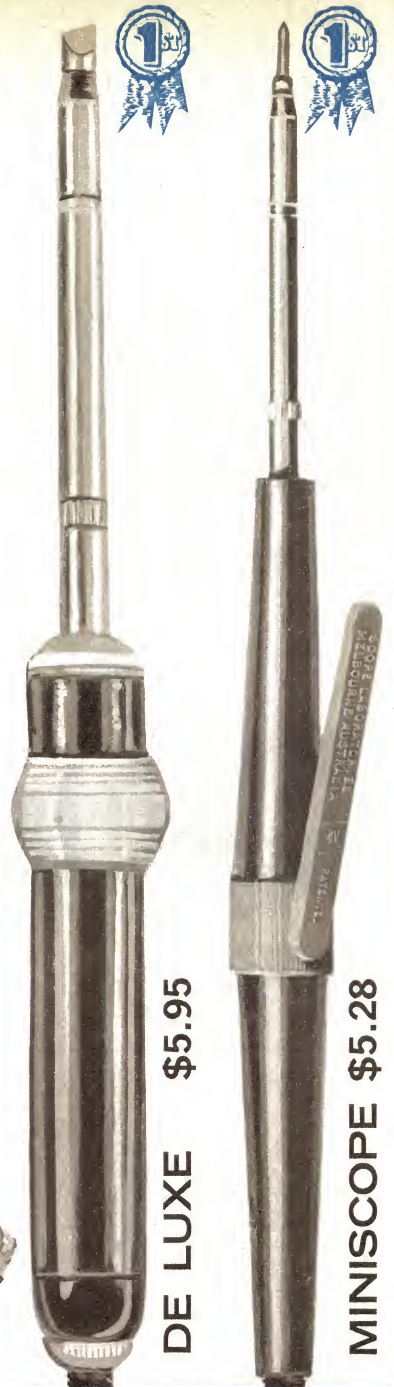

DE LUXE \$5.95

MINISCOPE \$5.28

Please post — free illustrated literature and specifications

Name

Address

APPRENTICESHIPS IN THE RAAF



Engines. Engine Fitter pictured at work checking equipment inside a Sabre Jet.



Electrical. An N.C.O. Electrical Fitter instructs Electrical Servicemen in the operation of the voltage regulator test bench.



Armament. Armament Fitters fitting a 30 mm. Aden Cannon to a mock-up of a Sabre fighter.



Instruments. Instrument Fitters reconditioning aircraft gyroscopic equipment at No. 2 Aircraft Depot, Richmond, N.S.W.



Radio. Radio Technicians (Ground) adjusting 3-Kilowatt high-frequency transmitter.



The Mirage Jet, the RAAF's most modern supersonic fighter.

RAAF sets the pace in worthwhile careers



for boys 15 & 16 years

THIS IS WHAT A RAAF APPRENTICESHIP OFFERS:

Thorough training in Radio, Instrument, Electrical and Mechanical Engineering at NO COST to parents • Full Trade Union recognition • Free medical and dental care • Free food and accommodation • All clothing and necessities provided • Generous pay while training • Six weeks annual leave with free return home travel.

Selected apprentices may be given Technical College Diploma or University Degree courses and appointed as commissioned officers in the Air Force Engineer Branch. Australia today lives in a technical world . . . it is a sphere of life that is giving young men the opportunity to rise to great heights and responsibility. Despite this wide scope, however, competition is tremendously keen, and it is the men with the better training and experience that will secure top technical positions. RAAF Apprentices receive expert training for a lifetime career in the growing field of electronics—or in the associated engineering fields of instruments, electrical, engines, airframe, mechanical transport or armament. Airmen who completed their apprenticeship only a few years ago are now qualified RAAF technicians and leaders in these fields and, later on, should they so desire, could be equally important in an appropriate civilian capacity. Ask yourself as a parent: Do you want security for your son? Do you want him to learn

a specialised skill? Do you want him to have the chance to travel? Do you want him to grow up in comradeship and a happy, healthy environment? All this can be his as a RAAF Apprentice. As a parent, what will you advise him to do?

QUALIFICATIONS. An applicant must be an Australian citizen or British subject or naturalised, granted permanent residence in Australia, aged 15 but not 17 years on 1st January, 1969, and be medically fit. He must have passed, or be currently studying, Fourth Form standard or its equivalent, with English, Mathematics and Science.

APPLICATIONS CLOSE AUGUST 28, 1968

clip out coupon

Staff Officer Recruiting
Headquarters Support Command, RAAF
Victoria Barracks, MELBOURNE
VICTORIA 3004

Please send full details of careers through
the RAAF APPRENTICESHIP SCHEME.

Name.....

Address.....

.....State.....

Director General of Recruiting, Department of Defence.

RA2,FP.58

All **KENWOOD**® Masterpieces In The Only Sound Approach

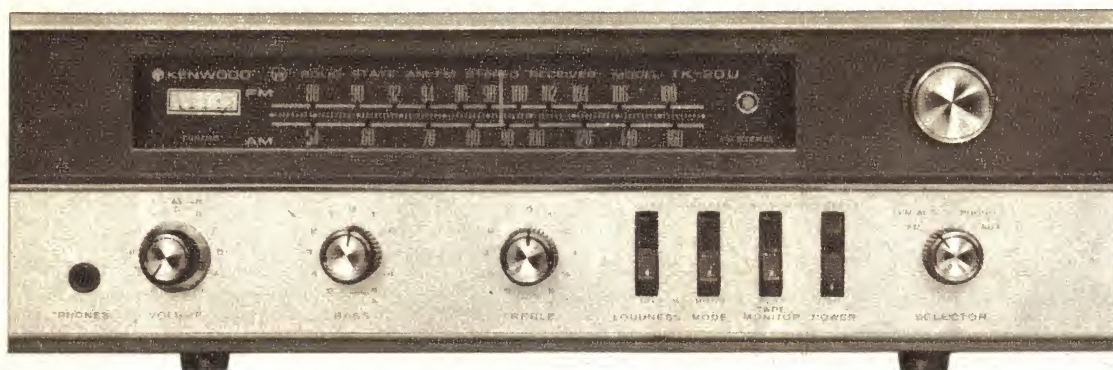

30 WATTS SOLID STATE FET AM-FM STEREO RECEIVER TK-20U

The TK-20U Solid State Stereo receiver powered by Silicon Transistors is reasonably priced (Aust. \$219). It performs equally as well as the more expensive models. The features include 30 watts of total music power, (F.E.T. Field Effect Transistor) 3 gang tuning condenser, 5 IF Stages and a magnificent bass and clean treble sound. For greater power, other amplifiers are readily available.

▼ TK-20U

*F.E.T. (Field Effect Transistor) 3 Gang Tuning Condenser frontend for superior sensitivity, image

rejection and cross modulation ratio.

*5 IF stages with 3 limiters and wideband ratio detector have been incorporated to provide 40dB alternate channel selectivity and freedom from noise and interference.

*4-position program source selector permits AM, FM AUTO, PHONO and AUX.

*USABLE SENSITIVITY:

FM: 2.5 microvolts (IHF Standard)

AM: 10 microvolts (IHF Standard)

*TOTAL MUSIC POWER:

32 watts (IHF Standard at 4 ohms)

30 watts (IHF Standard at 8 ohms)

*FREQUENCY RESPONSE: 25 Hz—40,000 Hz

*DIMENSIONS: 14 $\frac{1}{16}$ "(W), 4 $\frac{3}{4}$ "(H), 11 $\frac{1}{4}$ "(D)



BOOKSHELF TYPE

4-WAY 5 SPEAKER SYSTEM KL-60

▼ KL-60

*60 watts input, 5-speaker, 4-way system

*Designed for use with solid-state amplifiers

*Four-step tone selection

*Completely sealed enclosure

*Smooth 4-way crossover

*Mounted speakers: 12-inch, free-edge woofer×1 (Bass)

6 $\frac{1}{2}$ inch cone squawker×1 (lower midrange)

4 inch cone squawker×1 (higher midrange)

Horn-type tweeter×2 (Treble)

*Frequency response: 30Hz to 20,000Hz

*Dimensions: 15"(W), 25 $\frac{1}{2}$ "(H), 11 $\frac{1}{4}$ "(D)

Products- Circuit Engineering- To Quality

40 WATTS SOLID STATE STEREO AMPLIFIER TK-150U



- ▼ TK-150U
- *40 watts of IHF Standard total music power
- *All transistor amplifier provides wide 20 to 50,000 Hz frequency response and 20 to 60,000 Hz power bandwidth.
- *5 pairs of input terminals for MAG, AUX 1, AUX 2, TAPE REC and TAPE PLAY.
- *Damping factor: 40 (at 16 ohms), 20 (at 8 ohms)
- *Dimensions: 10 $\frac{1}{4}$ "(W), 4 $\frac{1}{8}$ "(H), 9 $\frac{3}{8}$ "(D).

60 WATTS SOLID STATE STEREO AMPLIFIER TK-250U



- ▼ TK-250U
- *60 watts of IHF Standard total music power
- *Very low IM distortion for exceptional clear sound low level to high level listening
- *High damping factor 23 (8 ohms), 46 (16 ohms) for excellent transient response
- *2 sets of stereo speaker terminal and front panel speaker selector switch.
- *Frequency response: 20Hz—50,000Hz (± 1 dB)
- *Power bandwidth: 18 Hz—60,000Hz (-3 dB)
- *Dimensions: 13"(W), 4 $\frac{1}{8}$ "(H), 9 $\frac{3}{8}$ "(D).

90 WATTS SOLID STATE STEREO AMPLIFIER TK-400T A TRIO KENWOOD PRODUCT



- ▼ TK-400T
- *90 watts of IHF Standard total music power to drive even low efficiency HI-FI speakers.
- *Blow out free exclusive automatic circuit breaker protects power transistors (U.S. Pat.)
- *NF type tone control.
- *Frequency Response: 20 Hz - 50,000 Hz (± 1 dB)
- *Dimensions: 15 $\frac{1}{4}$ "(W), 5 $\frac{3}{8}$ "(H), 12 $\frac{1}{4}$ "(D).



the sound approach to quality

KENWOOD®

products of TRIO CORPORATION, Tokyo, Japan.

SOLE AGENT: Jacoby, Mitchell & Co., Pty., Ltd. Head Office: 469-475 Kent Street, Sydney Tel: 26-2651 Melbourne: 15 Abbotsford Street Tel: 30-2491 Brisbane: 56 Edward Street Tel: 2-6467 Adelaide: Truscott Electronics, 64 Hindmarsh Square Tel: 23-3024

Ask for a catalogue or demonstration by your nearest dealer.

To: Jacoby Mitchell & Co., Pty., Ltd. EA
469-475 Kent St., Sydney.
Send me information on KENWOOD RECEIVER,
AMPLIFIERS, SPEAKERS & name of nearest
KENWOOD retailer.

NAME: _____

ADDRESS: _____

RECORDED VOICE SERVICES ARE

Each year, Australians make millions of telephone calls to the recorded information services provided by the Post Office. These services provide the caller with information such as the time of day, the weather forecast, the latest news, sports results, stock exchange reports and other classes of information. Many of these services use the latest type of magnetic drum recording equipment developed in Australia by the Rola Company.

The "talking clock" in Sydney and Melbourne, which began operating in 1954, was the first recorded information service provided by the Post Office. At that time, the magnetic drum principle had not been developed sufficiently for commercial application. These early units use an optical system similar to that used in film sound tracks, but with the photographically recorded voice patterns carried on rotating glass discs. This system has proved to be so reliable and durable that it is still regarded as the best for services which carry unvariable data, as in the case of the talking clock. (The system was fully described in the article "The P.M.G.'s New Talking Clock" in the January, 1955 issue of "Radio and Hobbies.")

However, for services which have to be continually changed and updated, the magnetic drum announcing system has obvious advantages, as the necessary changes of information can be made simply and quickly. The simplicity and versatility of this system have gained for it a wide acceptance, and since its perfection, the use of recorded voice messages has grown at a fast rate.

All Australian capital cities and some country towns now provide telephone inquiry facilities. Most of the recorded voice services in Australia are operated directly by the Post Office, but others—such as news and dial-a-prayer—are provided by private organisations which lease facilities from the Post Office.

Supervising technician Graham Trundwell checks Rola Variable Message Repeater units in use at the G.P.O. building in Sydney.



These services represent big business for the Post Office. The "talking clock" in Sydney alone receives on average more than 20-million calls a year and calls to other services in Sydney total more than 6 million a year. The last available figures for Sydney, for the period from July 1, 1966, to June 30, 1967, show that more than 21-million calls were made to the "talking clock" an average of 1.85 million a month or 61,000 a day. The total for the 1966-67 year was one million higher than for the previous year.

The totals of calls made to other services in Sydney during the 1966-67 financial year were as follows:

News	2,170,016
Weather forecasts	2,047,231
Sports results	950,373
Dial-a-prayer	340,373
Stock exchange reports ..	331,219
Theatre programs	267,793

The grand total for all services is in excess of 26-million calls a year. Even though a small percentage of these calls may be internal to the Post Office, and not revenue earning, it appears that in Sydney alone these services are currently earning in excess of \$1-million a year for the Post Office, at the present subscriber rate of 4c per call.

The really dramatic expansion of recorded telephone information services in Australia started about 10 years ago when the Post Office introduced weather and sporting services. The Post Office in 1957 approached the Rola Company (Australia) Pty. Ltd., now a Division of Plessey Components, and asked it to produce a drum announcing unit similar to one used by the British Post Office.

The earlier British equipment had some limitations, but there was little time to make radical changes in design. The services were wanted urgently for the England-Australia cricket Test series in 1958-59.

The new services were phenomenally successful from the outset. Cricket fans in Sydney, Melbourne, Brisbane, Adelaide, Perth and Hobart made 5,250,000 calls to get up-to-the-minute scores during the Test series.

The number of calls to the sporting service fluctuates widely from year to year, depending on whether there are major sporting events taking place. The number always shoots up whenever a cricket Test series is in progress. In fact, on occasions, the Post Office makes more money out of the telephone calls to the sporting service than does the club which stages the event.

In Sydney, information is recorded at the G.P.O. building. Recordings are made by either men or women announcers who work a number of shifts from early morning to late at night. They work in sound-proof studios at desk type consoles. To make a new recording the operator has only to press a button on the control console and speak into the microphone.

BIG BUSINESS

30 million calls annually in Sydney alone

The recording of a new message automatically erases the previous one.

Sporting information is kept current minute by minute as information is received from the sporting bodies concerned. Stock exchange reports and weather forecasts come in by teleprinter every few hours from the stock exchanges and weather bureaus. Other details, such as theatre programs, tourist information, snow reports for example, are obtained from authoritative sources. Each of these services uses two announcing units, either one of which is in operation while the other is on reserve or being used to record new messages.

The Post office has two "talking clock" systems in Sydney and another two in Melbourne. Each capital city has one system in reserve in case of breakdowns. If both systems should break down in the one city, time announcements could still be relayed from the other capital.

The time equipment is checked daily with Mt. Stromlo Observatory to ensure the greatest possible accuracy. In 24 hours, the equipment in Sydney may be only 2 thousandths of a second out in its timing.

One of the recorded phone information services operated by outside organisations is "Dial-a-prayer," which is run by the Seventh Day Adventist Church. In Sydney, the service operates from the Church's radio and television recording headquarters at Wahroonga, on the North Shore. The prayers, recorded by Pastor Hector Kingston, are generally changed every day.

"We have a library of tapes on hand," Pastor Kingston said, describing the system. "I record about six or eight new prayers at a time."

The prayers are recorded initially on tape and then transferred on to announcing units for relaying to phone callers. Each message lasts about 1 minute 10 seconds. "Dial-a-prayer" operates in Sydney, Canberra,



Recording latest racing information on Plessey VMR units from the central control located at Melbourne's TAB office.

Newcastle, Wollongong, Adelaide, Hobart, Perth, Bunbury, Shepparton and Hamilton.

In Sydney, it gets up to 30,000 calls a month, or nearly 1,000 a day. Sydney "Dial-a-Prayer" has received about 1,500,000 calls since it began in August, 1961, and the Wollongong service has received more than 70,000 calls since it started in 1963. The great success of "Dial-a-Prayer" in Australia has prompted the church to introduce it in other countries, including the United States and New Zealand.

The principal manufacturer of this type of announcer in Australia is the Rola Division of Plessey Components, based in Melbourne. This company has developed various types of drum-announcing unit for different applications.

One is a special type of magnetic drum-recording unit developed to inform callers of changed phone numbers or of services discontinued or out of order. This is a multichannel announcing unit in which each channel accommodates a single message of up to 15 seconds duration. The Post Office asked the Rola Company to produce such equipment to aid the massive task of introducing Extended Local Service Areas (ELSA) in the Melbourne area in 1960. The equipment was designed to inform callers of numbers changed as a result of the ELSA system.

This type of recorder has a large diameter drum which revolves once every 15 seconds so that a complete message of about 13 seconds duration can be accommodated on the track, to allow a short rest period between each repeat. The first units of this type produced by Rola had provision for 24 tracks, each of which was available for a different message. Later, as the equipment was introduced into more exchanges, it was decided that a 12-track unit was more practicable. The tracks are parallel on the surface of the drum. Since it takes the drum 15 seconds to return to the beginning of each message, it is desirable to keep all messages as close as possible to the full duration, in order to minimise breaks in transmission.

Multi-channel announcing equip-

Growing List of Recorded Voice Services

At present, there are 14 recorded information services operating in Australia, all working on a 24-hour-a-day basis. They are:

Time	Snow reports
Sports results	Theatre programs
Weather	Daily Bible readings
News	Ring-a-Recipe
Dial-a-Prayer	TAB racing results
Stock Exchange reports	Lottery results
Tourist information	Shipping information

Many of these services are also in use overseas, but some countries, notably America, have a wider range of services, including:

Train timetables	Daily horoscopes
Situations vacant	Educational talks
Election results	Road traffic and driving conditions
Dial-a-bargain	Services open weekends and holidays
Airline information	Popular music record of the week
Cosmetic advice	Myths, fairytales and Christmas stories

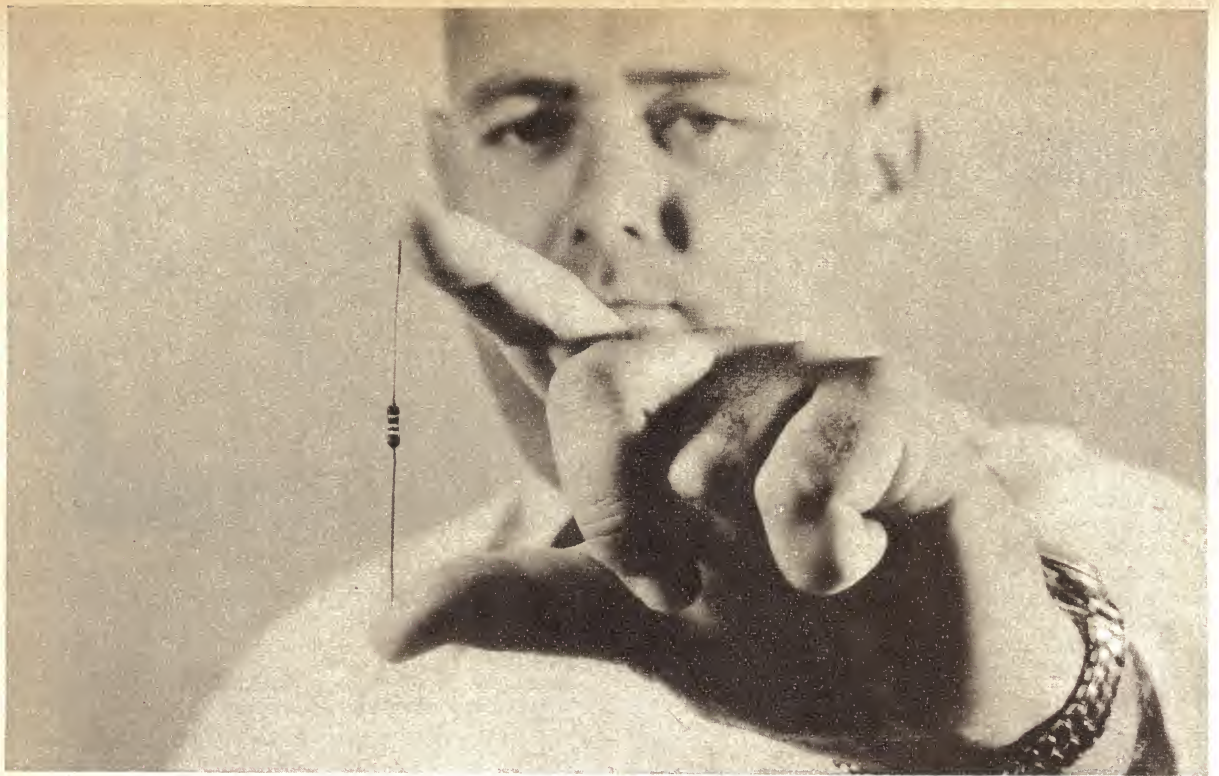

This Beyschlag resistor can save you 60%. Des Connors can tell you how!

BEYSCHLAG deposited carbon-film resistors, can cut your resistor bill by 60% — and we can prove it. BEYSCHLAG gives you high-performance stability at a really low price. In fact, it's the best performance-price ratio you can get today. Supplied on the continuous "Autoband" tape, BEYSCHLAG

resistors are ready for direct-from-pack feeding into automatic lead-cutting and bending machines. The packs are also suitable for conventional use. Like to save 60% on your resistor bills? For details, contact: Des Connors, Components Division **Standard Telephones & Cables Pty. Limited**, Moorebank

Avenue, Liverpool, N.S.W. 2170. Phone Sydney 602.0333 or phone Ian Chatwin, Melbourne 480.1255, Doug McCurdy, Canberra 49.8667, Bob Heelan, Brisbane 47.4311, Grahame Eime, Adelaide 51.3731, Roy Down, Perth 21.6461, Noel Pettifer, Newcastle 61.5172, Bill Norris, Wollongong 27974.

AN
ITT
ASSOCIATE

world-wide telecommunications and electronics



ment of this type lend itself to a variety of uses on the telephone system. It can be used:

- To inform callers of lines not in use, replacing the "number unobtainable" tone which people often find difficult to identify.
- To intercept calls to hospitals or other emergency centres in the event of a breakdown of lines.
- To inform telephone callers of congestion on trunk lines and the delay involved.

The drum-announcing unit developed by Rola Division for most announcing applications is of a type known as a Variable Message Repeater (VMR). These VMRs can record messages of between 10 seconds and three minutes duration. At the end of each message, a 50Hz cue pulse is applied to initiate a recycling action, which takes place within a few seconds.

The longer playing time is achieved by having the message recorded on a spiral track, only one track being recorded on a drum. The recording and playback heads are attached to a drop arm which is coupled by a parallel drop arm and pawl to a lead screw. As the drum revolves, the drop arm is moved along the drum to trace a spiral path. When the message has been recorded, a 50Hz cue note is impressed on the drum at the end of the message. In the replay mode, the drop arm is moved along the same spiral path as that taken by the record head until it reaches the 50Hz cue note. This cue note operates a relay which causes the lead screw to disengage, and a return spring causes the drop arm to return to the start position to repeat the cycle. The return action is air-damped to avoid jarring. (See picture, this page.)

When a caller phones, he is automatically connected to one of many relay sets working in conjunction with the drum-announcing unit operational at that time for the service he is calling. A caller may be connected to a drum unit in the middle of a message, but he will hear at least one complete message before the call is automatically disconnected.

Rola equipment of this type was recently exported to Hong Kong, to facilitate a major change in the colony's phone system. Because of the multilingual requirements of the system, it was necessary to have equipment capable of the maximum three minutes message time which the Rola equipment is able to provide. The announcing system is now operating, giving information about altered phone numbers in several languages.

Apart from the widespread use of recorded voices by the Post Office, there are many more uses which are not so widely known. Recorded voices are providing information in lifts, for example. As the lifts move from floor to floor, in a department store, a voice issuing from a loudspeaker informs customers of the range of goods available on each floor. Another example is to be found in airports, where "mechanical" voices automatically feed the time to recording tapes. The devices have been ordered by the Department of Civil Aviation for recording and safety purposes. The time announcements will be recorded along with conversation between airport officials and aircraft in flight. The time of any conversation will thus be on record for future reference.

The time-announcer equipment can also be pre-set as a time alarm. In the event of an airport emergency, the units can announce the time when certain safety procedures should be implemented. The announcers voice the time in the form of four digits—such as 0915—at regular intervals, or whenever required. The recording medium, as with other magnetic drum announcing equipment, is a neoprene band impregnated with ferric oxide.

The time announcer uses a ten-channel drum, with one channel used for each of the digits 0 to 9. The drum is divided into four quadrants, and the digits are repeated in each quadrant. A separate replay head is associated with each of the ten tracks, and switching

logic is used to select the correct combination of digits for any particular minute throughout the 24 hours. Thus, at 0139 hours, the switching is arranged so that the first quadrant of the 0 track is picked up by the replay head of that track, followed by the second quadrant of the 1 track, the third quadrant of the 3 track and finally the fourth quadrant of the 9 track.

The time announcers are among the latest recorded voice-announcing equipment developed by the Rola Division of Plessey Components.

Another type of magnetic drum-announcing equipment, the Auto Announcer, is used to provide a single 5-second message which needs to be repeated constantly. The unit was developed after the Overseas Telecommunications Commission asked the Rola Division of Plessey Components for a unit to advise operators on the newly opened COMPAC cable of the progress of their calls.

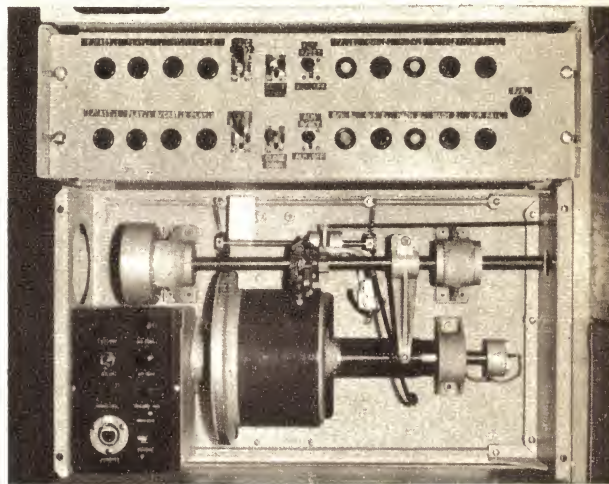

This photograph shows the main elements of the magnetic drum unit used with the Rola Variable Message Repeater system. Coming from the centre of the drum and to its right is the lead screw which causes the record and replay heads to move across the surface of the rotating drum to trace a spiral path. The heads are resting on the surface of the drum from a drop arm connected to the rod above the drum. Also coming from this rod is another drop arm which carries a pawl. When this pawl is engaged in the lead screw, the rod assembly will move to the left, carrying the head across the drum. When the replay head reaches the end of the recorded message, it encounters a 50Hz cue signal which causes the pawl to disengage from the lead screw. The rod assembly is then returned to the start position by a spring.

The equipment developed proved extremely successful and has since lent itself to many other uses. A number of electricity authorities adopted this type of unit to voice a constant announcement identifying the exchange areas in their own telephone systems. The equipment has been installed by the Electricity Commission of N.S.W., the Snowy Mountains Authority, and the State Electricity Commission of Victoria.

Any telephone service that involves a repetitive announcement can make use of these drum-announcing units. The equipment can relieve telephonists of much routine and often tedious work and can also mean savings in telephone service operations.

Mechanisation of these voice services is a logical development in the telephone and telecommunication world. Automatic telephone systems have been built up to replace the human element in the switching of telephone calls. It is only natural that telephone engineers now should seek some way of "mechanising" the human voice. ■

BRITAIN'S ISAAC NEWTON

By P. Lancaster Brown
B.Sc., F.R.A.S.



The inauguration of Britain's Isaac Newton 98-inch optical telescope by Queen Elizabeth last December marks the resurgence of observational astronomy in England after a lapse of many years.

The Isaac Newton telescope at the Royal Greenwich Observatory, Hurstmonceux, Sussex, England, is the fulfilment of a dream of the astronomers and engineers who first visualised such an instrument just after World War II.

In 1946, British observational astronomy was in decline compared with its great achievements during the eighteenth and nineteenth centuries, when Britain possessed the largest reflecting telescopes in the world. This decline had set in during the early part of the twentieth century—principally because of the lack of financial resources needed to re-equip observatories with large, modern telescopes. By comparison, North American observatories were able to attract practically unlimited funds from industrial benefactors ready to lend their names to great observational institutions.

Another factor in the decline, however, was a notion that large telescopes were unfruitful in Britain because of climatic problems. This myth has now been exploded by the erection and successful operation of large telescopes such as the 72-inch reflector built for the Dominion Observatory at Victoria, Canada, where the total of annual observing nights free of cloud is actually less than that of south-eastern England.

In 1946, the time was ripe for the regeneration of British observational astronomy. Professor H. H. Plaskett, sometime Plumian Professor of Astronomy at the University of Oxford, dedicated his presidential address to the Royal Astronomical Society that year to an inspired appeal for the erection of a large telescope and research institution to be located somewhere in southern England.

In Britain at that time, in spite of the serious lack of contemporary operational instruments, there was no shortage of optical expertise. The firm of Sir Howard Grubb Parsons had some

years previously been awarded a contract to design and erect a 74-inch reflecting telescope for the Radcliffe Trustees at Pretoria, South Africa. Grubb Parsons, with experience of building many other telescopes, had also incorporated an old and famous firm of telescope makers—Cooke Troughton and Simms, of York, England. This company had the optical workers and engineers needed to transform a design into reality if financial backing could be obtained.

Professor Plaskett's appeal reached the ears of the British Treasury, and, with the aid of a persuasive Astronomer Royal, Harold Spencer Jones, the day was won. On July 15, 1946, the first day of the Newton Tercentenary celebrations, it was announced by the President of the Royal Society that the scheme had the backing and financial support of the Government. There followed years of administrative delays, but the construction contract was finally awarded to Grubb Parsons in December, 1959.

The construction of a large astronomical telescope presents many kinds of problem. It is not simply a matter of providing a suitable high-quality optical system which, during production, can be controlled within fine limits. There are also practical difficulties concerning the mechanical and structural members required to hold the heavy, unwieldy optical parts safely and rigidly, at varying angles and within very fine tolerances.

No matter how perfectly an optical surface is finished it will perform only as well as the structures that control its stability and its alignments with secondary optical components. It is perhaps not common knowledge that there are a number of famous large reflecting telescopes which because of their lack of stability are much less valuable than they should be. Not long ago, a new large American telescope

flexed so seriously at certain altitudes that photography was impossible; drastic, but not wholly successful, modifications were required to make the instrument serviceable.

The disc of unprocessed glass used for the primary mirror of the Isaac Newton telescope had been manufactured in the U.S.A., in 1936, by the Corning Glass Company during the period in which it produced the disc for the Mount Palomar 200-inch reflecting telescope. The disc was a gift to the British Admiralty, in 1949, by the Tracy McGregor fund and the University of Michigan who had acquired it for a telescope project that never matured.

The mirror blank of Pyrex glass was far from perfect, owing to the presence of air bubbles and the marked striation caused during the cooling and annealing process at the glassworks. Conversion of the 9,000-pound disc into a precise, 98-inch diameter, optical tool presented quite a challenge. Nowadays it is possible to produce considerably larger discs of fused quartz glass, which are practically free of defects and which have an ultra-low coefficient of expansion. Nevertheless for reasons of financial economy it was necessary to use the presented disc.

A reflecting telescope mirror must have a true concave surface in the shape of a true paraboloid in order that the light rays it receives from the object under observation are focused to a point source. A spherical-shaped concave surface does not possess this particular property. To produce this hollow paraboloid surface required the use of non-standard grinding machines and other kinds of machine tool which were designed and built by the firm of Grubb Parsons before manufacturing operations began.

The first stage—rough grinding—was accomplished on a machine equipped with diamond abrasive wheels which produced a basic spherical-shaped hollow in the disc. The grinding action slowly abraded the surface, assisted by a copious flow of liquid coolant that also helped in washing away the pulverised glass fragments. When the surface had been hollowed to an accuracy of 0.01in, it was polished smooth in preparation for the final, most crucial, stage of the operation—known as figuring.

Figuring converts the highly polished spherical surface into a true paraboloid shape by the removal of minute quantities of glass. In the case under discussion the greatest thickness that required removal was only 0.001in. The surface was not polished over its entire area in one operation as this would have been extremely time-consuming and infinitely more difficult to control. Instead it was accomplished by localised fine grinding of individual zones, controlled by the use of a spherometer.

In the past it was customary for large reflecting telescope mirrors to receive final finishing touches and tests

OPTICAL TELESCOPE

STRUCTURAL DETAILS

in the dome in which the telescope operated. Grubb Parsons decided to depart from this practice, and the mirror was finished and tested entirely within its optical laboratory. The surface of the primary mirror was finally brought to an accuracy of one-millionth of an inch.

It is an historically interesting fact that before modern methods were devised, telescope makers had to adopt trial-and-error techniques of grinding and polishing, and testing methods varied according to the maker: Sir William Herschel, who built a 48-inch speculum-metal reflecting telescope in 1787, tested the figure of his mirrors by observing the masonry detail on Windsor Castle from his observatory three miles away. Grubb Parsons was able to guarantee that its mirror was optically nearly perfect even before it left the factory; any surface errors are much less than those that might be brought about by normal daily fluctuations of ambient temperature.

Concurrently with the work on the glass optics, the company's mechanical workshops were constructing the telescope's tube, cell, and mounting.

A major problem arose in connection with the need to support the heavy mirror in such a way as to leave it undisturbed at any angle while permitting it to contract or expand as a result of ambient temperature changes. Any system chosen had to allow for deformation within close limits. An additional complication—one that faces all designers of supports for large mirrors—was that no matter how many points were used to support the dead weight, only three could be used to align the mirror.

The designers' solution to all these difficulties was ingenious. They devised a support system incorporating an air bag made up in three sections and constructed of rubberised fabric a mere 0.00012 inch thick. The bag is pressurised at only 1.3lb/sq in. on which, perhaps somewhat surprisingly, the 9,000lb mirror floats comfortably. The engineers also succeeded in locating this bag to an accuracy in the order of 0.01in.

The design of the telescope-tube mounting is radically different from all previous attempts in the construction of large optical instruments. In principle it is related to what is known as a basic fork design, but the conventional polar axis—by which the telescope follows the apparent star-drift due to the Earth's rotation and which is traditionally a structurally weak point—has been replaced with one which can only be described as a "polar disc" of massive proportions.

The main polar drive is 22ft in diameter and weighs 40 tons. It is supported by a complex of externally pressurised oil-pads maintained at 200lb/sq in. To ensure perfect smoothness, the oil supply to the working face is recirculated with three stages of filtration in each cycle. Although this is the largest disc to be supported in such a manner, in practi-

As with all big telescopes, the mounting is designed to keep the mirrors undistorted, accurately aligned, and (despite the Earth's rotation) pointing for as long as may be desired in a fixed direction in space, namely that of the celestial object under examination. These requirements pose engineering problems of the greatest difficulty. Firstly, the surface of the main mirror must be maintained to the correct shape within a few millionths of an inch whilst its 4-ton mass is swung around as the telescope moves. Secondly, the instrument's moving part, weighing 87 tons, must be kept steadily following the star across the sky to an accuracy better than a second of arc—one part in 2,000 of the angular diameter of the Moon. Novel solutions to these problems have been devised.

The mirror is supported in its cell by an air bag in which the pressure is automatically adjusted, as the mirror tilts, to support precisely that fraction of its weight that acts axially. Radial support is provided in novel fashion by a series of counterweights acting through pivots on the edge of the mirror. The air bag is made in three annular parts pressurised slightly differently to allow for the fact that, since the mirror is concave, less support is needed in the middle than at the edge. When lying on its back its weight of four tons is counterbalanced to within a pound.

The main optical elements of the telescope are disposed along the "tube," a stiff open framework so designed that any residual flexure occurring as it swings around the sky leaves the mirrors parallel to one

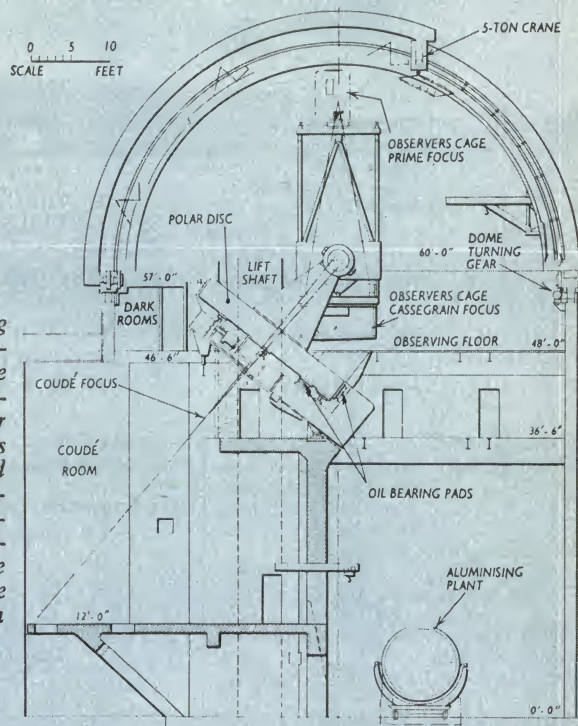

Diagram showing the general arrangement of the telescope. This diagram and the other information in this panel is reproduced from "The Engineer" (15th December, 1967) by arrangement with the Information Service of the British High Commission.

another and still in alignment. The tube swings in declination (i.e. north-south in the sky) between the lines of a conventional but very stiff fork mounting. In the other coordinate (east-west, the direction of diurnal motion) the mounting is entirely novel. In most big telescopes this motion is communicated to the tube by rotating a polar axis adjusted to be parallel to the Earth's axis. In the Isaac Newton telescope this axis takes the form of a hollow, mild steel disc 22ft in diameter, 3ft thick, and weighing 40 tons, floating on externally-pressurised oil-pad bearings set into the main bed-plate. These bearings (three radial, seven axial) are supplied with oil at 200lb/sq. in in continuous circulation and the 87 tons of moving parts are supported wholly on films of oil 0.004in thick. The polar disc had to be made in three parts, transported separately from the works to the site and there reassembled.

The total wander of the centre of rotation in one complete turn is less than 0.004in and the disc never deflects by more than 7 seconds of arc, in any position. In this respect particularly, the instrument can be said to represent a triumph of engineering skill, both in design and in execution.

TRIO

COMMUNICATIONS RECEIVER

9R-59DE

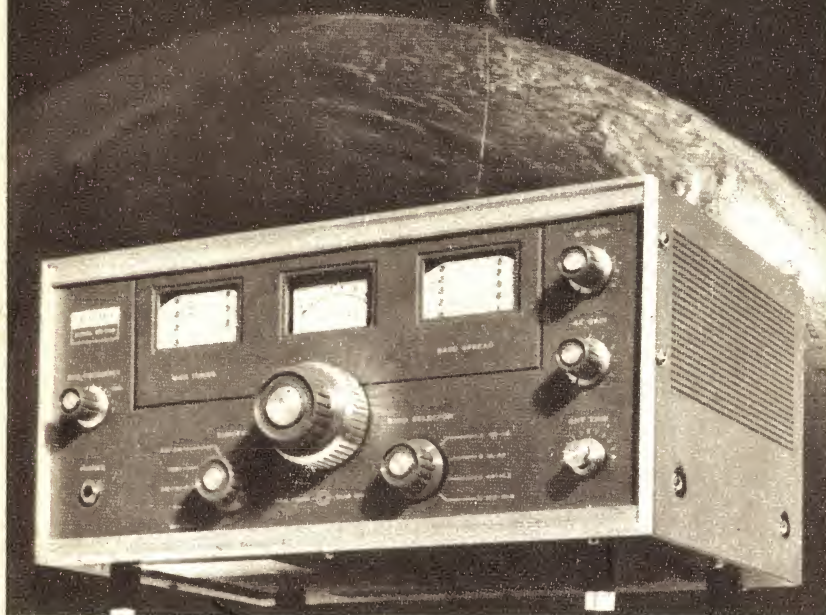

- 4 BANDS COVERING 540 Kcs. TO 30 Mcs.
- TWO MECHANICAL FILTERS ENSURE MAXIMUM SELECTIVITY.
- PRODUCT DETECTOR FOR S.S.B. RECEPTION.
- AUTOMATIC NOISE LIMITER.
- LARGE TUNING AND BAND-SPREAD DIALS FOR ACCURATE TUNING.
- CALIBRATED ELECTRICAL BANDSPREAD.
- "S" METER AND B.F.O.
- 2 MICROVOLTS SENSITIVITY FOR 10 dB S/N RATIO.

SPECIFICATIONS:

Frequency Range: Band A—550-1600 Kcs.
Band B—1.6-4.8 Mcs.
Band C—4.8-14.5 Mcs.
Band D—10.5-30 Mcs.

Calibrated Electrical Bandspread:

80 and 40 metres—5 Kcs. per division.
20 and 15 metres—20 Kcs. per division.
10 metres—50 Kcs. per division.

Antenna Input: 50-400 ohms impedance.

Audio Power Output: 1.5 watts.

Sensitivity: 2 μ V for 10 dB S/N Ratio (at 10 Mcs.).

Selectivity: ± 5 Kcs. at —60 dB (± 1.3 Kcs. at —6 dB).

When using the Mechanical Filter.

BFO Frequency: 455 Kcs. ± 2.5 Kcs.

Speaker Output: 4 or 8 ohms.

Headphone Output: Low impedance.

Power Consumption: 45 VA at 115/230 volts A.C. 50/60 Cps.

Tube Complement: V1—6BA6 RF Amplifier.
V2—6BE6 Mixer.
V3—6AQ8 HF Oscillator.

V4—6BA6 1st IF Amplifier.

V5—6BA6 2nd IF Amplifier.

V6—6BE6 Product Detector.

V7a—6AQ8 Beat Frequency Oscillator.

V7b—6AQ8 1st AF Amplifier.

V8—6AQ5 Audio Output.

IN60—AF Detector.

IN60, SW-05S—AVC.

SW-05S—ANL.

SW-05S x 2—Rectifiers.

Dimensions: 7" High, 15" Wide, 10" Deep.

Weight: 19 lbs.

PRICE: FOR/FOA SYDNEY: \$175.00

CONSULT YOUR LOCAL RADIO DEALER, OR

MAIL THIS COUPON *today*

Please forward free illustrated literature and specifications on Trio equipment.

Name.....

Address.....



(A unit of Jacoby Mitchell Holdings Ltd.)

376 EASTERN VALLEY WAY, ROSEVILLE, N.S.W.

Cables and Telegraphic Address: 'WESTELEC.'

Sydney. Phone: 40 1212

cal tests the balance was so delicate and friction-free that a small coin placed on the circumference was sufficient to unbalance the load and set the disc in motion.

In everyday use, control of the telescope is fully automated. The instrument can be pointed to any part of the sky by an assistant seated at a control desk, final adjustment being carried out by the astronomer when making observations from any of the focal positions at which he may be working. The telescope is powered by synchronous motors which have push-button controls and will give a wide variety of speeds. Errors in the driving mechanism have been found in practice to be less than one-quarter second of arc.

Problems associated with the provision of a new astronomical telescope are not limited to the instrument and its mounting. A suitable weatherproof telescope building—provided with laboratories, photographic darkrooms, workrooms and staff rest-rooms, preferably as an integral part of the building at a lower level than the telescope itself—is also necessary.

The traditional form of housing for large telescopes is a hemispherical dome-shaped structure which satisfies both functional and aesthetic requirements for such a building. The dome at Hurstmonceux is double skinned, with corrugated aluminium sheeting on the exterior. It is 61ft in diameter and stands almost 100ft above the surrounding parkland. Between the skins is an insulating sandwich-layer of polystyrene and hardboard to counter any thermal effect on the optical efficiency of the telescope.

Within the dome, the observing floor is 48ft above ground-level and can be reached by elevator or stairs; beneath this floor are the auxiliary workrooms. An important provision, to which much thought was given, is the visitors' gallery which is separated from the working area by panoramic glass panels and is reached by an independent stairway from an entrance at ground-level. The arrangement is thought to be unique in that large numbers of visitors have complete freedom to look on without interfering with the scientific program of the observatory.

At ground-floor level also is an aluminiuming plant where the telescope mirrors can be periodically recoated with aluminium film without incurring the potential hazards of their removal from the building to an outside factory.

Commissioning of the Isaac Newton telescope has already brought fresh prestige to British astronomy. Although considerably smaller than the instrument at Mount Palomar, it will, with the assistance of advanced designs of electronic image converter and image intensifier, be able to penetrate further into space than the Palomar telescope can do in its present form. It will be of immense importance in the search for and examination of quasars, the most mysterious and powerful sources of radiant energy in the universe.

On the practical side, one of the most important features of the Isaac Newton instrument is that it lends itself better than other large telescopes so far constructed to meeting the requirements of different geographical latitudes. It is also one of the most economical telescopes yet built, and its principle can be easily adapted to instruments with mirrors of up to 150in aperture.

Designing Lenses

By Computer

The designing of lenses involves thousands of calculations and the integrating of many different factors to achieve the best compromise result. Since it is precisely this type of work for which computers are best suited, it is not surprising to find that lens designers are now making extensive use of computers in their work.

By John Newell

The results have shown that the sum total of the small improvements computers can make in various directions can add up to a big advance in this traditional industry.

Seven years ago a group of scientists, under Dr C. G. Wynne, at Imperial College, London, started work on the use of computers in the design of optical systems. Soon it became apparent that the only real limitations are the size and speed of the available computers. More than a hundred different factors may be involved in designing one optical instrument, including such things as the degree of curvature of the surfaces of the lenses, their thicknesses and their separations from each other, and the densities and refractive indices of the glasses used. There are also commercial considerations, the costs of the different processes in manufacture. The computers which are now coming into use make it possible to cope with all these, so as to produce instruments which are, as nearly as possible, perfect in business terms and ideal technically.

Dr Wynne's computer-designed lenses have found and are finding plenty of uses. For example, a special system was required by French physicists for photographing the tracks left by atomic particles in a bubble chamber, at the French high energy nuclear physics research station at Saclay. Bubble chambers are filled with liquefied gas, in which the various particles, produced when atoms are smashed, leave visible tracks which can be photographed. The particles responsible and hence the nature of the reaction can be identified from the photographs. Dr Wynne's group was able to solve the problems involved and produce a suitable lens system within a matter of days, through the use of computer design. The problem would, literally, have taken a lifetime to solve in the pre-computer era.

Computer-designed lenses are as valuable in studying the universe as they are in studying sub-atomic structure. Almost every major astronomical observatory in the world has now approached Dr Wynne for some form of assistance in the design of what are called wide field systems for astronomical telescopes. These systems widen the field of view of a telescope tenfold, and produce less distortion and waste less light than any earlier systems.

Dr Wynne and his colleagues also designed the spectrograph for Britain's new Isaac Newton telescope.

This instrument analyses light picked up by the telescope into its component wavelengths. The important thing about Dr Wynne's spectrograph is that it has been

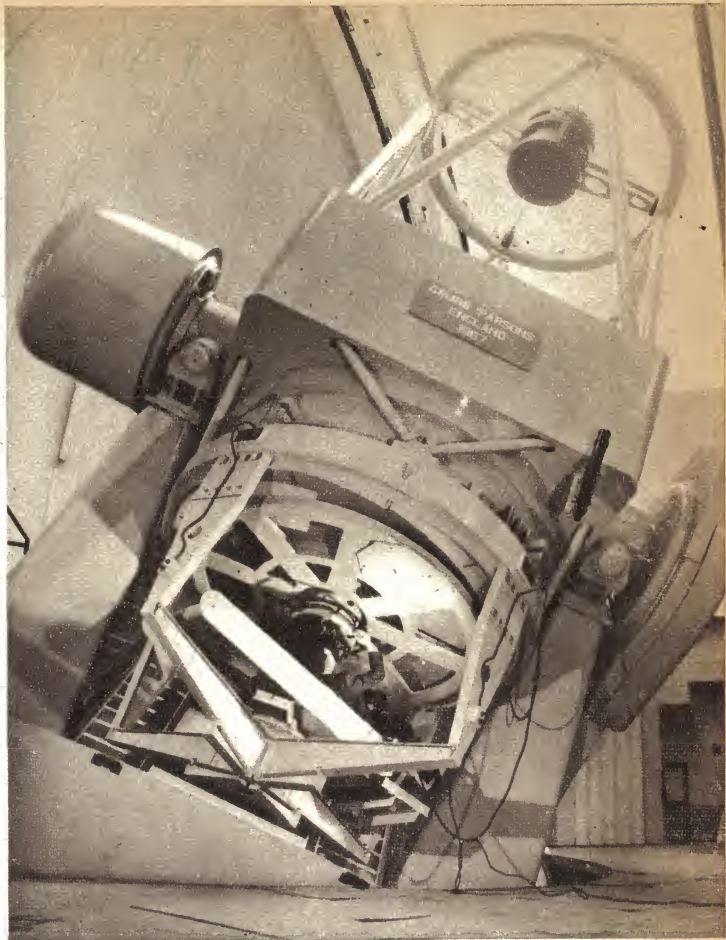

Dr Wynne and his colleagues used a computer to design the spectrograph for the Isaac Newton telescope described in the previous article and illustrated above. The spectrograph analyses light picked up by the telescope by separating the component parts of the light into their different wavelengths and displaying them as a spectrum.

specially designed to work with another new instrument fitted to the Isaac Newton telescope, the image intensifier designed by Professor McGee, who works a few doors away from Dr Wynne in the same department at Imperial College. Experts believe Professor McGee's image intensifier is the best design yet produced anywhere in the world. It amplifies the minute amount of light received from very distant objects, such as quasars, to the point where there is enough light for analysis. The combination of intensifier and spectrograph may allow the astronomers using the Isaac Newton telescope to answer the biggest question in cosmology today—the nature of the quasars.

While these new lens systems have been designed at Imperial College they have, in the main, been built by private concerns, and so British industry has had the advantage of early experience in the construction of the prototype lenses.

Dr Wynne's programs are now in general use by most of the British firms which manufacture high-performance optical systems. Direct help to industry in this field has been confined to the United Kingdom (although pure research projects in other parts of the world have been able to benefit). And students at Imperial College are now being taught the techniques involved. Almost any precision lens can be improved by computer techniques. These improvements apply to a variety of such things as microscope objective lens systems, wide-field lenses used in aerial photography, projectors used in shipbuilding design and machine tool control and all kinds of copying lenses and industrial spectrographs. New concepts can be made available faster via the computer, for example in the use of aspheric lenses which present much more complex problems in mathematical design, but which might offer substantial benefits, especially in astronomy. ■

New, low cost



3" Hi-Flux Tweeter

is an outstanding performer

Here at last is a low cost high frequency tweeter with the performance of expensive elaborate designs.

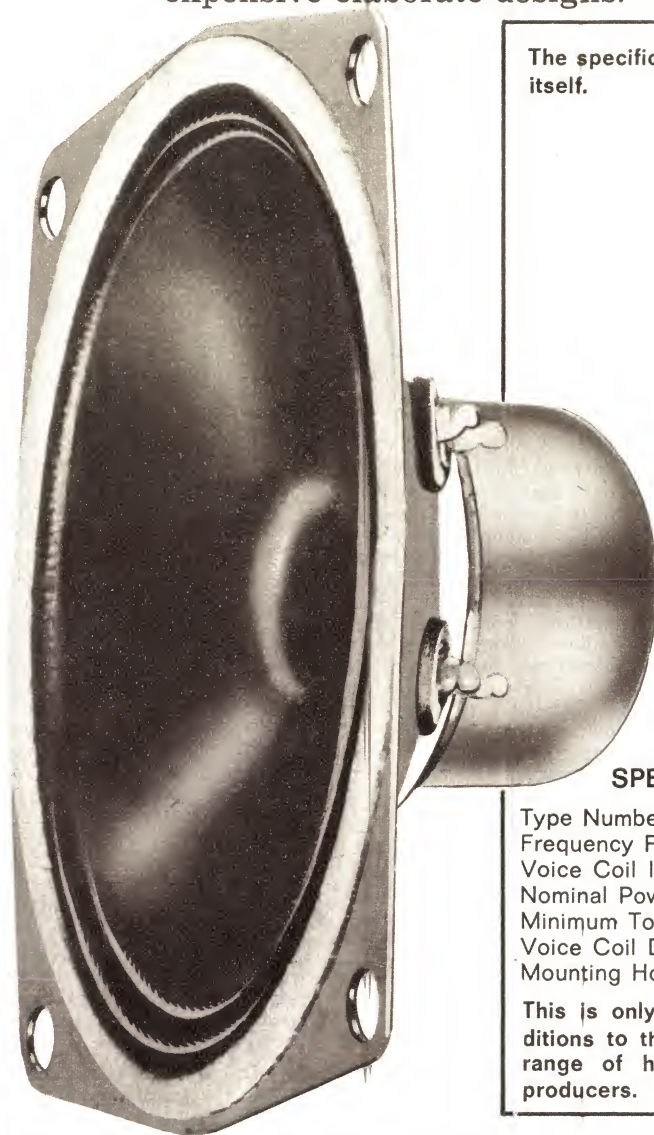

The specification below speaks for itself.

SPECIFICATION

Type Number 53418/3LB/15 HF
Frequency Response 5000-16000 Hz
Voice Coil Impedance 15 ohms
Nominal Power Handling 2 Watts
Minimum Total Flux 12000 Lines
Voice Coil Diameter 5/8"
Mounting Hole Centres 3 P.C.D.

This is only one of the latest additions to the comprehensive MSP range of high quality sound reproducers.



**MANUFACTURERS
SPECIAL
PRODUCTS
PTY. LTD.**

47 York Street, Sydney. 2 0233

ADELAIDE: Newton McLaren Ltd. 51 0111. **BRISBANE:** Chandlers Ltd. 31 0341. **HOBART:** Amalgamated Wireless (Australasia) Ltd. 3 3836. **LAUNCESTON:** Amalgamated Wireless (Australasia) Ltd. 2 1804. **MELBOURNE:** Amalgamated Wireless (Australasia) Ltd. 67 9161. Radio Parts Pty. Ltd. 30 1251. J. H. McGrath & Co. Pty. Ltd. 32 3731. **PERTH:** Amalgamated Wireless (Australasia) Ltd. 28 3425. Atkins (W.A.) Ltd. 21 0101. Carlyle & Co. (1959) Pty. Ltd. 21 9331. **SYDNEY:** Electronic Parts Pty. Ltd. 533 1277. George Brown & Co. Pty. Ltd. 29 7031.

Vietnam calling . . .

via MARS

A network of U.S. amateur operators known as MARS (Military Affiliated Radio System) is providing direct communications between American servicemen in Vietnam and elsewhere and their families in the U.S.A.

by Robert L. Moore



In amateur circles and in amateur radio journals such as "CQ" and "QST," MARS is widely known. But until recently, when newspapers in increasing numbers began stumbling on the feats of individual amateurs in their localities, it has been an entity little known to the public. Today, with the fast-growing volume of Vietnam calls — as well as heroic service in hurricanes, floods, earthquakes, and other emergencies—MARS is gradually becoming better known.

The network had its origin in a loosely knit organisation known as the Army Amateur Radio System formed in 1925 at the Fort Monmouth, N.J., base of the Signal Corps. By 1948, its membership and activity had spread to such a degree that it was reorganised as a joint Army-Navy-Air Force program called the Military Amateur Radio Service, or MARS. Four years later, the word "amateur" was supplanted by "affiliate" to describe more accurately its joint military-civilian affiliation.

Although an amateur who joins MARS operates on military frequencies and uses a MARS radio call sign, MARS administrators at the Pentagon emphasise that the network's members are not a group apart from the amateur fraternity. As Edward S. Lis-

combe (call letters K4KNV), chief of the Army branch of MARS, puts it: "Each civilian MARS member is an amateur first and a MARS member second. His talents are voluntarily devoted to serving the public interest through his affiliation with the MARS program."

Amateurs have been active almost from the inception of wireless. But never, according to the nation's top-most amateurs, has there been an organised service among them to match the present MARS program handling "phone patches" and messages to and from Vietnam. Here is the way it works:

Starting in December of 1965, the three Services began setting up MARS stations in the embattled Far-East country. Using equipment purchased with non-appropriated funds, other gear from surplus stores, and still more devised by "hams" in uniform with typical American ingenuity, they now have about 50 MARS stations scattered through Vietnam from the delta to the highlands. Simultaneously in the United States — including Alaska and Hawaii — MARS member amateur radio stations on military bases and in private homes were appointed and authorised to handle "phone patches" from the MARS stations in Vietnam.

A GI wishing to call home seeks out a MARS station in Vietnam which endeavours to place his call through one of the MARS stations in the United States as close as possible to the caller's home town. Such a station might be at an Army, Navy, or Air Force base or in the home of an amateur member of MARS. When contact is made, the amateur or military operator of the American station telephones the caller's wife, family, or other destinee and then flicks a switch that puts the radio signal into the telephone line, thus effecting a direct radio-telephone connection or "phone patch."

More often than not the connection is reasonably clear — and the only charge is the telephone call from the American MARS station to the recipient, usually on a collect basis. MARS officials give much credit to the telephone company long-distance operators who do their utmost to assist the American stations in getting the Viet-

nam calls through. Connections are not always easy to make. Time differences pose problems. So do atmospheric. And locating a strategic MARS station is sometimes difficult.

MARS radio traffic to and from Vietnam has built up in the last two years at a pace far exceeding the build-up of American forces there. In January, 1966, for example, the network handled 1,100 "phone patches" . . . by December, 1966, the number had reached 10,000 . . . by July, 1967, it exceeded 30,000. In the first half of 1967, the 50 MARS stations in the Vietnam organisation had handled 222,000 "phone patches" and 320,000 other messages, some administrative but most of them personal.

Military commanders in Vietnam consider the MARS network a big contributor to morale, for, just as the Bell System back home advertises that one is as close to home as the nearest telephone, so is the GI fairly close even though he is 12,000 miles away — although getting through is a bit more complicated than dialling an area code and a number.

The same is true for Americans stationed elsewhere around the world, sometimes in remote locations such as the radar bases in Thule, Greenland, and Clear, Alaska, or in far-away outposts in Turkey, the Middle East, Africa, or even the Antarctic. At the bleak Arctic outposts of the Ballistic Missile Early Warning System, personnel of the RCA Service Company — which operates the radar net for the Air Force — regularly man the MARS stations for calls through the network back home.

Although military personnel reap the greatest benefit of MARS service on a regular basis, there are hundreds of thousands of other Americans who owe much to the network — in some cases their lives. MARS today is a regularly organised communications net not only for the military but for Federal and State civil defence organisations in times of emergency. At times, it has been the only communications network left in service when the conventional channels went out — as in the Alaska earthquake of 1964,

(Continued on Page 71)



NEW FACILITIES FOR FESTIVAL RECORDS

Festival Records Pty. Ltd. recently occupied new premises at Pyrmont, close to the heart of Sydney, where they have installed a modern recording studio and the newest type of record-pressing plant.

The move was made necessary by the company's greatly increased business in recent years. The floor area of the new building is not only adequate for present requirements, but will allow for considerable expansion in the future.

Inclusion in the premises of the new studio complex indicates that Festival intends to continue its policy of recording local artists wherever possible. The studio is equipped with a range of high quality microphones, including condenser and dynamic types, and the basic design objective has been an acoustic environment in which sounds are established rapidly and decay smoothly over a wide frequency range.

The control room associated with the studio is equipped with a modern solid state mixing console with 24 input channels and four master output channels. This feeds an Ampex multi-track tape recorder which produces master tapes which can ultimately be used for the production of mono or stereo discs. In an adjoining room is the Neumann disc-cutting lathe where the master disc is cut from which all the subsequent discs used in manufacture (mothers and stampers) are produced.

In designing and building the new studio, one of the biggest headaches was the elimination of extraneous noise. The building is situated close to a busy main artery, along which large transport vehicles are continually passing. In addition to this, the building has a high level of internally generated noise, caused by the heavy machinery used. This noise is transmitted through the building structure.

A large initial reduction in airborne and building noise was made possible by making the studio a double-shelled structure, with the internal shell completely suspended on rubber mounts, and with the space between the shell filled with noise-absorbent materials. As a second step building noise was traced to its source and isolated, where possible, by introducing suitable noise-absorbent mountings for the

machines responsible. Pipes leading away from the machines were isolated from any walls through which they had to pass with sleeves of noise-absorbent material.

The 4in thick inner floor of the studio floats on rubber isolators, supported by a steel reinforced 12in floor beneath. The internal ceiling uses an aluminium grid system hung on rubber and again isolated from the outer ceiling.

The recording area comprises a main studio with a floor area of 1,500 sq. ft. and volume of 20,000 cu. ft. Associated with it is a smaller studio which can be used for recording performances by solo artists or small groups or for separately locating certain members of a large group for acoustic purposes. For example, it may be desirable to locate the drummer of a group separately to secure a desired balance.

Master discs produced in the recording studio are passed to the plating shop where plating baths of modern design put a microscopically thin layer of metal evenly over their entire surface by the process known as electro-deposition. The baths in the new Festival plating shop use the latest techniques, whereby the plating solutions are continually flushed against the face of the master disc, while the disc itself is spun in the solution. In this way, the coating built up is evenly deposited to within a very fine tolerance. The thin metal shell built up in this way is reinforced with copper. Mothers formed from this master disc are treated in the same way, and finally the stampers which are used on the presses are made from the mothers.

The pressing shop has been equipped with a number of the most modern presses now available, made by the Alpha Company, of Sweden, who are recognised as leaders in the manufacture of record-pressing equipment. This type of press is semi-automatic, and electronically programmed. The operator has only to place the slab of vinyl in position and operate a single control. The entire pressing operation is then carried out automatically, to produce discs of the highest quality.

BELOW: Festival's new recording studio in use during a recording session, featuring Australian artists.

RIGHT: From the control console, the recording engineer controls the level and frequency characteristics of the multi-channel inputs and the output to the four master channels fed to the Ampex tape recorder at rear.

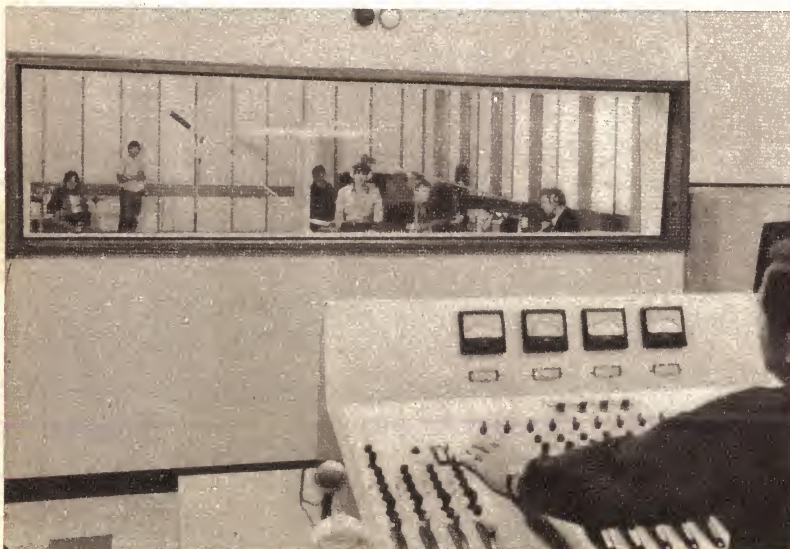

MICRO MA-88 PROFESSIONAL 16 in. TONE ARM

Designed to provide effortless tracking with the most delicate cartridges, the MA-88 accepts S.M.E. and ORTOFON head shells as well as the MICRO head shell. The latter may be used with any standard 1/2 in. mounting cartridge and cartridge location is adjustable by a fore and aft movement of approx. 1/2 in. Vertical and lateral movement is almost friction-free and is estimated at less than 20 milligrams. Height is adjustable and a bias scale and bias hook system eradicates lateral pressure of the stylus. Stylus tracking pressure is adjustable from 0.5 grams and is clearly indicated on the outrigger scale. Encel price including Sales Tax **\$35.50**

MICRO-MA-77S and MA-77 TONE ARMS Very similar in construction to the MA-88, these tone arms are 12 in. and 14 in. long respectively. A unique eccentric counter balance weight is employed with the "77" series. Connections of all MICRO arms are plug-in types to eliminate soldering, general construction is of machined solid brass and finish is satin chrome. All MICRO arms pivot on miniature ball races. Both these models incorporate the bias hook and weight system to eradicate lateral pressure. Encel price inc. Sales Tax **\$29.50**

LIFT NOW AVAILABLE FOR MICRO ARMS A tailored lifting/lowering device is now available for all MICRO arms. Easily fitted, pneumatically dampened action **\$8.50**

READ THE REVIEWS!

Your April, 1966, copy of "Electronics Australia" contains a review of the MICRO MA-77 tone arm on pages 126-127. If you subscribe to "Hi-Fi News" look up your February, 1966, copy for an extensive review of the MICRO MA-77 tone arm and the M-2000/5 magnetic cartridge. This particular review extends over 4 pages. Write now for copies!

LOW PRICED CERAMIC CARTRIDGE FOR BUDGET CONSCIOUS MUSIC LOVERS! Now the well-known Micro Model SC301 Ceramic Stereo Cartridge with diamond stylus is available for only **\$6.90**. Frequency response is 20-15,000 Hz. Tracking angle is 15°. This popular stereo cartridge is A1 value at (including Sales Tax) **\$6.90**

LOWTHER LOUSPEAKERS AVAILABLE FROM STOCK! Model PM6 and PM7 Lowther speakers are now available—but we cannot advertise the low Encel prices. Ask for prices and cabinet specifications. You'll save more at Encel Electronics!

THE COSMOS SW-30C . . . A LOW PRICE HIGH QUALITY STEREO AMPLIFIER! With an output of 8 watts R.M.S. or 15 watts I.H.F.M. in each channel, the Cosmos SW-30C has a wide frequency response and speaker matching for 4, 8 and 15 ohm loudspeakers. Sens. for mag p.u. is 5 mV. Headphone jack. Earlier shipments sold very quickly. Including Sales Tax **\$74.50**

THE NEW ORTOFON S-15 AND SL-15 STEREO CARTRIDGES AVAILABLE AT ALL ENCEL STEREO CENTRES! World wide acclaim provides significant testimony to the outstanding performance of the new Ortofon S-15 and SL-15 series. Ask for an EMQ or a trade-in valuation.

SONY AND NATIONAL TAPE RECORDERS If you're buying a tape recorder be sure to get an Encel price before you commit yourself elsewhere. Save yourself time, worry and cold, hard cash.

SAVE YOUR RECORDS . . . USE THE UNIVERSAL NIKKA-LUSTRE TONE ARM LIFT! This beautifully finished and functional universal tone arm lift will fit all tone arms . . . the lowering action is pneumatically dampened and extremely smooth. Risk of record damage may now be eliminated. Including Sales Tax **\$8.50**



HIGH FIDELITY STEREO HEADPHONES COST LESS AT ENCEL ELECTRONICS! Several wide range stereo headsets are in stock — and prices are as low as \$9.50 for one high quality "Sonics" headset. The popular "Sonics" Model HS-304 is very comfortable and response is excellent. Cost is only \$12.50. From P.M.L. in Sweden comes the "Pearl" headset . . . a particularly sensitive high impedance (400 ohms) type. This model is fitted with ear muffs for maximum comfort during lengthy periods of listening. Price is \$19.50. All Encel prices include sales tax. **\$9.50**

JUNCTION BOXES FOR STEREO HEADPHONES

If your amplifier is not fitted with a headphone jack socket a junction box is easily attached to the amplifier outputs. (inc. Sales Tax) **\$3.50**

TANDBERG "SERIES 12" RECORDERS AVAILABLE FOR IMMEDIATE DELIVERY! This professional stereo recorder has proved to be a best-seller and stocks have been in one door and out the other . . . but now delivery is immediate. Write for trade-in valuations or an EMQ. Your great leap forward to Tandberg could cost less than you imagined at Encel Stereo Centres . . .

NEW MODEL MICRO STEREO CARTRIDGE Micro have now released the Models 3100/5 and 3100/E (with elliptical diamond stylus). Prices are \$24.50 and \$29.50 respectively inc. sales tax. Both cartridges have an extended frequency response and performance is outstanding. Write or call for additional information.

MICRO DUST PICK-UPS This most effective record cleaner automatically removes dust and static charges as the record is being played **\$3.50**

KEF SPEAKER SYSTEMS Ask for an EMQ on the KEF system of your choice; copies of reviews are available for most current KEF speaker systems.

IMPROVE STANDARDS WHEN RECORDING . . . DEMAGNETISE! Two types of tape head demagnetiser are available . . . a single probe priced at **\$3.90** and the double probe at only **\$3.40**. Both prices include Sales Tax. Recording heads may be demagnetised in a few seconds and tapes improved considerably. From **\$3.40**

LOOKING FOR AN ADC CARTRIDGE? SEE ENCEL ELECTRONICS WITHOUT DELAY!

A full range of renowned ADC cartridges is now available and Encel prices cannot be advertised. However you can overcome this tragedy by writing for a personalised quote or a trade-in valuation. You'll save more at Encel Electronics!

NEW SOUND MODEL SAQ-203 SOLID STATE MAG. SENS. STEREO AMPLIFIER . . . ONLY \$64.50! Measuring only 10 3/4" x 4", the SAQ-203 is rated at 6 watts R.M.S. in each channel and has a frequency response of 30-20,000 Hz. Input sens. is 3 mV. for magnetic cartridges. An attractive die-cast front panel surrounds all essential controls. 18 low noise transistors. Headphone jack, scratch filter and mode switch are standard. Including Sales Tax **\$64.50**

NOW . . . SHURE CARTRIDGES AT ATTRACTIVE ENCEL PRICES!

Perhaps you've been saving for a Shure Cartridge . . . now you can make your purchase sooner than you expected. Encel prices include sales tax, all cartridges are brand new, each one is fully guaranteed.

Model M44G	Retail 26.00	ENCEL	\$16.50
Model M55E	Retail \$49	ENCEL	\$28.50
Model M75 E	Retail \$69	ENCEL	\$42.50
Model V15E Mk. II	Retail \$118.75	ENCEL	\$74.50

Stocks are limited . . . and Encel prices include sales tax. Ring, write or call at Encel Stereo Centres in Melbourne or Sydney. We believe that this is the first time SHURE cartridges have been offered at such interesting prices. Secure your SHURE cartridge now!

CONNOISSEUR STEREO CARTRIDGE MODEL SCU-1

Regarded as the finest ceramic stereo cartridge produced anywhere in the world, the SCU-1 will load any normal amplifier or tape recorder. Tip mass is 1 milligram, vertical compliance 8 x 10⁻⁶ cm/dyne, lateral compliance 12 x 10⁻⁶ cm/dyne. Audio quality is exceptional and includes a pleasant musical transparency. Ask for copies of reviews. Encel price including Sales Tax **\$10.80**



SOUND MODEL SAQ-505X — HIGH OUTPUT STEREO AMPLIFIER FOR \$109.50! Power output of the 505X is 25 watts R.M.S. in each channel into an 8 ohm speaker load. Frequency response is 20-20,000 Hz. plus or minus 1 dB. Sensitivity is 3 mV. for magnetic cartridges, all normal controls are provided as well as tumble switches for loudness, rumble, tape monitoring etc. **\$109.50**

TYPICAL TRADE-IN VALUATIONS ON A SAQ-505X

Your Star SA-30 is worth a minimum of \$50 as a trade-in on this fine amplifier . . . and it could be worth much more!

SAVE WITH AN ENCEL QUOTE ON YOUR NEW SANSUI AMPLIFIER

The full Sansui range is available—and Encel end-user prices are most attractive. Trade-in valuations on your old equipment are also at an all time high . . . so ask for a price now! Choose from the Models 220, 500A, 1000, 2000 and 3000A!

COMPLETE ENCEL STEREO SYSTEMS

The Encel organization has installed thousands of Encel Stereo Systems in Australian homes. Cabinets are carefully hand-crafted — you make your selection from the most extensive range of audio equipment available in Australia. Stock cabinets available in any period or style, polished or sanded ready for finishing by the handyman. Prices are the lowest in the Southern Hemisphere.

TRUVOX R44 PORTABLE AC RECORDER

The R44 is extremely popular — it's fully transistorised and features interlocking controls, a VU meter for positive indication of recording level and an output of 8 watts I.H.F.M. into an 8 ohm speaker load. Three speeds — 7 1/2, 3 3/4 and 1 7/8 ips. Takes 7" spools. Frequency response is 40-15,000 Hz. ± 3 dB. at 7 1/2 ips. Wow and flutter is less than 0.15% at 7 1/2 ips. Independent microphone and radio/pickup controls allow easy mixing of program material. See the review in "Amateur Tape Recording", Oct., '66, and "Audio and Record Review", Aug., '66. Ask for copies of reviews. Price to schools is only \$129. Price inc. Sales Tax **\$159**

ENCEL ELECTRONICS (STEREO) PTY. LTD.

Head Office:
431 Bridge Rd., Richmond, Victoria 3121. Tel. 42 3762.
Sydney Store: Ground Floor, 2SM Building,
257 Clarence Street, Sydney, N.S.W. 2000. Tel. 29 4563, 29 4564.
Australia's Greatest Hi-Fi Centre *Wholesalers *Trade-ins accepted

proven wharfedale high fidelity sound from two low priced compact speaker systems!

Several years of intensive research have resulted in the release of two new compact speaker systems by Rank Wharfedale Ltd. The problems associated with small speaker enclosures have finally been solved; until now these limiting factors have been restricted frequency response and lack of musical quality.

The "Denton" measures only 9¾" x 15" x 9" . . . the "Super Linton" is 19" x 10" x 10". Both systems feature a new type of bass/mid-range 8" drive unit with an exclusive Wharfedale Flexiprene surround, an extra-long throw voice coil and a new-type ceramic magnet. A specially designed paper cone is employed as laboratory tests reveal that a well-designed paper cone is far more sensitive to musical sound than those made from plastics or man-made fibres. Lower registers are reproduced without restraint or collapse.

Treble response is smooth, clean and satisfying; a new H.F. pressure unit incorporated in both enclosures features an "Acoustiprene" dome — the lightest material ever used in speaker manufacture.

the new Wharfedale Denton

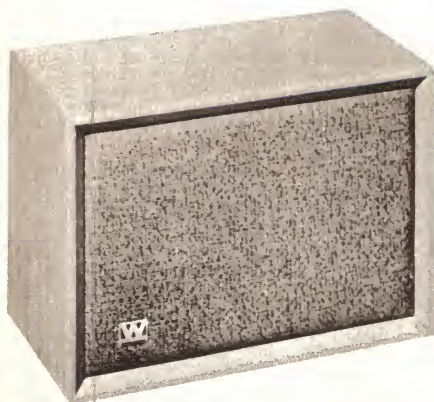

\$61.40

ea. inc.
sales tax.

Frequency response of the "Denton" is conservatively quoted at 65-17,000 Hz. Response of the "Super Linton" is 40-17,000 Hz. Impedance is 4-8 ohms.

Cabinets are finished in selected oiled teak or polished walnut veneers and have been designed to match both modern and period decor. Both "Dentons" and "Super Lintons" are supplied in acoustically matched pairs for optimum stereophonic performance.

When first you listen to these compact Wharfedale multiple speaker systems you will find it hard to believe; after several weeks you will still wonder how Wharfedale succeeded in putting high fidelity Wharfedale sound into extremely compact enclosures.

the new Wharfedale Super Linton

\$78.

ea. inc.
sales tax.



Australian National Distributors:

Simon Gray Pty. Ltd.

Head Office: 28 Elizabeth St., Melbourne, Vic. Tel. 63 8101*

Sydney Office: 22 Ridge St., North Sydney, N.S.W. Tel. 929 6816

Canberra Office: 31-33 London Circuit, Canberra City, A.C.T.
Tel. 49 6050

INTERSTATE REPRESENTATIVES:

N.T.: Pfitzner's Music House, Smith Street, Darwin. Tel. 3801

Q'land: Sydney G. Hughes, 154-158 Arthur St., New Farm, Brisbane. Tel. 58 1422

S.A.: Eilco Sales Pty. Ltd., 7-9 Osmond Terrace, Norwood, S.A. Tel. 63 4844

Tas.: K. W. McCulloch Pty. Ltd., 57 George Street, Launceston. Tel. 2 5322

W.A.: Athol M. Hill, 613-615 Wellington Street, Perth. Tel. 21 7861

SGW7/68

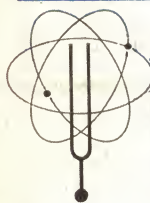

The vinyl used in disc manufacture has to be pressed within fine limits of temperature and pressure, then rapidly cooled to ensure setting of the material before removal of the finished disc from the press. The processes of heating, pressing and cooling are carried out automatically by the Alpha presses. After the pressing cycle is complete, the top platten lifts to allow the operator to remove the pressing. Surplus vinyl around the edges of the disc are removed by a rotating turntable fitted with a cutting knife, situated at the side of the press.

Presses making 12in discs are supplied with pressure at 1,000lb sq. in. and 3,000lb/sq. in. The lower pressure is used to close the press initially and once the two stampers are in contact with the vinyl the full 3,000lb pressure is applied to ensure even distribution of the vinyl right to the edges of the stampers. For the manufacture of 7in discs, the 1,000lb pressure is sufficient. The required pressure is generated by two hydraulic rams and piped throughout the factory.

The metal stampers are heated during the pressing process by steam of the correct temperature which is automatically admitted at the correct time in the pressing cycle by the electronic control unit.

After pressing, the plattens are cooled by a water supply at a pressure of 180lb/sq. in. The water circulating system is capable of delivering 280 gallons a minute, and this amount of water cannot be simply discharged as waste after use. It is therefore recovered and re-used. To lose the substantial amount of heat the water absorbs during the platten cooling process, it is passed through a series of cooling towers, where it is sprayed by fine jets into a cooling air stream.

This system employs the principle of evaporative cooling to bring the temperature down from about 138 degrees F when leaving the presses to about 68 degrees F after cooling.

Absolute cleanliness is essential in record manufacture and, to ensure that dust does not drift into the manufacturing areas from outside, a supply of filtered air is delivered into the working areas, to keep them under slight pressure. In this way, free air movement is always in the outwards direction.

Finished pressings are individually inspected for flaws before being packed into their polythene sleeves and liners. A set proportion of discs is given more rigorous testing to detect any wear occurring in the stampers. These are taken to a playing booth and sampled at various parts of the playing surface, and are then examined minutely for any sign of surface flaws.

The end of the line is the store and dispatch departments, where stocks of discs run into tens of thousands, and through which orders are continually being processed.

Commenting on the new premises, Festival managing director Frederick C. Marks says: "The move to a new location which occupies 75,000 sq. ft and has involved a capital expenditure of more than \$1 million, brings Festival into the line with major recording companies of world standard. The administration offices, studios, pressing plant and warehouse are the most modern and efficient in Australia." ■

One of Festival's new electronically controlled Alpha presses, which carry out the entire pressing operation entirely automatically once the operator has placed the vinyl in position and operated the "Start" control. On the right of the press is the trimming turntable which removes the surplus vinyl from the edges of the discs.



ELECTRONIC "NURSES" ON 24-HOUR DUTY

A miniature transmitter and receiver developed by Boeing Company in the U.S.A. may one day post invisible "nurses" on 24-hour duty at hospital bedsides.

But no longer would a patient come stark awake from icy fingers taking his pulse at three o'clock in the morning. Instead, an automated patient-monitor would gather and transmit such medical data as pulse and temperature from hospital patient to a central nursing control station. There, using readout equipment developed in connection with the space program, medical personnel could oversee each patient continuously and could respond instantly as required.

Developed for the National Aeronautics and Space Administration's Marshall Space Flight Centre, the patient monitor is an example of Space Age technology spinning off into other fields. Key to the system has been advancement in micro-circuitry and in data transmission and handling techniques on the Apollo-Saturn 5 program.

"This is a prototype," said Kenneth Skinner, Boeing patient monitor program manager, "But it indicates what may be accomplished in the future." It is not a substitute for direct medical attention, he pointed out, but a method of extending control in one of today's most demanding professions.

The patient monitor is divided into two subsystems, one for the patient and one for the central control station. Radio links the two. The prototype patient monitor subsystem is about the size of a package of cigarettes. It is powered by battery. The unit is strapped to the patient's arm or leg, and tiny wires extend to skin-surface sensors which report on six physiological conditions—three for the heart, two for temperature and one for blood pressure. No needles or implanted probes are used. Upon command from

the central control station, information on the patient is printed out on strip-cards, or displayed on an oscilloscope.

The control station operator has selection switches, enabling her to dial to specific patients on the circuit. Future installations could have banks of equipment displaying continuous patient-status information. Also computers could be tied in to keep records of patient data and to alert a nurse to any patient's immediate need for attention.

"Our job was to demonstrate that the patient monitor concept was feasible," said Skinner. "Further development could reduce the size of physiological measurements covered and expand the control station equipment. We feel the system will perform any medical requirement for which a sensor can be devised."

Credit for conceiving the system and its future possibilities goes to James Wiggins and Peter Petroff, of the Marshall Centre's Technology Utilisation Office. The Marshall group worked closely with Skinner's Boeing engineering team during the prototype system's design. The equipment was demonstrated recently for representatives of the University of Alabama Medical Centre, the Miami Heart Centre, and for Dr Wernher von Braun, of Marshall Space Flight Centre.

Looking to the future, the day may come when many people will wear a wrist radio health monitor, which in turn will be tied into a computer at their doctor's office. This could lead to an interesting shift in the historical doctor-patient relationship. Imagine the doctor calling to say, "You'd better come to the office. You don't feel well." ■

From Goldring:



high fidelity—low cost!

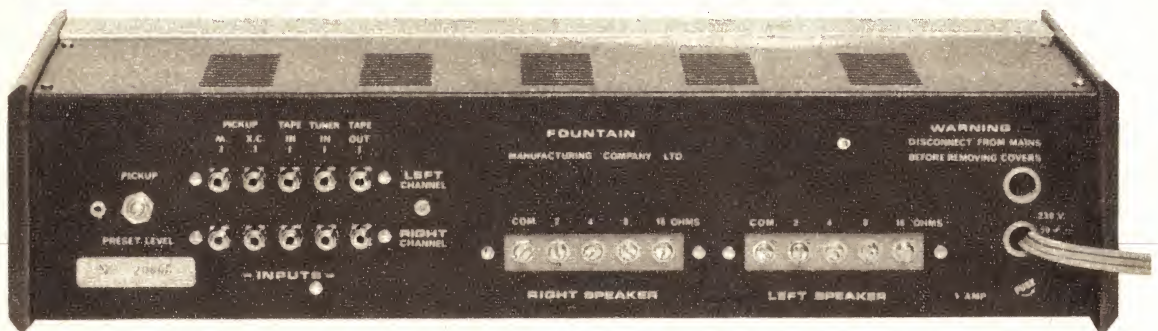

FOUNTAIN 10-10 GEMSONIC STEREO AMPLIFIER

Entirely new in Australia, the GEMSONIC is comparable on test, to most imported amplifiers that sell at much higher cost.

Basically it is comprised of two identical push-pull 10 watt amplifiers preceded by wide range treble and bass controls with controls ganged together. The volume controls are also ganged and a balance control permits adjustment between speakers.

The GEMSONIC has a particularly high sensitivity for record reproduction and will handle ANY cartridge.

INPUTS

The GEMSONIC can be used for stereo or monaural recordings, tapes, radio or hi-fi tuner. The FUNCTIONS switch converts the amplifier from 10 watts per channel STEREO to 20 watts MONAURAL.

INPUT SELECTION CONTROL

Crystal (X) Ceramic (c) or Magnetic (M) P/U's; Tuner or Tape depending on sound source.

OUTPUT STAGE

'Ultra linear' operation and sectionalised transformer windings are used to give better performance and lowest distortion.

LOUD SPEAKERS

All normal loudspeaker impedences — 2, 4, 8 and 16 ohms — are acceptable.

FREQUENCY RESPONSE

($\pm 1\frac{1}{2}$ db at .5 watts)

Tuner — better than 20 cps to 40 Kc/s.

Tape — better than 20 cps to 40 Kc/s.

X or C P/U — better than 20 cps to 30 Kc/s.

M P/U — better than 20 cps to 20 Kc/s.

HI-FI AT ANY VOLUME

Wide range bass and treble controls plus LOUDNESS COMPENSATION CONTROL and PRE-SET OVERLOAD provide high fidelity listening at low level with automatically correct compensation.



Full technical specifications available on request to:

Goldring Engineering (A'asia) Pty. Ltd.

N.S.W.: 443 Kent Street, Sydney. 291275. VIC.: 368 Little Bourke Street, Melbourne. 671197.
QLD.: 235 Edward Street, Brisbane. 27010. W.A.: 91 Hay Street, Subiaco, Perth. 84988. S.A.:
Ernsmith, 52-54 King William Street, Adelaide. 516351.

G:P431



Technical Review

Land navigation systems to beat airport fog problem

Aircraft can now be safely landed completely automatically in conditions of zero ceiling—zero visibility only to become immobilised on fog-bound airports after landing. Automatic land navigation systems now being developed are designed to overcome this problem.

The fact that an aircraft can now be landed safely in conditions of zero ceiling, zero visibility only serves to highlight the associated, if secondary problem of moving aircraft and vehicles on the ground in the same weather conditions. All airlines want to reduce the effect of weather on their operations and improve the punctuality of scheduled movements of aircraft. Even if take-off, landing and airborne times can be regulated, the restrictive effect on ground movement by very reduced visibility must still adversely hit aircraft timetables.

Airport ground movements can broadly be grouped into three types:

(a) Movement of emergency, control and service vehicles.

(b) Movement of operating aircraft to and from the runways.

(c) Movement of aircraft in parking and maintenance areas.

In the first instance, before aircraft can be accepted at an airport it must at least be possible for fire, rescue and ambulance services to be able to move to the scene of any emergency.

Secondly, it must be possible for aircraft, safely and expeditiously, to move between runways and terminal areas.

Thirdly, and to maintain operations, it is desirable that movement of service vehicles about the aerodrome and of aircraft between parking and maintenance areas can continue.

What is the information required by vehicle drivers in substitution for their normal means of navigation in known localities, to permit safe movement in featureless and barren areas?

Briefly: Where are they; where to go; how to get there; which direction to point the vehicle. In average low visibility conditions at an airport, ground vehicle visibility may be 10 to 20 yards. In these conditions, a driver can recognise the immediate surroundings but finds it difficult to know how far the vehicle has travelled along a track or runway. It is precisely

in these conditions that the automatic land navigation system can provide essential information with accuracy sufficient for a driver to maintain a course along one side of a road.

Basically, two essential data are required — a heading reference and vehicle speed. On the accuracy of both will depend the degree of exactitude with which the position of the vehicle can be determined. Using these two inputs, the distance in any direction can quite simply, automatically and

continuously be resolved and converted to east/west and north/south movement of a vehicle and then be transferred to provide a map display of grid co-ordinate positions. The practical application of this simple formula to blind land navigation is typified by the systems currently in wide-scale use by the British, Canadian and other military services and also under extended trial by the fire services at London Airport.

An exact and completely independent heading reference is provided by the Arma-Brown true-north-seeking gyro compass. Because of its small size, and separate control facility, it can be mounted in any convenient position, taking its power from batteries in the vehicle, via a static inverter. Because it is quite unaffected by vehicle movement, however rough the terrain, and impervious to magnetic influence,

The map display unit shown top right is carried in airport vehicles. The known starting position is shown by the arrow. The driver sets his manual pointer to the direction required and proceeds, keeping the pointers in line. After hooking up with the aircraft, the vehicle is navigated by reference to the map display, keeping the aircraft informed of turns and divergences while towing to the terminal area.

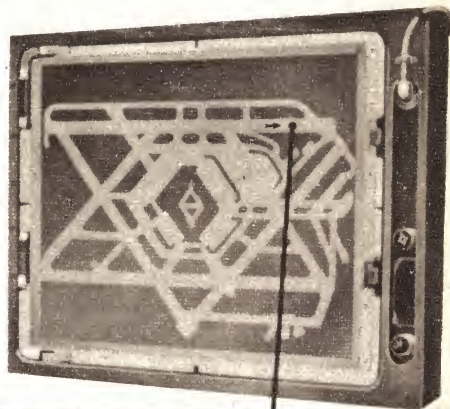

NEW from SONY®



Sony solid-state CASSETTE-CORDER *with features and facilities not found in other brands*

WONDERFUL NEW FEATURES INCLUDE:

■ Inbuilt transformer for 240V. A.C. or D.C. (batteries) operation ■ New cassette tape system—easy loading, one full hour of playing time ■ Extremely compact—measures 5 $\frac{1}{16}$ " x 2 $\frac{3}{8}$ " x 9 $\frac{3}{8}$ " and weighs only 3 lbs. 13 ozs. with batteries ■ Completely automatic recording volume control—"SONY-O-MATIC" ■ Wide frequency response with clear sound ■ Rich 1 watt output through oval dynamic speaker ■ Easy piano key operation ■ Reliable solid-state circuit including silicon transistors ■ Continuous playback tone control; auxiliary input and earphone jacks; remote control microphone ■ 2-track monaural recording and playback.

SPECIFICATIONS

Power requirements:	D.C. 6 V. (4 "C" size standard flashlight batteries or equivalents); A.C. 110, 117, 125, 220 or 240 V. 50/60 c.p.s.
Tape:	SONY Compact Cassette Tape C-60 or equivalent cassette tape.
Tracks:	Dual (monaural).
Power output:	1 watt.
Frequency range:	50-10,000 c.p.s.
Inputs:	Microphone jack; Remote control jack; Auxiliary input jack.
Output:	Monitor jack.
Speaker:	10 x 7 cm. (4" x 2 $\frac{1}{2}$ ") dynamic speaker.
Transistors:	8.
Diodes:	7.
Recording time (with C-60 cassette tape):	30 minutes per track, 1 hour in total.
Battery life:	Up to 10 hours of recording (with SONY Super UM-2 batteries or equivalents).
Dimensions:	140 (W.) x 60 (H.) x 237 mm. (D.) (5 $\frac{1}{16}$ " x 2 $\frac{3}{8}$ " x 9 $\frac{3}{8}$ ").
Weight:	1.75 kgs. (3 lbs. 13 ozs.) with batteries.
Optional accessories:	Telephone pick-up TP-4S; Microphone mixer MX-600M; Foot switch FS-5.

Model TC 100 (illustrated above). Latest from SONY, the compact, lightweight A.C./D.C. Cassette-Corder TC 100 uses internationally standardised, easy-to-handle cassette tape—a perfect ready-to-go portable tape recorder. Recording is just as easy as loading a cassette. The SONY-O-MATIC system automatically and instantly adjusts the incoming sound to proper recording level without your ever touching a knob, always delivering constant high-quality recordings. The set uses five pushbuttons for its basic operations and has separate volume and tone controls. All the controls are conveniently grouped near one end of the set so that it can be used lying flat on a table or while being carried in the case. Other features include: One full hour of recording on a single C-60 cassette, wide frequency range of 50 to 10,000 c.p.s., crisp, clear sound, reliable solid-state circuit, auxiliary input and earphone jacks, earphone monitoring while recording and stop/start switch on microphone for remote control. The set operates either on self-contained flashlight batteries or from house current. Complete with dynamic microphone, cassette tape C-60, magnetic earphone, SONY Super batteries, carrying case, etc.

DISTRIBUTORS—JACOBY, MITCHELL & CO. PTY. LTD.,
 469-475 KENT ST., SYDNEY, N.S.W.

MAIL THIS COUPON TODAY

To Jacoby, Mitchell & Co. Pty. Ltd., 469-475 Kent Street, Sydney.
 Please send me information on Sony Tape-Recorders.

NAME

ADDRESS

S42-EA-7.

S42

IMPROVED SCHOTTKY DIODES

there are virtually no limitations to its scale of use. Vehicle speed is obtained from the speedometer. Distance and direction of travel obtained from these sources are fed to a computer for conversion by ball resolver to east/west and north/south movement of the vehicle. The computer includes a means of adjusting the distance input to compensate for variations in speedometer cable ratio due to track wear, etc. Vehicle speed and latitude correction can be applied to the compass via the control box.

Three types of display are available and can be installed singly or in combination:

Position and Heading Indicator giving a six-figure E/W, N/S continuous map reference of position and also present heading of the vehicle.

Plotting Board displaying present position and direction of travel by an illuminated arrow projected through a map or plan of an airport or special area. The surface is designed for manual plotting.

Driver's Repeater showing the heading of the vehicle by an automatic pointer. A second, manually operated pointer can be set to the bearing of a desired route which the driver can maintain by steering the vehicle to keep the pointers in alignment. The repeater also enables a check to be made on how far round the vehicle must be turned at an intersection and on the general heading direction relative to the known direction of the track along which the vehicle is proceeding.

We now have a situation where aircraft can safely take off and land, with a means to get them to and from the runways in any visibility. Movement of emergency services on the ground is facilitated and airline flying schedules can thereby be maintained more regularly.

There still remains the much wider and more complicated problem of moving passengers and freight along public highways into and out of the airports in hazardous visibility conditions. One of the major limiting factors is the absence of a reliable anti-collision device and certainly its availability would also widen the scope and, perhaps, allow an increase in the speed of vehicles fitted with automatic land navigation at an airport.

There may well be a number of reasons why adequate solutions to problems of ground movement have in fact lagged behind development of automatic landing aids. Conditions on the ground may deteriorate while an aircraft is airborne and it must be landed somewhere in safety. There are further weather conditions at surface level that restrict flying—strong crosswinds, ice on runways and severe storms are examples not infrequently responsible for failures to keep to scheduled timetables, particularly in winter. Not all airports are subject to fog and similar visibility conditions and this must affect decisions on the scale of expenditure in the development of ground rather than airborne equipment. In any case, man through the ages has always retained some degree of mobility whatever the visibility and still manages more or less to cope with the comparatively recent problems at airports, which itself must influence priorities. ("Hawker Siddeley Review," Vol. 4, No. 3.)

Bell Telephone Laboratories of America claim to have improved Schottky barrier diodes to give them nearly ideal current-voltage characteristics. The improvement is considered to open the way to their use in high-frequency, high power rectifiers; in high efficiency microwave oscillators; and in logarithmic converters.

The reverse breakdown voltages of the improved diodes are said to approach the theoretical limit, averaging more than twice the voltage of more conventional Schottky diodes. In addition, the diodes have leakage currents of about two picoamps when reverse-biased.

Thus, Bell say, for the first time Schottky barrier diodes, which do not inject minority carriers, have achieved breakdown voltages and leakage currents comparable to the best PN junction diodes, which do inject such carriers.

The improved diodes are compatible with integrated circuits; the fabrication techniques are an extension of the beam lead technology previously developed at Bell Labs. Like other lower power Schottky diodes, they can be used in high-speed devices with switching times of less than one-tenth nanosecond.

As well as their high reverse-breakdown voltages, the improved diodes are claimed to have a nearly ideal exponential current-voltage characteristic in forward bias. This logarithmic current-voltage relationship holds in the new diodes for current values ranging from a picoamp to a tenth of a millamp.

This range, which is eight orders of magnitude, is a few orders of magnitude greater than that of PN junction logarithmic converters.

The high reverse-breakdown voltage of the improved diodes is due to a "guard ring" of P type silicon diffused around the metal-semiconductor junction. Other Schottky diodes are usually protected with a metal overlay, but have no guard ring diffused within the semiconductor around the periphery of the metal.

The new guard ring minimises the "edge effect" inherent in more conventional Schottky diodes. This edge effect results from a concentrated electric field at the interior corners of the metal-semiconductor junction. Until now, the edge effect has limited the

breakdown voltage of Schottky diodes to about one-half the theoretical limit.

Oscilloscope traces of current versus voltage for the improved diodes show abrupt reverse-breakdown at voltages close to the theoretical expectation.

Tests with electronic probes have verified that the breakdown occurs not at the edges of the Schottky junctions, but simultaneously across the whole junction surface. Schottky diodes have been made at Bell Labs with breakdown voltages ranging from 10 to 500 volts.

A clean junction between the metal (platinum-silicide), and the semiconductor (N-type silicon) contributes to the improved electrical characteristics of the new diodes. Current leakages in older Schottky diodes are often a result of the formation of surface states between the pure silicon surface and the evaporated metal. Any contamination at the semiconductor surfaces may degrade the operating characteristics of the barrier.

To avoid this problem, the surface of the N-dope silicon substrate is atomically cleaned by a "back-sputtering" process developed at Bell Labs. For this process, the silicon slice is placed on a cathode. Applying a high-frequency voltage (about 2,000 volts) to the cathode creates a glow discharge above the slice. The gas ions of this plasma bombard the silicon surface, removing any impurities there. Then, while the slice is still in the vacuum chamber, the RF voltage is turned off, and a smooth layer of platinum is sputtered on to the pure silicon from a second platinum cathode over the slice.

The result is a smooth layer of platinum-silicide, free of contamination, over a substrate of N-type silicon. Platinum-silicide has the characteristics of a metal, and serves as the metallic material of the Schottky junction. ("Electronics Weekly," 3/1/68.)

Current voltage characteristics of improved Schottky diodes (structure at right) are better than conventional type (top left). Improvements are due to a diffused guard ring of P-type silicon. Overlay contact on both Schottky diodes can be aluminium or titanium-platinum-gold alloy. The insulator (grey areas) is silicon dioxide. Platinum silicide (PtSi in lower drawing) serves as a metal in both barrier junctions. Diameter of platinum silicide areas, which defines the active areas of the diodes, is typically 40 microns for high-speed applications.

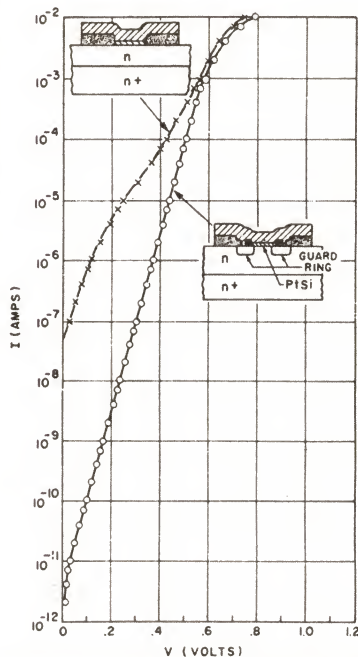

They **CLIP IN** and stay put: 'Lock-fit'

Transistors from Mullard

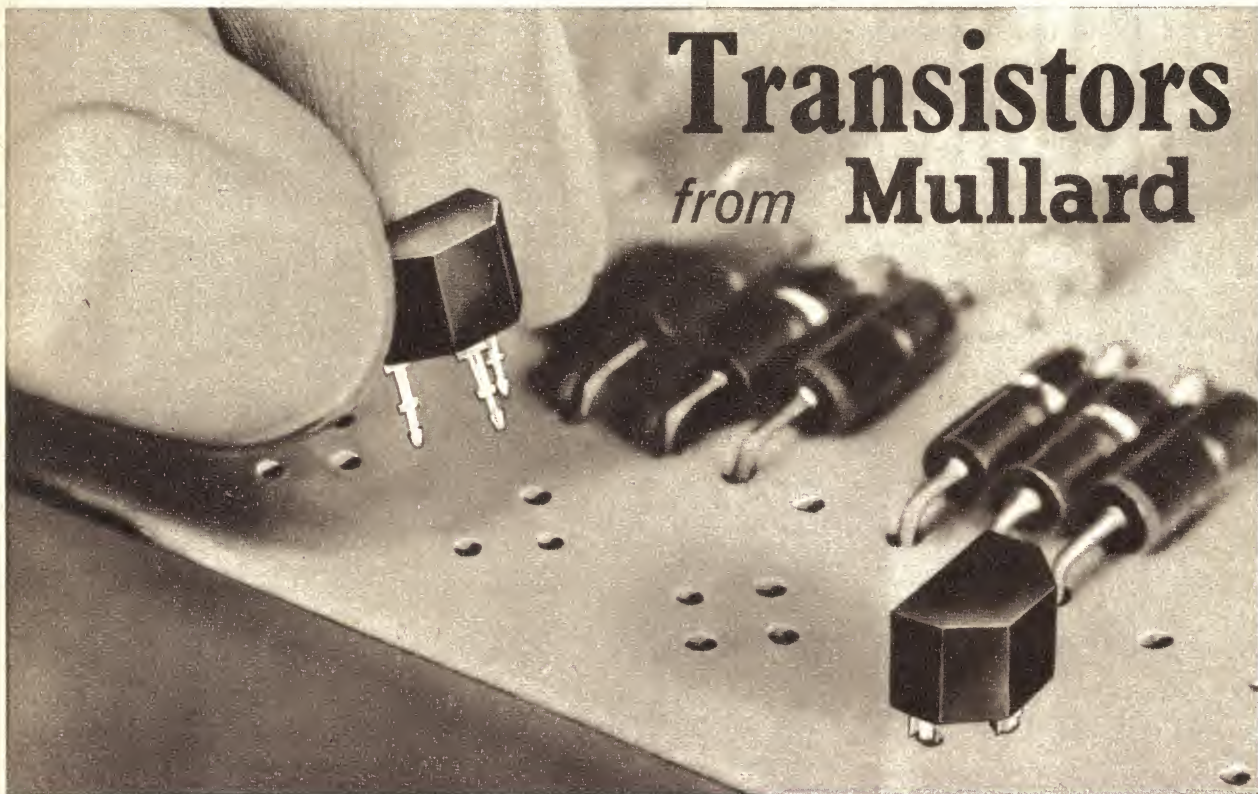

Now available for incorporation in new equipment designs

Mullard announces a complete breakaway from tradition . . . a family of 'lock-fit' transistors which offer three important advantages: 1—Self-locking pins. 2—Self-orienting shape. 3—Epoxy resin body. Now you just push a 'lock-fit' transistor in and it **stays** there until soldered. Let us give you more details on the ease of mounting 'lock-fit' transistors into printed wiring boards.

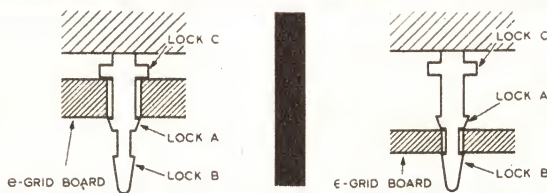

These diagrams show details of 'lock-fit' pins and function of three 'locks' when used with e-grid and the more closely spaced E-grid printed wiring boards.

LOCKFIT TYPE	EQUIV. METAL TYPE	DESCRIPTION	V _{CEO} (V)	I _{CM} (mA)	P _{tot} at 25°C (mW)	h _{FE} or h _{FE*}	at I _L (mA)	SPECIAL FEATURES
BC147	BC107	G.P. n-p-n	45	200	220	125-500	2.0	Typ. N.F. 2.0dB
BC148	BC108	AF n-p-n	20	200	220	125-900	2.0	Typ. N.F. 2.0dB
BC149	BC109	Low Noise n-p-n	20	200	220	240-900	2.0	Typ. N.F. 1.8dB
BC157	BC177	G.P. p-n-p	45	200	220	75-260	2.0	
BC158	BC178	AF p-n-p	25	200	220	75-500	2.0	
BC159	BC179	Low Noise p-n-p	20	200	220	125-500	2.0	Typ. N.F. 2.0dB
BC194	BF184	Mixer Osc. n-p-n	20	30	220	115*	1.0	Typ. N.F. 2.0dB
BC195	BF185	IF Amp. n-p-n	20	30	220	67*	1.0	Typ. N.F. 3.5dB

Mullard

Mullard-Australia Pty. Ltd.

35-43 CLARENCE STREET, SYDNEY, N.S.W. 2001. PHONE: 29 2006
123 VICTORIA PARADE, COLLINGWOOD, VIC. 3066. PHONE: 41 6644

Associated with MULLARD LIMITED, LONDON

M215

BRITISH BANK'S NATIONWIDE COMPUTER BANKING SYSTEM



Britain's first comprehensive nationwide computerised banking system is to be installed by the Midland Bank, which has branches all over the country.

By 1971, all of the bank's 2,000 branches will be connected directly to a network with access to five English Electric System 4-70 computers. These will be installed in two new computing centres, one in London, the other in Bootle, in the north of England.

This is how the system will work, as the customer sees it. At the moment, if a depositor with an account, say, in a Manchester branch, wishes to draw a cheque at a Brighton branch, he waits while an employee at Brighton telephones Manchester to check that he has a sufficient balance to meet the cheque. This is slow, inefficient and expensive if the telephone call is long distance. With the new scheme, the bank clerk at the Brighton branch will contact the central processors of the computer network through his terminal keyboard. He will send through figures corresponding to the account number and the amount which the depositor wishes to withdraw. Working in millionths of a second, the computer will check the level of the customer's account and flash back the information.

To install an "on-line" computer system to serve so many branches and record and process about 3 million transactions a day demands very fast computers with very fast interrupt times. The more places there are demanding access to the central processors the greater the peak load is likely to be. For this reason the Midland Bank has chosen the System 4-70, which is second only to the System 4-75, a multi-access scientific computer in capacity and speed among the English Electric range. These so-called "third generation" machines are the first which could tackle an on-line system of such magnitude. The use of the system will enable the Midland Bank to keep labour force steady and contain banking costs. It will also be possible to expand the range of banking services available to customers.

The keyboards have a small stored program of their own which enables a checking to be carried out on the accuracy of the information that is put into them. All transactions carried out over the counter will be converted into input for the computers by the keyboards.

Half the daily transactions of the bank are either deposits or withdrawals. The other half arise during the process known as clearing, when the banks sort out all the cheques paid into accounts and make the adjustments with other banks that are necessary. At this stage the transactions will be recorded and transferred into the computers by the process known as M.I.C.R. (magnetic ink character

recognition.) The central processors have to have sufficient capacity to take care of this large number of transactions, forming, as they do, part of the input of 2,000 terminals. All 2,000, after all, might be trying to feed data into the computers at the same time, and at a busy time in the banking day this could very well happen. To handle this the core store, for immediate access, has a large capacity and it is backed up by two other stores, both using discs. These are all involved in day-to-day transactions, but the names

one or other of the computer centres will naturally affect the other one. For instance, local transactions in the north of England by a company whose main account is held in London will need to be updated. For this purpose, the computers will be programmed to take advantage of any spare capacity that may be available during the night. As soon as spare capacity is available, for instance, the Bootle computers might ask London's network if it can receive some clearing data. London then answers, automatically, that it can accept the data, and Bootle begins transmitting. In this way, the computers will be "talking" to one another across the intervening 200 miles while Britain sleeps.

With any such automatic system

Diagram showing the proposed London-Bootle link which will be the basis for the on-line system planned by the Midland Bank. MCC is the multi-channel communications control unit which controls the lines to the branches. SCC is the single channel communications unit which links the computer centres.

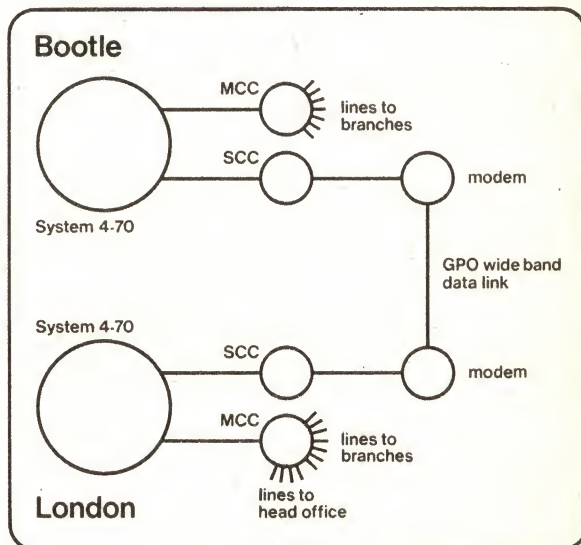

and addresses of customers are stored on magnetic tape.

Communication between the 2,000 branches and the two strategically placed computer centres will be by means of privately rented telephone lines from the General Post Office. To rent a line from each bank branch to one or other of the computer centres would be too expensive. So groups of branches are connected by what is known as the multi-drop line system, and then each group is connected by a single line to a centre. The G.P.O. restricts the number of drop points on each line to 12. The two computer centres are about 200 miles apart. The link between them obviously needs to have the highest capacity of any part of the system and for this reason the bank will rent a high-speed wide-band circuit from the Post Office.

During the night, the business of clearing cheques will carry on almost without intervention by human employees. In the course of a normal day many transactions conducted through

there must be checks to make sure that the data being transmitted is not in error. The program for the System 4-70 computers will include such checks so the computer system should be much less fallible than a human one.

The first of the 4-70 computers will be installed in London not later than December, 1968. A number of branches will be connected to it, and then in stages during the next three years other computers will be installed and more and more branches will be connected. By 1971 the business of balancing accounts at a local level will be a thing of the past. Automation in banking will be a reality in Britain. The fact that since the Midland Bank announcement three more of the five Joint Stock Banks have announced plans for similar systems, with different computers, shows the significance of the Midland initiative. In the 1970s computers will take over British banking to an extent undreamed of even a few years ago. ("Spectrum," November, 1967.)

New Ideas in Electronics

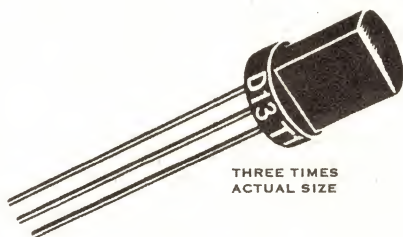

A low-cost
unijunction transistor
you can program
to fit your
design needs

General Electric's time-proven D5K1 and D5K2 planar complementary UJT's, with industry's highest level of performance predictability, are now joined by a pair of programmable unijunction transistors (PUT) that let you tailor characteristics such as η , R_{BB} , I_P , and V_P to meet your needs . . . by simply adding two external resistors.

GE's new D13T1 and D13T2 generally give this programmability without increasing circuit complexity, too. In fact, they often reduce circuit cost. And they offer the newest epoxy packaging, tighter parameter specifications, higher sensitivity, low unit cost, low leakage current, low peak point current, low forward voltage, and fast, high energy trigger pulse.

D13T2 is specifically characterized for long interval timers and other applications requiring low leakage and low peak point current. The D13T1 has been characterized for general use where low peak point current is not essential.

Applications include SCR triggers, pulse and timing circuits, oscillators, sensing circuits, and sweep circuits. For more information on how you can program a GE unijunction transistor to save you time and money, write Electronics Department, Australian General Electric Pty. Ltd., 103 York Street, Sydney, N.S.W. 2000. Telephone 29 7553; or 552 Lonsdale Street, Melbourne, Victoria 3000. Telephone 67 8221.

GENERAL  ELECTRIC*

*TRADE MARK OF GENERAL ELECTRIC COMPANY, U.S.A. — WORLD'S LARGEST ELECTRICAL ENTERPRISE

040-01/R

SCIENTIFIC AND INDUSTRIAL NEWS

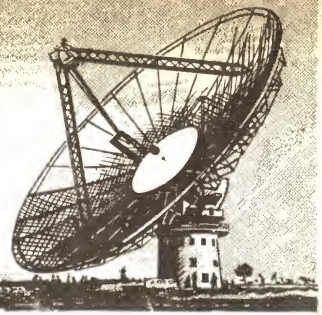

Radio University courses

The Division of Postgraduate and Extension Studies of the University of N.S.W. has announced details of the following courses, to be broadcast over Radio University, VL2UV, commencing in July and August.

Colour television. This will consist of ten radio lectures and two TV lecture/demonstrations designed to give an introduction to the principles and techniques of colour television. The lectures will be broadcast weekly over Radio University, VL2UV, commencing in July, 1968. The course covers the fundamentals of the NTSC, SECAM and PAL systems, the principles of colorimetry and the chromaticity diagram, the nature of chrominance signals, coding and transmission. The course will also deal with colour cameras, colour receivers, and testing and set-up procedures for colour systems. Students will be given an opportunity to operate a colour TV camera chain.

The art of communication. The Art and Practice of Written and Spoken Communication is one of a series of five courses on communication designed to train people in the compilation of information for transmittal by any method. The five lectures in this course will be followed by an evening seminar.

The course is directed toward executives of enterprises in all spheres of activity, and especially toward those concerned with communicating complex information, usually of a quantitative nature. The preparation of a factual dissertation, document or report will be dealt with, including selection, material plan, lay-out and format. The general aim of the course is to discuss written and spoken communication within a technical and commercial framework.

Reliability engineering. A course of ten one-hour lectures on reliability engineering. In addition, there will be two television lecture/demonstrations at the University's viewing centres. The course deals with the methods of measuring, predicting and improving the reliability of manufactured materials, parts, assemblies and systems, and will be of interest to designers, engineers and production managers in industry. It is desirable that intending students should have a reasonable mathematical ability.

Information regarding fees and enrolment dates should be obtained from the Division of Postgraduate Studies, P.O. Box 1, Kensington, N.S.W. 2033 (Phone 663-0351, ext. 2691).

Automatic inertial navigation

The U.S. Government recently approved American Airlines' engineering certification of the Litton LTN-51 automatic inertial navigation system for its scheduled airliners. Certification was achieved after more than a year's intensive research and development by American Airlines and Litton. A joint statement said that the LTN-51 had proved itself in more than 3,000 hours of exhaustive flight testing aboard A.A.L.'s 707-323C jet planes. The LTN-51 replaces present complex navigational procedures requiring fixes and calculations which

take navigators about 20 minutes to complete. Pin-point navigation is accomplished automatically in a fraction of a second by the LTN-51.

All that is needed by LTN-51 is the latitude and longitude of the flight's destination and check points along the way. The computer does the rest. Entirely self-contained, the 55lb system can navigate an aircraft anywhere on earth with precise accuracy. No outside radio command or information is needed for system operation. The pilot and co-pilot can ascertain in an instant the exact heading and position. Course change is a mere matter of adjusting the destination co-ordinates by pushing a few buttons on the display panel. Automatically provided by the system are steering commands and readings of ground speed, wind direction, attitude reference, range, bearing and time remaining on the flight.

CCTV for London underground

A contract for a closed circuit television (CCTV) network at stations on the new Victoria line of London's underground railway has been awarded to a company within the Philips Group. The network, one of the largest supervisory CCTV systems in the U.K., will include 74 cameras, 42 monitors, distribution equipment and specially designed camera and monitor enclosures to suit the decor of the new stations. The system will cover 12 stations and the 10½-mile section of the line between Victoria and Walthamstow, which will be opened to the public in stages between September, 1968, and the spring of 1969.

With closed-circuit television added to automatic operation of trains, and the automatic issuing, checking and collection of tickets, the Victoria Line will be one of the world's most technically advanced and labour-saving railways. At most stations, an operations room, generally at ticket hall level, will be equipped with 11in monitor screens on which the supervisor will be able to select pictures from any of the cameras

Tunable microwave filters

A range of compact, solid state tunable microwave filters has been developed by The Marconi Company, of the U.K. These filters use single crystals of Yttrium Iron Garnet (YIG) to provide a resonance which can be varied by altering the current in an electromagnet. These units make it possible to tune the microwave components of a communication system without any form of mechanical movement and provide a simple method of tracking a signal of varying frequency. The complete unit measures only 3½in x 3in x 2½in including the coaxial connectors.

A YIG filter on test is clamped between the poles of a powerful electromagnet used to magnetise the permanent magnetic component of the filter magnet. The coils of the electromagnetic control unit for the filter can be seen between the poles of the larger magnet.

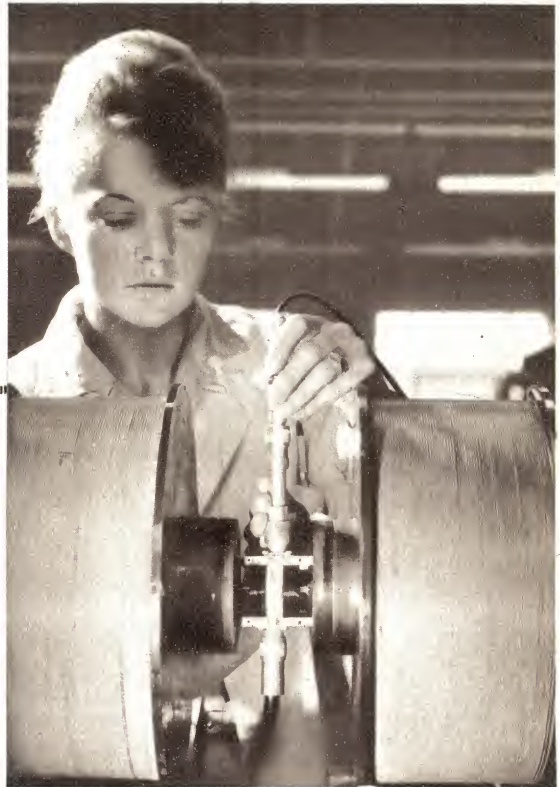

High Compliance tweeters

FT-502



SPECIFICATIONS
 Size: 50 mm (2 in.)
 *Impedance: 8 or 16 Ω
 Frequency Range: 2,000~20,000 c/s
 Sensitivity: 100 dB
 Power: 30 W max., 8 W nom.
 Dimensions: 82×82 mm, 29 mm depth
 Magnet Weight: 193 g (6.81 oz), Ceramic
 Weight: 615 g (1 3/8 lbs)

Price \$8.04.
 Plus Sales Tax \$1.68.

High Compliance wide range speakers

FE-103



Price \$8.64.
 Plus Sales Tax \$1.04.
 Size: 100 mm (4 in.)
 *Impedance: 8 or 16 Ω
 Resonant Frequency (f₀): 65~95 c/s
 Frequency Range: f₀~18,000 c/s
 Sensitivity: 96 dB
 Power: 5 W max., 3 W nom.
 Dimensions: 105×105 mm, 46.6 mm depth
 Magnet Weight: 193 g (6.81 oz), Ceramic
 Weight: 630 g (1 3/8 lbs)

FE-163



Price \$14.64.
 Plus Sales Tax \$3.05.
 Size: 160 mm (6 1/2 in.)
 *Impedance: 8 or 16 Ω
 Resonant Frequency (f₀): 40~60 c/s
 Frequency Range: f₀~20,000 c/s
 Sensitivity: 98 dB
 Power: 10 W max., 5 W nom.
 Dimensions: 166×166 mm, 73.7 mm depth
 Magnet Weight: 398 g (14.04 oz), Ceramic
 Weight: 1,260 g (2 3/4 lbs)

High Compliance woofers

FW-162



SPECIFICATIONS
 Size: 160 mm (6 1/2 in.)
 *Impedance: 8 or 16 Ω
 Resonant Frequency (f₀): 40~50 c/s
 Frequency Range: f₀~2,000 c/s
 Sensitivity: 97 dB
 Power: 30 W max., 10 W nom.
 Dimensions: 166×166 mm
 81.6 mm depth
 Magnet Weight: 500 g (1 1/8 lbs), Ceramic
 Weight: 1,660 g (3 3/8 lbs)

Price \$12.00.
 Plus Sales Tax \$2.50.

FW-202



SPECIFICATIONS
 Size: 200 mm (8 in.)
 *Impedance: 8 or 16 Ω
 Resonant Frequency (f₀): 30~40 c/s
 Frequency Range: f₀~2,000 c/s
 Sensitivity: 98 dB
 Power: 45 W max., 15 W nom.
 Dimensions: 208×208 mm
 90.8 mm depth
 Magnet Weight: 830 g (1 3/4 lbs), Ceramic
 Weight: 2,760 g (6 1/8 lbs)

Prices \$23.64.
 Plus Sales Tax \$4.93.

Coaxial speakers

FX-201



with horn tweeter
 Prices \$23.88.
 Plus Sales Tax \$4.98.
 Size: 200 mm (8 in.)
 *Impedance: 16 Ω
 Resonant Frequency (f₀): 45~75 c/s
 Frequency Range: f₀~18,000 c/s
 Sensitivity: 101 dB
 Power: 10 W max., 5 W nom.
 Dimensions: 206 φmm, 137.5 mm depth
 Magnet Weight: 240 g (8.46 oz)
 Weight: 2,200 g (4 3/4 lbs)

FX-200 G2

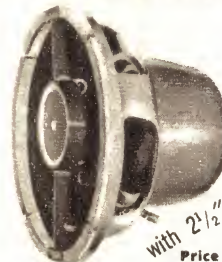

with 2 1/2" tweeter
 Price \$21.60.
 Plus Sales Tax \$4.50.
 Size: 200 mm (8 in.)
 *Impedance: 16 Ω
 Resonant Frequency (f₀): 45~75 c/s
 Frequency Range: f₀~18,000 c/s
 Sensitivity: 101 dB
 Power: 10 W max., 5 W nom.
 Dimensions: 206 φmm, 140.7 mm depth
 Magnet Weight: 234 g (8.21 oz)
 Weight: 2,200 g (4 3/4 lbs)

2-way network



LC-100
 Price \$6.60.
 Plus Sales Tax \$1.38.

Crossover Freq.: 2,500 or 3,500 c/s
 Impedance: 16 Ω
 Attenuation: 6 dB/oct.
 Dimensions: 63.1 φmm, 69 mm height
 Weight: 280 g (9.88 oz)

2 or 3-way network

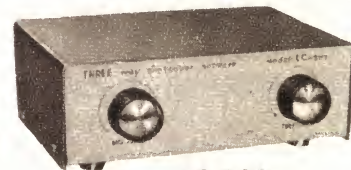

LC-300

Crossover Freq.: 350 or 700 c/s, 2,500 or 5,000 c/s
 Impedance: 8 or 16 Ω
 Attenuation: 6 dB/oct.
 Dimensions: 83 H×200 W×134 mm D
 Weight: 1,430 g (3 1/4 lbs)
 Price \$22.20.
 Plus Sales Tax \$4.63.

Double-cone speakers

PW-65A



Size: 160 mm (6 1/2 in.)
 *Impedance: 8 Ω
 Resonant Frequency (f₀): 70~100 c/s
 Frequency Range: f₀~15,000 c/s
 Sensitivity: 97 dB
 Power: 6 W max., 5 W nom.
 Dimensions: 164.9 φmm, 86.2 mm depth
 Magnet Weight: 77.6 g (2.73 oz)
 Weight: 476 g (1 1/4 lbs)

Price \$6.60.
 Plus Sales Tax \$1.35.

*at 400 c/s; †at 3,000 c/s



FHT-1

tweeter

Price \$11.04.
 Plus Sales Tax \$2.30.
 †Impedance: 16 Ω
 Frequency Range: 2,500~16,000 c/s
 Sensitivity: 100 dB
 Power: 10 W max., 5 W nom.
 Dimensions: 110 mm height, 95 mm depth
 Weight: 330 g (11.75 oz)

(SOLE AGENT)



ZEPHYR PRODUCTS PTY. LTD.

70 BATESFORD ROAD, CHADSTONE, VICTORIA

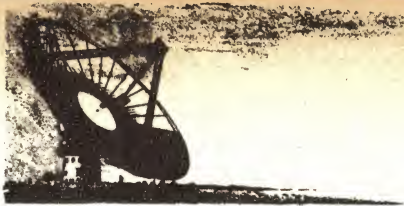

at his disposal. The line controller, sometimes miles away, will also be able to switch into the network and select pictures as he chooses. The train operators, who will sit in the front cab of the trains, will have monitor screens to see the rear half of the platform in crowded conditions.

Wind velocity data recorder

The Bureau of Meteorology in Melbourne has taken delivery of a data recording system which will be used to record data from upper-atmosphere wind velocity measurements experiments. Reflectors suspended from parachutes are placed high in the upper atmosphere by rockets, and are then tracked by radar. The recording system, designed and built by Dynamco Electronics Pty. Ltd., Crow's Nest, N.S.W., makes extensive use of ICs and similar modern techniques.

The electronic unit triggers the radar transmission and then receives from the radar details of the echo in digital form. It then translates this, together with real-time information from its own internal crystal time source, into a form suitable for recording. The recorder used is a Kennedy incremental magnetic tape unit which writes at 3,500 bits a second on half-inch magnetic tape in computer compatible form. The recorded tape is placed on a magnetic tape handler of the Bureau's IBM computer and the recorded information is instantly available at high speed to the programmer.

Reducing air pollution

A new and economic method of combating air pollution from oil heating plants has been developed in Sweden by the Bahco company, manufacturers of ventilating equipment. Called the Bahco SO₂ Scrubber, the cleaning device removes up to 98 per cent of the sulphur dioxide in flue gases from boilers using heavy oil, and also eliminates 90 per cent of the flue gas dust.

In the Bahco process, the flue gas is washed with a lime solution in two consecutive stages. The sulphur dioxide and lime solution form a sludge consisting of calcium sulphite, hydrated calcium sulphate and water. The sludge also contains soot and other solid particles in the flue gases. It is harmless

Lightweight brake discs



The lightness of beryllium is demonstrated by balancing four beryllium brake discs used on the giant U.S. Lockheed C-5 aircraft with a single steel brake disc of the same size. The beryllium brake discs, designed and produced by B.P. Goodrich Aerospace and Defence Products, are also better than steel in absorbing and dissipating heat.

and a refuse dump for the sludge would not constitute a nuisance, the company says. The Bahco Scrubber is intended for large heating plants, district heating and power stations, industrial boilers and other large-scale plants. Although developed primarily to collect sulphur dioxide, it can also be used for other gases, including the hydrochloric acid that forms during the combustion of PVC plastic in incinerators.

New computer family

A family of fast, integrated-circuit computer systems for medium-to large-scale real time control and scientific applications has been introduced by the Computer Control Division of Honeywell Pty. Ltd., 55 Macquarie Street, Sydney. The family, called Series 32, has been designed for the solution of on-line real-time problems.

The first member of the family, the H-632, features a full word cycle time of 850ns, and is said to be the fastest and most compact 32-bit computer currently available. The H-632 is a multiprocessor system, with the capacity for up to four central processors (CP) and one input-output processor, both types being multiprogrammable. Each CP is capable of controlling up to 40 program levels, while each of the input-output processors can handle up to 16 channel programs concurrently.

Error corrected telex

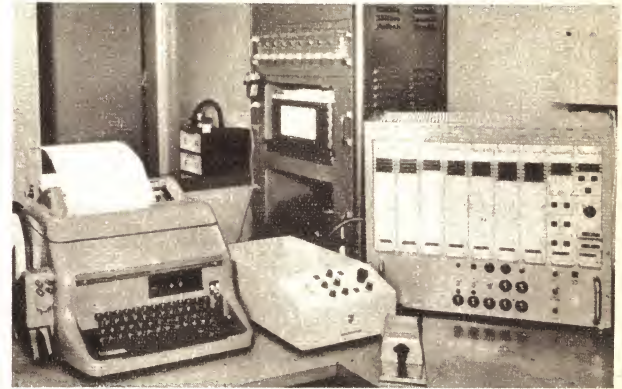

Philips' Simplex TOR equipment installed in the ship's radio station of the M.S. Bergehus. This equipment, in a small metal cabinet (right), ensures an error corrected teleprinter communication between the ship and shore. In this system, the transmitter sends out the message in groups of three characters. The receiving station checks the characters individually, and if one or more are found mutilated the whole block is considered faulty and retransmission is requested. The procedure is repeated until the block is received correctly, after which the next block is transmitted.

Memory size ranges from 8192 words to 131,072 words in 8192 word increments. The system allows for bit, byte, halfword, word and double word addressing, together with multilevel indexing and indirect addressing. Up to 144 high-speed instructions are provided, including fixed and floating point arithmetic, logical and shift operations, and byte operations.

A special multiprocess controller co-ordinates all processor activities within the H-632 system, and controls the execution of CP program levels and input-output channel activities. Standard software includes an assembler, Fortran IV Compiler, maths libraries, loader, basic operating system, and special routines for testing, debugging and maintenance of programs. Peripherals available include magnetic tape units, paper tape readers and punches, disc units, analog-to-digital and digital-to-analog converters, communications, and display subsystems, and adapters for attaching Honeywell's 16-bit computer (DDP 416 and 516).

Fog dispersal

American research aimed at finding ways to cope with fog has produced two experimental methods, both concerned with increasing the size of fog droplets, which restrict visibility because they diffuse light. Any procedure which reduces the amount of light diffused improved visibility. If tiny droplets can be made to combine into larger ones, there is more space between them and therefore greater visibility.

One method being investigated by the Cornell Aeronautical Laboratory at Buffalo, New York, consists of seeding fog by dumping large amounts of common salt into it from an aeroplane. Because the salt readily absorbs water, the fog droplets cling to the salt grains to form large drops of water, thus clearing the air. The size of the salt grains is the key to this technique. If too small, the water drops formed are not large



Presents a completely revised range of transformers

OUTPUT TRANSFORMERS

Type No.	Nom. Watts	Primary Impedance (ohms)	Secondary Imp. (ohms)
Medium fidelity 40-30,000 cps minus/plus 2db.			
OPM 1A	5	7000, 5000	S.F. 15, 8 3.7, 2
OPM19A	5	7000, 5000	S.E. 500, 250, 166, 100
OPM 2A	7	10000	P.P. 15, 8 3.7, 2
OPM 7A	15	(10000) 8000, 7000	P.P. 15, 8 3.7, 2
OPM 8A	15	(10000) 8000, 7000	P.P. 500, 250, 166 100
OPM10A	25	(8000) 6600	P.P. 15, 8 3.7, 2
OPM 9A	25	(8000) 6600	P.P. 500, 250, 166 100
OPM14A	35	(8000) 6600	P.P. 15, 8 3.7, 2
OPM13A	55	3500	P.P. 15, 8 3.7, 2

Impedance in brackets indicate screen taps available.

OUTPUT TRANSFORMERS

Type No.	Nom. Watts	Primary Ohms	Secondary ohms
Hi-Fi Using Oriented Grain Steel for Mullard 5-Stereo-7 Playmaster 2 & 4			
OP412	7	9000 + Screen Taps	PP. 15 7.5 3.7 2
Hi-Fi for Mullard 5-10 Amplifier			
OP308/15	12	8000, 6000	P.P. 15 3.75*

Ultra-Linear

OP301/15	12	8000 + Screen Taps	P.P. 15 3.75*
OP312/15	25	6600 + Screen Taps	P.P. 15 3.75*

For 6GW8's (ECL86's)

OP447/15	12	8000 + Screen Taps	P.P. 15 3.75*
----------	----	--------------------	---------------

Ultra-Linear Oriented Grain Steel For 6BQ5's (EL84's)

OP387/15	12	8000 + Screen Taps	P.P. 15 3.75*
----------	----	--------------------	---------------

*Also available in 8.4 and 2.1 ohms.

POWER TRANSFORMER General Purpose—Valve Rectifier

Type No.	Primary Volts	H.T. Volts	H.T. mA	Low-Tension Secondaries
PF619	240	150/150	30	6.3V—1.8A
PF299	240	285/285	40	6.3V—2A 6.3V—tap5V—2A
PF201	240	225/225	50	6.3V—2A
PF151	230, 240	285/285	60	6.3V—2A C.T. 6.3V—tap 5V—2A
PF1460	230, 240, 250	250/250	80	6.3V—2A C.T. 6.3V—2A 6.3V—tap5V—2A
PF130	230, 240	285/285	100	6.3V—2A C.T. 6.3V—2A 6.3V—tap5V—2A
PF174	230, 240	285/285	150	6.3V—3A 6.3V—3A C.T. 6.3V—tap5V—3A

POWER TRANSFORMER General Purpose—Voltage Doubling

Type No.	Primary Volts	H. T. Volt (R.M.S.)	DC Output After Volts	DC Output Doubler mA	Low Tension Secondaries
PVD100	250	120	310	80	6.3V—3A CT
	240	110	285		
	230	100	260		
PVD102*	250	120	310	100	6.3V—4A CT
	240	110	285		
	230	100	260		
PVD103	250	50	380	100	6.3V—5A CT
	240	140	355		
	230	130	330		
PVD104	250	120	310	125	6.3V—3A CT 6.3V—3A
	240	110	285		
	230	100	260		
PVD105	250	146	380	125	6.3V—3A CT 6.3V—3A
	240	136	355		
	230	126	330		
PVD108	250	173	450	150	6.3V—3A CT 6.3V—3A
	240	163	425		
	230	153	400		
PVD109	250	146	380	180	6.3V—3A CT 6.3V—4A
	240	136	355		
	230	126	330		
PVD110	250	193	500	200	6.3V—3A CT 6.3V—4A
	240	183	475		
	230	173	450		
PVD111*	250	124	310	150	6.3V—3A CT 6.3V—3A CT
	240	114	285		
	230	104	260		

*Also available in flat mounting;

LOW VOLTAGE EQUIPMENT TRANSFORMER

Type No.	Primary Volts	Secondary Rating
PF537	240	17V tapped 11.5V—0.4A
PF1848	240	17V—1.25A
PF265	240	17V tapped at 11.5V, 10V, 8.5V at 4.2A
PF2344	240	18V, 0, 18V, 2.5A
PF2114	24	20V, 0, 20V, —2A DC
PF2440	240	19.4V, 0, 19.4V, —1.5A DC
PF2228	240	30V—0.6A
PF1763	240	30V tapped at 25V, 20V—2A
PF2876	240	32V at 1A 32V at 1A
PF2004	240	35V, 0 35V,—750mA
PF114	240	50V—2.3A tapped at 24V—4.8A tapped 12V—9.6A
PF115	240	50V tapped at 30V, 25V, 15V—5A
PF2235	240	150V, 125V, 100V, 75V, 50V, 25V, or 75V 0 75V at 30mA 6.3—1.2A

FILAMENT TRANSFORMERS

Type No.	Prim.	Secondary Rating
PF1290	240	6.3V—0.6A insulated for 2500V working
PF2315	240	6.3V—1.2A
PF1728	240	6.3V—1.1A, 6.3V—1.1A or 12.6V—1.1A C.T. if series connected or 6.3V—2.2A parallel windings.
PF1630	240	5.3V—2.25A C.T.
PF476	240	6.3V—3A C.T.
PF162	240	6.3V—3A, 6.3V—3A C.T. or 12.6A—3A C.T. if series connected.
PF2565	240	12.6V—0.5A 12.6V—0.5A or 25V—0.5A if series connected or 12.6V—1A parallel windings.
PF2851	240	12.6V C.T. at 0.15A.

FERGUSON TRANSFORMERS PTY. LTD.

331 HIGH STREET, CHATSWOOD, N.S.W. • POST OFFICE BOX 301, CHATSWOOD. TELEPHONE: 40-0261 (8 LINES).
• TELEGRAMS: "FERTRAN."

178 BOUVERIE ST., CARLTON, VICTORIA. TELEPHONE 34-5814.

INTERSTATE AGENTS:

TASMANIA: Associated Agencies Pty. Ltd., 25 Barrack Street, Hobart, 7000, Phone: 2-1843.
A.C.T.: Erroll Nazer Pty. Ltd., 84 Barrier Street, Fyshwick, 2600, Phone: 9-0325.
QUEENSLAND: Keith Percy and Co. Pty. Ltd., Waterloo Street, Newstead, 4006, Phone: 51-5461.
WESTERN AUSTRALIA: Athol M. Hill, 613 Wellington Street, Perth, 6000, Phone 21-7861.
SOUTH AUSTRALIA: Wm. M. Matthew Pty. Ltd., 12 French Street, Adelaide, 5000, Phone: 23-6202.

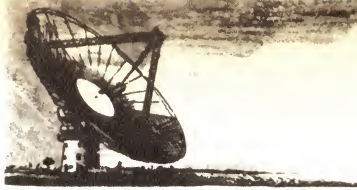

enough to clear the air. If too large, they fall through the fog before gathering sufficient water. The most effective grain size has not yet been determined.

The other technique under study is sponsored by the Air Transport Association, an organisation of U.S. airlines. The project uses an as yet undisclosed substance manufactured by the Dow Chemical Co. of Midland, Michigan. The substance, dispensed into fog from either aircraft or ground equipment, is a type of polyelectrolyte which creates electric charges in fog droplets causing them to combine into larger ones.

Plastic houses

Two experimental houses designed by the plastics laboratory of the Royal Dutch-Shell Group at Delft in the Netherlands are being put to intensive tests. One is being lived in and the tenant is sending periodical reports to Delft. The other is in use by the laboratory for tests on sound and heat insulation as well as general acceptability.

Essentially, the houses are built around a steel frame with exterior sandwich wall panels made from asbestos cement with a urethane core, finished with a coloured sand incorporating an epoxy adhesive. A high proportion of synthetics goes into the rest of the structure. Plastics and resins are used for insulation, floor coverings, pipes and protective finishes. Only the service areas—kitchen and bathroom—are fixed on the ground plan. The rest of the layout can be altered at will. The same elements are to be used in the construction of a new multi-storey laboratory at Delft.

Elements for atomic power



Pictured here are fuel elements in the fuel storage racks of the S.G.H.W. (Steam Generating Heavy Water) reactor of the U.K. Atomic Energy Commission's new powerstation at Winfrith, Dorset. The powerstation was officially opened recently by the Duke of Edinburgh. It is in fuel elements similar to this that pellets of the type shown on this month's front cover are used. The Winfrith station is capable of meeting all the power requirements of a medium-sized city. The new type of reactor used can be tailor made to the needs of small or large towns, and the stringent safety factors incorporated into the design enable it to be erected in built-up areas.

Electronic telephone system

What is claimed to be Britain's first electronic private telephone system has recently been brought into operation at the headquarters of British Petroleum at Moorfields, London. The system, manufactured by Plessey Telecommunications Group, is a 5500 line private automatic branch exchange (PABX) with 6000 telephones provided with push-button keys in place of dials. In addition it has facilities for incoming calls to be dialled direct to an extension, a separate internal telephone network, and 50 private wires to branches throughout the country.

The exchange is provided with nine operator positions, three enquiry positions and three supervisory positions. Lamps indicate busy lines and the number of waiting calls. Special facilities indicate executive calls.

A unique feature of this system is the magnetic drum memory. Up to 3000 of BP's most frequently required numbers (up to 17 digits) can be stored on the drum, each being allocated a 4-digit code. An extension user requiring one of the stored numbers keys the appropriate code. The equipment causes the digit train of the stored number to be pulsed out automatically routing the user to the required destination.

Carrier equipment for P.M.G.'s Dept.

The P.M.G.'s Department has awarded a contract valued at \$2.25 million to Philips Telecommunications of Australia Ltd. for the supply of channel modem and carrier supply equipment during the financial year 1968/69. Known as Type 66, the equipment will increase trunk channels and give wider application of direct dialling of long distance numbers.

A high-density form of the equipment allows 120 channels to be mounted on a special rack, while a version for mounting on general purpose racks can be used where only 12 to 60 channels are required. Channel units, common to both constructions, are plugged into sub-racks which in turn are plugged into the rack. The fully-transistorised channel units are hermetically sealed to give higher reliability and reduced maintenance. Maintenance is reduced to the simple operation of locating a faulty unit, plugging in a replacement, and returning the faulty unit to the factory for repair.

British metrication

The Council of the Confederation of British Industry has recommended to the Standing Joint Committee on Metrication that the British Government should make a clear statement of policy in favour of metrication and for the establishment of a Metrication Board. Such a body should be responsible for the co-ordination of research and planning for the change to the metric system and should have powers and duties similar to those of the Decimal Currency Board. Other recommendations are that there should be a clear timetable for the change in emphasis in teaching, and that the change-over in the retail trades should be in step with that in industry between 1970 and 1975.

The likely year of entry from which metric units will be introduced into teaching and examinations conducted by British universities, colleges and institutes was discussed at a recent conference organised by a joint committee of the Royal Society and the Council of Engineering Institutions. The conference made a strong recommendation that metric units be increasingly used in teaching, and in particular that numerical data appearing in examinations set to those students in science, engineering of technology who first enter courses of higher education in universities and colleges in 1969 or later, be quoted in SI (international standard) units.

The Royal Society Conference of Editors, after considering the role that scientific journals can play in promoting the general adoption of the metric system in the U.K., recently made two recommendations. Firstly, that the system of units known as SI should be adopted in all scientific and technical journals. Secondly, that, in order to keep to a minimum the difficulties that will inevitably arise during the transition period, the change-over should be effected as quickly as possible. The Royal Society has published a pamphlet giving the basic SI units, supplementary and derived units, fractions and multiples, and a selection of conversion factors for the guidance of editors and authors.

Doppler navigation

A new Marconi Doppler navigation system, type AD510, for helicopters is now undergoing development flying. Designed primarily for military applications, it uses microcircuits and a fixed aerial



One of the operator's consoles of BP's electronic private telephone exchange.



Changes for Mobile Radiotelephone Services

Licensees of V.H.F. land and harbour mobile radiotelephone services, now operating in 30 kc/s channelling areas, are advised that if they have not already installed equipment which meets the Australian Post Office 30 kc/s channelling specification, they must do so before 30 June, 1969.

This requirement has been brought about by the growing demand for V.H.F. mobile radiotelephone services in city areas which is taxing the existing channels available. The change to 30 kc/s channelling will enable more radiotelephone services to be brought into operation as they are required.

However, some changes to existing equipment will be necessary and the following programme for conversion, which is designed to cause the least inconvenience to all concerned, has been adopted:—

As from 30 June, 1969, licensees of V.H.F. mobile radiotelephone services operating in 30 kc/s channelling areas within the frequency bands 70-85 Mc/s and 156-174 Mc/s* will be required to make necessary changes so that:—

- (i) All base station transmitter/receivers (both amplitude and angle modulated) employed in a base station installation shall be of a type complying with the relative Post Office specification and approved for 30 kc/s operation and shall be operated in accordance with the terms of that specification.
- (ii) All angle modulated mobile transmitters shall be adjusted to function with a maximum deviation of ± 5 kc/s.

* This excludes the International Maritime Mobile V.H.F. Radiotelephone and the existing Australian Post Office Subscriber Services.

Early conversion will assist manufacturers in meeting delivery dates for equipment.

**FURTHER DETAILS MAY BE OBTAINED FROM THE SUPERINTENDENT
RADIO BRANCH, G.P.O., IN YOUR CAPITAL CITY.**

AUSTRALIAN POST OFFICE

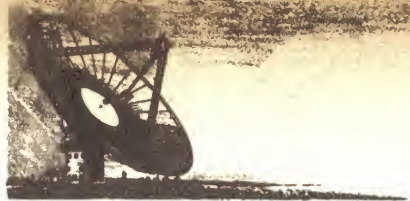

system for increased reliability, and is said to be one of the most compact and accurate navigation systems ever designed for this type of aircraft. The equipment will measure the three component velocities of a helicopter—forward, sideways, and vertically—making it possible to provide pilots with an accurate navigational aid completely independent of ground-based aids.

Still in the development phase is a derivative of this equipment, type AD520, designed for fixed wing aircraft capable of travelling at supersonic speeds. This also employs a fixed aerial and micro-circuits and will be particularly suitable for small aircraft in which it is difficult to accommodate existing equipment.

Helicopter radar

A new cross-beam radar system for helicopters, under development by Lockheed Electronics Co. of the U.S.A., has already been demonstrated in flight tests. It combines the vertical beam of a rotor-blade aerial with the horizontal coverage of a vertical aerial mounted on the nose of the helicopter. Thus the system provides unimpeded 360 deg. vision and, for a helicopter, the first look at the third dimension—elevation. Lockheed engineers believe it opens the way for a truly multi-function radar for helicopters.

Rocket motor testing

A ball-shaped steel tank designed as an ocean depth simulator is now being used by Lockheed Propulsion Co. of the U.S.A. to test fire tiny solid rocket motors in a simulated vacuum equivalent to an altitude of 150,000 feet. The 14ft diameter tank was built more than three years ago with a pressure capacity matching the 2600psi environment of mile-deep ocean depths. It was used to test an emergency surfacing system for submarines until it was mothballed when the program ended.

Engineers at Lockheed converted the ocean system chamber to vacuum simula-



During their Australian tour, six members of an Indonesian parliamentary delegation visited the A.W.A. works at North Ryde, N.S.W. An engineer, Mr F. Holloway, explains to the visitors the operation of communications receivers made by the company. Major-General Dr Sjarij Thajeb, Deputy-Speaker of the Indonesian Parliament and leader, of the delegation, is fourth from the left (in foreground).

tion to give a pressure of only .02 ounce per square inch. The conversion reduced motor test costs nearly eightfold to about \$US350 per rocket. This is expected to save the U.S. Government more than \$1-million in the first year of operation.

Translator station

The Postmaster-General has approved the establishment of a national television translator station to serve Gowrie Park, a construction township of the Tasmanian Hydro-Electric Commission. The station, to be provided as soon as practicable, will take its programs on relay from the national station at Launceston and will have a power output of one watt. A commercial translator station is already serving the area.

National TV station

The Australian Broadcasting Control Board has recommended the erection of a national television transmitter some six miles north-east of Geraldton, Western Australia. The transmitter will have a power of 10KW and serve approximately 17,000 people within a radius of 40 miles from the transmitter.

New broadcasting station

The National broadcasting station, 6PH, at Port Hedland, W.A., was officially opened by the Postmaster-General on February 26, 1968. It relays programs received from a parent station over a high-quality land line. The station operates on 2000 watts and uses directional aerials to prevent interference with other stations using the same frequency, 600KHz. An excellent service is available as far afield as Roebourne, Dampier and Mount Goldsworthy.

Combating oil waste

Tests in Sweden have shown that bark from ordinary pine can be used to combat oil discharges from ships and industries into the sea or other water courses. Experiments conducted by the Korsnas-Marma pulp and paper company at Gavle showed that powdered bark or pieces of bark stuffed "sausage-style" into booms of nylon net rapidly absorbed oil in water. The saturated bark powder and booms may then be used as fuel. The basic idea has been developed and refined during a series of tests over the past four years. Production of bark powder and "sausage" booms has already started with the opening of a new factory. ■

ROGERS CADET Mark Three



CHASSIS MODEL \$136.00

CASE MODEL \$150.00

The CADET III offers remarkable value for money and has become firmly established as the most popular medium-priced stereo amplifier on the British high-fidelity market. It combines versatile performance with attractive styling and permits the assembly of a complete home stereo system at a new low price.

TECHNICAL: Power Output: 10 plus 10 watts (sine wave), 12.5 watts (music power).

Harmonic Distortion: 5 watts .25 per cent at 1kc/s. 10 watts .8 per cent at 1 kc/s.

Output Impedance: 3-5 and 12-16 ohms. Operating voltage: 110-122-220-240 V.

Input Sensitivity: Radio: 100 mV (470 K). Tape Replay: 600 mV.

Disc (Magnetic): 3.8 mV (68 K); (Crystal/Ceramic); 65 mV (2 meg-ohms).

Tape Record Output: 600 mV. (External load not less than 100 K.)

High Pass Filter: 60 c/s 10 dB per octave. Low Pass Filter: 6.5 kc/s 10 dB per octave.

Cross-talk: 42 dB 1,000 c/s. 26 dB 10,000 c/s. Balance Control: 9 dB range.

Valves: 4 x ECL86. 2 x BY114 (Amplifier). 3 x low noise ECC807 (Control Unit).

Dimensions: 10in x 6½in x 4in (Amplifier). 10½in x 4½in x 4½in (Control Unit). 11½in x 4½in (Front Panel). 11½in x 11in x 5½in (Case Model).

Weight: 10lb. (Amplifier); 4lb (Control Unit); 19lb (Case Model).

(Supplied with Installation and Operation Instructions and all necessary connectors.)

For further details please contact:

**UNITED RADIO DISTRIBUTORS
PTY. LTD.**

Confidential Terms can be arranged

SHOP 32, ASH STREET,
ANGEL ARCADE, SYDNEY

Telephones: 28-3718, 28-3926

This year, our two travellers are really going places.

Our travelling portables are a big success.

Since we announced LM1619 and CD 1642 last year, they've been taken all over the world.

But we're not surprised. They can do so much. And they're so easy to take.

Look at LM 1619. It's a four-digit a.c./d.c. meter with fully

floating input, its own internal Weston cell for calibration, and a frequency range from 40 Hz to 10 KHz. Its accuracy is 0.2% on a.c. and 0.1% on d.c.

Yet it's rugged and compact, weighs only 11 lbs. and fits into a brief-case.

Or look at CD 1642. It's not often you'll see a portable oscilloscope with lab standard performance. With a trace this clear.

Its bandwidth is better than 15 MHz at 10 mV/cm. It weighs only 22 lbs. And plugs into any power supply from 100 to 130 V a.c. or from 200 to 260 V d.c., 44 to 440 Hz.

But you're not stuck with the mains. You can run CD 1642 from its own battery. Or from any

12-24 V d.c. supply—a car battery maybe.

There's no doubt about it. Both LM 1619 and CD 1642 are true portables. You can take them anywhere and they won't mind a bit.

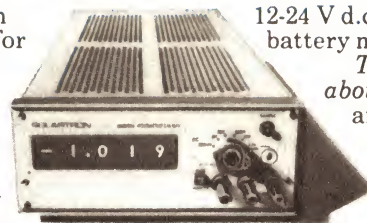

So drop us a line. Let us tell you more.

SOLARTRON

10445N

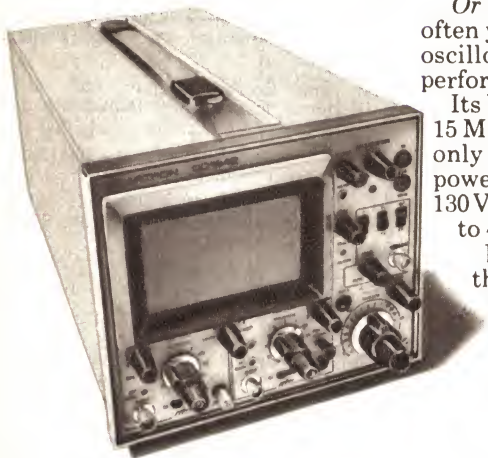

SOLARTRON, 112 High Street, Kew, Victoria, 3101. P.O. Box 138, Phone 869535. N.S.W. P.O. Box 297, Brookvale, 2100. Phone 61 6841.
A member of the Schlumberger Group.

DESIGNING A WIDE-BAND AM TUNER

Recently we described a simple solid-state broadcast tuner, using the new ceramic filters. We mentioned that we were working on a wide-band tuner, to meet the need for high quality reception of local broadcast stations. Development is now well advanced and the following article discusses the requirements of such a tuner and the problems which have had to be solved.

by Ian Pogson

The problems of obtaining high quality reception from an amplitude-modulated (AM) medium-wave broadcast station will be well known to many readers but we should perhaps re-state them for the sake of those who have not had occasion to give the matter much thought.

Some of the problems arise from the crowded nature of the frequency spectrum in which these stations have to operate. Others arise from the economics of receiver design.

In Australia, so many AM broadcast stations have had to be accommodated in the allocated band space, that none is separated from stations on adjacent frequencies by more than 10KHz.

An immediate result is that, in certain circumstances, signals from adjacent stations can heterodyne in a receiver tuned to one of them, to produce a 10KHz "beat" note. This is well within the audio pass band of a good amplifier and loudspeaker and may be heard by the listener as a continuous and annoying high-pitched whistle.

Again, if the stations are modulating with the full range of audible frequencies, the sidebands of each, spreading outwards from the carrier by an amount equal to the modulating frequencies, must overlap. This can produce a twittering kind of interference which goes by the rather graphic name: "monkey chatter."

The broadcasting authorities have done what they can to minimise 10KHz whistles and monkey chatter by seeing to it that stations adjacent in frequency are isolated geographically; by maintaining strict supervision of radiated power, and by requiring certain stations to use directional aerial systems. It is also recognised practice to restrict modulation of the carrier by frequencies higher than 10KHz. Despite all this, the problems remain in varying degrees, particularly at night, when distant stations increase in strength sufficiently to make their presence felt.

At the other end of the system, receivers must have sufficient selectivity to separate the wanted signal from the unwanted ones. However, at the level of economy and complexity considered appropriate for domestic receivers, the tuned circuits, in rejecting adjacent or other strong carriers, also substantially reject most of the wanted side-

bands beyond about 4KHz. As a result, receivers impose their own limitation on the higher audio frequencies, much more significant than that imposed at the transmitters.

Last but not least, the medium-wave AM system is inherently liable to noise from static due to atmospheric disturbances and to noise from faulty electrical appliances and power lines.

Such considerations strengthen the case for the system of FM broadcasting on much higher frequencies, which operates in many countries, as an alternative or parallel service. It provides scope for a greater number of transmitters, has no built-in limitation on audio response and is far more proof against atmospheric and electrical interference. In fact, an "experimental" FM service was operating in Australia, some years ago, within the internationally recognised VHF FM band, until the frequencies were re-allocated to other services, including television.

There are vague plans to set up an FM system at UHF in Australia but whether or when this will become a reality is completely a matter of speculation. The Government has yet to be convinced, apparently, that the average listener finds the present AM system so inadequate, and that the economic and technological involvements of an additional system are justified.

In the meantime, the AM position is not as completely unrewarding as we might seem to have painted it.

By paying more than the usual attention to the tuning circuits, it is possible to receive substantially all the frequencies which the stations transmit—and the difference between a tuner responsive to 9KHz or so, compared with one which cuts off at half the frequency has to be heard to be believed!

Furthermore, a suitable filter will remove the 10KHz whistle completely.

Monkey chatter may affect some stations in some locations on some nights but our own recent observations in what is admittedly a fairly good receiving location, revealed little real trouble on this score.

Nor did we experience much trouble with either atmospheric or electrical noise due, no doubt, to the power which our local stations now radiate.

In short, if experience with an ordinary radio suggests that you can receive good, clean signals in your area—and a great many can—and if you are interested in receiving better quality sound, then a modern wide-band AM tuner is well worth considering.

Having examined the case for wide frequency band reception of AM broadcasting stations, let us draw up a brief specification and see what can be done about meeting it:

1. Full response to modulation frequencies to the 10KHz limit.
2. Provision to increase selectivity, to enable more distant stations to be received, under less than optimum conditions.
3. The tuner must introduce as little intrinsic noise and distortion as possible.
4. Sensitivity should be ample for all likely locations.
5. Cross-modulation should be kept to a minimum.
6. Mechanically and electrically, it

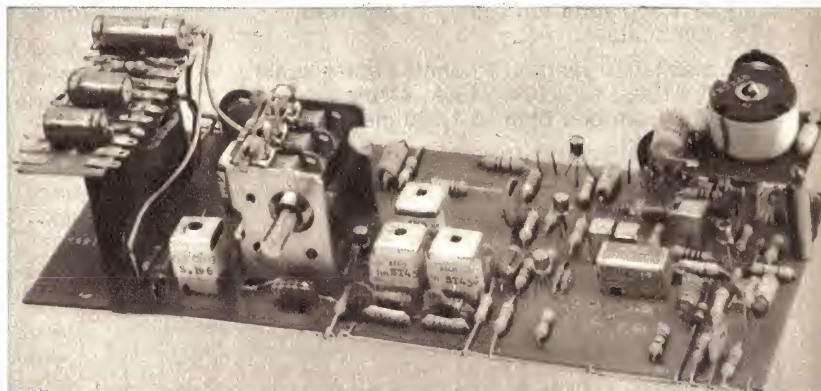

This picture of our original prototype gives some idea of the appearance of the model which will be produced on a printed board. The whistle filter is a separate assembly at the top right corner. The power supply at the left has been modified such that the transformer will be mounted separately from the printed board.

INTRODUCING the HEATH IM-25

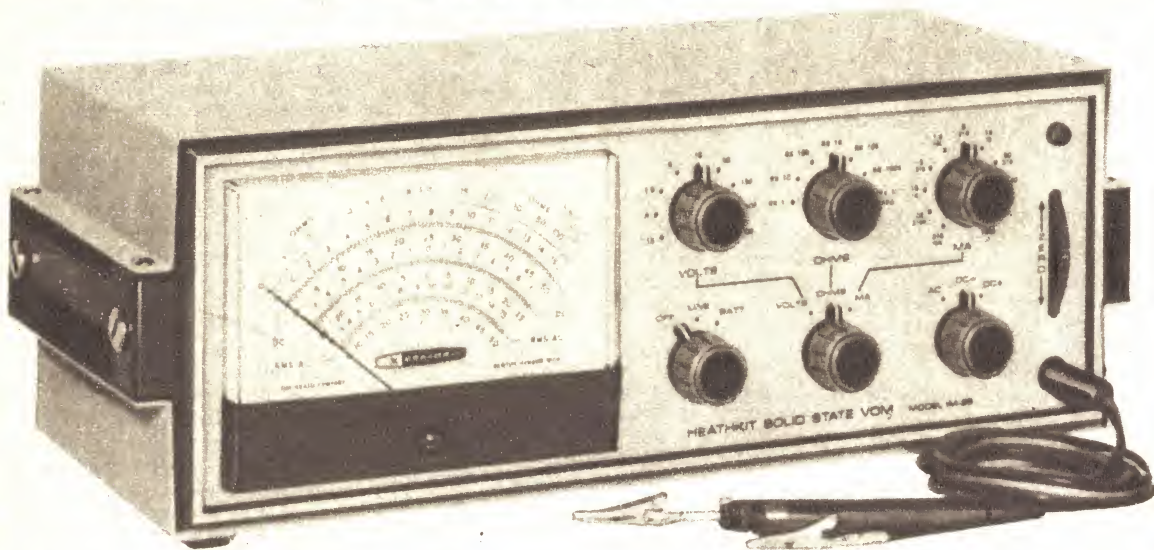

a high value, high performance, solid state V.O.M.
which can be line or battery operated

LOOK AT THESE "VALUE PLUS" FEATURES:

- 13 Silicon transistors plus 2 field-effect transistors.
- 11 megohm input impedance on DC.
- 10 megohm input impedance on AC.
- 9 DC voltage ranges from 150 millivolts full scale to 1,500 volts full scale . . . accuracy $\pm 3\%$ full scale.
- 9 AC voltage ranges from 150 millivolts full scale to 1,500 volts full scale . . . accuracy $\pm 5\%$ full scale.
- 7 resistance ranges, 10 ohms centre scale x1, x10, x100, x1k, x10k, x100k, x1 meg . . . measures from one ohm to 1,000 megohms.
- 11 current ranges from $15\mu\text{A}$ full scale to 1.5A full scale.
- 1% precision resistors.
- Superior accuracy on current measurements . . . $\pm 4\%$ on DC . . . $\pm 5\%$ on AC.
- AC response to 100 kHz.
- 6", $200\mu\text{A}$ meter with centre zero scales for positive and negative voltage measurements without switching.
- Separate switch for each function eliminates constant changing.
- Ten-turn thumbwheel zero adjustment for precision settings.
- Built-in 120/240 VAC, 50-60 Hz power supply plus in-cabinet holders for battery supply during portable operation.
- New Heath instrument styling with "unitized" construction and low profile appearance; color styled in handsome beige and black.

For full details contact the INSTRUMENTATION SPECIALISTS . . .



WARBURTON FRANKI

ADELAIDE: 23-3233; BRISBANE: 51-5121;
HOBART: 2-1841; LAUNCESTON: 2-1218; MEL-
BOURNE: 69-0151; MOUNT GAMBIER: 2-3841;
NEWCASTLE WEST: 61-4077; PERTH: 8-4131;
SYDNEY: 29-1111; WOLLONGONG: 2-5444.

WF140/68

must be compatible with existing audio systems.

7. Tuning facilities must be easy and accurate.
8. An effective AGC system to keep the volume level as near to constant as possible, under all conditions.
9. Solid state devices to be used throughout.
10. Integrated power supply to be provided.

Many designs in the past have provided for at least partial wide-band facilities. Initially, the TRF principle was popular, advantage being taken of the fact that the selectivity which the system offered, was inherently limited. However, although it sometimes gave a wider response than the ordinary superheterodyne, it was still far from optimum.

In our June, 1948, issue, a system was introduced for 455KHz superhet tuners whereby, for wide-band reception, one of the IF transformers was switched out of circuit and replaced by a non-selective resistance-capacitance coupling network. It was subsequently suggested that where practicable, the remaining transformer could be resistively loaded to reduce still further the selectivity and sideband cutting.

Quite a serious attempt to obtain a wider band width was made in August, 1952, and in subsequent related articles. This design was also for a superheterodyne tuner, but it started off with a band-pass tuning arrangement between the aerial and the frequency changer. The incoming signal was converted to an IF of 1.9MHz, chosen because the natural bandpass would be wider than that of a 455KHz IF channel. Published curves showed that the audio frequency response was carried out to 7KHz before roll-off.

Mention of past wide-band tuners would not be complete without reference to the "Basic Synchrodyne Tuner," which appeared in September, 1963. This unit possibly had the widest frequency range of all the tuners which we have described. However, as was pointed out in the descriptive article, the Synchrodyne principal poses some difficult problems and it has not enjoyed much popularity in consequence.

The writer has devoted quite a lot of thought to the ways in which the problems of a wide-band AM tuner may be resolved. Fundamental is the need to provide a pass-band which is twice the width of the actual audio frequency range required. In our case, this amounts to a nominal 20KHz. Furthermore, the top of this pass band should be as flat as possible, with steep sides or "skirts." This ideal gives the required frequency response and at the same time, ensures rejection of other strong stations in the listening area.

Assuming a tuner design using the superheterodyne principle, with an IF of 455KHz, we set to work to see if resonant L/C circuits could be adjusted in some way to give the desired 20-KHz band width. Investigations showed that this could be done without too much difficulty: Extra coupling between the tuned circuits and selected damping gave the needed band width but resulted in a skirt selectivity which left much to be desired. This was for

one pair of tuned circuits only. By cascading sufficient tuned circuits, we found the skirt selectivity could be made adequate for all practical purposes.

Having disposed tentatively of the selectivity problem in the IF stages, a similar but more difficult problem remained to be solved: Tuned circuits at signal frequency also will cut the upper modulation frequencies to some

circuit with an RF amplifier valve or transistor. In addition to giving the needed isolation, the added stage becomes available for AVC control.

It is still necessary, of course, to couple the aerial into the receiver, perhaps the most obvious method being to feed it directly, via a blocking capacitor, into the grid or base of the RF amplifier. In so doing, a further problem may be encountered: Because

This simplified circuit shows how each pair of switching diodes is so arranged that one diode is forward biased, while the other is reverse biased. This selects the circuit and retains short leads.

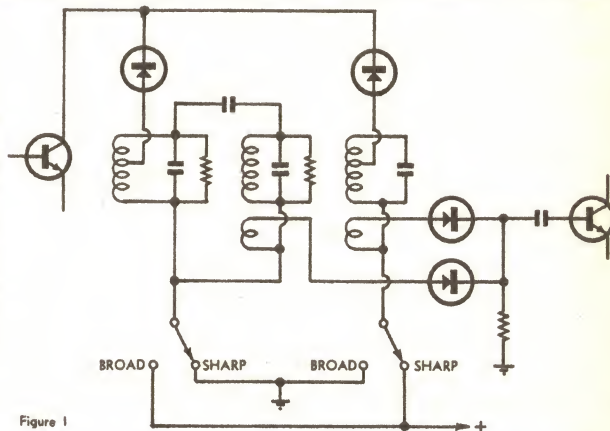

Figure 1

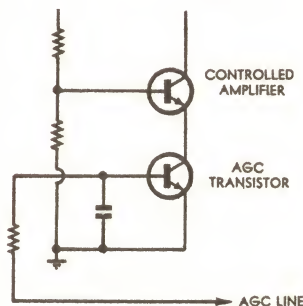

Figure 2

The "AGC transistor" functions as a variable resistor, giving rise to negative current feedback in the emitter of the amplifier transistor.

extent unless suitable precautions are taken, the effect being greatest at the low frequency end of the dial.

This problem, too, can be solved by overcoupling two tuned circuits. However, as the L/C ratio varies across the tuning range, so will the degree of overcoupling, unless counter measures are taken. An accepted approach is to use bottom coupling between the two circuits for the low-frequency end, in combination with a suitable amount of top coupling for the high-frequency end. Even with such provision, it is difficult to achieve the ideal, but the values can be adjusted such that the change is not great and the effect on overall results is insignificant.

This band-pass tuner must be located in front of the frequency changer stage and one would naturally expect that the aerial would be connected to the input of the band-pass circuits. Indeed, this is often done, but, for the perfectionist, it is open to a particular criticism: Variations in aerials can influence the tuned circuits, with consequent changes in the pass-band shape.

This problem can be obviated by isolating the aerial from the first tuned

there are no tuned circuits to discriminate between wanted and unwanted signals, cross-modulation can become a problem where very strong signals have to be dealt with. This particular problem can be alleviated by placing some form of attenuator between the aerial and the grid or base.

Quite elaborate attenuators are sometimes provided in the aerial circuit of communications receivers, to avoid the consequences of very strong signals, but something much simpler would normally suffice for the present application. A suitable attenuator for our tuner would possibly be a small variable capacitor or, better still, a potentiometer. Either can be set to give best results for the particular location.

Having envisaged provision of a 20KHz bandwidth for high-quality listening, the question arises of providing greater selectivity to receive stations which are not normally satisfactory under wide band conditions.

There are a number of possible approaches to this problem. One is to provide means of varying the bandwidth of the transformers in the IF strip. This can be done, but it usually requires special IF transformers for the purpose—a situation we prefer to avoid. Our suggestion is to use entirely separate IF transformers for the sharp and broad functions.

Whatever the method used, there remains the problem of switching from one mode to the other.

Switching can be nasty, in that it can involve active circuits with long leads. Even if stray coupling does not produce instability, it can seriously modify bandpass shape.

During a discussion on possible approaches to the overall project, one very practical suggestion was made for switching from broad to sharp reception. It involved using two separate IF strips, one broad and the other sharp, the output of the converter stage being split to feed each channel. The only switching involved would be to pick off the audio from the relevant detector of the strip to be used. In

ADCOLA

"M" SERIES PRECISION SOLDERING & DE-SOLDERING TOOLS

"The soldered joint is the link between components in the most scientifically designed and developed apparatus the world has ever known. One faulty joint can upset the functioning of the apparatus."

"The first important decision in Radio or Electronics is the careful selection of a Precision Soldering Tool."



M20 1 OZ. 1/8" DIA. TIP:

FOUR "TRICLAD" TIP SIZES
MICRO MINIATURE ELECTRONICS
6 volt, 12 volt, 24 volt, 32 volt, AC/DC



M64 3½ OZS. 3/16" DIA. TIP:

FOUR "TRICLAD" TIP SIZES
RADIO AND TV ASSEMBLY AND
SERVICING
230-250 volt and all lower voltage
ranges AC/DC



M207 4 OZS. 1/4" DIA. TIP:

TWELVE "TRICLAD" TIP SIZES
RADIO AND TV SOLDERING AND DE-
SOLDERING
230-250 volt and all lower voltage
ranges AC/DC

PRECISION MADE
THOROUGHLY TESTED
ACCURATELY CALIBRATED
EASILY APPLIED
EFFICIENT AND RELIABLE
CORRECT TIP TEMPERATURE
RIGHT TIP SIZE AND SHAPE
LIGHT WEIGHT
FINE BALANCE
FINGERTIP GRIP
SLIM BARREL
CONSTANT OPERATION
MAINS VOLTAGE APPROVED
AVAILABLE ALL VOLT RANGES
NO TRANSFORMER NECESSARY
STANDARD IN R.A.N.
STANDARD IN ARMY
STANDARD IN R.A.A.F.
STANDARD IN P.M.G.
STANDARD IN COMPUTER FIRMS
STANDARD IN SPACE TRACKING
AUSTRALIAN MADE
SERVICE IN ALL STATES
QUALITY GUARANTEED

ADCOLA

Available from all Principal Radio and Electrical Components Suppliers

Further information is available from:

N.S.W.: Adcola Products Pty. Ltd., 17 Burwood Rd., Burwood, N.S.W. 747-1606

S.A.: F. R. Mayfield Pty. Ltd., 11 Halifax Street, Adelaide. Tel.: 8-4131.

QLD.: T. H. Martin Pty. Ltd., 56-74 Edward Street, Brisbane. Tel.: 2-0555.

W.A.: Everett Agency Pty. Ltd., 17 Northwood St., West Leederville. 6007. Tel. 8-4137

ADCOLA PRODUCTS PTY. LIMITED, 12 CHURCHILL STREET, MONT ALBERT 3127

MELBOURNE. Tel.: 88-4351.

addition, the sharp strip would serve all the time as the source for the AGC line and tuning indicator.

While such a system offers certain advantages, it would obviously involve the duplication of a number of components—a point which could not be overlooked in a unit which would be using quite a lot of components anyway. Another problem involved the actual splitting circuitry, which threat-

this stage, compared with conventional IF transformers. On the credit side, these filters, in addition to having a wide pass-band, have steep-sided skirts. This is a decided advantage when there is difficulty in dealing with nearby channel interference under wide-band conditions. We have seen fit to use one such filter and more will be said on this subject at a later date.

Moving further along the circuit,

The task of getting an effective AGC system for transistor receivers is a challenging one, though the best systems are quite effective. These generally make use of the signal-derived DC voltage at the detector, which is fed back to the controlled stages, such that it varies the emitter current inversely with the strength of the signal. As this system is usually not sufficient to handle the strongest signals, a diode

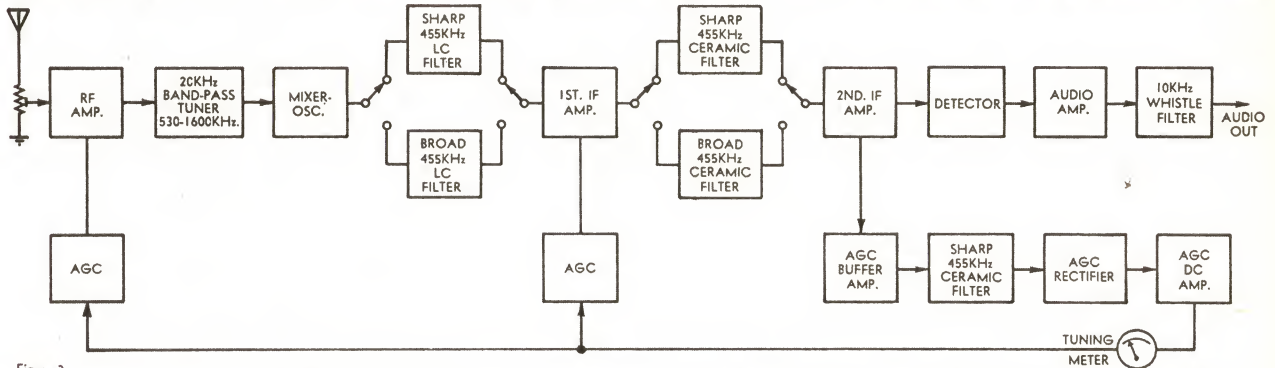
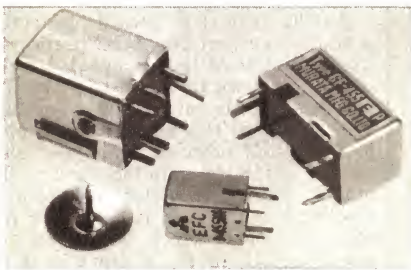

Figure 3

This complete diagram of the tuner design has been fully described in the text. While there appears to be quite a lot in it, construction has been made simple with a printed board. Alignment is also a simple matter.



This picture gives some idea of the small size of the filters used. At left is a miniature IF transformer. At right is the wide-band ceramic filter, with the sharp ceramic IF filter next to the drawing pin.

there appeared to be three general choices for a detector. A popular one for transistor use is the "class B," which is similar to the old valve "anode bend" detector. This has the advantage of giving a worthwhile amount of gain and a good level of output. However, the amount of distortion is open to question, for our purpose and we looked next to the transistor equivalent of the "infinite impedance" detector. This has attractions but, overall, did not seem to offer any more than the conventional diode detector and this is the one we settled for.

When used in transistor circuitry, the diode detector gives a low level of output, not sufficient anyway to meet the minimum nominal requirement of 250 millivolts RMS. A natural way out of this one is to add an amplifier but this requires careful thought. Under some conditions, the output of the detector could be sufficient to overload a low signal level transistor amplifier stage; moreover, and paradoxically enough, such an amplifier would give far more output than is needed. The appropriate course is to provide sufficient emitter degeneration, such that the stage will not be overloaded by the detector, yet still give enough output to drive any subsequent amplifier system.

The question of 10KHz whistles has to be faced but fortunately this can be dealt with quite easily. The "Bridged-T" filter is relatively simple and can be made to give a very sharp rejection notch at 10KHz. This is so sharp that it only starts to "dig in" just before 10KHz is reached and so no real band width is lost by its inclusion. One requirement for such a filter is that it should work from a fairly low impedance source, usually an emitter-follower. Fortunately, the low gain amplifier which we have just mentioned, has a sufficiently low output impedance for the purpose. The whistle filter is so effective that 10KHz whistles are inaudible.

is used such that it damps the tuned circuit of the first IF transformer. Overall, this is a most effective system and is the one which we used in our simple tuner described in the May issue.

Unfortunately, we are not able to use this method in our broad-band tuner, since the diode will dampen a vital tuned circuit in the broad-band position, producing an unacceptable pass band shape. We must look elsewhere for a solution.

In recent times, some high grade communications receivers have used a radically different approach to the question of automatic gain control—that of introducing degeneration into the emitter circuit of each stage which is to be controlled. It involves introducing an unbypassed variable resistor in series with the emitter of the stages in question. Perhaps you are out in front and have guessed it by now, if you did not already know! The variable resistor is, in fact, another transistor in the emitter circuit of the transistor amplifier to be controlled. This is shown in figure 2.

Under full sensitivity conditions, the AGC transistors are forward biased such that they are fully conducting and the effective resistance is very low and

ened to be more difficult than it first appeared. Two more transistors, for isolating purposes, might have to be introduced. Without completely abandoning this idea, we had a look elsewhere.

Happily enough, a neat solution to the problem of switching tuned circuits within the confines of a single IF channel came to us at a time when we should have been asleep! By making use of germanium diodes in the active leads, to be switched and by remotely forward or reverse biasing the diodes with DC, we could select the desired band width with nothing more than a toggle switch. The principle is shown in figure 1.

Before leaving the subject of IF channels, we have had a good look at the relatively new ceramic IF filters. These come in quite a range of types and they have some decided advantages, when compared with the conventional IF transformer. They are smaller and, for the simple types, so is the price. In addition, the centre frequency is fixed on 455KHz and so they do not have to be aligned. We have used some of these units to advantage in our new tuner.

Ceramic filters are also available in wide-band types, also centred on 455KHz. Although larger than the simple ones, they are still quite small. However, the price is rather high at



printed circuits

for all electronic industries

PHOTRONIC

515 PITTWATER RD. BROOKVALE N.S.W.

phone 93 7664

NOW distributed

by

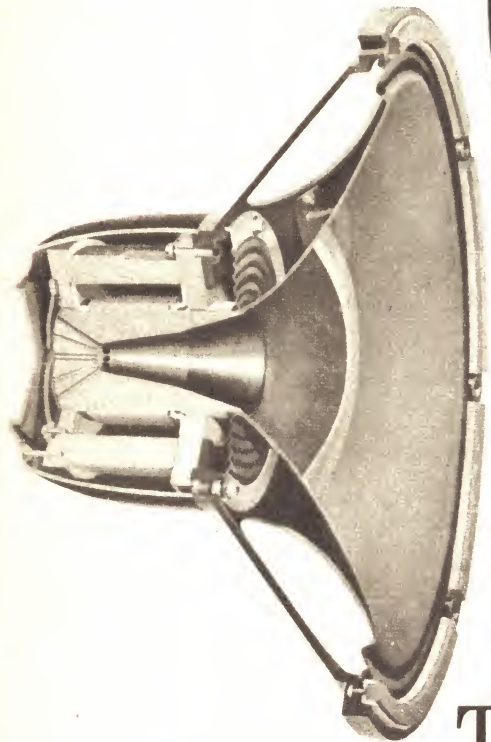

The range of world famous Tannoy

Monitor dual concentric loudspeakers.

The "Monitor" series dual concentric loudspeakers are the culmination of over 30 years' continuous research and incorporate many unique features including the revolutionary patented Tannoy magnetic shunt (possibly the greatest advance in loudspeaker magnet design over the past 10 years) giving a useful flux increase of up to 20%. This results in smoother response, better damping, improved transient response and higher efficiency.

TANNOY

Distributed through the Consumer Products Division of
AMALGAMATED WIRELESS (AUSTRALASIA) LIMITED
554 PARRAMATTA ROAD, ASHFIELD. 71 0791

167 Queen Street, Melbourne. 67 9161 • 70 Merivale Street, Brisbane. 4 1631
Cnr. Darby and King Streets, Newcastle. 2 5166 • Cnr. William and Newcastle
Streets, Perth. 28 3425-6
42 Frederick Street, Launceston. 2 1804 • 123 Murray Street, Hobart. 3 3836-7

the degeneration is negligible. As the received signal is increased in strength, the forward bias on the AGC transistors is progressively reduced and the effective resistance rises resulting in a proportional amount of emitter degeneration. Under extreme conditions of signal strength, the AGC transistor would appear almost as an open circuit but more will be said about that later.

This system of obtaining AGC is most effective, particularly in its more elaborate application to communications receivers, but, even with the simplified version which we have developed, the results leave little to be desired. The system holds the audio level almost constant over a wide range of input signal levels.

This is all very fine. However, the fact that we have introduced a broad band tuning system, presents a particular problem. How does the operator know when the tuner is set correctly, with the wanted signal in the centre of the pass band? The answer to this is found in the AGC detector and amplifier circuits.

As the first step towards generating a control current for AGC purposes, a small amount of the IF signal is picked off the collector of the last IF amplifier and fed directly into a buffer-amplifier. The output of this amplifier is coupled to the AGC detector and gate, via a narrow 455KHz ceramic filter. The output from the detector system is positive-going and is fed into the base of a transistor which is not forward biased at all, in the absence of a signal.

The detector output biases the transistor into conduction and the change in potential at the collector is used to feed the AGC line. A meter is also placed in series with the collector and the change in current is used as a means of tuning the wanted signal.

As mentioned earlier, in the narrow band reception condition, there are no problems in tuning the wanted station. In the broad band position, however, it is difficult to determine the centre of the pass-band with any accuracy. This applies particularly to unskilled operators who will be making considerable use of this type of tuner.

Although a tuning meter is fitted, it would be of little use, unless it could determine the centre of the pass-band. This explains the presence of the narrow ceramic filter between the buffer-amplifier and the detector system. The buffer-amplifier is so named because it has a dual role to perform. By adding an amplifier into the AGC loop, the system becomes more effective. Secondly, if we coupled the collector of the last IF amplifier straight into the ceramic filter, "suck-out" would result, compromising the wanted IF pass-band shape. The buffer avoids this problem.

From the foregoing, we trust that the reader has gained a fair idea of the problems in designing a wide band tuner and the general way in which they have been solved. The block diagram of figure 3 shows the overall arrangement of the functions of the system. At the time of writing, we have a preliminary prototype working in a very satisfactory manner. We hope to make a printed board and have the final model ready for the next issue.

Parameter Spreads and FET Preamplifiers

Over about the last eighteen months we have presented a number of articles, both constructional and of a more general nature, dealing with the junction field effect transistor (FET). To a large extent, we were motivated to use the FET by requests from readers, and by the advantage offered by their intrinsic high input impedance.

The particular junction FET which we featured, as readers will no doubt recall, is the 2N4360, an economy device manufactured by Fairchild. Over the past few months we have become increasingly aware of the problems involved in using the device, as it is supplied over the counter to individual readers.

Primarily, the problem is to arrange for the DC conditions of the circuit, in which the FET is to be used, to satisfy the varying requirements of devices which carry this type number. In short, production spreads make it virtually impossible to devise a biasing arrangement to cater for all samples, and still maintain the required stage gain.

While all parameters are subject to appreciable production spreads, there are two which have a profound effect on biasing and DC requirements. The first of these is I_{DSS} , the drain-source current with zero gate-source bias and a specified drain-source supply voltage.

With the 2N4360, this parameter has a spread covering a full decade in current values; the minimum specified value is 3mA, while the maximum is 30mA.

The second main parameter is V_p , the nominal pinch-off voltage. The spread in V_p for the 2N4360 is not fully specified by the manufacturer, who quotes only a nominal value of 5.5V and a maximum of 10V. However, from a consideration of the transconductance, the minimum pinch-off can be estimated as being a little below 1V. Hence, the parameter V_p also has a full decade of production variation.

For a more detailed insight into the factors and consequent problems involved with FET design, we would refer readers to the article "Factors In The Design Of An FET Voltmeter" published in the July, 1967 issue.

In the April, 1967 issue we described the Playmaster 115 amplifier; a 10 watt per channel unit stereo amplifier designed for use with high quality ceramic pickup cartridges. An FET of the type mentioned above was used in the control preamplifier in order to obtain the high input impedance necessary with crystal and ceramic pickups.

Of late, it has been brought to our attention that some difficulty has been experienced in obtaining suitable FETs for the preamplifier of the Playmaster 115. Unfortunately, there are devices which, while within the manufacturers' specified production spreads, will not operate in the circuit. Such devices are those which have an I_{DSS} of greater than about 10mA and/or a V_p of more than about 5V.

It is our intention to show, in this

article, how the difficulty can be overcome. While it is possible to arrange for all FETs to be correctly biased, in a modified circuit, it is not always possible to arrange for this circuit to provide the required gain. In short, the sacrifice is gain for bias stability. Alternatively, the FETs can be replaced by conventional transistors with little difficulty, using the existing printed circuit board.

First of all, though, one has to determine whether there is any fault in the FET stage. Such a condition can be easily diagnosed with the aid of a few voltage measurements.

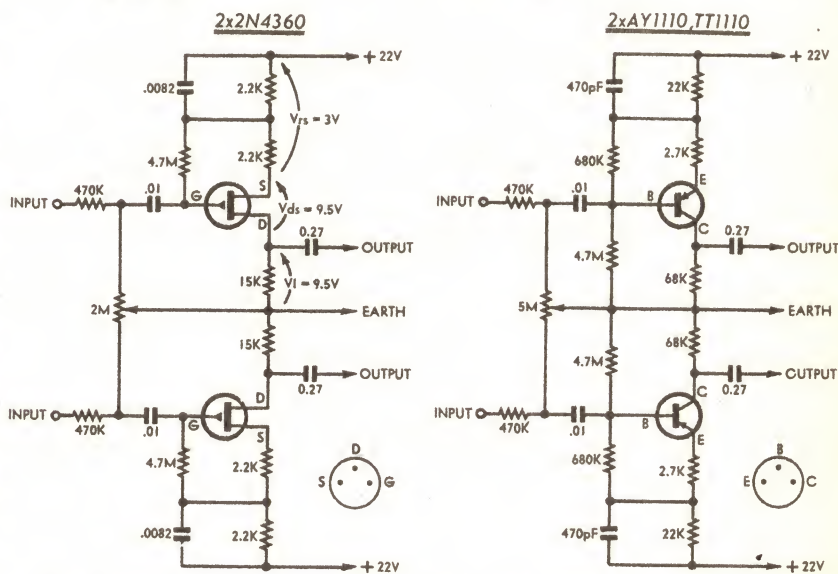

The circuit diagrams above show two high input impedance stereo preamp stages for use with crystal/ceramic pickups. The configuration using conventional transistors, shown at right, is designed to replace the FET arrangement, left.

The section of the original circuit containing the FET has been reproduced to aid in the discussion. In the original circuit, the optimum value of the drain-source current (I_{DS}) is about 0.6mA with the drain-source voltage (V_{DS}) about 9.5V.

The greatest variation, from optimum, which can be tolerated is for I_{DS} to be as high as 1mA and V_{DS} , consequently, to be reduced to about 2V. If V_{DS} is any lower than this, distortion of the signal is likely to occur. Hence, if upon measurement V_{DS} is less than 2V a modification may be necessary.

The exact voltage at which distortion will occur will depend, in the main, on the output voltage of the particular pickup used. Consequently some latitude in the 2V minimum V_{DS}

may be allowable, as dictated by the pickup.

Given that the FET circuit is not functioning correctly, there are two possible corrective measures which can be adopted. Either the FET circuit may be modified with an attendant loss of gain, or it may be replaced by the alternative circuit shown.

The modification consists of simply reducing the value of the 15K drain load resistor until the drain-source voltage (V_{DS}) is about 2V. However, reduction of the load will, at the same time, reduce the gain of the stage, which should be about three times. In addition, if only one channel is modified the reduced gain will cause stereo unbalance.

Provided that the reduction of the load resistor, and hence the gain, is small, the unbalance may be adjusted with the stereo balance control. But, in the case of more drastic gain reduction, we suggest that the other channel be modified similarly,

making the load resistors the same value.

Reduction of the second FET's load resistor will mean that the voltage developed across it will be reduced also. Consequently, steps must be taken to ensure that the voltage across the load resistor does not fall below a similar minimum of 2V. In other words, taking the two opposite extremes, the drain source-voltage of the first FET could be as low as 2V, while the second, after equalising load resistors, could be as high as 17V.

The disadvantage in reducing the value of the load resistors is that it produces a corresponding reduction in the stage gain, as we mentioned previously. Hence, a decision has to be made as to whether there is sufficient

(Continued on page 157)

**When the top 17
semi-conductor
manufacturers in
the world use the
Planar* process
under licence to
Fairchild...**

**doesn't that suggest
something?**

**Planar is a Fairchild-patented process*

Like Fairchild are the world
leaders in the technology and
manufacture of silicon semi-
conductor devices?

Right!



FAIRCHILD

AUSTRALIA PTY. LTD.

420 Mt. Dandenong Road, Croydon, Vic., 3136
P.O. Box 151, Croydon. Telephone: 723 4131
Cables: Fairchild Melbourne

If you keep on making small improvements
in the design of a valve

IT MAKES A BIG IMPROVEMENT TO THE WAY IT WORKS



Take our 6AU6, for example; it has been manufactured by A.W.V. for over 20 years. And our 1948 valve looks much the same as our 1968 one. But constant technological improvement has improved the quality, efficiency and operating life.

Here are some of the improvements—

Heater—Improved insulating material and tungsten processing greatly reduce hum and increase operating life.

Grids—Special chemical treatment of Grid 1 inhibits

oxide formation—considerably lengthens life.

Anode—Now made from gas-free aluminium clad iron instead of carbonised steel, thus increasing the life of the valve.

Mica and Glass Bulbs—The use of thicker mica and closer tolerance bulbs has considerably improved microphony.

Small changes? A.W.V. valves perform better and live longer because of them.



AMALGAMATED WIRELESS VALVE COMPANY PTY. LTD.
SYDNEY • MELBOURNE • BRISBANE • ADELAIDE

Projection Lamp Protector



Here is a unit that should prove a boon to people who operate projectors and other equipment using high wattage lamps. It will remove the risk of failure at switch-on and increase the life expectancy of the lamps.

By Leo Simpson

Most people who operate film projectors are familiar with the problem of lamp failure at the moment of switch-on. It is an irritating situation to say the least. There is an annoying delay while the lamp is changed — assuming there is a spare on hand — and the annoying thought of the money to be spent on a replacement, which can be considerable for the higher wattage types.

The reason for this failure at switch-on is that incandescent lamp filaments have a very low resistance when cold compared to their resistance when hot. The ratio of hot and cold resistances for typical tungsten filament lamps is around 15:1. For example, a 300 watt lamp will have a resistance of 13 ohms when cold and 190 ohms when hot. Similarly, a 1,000 watt lamp will have a resistance of 4 ohms when cold and about 60 ohms when hot. This large difference in hot and cold resistance means that the current through the lamp at switch-on will be many times larger than in normal operation. The current drawn by a 300 watt lamp will have a peak value of 26 amps during the first half cycle of the applied 240 volt AC mains supply. Similarly, a 1,000 watt lamp will draw 84 amps.

The whole point of all these figures is that a current-carrying conductor has an associated magnetic field which is proportional to that current and the force on parallel current-carrying conductors is proportional to the product of the currents in the conductors. Most projection lamps have their filaments arranged in parallel and it is the forces due to magnetic fields generated by the surge currents at switch-on which are the main cause of their destruction. The high surge current will also cause hot-spots which make the filament more vulnerable to damage from the forces described above.

Having established the cause of catastrophic failure in projection lamps (and it is a catastrophe as we noted at the beginning of the article) we can now describe the methods to prevent these failures.

The risk of damage due to surge currents is highest with those lamps which run directly from the mains supply. This is because the mains supply has a very low impedance and can maintain 240 volts across a virtual short circuit. The problem is not nearly so serious with those lamps which run

from a step-down transformer because the transformer will saturate before it can deliver currents much above its rated output. Some projectors are run with a resistor permanently connected in series with the supply and this will also afford protection from surge currents.

The simplest method of reducing surge current is to use a high power series resistor of suitable value which can be manually switched out of circuit a few seconds after switch-on. This method was described in the March 1961 issue. The drawback of this method is that the warm-up procedure might be inadvertently forgotten — with disastrous results.

Another method is the use of series thermistors — their negative temperature coefficient of resistance compensates for the positive temperature coefficient of the incandescent lamp. The initial high value of the thermistor prevents any surge and the operation is completely automatic, meaning that the user does not have to worry about any special switch-on procedure. Thermistor protection for projector lamps was described in the August 1961 issue.

The main drawback with thermistors is that the maximum current rating available for general use is 2 amps which limits the load they can protect to about 500 watts. At the time of the above-mentioned article it was suggested by the manufacturers that higher wattage loads could be protected by parallel thermistors provided they were thermally bonded together. However, thermistor parameters cannot be controlled closely enough during manufacture so that even though two thermistors may be at the same temperature they will not necessarily have the same resistance. This means that parallel thermistors will not equally share the current — and that they both fail eventually.

Another drawback involves the situation — admittedly rather rare — where the lamp is switched off for a short period and then switched on again. Depending on the type used, the thermistor may take from six to 10 minutes to cool adequately, during which time it can provide only partial protection.

What is needed then, is a foolproof automatic device which will enable incandescent lamps of any power rating to be operated from the mains without risk of failure due to

surge currents. The device described in this article is suitable for loads up to 1,200 watts — or higher with a small modification.

The heart of this warm-up unit is the Triac, a G-E development which provides a simple means of controlling AC power where rectification is not required. Although its internal operation and construction are complex it can be regarded as behaving like a pair of thyristors connected in inverse parallel, sharing a common gate electrode and common case.

Similarly, a thyristor can be regarded as a controllable silicon rectifier which, when forward-biased, can be triggered into conduction after which it normally stays "on" until the supply voltage is removed or reversed in polarity. Thus the output from a thyristor will be DC. Those readers wanting a more exact and detailed explanation of the operation of thyristors and triacs may refer to the articles on "Keeping up with Semiconductors" and "Variwatt Power Controller" in January, October and November, 1966.

The Triac used in the prototype was an SC40-D which has an RMS conduction rating of 6 amps. For triggering on either half cycle the SC40-D requires a 3V signal of either polarity applied between the gate electrode and terminal A1. Note that, since the Triac is a bi-directional device, it has no "cathode" or "anode" as such but the two end terminals are referred to as "anode 1" and "anode 2."

As the Triac is basically an "on-off" device it is not used as a variable series impedance power controller (as are the switched resistors and thermistors described above). The only means by which it can be used to provide a gradual control of power is to use it as a rapid switch which conducts a variable amount of current on each AC half cycle — by adjusting the instant during the half-cycle when it triggers into conduction.

The oscillograms should help in understanding Triac operation. They represent the voltage across the load taken at low power and a fairly high power. In the first case the Triac is conducting late in each half-cycle and in the second case it is conducting early during each half-cycle, thereby delivering most of the available power to the load. Thus, by varying the triggering point, the Triac may be used to vary the power to a load con-

A PERFECT SET-UP !

Combine Akai's Tape Deck, Amplifier and Speaker System

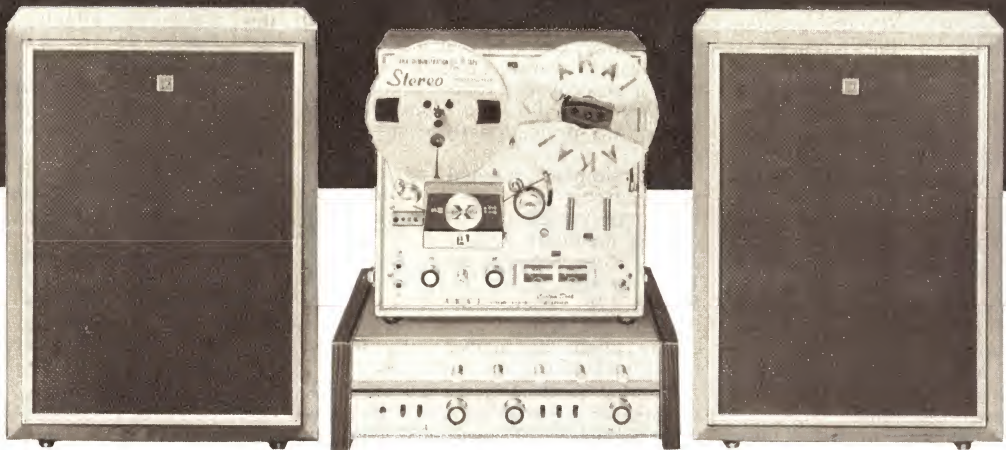

MODEL SW-130

**MODEL X-150D
MODEL AA-5000**

MODEL SW-130

FEATURES:

- *4-track stereo/monaural recording and playback.
- *4-speeds (15 ips optional) *3 heads.
- *2 speed hysteresis synchronous motor
- *Cross-Field frequency response—30 to 23,000 cps.
- *Signal to noise ratio—better than 50 db
- *Solid-State pre-amplifier
- *Automatic shut off, Instant stop lever
- *DIN jack, Stereo headphone jack
- *Tape cleaner *Oil finished wooden cabinet
- *Universal voltage selector (100 to 240V, 50/60 cycles)
- *AA-5000 and SW-130 can be matched with this deck

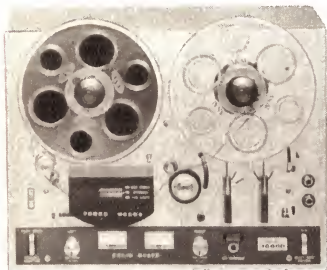

MODEL 3000D

FEATURES:

- *4-track stereo/monaural recording and playback.
- *2 speeds *3 heads
- *All silicon transistor pre-amplifier
- *Automatic shut off, Instant stop control
- *Tape cleaner
- *Equalizer for each tape speed
- *DIN jack
- *Stereo headphone jack
- *Beautifully grained wooden cabinet
- *Universal voltage selector (100 to 240V, 50/60 cycles)

AKAI

AKAI ELECTRIC CO., LTD. HIGASHIKOJIYACHO OHTA-KU TOKYO JAPAN

N.S.W.: Magnecord Australia Pty., Ltd. 210 Clarence St., Sydney VICTORIA: Magnecord Sales & Service, 3-Albury Rd., North Balwyn QUEENSLAND: Magnecord Sales & Service, 399 Montague Bd., West End; Brisbane S.A.: Magnecord Sales & Service, 8 Arthur St., Unley WA: Magnecord Sales & Service, 579 Murray St., Perth

tinuously from zero to "full-on." Zero power corresponds to the triggering being delayed until the half cycle has ended, i.e., the available voltage from the supply is zero.

The method of varying the triggering point used here is referred to as "phase control." This involves feeding the gate electrodes with a sharp pulse whose phase, relative to the AC, can be varied. This is done quite simply by means of a capacitor connected across the Triac in series with a variable resistor. The capacitor will charge during each half-cycle of the applied AC because of the voltage across the non-conducting Triac. The time it takes to charge will depend on its value and that of the series resistor.

The Triac is fired by applying the capacitor's charge to the gate electrode. This must be done via a voltage-sensitive device—one which conducts only when a certain voltage is applied. Varying the resistor in series with the capacitor controls the phase of the pulse delivered to the Triac gate be-

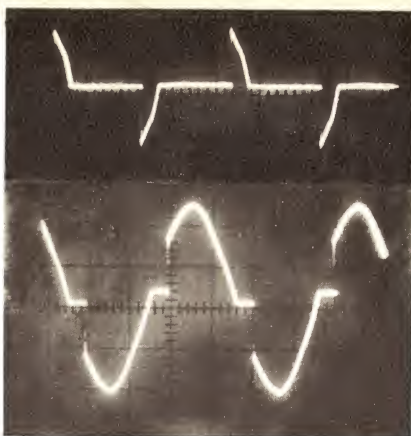

These two oscillograms show the voltage applied across the load with respect to time. The upper represents a low level of power with the Triac firing late in each half-cycle while the lower represents a higher level of power. Note that it does not represent the waveform applied across the load at full power.

voltage of approximately 32V in both directions, and is able to carry a peak discharge current of 2 amps. It will easily provide the 3V triggering voltage for the SC40-D Triac when discharging a 0.1uF capacitor.

Referring to the circuit of the warm-up device, the 0.1uF capacitor is the timing capacitor and the 220K resistor is the charging resistance which initially determines the power delivered to the load. Since the 220K resistor and 0.1uF capacitor have a relatively long time constant the triggering point for the Triac will be rather late in the AC half cycles, as represented by the first of the two oscillograms. Thus the power delivered to the load will be only a fraction of that available. Any surge current will take place over an extremely short time and will be small

due to the low voltage and so the load, the projector lamp, will be adequately protected.

As can be seen from the circuit diagram the voltage applied to the load is also applied across a 6V 50mA lamp in series with a 6.2K 15 watt resistor. This lamp, since it is being fed at "constant current," takes a significant time, a little less than one second, before it starts to glow. It is positioned over the LDR which is connected in parallel with the 220K resistor. Initially the LDR has a very high resistance so that the 220K resistor alone determines the triggering point of the Triac. However, as the 6V lamp begins to glow it decreases the resistance of the LDR to a value of around 1000 ohms so that the triggering point of the Triac is advanced to very early in the AC half-cycles and full power is applied to the load.

This means that the actual time of operation at low power is very short—of the order of one second. This is quite sufficient to warm the filament to its nominal resistance value so the full power can be applied. It should be noted that not all the available power is applied to the load due to the fact that the Triac is "off" for a very small part of each cycle. This power loss is negligible and we have not shown a voltage oscillogram of the "full power" operation as this would be merely a sine wave with a small blip at the start of each half-cycle.

All that remains to be explained is the purpose of the three 0.01uF capacitors and the small inductor, L1. These are for interference suppression; as may be seen from the oscillograms the Triac switches "on" extremely rapidly. This rapid rise time in the waveform is radiated as interference, a "buzzing" noise, to nearby radios and amplifiers unless it is suppressed. With the three bypass capacitors and L1, the interference is quite low and is audible only during the first "second" after switch-on.

PARTS LIST

- 1 Metal box, 6in x 3½in x 2½in.
- 1 G-E Triac silicon controlled AC switch; SC40-D for 1,200 watt loads, SC45-D for 2,400 watt loads; SC50-D for 3,600 watt loads.
- 1 G-E Diac symmetrical break-over diode, ST-2.
- 1 3-pin power socket.
- 1 screw-in fuseholder and fuse rated to suit Triac (see text).
- 1 220K ½-watt resistor.
- 1 6.2K 15-watt resistor, square cross-section, IRC PW-15.
- 3 0.01uF/2KV ceramic capacitors.
- 1 0.1uF/400V polyester or paper capacitor.
- 1 light dependent resistor, ORP12 or similar.
- 1 DPST power switch with each section rated at 3 amps or switch to suit Triac used.

MISCELLANEOUS

- 1 piece of aluminium for Triac heatsink, mains cord clamp, length of 10-amp 3-core power flex and 3-pin plug, 4 rubber feet, 13-lug tagboard, 2 ½in fibre rod spacers, blind-tapped 1/8in Whit. each end. Rubber grommet, 3/8in diameter.
- 1 2½in length of 3/8in ferrite rod, few feet of 18G enamelled copper wire, and plastic insulation tape.
- Connecting wire, solder, screws, nuts, etc.

cause it determines the instant at which the capacitor voltage reaches the firing voltage of the breakdown device.

In some low power applications where a relatively small trigger pulse is required a neon lamp can be used as the breakdown device. The SC40-D Triac requires a larger triggering current than can be delivered by a neon lamp and for this reason General Electric have developed a special three-layer symmetrical breakdown diode, the "Diac," for the purpose of triggering Triacs. The Diac is an open-circuit until the applied voltage rises to its breakdown voltage, when it becomes a low negative resistance.

The ST-2 Diac has a breakdown

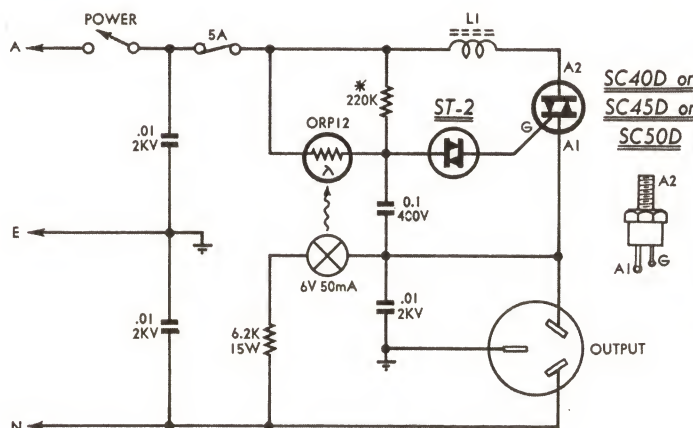

L1: 50T, 18 B&S ENAMELLED COPPER WIRE, CLOSE-WOUND ON 2-1/2" LENGTH OF 3/8" DIA. FERRITE ROD.

* MAY NEED ADJUSTMENT

CONTROLLED WARMUP UNIT FOR PROJECTION LAMPS

The circuit is quite simple and uses only a few relatively inexpensive components. The choice of thyristors, shown permits a range of power handling ability, as explained in the text.

Are you wasting time?



Save it in the workshop
and on service calls.
TV picture tube testing
can be fast, easy
and positive with a
Thomas Test Tube.

The Thomas Test Tube is lightweight, small in size and very easy to handle — it is plastic coated, implosion proofed and features a socket adaptor. The Tube comes complete in a metal frame with carrying handle and supporting feet.

Save time — ring your nearest Thomas distributor today.

THOMAS ELECTRONICS

SALES INQUIRIES AND TECHNICAL DATA AVAILABLE FROM: **N.S.W.:** THOMAS ELECTRONICS OF AUST. PTY. LTD. 12 Larkin St., Riverwood — Telephone 53-0721. **R. W. WINNING PTY. LTD.** (Selling Agents) 225 Clarence St., Sydney — Telephone 29 2111. **VIC:** THOMAS ELECTRONICS OF AUST. PTY. LTD. 131 Burwood Rd., Hawthorn, E.2.Vic — Telephone 81 0294. **QLD:** GRADWELL & CO. PTY. LTD. 42 Grenier St., Valley, Brisbane — Telephone 5 4881. **S.A.:** RADIO & ELECTRIC WHOLESALERS LIMITED. 10-12 Ormond St., Hindmarsh — Telephone 46 4041. **W.A.:** SIMON HOLMAN & CO. 10-12 Southport Street, Leederville, Telephone 8 2271. **TAS.:** W. & G. GENDERS PTY. LTD. HOBART 2 7201 — LAUNCESTON 31 2511. ALSO DEVONPORT AND BURNIE.

The construction of the unit is quite straightforward, with all the components mounted in a small rectangular metal case measuring 6in x 3½in x 2½in. The toggle power switch is mounted on the lid while the input power cord enters at one end on which is also mounted the fuse-holder. The output socket is mounted at the other end, as can be seen from the photograph. Four rubber feet complete the unit.

Inside the case, all components except the Triac are mounted on a length of miniature tagboard. The layout is non-critical, except that the small lamp should be positioned over the LDR. The photograph of the details inside the case should make layout straightforward. We have ensured that adjacent tags on the tagboard do not have the 240 volts applied between them, purely as a precautionary measure. The ST-2 Diac is obscured by the LDR in the photograph. Incidentally, the Diac has no preferred polarity; it can be wired into the circuit either way around.

Although there are few components in the case, care should be taken with the wiring and mounting as most of these have the mains supply applied to them. Ensure that the mains cord is securely anchored and that all components are mounted clear of each other and the case. The case should be earthed.

One minor problem concerned the 6.2K resistor used to supply the 6V lamp from the mains. This dissipates about 7 watts, sufficient heat to create problems in a small case like this. Our solution was to use an IRC PW15 resistor, a square section ceramic encased resistor rated at 15 watts. We then arranged that one of the flat sides of the resistor was pressed against the metal case, making the case function as a heat sink.

This arrangement solved the heat problem, but before we approved it we needed to be sure that the insulation of the resistor was adequate for the task, with a substantial safety margin, remembering that it is connected directly to the mains. According to the manufacturers, these resistors are designed to withstand a minimum of 1000V AC from the wire lead to the chassis, provided the resistor is mounted with the ceramic side against the chassis.

Reference to the "ceramic side" is intended to differentiate between the three sides of the ceramic trough into which the resistor is fitted, and the "fill side" where the trough is filled with suitable encapsulating material. The "fill side" should be avoided where maximum insulation is required.

To ensure intimate contact between the 6.2K 15-watt resistor and the metal case we made a small clamp, conforming to the resistor's dimensions, from a piece of 20 gauge aluminium. This was mounted underneath the tagboard and held by one of the tagboard mounting screws. The pictorial diagram should illustrate the idea.

The interference suppression inductor L1 is quite easily made: start by winding a layer or two of thin plastic insulation tape on a 2½in x ½in dia. ferrite rod (if only a full length rod can be purchased, file a nick around it 2½in from one end and

snap the rod as if it were of glass—don't try to saw it). Then close wind 50 turns of 18B&S enamelled wire over the tape. This number of turns will just fit in one layer with ½in to spare at each end. Finally,

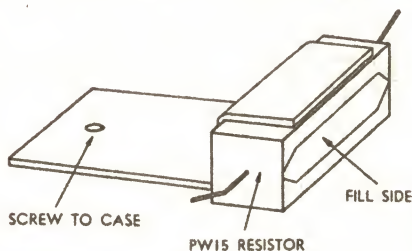

Details of a simple aluminium clamp used to anchor the 15W resistor. Note that the "fill" side of the resistor should not be clamped.

cover the winding with another layer or two of insulation tape.

The Triac is mounted on a heat-sink at one end of the case. A small heat sink is all that is necessary since the Triac is normally "on" for the complete AC half cycle and thus dissipates very little power. The hole in the centre of the heatsink should be a close fit for the mounting stud to ensure the most efficient heat transfer.

As this heatsink is connected to A2 of the Triac it is "live" and must be insulated from the metal case. This is done by supporting it on two ½in long fibre rods, blind-tapped 1-8in Whitworth at each end. The two screws used to fasten these insulators to the case are also used to mount the rubber feet at that end. The heatsink is made from a piece of 16G aluminium sheet, 3in x 2½in with a ½in section bent at right angles to provide a mounting flange.

The power switch used in the prototype was a double-pole, single-throw type with each section having a current rating of 3 amps. The two sections were wired in parallel to increase the rating. However, where the unit is likely to be used consistently at full rating, it would be better to fit a larger switch, such as a conventional power tumbler switch of about 10A rating. There is plenty of room for such a switch on top of the case.

As the unit stands it is suitable for loads up to 1,200 watts (5A). We have specified a 5A fuse, preferably one of the "quick blow" variety such as the English Electric Type Z590112. The more rapidly this fuse can open the greater the protection it affords the Triac in the event of a short-circuit.

The Triac itself is rated at 6A, giving a theoretical maximum of 1,400 watts. However, it may be difficult to obtain a suitable 6A fuse and any

(Continued on page 71)

At right: The complete unit assembled in a metal case. The "ON-OFF" switch is mounted in the lid, shown above the main case. The RF choke, wrapped in plastic tape, is seen above the terminal board.

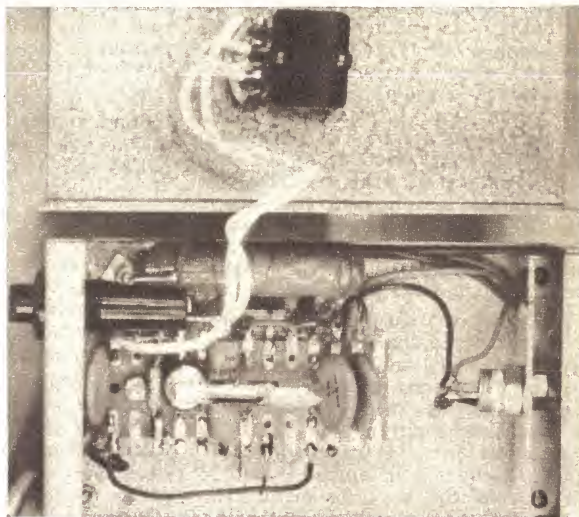

Below: A close-up view of the terminal board. The two ends of the 15W resistor are just visible protruding from beneath the board.

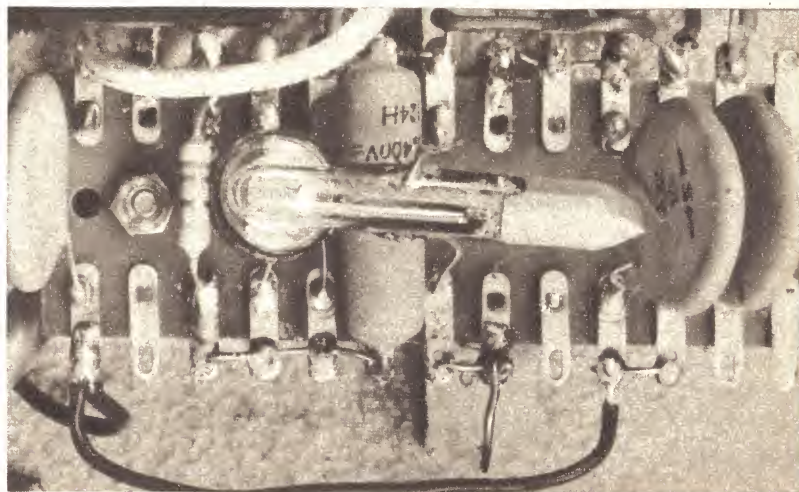

An up-to-date introduction to

Transistor and Diode Testing: Basic Principles

In many modern applications the performance of common semiconductor devices is sufficiently defined by a small number of basic tests. Explained in this article are the basic tests appropriate for diodes, bipolar transistors, field-effect transistors and unijunctions.

by Jamieson Rowe

Modern semiconductor diodes and transistors are intrinsically very reliable devices, but they are subject to rather wide production variations in performance parameters and may also be speedily damaged by abnormal or inappropriate circuit conditions. Device testing is therefore a frequent necessity.

There are many tests which may be applied to a semiconductor device, ranging from simple inter-electrode continuity or differential resistance tests using a bench multimeter to complex and refined measurements of parameters such as gain, rise-time, admittances and loss factors using high-frequency or pulse measurement equipment. Specialised transistor and diode testing instruments cover a wide range, from simple and inexpensive bench or pocket testers, measuring leakage current and DC current gain, to elaborate and costly computer-controlled parameter plotters.

While there exist a large number of testable characteristics and parameters for each semiconductor device, it is by no means necessary that all or even a majority of device parameters be tested to determine the suitability of a device for a given circuit application. Rather, it is probably true to say that in the majority of applications — particularly those in the servicing or development of domestic equipment — the performance of common semiconductor devices may be suf-

ficiently defined or predicted by a relatively small number of basic tests.

This means that a large majority of semiconductor device tests can be performed quite satisfactorily using a relatively simple and unpretentious testing instrument. In fact such an instrument often has a distinct advantage over more complex and refined testing equipment: it is usually simpler in operation, and can generally be used to perform tests at a significantly higher rate, even when operated by unskilled personnel. In addition it will generally involve a far lower initial outlay.

It is true that, even in the most routine applications, there will be occasions when measurements will be required of parameters beyond the range of a simple test instrument. However such occasions will generally be either sufficiently infrequent to justify individual test set-ups on each occasion, or otherwise concerned with sufficiently few or specialised parameters to justify construction of a custom-designed test instrument.

Knowledge of the basic tests appropriate to the various commonly encountered semiconductor devices is essential not only for the design and construction of suitable test instruments of the former type, but also for their efficient and effective use. The following discussion of the basic tests used for evaluating diodes, bipolar transistors, field-effect transistors and unijunc-

tions may help the reader to acquire this useful knowledge.

DIODES: Three of the most basic yet useful tests employed in evaluating semiconductor diodes are illustrated in the diagrams of figure 1. These consist of tests measuring (a) the voltage drop V_f of the diode during forward-bias operation, (b) the voltage drop BV of the diode during reverse-bias operation in the "breakdown" or avalanche-mode condition, and (c) the leakage current I_r during reverse-bias operation at voltages substantially below BV .

The forward voltage drop V_f is a characteristic which can be of considerable importance when a diode is to be used as a rectifier, non-linear element or level detector at low signal levels. It gives an indication of the order of forward bias voltage which must be applied to the device before appreciable current flows (for an "ideal" diode, V_f would presumably be infinitely small).

The diagram of figure 2 shows typical voltage-current characteristic curves for silicon and germanium diodes. As may be seen the two types are basically similar, the main difference being that forward conduction of a silicon diode occurs somewhat more abruptly and at a slightly higher voltage than for a germanium diode.

Fairly obviously the forward voltage V_f varies as a function of the forward

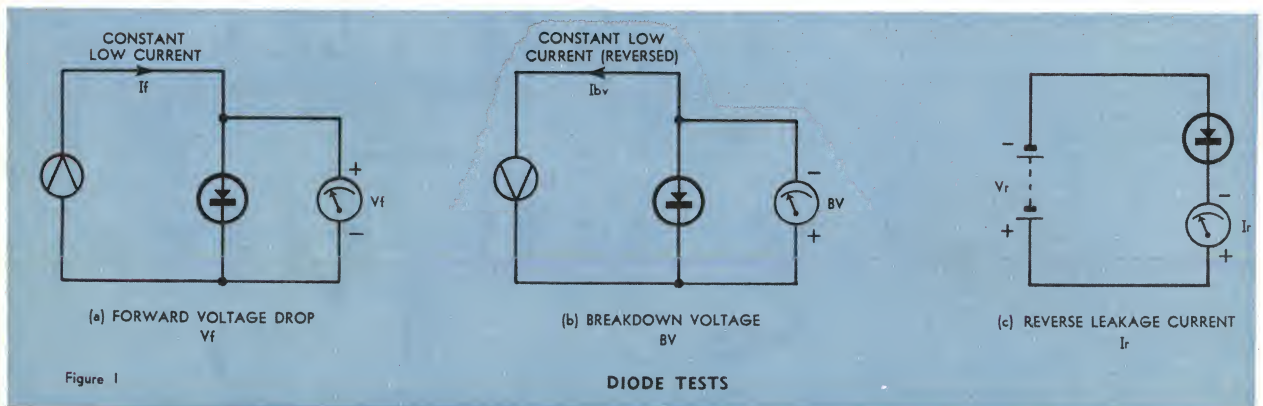

current, varying appreciably at low current levels but less at higher current levels. In order to measure the forward voltage on a comparative basis it is therefore necessary to perform the measurement with a specified forward current passing through the diode, as in figure 1 (a). (The symbol consisting of a circle enclosing an inverted "v" represents an ideal "constant current generator," which may in practice be approximated by a high voltage in series with an appropriately high resistance.)

The choice of the test current level used for this measurement is influenced by two rather opposing considerations. One is that higher current levels tend to give a truer picture of the "conducting" state of all devices, by ensuring that each device is operated on the high-slope (low resistance) portion of its forward characteristic. The other consideration is that device power dissipation during the test will rise fairly rapidly with test current, so that a high test current level risks damage of low-power devices.

In practice a test current level I_f of the order of 2 milliamps strikes a suitable compromise between these factors, permitting useful and meaningful comparison of devices while ensuring that device power dissipation during the test is very low. At this current the forward voltage drop V_{fg} for typical germanium diodes lies between approximately 0.35V and 0.55V, while for typical silicon diodes V_{fs} lies between approximately 0.5V and 0.9V.

The significance of readings obtained from a practical test circuit similar to that shown in figure 1(a) will depend mainly upon the approximation used for the constant current generator, and the current taken by the voltmeter relative to the diode current. For most practical purposes a 10V supply in series with a 4.7K resistor gives an adequate approximation for the current source, while a 0-2V voltmeter based upon a 50uA or 100uA meter movement will give negligible loading.

In passing, it may be noted that a voltmeter reading of zero during the V_f test does not indicate a "perfect" diode, but rather that the device is short-circuited. Conversely a full-scale reading would indicate an open-circuit. (To allow for the latter possibility it will normally be necessary to protect the voltmeter from overload.) Hence the V_f test is well suited to be that first applied to an unknown device.

Another important and useful measure of diode performance is the voltage drop BV of a diode when operated in the reverse-bias "breakdown" or avalanche region. This is often called the "breakdown voltage." Diode dissipation in the breakdown region tends to be relatively high, as appreciable current may be drawn by the device while it is sustaining a high-voltage drop.

For diodes to be operated in the breakdown region as "zener" or voltage reference diodes, BV is important because it represents the working voltage of the device. Conversely for diodes which are not to be permitted to enter the breakdown region, BV is again important because it in-

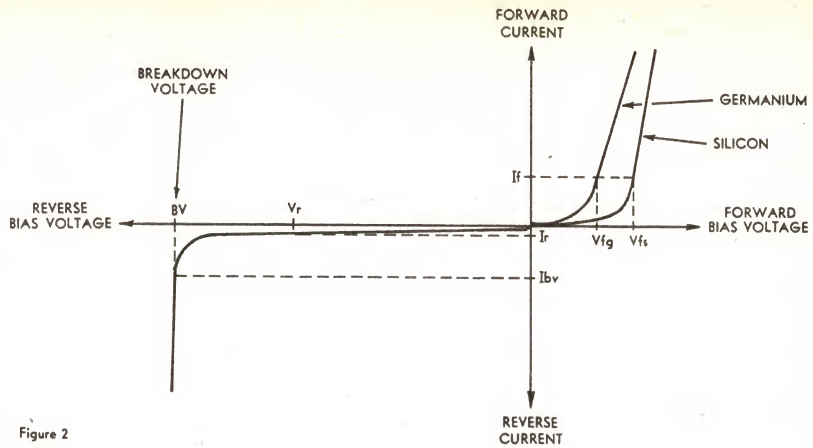

Figure 2

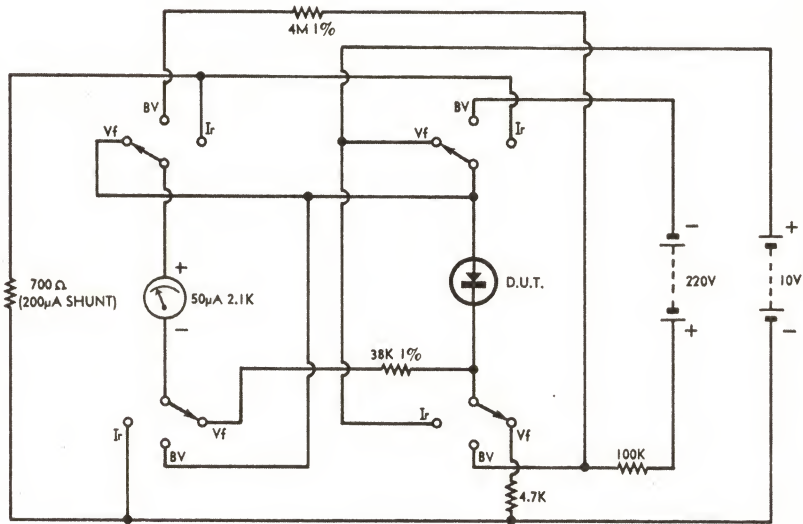

Figure 3

DIODE TEST CIRCUIT

dicates the limit below which must be kept the peak inverse voltage (P.I.V.) applied to the device in operation.

As shown by the diagram of figure 1(b), the measurement of BV is performed in a fashion very similar to that used for V_f . A constant current — in this case in the reverse direction — is forced through the device, and a voltmeter used to measure the voltage drop.

As before, the current level I_{bv} used for the test is dictated by the opposing considerations of reading validity and device protection. Higher current levels ensure that all devices are tested in the breakdown mode yet, even more so than before, also cause increased power dissipation and risk damage of small devices due to overheating.

With currently available low-voltage devices, a test current of the order of 2 milliamps again strikes a suitable compromise. At this current most devices are operated well into the breakdown region, yet device dissipation during the test is limited to approximately 200 milliwatts or less.

By intentionally degrading the approximation used for the constant-current supply device dissipation can in fact be kept below about 120 milliwatts even for devices with breakdown voltage drops of 100V or higher. Reading validity is reduced, but in most cases this is quite acceptable. A suit-

able practical circuit to perform the test of figure 1 (b) may thus consist of a 220V supply in series with a 100K 1W resistor, and a 0-200V voltmeter again using a 50uA or 100uA movement.

As with the test for V_f , the BV test is also capable of showing up shorted or open-circuited devices. A zero reading indicates a short, while a full-scale reading suggests either a very high breakdown voltage or an open circuit.

Although the BV test gives an important measure of diode performance in the reverse-bias mode, it does not indicate the behaviour of the diode at reverse bias voltages below breakdown. A third useful test of diodes is therefore that shown in figure 1 (c), in which is measured the leakage current I_r at a low reverse bias voltage. As may be seen the diode is simply connected in series with a source of voltage V_r and a current meter.

As one might expect the reverse bias voltage used for the I_r test is again something of a compromise. The lower the voltage used, the lower the leakage current levels involved; hence in order to be able to use simple metering circuitry it is desirable to use a fairly high bias voltage. On the other hand increasing the bias voltage generally means that devices with low breakdown voltage will be taken into the breakdown region and therefore invalidate the measurement.



The D202 dynamic, cardioid microphone is a new design in microphones. It consists of two, coupled, transducer systems contained in a single housing. One of these systems is used for high frequencies and the other for low frequencies, giving the microphone a smooth frequency response similar to that of a condenser microphone.

In addition it has an exceptionally good cardioid characteristic over the entire frequency range and bass attenuation from zero to -20db at 50 Hz.

In all applications where superb sound is required, think of A.K.G.

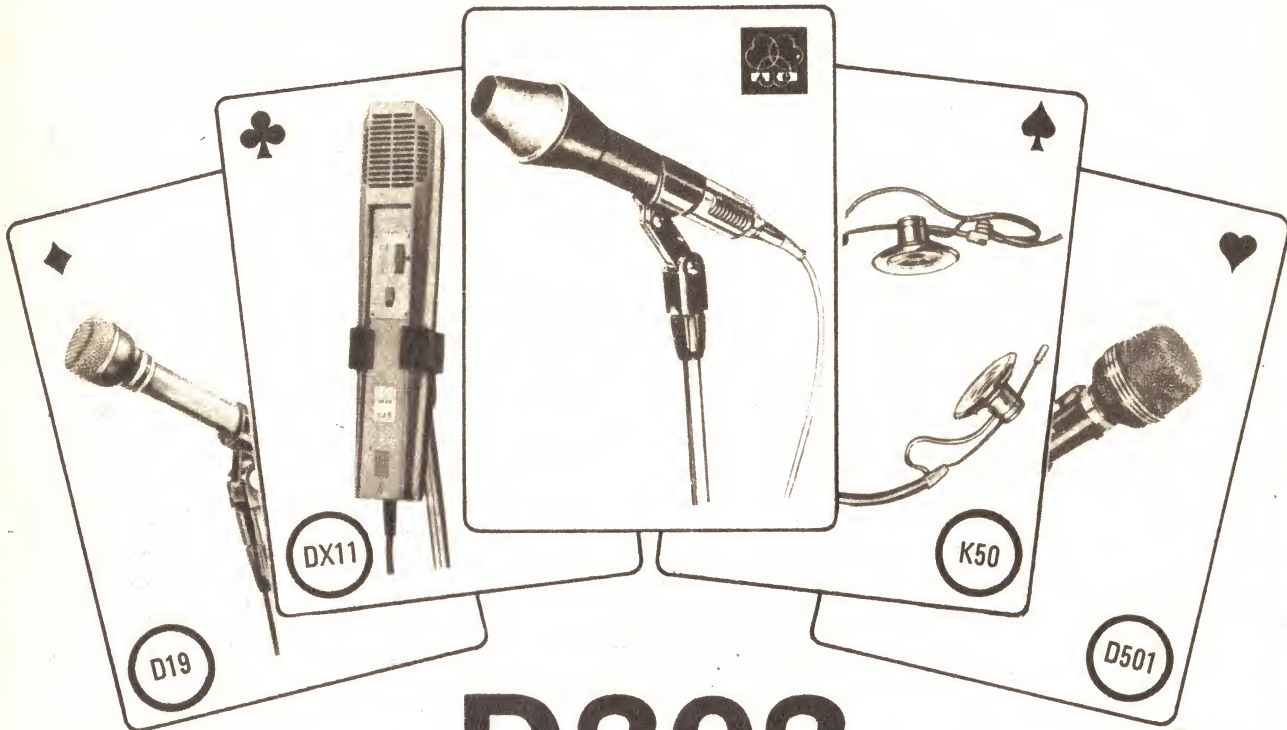

D202

Dynamic Two-Way
Microphone

A WINNING HAND — ALL ACES

Please write for full Technical Information



Engineering Products Division

422 LANE COVE ROAD NORTH RYDE NSW 88 6666

AMALGAMATED WIRELESS (AUSTRALASIA) LTD

MELBOURNE
67 9161

BRISBANE
4 1631

ADELAIDE
51 0111

PERTH
28 3425

LAUNCESTON
2 1804

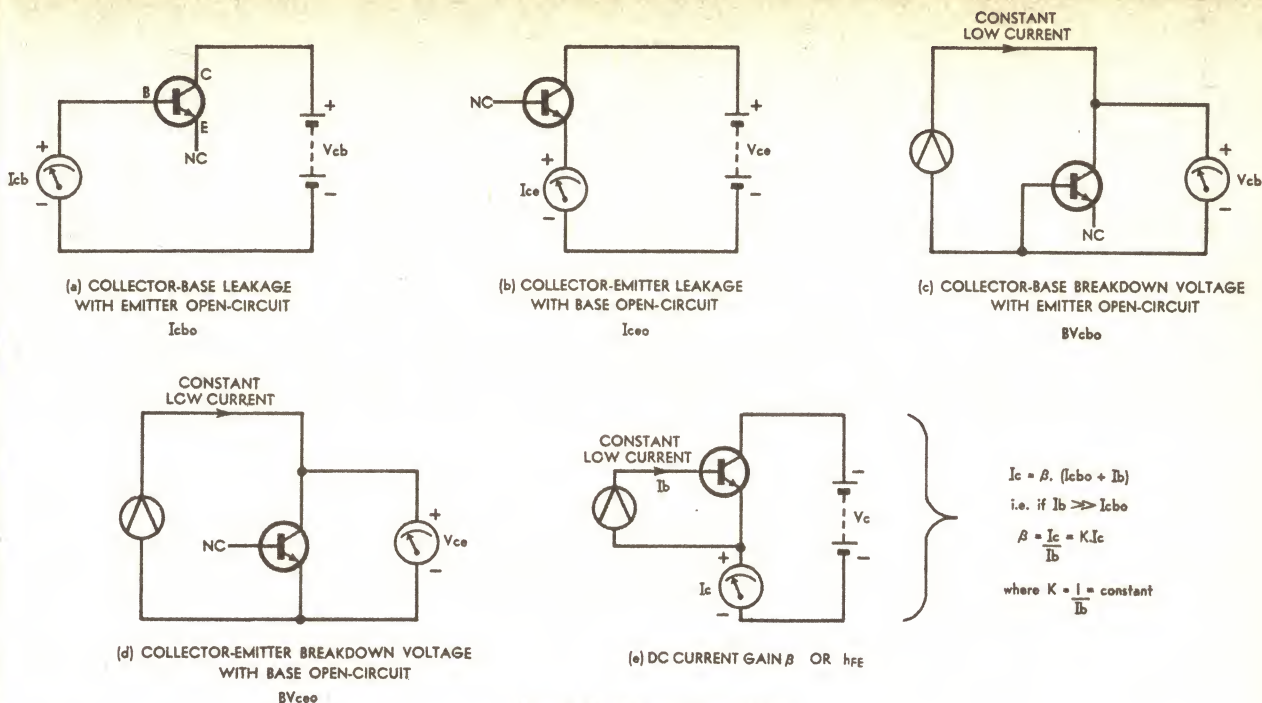

Figure 4

It is true that diodes with very low breakdown voltage will generally be those intended for use in the breakdown mode, as "zeners" or voltage reference diodes; hence for these devices the reverse leakage current before breakdown will in most cases be of little or no concern. This allows us to set V_r at a convenient level for the purposes of measurement—say 10V.

At this reverse bias typical modern diodes exhibit quite a low order of leakage current. Silicon diodes will generally draw less than 10-15uA, while germanium diodes may range somewhat higher.

Figure 3 shows the circuit of a practical diode tester which would perform the three tests just described. As may be seen a 4-pole 3-position switch is used to determine the test performed; if the reader cares to trace through the circuit in each case he will find that the test circuits correspond closely to those shown in figure 1.

Note that the meter movement is marked as having an internal resistance of 2.1K. This does not signify the use of a non-standard meter, but merely the use of a standard 50uA/2K meter together with an overload protection circuit consisting of a shunt silicon diode and a series 100 ohm resistor. For details of this method of meter protection readers are referred to the article by Philip Watson in the December, 1959, issue of "Radio, Television and Hobbies."

The meter ranges provided for the three tests performed by this circuit are as follows:

- Vf: 0-2V
- BV: 0-200V
- Ir: 0-200uA

Incidentally the letters "D.U.T." adjacent to the diode symbol in figure 3 are commonly used to indicate that the symbol represents the "device under test."

BIPOLAR TRANSISTOR TESTS (POLARITIES SHOWN FOR NPN DEVICES)

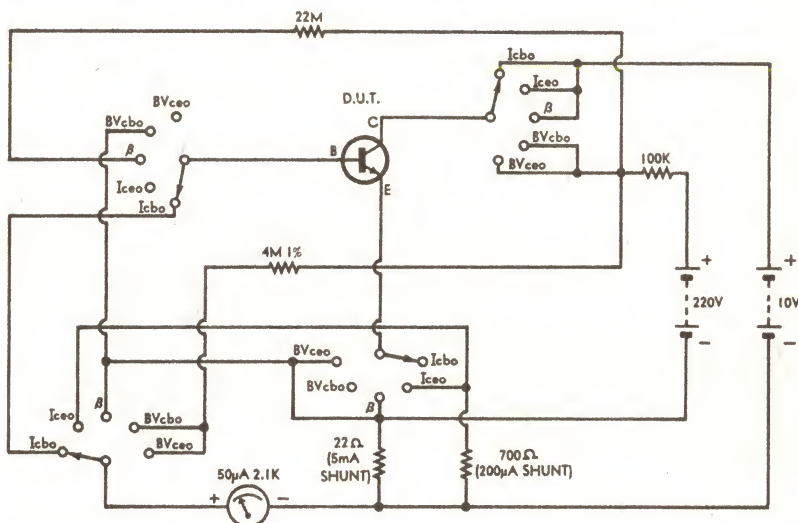

Figure 5

BIPOLAR TRANSISTOR TEST CIRCUIT (POLARITIES SHOWN FOR NPN DEVICE)

BIPOLAR TRANSISTORS: Five of the most basic and useful tests available for evaluating bipolar transistors are illustrated in figure 4. (The circuit symbols and polarities shown are those for NPN devices; for PNP devices the circuits would be unchanged but the transistor symbols and polarities changed appropriately.) There are two tests concerned with leakage currents, and two concerned with breakdown voltage drops; the final test deals with DC current gain.

Although a bipolar transistor has two P-N junctions, in normal operation only one is operated under reverse bias conditions: the collector-base junction. The leakage current of this junction is therefore of considerably greater interest than that of the base-emitter junction. This is particularly so, as the collector-base junction leakage can significantly influence the transistor operating point and its thermal behaviour in circuits involving high resistance base bias.

The usual method of measuring the reverse-bias leakage current of the collector-base junction is shown in figure 4 (a); as may be seen the circuit involved is similar to that used in figure 1(c) for a diode. As the test is made with the emitter disconnected the leakage current measured is designated I_{cbo} , where the "O" signifies that the third electrode of the device is left open circuited.

In this case the choice of reverse-bias voltage V_{cb} is simpler than in the diode test, as few transistors have collector-base avalanche voltages below about 25-30V. A test voltage of 10V is therefore in order, and this figure usually permits useful I_{cbo} readings to be made using a 50uA movement.

Low and medium power silicon transistors typically have I_{cbo} leakage of less than 5uA; germanium transistors of the same type may range to seven or eight times this figure. As with diodes, a full-scale reading on this test suggests either excessively high

Anatomy of a powerplant

180 Watts

Total power output.
Bandwidth from 15–30,000 Hz.
Distortion factor: 0.8% or less.

Functional Window Styling

Illuminates to show what functions the receiver is set to perform. For radio reception, dial scales are illuminated. For tape recording or phono functions, TAPE and PHONO are illuminated, etc.

Stereo-Only Circuit

Cuts out all monophonic broadcasts. FM Stereo programs are selected more rapidly.

FET and IC Circuitry

For new standards in FM sensitivity and selectivity.

Double Tuning Meters

For more accurate FM reception.

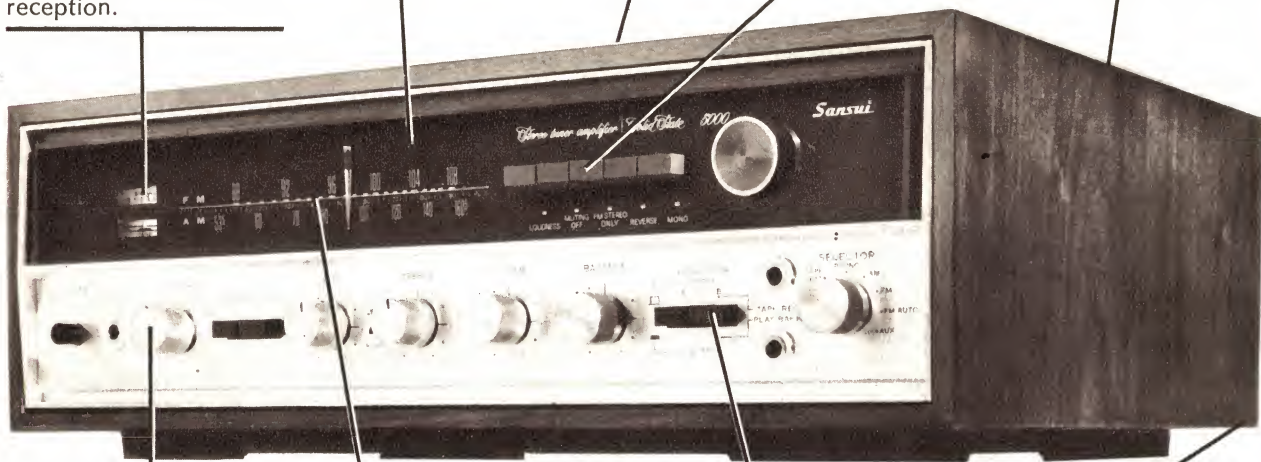

Three Speaker Systems

Accommodates up to three at a time. Fully controlled from front panel.

AM/FM Tuning Scales

Longer for easier, more precise tuning. Ideal for heavily congested signal areas.

Four Tape Recorders

Up to four tape recorders or decks can be handled simultaneously by two circuits, four inputs. Recorders can be of Microphone, Pin-Jack or DIN types.

Two Antenna Terminals

Works off either 75- or 300-ohm antennas.

Sansui 5000: The Complete Receiver

Sansui®

Fiji: PRABHU BROTHERS P.O. Box 183, Nadi, Fiji / SANSUI ELECTRIC COMPANY LIMITED 14-1 2-chome, Izumi, Sugunami-ku, Tokyo, Japan

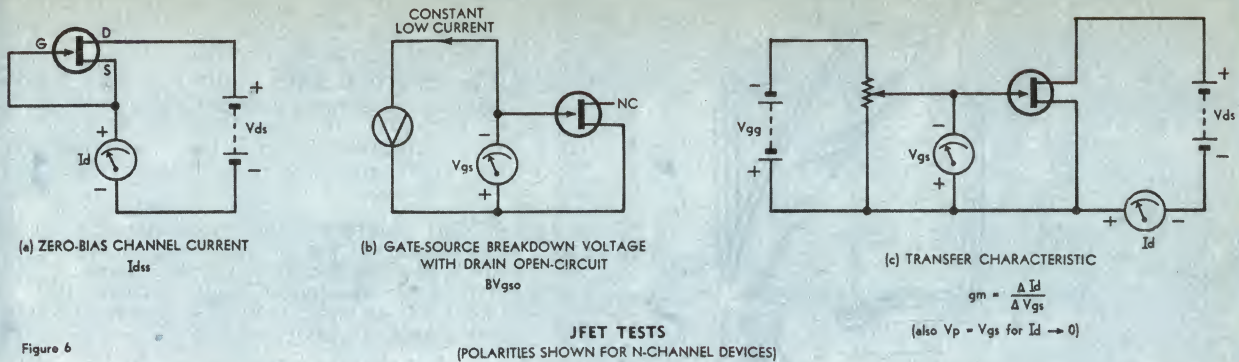

Figure 6

leakage or an internal collector-base short. With silicon transistors an effective reading of zero is often obtained, many devices having I_{cbo} figures of the order of a few tens of nanoamps; however, a germanium transistor giving a zero reading for I_{cbo} will usually prove to be open-circuit.

While measurement of I_{cbo} shows the basic leakage current of a transistor, it does not indicate the extent to which leakage will tend to influence the behaviour of the transistor in circuit. The latter behaviour will tend to depend largely upon the current gain; accordingly it is usual to make a second leakage measurement, using the circuit shown in figure 4 (b). The quantity measured in this case is I_{ceo} , the collector-emitter (amplified) leakage current with the base left open circuit.

As with the I_{cbo} test there is little worry about avalanche breakdown, and the testing voltage V_{ce} may be a convenient 10V. A current meter range of 200uA is usually appropriate for most modern transistors, as high-gain silicon devices have a typical I_{ceo} of 30uA or less while germanium types may range up to 5 or 6 times this figure. A hard full-scale reading would suggest either excessive leakage or a collector-emitter short.

Breakdown voltages are important with transistors, as with diodes, and in this case there are two measurements usually made: BV_{cbo} , the collector-base breakdown voltage with emitter open circuit; and BV_{ceo} , the collector-emitter breakdown voltage with base open circuit.

Although at first sight one might expect BV_{cbo} to be less than BV_{ceo} for a particular device — the emitter being further from the collector than the base—the reverse is generally the case. This is because BV_{cbo} involves what one might call "simple avalanche" breakdown, while BV_{ceo} describes behaviour under "amplified avalanche" conditions as a result of the influence of transistor current gain upon collector-emitter leakage current.

It may be seen from figure 7(c) and (d) that the circuits used for measurement of BV_{cbo} and BV_{ceo} are similar, and are both similar to that used for diode BV testing. As before, a constant-current source is used, with a sensitive voltmeter to measure the device voltage drop.

In determining the appropriate test current, there are again the opposing considerations of reading validity and device protection, and the designers

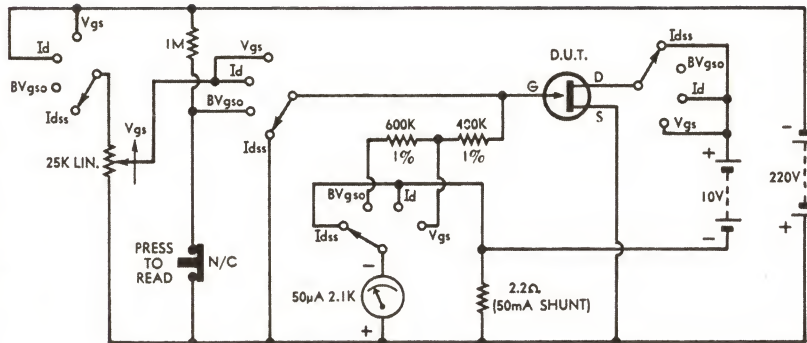

Figure 7

of test equipment diverge considerably in the current level chosen. Some advocate currents as low as 100uA; others are of the opinion that currents up to a few milliamps are desirable from the viewpoint of reading validity, while still not risking device damage.

The present writer is inclined to lean toward the latter school of thought, particularly if precautions are taken to ensure that devices with a high breakdown voltage are arranged to draw less current and thus dissipate less heat. Thus a BV_{cbo} or BV_{ceo} test circuit employing a (220V + 100K) approximation to a constant current source will give quite useful and meaningful readings, while limiting the maximum device dissipation to approximately 120mW, a figure which should be within the ratings of most devices commonly encountered.

As before the use of a sensitive voltmeter is necessary if loading errors are to be avoided. A basic 50uA or 100uA movement is usually found adequate.

A third breakdown voltage is occasionally measured: BV_{ebo} , the reverse-bias breakdown voltage of the base-emitter junction. This is not as important as the other two, but can be important in applications where high reverse base-emitter voltages can occur. As BV_{ebo} may be measured in a similar way to that used for BV_{cbo} , this test can usually be made quite easily when required simply by temporarily substituting the emitter for the collector lead in a BV_{cbo} test circuit.

The fifth transistor test illustrated in figure 4 is that for DC common-emitter current gain, shown in diagram (e). This transistor characteristic is commonly known as β (beta) or hFE.

It can be seen from the diagram that β can be measured by driving the transistor with a constant low base current, and measuring the resultant collector current with a known collector-emitter voltage V_c applied. The collector current will be equal to $\beta(I_{cbo} + I_b)$.

If the external base current I_b is large compared with the internal collector-base leakage current I_{cbo} —and with modern transistors this is fairly easy to arrange—then I_c will be a close approximation to βI_b . Thus since I_b is held constant at a known value I_c will be directly proportional to β , and the collector current meter may be calibrated directly in terms of current gain.

With most modern low- and medium-power transistors I_b may be set at 10uA, delivered by a circuit consisting of a suitably high voltage in series with an appropriate resistor (220V and 22M, for example). Then if I_c is measured during the test with a meter of say 5mA full-scale deflection (F.S.D.), the meter may be calibrated directly with a 0-500 β scale. Such a scale is appropriate for the majority of devices in current use, although a few very high gain devices have gain ranges extending to 600-700.

The choice of collector-emitter voltage V_c applied during the β test is not a critical one. The main considerations are that V_c be high enough to ensure that no device can saturate, yet low enough to prevent excessive dissipation. The range between these limits is a wide one, and a convenient figure of 10V is often selected.

Figure 5 shows a practical bipolar transistor test circuit based upon the five tests shown in figure 4. Again a protected 50uA meter movement is

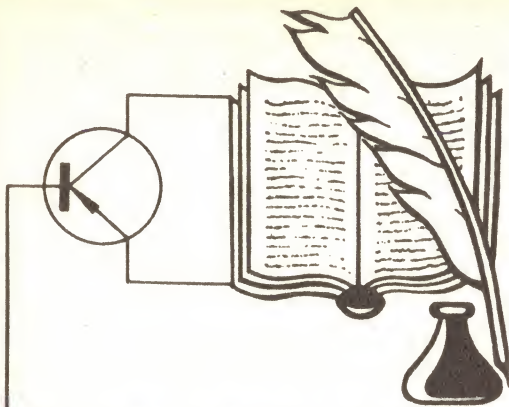

RON THOMAS & ASSOCIATES PTY. LTD.

RTA has written and published technical manuals for equipments and systems ranging from simple power supplies to sophisticated and complex systems which include:

- ◆ Airborne communication, navigation and guidance systems.
- ◆ Ground communications, radar, navigational aids and antenna systems.
- ◆ Automatic pulse distortion measurement and alarm systems used in telegraph equipment.
- ◆ Frequency modulated 920 channel man-pack transmitter-receiver.
- ◆ Multi-channel telemetry equipment with automatic readout and alarm facilities.

Types of Manuals

The technical manuals produced by RTA have included:

- ◆ Theory of operation.
- ◆ Circuit descriptions.
- ◆ Repair and maintenance procedures.
- ◆ Operating instructions.
- ◆ Routine servicing and test procedures.
- ◆ Fault diagnosis.
- ◆ Installation instructions.
- ◆ Parts breakdown.

Our Value to You

1. RTA can carry out the initial research and testing of an equipment or system and from the data thus compiled write the technical manual you require.

2. In addition to technical writing all other services associated with the production of a manual are carried out by RTA. This includes circuit drawing, illustrating, type setting, artwork, platemaking and printing.
3. As all facilities from laboratory to printed manual are available and in use "in house" by technical people, clients of RTA are assured of intelligent handling of their work through all phases, with single responsibility.
4. RTA is fully experienced in the production of manuals to Armed Forces specifications.
5. Our engineers and technicians will travel to any location for "on site" research, testing and writing.
6. As this company is solely established for the writing, production and publishing of technical manuals, our staff is not distracted or influenced by other activities.

Save Time and Money

Where your engineering staff have responsibilities other than the production of your technical manuals a specialist organization such as RTA can produce your manuals and simultaneously release your own technical personnel for projects where they are more profitably employed. Your manuals will be completed in far less time with a resultant reduction in costs.

MANUFACTURERS UNDER CONTRACT TO THE ARMED FORCES— RTA can produce your technical manuals to the relevant military specification. Our experience and association with the appropriate design authority can work to your advantage.

To Contact Us

You are cordially invited to contact us to arrange a personal discussion of your particular requirements.

PHONE: 232-5755 (2 lines).

WRITE TO: RON THOMAS & ASSOCIATES PTY LTD,
Box 173, Glen Waverley, Vic. 3150.

OR CALL AT: 1st Floor,
25 The Centreway,
"Pinewood",
Mount Waverley, Vic. 3149.

RON THOMAS & ASSOCIATES PTY LTD

Engineering Writers, Technical Writers and Publishers

■ A GOOD PRODUCT DESERVES A GOOD TECHNICAL MANUAL ■

used, with shunts and multipliers arranged to give the following ranges:

I_{cbo} : 0-50uA.

I_{ceo} : 0-200uA.

β : 0-500.

BV_{cbo} : 0-200V.

BV_{ceo} : 0-200V.

If the BV_{ebo} of a device were to be measured, this test could be performed with the circuit of figure 5 using the method noted earlier, which involves temporarily inserting the device with collector and emitter leads transposed. The reading required will then be obtained on the BV_{cbo} range.

Before leaving bipolar transistor testing it should be noted that the DC current gain (β) measurement just described is only one of a number of current gain measurements which may be made on a bipolar transistor. Another important parameter is h_{fe} , the "AC" or incremental current gain, which gives a more accurate description of the behaviour of a transistor in a common-emitter amplifier circuit.

Although h_{fe} and other related gain parameters are not particularly difficult to measure, they generally involve somewhat more elaborate test circuits than that shown in figure 4(e). For this reason provision for measurement of these parameters is not usually made on simple or "general purpose" testers, being provided mainly by more specialised instruments.

In general, measurement of β as the sole gain test applied to a device by a general-purpose tester may be justified on the grounds that it is simply provided, speedily performed and gives at least a convenient indication of the order of current gain provided by the device in a "typical" circuit.

FIELD-EFFECT TRANSISTORS (FETs): Although these devices fall into a number of different types, all consist basically of a "channel" element whose effective conductivity is a function of the potential applied to a closely coupled but isolated "gate" control element. In junction-type FETs (JFETs) the gate-channel isolation is provided by a reverse-biased P-N junction, while in metal-oxide-semiconductor (MOSFETs) and other insulated-gate devices (IGFETs) the isolation is provided by a thin layer of metal oxide. In both main types of FET the "common" and "output" ends of the channel are termed the "source" and "drain" respectively; MOSFET devices usually have an additional electrode, the substrate, which is in most cases connected to the source.

An important parameter describing FET performance is I_{dss} , the channel current which flows when zero external bias voltage is applied to the gate. I_{dss} is a measure both of the channel conductivity of a device and of its internal stabilising behaviour, and thus gives a good indication of the suitability of a device for practical circuit applications.

The measurement set-up required for I_{dss} is quite simple, and is illustrated in figure 6(a). A known drain-source voltage V_{ds} is supplied to the device with the gate electrode tied to the source, and a meter connected in series to measure the resultant current. Typical devices exhibit an I_{dss} between about 1 and 20mA; in general

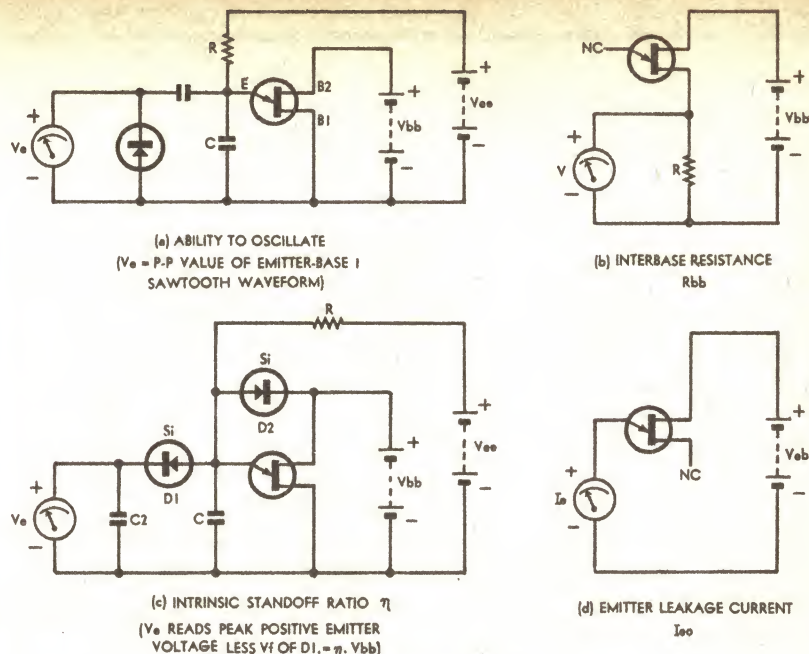

Figure 8

UNIJUNCTION TESTS

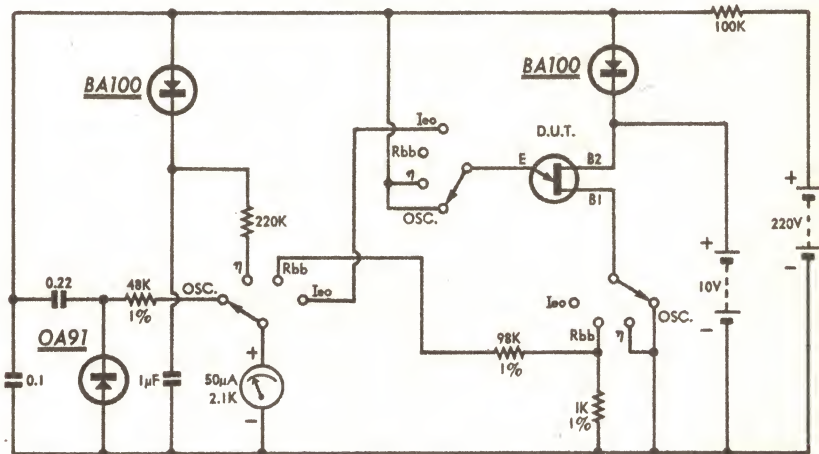

Figure 9

UJT TEST CIRCUIT

an I_{dss} of greater than 20mA predicts difficulty in arranging for the device concerned to give useful gain at acceptable channel current levels.

The choice of testing voltage V_{ds} is not critical, but too high a value will risk over-dissipation of devices exhibiting high I_{dss} . A suitable value for most purposes is 10V.

An important characteristic of JFETs is BV_{gso} , the breakdown voltage of the gate-channel junction with the drain open-circuited. BV_{gso} shows the absolute limit of gate reverse bias which may be applied to the device for normal operation.

The basic test circuit used for measuring BV_{gso} is shown in figure 6(b), and it may be seen that this circuit is similar to that used to measure breakdown voltages in diodes and bipolar transistors. The main difference is that in this case the test current level must be kept down to prevent excessive dissipation in the small and relatively fragile gate-channel junction; a convenient current level is 200uA, obtained using a 200V supply and a 1M series resistor.

It is most important to note that the BV_{gso} test must never be applied to

MOSFET or other IGFET devices, as breakdown of the gate insulation of these devices causes permanent damage.

A further aspect of FET performance which is generally quite important is the transconductance, which determines the "gain" of a device. As this parameter varies with channel current and is not constant a variety of characteristics are used to describe it, including the complete I_d/V_{gs} transfer curve.

For JFET devices the transfer curve closely approximates a parabola which is tangential to the V_{gs} axis at the so-called "pinch-off" voltage V_p and intersects the I_d axis at I_{dss} . At the latter point the curve has maximum slope, so that the maximum transconductance of a device occurs at zero gate bias and is commonly symbolised as G_{mo} .

If I_{dss} and the pinch-off voltage V_p are known, G_{mo} can be found quite easily from the following expression:

$$G_{mo} = -2.I_{dss}/V_p.$$

Figure 6(c) shows a basic circuit which permits both plotting of the I_d/V_{gs} transfer characteristic of a

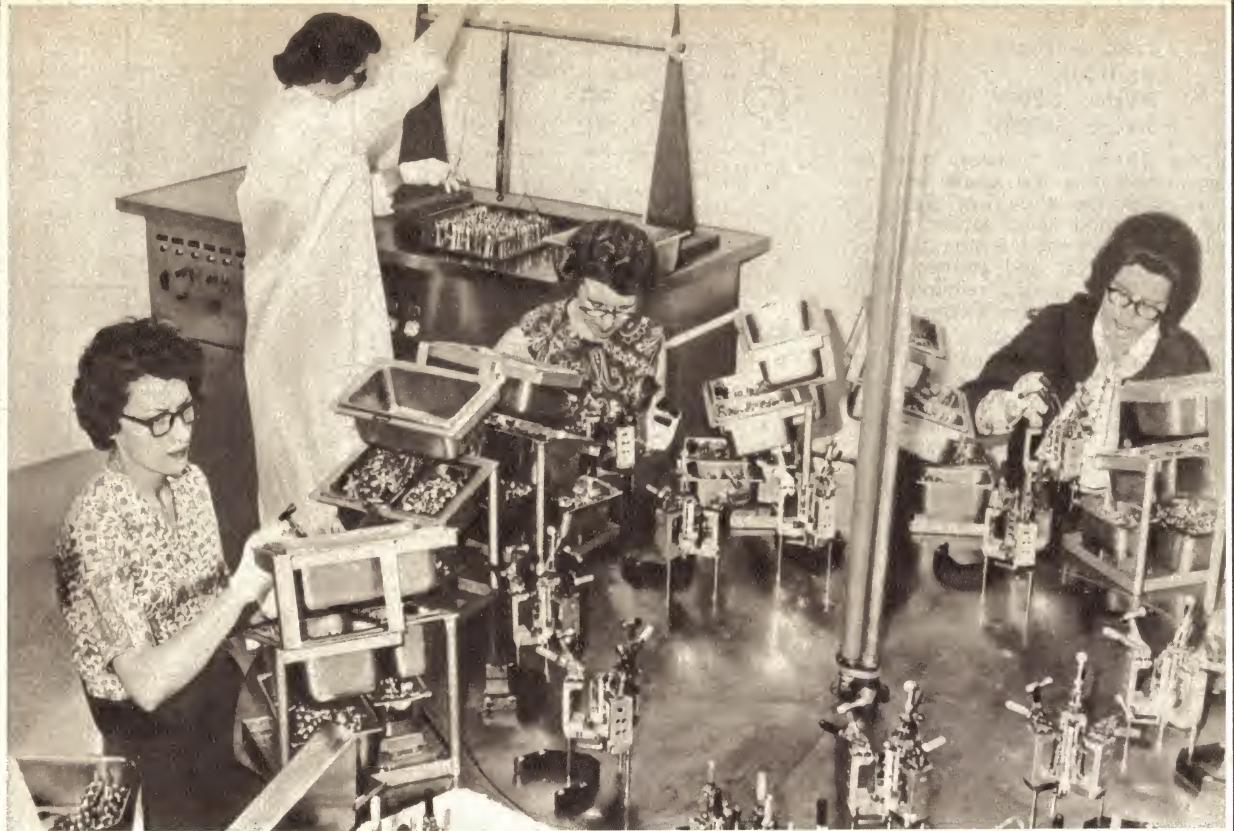

Because FREON solvents are nonflammable, relatively nontoxic and free from irritating odors, manufacturers can safely locate their cleaning equipment directly at the end of their assembly lines for maximum efficiency

6 reasons why you should use FREON[®] TF solvent in your cleaning operations

1. Superior cleaning action—Du Pont FREON TF fluorocarbon solvent has a selective solvent action that can achieve residue-free cleaning of assembled components. FREON TF dissolves grease and oil without affecting metals, plastics or elastomers. In addition, it has extremely low surface tension and high density, which allows it to penetrate the most minute crevices to get under and float away soils . . . even particulate matter.

2. Outstanding purity—Every lot of FREON TF is guaranteed to be at least 99.8% pure trichlorotrifluoroethane, with non-volatile residue content less than 2 ppm. It is packaged in specially designed drums to assure maintenance of purity.

3. Guaranteed quality—Every batch of FREON TF is analysed by vapor phase chromatography to guarantee that it meets Du Pont's exacting quality standards. Du Pont is the world leader in fluorocarbon chemistry, with more than 34

years of continuous experience. All major developments in fluorocarbon solvents originally came from Du Pont's research staff.

4. Utmost safety—FREON TF is nonflammable and relatively nontoxic. No special ventilation facilities are required.

5. Proven economy—In application after application, cleaning systems which use FREON TF have significantly reduced reject rates for manufacturers and processors. In addition, since it is a pure, stable chemical compound that contains no inhibitors, FREON TF can easily be recovered for re-use by distillation or adsorption.

6. Unexcelled versatility—The benefits of FREON TF can be obtained with ultrasonics, vapor degreasers, cold dips, sprays or in any other cleaning technique presently being used.

FREON TF is also used as a base for a variety of "tailored" solvents now available from Du Pont to meet special cleaning problems.

FREON TF is available in bulk and aerosol cans.



FREON Products Distributor

F. C. LOVELOCK PTY. LIMITED

SYDNEY
Phone: 2112811

CANBERRA
Phone: 95-1422

MELBOURNE
Phone: 61-2545

ADELAIDE
Phone: 51-2154

BRISBANE
Phone 2-3481

PERTH
Phone: 21-6546

device and determination of V_p . (The symbols and polarities shown are for N-channel devices, as with figure 6(a) and (b); for P-channel devices they would be changed appropriately.) As may be seen the circuit consists simply of an arrangement whereby the channel current I_d may be measured at various values of applied reverse gate bias voltage $-V_{gs}$. The pinch-off voltage V_p is found simply by noting the value of $-V_{gs}$ at which I_d effectively falls to zero.

A practical circuit which would perform the FET tests described in figure 6 is shown in figure 7. The circuit has been arranged to employ a single meter movement which is switched to measure $-V_{gs}$ and I_d alternatively for transconductance measurements. It again uses a 50uA protected meter movement, with 10V and 220V supplies to provide the operating voltages and currents. In order to prevent damage to IGFETs a normally closed pushbutton is connected across the BV_{gs} constant-current source so that the test cannot be made unless the button is pressed.

The meter ranges for the FET test circuit of figure 7 are as follows:

I_{dss} : 0-50mA
 BV_{gs0} : 0-50V
 I_d : 0-50mA
 $-V_{gs}$: 0-20V

UNIJUNCTIONS: Probably the most common requirement of these devices is that they be capable of producing oscillations in a simple relaxation circuit. A useful "first test" for a UJT is therefore one in which the device is connected into a suitable relaxation circuit and its ability to oscillate determined. In general if a UJT will oscillate in this fashion it will be at least potentially suitable for most other applications.

Figure 8(a) shows a basic circuit which performs this test. The base electrodes B1 and B2 of the UJT are connected to an interbase supply V_{bb} , while the emitter is connected to a simple R-C charging circuit connected to a second supply V_{ee} . A simple half-wave meter rectifier circuit is used to indicate the presence of the expected saw-tooth waveform at the emitter, the circuit performing in a similar fashion to a simple neon-tube relaxation oscillator.

A zero reading on this test generally indicates that the device concerned is faulty.

A further UJT characteristic used in circuit design work is R_{bb} , the internal "interbase" resistance. A convenient test circuit for measuring R_{bb} is shown in figure 8(b). As may be seen, it simply connects the interbase resistance of the device in series with a resistor R across the supply V_{bb} , to form a voltage divider. A voltmeter connected across R may be calibrated directly in terms of interbase resistance.

A supply voltage V_{bb} of 10V is usually quite satisfactory for this test, providing sufficient voltage for convenient measurements yet ensuring that the test device is not subjected to excessive dissipation. As typical devices have an R_{bb} falling in the range 2-5K a convenient value for R is 1K, in which case a 0-5V meter will give a useful R_{bb} scale having F.S.D. cor-

responding to 1K and a one-third F.S.D. reading corresponding to 5K.

For critical design of UJT circuits an important characteristic of a device is the so-called "intrinsic standoff ratio," which is nothing more than the proportion of the device interbase resistance effectively lying between the emitter junction and the B1 electrode. The intrinsic standoff ratio is symbolised by the lower-case Greek letter Eta, as shown in the test circuit of figure 8(c).

In this circuit the UJT is again connected in a simple relaxation oscillator configuration. However this time use is made of the fact that in such a circuit the peak voltage reached by the emitter before conduction is equal to the forward-bias voltage drop of the emitter-base junction plus a proportion of V_{bb} equal to the intrinsic standoff ratio. Hence by coupling a large capacitor C2 to the oscillator charging capacitor C by a silicon diode D1, the voltage developed across C2 during oscillation will automatically equal that fraction of V_{bb} given by the intrinsic standoff ratio.

Diode D2 permits calibration of the meter V_e directly in terms of the intrinsic standoff ratio. In the absence of a UJT, D2 clamps the junction of R and C at a voltage which exceeds V_{bb} only by the forward voltage drop of a silicon diode junction. As this voltage across C corresponds to a hypothetical intrinsic standoff ratio of unity, the meter may thus be arranged simply to give a full-scale reading. The fraction of F.S.D. indicated by the meter when a UJT is in circuit will then be equal to the intrinsic standoff ratio of the device concerned.

A full-scale reading on this test indicates that the device concerned has an open-circuited emitter. Conversely a zero reading indicates that there is an internal emitter-base short.

A fourth UJT characteristic which is useful in both design and servicing work is I_{eo} , the emitter junction leakage current. A device with excessive I_{eo} is generally unsuitable for level detection and timing applications, although it may be satisfactory for pulse generation. Typical devices have I_{eo} figures of less than 1uA, although some devices may range as high as 15uA.

It may be seen from figure 8(d) that the test circuit used for I_{eo} is similar to that used for leakage testing of diodes and bipolar transistors. A convenient value for the testing voltage V_{eb} is 10V, while the meter may conveniently be a 50uA unit.

Figure 9 shows a practical circuit which would perform the four UJT tests described in figure 8. As with the previous circuits it employs a single protected 50uA meter movement and 10V and 220V supplies. The meter ranges for the four tests are as follows:

OSC: 0-10V p-p.
 Eta: 0-1.
 R_{bb} : Inf — 1K.
 I_{eo} : 0-50uA.

Although the practical circuit of figure 9 and those given in figures 3, 5 and 7 could be constructed as individual device test units, a more economical approach is to combine them into a single comprehensive test set. Details of the resultant instrument will be given next month. ■

COMPLETE HI-FI RADIOGRAM-TAPE RECORDER ALL IN ONE

MODEL TR9

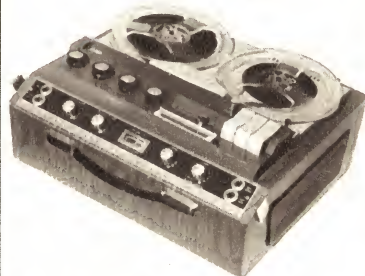

AS AN AMPLIFIER . . .

- Frequency response, 20-20000 cps.
- 7 Watts RMS. output per channel.
- Distortion less than 25%
- Separate treble and bass controls.

AS A RADIO . . .

- Being fully transistorised, can be switched on all day at full output without heat problems. Program can be recorded on tape without any external connections.

AS A TAPE RECORDER . . .

- Freq. response 30-18000 cps.
- 3 speeds. Meter level indicator.
- Push button operation.
- Superimposing.

PRICES:

2 track mono, \$159.00
 4 track mono, \$169.00
 4 track stereo, \$230.00

RADIO TUNER CAN BE FITTED TO ANY OF THE ABOVE MODELS FOR \$26.00 EXTRA.

TAPE DECKS

for the home constructor. COLLARO (Magnavox) tape decks complete with record/play and speed change switch wafers fitted . . .

2 tracks, \$48. 4 tracks, \$55. SPECIAL LOW IMPEDANCE HEADS for transistorised tape amplifier circuits (Mullard) available.

CLASSIC TAPE RECORDERS

938 LIVERPOOL ROAD,
 SUMMER HILL, N.S.W.
 Telephone 79-2618

MULTIDRAWER

A TRANSPARENT MULTI-COMPARTMENT DRAWER
AND OUTER CASE MADE OF STRONG CLEAR PLASTIC

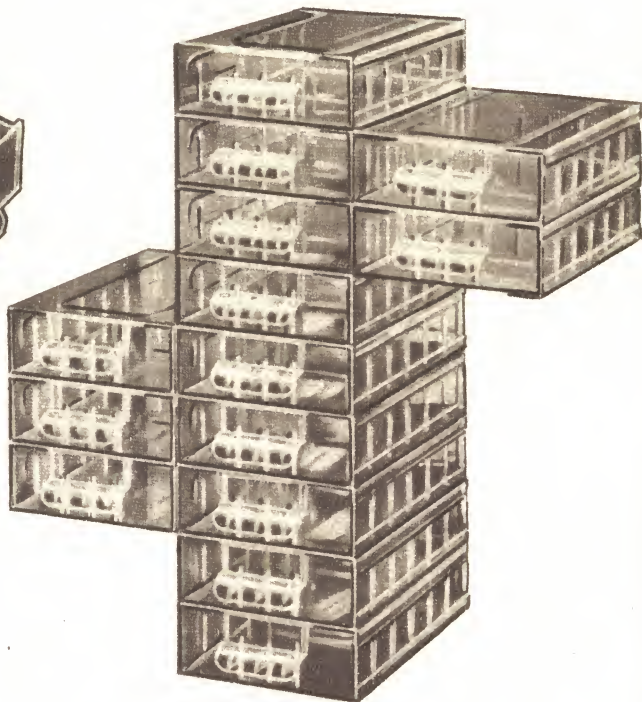
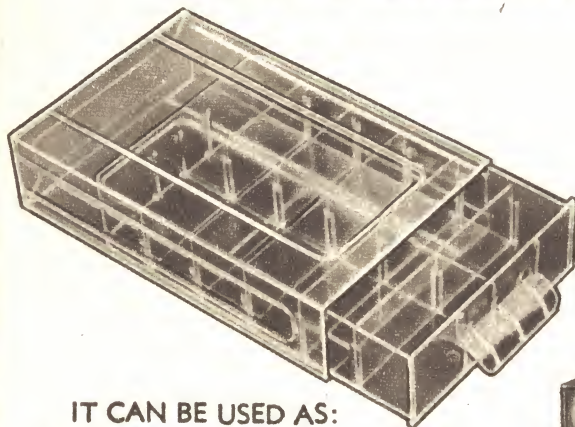

IT CAN BE USED AS:

- a self contained STORAGE BOX UNIT
- or a MULTIDRAWER CABINET by joining the individual units IMMEDIATE ASSEMBLY by sliding action
NO GLUE — NO TOOLS NECESSARY!

Each drawer can be partitioned into 12 varieties of compartment arrangements by removable dividers.

The Multidrawer consists of a drawer sliding into an outer case. Both parts are made of strong clear plastic to ensure immediate visual location of stored articles (opaque outer case also available). The outer case has built-in integral dovetails and grooves for vertical and horizontal assembly by means of sliding the corresponding sides. This assembly is achieved instantaneously without using any tools or cement.

The drawer has built-in grooved side ribs, which allow its partitioning into 13 possible combinations of compartments by simply dropping into the grooves standard dividers, available in 4 lengths. The longest of the dividers is provided with the same ribs as the drawer in corresponding positions, to firmly hold the smaller dividers.

The dividers can be left as removable for any future rearrangement, or could be cemented in by using TRICHLORETHYLENE.

The assembled cabinet will firmly stand on any flat surface and will not require additional reinforcement.

AT HOME: as a box for sewing, jewellery, haberdashery, hair accessories, cosmetics, medicaments, fishing accessories, writing utensils, small hardware, cigarettes and cigars, photographs, colour slides and many others,

AND IN: SHOPS, OFFICES, WORKSHOPS, LABORATORIES, STORES and FACTORIES.
for visible storage of small parts and also as production assembly aid.

THE MULTIDRAWER — THE STORAGE BOX OF 101 USES

SPECIFICATIONS: Drawer — transparent. Outer case — opaque (steel grey). Dimensions—Identical for both models are: Outer Case: Length: 9 5/16", width: 6 7/16", Height: 2 3/8". Drawer: Length, 9 3/8", Width: 6", Depth: 2". Protrusions of the handle — 3/4". Weight of the unit — 12 ozs.

Also available from General Accessories Interstate Branches.

Trade Enquiries Invited

Write to General Accessories for further information and Price List.

GENERAL ACCESSORIES

(A DIVISION OF ELECTRONICS INDUSTRIES)

116-118 CLARENCE STREET, SYDNEY 443 CONCORD ROAD, RHODES — 73-0211

Simple class or club project —

A BASIC BROADCAST TUNER

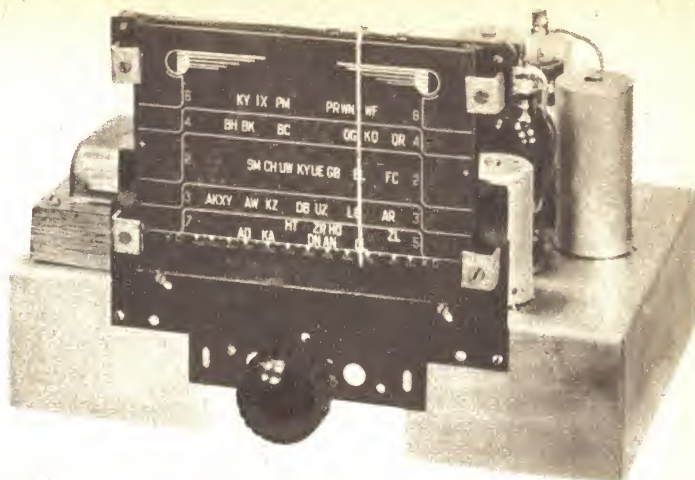

Prompted by the growing activity of radio clubs, particularly within our schools, we have produced another project in our "Basic" series. A standard tuner, it is an ideal companion unit to our Basic Mono amplifier of just over a year ago. Most of the parts can be salvaged from discarded sets.

By John Horsfield

Over the years we have presented a number of "Basic" projects; projects aimed at producing more or less standard pieces of equipment, without frills, but for which no one need apologise, and which could be constructed using a wide variety of components such as might be salvaged from discarded domestic receivers. These have been very popular and have enabled us to assist many a young enthusiast with a box full of parts but no instructions.

Our two most recent projects were amplifiers; A Basic Stereo Amplifier in June 1966 and A Basic Mono Amplifier in May 1967. The latter was inspired by a plea from a high school science master who pointed out that his allocations for electronic gear enabled him to acquire basic test equipment but left nothing over for the everyday units on which tests and demonstrations could be performed!

However, while he could not afford to purchase a new amplifier, radio tuner, etc., there appeared to be no problem about getting together enough older parts to build such items. Schoolboys have a way of scoring old parts from relatives, amateur operators and local servicemen and, in most situations, a teacher can usually find someone to put them together — given the right kind of guidance.

This tuner is intended as a companion unit to that amplifier. The two combined will constitute a radio receiver, a record player, and a public address system; all useful items in any school, with applications ranging from receiving school broadcasts, through innumerable PA applications, to presentation of music, poetry, and other recorded material.

The circuit is basically a two-valve superhet tuner, involving frequency converter, IF amplifier and diode detector. Operating under normal conditions, it handles just like the tuner of any household receiver, with good reception on all local stations using a modest aerial. Using a more elaborate aerial, good country and interstate per-

formance should be possible under favourable conditions.

Our prototype tuner achieved a sensitivity of around 7 μ V, varying only slightly over the band, on the basis of 50mV audio output when fed to a typical two-stage audio amplifier. The AGC characteristic limited the output increase to 11dB for a 60dB change in input. Selectivity and general quality were comparable with a normal broadcast receiver.

The power required is something like 250V at 20 to 25mA, plus energy for the heaters. Many amplifiers are designed for ultimate use with a tuner, for which reason a margin is allowed in the power transformer rating. However, where the transformer specifications have been varied or where the margin has not been allowed in the first place, the tuner may require its own power supply.

The schematic circuit provides for both conditions. If the main amplifier supply can carry the extra load, it is simply a matter of running the appropriate supply leads via a suitable plug and socket to the tuner. If, on the other hand, the amplifier supply is inadequate the alternative inbuilt power supply can be constructed on the tuner chassis as in our prototype.

Note that, when obtaining the supply from a main amplifier, the heater supply must not be earthed within the tuner. This connection will already have been made, and a second one could cause a short circuit.

When contemplating building something from oddment parts, it is necessary not only to allow for the greatest possible range of dimensions and ratings but also for the fact that the parts may no longer be true to label. In practice, resistors may change drastically from their rated value and capacitors may develop leakage and, in the case of electrolytic types, partially dry out, thereby losing capacitance.

The resistors and capacitors likely to be needed should be selected and then, if at all possible, checked before actual use. This could provide an exercise

for the class or club or it could mean a job for a parent or friend with access to test equipment.

CHASSIS: Size is not critical and a number of chassis could be pressed into service. Ours was fashioned from a standard blank aluminium chassis approximately 11in x 8in x 2 $\frac{1}{2}$ in, and several blank chassis about this size are available from electronic warehouses.

Actually, any chassis can be used which is large enough to hold all the selected components. For example, an old mantel radio may have a dial and tuning capacitor, some suitable valve sockets and a good mains transformer already mounted. Its chassis could in all probability be used, saving the time and trouble needed to obtain or make a new one.

However, if an existing chassis is used, some effort should be made to clean it up before construction begins. In some cases, a good wipe over or a touch-up with metal polish may suffice. In others, it may be better to block off redundant holes with tinplate or aluminium and spray paint it inside and out. Similar attention to other major components may well transform an obvious collection of oddments into something which looks quite respectable.

POWER TRANSFORMER: The first major component is the power transformer. This item is a most likely one to be salvaged from an old receiver and will probably be in one of two broad categories. From the larger, older console sets will come substantial units, seldom rated at less than 60mA, and having secondary windings of 285V, 6.3V, and 5V. From the smaller, somewhat later vintage mantel sets, will come physically smaller units, probably rated at 40mA, and with secondary windings around 200 or 150V, and 6.3V. Most of these should be suitable, neither the higher current rating of the larger ones nor the lower voltage of the smaller ones being a serious limitation.



PIONEER®

(pi-o-neer: noun—"one who leads the way or blazes a trail for others to follow"—Oxford Dictionary)

With hi-fi, as in most other fields, the value you get in the long run is just about what you pay for.

The facts of economic life dictate that a good article, too highly priced for its real value, will not sell for very long — a good article sold too cheaply will eventually put its supplier out of business — and then, of course, there is the "cheap and nasty" category where a few make quick but temporary profits from the more gullible consumers. PIONEER ELECTRONIC CORPORATION, of TOKYO, is the largest single Japanese manufacturer of loudspeakers with the phenomenal capacity of 2½ million units per month. This fantastic production supports the ONLY research and design department specialising in hi-fi equipment.

The PIONEER brand appears on everything from the itty-bittiest tweeter to the mightiest concert-hall integrated system. The range includes belt-driven turntables, magnetic cartridges, tuners, valve and all-solid-state amplifiers, stereo headphones and eleven different speaker enclosures. If you prefer to build your own enclosures, PIONEER has the widest choice of quality speakers.

The fact that PIONEER has led the field since 1938 is sufficient proof of the fact that you get the best value and performance from PIONEER hi-fi equipment.

If you still need convincing, ask for a demonstration from leading music or hi-fi dealers in your area.

*Trade enquiries to sole Australian Representatives —
ASTRONIC IMPORTS . . . All Capital Cities
A division of Electronic Industries Limited*

ASTRONIC IMPORTS

Some of the larger units may have tapped primary windings intended for use on 220, 240, and 260V supplies. Later designs tended to drop this feature. Where a 5V winding is provided it will be intended for the rectifier heater (directly heated type) with a 6.3V winding for the remaining valve heaters. Where there is a single 6.3V winding only it will be intended to supply all heaters, including the rectifier, which will be an indirectly heated type.

Generally speaking, the power transformer retrieved from an old set will

man, amateur operator, or an experienced enthusiast.

Use a 3-core cable for the incoming AC lead, connecting the third (green) "earth" wire to the appropriately marked lug on the transformer, which in turn should be connected to the metal chassis. This mains lead should be securely anchored to the chassis so no strain can be put on the connections. Discard any 3-core lead that shows signs of deterioration, such as perished rubber insulation, and if any doubt exists purchase new flex. This warning applies to any electrical appliance.

The rectifier socket, if salvaged from an old set, will most likely be a wafer type and must be thoroughly cleaned. If there are any signs of breakdown or charring between the pins, the socket should be discarded. Cleanliness is important for the rectifier socket, because it is subject to a considerable voltage and would be the first to break down if the insulation is impaired by charring or excessive dirt and flux. Bend or tighten the contacts if necessary, depending on the type of socket, so as to increase their grip on the valve pins.

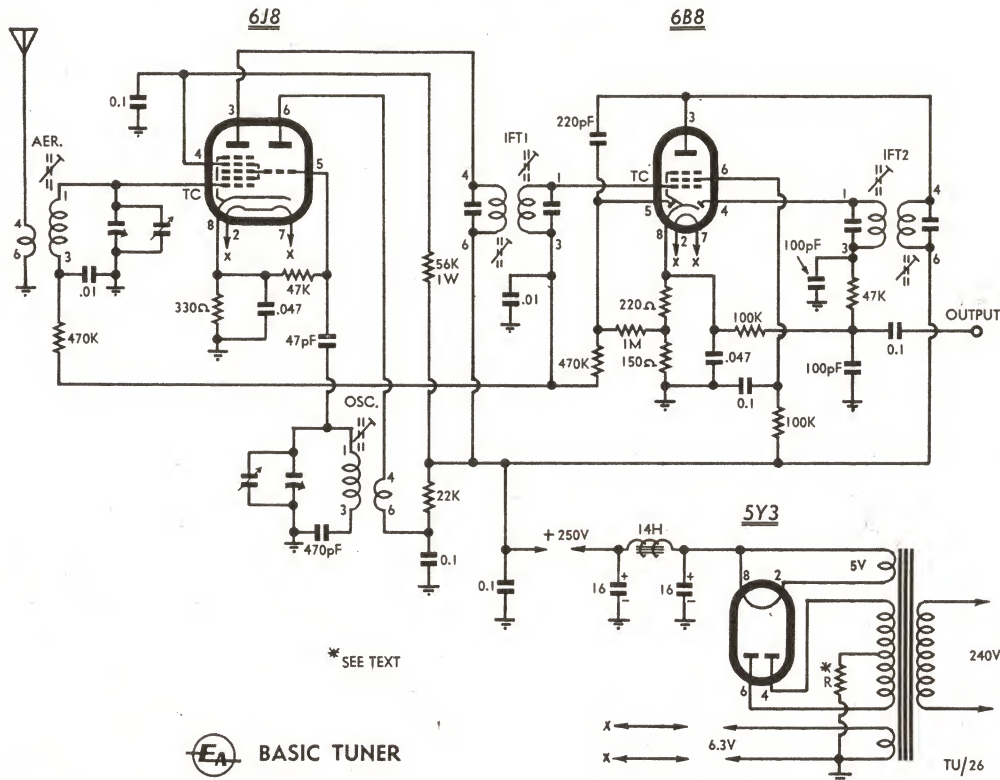

EA BASIC TUNER

The circuit is a perfectly standard arrangement, similar to the front end of conventional receivers, and capable of a similar order of performance. The power supply is optional and may be omitted if sufficient power is available from the associated amplifier.

either be good or bad. A close inspection will reveal whether it is in working order. Dust the transformer and the chassis in the near vicinity. If the transformer does not smell and the insulation isn't charred, it is most likely in working order. However, if the transformer smells or the winding has a charred appearance or the transformer and surrounding chassis show signs of a dark "gooey" mess which has been expelled from its inside, then the transformer is most likely useless.

The connections to an old-time power transformer were usually made by means of a terminal board, marked with the appropriate ratings. Cleaning with methylated spirit will reveal the figures if they have become obscured with dust and grime. If the figures are absent or the transformer termination is with leads instead of a terminal board, try to trace the wiring prior to removal from the original chassis.

If this cannot be done, use an ohmmeter to segregate the windings, apply 240V to the most likely primary winding and measure the other voltages. In a case like this, it may be advisable to seek the assistance of a local service-

RECTIFIER: Several types of rectifier are likely to be found in discarded sets, the most popular being the directly heated 5Y3 or even its four pin equivalent, the 80), and the indirectly heated types 6X5 and 6X4. Neither the heater nor the plates need to be connected with any particular polarity. In the case of directly heated types the HT positive is taken from either one of the heater pins. In the case of the indirectly heated types, it is taken from the cathode pin. Provided your transformer has a filament winding to suit the voltage of the rectifier, and can be isolated from all other functions in the case of the directly heated type, almost any rectifier type can be used.

Connection between the 5-volt winding and rectifier filament is made by means of twisted hookup wire. Since the output is taken from the heater, making the heater winding at the HT potential, this winding must remain insulated from chassis and other circuits. The extreme ends of the high voltage winding on the power transformer connect to the plates of the rectifier in the same manner as the heaters.

CONVERTER AND IF VALVES: There are a large number of valves suitable for these sockets, and we have prepared a table of typical types, together with component values, where these need to be changed. In some cases the converter may be critical in regard to the oscillator coil and, where possible, it is advisable to use a coil which is designed for or has been used with, the particular valve.

We used octal-based valves of old but trusty types which should be in ample supply in discarded radios, or can be bought new from a number of dealers. Only octal and miniature-based valves with 6.3 volt heaters are listed, since valves of this class and power transformers with heater windings to suit are likely to be most readily available. Older valves could conceivably be used but have them tested if possible before going ahead.

In the tables of substitute valves, we have not attempted to give comprehensive details, socket types, pin connections, etc., as we consider that most groups planning to build a tuner of this type will already have valve data books to hand. If these are not

20-100,000 cycles!!!

24-Watt Stereo Amplifier THE STAR SA-30

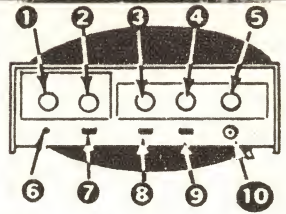
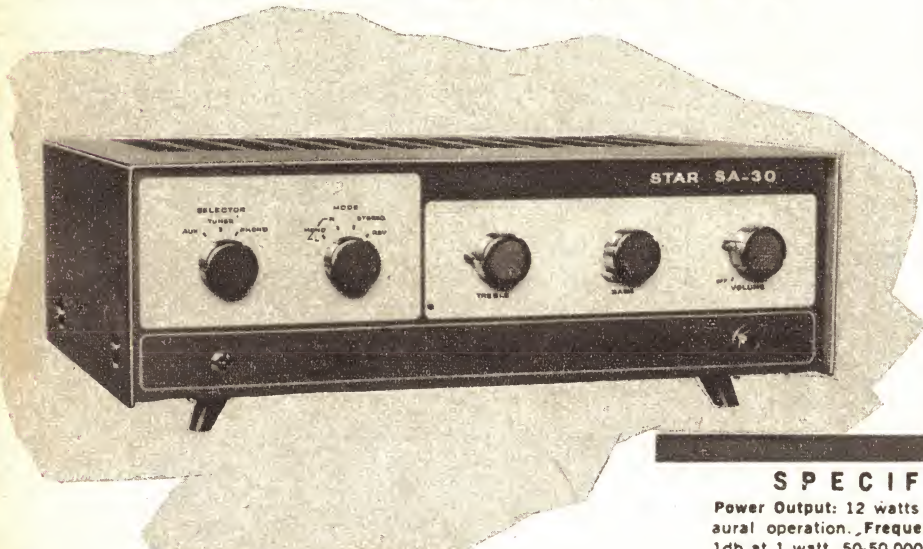

FULL STEREO CONTROLS

- ① 3-Position Selector Switch
- ② 4-Position mode Switch—Mono Left, Mono Right, Stereo, Reverse
- ③ Dual Concentric Treble Control
- ④ Dual Concentric Bass Control
- ⑤ Dual Concentric Volume/Balance Control
- ⑥ Pilot Light Indicator
- ⑦ Rumble Filter Switch
- ⑧ Phase Reverse Switch
- ⑨ Speaker-Headphone Selector Switch
- ⑩ Headphone Jack

SPECIFICATIONS

Power Output: 12 watts per channel stereo. 24-watts monaural operation. Frequency Response: 20-100,000 CPS \pm 1db at 1 watt, 50-50,000 CPS \pm 1db at 12 watts. Hum and Noise: Mag Phone—56 db below rated output, Tuner—73 db below rated output. Distortion: less than 1% total harmonic distortion at 12 watts (1KC), less than .25% total harmonic distortion at 1 watt (1KC). Sensitivity: Low Level (Mag Input) 5mv at full output, High Level .6v at full output. Outputs: Dual 8 and 16 ohm impedance speaker outputs. Dual Tape outputs, Tube Complement: Total of 8, 3-12AX7, 4-6GW8, 1-5AR4.

Dual 12-Watt Stereo Amplifier

Coupled With a Versatile Stereo Preamplifier . . . Performance
The Equal of Units 2 & 3 Times Its Power & Price.

CHECK THESE QUALITY FEATURES

- ✓ Stereo Headphone Jack
- ✓ Independent Concentric Bass & Treble Controls For Each Channel
- ✓ Concentric Volume Balance Control
- ✓ Frequency Response: 20-100,000 CPS \pm 1 db at 1 Watt
- ✓ Hum & Noise—73 db Below Rated Output
- ✓ High Sensitivity Allows Use With All Stereo Cartridges

Brilliant Stereo Performer . . . an amplifier with the wide-range frequency response, low distortion, low hum and noise characteristics you'd expect of amplifiers 2, even 3 times its power rating and many times its price. A full range of control facilities have been provided to assure complete Stereo capability and flexibility. Two dual concentric Bass and Treble controls provide separate and individual tone controls for each channel. A dual concentric volume Control acts as an independent level control for each channel and allows precise channel balancing. Fast, easy operation between Stereo, Reverse Stereo, Monophonic Left channel and Monophonic Right channel is furnished by a Mode switch. A selector Switch furnishes switching from Aux, Tuner or Phono music sources. In addition slide switches are included for: Rumble Filter (off-on) Phase (normal-reverse) and to take full advantage of the front panel Headphone jack a switch is provided for speaker or phone operation. Paired inputs located on the rear panel accommodate any of the ordinary stereo sound sources—inputs are included for magnetic, crystal or ceramic cartridges; Tuner, tape or auxiliary (high output) plus Tape Out jacks for recording through your tape recorder.

Beautifully styled in a low silhouette enclosure, color keyed to do justice to any decor. Ivory and gold front panel is contrasted by gold metal knobs and enclosure. Complete with cage and legs. Size: 5½Lx12¾Wx8½"D. Shpg. wt., 20 lbs.

**AVAILABLE AT ALL GOOD
HI-FI RETAILERS THROUGHOUT AUSTRALIA.**

already available, several can be bought quite cheaply. Suitable publications are the "Miniwatt Technical Data" published by the Miniwatt Division of Philips Electrical Pty. Ltd., the "Super Radiotron Valve Manual" published by Amalgamated Wireless Valve Co. Pty. Ltd., and "Radio Valve Data" published by Iliffe Books Ltd.

Table 1 lists alternative valve types suitable for the frequency converter, while Table 2 gives valves for the IF amplifier (with and without detector diodes). In some cases the type numbers will be found with the suffix -G or -GT, which simply indicates that the valve has been made with a glass envelope of a particular shape. The base connections and valve characteristics are the same.

FILTER CHOKE: This can be of any type which fits on the chassis to be used and which has a current rating of at least 25mA. It should be examined for any signs of damage, particularly discolouration and "burnt" smell. With an ohmmeter, ensure continuity of the winding and check for any leakage to earth.

FILTER CAPACITORS: These may be of 8 or 16µF and must have a voltage rating adequate for the particular transformer and rectifier used. Assuming a directly heated rectifier (5Y3, etc.) there will be a peak voltage during the warm-up cycle, due to the directly heated rectifier coming into operation almost immediately, and before the indirectly heated valves commence to draw current. Assuming a 285V transformer, the peak voltage will be 1.4 times this, or approximately 400 volts. In these circumstances, 500V ratings would be required.

In the case of an indirectly heated rectifier (6X4, 6X5, etc.) there will be no warm-up peak and the electrolytics need only withstand the normal running voltage. With a similar transformer, 350V types would be adequate. The combination of a lower voltage transformer and an indirectly heated rectifier could reduce the voltage ratings still further.

It is not advisable to use electrolytics that have been salvaged from old sets. The capacitance could be low and the leakage resistance may have fallen to the point where the rectifier and transformer are endangered. Fit new capacitors and be sure.

VOLTAGE LIMITING RESISTOR: The series resistor in the power supply between the centre tap of the trans-

former and the chassis is to limit the anode supply voltage to 250V after the filter. The value of the resistor will depend on the applied voltage from the secondary winding, the DC resistance and impedance of the filter choke and the current consumption of the tuner. This makes it very hard to state a definite figure for the resistor. However, it will not matter if you err on the high side initially.

The final value must be found largely by cut-and-try methods. A starting point would be 2.7K or 3.3K (8 or 10W), assuming a power transformer with a 285 volt per side secondary.

slightly, but this is not critical, provided the value is in the vicinity of 400pF.

If the dial has station call signs or frequency markings on it, it should ideally be matched to the gang. On the other hand, it should be possible to calibrate a suitable card and attach this over the old calibrations.

The circuit is relatively simple and non-critical and should present no problems, even to beginners. While we have used a particular chassis and layout, other arrangements are possible. In general, the idea is to keep the components for each individual stage adj-

Table 1, Frequency converters.

Type	Rs	Rat	Rgt	Rk
6AE8	56K-22K	33K-8.2K	33K	180
6AN7	56K-22K	33K-10K	22K	180
ECH35	47K-18K	47K-18K	47K	220
X61M	47K-18K	47K-18K	47K	220

Rs: Screen resistor. (1W). Rgt: Triode grid resistor
Rat: Triode anode resistor. Rk: Cathode resistor.

All other components unchanged.

Table 2. IF amplifiers (and detectors).

Type	Rs	Rk
6AD8	68K-27K	220
6BA6	33K-12K (1W)	68
6BH5	100K-27K	330
6K7	47K-10K	220
6N8	100K-33K	330
6SK7	56K-18K	270
EBF35	100K-33K	330
EBF80	199K-33K	330

Rs: Screen resistor. Rk: Cathode resistor.

Typical component values for other valve types. The lower values shown under "Rs" and "Rat" are for use with HT supplies of 150V.

The initial value of resistor should be connected into the circuit and the power switched on only long enough to measure the voltage. If it is excessive, an intelligent guess must be made to decide what value of resistor to try next. Where a lower voltage transformer is used, the resistor may not be needed.

TUNING CAPACITOR AND DIAL: It is usually possible to salvage a two gang tuning capacitor in reasonably good condition. The gang should be examined for bent and corroded plates. The insulators should be clean and free from mechanical damage. Values of tuning capacitors may vary

acent to the stage, and for the signal path to follow in logical sequence from input to output, as it does in the circuit. The photographs of the chassis should help prospective constructors with ideas for their own layouts.

When orientating valve and coil bases plan for the shortest possible signal leads. Grid and plate leads are the critical ones, the HT and AGC leads are not normally critical, since they are not, or should not be, carrying signals. If the heater circuit is to operate from the tuner's own power supply the heaters may be connected with a single wire, the other pin connecting to chassis in each case.

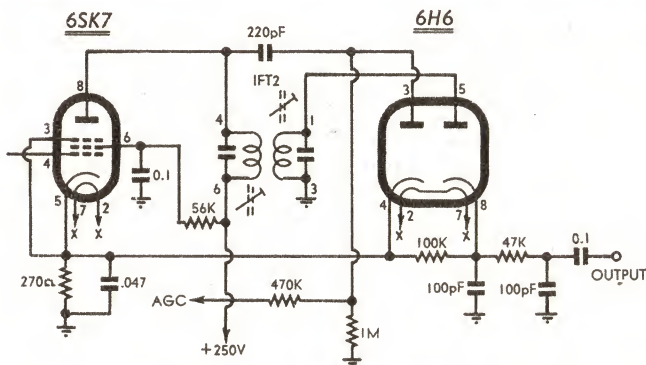

BASIC TUNER WITH SEPARATE VALVE DETECTOR

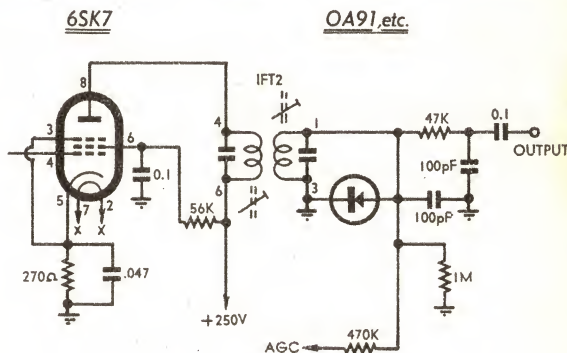

BASIC TUNER WITH SEMICONDUCTOR DIODE DETECTOR

Two alternative circuit arrangements for use with IF amplifier valves having no diodes. The one at the left uses a separate duo-diode valve in a virtually identical circuit. On the right is a slightly simpler circuit using a single solid state diode.

Now in every price range, every tracking force range

from sophisticated to budget priced
from $\frac{3}{4}$ grams to 5 grams.

With the introduction of our extremely low cost new M32E elliptical stylus cartridge ($2\frac{1}{2}$ to 5 gram tracking, 20 to 17,500 Hz), and M31E elliptical stylus cartridge (1 to 2 grams tracking, 20 to 18,000 Hz), you can now get Shure quality in the broadest possible spectrum of prices and specifications. Given our "druthers," we would prefer you bought the Shure V-15 Type 11 Super Tracability cartridge, because we feel it's the world's finest cartridge, and independent critics the world over agree with us. However if your equipment or your exchequer dictates another cartridge, be assured that Shure makes a really complete line of best-in-their-price-class cartridges. Note for instance the impressive line-up of elliptical styli cartridges below. Detailed literature on the complete Shure group with the reason for each is available at no cost from Audio Engineers, the Australian distributors for all Shure Brothers quality equipment.

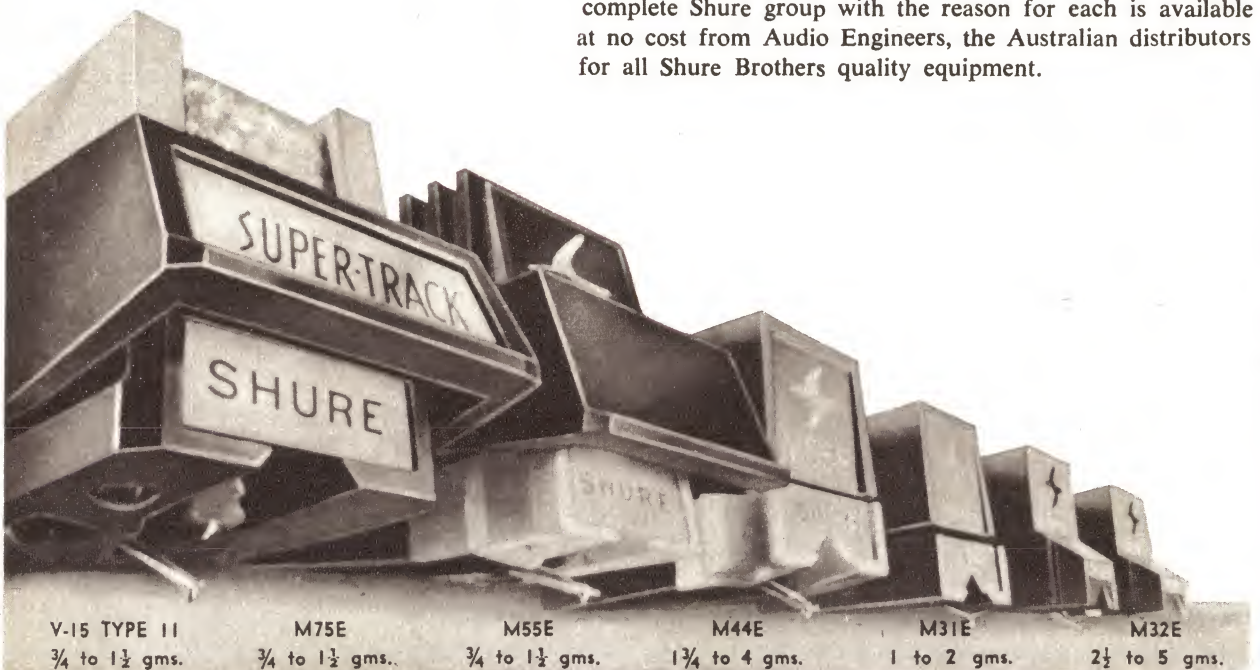

Distributed throughout Australia by:—

Audio Engineers Pty. Ltd.

342 KENT STREET, SYDNEY. 29-6731

This arrangement is normally a good deal simpler than using a twisted pair. However, where the tuner is to operate from another power supply, the heater circuit of which may already be connected to chassis, use twisted pair and keep both sides of the circuit remote from chassis.

Turning back to the basic circuit, this involves a 6J8 as the frequency changer, with a quite conventional set of components. You will need a standard aerial and oscillator coil — intended for valves, not transistors — and the oscillator coil should be of a type to suit the valve selected.

It will simplify matters if the coils are chosen to suit the cutouts in the chassis, but, otherwise, the brand does not matter. Before mounting the coils, take careful note of their connections. Much the same remarks apply to the IF transformers. They should suit the chassis cutouts, they **MUST** be for valve circuitry, and they should be suitable for a single-stage IF system.

Identifying the terminals on salvaged coils may be a problem. Some coils are coded with numbers, some with letters, and some according to some quite arbitrary code evolved by a particular manufacturer. Our circuit shows the numbering code normally used, while the lettering code would read "G" (grid), "F" (filament, cathode, AGC) "P" (plate), and "B" (B plus) for the 1, 3, 4, and 6 respectively. Where an arbitrary colour code only is used the problem is more difficult, but at least try to check the wiring of the coils before the old chassis is stripped down. Provided at least one terminal from each winding, e.g., plate and grid, can be identified, the remaining two may be identified by continuity.

In our prototype tuner, we used a 6B8 as a combined IF amplifier, signal detector and AGC detector. The circuit of each part is quite conventional, with delay for the AGC detector being obtained by tapping its load resistor into the cathode resistor of the amplifier section. If no delay is wanted, this load resistor should be connected to chassis, and if more delay is to be obtained, the load may be connected to the amplifier cathode.

Table 2 lists a selection of valves which could be used in place of the 6B8, some including diodes and others without. If a simple pentode is used in this position, a separate detector becomes necessary, and two alternative circuits are presented to meet this requirement.

In the alternative detector circuits, a 6H6 has been given as a typical valve which should be readily available. Other suitable valves are the EB34 (a plug-in replacement for the 6H6) and the 6AL5. Two semiconductor diodes could be used in place of the twin diode valve in the same circuit. The other circuit using one diode shows how both signal and AGC detection functions can be combined, although without delay for the AGC. Almost any semiconductor diode may be used in this position.

In terms of ordinary broadcast receiver practice, the 6BA6 has higher gain than most other IF amplifier valves and this may lead to instability. This is evidenced by a whistle which varies in pitch as the unit is tuned across each station.

This tendency to instability can be

readily controlled by the provision of a neutralising capacitor wired between the plate of the IF amplifier and the AGC lug of the first IF transformer. The presence and value of the neutralising capacitor affects the alignment, particularly of the IFT2 primary and the effect of the neutralising capacitor should only be judged on the basis of how the IF system behaves with the transformers peaked with the particular value of neutralising capacitor in circuit.

If the neutralising capacitor is too small, the IF system will go into oscillation as any or all of the cores are brought to the peak of resonance. If the neutralising capacitor is too large, the most obvious effects will be gross lack of sensitivity. A starting value for this capacitor could be 18pF or thereabouts.

If the wiring is free from errors and the tuner is connected correctly to the amplifier system, it should operate at switch-on. Its ultimate performance, however, and the position of stations on the dial will depend on proper alignment of the various tuned circuits.

An initial precaution, before commencing alignment, is to see that the pointer is set correctly in relation to the scale. If the scale has a "set pointer"

mark, the pointer should correspond with this when the tuning gang is fully in mesh. In the absence of such a mark, arrange matters so that the pointer over-runs the calibrations on the dial by an equal amount at either end of its travel.

The alignment procedure is quite straightforward and readers may follow any appropriate set of alignment instructions. The following paragraphs should, however, assist those who have no other reference available. The procedure will vary according to whether or not a calibrated signal generator (or service oscillator) is available.

If using a signal generator, the first step is to set the generator dial to 455KHz and, by feeding the signal into the mixer grid, to peak the four IF transformer windings for maximum response.

A point to watch, when aligning the IF transformers is that, in many types, the adjustable cores can be screwed right through each winding, so that two peaks can be found, one with the core passing from the end of the former into the coil, and another with the IF passing beyond the coil towards the centre of the former and the adjacent winding. Unless there are specific instructions to the contrary, the cores

Right: Rear view. The converter valve and aerial coil are at the left front of the chassis, and the IF amplifier towards the rear. The oscillator coil is just behind the tuning gang.

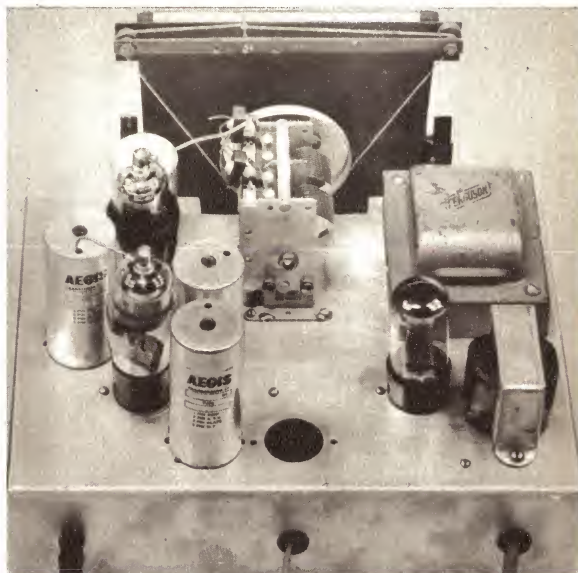

Below: Underside. Aerial coil is at top right, converter valve below it, and IF valve below that. The 1st IF transformer is to the right, the oscillator coil to the left. The 2nd IF transformer is at the bottom.

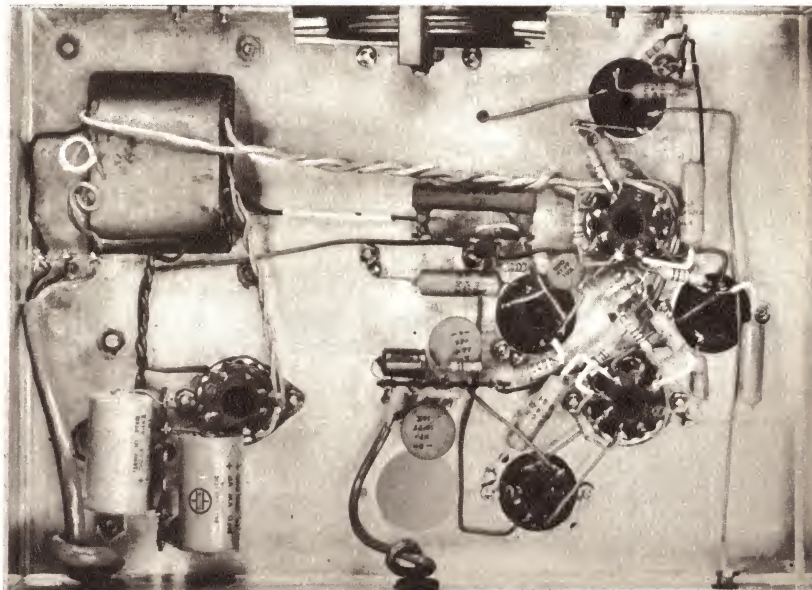

**MAKE YOUR NEXT
CHOICE A UHER**

UHER

**MADE IN
W. GERMANY**

"The World's most reliable name for precision tape recorders"

ATRAM PTY. LTD.

PRESENTS ANOTHER NEW
TECHNICAL PERFECTION IN

ACTION and SOUND!

The All New Breed

UHER ROYAL-DELUXE



UHER ROYAL STEREO DELUXE

Stereo home studio of the ultimate hi-fi class, 20 watts rms, push-pull output ● Complete independent hi-fi amplifier ● Horizontal or upright operation, can be hung on wall like a picture ● New tape comparator for automatic control of tape tension in all positions ● Optimal flutter performance ● 4 magnetic heads ● A+B monitoring ● 4 and 2-track operation ● 4 speeds. ● 11 exclusive recording functions. + Operated by one control knob. ● Including built-in dia-pilot, echo sound, synchro play, multi play. ● Two channel mixer for mono and stereo, and many other features.

SPECIFICATIONS

- Recording: Two-track and four-track options (Interchangeable head assemblies).
- 4 magnetic head—A + B monitoring.
- 4 Amplifiers—VOR
- Tape speeds: 7½ ips, 3¾ ips, 1.7/8 ips, 15/16 ips.
- Frequency range: 7½ ips, 20-20,000 hz.
3¾ ips, 20-15,000 hz.
1.7/8 ips, 20-9,000 hz.
15/16 ips, 20-5,000 hz
- Wow and flutter:
plus minus 0.05% at 7½ ips.
plus minus 0.1% at 3¾ ips.
plus minus 0.25% at 1.7/8 ips.
- Electronics:
39 low noise silicon transistors.
- AC supply: 110, 130, 220, 240v. 50(60)hz.
- Signal to noise ratio:
7½ ips 54 db.
3¾ ips 54 db.
1.7/8 ips 54 db.
- Residual noise after erasure: 7½ ips, 70 db, 1000 hz.
- Generator frequency: 100 khz plus or minus 10%.
- Signal transfer: 65 db, single channel + stereo.
- Output power: 2 x 10 watts, sinewave tone.
- Motor: Hysterisis synchronous external motor, Pabst system.
- Inputs: 2 x micro 200 ohms.
0.2 mv to 100 mv
Radio 47 k ohms.
2 mv to 1v.
Phono I 1 megohm.
50 mv to 10 v.
Phono II 50 k ohms.
200 mv to 10v.
- Outputs: 0.775v across 4 ohms 10 watts.
- Source impedance: 0.1 ohm.
- Monitor: 0.775v across 15 k ohms.
- Dimensions: 445 x 345 x 195mm with cover.
- Weight: 29lb.

The Royal stereo embodies every conceivable sophistication of the recording art. Expensive? How expensive is quality?

It is not our task to offer cheap tape recorders, only the very best. In case you can find a better one, then we suggest that you buy it, but it will be dearer, much dearer — First Royal Deluxe arriving in July.

ATRAM PTY. LTD.

**Sole Authorised Australian Importer and General Agent.
5 McLAREN STREET, NORTH SYDNEY**

Available in All States from Franchised Agents only.

N.S.W.: John Border Photographics Pty. Ltd., 175 Liverpool Street, Sydney. Tel.: 26-1106.
N.S.W.: Tomlins Radio, 528a Liverpool Road, South Strathfield. Tel.: 642-4215.
N.S.W.: Milversons (Chatswood) Pty. Ltd., 399 Victoria Avenue, Chatswood. Tel.: 41-2121.
VIC.: Atram Pty. Ltd., 28 Wellington Street, St. Kilda. Tel.: 51-4466, 51-4577.

S.A.: Kallin Distributors (Wholesale) Pty. Ltd., 140 Gawler Place, Adelaide. Tel.: 8-7171 (11 lines).
W.A.: Alberts TV and Hi-Fi Centre Pty. Ltd., 282 Hay Street, Perth. Tel.: 21-5004.
N.T.: N.T. Musical and Electrical Wholesale Pty. Ltd., 54 Cavanagh Street, Darwin. Tel.: 3072.
QLD.: A. E. Harrold Pty. Ltd., 123-125 Charlotte Street, Brisbane. Tel.: 31-3081.

should always be peaked in the outer position, that is, furthest away from the centre of the former winding.

Peaking, one or both cores, to the inner position can upset the coupling and the shape of the IF selectivity curve and may increase gain sufficiently to cause instability.

Having satisfactorily completed the alignment of the IF amplifier, it remains to adjust the aerial and oscillator circuits. Set the signal generator to 600KHz and feed its output to the tuner via the aerial and earth terminals. Tune in the signal and move it along the tuner dial by adjusting the core of the oscillator coil until the tuner dial is reading accurately 600KHz.

Because of the AGC action, the effect of adjustments is noted most easily when feeding a weak signal into the tuner. With a signal generator this simply involves suitable adjustment of the attenuator. With a modulated oscillator having a less effective attenuator, it may be necessary to unclip the active signal lead from the terminal and clip it instead around a scrap of insulated wire attached to the terminal.

Having set the low frequency end of the dial, tune the signal generator to 1500KHz and bring the pointer to the correct position on the tuner dial scale by adjusting the oscillator trimmer. Then peak the aerial trimmer for maximum signal strength.

At this juncture, tune across the band and see how the stations compare with their calibrated positions on the dial. Effect whatever compromises may be necessary by shifting the low frequency stations first with the oscillator CORE and the high frequency stations with the oscillator TRIMMER.

Having thus put the stations in the best positions on the dial, leave the

oscillator adjustments set and, using the signal generator once again, peak the aerial core on the low frequency end of the band and the aerial trimmer on the high frequency end of the band.

If no signal generator or oscillator is available, one can only proceed on the assumption that the IF windings were left somewhere near their intended frequency. Further that, while their resonance will have been affected somewhat by circuit wiring, the average will be somewhere near 455KHz. On these assumptions, leave the IF windings alone for the time being and proceed with the alignment of the aerial and oscillator tuned circuits.

Tune in a known local station towards the low frequency end of the band (typically 2FC in the Sydney area) and move it to its calibrated position by means of the oscillator core. Now peak the aerial core for maximum signal strength. It may be necessary to reduce the signal strength initially by unclipping the aerial or, better still, tuning to an adjacent steady but weak signal.

Now tune to a station near the high frequency end of the band, move it to its calibrated position by means of the oscillator trimmer and peak the aerial trimmer for maximum signal strength.

Finally, with the tuner set on a weak but steady signal — this should be no problem in daylight hours — touch up the cores in the IF transformers for maximum signal strength. As a general check, the whole procedure may then be repeated, using for preference weak but steady signals.

With care and a small element of luck, the performance of the tuner so aligned should be very close to optimum although, should the opportunity occur, it is always a good plan to have the job checked with instruments. ■

Vietnam Calling

(Continued from page 17)

when it handled more than 10,000 distress calls in the span of a few weeks . . . as in the disastrous Minnesota-Wisconsin floods of April, 1965 . . . as in Hurricane Carla in 1961, when 200 MARS members provided a communications network for the military, the Red Cross, and Civil Defence . . . and as in the more recent disastrous hurricane called Beulah, which hit Texas and Louisiana in the autumn of 1967.

By the time Beulah came along, MARS had a pre-arranged plan of operations. For days in mid-September, Roland Belk, 4th Army MARS director stationed at Fort Sam Houston in Texas, had followed the Weather Bureau's hurricane warnings. At 7.15 p.m. on September 18, using every available means of communications including his own, he requested all other radio traffic to relinquish the 4020- and 4030KHz frequencies for emergency use, and simultaneously he established liaison with state and local authorities. Fifty or more MARS amateurs pitched in; so did another 100 operators in RACES (Radio Amateur Civil Emergency Service); and before the crisis was over they were responsible for assisting in the evacuation of thousands of disaster-threatened residents, including 170 patients in a hospital in Hollingen, Tex., who might

well have perished were it not for a quickly established MARS station at the Air Force base nearby. As MARS Director Belk remarked on October 3, after he had restored the two frequencies to normal use: "Well, they know MARS is here to stay now; I couldn't have said that two weeks ago." (Condensed from "Electronic Age.") ■

Lamp Protector

(Continued from page 51)

larger fuse would provide little protection. If this order of load is contemplated it may be possible to use a 5A fuse, since they will usually take a small overload, but there is then the risk of premature fuse failure which, in nuisance value, is nearly as bad as a lamp failure.

For those readers who wish to "soft-start" larger loads, e.g., a bank of flood-lamps, we suggest alternative Triacs to the SC40-D. The SC45-D is suitable for loads up to 2,400 watts and the SC50-D up to 3,600 watts. Both these Triacs have identical triggering requirements to the SC40-D and can be used as direct replacements for it. The ratings of the fuse and the switch would have to be increased.

It may be possible to build this unit into the projector it is to be used with, but the LDR must be shielded from all light apart from that emitted from the 6-volt lamp. If it is to be used with a movie projector

AMPERE GROMMETS

Save time and money!

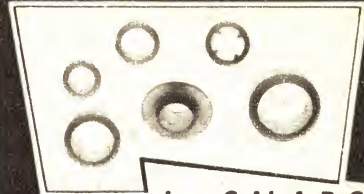

Just S-N-A-P-S into position

- Neat and tidy
- Transparent.
- Lightning fast assembly • Insulates Bare Metal edges • Does not mark or damage polished or lacquered surfaces • Slides smoothly on Suspension Rods

Plastic and Polythene Grommets available in sizes 1/4in to 1 1/4in. Ideal for insulating bare and sharp metal edges in Radiograms, Television Sets, Tape Recorders and other Electronic devices, etc.

AVAILABLE FROM ALL WHOLESALE HOUSES THROUGHOUT AUSTRALIA

DISTRIBUTORS:

N.S.W.: Jones & Park Pty. Ltd., 85 Planthurst Rd., Carillon—546-6144. QLD.: T. H. Martin Pty. Ltd., Martin House, 56 Edward St., Brisbane—2-0555. S.A.: H. R. Hill & Sons Pty. Ltd., 303B Prospect Rd., Blair Athol—65-6248; After Hours, 96-2714. W.A.: Everrett Agency 17 Northwood St., West Leederville, Perth—8-4137. TASMANIA: G.E.C.-A.E.I. (Australia) Pty. Ltd., 164-166 Elizabeth St., Hobart—34-3966, 187 Brisbane Street, Launceston—2-2041.

AMPERE ELECTRICAL MANUFACTURING CO.
174-176 HIGH ST. PRAHRAN,
MELB. 3181 PHONE 51 4333

ACOS CHANGER DUST BUG

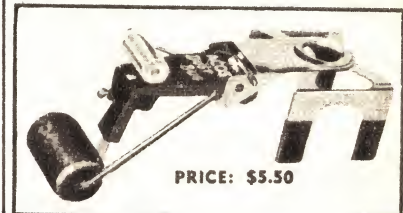

PRICE: \$5.50

Essential to all who value their records, the Changer Dust Bug clips easily over most changer arms and sweeps the record both before and behind the stylus, at the same time depositing a very fine antistatic film which prevents dust attraction through static changes. Record and stylus life can be increased by up to five times with a Changer Dust Bug. Spare fluid, bristles and plush pad are available in complete spares kit.

AMPLION (A/SIA) Pty. Ltd.,
29 Major's Bay Rd., Concord, N.S.W.

incorporating sound reproduction the output from the Triac must not be applied to the power transformer for the amplifier, as the gated sine wave input may generate large spikes which could cause damage to the Triac or the amplifier components. ■

OUR NAME HAS CHANGED

from

International Resistance Company (Australasia) Pty. Ltd.

to

IRH Components Pty. Limited

and for your convenience

ALL THE PRODUCTS LISTED BELOW

are

NOW AVAILABLE FROM ONE SOURCE

IRH COMPONENTS PTY. LIMITED

CTS: Volume Controls, Potentiometers and Rotary Switches.

DYMO: Embossing Tools and Tapes.

ELCO/VECTOR: Plugs, Sockets, Connectors, Matrix Boards and Kit Sets.

IPCO: Pyrometric Recorders.

I.R.C.: Carbon Composition, Metal Glaze, Deposited Carbon, Metal Film, High Voltage and Wire Wound Resistors, Single Turn and Multi-Turn Precision Trimmers, Silicon Rectifiers, Zener Diodes and other Semi-Conductor Devices, Fixed Attenuators, Rheostats and Sliders, Ceramic Capacitors.

K.L.F.: Pressure and Vacuum Gauges.

LUMOLITE: Indicator Lamps—Neon, fluorescent and filament.

MAGNETIC DEVICES: Relays and Solenoids.

MURATA: Ceramic Filters, Piezo-Electric Tuning Forks, Ultrasonic Transducers and other Piezo-Electric Devices, Posistors.

MULON: Micro-Switches.

N.K.K.: Miniature, Sub-Miniature Toggle, Lamp Lighted Switches.

ROBINSON-HALPERN: Transducers.

ROTOTHERM: Thermometers and Temperature Controllers and Recorders.

SEAELECTRO: 'Press Fit' Terminals, 'Conhex' Connectors and 'Seaelectoboard' programming boards.

SCOPE: Soldering Tools and Devices.

SCOTCH: Electrical and Recording Tapes.

TELETRON: Plugs, Sockets, Terminal Strips, A.P.O. Type Fuses, Telephone Plug and Socket, Relays and Solenoids.

IRH Components Pty. Limited

(A subsidiary of International Resistance Holdings Limited)

The Crescent, Kingsgrove, N.S.W., 2208

Telephone: 50 0111



The Serviceman



FAULTY FILM? FAULTY PROJECTOR?

One of the problems of being technically orientated is that you often get involved technically in situations which you were supposed merely to enjoy! I guess every serviceman gets his share of sentences beginning: "While you're here . . ."

In fact, only the other day I came across some discussion of over-awareness of technicalities in the entertainment columns of one of the daily papers. Special mention was made of the technically-minded person who seemingly delights in making remarks about flaws in the behind-the-story detail.

I can't exactly claim complete innocence in this regard myself. In scenes like cavalry charges, pursuits on horse-back, runaway coaches and so on, I automatically cock an eye to see how many times the action passes the same tree or the same rocky outcrop — the result of the film editors building up a sequence from shots of the same action taken from different camera angles.

And most of us, I guess, have been amused by the science fiction situation which hangs all kinds of out-of-this-world events on a laboratory equipped with an array of quite ordinary test equipment.

However, the crowning story in the column I mentioned concerned a young doctor who took his girl-friend to see a film rather outside the normal Hollywood formula. Behind a rather passionate love scene the sound track carried not "hearts and flowers" music but a heart beat. The doctor was not impressed. He broke the spell for his girl-friend by pointing out that, in the circumstances portrayed, the heart-beat should not be 78 but something over the hundred.

As you might imagine, these remarks were prompted by a particular situation in which I found myself, for social, rather than technical reasons. Strange as it may seem, a serviceman does have some sort of social and family life — which begins after 9 p.m. if he isn't careful to organise it otherwise.

However, I found myself one evening, sitting in a social group and watching a 16mm sound film in the company of the man who had organised the showing.

One thing that became immediately apparent after the start was that the sound level was barely sufficient for someone with good hearing, let alone anyone further back in the group who might have suffered from a hearing loss. My friend fidgeted for a few

minutes, then sneaked back to the projectionist to ask him to "turn it up a bit."

When he came back to his seat, it was to whisper that the projector amplifier was "flat out" and that the film must have had a poor sound track.

Suddenly, about 15 minutes later, with everyone still straining to hear, the sound suddenly blared out at well above the previous volume, such that the projectionist had to grab for the control.

I've handled enough sound films to know that sound variations do occur when segments of a film are replaced, as a result of damage, or when a couple of somewhat worn prints are cut and spliced to make a single, more usable print. But the jump in level of this particular film was a bit rugged, to say the least.

However, I would probably have forgotten the incident had not my friend rung next day to say that he had checked with the distributor of the film, who had stoutly denied both the poor level at the start and the jump in level half-way through. As far as he was concerned it was a relatively new and completely satisfactory print, requiring no more than the usual amount of monitoring by the projec-



Heavy-handed assembly in the factory had caused this EHT rectifier socket to crack, providing an air path for arcs to the "outside world".

tionist, to suit the particular situation and audience.

What did I think?

Well, it seemed clear to me that there was an intermittent of some kind in the projector amplifier and it would have to go back to the local agents. For this suggestion my friend showed a distinct lack of enthusiasm. He had another showing coming up within a few days and there was little chance of getting service done in the meantime.

Couldn't I help . . . please?

After further "arm-twisting," I finally agreed to have a cursory look at the amplifier and to fix anything that might emerge as obvious. But I wouldn't get involved with the mechanics or optics of the projector or do anything that I felt should be the concern of the agent. To this my friend agreed and, in short order, had dropped the projector on to the counter, complete with a modest instruction book.

It transpired that the amplifier was built into the base of the projector. Removal of a bottom cover plate gave access to the wiring, which was mainly on a flat bakelite board, with components hung on riveted lugs. To gain access to the top of the amplifier, it was necessary only to undo a knurled nut and tilt the projector forward.

So far so good.

It didn't take long to realise that I would not need a signal source to feed the amplifier. With no film in the gate and with the gain control fully advanced, there was enough 100-cycle modulation on the exciter light filament temperature to feed an audible hum through the system. All I had to do was to listen to the hum while I measured and prodded.

Basically, the amplifier consisted of an EF86 preamplifier, an ECF80 amplifier and phase splitter, and two EL95 output pentodes. My first action was to go over the circuit looking for unlikely voltage levels or evidence of leaky capacitors. As I prodded, I noticed the hum level changing, confirming that the gain of the amplifier was far from steady, for one reason or another.

Gradually the prodding led me to the ECF80 socket as being "touchy," though I couldn't be sure whether the stage was a source of trouble or merely a point from which impulses were affecting something else.

As a first step, however, I pulled the valve from the socket, checked the contacts as closely as I could for looseness and dry joints, then gave the socket a squirt of cleaning fluid. While it was still wet, I pushed the ECF80 in and out several times to rub off any surface-fouling of the pins or contacts.

When next I switched the amplifier on, the "touchiness" around the particular valve had disappeared and the general sound of the full-gain hum and hiss seemed much smoother. Maybe the trouble had been no more serious than a dirty socket!

Fortunately, however, I resisted the temptation to say "she's right, mate." Instead, I went on to clean and check each of the other sockets and then, with the amplifier in operation, began systematically to push and poke each wire, joint and component, while listening carefully to the hum.

All went without hint of trouble till I came to the cathode bypass for the

Let The World University Of Postal Education TRAIN YOU FOR A KEY JOB



BRANCHES THROUGHOUT THE WORLD

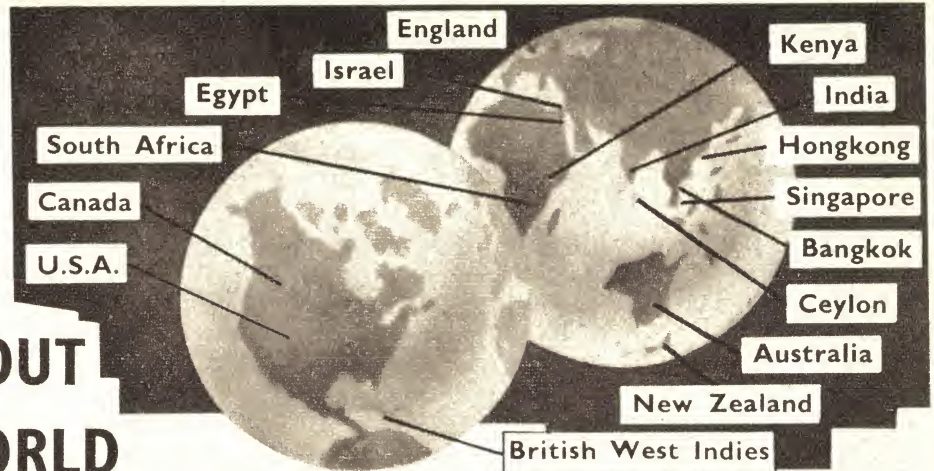

TODAY there are wonderful Opportunities for the forward-looking man and woman. However, the best jobs go to those who have the foresight to prepare themselves by proper Training. British Institutes have already trained some 300,000

men and women who have reached the top of the ladder. Therefore, it is up to **YOU** to make something of yourself. Don't delay, act **NOW**. Remember that an enquiry places you under no obligation but could be the turning point in **YOUR** career.

OVER 500 COURSES

Courses offered by British Institutes include:—

TECHNICAL

Aero Engines
Aeronautical Eng.
Air Conditioning
Arch. Drwg. & Design
Automation
Auto Elec. Equipment
Automobile Eng.
Automobile Repairs
Building (General)
Carpentry & Joinery
Chemical Engineering
Civil Engineering
Computers
Die & Press Tools
Diesel Engines

Draughtsmanship
Electrical Engineering
Elec. Installations
Elec. Measurements
Electrical Power
Electricity Supply
Electronics
Foundry Practice
Garage Management
Gas Turbines
Geology
Hydraulics
Illuminating Eng.
Industrial Chemistry
Jig & Tool Design
Mach. Drwg. & Design
Maintenance Eng.

Management
Marine Engineering
Mechanical Eng.
Metallurgy
Municipal Engineering
Naval Architecture
Painting & Decorating
Patternmaking
Petroleum Technology
Plastics
Production Eng.
Radar Technology
Radio Engineering
Radio Servicing
Refrigeration
Reinforced Concrete
Road Engineering

Rubber Technology
Sanitary Engineering
Structural Eng.
Surveying
Telecommunications
Television
Television Servicing
Timber Technology
Tracing
Welding Technology

Business M'gement
Commercial Art
Commercial Law
Company Law
Costing
Economics
Fiction Writing
Journalism
Secretaryship
Selling

COMMERCIAL

Accounting
Advertising
Auditing
Book-keeping

GENERAL

English
European Languages
Mathematics
Shorthand
Typewriting

And many other Subjects.

Details of Engineering and Commercial Exams., Certs. of Competency, Matriculation, etc.

CHECK THESE FEATURES:

- Modern streamlined methods . . . you learn the fast way and make rapid progress.
- Courses based on STANDARD TEXT-BOOKS . . . Lessons and Model Answers written and planned by experts.
- We provide all necessary text-books which remain your own property.
- Moderate fees payable by small monthly sums. Written guarantee.
- Courses can be "tailored" to individual requirements.

SECURE ONE OF THESE BOOKS



POST COUPON NOW!

BRITISH INSTITUTE OF CAREERS

College House, 113 Pacific Highway, North Sydney, 2060

I am interested in
Please send me the appropriate Career-Book.

NAME (PLEASE PRINT)

ADDRESS

E.L.-W-8

Occupation Age

BRITISH INSTITUTE OF CAREERS

In association with
British Institute of
Engineering Technology

THE B.I.C. GROUP LEADS THE WORLD IN POSTAL TRAINING

two output valves, when an end-wise push reduced the level from the loud-speaker by many, many decibels. A push the other way restored it.

Could it be a faulty bypass — and yet I was still puzzled. The bypass across a push-pull cathode circuit usually doesn't change gain all that much if it becomes open-circuited.

With the positive meter prod on the cathode end of the bypass, and the other prod to chassis, I tried pushing the bypass again; significantly there was a marked change in voltage at the cathodes.

So I transferred the positive prod to the earthy lead of the capacitor and repeated the test. This time, the voltage changed from the zero that it should have been, to several volts positive, indicating that the earth lead was not in fact earthy.

Close examination showed that the capacitor was anchored to a lug which was joined by a short busbar to an adjacent lug terminating the bias resistor. This was, in turn, earthed by another busbar. While the busbars were contained within generous blobs of solder, it was obvious enough that one of the joints was "dry," causing the cathode resistor and bypass to rise above earth. Nor did the dry joint yield to a hot iron.

Since there was a danger of scorching the bakelite by using too much heat, I simply took another scrap of busbar and made a parallel connection. After that, no amount of pushing would change the sound in the output. The earth return stayed firmly at earth potential and the output valves were saved the embarrassment of trying to work with a partially open-circuited cathode return.

Had I uncovered one fault or two? I shall never know. All I can say is that the projector is now working well.

★ ★ ★

"The set fizzes and cracks and the picture blinks" . . . so read the telephone message.

When I arrived at the house it was to find a very talkative gentleman waiting for me — presumably a shift worker who wasn't due on the job till the mid-afternoon. He volunteered the information that the set had fizzed and cracked and blinked on occasions for some time but that, lately, it had got really bad. What would be the trouble?

I could see by his manner that he wasn't the kind to be fobbed off and that my best approach would be to be reasonably communicative. I explained that it could be something quite simple like an excess accumulation of household lint and kitchen vapour between some point in the high voltage supply and chassis.

Then again, it might be due to a crack in the insulation surrounding some high voltage component, allowing a breakdown path to develop.

Would the recent humidity make it worse?

I said that it possibly could, but that, once a breakdown path developed, it usually got worse — until the surface was thoroughly cleaned, if that was the trouble, or the faulty component replaced.

By this time I had the back off the set and had it switched on. I didn't have long to wait. It obliged with a fizz, a crack and a blink and a bit of careful direction-finding with eyes and

ears seemed to indicate the source of the trouble was in the cage and more particularly in the vicinity of the EHT rectifier.

With this to go on, I duly switched the set off again and started undoing things to get a closer look at the components inside the cage. It soon became apparent where the fault lay. Floating around loose was a long sliver of pink translucent moulding, plus some small bits of the same material — bits that had once been one lug of the 1B3 EHT rectifier socket. The other lug was still in one piece — just. Radiating out under the head of the self-tapping screw holding it in place was a pattern of cracks.

Insofar as the socket and rectifier were still in position, this damage was not decisive. What was decisive was the pattern of cracks running lengthways down the skirt of the socket — as you see from the accompanying picture. It was through these hairline cracks that the EHT voltage had been discharging to adjacent metalwork.

It seemed evident enough that the original assembler hadn't been satisfied with the pressure initially applied to the skirts of the socket; like the proverbial heavy-handed plumber's assistant, he'd given them an extra twist "for luck." I found myself thinking back to

the all-moulded oetal and miniature sockets which appeared in radio sets, post-war, and the ease with which they could be parted from the moulded extensions by a whisker too much pressure.

However, my more immediate problem was whether I had a replacement socket in the truck. Fortunately, I did have but I didn't have a replacement with me for the small resistor wired inside the socket, in series with the 1B3 filament. This would have to be salvaged or I'd have a call-back on my hands.

Salvaging the resistor from beneath the socket took a bit of wangling with pliers and iron to uncurl the leads from the socket pins through which they had been twisted. In fact, the melt mark around the edge of the skirt in the picture are the result of my probings with the hot iron.

But, fortunately, patience won the day; with the resistor salvaged and re-installed beneath the new socket, order was restored.

When I switched the set on again, in due course, it didn't fizz, it didn't crack and it didn't blink. What's more, the owner didn't seem inclined to argue about the fee. With his own eyes he'd seen the serviceman do some real work. ■

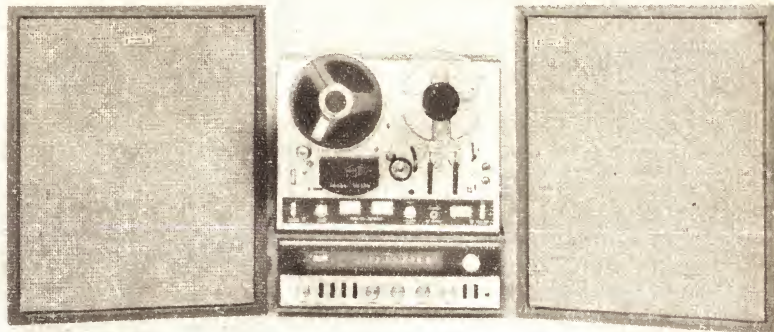

HERE'S A DRAMATICALLY EFFECTIVE STEREO SYSTEM WITH 10 SPEAKERS FEATURING AN AKAI TAPE DECK AND THE NEW COMPAX MODEL C-5000 STEREO TUNER/AMPLIFIER! ONLY \$395!

The famous Akai Model 3000D stereo tape deck features three heads, silicon transistor circuits, two speeds and is designed for 4 track monaural or stereophonic recording and playback. The external cabinet is beautifully grained selected timber and matches the cabinet of the solid state Compax Model C-5000 stereo tuner/amplifier. Output of the amplifier is 80 watts I.H.F.M. and the tuner brings in distant stations clearly and effectively. To these high quality instruments is added a matched pair of the popular Sonics Model AS-61 speaker systems. Each teak/walnut enclosure houses 4 bass/mid-range speakers and a special high frequency reproducer. Hear this magnificent, low priced stereo system at Encel Electronics! TOTAL ENCE PRICE (inc. sales tax) **\$395**

Encel

ELECTRONICS
(STEREO) PTY. LTD.

Head Office:
431 Bridge Rd., Richmond, Victoria 3121.
Tel. 42 3762.
Sydney Store: Ground Floor, 25M Building,
257 Clarence Street, Sydney, N.S.W. 2000.
Tel. 29 4563, 29 4564.

Wholesalers Trade-ins accepted
Australia's Greatest Hi-Fi Centre

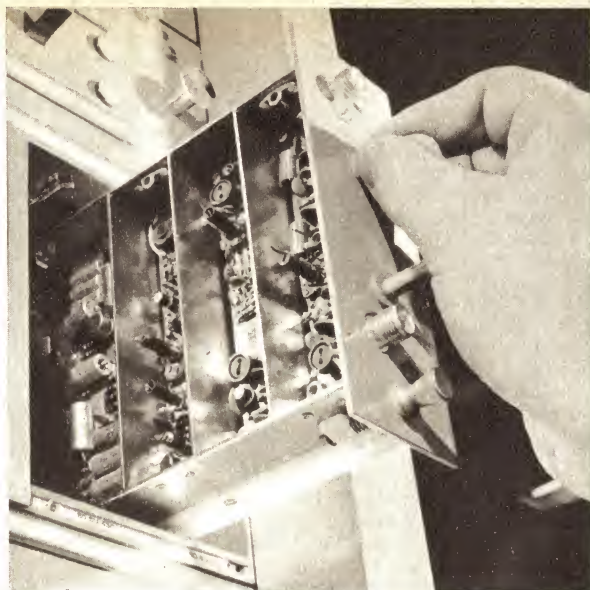
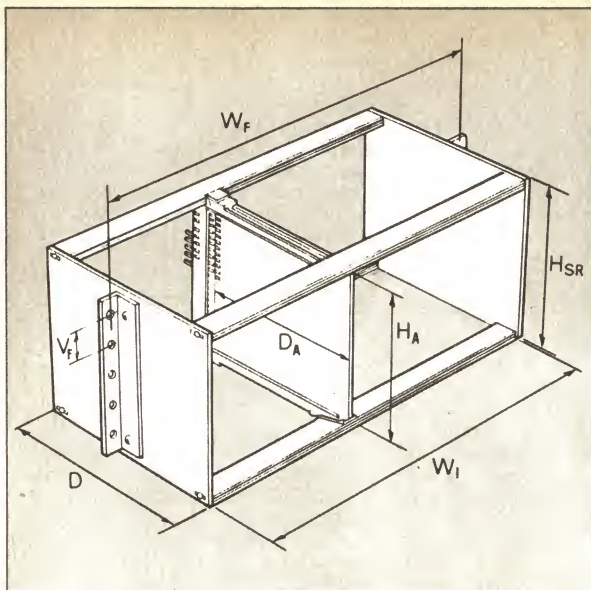

Modular Mounting and Connecting Rack Systems (ISEP) custom-built to your requirements.

Low-cost ISEP housing systems increase efficiency, speed assembly and servicing of electronic equipment.

Whether you are mass producing or building equipment to order, we can supply an ISEP modular housing system with a comprehensive range of racks, sub-racks, plugs, sockets and accessories to meet your exact needs.

Assembly is easy and fast. In design and electrical specifications, ISEP systems meet the highest professional standards. Plugs and sockets, for example, are rated at 250v. r.m.s., 4A. per connector,

and have a contact resistance of less than 5m/ohms.

Why not have one of our ISEP specialists call and show you how much an ISEP housing system can save you? His service is free, of course. Or — write for our illustrated technical booklet all about ISEP. The booklet's free also. **Standard Telephones & Cables Pty. Limited**, Components Division, Moorebank Avenue, Liverpool, N.S.W. 2170. Telephone 602.0333. Melbourne 480.1255. Canberra 49.8667. Brisbane 47.4311. Perth 21.6461. Adelaide 51.3731. Launceston 31 2511. Newcastle 61.5172. Wollongong 2.7974.

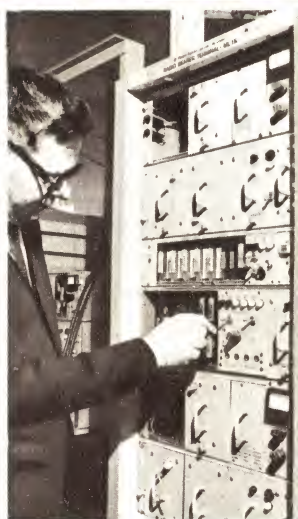

ISEP (International Standard Equipment Practice) is a simple and highly flexible modular mechanical mounting and connecting system developed by ITT.

AN **ITT** ASSOCIATE world-wide telecommunications and electronics



SOLAR AND SIDEREAL TIME FROM A SINGLE CRYSTAL

By D. J. Cole (Australian National Radio Astronomy Observatory, Parkes, N.S.W.)

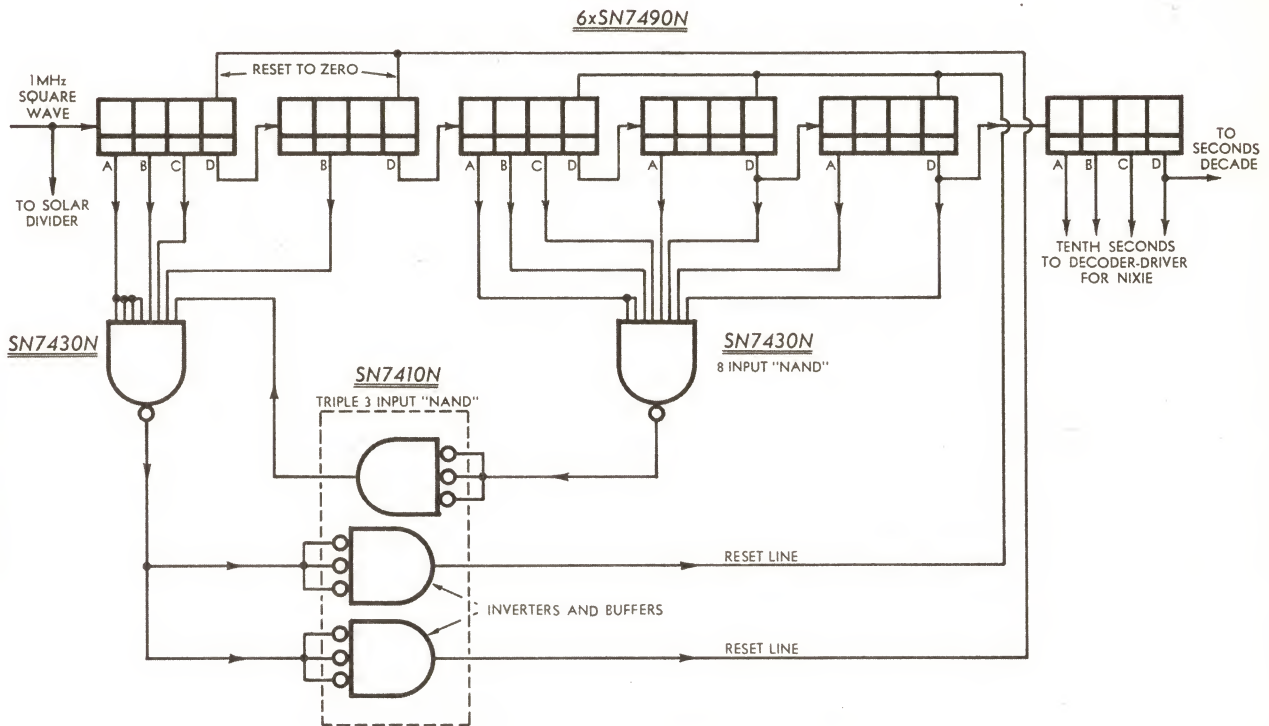

High accuracy solar and sidereal time signals are often required in astronomy and similar work. This note describes a system developed at the Parkes Radio-Observatory, whereby both time signals are derived from a single 1MHz reference.

Although the use of separate "solar" and "sidereal" reference oscillators and divider chains would be the simplest method of producing solar and sidereal time signals, this approach is not always feasible. At the Parkes installation, for example, both signals are required to have the stability provided by a caesium-beam frequency standard; it would be economically impractical to employ two such standards, one modified to produce a suitable sidereal reference signal.

A similar situation would exist in amateur astronomy work, where two crystal oscillators would probably take such a system beyond the financial reach of the amateur.

In our case it has proved more convenient to adopt an alternative approach, one which permits us to use a single caesium-beam standard to derive both signals. As the approach would be equally applicable to amateur situations where a crystal reference is employed, the following details may be of interest.

Two separate frequency divider chains are used, connected in parallel to the 1MHz reference signal. One divider consists of five standard

decades dividing by 100,000 to give tenths of solar seconds, while the other chain has feedback gating applied to produce a division ratio of 99,727. This gives an approximation to tenths of sidereal seconds which is accurate to within 4 parts in 10^7 . The tenth-second signals are fed to identical counting, decoding and readout circuits to give seconds-minutes-hours displays.

At Parkes the required accuracy for sidereal time is 1 part in 10^8 and, to develop this accuracy, a third divider chain is used to derive and inject additional tenth-second pulses at intervals of approximately 70 hours. In amateur situations this would probably not be necessary, as the basic accuracy of 4 parts in 10^7 corresponds to an error of less than 1 second in 4 weeks.

The accompanying diagram shows the feedback gating connections used in the sidereal frequency divider. As may be seen integrated microcircuits are used, the devices being Texas Instruments type SN7490N or similar. If desired, the last one can be used to drive an indicator tube displaying tenth-seconds. The solar divider consists of a similar chain of devices, but with the gating omitted and the

divider reset connections returned to ground.

The display counters each consist of a further SN7490N providing units of seconds, followed by either an SN7492N connected to divide by 6 or another SN7490N connected to reset to zero at six. Similarly for minutes. For "hours" the appropriate SN7490 counting tens of hours is arranged to reset at (20 and 4) using the built-in AND gate. The display tubes are driven by decoder drivers which may be either microcircuits or constructed from discrete components.

The supply leads to all divider elements should be filtered to ensure that mains transients cannot produce spurious triggering. Regular bypassing is also desirable to prevent triggering on load current transients. A further precaution is to completely shield all the divider circuitry, rounding the shielding to the mains earth. ■

WE SPECIALISE IN TAPE RECORDERS

EXPERT REPAIRS

To all brands by German technicians in modern equipped workshop.

Contact

REKLA

KLAPP ELECTRONICS PTY. LTD.,
224 CHAPEL STREET, PRAHRAN, VICTORIA.
TELEPHONE: 51-4653.

40 Watt & 60 Watt Instrol-Playmaster GUITAR AMPLIFIERS

All parts now available

Like all Instrol-Playmaster kits, the 116 and 117 Guitar Amplifier Kits are complete in every detail, down to the last nut and bolt, and precisely to "Electronics Australia" specifications. Chassis is ready drilled, cadmium plated and finally passivated to avoid fingermarking. The front label is beautifully finished with black lettering on silver-white background. Kits for both the 116 and 117 include extras such as 3 inputs (circuit included), vibrato and extra treble pull switches, and foot switch complete with chrome housing.



	PRICE
40 Watt complete kit of parts	\$84.36
40 Watt built and tested	\$91.49
60 Watt complete kit of parts	\$92.31
60 Watt built and tested	\$98.83
(Freight extra)	

All parts available separately if required.
 Chassis only **\$4.60** (plus 75c postage)
 Front Label **\$2.80** (plus 20c postage)
 Fuzz Box Kit **\$12.95** (plus 75c postage).



The new **INSTROL-PLAYMASTER 115 SOLID STATE STEREO AMPLIFIER** ("Electronics Aust.," April-May, 1967).

A fully transistorised 10 Watt Stereo Amplifier using the latest F.E.T. high-efficiency transistors.

Crystal/Ceramic Kit **\$95.00**
 Magnetic kit extra **\$10.50**

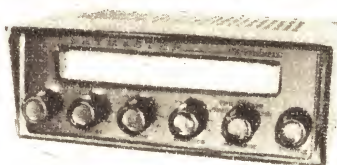

INSTROL-PLAYMASTER 106 AMP/TUNER ("RTV and H," Dec., 1963).

A high-quality amplifier/tuner with all stations clearly marked on dial. Amplifier 10 watts per channel.

Kit of Parts **\$96.50**

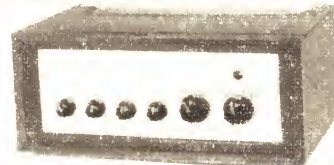

INSTROL PLAYMASTER STEREO AMPLIFIER No. 118

("Electronics Australia," July, 1967)

Kit of Parts (Less Case) **\$82.53**
 With Metal Case **\$86.53**
 With Teak Case **\$100.03**
 Magnetic Pre-Amp Kit **\$16.15**

TEST EQUIPMENT KITS

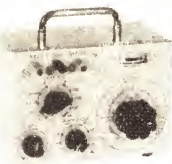

Send for Catalogue

Millivoltmeter	Jan., 65	\$44.78
Resonance Meter	Nov., 65	\$54.21
Audio Oscillator	Sept., 65	\$41.92
V.T.V.M.	Feb., 66	\$57.51
R.C. Bridge	May, 66	\$40.99
Frequency Meter	July, 66	\$46.52
Audio Generator	Feb., 67	\$34.12
3" C.R.O.	May, 66	\$125.99
Impedance Meter	March, 65	\$37.16
Protected Power Supply	April, 66	\$44.69
Postage extra on all kits.		



INSTROL-PLAYMASTER 120 CONTROL UNIT

("Electronics Aust.," Feb. 68)

A versatile, hybrid control unit which can accommodate crystal, ceramic or magnetic pick-up cartridges. Incorporating input/output facilities for use with tape recorders.

Kit of Parts . . **\$44.41.**



ELECTRONIC TOOL KIT
 For Servicemen and Hobbyists.

Comprises:—
 1 Soldering Iron 240V (Aust.); 1 Set 3 Spanners; 1 Coil Resin Cored Solder; 1 Pair standard pliers; 1 Pair Long Nose Pliers; 1 Pair Side Cutters; 1 Pair Tweezers; 1 Screw Driver Set; 2 Screw Driver Bits; 1 Philips Driver Bit; 1 Pointed Awl; 1 1-8 Spintite. . .
 Complete in attractive zip-fastened carrying case.
 Price **\$11.00, Plus Reg. Post, \$1.00.**

Tick catalogue required, and please include stamps for postage.

- | | |
|-------------------------------------|--|
| <input type="checkbox"/> Playmaster | <input type="checkbox"/> Test Equip Kits |
| <input type="checkbox"/> Toolkit | <input type="checkbox"/> M.S.P. Speakers |

Name

Address

Post Coupon for Free Catalogue.

OTHER PLAYMASTER KITS

	Price Add Post
111 Tuner	\$39.00 \$1.20
114 Tuner	\$47.00 \$1.20
107 Amp/Tuner	\$81.80 \$2.00
108 Amp/Tuner	\$69.80 \$2.00
101 Amp	\$61.00 \$2.00
No. 3 Amp	\$57.80 \$2.00
10W U/L Amp	\$85.80 \$2.00
No. 10 Control Unit	\$39.00 \$1.20
113 Amp	\$64.00 \$2.00
119 Tape Adapter	\$86.70 \$1.20
No. 4 Amp	\$73.00 \$2.00
Playmaster Designs are also available	
Completely Built and Tested.	

INSTROL PRINTED CIRCUIT BOARDS

High-quality, pre-fluxed boards to suit the 115 Amp. Clearly printed on reverse side with component location map. Easy to assemble.



PRICE
 Crystal Pre-Amp **\$2.00 ea.**
 Main Amp (2 required) **\$1.60 ea.**
 Magnetic Pre-Amp **\$1.60 ea.**
 (add 10c for postage)

BROADWAY ELECTRONICS PTY. LTD.

E.S.&A. BANK BUILDING, cnr. BROADWAY and CITY ROAD, SYDNEY. (opp. Grace Bros.) Phone 211-4244, 211-4224

INSTROL—high quality products

INSTROL Model T-101 Fully Transistorised WIDE BAND TUNER

A high quality hi-fi tuner designed to operate in conjunction with all makes of solid state amplifiers.

- Wide band 530 to 1600KHZ.
- Tuning Meter. • Efficient noise filter. • R.F. Stage. • Built-in AC Power Supply. • Major Stations, all States clearly marked on large illuminated scale. • Available in smart metal box or in teak cabinet. • Available as Amp/Tuner combination, with the Instrol 20-20 and 10-10 Amplifiers, in attractive Teak Cabinet as illustrated below, or less cabinet for panel mounting.

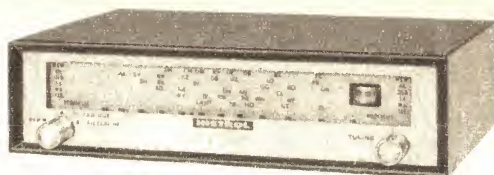

INSTROL MODEL 20-20 STEREO AMPLIFIER

Solid state, 20 Watts per channel max power 10w. R.M.S.) 30 to 20,000 Hz — less than 1½% harmonic distortion, suits ceramic and magnetic pickups — packed with features.



INSTROL MODEL 10-10 STEREO AMPLIFIER

10 Watts per channel, 5w. R.M.S. M.S.) ideal for ceramic and crystal pickups. High quality at low cost.



PRICE DETAILS

T101 TUNER (in metal case)	\$72
(\$6 extra for teak case.)	
20-20 AMP' (in teak case)	\$99
10-10 AMP' (in teak case)	\$58
Combined 20-20-T101 in teak case	\$176
Combined 10-10-T101 in teak case	\$135

INSTROL EDUCATIONAL ELECTRONIC KIT

In this Electronic Age, every person should have some knowledge, however elementary, of "how it works." The new Instrol 20 in 1 electronic kit will enable you to understand in an absorbing, simple manner the basic principles underlying computers, satellite communications, industrial electronic devices, etc., etc. You make 20 different experimental circuits, including 10 working radio transistor operated radio circuits.

Audio Amplifier circuits, home intercom, testing circuits including Audio Frequency Oscillator and Signal Tracer, Morse Code practice set and telegraph transmitter, etc. You use and learn about the amazing SOLAR CELL.

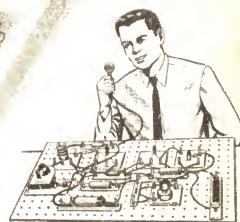

NO TOOLS OR SOLDERING IRON REQUIRED

All components pre-wired, ready for clip-on assembly. 50 page Instruction Manual supplied.

ONLY . . . **\$16.90** (Plus 60c for Registered Post)

INSTROL CASSETTE TAPE RECORDER

So simple a child can load and operate the Instrol Compact Cassette Tape Recorder. It may be used virtually anywhere for both speech and music, under almost any conditions. At picnics—in the home—at meetings—in the car—by Salesmen and Executives in the field—and most important—in the office as a complete dictating system. Headphones, footswitch and A.C. power unit, which are available as optional extras, combine to make Instrol Model 33 a personal, highly efficient, and really low-cost dic-

tating system suitable for both large and small offices, smart Teak trim, simple piano key-type operation, snap-in cartridges, microphone with on-off switch for remote control, light (weighs under 4lb), full 1-hour playing, outstanding performance with built-in speaker and remarkably efficient when connected to a large external speaker.

PRICE \$75.00
(Plus Reg. post \$1.00)



INSTROL METALWORK AND LABELS

Yes, we can supply hi quality metalwork to suit most "R.T.V. & H." and "Elec. Aust." designs. Also high quality anodised labels to suit all "Playmaster" designs, priced from \$2.00 to \$2.80. Full details in the free Instrol Metalwork Catalogue.

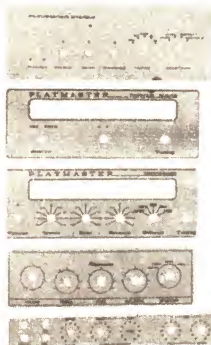

You are invited to write for any of the Instrol Products detailed on this page. (Please indicate what leaflets are required and enclose stamp to cover postage.)

TRADE ENQUIRIES ALSO INVITED

Produced, guaranteed, and serviced by
BROADWAY ELECTRONICS Pty. Ltd.

P.O. BOX 43, BROADWAY, 2007.
Telephone 211-4244, 211-4224.

Interstate Distributors: Vic.: J. H. Magrath & Co.
Qld.: A. E. Harrold Pty. Ltd.

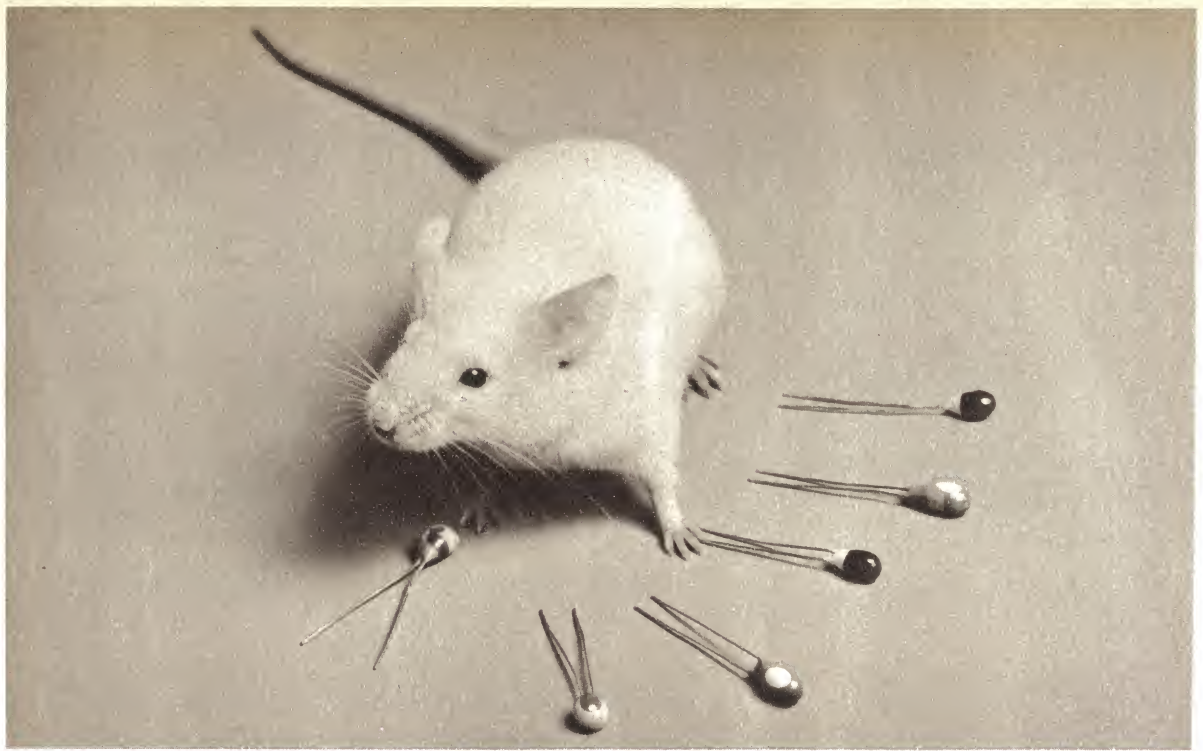

Do you have a circuit for a 68 μ F/3V mouse?

Meet Alice. She tried to make history. Tried to polish off one of our new TAG tantalum capacitors. (It would take her weeks to get through a conventional electrolytic capacitor). TAG looked just right. Sort of mouse size. And that's the point: where space is limited, or if miniaturisation is your aim, you'll find one tiny TAG capacitor will do the same job as the normal electrolytic type. Actual size is about the same as a match head. Just small enough

to save you a lot of sweat. And time. And money. We have a free booklet that tells you all about TAG. To get your copy, simply contact:

Components Division, **Standard Telephones and Cables Pty. Limited**, Moorebank Avenue, Liverpool, N.S.W. 2170. Phone 602 0333.

Melbourne 480 1255. Canberra 49 8667. Brisbane 47 4311. Perth 21 6461. Adelaide 51 3731. Launceston 31 2511. Newcastle 61 5172. Wollongong 2 7974.



(actual size)

TAG Tantalum Capacitors
3 to 35V., 0.1 μ F to 100 μ F,
.30" to .38",
-55°C. to +85°C.

AN **ITT**
ASSOCIATE

world-wide telecommunications and electronics



E546



Forum

Primary cells — still room for argument

Following our description of a "Signal Injector and R-C Bridge" in the April issue, we received a letter from a reader taking the author to task for his terminology concerning batteries, and also commenting on the statement that alkaline-manganese cells cannot be recharged. Assistant Editor Philip Watson takes it on himself to reply.

The reader's letter runs as follows:—

Dear Sir,

I really must point out an age-old fallacy in Mr Leo Simpson's excellent article "Signal Injector and R.C. Bridge" in the April issue.

His use of the term "carbon-zinc" cell appears to support the commonly held view that carbon (with graphite) forms the cathode of the dry Leclanche cell. However, the carbon materials are quite inert and, in point of fact, are the only cell constituents which do not enter into the electrochemistry involved.

As is well known, the cathode is manganese dioxide. The graphite is added to it merely to allow conductivity, while the carbon rod is no more than a suitable connecting device.

It might be worth adding (in view of Mr Simpson's reference to chargeability) that the dry Leclanche cell is capable of revitalisation by electroplating the zinc consumed back on to the inner surface of the can. This simple process is commercially economical in situations where large numbers of cells undergo regular and fairly heavy discharge rates. I have myself successfully recycled an ordinary D sized torch cell twelve times with consistently good power yields.

Yours, etc.,

J.G.

In reply, our first reaction is not to debate the technical accuracy of J.G.'s statement concerning the cathode, as much as the accuracy with which he has read and interpreted our text. He says, ". . . use of the term 'carbon-

zinc' appears to support the commonly held view that carbon . . . forms the cathode . . ."

But why should our use of this term "appear to support" this or any other view? The term "carbon-zinc" is one which is widely accepted as describing a particular type of cell, not only throughout the trade as a whole, but also throughout the battery industry. We have this on the assurance of one of the largest battery manufacturers in Australia.

The fact is that there is no standard which dictates that a battery is described by its anode and cathode materials, and there are plenty of examples which emphasise this. The battery under the bonnet of your car is commonly called a "lead-acid" battery, yet these terms do not refer to the anode and cathode. If we were to follow J.G.'s reasoning to its logical conclusion, we should call such a battery a "lead dioxide-lead" battery (if it was fully charged) or a "lead sulphate-lead sulphate" battery if it was discharged.

And what of the alkaline-manganese cell. Here the name is based on the electrolyte rather than the anode and cathode—for the very good reason that these latter are so similar to the zinc-carbon cell that confusion would be almost inevitable. Then there is a device called simply a mercury cell . . . but why go on?

Our correspondent may deplore the lack of standardisation in this regard—and we may even do a little "deploring" ourselves. Most of us prefer a "tidy" situation to an "untidy" one,

in terminology as in everything else, assuming it is practical. But it is not always practical, particularly in the realm of rapidly advancing technology such as we have today. Even if one sets out with the best intentions in the world, and formulates rules by which things shall be designated, one would need the most sensitive crystal ball ever dreamed of to look into the future and make sure that nothing likely to be developed in the next 1,000 years would not fit the rules without causing confusion. Or be such a mouthful that no one would use it!

It only remains to ask what term J.G. uses for such a device, or recommends that we use. A Leclanche cell? Fair enough, perhaps, but try asking for a Leclanche cell the next time you visit your local radio store, and see what kind of reaction you get!

In regard to the main point of J.G.'s letter—whether the carbon rod or the manganese dioxide constitutes the cathode — there is room for more serious discussion.

Once upon a time the classic textbook explanation of primary batteries in general, and the zinc-carbon cell in particular, was quite straightforward.

We quote:

"If a plate of zinc is dipped into dilute sulphuric acid, chemical action takes place—hydrogen is given off, zinc sulphate is formed in solution and considerable heat is produced, i.e., in addition to the chemical changes there is a conversion of energy from one form to another, the conversion being from chemical energy of constitution to heat energy in this case.

"A primary cell is a device by which the energy made available by chemical reactions may be converted to electrical energy instead of heat. This can be brought about by dipping a copper plate into the dilute sulphuric acid in addition to the zinc plate. As long as the zinc and copper rods are not connected, no chemical action takes place, but an EMF is set up between the rods. If they are connected by a wire, a current flows from copper to zinc in the wire and from zinc to copper in the electrolyte. As we are chiefly interested in what happens in the wire or external circuit, the copper is therefore looked on as the positive "electrode" or "anode" of the cell and the zinc as the negative electrode or "cathode." As soon as flow of current is made possible, the zinc starts to dissolve in the acid. The energy made available by this interaction of zinc and sulphuric acid appears in the form of electrical energy, which maintains a current round the circuit.

"Polarisation. — The action is accompanied by the liberation of

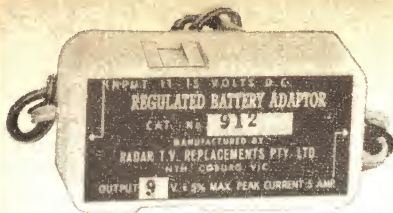

RADAR REGULATED BATTERY ADAPTER

Input 11-15 Volts D.C. Model 912. Output 9 Volts plus-minus 5 p.c. D.C. Model 712. Output 7.5 Volts plus-minus 5 p.c. D.C. Ideal for Cassette Tape Recorders. Model 612. Output 6 Volts plus-minus 5 p.c. D.C. Save your batteries while motoring. Size 2 1/2 ins x 1 1/2 ins x 7/8 ins.

\$8.75 Sales tax & Postage paid

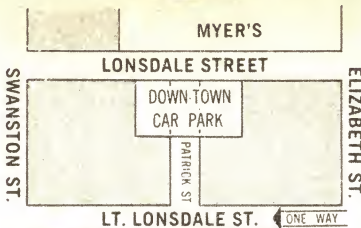

Magrath's provide the components for projects sponsored by "Electronics Australia", "Multard", "Outlook", "Philips", "Miniwatt Digest", "Radiotronics", etc.

Radar Solid State INVERTER

Ideally suitable for use in your car, boat or caravan. With it you can use your Electric Shaver, Tape Recorder, Record Player, Radio, Small P.A. System, Personal Fan, or any other A.C. Powered Unit up to 40 watts consumption. Simply connect the Unit to any 12V Car Battery. The Inverter will draw 4 amps. a full load equivalent to the consumption of one headlamp. With a fully charged battery the unit can operate for many hours without danger of battery drainage.

\$15 Sales tax paid post free

RADAR 05X POWER SUPPLY UNIT

Designed to operate the majority of ELECTRONIC APPLIANCES — Transistorised Tape Recorders, radios, record-players, small amplifiers, Radiograms, Battery Shavers, and all Battery-operated units of 6 volts, 9 volts and 12 volts at a maximum current of .5 amps. The only unit available incorporating these 3 power outputs. This unit features Full Wave Bridge Rectification with Capacitor and Choke Filtering. Select your Voltage by adjusting the Selector Switch then plug into any power point, 220 to 250 Volt A.C. Costs 1 cent per 100 hours — Saves dollars on Battery purchases. Can be used also for car batteries as a trickle charger.

\$26 Sales tax paid post free

SCOPE DELUXE

Complete with pouch pack. Stainless barrel. Only 6 seconds INITIAL heat-up time from cold. Exclusive "switch-ring" — no metal to metal contact to burn out.

\$5.95

SCOPE STANDARD

6 second INITIAL warm-up from cold. Performs work of irons requiring up to 150 watts.

\$5.50



MINISCOPE

Light, only 1 1/2 ozs. FIVE seconds heat-up time from cold. Ideal for reaching inaccessible spots

\$5.28

Matching "Scope" 3.3V transformer designed for these "Scope" products

\$7.65

VIBROSCOPE

Protects your property by etching on any metal, ferrous or non-ferrous or annealed, dull or polished. Produces deep penetration — lasting results

• All Post free anywhere in Australia.

\$3.50

J. H. MAGRATH & CO. PTY. LTD.
208 LT. LONSDALE STREET, MELBOURNE, VICTORIA, PHONE 32 3731

500V "UNIMEG" INSULATION TESTER

RANGE .25 to 50 megohms at 500 volts test potential, with centre scale at 3.5 megohms.

One of the most common faults causing the malfunction or failure of electrical equipment is **insulation breakdown**.

The gradual deterioration of insulation over a period of time can be detected by regular inspection and testing.

A quick and efficient test of electrical equipment, appliances and electrical wiring can be made by using University Graham's "UNIMEG."

This ruggedised portable transistorised insulation tester used regularly will detect failures in their early stages thus preventing expensive breakdowns which could occur at inconvenient times. The unit consists of a stable transistorised oscillator the output voltage of which is then stepped up by a transformer and in turn converted to 500 volts DC by high voltage rectifiers.

The power is supplied by a 9 volt transistor radio battery and by the nature of the unit's intermittent operation and its reserve voltage, long battery life can be expected.

For more information on "UNIMEG" or any electrical measuring problem consult:—

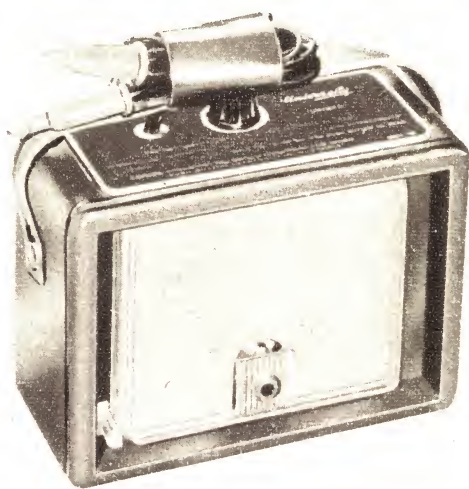

THE "UNIMEG" IS QUICK AND SIMPLE TO USE.

1. "Short" the test leads, press the push switch, and adjust the potentiometer, to indicate full scale on meter.
Note: (The 500 volt potential is present only when switch is depressed.)
2. Connect test leads to circuit under test, and press push switch.
3. Read resistance directly off scale.
Solid leather carrying case, with combined shoulder and hand strap, available as an extra.

REPRESENTATIVES:

W.A.: Atkins (W.A.) Ltd.,
894 Hay Street, Perth, W.A.
S.A.: George Procter,
52 Gawler Place, Adelaide, S.A.
VIC.: Eastern Instrument Services
Pty. Ltd.,
38 Milton Parade, Malvern, SE4.

QLD.: Keith Percy & Co. Pty. Ltd.,
Box 1478V, G.P.O., Brisbane, Qld.
TAS.: W. P. Martin and Company,
188 Collins Street Hobart,
and 134 Cambridge Street,
Launceston.

UNIVERSITY GRAHAM

INSTRUMENTS
PTY. LTD.

106 BELMORE ROAD, RIVERWOOD, N.S.W.

Telephones: 53-0644 (5 lines)

Telegraphic Address: "Raquip," Sydney

AUSTRALIA'S LEADING MANUFACTURER OF ELECTRICAL INSTRUMENTS (A UNIT OF INSTROL)

hydrogen at the surface of the copper. This has two bad effects:—

- (1) The conductivity of hydrogen is very much less than that of dilute sulphuric acid, and so the internal resistance of the cell is greatly increased.
- (2) If we could construct a cell with zinc and hydrogen electrodes in the same electrolyte, we should find that although a current still flowed from hydrogen to zinc in the external circuit, i.e., zinc was still the cathode of the cell, the current was much smaller than with a copper anode because the EMF developed between the electrodes was smaller. This is essentially what happens when a hydrogen film collects on the copper plate. Hydrogen becomes the anode of the cell, and its EMF is greatly diminished.

"This effect is called polarisation, and on the method adopted to avoid it, to depolarise the cell, depends very largely the efficiency of all primary cells.

"The essentials of a primary cell are thus:—

- (a) Positive and negative electrodes.
- (b) Electrolyte.
- (c) Depolarising device.

"The EMF of a cell depends only on the chemical nature of the electrodes and electrolyte and not at all on their size or quantity. The resistance of the electrolyte, like that of a metallic conductor, varies directly as its length and inversely as its area, and so the larger the surface area of the plates, and the less their distance apart, the smaller is the internal resistance of the cell. Naturally, also, the larger the cell the longer its life, since a greater quantity of chemicals is available.

"The Daniell and Menotti-Daniell cells consist of copper, zinc, dilute sulphuric acid, and copper sulphate solution (depolariser). Their EMFs are 1.1 volts each. Their resistances depend on their size. They give a steady current when in service.

"The Leclanche cell consists of carbon, zinc, salammmonic solution, and manganese peroxide (depolariser). EMF 1.5 volts. Resistance varies with size.

"When in service the current quickly falls, and so these cells are chiefly used for intermittent work such as bells. Nearly all dry cells are of this type, the salammmonic being contained in a paste or jelly."

Thus ran the classic explanation in no less a textbook than the "Admiralty Handbook of Wireless Telegraphy" 1938; a reference of extremely high standing, one regarded as "must" by most authorities for electronics students. And I don't think anyone would argue as to what the text was meant to convey. Taking into account the order in which the essential requirements are listed, and the preservation of this order in describing the Daniell and Menotti-Daniell cells, it is obvious that the description of the Leclanche cell is intended to read, "The Leclanche cell consists of carbon (positive electrode), zinc (negative electrode), salammmonic solution (electrolyte) and manganese peroxide (depolariser) . . ."

Two earlier textbooks, "Magnetism and Electricity," by Jude and Satterly (1921) and "Outlines of Electrical En-

For DX'ers

Dear Sir,

With reference to the article on the Solomon Islands Broadcasting Service in the April issue of "Electronics Australia," I wish to advise that the postal address is not, and never has been, Box A176. The correct address is either P.O. Box G6 or C11.

B. J. WHITEHALL,
Broadcasting Officer.

Radio Milne Bay

Dear Sir,

I noticed that, in my letter, which you reprinted, you showed VLAS Radio Milne Bay as being 25W. I assumed this to be a typographical error, but a subsequent letter from Art Cushen and another item in a later edition of the magazine indicated that there must have been an error on my part in the original letter. If so, my apologies.

The power should read 250 watts.

Since Radio Milne Bay's opening with test programs, another Administration radio station has opened, Radio

gineering," by Harold H. Simmons, A.M.I.E.E. (1909) describe the Leclanche cell in similar, if less precise, terms. Which all adds up to the same general impression: that the basis of the Leclanche cell is carbon, zinc, and salammmonic, with the manganese dioxide working "on the side" as it were in the role of depolariser. In fact, the writer has seen an instructor demonstrate to a class the "basic cell" consisting of carbon, zinc, and salammmonic, show that it will generate voltage, then go on to explain the limitations of such a simple cell, due to its tendency to polarise, and the need for a depolariser.

It is a nice, neat theory, easy to explain, easy to understand. There is only one thing wrong with it: it doesn't

Kieta on Bougainville Island. I am not sure of its current status or its frequency, but I know it has an output of 10KW with a "low power" output of 3KW. Details could doubtless be had from the Director of Extension Services, Konedobu, Papua.

Eventually, Radio Milne Bay will move to a new location at the town of Alotau, which, unlike nearby Samarai, is inside Milne Bay. During World War II what is now known as Alotau was the site of a big American base camp and hospital. This town will become the new Administrative headquarters for the Milne Bay district, with the first move of a department scheduled for July.

Alotau (pronounced AH-LOR-TOW, rhymes with HOW) is only about seven miles from Gurney airstrip, where a small force of Australians and New Zealanders stopped the Japanese advance.

F. J. BEITZEL,
Department of Posts and Telegraphs,
Samarai.

stand up to close inspection. Nowhere can we find any justification for representing the simple carbon, zinc, salammmonic combination as being the basis of the Leclanche cell. In fact, Georges Leclanche's own account of his cell (1868) describes it as consisting of a glass jar, a zinc rod, an electrolyte of salammmonic, and a porous pot containing equal parts of manganese dioxide and powdered carbon, plus a carbon plate to serve as collector of current. (Vinal, G.W., "Primary Batteries.")

Any lingering doubt should be dispelled by the title of Leclanche's description which, translated, is: "A Manganese Dioxide Cell Using A Single Liquid."

In recent years there have been many attempts to describe the opera-

MODEL C.P.4



NEW!

Polycarbonate Clear Thermoplastic METER HOUSING

. . . is Tougher—more Heat Resistant
and practically Indestructible!

- Can be supplied for all Moving Coil and Moving Iron ranges and functions.
- The Moving Coil version is normally equipped with Taut Band Suspension and is virtually indestructible (tests included being dropped 25ft. to a concrete path, as well as the usual controlled bump and vibration tests).
- Available with ultra-modern rear-of-panel mounting excutcheon as an optional extra.

For further details contact

PATON ELECTRICAL PTY. LTD.

N.S.W.: 90 Victoria Street, Ashfield, N.S.W. 71-0381 (6 lines)

Vic.: 469 King Street, Melbourne. 329-8873

COME TO

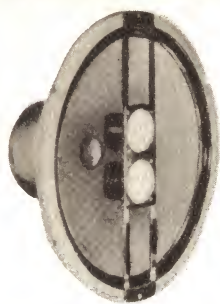

PEERLESS SPEAKERS

Now available the famous Peerless 12in Coaxial Speaker. This professional speaker is far superior to other speakers twice its price. Hear it now! With full range of tweeters and mid-range — also 15in woofers.

Don't forget our exclusive range of Peerless Professional Hi-Fi speakers. They are on line for you to see and hear.

CONVOY'S Specialised Hi-Fi Service Centre

Obtain expert service for your Hi-Fi equipment, amplifiers, turntables, tape recorders, P.U. arms and heads, speakers in our specially equipped service department, staffed by professional experts. Trade enquiries are welcome.

SELECT YOUR PROFESSIONAL HI-FI!

Convoy

FOR SOUND SATISFACTION

The Sound Experts
29-6475

A complete range to suit your exact requirements

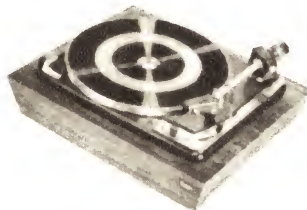

There is a turntable to suit your particular requirements in the Dual range.

We recommend the 1009SK as an outstanding turntable; not only is the price right but the performance is impeccable.

Features: Transcription quality with automatic facilities. Dynamically balanced low mass tubular arm. Cue-control, anti-skate bias, 4lb balanced platter, superb styling.

SPECIAL ACCESSORIES

Now available, adapter cords with plug conversions for all popular audio connections, as well as an extensive range of standard accessories.

CONVOY INTERNATIONAL Pty.Ltd. 449 KENT STREET, SYDNEY 29-6475

COMPARE THE SPECIFICATIONS AND THE VALUE OF THE "COMPAX" COMBINATION!



COMPAX CE-5000 SOLID STATE STEREO TUNER/AMPLIFIER, \$169

Power Output: 40 watts R.M.S. total (80 watts I.H.F.M. total)
20 watts R.M.S. per channel (40 watts I.H.F.M. per channel)

Frequency response: 20-20,000 Hz. \pm 2 dB.

Harmonic distortion: Less than 1%.

Signal to noise: — 60 dB.

Input sensitivities: Magnetic pickup—3 mV.

Crystal pickup—50 mV.

Aux. input—150 mV.

Speaker impedance: 4-16 ohms.

Bass and treble controls: Each \pm 10 dB. at 100 Hz. and 10 kHz. respectively.

Dimensions: 16 $\frac{1}{4}$ " x 10 $\frac{3}{4}$ " x 5 $\frac{1}{2}$ ".

Tuner frequency range: 535 Kc. to 1605 Kc. Sens. 50 mV.

Tuner intermediate frequency: 455 Kc.

Features include scratch, loudness and rumble controls; the external cabinet is beautifully finished in selected teak veneers.

The performance of this attractively priced stereo tuner/amplifier is quite outstanding.

Price: \$169



THE NEW COMPAX 2 SPEED TURNTABLE, \$39.50

Speeds: 33-1/3 and 45 r.p.m.

Method of drive: Belt driven around the platter perimeter.

Turntable material: Non-ferrous metal.

Diameter of platter: 12".

Height required below motor board: $\frac{3}{4}$ ".

Wow and flutter: 0.04%.

Turntable mat: Anti-static material (not an extra).

Motor: Completely sealed 12 pole synchronous type.

Speed change mechanism: Unique system (pat. applied for).

Number of moving parts: 3 (rotor, platter and drive belt).

Ratio of mass: Turntable mass and drive mass are almost identical.

Price: \$39.50.

Write for complete details to the Australian Distributors.

Trade enquiries to:—

INTERNATIONAL DYNAMICS (AGENCIES) PTY. LTD.

361 Bridge Rd., Richmond, 3121, Vic. Tel. 42 4403

tion of the Leclanche cell in more detail and with greater accuracy. This isn't easy, because the chemical reactions within the cell are quite complex. One authority (Adams, P. H., Proc. I.R.E., April, 1957, p.114) lists no less than three chemical equations to explain the reactions in a cell, any one of them being appropriate according to such factors as the degree of discharge, rate of discharge, and so on. What is more, the precise point at which one reaction will dominate the previous one cannot be determined.

The same authority sums up the previous confusion as follows:

"... it is only comparatively recently that there has been general agreement on the chemical reactions that take place during discharge. Originally it was considered that hydrogen was formed during discharge by the reaction between the zinc and the ammonium chloride, and that the purpose of the manganese dioxide was to depolarise the cell by oxidising the hydrogen to form water. Depolarisation is now regarded, however, as only a means of preventing evolution of hydrogen or oxygen. It was originally considered, not as the primary electrode process, but as a chemical reaction between the manganese dioxide and previously liberated hydrogen, but there is little basis for this view."

However, in spite of the chemical complexities, one point is clear and generally acknowledged; the manganese dioxide plays an active part in the generation of energy within the cell. In fact, it is responsible for about half the energy content of a modern cell, while still acting as a depolariser.

Yet, regardless of how deeply we delve into battery chemistry, we find that the people who work with batteries every day are inclined to adopt the view that the carbon and the manganese dioxide are so intimately associated, at least in the physical sense, that they are regarded as one composite unit, constituting the cathode. Maybe this concept is more "popular" than chemically accurate, but there it is.

Finally, we come to what J.G. refers to as "revitalisation." I have never heard this term before, but assume he is referring to the process of "reactivation"; a technical fad which enjoyed brief popularity some 15 years ago. If J.G. is interested he can refer to "Radio And Hobbies" for October, November and December, 1953, for our contribution to the subject—both theoretical and practical. If he is interested in a deeper discussion we recommend the previously indicated reference, Adams, P. H., "Some Problems Associated With The Charging of Dry Batteries," Proc. I.R.E. Aust., April, 1957, p.113.

Most discussions on the subject may be summarised along the following lines: On a purely chemical basis, there is justification for assuming that some reversal can be produced by application of a reverse EMF. As a result, the life of a dry cell can be extended by a significant amount, provided the reactivation is conducted with due care.

Our correspondent claims a recycling figure of 12 times, while other authorities have quoted similar, or even higher, figures, and there seems no reason to doubt any of these. The

ENJOYS READING OUR ARTICLES

Dear Sir,

The purpose of this letter is a request. You might forgive me, if I open by telling you a little about me, and what "R, TV And Hobbies," and now "Electronics Australia" has meant to me for many years.

The story starts in 1945, in Germany, where a couple of friends and I found some parked German Air Force planes, under British guard; we dismantled and made off with all the electronics we could lay our hands on. You can imagine what excitement we 15-year-olds had, first getting past the guards, and then building our own radios, up to three-stage tuners, UHF transmitters and receivers (for personal contact, and strictly illegal), etc.

I should confess that my own skills were practical, rather than theoretic, and most of the theory that I did learn, I have since forgotten. However, one of the first friends that I was glad to find in Australia, when I arrived here, was your magazine, then called "Radio, TV and Hobbies." A strange country can be a very lonely place, but with

friends one quickly finds the right attitude that leads to finding other friends, etc.

While I cannot follow technical discussions in depth, your magazine has done two other things for me. Firstly, it has given me the feeling of being up to date with the pace of developments; I am a professional manager in manufacturing industry, and being familiar, in a general way, with developments, strikes me as being most important as another basis for decision making, or as a basis on which to base inquiries and specific questions.

The other point concerns the pure enjoyment that I get from reading your articles, even if I don't understand the exact technology involved; it appears to me, that you treat your language with quite unusual respect, for I never lose touch with what you are about.

Language surely is the most important human activity by far, and after some of the garbled messages that I have to decipher, your magazine fills me with renewed hope.

A.B. (West Brunswick, Vic.)

important point to realise, however, is that these were achieved under laboratory, or at least carefully controlled conditions. As far as the average non-technical user is concerned the position is very different.

It must also be realised that "recycling 12 times" does not necessarily mean that the cell has achieved 12 times the life that it would otherwise have done. The true improvement can only be calculated if we know the depth of each cycle.

Any planning concerning reactivation must take into account a number of quite critical factors. Unless these are fully understood

and observed, the end result may range from a relatively small gain, through a "break even" condition, to an actual loss, i.e., less energy than the battery would have delivered had it not been reactivated.

The three main factors to be considered are:

- (a) The maximum permissible charging rate and charging time.
 - (b) The irreversibility of the chemical reaction once it has passed a certain point of discharge.
 - (c) The effect on shelf deterioration.
- Let us consider these factors in greater detail.

(Continued on page 158)

INTEGRATED CIRCUIT STEREO AMPLIFIER by



OFFERED FOR THE FIRST TIME IN AUSTRALIA

features include:—

- 7W per channel.
- integrated circuits.
- stabilised power supply using transistor control.
- treble, bass and volume controls in each channel.
- all components mounted on printed board (except controls).
- driver transistors.
- power transistors.

This unit is in kit form and comes complete with full assembly manual and information on integrated circuits. No specialised knowledge of electronics required to build this amplifier.

Available exclusively from:

TECHNICAL TRAINING INTERNATIONAL PTY. LTD.

P.O. BOX 83, DOUBLE BAY, N.S.W. 2028.

PRICE (including Sales Tax) \$79.50 CASH

Packed and delivered anywhere in Australia.

The Model JAYEM 555 Oscilloscope is a ruggedly-built, professional-quality oscilloscope which displays signals DC to 7 MHz. The instrument features a rise time of 50 nano-seconds and has a 5" cathode-ray tube. The JAYEM 555 is an attractively-finished instrument which makes extensive use of semiconductors. It is compact (8" x 11½" x 17½"), lightweight (24 lbs.), and highly-reliable. The instrument is easy to operate and all controls have positive action. The instrument features a particularly good automatic triggering circuit with a stability of a very high order for easy lock-on to signals over the full frequency range of operation.

SPECIFICATIONS:
VERTICAL AXIS
 Sensitivity: 0.02 V/cm-10 V/cm; 9 ranges: (± 3%).
 Response: DC—7 MHz and 2 Hz—7 MHz, AC connected.
 Rise Time: 50 Nano-seconds.
 Input: 600 V max.; impedance: 1 Megohm parallel 33 pF.
 Input Terminal: UHF receptacle (suits M-Type).
HORIZONTAL AXIS (Time Base)
 Sweep Times: 1 uSec/cm-1 Sec/cm; 19 ranges (± 5%).
 Expanded Sweep: 5 times (± 5%).
EXTERNAL SWEEP:
 Expanded Sweep Sensitivity: 200 mVp-p/cm (± 5%).

Frequencies: 2 Hz-200 KHz.
 Input Impedance: 1 Megohm parallel 40 pF.
SYNCHRONIZATION
 System: Self excited trigger sweep.
 Signal: Internal — External — Mains Frequency.
 Trigger Range: Internal: 20 Hz-7MHz, 10 mm on CRT.
 External: 20 Hz-7MHz, 1 Vp-p.
CALIBRATOR
 Output wave form: 1 KHz square wave.
 Voltage: 5, 0.5, 0.05 Vp-p (± 3%).

THIS OSCILLOSCOPE IS AVAILABLE IN A RACK-MOUNTED MODEL — PRICE & SPECIFICATIONS ON APPLICATION.

7MHz: 50_nS = \$210

Plus Tax 12½%

- DC - 7 MHz (-3 dB)
- 20 mV sensitivity
- 50 nano-seconds rise time
- 5-inch flat-faced screen
- Built-in calibrator
- Solid-State, Lightweight, Portable
- Low-capacity probe included
- 12 months' warranty

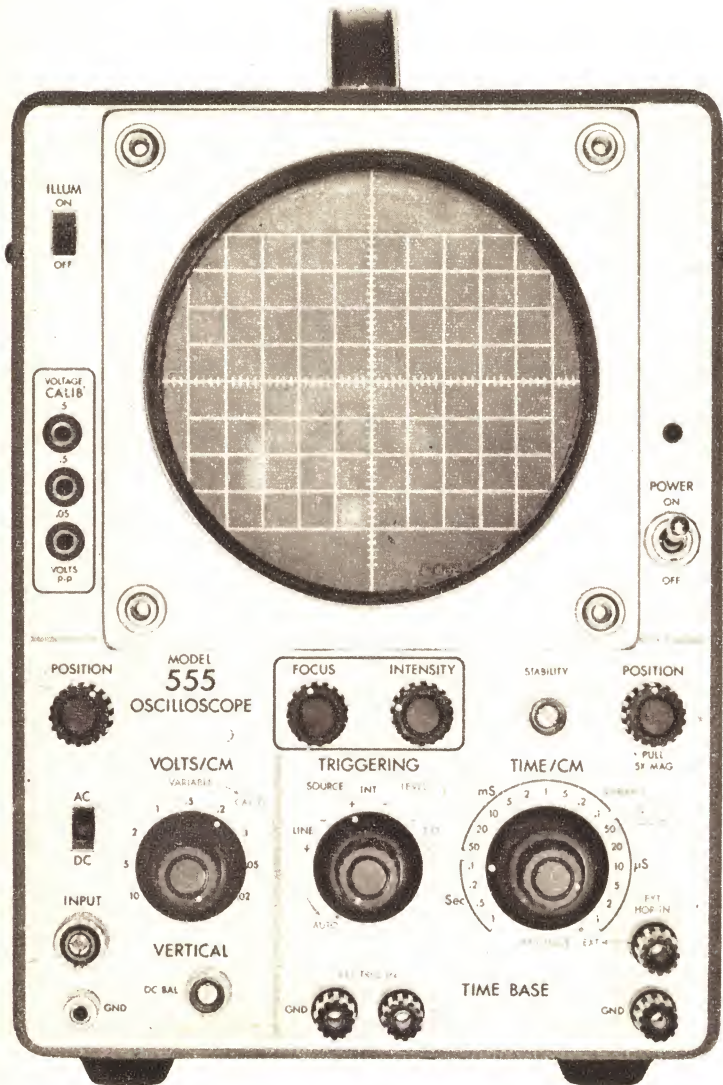

JACOBY, MITCHELL & CO. PTY. LTD.
 469-475 KENT STREET, SYDNEY
26 2651

MELBOURNE: 30 2491
 ADELAIDE: 53 6117
 BRISBANE: 2 6467
 PERTH: 28 1102
 LAUNCESTON, TAS.: 2 5322





A READER BUILT IT!

Circuits and devices which we have not actually tested in our laboratory but published for the general interest of beginners and experimenters.

EQUIPMENT FACILITATES TIME-LAPSE PHOTOGRAPHY

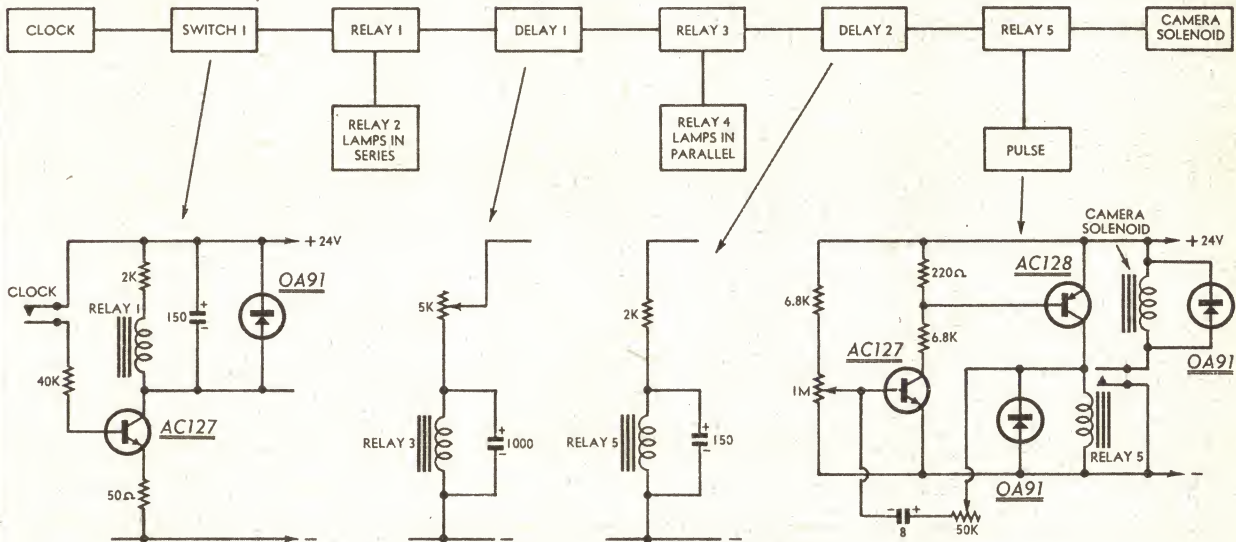

This rather unusual contribution comes from Mr N. H. Kennedy, 13 Thomas St., Kingsgrove, N.S.W. 2208. It should interest anyone who has an ambition to experiment with time-lapse photography. The article is substantially a quotation from Mr Kennedy's letter.

I am encouraged by an editorial answer to "P.E. Etc." (March, 1968, issue, in "Answer to Correspondents") to submit the enclosed material for your consideration.

Contrary to "P.E. Etc.," I think that it is often hard to find in publications simple enough explanations of electronic applications. My equipment shows, I think, how basic transistor circuits and delayed relay circuits may cover a range of control operations.

The device is a variable rate switching clock for (in my case) time-lapse movie photography, a photographic method of changing very slow movement to everyday rates, i.e., plants may be shown to grow, bloom and wither, crystals to grow, erosion to occur, etc.

The method of operations is as follows:—

(1) The clock, with a rotating circuit board on the minute hand spindle, and with an overhead pickup contactor, periodically operates the tran-

sistorised switch function, switch 1.

(2) The transistor switch closes relay 1, a small capacitor delay being incorporated to minimise inductive arcing on the circuit board and also chattering of relay 1.

(3) As relay 1 closes, it closes relay 2 — a heavy duty relay which switches four photoflood lamps into a series state.

(4) Relay 3 closes approximately $\frac{1}{4}$ second later, being controlled by a 1000μF capacitor and a 5K variable resistor.

(5) When relay 3 closes, it closes relay 4, switching two of the lamps off and the remaining two across the full supply voltage. At the same time, the capacitor across relay 5 begins to

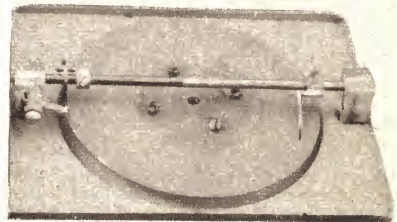

The printed circuit timing board fixed to the minute hand of the clock and, below left, an inside view of the completed equipment, showing the clock in position.

charge, the relay closing about 1/20th second later; this delay gives time for the lamps to reach full intensity before the next operation.

(6) On closing, relay 5 operates the camera solenoid, driving the camera forward by one exposure.

(7) For periods of less than one exposure per 12 seconds, the clock and relays 1, 2, 3 and 4 and the delay capacitor of relay 5 are switched out of circuit, the photoflood lamps remaining on. A supplementary pulse generator, controllable from one exposure per 6 seconds to three exposures per second is used to drive relay 5 directly. With the two facilities, the equipment has a range of one exposure per hour to three exposures per second.

It is necessary for artificial light to be available for much of the type of

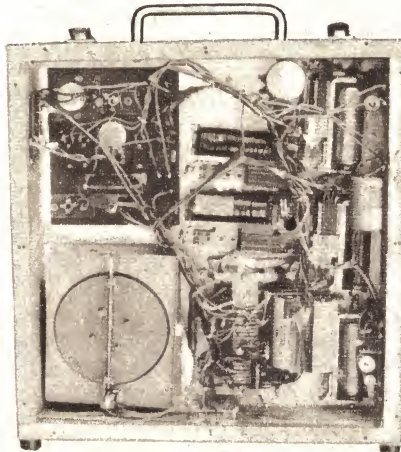

work encountered. It is also preferable that the lamps be treated electrically as kindly as possible, to give reliability and to avoid colour temperature change occurring too rapidly due to burning at full power for too long a period. Although four lamps are in use, only two are allowed to run at full temperature but the four are rotated periodically.

The power supply is fairly conventional using the three low voltage windings of a typical valve radio trans-

former in series, giving 24 volts rectified and smoothed in the usual manner. A 24 volt battery pack is used for field use.

The completed timer constructed by Mr. Kennedy. Sketched below is the pattern on the printed board, containing 300 lines in the outer ring, 120 and 60 lines in the next, 24 and 12 in the next, then groups of 4, 2 and 1.

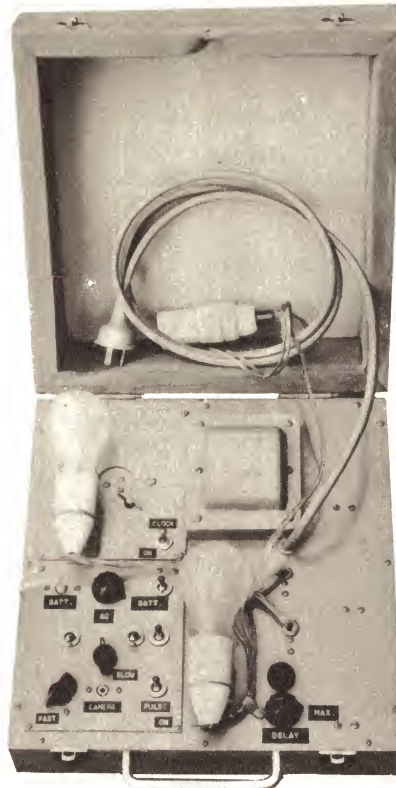
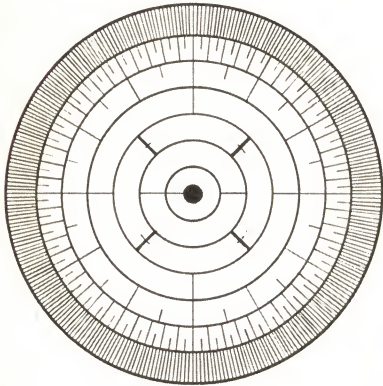

The relays used are 1,000 ohm, 12V, P.M.G. type, which lend themselves well to delayed action control and are easily converted, if need be, to the required change-over contacts for each stage.

The technique of increasing the supply voltage and using resistance and capacitance to achieve a time delay works well, the values depending to some extent on the particular relays used.

Relays 3 and 4 should have contacts capable of handling 240VAC at up to 10A.

The 24V supply is also handy for operating the camera solenoid. This may well be located at some distance from the control unit and the effects of voltage drop have to be minimised if reliable operation is to be secured. The diode across the solenoid winding stopped erratic operation of the system.

The solenoid is my own design but suitable types are available commercially.

BASIC RADIO COURSE

"Basic Radio Course" is a quarto-size 128-page book published by "Electronics Australia." In its 24 chapters, it starts from first principles and goes on to explain the operation of radio transmitters and receivers. It introduces the reader to test equipment, audio systems, radio servicing, amateur radio and tape recording. Copies may be obtained by writing to "Electronics Australia," Box 2728, G.P.O., Sydney, 2001. Enclose postal note, money order or cheque for \$1.60, which includes postage.

OUR PRICES ARE UNBEATABLE

UNIT 1: Phonosuper Stereo 2004 made in Germany with AM/FM shortwave 7 valves, 14 diodes, 6 x 1 AM, 10 VHF circuits, 4 wave bands, 6 press keys, stereo key and stereo balance control, complete with Schaub-Lorenz Tourcord cassette player which is world's best.
TOTAL PRICE **\$280**

UNIT 2: England's best amplifier, Armstrong 222 integrated stereo 10-watt RMS per channel frequency response from 30-20,000 cycles plus minus 1 dB less than 1/2% distortion measured at 8-watt RMS. Schaub-Lorenz Tourcord cassette player, 2 R. and A. 10" loudspeakers.
TOTAL PRICE **\$210**

Plus P.E. 34 Hi-Fi turntable with Decca Deram cartridge when bought together with the above unit. **Add \$80**

UNIT 4: Famous Schaub-Lorenz Tourcord Cassette Player (very favourable review in May, 1968 issue of "Electronics Australia," page 119). Pioneer 300B tuner/amplifier.
TOTAL PRICE **\$210**

PLUS 2 Heco Hi-Fi speaker systems. **Add \$80**

UNIT 5: Jordan Watts world-famous brilliantly designed loudspeakers frequency range on axis from 30-17,000 cycles, plus minus 3 dB, 25-20,000 cycles, plus minus 6 dB, frequency range 30 deg. off axis from 30-17,000 cycles, plus minus 6 dB, impedance suitability: 7.5 ohms to 16 ohms, power handling capacity: 12-watt RMS, Schaub-Lorenz Model 4000 tuner/amplifier 25-watt per channel AM/FM shortwave-longwave, P.E. 34 Hi-Fi turntable, Empire 888E cartridge, frequency response from 10-30,000 cycles.
TOTAL PRICE **\$570**

UNIT 3: Pioneer 300B tuner/amplifier 20-watt per channel magnetic input 2 broadcast AM shortwave and FM tuners complete with 2 Wharfedale 10in Golden RSDD loudspeakers.
TOTAL PRICE **\$230**

UNIT 6: Ampex Model 750 Solid State Stereo tape recorder deck with sound on sound, sound with sound, echo chamber, tape monitor, Armstrong 421 stereo fully transistorised amplifier 15-watt RMS per channel less than 12 per cent plus minus 1 dB on the full output of 15-watt RMS. Empire Model 2,000 loudspeakers complete in beautifully designed cabinets, frequency response from 30-18,000 cycles handling capacity: up to 60-watt of undistorted music power, ERA Mk4 turntable, Empire 888TE cartridge.
TOTAL PRICE **\$1046**

UNIT 7: Pioneer SA-400 amplifier, 2 Wharfedale 8in RSDD loudspeakers, Dual 1010 turntable complete with cartridge.
TOTAL PRICE **\$206**

UNIT 8: Armstrong 221 stereo amplifier 10-watt RMS per channel frequency response from 30-20,000 cycles plus minus 1 dB less than 1/2 per cent distortion measured at 8-watt RMS, P.E. 34 Hi-Fi turntable, Empire 808 cartridge frequency response from 10-20,000 cycles better than 30 dB separation with new metal shield, 2 R. and A. 10in loudspeakers.
TOTAL PRICE **\$280**

UNIT 9: 2 Tannoy Dual Concentric England's best 12in loudspeakers, Armstrong 226 tuner/amplifier 10-watt per channel, ERA Mk4 turntable complete with arm and base, Empire 808E cartridge frequency response from 10-25,000 cycles.
TOTAL PRICE **\$580**

UNIT 10: Schaub-Lorenz STV101 stereo-ionic transistorised amplifier power output 10-watt per channel frequency response from 20-40,000 cycles plus minus 1 dB, P.E. 33 Hi-Fi turntable, Empire 888TE cartridge frequency response 6-32,000 cycles, 2 Heco 3-speakers system Model B210 complete in cabinets, frequency response from 25-22,000 cycles.
TOTAL PRICE **\$690**

UNIT 11: NordMende Spectra tuner/amplifier most attractive ultra modern cabinet in 3 colours, 2 compact speakers in beautifully designed cabinets, broadcast shortwave pick-up and tape recorder inputs, Dual 1019 Hi-Fi turntable complete with Dual tunover cartridge.
TOTAL PRICE **\$500**

UNIT 12: 2 Empire 8200 speaker systems frequency response from 25-20,000 cycles power handling 60-watt, Armstrong 426 tuner/amplifier fully transistorised 15-watt RMS per channel less than 12 per cent distortion plus minus 1 dB on the full output of 15-watt RMS, ERA Mk3 world's most brilliantly designed turntable hydraulic arm lift 33-45 rpm stop between speeds power requirement 1.6 watts, Empire 999VE cartridge, frequency response from 6-35,000 cycles.
TOTAL PRICE **\$1345**

RECORDED MUSIC SALON

C. PINCZEWSKI

TRUE FIDELITY

WHOLESALE AND TRADE ENQUIRIES WELCOME

23 COLLINS STREET, MELBOURNE

Telephone 63-6257

AUDIO TOPICS



Equipment performance—some typical figures

Newcomers to the field of high fidelity sound reproduction frequently complain that the performance figures quoted in catalogues and advertisements mean little to them. This article seeks to explain, in quantitative terms, such things as frequency response, distortion, power output, etc.

As we have seen, it is possible to discuss the performance of sound reproducing equipment in purely general terms but the fact remains that conversations, specifications and advertisements will be far more meaningful to the enthusiast who can understand—and perhaps quote—facts and figures. Within the scope of one short article, it is not possible to examine all the data which can be recorded about audio equipment, but the enthusiast should be able to acquire a working knowledge of the more important quantities and qualities without too much mental effort.

Let's begin by thinking in more specific terms about frequency response.

A fairly logical assumption is that a sound reproducing system should be capable of reproducing the whole range of frequencies audible to the human ear, without significantly accentuating or attenuating any frequency (or group of frequencies) relative to other frequencies in the spectrum. To use common technical phraseology, its response should be "flat" over the entire audible spectrum; the term "flat" envisages a graphical plot of performance against frequency, the result being a straight, horizontal line. We shall have more to say about this later on.

There are those who claim that this concept is too limited and who maintain that we may well have some obscure kind of a response to sonic energy outside the range of frequencies, which we hear in the normal way, and which we traditionally associate with speech and music. The claim is little more than speculation, however, and quite unproven. Until otherwise demonstrated, we can afford to ignore it.

It is a fact that certain items of audio equipment do have a response extending beyond the audible spectrum but this does not support the theory just mentioned, and it does not necessarily confer any advantage in terms of ultimate reproduction. In designing equipment to cover the full audible spectrum, it is fairly common to find that the response extends to a greater or lesser extent beyond the target figures.

The lower frequency limit of hearing is about 15 cycles per second. To use a term which is gaining favour, we can alternatively define the limit as 15 Hertz, abbreviated to 15Hz. If ears are energised at a lower frequency than this, our senses tend to interpret the successive pulsations as separate events, rather than as components of a unit sound.

The upper limit of audibility for humans is about 18,000cps or 18,000Hz, which can alternatively be written as 18 Kilohertz, or 18KHz. Such a figure is common enough for people up to about their middle twenties and gifted with a high degree of aural acuity in terms of frequency. The limit reduces markedly with various physical impairments and advancing years and is more likely to lie in the region 12-16KHz for the average adult in the 30-50 age bracket. However, for many adults, and particularly those in the over-50 age group, the upper limit falls below 10KHz.

These figures all refer to the limit at which the aural response "cuts off," meaning that the ears fail to resolve sound, as such, almost irrespective of its intensity. The range of frequencies over which ears might be considered to be reasonably sensitive would be more limited again.

Based on all that has been said,

sound reproducing equipment can be considered as satisfying all possible requirements of frequency response if its response is substantially flat between the limits of 15Hz and 18KHz.

In practice there are good reasons why these limits might be regarded as unnecessarily wide.

Very low frequency sounds approaching the 15Hz limit occur very rarely in speech and music and, in any case, are extraordinarily difficult to sustain in the limited environment of a listening room.

At the other extreme, frequency components approaching 18KHz have a debatable significance in most program material and are imperceptible, anyway, to a large proportion of the potential listening audience.

More practical—and less demanding—frequency limits to aim for in sound reproducing equipment are 30Hz and 15KHz, and equipment which is substantially flat between these limits will leave little or nothing to be desired in terms of frequency response.

Any retreat from these amended limits must be regarded as a retreat from true high fidelity standards, as we currently accept them. This does not mean that sound reproduction to lesser specifications need be unacceptable. A response which is flat between, say, 50KHz and 10KHz will sound only marginally "restricted" to critical listeners and actually impressive to those who are accustomed to less ambitious sound. This last group would actually represent the majority of the present population.

A medium-priced furniture-style stereogram could be expected to have a

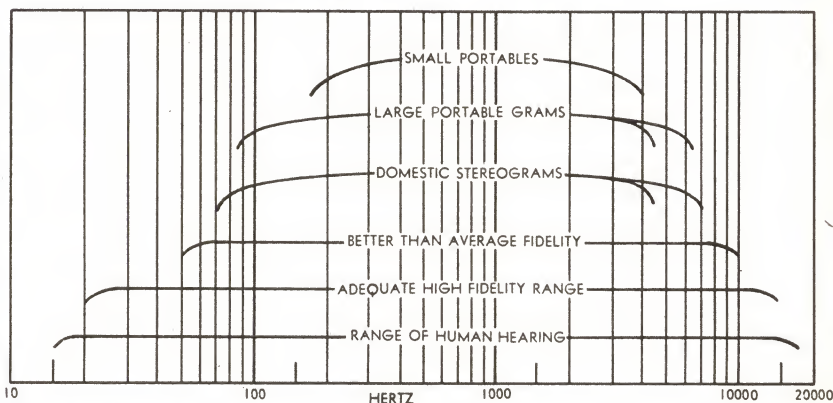

In a general way, this diagram depicts the frequency range for young and unimpaired human ears, and the frequency range of typical reproducing equipment. Note the progression from small portables to true wide-range high-fidelity equipment.

NEW ALL TRANSISTOR STEREO AMPLIFIER ULTIMATE IN DESIGN-LONG DEPENDABILITY

POWER OUTPUT: 12 watts per channel R.M.S. (24 watts total).
 FREQUENCY RESPONSE: From 20 cycles to 20,000 cycles plus/minus 1db.
 HARMONIC DISTORTION: Less than 1 per cent.
 HUM AND NOISE: Aux. 70db Mag. 30db.
 INPUT SENSITIVITY: Mag. 3mv. tape head 3mv., Aux. 150mv. Tuner 150mv.
 EQUALIZER: Mag. RIAA, Tape hd. NARTB.
 TONE CONTROL: Bass 50/c/s plus/minus 12db. Treble 10kc/s plus/minus 12db.
 LOUDNESS CONTROL: 50c/s plus 12db.
 RUMBLE FILTER: 50c/s minus 8db.
 DIMENSIONS: 13 3/8in wide, 4 1/8in high by 10in deep.



\$98.80 FREIGHT EXTRA

MODEL C200

PROVISION FOR STEREO HEADPHONES WITH SPEAKER-HEADPHONE SWITCH, MOUNTED IN OILED WALNUT TIMBER CABINET. The above C200 amplifier supplied with the new Garrard 60 MK II changer with cue control and fitted with Sonatone 9TA ceramic cartridges and diamond stylus and two Magnavox 8WR or 10WR high-fidelity dual cone speakers.

\$182.00 Freight extra.

HI-FI STEREO EQUIPMENT BY CLASSIC



Based on the R. & H. Playmaster 118 and 101 Amplifiers with these added features:

- Loudness control giving bass boost at low volume.
- Scratch Filter.
- Provision for tape recorder with separate record-play switch.
- Calibrated dial available for all States showing main stations in larger type.
- Fully guaranteed.

SPECIFICATIONS COMMON TO BOTH UNITS

● Inbuilt high gain tuner with a frequency coverage of 530 to 1,600 K.C. ● EH84 tuning indicator giving accurate tuning with ease. ● Two-channel tone control stage with separate bass and treble controls. ● Input facilities with switching for pick-up and stereo or mono tape recorder for record or play back. ● Chassis is plated and mounted in attractive and durable metal case finished in grey with control panel in black and silver with matching knobs. ● Valves used:—4 6GW8, 12AX7 or 12AU7, 6AN7, 6N8, EM 84 and 2 2.10 diodes. Dimensions 15 1/2" x 5 1/2" x 11".

118 UNIT WITH TUNER

- Output 8 watts per channel (16 watts).
- Incorporating Ferguson type O.P. 412 grain oriented output transformers giving a frequency response of 20 to 30,000 cycles.

\$115.50

118 AMPLIFIER WITH GARRARD CHANGER, AND HI-FI SPEAKERS

Type 50 MK II changer fitted with 9TA Sonatone ceramic cartridge and diamond stylus and two Magnavox 8WR or Rola 8CM. 8in HI-FI speakers.

\$172.00

101 UNIT WITH TUNER

- Output 11 watts per channel (22 watts).
- Incorporating Ferguson type O.P. 447 grain oriented output transformers giving a frequency response of 20 to 30,000 cycles.

\$119.50

101 AMPLIFIER WITH GARRARD CHANGER AND HI-FI SPEAKERS

Type 60 MKII changer fitted with Sonatone 9TA ceramic cartridge and diamond stylus and two Rola 12PX 12in speakers or two Philips 9710 dual cone HI-FI 8in speakers.

\$206.00

FREIGHT EXTRA.

NEW AMPLIFIERS AND TUNERS BASED ON THE PLAYMASTER 106 AND 107

107 AMPLIFIER AND TUNER

\$79.50

FREIGHT EXTRA

107 AMPLIFIER

- Output 5 watts per channel (10 watts). Ferguson output transformers with a response of 30 to 20,000 cycles.

● Valves used:
6AN7, 6N8, 2—
12AT7, 2—6BQ5, and
6CA4 rectifier.

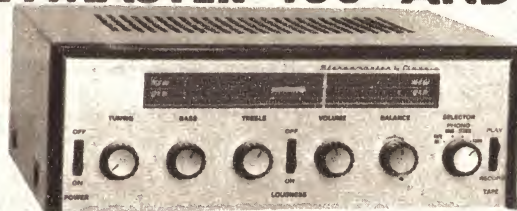

SPECIFICATIONS COMMON TO BOTH UNITS

- Inbuilt high-gain tuner with a frequency coverage of 530 to 1,600KC.
- Two-channel tone control stage with separate bass and treble controls.
- Switching facilities for pick-up and stereo or mono tape recorder for record or play-back.
- Loudness control giving bass boost at low volume.
- Chassis plated and mounted in attractive metal case finished in grey with control panel in silver and black with matching knobs and switches.
- Dimensions: 13 1/2in x 5 1/4in x 11in.
- Fully guaranteed.

106 AMPLIFIER AND TUNER

\$104.00

FREIGHT EXTRA

106 AMPLIFIER

- Output 8 watts per channel (16 watts). Ferguson grain oriented output transformers with a response of 20 to 30,000 cycles.

● EM84 tuning indicator.
● Valves used 6AN7
6N8, 12AU7 or 12AX7.
4—6GW8 and 2—OA210
rectifiers.

THE ABOVE AMPLIFIERS SUPPLIED WITH THE NEW GARRARD 1,000 CHANGER WITH RONETTE CARTRIDGE AND TWO MAGNAVOX 8WR OR ROLA 8CMX HI-FI SPEAKERS

107 — \$124.75

FREIGHT EXTRA

106 — \$149.25

CLASSIC RADIO

245 PARRAMATTA ROAD, HABERFIELD, N.S.W.

PHONE 798-7145

useful, though not necessarily flat, response between about 70Hz and 7KHz, using its own disc or tape source and with the tone control at full treble. On "AM" radio, the useful response would more likely lie between 70Hz and 4.5KHz.

Much the same figures would apply for the large portable (or transportable) 'grams and players, with perhaps, some further restriction on the bass due to limited cabinet size.

For still smaller equipment, limits can be expected to narrow progressively with decreasing size and cost to, say, 170Hz as the lower limit and 4KHz as the upper limit, and not very flat in between!

So much for figures of frequency response. But what do we mean by such terms as "not very flat," "substantially flat," etc.? Some quantitative assessment is obviously called for.

To assess the frequency response of a piece of audio equipment, engineers energise it with input signals of known (and usually standardised) amplitude and at a number of frequencies distributed across the audible spectrum. They measure the output from the device at each frequency and, by ordinary graphical methods, plot a curve of output against frequency.

In the case of a gramophone pickup or a tape head, the "input" is normally a series of test tones, ranging from very low to very high in frequency, which have been pre-recorded for just such a purpose on a frequency test disc or a frequency test tape. The output from the pickup cartridge or tape head is usually measured in terms of the resulting signal voltage, either taken directly across the unit or from an interposed network or amplifying stage, where this is appropriate to the unit concerned.

In the case of an amplifier the input is normally derived from an audio signal generator, producing signals of the required amplitude and frequency. The amplifier output is measured in terms of the audio voltage which the amplifier produces at the connecting terminals for the loudspeaker.

Loudspeakers are tested by applying to their terminals input signals of appropriate voltage and frequency and measuring their acoustic output in a suitable environment with a microphone/amplifier system of known characteristics.

In tabulating or plotting the results of such tests, engineers commonly make use of the "decibel" abbreviated in both the written and spoken language to "dB." In matters affecting the level of reproduced sound, the decibel provides a more meaningful basis for evaluation than results expressed only in terms of voltage, current or power.

This follows from tests which, long ago, established that our evaluation of loudness is not related in a linear fashion to the power involved. If we start with one unit of power and then double it, the average listener will notice a certain increase in loudness. To obtain further similar increases in apparent loudness, the power has to be raised to four units, then to eight units, then to sixteen, and so on. This non-linear relationship between actual sound pressure and apparent loudness is the reason, in fact, why the same ears which

can register the faintest rustle, can also cope with the sound of a multi-jet aircraft.

It transpired that the relationship closely follows a logarithmic ratio and the decibel, so beloved of audio engineers, is a figure obtained simply by taking the logarithm of any given power ratio and multiplying it by 10. A power ratio of 2 (log 0.3) is expressed as 3dB; a power ratio of 3 (log 0.48) would be 4.8dB; a power ratio of 4 times is 6dB, and so on.

In evaluating the performance of a piece of audio equipment, the tests aim to express in decibels what will be the effect, on the ultimate level of reproduced sound, of any departure of

3dB, 2dB) which happen to add up to 10dB.

Subjective tests have established that the smallest change in power level which listeners can detect under laboratory conditions is a ratio of about 1.6 times or 2dB.

A change in power level of 2:1 (or 3dB) is more easily noticeable but still not obvious to any but an attentive listener.

Based on these findings, it can reasonably be maintained that a sound reproducing system is indistinguishable from perfect, in terms of frequency response, if the sound output level as heard does not vary by more than 2dB across the frequency spec-

The response curves for a good quality amplifier and a good quality loudspeaker. The latter makes it pointless to worry about the last decibel of amplifier response.

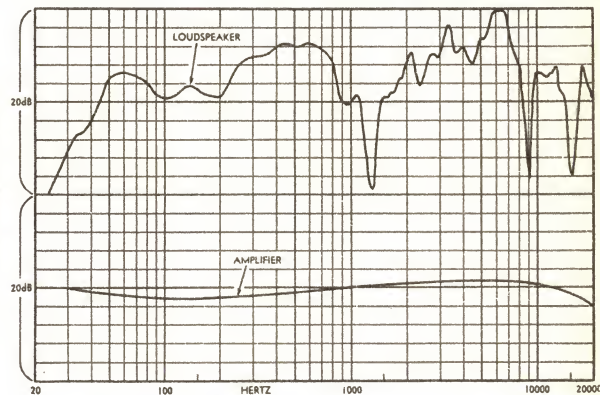

that equipment from the theoretical ideal.

By way of example, a gramophone pickup may be found to produce a certain output voltage over most of the range or at an arbitrary reference level such as 1KHz. But let's say that its output voltage is found to increase by 1.5 times at 7KHz, possibly due to a resonance in the stylus mechanism. If the level of signal voltage fed to the amplifier at 7KHz is 1.5 times normal, the actual power delivered by the amplifier would be 1.5 squared or 2.25 times normal. The log of 2.25 is .35 and, multiplying this by 10, yields the result that the pickup is "up" by 3.5dB at 7KHz.

In rather similar manner, variations in the overall amplification (or gain) of an amplifier, and variations in the acoustic efficiency of a loudspeaker can be expressed in decibels, insofar as they affect the level of the reproduced sound.

Visualising curves of output in decibels plotted against frequency, it is common terminology to suggest that a certain piece of equipment is "up" or "down" by so many dB at such and such a frequency. Again, the response curve might be described as exhibiting "peaks" or "troughs" or "prominences" — all words which are fairly obvious in their meaning.

The value of the decibel in this context is evident in that it establishes a relationship between such otherwise divorced quantities as the voltage output of a pickup or tape head, the amplification or gain of an amplifier and the acoustic efficiency of a loudspeaker system. What is more, a peak of 10dB in a particular frequency region amounts to the same thing, as far as the final sound is concerned, whether the peak arises from pickup, amplifier or loudspeaker alone, or from individual contributions (e.g., 5dB,

with a minimum of lenience, this figure can be extended to 3dB.

But such is the tolerance of our ears that variations of as much as 10dB, between different groups of frequencies, are interpreted as sound of slightly different balance but, none the less, of high fidelity. The realm of "ordinary" or "poor" sound would seem therefore to envisage variations over the spectrum of much greater than 10dB.

And here a word about terminology. All the references to this juncture, 2dB, 3dB, 10dB, etc., are on the basis that they represent the ratio between the highest and lowest power points on the curve. If a unit is credited with a frequency response which falls within plus and minus 2dB, the scope for variation is a total of 4dB. Similarly for any other figures.

In practice, it is not difficult to make an actual amplifier, these days, which is within 2dB from below 30Hz to above 15KHz.

The very best gramophone pickups and tape heads are hard put to it to stay within the 3dB limit over the same range, and the less expensive units under practical conditions come nowhere near doing so.

Loudspeakers in practical enclosures and in practical listening rooms never make the 2 or 3dB limits and are lucky to stay inside the 10dB limit! This is why even the best high fidelity loudspeakers sound "different" from one type to the next, even though all might be regarded individually as acceptable.

The accompanying curves will serve to validate the foregoing observations and also show what frequency curves look like.

Immediately obvious will be the very erratic nature of the response of even a high quality loudspeaker system

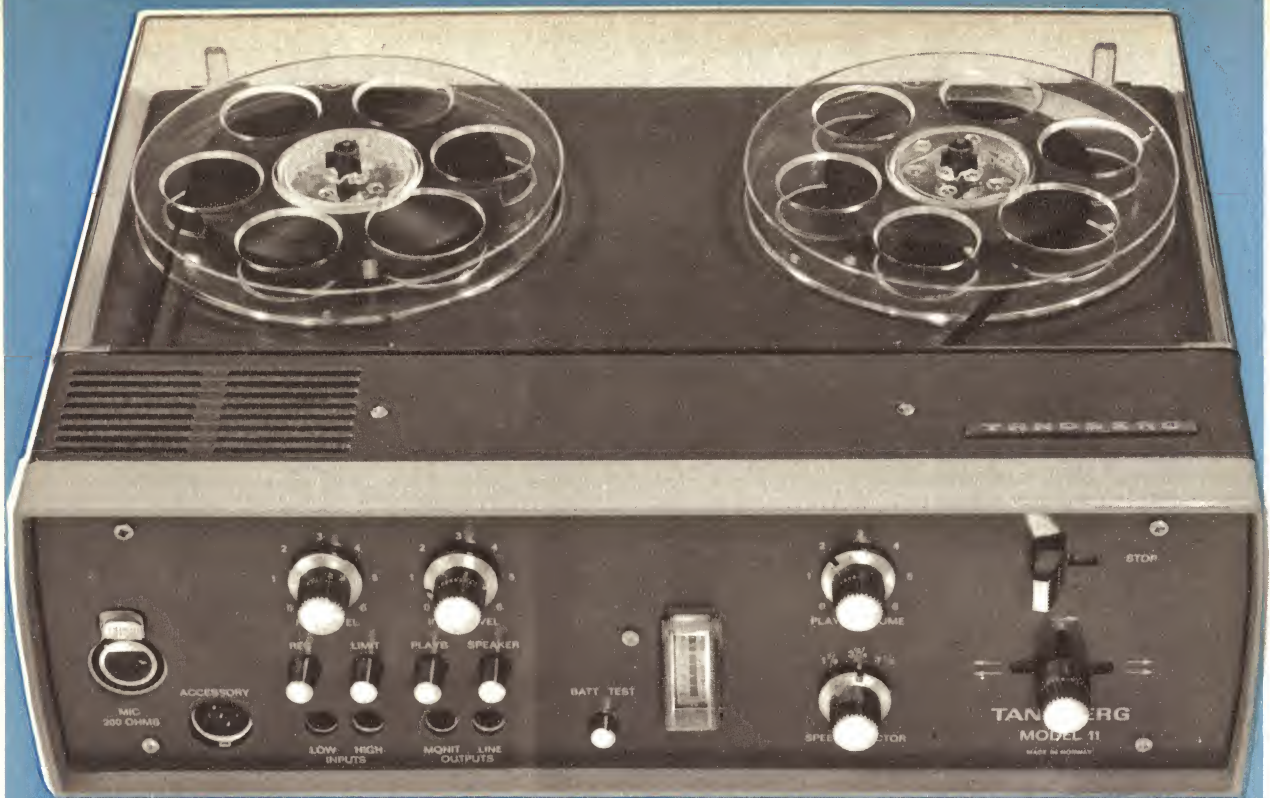

Now... a completely portable, professional quality, solid-state recorder from Tandberg

THE NEW TANDBERG "SERIES 11"!

Simon Gray proudly introduces a completely new, efficient, portable recorder from the world's leading manufacturer of high-fidelity recorders . . . the TANDBERG organization.

TANDBERG SOUND has become an international symbol for reality and natural sound reproduction . . . the sound of TANDBERG quality is unmistakable. The "Series 11" is no exception.

The "Series 11" is a battery driven monaural recorder designed for professional and semi-professional use. Three speeds are featured — 7½, 3¾ and 1½ lps. Operation is simple . . . the one control selects fast forward, rewind and normal drive for recording or playback. Push buttons are used to select recording or playback modes. Recording level is indicated precisely on a VU meter. An automatic gain control facility is also incorporated and can be selected when required. Control of recording is very simple; monitoring off the tape is facilitated by three heads and separate record and playback amplifiers. In addition to separate record, erase and playback heads, provision has been made for the addition of a fourth head to permit movie camera synchronisation. Mixing is possible as separate controls are provided for microphone and line inputs. Sensitivity is 5 mV. for the 10 K ohms Low Level input, 100 mV. for the 200 K ohms High Level line input. The microphone input sensitivity is 0.1 mV. at 200 ohms (balanced).

Power is provided by ten standard "D" type 1½ volt cells available in any store. An electronic speed regulator ensures precise speed $\pm 1\%$ during the entire life of the batteries. An optional AC power supply is available as well as an over-the-shoulder carrying bag, headphones and the popular Tandberg Model TM4 dynamic microphone. For the TM4 a balanced input with an impedance of 200 ohms is provided — a balanced output of 600 ohms may be used for external tape recorders and copying purposes.

The circuit contains 41 transistors and 10 diodes. Frequency response is 30-20,000 Hz. at 7½ lps, 30-13,000 Hz. at 3¾ lps and 30-7000 Hz. at 1½ lps. Wow at 7½ lps is better than 0.1%. Signal to noise is 58 dB. unweighted. Total weight including batteries is only 11½ lbs. Dimensions are 13" x 4" x 10¼".

The Tandberg "Series 11" accepts 7" spools with the lid open and 5" spools with the lid closed. The performance of this versatile recorder is quite outstanding. Audio quality, signal-to-noise ratio, freedom from distortion and wow . . . these are the features that set the "Series 11" apart, as they satisfy professional standards.

The Tandberg "Series 11" is available from Simon Gray offices and representatives in all states; it is backed by Simon Gray service facilities throughout Australia.

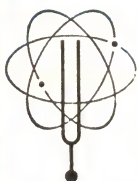

Australian National Distributors:

Simon Gray Pty. Ltd.

Head Office: 28 Elizabeth St., Melbourne, Vic. Tel. 63 8101*

Sydney Office: 22 Ridge St., North Sydney, N.S.W. Tel. 929 6816

Canberra Office: 31-33 London Circuit, Canberra City, A.C.T.

Tel. 49 6050

INTERSTATE REPRESENTATIVES:

N.T.: Pfitzner's Music House, Smith Street, Darwin. Tel. 3801

Q'land: Sydney G. Hughes, 154-158 Arthur St., New Farm, Brisbane. Tel. 58 1422

S.A.: Eilco Sales Pty. Ltd., 7-9 Osmond Terrace, Norwood, S.A. Tel. 63 4844

Tas.: K. W. McCulloch Pty. Ltd., 57 George Street, Launceston. Tel. 2 5322

W.A.: Athol M. Hill, 613-615 Wellington Street, Perth. Tel. 21 7861

in a typical listening environment. Because an amplifier has to be heard through a loudspeaker, and because it has to be fed from a signal source, with its own somewhat undulating response, it is quite pointless to make a fetish of the last dB in an amplifier curve. By all means seek an amplifier which has a flat and wide response, but there is nothing to be gained by insisting on a curve wider than the limits of audibility nor flatter than the inconsequential 2dB.

Let's turn, now, to **distortion**.

Used in its most general sense, the word distortion could logically be made to embrace any shortcoming in the reproduced signal occasioned by a technical imperfection.

In normal usage, however, the word has to do with lack of amplitude **linearity** in the equipment concerned; this simply means that the output of the device does not exhibit a strictly linear relationship (or is not strictly proportional) to the input. All practical equipment exhibits some degree of non-linearity over its working range, the effect becoming much more evident as any inherent limitation on the signal or power handling capacity of the equipment is approached.

The effects of non-linearity are commonly referred to by the collective term **non-linear distortion**. They can be heard, observed, defined and evaluated in a number of different ways.

Most obviously, perhaps, non-linearity modifies the waveshape of a test signal, as viewed on an oscilloscope. For example, a grammo. pickup tracing a sine wave recording (i.e. a pure single tone) might, at some frequencies, deliver an output waveform which departs noticeably in appearance from the smooth sinoidal form. Again, an amplifier fed with a sine wave might, under certain conditions, deliver an output in which the peaks appear slightly compressed or even obviously flattened; or there may be kinks in the sloping sides of the waveform.

It transpires that waveforms which are thus misshapen contain spurious frequency components which have been superimposed on the original signal as a result of the non-linear characteristic. Because these spurious frequencies are in harmonic relationship to (or are multiples of) the original signal frequency (or frequencies) they are described by the term **harmonic distortion**.

The presence of spurious frequencies can be detected and measured by the use of equipment such as a **Distortion Factor Meter**, which gives a net figure for all distortion present; or a somewhat more specialised instrument called a **Wave Analyser** which allows the harmonics which have been added to a test signal to be evaluated individually.

The amount of harmonic distortion present in the output of audio equipment has long been accepted as a measure of its quality, in terms of linearity; so much so that, unless otherwise indicated by qualification or context, the word distortion occurring alone can be taken to mean **harmonic distortion**.

Non-linearity has another effect in that it causes original signals which are being handled simultaneously to **intermodulate**, producing additional spurious frequencies equal to the sum and difference of all frequencies so involved. Thus, signals at 400 and 1000Hz might intermodulate to

produce resultants at 1400 and 600Hz. This, in addition to natural harmonics, as already outlined.

Test procedures have been evolved to measure **intermodulation distortion** and it is frequently quoted, at least for amplifiers, in addition to the more commonly quoted (harmonic) distortion. For a given amplifier, the figure yielded by an intermodulation test is usually from three to five times that of the harmonic distortion test and this should be allowed for in looking at specifications.

While the effects of non-linearity can thus be observed and measured by special instruments, the question must follow as to how these observations and measurements relate to the audible result.

In fact, listener reaction to non-linearity and the resulting distortion varies enormously with circumstances.

Teenagers quite commonly operate portable receivers under such conditions of overload that the distortion can only be described as gross, and unacceptable by any other standards.

At the other extreme, high fidelity enthusiasts can become sharply aware of very small amounts of distortion, and may be critical of sound quality which the average person will accept as perfectly normal.

It is relevant also to mention that listener reaction to distortion varies widely with the order and the magnitude of the spurious harmonics and the signal frequencies from which they originate.

Loudspeaker systems, for example, commonly suffer from serious non-linearity when fed with signals of high amplitude and low frequency—say 60Hz or lower. They tend to "double" or "triple," producing an inordinate proportion of spurious signal at double the original frequency (second harmonic) or triple the original frequency (third harmonic). By and large, this very considerable order of distortion at the low bass end passes unnoticed by most or raises no more comment than something to the effect that the bass is "high pitched" rather than "throbbing."

Again, grammo. pickups fairly commonly encounter difficulties in accurately tracing modulation patterns at the higher frequencies, say 7KHz or above. The resulting output waveforms are noticeably misshapen on an oscilloscope and would yield quite high distortion readings on a distortion factor meter. Fortunately, the audible effects of such distortion are minimal because the spurious frequencies so generated are near to or beyond the upper limit of human hearing, whereas the same order of distortion related to signals lower in the range might be quite intolerable.

In the face of these and other such considerations, it is not possible to make any simple statement about the amount of distortion which might be tolerable in a high fidelity situation. Too many qualifications would have to be added about the order of the harmonic involved (2nd, 3rd, 4th, etc.) and the original signal frequency. But, even if this were set out, it would be useless because the information is rarely available for key items of equipment.

Distortion in the output of an audio device is normally expressed as a percentage of the total output.

For an amplifier, the figure can be

derived fairly easily, using a high quality audio signal generator and a distortion factor meter. Distortion figures are commonly quoted for amplifiers and are an important element in competitive marketing.

Distortion is much more difficult to measure accurately for a grammo. pickup or a tape player because of the difficulty of arranging a disc or tape signal source which has the very precise characteristics necessary for measurement purposes over a wide selection of frequencies.

With a loudspeaker, it is even more difficult, because few laboratories in the world can provide the sound-proof echo-less (anechoic) chamber and precision microphone equipment which is necessary.

Because of these difficulties and the unflattering figures which might emerge, anyway, accurate distortion figures are seldom taken on transducers (pickups, tape heads, but particularly loudspeakers) and are published even less frequently. Resort is had, instead, to fine descriptive phrases!

During the thirties, a figure of 5 per cent was fairly commonly quoted as an arbitrary limit for the permissible distortion level in an audio amplifier.

After the war, with the emergence of better output transformers and a greater utilisation of negative feedback techniques, the figure was progressively reduced until the majority of well-designed quality amplifiers were able to exhibit a distortion content of 1 per cent or less. In fact, a figure of 0.1 per cent gained acceptance as some kind of a design ultimate.

The current generation of solid-state amplifiers, with no output transformers and with a very high order of negative feedback, meets and betters this specification easily enough over most of the frequency range — though, curiously, some produce rather more distortion at low power output levels.

While it makes good sense to select an amplifier having the lowest available distortion content, there is no point in making a fetish of the exact figure, below a certain minimum. Purely as a guide, if an amplifier can be shown to exhibit less than 1 per cent distortion, it is extremely doubtful whether any improvement could be discerned in the final sound if it were replaced with another having a lower figure.

As has already been mentioned, loudspeakers commonly introduce distortion on to test tones which is plainly audible to the ear and plainly visible on an oscilloscope fed from a monitoring microphone. Such orders of distortion are almost certain to be so far in excess of the fractional percentage attributed to the amplifier that the latter is of little consequence. It is further swamped by distortions which occur before the program signal ever reaches the amplifier input.

In short, buy the best amplifier you can but don't make a fetish of harmonic distortion figures below 1 per cent. Concentrate rather on providing a loudspeaker and grammo. pickup which, in your own opinion, or that of accepted reviewers, sounds particularly "clean," "transparent," etc. — descriptions which can reasonably be interpreted to mean lower than average distortion.

(TO BE CONTINUED)

Public Address Units — Geiger Counters — Metal Locators — Decade Boxes — Mixers — Battery Chargers — Oscillators — Bridges — Parts Supplied for Projects in Electronics (Aust.), Wireless World, Practical Wireless, Electronics World, Electronics Illustrated, Practical Electronics, etc.

1966 3in C.R.O. (MAY)



TRANSISTOR AUDIO OSCILLATOR
1965 (Sept.)

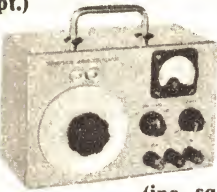

(inc. sq wave).



REGULATED POWER SUPPLY
1966 (June)



SENIOR TACHO and DWELL TESTER. 1964 (October)

1966 V.T.V.M. (Feb.)

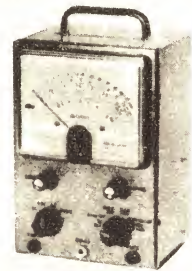

TRANSISTOR M./VOLT METER
1965 (January)

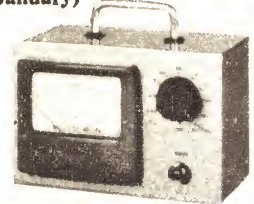

- INSTRUMENTS**
- 5" Wide Range C.R.O.
 - 3" Fully Calibrated C.R.O.
 - Audio C.R.O.
 - 1966 3" C.R.O.
 - 1968 3" C.R.O.
 - C.R.O. Electronic Switch.
 - C.R.O. Wide Band Pre-amplifier.
- MULTIMETERS AND VTVM'S**
- 20,000 ohm/volt Protected Multimeter
 - 20,000 ohm/volt Protected Multimeter Probe
 - Protected D.C. Multimeter
 - Meterless Voltmeter
 - Millivoltmeter (A.C.)
 - Transistorised Millivoltmeter (A.C.)
 - Noise Distortion Millivoltmeter
 - VTVM
 - 1966 VTVM 5% Resistors
 - 1966 VTVM 1% Resistors
 - 1966 VTVM Probes
 - 6ALS Diode Probe

- BRIDGES**
- R.C. Bridge
 - 1966 R.C. Bridge
 - 1968 R.C. Bridge and Signal Injector.
- SIGNAL GENERATOR AND OSCILLATOR TV INSTRUMENTS**
- Sweep and Marker Generator
 - 5-5 and 35 MHZ Sweep Generator
 - Silicon Diode Noise Generator
 - Silicon Diode Sweep Generator
 - Pattern Generator
 - Transistorised Pattern Generator
 - Wide Range Pulse Generator

- AUDIO INSTRUMENTS**
- 1960 Audio Oscillator
 - 1962 High Performance Audio Generator
 - Crystal Locked Standard
 - Electronic Tuning Standard (Less C.R.T.)
 - Transistorised Audio Oscillator (Inc. Square Wave and Meter Facilities)
 - Direct Reading A.F. Meter
 - Square Wave Generator (10HZ-1MHZ)
 - Transistor Audio Signal Generator
 - Additive Frequency Meter

- Additive Frequency Meter (Less Crystals)
 - A.F. Tone Burst Generator
- R. F. INSTRUMENTS**
- 6 Band service oscillator
 - Transistorised wave meter
 - G.D.O. Adaptor
 - Transistorised service oscillator
 - Simple Signal Injector
 - Wide Range G.D.O.
 - Transistorised Signal Tracer
 - Transistorised Oscillator (Inc Crystal)
 - Basic Test Oscillator
 - Transistor Test Oscillator
 - Signal Injector and R.C. Bridge

- MISCELLANEOUS INSTRUMENT RITS**
- Transistor Tester
 - Valve and Transistor Tester
 - Electronic Stethoscope
 - Moisture alarm
 - Electronic Pistol
- 56. Geiger Counter Transistor**
- Light Beam Relay Alarm.
 - Flasher Unit.
 - Transistor Alarm.
 - Electronic Switch.
 - Photo Timer.
 - Direct Reading Impedance Meter.
 - Electronic Anomometer.
 - S.W.R. Indicator.
 - Simple Proximity Relay Alarm.
 - Pipe and Wiring Locator.
 - Resonance Meter.
 - Electronic Metronome.

- BATTERY CHARGERS**
- Universal Charger 6V at 5A-12V 3.5A.
 - 1 Amp Charger 6 or 12V at 1A.
- REGULATED POWER SUPPLIES**
- Transistor 9V Regulated Supply—1.9V at 70 MA.
 - Transistor Fully Protected Supply—6.25V at 500 MA.
 - Transistor Fully Protected Supply (Less Meters).
 - 1965 H.T. Regulated Supply—190-270V at 40 MA.
 - 1966 H.T. Regulated Supply (Less Meters).
- VOLTAGE/CURRENT CONTROL UNITS**
- Varl-Watt Power Controller.
 - Vari-Tach Motor Speed Controller.

- 2KW Automatic Light Dimmer.
 - 4KW Automatic Light Dimmer.
 - Model Train Control Unit. W/Simulated Inertia.
 - High Power Model Train Control Unit with Simulated inertia.
- TACHOMETER UNITS**
- 6 or 12 volt standard Kit.
 - 6 or 12 volt Mullard Kit.
 - 6 or 12 volt with Dwell Angle.
 - Tachometer and Dwell Angle Unit for Service Stations.

- TRANSISTOR IGNITON**
- 6 or 12 volt RO-FO Coil Kit.
 - Special Ignition Coil.
 - 6 or 12 volt Kit (Ignition Transformer Type).
 - Automotive Voltmeter-Exp Scale.

- CONVERTER**
- DC-DC Converter—60 Watt.
 - 40 Watt Unit (DC-DC) Converter Transistor.
 - 40 Watt Unit (DC-DC) Converter 12V Input.
 - 70 Watt Unit (DC-DC) Converter 12V Input.
 - 100 Watt Unit (DC-DC) Converter 12V Input.
 - 140 Watt Unit (DC-DC) Converter 24V Input.
 - 225 Watt Unit (DC-DC) Converter 24V Input.

- HIGH FIDELITY AMPLIFIERS MONO UNITS**
- Hi-Fi 3.
 - Mullard 3.3.
 - Mullard 5-10 Single Unit.
 - Mullard 5-10 Two Units.
 - Mullard 5-10 (Trans.).
 - Transistor — 20 Watt.
 - Transistor — 60 Watt.

- STEREO UNITS**
- Mullard—2-2.
 - Mullard—3-3.
 - Mullard—10-10
 - Mullard—5-5 (Trans.).
 - Mullard—10-10 (Trans.).
 - Philips—Twin 10.
 - Wireless World 20-20 (Trans.).
 - Hi-Fi 60-60 (Trans.).
 - Playmaster Standard 2-2.

- Playmaster Unit 3.
 - Playmaster Unit 4.
 - 4KW Playmaster Twin 10.
 - Playmaster 101 Basic Amplifier.
 - Playmaster 105 (Trans.).
 - Playmaster 113 (Trans.).
 - Playmaster 115 (Trans.).
 - Playmaster 118 Valve.
- P.A. & GUITAR UNITS**
- 10 Watt Standard P.A.
 - 25 Watt Standard P.A.
 - 35 Watt Standard P.A.
 - 100 Watt Standard P.A.
 - Stereo P.A. AMP.
 - 10 Watt Guitar.
 - 25 Watt Guitar.
 - 35 Watt Guitar.
 - 50 Watt Guitar.
 - 70 Watt Guitar (Trans.).
 - Playmaster 102 Guitar.
 - Playmaster 103 Guitar.
 - Playmaster 116 Guitar, 40w.
 - Playmaster 117 Guitar 60w.
 - Guitar Fuzz Box.

- STEREOGRAM UNITS**
- Playmaster 106.
 - Playmaster 107.
 - Playmaster 108.
- CONTROL UNITS**
- Playmaster No. 9 Mono.
 - Playmaster No. 10 Mono.
 - Playmaster 104 Stereo
 - Playmaster 112 Stereo
 - Playmaster 120 Stereo
 - Mullard 2 Valve Mono.
 - Mullard 3 Valve Mono.
 - Phillips Miniwatt Unit.
 - Wireless World Systems — Stereo.

- PREAMPLIFIER UNITS**
- Transistor Mono.
 - Transistor Stereo.
 - Transistor Silicon Mono.
 - Transistor F.E.T. Mono.
 - Transistor DYN MIC Mono.
 - Transistor DYN MIC Mono.
 - Playmaster 115—FET—Stereo.
 - Playmaster 118 — Magnetic.
 - Sound Projector Pre-amp.

- MIXER UNITS**
- Transistor—4 channel.

- Transistor—4 channel.
 - Valve—4 channel.
- TUNER UNITS**
- Playmaster — Unit style.
 - Playmaster No. 11.
 - Playmaster No. 114.
 - Phillips Miniwatt.
 - Mullard Wide Band with Preamp.
 - Transistor — Long Range.
- TAPE AMPLIFIER UNITS**
- Transistor Tape Pre-amp.
 - Playmaster 110
 - Playmaster 110 Stereo.
 - 110 Power Unit.
 - Playmaster 110 Adaptor.
 - Playmaster 119 Tape Adaptor.
 - Transistor VOX.
 - Tape Actuated Relay.
- RECEIVERS—AMATEUR, HF and VHF.**
- Freemodine 4. Complete Kit.
 - Freemodine 4 RF Section Only.
 - Communication RX.
 - Synchrodyne Tuner.
 - Deitahet RX
 - 3-Band Double Change Superhet RX Explorer—AM/FM VHF (Transistor).
 - Interceptor 5 Semi Communication RX.
 - 1957 All Wave 5.
 - 1967 All Wave 6.
 - 1957 All Wave 7.

- GENERAL PURPOSE RECEIVERS**
- All Transistor Car Radio.
 - Transports 7 (with RF) Transistor.
 - Little General 1961.
 - 3-Band 8 Transistor Set.
 - 3-Band 2 RX with Speaker.
 - 5-Band 3 RX (AC).
 - Interstate 5 (AC).
 - Versatile Mantel Set.
 - All Wave Transistor 3.
 - A.B.C. 3 Receiver (AC).
 - 1957 All Wave 2.
 - 1967 All Wave 3.
 - F.E.T. 3
 - 144 MH3 Linear Final (50W).
 - 144 MH3 (TX) (20W).
 - 144 MH3 TX (75W)
 - 144 MH3 TX (18W)
 - 144 MH3 SSB (TX)
 - 3-Band AM TX.
 - Basic 3-Band TX.
 - 5-Band SSB TX.
 - SSB TX Complete.
 - SSB TX Less Crystals.
 - SSB TX Less Mech Filter.
 - Less Crystals and Mech. Filter.

**K
I
T
S**

AMPLIFIERS — PREAMPLIFIERS — TUNERS — CONTROL UNITS —
GUITAR UNITS — INSTRUMENTS — INVERTERS — CONVERTERS —
RECEIVERS — TRANSMITTERS — REGULATED POWER SUPPLY —
TRANSISTOR & VALVE TYPES.

**K
I
T
S**

PRE STOCKTAKE BARGAINS

LOUDSPEAKERS — METERS — TRANSFORMERS — AND MANY
OTHER ITEMS (GOODMANS — MSP — ROLA — A & R — FERGUSON
— MASTER — UNIVERSITY). T.V. I.F. STRIPS — D.C. — A.C. INVER-
TERS — AND MANY OTHER ITEMS —

UP TO 50% OFF LIST PRICE

Write for our June-July SPECIAL BARGAIN LISTINGS

POPULAR KITS - TOP QUALITY - LOWEST PRICES

**PLAYMASTER UNIT 4
STEREO AMPLIFIER**
R.T.V. and H. March 1962
FULL KIT:



**PLAYMASTER 110
TAPE AMPLIFIER**
ELECTRONICS (Aust.),
March-April, 1965

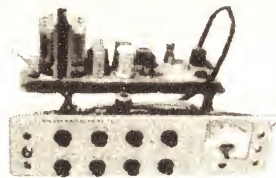

**PLAYMASTER 106
STEREO AMPLIFIER with
IN-BUILT TUNER,**

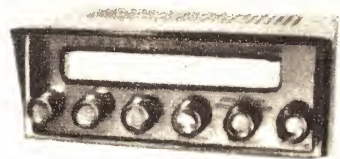

**PLAYMASTER 111
WIDEBAND TUNER,**
(October, 1965)



PLAYMASTER 112
December, 1965



PLAYMASTER 113
March, 1966



PLAYMASTER 116-40 watt ELECTRONICS Australia, June, 1967

COMPLETE KIT FOR AMPLIFIER . . . Only **\$93.80**

PLAYMASTER 117-60 watt ELECTRONICS Australia, July, 1967

COMPLETE KIT FOR AMPLIFIER . . . Only **\$102.45**

Phone 63-3596
63-5973

E. D. & E. PTY. LTD.

(SALES)

Phone 63-3596
63-5973

232 FLINDERS LANE, MELBOURNE, VICTORIA



Classical reviews

By JULIAN RUSSELL

Elektra . . . Strauss' best opera

STRAUSS — *Elektra* (Complete Opera). Regina Resnik (Klytemnestra); Birgit Nilsson (Elektra); Marie Collier (Chrysothemis); Gerhard Stolze (Aegisthus); Tom Krause (Orestes). Vienna Philharmonic Orchestra conducted by Georg Solti. Decca SET354/5.

It is fashionable nowadays for bright young musicians — and some of their elders who should know better — to disparage the work of Richard Strauss. They sneer at him for having been a revolutionary who gave up the struggle and settled for the comfortable security of tradition. Nothing could be further from the truth, Strauss, after composing "Salome," "Elektra," and "Die Frau Ohne Schat-

ten," in which he explored and exploited harsh dissonance to express highly neurotic subjects and characters, returned to a more lyrical style because he found 12-tone composition an unsuitable style for opera. And whether he was right or wrong it is significant that since Strauss only one atonal opera has remained in the repertoires of the world's great opera houses — Alban Berg's "Wozzeck."

True, many have been written, and for a while it looked as though Dallapiccolo's "The Prisoner" might survive, but today it has only widely spaced revivals. The others are given a few performances and disappear for ever. Schonberg's "Moses and Aaron," attended by giant-sized publicity cam-

paigns and with the public appeal of a ferocious bacchanale, might receive an occasional performance to satisfy public curiosity but it is too expensive a production to mount for the small coterie that supports 12-tone music.

Of Strauss' four finest operas "Salome" "Elektra" "Der Rosenkavalier" and "Ariadne Auf Naxos," his greatest is "Elektra." "Salome" has its great moments which crest a score that is colourful with a forceful dramatic urge and subtle characterisation, all helped by the Oscar Wilde play on which it was based. "Rosenkavalier" re-creates the atmosphere of aristocratic Vienna during the reign of Maria Therese with imperishable beauty. "Ariadne" is a mixture of wit and elegance of which I personally, never tire. But "Elektra" is Strauss' supreme achievement for the theatre.

The librettist Hoffmannsthal supplied the composer with a text based on the noble play of Sophocles, and Strauss realised its savage grandeur with unflinching inspiration and deep understanding of the characters and their conflict. For even at her most degraded, Elektra remains noble in her pursuit of revenge for the murder of her father by his wife (Elektra's mother, Klytemnestra) and her lover, Aegisthus. And the opera builds up to a climax of almost unendurable fury when these two are executed by Elektra's brother, Orestes. I am not exaggerating when I describe the final scene as stunning in its impact no matter how often I see or play it.

Bergonzi in Traviata — "world's best"

VERDI — *La Traviata*. Montserrat Caballe (Violetta); Carlo Bergonzi (Alfredo); Sherril Milnes (Germont); Dorothy Krebill (Flora); Fernando Iacopucci (Gastone); Gene Boucher (Douphol); Harold Enns (Grenvil). RCA Italiana Opera Orchestra and Chorus conducted by Georges Pretre. RCA LSC8005.

The outstanding performance in this set comes from Carlo Bergonzi as Alfredo. He is at the very top of his form throughout, which means that he is the finest bel canto tenor in the world today. His voice is silky in texture without those lachrymose moments so popular among Italian singers since Gigli, moments that always suggest to me that the tenor is suffering from some nagging pain or emotional affliction. He takes the highest notes without apparent effort and has an immaculate sense of style.

This is an opera in which, as a rule, the tenor is eclipsed to some extent by the richness of the soprano's part, one of the most grateful in any Italian opera. That this does not happen here is due to the beautiful smoothness and purity of tone of Montserrat Caballe's performance in the title role. While this is an exemplary example of the singer's art it tends to drain a little of the character away from the heroine's dramatic potentialities. Here is a performance of which every note can be enjoyed, though it occasionally sacrifices drama for vocal perfection.

Another example of this vocal perfection at some sacrifice to the character's humanity is to be found in Sherril Milne's Germont, which is

also a delight to the ear even if its dramatic impact is slighter than it might be. The smaller roles are all competently handled and the ensembles cohere nicely under the direction of Georges Pretre. Chorus and orchestra sing and play musically and Pretre is not too French-minded to add here and there a dramatic Verdian surge when it comes along. Yet despite the undeniable merit of much of his conducting he does not seem quite as comfortably at him in this Italian climate as either Serafin or Pritchard in recordings for H.M.V. or Decca respectively.

Notable in this set is the resourceful use of stereo techniques. The second party scene is very difficult to bring off successfully on disc. The stage action has several different groups, gamb'ers, flirting couples and people discussing serious matters all contributing at much the same time. The way in which the various groups have been separated so that one has a clear aural picture of the scene is executed here in masterly fashion. Another such triumph is won in the last act bedroom scene in which sounds from the street outside can be heard in beautiful perspective.

This is not my favourite recorded performance of "Traviata." I prefer either of the two I have mentioned above for one reason or another. But it is a highly meritorious one, and one which I can recommend without too many reservations. Indeed, if you haven't heard the others, and perhaps even if you have, I don't think you will find any really serious faults in the RCA set.

Up till now, the only recording of this masterpiece worth having has been the DGG version. An earlier one by Metropoulos was a disaster. Now Decca have issued a recording worthy of its great subject. First there is the superb performance of Birgit Nilsson in the title role, vivid in its agony, terrifying in its deadly purpose, heart-breaking in its one moment of happiness when she recognises the brother she thought was dead. She is in magnificent voice all through, and although there is an occasional passage where she is not dead on the note, these are swept aside by the implacable pursuit of her destiny.

As her womanly sister Chrysothemis, Marie Collier sings admirably, making a perfect foil for her bloody-minded relative. And as Klytemnestra, Regina Resnik's performance is at once powerful and deadly in import, suggesting that even the gods themselves could never raise her from the depths of her degradation.

In the comparatively small part of Orestes, Tom Krause is never less than admirable in his fearful responsibility of matricide. The playing of the Vienna Philharmonic under Georg Solti is beyond praise, and the producer, the peerless John Culshaw, has seen to it that a perfect balance is always preserved between the singers and the heavily scored orchestral part. The latter is never obscured by the voices however forcefully they might be used.

After so moving a production it seems like quibbling to mention two slight faults: the overdone weeping of Miss Collier — overdone despite the composer's direction "heftiges Weinen"; and the woefully exaggerated laughter of Klytemnestra when she

hears the false report of Orestes' death. But these are the only blots on a performance which is unlikely to be matched for many a long year.

By the way, unlike any previously recorded set (or any performance I have heard in an opera house) this version is given complete. It includes all the cuts that Strauss authorised, though there is no evidence that he approved them.

★ ★ ★

WHAT EVERYONE SHOULD KNOW ABOUT MUSIC. A Lecture by Ernest Ansermet. Decca Stereo SXLA6313.

This is a lecture that amply repays close study. Whether or not you will agree with Ansermet will depend on how far you are committed to 12-tone music. If, like me, you regard much of it with suspicion and doubts as to its being anything but an unsolved process of change, you will approve most of what Ansermet has to say on the subject. If, on the other hand, you can find, or perhaps claim to find, enjoyment in the 12-tone method, you will dismiss Ansermet as an old fogey. But to these I would recall that he was one of the prime movers in the popularisation of the music of Stravinsky — until he, too, went 12-tone in such works as "Agon." And this happened as far back as World War I days.

Ansermet's main point is that avant garde composers confuse the dissimilarity between sounds and music and ignore the relationship between the psychic and physical properties of music. To illustrate this he describes the anatomical mechanics of hearing and the effect that a sound perceived through the ear has on the brain and so on the emotions of the listener. And when you listen to this part of the lecture it might be as well to remember that before adopting music as a career — in the early 1920s — he resigned the chair of mathematics at the University of Lausanne.

But while the examples Ansermet plays to you here may be simple, his arguments are certainly not. Indeed he warns that his talk is not to be taken as entertainment, but "a talk that seeks to be illuminating, which it will not be unless it is followed closely, even, perhaps, several times."

Strangely his aversion to serial and 12-tone music is only lightly touched upon in his lecture. He reserves his big guns for the sleeve notes that accompany the record. In these he writes: "For (serial composers) music is no longer the music of the heart but a language of sounds. Their music is no longer the product of an activity of feeling but of their intellect. They make it not with notes but with sounds, and determine its structure by quantitative measure, both in the tonal and temporal sphere. This kind of 'sound art' disconcerts the listener who asks himself whether this is still music or whether it is he who is no longer capable of following the historical evolution of our art. This record will show him, I hope, that he has reason to be disconcerted, and that it is not he who has lost his head."

If this disc interests you enough in Ansermet's theories, more extended discussion of them can be found in his book, "Les Fondements de la Musique dans la Conscience Humaine," which,

you, as a music lover know the type of equipment you want . . . mastersound knows too and that's why,

MASTERSOUND HAS WHAT YOU WANT



Mastersound breaks the price barrier on the world's best speaker systems.

If you know the WHARFEDALE 'AIREDALE' at \$700 (W15"RS, SUPER 8"RS/DD, SUPER 3).

Try Mastersound's 3-way WHARFEDALE at only \$375 (W12"FRS, SUPER 8RS/DD, SUPER 3).



\$375



\$250

If you like the expensive sound of K.E.F. at \$450.

Listen to Mastersound's K.E.F./WHARFEDALE at only \$250.

The SONY Speaker system measures a tiny 16½" x 16½" x 7½" (with power handling at 20 W and freq. response 30-20 KC). Regardless of its size, this is a top-class system. Priced at only \$112 a pair.



\$112 a pair

MASTERSOUND SALES PTY. LIMITED,
400 KENT STREET.
SYDNEY. 29-1257

PRESENTING LEAK FRANCHISED RETAILERS

NEW SOUTH WALES

Arrow Electronics Pty. Ltd.,
342 Kent Street, Sydney,
N.S.W. 2000.

John Border Sight & Sound P/L.,
175 Liverpool Street, Sydney,
N.S.W. 2000.

Magnetic Sound Industries,
387 George Street, Sydney,
N.S.W. 2000.

Master Sound Sales P/L.,
400 Kent Street, Sydney,
N.S.W. 2000.

A. Victor & Co.,
196 Elizabeth Street, Sydney,
N.S.W. 2000.

W. C. Wedderspoon P/L.,
193 Clarence Street, Sydney,
N.S.W. 2000.

Auburn T.V. Centre,
58 Auburn Road, Auburn,
N.S.W. 2144.

**Broadway Electronics (Sales)
P/L.**,
32 Glebe Point Road, Glebe,
N.S.W. 2037.

**Elton Butler Radio & T.V. Sales
& Service**,
18 Park Street, Mona Vale,
N.S.W. 2103.

Ted Cooper's Appliance Centre,
349 Kingsway, Caringbah,
N.S.W. 2229.

Dickens & Carey (Bathurst) P/L.
76 Keppel Street, Bathurst,
N.S.W. 2795.

Glendor Camera Centre,
43 The Corso, Manly,
N.S.W. 2095.

Kensington T.V. P/L.,
14 Gardeners Road,
Kingsford, N.S.W. 2032.

Kunos T.V.,
4 Ilford Street, Rylstone,
N.S.W. 2849.

Milverson Sound Centre,
Shop 4, Chatswood Arcade,
339 Victoria Avenue,
Chatswood, N.S.W. 2067.

Pitmans T.V.,
38 Bayliss Street, Wagga,
N.S.W. 2650.

Albert Wright Radio Service,
795 New Canterbury Road,
Hurstone Park, N.S.W. 2193.

Edels Pty. Ltd.,
88 King Street, Sydney,
N.S.W. 2000.

Farmer & Co. Ltd.,
436 George Street, Sydney,
N.S.W. 2000.

D. Maskall,
Princes Highway, Batemans Bay,
N.S.W. 2536.

Peter Shalley Electronics Pty. Ltd.,
127 York Street, Sydney,
N.S.W. 2000.

Vista Distributing Services,
78 Robert Street, Wickham,
Newcastle, N.S.W. 2293.

A.C.T.

Homecrafts P/L.,
Petrie Street, Canberra,
A.C.T. 2600.

J. B. Young Ltd.,
Kingston, A.C.T. 2604.

VICTORIA

Peter Fox Sound Centre,
243 Collins Street, Melbourne,
Victoria. 3000.

Myer (Melb.) Ltd.,
314 Bourke Street, Melbourne,
Victoria. 3000.

Recorded Music Salon,
23 Collins Street, Melbourne,
Victoria. 3000.

Suttons P/L.,
105 Elizabeth Street,
Melbourne, Victoria. 3000.

Thomas P/L.,
92 Bourke Street,
Melbourne, Victoria. 3000.

Myer (Chadstone) Ltd.,
1341 Dandenong Rd.,
Chadstone, Victoria. 3148.

Windsor Hi-Fi Salon,
92 Chapel Street, Windsor,
Victoria. 3181.

STA Electronics,
731 Centre Road, East Bentleigh,
Victoria. 3165.

Stereo Sound Systems P/L.,
10 McKay Court, Ringwood,
Victoria. 3134.

QUEENSLAND

Brisbane Agencies Audio Centre,
76 Wickham Street, Valley,
Brisbane, Queensland. 4006.

Kennedy & Hawkins P/L.,
420 Queen Street, Brisbane,
Queensland. 4000.

Reg Mills,
191A Logan Road, Buranda,
Queensland. 4102.

Angus Smith's Photographics,
372-374 Flinders Street,
Townsville, Queensland. 4810.

SOUTH AUSTRALIA

Truscott Electronics,
62-64 Hindmarsh Square,
Adelaide, S.A. 5000.

Macks Electronics,
199 Rundle Street, Adelaide,
S.A. 5000.

WESTERN AUSTRALIA

Alberts T.V. & Hi-Fi Centre P/L.,
282 Hay Street, Perth,
W.A. 6000.

Carlisle & Co. P/L.,
1-9 Milligan Street, Perth,
W.A. 6000.

TASMANIA

Homecrafts Tasmania,
199 Collins Street, Hobart,
Tas. 7000.

NEW GUINEA, PAPUA,
FIJI, NEW HEBRIDES Burns Philp & Co. Ltd.

LEAK FRANCHISE RETAILERS FROM COAST TO COAST

LEAK the first name in high-fidelity!

See and hear LEAK equipment today at these
leading Hi-Fi stores and sound centres.



LEAK SANDWICH MK11
speaker system \$139.00



LEAK MINI Sandwich
speaker system \$99.00



LEAK
'Stereo 30' amplifier
\$198.00

For leaflets and information write to—

H. J. LEAK (AUST.) PTY. LTD.

P.O. Box 14, French's Forest, N.S.W. 2086.

Factory: 1 Campbell Parade, Manly Vale, N.S.W. Telephone: 94-4902.

Cables: Lectron. Sydney.

Professional equipment enquiries to Simon Gray offices or Representatives in all states



RESEARCH • ENGINEERING • MANUFACTURING

however, has not yet, to my knowledge, been translated from the French. You can also find more of what Ansermet thinks on the subject in Nos. 13 and 14 of "Recorded Sound," the journal of the British Institute of Recorded Sound, in which two lectures which Ansermet delivered in London in 1963 are excellently translated into English. These can be obtained from the secretary of the Institute, 38 Russell Square, London, W.C.1.

Ansermet's views deserve to be made known here in Australia, where a small coterie of avant garde composers and critics make all kinds of extravagant claims for their method, often at the expense of more traditional music, especially that which is firmly rooted in tonality. I recommend his lecture to all unprejudiced musicians, and those members of the public who find themselves illiterate in the new musical language that is being foisted upon them.

★ ★ ★

BELLINI—*Beatrice di Tenda*. (Complete Opera). Cornelius Ophthof (Filippo); Joan Sutherland (Beatrice di Tenda); Josephine Veasey (Orombello); Joseph Ward (Anichino and Rizzardo). The Ambrosian Opera Chorus and the London Symphony Orchestra conducted by Richard Bonyngue. Decca SETA-320/2.

Joan Sutherland and her conductor-husband Richard Bonyngue continue to explore the early 19th century for operas to perform in opera houses and recording studios. Their allegiance has revived interest in many neglected works well worth resuscitation. The chief reason for the disappearance of these works from current repertoires is that it is almost impossible nowadays to assemble a cast capable of doing justice to the vocal parts. It must be confessed that the standard of singing, especially of florid music, has degenerated sadly since the days of Rossini and Bellini. With luck you may get together two or three singers capable of handling this difficult music, but gone are the days when such operas could be offered with a flawless cast.

Joan Sutherland, who has for many years specialised in this type of singing, was an obvious choice for the title role and I am sorry to have to write that faults which, in recent performances, have tended to disappear, have again turned up in this new recording. I am referring to her frequent fussiness of phrasing, even in the simplest of passages, that has the effect of breaking up the musical line. You become aware of the too-precious enunciation of every word in the sentence—though unfortunately this doesn't make her diction any clearer — and a reluctance to blend sentences into paragraphs. This is not to say that she doesn't have glorious moments, but they are few and far between. The bulk of her performance is marred by vagueness of outline and fidgety emphasis on trivia.

The young baritone, Cornelius Ophthof makes an impressive recording debut as Filippo, using a fine masculine voice with vigour and discretion. I look forward to hearing more of his work in the near future. The tenor, Luciano Pavarotti, is also rewarding to listen to. He can take high notes with-

out any apparent strain or pinching and has that silky quality characteristic of the best bel canto tenors. He might, with maturity, add more subtlety to his roles, though even at present his is an eminently acceptable performance.

Josephine Veasey, though an Azucena-type mezzo, is nevertheless a splendid Agnese, a part mostly sung by sopranos. Indeed, she offers one of the most enjoyable sequences in the opera in her offstage opening aria. But most of the credit for the production must be awarded to the conductor, Bonyngue, who keeps the show moving without undue haste and always has the ensemble under secure control. I enjoyed his Bellini style much more than that of Georges Pretre whom I heard conduct "Norma" with Callas in the title role at the Paris Opera in 1965. Bonyngue has the London Symphony Orchestra generously responsive to his most exacting demands and the Ambrosian Singers alertly expressive.

The work is very uneven, at one moment lifting you up on the sweep of a soaring melody only to dump you into passages of the utmost banality a minute later. If you follow the work with the original score—a vocal one, in my case—you will notice eight cuts, some of which might have been retained with profit. But most of them will not be missed. And curiously, the only time Bonyngue seems to be not quite at the top of his form is in his accompaniments for his wife. Bellini intended to revise the score, but died at a tragically early age before he could do so. As it stands today, despite its many luscious tunes, it is not one of Bellini's most successful works.

★ ★ ★

DREYFUS — *Galgenlieder* (Gallows Songs). Song cycle for baritone, flute, clarinet, violin and bassoon to poems by Christian Morgenstern. Ronal Jackson (baritone), Neville Amadio (flute); Donald Westlake (clarinet); Donald Hazelwood (violin); John Cran (bassoon).

Trio for flute, clarinet and bassoon. Op. 1. Players as in *Galgenlieder*. Philips Stereo AY842721.

George Dreyfus was born in Central Europe but has lived for many years in Australia. His music can often be heard on the A.B.C. and is sometimes featured at avant garde concerts of contemporary music. This disc, however, will offer no avant garde problems of appreciation and regular concertgoers of the more conservative type should find much in it to enjoy. First and foremost Dreyfus is an expert musician who knows just what he wants to say, and, what is more important, exactly how to say it.

He combines fertile invention with a highly polished technique. His style, at any rate in the items offered here, is palatably tonal and his tones, some of them quite enchanting, have the immediate appeal of freshness and spontaneity. The "Galgenlieder" cycle deserves wide popularity among recital singers on the lookout for something new to add to their repertoires. The vocal line is gratefully placed, the accompaniments as resourceful as they are ingenious. The music that seems

to have influenced him most is the Mahler of mordant irony—though without his indulging in slavish imitation—and the bitter-sweet confections of the Paris school of the 1920s and early 1930s.

In the "Galgenlieder," the texts of which combine the grisly with the witty, he enjoys the benefit of accompaniments played with high technical polish and unremitting good taste by the New Sydney Woodwind Quintet. When I reviewed this record for "The Sun" I remarked that this combination can compare with the world's best and should be sent overseas to demonstrate at foreign and British music festivals the high level of the players' skill. Since I wrote this I have learned that an overseas trip is now almost certain and I heartily endorse it.

Ronal Jackson sings the cycle in sophisticated style and, give or take an occasional uncovered top note, with a pleasing expressive baritone.

The Trio is also a highly-skilled piece of music which achieves outstanding clarity of line in a medium that is anything but easy to write for. You can listen to it completely relaxed in the certainty of hearing a most accomplished performance of very attractive music. The recording was made by Philips with the assistance of the Australian Performing Rights Association (A.P.R.A.).

★ ★ ★

BRUCKNER. — *Symphony No. 8 in C Minor*. Leopold Nowak Edition. Vienna Philharmonic Orchestra conducted by Georg Solti. Decca SET335/6.

Solti gives a stately performance of this spacious work. Unhurried, he makes the most of every long sentence, carrying the thoughts on into paragraphs and the whole into chapters. The result is cohesion, in a work

*AEGIS

**Transistor tuning coils
Transistor 1F transformers**

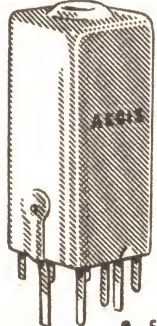
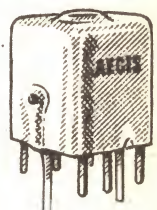
- 5 201 B/C Oscillator coil
- ST 45C 455 KHz 1F transformer
- 5 203 B/C Aerial coil

As used in "Electronics Australia," May, 1968, Transistor Broadcast Tuner.

Write for technical details and prices.

AEGIS PTY. LTD.

347 Darebin Rd., Thornbury, V.Xc. 3071
Phone 49-1017, 49-6792, P.O. Box 49,
Thornbury, Vic. 3071.

NEW ADDRESS

Clients are advised that our three organisations are now all located at our new address:—

**74A IVY STREET,
CHIPPENDALE, N.S.W. 2008**

SALES:

Telephone 69-8684

BILL BARDSLEY-SMITH

ASDIC STEREO SPECIALISTS

DISTRIBUTION:

BARDSLEY IMPORT TRADING CO.

ENGINEERING:

H. BEN WILSON

Telephone 69-8685

(S.M.I.R.E.E., M.I.I.C.A., Chartered Electronics Engineer)

all previously located at Glebe Road, Glebe

of which the proportions can get cumbrously out of hand, if not tightly assembled. The movements are nicely contrasted. The first states at leisure arguments of the utmost seriousness. The next, a scherzo, and in my opinion one of Bruckner's least interesting, scuds along as briskly as I have ever heard it, though not even Solti, the last man in the world to let such an opportunity go unexploited, can make it have even the semblance of lightly shod grace.

In the Adagio, the type of movement in which Bruckner's pious cogitations are expressed at their most convincing, Solti moves in an atmosphere of majestic breadth. Then, this behind him, he launches into a Finale of quite electrifying vitality. Throughout Solti and his orchestra, the great Vienna Philharmonic, are awarded splendid engineering of greater than usual dynamic range that goes all the way from barely audible pianissimos to climaxes that reveal the glory of the orchestra's sumptuous tone in as full as measure as I've ever heard.

Traditional Brucknerians might think Solti's reading a little too volatile. They may prefer a more ponderous approach. I, myself, though no great admirer of Bruckner's symphonies — which, by the way Brahms described as "symphonic boa constrictors, the work of a crafty village schoolmaster" — prefer Solti's essentially vivid interpretations to the more solemn musings of Bruckner's better known exponents.

★ ★ ★

STRAVINSKY. — *Les Noces* (Complete Ballet). Chorus and Orchestra Soloists of the Paris Opera. *Pleasant Songs* (Jacqueline Bru-maire). *Cat's Cradle Songs* (Denise Schar-ley). *Russian Songs* (Jacqueline Bru-maire). *Four Peasant Songs*. (Choral Songs for Female Voices). Concert Hall SM2433.

Pierre Boulez has ceased to surprise me. An avant garde composer of enormous and far-reaching influence, he has demonstrated that he can conduct with complete understanding music by composers as widely different as Handel, Wagner and Debussy, to mention only a bare minimum. Yet I must confess to some slight unpreparedness for the amount of lyricism Boulez finds in Stravinsky's usually harsh score of "Les Noces." And he brings this to the fore without sacrificing any of the work's rhythmic propulsion or disguising its peasant origin.

The sound is excellent, especially in the way the problems of recording four pianos playing simultaneously are solved. They never clatter and are reproduced with the highest fidelity, unmarred by the effect of the intrusive noise of the dampers. The singers are good, too, except for their unclear diction. Although I am fairly fluent in French it took me quite a time to recognise this language as it was recorded here.

The songs, too, on the reverse side, are well worth having, to fill what is probably a blank space in your library of Stravinsky's works. ■

* FREE 16 PAGE BOOK!

ASDIC STEREO SPECIALISTS

74A Ivy Street, Chippendale, N.S.W. 2008

Please forward free and post free, your 16 page book on this unique Tape Recorder.

NAME

ADDRESS

..... State

Reviewed by Glen Menzies

"I HAVE A DREAM": THE REV. MARTIN LUTHER KING JUN., 1929-1968. The Original Address from The March on Washington, August 28, 1963. 20th Century-Fox Records, released by Festival. Mono TL 32904.

As I write this review the news of the assassination of another famous American, Robert Kennedy, is in the headlines all too soon after the equally violent death of Martin Luther King.

Every so often, throughout history, speeches have been made which have had a great and memorable impact. The speech that Martin Luther King made on a late summer afternoon in Washington, in 1963, was one of these. It brought the march on Washington to a climactic close before a gathering of over two million people. In such a setting, and at such a time, the speech was pitched on a high rhetorical note, and it is at its most moving where Dr King, with great effect, reiterates the now famous phrase, "I have a dream." Within the context of a great mass meeting it is a superb oration, spoken with obvious sincerity, and it is an eloquent plea for a non-violent solution to the problems of the American Negro.

After listening to this recording, one is surprised to realise that it was made as long ago as 1963. In 1968 it has lost none of its validity.

There are also six speeches by other Negro leaders who took part in the march; these sound somewhat anticlimactic after the "I Have a Dream" oration, which, in my view, has been wrongly placed at the beginning of side one. Some of these speakers are very effective and what they have to say helps to fill in the background to the Negro Civil Rights Movement, but they should be heard before rather than after Dr King's speech.

Nat Hentoff, in an otherwise excellent background note, omits to mention the actual relationship of these speakers to Dr King and the Civil Rights Movement. The sound of the huge crowd is picked up by the microphone, but is not in any way obtrusive — in fact, it adds drama to an historic occasion.

★ ★ ★

BONNIE AND CLYDE. Original music and dialogue excerpts from the soundtrack of the film, with Warren Beatty and Faye Dunaway. Music by Charles Strouse. Warner Bros. Stereo WS 1742.

Unless the film concerned is a musical or the screen version of a well-known play, there seems to be little point to the releasing of soundtrack albums. The one under review is a case in point where the excerpts convey very little to anyone who has not seen the film.

The soundtrack of "Bonnie and Clyde" is not untypical of any rea-

sonably well conceived feature film in that the sound and vision are so closely integrated as to make some of the conversations on this disc sound distinctly disembodied. The bits and pieces heard here add up to just over half an hour of words and music; the cover note euphemistically describes them as audio highlights.

As for the musical score by Charles Strouse, this is competent in the same way that 100 others are but away from the film it has little intrinsic merit to hold our interest.

The accents of Bonnie and Clyde as portrayed by Faye Dunaway and Warren Beatty are not of the most ingratiating kind, and as we cannot see them we tend to notice only the banal nature of their verbal exchanges. Sporadic outbursts of machine-gun fire and the revving up of motor car engines are equally inexplicable when removed from the visual experience.

In mitigation, it has to be admitted that this is not the first nor will it be the last soundtrack album that suffers from these obvious drawbacks. Allowing for the normally disconcerting "sound" on these albums of material originally intended to be heard in the cinema, these excerpts reproduce quite impressively through wide range equipment with some effective stereo spread.

★ ★ ★

THE MASHUGANISHI YOGI. Joey Forman. Presented by the Bill Dana Comedy Theatre. Produced by Bill Dana. A. and M. Records, released by Festival. Mono AML32864.

In a sub-heading, this album is called "An Affectionate and Transcendental Tribute To The Good Humour Of The Maharishi Mahesh Yogi," and I'm almost certain that the Maharishi would enjoy this clever and witty send-up almost as much as anyone.

This record deserves an award as one of the funniest of 1968. It is of course easy enough to make fun of the Indian mystic with his unusual accent and giggle, but it requires a keen sense of the ridiculous to observe some of the earnest people who unconsciously send themselves up with the inane questions they insist on asking V.I.P.s.

Joey Forman, the talented actor and comedian, who takes the part of the Mashuganishi, as he is called here, impersonates the Yogi with obvious relish and fends off questions with devious wit. He does this in several situations, at an Airport Press Conference, during his celebrated "Discourse on Love" and at a Student Conference. Perhaps the most amusing is at the beginning of Side 2, "The Mashuganishi at the P.T.A.": a delicious send-up of a question time period with typical American parents asking the Yogi's advice with incredible tongue-in-cheek seriousness. Then there are seven very short sketches dealing with individual problems and a hilarious airport

farewell scene where the Mashuganishi's patience and good humour finally break under the strain.

The scripts were written jointly by Jerry Mayer, Joey Forman, and Bill Dana, and the members of the Bill Dana Comedy Theatre have a "ball" with material which is worthy of the best intimate revue standards. If you have heard the LP of the Maharishi Yogi himself reviewed here a couple of months ago, then this will heighten the fun, but the sketches are still very funny even without this. □

Errata and Notes

SOLID-STATE AF MILLIVOLT-METER (May 1968): We have been advised that the PA-230 microcircuit devices used in this project are now supplied without the heat-sink tab shown in the drawing and photographs of this article. Absence of the tab has no effect upon device operation; however constructors should make sure that they connect to the correct device lugs. With the "notch" end of the package to one's right, the "front" face of the device is that facing you when the plane of the lugs is further away. The connections are then as shown in the circuit diagram.

DELTAHET RECEIVER (October, 1964, page 34): Two errors relating to the filter frequencies. The crystal spacing should read 1.852KHz, instead of 1.825KHz. This leads to the centre frequency, which should read 475KHz, instead of 475.02KHz. These points are purely academic and make no difference to the original design.

antenna tuning problems?



omega-t has the answer in its unique, new antenna noise bridge!

- ... test resonant antenna system for both frequency and operating impedance.
- ... replaces VSWR bridges or other antenna test equipment
- ... optimum performance through alignment and test of mobile or fixed station antennas.
- ... tests beams—whips—dipoles—quads or complete antenna tuner systems.
- ... for use over entire range—1 to 100 MHz.

Omega-t Systems Incorporated
\$29.95 Plus Sales Tax
 ex-stock

Available from
ELEMEASCO INSTRUMENTS PTY. LTD.,
 41 Carter Road,
 Brookvale, N.S.W. 2100.
 Telephone 93-6222.

Dual

1019

FOR THE PERFECTIONIST



CHECK THE FEATURES:

Dynamically balanced low mass pick-up arm stable in all planes—Extremely simple and positive arm balancing—Continuously variable tracking force from 0-7 grams —Direct Dial continuously variable Anti Skating compensation — Flawless tracking as low as $\frac{1}{2}$ gram with automatic stop and shut off — Vernier speed adjustment on all standard speeds—Four-pole induction motor with special hum shielding and elastic torque suspension — Smooth and constant rotation assured by dynamically balanced $7\frac{1}{2}$ lb non-ferrous turntable—Vibration free self returning slide switch controls—Feather touch Cue Control for manual or automatic play—Manual and automatic single play, plus automatic changer operation—Single play spindle locks on turntable and rotates with record—Entire unit suspended in friction-damped rubber cushioned springs to eliminate acoustic feedback.

Price — 1019 (Without Cartridge) \$163.00

FRED A. FALK (SALES) PTY. LTD.

28 King Street, Rockdale, N.S.W. — Phone 59 4783 - 59 7731

Distributors:

N.S.W.—All leading Electrical Houses.

VIC.—Radio Parts & Electrical Houses.

QLD.—Ron Jones—P/L 7-9 Merton Road South Brisbane.

S.A.—Truscott Electronics & all leading Electrical Houses.

W.A.—Athol M. Hill, 613 Wellington St., Perth

TAS.—All leading Electrical Houses

VARIETY FARE

Reviews by: Neville Williams Harry Tyrer
T. Forbes Cameron

Devotional

THE RESTLESS ONES and other original Ralph Carmichael Songs. Stereo, Sacred LPS-74046 (Gospel Film Ministry). Also available in mono.

Interest: Gentle Gospel rhythm.
Performance: First rate.
Quality: Excellent.
Stereo: Excellent.

Well-known Gospel songwriter and arranger Ralph Carmichael has turned right away from the familiar "singing strings" formula to experiment with a smaller group built around acoustic guitars, harpsichord, piano, flute, French horn, cello string bass and percussion. And a very successful experiment it is.

Having scored the music for the new Billy Graham film "The Restless Ones" he has rearranged a group of his other compositions in similar style and in a manner which I will imagine will appeal strongly to the younger and the older generations alike. The sound is modern, gently rhythmic and yet smooth and relaxed.

Included are: Oh, I Shall Never Forget The Day—I Cannot Hide From God—Like a Lamb Who Needs a Shepherd—My Friend And I—I Heard About—The Heart Is A Rebel—The Restless Ones—Closer Than a Brother—Land Without Tears—Now I Only Know In Part—Return.

You don't have to be in any particular age group or of any particular creed to enjoy this disc. And you can play it to feature or as background. Recommended. (W.N.W.)

★ ★ ★

LORD, I'LL BE WILLING. The Proclaimers. Mono 45EP, Challenge CGS-1. (From Challenge Recording Co., 65 Henley Beach Rd., Henley Beach South, S.A. 5022. Price \$1.60).

Interest: Up tempo Gospel.
Performance: Very good.
Quality: Good.

Based, apparently, on the Rosanna Baptist Church, Melbourne, The Proclaimers are a group of young people—choir and instrumental quintet—who have adopted the traditional Negro sound, but in combination with modern up-tempo Gospel songs. Their style is modelled, in fact, on the all-Negro "Angelic Choir."

The four numbers presented on this 45EP are: Lord, I'll Be Willing—I Can Put My Trust In Jesus—Never, Never—He's Risen.

In its style, the performance is very good but not for one moment would

I recommend it to anyone on the plus side of 25. But teenagers in church youth groups—and a lot of others who aren't—should really dig it! Just the thing for church coffee shops. Congratulations. (W.N.W.)

★ ★ ★

SURELY GOODNESS AND MERCY. George Beverly Shea with the Blackwood Brothers Quartet. Stereo, RCA Dynagroove LSP-3864. Also in mono LPM-3864.

Interest: New artist grouping.
Performance: Very good.
Quality: Right up to standard.
Stereo: Normal.

After a period when some of the releases appealed to the reviewer as somewhat indifferent, the Bev. Shea albums issued recently suggest a good deal more care in their planning and execution. The Blackwood Brothers quartet is well known in its own right and the association here with Bev. Shea and the resources of RCA's Nashville studio has resulted in an album which should have wide appeal.

With a main theme of praise and thanksgiving, Bev. Shea retains the lead for the most part, but the quartet contributes welcome support and variety. Surely Goodness and Mercy—Where The Roses Never Fade—Jesus Walks Among Us—Heavenly Sunlight—O Day Of Rest and Gladness—Tell It Again—Bringing In The Sheaves—Thanks To God—Just a Wayward Lamb—With Christ As My Pilot—Take My Life And Let It Be—Amazing Grace.

It would require a feat of memory to compare this new release with the many Bev. Shea albums that have been issued through the years but my impression is that it would rate with the best of them. A good one for Bev. Shea fans and a good one, too, for those who prefer a little relief from the straight solo voice. (W.N.W.)

★ ★ ★

ROSALIND KEENE SINGS. The Nun's Chorus and Other Songs Of Faith. With Eric Smith at the Hammond organ. Stereo, Festival SFL-932,791.

Interest: Established favourites.
Performance: Disappointing.
Quality: Clean, but . . .
Stereo: Another "but."

One can suggest several reasons why this recording should have been successful. N.S.W. winner of the ABC's Concerto and Vocal competition, Rosalind Russell has since gained a lot of experience on the operatic and concert stage and has appeared regu-

larly on Bobby's Limb's TV show "Sound of Music."

At the Hammond organ, Eric Smith displays generous talent and, if I can read the signs, Festival have tried hard with the recording itself.

But something seems to have gone wrong. Much of the time the organ and voice are competing with, rather than complementing each other. Again, even when Rosalind Keene dominates a particular channel, there is a remoteness about her voice, which reduces diction and aggravates an apparent tendency on her part to suppress the first consonant in each word.

Could it be that the whole performance has been geared to the studio/visual situation of stage and TV screen, overlooking the fundamentally different balance requirements of an audio only presentation?

The titles: You'll Never Walk Alone—Easter Hymn—Alleluiah—I Believe—When I Survey—Nun's Chorus—In A Monastery Garden—Panis Angelicus—Such Lovely Things—Come Unto Him—Ave Maria—At The End Of The Day.

Others may react differently to this presentation. One would hope that they did but, personally, I was disappointed. (W.N.W.)

"INNERBOND" (Regd.)

BONDED ACETATE FIBRES

FOR PACKING IN
SPEAKER ENCLOSURES

A new resilient Bonded Wadding made from ultra fine Cellulose Acetate Fibres that gives high efficiency for Sound Absorption.

"INNERBOND" is light, clean, dust free and easy to handle. Because all the fibres are bonded "INNERBOND" will hang as a "curtain" and will not fracture or break down due to vibration.

"INNERBOND" is odorless, highly resistant to attack by bacteria or fungus and is vermin repellent; "INNERBOND" at 16oz sq. yd. has a nominal thickness of 1" and at this density is recommended as a packing in Speaker Enclosures for Sound Absorption.

STOCKISTS:

SYDNEY: Arrow Electronics Pty. Ltd., 432 Kent St.; Broadway Electronics Pty. Ltd., Broadway and City Rd.

MELBOURNE: J. H. Magrath & Co. Pty. Ltd., 208 Little Lonsdale St.

BRISBANE: A. E. Harrold Pty. Ltd., 123 Charlotte St.; Brisbane Agencies, 78 Wickham St., Fortitude Valley.

ADELAIDE: Duncan Agencies, 57 Woodville Rd., Woodville; General Accessories, 81 Flinders St.

PERTH: Atkins (W.A.) Ltd., 894 Hay St.; Carlyle & Co. Pty. Ltd., 1 Milligan St.; General Accessories, 46 Milligan St.

HOBART: Homecrafts-Tasmania, 199 Collins St.

If unobtainable

For 1 sq. yd. as above send \$2.00

For 2 sq. yds. as above send \$3.75

For 4 sq. yds. as above send \$6.50

Postage paid in Australia and Territories to the manufacturers

WONDER WOOL

PTY. LIMITED

87 James Street, Leichhardt, N.S.W., 2040.
BOX 548 — G.P.O., Sydney, 2001.
Phone: 56-2780.

UNQUESTIONABLY SO

ADC CARTRIDGES ARE THE FINEST MONEY CAN BUY

And there are playback-heads for EVERY application ranging from \$17.00 to \$80.00. Acknowledged throughout the world and top-rated by leading high-fidelity publications and independent rating organisations ADC Cartridges still outsell other fine brands. What is the secret of such truly remarkable success?

Here is Audio Dynamic Corporation's own product story:—

"Can magnetics cartridges be THAT different? ADC cartridges are. They embody a concept sufficiently unique, to establish new types of playback heads. We call them 'INDUCED MAGNET TRANSDUCERS.' But that is not the only reason for putting them in a class by themselves. We also believe them to be the most advanced cartridges available anywhere today.

"Although there are many magnetic cartridges, the term embraces a wide variety of variable reluctance, moving coil, moving magnet, and moving iron designs. Each is a distinct type, with advantages and disadvantages unto itself. Much hard thinking has gone into ways of wedding the virtues, while skirting the drawbacks. The result, in this case, was something more than the best balance of compromises and reconciliations. The 'Induced Magnet Transducer,' in achieving new and impressive goals, goes about the business of reaching them in its own way.

"The cold specifications are here. Proof of what they mean is up to your own ears. Some of the points, however, to which we should like to call special attention are the significantly reduced mass of the moving system, the optimum tracking angle of 15 degrees, the extremely low distortion, and the high compliance.

"As to the mass, let us remember that the first duty of the stylus is to track the shape of the recorded groove as accurately as possible. To the extent that it falls short here, we cannot have complete fidelity. Unfortunately, to finish its job, the stylus must also push a load that will ultimately produce an electrical signal. Whatever the load —

it may be a magnet, a set of coils, or a bit of iron or steel — IT HAS MASS. And this mass must inhibit the freedom of the stylus to track the groove. Mass of the moving system in ADC cartridges is reduced to half or less that of systems previously regarded as low-mass designs.

"How was this done? Consider the usual load on the stylus. Sometimes the cantilever or stylus arm is itself the heavy, steel armature that must be moved. Sometimes the arm is a desirably light, aluminium tube, which must — nevertheless — in turn, move a heavy magnet or set of coils. The ADC stylus is mounted at one end of the desired aluminium tube, but the other

cartridge body. In fact, it is mounted on the easily replaceable stylus assembly and positioned to induce high density of magnetic flux in the armature. The efficiency of this method actually assists in permitting armature weight to be reduced.

"The end of the pivoted armature away from the stylus is near the pole pieces of the pickup coils, with the coils being well back into the cartridge. The remote position of the magnet with respect to the main structure, including the coils, ensures freedom from saturation and hysteresis distortion — serious effects that are beyond control by conventional shielding.

"The physical configuration of the stylus assembly yields another important advantage. With the pivot brought close to the record surface, obtaining the now established tracking angle of 15 degrees is no problem. This requirement may seem simpler than it is, at first. But the pivot point of the stylus assembly is often high above the surface, because the assembly must move something well up into the 'guts' of the cartridge. It is well understood, that the most important factor in the tracking of a tone arm is the location of its pivot point. THE ANALOGY HOLDS TRUE FOR THE PIVOT OF A STYLUS ARM, AS WELL.

"On the practical side, the stylus assembly is exceptionally easy and convenient to replace. The stylus itself is retractable, to protect itself and your valuable records. As to the quality of the sound, we have already said that it is up to you and your ears. We can only hope that you try ADC CARTRIDGES with equipment that will do them justice."



ADC.10E/II

end extends into a light armature of soft, magnetically permeable iron tubing.

"A heavy magnet is on the premises, BUT IT HAS NO PHYSICAL CONNECTION WITH THE MOVING SYSTEM. It is completely outside the

J. H. REPRODUCERS PTY. LTD.

293 HUNTINGDALE ROAD, CHADSTONE, VICTORIA, 3148

TELEPHONE: 277-3066

Exclusive Australian Representatives of ADC, U.S.A., and KEF, U.K., and manufacturers of the J. H. SYNCHRONOUS TURNTABLE.

Instrumental, Vocal & Humour

ANVIL CHORUS. The Mormon Tabernacle Choir and the Philadelphia Orchestra conducted by Eugene Ormandy. CBS stereo SBR235251.

Interest: Popular choruses from opera.
Performance: Patchy.
Quality: Excellent.
Stereo: Good spread.

The basic idea here was a good one — to present some of the rousing choruses of opera which are usually not included in highlight records, where the tendency is to devote the time to the principal arias. There are certainly some very good tunes included in this selection, but I feel the Mormon Tabernacle Choir are out of their depth in some parts. They certainly do not lack in enthusiasm and spirit, but this class of music requires months of preparation, and it is plain that they have not had that much time for rehearsal. The result is some rather ragged singing. On the other hand, the orchestra provides a sparkling performance which goes a long way to compensating for the choir's shortcomings.

The selection comprises: Les Voici! from "Carmen" (Bizet)—The Lord Now Victorious from "Cavalleria Rusticana"

(Mascagni) — Soldiers' Chorus from "Faust" (Gounod)—Hail, Bright Abode from "Tannhauser" (Wagner)—Humming Chorus from "Madame Butterfly" (Puccini)—Anvil Chorus from "Il Trovatore" (Verdi)—Pilgrims' Chorus from "Tannhauser" (Wagner)—Bell Chorus from "I Pagliacci" (Leoncavallo)—Bridal Chorus from "Lohengrin" (Wagner)—Huntsmen's Chorus from "Der Freischutz" (Weber)—Grand March from "Aida" (Verdi). These are all so well known to opera lovers that no further comment is needed, except that "Les Voici!" will possibly be better known as the famous "March of the Toreadors." The sound and stereo are of excellent standard. (H.A.T.)

★ ★ ★

LES SYLPHIDES and CARNAVAL BALLET SUITES. The Philharmonia Orchestra conducted by Robert Irving. World Record Club stereo S/T4007.

Interest: Romantic ballets.
Performance: Very pleasing.
Quality: Good standard.
Stereo: Normal spread.

The idea of a ballet based on the piano music of Chopin was first conceived by the great choreographer, Fokine, and the ballet received its pre-

miere performance in 1908 with the title "Chopiniana," using orchestrations by Glazounov. The following year it was revised and presented as "Les Sylphides," the title it has retained ever since. The music has withstood the process of transcription from the piano to the orchestra extremely well and, with the great romantic tunes with which it abounds, it is no wonder that it is one of the most popular of ballets. I have had this version in my collection for some years, since it was released by E.M.I. on CSD 1271 and have enjoyed playing it on numerous occasions. The performance may seem too "schmaltzy" for some people, but I happen to like it that way, and I am sure many others will agree that this music calls for this type of treatment.

The choice of "Carnaval" as a coupling to "Sylphides" was a good one since the two works have much in common. The music is an assortment of pieces from the piano works of Schumann, which the composer had collected together under the title of "Carnaval" but orchestrated by a number of Russian composers for the Ballet Russe. It received its first performance in 1910 in Paris, and was an immediate success. In this case I must say I prefer the original piano version, as I do not consider the music has transcribed so well as "Sylphides." Nevertheless, it is tuneful and pleasant listening, and sounds very well in this performance.

Although first issued in 1959, the sound quality of this recording is of very good standard, and this pressing for World Record Club is commendably free of surface noise. (H.A.T.)

★ ★ ★

MUSIC OF VAUGHAN WILLIAMS. The Utah Symphony Orchestra conducted by Maurice Abravanel. Vanguard stereo VSD7 1160.

Interest: English classics.
Performance: Very pleasing.
Quality: Satisfactory.
Stereo: Normal.

The Utah Symphony Orchestra and its conductor Maurice Abravanel have proved in earlier recordings that they are capable of fine performances in many fields of the classics, but I must

Indian music

AN ANTHOLOGY OF INDIAN MUSIC, Volume I, with examples by leading Indian musicians and with a history and appreciation of Indian music, presented by Pandit Ravi Shankar. Liberty Records (Festival) stereo WDS-26200 (three record set).

Interest: As per title.
Performance: By experts.
Quality: Excellent.
Stereo: Good spread.

This beautifully presented three-disc set is a very welcome release, coming as it does when the interest in Indian music is very high. It comes in a box and is supplied with a beautifully printed and illustrated booklet containing background information on the music, the instruments, the artists and the programs presented. A glossary of the principal terms used is also included.

Four of the six sides are devoted to examples of the various forms of Indian music, beginning with two ragas — Raga Jai-Jawanti, which is an evening raga and Raga Basant Mookhari, a morning raga. These take a whole side each. Sides three and four contain examples of some other forms of Indian music for various combinations of instruments: Ninnu Vinagamari (Ragam) — Samajavagamana (Ragam Malkuns) — Tabla Tarang — Pakhawaj and Tabla — Tabla (Ekta) — Tabla (Rupak Tal).

On sides five and six, Ravi Shankar, who will be known to many people as one of India's leading musicians, discusses the history and development of Indian music, with appropriate examples provided by experts in the particular modes discussed. This is extremely interesting and informative. One learns, for example (although this point is not made by Ravi) that Indian music has basically the same sources as Western music, in that it grew out of a form of plainchant use by the monks.

His examples of the raga scales show that these have marked similarity to the old Greek modes from which the major and minor scales now used in Western music were developed. It is also fascinating to find that the vocal form in some Indian music is almost identical to the cantor style used in Spanish flamenco, despite the centuries which have passed

since wandering tribesmen from India (the ancestors of the gipsies) brought the art to Spain.

Useful though it is as an introduction to Indian music, this lecture is too short to answer all the questions which arise in the Western mind not familiar with the Indian idiom. Nevertheless, it is a very useful introduction to the art for those who are curious to know more about the subject. It is to be hoped that Volume II, which we understand is to be released shortly, will also contain some spoken material to carry the subject further.

The recording quality of this set, which was made in the U.S.A., is extremely good, entirely free from any noticeable distortion and surface noise. (H.A.T.)

ACOS REPLACEMENT CRYSTAL CARTRIDGES

Acos 90 Series — a brand new family of four pick-up cartridges, covering all the main types needed to-day, each fitted with Diamond Stylus at no extra cost.

GP91-1 Replaces GP67-1G MONO CRYSTAL	\$5.95
GP91-2 Replaces GP67-2G HIGH OUTPUT MONO CRYSTAL	\$5.95
GP92 MONO CERAMIC	\$6.55
GP93 Replaces GP73-2A STEREO CRYSTAL	\$7.55
GP94-1 Replaces GP81 STEREO CERAMIC	\$7.95
GP94-5 STEREO CERAMIC FOR TRANSISTOR AMPLIFIERS	\$8.95

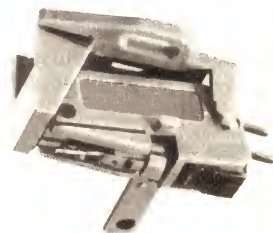

fitted with
DIAMOND
Stylus at no extra cost.

TECHNICAL DATA SHEETS SENT FREE ON REQUEST

Sole Australian Agents:

AMPLION (A'SIA) PTY. LTD.

29 Majors Bay Rd., Concord,
Sydney, N.S.W. Phone 73 1227



NEW from QUAD SOLID STATE

303 POWER AMPLIFIER AND 33 CONTROL UNIT



QUAD has introduced two new models, the SOLID STATE Quad 303 and Quad 33. What's new in these models? . . . 30 watts power rating (R.M.S.) per channel with frequency response of—1 db, 20 to 35,000 Hz. Fully silicon transistorised.

Entirely new circuit design provides outstanding high quality reproduction and output circuit protector which cannot be accidentally upset by misuse, overdriving, shorting or disconnecting speakers. Distortion is less than 0.03% at any level up to 45 watts per channel into an 8 ohm load at 700 Hz and is 10 times lower than in the best of valve amplifiers. With the professional look and the professional touch, the price of these two new Quad units is \$486.00.

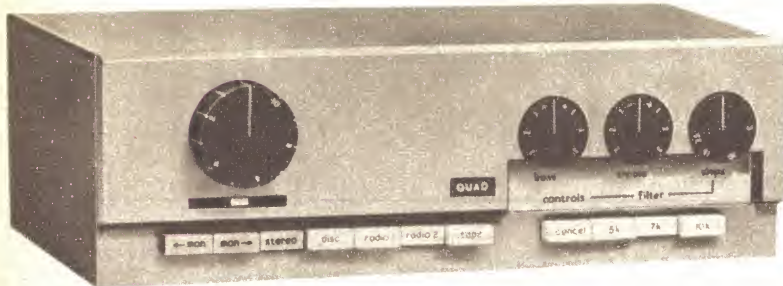

QUAD ELECTROSTATIC LOUDSPEAKER

Using closely coupled moving elements some 200 times lighter than the diaphragms of moving coil loudspeakers, and being entirely free of cabinet resonances and colouration, this loudspeaker overcomes the usual major problems of loudspeaker design and provides remarkably natural reproduction of sound. The real test is to listen to the music it reproduces—a comparative demonstration is strongly recommended.

QUAD for the closest approach to the original sound.

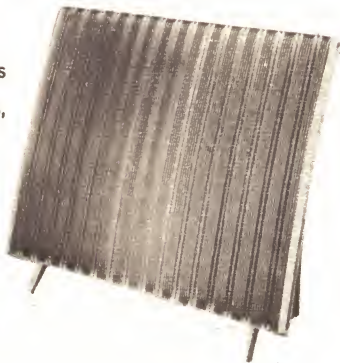

Please send me a copy of the new QUAD leaflet.

NAME

ADDRESS

BRITISH MERCHANDISING PTY. LTD.
49-51 York St., Sydney. Telephone 29-1571.
(sole Australian agent.)

say I had my doubts about their ability to present satisfactory accounts of such essentially English music as that composed by Ralph Vaughan Williams. However, any prejudice I might have been harbouring was very quickly dispelled and I can say that this is a very fine performance indeed of two of the more easily appreciated works of the great English master.

The two works presented here were composed over a period separated by the 1939-45 war. The larger work is the Symphony No. 6 in E Minor, which the composer began shortly after the war and which was performed for the first time in 1948. It is generally regarded as a musical reflection of the sad years which preceded it, and lacks the fierce statements of the Fifth Symphony composed during the war years. While the musical idiom is modern enough for most tastes, it is not a difficult work to listen to. In fact, it has long reflective passages in tranquil mood and also contains some wonderful tunes.

The second work is "Five Variants on Dives and Lazarus" and it should be noted that the word "Variants" in the title does not mean variations. This is not a set of variations in the normally accepted musical sense. Instead, it is the composer's reflections on various versions of a popular folk song of Britain from the Middle Ages, beautifully orchestrated for strings and harp. It is completely pastoral in feeling, with long flowing phrases and solid conventional harmony. It was originally written for performance at the New York World Fair of 1939, and no doubt the composer was aware that he had to make some concession to contemporary musical taste for the work to achieve its purpose. Even those who do not normally enjoy the composing style of Vaughan Williams should have no difficulty in appreciating the qualities of this work. (H.A.T.)

★ ★ ★

TANGO DE LUXE. The Tokyo Cuban Boys. Calendar (Festival) Stereo SR66-9,517.

Interest: Tangos for dancing.
Performance: Tasteful.
Quality: Excellent.
Stereo: Good spread.

I have now ceased to wonder at the ability of the Japanese to outperform Western bands in this type of essentially Western music, so the fine performance of the players on this disc came as no surprise. This is a very enjoyable presentation of some standard tangos, performed in strict tempo for dancing, with fine feeling for the style and brightly played. The orchestral make-up is a little unusual, in that it has no strings, but relies on accordions with woodwinds, brass and percussion. The resulting combination is very effective. The disc originates in the catalogue of King Records of Japan, and is excellently recorded with good stereo spread.

The selection comprises: El Amanecer—El Huracan—Adios Muchachos—Yira Yira—La Moroaha—Inspiracion—Adios Pampa Mia—Canaro en Paris—Mama Yo Quiero un Novio—La Cumparsita—Caminito—A Media Luz. Excellent fare for dancing, but good for listening, too. (H.A.T.)

Astor pre-recorded Musicassettes.....

Recently to hand was a list of some seventy pre-recorded Musicassettes, now available through recorded music outlets on the Astor label. Three typical cassettes are reviewed below.

Electronics Industries Ltd. are most optimistic about the future of their "Astor" Musicassettes and Mr Neville Smith, General Manager of the Recording Division, has suggested that sale of pre-recorded tapes may well overtake that of discs within the next five years.

The company has installed dubbing equipment made by the Ampex Corporation and claimed by them to be the fastest in the world. The equipment is the first in Australia and only the third such installation anywhere in the world. Present output from the Melbourne plant is from 500 to 700 cassettes per day.

The initial catalogue is directed towards the middle-of-the-road musical market and would appear to be largely the programs already well proven on long-selling LP discs.

The 101 Strings Orchestra is strongly represented; there is music from the screen and stage, the Ray Charles Singers, the Tijuana sound, dance selections, German drinking songs and German bands. There are Strauss waltzes and fringe-classic selections. It is, in fact, the stuff of which these "Variety Fare" columns are made.

Standard retail price quoted for the Musicassettes is \$5.95.

The three typical cassettes made available for review, though stereo, were played as most are likely to play them for the time being—in a mono player with the head scanning right across the two side-by-side tracks. In fact, we used Philips cassette recorder/player type EL 3302, on one occasion fed through an external wide-range system, on another fed directly through a wide-range loudspeaker. There was no suggestion of speed variation, of wow or flutter, even on sustained tones, which reflected credit both on the cassettes and on the relatively simple player.

The sound was clean, the general frequency balance good, and there was no evidence of tape hiss under the playing conditions specified.

High fidelity? No, not really. Without attempting to be too specific, my guess is that the upper limit of the system was about the figure with which practical 1-7/8ips cassettes are credited at present:

THE WORLD'S MOST GLORIOUS MELODIES, Reginald Kilbey and his Strings. Studio 2 Stereo (E.M.I.) SCXO 7834.

Interest: Popular light classics.
Performance: Splendid.
Quality: Excellent.
Stereo: Good spread.

The selection of tunes included here should ensure that this disc will have automatic appeal to those with a liking for light classics: Liebestraum (Liszt) — To a Wild Rose (Macdowell) — Humoresque (Dvorak)—Minuet from "Berenice" (Handel) — Greensleeves—Minuet (Boccherini)—Agnus Dei from "L'Arlesienne" (Bizet)—Air on the G String (Bach)—Largo (Handel)—Jesu, Joy of Man's Desiring (Bach)—Ave Maria (Schubert) — The Lost Chord (Sullivan). Few people would quarrel with the description of these appealing tunes as "glorious melodies."

The sleeve note says that the conductor, Reginald Kilbey, is here directing an orchestra of London's leading



6 to 7KHz. But the reproduction was clean, pleasant and very suitable for entertainment in the variety of conditions which the cassette system envisages—home, car, picnic or simply walking.

ORIGINAL JOHANN STRAUSS WALTZES. The Danube Strings. Astor Musiccassette AC2002.

A typical string-rich Viennese orchestra playing an equally typical program of favourite waltzes: Vienna Woods—Blue Danube—Artist's Life—Acceleration—Wine, Women And Song—Voices Of Spring—Of Youth—Die Fledermaus—Emperor Waltz.

101 STRINGS: R. RODGERS AND L. HART. Astor Musiccassette ACT 2059.

The 101 Strings Orchestra is well known for the many LP albums they have produced — singing, romantic strings keyed, for much of the time, to a gentle rhythm. Easy on the ear: Bewitched—My Funny Valentine—The Lady Is A Tramp—I Could Write A Book—I Didn't Know What Time It Was—A Small Hotel—With A Song In My Heart—Where Or When — Opening Night — Manhattan —Curtain Time.

CAFE CONTINENTAL. Les Cinq Modernes. Astor Musiccassette ACT 2017.

As a change from the string-rich sound of the other two and true to its title, this cassette whisks one into "the romance of Paris and Rome at night." Against a background of toe-tapping rhythm, the group presents: Alouette—Moritat—Petite Fantasy—La Violetera—Arrivederci Roma—Volare—Petite Fleur—Blanc Sur Blanc—Sorrento—Germain. As before, pleasant and easy on the ear. (W.N.W.)

string players. It is certainly a very fine group of players, who perform these familiar tunes with fine sensitivity and without a trace of condescension. The only complaint I have is a tendency to unnecessary fussiness in some of the arrangements. The technical quality of the disc is of high standard and the acoustics of St. Augustine's Church, Maida Vale, N.W. London, where these recordings were taken is wonderfully natural and warm. For lovers of light classics, warmly recommended. (H.A.T.)

★ ★ ★

THE BEAT OF THE BRASS. Herb Alpert and the Tijuana Brass. A. and M. Records (Festival) Stereo SAML-932861. Available in mono.

Interest: More Tijuana Brass.
Performance: Sounds bored.
Quality: Excellent.
Stereo: Well spread.

I like Herb Alpert's style of playing, and I admire his musicianship which

You
May
Have
Missed
The
DAWE
Exhibition
But
We
Can
Still
Show
It
To
You

ASTRONIC IMPORTS

DIVISION OF ELECTRONIC INDUSTRIES LTD.

MELBOURNE

489-1911

ADELAIDE

23-4022

PERTH

28-3111

SYDNEY

31-6721

BRISBANE

2-0271

HOBART

2-2711

ARROW ELECTRONICS

Proudly present to the hifi enthusiast **FIVE** components that are absolutely the best in their respective class. Quality is never cheap but each item illustrated is real value!

Call in for a demonstration **NOW**

THORENS TD124 Mk. 11 — The finest transcription turntable in the world. Built to last a lifetime. For years considered the classical design and standard for all turntables. (Illustrated with the new Thorens TP14 arm but available without arm.) Pre-cut boards available to suit SME 3009 and 3012 arms.



SME Series II 3009 and 3012 tone arms — Complete with 4ft lead and Ultra Lightweight Shell. You will find no finer engineering than in the SME arms. English know-how at its very best.

The New Quad 33/303 Amplifier and Pre-amp combination — Undoubtedly the finest amplifier available today. Distortion an incredibly low .03%. Hum and noise — 100db below full output! Beautiful styling and fastidiously built.

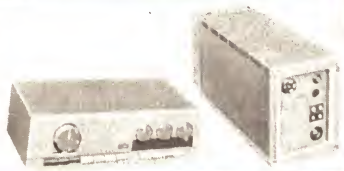

Wharfedale AIREDALE 3-speaker system. This magnificent system is a real musical instrument designed for the connoisseur. It has to be heard to be believed. True omnidirectional sound via a 15in woofer — 8in mid range and 3in high frequency unit. Frequency response 20-20,000 Hz.



Shure V15 type II Stereo Pick-up Cartridge. The perfect mate for the SME arms. Computer designed for the connoisseur. It represents the most important advance in phono cartridges since the advent of stereo!

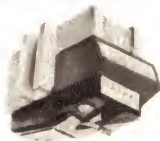

ARROW ELECTRONICS

342 KENT ST.
SYDNEY, 29-8580

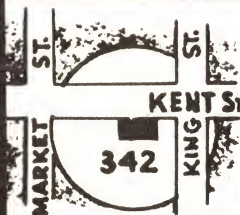

has never displayed the slightest trace of vulgarity. It is therefore with sorrow that I have to say that this disc shows signs of degeneration when compared with the earlier "classic" Tijuana Brass" performances. The playing is ragged and the performers sound bored with it all. I am afraid I must now agree with what some critics have been saying for some time—it is time for Herb Alpert to disband the Tijuana Brass and devote his undoubted musical talents and superb sense of showmanship to producing discs by the talented artists he has signed up for his company.

As for the music in this disc, Herb has obviously been trying to bring new elements into the performance of the Brass, and in places there are signs of progressive jazz mingled with the mariachi sound. This attempt to find a new success formula has failed miserably, and the Brass now sounds like any other second-rate orchestra. Die-hard Tijuana Brass fans may not agree with me, but I do suggest that intending purchasers should at least try to hear some sections before committing themselves. Incidentally, Herb himself attempts to sing in "This Guy's in Love With You," his first effort in this direction, and I sincerely hope it will be the last time too.

Titles are: Monday Monday — A Beautiful Friend—Cabaret — Panama —My Home Town—Talk to the Animals — Slick—She Touched Me — Thanks for the Memory—The Robin —This Guy's in Love with You. (H.A.T.)

★ ★ ★
36 HOLLYWOOD HITS. Warren Carr, pianist. Calendar (Festival) Mono R66-498.

Interest: Cocktail piano.
Performance: Entertaining.
Quality: Good.

Sydney pianist Warren Carr plays in sparkling fashion through 12 medleys, each of three well-known tunes, in this selection. His clever keyboard work is backed by some competent support from anonymous artists playing electric guitar and drums. All the tunes have associations with some Hollywood film epic, and included here are such old-timers as "Easter Parade" and "Over the Rainbow" to the more modern hits such as "Que Sera" and "Moon River." The titles are too numerous to give in full, but here are some of the best known: Buttons and Bows—Moonglow — Come Prima—High Noon—Laura — Harry Lime Theme—Ebb Tide — More—Unchained Melody—Theme from "Exodus." If you like cocktail style piano playing, this Calendar disc is good value. (H.A.T.)

★ ★ ★
FLAMENCO FIESTA ESPANOL.

Angel Garzia Peralta, guitar and vocals. CBS Stereo. SBP235501.

Interest: Flamenco.
Performance: Progressive style.
Quality: Excellent.
Stereo: Adds atmosphere.

Angel Garzia Peralta lives in Australia now but his previous career has all the elements of a seasoned concert performer. He has given concerts in Spain, London, Paris, Mexico and South America, both as soloist and accompanist to dancers and singers. He is a little unusual as a flamenco

artist, in that he includes in his program popular Spanish and Latin American songs. His voice, not unmindful of that of John Gary, soars easily up to the falsetto region. Apart from this quirk, he performs the standard flamenco styles, as this program shows: Sueno de Torero—Malaguena—Cinco Sevillanas—Fantasia Inca — Fantasia Arabe—Tanguillo — Tany—Bulerias—Alma Llanera — Hombre del Campo — Rumba Flamenca—Mi Fandango.

Senor Peralta is a skilled guitarist and his singing is enjoyable too. His style of flamenco might be styled "progressive" so if you are one of those enthusiasts who likes traditional flamenco, you might be wise to try to hear samples of these tracks before buying. The technical standard of this local recording is excellent. (H.A.T.)

★ ★ ★

LONELY HARPSICORD, Jonathan Knight. Viva (Festival) Stereo SFL-932,840. Available in mono.

Interest: Mood music.
Performance: Heavily sentimental.
Quality: Very good.
Stereo: Exaggerated.

Against a background of artificial rain and rolling thunder provided by the sounds effects department, Jonathan Knight strums some familiar sentimental tunes on a harpsichord. He is backed by flute and percussion only, but the results are pleasing enough. The approach throughout is one of heavy sentimentality, in keeping with the aims of the disc, which is apparently intended to appeal to "young romantics." The tunes are: Shangri-La—Stranger on the Shore—Cast Your Fate to the Wind — Pagan Love Song — Yellow Bird — Quiet Village — Flamingo — Bali Ha'i — Tiki Waterfall — Dream Theme — Midnight Hideaway — Soft Hands.

The sound quality is of good standard, but the stereo is rather gimmicky. The harpsichord is presented in duet form, by dubbing, so that the sound of two harpsichords is heard, allocated one to each track. The percussion takes the "centre channel" with the flute occupying an indeterminate position in between. (H.A.T.)

★ ★ ★

SERENADE No. 1 IN D MAJOR (Brahms). The Symphony of the Air conducted by Leopold Stokowski. Calendar Classics (Festival) Stereo SC66-9363.

Interest: Lyrical Brahms.
Performance: Disciplined.
Quality: Dated, but acceptable.
Stereo: Normal.

The Serenade in D was Brahms' first major orchestral work, and although it is full of the most wonderful melodies it has never been popular, at least with recording companies, the available recordings being few indeed. This recording under Stokowski is lush, very lush in fact, but this type of work can stand the treatment, and I am sure many will find the performance to their taste. Those who know Brahms only from his more mature works will probably be surprised at the relaxed style of this work, but surely nobody could quarrel with this amiable music—particularly the wonderfully melodic Adagio. The orchestral playing is of a high standard, and it could hardly be

otherwise under this conductor. Technically, this disc does begin to show its age — it must be nearly ten years old — but the sound quality is still acceptable enough. (H.A.T.)

★ ★ ★

GERMAN FOLK SONGS, sung by the Obernkirchen Children's Choir. London (E.M.I.) stereo SAHA 7775.

Interest: As per title.
Performance: Very enjoyable.
Quality: Very good.
Stereo: Good spread.

The cover picture shows this choir to consist of young children whose ages range from about eight to 14 years. How such young performers can be taught to sing as well as they do here is beyond comprehension. Not only do they sing right in pitch with precise timing but they tackle quite difficult contrapuntal passages with complete aplomb. Furthermore, they sing right through each side of this disc without a break, taking in nine songs each time. This is wonderfully happy singing, and is highly recommended to those who find pleasure in the clear innocent voices of young children who have been carefully trained.

I hardly feel it is necessary to give the titles of the 18 German folk songs included, but I should mention that the first song on side one, entitled "Das Wandern ist des Mullers Lust," is a setting of the poem from "Die Schone Mullerin," but this is not the well-known setting by Schubert. Since no composer is mentioned, we must assume that the tune is traditional. The sound is of excellent standard, and the stereo is nicely spread. (H.A.T.)

★ ★ ★

FROM THE HUNGRY I. The Kingston Trio. World Record Club stereo S/4358.

Interest: Popular singing group.
Performance: With professional polish.
Quality: Good, clean sound.
Stereo: Normal.

The Kingston Trio are no longer recording, having disbanded voluntarily while still very popular—a wise move quite in keeping with the high intelligence they have shown throughout their career as entertainers. If they had continued until their act died of disinterest, there would certainly be no reissues such as this from the World Record Club. As it is, their records will probably sell well for years to come.

This particular recording was made during an actual performance at the famous "Hungry I" restaurant in San Francisco. The trio produce their usual polished performance, which is largely wasted on a particularly moronic audience who laugh in all the wrong places. The program comprises: Tic, Tic, Tic—Gue, Gue—Dorie—South Coast—Zombie Jamboree—Wimoueh—New York Girls—They Call the Wind Maria—Merry Minuet—Shady Grove—Lonesome Traveller—When the Saints Go Marching In. A varied program, ranging from a tender French lullaby (Gue, Gue) to modern cynicism (Merry Minuet). The sound is of very good standard, but the group has been miked very closely, so that the intake of breath at the end of every phrase is clearly audible. (H.A.T.)

If you want STEREO EQUIPMENT

You'll deal better with H. B. RADIO SALES

JULY SPECIALS

TRIO TK150E AMPLIFIER, two Goodmans Twin-Axiom 10 Speakers in 3 cubic ft. Teak Cabinets, and Garrard AT60 Mk. II Player/Changer \$278.00
NEW B.S.R. UA70 Hi-Fi Stereo Changer/Player and Teak Platform \$45.00
PALACE 8-WATT Stereo Amplifier, two Magnavox 8" Speakers and Garrard 1000 Changer/Player, \$69.00
MAGNAVOX or ROLA design slimline cabinet with 8 W.R. (V.C. 15, 8 or 3 ohms) or 8 CMX speaker fitted \$26.50
Cabinet Kit only \$10.50
MAGNAVOX 10 W.R. and 3 T.C. Tweeter with Crossover network in 2 C.F. cabinet 3" material \$39.00
12 W.R. in 3 cubic ft. cabinets \$42.00

GOODMANS design 3 CF Cabinet and Twin-axiom 10 speaker, 4in material \$54.00
Cabinet Kit and Speaker . . \$44.20
WHARFEDALE design, 3 CF cabinet (R3) 4in material and Golden 10 speaker \$57.00
Cabinet Kit and Golden 10 Speaker \$47.00

Special quotes for other Wharfedale or Goodman speakers. Available in Maple, Walnut or Rosewood colours. Teak veneer \$1 extra for Slimline and Bookshelf models. \$3.00 extra for others.

PLAYMASTER Bookshelf Speaker System. Complete, \$30.
Cabinet kit only \$7.
All other parts, including speakers, inner bond, etc., \$15.40.
MULLARD Mini BS Unit.
Kit of parts, including Cabinet, made and polished, speakers, inner-bond and condenser, \$21.50.
Unit complete, \$25.
PLAYMASTER Super Bookshelf System. Complete, \$43.00.
Cabinet kit only \$10.50.
All other parts, including speakers, inner bond, etc., \$25.00.
Teak, \$1.00 extra.

Postage, N.S.W., \$1.00; Qld., Vic., Tas., \$1.40; Other States, \$2.00.

SPECIAL QUOTES

For Complete Sets Based On
LEAK — MAXAMP — PEAK
— PIONEER — QUAD —
SANSUI — TRIO.

Write for Stereo Catalogue

H. B. RADIO SALES

Manufacturers of Quality Radio and Radio Furniture for 36 years

103-105 Catherine Street,
LEICHHARDT, SYDNEY
Telephone 56-5580

ACOUSTIC SUSPENSION SPEAKER SYSTEM

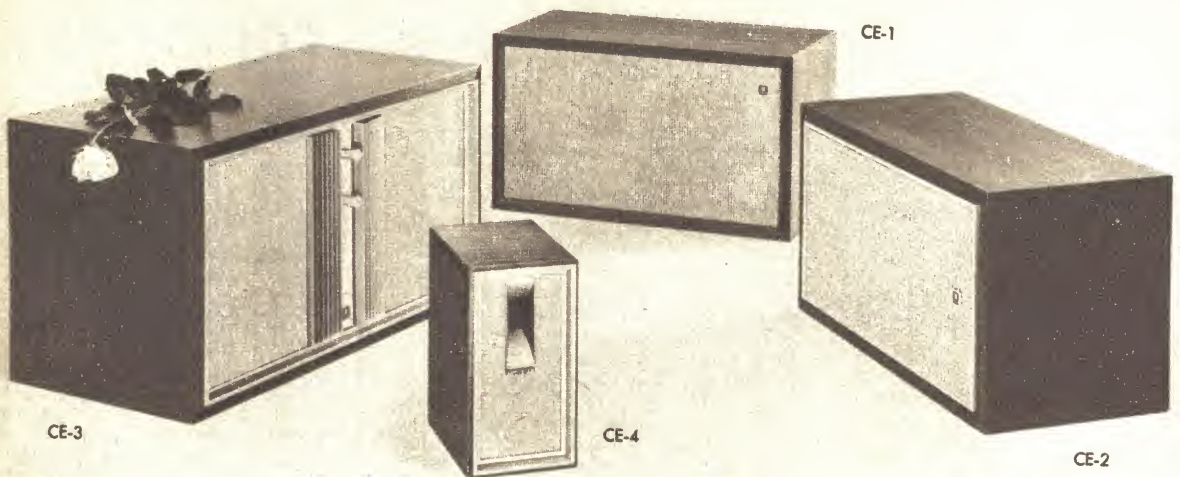

MATCHLESS PERFORMANCE

Whether it is flawless sound reproduced by the above Acoustic Suspension type speakers or those shown below of bass reflex, enclosed, phase inversion and infinite baffle types, if the name is Chrysler you are assured of fine quality. Dynamic low frequency sound which approaches that of natural sound. Distortion-free. Distinct. Chrysler specializes in speakers of total performance capability. More than one million have been sold to discerning users everywhere.

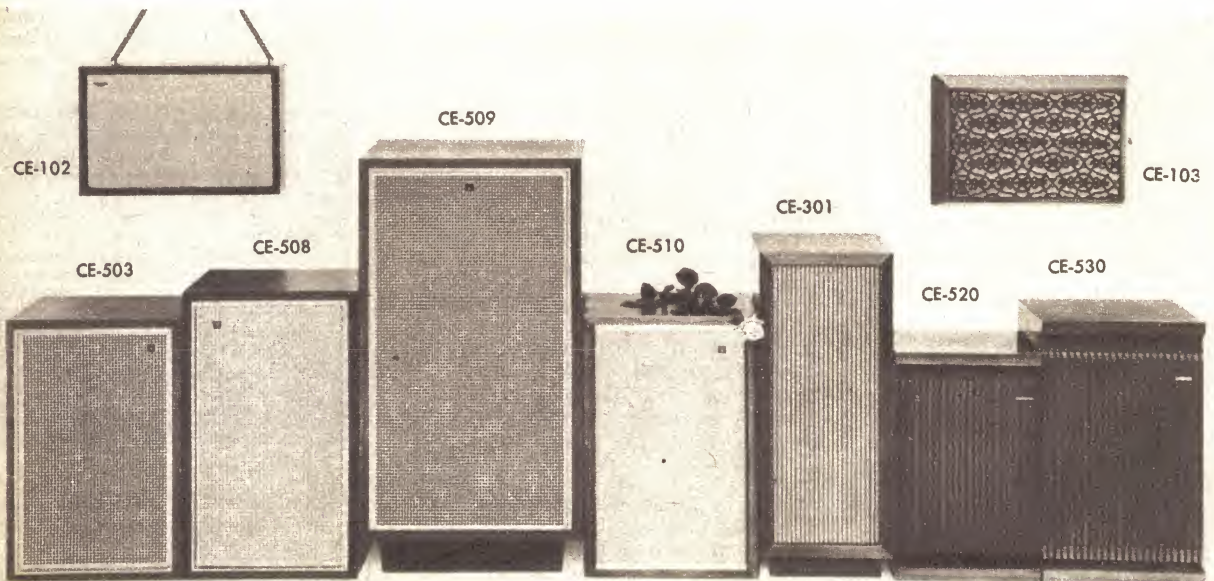

★ Free catalog on request

CF CHRYSLER
ELECTRIC CO., LTD.
IN JAPAN

No.1-10, SASAZUKA 2-CHOME, SHIBUYA-KU, TOKYO, JAPAN

CONNIE IN THE COUNTRY. Connie Smith. RCA Camden stereo CAS-2120. Available in mono. Interest: Country and western. Performance: Sounds authentic. Quality: Very good. Stereo: Normal.

The sleeve note with this disc makes much capital of the fact that Connie Smith is a genuine country gal who sings country and western songs in the authentic manner. Well, she is certainly not alone in that—there are dozens of excellent singers who can claim the same thing. However, I do concede that

Miss Smith has a fine way of presenting these numbers, whether she is sentimentalising as in "World of Forgotten People" or cutting loose as in "I'm Little But I'm Loud." She certainly sounds genuine enough for me. The other numbers she sings are: Cry, Cry, Cry—Foolin' Around—Slowly—I Overlooked an Orchid—A Sleeping at the Foot of the Bed—You Ain't Woman Enough—Y'All Come—Love's Gonna Live Here. The sound quality and stereo are both fine, and at the Camden price this disc is well worth considering by country and western fans. (H.A.T.)

Popular Jazz

LIVE AT THE MANNE-HOLE—Shelly Manne and His Men. Contemporary (RCA). Volume 1—Stereo S3593. Volume 2—Stereo S3594. (Also in mono.)

Interest: West Coast jazz. Performance: Competent but dull. Quality: Very good for location recording. Stereo: Not much advantage.

These two albums are typical examples of the West Coast small groups of the fifties and early sixties. The music is very competently played and rather dull.

Shelly Manne is, of course, one of the finest drummers in jazz, a melodic player who swings easily and keeps his rhythmic patterns interesting. Russ Freeman, one of my favourite pianists, plays extremely well and the bass player, Chuck Berghofer, is accurate and steady.

The dullness arises, I think, from the front-line. Trumpeter Conte Candoli, one of the busiest West Coast session men, is a very ordinary soloist, while Richie Kamuca's pale imitation of Stan Getz (without the edge) quickly falls.

The tunes are very familiar ("Green Dolphin Street," "Love For Sale," "What's New," "If I Were A Bell" and five more) and fail to inspire the musicians to any great heights.

I suspect that few people will wish to invest in both volumes and, if anything, the first is slightly better.

The recording dates (not mentioned on the sleeve) were 3rd, 4th and 5th March, 1961, and the playing times are 37½ minutes and 40 minutes respectively. (T.F.C.)

★ ★ ★
KANSAS CITY PIANO—Count Basie, Pete Johnson, Jay McShann, Mary Lou Williams. Festival Jazz Heritage Series DL-32704.

Interest: Four great pianists, 1936-41. Performance: Magnificent throughout.

Quality: Well recorded and remastered.

This record has given me as much pleasure and musical satisfaction as any in the past year or so. The Basie tracks are certainly minor jazz classics and the others are first-rate examples of the style of piano-playing which emerged from Kansas City in the late 1930s.

The Basie tracks are four of the ten which he recorded for Decca in 1938-39 with the definitive rhythm section of Freddie Greene, Walter Page and Jo Jones. Apart from being

the complete band pianist, Basie has one of the most satisfying solo piano styles, perfectly balanced, swinging yet relaxed and always tasteful. These tracks show him at the peak of his form.

Two of the three tracks by Mary Lou Williams were recorded in 1936 (she made five in all then) while her fascinating version of Morton's "The Pearls" comes from a 1938 session. At the time, she was playing and arranging for the wonderful Andy Kirk band and her direct, down-to-earth approach showed the influence of Earl Hines and the Kansas City boogie pianists.

Pete Johnson was perhaps the greatest boogie pianist of all, although it should also be said that there was a lot of Harlem stride in his playing. His four tracks come from the one session in 1941 and they include the famous "Basement Boogie" and "Death Ray Boogie."

The fourth pianist represented is Jay McShann. McShann's standing in jazz history stems mainly from his employment of Charlie Parker, but he was (and still is) a superb pianist. McShann's solo style was very much in the Basie mould as was his band. These three tracks, which were recorded in 1941, are excellent examples of his work, partly because of the splendid rhythm section of Gene Ramey and Gus Johnston.

If I haven't made it clear already, this album is highly recommended. Nat Pierce's sleeve-notes are particularly helpful and the album plays for about 40 minutes. (T.F.C.)

★ ★ ★
CORROBOREE IN DIXIE—Graeme Bell All-stars, RCA. Stereo. SL101797 (also in mono).

Interest: Australian traditional jazz.

Performance: Marred by unsuitable material.

Quality: Well recorded. Stereo: Good separation.

This record is a classic example of a very good—even great—band being handicapped needlessly and most damagingly by completely unsuitable material.

Let me make it quite clear that I hold this Bell band—individually and collectively—in the highest regard. Indeed, I only regret that Graeme was unable to take these musicians to Europe with him, for they would undoubtedly have created a tremendous impact.

The original idea of recording Australianiana is attributed to Bob Crosby in Ron Wills' sleeve-note. But I really



A PRECISION TONE ARM WHICH TRACKS AT ¼ GRAM FOR ONLY \$19!

This excellently engineered instrument, the Nikka-Lustre Model CP3, employs miniature ball races throughout; it will track down to ¼ gram with suitable cartridges. An open front head shell accepts all standard ½" mounting cartridges and Ortofon or SME cartridges may be used without modification. An outrigger bias adjustment sets stylus pressure... finish is in satin chrome and black anodised aluminium. A tailored lifting/lowering device is available at \$7.50 more; if the lift is ordered with the arm total price becomes only \$23. Action of the lift is pneumatically dampened.

The arm was revived in "Electronics Australia". Here are some excerpts... "Although of impressive appearance and an excellent performer, the tone arm sells at quite a modest price!"—"Specifications for the arm show that it is designed to track at stylus pressures as low as half a gram, so we adjusted the stylus pressure accordingly. We found that the arm will indeed track under these conditions, without groove jumping or skating, even with loud passages towards the centre of the disc, where conditions are most severe".

Write for your copy of this report.

PRICES:

CP3 arm only — \$19 (inc. sales tax).

CP3 with lift — \$23 (inc. sales tax).

Lift only — \$7.50 (inc. sales tax).

Encel ELECTRONICS (STEREO) PTY. LTD.

Head Office:

431 Bridge Rd., Richmond, Victoria 3121. Tel. 42 3762.

Sydney Store: Ground Floor, 25M Building, 257 Clarence Street, Sydney, N.S.W. 2000.

Tel. 29 4563, 29 4564.

*Wholesalers *Trade ins accepted

Australia's Greatest Hi-Fi Centre

EMPIRE CARTRIDGES

PRECISION

MATCHED TO EVERY PLAYBACK SYSTEM

DELUXE EMPIRE CARTRIDGES designed to meet the Optimum-Performance requirements of high quality turntables and record changers.

THE EMPIRE 999VE PROFESSIONAL CARTRIDGE FOR HIGH-PERFORMANCE PLAYBACK SYSTEMS ONLY

TECHNICAL SPECIFICATIONS

Frequency response: 6 to 35,000 Hz.
Output voltage: 5 millivolts per channel.
Channel separation: more than 30 dB.
Load Impedance: 47,000 ohms.
Weight: 7 grams.
Compliance: 30×10^{-6} cm/dyne.



Tracking force: .5 to 1.5 grams
Stylus: .2 x .7 mil elliptical diamond.
Terminals: 4.
Mounting: Standard 7/16 or 1/2" centres.
Tracking angle: 15 deg.
Price in Australia \$85.00

888TE



Empire 888TE cartridge for high-quality turntables and record changers. With a vertical and horizontal compliance of 25×10^{-6} cm/dyne, this outstanding cartridge delivers a frequency response of 6 to 32,000 Hz in top-quality changers and tone arms tracking at 2 grams or less. The .2 x .7 mil bi-radial elliptical diamond stylus tracks at 15° with more than 30 dB of channel separation. Output voltage, 8 millivolts per channel. Weight, 7 grams. Mounts on standard 7/16 and 1/2in centres, with four terminals.

Price in Australia \$60.00

888E



888E cartridge for most of today's better record changers and automatic systems. Designed to track at 3 grams or less, this cartridge provides users of automatic changers with the superior performance of a .4 x .9 mil elliptical diamond tracking at an angle of 15°. The 888E will faithfully reproduce frequencies from 10 to 30,000 Hz, while maintaining more than 30 dB of channel separation. Weight, 7 grams. Output voltage, 8 millivolts per channel. Compliance, 12×10^{-6} cm/dyne. Four terminal output with standard 7/16 and 1/2in mounting centres.

Price in Australia \$40.00

888



888 cartridge for general record changers. Changers requiring a tracking force of up to 4 grams will deliver superior performance when equipped with this fine cartridge. A .7 mil diamond stylus tracking at 15° delivers a frequency response from 12 to 25,000 Hz, with 30 dB channel separation. Vertical and horizontal compliance, 10×10^{-6} cm/dyne. Weight, 7 grams. 4 output terminals and standard 7/16 and 1/2in mounting.

Price in Australia \$30.00

808E



808E—Perfectly adapted to automatic playback systems able to track at less than 3 grams, this superior cartridge combines a compliance of 12×10^{-6} cm/dyne with a frequency response of 10 to 25,000 Hz and utilises a .4 x .9 mil elliptical diamond set at the preferred 15° angle. Stereo separation exceeds 30 dB. Weight, 7 grams. Mounting, 7/16 and 1/2in centres. Output terminals, 4.

Price in Australia \$32.00

808



808—Capable of delivering 10 to 20,000 Hz with 30 dB of stereo separation, the 808 is an outstanding cartridge value for those with automatic changers requiring tracking forces up to 4 grams. Compliance is 8×10^{-6} cm/dyne, and the 7-gram cartridge employs a .7 mil conical diamond stylus tracking at 15°. 4 output terminals and standard 7/16 and 1/2in mounting.

Price in Australia \$24.00

AMPEX

World's finest tape recorders made in U.S.A. recommend Armstrong amplifiers made in England, for which we are sole agents for Australia, to be used in conjunction with their brilliantly designed tape deck.

SOLE AGENTS FOR AUSTRALIA FOR WORLD'S BEST HI-FI STEREO EQUIPMENT

RECORDED MUSIC SALON
23 Collins Street,
MELBOURNE

TRUE FIDELITY
C. PINCZEWSKI
Tel. 63-6257

cannot understand how tunes like "The Pub with No Beer" and "Hot Pie and Tomato Sauce" could possibly be expected to produce good jazz.

The first side is by far the better and "Road to Gundagai," Graeme's own composition "Corroboree in Dixie" and even "Waltzing Matilda" are reasonably successful. But if it were not for the brilliance of the front-line (especially Bob Barnard and Ken Herron) the 36 minutes of this album would have been unbearable.

My suggestion to RCA is that, as soon as Graeme returns from Europe, they invite this same band into the studio and have them record another album of good jazz material. Furthermore, they would do Australian jazz a service by arranging for the LP to be released in the U.K. and the U.S.A. This is the least that Graeme and the band deserve. (T.F.C.).

★ ★ ★

THE FAMOUS CASTLE JAZZ BAND—Good Time Jazz (RCA). Stereo S12030 (also in mono).

Interest: Revival jazz.
Performance: Surprisingly good.
Quality: Bright recording.
Stereo: Barely evident.

The fascinating story of the Castle Jazz Band is told in some detail in Lester Koenig's sleeve-note.

Briefly, this co-operative, amateur band was active in Portland, Oregon, in the late forties when Kid Ory and Lu Watters were at the height of their popularity in Los Angeles and San Francisco respectively.

The band broke up around 1950 but Contemporary Records reassembled it in 1957 to record the twelve tracks on this album. They are, in fact, the only commercial recordings which the band ever made.

While the Castle Jazz Band was never more than a part-time venture, all its members were at one stage professional musicians and four of them worked with Turk Murphy.

"This is happy and uncomplicated jazz. With the exception of Don Kinch on trumpet (the tuba player with the Firehouse Five), the band lacks soloists of genuine stature but the ensemble sound is enthusiastic and spirited.

The numbers are well-tried standards like "Royal Garden Blues," "Careless Love" and "Dippermouth Blues," but in the hands of the Castle Jazz Band they have a surprising freshness.

All in all, the 37 minutes on this album are a happy experience and it can safely be recommended to collectors of revival jazz. (T.F.C.)

★ ★ ★

SAN FRANCISCO JAZZ — Turk Murphy's Jazz Band—Good Time Jazz (RCA). Mono M12026.

Interest: Jazz revival of late forties.
Performance: One very good side.
Quality: Fair.

This is the kind of record which can involve a reviewer in lengthy and often heated correspondence. Let me, therefore, make it clear that I respect the integrity and principles of the revival movement. Particularly at its extreme, however, I regard its musical objectives as barren and retrogressive.

Despite this, I was extremely disappointed that, on my one day in San Francisco, Turk Murphy had his night

off at Earthquake McGoon's, where he still plays.

Turk Murphy established his reputation in Lu Watters' Yerba Buena Jazz Band with whom he recorded until 1947. The first side of this record (made in 1949) was only his second session under his own name. The second, and much better side, was recorded early in 1950.

On the later session, Murphy used a drummer and, in addition, both he and Bob Scobey played with much more assurance. The substitution of Bill Napier for Bob Helm on clarinet also improved the band.

As with most Murphy sessions, the material is interesting, ranging from "Chimes Blues" by King Oliver to "Waiting For The Robert E. Lee"; from Morton's "Grandpa's Spells" to two of Murphy's own and rather good compositions.

Potential buyers of this album should make a point of hearing side one first. The playing time is generous at 47 minutes. (T.F.C.)

★ ★ ★

MODERN JAZZ CLASSICS — Art Pepper plus Eleven (arranged by Marty Paich) Contemporary (RCA). Stereo S3568 (also in mono).

Interest: West Coast Jazz (1959).
Performance: Good Pepper, but not completely successful.
Quality: Bright, clean recording.
Stereo: Good separation.

Art Pepper has received nothing like the recognition which his superb playing deserves. He is, in my view, the greatest of the post-Parker, pre-Coleman alto players, a warm, sincere and intelligent musician. This album, which was recorded in 1959, finds him in good form.

It is not, however, a complete success. For one thing, the tracks (12 in all) average only three and a half minutes each and Pepper has insufficient time to develop his ideas.

In addition, Marty Paich's arrangements for the medium-size group (good as they are) do not give Art the freedom he needs to cut loose in his improvisations.

The tunes are all familiar jazz standards and, on the majority of them, Pepper seems very much at home. Although he sounds best on alto, he plays excellent tenor on some tracks including "Walkin'". The real surprise, however, is the brilliance of his clarinet playing on "Anthropology," the finest modern clarinet solo I have heard. (T.F.C.)

★ ★ ★

DIXIELAND FAVOURITES—Firehouse Five Plus Two. Good Time Jazz (RCA). Stereo S12040 (also in mono).

Interest: Disnevland Dixieland.
Performance: Energetic.
Quality: Good clean recording.
Stereo: Normal separation.

I must confess that I have not followed the recent fortunes of the Firehouse Five Plus Two. At the time of these recordings (1958-1960), however, all the members of the band were employed at the Walt Disney Studios and the FH5 was, therefore, very much a part-time hobby for them.

This band is not in the class of their fellow-amateurs, the Castle Jazz Band, whose LP is reviewed elsewhere on these pages. All the tunes, unfortun-

ately, are traditional standards like "Doctor Jazz," "Sister Kate" and "Jazz Me Blues," and nothing very new happens.

Don Kinch, the trumpeter with the Castle Jazz Band, plays tuba on these tracks, but he is a far better trumpeter than Danny Alguire. This band also lacks outstanding soloists, with the possible exception of George Probert on soprano.

I find it difficult to imagine any serious collector buying this record, but potential purchasers should know that the recording quality is good and the playing time is 44½ minutes. (T.F.C.)

NEW EQUIPMENT CABINETS



MODEL 192

Record Storage or Equipment cabinet. Dimensions 36in wide, 21in high, 15½in deep, plus 9in legs.

Record bins: 14in high, 8½in wide. Horizontal shelf 5½in high. Features: sliding doors, mitred corners semi-square legs. Price: Made and polished, \$52, maple, walnut and rosewood. Kit of parts, \$31.50. Teak, \$6.00 extra. Packing, \$1.30.

New Player Platform model 175 is 16in x 14in x 3½in. Price \$7.50 for maple or walnut. Kit of parts \$4.00. Teak 50c extra. Perspex cover, 3in high, \$8.20 and \$1.50 extra if required hinged. Please specify cutout required.



MODEL 186

New Player Cabinet model 186 is 9in high, 17in wide, 16½ deep and 5½in above shelf. Finished with attractive hinged, tinted perspex top. Price: \$20.00 for maple or walnut.

Kit of parts: \$13.50. Teak: \$1.00 extra. Height of this model can be increased to take various amplifiers. Tailored cut out. Ask for quotation. Free on rail.

Write for Catalogue and Player Guide.

H. B. RADIO SALES

Manufacturers of Quality Radio and Radio Furniture for 36 years.

103-105 Catherine Street, LEICHHARDT, SYDNEY. Telephone 56-5580.

TRADE REVIEWS AND RELEASES

Solartron LM1619 Digital Voltmeter

Pictured is the LM1619 Digital Voltmeter, a recent addition to the range of laboratory instruments manufactured by the Solartron Electronic Group Ltd. A compact AC-DC instrument having a display of three full decades plus single digit over range, and featuring an internal saturated standard cell for calibration, it provides a most impressive standard of performance at a moderate cost.

The LM1619 provides nine measuring ranges, five for DC measurements and four for AC. Maximum registrations on the DC ranges are 199.9mV, 1.999V, 19.99V, 199.9V and 1000V, while those for the AC ranges are 1.999V, 19.99V, 199.9V and 750V. (A simpler instrument offering only the DC ranges is available, designated the LM1920.) Range selection is by a manual control switch which automatically positions a decimal point on the display. The polarity of the input voltage on DC is sensed and displayed automatically.

Maximum resolution on the DC ranges is 100uV, with an accuracy of $\pm 0.1\%$ of the reading ± 1 count in the L.S.D. (0.05% of maximum range registration). The inbuilt mean-reading RMS scaled AC/DC converter gives a maximum AC resolution of 1mV, with an accuracy of $\pm 0.2\%$ of reading ± 2 counts in the L.S.D. (0.1% of maximum range registration). The quoted warm-up time required to meet this accuracy is 10 minutes. Frequency range on AC is quoted as 40Hz—10KHz on all ranges.

The internal saturated cell provides a calibration check and adjustment reference sufficient to maintain full rated accuracy over the temperature range 15-40°C. Stability of the standard cell is quoted as less than 0.05% per year, giving an instrument stability of better than 0.1% per year on all ranges. (Full accuracy may of course be obtained at any time by calibration with an external standard.)

The LM1619 is a charge-transfer instrument, in which a capacitor is charged rapidly to a voltage proportional to the input voltage, and then discharged at an accurately controlled rate during which a gate is opened to admit 100KHz clock pulses to the counting decades. The input terminals of the instrument are fully floating on both the DC and AC ranges, and may be raised above the instrument by $\pm 250V$ DC or peak AC. A link is provided on the front panel for connecting the "low" input terminal to chassis when desired; with the link disconnected the isolation impedance to ground is 200M/1000pF.

Common mode rejection on the DC ranges with up to 1000 ohms unbalance in either input lead is 80dB on the two lowest ranges, 40dB on the third and fourth ranges and 20dB on the 1KV range, measured at both DC and 50Hz. Corresponding figures for the AC ranges are 60dB for the two lowest ranges and 40dB and 20dB for the remaining ranges respectively. Series mode rejection on the DC ranges is provided by an input filter giving more than 40dB attenuation at 45Hz and an attenuation slope of 12dB/octave. Settling time for the filter is 1 second.

Zero stability of the instrument is sufficiently high that no zero adjustment is necessary over the operating temperature range, which is 0—50°C; accordingly no zero adjustment control is provided. The only control switch positions other than those for the nine measurement ranges are a "cal" position, in which the instrument measures the inbuilt reference cell, and a "battery check" position in which the instrument reads the voltage of the AC/DC converter supply batteries. (The latter are necessary as a result of the floating input circuitry; battery life is quoted as better than 800 hours.)

Power requirements for the LM1619 are 115/230V $\pm 15\%$, at a frequency of 44Hz—440Hz; the loading is 25VA. The instrument weighs 11lbs and measures approximately 8½in x 4½in x 16in, being available in two versions suitable for either bench use or rack mounting respectively. It comes complete with shielded input lead, terminal block, alligator clips, and technical manual, with a multi-way printout connector available as an optional extra.



Overload protection is fitted for both the DC and AC ranges, the DC ratings being 350V continuous for the two lowest ranges and 1000V continuous for the upper ranges. The corresponding AC range ratings are 150V RMS and 750V RMS.

Sampling of the LM1619 may be initiated in three ways—automatically at a rate of approximately 2Hz ("AUTO"), manually via a panel pushbutton, or remotely via a contact closure or a -6V command pulse having a rise time of less than 50uS. Full print-out information in 1248 BCD code is available on a multi-way rear connector for logging and/or computer sensing.

Input impedance of the instrument on the two lowest DC ranges is greater than 1000M, while that on the remaining DC ranges is 10M. Input impedance of the lowest AC range is 10M/50pF, and that of the remaining ranges 1M/50pF. Input current on the DC ranges is less than 0.1mA.

Tested in our laboratory, the sample LM1619 pictured gave a most impressive performance indeed. As far as we were able to determine its performance in every respect equalled or exceeded the manufacturer's ratings. Particularly noteworthy was the zero and calibration drift, which both appeared to become negligible after less than one minute; also the AC frequency response, which extended to above 30KHz within the rated accuracy limits. Readout display was clear and bright, the controls unambiguous and the overall finish of the instrument most satisfying.

In short, we find the LM1619 a well-designed and produced instrument which offers compact and high-performance facilities for precision digital voltage measurement. As such it would seem to represent particularly good value at the quoted price of \$649 plus tax.

Enquiries may be directed to Solartron Australia, at either P.O. Box 138, Kew 3101, Victoria, or P.O. Box 297, Brookvale 2100, N.S.W. (J.R.)

High power semiconductors

Amalgamated Wireless Valve Co. Pty. Ltd., wish to remind readers that they have available a wide range of high power semiconductor devices in addition to those intended for low and medium power applications. The devices available include high power transistors (150W Pt. ratings), silicon rectifiers and stacks (up to 40A, 12,000V), bridges (up to 92A) and thyristors (up to 35A).

Pictured is the 1N1184A silicon rectifier, which has an average If rating of 40A and a V_{rm} of 100V. Measuring only 1-3/8in overall, this device is suitable for applications such as battery charging, DC motor supplies, electroplating, machine tool control, transmitter and other equipment supplies, welding and carbon arc lamp supplies.

Enquiries regarding the 1N1184A or other power semiconductors should be directed to the above firm at 348 Victoria Road, Rydalmere, 2116, N.S.W.



BEECH "POINT-FOUR" LOUDSPEAKER SYSTEM

Beech Electronics, a new manufacturer in the field, recently submitted for review a sample Playmaster Point Four speaker system. It is very rigidly constructed and well finished.

The enclosure is made of flakeboard, 11/16in thick for the sides and 3/4in thick, front and back. Partly because of the thicker materials the manufacturers have increased the dimensions over those specified in the February 1968 issue. The dimensions are 15 1/4in x 9 1/4in x 8 1/4in which obtains an increase of about 10 per cent in internal volume. This is not undesirable, although any further increases should be approached with caution. The larger overall dimensions certainly do not detract from the appearance, nor do they make all that much difference to shelf space.

The cabinet is finished in Laminex "vertical veneer" in glossy teak, the only finish available. The joins in the veneer have been made very neatly and are almost imperceptible.

The front and back are sealed with a non-hardening putty to obtain a good air-seal. Some reservations were felt about the small number of screws securing the back — there were six — but when we tried to remove the back we found that it was very well sealed indeed. Nevertheless, the manufacturers have assured us that the number of screws will be increased. Incidentally, if the back is removed and replaced several times the back may not seal as well as originally. This is of academic interest, however, as the normal listener will not have reason to keep unscrewing the back.

Set up in a listening comparison with the prototype Playmaster Point Four the sample system sounded every bit as im-



pressive as the original. We have no hesitation in recommending the Beech unit.

The system is available only in completely finished form at \$33.50 from Beech Electronics, P.O. Box 160, Kogarah, N.S.W., to whom all inquiries should be directed. (L.D.S.)

Rola 6-in woofer suitable for "Point-Four"

Of special interest to hi-fidelity enthusiasts is an announcement by the Rola Company that they are releasing their 6in woofer Type C-650 for immediate sale.

To the present juncture, production of this loudspeaker has been reserved for use in the company's own "Mini-Fi" loudspeaker system, reviewed in September and November last.

The specifications of the C-650 are such that it invited consideration as an alternative woofer in our own "Point-Four" loudspeaker system, described in the February, 1968, issue. The C-650 has the same nominal diameter as the imported loudspeaker originally specified, a long-travel cone and voice coil assembly, a very compliant suspension system and a very low system resonance. It also has a generous magnet system, to offset the loss of sensitivity which compact enclosure design normally involves.

Following the announcement and receipt of a current production sample, we lost no time in installing a C-650 in one of the original "Point-Four" enclosures.

Some difficulty was anticipated because the roll surround of the C-650 cone protrudes beyond the outer pad ring, requiring special care in packing and handling. It was found, however, that the speaker could be fitted into the existing enclosure provided the inner edge of the woofer cutout was chamfered slightly to clear the outer fringe of the roll surround. Since this is glued under the pad ring, only limited movement and clearance are necessary.

On listening tests the enclosure containing the C-650 was just perceptibly biased in favour of the middle and lower range, suggesting that the C-650 might



have had a very slight advantage in terms of sensitivity. In terms of reproduction quality and power handling capacity there appeared to be nothing to choose between the two enclosures and we have no hesitation in recommending the C-650 as an alternative woofer for the "Point-Four" system.

Retail price of the C-650 is quoted as \$18.25, including tax. It is available, at present, only with an 8-ohm voice coil.

The Rola Company emphasises, by the way, that the C-650 woofer must never be energised except in an approved and sealed enclosure, since, like all other comparable units, it relies on air loading behind the cone to restrict cone travel to safe limits.

The Rola Company have also stated that they are shortly to release a companion 3-inch tweeter for the C-650 woofer and this will be available for inclusion in systems such as the "Point-Four." (W.N.W.)

SIMPLIFY INTRICATE WORK with



'1000' RANGE SPECIAL PURPOSE PLIERS

Designed specifically for instrument and electronic technicians to handle fine, precision work, the Elliott-Lucas 4 1/2" size '1000' series is available in Box Joint or Single Joint Tools. All bright finish, in individual Display Packs or in Plastic Tool Roll sets of three or six.

DIAGONAL
CUTTING
NIPPERS

SNIPER NOSE PLIERS

SNIPER NOSE SIDE
CUTTING PLIERS

FLAT NOSE PLIERS

ROUND NOSE PLIERS

END CUTTING
NIPPERS

Australian Representatives:

THOMAS C. BROWN

& CO. PTY. LTD.

Sydney • Melbourne • Adelaide
Brisbane • Perth

TCB/82

SAVE

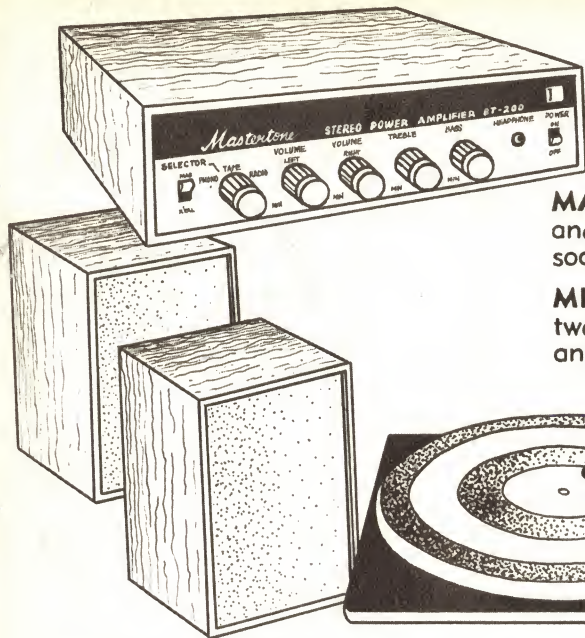

MASTERTONE 30W, STEREO AMP: With Tape-in and out, Phono and Tuner inputs. Stereo phone socket. 20-20,000 C/S. Fully Transistorised.

MINY SQUIRE Speaker System. (10 x 15 x 9) with two 8WR Twin Cone speakers plus 3in Tweeter and cross over. Finished in oiled teak or walnut.

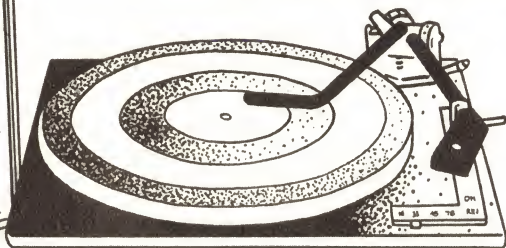

AU70 Deluxe Turntable with 4 pole shielded motor, counter balance arm, micro lift, cueing device, anti skate, etc.

ADC220 High Compliance Magnetic Cartridge with diamond stylus. On platform.

SPECIAL PACKAGE DEAL, THE LOT FOR ONLY \$199.00 FROM \$30.00 DEPOSIT
Hundreds of other combinations including Tape Recorders, Tape Decks, etc.

PETER SHALLEY ELECTRONICS

127 YORK STREET, SYDNEY.
29-3767 29-7021

MASTERTONE ELECTRONICS

PTY. LTD.
824 PITTSWATER ROAD,
DEE WHY. 982-2384



PLUGS & SOCKETS IN-LINE CONNECTORS

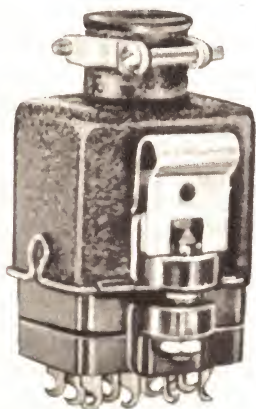

Sole Agents



ZEPHYR PRODUCTS PTY. LTD.

70 BATESFORD ROAD, CHADSTONE, VICTORIA

DISTRIBUTORS:—A. E. Harrold Pty. Ltd., 123-125 Charlotte Street, Brisbane. Qld.—Homecrafts Tasmania, 199 Collins Street, Hobart. Tas.—Newton McLaren Ltd., 82 Gilbert Street, Adelaide, S.A.—Atkins (W.A.) 894 Hay Street, Perth, W.A.—George Brown & Co. Pty. Ltd. 267 Clarence Street, Sydney. N.S.W.

New products from E.M.I.

Pictured are representative samples from new product lines recently released by E.M.I. (Australia) Limited, Electronics Division. Included in the new products are compact resistor and capacitor decade boxes, circuit development and experimental aids and extremely fine metallic mesh material suitable for application in microscopy, spectrography and optics.

The resistance decade box type RB2 measures 5½in x 3-1/8in x 2½in and weighs 15oz. It covers a four-decade range from 10 ohms to 99,990 ohms with a rated tolerance of plus or minus 1 per cent of the selected value. The equivalent self-capacitance is 10pF. The resistors used are panclimatic high stability carbon types, while the rotary switches are robust and reliable types having a "click" action and a rated contact resistance of less than 5 milliohms after 10,000 operations.

The type CB1 capacitive decade box is of identical size and weight to the RB2, and uses three of the same switches to cover the three-decade range from 1000pF to 0.999uF. The capacitors employed are polyethylene film types having either tin or aluminium foil electrodes and a hermetically sealed outer case. Rated tolerance of



to which are screwed various numbers of integrated microcircuit "stations," each such station consisting of a device socket together with a fan-out of connectors. Between the stations are groups of the patent Q connectors to aid in making interconnections, while



Above is the type RB2 resistance decade box, and at left the type CB1 capacitance decade box, both compact and sturdy units offering high reliability at a modest cost.

Another recent release by E.M.I. Electronics Limited Valve Division in the U.K. is "Micromesh," an extremely fine metallic mesh material originally designed for provision of equipotential planes in camera tubes and other special-purpose valves. Available in copper, silver, nickel and gold, and in mesh densities from 200 to 2,000 cells per inch, Micromesh has found application in many fields other than



At left is the 6-station Howard I.C. Board, while below right is a sample Q-Board assembly.

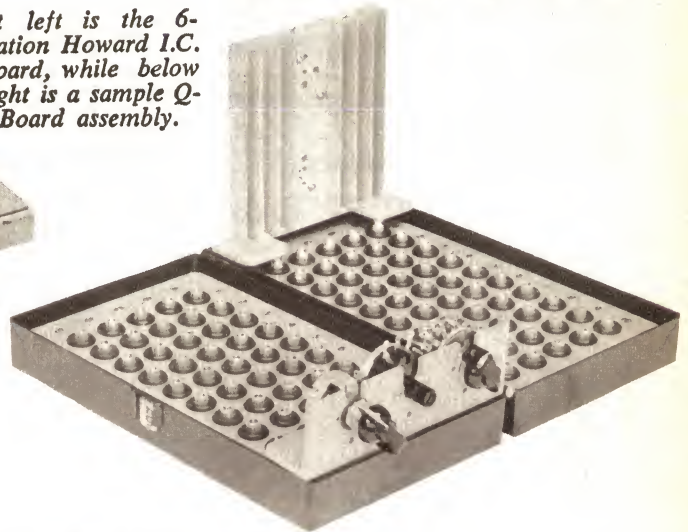

the CB1 is plus or minus 2 per cent of the selected value with a power factor of better than .0006 at 1KHz.

Prices for both the RB2 and CB1 decade boxes are quoted at \$28 each duty free, or \$35 duty paid.

From the English firm Howard Electronic Industries Ltd. come the circuit development and experimental aids, which are known variously as "Q Boards" and "IC Boards." The former consist of rectangular sections of S.R.B.P. sheet fitted with large numbers of patent multi-way connectors. The latter enable resistors, capacitors, transistors, diodes, inductors and connection wires to be assembled speedily into mock-up circuits, and to be disassembled equally rapidly when required without damage to the components. They would seem to be well suited for use in development laboratories and teaching laboratories in universities and technical colleges.

Closely related to the Q Boards are the IC Boards, which as the name suggests are designed to facilitate development work involving integrated microcircuits. These boards consist of an S.R.B.P. printed-wiring base board

printed conductor bus lines are available adjacent to each station for supply and signal connections.

There are four basic versions of the IC Boards, one having 24 stations, two 12 stations and the fourth six stations (pictured). The stations are available in versions to suit dual in-line, TO-5 and flat-pack microcircuit packages. In view of the difficulty involved in assembling prototype circuits using microcircuits the boards seem a particularly attractive proposition for circuit design and development work.

Price of the six-station IC Board complete with six stations of the desired type is \$43 duty paid, while the individual stations are available separately at \$5.30 duty paid. Price of the Q Board type Q1001/A/1 also pictured is \$25.80 duty paid, with the heat sink fittings \$5 and the universal control bracket \$2.20.

that for which it was originally developed.

These include optical and electron microscopy (as supports for specimens, also as stage micrometers), mass spectroscopy (as an equipotential plane surface which is transparent to particles), biology (as filters and sieves), and optics (as neutral density filters). A special "reinforced" mesh having cell matrices within larger cells is available for special filtering and sieving applications.

Inquiries regarding additional possible uses of Micromesh would be welcomed by E.M.I. (Australia), as would inquiries concerning the other products listed above. In N.S.W. the firm may be contacted by writing to P.O. Box 352, Haymarket, 2000. (J.R.)

TRUMPET SPEAKERS

Choose from an extensive range of Top Quality Unipex Speakers — including Combination and separate Driver Types.

H.25.
Horn Speaker.
Trade Price
\$22.70 plus
Sales Tax.



H.20 R.
Diffuser
Speaker.
Trade Price
\$32.93 plus
Sales
Tax.

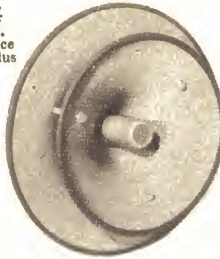

OB 15. Wide Range
High Fidelity Coaxial
Trumpet Speaker.
150 to
15,000
C.P.S.
Trade
Price
\$47.15
plus
Sales
Tax.



SH.C. 6 Throat
Cast
Aluminium
Horn Speakers
—One Driver
Unit Entry.
Trade Price
\$49 plus
Sales Tax.

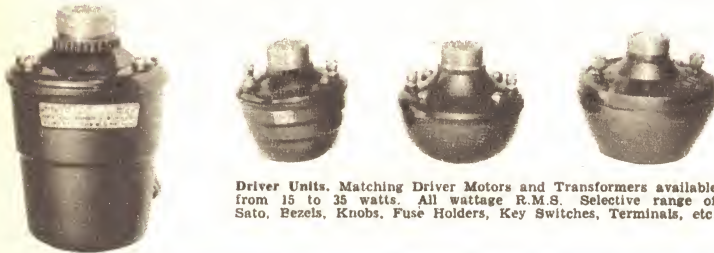

Driver Units. Matching Driver Motors and Transformers available from 15 to 35 watts. All wattage R.M.S. Selective range of Sato, Bezels, Knobs, Fuse Holders, Key Switches, Terminals, etc.

A.S.T. Solid State Amplifiers available:—
3/5 Watts, 12/15 Watts, 30/40 Watts, 60/70 Watts,
100/120 Watts. All 100 Volt Line.
Manufacturers of most Comprehensive Language
Laboratories to Victorian Education Department
Specification.

Wholesale prices on application.

SPECIAL OFFER! Heavy duty "PRINCESS" RECORD PLAYERS, \$10 each plus Tax.

Australian Sound & T.V. Co. Pty. Ltd.

35-39 Yarra Bank Rd., South Melbourne. 3205
Phone: 61 3024, 61 3192 (A.H. 288 3693)

Homecrafts • RADIO PARTS

289 ELIZABETH STREET, MELBOURNE, 60-1441

PIEZO PICK-UP AND CARTRIDGES

PU-86 Pickup LP/78 T/O Crystal cartridge. Length 240mm Ea.	\$2.95
Y700 Ceramic Cartridge. Mon. LP/78	..	\$2.20
PU-86 Pick-up Ster-LP/78. T/O Cartridge. Length 204mm Ea.	\$4.00
Y200 Ceramic Cartridge. ST LP/78	\$3.00
PU-54 Pick-up LP/45 only. Length 1.25mm Ea.	\$2.10
Y400 Crystal Cartridge. LP/45	\$1.20
Y130 Crystal Cartridge. T/O Type Ster/LP Ea.	\$2.70
Sapphire Replacement Styl. Each Ster/LP	30c

TRANSISTORISED CALLING AND TALK-BACK SYSTEMS

Battery Operated		
2 station 1 master 1 slave	\$20.00
3 station 1 master 2 slave	\$22.50
4 station 1 master 3 slave	\$30.00
5 station 1 master 4 slave	\$35.00
7 station 1 master 6 slave	\$50.00
Complete with cable and batteries.		
3 station, all master	\$36.00
4 station, all master	\$48.00
Complete with batteries. Suitable cable from 20c yd. Plus 50c postage.		

SUB MINIATURE

I.F. TRANS., 7 x 7mm.		
In sets of 3, \$2.00 per set		
OSC. COILS, 7 x 7mm. To match I.F. Trans.	..	70c each.
5K Sub-Min Pots, W/switch	65c

PIEZO MICROPHONE INSERTS

MC-3 Crystal, 50-7K, 35 x 25 x 8mm. -57 DB	..	\$1.00 ea.
MC-7 Crystal, 100-7K. 39mm Round x 11mm. -56 DB	..	\$1.00 ea.
MC-8 Crystal, 50-8K. 48mm Round x 9mm. -50 DB	..	\$1.00 ea.
MC-9 Crystal, 50-8K, 25mm Round x 9mm. -68 DB	..	\$1.80 ea.
MC-33 Crystal, 50-10K, 33mm Round x 9mm. -60 DB	..	\$1.30 ea.
MD-5 Dynamic, 100-15K. 33mm Round x 14mm. -55 DB	..	\$1.80 ea.

TRANSISTOR SET ACCESSORIES

Magnetic Earpiece with 3.5mm Plug 75c
Crystal Earpiece with 2.5mm Plug 75c
Crystal Earpiece with 3.5mm Plug 75c
Jacks, 2.5 and 3.5mm 20c
3.5mm Plug and Cord Ext. Jack Pair 30c
Metal Co-axial Plugs and Line Sockets 65c
Pr. "Din" and "Hirschmann," 2, 3, 4 and 5-pin Plugs, Chassis and Line Sockets, carried ex stock.	
Prices on application.	
P.M.G. type Plugs from 50c
P.M.G. type Jacks from 35c
P.M.G. Line Jacks from 55c

Capacitor Substitution Box, 1,000 VW \$5.00
Resistor Substitution Box, 1 Watt. Plus Post, 20c. \$4.50

TRANSISTOR AERIALS

4in extends to 27in \$1.60
5in extends to 39in \$1.70
6in extends to 43in \$1.40
6in extends to 32in \$1.00
6in extends to 28in \$1.00
7in extends to 39in \$1.20
9in extends to 39in 95c
6in extends to 4ft 6in \$1.80
7in extends to 5ft 8in \$2.10
Plus Post 15c.	

CRYSTAL SET BUILDERS

Coils 65c	Tuning Conds. \$2.00
Diodes 35c	Terms .. Ea.	.. 12c
Headphones \$2.50	Plus Postage.	

KEW METERS

MR-2P 0-1 m/A \$3.95	MR-2P Stereo Balance \$5.25
MR-2P 0-50 u/A \$5.00	MR-2P 0-20v D.C. \$4.30
MR-2P 0-100 u/A \$4.00	All Meters in clear plastic cover.	
MR-2P 0-500 u/A \$4.50		
VR-2P V.U. Meter \$5.80		

TAPE RECORDER ACCESSORIES

2 1/2in Spools 30c	3in x 600ft Tape \$2.35
3in Spools 35c	5 3/4in x 1,200ft Tape \$3.10
5in Spools 40c	7in x 1,800ft Tape \$5.10
5 3/4in Spools 70c	5in Plastic Tape, boxes 60c
7in Spools 50c	7in Plastic Tape, boxes 90c
2 1/2in x 100ft Tape 60c		
2 1/2in x 300ft Tape \$1.30		
Plus postage			

STEREO PLUGS AND JACKS

Metal Plugs 95c	Bakelite ext. sockets 70c
Bakelite 70c	Chassis Jacks 65c
Metal ext. sockets 95c		

O.T.A. SWITCHES

(Rocker Type)			
S.P. Changeover 1A 45c	D.P. Changeover 1A 50c
		S.P. On-Off 1A 50c

TOGGLE TYPE

SP On-Off 1/2in Long Neck 60c
SP On-Off Short Neck 50c
SP Change-Over Centre-Off 75c
DP ST On-Off 50c
DP DT 1/2in Long Neck 80c
DP DT Short Neck Centre-Off 75c
Bulgin — Push-On — Push-Off DP Change-Over for Fuzz Box, Etc. \$1.70

SATO TEST LEADS

With fine pins 55c	With Alligator Clips 55c
With Banana Plugs 60c	With Battery Clips 50c

MAIL ORDER SPECIALISTS

NEW INSTRUMENTS FROM PRINCETON APPLIED RESEARCH

From Tecnico Electronics comes information on a new range of modular instruments introduced by Princeton Applied Research Corporation, of U.S.A.

Princeton has called the new range the RIM (Research Instrument Module) system. The units are compatible with the already established NIM (Nuclear Instrument Modules) system which has gained wide acceptance in the nuclear field.

The initial range of RIM equipments being offered by Princeton can be assembled into a wide variety of research systems. Typical experiments which can use one or more of these systems include measurements concerned with Hall effect, fluorescence decay, spectral analysis, noise in gaseous discharges, plasma waves, absorption spectrophotometry and many others. The range will be expanded still further to increase the number and variety of research systems which can be assembled.

The RIM range already introduced is sufficiently comprehensive to allow the experimentalist to assemble many complete systems. It includes DC, AF and HF signal processing equipment, precision power supplies, recorders, impedance bridges, operational amplifiers, filters and analog multipliers, for example.

Complex systems can be formed by plugging standard modules into a power supply "bin" and interconnecting them without concern as to signal level, impedance compatibility and power supply voltages.

The following are representative instruments of the RIM range available from Princeton Applied Research:

Model 210 Selective Amplifier. Can function as a variable Q (1 to 100) tuned amplifier, notch filter, or a two-phase oscillator, range 1Hz to 110KHz.

Model 213 Preamplifier. A low noise amplifier with a gain of 1 to 1000. High impedance RC coupled input or low impedance input through self-contained step-up transformer.

Model 214 Power Amplifier/Supply. Operates simultaneously as a wide-band power amplifier and/or a -20 to +20V (at 1A) power supply.

Model 215 Operational Amplifier. Open loop gain of 10^6 , 6dB octave roll-off, gain-bandwidth product of more than 10MHz. Integral, widely variable, input and feedback RC networks.

Model 222 Variable Speed Light Chopper. Operates over frequency range of 2Hz to 4800KHz. Automatically phase-locks to external reference signal.

Other instruments available in the series are Model 230 Multiplier, Model 270 DC Photometric Electrometer, Model 280 HV Power Supply and Model 281 Power Supply.

The following instruments have also been announced by Princeton Applied Research:

Model 160 Boxcar Integrator: This instrument is intended for applications where noise interferes with recovery of repetitive complex waveforms. It is especially useful in pulsed laser and nuclear

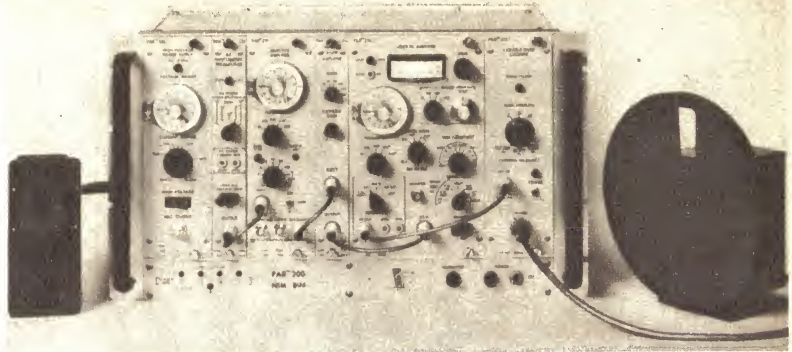

RIM units arranged for optical signal processing.

magnetic resonance studies, measurement of evoked response in physical and biological systems and absorption and emission spectrometry.

BRIEF TECHNICAL DATA

Input sensitivity: $\pm 0.5V$ to $\pm 10V$ in 1-2-5 sequence for $\pm 10V$ output.

Dynamic range: 3000:1 for aperture times longer than 5 μV . 500:1 for aperture times less than 5 μV .

Integration time constant: 3nS to 1000- μS in high resolution operating mode. 0.1mS to 100S in normal resolution operating mode.

Time base: 2 μS to 20S full scale in 1-2-5 sequence. Provision for external time base.

Automatic scan range: 1min. to 1000 min. in 1-2-5 sequence. Provision for external scan.

Model 102 Fourier Analyser: This unit is intended to be used with the Princeton Model 100 or 101 Correlation Function Computer for the study of the behaviour of such quantities as velocity in a flowing turbulent liquid; potentials in active plasma pressure density or void volume in boiling fluid; current flow across a reversed biased PN junction.

It extends the usefulness of the Model 100/101 units by Fourier transforming the auto- or cross-correlation output functions of these units into a frequency spectrum. The Fourier Analyser takes control of the Correlation Function Computer's memory readout system. For each frequency, it scans the memory for a sample of $C(t)$, the correlation, and multiplies it by that specific frequency sine or cosine function of the delay (t). The

integrals of the product are presented sequentially at the output as the desired spectrum.

Full technical data on all these instruments can be obtained by writing, on company letterhead, to Tecnico Electronics Pty. Ltd., Box 12, Marrickville, N.S.W. 2204. □

CALLING ALL PROSPECTIVE AMATEURS

The Wireless Institute of Australia was established in 1922 to further the interest of Amateur Radio. With over 45 years experience, who could be more experienced in the teaching of this subject?

We are a non-profit making Organisation. Correspondence Courses are available at any time. Personal Classes commence in February of each year.

For further information write to:
THE COURSE SUPERVISOR, W.I.A.,
14 Atchison Street,
CROWS NEST, N.S.W.

For details and illustrated catalogue all about

CRYSLER SPEAKERS

(see Full Page Advertisement this issue Page 110.)

Contact

RADIO PARTS PTY. LTD.
157 Elizabeth Street,
Melbourne, Vic.
Telephone 67-3263

SERVICE

BILL TURNBULL offers you service on Hi Fidelity equipment tape Recorders, Communication Receivers and Electronic Test Equipment.

25 years experience
All work guaranteed

BILL TURNBULL
11 ELLALONG ROAD,
CREMORNE, N.S.W. 90 4825

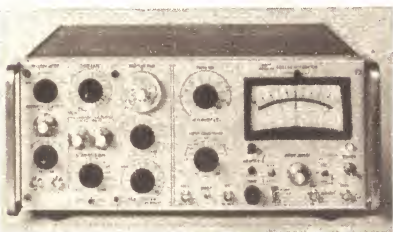

Model 160 Boxcar Integrator

Agfa helps tape editors

enjoy the splice of life

The only
accessory we don't make is a tape recorder. But if you want
professional precision in your tape editing — then AGFA
has all the accessories you'll ever need.

ALWAYS KEEP SOME EMPTY SPOOLS

Mighty handy when you want to run off a short tape or when you've spliced tapes together. AGFA spools run evenly and true. Sizes: 3", 4", 4½", 5", 5½", 7", 8½", 10". From 50c.



THE COMPLETE, COMPACT SPLICER

The AGFA Magnetron Splicing set comes with splicing tape, splicing template, and tape cutter. Handy, because it is useful with even the smallest recorder. \$1.15.

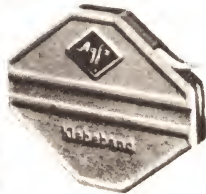

FULL, PROFESSIONAL EDITING KIT

The AGFA Magnetron editing kit comes with red, green, and white leader tape, with splicing tape, silver stop tape, anti-magnetic scissors, tape clips, and splicing template. It's a complete, 1st class editing kit. \$8.00.



PROTECTION FOR VALUABLE TAPES

You can build AGFA plastic spool cases into a neat tape library that protects your valuable recordings. 5", \$1.20; 5½", \$1.50; 7", \$1.72.

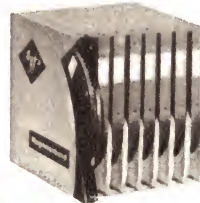

OTHER AGFA TAPE ACCESSORIES.

Leader tape in red and green, 80 ft. \$1.38. Silver stop/Switch tape in rolls of 33 ft. 98c. Special adhesive splicing tape, 33 ft. \$1.12. Neat-fit tape clips in boxes of 25 for \$2.30. Special anti-magnetic splicing scissors \$6.60.

PE31PE31RPE31KPE41PE41RPE41KPE65PE65RPE65K?

Write for FREE leaflet on Agfa Recording tapes and accessories.
To AGFA-GEVAERT LIMITED
P.O. Box 48, Nunawading, Victoria. 3131

NAME

(PLEASE PRINT)

ADDRESS

STATE POSTCODE



TAPE RECORDING
ACCESSORIES

*Registered trademark AGFA-GEVAERT Antwerp/Leverkusen

A333B

TRADE RELEASES - IN BRIEF

SOLARTRON AUSTRALIA has announced a high accuracy and increased scale-length version of the LM 1420 Digital Voltmeter. Designated the LM-1426, it retains the high sensitivity and noise rejection of the LM 1420. A nominal scale length of 9999 is further extended to 11000 by using an automatic over-ranging facility. The internal Weston Cell, used for calibration purposes, can be set with a five-figure resolution, 1.0193. Series mode interference is eliminated using the integration technique of the LM 1420, while the totally isolated input stage rejects common mode noise signals irrespective of frequency.

Specifications for the LM 1426 include: 2.5uV to 1000V in six ranges; 25 conversions per second; accuracy of ± 0.01 per cent of full scale or of ± 0.02 per cent of reading; input resistance greater than 10,000M Ω up to 10V; common mode rejection greater than 150dB. A variant of the LM 1426 provides for the remote changing of sensitivity for direct application in data logging systems with only a slight increase in cost. Inquiries to Solartron Australia, P.O. Box 138, Kew, Vic. 3101, or P.O. Box 297, Brookvale, N.S.W. 2100.

ENGLISH ELECTRIC CO. OF AUST. PTY. LTD. is manufacturing a new range of equipment for all types of industrial control, from simple measuring instruments to large computers. Known as System "M," all the products within the range are of modular construction, whether controlling a single function or forming complete industrial systems. Strict design rules for the connections (or interfaces) between modules ensure compatibility between units. System "M" has been divided into 10 separate groups — Series M2100 to M3000. Details of the new system may be obtained from the company at 365 Sussex Street, Sydney, N.S.W. 2000.

RUTHERFORD ELECTRONICS PTY. LTD. has announced that four special features have been added to the standard Pixiepot potentiometers. They are: special shaft lengths up to 1.8in; plastic shafts instead of the standard stainless steel; minimum torque to 2.0oz-in; and special resistance values. The standard Pixiepot sells for \$4.27 in production quantities. Specifications are available from the company at 833 Doncaster Road, Doncaster, Vic. 3108.

WM. J. McLELLAN AND CO. PTY. LTD. informs that filament type lamps have now been added to the Lumolite range of neon and fluorescent indicators, and can be supplied in 6v, 12v 24v and 32v types. These are available in various housings with clear, red, yellow, green or blue lens. Information regarding filament, neon, or fluorescent indicators may be obtained from the company at P.O. Box 69, Kingsgrove, N.S.W., 2208.

EAI ELECTRONIC ASSOCIATES PTY. LTD. has released PACE II — a fully programmed, digital computer system developed for use in chromatographic laboratories. The system, built around the EAI 640 scientific digital computer, is tied directly to the detector or electrometer output of each of 40 or more gas chromatographs. It automatically collects, attenuates and monitors all input signals; measures peak areas and retention time; allocates overlapping peak areas; applies response factors; calculates component concentrations; and types a completed analytical report ready for distribution.

A basic PACE II system, complete with all software, technician stations, and com-

puter with 8,000 words of core memory, sells for less than \$80,000. For further information write to the company at 26 Albany Street, St. Leonards, N.S.W. 2065.

TYREE INDUSTRIES LTD. has purchased all the Australian transformer manufacturing business of the GEC-AEI group. The purchase will give Tyree direct or indirect transformer manufacturing interests in all States except Tasmania and will make the company the largest producer of transformers in Australia, a company spokesman said. GEC-AEI have undertaken not to recommence manufacturing transformers for a specified period. Future development plans will be largely based on Tyree's licensing agreement with Westinghouse Electric Co. of U.S.A.

MOTOROLA SEMICONDUCTOR PRODUCTS INC., Phoenix, Arizona, U.S.A., announces a series of silicon controlled rectifiers for fast switching, high current pulse forming networks. The series, MCR1336-5 to MCR1336-10, has a repetitive peak forward current rating of 300A, is capable of a 75nS typical rise time at 100A forward current in a capacitive discharge circuit with a gate current of 500mA at 25deg. C. Turn off time is 7uS typically in a pulse forming network. The units have peak forward blocking voltages from 300 to 800V. For further information contact the Australian agents, Cannon Electric (Aust.), P.O. Box 22, Brighton East, Vic. 3187.

SOLARTRON ELECTRONIC GROUP has introduced a new data logging system named IDAS (for Industrial Data Acquisition System), which is said to be programmable, modular and with a truly industrial specification. IDAS is highly flexible allowing a user to expand by adding new modules or programs as the need arises. All manual controls are in a simple, desk-top unit which can be sited at any remote point from the main logger cabinet. The cabinet houses the heart of the system and is dust sealed, requiring



All manual controls of the Solartron IDAS system are contained in this compact desk top unit.

no operator access. The system has been designed to operate in severe environmental conditions. For further information contact Solartron Australia, P.O. Box 138, Kew, Vic. 3101, or P.O. Box 297, Brookvale, N.S.W. 2100.

RUTHERFORD ELECTRONICS PTY. LTD. has been awarded a contract for the development and production of a data retrieval system for the C.S.I.R.O. The system is being designed to read 800 punched cards per minute, comparing the intelligence thereon with that programmed in the input and making a logical decision. The small, low cost, high speed system will be ideally suited in fields where a number of distinct disciplines are operating and groups or sections maintain their own card files. It is anticipated that production units will be available by December, 1968.

AUSTRALIAN GENERAL ELECTRIC PTY. LTD. has introduced the newest member of its GE-100 line of computers. As a logical extension of the line, the new GE-130 (with integrated circuits) has a memory cycle of 2mS, memory size up to 32K octets and greater logic capability through a wider instruction repertory. A major feature is an interrupt capability which can be used in low-cost real-time applications. Overlapping is possible among input-output operations and computations, raising the total throughput



TRANSISTOR MODULES

- UNIT 1. 25W Amplifier \$30.00 plus tax.
- UNIT 2. 10W Amplifier 1.3 ohms \$15.00 plus tax.
- UNIT 3. 10W Amplifier 8 ohms. \$20.00 plus tax.
- UNIT 4. Pre-Amplifier. \$12.00 plus tax
- UNIT 11. 70W Guitar and HiFi Amp. \$36.00 plus tax



PALACE 8-WATT STEREO AMPLIFIER

Freq. Range 50 to 15,000 Kc/s. \$32.50
Also Solid State Model 10W. \$38.50.

TAPE RECORDER KITS

- UNIT 14. TAPE PRE-AMPLIFIER. Unit 15. 60-90 Kc/s Push/Pull Transistorised bias erase Oscillator Module. Unit 16 Transistor Tape Recording Amplifier Module. Used with Unit 14.
- NEW TAPE KIT: Complete Record Erase and Output Stage \$46.00 plus tax



ELECTRONIC PROJECTS

- BROADCAST TRANSISTOR RADIO KIT with 4in speaker \$13.00
- SHORTWAVE Radio Kit 3 BAND. \$18.75.

TAPE DECKS AVAILABLE

With or without Pre amp. Van De Molen, BSR, Magnavox, Van Der Molen.



TUNER

Bandwidth 8 K/cs.

- Unit 10 with Power Supply \$23.00. Plus Tax.
 - Unit 10 with RF Stake and Power Supply. \$31.00 plus tax
- Also Tuner Modules available.



DON BOSCO

"Mosquito" Signal Injector A Signal Source for every electronic application. \$14.00 complete.

S. E. WILLIS TRADING CO.

38 Riversdale Road, Camberwell Junction, Vic. 3124. Phone 82-5787. Please include Freight — Sorry No C.O.D.

NEW! ELECTRONIC KIT

20 Models in 1. Complete with Instructions. \$15.90.



NEW! 80,000 CANDLEPOWER FLASHLIGHT!

A portable searchlight. Yacht sails visible at 1,000 yards. A newspaper at 3,000 yards. Water and rust proof. \$11.00.



6 TRANSISTOR RADIO KIT

Complete, Incf. Instruction. \$13.95. Wired and tested, \$15.95.

TRANSISTORS and DIODES Special Prices including

5C107, \$1. AF114, 95c.
AC125, 90c. BC108/AT327, 90c.
AF115, 95c. 2N301, \$2.50.
BC109, \$1.30. AF116, 90c.
OC 74, 95c. Also Components, Tape Film, etc. Send S.A.E. for Details and List.



Goldring Trendsetters in sound equipment



Latest release, Swiss made precision transcription unit GL75

Integrated transcription motor unit and arm, built to instrument standards of quality and appearance. The drive system is the unique Goldring-Lenco constant velocity 4-pole motor with conical shaft coupled to the underside of the turntable by a knife-edged idler (automatically disengaged by the on/off switch, which is fully click-suppressed and also operates a turntable brake).

The turntable is die-cast from non-ferrous material, weighs 9 lb and is dynamically balanced.

Speed is continuously variable from

86-30 rpm and from 18-15 rpm with adjustable positive stops for the four standard playing speeds. There is only 0.2% change of speed for 10% mains voltage change.

The transcription arm is the Goldring-Lenco L75 with knife-edge bearings, full balancing facilities, calibrated stylus pressure adjustment, and 'anti-skating' bias compensation. It is lowered hydraulically by a lever fitted to the deck plate. Shock-damping mountings are supplied with the unit.



Goldring '800' series free field stereo cartridge

800: In this cartridge a very lightweight tube of magnetic material lies in a "free field" generated by a fixed source coupled to a low mass diamond point. It features low mechanical impedance (tracks at 1 to 3 grams), screening from external hum fields, gold-plated contacts. Stylus is replaceable. Rivals finest in the world. Frequency response 20-20 kHz, compliance 20 x 10⁻⁶.

800E: Using the same cartridge body as the standard model, an elliptical diamond stylus is fitted. Compliance is substantially increased resulting in brilliant linear, resonant free, performance. Frequency response 20-20 kHz, compliance 30 x 10⁻⁶.

GOLDRING ENGINEERING (AUSTRALASIA) PTY. LTD.

N.S.W.: 443 Kent Street, Sydney. 291275. VIC.: 368 Little Bourke Street, Melbourne. 671197. QLD.: 235 Edward Street, Brisbane. 27010. W.A.: 91 Hay Street, Subiaco, Perth. 84988. S.A.: Ernsmith, 52-54 King William Street, Adelaide. 516351.

From the ever-widening range of hi-fi equipment available from Goldring.

rate to one of the highest for any machine in its price range. Up to 34 single or multiple peripheral subsystems can be connected including a new removable disc storage unit with 7.6 million alphanumeric characters per disc. Inquiries to the company at 103 York Street, Sydney, N.S.W. 2000.

VARIAN ASSOCIATES has developed a new series of electrostatic recorders, designated Statos III. This series of graphic recorders is said to offer the following advantages: eight channels, each 40mm. wide on 15½in x 500ft chart paper; no moving parts in the writing process; maximum total error equal to 1 per cent (0.1dB), 40 mm. peak-to-peak from DC to 1500Hz; rise time of 200µs for 40mm. signal (0-100 per cent) with no overshoot; continuously variable chart speeds up to 50cm per sec. with correlated time-base logging; choice of either analog or digital (BCD) signals simultaneously recorded by a fixed recording head assembly; integral chart grid imprinting with interchangeable grid patterns; direct interface for computer readout or computer processing.

For information on the Statos III recorders, write to Varian Pty. Ltd., 38 Oxley Street, Crow's Nest, N.S.W. 2065.

IBM AUSTRALIA LTD. has announced a new multi-purpose punched card machine specifically designed for use with data logging and data collection systems. The unit, known as the IBM 545, provides a low-cost facility for producing punched cards as output from a data logging process. It can also be used as input to a data processing system. The unit reads and punches cards serially at speeds up to 20 columns per second, and can be linked to logging systems by means of a connector socket. A printing model is available which prints along the top of each card the data recorded for visual reading by operators. Inquiries to Communications Department, IBM Aust. Ltd., IBM Centre, Bradfield Highway and Kent Street, Sydney, N.S.W. 2000.

MOTOROLA SEMICONDUCTOR PRODUCTS INC., Phoenix, Arizona, U.S.A., has announced a new IC dual preamplifier, specifically designed for high-fidelity amplification of low-level stereo signals. Called the MC1303P, the monolithic device features a short-circuit-proof design. The unit provides a channel separation of the minimum at 10KHz with less than 0.1 per cent total harmonic distortion at the minimum rated output voltage swing of 4.5V RMS. The large output voltage is complemented by a minimum open loop voltage gain of 8,000. For complete specifications, contact the Motorola agent for Australia, Cannon Electric (Aust.) Pty. Ltd., P.O. Box 22, Brighton East, Vic. 3187.

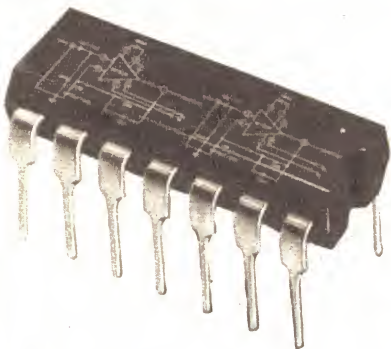

The Motorola IC dual preamplifier MC 1303P. The circuit on the device is of its application in a broadband audio amplifier with 3dB points at 10Hz and 50KHz typically.



The Philips "Practronics" courses come with all essential instruments, components and textbooks, as illustrated.

PHILIPS ELECTRICAL PTY. LTD. is marketing a course in electricity and electronics, known as Practronics, which combines theory and practice by the use of advanced teaching techniques. The course material consists of instruments and loose-leaf text books to supplement each other. Part 1 deals with linear networks, DC and AC, and is suitable for students from about

14 years upwards. It comprises three books, an audio test set, a matrix and a set of components. Part 2 introduces the principles involved in the basic operation of transistors and other semiconductors, and deals in detail with circuitry. Further information can be obtained from Educational Marketing Department, Philips Electrical Pty. Ltd., 79 Clarence Street, Sydney, N.S.W. 2000.

Celestion LOUDSPEAKERS

Highly respected for performance, Celestion speakers are advanced in design and engineering . . . these are the speakers overseas reviews have given "rave" notices. Speakers of equivalent quality and similar price in the U.K. cost at least 50% more than Encel prices in Australia. Frequency response is conservatively quoted in the best British traditions.

CELESTION "STUDIO SERIES" CO-AXIAL HIGH FIDELITY LOUDSPEAKERS

Celestion 12 in. co-axial loudspeakers have been received most enthusiastically by audio enthusiasts and music lovers in Australia. Clarity, transient performance and attack are particularly satisfying. Both models feature co-axial tweeters with electrical cross-overs at 4 kHz.



STANDARD 12" CO-AXIAL CX1512

The Standard Model CX1512 has a frequency response conservatively quoted at 30-15,000 Hz. and is rated at 15 watts R.M.S. Encel Price including Sales Tax

\$39.50

DELUXE 12" CO-AXIAL CX2012

The "Celestion" Deluxe Model CX2012 is rated at 20 watts R.M.S. and frequency response is conservatively quoted at 30-18,000 Hz. A special "Brilliance" control operates in the tweeter circuit — the electrical cross-over is at 4 kHz. See reviews in the "Gramophone", p. 511, April, '65, and "Hi-Fi News", p. 75, June, '65. ENCEL PRICE CX2012 (inc. Sales Tax)

\$59.00

CELESTION "DITTONS" ARE NOW AVAILABLE!

Both the "Ditton 10" priced at \$59 and the new "Ditton 15" which sells at \$89 have proved very popular in Australia. Ask for complete specifications.

Encel
ELECTRONICS
(STEREO) PTY. LTD.

Head Office:
431 Bridge Rd., Richmond, Victoria 3121.
Tel. 42 3762.

Sydney Store: Ground Floor, 25M Building
257 Clarence Street, Sydney, N.S.W. 2000.
Tel. 29 4563, 29 4564.

*Wholesalers *Trade-ins accepted

Australia's Greatest Hi-Fi Centre

YOURS FREE FOR 7 DAYS

The New 'Picture-Book' way of learning

BASIC ELECTRICITY [5 vols.] ELECTRONICS [6 vols.]

You'll find it easy to learn with this outstandingly successful new pictorial method—the essential facts are explained in the simplest language, one at a time; and each is illustrated by an accurate, cartoon-type drawing.

The books are based on the latest research into simplified learning techniques. This has proved that the Pictorial Approach to learning is the quickest and soundest way of gaining mastery over these subjects.

POST NOW FOR THIS OFFER!

TECHNICAL BOOK AND MAGAZINE CO.

295-299 SWANSTON STREET, MELBOURNE — PHONE: 32-3951

Please send me Without Obligation to Purchase, Basic Electricity/Basic Electronics on 7 Days' Free Trial. I will either return set, carriage paid, in good condition within 8 days or send down payment of \$2.50 (Basic Electricity) followed by 5 fortnightly payments of \$2.00. Down payment of \$2.50 (Basic Electronics) followed by 5 fortnightly payments of \$2.50. Alternatively, I will send \$11.00 (Basic Electricity—5 parts). \$13.10 (Basic Electronics—6 parts) post free. This offer applies to Australia only.

Tick against set required (only one set allowed at a time on free trial).

BASIC ELECTRICITY

BASIC ELECTRONICS

Signature.....
(If under 21, signature of parent or guardian)

Name.....
BLOCK LETTERS BELOW

Address.....
FULL POSTAL



ALSO AVAILABLE IN THE SAME SERIES:—Payment with order only.

FREE TRIAL OFFER DOES NOT APPLY TO THOSE BELOW.

- BASIC SYNCHROS and SERVOS**
- BASIC ELECTRONIC CIRCUITS**
- BASIC INDUSTRIAL ELECTRICITY**
- BASIC TELEVISION, PART ONE:**

These three sets are each of two parts and contain between 240 and 288 pages, 300 illustrations and are uniform in size with BASIC ELECTRICITY and BASIC ELECTRONICS. Each set of two volumes is priced at \$5.90 plus postage 30c.

This is a new series, part 2 of which will be published at a later date. Uniform with other titles in this series. **Price \$3.60, postage 30c.**

THE PURPOSE OF THE MANUALS is to train technicians, not high grade engineers. They are, therefore, admirably suited for self-instruction and for use in Colleges and Technical Institutes; also for Apprentices Training Schemes in many branches of industry.

Published by the Technical Press, London

TECHNICAL BOOK & MAGAZINE CO.

295-299 SWANSTON STREET,
MELBOURNE Tel. 32 3951

TECHNICAL BOOK & MAGAZINE CO.
295-299 SWANSTON STREET, MELBOURNE

Please post by return the items ticked for which I enclose remittance of \$.....

- Basic Synchros and Servos
- Basic Electronic Circuits.
- Basic Industrial Electricity.
- Basic Television, Part One.

Name

Address

TECHNICAL BOOKS AND PUBLICATIONS

Digital Equipment

CIRCUITS FOR DIGITAL EQUIPMENT, by C. J. Dakin, M.A., and C. E. G. Cooke, B.A. Published by Iliffe Books Ltd., London, 1967. Hard covers, 6½ x 9½ in, 433pp., many circuits and diagrams. Price in Australia \$16.30 plus 35c postage.

A book for the designer of digital equipment, particularly those with little previous background in the digital field. It is neither a text nor a collection of "selected" circuits, but rather a collection of in-depth analyses of many digital circuit blocks and elements.

Two introductory chapters deal briefly with the switching characteristics of semiconductor diodes and junction transistors. These are then followed by chapters dealing in depth with multivibrators, pulse amplification, voltage logic, current switching logic, tunnel diode logic circuitry, ferrite logic, delay line stores, ferrite core stores, thin film stores, tunnel diode stores, magnetic drum, disc, tape and card stores, non-destructive readout stores, digital-to-analog and analog-to-digital converters, indicators and display devices, and reliability.

Each section, while including the appropriate theory, is strongly orientated toward practical design requirements and considerations. The emphasis is on current design practice, and little space is given either to obsolete design techniques or to esoteric experimental techniques which are as yet unproved. Each chapter ends with a comprehensive bibliography, while the book includes a number of art plates of contemporary digital equipment.

The style throughout is concise, and the content clearly presented. Those for whom the book is written should therefore find it of considerable value as a design reference.

Our copy came from the Technical Book and Magazine Company Pty. Ltd., of 289-299 Swanston Street, Melbourne, 3000, who advise that copies are in stock at all major bookstores. (J.R.)

Microwave Devices

MICROWAVE GAS DISCHARGE DEVICES, by Andrzej Kraszewski. English edition by F. A. Benson, D.Eng. Published by Iliffe Books Ltd., London, 1967. Hard covers, 5½ x 8½ in, 338pp., many diagrams. Price in Australia \$14.90.

Not a book for the general electronics reader, but rather a thorough treatise on gas discharge devices for the microwave equipment designer and graduate student. The author is on the staff of the Polish Academy of Science, and states in his preface that the book has been written at least partly as an up-to-date companion to the long-standard work "Microwave Duplexers" published in 1948 by Smullin and Montgomery of M.I.T. Radiation Laboratory.

The content can be judged from the chapter headings: Introduction — High-Frequency Gas Discharge—Narrow-Band Tubes—Broad-Band Tubes—Plug-in Tubes—Switching Tubes in a Branched Duplexer—Technology of Microwave Gas-Discharge Tubes—Microwave Techniques. Each chapter concludes with a list of references.

The book presents its material smoothly and concisely, the text being well illus-

trated by diagrams. In short, a well-produced reference and textbook for those working in the microwave field.

Our copy came from the Technical Book and Magazine Company Pty. Ltd., of 289-299 Swanston Street, Melbourne 3000, who advise that copies are available ex-stock direct or on mail order. (J.R.)

Semiconductor Circuits

HANDBOOK OF SEMICONDUCTOR CIRCUITS, Published by Tab Books, Blue Ridge Summit, Pennsylvania. Hard covers, 6 in x 9 in, 448pp., many circuits and diagrams. Price in Australia \$9.95.

ELECTRONIC CIRCUIT DESIGN HANDBOOK — Second Edition, Edited by George Rotsky. Published by Tab Books, Blue Ridge Summit, Pennsylvania. Hard covers, 8½ x 11 in, 320pp., many circuits and diagrams. Price in Australia \$18.70.

Two rather similar recent releases by Tab Books. Both consist of collections of "selected contemporary circuits," although there is a difference in the approach. Whereas the second simply presents a series of circuits grouped into various functional categories, the first adopts a more in-depth approach in which each group of circuits is accompanied and prefaced by a discussion of the design techniques and considerations appropriate to that type of circuit. Much of the value of the first book should therefore remain when the specific circuit examples given in both itself and the other book fall into the ignominy of obsolescence.

According to the information supplied by the publisher the first book was originally published by the U.S. Government Printing Office for the Armed Forces Supply Centre under the title "Military Standardisation Handbook, Selected Semiconductor Circuits" (MIL-HDBK-215). Its military origin is evidenced mainly by a tendency toward baldness of explanation; however, this granted, the material is presented with commendable thoroughness and discipline, the text being concise and well-ordered and the illustrations well chosen. This being the case it would seem a very appropriate volume for students, technicians and designers as well as hobbyists.

The chapter headings give a good idea of the wide scope covered: Direct-Coupled Amplifiers — Low-Frequency Amplifiers — High-Frequency Amplifiers — Oscillators — Switching Circuits — Logic Circuits — AC to DC Power Supplies — Power Converters — Small-Signal Non-linear Circuits. Each section includes a bibliography and a list of references following the design discussion.

The second book is the second edition of a volume published in 1965 and reviewed in this magazine in July 1966, and based on circuits originally published in the American design journal "EEE." The second volume is increased in size from 254 to 320pp., and features something like 100 additional circuits of recent origin.

As mentioned earlier, this book is basically a collection of selected circuit designs, each circuit accompanied by a short explanation and note. The notes vary in length from a few short paragraphs to some hundreds of words, and are generally

at a fairly advanced technical level. In view of this the book will probably be of most value to design engineers and technicians as a source of inspiration, although the advanced amateur may find it interesting as a means of insight into modern advances in circuit and system design.

The 19 sections of the book are titled: Control Circuits — Regulator Circuits — Protection Circuits — Filter and Suppression Circuits — Pulse Circuits — Comparison Circuits — Amplifier Circuits — Oscillator Circuits — Indicator and Alarm Circuits — Counting and Timing Circuits — Test and Measurement Circuits — Generator and Simulator Circuits — Converter and Inverter Circuits — Power Supply Circuits — Detection and Sensing Circuits — Display and Readout Circuits — Gating and Logic Circuits — Relay and Switching Circuits — Miscellaneous Circuits.

The review copies of both books came direct from the publishers. However, local price information came from the Australian agents for TAB, Grenville Publishing Co., who advise that both will be available when this review is published. (J.R.)

Audio Amplifiers

AUDIO AMPLIFIER DESIGN, by Carl J. Waters. Published by W. Foulsham and Co. Ltd., Slough, Bucks, England. Stiff covers 8½ x 5 inches, 160 pages, freely illustrated with diagrams and graphs. Australian price \$4.25.

According to the note on the fly cover, the aim of this book is to enable the audio enthusiast to design his own amplifiers. A very natural question follows: What kind of enthusiast does the author have in mind?

The answer, apparently, is an enthusiast who needs to have explained to him the nature of sound (Chapter 1); to whom it is appropriate to introduce the amplifier as a kind of electronic lever (Chapter 3). Yet, within a page of the lever analogy, the reader is in a world of load lines. That's real progress!

Closer examination of the text revealed the rather unclear statement about loudspeakers that: "circular" pleats in a paper

RADIO ENTHUSIASTS

Learn amateur radio in your spare time.

Whatever your interests are in amateur radio, there's a Stott Radio course for you. Easy to follow. Practical. Modern. Guidance all the way by top-flight radio engineers. Radio for amateurs. Learn the exciting skills of building modern radio receivers. Learn about the latest advances in electronics, design, construction and operation. Let Stott's show you how. Amateur Operator's Certificate Course. Broadcasting is fascinating. Stott's offer an entirely new course that enables you to sit for the Amateur Operator's Certificate of Proficiency Examinations with complete confidence. Get full details now on Stott's Radio Courses.

Stotts

TECHNICAL CORRESPONDENCE COLLEGE
159 Flinders Lane, Melbourne, 303 George St., Sydney, 290 Adelaide St., Brisbane, 45 Gilles St., Adelaide, 1130 Hay St., Perth.
Post this coupon:

TO STOTT'S: Please send me, free and without obligation, full particulars of your Courses in Radio for Amateurs.

MR/MRS/MISS

ADDRESS

..... AGE

I understand no representative will call. RH768

Electronics Technicians



ENJOY HIGHER PAY AND MORE SECURITY

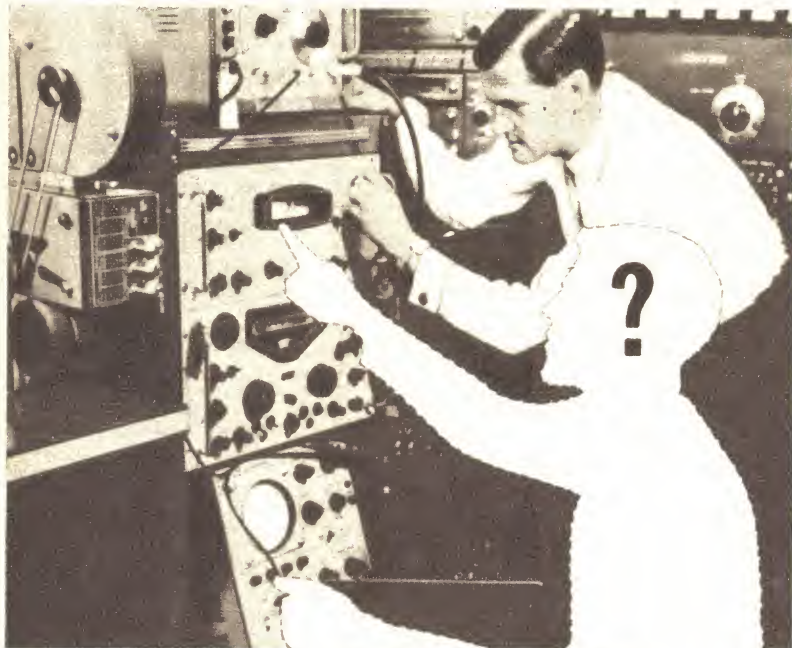

WHY NOT YOU?

Put yourself in this picture! With training through T.T.I., you could qualify for a start in the Electronics Industry as a:

- Radio-television technician • Telecommunications technician • Instrumentation technician • Business machine technician • Automatic control technician • Industrial electronic technician—and many other skilled positions.

WILL YOU FILL THE BILL WHEN THE TIME COMES?

The "good job" you hold down today may offer you less and less opportunity for advancement as Electronics increase their impact in all branches of industry.

TECHNICAL TRAINING INTERNATIONAL, a world-wide company with over 27 years' experience in the field of specialised technical training, now offers the latest Electronics training programmes available in Australia.



THIS IS A PRACTICAL PROGRAMME

You receive—and keep, the practical tools to complete your training—from tool kit to oscilloscope.



IF YOU ARE BETWEEN 18 AND 45 YEARS, AND EARNING LESS THAN \$80 PER WEEK . . . IF YOU ARE SERIOUSLY INTERESTED IN TRAINING FOR A CAREER IN ELECTRONICS, FILL IN THIS COUPON FOR FURTHER INFORMATION WITHOUT OBLIGATION.

E To: Technical Training International Pty. Ltd.
P.O. Box 83, Double Bay, N.S.W.
Please tell me more about T.T.I. Electronics Training, without obligation to me.

Name.....

Address.....

Age..... Present occupation.....

T.T.I.—The Industry-approved Technical Training Organisation EA

cone permit the cone to vibrate." Again: "frequency response is primarily dependent on cone diameter." On the same page, tape heads are credited with a response from 30 to 15,000Hz, without any hint of the need for extensive frequency compensation.

In the same strain, a specimen preamplifier design for a dynamic pickup examines such things as series and shunt reactance to ensure a flat response between 30 and 10,000Hz but completely ignores the basic requirement for RIAA frequency compensation that such a preamplifier would have to provide! The same preamplifier includes a general purpose triode operating with the unlikely load of 8,100 ohms and 7mA of plate current.

Skipping to chapter 10 for more sample reading, this time on controls, one finds the author laying stress on the difference between a volume control and a gain control. The latter is depicted as a potentiometer wired so as to completely or partially short across the plate load of a preamplifier valve. No allowance is made for the disturbance such a procedure would have on the DC operating condition and, in fact, the cathode is shown as directly earthed!

To such remarks must be added qualifications which appear in a preliminary chapter by W. Oliver, introducing the original American text to English readers.

To this reviewer, the whole work appears as an attempt at too much, in too small a space, in too short a time, and without the benefit of diligent criticism at the manuscript stage. I, personally, can't recommend it to anybody. The book is being distributed through Australian booksellers by Grenville Publishing Co. Pty. Ltd., 401 Pitt St, Sydney. (W.N.W.).

Test instruments

HOW TO USE YOUR VOM, VTVM AND OSCILLOSCOPE, by Martin Clifford. Stiff paper covers, 190 pages, 8½ x 5½ inches. Published by TAB Books, Blue Ridge Summit, P.A. U.S.A. Price in Australia \$8.70 hard-bound, \$4.95 paper covers.

"Having a VOM is one thing, knowing how to use it properly is another." This sentence from Chapter 1 of the book sums up very well what would appear to be the author's basic motivation. And it is certainly a very valid one in these days of relatively inexpensive multimeters. Many an enthusiast, having acquired such an instrument finds that he doesn't have much of an idea how to put it to proper use.

The author begins with a chapter on "How a VOM Works," VOM by the way being a contraction of volt-ohm-milliammeter and signifying what we more commonly refer to as a multimeter. He explains about meter movements, meter scales and basic metering circuits for resistance, current and voltage, both AC and DC. He shows how these techniques are combined into the one basic and popular style of test instrument.

Chapter 2 on "Using the VOM" covers the use of the instrument to test components and considerable and appropriate stress is laid on the continuity and resistance measurements. Chapter 3 "Servicing with the VOM" explains how the instrument can be used to check for faults in typical circuitry and, while no such chapter can turn a novice into a serviceman, at least it can put the novice on to the right track.

Having covered the multimeter and its uses at considerable length, the author nominates the VTVM (vacuum-tube voltmeter) as possibly the next most useful instrument favoured by hobbyist and professional alike. The same approach is adopted as before: "How a VTVM Works," "How to use a VTVM," and "Servicing with the VTVM."

The final chapters deal in similar manner with oscilloscopes — the internal workings of the instrument, the kind of tests that can be performed with them and their use in fault-finding situations.

Sample reading of the text indicated a great deal of planning and care in the presentation and marked the author as a person who knew his subject, knew where the emphasis should lie for the intended readers and knew how to express it.

This is an excellent book for students, would-be amateurs, would-be servicemen, or hobbyists, who want to discover what instruments and testing is all about. By the time they have finished it, they should have picked up a lot of very useful background. A book I would recommend.

Our copy came from the Australian distributors, Grenville Publishing Company. This firm advises that copies should be available at all book stores by the time this review appears. (W.N.W.).

Nomograms

ELECTRONIC ENGINEERING NOMOGRAMS, by Max H. Applebaum. Published by TAB Books, Blue Summit Ridge, Pennsylvania, 1968. Hard covers, 11½in x 8½in, spiral wire bound. Price in Australia \$12.40.

One is likely to find strong lines of demarcation, in technological circles, on the subject of nomograms. Some use them regularly in the course of their work and find them convenient. Some have never been partial to them for reasons best known to themselves. Some younger students may hardly know what they are.

Well, nomograms are graphical displays of quantities, relationships and equations which allow one to find answers by the use of a straight-edge, which would otherwise involve recourse to tables, formulas, the slide-rule, etc.

In this collection, intended for use by electronic engineers and others with like needs, are over 100 nomograms occupying 175 larger than quarto size pages. The lines and figures are clearly printed on good quality paper and each nomogram is accompanied by explanatory and procedural notes explaining the kind of problem it is intended to solve and the procedure for so doing.

At elementary level, there are nomograms for such things as resistors in parallel, frequency vs. wavelength and peak/average/RMS conversion for AC wave forms. At the other extreme are large sections on filters and transmission lines and such specialised component design data as the current vs. deflection angle for TV yokes.

The hard covers should protect the contents against all reasonable handling and the spiral binding allows each nomogram to be opened completely flat on the table for ease of working.

The book is broken up into the following chapters: Chapter 1 — Reactance, temperature conversion, Decibel ratios, etc. Chapter 2 — Attenuators and Filters. Chapter 3 — Transmission Lines. Chapter 4 — Passive Components (Coils, capacitors, etc.). Chapter 5 — Vacuum Tubes and Transistors. Chapter 6 — Miscellaneous: Amplifier gain; Light intensity; Time constant; Rise time, etc.

In all, it would seem quite a useful volume for engineers, particularly the chapters on attenuators, filters and transmission lines. Copies will be available from all major technical bookstores by the time this issue is on sale. The Australian distributor is Grenville Publishing Co. Pty. Ltd., 154 Clarence St, Sydney. (L.S.)

TV Service

NEW WAYS TO DIAGNOSE ELECTRONIC TROUBLES, by Jack Darr. Published by TAB Books, Blue Summit Ridge, Pennsylvania 1968. Soft Covers, 8½in x 5½in, 287 pp., many diagrams, circuits and photographs. Price in Australia \$4.95 for the soft-cover edition and \$9.95 for the hard cover version.

This book is written by the same author who writes the servicing series, "In the Shop—with Jack" in the American elec-

tronic magazine, "Radio — Electronics," and is written in much the same style. In spite of its title, this is basically a book on TV servicing. However, as the author explains in the preface, "The principles and methods in this book apply to all kinds of electronic maintenance: entertainment, industrial, broadcasting — all branches of our industry." Hence the deliberate use of the word "electronic" in the title.

One disappointing aspect of the book is that one could easily conclude that the author had never heard of transistors and ICs being used in TV circuitry. There is also very little discussion of colour TV circuitry, apart from one chapter on colour sweep circuitry. The book could have been written five years ago, for all the emphasis it places on these aspects of current circuitry. One can only assume that, while the book itself is a recent release, much of the material has been gathered over a period of several years. In fact, the author goes to some pains to emphasise that all the techniques he recommends have been tried and tested, on the service bench, over a long period. Nevertheless, some solid state versions of the "typical circuits" presented and discussed would have been a worthwhile improvement.

Putting aside these limitations, one must concede that this is a good book. The author obviously believes in a logical approach to all electronic problems, based on a thorough knowledge of how each section of the device is supposed to work. In contrast to some "servicing" textbooks, this is no mere list of commercial circuits and faults which are peculiar to those sets. All the emphasis is on systematic diagnosis based on a knowledge of basic principles.

The first chapter is titled "The Art of Electronics Servicing" and is one of the most informative, though shortest, chapters in the book. One of the key points is that faulty equipment must have worked correctly at some time and so it is not the job of the serviceman to redesign it, but simply to repair it. Many servicemen would do well to remember this. And so, the book carries on in this vein till the end. It is written in a very conversational tone, to the point of being downright ungrammatical in some places. In fact, I sometimes found myself mentally pronouncing the words with an American accent!

Most of the chapters are devoted to a different section of the TV set—describing how it works and how different faults manifest themselves in typical circuits and the necessary measures to cure the trouble. The list of chapters is as follows:

- (1) The Art of Electronics Servicing.
- (2) How To Use The Method.
- (3) The Typical Schematic.
- (4) Power Supplies.
- (5) Special Power Supplies.
- (6) Horizontal Sweep and High Voltage Systems.
- (7) Servicing the Horizontal Output Stage.
- (8) Colour Sweep Circuit and High Voltage Problems.
- (9) Vertical Oscillator and Output Stages.
- (10) The Picture Tube and its Circuits.
- (11) Video Amplifier Stages.
- (12) Video IF Amplifiers.
- (13) Tuner Circuits.
- (14) AGC Circuits.
- (15) Sync Circuits.

The book is profusely illustrated with circuit diagrams and photographs, as is usual with books of this kind. But in this case photographs illustrating how faults in a TV set show up on the picture tube are very good examples and are well related to the text.

In short then, I can recommend this book to the hobbyist or amateur radio operator who wants to learn servicing techniques as applied to valve TV. There are the usual qualifications, of course, in that the book is written for the American scene and our sets do not feature such things as series heater strings,

PLAN YOUR FUTURE

CHOOSE a career in the field of **ELECTRONICS*** — the Nation's most progressive and fastest expanding industry.

✳ Advancement in this modern science demands technical ability, a sound knowledge of basic principles and applications.

YOU can master the subject by training at the **MARCONI SCHOOL** and be ready to grasp the opportunities that occur in the three fundamental branches of Radio-technology.

KNOW WHERE YOU'RE GOING

A = APPLIED SERVICING

Comprehensive training in the maintenance and repair of radio and television receivers offers substantial rewards to competent technicians. Marconi School training covers all aspects of radio and television receiver circuit applications, practical exercises in fault finding and alignment procedures.

B = BROADCASTING

A thorough and practical grounding is available to students in broadcasting transmitter performance standards and maintenance techniques, with individual instruction in station operation and studio control and testing.

C = COMMUNICATIONS

Combines all the foregoing, together with radio aids to navigation, mobile telephony, marine service application and international wireless telegraph regulations, qualifying the successful student for the Commonwealth Government Certificate of Proficiency and the Marconi School Diploma in Radiotechnology. Classes are conducted at 21 Pier Street, Sydney (at the foot of Goulburn Street).

Daily: 9.30 a.m. to 4.30 p.m.

Evenings: 6 p.m. to 8.30 p.m.

or by Home-Study Courses (except practical instruction on equipment).

STUDY NOW

Send for training syllabus. There is no obligation.

NAME.....
ADDRESS.....

the **MARCONI SCHOOL** of
wireless

G.P.O. Box 2516, Sydney

A Service of Amalgamated Wireless (Australia) Ltd.

LAFAYETTE Most Popular Hi-Fi Combination at a Low Price



MODEL LA-224T \$99.50

30 WATT SOLID STATE STEREO AMPLIFIER

A "Remarkable" value by any standards of comparison. All the characteristics of a quality Hi-Fi amplifier have been incorporated into the LA-224T. Attractive slim styling and 30-watts power supplied through the use of 16-transistors, 4 diode circuitry for instant, cool operation, low current drain, minimum distortion and noise, excellent frequency response. Suits speakers 4, 8 and 16 ohm impedance. SPECIFICATIONS — POWER OUTPUT: 30-watts IHF, 24-watts continuous. FREQUENCY RESPONSE: 30-20,000 cps \pm or $-$ 2db. HARMONIC DISTORTION: Less than 1%. SENSITIVITY: (Mag. Input) 3mv; tuner/auxiliary 250mv. CONTROLS: Power On/Off, Spkr/Phones, Bass, Treble, Volume/Balance, Mode (Mono, Stereo). POWER REQUIREMENTS: 220/249 volts AC 50 cps.



"CRITERION" 50 \$45.50

2-WAY BOOKSHELF TYPE SPEAKER SYSTEM

Ideal matching speakers for the LA-224T amplifier. Offers impressive hi-fi sound, yet measures only 19"W x 8½" x 10½". 8" woofer plus 4" Tweeter in an acoustically "tuned" enclosure, fully lined, assures smooth, resonant-free sound, yet measures only 19"W x 8½" x 10½". 8" woofer plus 4" Tweeter in rubbed oiled walnut veneer tastefully framed in an ebony and gold picture frame moulding with white and gold acoustic grill material.

SPECIFICATIONS — 8" Woofer plus 4" Tweeter, "Tuned" enclosure with Tube-Type ducted port, Overall Response 35-18,000 cps, Power rating 20-Watts but efficient at low power, 3,000 cps Electrical Crossover.

LAFAYETTE ELECTRONICS

Division of Electron Tube
Distributors Pty. Ltd.

All Mail Enquiries and Orders to:

VICTORIAN SALES CENTRE
AND HEAD OFFICE,
15A WELLINGTON STREET
WINDSOR, VIC., 3181. Ph.: 51 6362

LAFAYETTE Hi-Fi Equipment is also
available from Selected distributors
throughout Australia.

while Australian transmission standards and bandwidths are different from those of America.

The book will be available in soft or hard covers from all major technical book stores and is distributed in Australia by the Grenville Publishing Co. Pty. Ltd., 154 Clarence Street, Sydney. (L.S.)

Audio Equipment

TROUBLESHOOTING AUDIO EQUIPMENT by M. Horowitz, with a special introductory chapter for English readers by W. Oliver. Published by W. Foulsham and Co. Ltd., Slough, Bucks., England. Hard covers, 160 pages 8½ x 5½ inches. Price in Australia \$4.25.

According to the notes on the fly cover, this book has been written primarily for the serviceman who may be inclined to break away from the radio and television routine into audio system—both hi-fi and public address. Consistent with this expressed intention, it progresses rapidly from point to point in the discussion at a rate which might be tolerable on a "fill in" or revision basis, but which would probably baffle the uninitiated.

The first chapter takes a general look at the audio field and outlines the difference between specialised audio equipment and the amplifier end of radio and TV receivers.

Chapters 2, 3 and 5 are in the nature of revision and preparation for what is ahead: a review of basic theory, basic amplifier stages, test instruments and test set-ups. The author has elected to draw a strong parallel here between triode valves and NPN transistors, with pentode valves and PNP transistors given but brief mention.

The remaining chapters move progressively through the amplifier, covering power supply, power output stages, phase inverters, preamplifiers and tone controls. Basic principles are explained, typical troubles and how they may be rectified. Chapter 13 deals with tape recorders and chapter 14 with stereo systems.

One would judge the author to be heavily biased in favour of triodes leading, on page 33, to a statement that most designers prefer triode valves and the same pattern is evident in transistor equipment. Such a statement ignores the common preference for tetrode or pentode output stages, the fact that there is little else to choose but 3-element transistors and that these have pentode-like characteristics, anyway! Another statement on page 70 ignores findings that there is an optimum tapping point on the output transformer for the screens in an ultra-linear stage. On page 68 is a very debatable sentence to the effect that "a perfect class-B circuit has cross-over distortion."

Statements like these — and others we noticed — would probably not disturb the partially informed too much, but they could mislead the newcomer still in the process of forming basic concepts.

However, for the intended reader group, there is a lot of basic and helpful information and it could be assimilated with profit by those who see an outlet for their servicing abilities in the audio field.

Our copy came from the Australian distributors, Grenville Publishing Co. Pty. Ltd., 401 Pitt Street, Sydney, 2000. It should be available through retail book-sellers. (W.N.W.)

LITERATURE—in brief

INTRODUCTION TO DITHER TUNED MAGNETRONS is a 16-page booklet available on request from S-F-D Laboratories, Inc., a subsidiary of Varian. The booklet has the following sections: Why Dither Tuned Magnetrans — How Frequency Agile Systems Work — System Considerations — Tube Design Principles — Broadband Tuning Readout — Narrow Band Tuner Readout — Tube-

System Interaction — Servo-tuned Designs — Frequency Adjustable Systems — Combining the Broadband/Narrow Band Readouts. Inquiries should be addressed in the first instance to Varian Australia Pty. Ltd., 38 Oxley Street, Crows Nest, N.S.W. 2065.

HEWLETT - PACKARD JOURNAL, Vol. 19, No. 7 (March, 1968) has the following major articles: Electronic Technique in Gamma Ray Spectroscopy and Timing; Multichannel Pulse Height Analyser with a very fast analog-digital converter; A Charge Sensitive Pre-amplifier for Nuclear Work; A Nuclear-type Linear Amplifier with plug-in pulse-shaping delay lines; A Single-channel Analyser with fast multiple-pulse resolution. Inquiries to Hewlett-Packard Australia Pty. Ltd., 22-26 Weir Street, Glen Iris, Victoria, 3146.

ANODEON SALES DIVISION has available data sheets for the following devices.

NPN Silicon Transistors: AT318 to AT324, general purpose AF and RF applications; AT326 to AT328, AT330, and AT337, audio preamplifier; AT329, audio output to 800mW; 2AT329, matched pair of AT329; AT335, sound IF of TV receivers. **PNP Silicon Transistor AT331**, class B audio output to 500mW. **PNP Germanium Transistors**, AT1138/A/B, high power AF amplifiers, switching circuits, etc.

Silicon Rectifiers: AD100 and AD1000, 750mA at 100V and 1000V; AD4001 to AD4007, 1A up to 1000V; 1N3193 to 1N3196, 750mA to 800V; 1N2353T/P to 1N3255T/P, 750mA to 600V; 1N3491 to 1N3493, 25A to 200V; 1N3659 to 1N3660, 30A to 200V. Germanium point contact diodes, 1N60A, 1N66A to 1N68A, 1N294A, 1N295A and 1N297A, various applications. Polyester film capacitors, 160V to 630V working.

Also available are the following short-form catalogues: Anodeon Semiconductors; Hitachi Semiconductors for entertainment use. KCK Ceramic Capacitors, Allen-Bradley quality electronic components; Erie Electronic Components.

Copies of these may be obtained by writing, on company letterhead to Anodeon Sales Division, Electronic City, 443 Concord Road, Rhodes, N.S.W. 2138; or, in Victoria, Electronics Park, Hamilton Street, Huntingdale, 3166.

TELECOMMUNICATIONS JOURNAL for May, 1968 (Volume 35, No. 5) contains an article by Mr H. Kusakabe of Japan on radio monitoring in the present age and a study by Mr W. J. Fijalkowski of Poland entitled "Considerations on the types and essential features of telecommunications technique training establishments set up with Special Fund assistance." In another article, Mr F. W. Bodeman and Mr M. Schonfeld (German Federal Republic) describe the behaviour of large antennas without radomes. Regular features included are reports on I.T.U. activities and "Ideas and Achievements."

"Telecommunication Journal" is published by the International Telecommunication Union in English, French and Spanish editions. Annual subscription is 25 Swiss Francs. Inquiries to Publications Service, I.T.U., Place des Nations, 1211 Geneve 20, Switzerland.

PYE PTY. LTD. now has available copies of a reprint of their booklet "Quartz Crystal Units" which has been out of print for some time. This has general and technical information on the range of Pye quartz crystal products and ordering information. Inquiries should be addressed to Pye Pty. Ltd., P.O. Box 105, Clayton, Victoria 3168.

EMERSON AND CUMING, Inc., of U.S.A., has published a one-page supplement to "New Designs 7." This supple-

ment describes the recently completed shielded anechoic chamber at the Technical University of Denmark. The chamber has a quiet zone 8ft in diameter and 33 feet long, and is lined with 80in-long pyramids of Eccosorb HPY-80. The floor is a fibreglass foam laminate mounted on similar pyramids, each of which has a special reinforcing column in the centre. The 14ft square door is one of the largest ever installed in an anechoic chamber. Average reflectivity is 40dB down or more from 100MHz to 10GHz. Illustrations showing some of the more interesting features of the chamber are included in the supplement. Inquiries should be addressed to the Australian agents, who are Wm. J. McLelland and Co. Pty. Ltd., The Crescent, Kingsgrove, N.S.W. 2208.

TECHNICAL NEWS BULLETIN, published in the U.S.A. by the National Bureau of Standards, has the following articles in the April, 1968, issue: NBS advances new concept in low-temperature measurement — Precise temperature control — New tool for energy transfer studies — Engineering data obtained from titanium-nickel alloy — Ion chamber provides calibrated ultraviolet detection — NBS to aid National Conference of State Building Administrators — Cryogenic temperature medium investigated — Research associate completes assignment at NBS — Laser used to detect particles in liquids.

"Technical News Bulletin" may be obtained from the Superintendent of Documents, U.S. Government Printing Office,

Washington, D.C. 20402. Annual subscription is \$US2.25.

NEWS BULLETIN Vol. 3, No. 64 from A. F. Bulgin and Co. Ltd., of U.K., has information on latest additions to the Bulgin range of products, including the following: Sub-miniature micro-switches—miniature screened side-entry jack plugs; "Overlight" E.S. lampholder; moulded body semi-rotary and key switches; miniature neon signal lamp; panel mounting battery holder; "Press-for-Off" switches; "Desk-to-door" signal system; various other switches and signal lamps. Inquiries should be addressed to the Australian agents, R. H. Cunningham Pty. Ltd., 8 Bronham Place, Richmond, Victoria 3121.

STANDARDS ASSOCIATION OF AUSTRALIA is seeking comment on a draft Australian "approval and test" specification for domestic electric photographic projectors, issued for public review as Doc. 1284. The draft is concerned with safety matters in respect of domestic projectors, viewing machines and editing machines, and outlines conditions which must be met to secure approval for their sale and use. Special tests are included to ensure that no hazard arises in the event of operation of the appliance with any ventilating fan stalled or any ventilating apertures blocked.

Copies of the draft may be obtained from the various offices of the Association in all capital cities and Newcastle. Comment must be submitted before July 31. ■

Be Paid What You are REALLY WORTH!



Develop your aptitudes at your own pace, for recognition that brings HIGHER PAY. Begin YOUR Progress Today! Select the course you want and which will benefit you most. ICS will send YOU promptly — a FREE illustrated BOOK, giving FULL DETAILS.

GENERAL

Journalism — Short Stories
Writing for Radio & TV
Interior Decorating
Etiquette & Entertaining
Textiles
Photography
Mathematics
General Education
Dressmaking

DRAUGHTSMANSHIP

Architectural
Builders' Plan Drawing
Mechanical Structural
Surveying & Mapping

ILLUSTRATING

Still Life — Landscape
Caricature & Cartoons
Oil & Water Colour
Fashion Drawing
Showcards & Tickets
Signwriting

COMMERCIAL

Accountancy
Cost Accountancy
General Bookkeeping
Salesmanship
Shorthand Typing

Retail Management
Commercial Management
Small Business Owners
Hotel-Motel Management
Club Administration
Window Dressing
Business Letters

BUILDING

Architecture
Building Contracting
Carpentry, Joinery
Structural Engineering
Concrete Engineering
Estimate & Quantities
Roofing, Steel Square
Timber Home Building

INDUSTRIAL

All Mechanical Eng.
Fitting & Turning
Soft Drink Manufacture
Air Conditioning
Gas or Elect. Welding
Chemistry, Plastics
Electronics
Electrical Mechanics
Radio Eng. or Service
Television
Refrigeration
Diesel Engines

Auto Mechanics
Civil Engineer
Production Management
Industrial Management
Executive Training
Modern Supervision

SPECIAL EXAMINATION COACHING COURSES

Account'cy: All Exams
Institute of Secretaries
Inst. Cost Accountants
Inst. Sales & Marketing
Metric. or Leav. Cert.
Intermediate Certificate
Senior or Junior Public
C'wealth Clerical Exams
Police Entrance Exam
Nurses' Entrance Exam
Steam Certificate
Refrigeration Certificate
Radio Examinations
Inst. Auto. Mech. Engrs.
Inst. Diesel Engineers
Shire Overseers' Exam
Engineers' Institutions.

ADVERTISING

Copywriting
Commercial Art
Advertis'g Inst. Aust.

TO INTERNATIONAL CORRESPONDENCE

Dept. 526 **SCHOOLS.**

SYDNEY: 400 Pacific H'way, Crow's Nest. Tele.: 43-2121.

MELBOURNE: 234 Collins Street. Tele.: 63-7327.

BRISBANE: Heindorff House, 171 Queen St., Brisbane. Tele.: 2-6125.

ADELAIDE: T. & G. Building, King William St. Tele.: W-4148.

PERTH: C'wealth Bank Building, 55 William St. Tele.: 21-7268.

NEW ZEALAND: Wellington, 182 Wakefield St. Tele.: 53-109.

Please send Free Book on

NAME (Mr, Mrs, Miss) AGE

ADDRESS

..... STATE Dept. 526

OCCUPATION PHONE

EA 5 68

SPECIAL PURCHASE-NEW B.S.R. TAPE DECKS SUPPLIED WITH KIT OF PARTS FOR MONO PRE-AMP



These New B.S.R. single speed (3 1/2 in) Tape Decks are fitted with Bradmatic two-track heads and will take spools to 5 1/2 in. With each deck is supplied a mono transistor pre-amp kit as advertised separately on this page. Circuit of pre-amp is supplied.

\$30.00

Post and Packing Extra—N.S.W. \$1.25; Interstate \$1.75.

NEW IMPORTED SLOT CAR KITS AT LESS THAN HALF PRICE



Complete kit of parts including 12V motor and full instructions.

\$2.00 post 25c

NEW AMERICAN TWIN TELESCOPE TV AERIAL

Extends to 36in, each section can be used singly for car or portable ... \$1.50. Post 20c.

SINGLE TELESCOPIC

Aerial 12in extends to 33in. 60 cents. Post 10 cents.

**NEW 4-SPEED STEREO
PLAYER F.O.R. \$23.50**

**NEW STEREO CHANGER,
4-SPEED F.O.R. \$29.50**

**SLIDER-SWITCHES
10-pole 2-way silver-plated contacts 38c**

POWER TRANSFORMER

Prim. 240V Sec. 350 volts a side. 60 M.A. One 6.3V, one 5V Fil.

\$2.75

Post N.S.W. 60c, Interstate 80c.

72 ohm CO-AXIAL CABLE

20c per yard, Minimum order 5 yards.

NEW SELENIUM RECTIFIERS

New Selenium Rectifiers, 6 or 12 volt at 4 amp., \$3.75. Post, N.S.W., 20c; Interstate, 20c. Transformer for above rectifier tapped for 6 to 12 volts, \$4.75. Post, N.S.W., 75c; Interstate \$1.00. As above, 6 or 12 volt, at 2 amp., \$2.75. Post, N.S.W., 35c; Interstate, 45c. Transformer for above, \$3.75. Post, N.S.W., 35c; Interstate, 45c.

TRANSISTORISED SIGNAL INJECTOR, \$5.50

A MUST FOR QUICK TROUBLE SHOOTING Using TWO Transistors, complete with instruction sheet and battery. Post free.



NEW VALVES AT BARGAIN PRICES

7193 25c
807 \$1.75
1C7G 30c
1D8GT 95c
1K5G 40c
1K7G 40c
1M5G 40c
1P5G 25c
1Q5G 25c

1T4 45c
3Q4 75c
354 \$1.00
5V4G \$1.00
6BB \$1.00
6C8G 80c

6H6G 35c
6K7G 45c
6K8G 68c
6SA7GT 95c
6SJ7 98c

6SS7 equiv. 6SK7 85c
6U7G 45c
6X5GT 75c
7C7 35c
12AT7 \$1.00

1A7GT 75c
1L5G 95c
12SK7 80c
12A6 80c
12X6 80c
12SH7 80c
866 1.80
954 25c
955 25c
EK32 60c

Please add postage on all valves.

NEW "TECH" V.T.V.M. MODEL TE65

23 RANGES. 240V. A.C. powered.

D.C.V. 1.5, 15, 50, 150, 500, 1,500
A.C.V. 1.5, 15, 50, 150, 500, 1,500.
D.B. -10db to +60db.

Resistance. 1 ohm to 1,000 megohm.

\$42.50

POST \$1.00



NEW 240V ELECTRIC MOTORS

3300 R.P.M. can be supplied with or without 4-speed reduction mechanism. Size 3 1/4" x 2 1/4" x 3 1/2, including spindle.

\$2.75

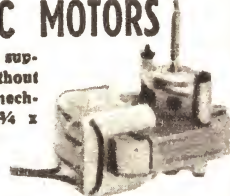

New Electrolytic Condensers

These condensers are miniature pigtail type insulated new stock in packets of 12, each packet containing; 3 16mfd 300 V.W., 2 32 mfd. 300 V.W., 1 25 mfd. 450 V.W. and 6 low voltage electrolytics. \$2.50.

Post and packing 20c extra.

NEW IMPORTED 4" P.M. SPEAKERS

Available with a 4 or 16 ohm voice coil. \$2.00. Post and packing 30c extra.

NEW POWER TRANSFORMERS

60mA prim.: 240v with 230v tapping Sec. 285 x 285 with 6.3v filament winding. 60mA, \$3.00. Plus Postage: N.S.W., 35c; Interstate, 52c. Prim.: 240v, Sec. 385 x 385 at 80mA, fil. 6.3 and 5v, \$4.50. Post.: N.S.W., 40c; Interstate, 75c. 60mA H.T. Chokes, 75c. Post.: 20c.

TYGAN AND SARLON SPEAKER GRILLE FABRIC

List price \$8.00 per yard. To clear at \$5.50 per yard.

Postage and packing N.S.W., 35c. Interstate, 45c.

NEW MINIATURE MOTORS

Ideal for models, toys, etc. 1 1/2 to 3 volts, 6,000 r.p.m. 39c each or \$3.50 per doz. Post 10c.

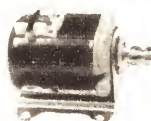

NEW MIDGET POWER TRANS. \$3.25

40mA prim., 240v. Sec 225 x 225 with Postage: N.S.W., 25c; Interstate 45c. 6.3v Fil. Winding.

30mA 240v Prim. 150 x 150v. Sec. with 6.3v Fil. Winding.

\$3.25

Postage: N.S.W., 25c. Interstate 35c.

NEW B.S.R. TAPE DECKS

These new 3-speed B.S.R. Decks are fitted with a digital counter and will take 7in spools. 2 Track, \$35, 4 Track, \$40.

NATIONAL RADIO SUPPLIES

332 PARRAMATTA ROAD, STANMORE, N.S.W. PHONE 56-7398

NEW RANGE OF RESISTORS, CONDENSERS AND POTENTIOMETERS

WE HAVE JUST PURCHASED THE COMPLETE STOCK OF RESISTORS, CONDENSERS AND POTS. OF A LARGE MANUFACTURER AND CAN OFFER SAME AT LESS THAN 25 PER CENT OF LIST PRICE.

The resistors are mainly I.R.C. and Morganite and are in a wide range of values from 200 ohm. to 3meg. in 1/2, 1 & 2watt also included are I.R.C. 3watt wire wound 2,200 ohm. 3,300 ohm 4,700 ohm. etc.

List price \$9.00 per 100 our price \$2.00 per 100 post & packing 25c extra.

The condensers are in most popular makes and include Polyester, Paper, Mica, Ceramic & Electrolytic in standard values including 4mfd, 8mfd, 16mfd 300V etc.

List price \$11.00 per 100 our price \$2.00 per 100 post & packing 30c extra.

The potentiometers are all current types and include switch pots, dual concentric, 1meg. tandem, 1/2meg switch, tab pots etc.

List price \$12.00 per dozen our price \$2.50 per dozen post & packing 30c extra.

FREE With each lot of resistors, condensers or pots, we will supply free one new valve type 6U7G, 6X5GT, 1T4, 6K7G, or 12AT7. Resistors, condensers and pots are in packs of 100 or 12 and we regret we cannot supply to individual Lists of values or types.

New Hi-Fi Sound Recording Tapes. All Mylar Base.

3" x 150ft	60c
3" x 225ft	75c
2 1/2" x 300ft	85c
3" x 300ft	85c
3 1/4" x 600ft	1.75
5" x 600ft	1.50
5" x 900ft	2.00
7" x 1200ft	3.00
7" x 1800ft	3.75

Post and Packing,
25c extra.

LEADER SIGNAL GENERATOR LSG11

240V A.C. operated, 6 band
120KC to 390 Megs. Pro-
vision for crystal. Post
N.S.W., 75c; Interstate, \$1.25.
\$34.00

USED HIGH-SPEED 240V. AC/DC MOTORS

These 240v. A.C. or D.C.
motors are 1/8 H.P. with a
speed of 7,000 R.P.M. and
are ideal for small drills,
grinders, etc. Dimensions,
5 1/2in x 3 1/2in, with 5/16in
spindle \$3.75.
Post, N.S.W., 50c; Inter-
state, 85c.

Switches for Hi-Fi Equipment Etc.



ROTARY SWITCHES and ROCKER SWITCHES

Bank 11 x 1 or 5 x 2, 69c
1 Bank 3 x 3 60c
2 Bank 5 x 2 \$1.20
Rocker Type D.P., D.T.,
50c.

Post and Packing
15c extra.

NEW BOOKSHELF SPEAKERS

Uses 6" Magnavox Dual
Cone Speaker plus 3TC.
Tweeter with cross-over con-
denser.
Dimensions
14" x 8" x 9"
deep.



\$17.50

Post and Packing
Extra.
N.S.W. \$1.50.
Interstate \$2.00.

THE NEW COLLARO 3-SPEED 4 TRACK TAPE DECKS \$55.00

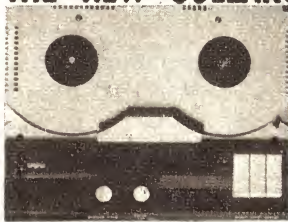

The ideal deck for the
home constructor, as am-
plifier and all controls can
be mounted on deck.

• 3-speed 1 1/2, 3 1/4, 7 1/2. • Pause control. • Takes 7in spools.
• Simplified controls, 4 Tracks, \$55. OSC Coils, \$1.50.

NEW 4" EXTENSION SPEAKERS

These 4" speakers are mounted in
plastic cabinets suitable for use as
intercom, units or extension speakers.
Fitted with switch and volume control.
**SPECIAL PURCHASE ENABLES
US TO SELL THESE UNITS AT
\$5.00. Post and Packing, N.S.W.,
68c. Interstate, 98c.**

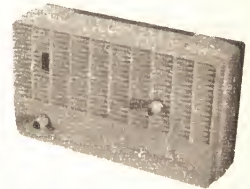

A PREAMP FOR MAGNETIC PICK-UP OR TAPE HEADS

SUITABLE FOR USE WITH THE COLLARO OR B.S.R. TAPE DECKS

Using 3 silicon transistors as featured in October Electronics Australia complete with kit of
parts including transistors mono \$7.50, stereo \$13.00, 240 power supply for above \$7.00.
Please specify if required for pick-up or tape heads.



NEW 17 & 25 WATT P.A. AMPLIFIERS

The 25 Watt Amplifier uses 5 valves plus 2 rectifiers including two EF86 low noise valves as
microphone preamplifier and two EL34 valves Ferguson push-pull output.

All amplifiers are fitted with Ferguson output transformers with voice coil tappings of 2 to 15
ohms. The 25 watt amplifier can be supplied with line output transformers tapped from 100
to 600 ohms if required at \$2.00 extra.

Inputs provided for microphones, pick-up, and radio with mixing facilities and tone control.
The 15 watt is as above but using two 6BQ5 valves in push-pull output.

12in speaker for above (10 watt) \$7.75
Crystal Microphones for amplifier \$5.75

25 Watt \$59.75
17 Watt \$48.75
Post Extra on 17 Watt.
N.S.W., \$1; Interstate, \$1.50
25 Watt by Rail or Air.
Too Heavy for Post.

NATIONAL RADIO SUPPLIES

332 PARRAMATTA ROAD, STANMORE, N.S.W. PHONE 56-7398

NEW TRANSISTOR 8 KIT SET

SPECIAL PURCHASE ENABLES US TO OFFER THIS KIT SET AT \$24.00

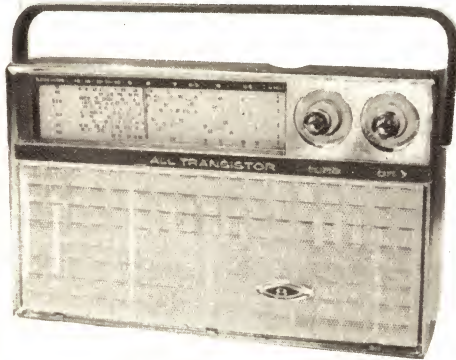

DIMENSIONS
9" x 5" x 3" DEEP

(WIRED AND TESTED \$6.00 EXTRA)

- Complete kit of parts with circuit and full instructions
 - Eight transistors.
 - Magnavox 5X3 speaker gives excellent fidelity.
 - High sensitivity, suitable for city or country use.
 - Heavy duty battery for economical operation.
 - Modern design, plastic cabinet with gold trim.
 - Dial calibrated for all states.
 - Available in colours of off-white, red, black or light green.
- Post & Packing extra. N.S.W. \$1.25, interstate \$1.75.

NEW TRANSISTOR CAR RADIO

New transistor six car radios with R.F. stage, of Aust. manufacture using A.W.A. components and transistors. Available in manual or push-button models with dial calibrated for all Australian States. Supplied with speaker (5", 6", 5 x 7" OR 6" x 9") and lock-down aerial. Suitable for 6 or 12 volts for positive or negative earth.

MANUAL MODEL \$43.00
PUSH-BUTTON MODEL \$48.00
Post and Packing N.S.W. \$1.50, Interstate \$2.50.



Suitable for 6 or 12 volts for positive or negative earth.



\$23.75

NEW TRANSISTOR SIX PORTABLE KIT AT LESS THAN HALF PRICE (DESIGNED TO SELL AT OVER \$60.00)

Excellent fidelity is obtained in this new kit set by the use of large speaker and polished timber case with attractive gold metal front panel. By using heavy duty batteries it is economical to operate and is ideal for portable use or that second set. Complete kit of parts is supplied with full instructions.

Post and packing N.S.W., \$1.25 — Interstate \$1.75.

SPECIAL — OFFER

Complete KIT for TRANSISTOR 6 PORTABLE \$17.50

The complete kit of parts for the transistor six includes six transistors, printed circuit board, coil kit, 4in speaker, Ferguson driver and output transformers, heavy duty battery and all necessary parts to complete the set with full instructions. Set is housed in attractive plastic case as illustrated.

Dials available for all States. Post and Pack: extra. N.S.W., \$1.00, Inter., \$1.30.



NEW ENGLISH and AMERICAN TRANSISTORS AT 1/4 LIST PRICE

Ideal for the experimenter or service man.
Each package of 12 contains 3 of each of the following types.

PACKET OF 12 FOR \$3.00

Mazda XA101.	Equivalent:	OC45 R.F. Transistor.
Texas 2N1108.	"	OC44 OSC. Transistor.
Texas 2N1111.	"	OC75 General purpose
Texas 2N1110.	"	OC45 R.F. Transistor.

THESE TRANSISTORS
CAN BE SUBSTITUTED
FOR MANY OTHER
TYPES.

Post and Packaging 10c
extra.

NATIONAL RADIO SUPPLIES

332 PARRAMATTA ROAD, STANMORE, N.S.W. PHONE 56-7398

AMATEUR BAND NEWS AND NOTES

What is the amateur radio society's role?

The support given to national amateur radio societies is the subject being assessed by those interested in the future of amateur radio.

By Pierce Healy, VK2APQ*

Surveys made by many of the large societies throughout the world show that when it comes to giving positive assistance and giving up some spare time, members who prove by action that societies are worthwhile are few in number. The great majority seem content to leave it to the other fellow. Although in some of the major societies, staff is employed to handle the routine office work, in general, all officers of amateur radio societies act in an honorary capacity.

The need for action in the endeavour to preserve the facilities available to the amateur service is one which is of great concern to those associated with the organisation of national societies. The success of the Region III division of the International Amateur Radio Union will depend on the support that amateurs throughout the region give to the project.

A great deal of work needs to be done to bring the regional organisation on a par to that of Region I. As the strength of any organisation is in its members and is judged by the percentage of the total number of possible members, it is safe to say that, due to the special nature of amateur radio, the percentage of licensed operators who are members of their national society could well be expected to be better than 90 per cent.

What do national radio societies do for their members? This question could be answered by another — What could national radio societies do if all licensed operators were members? One answer would be, a much stronger organisation would exist to represent the amateur service when amateur frequency allocations are being challenged.

Unfortunately, non-members receive very little information on their national society's activities but in many cases benefit directly from negotiations undertaken with Government authorities by the national societies. It is then up to members to provide the incentive for membership.

The statement from the Region III Congress published last month, though brief, sets out what is considered a not impossible task, if undertaken with the support of all national societies in the Region. The support national societies can give depends on the strength of their numbers.

All societies have an open invitation to

* News and notes of Divisional and Club activities submitted for inclusion in these columns should be forwarded direct to Pierce Healy, 69 Taylor St., Bankstown, N.S.W., 2200.

those wishing to become members. An easy way to accept this invitation is to contact a member, who will no doubt be pleased to arrange nomination. Members should extend a personal invitation, which the non-members will no doubt be pleased to accept.

REGION III ORGANISATION

Following the decisions made by the delegates to the first Region III I.A.R.U. Congress held in Sydney last Easter, when the Wireless Institute of Australia was nominated to form the secretariat for the organisation, the matter has been resolved and the following appointments made:

Secretary-General	Peter Williams	VK3IZ
Members	David Rankin	VK3QV
	Michael Owen	VK3KI
	David Wardlaw	VK3ADW

It was also resolved that the President of the Wireless Institute of Australia be elected as W.I.A. Director of the Region III organisation.

The initial work of the secretariat is to formulate draft rules for submission to directors for discussion on the method of operation for the organisation.

ITU NEWS

The International Telecommunication Union is the specialised agency of the United Nations for telecommunications. It was founded in 1865 and has 134 Member countries. Its headquarters in Geneva comprise four permanent organs: the General Secretariat; the International Frequency Registration Board (IFRD); the International Radio Consultative Committee (CCIR); and the International Telegraph and Telephone Consultative Committee (CCIT).

The 23rd session of the ITU Administrative Council was opened on May 11th. At its first Plenary Meeting, the Administrative Council elected as Chairman of the 23rd session Mr Henryk Baczko, of the People's Republic of Poland; and as Vice-Chairman Mr William James of Canada.

The chairman and Mr Mohamed Mili, Secretary-General of the ITU, outlined the many tasks facing the Council, reaffirming the union's responsibility in the field of space communication. In a brief review of the session's program of work, Mr Baczko indicated that a thorough study would be made of the problems raised by space communication to enable decisions to be reached that would help the union to go firmly forward with its mission in this sector.

In his welcoming address to the council, Mr Mili reviewed the various administrative and technical problems involved in ITU activities and stressed the

gratifying development achieved in technical co-operation. With regard to space matters he said:

"I consider it my duty to state here, in your presence, the extent to which the future of the union is bound up with this tricky problem and how great are our responsibilities. Indeed, the clear definition of the action which the ITU should take with conviction and resolution in space matters is the basic item of the session's agenda."

INDIA

An interesting letter has been received from G. V. Sulu, VU2GV, who in the past has kept me informed on the activities of the Bangalore Amateur Radio Club and its publication "SIRAN." VU2GV has been transferred to Panjim, the capital city of Goa, which up to 1960 was Portuguese territory, CR8 call area. To quote from his letter:

"When I came here I was the only amateur in this territory. So started the work all over again; got a couple of articles published in the local English daily newspaper and collected a group of enthusiasts and started the Goa Radio Amateurs' Society (GRAS).

"As I was the only amateur operator here and wrote about amateur radio in the local paper, the local All India Radio Station interviewed me in the Youth Program on 3rd and 10th April. The first day it was on amateur radio in general and the second on social and technical aspects of amateur radio, based on the Stanford Research Institute's report.

"Now one more member, Didier Jose de Melo, the treasurer of our society, has got his ticket, VU2DM. We have started Morse classes in Panjim and in another town, by name Vasco da Gama. Our authorities have agreed to have a centre for the amateur licence test in Panjim.

"We are bringing out a small newsletter too. I am sending a copy of the newsletter and RESI publication on Amateur Radio Regulations, for your reference."

Mention was also made of the fact that it was the first time that an amateur radio operator had been interviewed over All India Radio. Interest was also expressed in the Region III organisation.

VU2GV's work for amateur radio is significant, as only about one person in a million in India is a radio amateur operator.

OVERSEAS VISITOR

Last December, mention was made in these notes of a message being passed via amateur radio to the King of Sweden. The name of the A.D.C. who handed the message to his Majesty was Col. Carl-Erik Tottie, SM5AZO.

Early in May, Carl-Erik passed through Melbourne and Sydney on his way to take up a term of duty in Korea. In Melbourne he was met by David Rankin, VK3QV, and in Sydney by myself, VK2APQ. As Carl-Erik wanted to see as much of Sydney as possible during his 36 hours stop-over, he was not able to include amateur radio in the available time.

During his tour around Sydney, the conversation naturally turned to the amateur service in the international field.

RADIO HOUSE PTY. LTD.

306-308 PITT STREET, 6 ROYAL ARCADE & 760 GEORGE STREET, SYDNEY

NEW FROM GERMANY



**THE OXFORD
CORDLESS
ELECTRIC RAZOR**
Battery Operated

Twin blades
rotary cutting
head, spare
batteries. 15c
Size 5in x 1½in.

**Posted
\$8.75**



Key
Ring

Actual Size

"KEYLITE" \$3.95

Free. One spare mercury cell.

With fob keyring, attractive gold finish case. Simply squeeze. Illuminates car and house locks, etc.

\$4.00 Posted anywhere

MULTIMETER TESTERS

Model RH-50

Modern Design, 33 Micro Amp Meter.
30,000 Ohms per Volt D.C.
13,000 Ohms per volt A.C.
1 p.c. Multipliers and Shunts used.
Printed circuit.
Clear Scale, rugged moulded case.

SPECIFICATIONS:

DC Voltages: 0-0.3-1.2-3-12-30-120-300-600-1,200 V at 30,000 Ohms per volt.
AC Voltages: 0.3-12-30-120-300-600-1,200 V at 13,000 Ohms per volt.
DC Current: 0.06-6-60-600 mA, 0-12 A.
Resistance: 0-60K-6M-60M (350, 35K, 350K at mid-scale).
Decibels: Minus 20 to plus 57 dB (0 dB equals 1 mW, 600 Ohms).
Audio Out: Capacitor in series with AC Volt ranges.
Short Test: Internal buzzer.

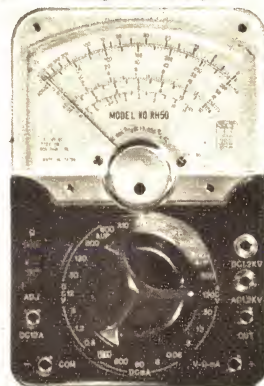

Price \$31

With leather case, \$38.00.
Postage 50c to \$1 extra.

Accessory: 1 pr. heavy test leads.

Batteries: 1 (1.5V), 1 (15V).
Size: 3 5-16" x 6 5.16" x 2½"

Weight: 1.4lb approx.

NEW MODELS 'KAISE'



Volt, Ohm, Milliamp Meters, all with overload protection and mirror scale and test leads and instructions.

Model 55 \$20 30,000 o.p.v.

Model 60 \$25 50,000 o.p.v.

Model 70 \$22.50 30,000 o.p.v.

Model 80 \$18 20,000 o.p.v.

Postage extra 50c.

Double jewelled 2% ± meter
1% Stabilised film resistors

NEW MODEL A-10 MULTIMETER AND SIGNAL INJECTOR

With Test Leads and Injector Probe



30,000 O.P.V.

SPECIFICATION: 6in x 2½in scale.

DC Voltage: 0-0.5, 2.5, 10, 50, 250, 500, 1,000 V at 30,000 o.p.v.

5,000 and 25,000 V at 10,000 o.p.v.

AC Voltage: 0-2.5, 10, 50, 250, 500, 1,000 V at 10,000 o.p.v.

Volume Level in Decibels.

DC Current: 0-50 uA, 1, 50, 250 mA, 0-1 and 10 amps.

AC Current: 0-1, and 10 amps.

Resistance: 0-10K, 100K, 1M, 100 Megohms. Signal Injector Output Jack. Zenor Diode Overload Protection.

Price \$54.00

TRANSISTOR HEARING AID



"APOLLO" Model 300. 3 Transistors. This Hearing Aid is an ultra-modern unit. It incorporates the following outstanding features:
Ample power and clear tone.
Compact—2in x 1½in.
Precision printed circuit design.
Magnetic earphone.
Separate Tone and Volume Controls.

Torch Cell—UM5 Battery.
Complete with leather case.

NEW MINIATURE MODEL, \$39.00

Replacement Battery only 15c.
Postage 50c extra.



Cordless battery-operated Electric scissors cuts all materials fast and clean. 1 torch cell fits in handle, complete posted. **\$4.95**

Model RH-5

- High sensitivity—20 000 Ohms/V DC, 10,000 Ohms/V AC.
- 3in Meter.
- Handy pocketable size.

SPECIFICATIONS

DC Voltages: 0-10-50-250-500-1000 V (20,000 Ohms/V.)
AC Voltages: 0-10-15-250-500-1000 V (10,000 Ohms/V.)

DC Current: 0-50uA, 0-5-50-500mA.

Resistance: 0-10K, 0-100K, 0-1Meg, 0-10 Meg.

(62 Ohms, 620 Ohms, 6.2K, 62K at centre scale).

Capacitance 0.0001uF-0.005uF, 0.05uF-1uF.

Decibels: minus 20db to plus 36db in 2 ranges.

Dimensions: (3½in x 5¼in x 1¼in).

Weight: 15oz approx.

Price \$18

Postage 50c to \$1 extra.
Complete with internal battery testing leads with prods.



New Home or Office telephones complete with internal batteries \$9.75 for two units and 50 feet connecting wire. Postage 75c.



\$4.90 Each

He regretted that he was unable to be in Sydney for the Region III inaugural congress at Easter. As a past president of the Swedish Amateur Association he had been active in the Region I division of the International Amateur Radio Union and passed his best wishes for the future of the Region III organisation.

A most interesting personality, a very pleasant meeting and an unexpected opportunity to discuss international amateur radio.

A Personality Retires

Mr A. C. Edwards, G6XJ, one of the men who pioneered the production of radio equipment for the amateur, has retired from his post as Commercial Director of Eddystone Radio Ltd., of U.K., for health reasons. Mr Edwards, who held joint executive responsibility for the firm, has forty years' association with the trade name Eddystone which has an international reputation among professional and amateur radio operators.

Arthur Edwards was born in Birmingham in 1906, and educated at Aston Secondary School in Birmingham. After working for the Exide Battery Company for a number of years, he joined Stratton and Company, (which manufactured the range of Eddystone radio equipment) in 1927, as assistant to the General Manager and rapidly became responsible for much of the sales and general management of the company. After his return from service in the Fleet Air Arm during World War II, he was appointed Commercial Director, a position he has held until his retirement.

In 1965, English Electric acquired the Stratton Company to operate as a subsidiary of the Marconi Company. The name was changed to Eddystone Radio Ltd., incorporating a trade name that had become famous for high quality and reliability. In the 1920s, Stratton produced a relatively small quantity of Eddystone wireless parts and complete receivers. Now their exports are well over half the total production and go to nearly every country in the world.

Arthur now plans a round-the-world trip in a freighter and looks forward to much more amateur radio activity than he has been able to pursue in recent years, due to pressure of work.

The Transistor

"Editor's Wavelength" by Bernard Zinover in the February-March issue of International Electronics gave some intimate details of the history of transistors.

As the details refer to facts not given in transistor manuals nor known by the vast majority, the article is summarised below.

Twenty years have passed since a trio of scientists at Bell Telephone Laboratories — John Bardeen, Walter Brattain and William Shockley — showed the world that a small piece of germanium could be made to amplify a speech signal about forty times.

They called it a point-contact transistor — point contact because of its design, two pointed metal contacts pressed on a chip of germanium; transistor because of its similarity to the "transfer resistance" characteristic of the valve. It was the start of a \$20,000-million industry.

In 1948, William Shockley patented the junction transistor. Nearly all transistors today are classed as junction transistors. They are solid-state devices with three layers of alternatively negative or positive type semiconductor material. In the early 1950s, work at GE, RCA and Bell Labs led to a commercial process for making germanium transistors by alloying techniques.

Further impetus to the transistor industry was given in 1954 by the Bell Labs development of diffusion and oxide-masking techniques for making PN junctions. The development of the revolutionary zone refining technique at Bell Labs made

available ultra-pure semi-conductor crystals. The immediate result of these two advances was that the diffused base, high-frequency transistor was mass-produced at low cost. In the same year, 1954, Texas Instrument Company was the first to devise a method of making silicon transistors on a commercial scale.

Another important innovation was made by the Fairchild Semiconductor Company in 1960, when they introduced a new type of planar geometry for the junction transistor, based on the earlier oxide masking and diffusion techniques. During the same year, the epitaxial transistor was developed

at Bell Labs, further improving performance and lowering costs.

The silicon planar epitaxial transistor, together with advances in oxide masking, diffusion and photolithography, paved the way for the integrated circuit; now the fastest growing segment of the semiconductor industry. Sales of ICs climbed better than 50 per cent last year and there seems to be no end in sight. By 1971, some 200 million integrated circuits are expected to be sold annually for the consumer-entertainment market alone.

Quite a Christmas present Bell's trio of researchers gave to the world 20 years ago.

WIRELESS INSTITUTE ACTIVITIES

The following have been appointed officers of the Wireless Institute of Australia Federal Executive, for the year 1968-1969.

Executive:—

Federal president: John Battrick VK3OR.

Federal Vice-president: Michael Owen, VK3KI.

Federal sec.: Peter Williams VK3IZ.
Federal treasurer: Kevin Connelley, VK3ARD.

Federal activities officer: David Rankin, VK3QV.

W.I.A. I.T.U. Liaison Officer: George Pither, VK3VX.

Member of Executive: Alf Seedsman, VK3IE.

Co-opted Officers:

Federal QSL Manager: Ray Jones, VK3RJ.

Federal SWL Co-ordinator: Eric Terbilcock —

Federal Awards Manager: Geoff Wilson, VK3AMK.

Federal Historian and Policy Officer: George Glover, VK3AG.

Federal Intruder Watch Co-ordinator: David Wardlaw, VK3ADW.

Federal Contest Manager: Neil Penfold VK6ZDK.

Federal W.I.A., Y.R.S. Co-ordinator: Jim Webster, VK2ZCW.

1968 Remembrance Day Contest

At the recent Federal Convention of the Wireless Institute of Australia there was a lengthy discussion on the new rules introduced for the first time in the 1967 contest. It was pointed out in the Federal Contest Committee's report, and supported by several delegates, that the formula for determining the individual State score did not offer the solution that had been sought for several years on this contentious point.

It was resolved that the rules in general, and the formula used for a number of years prior to the 1967 contest, be reintroduced with the addition of the provision for active participation by Limited Licensees on the VHF bands.

It was also agreed that Divisions discuss the matter among their members and submit their recommendations to the Federal Contest Committee for correlation and circulation to Federal Council.

The contest is held each year in August, on the weekend nearest the date of the cessation of World War II hostilities in the Pacific area.

At the time of compiling these notes, the rules for the 1968 contest were not to hand, but it is expected that they will be available for publication in next month's notes.

Ross Hull Memorial Contest

In their review of the 1967-1968 Ross Hull Memorial Contest, the Federal Contest Committee of the W.I.A. reported a trend towards the 144MHz band and higher for scoring points. The overall scores were much lower than in previous years and the almost total absence of New Zealand and elusive Japanese stations on the 52MHz band probably accounted for the lack of activity and low scores.

It was also stated that if some of those VHF operators who had not participated in the contest had given only one day to the contest and submitted a log, the results could have been very useful to the committee and provided additional general interest.

The Ross Hull Contest has been in existence since the summer of 1950/51 and a handsome trophy is held by the winning station until the next year's winner is determined. On shields mounted on the base of the trophy the following stations are recorded:

1950/51	VK5QR,	1951/52	VK5BC,
1952/53	VK4KK,	1953/54	VK6BO,
1954/55	VK4NG,	1955/56	VK3GM,
1956/57	VK3ALZ,	1957/58	VK3ALZ,
1958/59	VK3ALZ,	1959/60	VK4ZAX,
1960/61	VK3ARZ,	1961/62	VK5ZDR,
1962/63	VK4ZAX,	1963/64	VK5ZDR,
1964/65	VK3ZER,	1965/66	VK3ZDM,
1966/67	VK5HP,	1967/68	VK3ZER.

1967-68 results:

Trophy winner: R. W. Wilkinson, VK3ZER 2158 points.

Award winners: E. Penikis, VK1VP, 421 points; R. Norman, VK2ZCF, 988 points; G. McLucas, VK4ZMG, 399 points; J. Lehmann, VK5HP, 1864 points; S. Stewart, VK6ZAS, 607 points; D. Kelly, VK7DK, 974 points;, VK8ZMP, 11 points.

In Lighter Vein

At the Federal Convention of the W.I.A. held in Sydney last Easter a special award for the 1967 "VKZL...Oceania" contest was presented to VK2APQ.

The citation on the award reads: Awarded for:

Meritorious operating, above and beyond the call of the amateur service, while located in foreign territory.

Operating portable VK5, using SSB at the QTH of VK5PS, and making contact with JA1AD on 14MHz at 1045GMT on 6/10/67.

NEIL PENFOLD,

Federal Contest Manager.

Single-sideband operators and readers of VK5PS notes in the magazine "Amateur Radio" will no doubt appreciate the significance of the award.

My thanks go to Warwick, VK5PS, for his hospitality which resulted in gaining what was then an unknown award and certainly an unexpected memento of a pleasant interesting discussion on amateur radio. VK2APQ.

NEW SOUTH WALES

Following the 1968 election for the divisional council the members elected to office were:—

President: Keith Finney, VK2KJ.
Vice Presidents: Peter Campbell, VK2AXJ, Ross Mudie, VK2ZRQ.
Secretary-Treasurer: George Wilson, VK2AGO.

Plant and Property: Chas Wilkins, VK2ALB.

SATO PARTS

Millions of our various electric parts are being exported to many countries of the world. Free catalogues are available upon your request to the manufacturer or through trading companies.

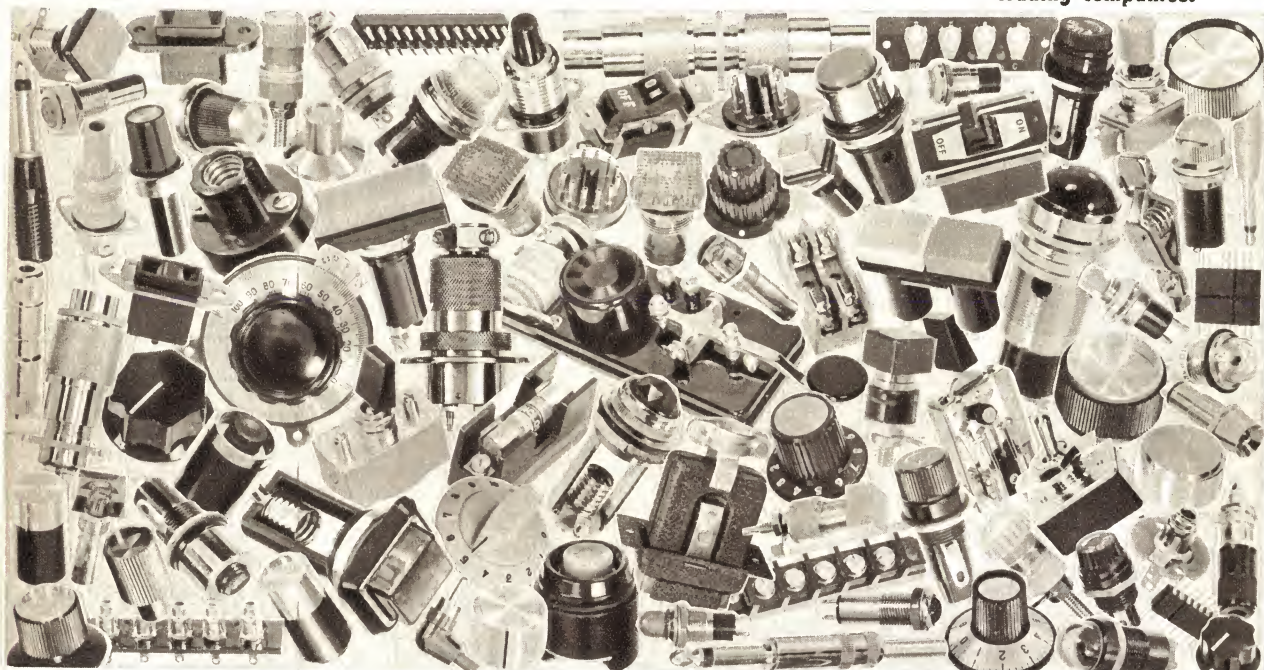

SATO PARTS CO., LTD.

HEAD OFFICE: 2-12 EBISU, SHIBUYA-KU, TOKYO, JAPAN
TEL. 442-8505~8
BANK ACCOUNT: MITSUBISHI BANK EBISU BRANCH



BAKER ELECTRIC GUITAR AND BASS LOUDSPEAKERS

12" Group 25 25 watts (50 watts U.S.A.)
12" Group 35 35 watts (70 watts U.S.A.)
15" Group 50 50 watts (100 watts U.S.A.)

High quality cast chassis loudspeakers at unbeatable prices.

These speakers are designed to take the punishment of Guitar and Organ work.

Send for leaflet and prices.

Baker Loudspeakers—Renowned for quality since 1925.

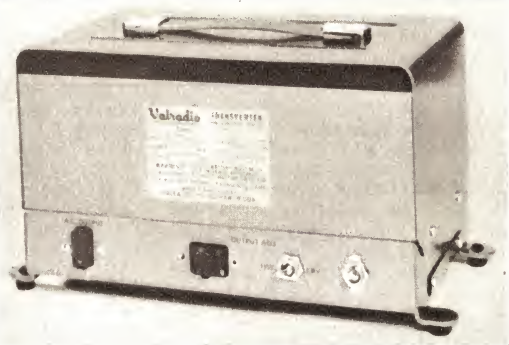

Valradio

TRANSVERTERS

- * FREQUENCY REGULATION OF PLUS, MINUS .005% WITH ADDITIONAL "RESONATOR."
- * INFINITE LIFE.
- * WILL OPERATE ALMOST ANY ELECTRONIC OR ELECTRICAL EQUIPMENT.
- * SUITABLE FOR SUPERSENSITIVE RADIO AND AUDIO EQUIPMENT.
- * FULLY TRANSISTORISED.
- * SINE WAVE OR SQUARE WAVE OUTPUT.
- * HIGH EFFICIENCY UP TO 95%.
- * INSTANTANEOUS OUTPUT.
- * NO RF INTERFERENCE.
- * NO MAINTENANCE
- * COMPACT, READY FOR INSTANT USE.

Distributed in Australia by:

LEROYA INDUSTRIES PTY. LTD,
672 HAY STREET, PERTH, W.A.

Technical Services: Don Miller, VK2GN.

VHF Liaison Officer: Chris Jones, VK2ZDD.

Since the appointments were made, Peter Campbell, VK2AXJ, has been forced to resign for health reasons: Paul Gibson, VK2ZPG, has been co-opted to fill the vacancy. Also, George Wilson, VK2AGO, has withdrawn as a member of council but will continue as a co-opted member in the position as treasurer. No appointment to the vacancy on council had been made at the time these notes were being compiled.

Other co-opted officers in the division are:

QSL Bureau Manager: Ted Whiting, VK2ACD.

Education Officer: Harold Burtoft, VK2AAH.

A.O.C.P. Class Manager: Cec Bardwell, VK2IR.

Morse Tape Supervisor: Ern Hodgkins, VK2EH.

WICEN State Co-ordinator: Vic Cole, VK2VL.

Y.R.S. Supervisor: Dave Jeans, VK2BSJ.

News and Publications: Stan Dogger, VK2ZRD.

O.I.C. Dural: Bill Jenvey, VK2ZO.

Librarian: Phil Tavares, VK2ATA.

Ladies' Committee organiser: Hebe Grouse, VK2AOK.

The division provides a lecture course for the P.M.G. A.O.C.P. examination as well as a correspondence course for those unable to attend the personal classes at the Wireless Institute Centre, 14 Atchison Street, Crows Nest. Morse code practice sessions are transmitted nightly at 7.30 p.m. on 3550KHz, the station call sign being VK2AWI. Also a morse tape hire service is available; for details of this service write to Ern Hodgkins, Mangrove Road, Narara, N.S.W., 2251.

Information on both the lecture and correspondence courses may be obtained by writing to: Class Supervisor, W.I.C., 4 Atchison Street, Crow's Nest, N.S.W., 065.

A series of half-hour television programs was arranged by Channel 10 in Sydney, on the subject of amateur radio or their student workshop program on Sunday mornings. The first of the series was scheduled to go to air in June. The total number to be televised had not been finalised. Those interested should drop a watch on Channel 10 programs from 9 a.m. Sundays.

BLUE MOUNTAINS BRANCH

The annual meeting of the Blue Mountains Branch of the N.S.W. Division was held in April, the officers appointed for the ensuing year were:

President: Bill Moore, VK2HZ.

Secretary: Dan Cliff, —.

Vice-president: Alex Outtrim, VK2EX.

Treasurer: Alf Griffard, VK2ZMV.

Construction Committee: Bob Lear, K2ASZ; Graham Wilson, VK2ZGW; Eric Broderick, —; Peter Eishauer, —.

Publicity Officer: Dan Cliff, —.

Bill Moore, VK2HZ, who has been secretary, since the Blue Mountains Branch was formed 10 years ago, has taken the position as chairman and a newcomer to the amateur ranks, Dan Cliff, who is awaiting the allocation of his limited call sign, has been appointed secretary.

Branch members extend an invitation to visitors to attend the meetings, which are held at the old council chambers, Lawson, on the third Friday of each month, commencing 8 p.m. Local radio enthusiasts are also invited to attend.

Full details of branch activities can be obtained by contacting the Secretary, 152 Usden Road, Blaxland, 2774.

CENTRAL COAST BRANCH

The reports presented by the officers of the Central Coast Branch of the N.S.W.

JACK FILES MEMORIAL CONTEST

In an effort to encourage activity among amateur operators in Queensland, an annual contest is held. This contest is now intended to recall the work of the late Jack Files, VK4JF, as a member of the Queensland Division of the W.I.A. The 1968 contest will be held over the weekend July 20-21.

There will be four sections in the contest.

- (a) Transmitting high frequency bands.
- (b) Transmitting very high frequency bands.
- (c) Transmitting open (all bands).
- (d) Receiving (all bands).

RULES:—

Operating times:
HF bands 1900-2100 EST 0900-1100 GMT, 20th July; 1000-1200 EST 0001-0200 GMT, 21st July; 1400-1700 EST 0400-0700 GMT, 21st July.

VHF bands 0111-2359 EST 1400 GMT 20th July to 1400 GMT 21st July.

ELIGIBILITY: Any person licensed to operate in Queensland fixed, portable or mobile as well as listeners, may participate.

Only members of the Queensland Division of the W.I.A. are eligible for awards.

Bands:— All authorised amateur bands may be used. Only one contact per station per band per hour is allowed, and pre-arranged schedules for contacts on other bands are prohibited.

A second contact with the same station on the same band cannot be made within 60 minutes for scoring purposes. Cross band contacts are not acceptable for scoring purposes.

Multiple operators: Only one licensed amateur is permitted to operate any one station under the owner's call sign. Should two or more operate any particular station, each must submit a separate log under his own call sign. Club stations are welcomed, but under the above arrangements cannot receive an award as a club station if more than one operator participates.

Scoring:— HF bands:— One point per VK4 contact under the above rules.

VHF bands:—

Stations 0-15 miles apart, 1 point per VK4 contact; 15-75 miles apart, 2 points per VK4 contact; 75-150 miles apart, 3 points per VK4 contact; over 150 miles, 4 points per VK4 contact.

Listeners: One point for each contact where both VK4 stations are logged.

Entry Logs: Before points may be claimed for a contact, serial numbers must be exchanged and acknowledged. (Report followed by serial number e.g. 59001, etc.). Logs must show time, band, call-sign, report and serial numbers sent and received and points claimed. In addition V.H.F. logs must give mileages when more than one point is claimed.

Listeners' logs must give both call-signs.

Entries to be forwarded to:— VK4 Contest Committee, Box 638J, G.P.O., Brisbane 4001, in time for opening on the evening of August 10, 1968.

A bonus of 20 points will be allowed for each entry using GMT entirely.

Awards:— Awards will be made to the top scorer in each section, except that more than one award cannot be made to one entrant.

Contestants must operate within the terms of their licences.

Each log must show at least six different contacts in any section.

The contest committee reserves the right to disqualify any entrant who has not observed the regulations or who has consistently departed from the accepted code of operating ethics. The ruling of the committee shall be final.

Division at the annual meeting of the branch recorded another successful year. The following members were elected to office for the ensuing year.

President: Lindsay Douglas, VK2ON.

Vice-presidents: Ern Hodgkins, VK2EH; Les Lackie, VK2AKL; Alec Swinton, VK2AAK.

Secretary: Dick Maitland, —.

Treasurer: Phil Levenspiel, VK2TX.

Public Relations: Gordon Proctor, —.

Two outstanding events recorded were the very successful field day held at Gosford in February and being host to inter-State and overseas delegates attending the International Amateur Radio Union Region III congress during their visit to Gosford on Easter Sunday.

From discussion on the question of club premises a committee of four was formed to investigate the possibilities and report their findings to the next meeting.

COMTEL TAPE TRANSCRIPTOR

4 TRACK, 3 SPEED, MONAURAL OR STEREO DECK

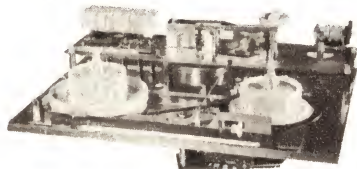
(Deck with Top Cover Removed)

VERTICAL OR HORIZONTAL OPERATION PROVISION FOR THIRD HEAD TAKES UP TO 7" REELS.

WOW & FLUTTER .2% at 7 1/2 I.P.S.

FREQUENCY RESPONSE 50-20000 Hz ± 3db 7 1/2 I.P.S.

PRE-AMPLIFIER RECORD/PLAY UNIT AVAILABLE

Australian Distributors:

COMTEL INTERNATIONAL (Vic.) PTY. LTD.

17 ROKEBY STREET, COLLINGWOOD. 41-1478

Maya NEWLY DESIGNED PRODUCTS!

Combination Type Moulded Knob Series

Any of your special order-Acceptable



Fitted with Brass Insert for $\frac{1}{8}$ in Shaft — Locking by grub screw.

(SOLE AGENT)



ZEPHYR PRODUCTS PTY. LTD.

70 BATESFORD ROAD, CHADSTONE, VICTORIA—PHONE 56-7231

MANUFACTURERS OF RADIO & ELECTRICAL EQUIPMENT & COMPONENTS

INTERSTATE AGENTS:

N.S.W.
Jacoby Mitchell & Co.
Pty. Ltd.,
469 Kent Street,
Sydney, N.S.W.

S.A.
Neil Muller Pty. Ltd.,
8 Arthur Street,
Unley, S.A.

TASMANIA
Homecrafts-Tasmania,
190 Collins Street,
Hobart, Tas.

Nichols Radio &
Television,
91 Wellington Street,
Launceston, Tasmania.

W.A.
D. K. Northover & Co.,
337 Wellington Street,
Perth, W.A.

QLD.
T. H. Martin Pty. Ltd.,
56 Edward Street,
Brisbane, Qld.

It is thought that with more suitable rooms there would be an increase in membership, together with an extension of Youth Radio Scheme activities.

Members elected to the investigation committee are Ern Hodgkins, Les Lackie, Bill Smith and Dick Maitland.

Branch meetings are held in the School of Art Hall, Gosford, commencing at 8 p.m. on the third Friday of each month. Visitors are always welcome.

VICTORIA

The Eastern Zone Convention of the W.I.A. Victorian division was held over the weekend April 20-21, at Mirboo North, central Gippsland, about 100 miles east of Melbourne. Seventy members and their wives attended.

Following registrations and dinner on Saturday evening the ladies were entertained with a pottery demonstration by Dennis Dwyer and the annual zone meeting was held.

The meeting was chaired by George Francis, VK3ZCG, the retiring president, with secretary Stan Baxter, VK3ZAB in attendance.

The election of officers for the ensuing year resulted in the following appointments being made:

President: Stan Platt, VK3ZPL.
Vice-pres.: David Godfrey, VK3ZOZ.
Secretary: Lee De Vries, VK3ZSS.
WICEN Co-ordinator and Zone Organiser: Graham Colley, VK3QZ.
Official Zone call back stations: VK3AWV and VK3DY.

Zone correspondents: Rodney Champness, VK3UG; Geo Francis, VK3ZCG.
A very interesting lecture was given by David Rankin, VK3QV, on quartz crystals and this was followed by the screening of a film dealing with WICEN activities in a disaster emergency.

On Sunday morning there was a trade display when a talk was given on single-sideband equipment by Fred Bail, VK3YS. This was followed by a talk on amateur built solid-state VHF and UHF equipment by Les Jenkins, VK3ZJB.

Field events and competitions were held in the afternoon. The hidden 144MHz transmitter hunt was won by Trevor Gregory, VK3ZGA. The "David Scott Award" was won by Rodney Champness, VK3UG ex VK0CR.

QUEENSLAND

At the Annual General Meeting of the "C.O." branch of the W.I.A. the following members were elected to office for the ensuing 12 months.

Patron: R. P. J. Pilbeam.
President: H. Hobler, VK4DO.
Vice-president: R. Greenwood, VK4NG.
Secretary: C. W. Bennetts, VK4ZBG.
Assistant Secretary: F. Roden, VK4FR.
Treasurer: G. Fox, VK4FK.
WICEN Officer: F. Nolan, VK4FN.
Publicity Officer: L. Merrill, VK4ZIM.
VHF and Social Activities Officer: L. Dobbs, VK4ZLD.
Councillors: J. Stone; G. Adams; L. Dobbs; L. Merrill, D. Kraatz; J. Brett.

The branch had a most successful year with reports on 50MHz DX contacts by members with Japanese stations totalling several hundreds. Visitors to Rockhampton have a standing invitation to contact the secretary, C. W. Bennetts, 351 East Street, Rockhampton.

SOUTH AUSTRALIA

The election of council for the 1968-969 term in the South Australian Division and the subsequent meeting of elected members resulted in the following appointments being made.

President: T. Laidlaw, VK5TL.
Vice-presidents: A. Allan, VK5UL; G. Taylor, VK5TY.
Secretary: A. Rechner, VK5EK.
Treasurer: H. Roberts, VK5MY.

Minute Secretary: T. Slater, VK5ZIS. Broadcast and VHF Officer: R. Elms, VK6BE.

Publications Officer: R. Dow, VK5KF.

In the annual report presented by the retiring president, M. Burford, VK5ZQ, reference was made to an increase in membership during the year being due to "natural increase" rather than a concerted effort on the part of members to encourage fellow amateurs and enthusiasts to join the institute.

The financial status of the division remains stable but the increase in revenue from subscriptions did not offset rising costs, resulting in a small deficit for the year.

For VHF operators who may be visiting Adelaide, the VHF Group meets at the Clarence Park Kindergarten Hall, Parker Street, Clarence Park (opposite the Clarence Park Railway Station). The program of activities scheduled for the next six months is:

August 2: 8 p.m. General meeting. Address: "Long distance propagation," by Brian Tideman, VK5TN.

September 1: VHF Field Day.

October 4: 8 p.m. General meeting. Address by Ken Hanson, VK5ZCH.

November 22: Annual Picnic. Gold Escort ground National Park.

December 6: 8 p.m. Members Technical night.

December 14: 6.30 p.m. Christmas Barbecue.

February 7, 1969: Annual general Meeting.

WESTERN AUSTRALIA

Officers of the Western Australian Division for the ensuing year are:

Patron: W. G. Hayman, VK6GH.

President: R. Elms, VK6BE.

Vice-Presidents: J. Rumble, VK6RU, K. Khuen-Kryk, VK6IZ.

Treasurer: K. Moore, VK6ZBT.

Assistant Treasurer: R. Lockley; Assoc.

Secretary: N. Penfold, VK6ZDK.

Youth Radio Supervisor: Rev. Bro. J. Morgan, VK6RT.

A. R. Sub-Editor: R. Greenaway, VK6DA.

Technical Officer: K. Bicknell, VK6ZCB.

Q.S.L. Officer: J. Rumble, VK6RU.

Bulletin Editors: R. Elms, VK6BE, J. Sullivan, VK6ZFO.

Bulletin Distribution: G. Sturcke, VK6ZEZ.

Program Organiser, K. Khuen-Kryk, VK6IZ.

Business Manager: K. Miller, VK6KL.

Minute Secretary and Equipment Officer: D. Priestley, VK6ID.

Membership Secretary: J. Sullivan, VK6ZFO.

Roy Chamberlain, VK6RY, retiring president, commented in the annual report on the increase in social activity in the division and recommended that consideration be given to continuing this type of event. It was also reported that there has been a steady increase in the number of Youth Radio Clubs.

The financial side of the division is quite sound and a small surplus over expenditure accrued during the year.

YOUTH RADIO SCHEME

Over the weekend, June 1st and 2nd the first interstate conference of Youth Radio Scheme supervisors was scheduled to be held in Melbourne. The basic principles of the scheme were discussed at the W.I.A. Federal Convention in Sydney at Easter, when the Federal Council recommended that action be taken to further standardise activities throughout the Commonwealth. It is anticipated that a report on the meeting will be available for next month's notes.

BRIGHT STAR CRYSTALS

PREFERRED BY LEADING MANUFACTURERS
THROUGHOUT THE COUNTRY FOR—

ACCURACY - STABILITY - ACTIVITY - OUTPUT



All types of Crystals Available.
Such As DC 11, FT 243 HC 6U CRA
B7G, HC18U, ETC.
TOLERANCES: .0015%, .002%,
.003%, .005% ETC.

Consult us for Crystals for any mobile Radio.
Prices depend on tolerance and frequency required.

DISCOUNT FOR QUANTITY ORDERS

Established 36 Years



AMATEUR AIRCRAFT and ULTRASONIC CRYSTALS also AVAILABLE

Our new Factory employing the most modern equipment allows us to offer you PROMPT DELIVERY for all your CRYSTAL requirements.

DEVOTED EXCLUSIVELY TO THE MANUFACTURE OF

PIEZO ELECTRIC CRYSTALS

Contractors to Federal and State Government Departments

REPRESENTATIVES AUSTRALIA AND NEW ZEALAND—MESSRS. CARREL & CARREL,
BOX 2102, AUCKLAND.

MESSRS. ATKINS (W.A.) LTD.,
894 Hay Street, PERTH.

MESSRS. LAWRENCE & HANSEN
ELECTRICAL (VIC.) PTY. LTD.,
34 Brisbane Street, HOBART,
and 29 St. John Street,
LAUNCESTON, TASMANIA.

MESSRS. A. E. HAROLD PTY. LTD.,
123-125 Charlotte Street, BRISBANE.

BRIGHT STAR RADIO

546-5076

LOT 6 EILEEN ROAD, CLAYTON, VICTORIA

546-5076



CRYSTAL CONTROLLED OSCILLATORS

RANGE 1.5 KHz to 100MHz

In order to relieve the designer of the sometimes difficult and invariably time consuming task of oscillator design and layout Pye Pty. Ltd. of Australia has produced a range of crystal oscillators, all of known stability and with guaranteed output levels, in the range of 1.5 KHz to 100 MHz for incorporation as complete sub-assemblies in larger pieces of equipment or for use individually as frequency markers or reference oscillators.

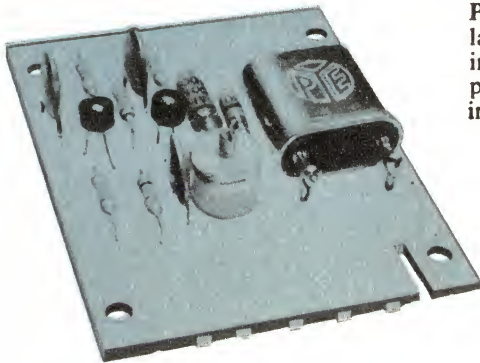

PYE XL688
Size 2.5" x 2"

Model	Frequency	Output	Price
XL687	1.5 KHz	to 6 KHz	37.28
XL683	+ 6 KHz	to 50 KHz	31.50
XL681/A1	+ 50 KHz	to 60 KHz	22.58
XL681/A2	+ 60 KHz	to 75 KHz	22.58
XL681/A3	+ 75 KHz	to 150 KHz	20.79
XL682	+150 KHz	to 525 KHz	14.37
XL692	500 KHz	to 1 MHz	21.43
XL688/A1	+ 1 MHz	to 6 MHz	13.13
XL688/A2	+ 6 MHz	to 20 MHz	11.03
XL690	+ 20 MHz	to 60 MHz	11.03
XL691	+ 60 MHz	to 100 MHz	12.69
67-536	In-line Socket (optional extra)		0.56

Plus Sales Tax if applicable

PYE PTY. LTD.

Q.C.B. APPROVED ORGANISATION



P.O. BOX 105., CLAYTON, VICTORIA. 3168

Tel. 544 0361 TELEGRAMS: "PYTRONIC" MELBOURNE
Brisbane, Sydney, Adelaide, Perth, Hobart, Canberra, Geelong.



**NEW IMPROVED
30 WATT
NOMINAL
54w MAX.**

12v. All Transistor P.A. AMPLIFIER

Complete kit of parts, No. 591C, \$58
WIRED READY TO OPERATE:
15 ohm output, No. 591D ... \$60
125, 250 500 ohm output,
No. 592D ... \$60
All metal work, pane and knobs
only, No. 597 ... \$10.50
POWER SUPPLY, No. 714 ... On App.
All dimensions: 6 1/2 in w. x 3 1/4 in h. x
8 1/2 in d.

MAGNETIC STEREO PRE-AMP

In 5Mv. out
500Mv. Bass
and treble 18
D.B. No.
700C. \$29. Wired ready for use \$31.
Postage 30c.

COILS & IF's 455 Kc
Aer., R.F. osc. and IF's ... \$1.70 ea.
Ferrite Aer. ... \$2
No. 265 Universal Tape OSC coil, \$6.
Postage 10c. Write for details and price.



STEREO

MULLARD 12 TRANSISTOR
5 watt x 5 watt.
Distortion 1/2 of 1%. Frequency re-
sponse 30 cycles to 18Kc. Output 15
ohm speaker.
12in lg. x 7in d. x 4in h.
Pre-Amplifier kit No. 616C \$26.00
2—5w Main Amplifiers No.
675C ... \$34.00
1—5w Power supply No. 681C \$16.00
Steel chassis, plated No. 649 \$ 2.50

COMPLETE KITS, nuts, screws,
etc. No. 471C ... \$78.50
Wired and tested, No. 471D, extra
\$5.00. Freight extra. Write for blue-
print list of parts.

R.C.S. PRINTED CIRCUITS

For all R. and H., E.A., Mullard, Philips and other designs. Clearly coded. White letters and numbers, easy assembly and service, polished and resined for easy soldering. With blueprint parts list.

New Printed Circuits		Recent Designs	
700 Magnetic pre-amp	\$3	Part No.	
704 Pre-amp 67-P2	\$2.50	684 Pre-amp. 65-P10	\$2.50
707 10W stereo, 67. P3	\$2.50	685 Pre-amp. 65-P12A	\$2.50
708 10W, amp. 67. A3	\$2.50	686 Pre-amp 65-P12B	\$2.50
709 Pre-amp 67-P5	\$2.50	690 Phillips 10W amp	\$2.50
675 Hi-Fi 5W, amp.	\$2.50	715 Mull. 10W stereo	\$3
		716 Mull. pwr. supply	\$2.50
		723 B/C tuner	\$2.50
		EA68-5T	\$2.50

Write for full list. Immediate despatch. Postage 10c.

**R.C.S. COMPLETE
DO-IT-YOURSELF KITS**
Peak reception, low price. No ex-
pensive test equipment. Everything
fits. 1964 RF Transporta 7. Complete
kit—No. 640 ... \$43.50
Portable car radio, identical to 640
above, plus extra switch and car coil
etc. No. 642 ... \$46.00
(Write for booklet on 640 and 642)

**HI-FI BROADCAST TUNER UNIT
4 TRANSISTORS—HI SENSITIVITY**
R. F. mixer, I.F., pwr., dectr. stages, adjustable aerial
coupling. Complete as illust., wired and tested with 451
dial, knobs and switch pot. No.
474, \$31. Complete kit of parts
for above, No. 474C, \$30. Postage
\$1.

WHISTLE FILTER for above
set for 8Kc band width (can be
altered to 9, 10 or 11Kc). No.
128, \$4. Post
10c.

IMPROVED BATTERY SAVER KIT
4 1/2, 6 or 9 volts. Replaces transistor
battery power Input 240 volts A.C. Maxi-
mum milliamps 100. Hum-free operation.
Size 3 1/2 in l. x 2 1/2 in w. x 1 1/2 in h. No.
657, \$6.50 (post 10c).

PERSONAL PORTABLES

Range 30 miles. 2 TRANSISTORS
200 with short
aerial and earth.
Earpiece only, no
speaker. Wired
ready to use. No.
666D, \$10.



Postage 20c.
Do-it-yourself kit.
No. 66C, \$9.00.
1 TRANSISTOR — 1 DIODE
582 Do-it-yourself kit, \$5, post 10c.
593 Wired ready to operate, \$6, post.
10c.

DIAL KITS
Scale gold with white letters.
Size 6 1/2 in x 2 1/2 in
● No. 459 to match 300 pf gang.
Price ... \$4.50
● No. 461 to match 200 pf gang.
Price ... \$4.50
Post 20c.

NEW AUDIO AMPLIFIER
4 transistors.
1/2 or 1 watt
Small size cab-
inet 3in x 2in x
1in plastic.
Suitable crystal
P./up. inter-
com. micro-
phone radio,
etc. (9 volt).



DO-IT-YOURSELF KIT 665, \$10 (Post
10c). Wired ready for use, 665D \$11.50

NEW TRANSISTOR PREAMP KIT
SIZE 3 x 2 x 1in 2 req. for Stereo.
LOW IMP. Input 2 trans. 672C ... \$8
Wired ready for use, 672D ... \$8
HIGH IMP. silicon 3 tran. 682C \$8
Wired ready for use, 680D ... \$8
HIGH IMP. silicon 3 tran. 682C \$8
Wired ready for use, 682D ... \$9.50
Postage 10c each. Write for data.

**R.C.S. Order by Mail Order, Postal Note or Money Order (add post.), direct to—
RADIO PTY. LTD., 651 FOREST ROAD, BEXLEY, N.S.W., 58-3491, 58-5385**

TAREE O.K. YOUTH RADIO CLUB

A Youth Radio Scheme group has been formed within the structure of the Intermediate Order of Knights, a youth organisation of the Methodist Church, at Taree New South Wales.

Leaders of the group had been concerned at the falling away and lack of interest on the part of the Intermediate boys, and as a means of revitalising the group, it was decided to form two clubs within the Intermediate Order of Knights. One known as the Motor Club will play around with car engines and the other will be known as the O.K. Radio Club. The boys were allowed to nominate their own choice of club, and as it eventuated the group divided evenly between the two clubs.

The Radio Club has been registered with the Y.R.S. and is following its syllabus of instruction. At present, members are devoting their efforts to learning the fundamental theory and the construction of crystal sets and similar simple projects.

It is expected that by the end of the year 10 of the lads will have attempted their Elementary Certificate. Instruction is being given by Geoff Hunziker, VK2BGF, who is the Club Leader. An amateur station licence has been granted by the Postmaster-General's Department, the call sign allocated being VK2BRC.

The club meets on Friday nights at 7 p.m. Regular on-the-air activity is not contemplated just yet, but as soon as the boys qualify for their Elementary Certificates, they will certainly be rewarded with on-air activity, under the club call-sign VK2BRC.

Recently the club station was used to demonstrate amateur radio to the Taree Men's Brotherhood. The occasion was an interstate contact arranged with Don Asmussen, VK4FA, as a practical demonstration to the Holland Park Men's Brotherhood in Brisbane.

SOUTH AUSTRALIA

The Elizabeth Radio Club has 22 new members doing the Elementary Certificate course this year and six members from last year are continuing their studies for the Intermediate Certificate. One girl student is among the new members. At the present time there is only one girl in South Australia who has won a Youth Radio Scheme Certificate; she is Debra Casey of the Gladstone Club who obtained her Elementary Certificate last year.

The Port Pirie Radio Club has a regular attendance this year of 23 members studying for the Elementary and Junior certificates.

The Gladstone High School club is at present without the services of an instructor. Any amateur or person in the area who is willing to take up the task should contact the school headmaster as soon as possible. Classes are usually held during lunch hour.

The current list of active Y.R.S. clubs in South Australia are:

Christies Beach Youth Radio Club — 13 members, club station callsign VK5OD.
Nailsworth Boys Technical High School Radio Club — 13 members, club station callsign VK5NH.

Port Pirie Youth Radio Club — 23 members, club station callsign VK5PP.

Elizabeth Amateur Radio Club — 22 members, club station callsign VK5LZ.

Gladstone High School Radio Club — members, no club station.

Port Augusta Youth Radio Club — 12 members, no club station.

Peterborough High School Radio Club — no figures available, no club station.

Waikerie High School Electronics Club — new club just forming.

The second South Australian Y.R.S. convention was scheduled to be held at Elizabeth on Sunday, June 10. The purpose of the meeting was to discuss matters arising from the national convention held the previous weekend.

Bert Hollebon, publicity officer for the South Australian Y.R.S. organisation, invites clubs to send him details of their activities, addressed to 26 Nelson Street, Port Pirie, 5540.

VK-ZL-OCEANIA DX CONTEST — 1967 RESULTS

The award winners in the 1967 contest were:

AUSTRALIA AND NEW ZEALAND				Call Sign	Points	Call Sign	Points
Phone:				HA0LC	12	SM5API	3861
Call Sign	Points	Call Sign	Points	W0GTA/LA	5760	OX3BX	1170
VK1QL	5290	VK7DK	13495	U.S.S.R.:			
VK2APK	17230	VK9GN	15455	UA1KBW	2580	UB5KMX	5150
VK3AMK	10035	ZL1AJX	19080	UA3KBO	4056	UC2AA	5088
VK4LT	12510	ZL2AYI	5010	OVERSEAS — CW SECTION			
VK5BB	9890	ZL3QH	14890	Oceania:			
VK6XX	19320	ZL4BO	2115	KH6IJ	17	VR2DK	1770
CW:				North and South America:			
VK1GD	12250	VK8HA	11790	VE3AU	1190	W7PGX	14608
VK2APK	18470	VK9GN	14705	W1EVT	9728	WBDWP	160
VK3AXK	15126	ZL1AJU	18965	W2LWI	4872	WPKK	574
VK4SS	9510	ZL2CD	9600	W6EWN/3	6014	WA0CJU	1170
VK5FO	5495	ZL3QH	15860	W4NBV	3796	HC1TH	1008
VK6RU	19005	ZL4BO	15625	W5WZQ	7956	PY2BJH	1232
VK7SM	10595			W6EPQ	14520		
AUSTRALIAN AND NEW ZEALAND LISTENERS' SECTION				Japan:			
Phone:				JA1MIN	4611	JA5BFN	650
VK2-L2074	580	VK5-L5080	925	JA2LA	1530	JA7CDU	5270
VK3-L6021/VK3	15215	VK6-L6042	8845	JA4BJO	2116		
VK4-L4144	12050	VK7-L7031	2145	Asia:			
VK4-L4144	12050	ZL149	13980	EP2BQ	2548		
CW:				Antarctica:			
VK3-L3042	6515	VK-6L6042	11760	UA1KAE	220		
OVERSEAS — PHONE SECTION				Europe:			
Oceania:				DL7AA	6975	ON4XG	1554
DU1FH	16440	KH6IJ	16359	F3KW	520	OZ1LO	3024
KG6AQI	4011	VR2DK	2530	G3RHJ	6960	PA0VO	1360
North and South America:				HE9GMP	602	SM5API	2001
HP1JC	6512	K2DJP	2376	W0GTA/LA	598	SP3AJ	585
KP4CK	1200	W4NBV	5376	OHSUX	3042	YU1BCD	2200
LU1DAB	1938	K5JEF	1740	U.S.S.R.:			
PY2SO	2010	WAGEPQ	14825	UA1KBB	748	UA9OH	1045
TG8IA	3100	W7SFA	9287	UA3UJ	1827	UA0ML	972
VE7AHG	4031	W9LKI	2369	UA4KC	520	UB5HFF	960
WA0CJU	5017	YV1EL	2240	UA6KA	750	UL7BG	1900
Japan:				OVERSEAS—SHORT WAVE LISTENERS:			
JA1ADN	3146	JA6AD	6886	BR5-26431	6264	UA9-2847/UA3	1260
JA2FTJ	980	JA7CDV	5940	DL12090	3094	UB5-5970/UA4	1260
JA4FM	804	JA8SW	1726	ITL-12567	720	UM8-8451/UL7	968
JA5LI	1541			JA7-1819	882	UQ2-037-10	1864
Asia:				JA0-1320	1562	UB5-45067	4600
UA9OH	1287	EP2BQ	2820	ONL-363	10912	VU-SWL0020	620
ZC4CN	2200			NL819	585	WPE2MLU	1708
Europe:				REF18783	1296	WPE7BLN	2226
DJ2YL	7140	OH7PI	5096	UA1-74512	810	WPE8AA	560
F3KW	2964	ON4DH	960	UA3-12982	676		
G3IAR	897	OZ8RH	940				

Coilmaster NEW DELUXE

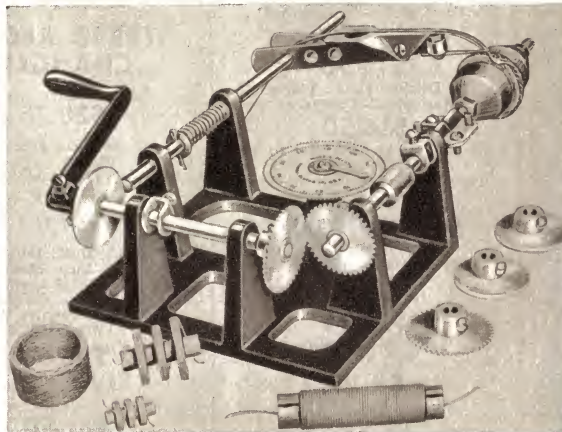

**ACCURATE
COIL
WINDER**

\$13.95

£6/19/6

Post paid

This new, Easy-to-Use machine winds honeycomb, spiderweb and solenoid coils of various widths and diameters—equal in appearance to a factory job. Also suitable for winding chokes, transformers and filter inductors. Indicator counts number of turns on coil. The COILMASTER is suitable for both experimental and practical work. Supplied with accessories including wood spools, metal pegholders and extension for making long solenoid coils. Instructions included, but less coil forms and pegs.

SEND REMITTANCE WITH ORDER FOR IMMEDIATE DELIVERY ANYWHERE TO THE SOLE AUSTRALIAN AGENTS.

VICTORIAN SALES CENTRE
AND HEAD OFFICE

Electron Tube

Distributors Pty. Ltd.

15A WELLINGTON STREET,
WINDSOR, 3181, Vic. 51-6362

"MYERS" AUTOMOBILE STEREO TAPE PLAYER

Power Supply: 12V DC (Rated Power requirement less than 1.0 ampere.) Cartridge Tape: Size 3 Cartridges of both 4 and 8 track. Playback Head: 4 and 8 track compatible, automatic starting and automatic channel selecting.



Transistors: 12-transistor (Silicon-used and OTL system). Tape Speed: 3-1/2" per second, plus 3% minus -1%. Drive Motor: DC Micro motor with Governor. Frequency Response: 70-10,000 cps. Wow and Flutter: Less than 0.3% WRMS (when using standard tape). Separation (Cross Talk): Better than 45db. Signal to Noise Ratio: Better than 40db. Price \$99.50. Also available for 240V A.C. Operation only. Includes Pick-up or Radio Inputs. \$99.50.

MULLARD MAGNAVOX

BOOKSHELF ENCLOSURE Maple, Teak or Walnut Complete \$24.75 SUPER BOOKSHELF \$36.75.

Post: N.S.W. 50c. Interstate \$1.00. CABINETS ONLY R. H. BOOKSHELVES \$11.50 MULLARD \$10.95

PLAYMASTER BOOKSHELF UNITS 6in 8in 10in 12in \$27.75 \$33.50 \$35.50 \$36.50



PLAYMASTER 106 AND 107



Feb. and March Elect. Aust. 106 WIRED AND TESTED \$88.75 107 WIRED AND TESTED \$79.00

CHANGER PLATFORMS

Teak Finish. PERSPEX DOMES Fits All Current Models. MINIBOX SPEAKER CABINETS Teak or Walnut Finish. Takes Magnavox 6in Speaker and 3in Tweeter. All One Price \$7.50 EACH Post. N.S.W. 65c., Interstate \$1.00.



240v A.C. POWERED SOLID STATE STEREO T.S.135 18 Transistor. 15-watt per channel. Inputs for Tape, Mag. P.U. Ger. P.U. Radio Aux. Freq. Range 30c to 20KC. Max Sensitivity 3 MV. Speaker matching 4 to 15 ohms. \$78.00

FUZZ BOX

FUZZ BOX E. AND A. AUG. WIRED AND TESTED. \$15. Post., 75c.

REVERB UNIT

COMPLETE with AMPLIFIER. E.A. October issue. Kitset \$39.95. Wired and tested, \$41.95.

ELECTRIC GUITAR

Pickup Units \$8.75 Accordion Pickup Units \$8.75 Harmonica Pickup Units \$1.95 Post. N.S.W. 40c; Interstate. 75c.

GUITAR AMPLIFIERS

10-Watt, Two-Channel, with Twin Cone Speaker \$53.55 14-Watt, 4 Inputs, Bass and Treble Boost. 2 Twin-Cone Speakers. \$63 17-Watt, Four-Channel, Bass and Treble Boost. Two Twin-cone Speakers \$76.25

35 WATT

4-Channel, Bass and Treble Boost. 4 Twin-Cone Speakers \$109.05 Vibrato with foot control and 2 preset controls for frequency and intensity. \$10.50 extra on above models.

14 plus 14 WATT

With Reverberation. May be used as 28 Watt or as 14 Watt plus 14 Watt Reverb. Two 9 x 6 Woofer Speakers. Two 9 x 6 Twin-Cone Speakers. 4 Channels Bass and Treble Boost. Foot Vibrato control included. \$163.50

SLAP BASS OR BASS GUITAR 40-WATT AMPLIFIER 4 Input Channels, Bass and Treble Boost. Two 12in Radial Beam Speakers. Perfect reproduction on 20 cycles. \$159.75

PIGGY BACK GUITAR AMPLIFIER

30 Watt \$79.75 45 Watt \$99.75 60 Watt \$119.75 4 Inputs. Bass and Treble Boost. Vibrato if required, \$10.50 extra.

TEST EQUIPMENT

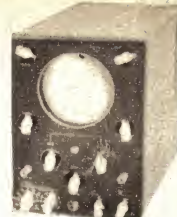

WIDE BAND OSCILLOSCOPE

5 Meg. Bandwidth Push-pull vertical and horizontal Amplifiers, 8 positions, high sensitivity vertical Amplifier, Frequency Compensated on all positions. Calibrated .02 to 600 volt. Hard time base, 20 cycles to 75K. Latest American R.C.A. circuitry. Complete with probe.

3-inch \$99.75; 5-inch \$111.50

PLAYMASTER 115

The new solid state Stereo-Amplifier. April issue. Wired and tested \$104.00 Kit Set \$90.00 Pre-amp to suit magnetic cartridge \$12.00



119 STEREO TAPE ADAPTER

Suits all Playmaster Stereo amplifiers and others that accept crystal P.U. Kitset \$79.00 Wired and tested \$96.00

TAPE PLAYBACK KITSET

BSR deck with parts for transistor pre-amp and circuit. \$30.00 Post \$1.25 N.S.W., \$2.00 Interstate. Easy to build. Mi-Fi quality.

TAPE DECKS B.S.R.

2 Track, 3 1/4 I.p.s. \$25.50 4 Track, 3 Speed Stereo. \$41.50



A.C. STEREO AMPLIFIER

5 WATTS PER CHANNEL. Valve Unit. 240v A.C. Input for Crystal and Ceramic P.U. Radio and Auxiliary. Output for 4, 8, 15 ohms. Cross talk better than -40db. Sensitivity 50 MV. \$47.50

SIGNAL GENERATOR

Deluxe Model TE-20D. Freq. range 120 KC-500 Mhz. 7 Bands. Accuracy 2 per cent. Output 8V. Provision for Xtal. Suitable for self calibration Marker generator. Printed circuit. 240 V.A.C. \$27.50 Post. N.S.W., 75c; I' state \$1.25. Leader L.S.G. II \$29.75.

PLAYMASTER 118 KITSETS \$79.75.

Wired and tested, \$89.75. Fitted with Pre-Amp to suit Magnetic Cartridge. \$12.00 extra

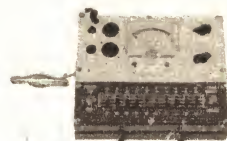

VALVE TESTER

Tests all valves, diodes, rectifiers, checking filaments, shorts. Merit on direct reading. Good-bad meter. Complete with tube chart. \$26.75

Post., N.S.W., 25c; I' state, \$1.25. T.E. 50-99-5011 Checks, Nu Vistas, Compactrons, etc. \$34.25

G.D.O. UNITS

Leader 810. 6-Band. 2 Mhz to 260 Meg. NuVistorised. 240 V.A.C. Operation. Modulated. Calibration. Accuracy 2 per cent. \$41.50

T.E. 18 Lafayette. 8 Bands. 360 K.C. to 260 Megs. 240 V.A.C. operation. \$39.50

Post., N.S.W., 50c; I' state, 75c. T.E. 15 Transistorised. 7 Band, 360 Kc to 270 Megs. \$34.75

AUDIO GENERATOR

De Luxe Model TE-22D. Freq. range. Sine 20 cps-200 KC. SQ. 20 cps-25KC. Output voltage. Sine 7V. SQ. TV P-P. Output impedance 1000 ohms. Acc. 5 per cent. Distortion less than 2 per cent. 4-range attenuation. 1/1, 1/10, 1/100, 1/1K. Printed circuit. 240V A.C. \$41.50

SIGNAL INJECTOR

Transistorised. Fountain pen-sized Unit for Signal Tracer in Radio, TV and Amplifier Service. Price \$4.75.

PLAYMASTER 117

60-Watt KITSETS \$90.75 Wired and tested, \$96.75.



WARBURTON FRANKI

NEW EDDYSTONE COMMUNICATION RECEIVER EB36

- Fully Transistorised • Internal Battery Supply (6 x 1050) • A.C. Power Supply (available extra)
- Logging Scale • May be used as tuner for Hi-Fi system • May be used as amplifier for record playing, etc.

Frequency Coverage: Band 1, 8.5 Mc to 22 Mc, Band 2, 3.5 Mc to 8.5 Mc, Band 3, 1.5 Mc to 3.5 Mc, Band 4, 550 Kc to 1500 Kc, Band 5, 150 Kc to 350 Kc.

SIZE 6 3-8in x 12½in x 8in. **WEIGHT** (with batteries) 13½lb.



Full specifications on request

\$195

includes freight anywhere in Aust.

AFTER STOCKTAKING BARGAINS

- DPDT Toggle Switches (8 terminal) 75c
- SPST Toggle Switches 6 AMP 75c
- DPST Toggle Switches 10 AMP \$1.50

SPECIAL CONDENSER POLYPAC NO. 20

Contains 25 assorted condensers including ceramic, electrolytic, metal pack, mica, paper tubular \$1 plus postage 5c (or 6 for \$5.50 including postage).

PVC TWO GANG CONDENSERS as used in transistor radios—\$1.20

- 3 m.m. BANANA PLUGS and SOCKETS (red or black) — 25c pair.
- 6-pin VIBRATOR CARTRIDGES 4v Synchronous 60c.
- 7-pin VIBRATOR CARTRIDGES 12v Synchronous \$1.25.
- 4-pin VIBRATOR CARTRIDGES 24v Non synchronous \$1.

CO-AXIAL CABLE

4 foot lengths. Suit car aerial leads — 15c.

CRYSTAL MICROPHONES

boxed with lead, \$1.95.

SPEAKER TRANSFORMERS TYPE "K"

(5000/3.5) (5000/15) (7000/3.5) (7000/15) — \$2.25

DYNAMIC MICROPHONES

High Impedance

Miniature hand held type (wire stand supplied for desk use) — \$3.85.

OVAL SPEAKERS

- 6in x 4in 15 ohm or 33 ohm voice coil \$3.50
- 5in x 3in 15 ohm voice coil \$3.25

ROUND SPEAKERS

- 8in 2.7 ohm or 15 ohm voice coil \$5.25

3 SPEED PORTABLE ELECTRIC RECORD PLAYERS

Good tone. Attractive plastic cabinets . . . \$23.50

KEW PANEL METERS

- VR4-P V.U. meters 4½in x 4in \$7.35
- MR3-P 0-500 microamp 3½in x 3in \$5.35
- MR3-P 0-1 milliamp 3½in x 3in \$5.35
- EW16 0-1 milliamp 3½in x 1in (edge reading) \$6.00
- MR2-P 0-500 microamp 1½in square \$3.50

SEW PANEL METERS

- Type SO45— 1 7-8in square
- 0-10, 0-20, 0-30, 0-40v AC/DC.
- 0-1, 0-5, 0-20 Amps AC/DC, \$3.20.
- Type S065, 3½in Round 0-300v AC/DC, \$4.



WARBURTON FRANKI

220 PARK ST., STH. MELB., VIC. Ph. 69-0151 (30 lines)

ALL prices include postage or freight unless otherwise stated.

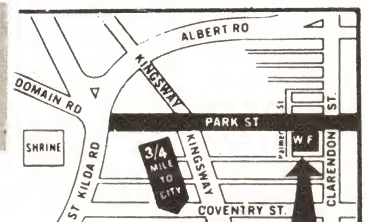



LISTENING AROUND THE WORLD

Art Cushen's monthly report on long-distance short-wave, television and broadcast band reception.

DX Article Creates Interest

The article in the March issue entitled "Sunspots, the Ionosphere and DX" has aroused considerable interest among short-wave listeners. It would appear from many letters received that some younger listeners need guidance on the subject of the short-wave bands, particularly on how to identify them on the receiver's tuning scale.

Most receivers have a dial calibration which shows the frequency range which the set covers, and many domestic receivers cover from 6-18MHz (6000-18,000KHz, 50-22 metres). To elaborate on the various bands we quote from an article by Jim Vastenhou, of Radio Nederlands, on the subject of the short-wave bands.

"In the short wave bands, much of the available frequency spectrum is allocated to fixed stations and mobiles used for point-to-point communication, as in aircraft, radio-telephone, shipping and the like. Only 10 per cent is available for international short wave broadcasting.

"The international short wave stations regard DX-ers as forming a reliable source of information on reception of their broadcasts and give them every encouragement.

"The short-wave broadcast bands are between 3MHz and 30MHz. The lowest band, the 90-metre band, is from 3200 to 3400KHz. This band is shared with others, namely fixed and mobile services (with the exception of the aeronautical mobile stations). The 90-metre band is only allocated to broadcasting in the so-called "tropical zone" of the world. This zone stretches between 30 degrees northern latitude and 35 degrees southern latitude, but is smaller in the Americas, where it runs from 25 degrees N to 25 degrees S.

"The 60-metre band, which runs from 4750KHz to 5000KHz, has the same limitations: it can only be used by stations situated in the tropical zone. In between we find the 75-metre band, a very small frequency stretch ranging between 3950 and 4000KHz. This band is not allocated on a world-wide basis.

"The tropical bands and the 75-metre band are designed for regional short-wave broadcasting. International broadcasting takes place on higher frequencies, the lowest of which is the 6MHz, or 49-metre, short-wave band, situated between 5950 and 6200KHz. This band is also the lowest short-wave range on many sets, and its value is best in regional broadcasting; international coverage is limited, especially in the day-time.

"The next higher frequency range is 41 metres, to be found between 7100 and 7300KHz. It is not allocated on a world-wide basis. The 41-metre band belongs to the same category as the 49-metre band, and is little used for international broadcasting. Its main use is for long-distance propagation when sunspot activity is low and the season bad.

"The 31-metre or 9MHz band, which

extends from 9500 to 9775KHz, is greatly used for long-distance short-wave broadcasts, and is also a very popular range for near-distance communication.

"The 25-metre band is found between 11700 and 11975KHz, the 19-metre band occupies the spectrum between 15100 and 15450KHz, the 16-metre band is the range between 17700 and 17900KHz, 13 metres between 21450 and 21750KHz and 11 metres, which is the highest short wave broadcast band, ranges from 25600 to 26100KHz. The total frequency-occupation of the international short wave bands, beginning at 6MHz, is 2350KHz. Of this, 800KHz (that is, about one-third) is situated above 20MHz.

We note that in the above article no mention is made of the 120-metre band. This covers the range from 2300 to 2500KHz, and is used by stations in the tropical area and is the band for many stations in Indonesia, Brazil, and other South American countries.

Some may wish to know how many stations can be accommodated within this frequency range. It is hard to say, but on the assumption that the spectrum allocation of a transmitter is 10KHz, we might be led to believe that only 235 stations can be accommodated. This is untrue, because the stations are situated in different parts of the world and with a proper combination of frequency schedules and signal trajectories it must be possible to squeeze four times as many, or about 1,000 stations into the spectrum, without causing mutual interference. However, the number of short-wave transmitters is estimated at between 4,000 and 5,000, so it will be clear that the short-wave broadcasting bands are seriously overcrowded.

SURVEY OF AFRICAN SIGNALS

Several of our readers continue to report interesting signals from Africa. This month we feature these stations, using information supplied by Bob Padula, of Melbourne, with additional information from Dene Lyneberg, of Wellington, and Tony Marr, of Auckland, and supplemented by our own observations.

- KHz
- 2446 St. Denis, Reunion, has been heard from 1700 to sign off at 1830GMT.
- 3218 Lourenco Marques, Mozambique, in English and Afrikaans, from 1630 GMT.
- 3222 Lome, Togo, with news in English at 2100GMT, now with 100KW.
- 3255 FLBC, Monrovia, Liberia, heard at fair level at 0600GMT.

- 3265 Lurengo Marques, with Portuguese service at 2100GMT.
- 3288 Tananarive, Malagache, with French program at 2000GMT.
- 3316 Freetown, Sierra Leone, heard at times at 0600GMT.
- 3306 Salisbury, Rhodesia, closes on Saturdays at 2010GMT.
- 3331 ORTF, Comores Island, news in French at 1700GMT.
- 3339 Radio Tanzania, Zanzibar, heard at 1900 with vernacular programs.
- 3346 Lusaka, Zambia, with news in English at 2000GMT.
- 3380 Malawi, heard with English program at 1930GMT.
- 3396 Salisbury, Rhodesia, received with English at 2000GMT.
- 4765 Brazzaville, Congo, with French program to close down at 2100GMT.
- 4785 Dar-es-Salaam, Tanzania, at 1800-GMT with news in English.
- 4807 ORTF, St. Denis, Reunion, leaves the air at 1830GMT.
- 4813 Ougadougou, Upper Volta, French program at 1800. Also observed opening at 0700.
- 4820 Radio Angola, Luanda, heard in Portuguese at 2100GMT.
- 4850 MBS Forestside, Mauritius, closes down at 1830GMT.
- 4850 Nauakchoti, Mauritania, with Arabic program around 2030GMT.
- 4855 Lourenco Marques, with English program at around 1800GMT.
- 4865 Ponta Delgada, Azores, relays the program from Lisbon and opens at 2000GMT.
- 4870 Cotonou, Dahomey, heard at 0530 and also around 2000 in French.

REAL FLYING ROCKETS



IT'S a hobby that appeals to the whole spectrum of model enthusiasts. The thrill of Blast-Off! The immaculate detail of scale models! The challenge of design, experimentation and exploration in a whole new range of sciences.

MODELS POWERED BY HIGH IMPULSE SOLID PROPELLANT ROCKETS engines. Safety approved by Mines Dept.

PARACHUTE RECOVERY! Write today for our latest 88 page, colour, fully illustrated Catalogue. Send 35c for your copy now. Refunded with first order over \$2.00.



MODEL ROCKET INDUSTRIES.
BOX 144,
CAMPBELLTOWN, N.S.W., 2560.

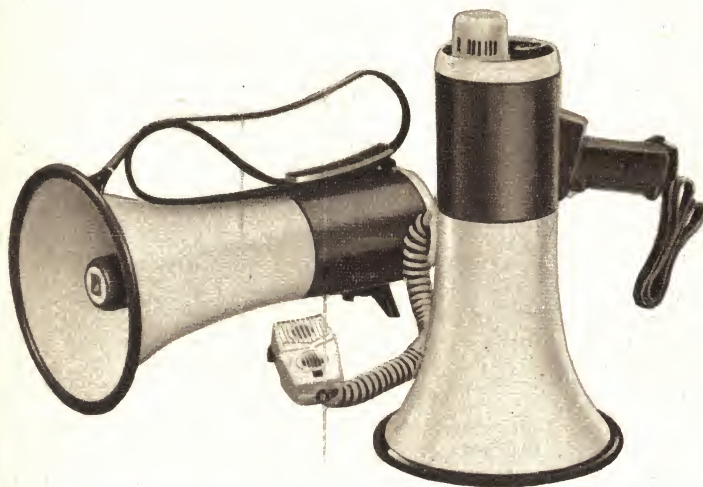

World
renowned
TOA P.A.
equipment.
From AWA

FULL-COLOUR SOUND!

TOA comes to Australia backed by the unrivalled AWA sales and service organisation. Public address equipment of all kinds is TOA's exclusive speciality; for public events, for patrol cars, for transport systems, for sports meetings and for all indoor P.A. requirements. TOA equipment delivers high-efficiency, long life and the kind of full-colour sound that stretches carrying power and reliability to greater ranges in the most

difficult conditions. TOA ... one of the top manufacturers of P.A. equipment in Japan. TOA ... recognised leader in reflex horn speakers. AWA ... Australian-owned and the most experienced electronics organisation in the Southern Hemisphere. What a combination! AWA are now sole distributors for TOA P.A. equipment in Australia and New Guinea. Contact your AWA office for literature and full details.

AMALGAMATED WIRELESS (AUSTRALASIA) LIMITED
Australia's National Wireless Organisation



TOA ELECTRIC CO. LTD., Japan
Public Address Equipment

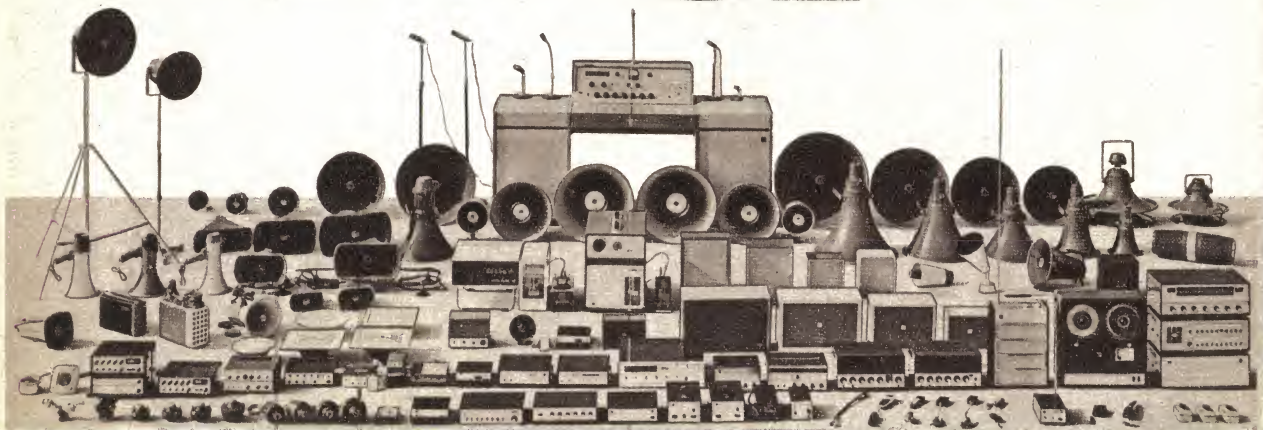

AMALGAMATED WIRELESS (AUSTRALASIA) LIMITED • 554 Parramatta Road, Ashfield, N.S.W. 2131 Tel. 71 0791 • 167 Queen Street, Melbourne, Vic. 3000 Tel. 67 9161 • 123 Murray Street, Hobart, Tas. 7000 Tel. 34 3836 • 42-44 Frederick Street, Launceston, Tas. 7250 Tel. 2 1804 • 70 Merivale Street, Brisbane, Qld. 4000 Tel. 4 1631 • 231-233 Bulwer Street, Perth, W.A. 6000 Tel. 28 3425 • Cnr. King & Darby Streets, Newcastle, N.S.W. 2300 Tel. 2 5166 • 4 Thompson Street, Garran, A.C.T. 2605 Tel. 81 5193

659 E

- 4885 Nairobi, Kenya, with news bulletin in English at 1800GMT.
- 4904 Fort Lamey, Tchad, with programs in French at 2100GMT.
- 4915 Accra, Ghana, has English program with strong signal at 2100GMT.
- 4926 Radio Ecuatorial, Spanish Guinea, has news relay in Spanish from Madrid at 2000GMT with sideband interference from Brisbane 4920KHz.
- 4934 Nairobi, Kenya, National Service in Swahili is received at 2000GMT.
- 4972 Radio Yaounde, Cameroons, has French program at 2100GMT.
- 4976 Kampala, Uganda, has news in English at 2100GMT.
- 4985 Tananarive, Malagache, closes at 1930GMT with anthem.
- 4990 Lagos, Nigeria, with local program at around 2100GMT.
- 4994 Omdurman, Sudan, has Arabic program to 2100GMT.
- 5010 Tananarive, Malagache, with French Network, to sign off at 1930GMT.
- 5050 Radio Tanzania, Dar-es-Salaam, has news in Swahili at 1900GMT.
- 5985 Radio Tanzania, Dar-es-Salaam, heard with good signal in Kiswahili to 2000GMT.
- 6015 Radio Abijan, Ivory Coast, opens at 0630 with anthem then announcements in French.
- 9550 ETLF, Addis Ababa, Ethiopia, has Gospel program in English at 1755GMT.
- 9745 Bamako, Mali, has African music with French announcements 2215-2300GMT.
- 15135 ETLF, Ethiopia, opens in English at 0445GMT.
- 15400 ETLF, Ethiopia, opens at 0430 with Gospel program.
- 21535 Radio South Africa, Johannesburg, heard opening to Ghana and Nigeria at 2100GMT.

SUNSPOT COUNT DECREASES

As reported in a recent issue, the maximum sunspot count was expected around April-May and according to a Swiss report the count is now on the decrease. With the 11-year cycle now past its peak, there will be a tendency for short-wave stations to use the lower frequency bands again. According to the Zurich Observatory and its stations at Arosa and Locarno, the predicted count for the next few months is as follows:

June	116
July	115
August	113
September	111

HIGHER POWER STATIONS

A list of the many stations throughout the world which propose to increase their power shows that listeners will be able to receive many new stations on short-wave, while unlisted stations on both the MW and SW bands are also expected to be heard, with many stations coming into operation. A summary of the major news in this field shows that stations in all continents are planning to install new and higher-powered broadcasters or to increase the power of existing stations.

PERU: Radio Nacional del Peru, Lima, operated by the Government of Peru, is to boost the power of its transmitters and commence an International Service. The new schedule is to be 1100-0500GMT, using 150KW on 9560, 11715, 15150, 17890, and 21600KHz. Radio del Pacifico has been granted a licence by the Peruvian Government to operate a 5KW transmitter on 4975KHz.

ST. HELENA: Radio St. Helena, Jamestown, operates on MW 1511KHz with 1KW. The station is a Government station, and is on the air Friday 0945-1100, Saturday 1700-1800 and Sunday 1200-1300, 1700-1800GMT. A new powerhouse will be installed next year. The station will then increase broadcasting times and also operate a BBC relay station.

LIBERIA: ELWA is installing a new SW transmitter and a new antenna which has recently arrived at Monrovia. This

NEW SCHEDULES OPERATING

BROADCASTS FROM AUSTRIA

The present schedule of the Austrian Radio, Vienna, in operation until September 1, is as follows:

GMT	KHz	Area served	
0430-2300	6000	Europe	
0500-1300	6155		
0900-1300	7245		
1700-2200	6155		
2000-2200	7245		
1800-2000	11925		Europe (North)
1000-1200	9770		Europe (East)
1300-1500	11785		Europe (South), N. Africa
0700-0900	7245		Europe (West)
1300-1700	9770		Europe, Near East
1500-1700	11785	N. Africa, Near East	
2300-2400	6155	North America	
0000-0400	6155	North America (East)	
2300-2400	9770		
0000-0400	9770		
0000-0200	15430		
2300-2400	9525	Central America	
0000-0200	9525	South America (East)	
0200-0400	11760	South Africa	
1800-2100	15210		
0700-1000	17855		
1600-1800	17750		
0600-1000	15410	Near East	
1700-2000	15410	India, Indonesia	
0400-0700	17715		
1400-1600	17895		
1000-1200	17885		
1200-1400	15400	Australia, New Zealand	
		Japan	

RADIO PRAGUE SCHEDULE

The present schedule of Radio Prague, Czechoslovakia is in operation to November 3 and is as follows:

GMT	KHz	To Europe Language
0800-0930	6055, 9505	German
0930-1100	6055, 9505	German
1100-1200	6055, 9505	French
1200-1300	6055, 9505	Italian
1200-1230	9560, 11960, 15285	English
1230-1330	6105, 11960, 15285	Spanish (Sat., Sun. only)
1300-1430	6055, 9505	Italian (Sat., Sun. only)
1630-1700	5930, 7345	English
1700-1730	5930, 7345	Spanish
1830-1900	5930, 7345	Spanish
1900-1930	5930, 7345	English
1500-1530	6055, 11990, 15285, 17840, 21735	To Africa
1530-1630	6055, 11990, 15285, 17840, 21735	Swahili
1630-1730	9600, 11990, 17840	English
1730-1830	5930, 7345, 9600, 11990, 17840	Arabic
1830-1930	9600, 11990, 17840	English
1930-2030	5930, 7345, 9600, 11990, 17840	French
2030-2130	5930, 7345, 9600, 11990, 17840	Portuguese
2130-2230	7345, 9600, 11990, 15365, 17840	Czech, Slovak
2230-2300	7345, 9600, 11990, 15365, 17840	Czech, Slovak
2300-2400	7345, 9540, 9630, 11990, 15365, 17840	Spanish
0000-0100	7345, 9540, 9630, 11990, 15365, 17840	Portuguese
0200-0300	7345, 9540, 9630, 11990, 15365	Spanish
1330-1400	15448, 17840, 21450	To North America
1400-1500	15448, 17840, 21450	Czech, Slovak
0100-0200	7345, 9540, 9630, 11990, 15365, 17840	English
0300-0330	7345, 9540, 9630, 11990, 15365	English (Sun. only)
0330-0430	7345, 9540, 9630, 11990, 15365	Czech, Slovak
0700-0800	6055, 9575, 11800, 15310, 21450, 21700	English
		To Australasia
		English

BROADCASTS FROM THAILAND

The present schedule of the Thai National Broadcasting Station in Bangkok, is as follows:

GMT	KHz	Overseas Service Language
0415-0515	11910, 7115	English
0930-1020	11910, 7115	Thai, Cambodian, Vietnamese
1025-1157	11910, 7115	General Service
1300-1400	11910, 7115	English (1025) Malay (1130)
		English, Malay
2300-0700	11910, 7115, 4830	Home Service
1030-1530	11910, 7115, 4830	Thai
0530-0600	1190	Thai
		French (Monday to Saturday)

Some of these broadcasts are also carried on medium wave, 923, 830, 810KHz.

When 'Eveready' talks transistor life, the experts listen

So strong for so long. That's the 'Eveready' Battery promise. And 'Eveready' Batteries don't make promises they can't keep. The experts know that. That's why they listen. There's the standard all-purpose silver label battery with long life for torches, toys and transistors at a popular price. For extra long life in transistors, toys and other continuous drain equipment, the premium red label battery outperforms all others. Stock and recommend 'Eveready'—the batteries that sell themselves. The only dry batteries advertised on TV. 'Eveready' Batteries are so strong for so long. That's a promise.

**SO STRONG
FOR SO LONG**



BATTERIES Products of



'Eveready' and 'Union Carbide'
are registered trade marks.

ES96



will increase Arabic broadcasts of ELWA from 13 to 21 hours per week. A new station, The Voice of Africa, will be erected in Liberia for broadcasts in Arabic, English, French and Swahili. It is financed by a lottery, run by the KRO, The Roman Catholic Broadcasting Society in Hilversum, Holland.

NETHERLANDS ANTILLES: Radio Nederlands relay station at Bonaire is expected to commence operation in December. The station will use five 300KW transmitters to relay programs from Hilversum and beam them into Africa, America and the Pacific.

INDIA: The first material for a 2000KW medium wave transmitter has arrived in Calcutta from the Soviet Union. The new transmitter will serve the South-East Asia area.

UNITED STATES: The North American Broadcasting Corporation has announced that it will build a new shortwave station to beam programs to overseas listeners at a cost of \$US2,500,000. Programs, which will be on the air 18 hours a day, will originate at the new N.A.B.C. studios at Monterey, California, which are being built at a cost of \$US3 million.

FLASHES FROM EVERYWHERE

EUROPE

BULGARIA: Radio Bulgaria, Sofia, has the slogan "Radio Rodina" for a service for Bulgarians living abroad. Transmissions are 1100-1110GMT on 9700, 11765, 11955KHz, and 2200-2210GMT on 6145, 7670, and 11765KHz. A further frequency, 15350KHz, is also used, but this is mixed with the Russian transmission which also uses the slogan "Radio Homeland."

BELGIUM: Brussels is still being received on the channel of 21690KHz, and has been heard at 1100GMT with a transmission in Congolese to Africa. The same program is also being received on 21510KHz, which is better at 1000GMT on opening.

SWITZERLAND: Berne continues to provide excellent reception in English in the 0700-0800GMT transmission, and the best frequency is 9590KHz, reports Allan Evans, Beaudesert, Queensland. The other channel, 11775KHz, also provides good reception in Queensland.

AFRICA

CONGO: Radio Kinshasa has English lessons on Sundays and Wednesdays at 2100-2130. It is heard with a good signal on 15240KHz and also on 9775KHz. Radio Kinshasa has been heard testing on the new frequency of 21510KHz in French at 0700-0705GMT. The regional station at Kukavu is carrying out test transmissions on 9643KHz.

SENEGAL: Radio Senegal-Inter has replaced 15115KHz with the new frequency of 15175KHz. The station is noted with French news at around 1900GMT.

CAPE VERDE ISLANDS: Radio Barlavento, now operating a 1KW transmitter on 3910KHz, has ordered a new transmitter of 100KW according to Sweden Calling DX-ers.

ASIA

TAIWAN: Radio Taiwan, Taipeh, is now verifying reports to the Voice of Free China programs with a new pennant. The Chinese station, Radio Liberty, is using the frequencies of 17720 and 17780KHz, and is heard in Russian at 1030GMT. The signals both suffer from severe jamming.

INDIA: All India Radio, Delhi, in the General Service in English, has been heard in south Asia on the new channel of 15265KHz from 2300GMT to after 0030GMT. The reception is good, but

Visit to Radio Hauraki

Our short-wave correspondent, Art Cushen, was privileged recently to visit the unofficial Radio Hauraki, operating from a ship off the coast of New Zealand. Here, he reports on what he found.

Radio Hauraki has received world-wide publicity for its off-shore broadcasts in the Hauraki Gulf and its transmissions have been heard widely in Australasia and in North America on 1480KHz.

The New Zealand Government's radio laws do not permit the operation of private broadcasting stations at the moment. In 1966, several young New Zealanders announced plans to go to sea and start a broadcasting station and so, in December, 1966, Radio Hauraki commenced to broadcast on 1480KHz with 2KW from a site near Great Barrier Island in the Hauraki Gulf with Auckland as its major target area. The influence this station has had on New Zealand radio is difficult to assess, but the N.Z.B.C. has made considerable changes in its programming.

The first vessel, the Tiri, was a small ship, but, nevertheless, moored in international waters, it operated a broadcast schedule for 20 hours a day, until Saturday, January, 28, 1968. At that time, after searching for a man lost overboard in the area from another vessel, the M.V. Tiri drifted helplessly with engines failing, and was wrecked on Great Barrier Island. A few weeks later, the broadcasts were back on 1480KHz, using the scow Kapuni, renamed M.V. Tiri II. This vessel had a 160ft mast and was much larger than the original vessel, being 104ft long and provided with four engines and much more powerful equipment. The vessel is now operating from the old site, in Colville Channel.

Since the new ship went into service it has suffered from the disastrous hurricane which hit New Zealand on April 11, during which it lost some of its mast. Hauraki is now the only broadcasting station in international waters on regular schedule anywhere in the world.



The M.V. Tiri, from which Radio Hauraki programs are broadcast, at its moorings in international waters off the coast of Auckland.

The Radio Hauraki programs are recorded in studios at 93-95 Anzac Avenue, Auckland, and flown to the vessel by amphibian each week. The programs are recorded exactly one week in advance, right to the minute, and a change of tapes is required each 30 minutes of program time. This enables news and late items to be inserted on the hour and half-hour by announcers on the vessel.

This means that with the 20-hours-a-day transmission, over 280 tapes are required each week. The station has also extended its hours and is now on the air all night on Friday and Saturday. This additional program time is live from the vessel for the period 1 a.m. to 9 a.m., Saturday, and the same time on Sunday morning.

some sideband interference is noted from the Ascension Island relay of the B.B.C., using 15260KHz.

INDONESIA: The Council of Churches on Java has started Radio Oikoumene, which operates on 4087KHz at 0730-0930, 1500-1700 and 1930-2200 local time, according to Sweden Calling DXers. This means that the transmission

is 0030-0230, 0800-1000, 1230-1500GMT. **LEBANON:** The latest schedule from the Labanon Broadcasting System includes transmissions to Africa, North and South America, as follows:

GMT	KHz
1830-2030	15340
0130-0400	15440
2300-0100	17715

TEL-LEIGH-TUBES PTY. LTD.

(SYDNEY AND MELBOURNE)

Tel-Leigh-Tubes have extended their business interests to Victoria having bought out the TV Picture Tube Manufacturing Plant of K.G. Luke Eng. Pty. Ltd:

Premium quality replacement picture tubes (including 23in laminated tubes) are available at very competitive prices and are acceptable by insurance companies. Deliveries are promptly executed. Broken-necked, marked or discoloured screened tubes are acceptable for exchange (ion-burns excepted).

Send old tubes to Petersham Station, N.S.W., or Highett Station, Vic.

ALL TUBES ARE GUARANTEED FOR TWO YEARS

N.S.W.: Tel-Leigh-Tubes, 51 Reuss St, Leichhardt, Sydney, N.S.W. 2040
Telephone. 51-8498

VICTORIA: Tel-Leigh-Tubes (Melbourne) 32-34 Graham Rd.,
Highett, Melbourne, Vic. 3190. Telephone: 95-4086.

Normatest: a compact multi-range measuring instrument for laboratory, service, and field use.

The handy, light-weight and stable Normatest unit has many multi-purpose applications. With high reading-accuracy it is insensitive to shock and trouble free. AC/DC voltage and current ranges. Taut-band suspension movement. D.B. scale. Temperature measurement with thermocouple-probe available. 20,000 ohms/volt.

Normatest

- 37 MEASURING RANGES
- HIGH READING ACCURACY
- PRICE IS RIGHT AT \$30



jacoby, mitchell
& co. pty. ltd. 26-2651
469-475 kent street, sydney

MELBOURNE 30-2491
 ADELAIDE 53-6117
 BRISBANE 2-6467
 PERTH 28-1102
 LAUNCESTON 2-5322



THE AMERICAS

DOMINICAN REPUBLIC: The reported introduction of a new service from Santo Domingo has been confirmed with the reception in North America of some transmissions. The new external service "Radio Quisqueya" has been received from 0000 to after 0200GMT, with religious and cultural programs, mostly supplied by the Broadcasting Foundation of America. The frequencies and powers in use are: 9505KHz, 50KW; 6090KHz, 20KW; and 3215KHz, 7500W.

BRAZIL: Radio Emisora de Paratinga, Sao Paulo, is building a new 100KW transmitter for use on 11745KHz. The call has been assigned as ZYR65. A substantial power increase for ZYN63 (6025KHz) is also planned. Both frequencies have 10KW power at the moment. A further station in Brazil, Radio Clubs de Para (4865KHz) is now on the air daily on 0900 to 0300GMT. In a verification letter, the station gives its extended schedule, and wants reports to C.P. 533, Belem, Para, Brazil. Best reception is at 0900GMT in this area. An airmail verification letter has come to hand from station PRL3 operated by the Ministry of Education and Culture in Rio de Janeiro. The letter was

NOTES from readers should be sent to **ARTHUR CUSHEN, 212 Earn Street, Invercargill, N.Z.** All times listed are Greenwich Mean Time, add eight hours for Perth, 10 hours for Sydney and 12 hours for Wellington time. Frequencies are listed in Kilohertz (KHz).

signed by Eremildo Luzi Vianna and informed us "we wish to declare the great satisfaction your message gave us in view, principally, of its far-reaching distance." The station was heard on 11950KHz at 0930GMT with morning exercises.

ECUADOR: Radio HCJB Quito now has the "DX Partyline" program to Europe on Monday at 2100GMT on 17880, 15325KHz; to the Americas every Monday at 0230GMT on 15115, 11915, 9745KHz; to the South Pacific on Wednesday at 0930GMT on 15325, 11915, 9745, 6050KHz

BROADCAST BAND NEWS

AMERICAN SAMOA: Radio WVUV Pago Pago, American Samoa, which now has a more powerful transmitter, has been received in New Zealand at good strength on 1120KHz. This is a new country for most listeners as in the past the low power did not allow reception, because of interference in the early evenings from KMOX, St. Louis, U.S.A. and later from 4BC in Brisbane. The new power of 10KW makes reception possible from as early as 0500GMT to sign off at 0920GMT. Transmissions on Friday and Saturday are sometimes later. The full schedule is from 1630GMT sign on, and reception at this time is possible with interference from 4BC during its all-night transmission. The station announces as "This is Radio WVUV Pago Pago, American Samoa, the Voice of the South Pacific, 1120 on your radio dial."

The station has news on the hour and carries many United States network features. American Samoa is 11 hours behind GMT.

INDIA: All India Radio has opened some additional stations and programs have been heard in New Zealand after 1500GMT on the new stations on 980 and 1430KHz. A new broadcasting station at Parbhani is also now in regular operation on 1300KHz. The station carries programs from the West Regional stations at Nagpur and Poona. Studio facilities to originate its own programs when required, are also provided at Parbhani.

As a service to readers "ELECTRONICS Australia" is able to offer: (1) Photographs, dye-line prints and other filed material to do with constructional projects and (2) A strictly limited degree of personal assistance by mail or by reply through the columns of the magazine. Details are set out below: REPLY BY POST: This provision is made primarily to assist readers in matters relating directly to articles and projects published in "ELECTRONICS Australia" within the last 12 months. Note, however, that we cannot provide lengthy answers, undertake special research or modifications to basic designs. A 20c query fee must be enclosed with letters to which a postal reply is required; the inclusion of an extra fee does not entitle correspondents to special consideration. OTHER QUERIES: Technical queries which fall outside the scope of "Replies by Post" may be submitted without fee and may be answered through the columns of the magazine at the discretion of the Editor. Technical queries will not be answered by telephone. COMMERCIAL EQUIPMENT: "ELECTRONICS Australia" does not maintain a directory of commercial equipment, or circuit files of commercial or ex-disposal receivers, amplifiers, etc. We are therefore not in a position to comment on proposed adaptation of such equipment, or on its general design. "ELECTRONICS Australia" does not deal in electronic components. Prices, specifications or other assistance must be sought from the appropriate advertiser or agent. REMITTANCES: These must be in a form negotiable in Australia. Where the charge may be in doubt, an open cheque, endorsed with a limitation, is recommended. ADDRESSES: All requests for data and information, as set out above, should be directed to The Assistant Editor, "ELECTRONICS Australia," Box 2728 G.P.O., Sydney, N.S.W., 2001. Other correspondence should be directed to The Editor.

"ELECTRONICS Australia" Information Service

PHOTOGRAPHS, DYE-LINE PRINTS: Original photographs are available for most of our projects, from 50c plus 8c postage for a 6in x 8in glossy print. In addition, metalwork dye-line prints are available for most projects for 50c each; these show dimensions and the positions of holes and cut-outs but give no details of wiring. BACK NUMBERS: A fairly good section is available. On issues up to 6 months old there is a surcharge of 5c. On issues from seven to 12 months old the surcharge is 10c. Over 12 months, it is 20c. Packages and postage is 10c extra in all cases. REPLY BY POST: This provision is made primarily to assist readers in matters relating directly to articles and projects published in "ELECTRONICS Australia" within the last 12 months. Note, however, that we cannot provide lengthy answers, undertake special research or modifications to basic designs. A 20c query fee must be enclosed with letters to which a postal reply is required; the inclusion of an extra fee does not entitle correspondents to special consideration. OTHER QUERIES: Technical queries which fall outside the scope of "Replies by Post" may be submitted without fee and may be answered through the columns of the magazine at the discretion of the Editor. Technical queries will not be answered by telephone. COMMERCIAL EQUIPMENT: "ELECTRONICS Australia" does not maintain a directory of commercial equipment, or circuit files of commercial or ex-disposal receivers, amplifiers, etc. We are therefore not in a position to comment on proposed adaptation of such equipment, or on its general design. "ELECTRONICS Australia" does not deal in electronic components. Prices, specifications or other assistance must be sought from the appropriate advertiser or agent. REMITTANCES: These must be in a form negotiable in Australia. Where the charge may be in doubt, an open cheque, endorsed with a limitation, is recommended. ADDRESSES: All requests for data and information, as set out above, should be directed to The Assistant Editor, "ELECTRONICS Australia," Box 2728 G.P.O., Sydney, N.S.W., 2001. Other correspondence should be directed to The Editor.

When writing, please make sure your address is complete, including the POSTCODE. Addition of the latter will ensure minimum delay in handling your letter. Also make sure that your address is legibly written or, for preference, PRINTED. A significant number of letters are returned to us each month because the original address was incomplete or illegible. We agree that the reproduction from magnetic stripe often leaves much to be desired, V.H., and we read the photo-trial? (V.H., Blakhurst, N.S.W.) Would it be possible for you to describe a system of this type in Electronics Australia? We agree that the reproduction from magnetic stripe often leaves much to be desired, V.H., and we read the photo-trial? (V.H., Blakhurst, N.S.W.) Would it be possible for you to describe a system of this type in Electronics Australia? We agree that the reproduction from magnetic stripe often leaves much to be desired, V.H., and we read the photo-trial? (V.H., Blakhurst, N.S.W.) Would it be possible for you to describe a system of this type in Electronics Australia?

When writing to us:—
 ● Please give your name and full postal address, including the State.
 ● Write the above information clearly or, for preference, print it in block letters. Your co-operation will facilitate delivery of replies by mail, where such are called for.

ANSWERS TO CORRESPONDENTS

COLOUR BLINDNESS. Reference your "Forum" article of April, 1968, on colour systems, and efforts are being made to swing back to synchronised tape sound systems, and efforts are being made to produce a system of the latter type which will give high quality lip-synch yet be simple and straightforward in operation. I enclose photocopies of two reviews of new equipment of this type released recently in Europe, for your interest. Would it be possible for you to describe a system of this type in Electronics Australia? (V.H., Blakhurst, N.S.W.) We agree that the reproduction from magnetic stripe often leaves much to be desired, V.H., and we read the photo-trial? (V.H., Blakhurst, N.S.W.) Would it be possible for you to describe a system of this type in Electronics Australia?

DESIGNS WANTED. I would like to know if you have circuit diagrams for a 10 to 100W amplifier and a 120 to 150W P.A. amplifier, both with provisions for vibrator and reverse units (such as described in Electronics Australia, October, 1967). I also require details of a five channel mike mixer. (A.C., Mosman, N.S.W.)

● The Playmaster 117 Guitar Amplifier, published in July, 1967, is the highest power guitar amplifier we have developed. This produces 60W which is equivalent to about 120W peak power as quoted in the U.S.A. We published a 100W P.A. amplifier in July, 1966 but this does not include vibrator and reverberation facilities. A 4-channel Audio Mixer was published in February, 1966. Details are given in the next whereby it can be used with a greater number of inputs. Copies of all these articles are available through the Information Service for the usual fee of 50c each.

ELEMENTARY CIRCUITS. I would be grateful if you could supply me with some elementary circuits using one to three valves or transistors which you have printed in previous issues. (G.P., Bendigo, Vic.)

● We have published a wide variety of circuits intended for beginners using both valves and transistors. If you can be more specific and tell us whether you want a broadcast receiver, mono amplifier, or some piece of test equipment, etc., we can apply a suitable article through our Information Service for the usual fee of 20c per article.

FOUND FOR HOME MOVIES: Although magnetic stripe sound has become popular among home movie enthusiasts, it tends to be of variable quality. Although with a good projector and high quality stripe the performance can be all that one could desire, more often than not it is degraded quite badly by dropouts, level changes, wow and flutter. Largely as a result of the disadvantages mentioned above, it is recommended that the charge may be in doubt, an open cheque, endorsed with a limitation, is recommended.

CRYSTAL CLOCK. In an American publication of 1963 there is an article describing a quartz crystal clock using tunnel diodes which is accurate to within five seconds per year. The circuit is basically that of a design from the General Electric transistor handbook. I have been interested in this circuit, but the coils are of American origin and several other details are a bit vague so that I temporarily suspended the project until I noticed that the subject had come up again in Electronics Australia. I feel that this particular circuit using tunnel diodes shows great promise and is worth considering. (D.S., Fenshurst, N.S.W.)

● Thank you for the information, D.S., which may be of assistance to us. We have not finalised any plans for this project, but hope to publish a design in the near future.

HAM

RADIO SUPPLIERS

323 ELIZABETH ST., MELBOURNE, VIC., 3000. PHONE: 67-4286
2 DOORS FROM LITTLE LONSDALE STREET

ESTABLISHED 1947

CITIZENS BAND CRYSTALS

To suit Japanese Walkie-Talkies and Transceivers, P.M.G. Approved Freq. 27.240 Mc. (Transmitter), 26.785 Mc. (Receiver).
HC6/U Subminiature 1/2" pin spacing 27.240 or 26.785 \$3.50 each, or \$6.50 a Pair.
HC18/U Miniature 1/4" pin spacing, 27.240 or 26.785, \$3.50 each, or \$6.50 a Pair. (HC18/U also available with flying leads.)

SWR METERS Model KSW-10



SPECIFICATIONS:

Standing Wave Ratio: 1:1 to 1:10.
Accuracies: Plus or minus 3% scale length.
Impedance: 52 ohms and 75 ohms.
Meter: 0-100 DC microamperes.
PRICE: \$19. inc. Tax.

TRIO COMMUNICATION RECEIVERS
TRIO Model 9R59DE, 4 Bands covering 540 Kc. to 30 Mc., two mechanical filters for maximum selectivity, Product Detector for SSB Reception, Large Tuning and Bandspread Dials for Accurate Tuning, Automatic Noise Limiter, Calibrated Electrical Bandspread, "S" Meter and B.F.O., 2 Microvolts sensitivity for 10 db S/N Ratio.

\$175

TRADE-IN ACCEPTED. LOUDSPEAKERS, "PEAK" HI-FI

Type	Size	C/S	Input	Price	
Twin Cone Types:					
6A7	6in	60-16,000	5 watts	\$5.50	
8A7	8in	50-16,000	8 watts	\$7.50	
12A9	12in	30-13,000	20 watts	\$18.75	
Coaxial Type with "Free Edge" bass cone and horn tweeter					
8CX50	8in	30-22,000	15 watts	\$23.75	
10CX50	10in	25-22,000	20 watts	\$36.00	
12TX50	12in	18-22,000	25 watts	\$62.50	
Single Cone "Free Edge" type:					
5A50	5in	50-15,000	8 watts	\$15.00	
Professional Series:					
H50	Horn	2,000-20,000	15 watts	\$11.10	
6M50	6 1/2in	Speaker	200-6,000	25 watts	\$21.00
8L50	8in	Woofer	37-4,000	15 watts	\$28.25
10L50	10in	Woofer	25-3,000	20 watts	\$41.00
12L50	12in	Woofer	17-2,500	30 watts	\$64.00

Please Note:—A7 and A9 types are available in either 8 or 16 ohm Voice Coil, A50, CX50, TX50 and Professional types, 16 ohms only.

WALKIE-TALKIE

TRANSCEIVERS CITIZENS BAND
"TOKAI" Model TC-911, 9 Transistor, Super-heterodyne, Crystal Locked, Individual speaker and Microphone, PMG approved 27.240 Mc., all metal construction, complete with leather case. Range approx. 1 to 8 miles in open country.
Price \$70 a pair SPECIAL

JUST ARRIVED: "NIKKA" 14 TRANSISTOR, 1 WATT TRANSCEIVERS. Solid State circuit, long-range boost circuit, buzzer call system. Provision for 2 channels, squelch control, R.F. Stage. All Metal Construction, NORMALLY \$220.

OUR PRICE: \$175.00 a Pair, including Leather Case.

Miniature, 1/4in 5000 ohm. Switchpot .. 65c
Miniature 3/8in 5000 ohm. Switchpot .. 65c
PVC Tuning Gang, Aerial 6-142pF, Oscillator 6-6 1/2pF .. \$1.60
Calibrated Knob 10c extra.
360 Microhenry Oscillator Coils .. 75c
455 K/c IF. Transformers. Miniature (Ducon type): 1, 2, 3, 75c each, or \$2-3.
Driver Transformers, 8000-3000 ohms .. \$1.00
Output Transformers 480/8 ohms .. \$1.30
Earphone, Magnetic 8 with small plug 50c
Earphone Crystal, Hi-imp. Med. Plug 60c each

TRANSISTOR AND DIODE SPECIALS
2SA 29 equals OC44N, 2N410 equals OC45N, 2N218, 2N188 equals OC74N.
ANY TYPE, 50c each or 5 for \$2.

SILICON RECTIFIERS

50 p.i.v. 750 Ma, 50c each or 5 for \$1.75.
400 p.i.v. 750 Ma, 75c each or 3 for \$2.00.

IMPORTED SPEAKERS

8 inch Twin Cone, 10 Watt, 50-15,000 C/S. SPECIAL. \$7.25.

POTENTIOMETERS NEW ex-factory stock, short shaft 1" 2 gang concentric 1 Meg./50K ohm 25c, 2 Meg./2 Megohm, SPST Switch, 50c, 1.5 Meg/50K ohm 25c, STANDARD TYPE (short shaft 1/4in long) 2 Gang, 10K/10K ohm 50c.
20K/20K ohm 50c, 50K/50K ohm 50c.
50K stand. Pot 20c, 50K TAB Mount 15c, 1.5 Meg. TAB Pot 10c.
9 pin valve sockets and Shields 20c each or 12 for \$2.
9 pin standard valve sockets McMurdo, 6c ea. or 10 for 50c.
7 pin standard valve sockets McMurdo 6c ea. or 10 for 50c.

VERNIER DIALS AND DRIVES

JACKSON 36/6 Vernier Dial, and Eacutcheon (suit Fremodyne 4), \$4.50.
JACKSON 6:1 Vernier Drive, \$1.50.

LOCK DOWN CAR RADIO AERIAL TYPE LO3

Complete with Lead and Key, \$4.25.
25c Post.

NEW HIGH IMPEDANCE HEADPHONES

2000 ohms each, \$2.25. Post 25c.

HI-FI SPEAKERS

6A7 6in 5 watt Twin Cone. Available in 8 or 16 OHM, \$5.50, post 30c.
8A7 8in 10 watt Twin Cone. Available in 8 or 16 OHM, \$7.35, post 30c.
12A9 12in 20 watt Twin Cone. Available in 8 or 16 OHM, \$18.75, post 50c.

RADIO SPEAKERS

2 1/4in 8 OHM, \$1.75, 4in 8 OHM, \$2.25. Post 20c.

COAXIAL CABLE

72 OHM—3/16in Diam. 35ft rolls, 75c. Post 15c.
120 OHM—3/8in Diam. Up to 200yd rolls. 25c /yd, \$38.00 per 200yd roll.

W.W. POTENTIOMETERS

50 Watts. 200 OHM, \$3.00.

STEPDOWN TRANSFORMERS

240V—24 volt—28 volt and 32 volt A.C. 50 cycle. SEC.A 1-88A. With on/off switch, 2 outlet sockets, \$7.00, post \$1.00.

LATEST MINIATURE TYPE

SILICON PLANAR N.P.N. TRANSISTORS
Type 325 replaces BF115—SE1010.
Type 327 replaces BC108—2N3565-SE4002.
Type 328 replaces BC109—SE4010.
All 75c each or 3 for \$2.00.

DISPOSAL SPECIALS

TRANSISTOR TRANSFORMERS "E" Type.
DRIVER 3000/1330 ohms CT .. \$1 each
OUTPUT 300 CT/15 ohms .. \$1 each
OR \$1.75 a pair.

MO 65 METERS

1mA, 5mA, 10mA, 25mA, 50mA, 100mA, 150mA, 250mA, 500mA. Size 3/4in m/hole 2 1/2in. Price: \$4.50, Postage: 20c.
1 amps DC, \$4.50; 5 amps DC, \$4.50; 10 amps DC, \$4.50; 30-30 amps DC, \$9.25, Postage: 20c.
15 volts DC, 30 volts DC, 300 volts DC, \$4.50, Postage: 20c.

300 volts AC, \$5.00, Postage, 20c.

SPECIAL 6 TRANSISTOR POCKET RADIO
Complete and with leather carrying case and earphones.

PRICE, \$15.00. Postage 30c.
Also 12 months' guarantee.

RESISTORS

1/4 and 1/2 watt, 8c ea; 1 watt, 10c ea. Postage, 10c.
Ranging from 10 ohm-4.7 meg.

CASSETTE CARTRIDGES (PLUG IN)
C 90 \$3.75; C60 \$2.75.

CRYSTAL PICK UP ARMS

MO13 Stereo complete with crystal cartridge
PRICE, \$4.25; Postage, 20c.

GARRARD TURNTABLE BASES

Suit all Garrard turntables finished polished teak \$8.50
Also SRP22 bases finished polished teak \$8.50
Postage, 40c.

F.M. TAXI RADIOS

T.C.A. (Phillips) Low End, F.M. Mobile Units, 12 volt. Xtal locked 120 Kc. Bandwidth, Operating Freq. approx. 80 Mc, complete with all valves and Vibrator and Microphone. Suit Amateur Conversion, GOOD CONDITION.

OUR PRICE, LESS CRYSTALS, \$25.00. Freight and Packaging extra.

V.H.F. TRANSCEIVERS

TR1987 (TR1935) Supersedes SCR522, Freq. Range 115-145 M/C, Crystal Locked, 21 Valves comprising 6CQ5, 6AM6, EB91, 1AM5, TT15, QVO4/7. Suitable for conversion to 44 M/C Band. (Still current for aircraft bands). Brand new condition less crystals. \$30.00

ALARM BELLS

(Parachute type), 6 volt, Suitable for Burglar Alarms, etc., complete with trip rope, etc.
PRICE \$1.25, postage 50c.

No. 62 TRANSCEIVERS

Wireless Set No. 62 Mk. II (PYE). Frequency Range 1.6 to 10 Mc/cycles in 2 Bands, Inbuilt Genemotor Power Supply for 12-volt operation. Clean condition.
\$30 inc. circuit diagram. Packing 75c, F.O.R. Circuit Diagram 95c extra.

BENDIX FREQUENCY METERS

BC-221 Frequency Meters. Freq.: 125 Kc. to 20 Mc., including Crystals, A.C. Power Supply and Calibration Book. AS NEW.
\$49.50, Packing 50c, F.O.R.

(BC221)

Also available (as above) but including modulation facilities, spare valves and headphones. Brand new in original packing case.

Price: \$65.00.

RECORD CHANGERS (Stereo)

VERY well-known make, 8-inch, Automatic or Manual operation, 4-speed Ronette 105 Cartridge, Diamond Stylus, Guaranteed BRAND NEW in carton.
\$32.50. Polished Teak Base \$8.50 extra.

PICK-UP CARTRIDGES

Crystal (Mono), 1/2in mount, Sapphire Stylus .. \$2.00
Crystal (Stereo), 1/2in mount, Sap. Stylus 310 .. \$2.50
Ceramic (Stereo), 1/2in mount, Sap. Stylus 510 .. \$3.50
MAGNETIC .7 mil. Diamond Stylus, 20 cycles to 21,000 cycles, 6 mV (1 kc), Tracking Weight 2 to 4 grams/1/2in mount, Spare stylus available .. \$9.50

SOLID STATE STEREO AMPLIFIERS

7 WATTS (3.5W per channel), 8 Transistor, 2 Diode Circuit, 50-20000 c/s, Crystal/Ceramic Input (10,000 ohms), Harm. Distortion less than 2 per cent, 8 to 16 ohms output impedance, polished Teak cabinet, metal front.

\$40. Post \$1.25.

ANSWERS TO CORRESPONDENTS - continued

TRAIN CONTROLLER. I am a model train enthusiast of short standing and have read your articles on train controllers published in February and March, 1967, and in February, 1968. I have decided to build the latest unit and have started on the metal work. At the same time I decided to build the simple controller of February, 1967, but I wondered if it is possible to use a C20D thyristor in lieu of the C106Y1 to give more power. I am not red-hot on electronics, but the articles are very good and I can follow most of the working as explained. One thing I noticed in the circuit of the February, 1968, controller is that R13 resistor is shown as 1 ohm whereas the layout diagram shows three 3-ohm 10W resistors in parallel. Is this the case? I have discussed this controller with a TV mechanic and he says that a power transistor would work in place of the thyristor. I do not agree with this, and it seems to me that if it did work quite a lot of heat would be generated. What's your answer to this? I am keen to get going and see the controller in action. It sure sounds the goods! (K.E., Gunnedah, N.S.W.)

● Thank you for your appreciative comments, we hope that you find the controller satisfactory. Although we have not tried it ourselves, we feel sure that you could substitute a C20D or other high power thyristor in the simple controller as you suggest. The only changes necessary are the fuse (to 5A), the lamp (to 6V 6-36W) and the current-limiting resistor (to 1 ohm). The three 3-ohm resistors are in parallel to give an equivalent resistance of 1 ohm with the required power rating. We would suggest a similar arrangement or a higher power simple controller. Your TV mechanic is obviously not very familiar with thyristors. As you say, and as we stated in the articles, a transistor used in a train controller must dissipate power as heat because it behaves as a variable resistance. The thyristor, on the other hand, acts as a switch and has to dissipate negligible power. Incidentally, K.E., inquiries should be addressed to the Assistant Editor (see panel on first page of this section for details) and not to individual members of the staff.

W RECEIVER. I suggest that you feature a small solid-state 50KHz to 30MHz tuner in the near future. Selectivity and sensitivity should be the main features. An output of about 50mW would be sufficient, as most readers would have a suitable amplifier to boost this to good listening level. (M.W., Lindfield, N.S.W.)

● We would have to be convinced of the demand for such a tuner before embarking on the considerable task of designing it, M.W. While we recognise that there is a considerable body of short wave listeners in this country, we are by no means convinced that sufficient numbers of them could be prepared to construct a tuner as elaborate and expensive as this would have to be.

AMATEUR RECEIVER. I hope that you are interested in describing a new amateur receiver in the near future. I think that the last one was in 1965, which is now obsolete. (W.P., Hurlstone Park, N.S.W.)

● We agree that the 1965 amateur receiver — and the communications receiver of the same year — are not recommended designs as the tuner is no longer available. However, the 1967 series of All Wave receivers should meet most requirements. We are considering the possibility of developing an amateur receiver at some future date but other projects must take precedence.

EW DXER. I am a newcomer to the field of listening to radio on any band other than broadcast. Could you please tell me what QSL cards are for and how

does one obtain them? Since I am considering becoming an amateur radio operator in the future, will the G.P.O. supply information on sitting for a licence by mail, or do I have to inquire at a Radio Institute? (G.C., Balgowlah Heights, N.S.W.)

● The March, 1968, issue of Electronics Australia included an article on shortwave listening. This explains that a QSL card is a form of confirmation of receipt of a listener's report on a station's broadcasts. Hints on starting in the hobby of DXing are given along with the address of the Australian and New Zealand national DX bodies. A letter to either of these could start you in the hobby. Similarly, if you are interested in becoming an amateur radio operator we would suggest that you contact the Wireless Institute of Australia, (14 Atchison Street, Crow's Nest, N.S.W. 2065) for details of the examination requirements.

SHORT WAVE RECEIVER. I am interested in obtaining a circuit of a fully transistorised short wave receiver enabling me to receive broadcasts of amateurs around Adelaide and districts. Could you please supply me with information on the fees and the details of how I would obtain a circuit? (M.B., Para Hills, S.A.)

● We published a simple all wave two transistor set in June, 1960. Also, in the Basic Radio Course is a three transistor shortwave receiver. Either of these circuits would probably meet your requirements. Copies of the articles describing these receivers may be obtained through the Information Service for the usual 20c fee. See the panel at the foot of the first page of "Answers to Correspondents" for full details of this service and how to obtain information.

ELECTRONIC ORGAN. Recently you published articles on the single note organ which have sparked off my interest to build a three octave organ. Have you ever published a full circuit of such an instrument? If not, could you tell me where such a circuit could be obtained using locally available components? (K.H.F., East Bentleigh, Vic.)

● We published a series of articles describing an electronic organ from November, 1961, to June, 1962, inclusive. However, there may now be some difficulty in obtaining some of the parts. We are hoping to develop a new design at some future date, but as this involves a considerable amount of time we cannot predict any publishing date. We cannot advise as to any alternative source of such a design.

MARINE RADIO. I have a suggestion which has been on my mind for quite a while. How about investigating marine radio for fishing craft, yachts, etc? Say a transceiver and/or a receiver for marine frequencies with a direction finding loop? (N.P., Lindsfarne, Tas.)

● Every transmitter or transceiver to be licensed for marine radio must be examined by the P.M.G.'s Department. Home built equipment may not pass this test. For this reason, we have not entered this particular field of electronic design. We might investigate a receiver for these frequencies if there is sufficient reader demand.

You might consider the Universal Converter, which we published in September, 1961, as a solution to this problem. This can be crystal locked to frequencies from 1.6MHz to 60MHz and works from a 150-175V HT and a 6.3V LT supply. Copies of the article may be obtained through the Information Service for the usual 20c fee. A simple direction finding loop gives an ambiguous result (180 degrees error is possible.) To overcome this introduces problems which would demand more of our time than we feel could be justified at present.

WANTED

BY ALL
PRODUCTION ENGINEERS

ORYX

miniature
soldering instruments

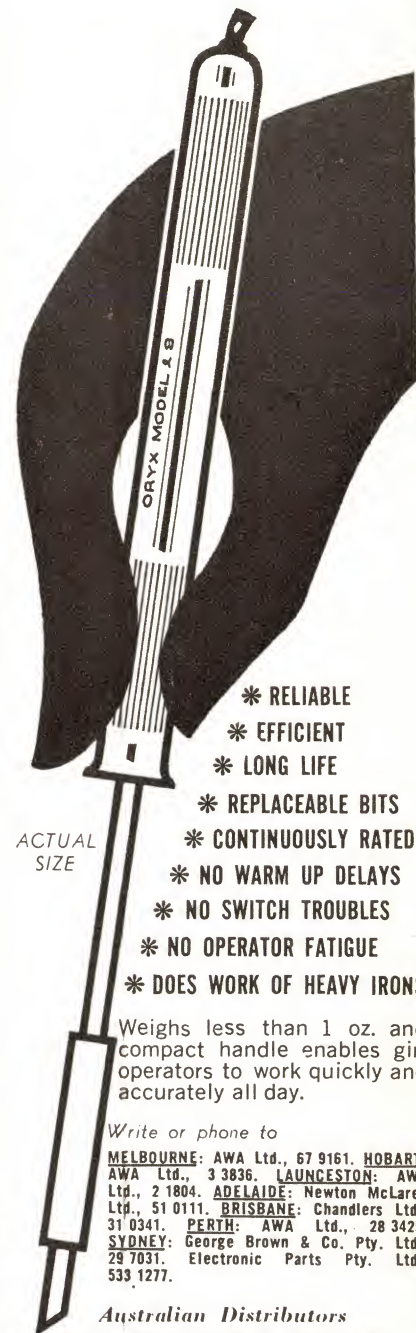

ACTUAL
SIZE

- * RELIABLE
- * EFFICIENT
- * LONG LIFE
- * REPLACEABLE BITS
- * CONTINUOUSLY RATED
- * NO WARM UP DELAYS
- * NO SWITCH TROUBLES
- * NO OPERATOR FATIGUE
- * DOES WORK OF HEAVY IRONS

Weighs less than 1 oz. and compact handle enables girl operators to work quickly and accurately all day.

Write or phone to

MELBOURNE: AWA Ltd., 67 9161. HOBART: AWA Ltd., 3 3836. LAUNCESTON: AWA Ltd., 2 1804. ADELAIDE: Newton McLaren Ltd., 51 0111. BRISBANE: Chandlers Ltd., 31 0341. PERTH: AWA Ltd., 28 3425. SYDNEY: George Brown & Co. Pty. Ltd., 29 7031. Electronic Parts Pty. Ltd., 533 1277.

Australian Distributors
MANUFACTURERS SPECIAL
PRODUCTS PTY. LTD.

47 York Street, Sydney. 2 0233, Ext. 284

ANSWERS TO CORRESPONDENTS—continued

OSCILLOSCOPE. I was wondering if you could publish a project in your magazine for a cathode ray oscilloscope. If you have already done this in a previous issue, I would be pleased if you could tell me

the month of issue so that I can obtain a copy of the article. (R.H., Altona, Vic.)

● We have published a new oscilloscope design nearly every year for many years. The latest was in the April, 1968, issue

which you have already seen. If you want an earlier design please specify what you need in the design and we will try to find a circuit to meet your requirements. Copies of the articles (or circuits only for the older projects) may be obtained through the Information Service for the usual 20c fee.

ELECTRONIC IGNITION. I want to build an electronic ignition system for a car with 12 volts and negative chassis. I understand that a capacitive discharge system was once published by Electronics Australia. Could I obtain a copy of this edition, or information on circuitry and components necessary to build this type of ignition system? (F.D., Clayfield, Qld.)

● The only form of electronic ignition system we have described was the more conventional transistor ignition. We published a series of articles on the subject from January to April, 1964, inclusive with a follow up article in June, 1964. Copies of each of these articles may be obtained through the Information Service for the usual 20c fee.

MALPRACTICE: I want to report a blatant example of a misleading advertisement. It says every reel 7-inch but, when you receive it, it is only half-full, with a very large centre hub — about 600ft of tape all told. Surely one has a right to expect a full reel. (W. F., Merrylands, N.S.W.)

● When we first read your letter, we thought it was a case of someone selling half-full reels of blank tape instead of full reels. Had this been so, we could hardly have blamed you for complaining. When we turned up the advertisement, however, we realised that it was for pre-recorded tapes. These are sold in various formats but one such format is 7-inch reel, 4-track stereo, 7ips. When the format is used to accommodate a major work, the reel may be full. When used to accommodate what is virtually the contents of an LP pressing, the reel may be more like half-full. In fact, all the pre-recorded "selections" we have in our possession would be similar to the one you mention, though carrying different labels. The price generally reflects the length of the work and its musical status — whether it is a recent performance by a big-name orchestra or a performance that is older or less notable. As far as we can see, the company is following accepted industry practice for pre-recorded tapes. The customer will be the ultimate judge as to the value of the product.

CRYSTAL CLOCK. In January you discuss the possibility of a crystal controlled clock. Such a unit would have to use solid state devices, to overcome mains failure problems. I had intended to use a 1MHz crystal with dividers to 100KHz, 10KHz, 1KHz and 50Hz. This would enable the instrument to be used for frequency checks for amateur radio equipment and provide an accurate 50Hz drive for an astronomical telescope. An article in the G.E. Transistor Manual describes a clock using tunnel diodes but these may be expensive and difficult to obtain. A digital readout would be rather expensive but could be investigated further. (B.D., Bald Hills, Qld. 4036.)

● Thank you, B.D., for your comments and suggestions. We agree that the unit should use solid state devices on the score of power consumption as well as space and other considerations. As to whether the unit would be operated from the mains is still open to debate. The idea of using a 1MHz crystal with the dividers as you suggest has considerable merit and it could be very useful. However, this suggestion is coupled with its use also for driving an astronomical telescope. Provided the gearing for the telescope is arranged for 50Hz based on the standard second then all would be well. However, if the clock is to be used for sidereal time then a crystal a little higher in frequency would be needed.



LUX SQ-1220

If you buy a stereo amplifier without hearing the LUX series you may be depriving yourself of complete satisfaction!

More LUX amplifiers have been sold in the time they have been available in Australia than any other high quality, high fidelity amplifier ever marketed in Australia. This is a big claim—and the LUX is a big amplifier. Each model offers tremendous value in terms of quality, features and performance. Many LUX circuits are patented in the U.S. and elsewhere; engineering and wiring will withstand the most critical examination.

THE NEW LUX SQ-1220 SOLID STEREO AMPLIFIER OVER 100 WATTS R.M.S. TOTAL OUTPUT!

The new and outstanding Lux SQ-1220 is rated at over 50 watts R.M.S. into an 8 ohm speaker load. Distortion is so minute it is difficult to measure even at high outputs. 40 transistors and diodes. Frequency response is 10-50,000 Hz. ± 1 dB. Provision is made for separate bass and treble controls in each channel, low and high filters, frequency selectors and tape monitoring. Ask for complete and unabridged specifications for this sophisticated Lux amplifier. Performance can only be described as superlative.

\$350

TYPICAL TRADE-IN VALUATIONS ON A LUX SQ-1220

The maximum you will pay with your Leak "Stereo 30", Leak "Stereo 20" (with Varislope pre-amp.) or Fisher 101 will be \$190. With your Quad Mk. II pre-amp. and power amplifier the amount will be a maximum of \$120. And it could well be even less!

LUX SOLID STATE STEREO AMPLIFIER — THE MODEL SQ-77 TW — \$169

Using silicon power transistors the SQ-77TW is rated at 30 watts R.M.S. in each channel with a 4-6 ohm speaker load. Frequency response is 10-50,000 Hz. plus 0, minus 3dB. Input sensitivity is 1.8 mV. for magnetic pickup or tape head, aux. Inputs being rated at 200 mV. and 800 mV. Controls include stereo volume, stereo balance, mode switch, treble and bass (separate controls for each channel), input selector, headphone jack and switch, tape monitor switch, rumble and scratch filter switches, etc. Use of advanced circuitry and ultra-modern solid state devices results in complete reliability and unique musical performance. In a beautiful timber cabinet. (Inc. Sales Tax).

\$169



MODEL SQ-77 TW

TYPICAL TRADE-IN VALUATIONS ON A LUX SQ-77TW

Changing up to a silicon transistor stereo amplifier can be quite economical; if you trade your Leak "Stereo 30", Leak "Stereo 20" (with Varislope pre-amp.), Fisher X100A or Pioneer SM83 your new amplifier will cost you a maximum of \$20. With your Peak TRM-40 you will pay only \$60, with your Star SA-30 the cost will be \$110 and with your Linmark SA-200 the changeover will cost a maximum of \$135. If your equipment is in excellent condition your payout can be substantially less!

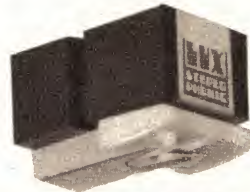

NEW LUX MOVING MAGNET STEREO CARTRIDGE

The Lux T-15-M has been acclaimed as a brilliant performer by discriminating audio enthusiasts — frequency response is conservatively quoted at 20-20,000 Hz. and stylus pressure is from 1 to 2½ grams. Tracking angle is 15°, output is 5 mV. at 1 kHz. Stylus sizes available are 0.7 mil. conical diamond and the new elliptical diamond (T-15-ME). T-15-ME: \$29.50. T-15-M7B (conical diamond stylus) Inc. Sales **\$24.50**

\$24.50

Encel
ELECTRONICS
(STEREO)PTY. LTD.

Head Office:
431 Bridge Rd., Richmond, Victoria 3121.
Tel. 42 3762.

Sydney Store: Ground Floor, 2SM Building,
257 Clarence Street, Sydney, N.S.W. 2000.
Tel. 29 4563, 29 4564.

*Wholesalers *Trade-ins accepted
Australia's Greatest Hi-Fi Centre

The article in the G.E. Transistor Manual is an excellent one and we are familiar with it. Fortunately, and contrary to your suggestion, tunnel diodes are available and they are not expensive. We agree with your remarks on the digital readout.

CRYSTAL CLOCK. I see that one of your correspondents is interested in a crystal controlled clock. Some years ago, a book which I believe was written by Rufus Turner referred to a circuit of a 100KHz crystal oscillator, developed by the U.S. Bureau of Standards. Stability was of the order of parts in 10^9 and 10^{10} . As I am away from home at present, I am speaking from memory only. Something over a year ago, I noticed the crystal controlled chronometer in the G.E. Transistor Manual. This uses a 100KHz crystal, with tunnel diode dividers dividing to 50Hz. No constructional details were given and I was wondering if the staff of "Electronics Australia" could develop a unit along these lines and publish it in due course. I am also interested in the (G.E.) audio amplifiers which seemed to be simple, yet were capable of a high quality performance. Perhaps you would be able to publish something along these lines in the near future. Also, could design details be given, so that readers could make suitable alterations to meet their own requirements. (R.W.F., Finschhafen, Territory of New Guinea).

Thank you, R.W.F., for your interesting comments. We are not familiar with the particular article on the crystal oscillator as developed by the National Bureau of Standards. However, we are aware of the work which they do along these lines. The orders of accuracy which you quote are easily attained at professional level and can even be bettered with modern devices. At the same time, we do not aspire to reach such orders of accuracy for the clock which we envisage! We are familiar with the crystal controlled chronometer which was included in the G.E. Transistor Manual and we hope to do something comparable with this sort of thing in the reasonable future. We agree that the audio circuits published in the same Manual look very good indeed. However, we have published a number of designs in the recent past and one of these may meet your need. The idea of giving enough design information for readers to make their own modifications would take up a prohibitive amount of space and even if we did, we would think of what nature some of the modifications might turn out to be.

ARTICLE REQUESTS. I have collected most issues of your magazine since August, 1962, and enjoyed every one. Can you tell me if you have published articles in any of the following subjects in recent years and, if so, in which issues? Electric fly trap similar to those in butchers' shops. RF oven suitable for domestic cooking. Sensitivity of a meter with mA FSD. Deviations from indicated value of old resistors. Linearity of scales in resistance measurements. Index reference to subjects and projects covered in the magazine. Cost of beginners' projects. (E.L., Armidale, N.S.W.)

Thank you for your comments, E.L., we are always glad to hear from a satisfied reader. We published a general article dealing with microwave heating in July, 1965, which may be of interest to you. We would not regard a device of this nature as suitable for home construction. We have not published an electric fly trap. An index is published each volume in the March issue. Incidentally, the mA FSD you quote is the sensitivity of meter movement. We assume you are concerned with the sensitivity of this basic movement when used in a voltmeter. The figure will be 1000 ohms per volt.

CAPACITOR VALUES. In your articles on cathode follower probes for CROs (September, 1957, and September, 1963), the circuits show the probe coupling capacitors as $2 \times 6800\text{pF}$, whereas in the photos the values are $2 \times 680\text{pF}$. Could you let me know which is correct? The

Technicians, Students, Hobbyists, Servicemen!

—a limited number of versatile, compact **TT1**

OSCILLOSCOPES

240V mains operated

are available at the unrepeatable price of

\$72

+ 12½% Sales Tax (\$81)
—complete with handsome vinyl carrying case

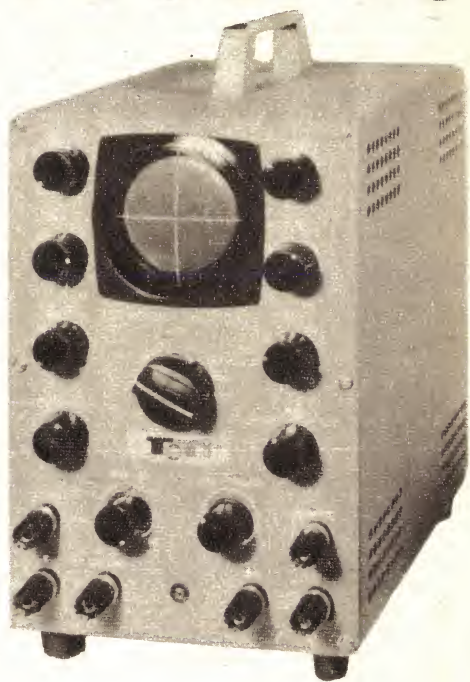

Here's your opportunity to acquire a practical oscilloscope at a truly unrepeatable price. Indented from a leading Japanese manufacturer, the TT1 CO-50 is an amazing versatile and compact oscilloscope. It is an indispensable instrument

to have in the Lab. or on the workbench, and because of its compact, portable design, a most handy tool to carry along on field trips or service calls—especially useful in trouble shooting radios, amplifiers and TV sets efficiently.

APPLICATIONS INCLUDE —

- **ORDINARY APPLICATION**—most widely used for waveform observation and measurement of voltages.
- **CHECKING IF SELECTIVITY CURVES**—this is done together with a Sweep Generator and the two instruments are important tools for efficient IF alignment.
- **UTILIZATION OF LISSAJOUS FIGURES**—this method is used for frequency measurements.
- **MEASURING PERCENTAGE OF MODULATION**—the Test signal is routed DIRECT to the deflection plates. This is used for adjusting transmitters.

Terms—cash with order, Freight Free within Australia from—

J. H. MAGRATH & CO. PTY. LTD.

208 Little Lonsdale St., Melbourne, Victoria, 3000. Phone: 32 3731.

WATKIN WYNNE PTY. LTD.

32 Falcon St., Crow's Nest, N.S.W., 2065. P.O. Box 392, Crow's Nest. Phone: 43 2107, 43 1912.

SOUND PROJECTORS

Cinevox Prefect and Hamour and Heath 16mm in good working order. 240v operated, complete with speaker and amplifier. from \$90

CIRCULAR SLIDE RULE

3/4in diameter. Will do the same work as the conventional slide rule. Instruction book included. \$1.25 each. Post 10 cents.

REFLECTOR GUNSIGHT

Contains these lenses:
1 Lens 1in Focus, 1/4in diam.
1 Lens 1 1/16in Focus, 1/4in diameter.
1 Air-spaced Lens, 1/4in diam.
1 Filter Lens, 1 Graticule,
1 Lampholder. \$1.85
Post.: N.S.W., 30c; Interstate: 40c.

P.M.G. TYPE TELEPHONES

Standard desk type with magneto bell calling device. Range 30 miles. Uses standard batteries at each phone. Any number can be connected together on single line. \$23.00

(2 TELEPHONE SETS)

30c cartage to rail. Freight payable at nearest attended railway station.

Please note we are now able to include 1/2 mile of telephone cable FREE with each set of Phones.

BATTERY CHARGERS

240 volt A.C. input. Each Battery Charger will charge either 6 or 12 volt batteries.
1 1/2 amp. without meter, \$13.75
1 1/2 amp. with meter, \$15.75
4 amp. with meter, \$19.50
Post N.S.W. 70c, Interstate 95c.

MINIATURE ELECTRIC MOTORS

1 1/2 to 3 volts DC. Ideal for model boats, cars, planes, etc. Strong torque. Only 65 cents each or 10 for \$4.00 (Post 7c)

TRANSCEIVER

(2-way radio) R.C.A. America RT 68. 24 volt. operated 10 watt output 38-54 meg/cycles F.M. crystal locked. Transmitter and receiver using frequency synthesiser in 100 K/c. step 10 channel per meg/cycle with power supply. Leads, mike and headphones \$90.00. 60c cartage to rail. Freight payable at nearest attended railway station.

GOOSE NECK LAMP

NEW. IDEAL FOR DESK or WORK BENCH. Adjustable shade Strong metal lacquered base and frame. Height 18in. Complete with lead. \$1.25 Post. and packing. \$1.

TRANSCEIVER

(2-way radio) 62 set ideal small ships, Hams, etc 1.6 to 10 megs. Crystal locked or B.F.O. controlled 5 watt output. Complete with antenna, headphones and mike but not air tested. \$60, air tested \$90. 60c cartage to rail. Freight payable at nearest attended Railway Station.

HEAD PHONES

Low impedance moving coil fitted with rubber muffler to reduce external noise, fitted with press to talk, dynamic hand microphone, ideal for use with all types of transceivers, \$3.50 pair. Same with black felt muffler, \$4.50 pair. Post. N.S.W. 25c; Interstate 30c.

RECORDING TAPE SPECIALS

EMI TAPE at a fraction of the Retail Price, direct from one of Australia's leading Broadcast studios. Used in good condition. 1,400ft. 7in spools, \$2.75, post 25c
900ft. 5in spools, \$1.60, post 25c
300ft. 3in spools, 65c, post 13c

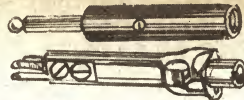

P.M.G. Phone Jack and plug, 25c each, 45s the pair. Post 7c.

NIFE CELLS

1.2 Volt fully charged, 4in x 3in x 1in 4 AH. \$1.00 each
Post. N.S.W., 25c; Interstate, 35c.
1.2 volts 15 AH, 6in x 4in x 2in, \$3.95
2.4 volt 10 AH, 6in x 2 1/2in x 2in, \$2.50
Post. N.S.W., 30c; Interstate, 40c.

WALKIE TALKIE TWO WAY RADIOS

P.M.G. Approved Citizen Band. 5 Transistor, \$37.95 per set of 2
9 Transistor, \$75.00 per set of 2
10 Transistor, \$98.00 per set of 2.
Post. N.S.W., 50c; Interstate, 60c.



P.M.G. TYPE KEY SWITCHES. 45c each, Post., 15c.

45 x 40 coated Lens with tripod. \$10.95

30 x 30 Power Coated Lens. Brand new. \$3.75

60 magnification with a 60mm coated objective lens. With tripod. \$23.00

As illustrated. Postage, 95c; Interstate \$1.20.

As illustrated. Postage, 95c; Interstate \$1.20.

HIGH STABILITY RESISTORS

I.R.C., brand new 1/4w., 1w, 2w, tolerance between 1 and not exceeding 5 per cent including 100, 360, 560, 750, 15K, 22K, 27K, 100K, 180K, 220K, 560K, 820K, ohms. Usual price 40c each, 50 assorted different values for only \$3.75 Post 15c.

522 TRANSCEIVERS

100 to 150 m/c. \$35.00

TYPE S POWER SUPPLY
(240 Vac supply for AT 5-ARB) suit most types of Disposal transmitters and receivers outputs 250 volt, 10ma, 550 volt 200ma, 300 volt 100ma, \$30.00.

TELEPHONE WIRE
21 gauge copper, plastic covered. Ideal telephone or bell wire. 1,320ft coil of twin (equal 1/2 mile). \$7 per coil. Post. N.S.W. 70c; Interstate \$1.20.

SWITCH BOARD FRAMES
Steel ex-P.M.G. Height 4 1/2in x 27in x 3 1/2in, will make ideal test bench. \$10. \$1.00 cartage to Rail. Freight payable at nearest attended railway station.

WHIP AERIALS
9ft in seven sections. \$3.75 Post: N.S.W., 75c; Interstate 30c.

SCOOP PURCHASE
Gramo. Motors. New. Made in U.S.A. 4-speed 240 volt A.C. 50 cyc. Only \$2.75 each. Post. N.S.W., 30c; Interstate, 40c.

AMPLIFIER
Subminiature 4-Transistor, Audio Push-Pull. \$7.00 Post 50c.

VALVES BRAND NEW IN CARTONS.

Special discount for quantity

807	75c	X61M	\$2.20
65N7GT	95c	CV850	\$1.50
89	\$1.00	1H6G	30c
12SA7	\$1.25	832	\$5.00
5U4G	95c	6F13	75c
77	\$1.00	6AK5	\$1.50
EF50	35c	6X4	\$1.00
6U7	75c	6F8	75c
V1103	\$1.00	12SK7	50c
VH120	75c	VR1120	50c
1L4	\$1.00	VR118	75c
5Y3	\$1.75	VR65	25c
6C4	50c	VT4C	75c
CV2184	\$2.95	AU8	\$1.00
2 x 2	75c	80	\$1.25
6AG5	50c		
12AU7	\$1.00	6AK5W	\$1.50

PLEASE ADD POSTAGE ON ALL ARTICLES

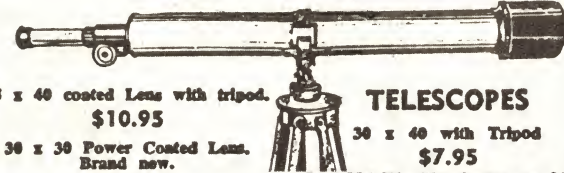

TELESCOPES

30 x 40 with Tripod \$7.95
Post N.S.W., 70c; Interstate \$1.20

EX ARMY TELESCOPES

4 x 40 Handley \$6.50
7 x 40 Otway telescope, \$9.85.
Freight payable at nearest attended railway station.

C.M.A. CABLE

240 volt 3/.036 black, new and perfect. 100yd rolls \$3.00; 6 or more. \$2.50

30c cartage to rail. Freight payable at nearest attended railway station.

MICROMETERS

Brand new Slocombe, 1in-2in, \$7.85. Post, 32c.

VIBRATORS, 6 volts, 7-pin, 75c each.

UNISELECTORS, 4 BANK, \$4.00 Post. N.S.W., 25c; Interstate, 30c.

INSTRUMENT TRIPODS, sturdy, wooden frame. Telescopic. Extend to 4ft 6in \$13.00

SELSYN MOTORS MAGSLIP Mk. II \$5.25 ea.

No. 19 2-way radios, with hand set, power supply, leads, \$35.00. Meggers, bridge type, complete and tested \$75.00

EVERSHED and VIGNOLES, 500 volts.

BINOCULARS

PRISMATIC. Coated Lenses. Brand new. Complete with case.

8 x 30	\$18.75
7 x 50	\$22.15
10 x 50	\$23.07
12 x 50	\$23.95
20 x 50	\$26.50

Post. N.S.W., 70c; Interstate, \$1.20

3000 TYPE RELAYS
P.M.G. 200 Ohm - 1,500 Ohm Colls. \$1.25 each.

MINE DETECTORS
Ex A.M.F. No. 2 Mk. 3, with Instruction Book. Complete in wooden case. Ideal for plumbers, councils for locating buried pipes, etc. Freight payable at nearest attended railway station. \$39.00

4 DIGIT RELAY COUNTERS
50-volt D.C., suit slot car. Lap counters, etc. \$1.25 each. Post 13c.

ALTEC STUDIO MICROPHONES
639B Western Electric, top grade, original cost \$250, Ideal Broadcast Studio, music recording, Church and play recording, etc. Fraction of original cost. Price on Application.

240 VOLT 522 POWER SUPPLY
Supplies all necessary voltages to operate 522 transceiver from 240 VAC. Complete and ready to plug in, \$30.00.

SPECIAL lucky dip valve offer. 15 new valves in cartons for only \$2.00. We haven't got time to sort them, so you reap the benefit. Post, 60c.

SOLENOIDS
Plunger Type 12V 300M.A. Suit electric camera control, miniature trains, radio, etc. \$1.25. Post, 10c.
200 Mill. amp., 24 volt, 1/8in push movement. \$1.25. Post 10c.

TELEPHONES
Sound Powered. Can be used as Microphone and Receiver. New. With 50ft cable, \$3.85 pair. Post, 25c; Interstate 40c.

MOBIL 2-WAY RADIOS
A.W.A. or S.T.C. Two-way radio. 75-80 M/c. 12-volt operated. \$45 each.

MINIATURE CRYSTAL EARPHONE
With Cord and Plug. 75c. Post, 4c.

FOUR CHANNEL BRANCHING AMPLIFIER
With 4in Va. meter GLORAD. Complete with Portable Power Converter, 600 ohm balanced input and output. Ideal for outside broadcasting, etc. \$39.50

BRIEF CASE AMPLIFIER
A.W.A. portable outside broadcast type G56830, 3 Channel. \$75.00

MONITOR SPEAKER UNIT
Ex-A.B.C., consisting of low resistance 6in speaker in Acoustic Labyrinth Baffle Box, complete with 10-watt amplifier, 600 ohms plus 5dbm input, 240 volt A.C. operated. \$37.50

TEN CHANNELS VHF TRANSCEIVER
Types TR1934 100-125 meg/cyc. and TR1935 125-150 meg/cycles. 28 volt DC operated AM single crystal locks both TX and RX on same channel complete with generator. \$33.00

CRYSTAL CALIBRATOR
With 500Kc crystal up to 32 meg/cycles. \$15.00

BENDIX BC221 FREQUENCY METERS
Built-in 240 volt power supply, perfect condition. \$90.00

Deitch Bros.
70 OXFORD STREET, SYDNEY, 2010
SORRY, NO C.O.D.

ANSWERS TO CORRESPONDENTS—continued

magazine's content is generally appreciated. An editor's job of maintaining a content which keeps up with the "state of the art" must be really difficult. How about an article on wiring to minimise the effects of capacitive pickup? (H. H., Fairfield, N.S.W.)

● Thank you very much for your appreciative comments, H.H. We believe that the problem of the capacitor values was published as an erratum, but before we started indexing them in the magazine. The correct value for these coupling capacitors is $2 \times 6800\text{pF}$, and we will publish an erratum to confirm this. The wiring problem will be considered, but has been covered many times in articles describing the construction of projects.

"POP" REVIEWS. I have found "E.A." to be the best magazine of its type available. However, I have one grievance in that there are a dozen or so pages devoted to record reviews but no attention is given to "pop" music. I would also like to suggest that teenagers interested in electronics try to get a holiday job in the industry to give them some idea of what the work is like. (M.W., Lindfield, N.S.W.)

● We have to draw the line somewhere in the time and space allocated to record reviews. Our assumption is that the majority of readers who have an interest in recorded music would have a preference for the range offered. Another point is that, in the pop field, technical quality is often made second to urgency and this doesn't mix too well with hi-fi concepts. We repeat your suggestion about holiday work but there is the very practical problem that many of the electronics factories shut down in January and casual work may be hard to find.

HOLES CANT MOVE: Congratulations on doing a fine job with so many diverse interests to satisfy. Two projects I would like to see repeated are the June, 1960, C.R.O. and the 1954 Signal Tracer. Finally, after reading up on semiconductors I remain unconvinced that holes can move. (J.C., Brunswick, Vic.)

● Thank you for the complimentary remarks. We doubt the wisdom of encouraging readers to spend money on a C.R.O. using a 5BP1 obtained through disposals sources. Tubes which might be 25 years old could easily turn out to be "duds." With the coming of TV, the emphasis seems to have gone off elaborate signal tracers and, if they are used at all, they are usually detector/amplifier types. The idea of a hole moving as a physical entity is stretching things somewhat. Think, rather, that the deliberate introduction of an impurity creates a discontinuity in the atomic structure and this creates a situation in which electrons can jump into a "hole," leaving behind a hole into which another electron can jump, particularly under the influence of an external field. In short, vacancies appear throughout the structure into which electrons can move. Please yourself whether you regard these as migrating holes.

GUITAR GIMMICKS. I have already added the fuzz-box and reverb unit to my Playmaster 60-watt guitar amp, and now have two suggestions to make. I would welcome the inclusion of a footswitch to key the reverb effect in and out, with a design that eliminates all clicks when keying. I visualise a circuit incorporating a second pot enabling a switch from one level of reverb to another predetermined level, and also a variable fade in and out of reverb. I wonder if you have considered presenting tape echo with its possible gimmicks. The retail prices of these devices is too much, and I would welcome such a design. Would the circuitry be too complex for home constructors? (J.K., Blacktown, N.S.W.)

● The switchable reverb unit might be a possibility if we thought there was sufficient reader demand, although the

circuitry involved may be fairly complex. The tape echo, however, cannot be done cheaply, as this unit must include most components of a normal tape recorder plus, for preference, multiple heads.

TRANSISTORISED TUNER. I am very interested in a transistor radio tuner to work with a commercial hi-fi amplifier. I am only interested in a unit covering the broadcast band, with an RF stage as I live well away from the chief city radio stations. Would you please let me know if you have described such a unit, and if so in what issue? (G.C.F., Caloundra, Qld.)

● We published a simple transistor broadcast tuner in the May, 1968, issue, and hope to give details of a more elaborate unit in the near future. The latter may not be suitable for your requirements, however, since it was not designed for high sensitivity and has no RF stage. It is intended primarily for wide range reception in good signal areas, although its performance when switched to narrow band would be similar to that of a conventional tuner.

SIDEBANDS. I have only just started short-wave listening but have often heard sidebands mentioned. What are sidebands, and how do you convert an ordinary receiver to receive them? (T.D., Turner, A.C.T.)

● This is much too big a question to answer in detail and one which really demands that you have to resort to a suitable textbook. Briefly, however, sidebands form an integral part of all modulated radio transmissions. They are additional frequencies, adjacent to the radio frequency carrier (hence the term sidebands) which are formed when a carrier is modulated. All the broadcast and short-wave stations to which you would normally be listening use amplitude modulation and radiate a carrier plus a pattern of sidebands which varies from instant to instant with the modulation. Your receiver is designed to accept and use the carrier and sidebands as part of its normal opera-

tion. We tip, however, that your question may be prompted by an expression that amateurs use, rather loosely, when they say that they are transmitting "on sideband." More correctly they should say that they are transmitting "single sideband" or "SSB" (with suppressed carrier). Here, one set of sidebands is removed and the carrier is also suppressed. To receive such a transmission properly requires a receiver which is not modified, but designed from the outset to have a very high order of ease and stability in its tuning system along with means of re-creating internally a signal which will replace the radio frequency carrier.

CRYSTAL CLOCK. Regarding your request to hear from readers interested in the proposed crystal clock project. My chief interest in such a project would be from a viewpoint of astronomy, both as normal sidereal timepiece, and to drive an equatorially mounted telescope. Although digital readout would be a great advantage, I feel that as this will be a relatively expensive project a major consideration should be that of cost. (T.D.K.S., Kingsford, N.S.W.)

● Thank you for your comments which are greatly appreciated.

GUITAR AMPLIFIER. I am interested in building a guitar amplifier and hope that you can send me a suitable circuit diagram. I wish to build a two channel amplifier of about 40 to 60 watts output, preferably using transistors, with vibrato or reverberation. (G.D., Newcastle, N.S.W.)

● We have not published any transistorised guitar amplifiers. However, we recently published two amplifiers using valves, both single-channel and incorporating vibrato. The Playmaster 116 (June, 1967) gives 40W output, while the Playmaster 117 (July, 1967) gives 60W. Reverberation was discussed in an article published in October, 1967. Other associated articles published at about the same time covered the subjects of a fuzz-box (August, 1967) and speakers for guitar amplifiers (September, 1967). Copies of each of the articles referred to may be obtained through the Information Service for 20c.

PARAMETER SPREADS AND FET PREAMPS

(Continued from page 45)

output from the pickup cartridge to tolerate some gain reduction. Probably the best approach would be to make the modification and then decide if there is sufficient output from the amplifier.

Alternatively, if, after having diagnosed an unsuitable FET, it is felt that the modification just described is rather involved or is just too "fiddling" a second modification is possible. The second approach is to completely replace the field effect transistors with the more conventional bipolar transistors.

As it works out such replacement requires no change of the printed wiring board pattern, but simply the replacement of a few existing components on the board, and the addition of a resistor soldered across the back of the printed wiring board. A circuit diagram of this modification has been included alongside the original section of the circuit concerned, to aid in the replacement.

Most of the resistor values have been changed, and care should be exercised, when connecting up the transistors, to ensure that the emitter, base and collector leads are in the correct positions. It may be seen from the

connection diagrams that the analogous transistor base lead and the FET gate are transposed in the respective devices.

Further, in the interests of retaining the high input impedance we suggest that the balance potentiometer should be made 5Mohms. With the modifications as shown, the input impedance remains unchanged from the original. However, before discarding the original 2M potentiometer it may be well to perform a suitable listening test, as it may be found that in some cases the bass response is perfectly satisfactory with a slightly lower input impedance.

Finally, the 600K base bias resistor must be soldered to the back of the printed wiring board as there was no equivalent component in the original design. Inspection of the wiring board will reveal the appropriate position for this resistor, from the base to the junction of the 2.7K and 22K resistors.

Well, there are the modification details, if required. Possibly the quickest and most convenient approach is the second modification, simply involving the substitution of required components.

(a) The discharged energy should be replaced on the basis of between 120 and 180 pc and the charging cycle should be spread over not less than 12 hours. Charging at an excessive rate, or for an excessive time, will generate heat within the cell which will hasten its ultimate failure.

(b) The conventional secondary cell, such as a lead-acid cell, can withstand being completely discharged, and can be immediately recharged with little apparent effect on its performance, even though this practice is not recommended in the interests of the long term life of the cell. The Leclanche cell, on the other hand, simply will not withstand such a complete cycle. It is generally considered that once the cell falls below one volt, no further reactivation is possible. Best results are obtained when the cycle is kept as shallow as possible, recharging is performed as soon as possible after discharge, and follows the recommendations in (a).

(c) All authorities appear to agree that any form of reactivation, no matter how carefully performed, will accelerate the shelf deterioration of the cell.

Now, what do all these requirements mean in practice? In broad terms they add up to a quite critical procedure; far more critical than recharging as normally practised with secondary cells.

If the cell is overcharged, either in rate or time, it will be damaged. If,

in an endeavour to avoid this complication, the charge rate or charging time is deliberately restricted the full potential of the reactivation process is sacrificed. To many, this may be an acceptable compromise, on the basis that any improvement is better than none. Thus, whereas J.G. and other enthusiasts may increase the energy yield of the cell by 8 or 10 times, the non-technical user may feel that the process is worthwhile if it increases performance by a much smaller factor, provided this can be achieved with negligible effort on his part.

This, in fact, was the basis of reactivation as it was presented to the public during the 1952-53 era. Battery operated valve sets, designed basically as portable sets, were fitted with an alternative mains power supply, so that the set could be used as a domestic receiver during the week, and at the beach at the weekend.

There were two popular systems of reactivation. In one, reactivation took place while the set was operating from the mains. In the other, it occurred only when the set was switched off, but while it was still connected to a live power point. This latter arrangement gave the user some control over the period of reactivation, if he wished to exercise it.

Because of the limitations already noted, the most that the set manufacturers dared do was provide minimum reactivation, such that under the worst conditions the risk of damaging the batteries was reduced to a minimum,

while under the best conditions one could hope that their life would be extended by around three times.

Once again, on the basis that it was something for nothing and that one does not look a gift horse in the mouth, this would seem to be an acceptable arrangement. Unfortunately, there is still one snag. Where the normal life of a battery extends over many months, shelf deterioration cannot be ignored. Thus factor (c) becomes significant.

According to the reference already quoted (P. H. Adams), it was possible to nominate a pattern of usage in which operation was predominantly from the mains with regular but relatively short periods of battery operation at the weekend. Under these conditions the life of a typical 90V "B" battery was reduced (by reactivation) to about 0.8 of its normal life.

Considering all the foregoing factors, and the "ifs" and "buts" which arise from them, it is not surprising that reactivation enjoyed only a brief popularity on the consumer market. Any lingering temptation there may have been to retain it vanished when the transistor replaced the valve and the cost of operating a portable set dropped dramatically.

One final point. In the original article which prompted J.G.'s remarks, our comments were confined to the alkaline-manganese cell. They were prompted by what appears to be a popular misconception; that this is a secondary cell, designed for recharging. This is apparently due to confusion with the nickel-cadmium cell.



EDDYSTONE "EB36" RECEIVER



Devaluation Price.
Only \$190.80 F.O.B.
(Inc. S.T.)



Frequency Coverage
Range 1 8.5—22.0 MHz
Range 2 3.5—8.5 MHz
Range 3 1.5—8.5 MHz
Range 4 550—1500 KHz
Range 5 1500—350 KHz

Also available for
Export ex Bond.

The "EB36" is a fully transistorised broadcast model, light, compact, easily transportable and engineered to give the best possible performance. It is a versatile receiver giving coverage of the long, medium and shortwave bands including the marine frequencies used by coastal vessels.

Comprehensive information from
Australian representatives

R.H. Cunningham

608 COLLINS ST., MELBOURNE, VIC. 3000, 61-2464
64 ALFRED ST., MILSON'S PT., N.S.W. 2061, 929-8066

L. E. BOUGHEN & CO., 95 CENTRAL AVE., SHERWOOD, QLD. 4075, 79-2207

H. J. McQUILLAN PTY. LTD., 1017 WELLINGTON ST., WEST PERTH, W.A. 6000, 21-4821

K. FARMER SALES PTY. LTD., 286 GILLES ST., ADELAIDE, S.A., 5000, 23-6131

ADVERTISING INDEX

A.C.E. Radio	142, 143
Adcola Products Pty. Ltd.	40
Aegle Pty. Ltd.	39
Agfa-Gavarr Ltd.	120
Akal Electric Co. Ltd.	48
Amalgamated Wireless (A'asia) Ltd.	42, 54, 146
Amalgamated Wireless Valve Co. Pty. Ltd.	46
Ampere Electrical Mfg.	71
Amplion (A'asia) Pty. Ltd.	71, 105
Arrow Electronics Pty. Ltd.	108
Asdic Stereo Specialists	100
Astronic Imports Division	64, 107
Atram Pty. Ltd.	70
Audio Engineers Pty. Ltd.	68
Aust. Radio and TV College Pty. Ltd.	Back Cover
Aust Sound and TV Pty. Ltd.	118
Beech Electronics	159
Bright Star Radio	139
British Institute of Careers	74
Broadway Electronics Pty. Ltd.	78, 79
Broadway Electronics (Sales) Pty. Ltd.	2, 3
Brown, Thomas C. & Co. Pty. Ltd.	115
Chapman, Maurice and Co. Pty. Ltd.	66
Chrysler Electric Co. Ltd.	110
Classic Radio	90
Classic Tape Recorders	61
Classified Advertisements	159
Comtel International (Vic.) Pty. Ltd.	137
Convoy International Pty. Ltd.	84
Cunningham, R. H. Pty. Ltd.	158
Deitch Bros.	156
E.D. and E. Sales Pty. Ltd.	94, 95
Electronic Tube Distributors	141
Elmes Inst. Pty. Ltd.	101
Encel Electronics (Stereo) Pty. Ltd.	19, 75, 111
	123, 150
Fairchild Australia Pty. Ltd.	44, 45
Falk, Fred A. (Sales) Pty. Ltd.	102
Ferguson Transformers Pty. Ltd.	32
General Accessories Ltd.	62
General Electric Company	28
Goldring Eng. (A'asia) Pty. Ltd.	22, 112
Gray, Simon Pty. Ltd.	20, 92
G.R.D. Instruments Pty. Ltd.	Inside Back Cover
Haco Distributing Agencies Pty. Ltd.	Inside Front Cover
Ham Radio Suppliers	152
H.B. Radio Sales	109, 113
Homecrafts Pty. Ltd.	118
International Correspondence Schools	129
International Dynamics Pty. Ltd.	84
I.R.H. (A'asia) Pty. Ltd.	72
Jacoby, Mitchell and Co. Pty. Ltd.	24, 86, 150
J.H. Reproducers Pty. Ltd.	104
Kiapp Electronics Pty. Ltd.	77
Lafayette Electronics Division	128
Leak, H. J. (Aust.) Pty. Ltd.	98
Lerova Industries Pty. Ltd.	136
Loveiock, F. C. Pty. Ltd.	60
Magrath, J.H. and Co. Pty. Ltd.	82
Manufacturers Spec. Prod. Pty. Ltd.	16, 153
Marconi School of Wireless	127
Mastersound Sales Pty. Ltd.	97
McLellan Wm. J. and Co. Pty. Ltd.	4
Model Rocket Industries	145
Mullard-Australia Pty. Ltd.	26
National Radio Supplies	130, 131, 132
O'Rourke Industries	159
Paton Electrical Pty. Ltd.	83
Philips Electrical Pty. Ltd.	159
Phonetic Australia	41
Postmaster-General's Dept.	34
Pye Pty. Ltd.	140
Quad	106
R.A.A.F.	5
Radio House Pty. Ltd.	134
Radio Parts Pty. Ltd.	119
R.C.S. Radio Pty. Ltd.	140
Recorded Music Salon	88, 112
Sansul Electric Co. Ltd.	56
Sato Parts Co. Ltd.	136
Shalley, Peter Electronics Pty. Ltd.	116
Solartron Australia	36
Standard Telephones & Cables Pty. Ltd.	10, 76, 80
Stott's Tech, Correspondence College	125
Technical Book & Magazine Co.	124
Technical Training Int. Pty. Ltd.	85, 126
Tel-Leigh-Tubes	149
Thomas Electronics of Aust. Pty. Ltd.	50
Thomas, Ron & Associates Pty. Ltd.	58
Trio Corporation	6, 7
Turnbull, Bill	119
Union Carbide Australia Ltd.	148
United Radio Sales	35
University Graham Inst. Pty. Ltd.	82
Warburton Frank Ltd.	38, 144
Watkin Wynne Pty. Ltd.	155
Weston Electronics Pty. Ltd.	14
Wills, S. E. Trading Co.	121
Wireless Institute of Australia (N.S.W.)	119
Wonder Wool Pty. Ltd.	103
Zephyr Products Pty. Ltd.	30, 116, 138

CLASSIFIED ADVERTISERS ELECTRONICS Australia Classified Columns

USE THIS FORM FOR YOUR NEXT ADVERTISEMENT TO APPEAR IN THE

To the Advertising Manager,
ELECTRONICS Australia,
Box 2728 G.P.O.
Sydney. 2001

Endorsement
Residential Address
State

● Please insert the following
advertisement in the
..... issue

● I enclose P. Note/Cheque for \$.....
being full payment for..... lines at \$0.60 per line.

FOR SALE WANTED READER SERVICE POSITION VACANT

Please write in block letters with ink or ball-point pen. Number of insertions

"ELECTRONICS Australia" SPECIAL ORDER FORM

Guarantee yourself a complete set of issues for
your library with no copies missing.

SUBSCRIPTION RATES

	PER YEAR
Australia, New Guinea, Fiji	\$4.00
New Zealand	\$5.00
United Kingdom and British Commonwealth	\$6.00
Elsewhere	\$6.00

POST THIS COUPON TO:—

The Circulation Manager, ELECTRONICS Australia,
Box 2728, G.P.O., Sydney, 2001, Australia.

Name

Address

Enclosed is \$ for years. Start with

(Please use cheque, money order, etc. Do not enclose cash)

Is it possible for all
these features to be concentrated
in ONE turntable?



Model 655

Yes, LABCRAFT
has them all!

A highly advanced transcription turntable with professional wow, flutter and rumble specifications. The Labcraft ranks amongst the world's top semi-professional turntables; wow and flutter <math><0.15\%</math> peak, rumble 35 db below reference level at 1.4 cm/100cs. The Labcraft is designed for the exacting audiophile who insists on highest quality in performance and design. Its unique construction with several exclusive features insures faultless operation and reduces service to practically nought.

G.R.D.

Instruments Pty. Ltd., 6 Railway Walk,
Camberwell, Vic. 3124. Phone 82 1256

■ Belt drive from patented motor suspension which isolates all vibration from base plate, arm and turntable.

■ Functions perfectly — "rumble", "wow" and "flutter" completely eliminated.

■ Outstanding Danish design produced under strict quality control: every turntable individually test-run and carefully checked before leaving the factory.

■ Drive spindle ground and polished to extremely fine tolerances. (0.000,04").

■ Fully shielded motor, (windings "potted" in epoxy resin), placed at left rear corner enabling use of the very lowest level unshielded magnetic pickups.

■ The turntable is provided with nylon and bronze bearings. These are self-lubricating and no lubrication should ever be necessary.

■ The speed can be adjusted manually. The asynchronous motor (not tied to mains frequency) has a special governor independent of mains voltage and frequency.

■ Stroboscope lines are moulded in the turntable mat for a guide in speed adjustment.

■ Base plate ready drilled to take "All Balance" or "B & O" pickup arms.

■ Motor fitted with special secondary winding providing a free source of 15 volts A.C. supply for powering a transistorised pre-amplifier.

■ Pickup arm rest with built-in start/stop switch.

■ Accessories include ash, teak or palisander base, plastic cover, lightweight metal arm, oil damp arm lowering device, automatic off-switch, solid state stereo pre-amplifier.

Labcraft



for those who
consider design and quality
before price



YOU CAN EARN BIG MONEY IN TELEVISION

ASK YOURSELF THESE 3 QUESTIONS!

1. Am I in a dead-end job?
2. Could I earn more by learning more?
3. Could I use my spare time to get ahead?

If the the answer is yes, there is room for you in radio/television!

NOW IS THE TIME TO TRAIN!

Does your job offer good prospects — real security? Does it hold your interest? If not, now is the time to do something about it. Television is expanding daily. It's the most exciting subject you can study. The sky's the limit for the trained man . . . but only the trained man. Radio and television technicians are in huge demand. Train for success now, in Australia's fastest-growing industry! Join the ranks of skilled men . . . the Australian Radio and Television College can train you for a bright future with unlimited prospects. Send for the free booklet "Careers in Radio and Television" . . . and find out how A.R.T.C. can bring you success—in your own business or as well-paid technical staff!

A.R.T.C. CAN TRAIN YOU AS IT HAS THOUSANDS OF OTHERS

For over 30 years A.R.T.C. has successfully trained thousands of progressive Australians who realised how much the training could mean to them. Now they're making big money in radio and television. Training can bring you success, too.

FOR A FEW PENCE PER DAY YOU CAN STUDY THE A.R.T.C. WAY

. . . in your spare time, you can equip yourself for a rewarding career in radio/television. The future belongs to the trained.

The A.R.T.C. "Service Engineering Course" teaches you from the ground up . . . step by step . . . at your own pace. Remember, opportunity is always knocking for the trained man!

PRACTICAL UP-TO-DATE LESSONS

At the work benches and lecture halls of A.R.T.C. — or in your own home by correspondence — you can learn every necessary aspect of radio and television, every application of fundamental principles. The Course gives you both basic and advanced instruction in all phases.

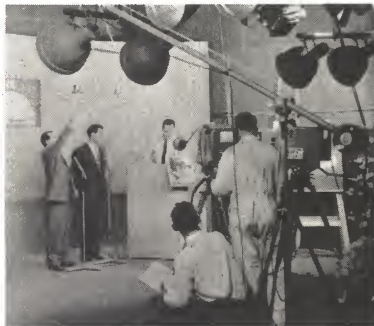

No previous experience or high educational standard required . . . only enthusiasm and normal intelligence. A.R.T.C. will give you all the instruction you need. Each lesson is made easy to understand by numerous illustrations and diagrams. The Course adapts itself to your requirements, your speed. It's up to you! Instruction is individual and intensely practical.

THOUSANDS OF SUCCESSFUL STUDENTS HAVE PROVED THIS

Make spare-time money!
Make your spare time earn money for you while training at home.

Many students make extra money after only a few weeks' tuition. Use the modern A.R.T.C. workshops, if more convenient.

GET INTO ONE OF THESE PROFITABLE CAREERS IN RADIO/TELEVISION

GET INTO ONE OF THESE PROFITABLE CAREERS

There is a career for you in one of the many phases of radio/television, including manufacture, servicing, research, sales, executive positions in broadcasting and television, armed forces.

A.R.T.C. can help you gain one of these sought-after careers. Remember, it's the trained man who wins, every time!

MAIL COUPON NOW!

Safeguard your future! You are invited to send in the coupon below. A.R.T.C. will mail you by return their big free and post-free booklet, "Careers in Radio and Television." This exciting book shows you definite steps you can take towards a big future—how you can succeed in life and find satisfaction in doing a worthwhile job well.

AUSTRALIAN RADIO AND TELEVISION COLLEGE

PTY. LTD.
E. S. & A. BANK BUILDING,
Cnr. Broadway and City Road, Sydney.
(Opp. Grace Bros.) Phone 211-4244 (3 lines.)

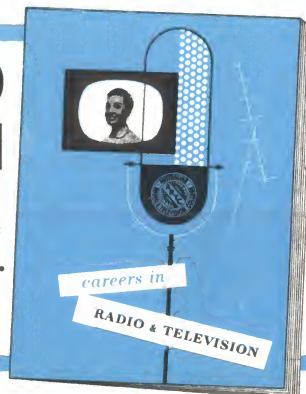

AUSTRALIAN RADIO & TELEVISION COLLEGE PTY. LTD.,

206 Broadway, Sydney, N.S.W.

Dear Sir,

Please send me, without obligation, your free booklet "Careers in Radio and Television."

NAME

ADDRESS