

# DRAGON



# USER

The independent Dragon magazine

December 1986

## Contents

- Letters** 2  
Pokes ... puzzle conversion...competition answers please ... tape head tales ... any CAD?
- People's Chart** 3  
Who is top of the pop, whiz, pows for Christmas? Vote and see.
- News Desk** 4,6  
Packet radio software ... handy paper hanger ... Analyzer corrections ... Incentive move ... joysticks now available ... arcade game ... Basic 42 update .. NDUG ... greetings, disasters and apologies.
- Communication** 5  
Send us your questions; send them your answers.
- Take command** 8  
The last and final part of the Orbaum and Campbell Machine Code Quest ... this time around.
- Dragon Soft** 10  
New utilities from Grosvenor and Knechtel; music and games from Maridian; re-review of Ninja Warrior, by special request; Gordon Bennet from Smithson. Shock, horror!
- LHEX** 12  
Malcolm Cowan provides a flex dump command with a Welsh accent.
- The Story of C** 14,16  
Brian Cadge looks at a language which is gaining ground in industry.
- Basic 42** 18  
Roy Coates reviews the new system software and utilities from Harris Micro Software.
- Shuffle Word** 20  
P. Marlow plays musical anagrams in the first of a pair of word-wobbling games.
- Arcade Arena** 24  
Read the Expert's Christmas wants list first — then you can read the super games poke list. Plus a map of Fantasy Fight.
- Joystick** 27  
A small hardware conversion to bring switching action to Dragon-compatible joysticks.
- Disc to Tape** 28  
Peter Whittaker demonstrates how to save disc programs onto tape and save costly storage space.
- Adventure Trail** 32  
Mike Gerrard reviews new adventure software from readers and writers.
- Competition** 38  
Out on the tiles for starters, but finish by crossing Santa with a Snowman to make a perfect square. Well, almost ...

## Editorial

FAIR, fat and forty pages this month. The Dragon trading nation has been saving up its pennies for Christmas, with the result that our advertisers are back in force this month. I hope you lot have been saving your pennies for an extra game or two to make their effort worthwhile. So, you get tired of a game in the end? So donate it to Mr. Orbaum. With disc drives like his, he needs something he can play on tape ...

The Royal Horticultural Halls in London, Mecca of the minor micro (as I write, the Electron users are gathering for their annual show), is host to Microdeal and the 6809 Show on 22 November. Be grateful that I have a prior engagement in York, or you could find me there with a tray of backissues. Dragons, Dragons, lovely Dragons, get your Dragons here.

I have half a dozen July '86 issues here in the office. £1.25 each, first come, first serve. We may subsequently have news on where you can get good copies of this rarity. Sorry, I can't tell you where they came from — nobody seems to know. The tooth fairy?

One of our good suppliers may not be back in the Dragon market next year. See if you can spot which one, and send 'em a Christmas card, because they've done well by the old machine. And a happy Christmas to you all if I don't see you till after the hols...

**Telephone number**  
(All departments)  
437-4343

**Editor**  
HELEN ARMSTRONG

**Production Editor**  
BARBORA HÁJEK

**Associate Editor**  
JOHN COOK

**Editorial Secretary**  
ANNE MARIE O'DWYER

**Advertisement Manager**  
RODNEY WOODLEY

**Administration**  
GERALDINE SMYTH

**Marketing Manager**  
Helen Perry

**Managing Editor**  
PETER WORLOCK

**Publishing Director**  
JENNY IRELAND

**Subscriptions**  
UK £14 for 12 issues  
Overseas (surface) £20 for 12 issues  
ISSN 0265-177. Telex: 296275  
Dragon User, 12/13 Little Newport Street,  
London WC2H 7PP  
US address: c/o Business Press International,  
205 East 42nd St, New York, NY 10017  
Published by Scot Press Ltd.

© Scot Press 1986  
Typesetting and Production by Artext Limited,  
London NW1.  
Printed by Headley Brothers Ltd. Ashford, Kent  
Registered at the Post Office as a newspaper.  
Dragon and its logo are trademarks of  
Eurohard Ltd.

### How to submit articles

The quality of the material we can publish in *Dragon User* each month will, to a very great extent depend on the quality of the discoveries that you can make with your Dragon. The Dragon computer was launched on to the market with a powerful version of Basic, but with very poor documentation.

Articles which are submitted to *Dragon User* for publication should not be more than 3000 words long. All submissions should be typed. Please leave wide margins and a double space between each line. Programs should, whenever possible, be computer printed on plain white paper and be accompanied by a tape of the program.

We cannot guarantee to return every submitted article or program, so please keep a copy. If you want to have your program returned you must include a stamped addressed envelope.



## Computer program

I ACCIDENTALLY discovered that it is possible to tune in an ordinary VHF radio and hear the Dragon processing. If you place the radio tuned in to any space between broadcasting stations and run a program, you will hear definite signals. Loading, entering, processing data, displaying the results and waiting for an input all produce different sounds. I wonder if it would be possible to fit an antenna to the co-ax socket to improve the broadcast!

Paul Scott  
15 Ryde Court  
St. Thomas St.  
Ryde  
IOW

PS Why do advertisers' postage and packing rates vary so much? How can one company justify £2 for posting a cartridge when another charges 75p or 50p or nothing at all?

**COULD BE handy if you're making coffee in the kitchen, Paul. But are you sure you weren't just picking up one of**

Tommy Vance's late nighters?

P&P charges often incorporate other overheads associated with running a mail order service, which is why big companies sometimes seem to make disproportionate charges for small packages. That, and the well known toss a coin method!

## Win and load

MAY I raise my voice in support of Mr. O'Malley in his request for the solutions of the competitions to be published. I frequently attempt the competitions but often fail to reach a conclusion. It would be interesting to know the methods which the winners use. As for what should be left out, well, I have never seen the use of charts so I would not be sorry to see the People's Chart go.

Another way of saving space lies in the area of machine code programs. Every machine code program is accompanied by a loader program. Regular readers (and we must all be

regular readers now) must have umpteen such programs or at least the ability to write their own, so why not drop them? Alternatively, print one program that can be adapted to different line lengths and give notice that no more will be published.

D. Bateman  
14 Hawthorn Way  
Royston  
Herts SG8 7JP

WELL, we're working on it — it's now partly down to Gordon Lee, a hard working chap like most of us, finding the time to write a bit more for us each month. However, as the winners are judged on their elegance, it won't always be the winning few who get the guvnor's scrutiny - as much can be learned from looking at the less well turned programs as from the 'best' ones.

Secondly, it's a fundamental of all technical publishing below professional level that articles are self contained. You wouldn't believe the number of letters we get from people looking for a 'loader' program of one sort or another. Don't be tempted, Mr. Bateman!

different modification to the program.

David Gray  
570 Acklam Road  
Middlesborough  
Cleveland, TS5 8BE

## Free pokes

I HAVE just finished compiling two A4 sheets containing pokes and cheats for Dragon games. They are designed as quick reference sheets so that you can easily find the poke you want without searching through your collection of Dragon Users looking for the right month. There are 55 games covered, including The Dark Pit, Jet Set Willy, Manic Miner, Shock Trooper and many pokes which have never been printed.

If any DU readers would like copies of these sheets then I'll be happy to supply them if they send me a stamped self addressed envelope, plus a 20p coin to cover the cost of photocopying.

Paul Burgin  
18 Moorcroft Road  
Sheffield, S10 4GS

## Tape head tales

COMPLIMENT: October edition is best one yet.

Suggestions box: hopefully most Dragon users with cassette based media no longer suffer the dreaded I/O Error syndrome, but for those who do, try adjusting the head azimuth of the tape recorder. Shock horror! Yes, it is safe to do. Use the Audio On and Motor On commands to listen to the tape through the TV/Audio output, and using a jeweller's screwdriver, adjust the azimuth by turning the screw located behind the Play head. This is normally accessible through a tiny hole in the top case. After adjusting the head for maximum volume and sharpness of sound, the tape should load OK. If your other tapes then refuse to load, simply repeat the process using one of your previously saved program tapes.

Questions: anyone tried the Rainbow mod to get switchable normal/inverse video on the CoCo to see if it works on the Dragon? Anyone got a non working DOS cartridge for sale? Or a cheap working one? (Need it to house own DOS.)

Warning: I have a Sanyo DR101 data recorder, out of guarantee, well used, expensive — it now erases every tape I try to load with it. When the problem started happening (only occasionally at first) I thought it was me. Prognosis: terminal, caused by wear in the plastic erase head guides (bin it).

Paul Read  
7 Fairview Avenue  
Whetstone  
Leicester LE8 3JQ

**WHOA, hold on, just one moment...call Sanyo Marubeni on 0923 46363 before you bin your investment, ask for the Service department, and you will find that they can either sell you a replacement part (if you are able to fit it) or quote you for a repair. Let's be fair, you would wear out too if someone was dragging a length of iron-impregnated plastic across you for hours on end.**

For postal enquiries, Sanyo's address is Otterspool Way, Watford, Herts WD2 8WD.

## Magic puzzle

I RECENTLY found lurking on the local micro-shop shelves a DragonDOS version of Sprite Magic. To my dismay it would not run with DragonDOS version 4. Investigating the problem, I found that the word list and function list addresses and the addresses of word and function display tables were different from those expected by Sprite Magic.

Using a backup copy (prudent precaution in the event of a mistake) I found the following method overcame the problem:  
CLEAR 200,&H6000  
PROTECT OFF  
"SMCODE.BIN"  
LOAD "SMCODE.BIN"  
POKE &H6EFD,&HDA  
POKE &H6F02,&HC1  
POKE &H7865,&H8D  
SAVE  
"SMCODE",&H6E80,&H7FFF,&H6E80

I assume that CumanaDOS and SUPERDOS users will face the same problem but will require a

THANKS, Paul. When sending coins through the post, tape 'em well down to the paper and wrap at least two sheets round them. Loose coins have a way of leaving envelopes en route.

## Any CAD?

IT IS heartening to see that DU has been able to run four extra pages. I rely on the magazine to keep me up to date, so while looking forward to its monthly appearance, I also look forward to its long term survival.

My children use the Dragon for games, while I mostly use it for preparing technical papers, lectures, etc. A very useful extension for me would be the ability to use it for draughting or Computer Aided Design. The problem here is that there no longer seem to be people rushing to produce CAD programs for the Dragon - could you consider an article which reviews the CAD software available for the D32 and D64?

M. L. Monaghan  
18 Downsway  
Shoreham-on-Sea  
West Sussex BN4 5GN

# Dragon User People's Chart

JINGLE BELLS! Jingle bells! The pantomime season must be here again, because *Bean Stalker*, from Micro Vision, has clearly been applying some strong stuff to its roots and has shot up to the top slot. Look out for falling toilet rolls ...

What about all this new stuff, then? We were going to announce grandly that if all those hardworking software writers out there worked their fingers just a little nearer to the bone, if the avalanche hit us in time for Christmas, we should see some new names in the Chart. Well, we can't speak, can we? Four new reviews down the plug to oblivion. When Jason rang to say he'd had a crash, we thought he must have fallen down the stairs, but it was worse than that...

But at last! At last! We have the X factor! A bit of a narrow squeak, to be sure, but he's gone and done it. Mr. Robin Hemmings of Wigston, Leicester, sends us this tie breaker: "I 'Juxt' need Part III!". Alas, it is not to be — but he should be getting some freebies soon.

Vote! Vote! Send in the form printed here, or a copy, with your five favourite progs, and if you send us a knee-knotting tiebreaker made up from the letters (or some of 'em) of your own top three, you could win £25 worth of games software from MICRODEAL.

## Results November 1986

- 1 **Bean Stalker**.....(Micro Vision)
- 2 **Juxtaposition** ..... (Wintersoft)
- 3 **Shaolin Master**.....(Quickbeam)
- 4 **Shocktrooper** ..... (Microdeal)
- 5 **Jet Set Willy**.....(Software Projects)

## Chart Ten

Voting for Chart No. 10 closes at 1pm on Friday, 12th December 1986. Entries received after that time will not be eligible for inclusion in that month's voting. The editor's decision is final. Only one entry per individual per month will be allowed.

My top 5: Voting Month 10

- 1 .....
- 2 .....
- 3 .....
- 4 .....
- 5 .....

My phrase is:.....

Name .....

Address .....

.....

.....

.....

.....

.....

100 SCREEN

From... **Smithson Computing**

**FRANKIE**

£6.95

WITH **HACKER'S DELIGHT**

THE MOST AWESOMELY BRILLIANT GAME YOU WILL EVER PLAY ON YOUR DRAGON

Frankie. An incredible 100 screen all action arcade game. Can you as Frankie Stine escape the madcap mayhem created by the evil Doctor Van Load? Negotiate the lifts, slides, collapsing and electric floors, moving platforms as well as the rock dropping vampire bat flying across and guarding the exit. Egor, the evil doctors willing slave, has been sent to make sure you never make it. Be careful as he scales the sides firing lightning bolts at you. Shoot, yes! you are equipped with a laser, at the bolts to neutralise them (not to mention the feet, eyes, noses, mouths, hands etc. that bounce about the screen). The trouble with shooting your laser is that your energy goes down quicker — more problems! However, help is at hand with the aid of 'Hackers Delight' — if you can find our how of course....

SMITHSON COMPUTING, 24 COAL HILL GREEN, BRAMLEY, LEEDS, LS13 1DR. Tel: 0532 551631.

DR17



## Analyzer corrections

The author of analyser has contacted us with corrections for two errors concerned with the row insert command.

The altered lines, to replace the lines with the corresponding numbers in the listings, are as follows:

```
12 POKES1,T+O:GOSUB1:
RETURN
85 Z=VAL(MIS(T$(X),T+1,2)):
IFK=.GOSUB125:NEXT:
RETURN
114 IFAS(M)="ANDBS(M)="
ANDCS(M)="ANDDS(M)="
NDES(M)="ANDFS(M)="
ANDGS(M)="ANDHS(M)="
ANDIS(M)="ANDJS(M)="
THENM=M1:GOTO114
122 IFL(X)=R THENL(X)=
L(X)+1
123 NEXT:FORX=70TOY:IFM
(X)>R*Q THEN(X)=M(X)+Q
124 NEXT:GOTO29
125 IFR>Z THENRETURNEL
SEMIDS(T$(X),T+1,2)=RIGHT
$(STR$(Z+1),2):RETURN
```

## Monsters

Monster Alley is a multi screen arcade game which runs under (and only under) Sprite Magic. Players are required to collect keys while avoiding monsters, and a built in cheat mode accesses the next screen.

The game costs £2 from K. Hunt, 11 Demarnham Close, West Bromwich, B70 6RI. The first 25 orders will receive a 'free adventure' with it. Sprite Magic is not on sale with the game.

## Apology

Quite inadvertently, Dragon User, The Expert and reader David Barclay combined to give the impression that the map of Juxtaposition on page 29 was Mr. Barclay's own work. The map was in fact originally supplied by Wintersoft, a point not made sufficiently clear by Mr. Barclay, who simply wanted to share his good fortune other readers. In a letter to The Expert, he says 'Please could you stress that I only sent it in for the readers, and give the credit to Wintersoft, as I

don't want to get a bad name for myself.' Dragon User and Mr. Barclay would like to apologise to all concerned for this misunderstanding.

## Incentive move

Incentive Software, known to Dragon users for Moon Cresta, have appointed an International Sales Manager, Phil Ingram and a Designer/Programmer, Chris Andrew. This expansion is accompanied by a move to bigger premises at 2 Minerva House, Calleva Park, Aldermaston, Berks RG7 4QW.

## More joy

Konix, makers of the smooth, flash and till now very exclusive Speed King joystick, have announced that production has finally caught up with demand by upping their capacity from 3,500 a week last January to 50,000 a week right now.

Since the Speed King was launched many prospective customers have either had a long wait, or been unable to lay hands on the device at all. Now it should be freely available from computer dealers.

As well as the Dragon 32, the Speed King is compatible with most other micros, including many of the Amstrad models. It

costs £12.95. For more information (and mail order) contact Konix at Unit 12-14, Sirhowy Hill Industrial Estate, Tredegar, Gwent NP2 4QZ.

## Harris update

Harris Micro Software's BASIC42 (reviewed in this issue) has now been updated to work correctly with 'patched' versions of DragonDOS as well as Eurohard's versions 4.0 and 4.1. The Eurohard compatible version is designated at BASIC42 1.0(E) to cope with different locations in the Eurohard DOS.





# VDU OPERATORS DO IT WITH A



Patent Pending

# THINGI<sup>®</sup>

computer copy holder

THINGI<sup>®</sup> MADE IN ENGLAND  
WORLD PATENTS PENDING

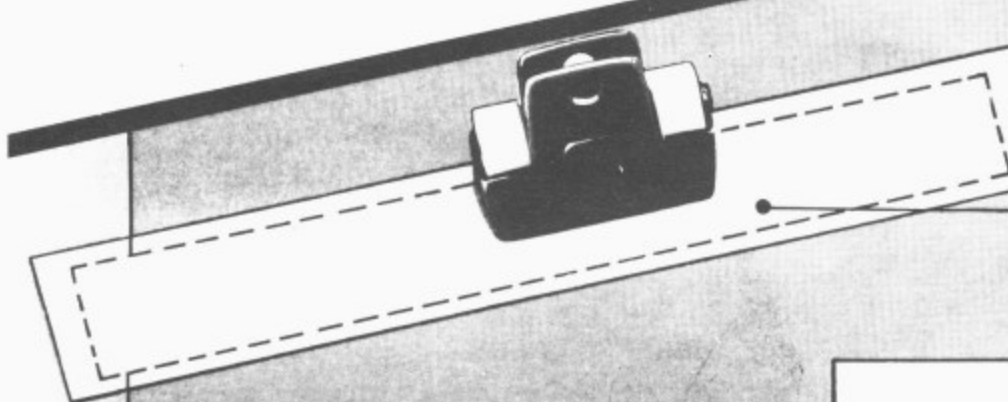

PROMOTE YOUR BUSINESS  
HERE  
*Keep your name in front!*

Makes an Ideal Gift -  
Everybody needs a Thingi!

- Unique Velcro<sup>™</sup> Fastening

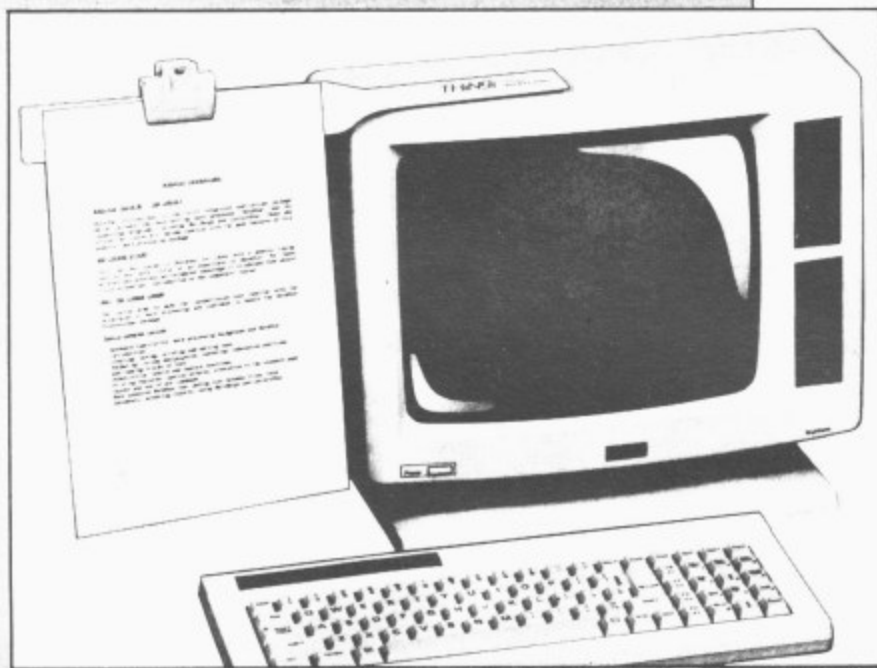
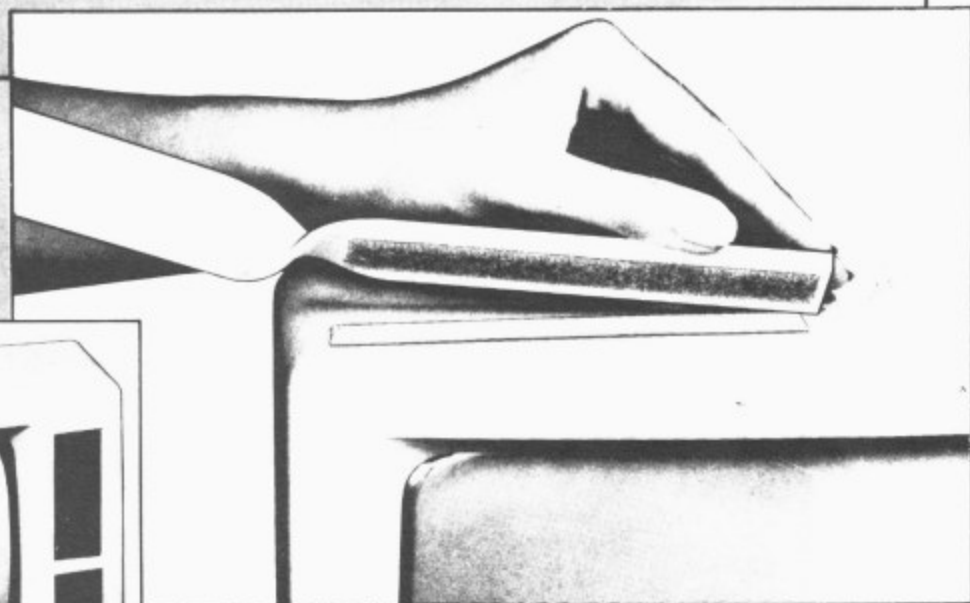

The Thingi creates working space out of "thin air".

- Left hand or right hand versions.
- The compatible low cost solution to the problem that plagues all computer users!

*Don't struggle any longer -  
GRAB YOUR THINGI NOW !!!*

#### SPECIFICATION

- Scientifically designed, holds single/multiple sheets or magazines hundreds of applications not just computers.
- Completely adjustable, holds copy in optimum position to reduce neck and eyestrain.
- Will increase productivity dramatically by improving accuracy and input speeds.
- Virtually indestructible in normal use.

**DIRECT ORDER HOTLINE**

Your nearest Stockist is:

**OVERBASE LTD.**  
1st Floor Trace Building,  
176 Conway Street,  
Birkenhead, Wirral L41 3JB  
England.  
Tel: (051) 647 8981 (6 lines)

R.R.P.

£6.99

exc. VAT  
and P & P

Telex: 265871 MONREF G Ref 72: Mag 20290

ANOTHER GREAT BRITISH PRODUCT EXPORTED WORLDWIDE • DEALER ENQUIRIES WELCOME



## Packet radio

Grosvenor Software have launched a major new product for radio amateurs with Dragon 32/64s or Tandy Color Computers. Known as the AX25 system, the makers say that this is the first software solution to AX25 packet radio developed in the UK for any computer.

Packet radio uses a radio transceiver and a computer to utilise other AX25 radio stations as 'digipeaters' (digital repeaters) to send signals far greater distances than could otherwise be achieved. With

satellites such as the Japanese JAS-1 (already in orbit) and PACSAT (to be launched soon) reliable world wide contact at 1200 Baud, using amateur power VHF transceivers is already a reality. The AX25 package contains complete error checking, with auto-retransmission where needed, and can also be used on HF where the standard is 300 Baud.

A packet radio Terminal Network Controller costs around £200 — the AX25 system, written by Mike Kerry G4BMK, halves this by allowing a Dragon to be used alongside a conventional modem which, as it is not hooked into the

telephone system, does not have to be BT approved.

The software comes on ROM cartridge or disc, and supports 300 and 1200 Baud operation. Six contacts can take place at once, with text for contact selectable on the display, with full scrolling even in conversation. The 'transparent' option allows the transfer of text files and programs. Up to eight repeater stations can be specified.

A complete package with ROM software and a 1200 Baud VHF modem is available for £99. The software alone costs £49, and an HF modem adaptor will be available shortly.

Tandy computers need extended Basic and 32k minimum RAM to operate.

Grosvenor, who specialise in amateur radio software, also have packages available for RTTY, ASCII, Morse and AMTOR receive and transmit, and SSTV receiving. Up to three programs can be supplied on one cartridge.

Customers should state their computer model and (if they have one) callsign when ordering. Orders to Grosvenor Software, 2 Beacon Close, Seaford, East Sussex BN25 2JZ. Please send an SAE for further information about any of their programs, or phone (0323) 893378.

## Your own THiNGi

HOW many THiNGis to a NiNGi? Who cares — the British creators of the THiNGi are richer by £5000 and a slap on the back after winning the Business Idea of the Year award for their brainchild. Overbase Ltd., the happy company, call the THiNGi 'The greatest contribution to information handling since the paperclip'.

The THiNGi is actually a tres simple little device based on Velcro and a bulldog clip for holding type copy exactly on a level with a VDU. The attraction is that the copy is upright, next to the screen, and won't blow away when the door opens. It

reduces, claim the makers, neck, back and eye strain, and improves accuracy and typing speed. And people won't put their coffee mugs down on your copy ever again.

Quick to attach and fully adjustable, the THiNGi looks like a cheap solution to copy holding, as well as a convenient and versatile one. It's available in left and right hand versions, and can also be customised with the name of a club or company for promotion and fund raising.

THiNGi costs £6.99 plus VAT and p&p — for further information contact Overbase Ltd. on 051 647 8981.

## Business books

A new guide for small business managers who buying their first computer systems has been published by the author, Enid Mumford, Professor of Organisational Behaviour at Manchester Business School.

The 78 page book, Using Computers for Business Success, explains in straightforward, step by step terms how to analyse business needs before choosing hardware and software, how to reorganise the business environment and job specifications to make the best use of new technology.

The book is available from Manchester Business School, Booth St. West, Manchester M15 6PB, and costs £8. Professor Mumford is the deviser of the ETHICS method (Effec-

tive Technical and Human Implementation of Computer-based Systems), and has written this and three other titles on setting up systems for working environments, based on this method. In 1983 she was awarded a gold medal for her contribution to information science.

## NDUG

The National Dragon Users Group is still going strong. Their newsletter, Dragon Update, appears monthly with articles, reviews and technical tips. For more information contact the Chairman, Paul Grade, 6 Navarino Road, Worthing, Sussex.



## SEASONS GREETINGS

The staff, publishers and contributors of Dragon User wish all our loyal readers and our commercial supporters a happy Christmas and a prosperous Dragon year in 1987.

The sceptics said that the Dragon couldn't survive, but they reckoned without the machine's own sterling qualities, which has kept an enthusiastic bunch of users active. Long may it continue!

## Disaster

Dragon User was intending to run several games reviews in this issue, including Microdeal's Tanglewood, and Quickbeam's 68098 Express and People's Chart regular Shaolin Master. Unfortunately, our reviewer's disc drive went down at the wrong moment, leaving him to rewrite approximately 20 pages of typed copy. The missing reviews should be back in place next month.



# Communication

Send in your questions, requests, and pleas to Communication, Dragon User, 12-13 Little Newport Street, London WC2.

**Problem** 1) Can you tell me if there is a way to read and load a disk in DragonDOS format with the Premier DeltaDOS because I want to make a backup of such a disk 2) Is there a way to use the Dragon in 64k mode with the Premier DeltaDOS?

**Enquirer** Eric de Pessemier, 33 Rue Klakkedelle, 1200 Brussel, Belgium.

**Problem** I want to use my Dragon 32 to communicate via a MIDI link with a Roland TR-707 drum machine. I intend to use a 6850 ACIA but I need to know what function each of the pins in the cartridge port do. Also, I am writing a machine code program to play Othello and I would be grateful for the address of routines which perform arithmetic (including EXP(X)) and where to put the operands.

**Enquirer** Paul Etchells, 28 Pinderfields Road, Wakefield WF1 3NQ.

**Problem:** Does anyone know how to connect the speech chip SP0256AL 2 to the Dragon's printer port? I can't get it working.

**Enquirer:** Henk Bender, Beatrixstraat 1, 3286AA Klaaswaal, The Netherlands.

**Problem:** I require a text editor for the OS9 operating system, to use with the Pascal compile, or can anyone tell me how to prepare or edit pascal files and programs?

**Enquirer:** Mr. A. Durant, 11 Heaton Park Road, West Yorkshire BO9 5QA.

**Problem:** I can't get in touch with Steve Gathercole — has anyone got a copy or whole listing of SS.RAM by Darren

Eteo from *Personal Computer News* 1983?

**Enquirer:** Philip Callaghan, 54 Penkvale Road, Moss Pit, Stafford ST17 9EY.

**Problem:** Help and advice wanted on hacking programs etc., how to discover pokes for changing program details. **Enquirer:** A. M. Burton, 9A Riverview Road, South Benfleet, Essex SS7 1JT.

**Problem:** I am in desperate need of an instruction booklet for the TEHTSTAR. Do you know where I can purchase

one, or any of the readers of your magazine? I would willingly pay for it if necessary.

**Enquirer:** Mr. R. A. Hall, 66 Sterry Road, Heathway, Dagenham, Essex RM10 8NX.

**Problem:** Wanted: Stylograph word processor. Also, does anyone have a screen dump for the EPSON P40 printer? **Enquirer:** J. Boyle, 9 Inchmurrin Crescent, Balloch, Alexandria G83 8JJ, Scotland.

**Enquirer:** Mrs. L. Fitzgerald, 62 Langdon St., Sharrow, Sheffield S11 8BJ.

## Communication

Stuck for a routine? Need some obscure equipment? Feeling cut off? Fear not — someone, somewhere can help you! Write down your problem on the coupon below (make it as brief and legible as possible) together with your name and address and send it to Communication, Dragon User, 12/13 Little Newport Street, London WC2H 7PP. We'll publish it as soon as we can — meanwhile, maybe there's someone you can help this month!

**Problem** .....

.....

.....

**Name** .....

**Address** .....

.....

SAVE £3 !!!!!!! SAVE £3 !!!!!!! NOW ONLY £14.95 POST FREE!!

## THE NEW DE-LUXE TOP VALUE LIGHT PEN

FOR THE DRAGON 32/64

THE NEW ADVANCED PROGRAM

for the Trojan light pens include the following facilities —

- DRAW BOX
- DRAW CIRCLE
- DRAW LINE
- DRAW PICTURES FREEHAND
- COLOUR FILL DESIGNATED AREAS
- SAVE AND LOAD PICTURES TO AND FROM TAPE
- FULL ERASE FACILITIES

All in Hi-Res screen in any of 4 colours for the Dragon 32/64.

PLUS: FREE voucher entitling you to a £2 DISCOUNT off top Dragon games. (Applies to orders received by 24th December

Now available from exclusive distributors PEAKSOFT, 48 Queen Street, Balderton, Newark, Notts. NG24 3NS. (Same day mail order service

By phone with credit card



0636 705230.



- DATA ENTRY AND PROCESSING
- MENU SELECTION AND CONTROL
- GAMES PLAYING

This is a first class program which gives hints and tips on how to write programs for the pen. Ideal for many educational uses.

A top quality pen plus a first-class program. The best value pen package available.

# TROJAN



Micro Computer Software & Accessories



# Take command

*The last part — for now — of Orbaum and Campbell's machine code tutor*

ACTUALLY, although we've called this the final part of the machine code epic, what it actually represents is the termination of the first part of the series. If you hold on for a bit, you may get another part.

This month we give you a list of every command you will need to program simple machine code, complete with an explanation, in fairly complex terms, of what each command does. The explanations should be no problem if you have taken in all the other articles in this series.

Firstly though, note that any assembler file must begin with an ORG command.

This tells the assembler at which place in memory the assembled code is to be put. This area of memory must be cleared before use. Therefore, if your program begins with the command 'ORG 20000' (which is where we place most of our code), then before assembling one should type CLEAR 200, 19999 to clear the memory.

To assign labels storage areas the commands FCB, FCC, and FDB are used. For example, if one wishes to use a location to store cursor position then the command 'CURSOR FDB 0' will set up a double (hence, the D) precision location at the ad-

dress assigned to the line on assembly. FCC allows entry of text to be converted for, say, a data table for an adventure. More details on assembler directives can be found in the manuals of most good assemblers.

Now, the table (please note that this does not contain the branch instructions as they have already been covered in some detail):-  
ADD: adds into register specified after command memory location specified after register, ie ADDA \$400 adds the contents of memory location \$400 into A. ADDD £\$400 adds \$400 into D. Works with A, B, and D. Affects H, N, Z, V, & C flags in CC

**AND:** Logically ANDs 8 bit register specified with memory location storing result in 8 bit register, ie ANDA \$400 logically ANDs A with the contents of location \$400 while ANDB £127 logically ANDs B with the number 127 thus clearing the top bit of B. Affects N & Z, clearing V in CC flag.

**ASL:** Arithmetic shift right: shifts all bits in specified register one bit to the right thus multiplying register by two. A zero goes into bit zero while bit seven goes into C in CC.

**ASR:** Arithmetic shift left: shifts all bits in specified register one bit to the left thus dividing by two. Bit zero goes into C of CC while bit 7 remains the same.

**CLR:** Sets an 8 bit register or memory location to zero. Clears N, V, & C, and sets Z in CC.

**CMP:** Compares two values, a register and a memory address, does not affect either value, simply affects CC bits N, Z, V, and C.

**DEC:** Subtracts one from specified 8 bit register or memory address.

**EOR:** Logically exclusive ORs a register with a memory location storing the result in the register.

**EXG:** Exchanges the values in any two registers of like size.

**INC:** Adds one to the content of any eight bit register or memory address.

**JMP:** Jumps to a given address.

**JSR:** Jumps to subroutine.

**LD:** Loads a register from a memory address with a value through the user of £).

**LEA:** Used for addition and subtraction within X & Y for simple programming, ie LEAX 3,X will add three to X. LEAY -14,Y will subtract 14 from Y and LEAX D,X will take the value of D as a two's complement number and add or subtract from X accordingly.

**NEG:** Negates an eight bit register or a memory address.

**NOG:** No operation. Does absolutely nothing.

**OR:** Logically ORs register with memory location storing the result in register.

**PSH:** Pushes registers onto stack (named as S or U).

**ROL:** Rotate a specified register left. All bits in named register go one bit left, bit zero takes carry and bit seven re-fills it. Therefore to shift all or register D left one must clear the carry, then ROLB, ROLA.

**ROR:** As ROL only rotates right.

**RTS:** Return from subroutine.

**ST:** Store specified register at specified memory location.

**SUB:** Subtract contents of memory location from register.

**TFR:** Copy the contents of specified register into second specified register. Registers must be of like size.

**TST:** Tests a specified register or memory location to see if it is zero. Sets N & Z flags in CC.

And there you have it. The end of Part One. Hopefully if you start playing around with the commands you now know them by the time Part Two gets here you should find it really easy! Happy coding.

# CRAZY SALE

EXCLUSIVE  
TO DRAGON USER

## OF INCENTIVE BLOCKBUSTERS

ARCADE

### BACKTRACK

DRAGON USER STAR GAME

— 5 DRAGON RATING —

Normal RRP £6.50

CRAZY SALE

PRICE

**£2.95**

STAR  
GAME

ADVENTURE

### THE KETTRILOGY

3 ADVENTURE FOR THE  
PRICE OF ONE!

Normal RRP £9.95

CRAZY SALE PRICE

**£3.95**

### EDDIE

### STEADY GO

DRAGON USER

5 DRAGON RATING

ARCADE 66 LEVELS

Normal RRP £6.95

CRAZY PRICE SALE

**£3.95**

### MOON

### CRESTA

5 DRAGON RATING AGAIN!  
THE OFFICIALLY LICENCED  
SHOOT EM UP CLASSIC

Normal RRP £7.95

CRAZY SALE PRICE

**£3.95**

ARCADE

ARCADE

### CRAZY SALE ORDER FORM



Please rush me (1st Class Post)

Backtrack £2.95

Kettrilogy £3.95

Moon Cresta £3.95

Eddie Steady Go £3.95

I enclose my cheque \_\_\_\_\_ please debit card no. \_\_\_\_\_

Name / Address \_\_\_\_\_

Incentive Software, 2 Minerva House, Calleva Park, Aldermaston,  
Berkshire RG7 4QW.

Orders only accepted with this form or photocopy received by 31st  
January 1987.

DR30



## Postman in cross-channel cheek shock!!

**Program:** *Disk Support Tool 1.5, 1.6*

**Supplier:** Bernd Knechtel Software, Arnold-Wilhelm-Str.9, 5630 Remscheid 11, West Germany.

**Price:** £7 + £2 p&p

ANOTHER disc doctor/utility type program, this time from West German Bernd Knechtel Software, for the Dragon with DragonDOS. Two versions of the program are available: version 1.5 is for DragonDOS 1.0 to 1.2, and version 1.6 is for DragonDOS 4.0 (Eurohard's ROM). In terms of options, both programs are identical.

I first saw a pre-production version of this program some months ago (it was called 'Disk Doctor' then). Since then, Knechtel has added a few new options and removed a couple of completely useless ones. So, for software which has been so long in development, which do you get?

A completely menu driven, very user friendly (almost to excess) suite of utilities called by BOOTing the disc. The first options allows a disc to be formatted - nothing very special in that, except that it will also put a loading utility on the disc which allows a program to be loaded and the DOS then shut down: useful for programs like Telewriter.

The second option is a 64k backup program which can also be used on Dragon 32s if you are lucky enough to have working 64k RAM chips fitted (these were on the later Dragon models). Single drive users can use this option to backup a disc with only eight swaps.

Similar to Backup is the next option, 'Filecopy'. Rather than copy the disc sector by sector, it copies it file by file. This allows you to append files to a disc from another, or backup a disc with some bad sectors.

A printer directory can be output using the next option, including information on start, length and entry addresses for machine code programs. Of course, from Basic a normal directory listing can be output by typing POKE III,254:DIR.

Option 5 is called 'Re-write', and reads in each sector before writing it back out to the

disc. The manual says it is 'used to refresh the contents of the disc', and if you believe that ...

The 'Rename' option allows files to be renamed as in Basic, but also allows the infamous 'null named' file to be renamed.

More useful for single drive owners is option 7, 'Single Drive Copy'. This works the same as the DragonDOS COPY command, but with a single disc system - copying individual files between discs.

The backup directory option simply copies track 20 (the directory) to track 16 (the backup directory). This is very simple to do from Basic, using SPREAD/SWRITE.

The majority of directory errors are caused by 'CC' (cyclic redundancy) errors on the directory track, so an option to

copy the backup directory to track 20 would have been useful. Unfortunately, the nearest you get is 'exchange directories' which does the job, but fails if either track cannot be read!

Finally, option 10 allows you to access Basic and DragonDOS commands (or some of them), such as CREATE, KILL, PRINT etc.

Overall, there are a few useful options available in this software, such as the FORMAT/LOAD utility and the single drive file copy. There are also a lot of utilities which can easily be done in one line of Basic, such as the directory backup copy and the directory print.

I mentioned earlier that the program is very user friendly, which is useful to begin with

but tedious when you have to confirm that you want to execute a particular option several times over.

Originally, this software was priced at £15, which, it seems, even Knechtel has now realised is too high. At half the price, it is worth considering, but there are a lot of other disc utilities around which offer comparable or better features. Knechtel states in the manual that if you get a faulty disc, then return it with a postal order for £3 to get a replacement. What a cheek!

*(A supplier who supplies faulty goods should replace them free of any charge, including post and packing - Editor.)*

Brian Cadge



## Full support and no bugs, either

**Program:** SuperDOS disc controller ROM

**Supplier:** Grosvenor Software, 2 Beacon Close, Seaford, E. Sussex BN25 2JZ.

**Price:** From £10 plus p&p (see advertisements).

GROSVENOR Software come up with apt names for their software, and their new SuperDOS disc cartridge ROM chip again lives up to its name. Apart from the riddance of all bugs known to Grosvenor through their intimate knowledge of DragonDOS and errors reported in the pages of *Dragon User*, this DragonDOS compatible chip is FULLY SUPPORTED — that alone makes it worth its weight in gold, so it is superb value at £10. The removal of the FE error made it a particularly worthwhile investment for me (I know that DragonDOS 4.0 removed this bug, but I couldn't stand its DIR operation and couldn't boot up OS9 either...). Being fully supported, I threw in a few faults that I had come across that had not been corrected in early SuperDOS issues, and I now have for the first time what I consider to be a totally error free DOS — and many of you must know what a bashing I give my system.

Why should use SuperDOS? Everyone with a Dragon Data or Cumana disc controller. Cumana DOS users will lose the SCOPY facility, but that is a minor loss compared with what will be gained. DragonDOS 4.0 users will still be taking a giant step forward as 4.0 is still littered with bugs. Grosvenor offer a cheap fitting service for those not wishing to dabble inside their controllers themselves.

**I now have for the first time what I consider to be a totally error free DOS...**

Is it really DragonDOS compatible? If you have enhanced from DragonDOS 1.0 to 4.0, you will know that the 'end address' parameter of the machine code "SAVE" statement has been corrected to match the originally intended cassette "CSAVEM" so that programs containing such a SAVE command will need to

have a byte lopped off that parameter (only actually necessary if the additional byte save affects operation when the file is reloaded). Otherwise, all software that references the DOS using Basic commands or the 'jump' table will run without modification. Early versions of Disc Telewriter will need an upgrade (free) from Microdeal to the version that uses only 'standard' DOS calls and Smithson Computing's Electronic Author (version 2.0) needs a 2 byte patch for its DIR facility to work with SuperDOS. Any other compatibility problems will be investigated as advised to Grosvenor Software.

Should you be considering investing in a disc system, include the cost of SuperDOS in the evaluation — PNP Controllers come fitted with SuperDOS — as what is the point of having a faulty engine in a Rolls Royce of a disc system? That, unfortunately, unlike some other home micros, is what we have got with the Dragon. Give your disc system a treat — give it a super duper SuperDOS.

Pam D'Arcy



## Reviewer in four letter word horror!!

**Program:** Gordon Bennett  
**Supplier:** Smithson Computing  
**Price:** £4.99

BLAH blah blah Manic Miner clone blah blah blah Even I'm getting fed up with them blah blah nicely done blah blah but who's interested in these days anyway? blah blah good sound, if a bit irritating blah very good graphics blah blah clever title page blah blah but why does it have nothing to do with the game? blah blah blah same old concept blah collect objects, avoid cowpats, toilets, etc. etc. etc. blah blah walkways that fall away blah conveyor belts blah main problem is that it's too damn difficult blah one variation on original theme, four interlinked screens must be completed as

opposed to one small one to have completed a sheet blah blah doesn't add much to the program blah blah great game blah blah well designed, well

executed blah blah great presentation blah who needs another Manic Miner clone though? blah give it a good rating 'cause its faultless blah

blah but be warned! It's nothing new!

Jason Orbaum

(Four little dragons)

## Still getting a kick out of this one

**Program:** *Ninja Warrior*  
**Supplier:** Computape  
**Price:** £2.95

OKAY, OKAY, you asked him, you begged him, you pleaded with him, some of you sent him money, the more sensible of you sent him threats, so at last 'Orbaum of the Warped Mind' presents the re-review of *Ninja Warrior*.

Firstly let me say re-reviewing is a pain in the derriere. However, with a good game the retread is not such a

task, and this is a good game. The graphics are simple in motion but well designed, and the game is simple in concept, but I have yet to see anyone complete the fifth belt. You are the *Ninja Warrior*, and as the game progresses you jump pits, smash boulders with your bare feet and generally do lots of ninja-type things to gain belts. The game can be played by many people at the same time, and I find it very good fun.

I invited a group of idiots who presume that they're my

friends but won't be paid for helping me with this review, and we played it solidly for a couple of hours. The verdict? I was the only one who liked it. I believe their words were 'Dash this, it's rather blooming boring', but I may have misquoted them slightly.

Still, I like it, and Computape are plugging it like crazy and selling it rather cheap, so I'd say it's well worth while getting your hands on one.

Jason Orbaum



## Take note

**Program:** *Dragon Music*  
**Supplier:** Maridian Software, Birchmore Cottage, Nairdwood Lane, Prestwood, Great Missenden, Bucks HP16 0QQ.  
**Price:** £3.95 each, £8.95 for three.

'Why?' asked our intrepid reviewer. *Dragon User* don't pay up just for asking difficult questions. 'Why' is not the point. 'These are three entirely separate performances of Scott Joplin music (1) and Bach music (2) in four part harmony, played entirely on the *Dragon*. You cannot play games with them, write spreadsheets with them, assemble with them, or indeed do anything except listen to them, but at £3.95 each they are cheaper than buying a whole new stereo player, and quicker than waiting for the respective pieces to come up on the radio' is the point, so cut the philosophy, pal. The public wants Scott Joplin played on a *Dragon*, the public gets Scott Joplin played on a *Dragon*. Don't blame us.

*A team of Gnomes.*

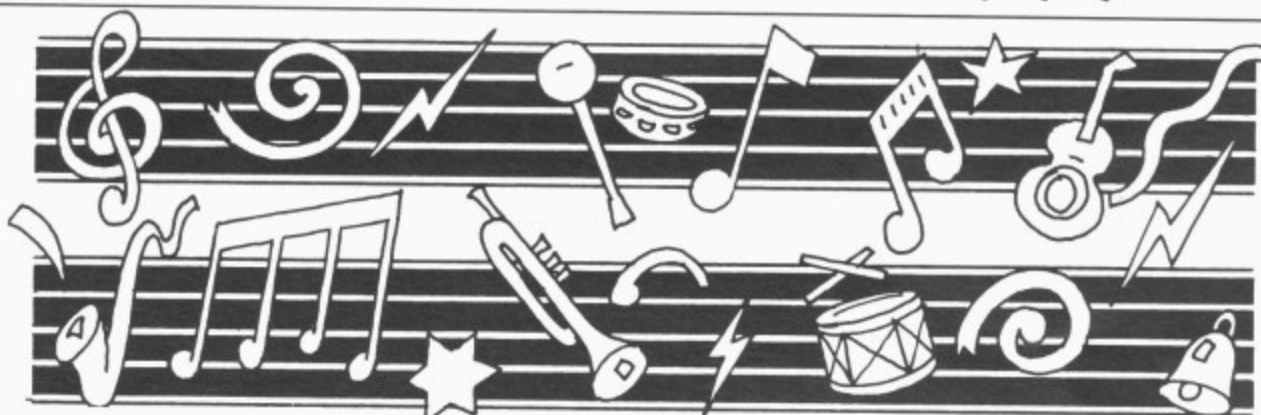

## And now over to you, Brian

**Program:** *Decathlon*  
**Supplier:** Maridian. Birchmore Cottage, Nairdwood Lane, Great Missenden, Bucks HP16 0QQ.

**Price:** £3.95

YOU JOIN us here at this splendid stadium for Daley Orbaum's first year in this Computer Decathlon contest. And he's at the keyboard. AND they're off. And what a splendid event this really is. Ten simple games, but so excellently programmed. Yes, every one of these games is what *Cascade's* disappointing try four years ago should have been.

And my word Orbaum's on good form today, he takes the first event without a hint of trouble, getting all the purple blobs with his big white blob and setting, I think, yes, yes, YES, it's a new *Dragonwealth* record for

this event, now then, the Anagram, and oh my word, what a difficult one this really is. It's got eight letters and oh! won't it be disappointing to see Orbaum go down in this event, on which he performed so marvellously in his trials, re-arranging antidisestablishmentarianism in only six seconds and OH MY WORD the timer has run out on him and he's failed on 'computer'. Still, he's got the copta-landing event to go, and yes, I can see him pon the launch pad, all ready to go, and he eases it gently up but he's drifting too far and, yes, I'm sure that he's failed on this too, so, three events in, his competitors have a frightening lead on him, but there's still the other seven to go tomorrow when, hopefully, we won't have so much rain for the hangman game and the

spider evasion, not to mention the other five...now, back to the studio.

Thank you, David. So, to sum up, a good program for groups of friends playing together who aren't out for anything too complex, and it's quite reasonably priced, which is a relief in these days. And now, over the the main event of the day, the 'Naked Editors Wrestling in Mud' live from Little Newport Street, our on the spot commentator is Helen Armstrong, over to you Helen...



*The Mad Commentator*

((That isn't mud, Brian. That is overspill from the coffee machine.))



# LHEX

*Malcolm Cowan bows to OS-9 and provides a dump command for Flex*

USERS of OS9 will know the DUMP command which prints out a file in ASCII and as printable characters. The listing printed here gives a Flex version of DUMP, which was originally developed for Martin Vernon of the OS9 User Group.

I called the program LHEX partly because it stands for List Hex, which makes more sense than DUMP! and partly because I just liked the sound of it. You can pronounce it any way you like. I say it as if it were the LL sound in Llandudno. (I assume Martin can pronounce Llandudno, seeing as he lives there.)

The program takes one parameter, such as a filename. For example,  
LHEX 1.FRED.CAL

will list the file 1.FRED.CAL.

P LHEX 1.FRED.CAL  
which will list out to the printer, is as usual for the P command.

As it stands, the program assumes an 80 character output, as on most printers, and on the Compusense Plus video board. If you want a different size of output line, that can be arranged quite easily by altering the two lines

```
LLEN FCB 16
LINE RMB 16
```

These define the number of bytes to be output per line. Since each byte takes up four characters on the print line, plus the two spaces between the hex part of the line and the ASCII part, you will see that changing

the two values of '16' to read '12' would make the output fit quite well on a 51 character screen.

To compile the program, copy the source given into a file called LHEX.TXT, then enter the command

```
ASMB LHEX
```

which will create a file called LHEX.BIN. This will need to be copied to your system drive and renamed LHEX.COM, so that FLEX will recognise it as a new command.

The listing is annotated. Should anyone be confused by the word 'JIF', let me explain that this is an abbreviation for 'JUMP IF'. I picked it up from writing bits of operating system for ICL some years ago, and found it a useful bit of shorthand.

```
File 1 ASMBDEFS.TXT*
* Standard system definitions
* Malcolm Cowen 09/08/86
*
* DOS Equates
WARMS EQU $CD03      Flex reentry point
INCH  EQU $CD09      Low level input a char
OUTCH EQU $CD0F      Low level output a char
GETCHR EQU $CD15     Input a char
PUTCHR EQU $CD18     Output a char
PCRLF EQU $CD24      Print cr and lf
GETFIL EQU $CD2D     Get file description
SETEXT EQU $CD33     Set default name ext
OUTHEX EQU $CD3C     Output a char in hex
RPTERR EQU $CD3F     Report disc error
OUTADR EQU $CD45     Output a hex address

* FMS Equates
FMS EQU $D406
FMSCLS EQU $D403

* System Equates
FCB EQU $CB40

File 2 LHEX.TXT
*
* LHEX - Program to output a file in hex and literals
* Malcolm Cowen 09/08/86
* Copyright Cowen Software Ltd 1986
* This program may be used free of charge by private
* individuals for domestic purposes, and may be included
* in libraries of Public Domain Software for that purpose
* Cowen Software Ltd 10-8-1986
*
LIB ASMBDEFS
ORG $1000
BRA START
VN FCB 1
LLEN FCB 16
LINE RMB 16      Output line for screen/printer
LINEY EQU *
LINEX FDB LINEY  Points to l+end of input buffer
CLEN FCB 0       No of chars actually read
CEND FDB 0       Points to l+last char read
CLINE RMB 2
IADDR FDB 0      Byte count of input
ENDIT FCB 1      Set nonzero when eof read

START LDX $FCB
      JSR GETFIL  Get file spec
      LBCS ZA     Jif error
      LDA $1
      STA 0,X     Open for reading
      JSR SETEXT  Set ext of TXT

      JSR FMS     Open file
      LBNE ZA     Jif error

AA JSR PCRLF     First do a n/l and
   CLR CLEN
   LDX $LINE     Prespaciante the char buffer
   STX CLINE
   LDA $'
AB STA X+
   CMPX LINEX
   BNE AB

AC LDX $FCB
   JSR FMS       Read a char in
   BNE AM        Jif exception

      LDX CLINE
      STA ,X+
      INC CLEN
      STX CLINE
      CMPX LINEX
      BLO AC
      BRA BA

AM LDA 1,X       Get error status
   SUBA $8
   LBNE ZA      Error if not eof
   STA ENDIT    Else mark last pass

BA LDA $'$
   JSR OUTCH    Output '$' and hex byte count
   LDX $IADDR
   JSR OUTADR   Output old value
   LDX IADDR
   LDA LLEN
   LEAX A,X
   STX IADDR    Update byte count
   BSR SA       Prepare for first pass

      LDA CLEN   Set the end of valid input buffer
      LDX CLINE
      LEAU A,X
      STU CEND

BD CMPX $LINEX
   BHS CA       Go to do literal output if end

      CMPX CEND
   BHS BF       Jif past end of valid data

      JSR OUTHEX Output the hex nos
      BRA BH

BF BSR TA       O/p 2 spaces if past valid data
   BSR TA
```

BH	BSR TA	Output a space	JSR PCRLF		
	LEAX 1,X		LDA £4		
	BRA BD		LDX £FCB		
CA	BSR SA		STA 0,X		
CC	LDX CLINE		JSR FMS	Close file	
	CMPX LINEX		BNE ZA	Jif error	
	BHS DA	Go to end	JMP WARMS	Exit to flex	
	LDB ,X+		SA	LDX £LINE	Reset pointer, output 2 spaces
	STX CLINE		STX CLINE		
	LDA £'		BSR TA	Output 2 spaces	
	CMPB £32		BSR TA		
	BLO CD	Jif a control ch	RTS		
	CMPB £128		TA	LDA £#20	Output a space
	BHS CD	Jif char > 128	JSR OUTCH		
	TFR B,A	Print char if 31<CHAR<129 else "."	RTS		
CD	JSR OUTCH		ZA	JSR RPTERR	Report error, close files, exit
	BRA CC		JSR FMSCLS		
			JMP WARMS		
DA	TST ENDIT		END	START	
	LRNE AA	Go for next lines worth			

Example of print

```

$0000 41 42 43 44 45 46 47 48 49 4A 4B 4C 4D 4E 4F 50 ABCDEFGHIJKLMNOP
$0010 51 52 53 54 55 56 57 58 59 5A 0D 31 32 33 34 35 QRSTUVWXYZ,12345
$0020 36 37 38 39 30 0D 51 57 45 52 54 59 55 49 4F 50 67890,QWERTYUIOP
$0030 41 53 44 46 47 48 4A 4B 4C 5A 58 43 56 42 4E 4D ASDFGHJKLZXCVBNM
$0040 0D 31 21 32 22 33 23 34 24 35 25 36 26 37 27 38 .112"3£4#5%6&7'8
$0050 28 39 29 36 3A 2A 2D 3D 51 71 57 77 45 65 52 72 (9)0:+=@qWwEeRr
$0060 34 74 39 79 55 75 49 69 4F 6F 5D 7D 4D 4D 41 61 TtYyUuIiOoPp@Aa
$0070 53 73 44 64 46 66 47 67 48 68 4A 6A 4B 6B 4C 6C SsDdFfGgHhJjKkLl
$0080 38 28 5A 7A 58 78 43 63 56 76 42 62 4E 6E 4D 8D ;+ZzXxCcVvBbNnMm
$0090 2C 3C 2E 3E 3F 0D 54 68 69 73 2D 6F 73 2D 74 ,<.>/?..This is t

```

(— SMALL DRAGONS —)

**H.C. ANDERSEN COMPUTER A/S**  
**HIGHLY RELIABLE**  
**SOFTWARE AND HARDWARE**

SOFTWARE AND HARDWARE FOR THE DRAGON:

**DRAGON DISK DRIVE PACKAGES** 200KB incl. DISC CONTROLLER, DOS 1.0 AND INSTRUCTIONBOOK (ENGLISH 64 PAGES) £363.25  
**DRAGON DISK DRIVE PACKAGES** 2X1000KB INCL. DISC CONTROLLER DOS 1.0 AND INSTRUCTIONBOOK (ENGLISH 64 PAGES) £886.70  
**EXTRA 1000KB DISK DRIVE** £363.25  
 "STEP TWO" 40 TRACK STEPPER TO 80 TRACK DRIVE (NEED MODIFICATION OF DISC CONTROLLER) £63.20  
**POWER ADAPTOR** THE ORIGINAL DRAGON ADAPTOR. £22.65  
**DRAGON FORTH** SUPER-FAST, HIGHLEVEL LANGUAGE, TAPE £27.20  
**DREAM EDITOR/ASSEMBLER**, TAPE £15.00  
**DREAMBUG** DISASSEMBLER 6809, TAPE £15.00  
**ALLDREAM** EDITOR, ASSEMBLER, DISASSEMBLER 6809, CARTRIDGE £44.15  
**BRIDGE MASTER** TAPE + CARTRIDGE £44.25  
**COMPUTAVOICE** MAKES YOUR DRAGON SPEAK, TAPE £10.55  
**TIMESCRIP/SPEED WRITER** TEXT FORMATTING, EDITING + A UNIQUE SYSTEM OF TWO-CHARACTER MNEMONICS, TAPE OUR PRICE: £3.20  
**PIXEL EDITOR** PRODUCES AND EDITS GRAPHIC SHAPES TAPE £7.30  
**GRAPHIC ANIMATOR** £3.20  
**BOOKS:**  
 "INSIDE THE DRAGON" ALL YOU'LL EVER NEED TO KNOW ABOUT YOUR COMPUTER INCL. DATA SHEETS FOR THE M6809 PROCESSOR. (360 PAGES) 27.15  
 "DRAGON MACHINE LANGUAGE FOR THE ABSOLUTE BEGINNER" £17.75  
**H.C. ANDERSEN COMPUTER A/S**  
**ENGLANDSVEJ 380 DK-2770 KASTRUP**  
**TELEPHONE: 01-52 44 04 TELEX: 31484**  
 OS-9 IS REGISTERED TM OF MICROWAVE AND MOTOROLA, USA FLEX UNIFLEX IS REGISTERED TM OF TECHNICAL SYSTEM CONSULTANTS, USA CAD IS REGISTERED TM OF H.C. ANDERSEN COMPUTER, DENMARK.

**WE HAVE THE DRAGON OS-9 OPERATING SYSTEM** OUR PRICE £78.00  
**SOFTWARE FOR THE OS-9 OPERATING SYSTEMS:**  
**CAD DMODEM** COMMUNICATION PROGRAM FOR TRANSMITTING/RECEIVING VIA MODEM £89.00  
**CAD PATCH 80** MODIFIES YOUR ORIGINAL OS-9 STYLO, DYNACALC OR RMS TO USE 80 CHARACTERS PR. LINE IF YOU HAVE PLUS EXPANSION £54.90  
**CAD DISKFIX DS80** (DOUBLE SIDED 80 TRACK DRIVER AND BOOTER) UPGRADES YOUR 40 TRACK OS-9 OPERATING SYSTEM FLOPPY DISK TO AN 80 TRACK DOUBLE SIDED OS-9 OPERATING SYSTEM FLOPPY DISK. £80.40  
**CAD TROUBADOUR** REAL-TIME DISSASSEMBLER £54.90  
**OS-9 CAD INVOICE AND DEBTS** ADMINISTRATIVE INVOICE WITH ACCOUNT RECEIVABLE (NEED RMS RECORD MANAGEMENT SYSTEM).  
 EXCL. BASIC09 SOURCE £263.20  
**OS-9 CAD INVOICE AND DEBTS** INCL. BASIC09 SOURCE £323.20  
**SOFTWARE FOR THE DRAGON:**  
**CAD SUPER-WRITER II** TEXT PROCESSOR. UPGRADE TO DISK £33.30  
**DDL SUPER-WRITER II** TEXT PROCESSOR ON CARTRIDGE INCL. CAD SUPER-WRITER DISK UPGRADE. £77.65  
**SR ANT-TALK** DRAGON DOS DRAWING SOFTWARE A/LA LOGO £26.50  
**CG DATAMAX** DRAGON DOS FILING PROGRAM THAT MAKES FILES OF YOUR CHOISE, NAMES, ADDRESSES, MUSIC. YOU CAN THEN PRINT YOUR FILES ON LISTS OR LABELS. OUR PRICE: £49.35  
 WE STOCK SOFTWARE AND HARDWARE FOR OS-9. FLEX AND UNIFLEX. PRICES ARE INCL. VAT. 12 MONTHS GUARANTEE ON SOFTWARE AND HARDWARE. POSTAGE AND PACKING ADD 10 PERCENT FOR HARDWARE (MIN 2 MAX 20.) AND 5 PERCENT FOR SOFTWARE (MIN. 2 MAX 5). CREDIT BY EUROCARD, MASTERCARD OR SEND CHECK MADE PAYABLE TO:  
**DRAGON DISTRIBUTOR IN DENMARK.**



# The Story of C

*Brian Cadge looks at the language which came after B*

THE 'C' language is fast growing in popularity in the commercial programming scene — slowly gaining ground against the likes of Cobol and dBase. Although a general purpose language, C is most at home in the Systems Programming environment with its control flow, data structures and low level access. It is not a very 'high level' language, in fact it includes very few 'built-in' commands; most are implemented as library functions, but more on this later.

The history of C starts with the now seldom used language 'BCPL' written by Martin Richards. In 1970, Ken Thompson developed the language 'B' from BCPL. Both BCPL and B were 'typeless' languages — that is there were no distinctions between variable types (character, integer, pointer etc). The only data type was a machine byte or word. B has now passed on and it not used at all in the commercial programming world. From these two languages Dennis Ritchie developed the 'C' programming language almost as we know it today.

Due to a clearly defined standard, C is a very portable language; it is not tied to any particular hardware or processor. Originally it was designed for the DEC PDP-11 running the UNIX operating system. UNIX itself has since been rewritten in C and other well known operating systems are now written in C, for example GEM as found on the Atari STs.

## Object code

C provides basic operators and functions to handle the low-level data types found on most computers — ie characters (bytes), integers (words), and pointers (addresses). In addition, floating point is also part of the standard. Most processors include facilities for directly manipulating some or all of the above data types (the 6809 handles all but f.p.) directly by hardware so C can produce efficient, compact object code.

There are no built in operations to handle strings, arrays or other data types and all variables must be declared at compile time — there is no heap allocation as in languages such as Pascal. There are not even any built in commands for I/O.

The advantages of this compact language are that it is easy to define, easy to learn and easy to implement on different machines. All of the 'missing' features are provided as functions which can be called as if they were in fact built-in commands.

For the purposes of this article I used the Microware OS-9 C Compiler kindly supplied by John Penn Software. As an example of a complete (if very simple) C program,

take a look at figure one. This shows a program called 'FIND' which will search an ASCII file and display any line which contains a specified string.

The program starts with some comment lines which are always enclosed in '/' and '/' in C. Next come the compiler directives, which always begin with the '£' symbol. The '£include' directive tells the compiler to include the ascii file (in this case 'stdio.h') at that point in the compilation. There can be any number of £includes in a program; stdio.h is always included as it defines certain standard I/O characteristics of the system. If you write a useful function which is often used it is worth putting in a .h file to be included in other programs.

## No constants

C does not support 'constants' as found in languages such as Pascal. The nearest you get is compile time substitution using the £define command. This tells the compiler to replace the first string with the second throughout the program text. So any occurrences of TRUE will be replaced with '1' and FALSE with '0'. You may have guessed that C does not support boolean variables either — any non-zero value is deemed TRUE.

Variable scopes, as discussed in some detail in the Pascal article, are supported at two levels, the global and local variable. Any global variables would be defined before the definition of the first function. There must always be a function called 'main' in any program as it is this function that is first called when the program is run. It does not, however, have to be the first function defined in the program. Any parameters are given in the brackets after the function name, these brackets are always present so if a function is parameterless one would type main(). Functions may return values using the 'return(value);' command, many functions do not however return values and therefore act simply as procedures.

The parameter types are defined immediately before the body of the function. The basic types are int, char, float, double etc. Pointers to (addresses of ) types are defined by including a '\*' before the variable name. For example, to define a variable 'letter' as a character you would use the form char letter; and to define a variable 'string' as a pointer to a character you would use char \*string; this is how strings are defined in C — as pointers to the first on an array of characters.

Arrays are defined using square brackets. So char string(80); defines a 'string' array of 80 characters (numbered 0-79). In implementation terms, 'string' is defined as a pointer, so the form

X=string(52) would take the address of 'string' and added 52 to it and return to value found at that address — it is therefore identical to typing X=\*(string+52) which is indeed quite legal.

Types such as 'FILE' in the program are composite types made up of a number of elements and are defined in the file stdio.h — these will vary with different implementations of the language and so are given the name FILE in all implementations to maintain portability.

The variables 'argc' and 'argv' are special and contain the number of arguments passed and a list of pointers to those arguments when the command is executed. So typing the command FIND fred bill would cause 'argc' to have a value of 3 and argv(0) to point to 'FIND', argv(1) to point to 'fred' and argv(2) to point to 'bill'.

The commands such as 'printf', 'gets' and 'strlen' are not built into C they are implemented as functions and are to be found on all standard implementations.

All parameters are passed to functions by value, not by address so it is not possible to permanently change the value of a parameter within a function (unless you pass a pointer to the value as the argument). Functions can be called recursively with a new 'set' of local variables being generated each time.

Most variables are 'static' variables — that is they are stored in normal memory known to the compiler. There are also variables called 'automatic' variables which are stored (if possible) in a hardware register for increased speed.

The C 'structure' is the main building block for data structures and may be compared to the Pascal 'Record'. A structure is defined in C as follows;

```
struct birthday
{
    char name(40);
    char date(7);
    int age;
    listl(50);
}
```

This defines a structure type 'birthday' consisting of the named elements and defines 'listl' as an array of 50 of these structures. A particular element is accessed in a similar way to Pascal, using list(1).date etc.

The OS-9 C Compiler used for this article is worth looking at in more detail here. To use it you will need a 64K Dragon, OS-9 Operating System and at least two disk drives. In addition, you will need some sort of text editor to prepare the ASCII source code files — Stylograph is ideal for this purpose.

The compiler is supplied on two disks both of which must be present in the drives

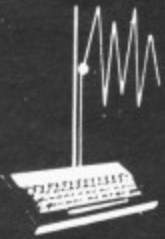

# GROSVENOR SOFTWARE

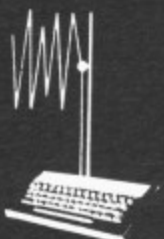

2 Beacon Close Seaford East Sussex BN25 2JZ Tel(0323) 893378

## ALLDREAM - DSKDREAM

ALLDREAM: The most highly acclaimed Dragon machine code development system, containing:-  
A powerful full-screen text editor, a comprehensive multi-pass assembler - a disassembler - and a complete machine code debugging and learning aid featuring memory and register examine and change, testing with breakpoints (up to 10 concurrent) and extensive trace facilities through RAM or ROM.  
ALLDREAM Tape £12.95 Cartridge £24.95 DSKDREAM - Dragon/SuperDOS version with disk I/O £19.95  
DREAMPRT An adaptor giving 64 character print lines for letter/report writing £3.50  
DREAMREF Prints a sorted list of all labels/addresses used in a DREAM assembly. £3

## NEW - DSKDREAM in ROM!

Imagine the advantages in having the facilities of DSKDREAM always available in ROM, freeing 8K RAM space. Now it can be fitted inside all DOS controllers except Delta DOS (sorry!).

Due to space restrictions, the breakpoint and trace facilities are omitted from the ROM.

For £5 extra will supply in addition a full DSKDREAM on disk.

CumanaDOS 1.2 onwards: A 16k ROM for you to fit yourself, with SUPERDOS & DSKDREAM £19

Or send your controller to us (well wrapped) for a re-fit £20

DragonDOS: Send your controller to us for an 8K to 16K ROM conversion adding DSKDREAM £14

OR we can fit SUPERDOS plus DSKDREAM for £20

SUPERDOS: A totally DragonDOS compatible disk operating system - but without the bugs!

Strongly recommended as a replacement for DragonDOS or CumanaDOS 1.2 onwards.

Recommended by Pam D'Arcy! Compatible with Telewriter, Basic42 etc etc.

Supplied as a ROM to fit yourself, with full fitting instructions £10

Or send your controller to us for a same-day return service £12

A Programmer's Guide to DragonDOS. The only source of detailed information on the workings of Dragon/SuperDOS. A full DOS memory map, details of the directory tracks, details of all routines in the DOS that can be called from machine code, with programmed examples. £2.50

## D.R.S. DATA RETRIEVAL SYSTEM

A full-featured database program suitable for all sorts of filing and record keeping purposes. Data files may be kept on tape or disk (Dragon/SuperDOS). DRS features a full screen editor, user defineable screen layouts, and powerful search, add, ammemd, delete, sort and printer report facilities. DRS is written wholly in machine code making it the fastest and most professional database program available for Dragon computers. Tape (transferable to disk) £9.95

## AMATEUR RADIO SOFTWARE

RTTY: feed audio from a short-wave receiver directly into the cassette port, and see international news agencies, weather reports, shipping information decoded by our software appearing on your TV. Add a tone-demodulator to receive radio amateurs also. Program on tape £12

CW: Receive and send Morse code. Program features automatic speed tracking with lock facility. Sending speeds up to 200 wpm. Needs a demodulator (see below). Program on tape £10.75

AMTOR: Full FEC and ARQ transceive software only needing an RTTY terminal unit and clock/PTT unit. Tape £29 Cartridge £39. Receive only tape £19. Cartridge with AMTOR RTTY and CW £59

TONE DEMODULATOR for RTTY CW and AMTOR £22 complete with lead / Dragon connector.

TONE GENERATOR for RTTY/AMTOR transmission £15 AMTOR clock/PTT unit £17.25

AX25 PACKET RADIO. The UK's first software solution to this exciting mode. Only the 3rd such system in the world. Halves the cost of a plug-in-and-go AX25 system. Fully scrollable screen display with each QSO individually selectable makes multiple connections easy.

Software only (cartridge/disk) £49. Packaged with 1200 Baud VHF modem £99

Software supports 1200 and 300 Baud. HF modem adaptor available soon.

State callsign (if any). Send SAE for further details. Add 40p P&P. (£1 Europe, £3 elsewhere)



**FIGURE 1 - A Simple C program**

```
/*      FIND.C - This program lists the lines of a file
           which contain the string prompted for.
*/

#include <stdio.h>
#define TRUE  1
#define FALSE 0

main(argc,argv)
int  argc;
char *argv[];

{
FILE *fp;
int  line;
char search[80],string[256];

if (argc != 2)
{
    fprintf(stderr,"Usage: FIND pathname\n");
    exit(1);
}
fp=fopen(argv[1],"r");
if (fp==NULL)
{
    fprintf(stderr,"Cannot open file %s \n",argv[1]);
    exit(1);
}
printf("FIND 1.0\nEnter Search String: ");
gets(search);
if (strlen(search)==0) exit(1);

line=0;
while (fgets(string,255,fp))
{
    line++;
    if (findstr(1,string,search))
    {
        printf("%5d %s \n",line,string);
    }
} /* end while loop */
fclose(fp);
} /* end main */
```

for a program to be compiled. Executable OS-9 commands are the output from the compiler. Efficient code is produced — only routines used within the program are actually included in the runtime code produced.

### Split compiler

Due to memory limitations, the compiler has been split into two passes for OS-9 level one and so can take quite a long time to compile even a simple program. Even with the two pass version of the compiler, there is not enough RAM left to run the 51 column screen whilst using the compiler, although compiled programs can of course use this screen.

The compiler supports almost all of the standard UNIX system calls, including 'os9fork' for parallel process running. All of the features of OS-9 are available through the system calls which make this compiler a very powerful systems language for any serious OS-9 programmer.

The error reporting and recovery seem quite powerful and all error messages are usually self explanatory.

A potentially very useful section of the manual deals with the linking of program modules written in other languages, particularly BASIC-09, to C code. Therefore, it will not be necessary to scrap all of your favourite routines written in BASIC-09 in order to move up to C.

Once again it has only been possible to give a very brief overview of the 'C' language, but enough I hope to encourage you to look further at this programmers language.

System Used: Microware OS-9 C Compiler

Requires: 64K Dragon, Dual Drives, OS-9 Operating System and Text Editor.

Supplier: John Penn Software, Dean Farm Cottage, Kingsley, Borden, Hants GU35 9NG (Tel: 04203 5970).

Price:£27

# NEW — PI-6809

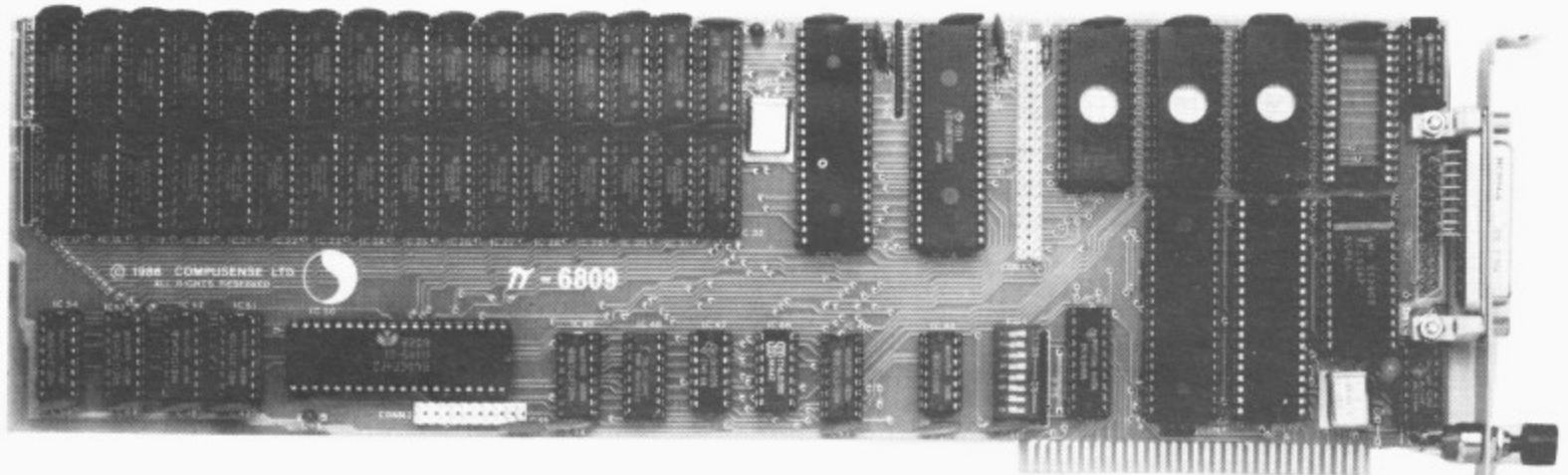

Could this be the answer to a prayer? PI-6809 is a **PC compatible 6809 co-processor**. It features ONE MEGABYTE of RAM, 128K Eprom space, RS232 port, and has a full FLEX system on board. (OS9 support soon!). PI-6809 allows you to use DRAGON FLEX disks on a PC Compatible and to create and store files on the PC. It allows full access to PC floppy disk, hard disk, networks, printer and uses the PC display and keyboard. Can you afford to ignore the keen pricing and vast resources of the PC market? **NOW YOU CAN USE THE MOST POPULAR MICROCOMPUTER IN THE WORLD** while retaining the software benefits of your DRAGON system. If you want to know more then CALL OR WRITE FOR MORE DETAILS.

## DRAGONPLUS

Update YOUR Dragon to 128K memory with an 80 column display. Hundreds of satisfied customers. Installation service available. Requires DRAGON64 (CALL US for details of 32K upgrades). Software to drive DRAGONPLUS is available in cartridge, DRAGONDOS, FLEX and OS9 formats.

DRAGONPLUS	— 103.50
FLEX or OS9 drivers	— 5.75 each
EDIT + 80 col BASIC	14.95 (cartridge or disk)

## FLEX SOFTWARE

Get the most out of your DRAGON with FLEX is in our opinion the BEST way to use a DRAGON computer for serious applications.

FLEX Editor/Assembler/DBASIC	— 99.99
DYNACALC spreadsheet	— 49.50
RMS Database	— 49.50
SPE word processor editor	— 65.00
*** COMPLETE PACKAGE	— 199.00
LUCIDATA PASCAL	— 75.00
CHATPLUS 2 modem software	— 24.95

## HARDWARE

CALL US for best prices on disk drives. We give you 10 free diskettes and a VERY FAST SERVICE.

CUMANADOS disk controller cartridge	— 75.50
RACE EPROM PROGRAMMER	— 78.00
BLANK cartridge — 16K capacity	— 5.00

## BARGAINS

EDIT + CARTRIDGE or DISK for DRAGON32/64	— 8.95
DASM/DEMON CARTRIDGE or DISK for DRAGON32/64	— 8.95
** 10 FLOPPY DISKS — certified double density	— only 9.95 **

**\*\* ALL LISTED PRICES INCLUDE VAT \*\***  
**\*\*\* POST AND PACKING 2.00 per order. \*\*\***



**FAST MAIL ORDER**

Telephone:  
 01-882 0681 (24 HR)  
 01-886 6936

**COMPUSENSE**



P.O. BOX 169  
 286C GREEN LANES  
 PALMERS GREEN  
 LONDON N13 5XA

DR36



# Basic 42

Harris Micro Software's new package reviewed by Ron Coates

THE Dragon's normal text display of only 32 x 16 upper case characters is undeniably very poor and outdated by just about any other home micro on the market today, making the machine unsuitable for displaying more than the most basic information. Even the simplest word processor requires a display beyond the capabilities of the Dragon as we know it. The answer has always been to use the hi-res graphics screen and 'draw' each character as required. This is a reasonable solution until you try to scroll the screen for listings or use standard Dragon facilities such as PRINT@ etc.

A basic rule of thumb says that the home micro of tomorrow is the business micro of today. A look at today's business machines will reveal windows, pull down menus and lots of other clever goodies, all normally beyond the Dragon.

## Good news

Well, having depressed every Dragon owner south of the North pole, the good news has come from Harris Micros in the form of a package for '64 owners running DragonDOS called BASIC42.

The BASIC42 package is probably the best step so far towards alleviating these problems without losing compatibility with existing software. BASIC42 is not simply another hi-res text utility but as described in the accompanying manual is the central core of an operation system which will help bring the Dragon up to date. The package comes on disc and simply requires the BOOT command to bring it to life with a hi-res screen displaying the usual copyright message and an OK prompt.

BASIC42 copies both the BASIC operating system AND the DOS software into RAM where it can easily be hacked, sorry, 'altered' to suit the user's requirements. This is achieved by using the Dragon's memory map type 1, which configures the Dragon to be 64 glorious k of wonderful RAM, not a byte of ROM in sight! Because the entire system is now in RAM, the BASIC42 software is loaded into memory above the DragonDOS software and so does not deprive BASIC of a single precious byte.

Having booted the BASIC42 system and looked at the usual 42 column hi-res display, it looks like many other hi-res utilities, but a few minutes experimenting reveals that this is probably the fastest hi-res screen driver written for the Dragon, and turning the pages in the manual reveals all sorts of well thought out additions to the normal system. In fact there are so many features of the BASIC42 system it would have been far easier to simply reprint the manual. The character set, being in RAM, may be changed to one of several supplied on the system disc by simply issuing the command USE "FRENCH.SET" or alter-

natively, an entire character set may be created or editing using the supplied program DRAWCHRS.

## No more fiddling

A major improvement in the use of this system is the ability to enter commands in either upper or lower case characters, which means no more fiddling about with that horrible SHIFT/0 combination which I am sure has beaten all of us at some time or another. All keys now have an auto repeat feature which may be disabled or altered by simply poking a few memory locations specified in the manual. Unlike many other hi-res drivers, it is very easy to revert back to the normal display by using the command TEXT, and back again to the hi-res display using the command hi-res. Simple, eh?

It is nice to see that this driver has been very neatly interfaced with the rest of the Dragon's operating system and pressing the RESET button shows this as the display remains quite happily in the hi-res mode with the cursor patiently flashing away.

Possibly one of the most important features of BASIC42 is its support of the now highly fashionable 'windows'. There are a total of ten separate windows available to the user, eight of which may be easily re-defined by the user through the FRAME command to suit any particular application. For the uninitiated, a window is a 'section' of the screen which may be used as a completely separate screen in its own right and which may be cleared and scrolled without affecting the rest of the screen. This feature is perfect for the programming of pull-down menus, etc. Windows 0 and 9 are not re-definable by the user, since window 0 is the whole screen and window 9 is a special screen that has its own memory in order that it will not destroy what was on the screen in that area before the window was called.

Cursor positioning and character highlighting have been included in this package in the form of simply commands such as ROW, COLUMN and UNDERLINE with cursor position reporting being available through commands such as REPOS and COLPOS which return the current row and column of the cursor. The state of the current window may also be interrogated with the HEIGHT and WIDTH commands. A rather clever command CATCH allows you to access one window while actually being in another, a useful example of this being given in the manual. This shows how a Basic program may be run in one window with any error messages appearing in the other, very useful when de-bugging a program.

The operating system itself is only very small in terms of memory usage, and so there is an area of some 3.5k available in which to load utility programs. No doubt more of these utilities will become available

from Harris Micros as time goes by, but there are two immediately available, HELP and SPOOL.

The HELP utility allows the user to change easily features of the BASIC42 system such as the auto repeat speeds, setting of control keys and the screen scroll mechanism. The enabling or disabling of the BREAK key is also achieved through the HELP utility. HELP also provides a much improved TRON utility which redirects the line number printed by the TRON routine to the top right hand corner of the current window so that normal output from a program is not corrupted and the PAUSE command enables a program or listing to be used in 'single-step' mode, so that the effect of each line can be decided before continuing. HELP also provides expanded error messages so no more funny error messages like '?SC error in line 100' to add to the confusion! While installed in memory, the HELP utility will also give details of the commands and functions of BASIC42.

The other utility, SPOOL, the other utility, SPOOL, I had to say it twice (*I hope that caught you lot out as well — Ed.*) 'coz I didn't believe it at first! At long last someone has sat down and written a printer spooler for the dear old Dragon. Although a decent commercial printer-spooler buffer will have between 64k and 128k of buffer memory, the 3.5k used by SPOOL is 110% better than the standard system. As soon as there is less than 3.5k of data to be printed, the Dragon is once again available for use while the SPOOL utility looks after the printer. Any print job may be aborted by simply typing SPOOL OFF (now there's a new insult for you).

## Software range

For the Dragon-owning business user, the extra good news is that the Harris range of business software (MONEYBOX, CASHBOX etc.) will all work with BASIC42, providing that a patch program BOXPATCH is used, giving far better screen displays. Unfortunately, I have not seen these programs running and so cannot say just how improved they are.

In conclusion, BASIC42 transforms the Dragon into a decent system for use by small businesses or Basic users.

For the effect this package has on the Dragon it is well worth the asking price and the utilities are remarkable well priced at £5.00 when you consider that on average a blank disc cost between £1 and £2. I sincerely hope that this system will get the recognition it deserves.

**Program:** BASIC42  
**Supplier:** Harris Micro Software  
**Price:** £14.95. Utilities £5 each.

WE PROBABLY HAVE THE WORLD'S LARGEST RANGE OF DRAGON ACCESORIES —  
IF IT'S NOT LISTED, PLEASE ASK — WE SHOULD HAVE ONE SOMEWHERE

## PEAKSOFT DRAGON SUPPLY CENTRE

48 QUEEN STREET, BALDERTON, NEWARK NOTTS. NG24 3NT. Tel: 0636 705230

SERVING THE DRAGON SINCE 1982  
SAME DAY DESPATCH OF MOST ORDERS RECEIVED BY 12 NOON

PLEASE PHONE FOR MORE DETAILS OF ANY ITEM, OR SEND SAE FOR FACT SHEETS ON  
PRINTERS, MONITOR, CHOOSING A JOYSTICK, OR DISC OUTFITS

The arcade expert's favourite joystick! **CHEETAH 125 AUTOFIRE** WITH # DRAGONISER interface  
£14.95. FOUR(!) fire buttons plus autofire.

# **PRO-STICK** Genuine double potentiometer floating joystick, suitable for general-purpose, precision  
use. OUR PRICE £9.95 pair, £5.50 each!

!!SAVE £3!! Trojan **LIGHT PEN** De Luxe £14.95! (RRP £17.95) !!SAVE £3!!

Dragon # **T-SHIRTS** £2.49 (RRP £3.50) # **SWEAT SHIRTS** £4.99!! (RRP £7.50)  
Please state S,M,L or XL size

Superb # "I LOVE MY DRAGON" re-usable red+white **CAR STICKER** 99p

**DRAGON BOOKS:** Inside The Dragon (THE book!) £7.95, Dragon Magic (children's tutor) £4.95,  
Dragon Trainer (beats the manual) £5.95, Dragon Games Master (basic games writing) £5.95, Working  
Dragon (utilities) £5.95, Advanced Sounds and Graphics on the Dragon £5.95, Artificial Intelligence on  
the D'n (cheaper than keeping a wife) £6.95.

# New A1 SupaSmooth computer **POWER SUPPLY** with 2-year guarantee £16.95 complete. # Dragon  
Data disk drive **TRANSFORMER** £14.95

**LEADS:** AERIAL £2.50, CASSETTE £2.50, PRINTER £11.95.

Heavy duty # **DUST COVER** with Dragon logo £3.95 also fits most dot matrix printers).

# Briefcase-style padded **CARRY CASE** for Dragon and power supply £11.95

Transform your 32 or 64 with a *fast-action*, silky-smooth replacement # **KEYBOARD** £19.95. Please  
not that these are the LAST new keyboards to be found ANYWHERE.

**MAGAZINES** # DRAGON MONTHLY AND # DRAGON USER back number and # RADIO DRAGON  
printer dumps — please phone or write about availability.

**PRINTERS** Epson P-40 thermal dot matrix £59.95, or save £75 on Panasonic's fast and immaculate  
KX-P1080 — £194.95!!!

Fidelity colour **MONITOR** £199.95 — the Fidelity is RGB + Composite, so you can use it with your  
video recorder, and if you ever change your computer, you won't need a new monitor.

You won't believe our prices for complete Cumana (Dragon DOS compatible) **DISC DRIVE** outfits...  
please ask!!!!

# means that we hold the only, or final stocks of these items.

**TO ORDER:** Just note your name, address and goods required on the back of your cheque or postal  
order, payable to "Peaksoft". ACCESS / VISA orders accepted by phone. Minimum credit card order:  
£5. Postage on all items is FREE. Personal callers welcome (please phone first). Please ask for details  
of credit, COD or optional Securicor delivery.



# Shuffleword

Anagrams galore for you to solve in this game by P Marlow

SHUFFLEWORD is an anagram game that gives the player anagrams to solve. The player chooses the length of each anagram (there are two, four, six, eight and ten letter words). Then a choice is given whether music plays or not. Then, a word is chosen at random from a list held in the DATA statements, and an anagram is made of the letters.

The player is given ten guesses at the original word. If the word is guessed correctly the first time, then bonus points are awarded. If the word is not guessed after ten

tries, the correct word appears on screen. A count is kept of how many times the player presses ENTER for each word. If the count goes up to ten for a word, penalty points are deducted from the player's score — a random number of points between one and ten! So you cannot calculate how many points you can afford to lose!

The title screen uses the anagram routine to draw anagrams of the title SHUFFLEWORD onto the hires screen.

The DATA statements each contain twenty words, but this can be altered by chang-

ing dimensions FOUR\$, SIX\$, EIGHT\$, and TEN\$ if line one twenty, and altering the FOR next loops in lines one forty, one seventy, two hundred and two thirty.

If there are any problems I can supply a copy of SHUFFLEWORD on cassette for £3.00. As I have only a Tandy CoCo, Dragon owners will have to use the Dragon/Tandy conversion program listed in the December 1984 issue of Dragon User.

(Photocopies of the December 1984 article are available from Dragon User as usual, price £1.)

```
10 '*****
20 '***** SHUFFLEWORD *****
30 '***** BY P. MARLOW *****
40 '***** 01/6/86 *****
50 '***** 50 LIME AVENUE *****
60 '***** BENTLEY *****
70 '***** WALSALL *****
80 '***** WEST MIDLANDS *****
90 '***** WS2 0JP *****
100 '*****
110 CLEAR 1000
120 DIM FOUR$(20),SIX$(20),EIGHT$(20),TEN$(20),Z$(89),I$(89)
130 PCLS:PCLS2:GOSUB 1000:GOSUB 1200
140 FOR F=1 TO 20
150 READ FOUR$(F)
160 NEXT F
170 FOR S=1 TO 20
180 READ SIX$(S)
190 NEXT S
200 FOR E=1 TO 20
210 READ EIGHT$(E)
220 NEXT E
230 FOR T=1 TO 20
240 READ TEN$(T)
250 NEXT T
260 CLS
270 PRINT TAB(10);"SHUFFLEWORD"
280 PRINT TAB(10);"=====
290 PRINT:PRINT"THE COMPUTER WILL CHOOSE
  A WORD AT RANDOM, ";
300 PRINT "YOU CAN CHOOSE THE
310 PRINT "NUMBER OF LETTERS IN THE WORD
  "
320 PRINT "(EITHER 4,6,8 OR 10 LETTERS).
  "
330 PRINT "THE COMPUTER WILL SHUFFLE IT'S
  WORD ";
340 PRINT "AND YOU MUST GUESS THE"
350 PRINT "ORIGINAL WORD.YOU HAVE TEN
  GUESSES."
360 PRINT@448, "HOW MANY LETTERS? "
370 N$=INKEY$:IF N$="" THEN 370
380 SOUND 100,1
390 N=VAL(N$):IF N=1 THEN N=10
400 IF N=4 OR N=6 OR N=8 OR N=10 THEN 44
  0
410 PRINT@448, "INVALID CHOICE--TRY AGAI
  N";
420 FOR X=1 TO 1000:NEXT X
430 GOTO 360
440 PRINT@448,"MUSIC ON (Y/N) ? ";
450 O$=INKEY$:IF O$="" THEN 450
460 SOUND 100,1
470 IF O$="Y" OR O$="N" THEN 490 ELSE 48
  0
480 PRINT@448,"INVALID SELECTION--TRY AG
  AIN":FOR X=1 TO 1000:NEXT X:GOTO 440
490 IF O$="Y" THEN O=1 ELSE O=0
500 CLS:GOSUB 700
510 PRINT TAB(10);"SHUFFLEWORD"
520 PRINT TAB(10);"=====
530 QU=0
540 PRINT "JUMBLED WORD IS ";A$
550 FOR X=1 TO 10
560 PRINT "GUESS NO. ";X:;INPUT G$:IF G$=
  "" THEN QU=QU+1
570 GOSUB 870
580 NEXT X
590 IF R=1 AND O=1 THEN PRINT "WELL DONE
  YOUR SCORE IS";SC:PLAY "T8B04CD03B04C03
  ABGAF#T4GBT7DP6T804CDECD03B04C03ABGT4F#A
  T7DP6T8EF#GDEF#GEF#G#AEF#G#AG#AB04C03B04
  CDEC03AF#GDGBT4G":GOTO 640
600 IF R=1 AND O=0 THEN PRINT "WELL DONE
  YOUR SCORE IS";SC
610 IF QU=10 THEN PRINT "YOU CHEATED";:C
  HEAT=RND(SC):PRINT USING "###.##";CHEAT;
  .PRINT"POINTS DEDUCTED":R=1:QU=0:SC=SC-C
  HEAT:CHEAT=0
620 IF R=0 AND O=1 THEN PRINT "SORRY THE
  ANSWER WAS ";C$:SC=SC-N:PLAY "ET4P60EP6
  0T8ET2P60ET4GF#F#EED#T2E":PRINT "YOUR SC
  ORE IS";SC: ELSE IF R=0 AND O=0 THEN PRI
  NT "SORRY THE ANSWER WAS ";C$:SC=SC-N:PR
  INT@448,"YOUR SCORE IS";SC
```

```

630 FOR X=1 TO 1000:NEXT X
640 PRINT@448,"ANOTHER GAME (Y/N) ?";
650 F$=INKEY$:IF F$="" THEN 650
660 IF F$="Y" THEN PRINT STRING$(13,32);
:SOUND 100,1:GOTO 690
670 IF F$="N" THEN 680 ELSE 650
680 SOUND 100,1:CLS4:PRINT@261, "THANK-Y
OU FOR PLAYING";:FOR T=1 TO 15:SCREEN 0,
1:FOR Y=1 TO 300:NEXT:SCREEN 0,0:FOR Y=1
TO 300:NEXT Y,T:CLSRND(8):END
690 GOTO 360
700 REM SHUFFLE
710 C=RND(20):A$="":C$="":R=0
720 IF N=4 THEN A$=FOUR$(C):Q=4
730 IF N=6 THEN A$=SIX$(C):Q=6
740 IF N=8 THEN A$=EIGHT$(C):Q=8
750 IF N=10 THEN A$=TEN$(C):Q=10
760 M=Q*100
770 C$=A$:J$=""
780 FOR K=1 TO LEN(C$)
790 L=LEN(A$)
800 P=RND(L)
810 J$=J$+MID$(A$,P,1)
820 A$=LEFT$(A$,P-1)+RIGHT$(A$,L-P)
830 NEXT K
840 IF J$=C$ THEN 710
850 A$=J$
860 RETURN
870 REM CHECK
880 FOR H=1 TO 10
890 IF G$=C$ AND X=H THEN GOSUB 920
900 NEXT H
910 RETURN
920 IF X=1 THEN SC=SC+10+RND(M):X=10:R=1
:RETURN
930 SC=SC+INT(10/X)
940 X=10:R=1:RETURN
950 REM WORDS
960 DATA BAST,CHAR,CRAG,EVER,EXIT,FOIL,F
ORD,FORE,LEGO,MASK,MAUL,MULE,MUSK,PERT,S
ACK,SHAG,TEAK,TILT,TOBY,ZULU
970 DATA ADDICT,APACHE,AZALEA,BLOUSE,COR
DON,CORYZA,COURSE,IAMBUS,INTONE,MINUTE,P
ERIOD,PILFER,REVERE,SHABBY,SIGNET,TANNER
,TRIBLE,VACATE,YORKER,ZYGOTE
980 DATA ANALECTS,ASTONISH,CASSETTE,COMP
UTER,CONDENSE,CONTRAST,DULCIMER,HARMONIC
,KILOGRAM,MARZIPAN,MELINITE,PRIMEVAL,REC
ORDER,SEMESTER,SHAMBLES,TRAINING,WARRIGA
L,WEDGEWOOD,XENOGAMY,ZOOPHYTE
990 DATA ,ANTITOXINS,BELLADONNA,BRIGHTNE
SS,COMMODORES,DICTIONARY,EXPERIMENT,INIT
IALISE,LANUGINOUS,MANCHESTER,MATHEMATIC,
MICROPHONE,MOHAMMEDAN,PRIMORDIAL,REFEREN
CES,SHENANIGAN,TELEPHONES,TELEVISION,TRA
NSISTOR,WELLINGTON,XENOPHOBIA
1000 Z$(65)="BR16R8F16D40L8U24L24D24L8U4
0E16B0D8BR4F12D4L24U4E12"
1010 Z$(67)="BR8R24F8D8L8U4H4L16G4D32F4R
16E4U4R8D8G8L24H8U40E8"
1020 Z$(68)="R32F8D40G8L32U56BF8R20F4D32
G4L20U40"
1030 Z$(69)="R40D8L32D16R24D8L24D16R32D8
L40U56"
1040 Z$(70)="R40D8L32D16R24D8L24D24L8U56
1050 Z$(72)="R8D24R24U24R8D56L8U24L24D24
L8U56"
1060 Z$(73)="BR8R24D8L8D40R8D8L24U8R8U40
L8U8"
1070 Z$(75)="R8D24E24R8G28F28L8H24D24L8U
56"
1080 Z$(76)="R8D48R32D8L40U56"
1090 Z$(77)="R8D12F12E12U12R8D56L8U36G12
H12D36L8U56"
1100 Z$(78)="R8D12F24U36R8D56L8U12H24D36
L8U56"
1110 Z$(79)="BR8R24F8D40G8L24H8U40E8BD8B
R4R16F4D32G4L16H4U32E4"
1120 Z$(80)="R32F8D16G8L24D24L8U56BF8R20
F4D8G4L20U16"
1130 Z$(82)="R32F8D16G8L16F24L8H24D24L8U
56BF8R20F4D8G4L20U16"
1140 Z$(83)="BR8R24F8D8L8U4H4L16G4D8F4R2
0F8D16G8L24H8U8R8D4F4R16E4U8H4L20H8U16E8
"
1150 Z$(84)="R40D8L16D48L8U48L16U8"
1160 Z$(85)="R8D44F4R16E4U44R8D48G8L24H8
U48"
1170 Z$(87)="R8;D36;E12;F12;U36;R8;D56;L
8;U12;H12;G12;D12;L8;U56"
1180 Z$(89)="R8D12F12E12U12R8D16G16D24L8
U24H16U16"
1190 RETURN
1200 X=3:Y=0:AA$="WELCOME TO"
1210 GOSUB 1270:GOSUB1400
1220 AA$="SHUFFLEWORD":FOR Q=1 TO 2:GOSU
B 1310:GOSUB 1400:NEXT Q:AA$="SHUFFLEWOR
D":GOSUB 1270:GOSUB 1400
1230 AA$="":GOSUB 1270:GOSUB 1400:AA$="
HIT ANY KEY":GOSUB 1270:GOSUB 1400
1240 S$=INKEY$:IF S$="" THEN 1240
1250 SOUND 100,1
1260 RETURN
1270 FOR I=1 TO LEN(AA$)
1280 I$(I)=MID$(AA$,I,1)
1290 NEXT I
1300 RETURN
1310 K$=AA$:M$=""
1320 FOR K=1 TO LEN(K$)
1330 L=LEN(AA$)
1340 N=RND(L)
1350 M$=M$+MID$(AA$,N,1)
1360 AA$=LEFT$(AA$,N-1)+RIGHT$(AA$,L-N)
1370 NEXT K
1380 AA$=M$
1390 GOSUB 1270:RETURN
1400 PMODE 3,1:SCREEN 1,0
1410 DRAW "S2"
1420 FOR Z=1 TO LEN(AA$)
1430 COLOUR=RND(4)
1440 IF COLOUR=2 THEN 1430
1450 DRAW "C"+STR$(COLOUR)
1460 DRAW "BM"+STR$(X)+","+STR$(Y)+Z$(AS
C(I$(Z)))
1470 X=X+23
1480 NEXT Z
1490 Y=Y+32:X=3
1500 RETURN

```



# DRAGON & TANDY COLOUR OWNERS ...

## 3 NEW RELEASES

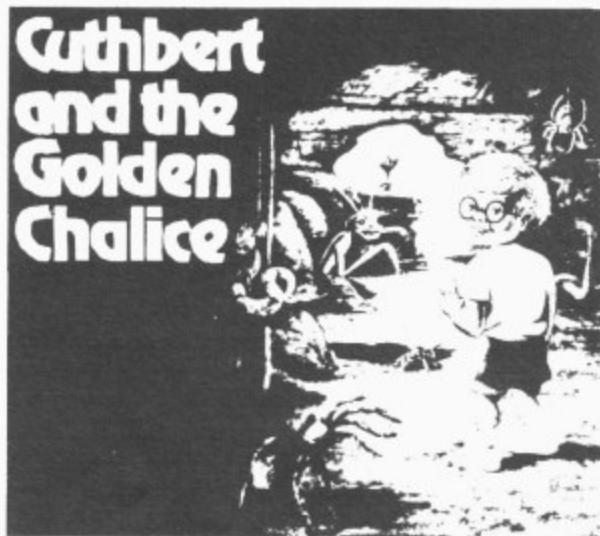

### CUTHBERT & THE GOLDEN CHALICE

Legend tells of a fabled GOLDEN CHALICE that can bring wealth and long life to whoever it belongs being placed at the end of a deep cave. Having heard these tales Cuthbert sets off to try and collect the chalice, but will he succeed where many others have failed. The cave is filled with deep pits that will mean instant death should he fall in. Other hazards include poisonous snakes, swarms of fast moving bees and giant deadly spiders. Will you be able to take on the challenge and guide Cuthbert to the GOLDEN CHALICE.

DRAGON 32/64 TANDY COLOUR 32K CASSETTE £5.95



### TANGLEWOOD

If you go down in the woods today ... You've never played an adventure like TANGLEWOOD! There are five characters for you to control, each one of which behaves differently, and has different problems for you to solve. At the same time, you must avoid contact with the evil Schark, who will continually try to thwart your plans. There are over 700 accessible locations in nine sections, all in colour graphics: the woods, Dwarf Dive (platforms, lifts and ladders), Schark castle (a 3-D maze on five floors) and six smaller text-only sections. The entire game loads at once. TANGLEWOOD provides many helpful features, including the ability to return to a previous position without having saved it to tape. There is no sudden death, and although it is possible to get yourself completely stuck, you have to be very careless to do so. TANGLEWOOD is also a real-time game and some things are possible at night which are not, during the day!

TANGLEWOOD ON CASSETTE FOR DRAGON 32/64 & TANDY COLOUR 32K £5.95



### WIZARDS QUEST

If you've played Atic Atac on the Spectrum then you'll love WIZARDS QUEST! As Arcade Games go this must be one of the all time greats ...

WIZARDS QUEST ON CASSETTE DRAGON 32/64 TANDY COLOUR 32K £5.95



Name \_\_\_\_\_ Address \_\_\_\_\_

Post to \_\_\_\_\_

Please send me

- Tanglewood
- Cuthbert & the Golden Chance
- Wizards Quest
- Post & packing 75p



Box 68  
St Austell  
PL25 4YB

Credit Card Orders  
by phone 0726 68020



# NEW RELEASES HALF PRICE!

YES NOW YOU CAN PURCHASE ALL OUR  
NEW RELEASES AT LESS THAN HALF  
THEIR REGULAR PRICE BY SIMPLY  
JOINING OUR **DAY 1 CLUB**

IF YOU HOLD A MAJOR CREDIT CARD THEN YOU SIMPLY FILL  
IN THE ORDER FORM BELOW AND WHENEVER WE RELEASE A  
NEW LINE FOR THE DRAGON/TANDY COLOUR WE WILL SEND  
YOU A COPY AT HALF PRICE ON **DAY 1** AND CHARGE IT TO  
YOUR CREDIT CARD! YOU MUST UNDERTAKE TO TAKE AT  
LEAST 6 NEW RELEASES BUT AFTER THAT YOU CAN CANCEL  
AT ANY TIME.

YOU KNOW AS A PREVIOUS CUSTOMER OF MICRODEALS  
THAT ALL OUR PRODUCTS ARE OF HIGH QUALITY AND  
WORTH PURCHASING. ALL OUR FUTURE RELEASES WILL  
COST £5.95 AND YOU PAY ONLY £2.95 PLUS OUR REGULAR  
75p POST & PACKING, SO SIGN UP **NOW!**

I would like to become a member of the **DAY 1** Club and agree to allow Microdeal to charge  
£2.95 at regular intervals against my credit card.

Credit Card Type: \* Access/Barclaycard/American Express/Diners

Credit Card Number ..... Expiry Date.....  
Tick here if you want the latest releases sent straight away

Signed .....  
\* = Delete

Post to:



Box 68, St Austell PL25 4YB

Name .....

Address .....

.....

.....

Post Code.....



# Expert's Arcade Arena

Write to 'The Expert' at Dragon User  
12-13 Little Newport St, London WC2H 7PP.  
with all your arcade tips and hints.

YES, it's that time of year again, when treetops glisten, and children listen, to hear the sleighbells in the snow. Yes, it's novelty song time, it's ceaseless adverts for Transformers (robots in disguise) time, it's compilations and Bond films time, it's getting far too drunk and pigging out on far too many birds (*he means turkeys — Ed.*), it's old people freezing to death in their unheated council houses while you buy Auntie Henrietta a bottle of perfume the size of a pea for fifty quid, it's a time of trying to work out just how much money you're going to get so you can make a profit by spending less than that amount on everybody else. Yes. It's Capitalist Christmas time! (Actually, you'll probably be reading this in November when you won't even have started to worry about the number of 'shopping days' left!!).

And so, in the true Christmas spirit (that of the pleasure of receiving), before I give you all my present, here's a list of gifts I'd like to receive from various people out there..... Some of them are rather silly, but you'll notice that there's a list of Games at the beginning. These are games that I don't possess a copy of and so cannot really write much about, so if anyone has one they really can't stand any longer (or just want to suck up to me), I suggest they donate it to your truly.

## THE EXPERT'S CHRISTMAS LIST.

A car sticker with 'I don't even want a Porsche.' written on it.

A vast sum of money (bigger than any of you possess so don't bother with this one.)

A time share flat in Nicaragua.

No more letters in stupid luminous pen (especially you Andrew Ridgely).

Copies of : *Astro Blast, Cosmic Cruiser, Cave Fighter, Dunkey Monkey, Death Mines of Sirius, Galactic Raiders, Horace Goes Skiing, Invader's Revenge, Moonhopper, Morrison Chess, Quazimodo, Sea Dragon, and Space Raiders.*

More maps (when am I going to get one of *Brock's Kingdom?*).

More of those sort of letters that say 'I wish your column was 20 pages long.'

More of those letters that come with a big bottle of gin with them.

More of those letters that come with millions of cigarettes.

In fact, send anything you can lay hands on!

A \*PRIZE\* (of the usual Arcade Arena standard) will be sent to the person who sends the most stupid present to the above address! (Oh darn. And I was going to demand a percentage. Ed.)

Now, here's my presents for you. Firstly, this rather splendid '*Fantasy Fight*' map drawn by M. Borthwick (who suggests that I am in fact "The great blue writer Ardvark of Arbu" — Completely wrong, so no prizes there).

Secondly, the great POKE LIST:

ASTRO BLAST: Colour 21067

BEANSTALKER: Access code is 'REGISTER', answer NO to tape, go back to

main screen, hold down X/ENTER/8 to go to editor. Clear/N to go to next screen. Clear/X to increase lives. Colour 27780. Reset 27801.

BUBBLE BUSTERS: Once running a game press reset then play again and bubbles fall in order.

BUZZARD BAIT: Poke 21093, &HE0 to get PMODE3:SCREEN 1.0. CSAVEM "BUZZARD", 7168, 32755, 7168 \*\*\* No dongle required on re-load \*\*\* Reset 20360.

BEAM RIDER: Crash with RESET: POKE 7783, LIVES or POKE 11840, 13 for infinite lives. EXEC 7683.

CAVERNS OF CHAOS: PIGLET when playing. "E" for next screen. Colour 26860. Lives 26865 (Zero for infinite).

Colour: Poke this location to 224/232/240/248 to give Green 4 colour/buff 4 colour /Green & Black/White & Black.

COSMIC CRUISER: Lives 9398. Zero is infinite.

CU\*BER: Lives 10454. Reset 20481.

CUTHBERT IN THE COOLER: Lives 8925 (up to 14).

CHAMBERS: Lives 133339.

CAVE FIGHTER: Lives 27078 (zero equals infinite).

CRAZY PAINTER: Let space invader reach the bottom, when paint reaches zero leave it and you have an infinite supply.

DUNKEY MUNKEY: Lives 15120. Colour 19862.

DARK PIT: Pause game, press 8/L/M/C. Use cursors and Enter to select a screen, position man same way and restart. Lives 11255.

DUNGEON RAID: Press "C" to continue on screen you just finished on.

DANGER RANGER: Lives 10510.

DEATH MINES OF SIRUS: Codes are CBLW & TLL.

ESCAPE: Code is 79245.

EDDIE STEADY GO: Lives 27152.

FEARLESS FREDDIE: Lives 28052. Reset 20363.

GALACTIC RAIDERS: Lives 19664.

HUNGRY HORACE: Stay on park bell, lives and score soon mount up. Guard can't get you when you're both in the tunnel.

HORACE GOES SKI-ING: Colour 28356.

ICE CASTLES: Go into tunnel on screen one on first go, jump, thus giving yourself 140000 points and getting onto a level somewhere between 20 and 30. Lives 19160. Colour 13071. Reset 12290.

INVADERS REVENGE: Lives 14719.

Reset 11571.

JET SET WILLY: While game is in progress press keys M/A/X together, flick through screens with cursors, press space, position Willy (sorry Ed!), press space to continue.

JET BOOT COLIN: Colour 7329. Reset 12336. Infinite lives POKE 8759,77:POKE 9099,77.

THE KING: SKIPF: CLOADM: FOR X=12850 to 12894: PRINT X: POKE X,255: NEXT X: EXEC This gives hundreds of lives!

LUNAR ROVER PATROL: Lives &H5728.

MUDPIES: Colour 22902.

MANIC MINER: PENGUIN to get boot. Colour 13825. Lives 13146 (up to 25).

MOON HOPPER: Colour 12827.

MORRISON CHESS: Crash with reset, then POKE 8401, 224: EXEC 7700. Improves colour drastically.

NINJA WARRIOR: Lives 9489.

PLANET INVASION: Lives 7438.

PEDRO: Use SKIPF: SKIPF: CLOADM to load then any of: Seeds — 23603. Bricks — 23620. Stop tramp — POKE 16047, 125. Run with EXEC.

PENGON: Infinite lives — POKE 11633, 125.

QUAZIMODO: Lives 15644.

ROBIN HOOD: Lives 15712. Colour 19884.

ROMMEL'S REVENGE: Lives 16516. Reset 23724.

Reset: This location should be poked to zero for warm start.

RUBY ROBBA: POKE 21117, 125 (infinite time). Lives 22014.

SEA DRAGON: Colour 20599.

SHOCKTROOPER: Poke 17075, 125 (infinite lives).

Pause game, Press SHIFT/0 then R then SHIFT/S to make yourself invulnerable to bullets.

SPACE RAIDERS: CLOADM "", 32000: POKE 32184, 57, EXEC 32159: POKE 2304, lives (up to 45): EXEC 16384.

SCREAMING ABDABS: Colour 10999 (232 only).

TEA-TIME: On the sugar cane screens you can't be hit in the top left corner. Infinite lives — POKE 19996. 109.

TIM LOVE'S CRICKET: Use a Quickshot 11, play computer, bowler as far down as possible, arm top left, bowl, gives a full toss at top of off stump.

TUBEWAY ARMY: Lives 12367. Stage 12388 (1-6). Reset 12301.

ZAK'S SUN: Lives 16670.

That's all folks. Merry November.

Key

- Blue door
- Red door
- × Green door
- ↑ Thunder bolt
- ↖ Arrows
- ⌘ Money
  
- £ Blue key
- ℓ Red key
- ⌘ Green key
- Ⓡ Blue ice ray
- Ⓡ Red fire ray
- Ⓡ Green destruction ray
  
- ← Bow
- Ⓢ Sword
- Ⓜ Mace
- Ⓛ Link
- ↖ Arrows

# Fantasy Flight The Map

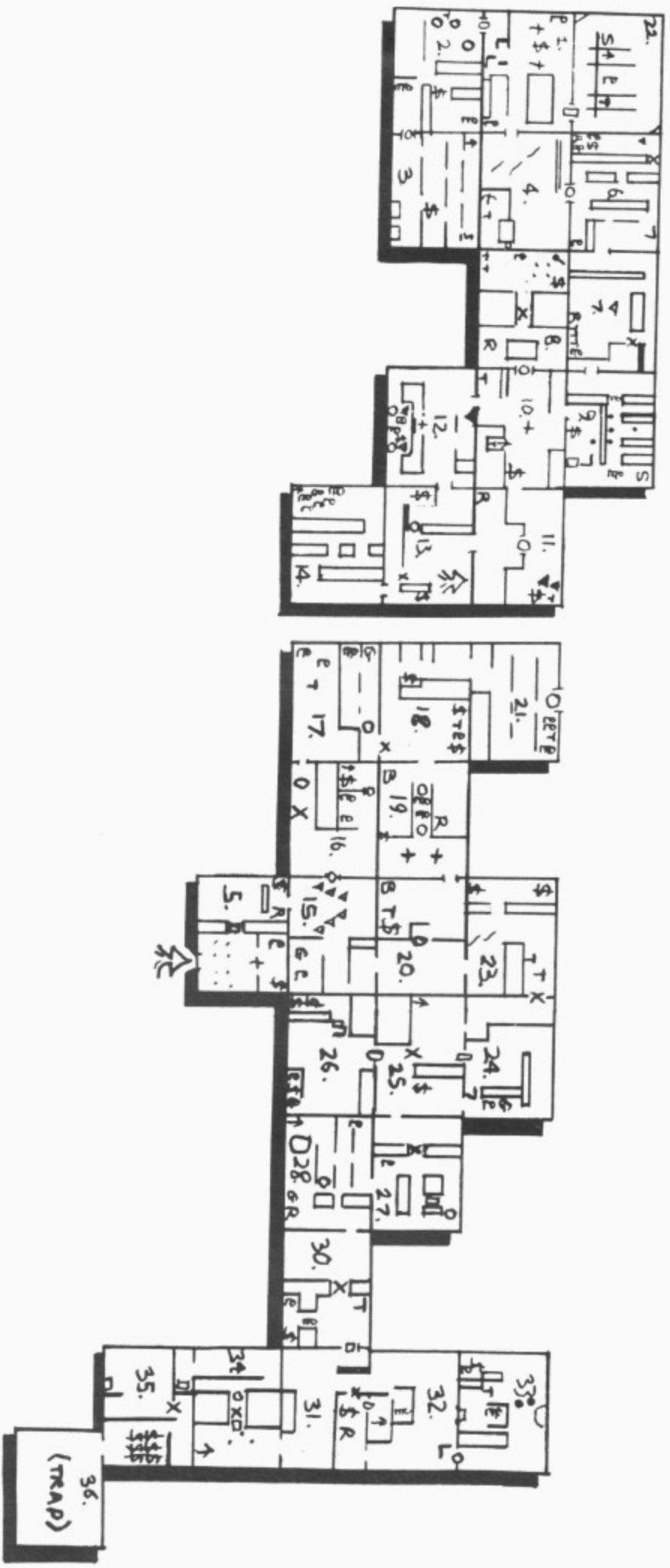



# MXT REAL TIME CONTROLLER

**INTERFACE YOUR DRAGON 32 TO THE REAL WORLD**

**As reviewed in April '86 "Dragon User"**

**FEATURES:**

- Control up to 4 external devices using relays.
- 4 switch input detection channels.
- Internal real-time clock
- Uses 7 new built in Basic Commands plus ROM resident Machine code monitor.
- Extensive manual with sample programs

4 relay version ..... **£32.95**

2 relay version ..... **£24.95**

Prices include VAT and Postage

**Some of the many uses**

- Burgler Alarm
- Central Heating controller
- Laboratory experiment controller
- Model controller
- Educational experiments

DR32

Cheques/Postal Orders/Dealers enquiries to:

**Beam Microsystems**

Kadock, Longlands Road, East Wittering, Chichester. PO20 8DD.



# FREE GAME

when you subscribe  
to **POPULAR**  
**Computing**  
WEEKLY

**Your choice of any one of the games listed below is free when you subscribe to Popular Computing Weekly**

Please enter my annual subscription to **Popular Computing Weekly** at **£25.00** U.K. (**£39.95** Overseas), and send my free game as marked below.

- Commodore 64**
- Willow Pattern
  - Chicken Chase

- Amstrad**
- Don't Panic
  - Chimera

- Spectrum**
- Willow Pattern
  - Chicken Chase

- BBC Micro B**
- Fat Man Sam
  - Microcosm

- I enclose a cheque made payable to Sunshine Publications Ltd.
- Please charge my Visa/Access card No:

Expiry Date.....

Name:..... Address:.....

Computers owned: ..... Age: .....

Return this form together with your payment to: **PCW Subs**, 12-13 Little Newport St., London WC2H 7PP (Allow 28 days for delivery).

# Switching joysticks

A simple hardware modification by Stephen Denning

READERS with switching joysticks may be interested in the following simple circuit to enable them to use them with their Dragons. I was able to build it into a Quickshot 1 joystick with only minor PCB modifications for about £1.00. As readers will doubtless be aware, the Dragon joystick ports are read via 6 bit A to D converters which return 64 different values for voltage levels between 0 volts and 5 volts. Dragon joysticks are normally the potentiometer type wired between 0 volts and 5 volts (figure 1) which send a voltage corresponding to the joystick position from the slider of the potentiometer to the relevant joystick input (referred to as JOYSTICK 0 to 3). Most games are programmed for three joystick positions, ie. (for JOYSTICK 0) left, centre and right, which reduces the need for voltage levels to 3, which are 0 volts, 2.5 volts and 5 volts. The 2.5 volts can easily be obtained with a potential divider, and the 0 volts can be obtained by connecting the 2.5 volts to earth with the 'Left' switch, but the 5 volts is marginally more technical.

In figure 3 the potential divider is formed by R1 and R2, whose junction is connected to the JOYSTICK 0 input. The lower end of R2 is connected to the collector of TR2 which is normally held hard on by R3. Thus with a centred joystick TR2 collector will be as near to 0 volts as makes no difference and the JOYSTICK 0 input will be at 2.5 volts as R1 and R2 are equal. If the 'Left' switch is closed it earths the JOYSTICK 0 input which then becomes 0 volts. If the 'Right' switch is closed it earths the base of TR2 thus switching it off. The JOYSTICK 0 input is then connected to the 5 volt supply via R1 and is thus effectively 5 volts. R1, R2, R4 and R5 are 5.6kohms; R3 and R6 are 4.7kohms. Any type of NPN general purpose transistor can be used for TR1 and TR2. In the case of the Quickshot 1, there is ample space on the PCB to glue the transistors and resistors onto it and hard wire them as required. This circuit can be used in any switching joystick that has all the switches switching to earth, and can be adapted to work with any other type. Great care should be taken with the wiring as it is possible to short circuit the 5 volt supply in the computer with expensive consequences. Otherwise, a cheque for \$6.50 made out to S. Denning and sent with the joystick to me at the above address will cover the cost of parts, return postage and conversion.

This type of joystick is not fully suitable for software that requires a proportional input, eg. Flight simulators — it does work with Speedracer, but makes it awkward to select circuit 3 and adds a certain brutality to the steering response.

(Editorial note: opening or altering a joystick within its warranty period will normally invalidate the warranty in case of breakdown.)

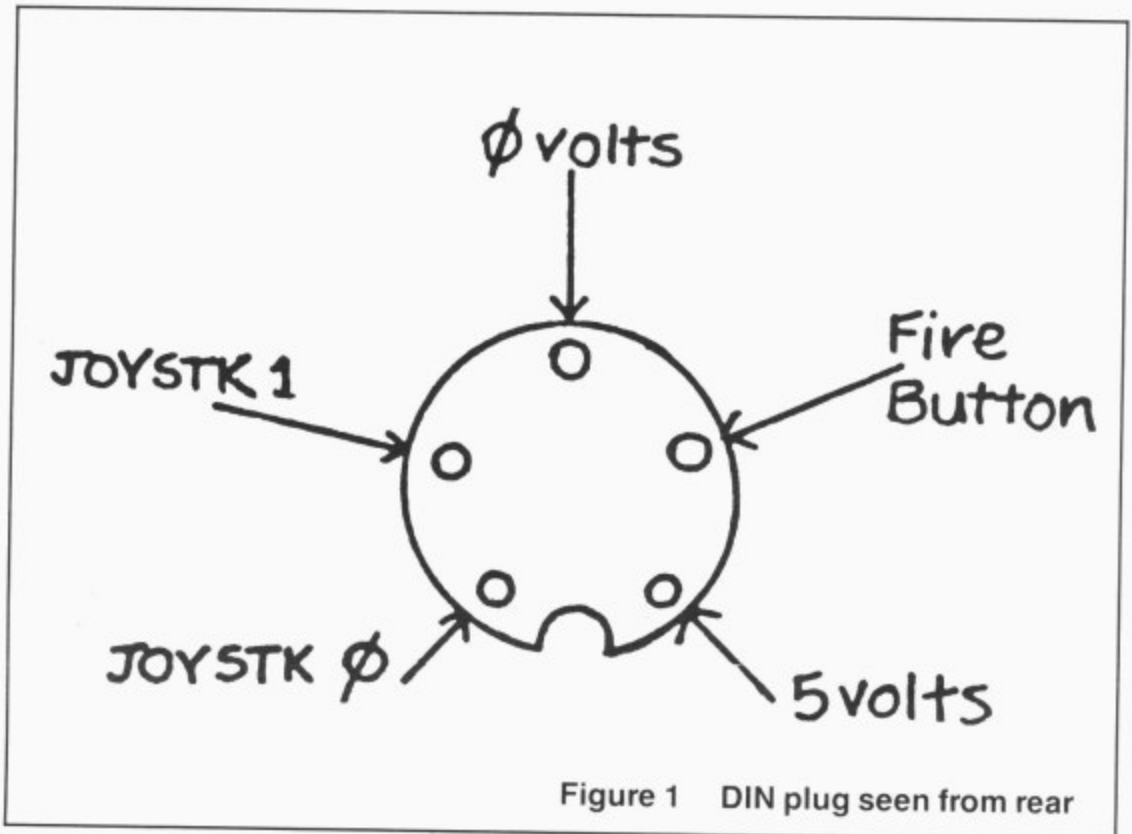

Figure 1 DIN plug seen from rear

## Parts list

R1,2,4,5.....5.6kohm resistor  
 R3,6.....4.7kohm resistor  
 TR1,2.....any general purpose NPN transistor  
 Epoxy adhesive,  
 solder,  
 fine insulated wire.

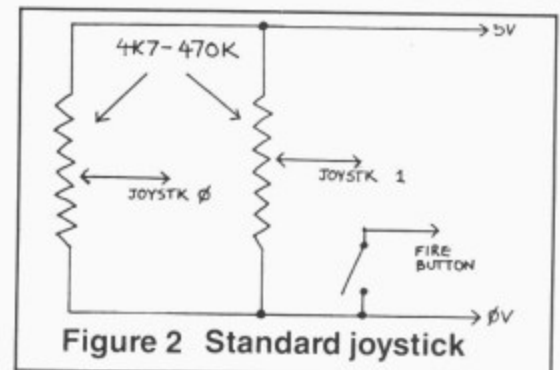

Figure 2 Standard joystick

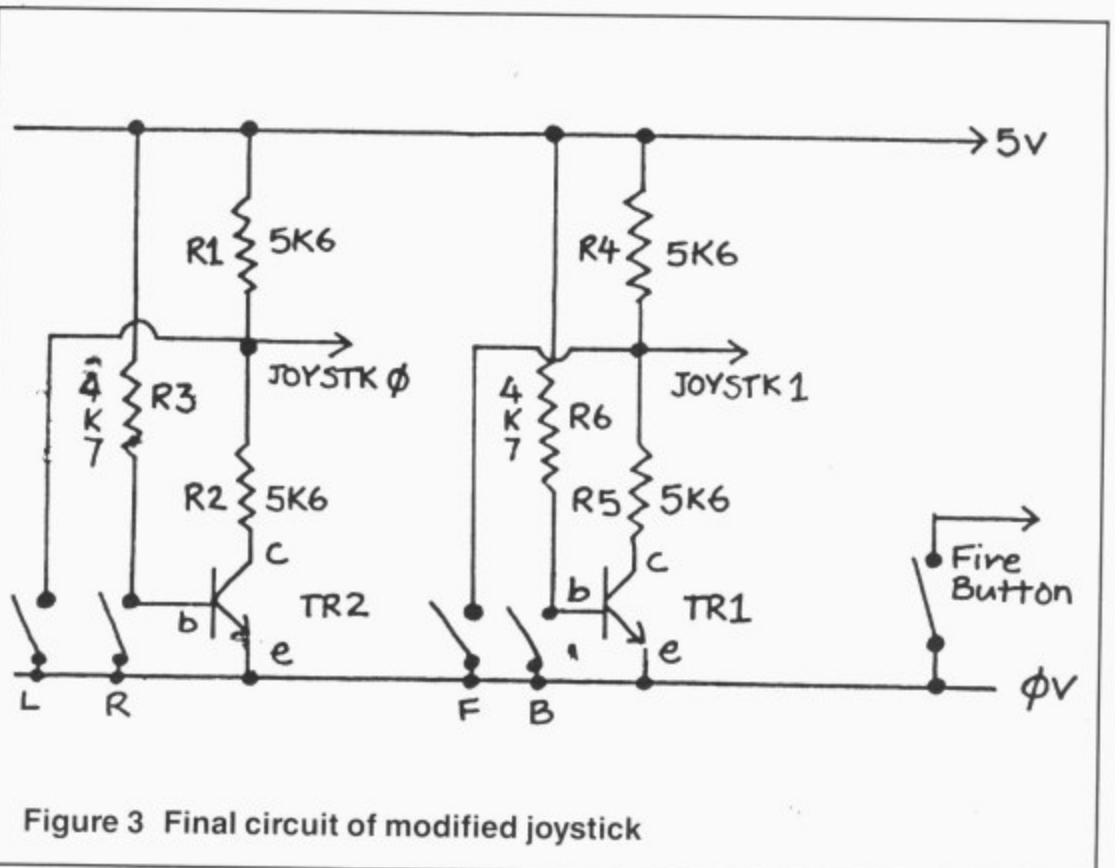

Figure 3 Final circuit of modified joystick



# Disc to Tape

Save disc space by backing up your data on cassette says Peter Whittaker.

ALTHOUGH I started using my Dragon with only a slow cassette recorder, I eventually upgraded to a disc drive, which I would now be unable to do without. Unfortunately, discs are a lot more fragile than cassette tapes. Even in the most careful of hands, a disc can fall victim to a cup of coffee or to someone sitting on it. While a cassette tape might survive the event, a disc will be completely destroyed, so disc users are advised to have backup copies of all their discs.

To backup all my discs to disc would cost quite a lot of money, and would be a waste of discs I couldn't use. However, the alternative of trusting to luck that they will remain undamaged for ever is also unappealing. As a solution to the problem, I have written this program to transfer all the contents of a disc to a cassette tape. It uses less than twenty-two minutes of tape to record a forty track disc, so four discs can be saved on one C90 cassette. This enables one to have copies of all one's discs for much less than a quarter of the cost of duplicate discs.

The program works by protecting mem-

ory above 9500, and copying the contents of the disc, five tracks at a time, into the protected area. This is then saved to tape as a machine code file. Eight files are required to save an entire disc. Each file has the same name, identifying the disc it comes from, and a number telling which of the eight files it is. So, a UTILITY disc would be saved as UTILITY1, UTILITY2, UTILITY3, and so on. To restore a disc, the program runs in reverse. Each file is reloaded into protected memory, and then copied back out to the relevant track and sector.

When RUN, the program displays an option list. Press the <S> key, and then place the disc to be saved in the disc drive. Place the cassette in the tape recorder, and set it to record. Now type in the disc title, remembering that only the first seven letters will be used. (The last space is used for the file number.) Now go and have a coffee while the program transfers the disc to tape. Whilst it runs, the program will display the Track and Sector number it has reached, at the top of the screen. When the disc has been saved the program will print a

message saying so, play a tune, and then return to the options list. Press the <Q> to quit.

When a disc gets damaged, and you want to restore it from tape, run the program and press the <L> key. Insert a disc in the drive, and ready the tape recorder to load the data back in. Type in the name of the files to be loaded, and then go have another cup of coffee whilst it runs. Once again the program will print the Track and Sector number it has reached, at the top of the screen. When the disc has been reloaded, the program will print a message saying so, play a tune, print out the DIRectory, and then stop.

## Program Explanation

There is little fancy programming in this routine. The sectors are loaded using two of the disc ROM routines. Simply POKE 236,DISC TRACK(0-39), POKE237,DISC SECTOR (1-18),PROKE238/9,STARTSAVE/LOAD ADDRESS. Then EXEC40409 to copy the next 256 bytes to the selected track and secto, or EXEC49412 to copy the selected sector down into memory.

```
10 CLS@:CLEAR200,9500
20 PRINT@128,"          DISC TO TAPE":P
   RINT:PRINT"<S>....SAVE DISC TO
   TAPE.":PRINT"<L>....LOAD DISC F
   ROM TAPE.":PRINT"<Q>....QUIT PR
   OGRAM."
30 A$=INKEY$
40 IF A$="Q"THEN STOP
50 IF A$="S" THEN 80
60 IF A$="L" THEN 260
70 GOTO 30
80 MOTORON:PRINT"INSERT DISC IN DRI
   VE.....":PRINT"READY TAPE TO R
   ECORD DISC....":INPUT"ENTER TIT
   LE OF DISC TO SAVE      ":A$
90 MOTOROFF
100 FOR BLOCK=0 TO 39 STEP 5
110 FOR COUNT=0 TO 4
120 TRACK=BLOCK+COUNT
130 FOR SECTOR=1 TO 18
140 POKE236,TRACK:POKE237,SECTOR
150 LD=9500+COUNT*4608+(SECTOR-1)*2
   56
160 POKE238,INT(LD/256):POKE239,LD-
   PEEK(238)*256
170 EXEC 49412:'LOAD SECTOR FROM DI
   SC
180 PRINT@0,"TRACK: ";TRACK:PRINT@1
   6,"SECTOR: ";SECTOR
190 NEXT SECTOR,COUNT
200 WAIT 5000
210 CSAVEM A$,9500,32540,41194
220 NEXT BLOCK
230 PRINT"DISC SAVED....."
240 FOR A=1 TO 3:FOR B=100 TO 10 ST
   EP-10:SOUND B,1:NEXT B,A
250 RUN
260 PRINT"INSERT BLANK DISC IN DRIV
   E..... READY TAPE TO LOAD DISC.
   ....":INPUT"ENTER TITLE OF DISC
   TO LOAD      ":A$
270 FOR BLOCK=0 TO 39 STEP 5
280 CLORDM A$
290 FOR COUNT=0 TO 4
300 TRACK=BLOCK+COUNT
310 FOR SECTOR=1 TO 18
320 POKE236,TRACK:POKE237,SECTOR
330 LD=9500+COUNT*4608+(SECTOR-1)*2
   56
340 POKE238,INT(LD/256):POKE239,LD-
   PEEK(238)*256
350 EXEC 49409:'SAVE SECTOR TO DISC
360 PRINT@0,"TRACK: ";TRACK:PRINT@1
   6,"SECTOR: ";SECTOR
370 NEXT SECTOR,COUNT
380 WAIT 5000
390 NEEEXT BLOCK
400 PRINT"DISC LOADED....."
410 FOR A=1 TO 3:FOR B=100 TO 10 ST
   EP-10:SOUND B,1:NEXT B,A
420 DIR
430 '(C) 1986 BY PETER WHITTAKER.
```

**NEW**  
**ONLY**  
**£7.95**

**DRAGON DRAW**

This superb lightpen-driven drawing program allows the DRAGON's hi-res graphics commands to be used directly from the on-screen menu shown here. There are a wealth of commands available and the lightpen response is virtually instantaneous.

- ★ 4 pen sizes
- ★ Dotted lines, adjustable spacing
- ★ Shape linked brush
- ★ 2 drawing screens
- ★ Solid and empty boxes
- ★ Polygons
- ★ Freehand sketch
- ★ Solid and shaded fill
- ★ Printer/Plotter dump
- ★ Save and Load
- ★ Get and Put from different screens

PENS	SHAPE	DRAW	PAINT	COLOUR
		PLOT		
		PLOT		
		SKETCH		
		SKETCH		
BLOCK	CLS	EXIT	MOVE	SCREEN
GET 	CLEAR SCREEN 	EXIT 		
PUT 				

**SPECIAL OFFER:**  
**DATAPEN LIGHTPEN and**  
**DRAGON-DRAW Software**  
only **£29.95**



**DRAGON SOFTWARE SUPPLIED WITH LIGHTPEN**

**SKETCH**

- ★ PMODE 4 with 2-colour drawing
- ★ PMODE 1 with 4-colour drawing
- ★ On screen menu
- ★ Circles, Lines, Colour Fill
- ★ Erase and adjustable locked grid for accurate drawing

**SHAPE**

- ★ PMODE 4
- ★ On screen menu
- ★ Design shapes on enlarged scale
- ★ Construct shape libraries
- ★ Plot shapes
- ★ Rotate, Join, Fill
- ★ Use pictures in SKETCH or DRAGON-DRAW

PLUS details for use in your own programs

ALL FOR ONLY **£25.00** inc. VAT and Postage

**Datapen**

Available from: DEPT. DU  
Datapen Microtechnology Ltd., Kingsclere Road, Overton, Hants RG25 3JB  
Tel: (0256) 770488



**HAVE YOU EVER SEEN INSIDE A RAINBOW?**

You can with a subscription to THE RAINBOW, the most complete magazine available for the Color Computer. While THE RAINBOW is written for the Tandy CoCo, many of our programs can be typed in with few or no changes for use on the Dragon Computer.

Every month, we bring you an average of 250 pages packed with programs, tutorials, questions and answers, product reviews, hints and tips for expanding your computing horizons. It can all be yours by subscribing to THE RAINBOW today!

U.K. Subscription Rates:  
Surface — \$68 (U.S.)  
Airmail — \$103 (U.S.)



Subscriptions to THE RAINBOW are \$31 in the United States. Canadian rate is \$38 (U.S. funds). Surface rate elsewhere is \$68 (U.S.). Airmail \$103 (U.S.). All subscriptions begin with the current issue. Please allow 6 to 8 weeks for first copy. Payment accepted in U.S. currency only.

**The RAINBOW:**  
(502) 228-4492

**The Falsoft Building**  
P.O. Box 385  
Prospect, KY 40059

**YES! Sign me up for one year (12 issues) of The RAINBOW**

Name \_\_\_\_\_

Address \_\_\_\_\_

City \_\_\_\_\_ State \_\_\_\_\_ ZIP \_\_\_\_\_

Payment enclosed

Charge my:  VISA  MasterCard  American Express

Account # \_\_\_\_\_

Interbank # \_\_\_\_\_ Exp. Date \_\_\_\_\_

Signature \_\_\_\_\_

For credit card orders only, call (800) 847-0309, 8 a.m. to 5 p.m. EST. For other inquiries call (502) 228-4492.



# Text Screen Dump

*Mike Hides gets lower case into ASCII and out onto the printer*

THE PROGRAM is to dump the contents of the text screen to a printer. The program works by examining the locations 1024 to 1535 and sending the appropriate ASCII code to the printer. The difficulty in writing this program was that the Dragon only stores the *uppercase* letters in ASCII format. The program can be located anywhere in memory and is executed by using the address of the first instruction (Listing 1).

The program looks at the locations 1024

to 1535 in turn and puts the contents in the A register. If the contents are between 64 and 95 they are sent to the printer unchanged. This is because they are the correct ASCII codes. The JSR \$800F is a ROM routine for sending the contents of the A register to the printer. If the value in A is below 63 the TOLOW loop adds 96 to its value which produces the correct ASCII code. The TOHI loop works in a similar way but subtracts 64 to obtain the correct ASCII

code. The GRAPH loop is a trap for codes which the Dragon uses for block graphic characters which cannot be correctly interpreted by printers. They are converted to ASCII code 32 which produces a SPACE on a printer. The B register is used to check when a line has been completed and sends code 13 to produce a carriage return every 32 characters. The loop BACK decreases the contents of the B register every time a character is sent to the printer.

Listing 1		BACK	DECB		ADDA	#96	
			CMPB	#0	JSR	\$800F	
	ORCC	##50	BNE	LOOP	BRA	BACK	
	LDX	#1024	LDA	#13	TOHI	CMPA	#128
LINE	LDB	#32	JSR	\$800F	BHS	GRAPH	
LOOP	LDA	,X+	CMPX	#1535	SUBA	#64	
	CMPA	#63	BLE	LINE	JSR	\$800F	
	BLS	TOLOW	ANDCC	##AF	BRA	BACK	
	CMPA	#96	RTS		GRAPH	LDA	#32
	BHS	TOHI	TOLOW	CMPA	#27	JSR	\$800F
	JSR	\$800F	BHS	GRAPH	BRA	BACK	

## Listing 2 — Basic Loader

```

10 CLEAR 200,31999
20 FOR N = 32000 TO 32066
30 READ A$
40 POKE N,VAL("&H"+A$)
50 NEXT N
60 DATA 1A,50,8E,04,00,C6,20,A6
70 DATA 80,81,3F,23,19,81,60,24
80 DATA 20,BD,80,0F,5A,C1,00,26
90 DATA EE,86,0D,BD,80,0F,8C,05
100 DATA FF,2F,E2,1C,AF,39,81,1B
110 DATA 24,12,8B,60,BD,80,0F,20
120 DATA E3,81,80,24,07,80,40,BD
130 DATA 80,0F,20,D8,86,20,BD,80
140 DATA 0F,20,D1
To save CSAVEM"DUMP",32000,32066,32000
To initiate the program use EXEC32000.

```

# BLOCK· BUSTER QUIZ II

FOR THE  
DRAGON 32 / 64

**£6.50**

TRADE  
ENQUIRIES  
WELCOME

ANOTHER mammoth 500 Questions and Answers are contained in this ever-popular brain-teasing quiz.

DR31

To obtain your copy, just send a cheque or postal order to the address below. (We despatch immediately by 1st Class Post) Cheques / POs should be made payable to COMPUTERWARE.

**COMPUTERWARE**  
PO Box 318, Stoke-on-Trent, ST6 6UX





LAST MONTH I promised you I'd get back to dealing with letters, but here I am beginning by breaking my promise. Can you trust no-one these days? Well it's not my fault there have been two interesting and cheap adventures released this month, and I will have space to deal with some of your letters before the end of the column. Promise.

First past the starting gate is The Thirteenth Task at just £3 from Arc Software, 272 Mearns Road, Newton Mearns, Glasgow G77 5LY. This is definitely one for wimps with ambitions as you get to play the part of Hercules, and don't ask which part. Not content with the fabled Twelve Labours of Hercules, Arc Software has decided to give him a thirteenth job to do, and that's killing Hades, the ruler of the Underworld. Could be unlucky for some.

### Herculean tasks

If you know about Hercules's previous problems then that'll be a help as some of them re-appear, and a knowledge of Greek mythology won't come amiss either. A neat 4-page inlay is provided with the tape, and author Alan Cook has obviously gone to a lot of trouble to present a decent-looking product, so three cheers for that. The inlay provides a good introduction, along with some of the verbs the game understands, though a full list would be better as some of the others are just a little out of the ordinary: SLAUGHTER, STRANGLE, LEASH, SLAY and THROTTLE, for example, and these also give you a flavour of the violent nature of the game, though that's just a reflection of the violence of Greek mythology itself. Rambo's a seven-stone weakling when compared to the ancient Greeks. However, a help sheet and full verb list is available from Arc Software, and also from myself if you happen to be writing to me.

I promise I didn't look at the sheet when playing the game, though, and I have to say that its main drawback is that it seems to be comparatively easy. At least to begin with, though the problems were getting more complex when I ran out of time and actually had to start writing about the adventure. The game's got 135 locations, and this is made possible by a bit of repetition in the descriptions used. Quite how all those Alpine paths got to ancient Greece I'm not sure! After dealing with a lion in the first location, you wander off and spy a hind...this is what's known as hindsight, I suppose, a useful thing in any adventure.

Trouble is, the hind senses you and runs away, but it can be cornered somewhere and will then earn you a few points. A few weapons are picked up, you encounter the Graeae (three hags with one tooth between them, like a geriatric Beverly Sisters), through the Minotaur's maze and out the other side to deal with old favourites like the Hydra, Gorgon, Muses and Cyclops.

The vocabulary supports LOAD, SAVE, HELP, SAY, EXPLAIN, EXAMINE and other useful commands, all of which can be abbreviated to the first three letters, although the character set hasn't been redefined so the screen layout is a little pedestrian. But well worth investing three quid in, despite my few criticisms.

For £3.95 you can have a copy of Underbeings of Croth from Maridian at Birchmore Cottage, Nairdwood Lane, Prestwood, Great Missenden, Bucks HP16 0QQ, and this is also worth parting with your hard-earned pennies for. This time the character set has been redesigned, and also the screen so that the text scrolls up through, appropriately enough, a scroll. Presentation is excellent all round, with dramatic music to accompany the instructions, and this slowly fades when you press ENTER to start the game proper.

The story? You have discovered the secret entrance to an underground village, but unfortunately the village's guardians have also discovered you, and you begin the game in an iron cage suspended by a chain above a dark pit from which rather violent roars emerge. Get out of that, as they say. Then make your way to freedom. The first task has that nice balance of difficulty, so that it takes you a little time to accomplish it, but not so hard that it puts you off. Just examine everything and think whether some objects might have more than one use.

If you can get out of the next few locations (don't linger down below), you'll be promptly thrown into a cell, and the map around here shows some nice touches of reality as you come across doors that can only be opened from one side, then later on you might find yourself on the other side and able to open the door to pass through. Watch out for the ape-guards, although I haven't yet met the Toothworms the cassette cover promises. And I never will, if I don't devise a way of getting the box out of the well without getting myself trapped at the bottom. And how can I get the owl to give up the shiny object in its beak, especially as

I'm told I can't climb trees?

The atmosphere of an underground village is well-evoked, and this game too supports lots of useful commands. Not just GET, EXAMINE, SAVE, LOAD, SEARCH, SAY and so on, but multi-inputs if linked by the word AND, and the program also understands the word IT to refer to the previous object, e.g. TAKE BOX AND OPEN IT. There's a FAST option, if your Dragon can cope with the high-speed POKE, and all-in-all this is another for Dragon adventurers to add to their Christmas shopping lists.

### Entanglements

Some of you, in fact lots of you, have already been shopping for Tanglewood, and I've had many letters praising that game, so anyone who's not yet bought it is obviously missing out. Simon 'The Solver' Hargrave has come up with lots of clues, though he hasn't yet managed to finish it completely. To get Peabody home, go to the north-eastern garden, get the spade, then dig in NEDRAG NRETSEW and put what you find in ESUOH GOD EHT. To get rid of the ants: YSNAT WORHT. To get gold coin, tell GABNAEB to DNOP OTNI EVID and search for it. It is there, promises Simon. To make rockcakes first LLIM MORF RUOLF TEG, and SEKAC KOOC in NEHCTIK EGATTOC DOOWGOD.

Simon asked for help on Colossal Cave, where he was unable to get his last treasure, the bear's chain. Just NIAHC TEG, though you need SYEK EHT to do it. Simon's happy to help with this list of adventures: Tanglewood, Wizard's Quest, Vortex Factor, Trekboer, Juxtaposition, Ring of Darkness, Return of the Ring, Colossal Cave, Keys of the Wizard, El Diablero, Madness and the Minotaur, Franklin's Tomb and Lost in Space. Plus some others, he says. The man's a glutton for punishment, and you can punish him by letter plus s.a.e. to Crawley Hill Farm, Uley, Dursley, Glos. GL11 5BH; by phone on 0453-860361 after 4 p.m. weekdays only; or on Prestel mailbox 453860361. Finally he says if there are any other Dragon owners playing the multi-user game, Shades, then try to contact him as 'Cuthbert' as he needs your help!

Proving that Simons are far from simple comes a letter from Simon Harrison of The Vicarage, 56 Norwich Road, Watton, Thetford, Norfolk NR25 6DB. This one's just polished off Syzygy, as well as Dragon



27 COOMBE ROAD SOUTHMINSTER, ESSEX. CMO 7AH

TEL: 0621 772589



WOULD LIKE TO WISH ALL OUR CUSTOMERS A VERY MERRY XMAS AND NEW YEAR. MANY THANKS FOR YOUR SUPPORT.

SOFTWARE PROJECTS

Manic Miner
Jet Set Willy
TWIN PACK — £7.95 (OR £5.00 EACH)

DESIGN DESIGN

Dark Star
Rommels Revenge
TWIN PACK £7.95 (OR £5.00 EACH)
\*\*\* Tubeway Army £2.99 \*\*\*

INCENTIVE

Back Track £5.50
The Ket Trilogy £7.95
Eddy Steady Go £6.95
Moon Cresta £7.50

\*\*\* MASTERTRONIC \*\*\*

Bug Driver £1.99
Vegas Jackpot £1.99

HEWSON CONSULTANTS

3D Lunattack £2.99
3D Space Wars £2.99
3D Seiddad Attack £2.99

PEAKSOFT

Tim Loves Cricket £5.00
NEW Champions £7.95
Photo Finish £3.00
Ossie £3.00

OCEAN ONLY

Hunchback £1.99

ADVENTURES

A/INTERNATIONAL TWIN PACKS
Strange Odyssey
Adventureland
Secret Mission
Pirate Adventure
Voodoo Castle
Mystery Fun House
Pyramid of Doom
Ghost Town
Golden Voyage
Savage Island — Part 1
Savage Island — Part 2
The Hulk
Sorcerer of Clay, Cattle
Time Machine
Escape From Pulsar 7
Arrow of Death — Part 1
Arrow of Death — Part 2
Circus
Ten Little Indians
Perseus and Andromeda
Wizard of Akryz
CHOOSE YOUR TWIN PACK
FROM THE ABOVE TITLES FOR
ONLY £6.50 per Twin Pack

NEW!

NEW!

NICKS SOFTWARE

"Island Adventure"
and "4D"
BOTH FOR ONLY £3.95

COMPUTAPE

Madness & the Minotaur £2.99
Hint Sheet SAE + £0.50

IMAGINE ONLY

Pedro £1.99

ARCADE GAMES



\*\*\* MICROVISION \*\*\*

The Talisman £7.50
Beanstalker £7.50

BLABY GAMES

Kung Fu — The Master
Boulder Crash £5.00
Temple of Doom £5.00
Cosmic Crusader £5.00
Olympia £3.99
Gis A Job £3.99
Sword & the Sorcerer £3.99
Morbid Mansion £3.99
Caverns of Chaos £3.99
Fingers £3.99
Trun (4 Games in one) £3.99
Wizards Lair £3.99
Starman Jones £3.99
Karma Crazy £3.99
Detonate/The Alien £2.99
Hubert £2.99
Boris the Bold £1.99
Ruby Robba £1.99
Star Swoop £1.99
Bombs Away Basil £1.99
MacDougals Last Stand £1.99
The Bells £1.99
Laser Run £1.99
Desperado Dan £1.99
Mutant Wars £1.99
Darts £1.99
Star Defence £1.99
Perilous Pit £1.99
Brocks Kingdom £1.99
Dodo £1.99
Copta Snatch £1.99
Barmy Burgers £1.99

PROGRAM FACTORY

Ninja Warrior £2.99
Taskship £2.99
Pacdroids £2.99

B & H SOFTWARE

Pub Crawl £3.99
And All Because £3.99

\*\*\* A & F SOFTWARE \*\*\*

Chuckie Egg £2.99
Screaming Abdabs £2.99

THE END OF A CLASSIC!
ONLY 350 CHUCKIE EGG LEFT!
AND 150 SCREAMING ABDABS!

IMPISOFT

Chicken Run £1.99
Fruity £1.99

(OR £3.50 THE PAIR)

C.R.L.

Keys of Roth £1.50

CABLE SOFTWARE

Quazimodo £1.99
Zak's-Son £1.99
Superbowl £1.99
Fantasy Fight £2.99

COMPUTERWARE

Linkword £3.50
Showjump £3.50
Blockbusters 1 £3.50
Blockbusters 2 \* £6.50
Wordsearch \* £4.50

COMPUTAPE

Whirlybird Run £2.99

MELBOURNE HOUSE

Horace Goes Ski-ing £1.99
Hungry Horace £1.99
(NO INLAY CARD)

MICRODEAL

Frogger £1.99

OASIS

Chess £2.99

SOFTEK

Ugh! £2.99
Galacticans £2.99
Ultrapede £2.99

ROMIK SOFTWARE

Romik Cube £1.50

RICHARD SHEPHARD

Transylvanian Tower £1.50

TUDOR WILLIAMS

Aces High £5.50
Time Attack £5.50
(OR £10.00 THE PAIR)

WINTERSOFT

Ring of Darkness £5.00

MISSION ONE

Project Volcano £1.99
(Become a Spy for a day)

PERIPHERALS + EDUCATIONAL

JOYSTICKS

CONSUMER ELECTRONICS —
Pair Strike Control
Joysticks £19.95
PEAKSOFT Multi-Direction Joysticks —
£5.50 EACH £9.95 PAIR

CABLES

Cassette Lead £2.50
Centronics Printer Cable £11.95
Ariel Lead £2.50
DUST COVERS £2.99

EDUCATIONAL

MERIDIAN SOFTWARE

Spellbox £5.95
Mazerace £5.95
Underbeings of Croth £5.95

SULIUS SOFTWARE

Beseiged £2.99
Word Power £2.99
(Two programs to aid spelling from 7
years and upwards)

CROUCHER COMPUTER SOFTWARE

C.A.D. 34 £4.95
A computer aided design program to
help you design your own screens.

BOOK SALE!

THE DRAGON TRAINER £2.50
Learn Basic on your Dragon with simple step by
step instructions.

DRAGON 32 GAMES MASTER £2.50
A great help to all those writing their own
games. It covers sound, graphics, colour,
movement, scoring and many other items.

THE WORKING DRAGON 32 £2.50
A collection of programs covering topics such
as data storage, finance, household
management, education and games of skill.

ADVANCED SOUND AND GRAPHICS £2.50
This book describes all the major aspects of
sound and graphics on your computer from 3D
projections, animation, screen saving through
to keyboard sound synthesis.

ARTIFICIAL INTELLIGENCE ON YOUR
DRAGON 32 £2.50
How to implement A1 routines on your
computer and turn it into an intelligent machine
with which you can even hold a conversation.
ORDER 2 BOOKS OR MORE FOR ONLY £2
EACH

UTILITIES

HARRIS SOFTWARE
Moneybox (Personal
Accts) £14.99
Mailbox (Mailing List) £16.99
Sharebox (Stocks and
Shares) £16.99
Salesbox (Sales Ledger) £19.99
Billsbox (Purchase
Ledger) £19.99
Cashbox (Nominal
Ledger) £19.99
Stockbox (Stock Control) £19.99
Orderbox (Invoicing) £16.99

SMITHSON COMPUTING
"Electronic Author" Word
Processor — ONLY £14.95
Disc version — £19.95
(Very good value for money)
Frankie (Brilliant) £6.95

ASTROCALC — Astrology
Learn how to calculate a horoscope
SPECIAL PRICE — £7.95

OCCULT SOFTWARE
Numerology OUR PRICE — £6.50

PAMCOMMS
Source Maker £8.00
Disc Kit — Dragondos £10.20

ELKAN ELECTRONICS
Dragon/Tandy Colour Cruncher £7.95
Converts Basic Dragon Programs to
Tandy and visa versa

FOR A FAST MAIL ORDER SERVICE send your order to the above address making all
cheques/Postal Orders payable to COMPUTAPE.
For Catalogue only, please send SAE. OR TELEPHONE 0621 772589
FOR 24HR CREDIT CARD SALES.

Prices include FIRST CLASS POSTAGE and packing. OVERSEAS ORDERS WELCOME.

COMPUTAPE: The only Software Company to make your Dragon Chips fry not cry!

PLEASE REMEMBER XMAS LAST POSTING DATES

UK — 10th December. — ABROAD — 20th December.



Mountain and Calixto Island. He'll help on those and would love to hear from anyone able to help him solve his biggest problem, which is how to prise his sister away from Chuckie Egg so he can use his Dragon again!

C.Vollbracht of 110 Alpine Rise, Styvechale Grange, Coventry, West Midlands CV3 6NR needs someone's help as he's having difficulty buying copies of Fishy Business, Lost in Space, Death Mines of Sirius, If I Had a Million and Mission Moonbase. Anyone willing to sell? He (or maybe she) is prepared to help for the usuals.a.e. on Williamsburg, Mansion, Final Countdown, Eno, The Golden Baton and The Emperor Must Die.

### Looking for openings

Keith Marshall is in danger of losing his sanity, he says, unless someone can tell him how to get a light in The Vortex Factor, open the door in Pyramid of Doom and open the gate in something called 1200. In return he can assist on Danger Island, Mystery of the Java Star and Aquanaut 471.

Needing help on Syzygy is Ian Barford, 79 Hertford Road, Stevenage SG2 8SE, and Ian also asks about the Adventurers Club Ltd, which I recommended several issues ago. In fact the club seems to have gone out of business, despite giving excellent value-for-money service for over a year, and although there is talk of it getting going again soon I wouldn't suggest anyone send off any money to them for the moment. If you're already a member you'll be aware of the long summer silence, and promises of an autumn return.

If you want to sample the Adventure Contact club run by Pat Winstanley then you'll only need to fork out 50p for a sample issue of their monthly newsletter. The aim of this club is different, it isn't a helpline but is a more of a forum for adventure writers who want to share ideas and hints. Inevitably this means a bit of concentration on successful

utilities like The Quill and Graphics Adventure Creator, not available to Dragon users, but there are also articles on marketing games, royalties, duplication, cost of cassette covers, and so on. Worth it if you're seriously interested in that side of things.

Stephen Hooton, 4 Bankcroft, Longton, Preston, Lancs PR4 5AL wants help on Tanglewood, like how to get the shrimp net and what use is the scanner, and Paul Marsh asks if anyone else is playing some lesser-known adventures, Horror Castle and Pirates Ahoy. If so, contact Paul at 7 Earlsmead Crescent, Cliffsend, Ramsgate, Kent CT12 5LQ.

Calling Tunbridge Wells, calling Tunbridge Wells. Any Dragon owners out there? If so, contact Richard Tyler, 11 Madeira Park, Tunbridge Wells, Kent TN2 5SX. He needs help on Rings of Darkness, Wings of War and Juxtaposition, particularly as his SAVE/LOAD command won't work in that last one. Anyone know why he might be getting a syntax error when he tries to use it? Richard has finished Aquanaut 471 and offers help on that one.

More problems of an unadventurous nature, this time on Castle Adventure for

Gary Alford, 35 Victoria Road, Fair Oak, Eastleigh, Hants SO5 7FY. His version keeps crashing with an OM error despite using the POKE 25.6 and NEW commands before loading. Anyone else experienced that problem and, more importantly, solved it?

Neil Bowden's having trouble with The Sorcerer of Claymorgue Castle, and would appreciate help at 73 Erskine Hill, Polmont, Falkirk FK2 0UH, while Philip Ravenscroft wonders how he'll ever defeat Vader in Syzygy. Philip lives at 40 Cedar Road, Willenhall, West Midlands WV13 3BZ.

Finally, if you've got access to Prestel then you might like to try calling up The Drag Mag, run by Simon Jones and at present the only Prestel magazine devoted to the Dragon. He (yet another Simon) says that there's a large section devoted to adventuring, which recently featured an interview with someone called Mike Gerrard. Now that has to be worth looking at, and can be looked at on page x700110161. And if anyone has worked out why so many people called Simon are into Dragon adventuring then please let me know as I'm quite baffled.

## Adventure Contact

To help puzzled adventurers further, we are instituting an Adventure Helpline — simply fill in the coupon below, stating the name of the adventure, your problem and your name and address, and send it to Dragon User Adventure Help-

line, 12/13 Little Newport Street, London WC2H 7PP. As soon as enough entries have arrived, we will start printing them in the magazine.

Don't worry — you'll still have Adventure Trial to write to as well!

**Adventure** .....

**Problem** .....

.....

**Name** .....

**Address** .....

.....

## Adventure contact

**Adventure** Calixto Island

**Problem** I cannot get the paddles

**Name** Simon Kennerley

**Address** Duxmore Farm, Newport, Isle of Wight, PO30 2NZ.

**Adventure** Trekboer

**Problem** How do I land on the planet?

**Name** Laura Hodgson

**Address** 6 Gordon Place, Kinross, Tayside, Scotland.

**Adventure** 1) Juxtaposition 2) Trekboer

**Problem** 1) Where is the red cetite ore? 2) How to stop Xen-dos plant from dying?

**Name** David Kelsall

**Address** Woodtop Farm, Goosnargh, Preston, Lancs PR3 2ER.

**Adventure** The Cricklewood Incident

**Problem** How do I travel by bus or train?

**Name** Scott Taylor

**Address** 14 Pembroke Gardens, Wellesbourne, Warwick CU35 9PX.

**Adventure** 1) Juxtaposition 2) Trekboer

**Problem** 1) Where is the receiver, sender and deeds of the brown? 2) How do you get past the forcefield?

**Name** James Baker  
**Address** 3 Haycock Road, Bangor-On-Dee, Wrexham, Clwyd, North Wales.

**Adventure** Return of the Ring  
**Problem** How do you get the key of the genie on the forest moon?

**Name** Wayne Holt  
**Address** 10 Thirlemere Road, Bedworth, Nuneaton, Warwickshire CV12 8BY.

### POOLSCASTER

The Pools forecasting System by Trident Software.

- 1) Forecasts Homes, Draw AND Aways.
- 2) Contains both British AND Australian versions on one cassette. Easily updated — Unique system allows you to find team names with the minimum of effort — no codes or numbers to memorise.
- 4) Screen AND/OR Printer option.
- 5) Guaranteed better than chance.

### THE ULTIMATE QUIZ

A Quiz game for 1 to 6 Players. Load any of the Question & Anser files; set the time limit; enter the players names and away you go. Questions asked at random (but not repeated), bonus's awarded fairly and scores kept up to date. Includes a 500 question and Anser file.

### 'CREATE'

With 'CREATE' you can make your own Question & Anser files to run on the above program. Think of the possibilities! 'CREATE' ensures that you will always find a new use for THE ULTIMATE QUIZ.

'POOLSCASTER' ..... £5.95 'ULTIMATE QUIZ' ..... £5.95  
'CREATE' ..... £3.95 Additional Q & A files ..... £2.95

fully inclusive or S.A.E. for further details to: Trident Software, 6 Neptune Terrace, Sheerness, Kent. ME12 2AW.

DR38

# BLABY COMPUTER GAMES

This may well be your last chance to buy at these silly prices as we are unfortunately discontinuing Dragon Games

- |                                |       |                             |       |
|--------------------------------|-------|-----------------------------|-------|
| ★ MORBID MANSION .....         | £2.50 | □ BELLS.....                | £1.00 |
| □ COSMIC CRUISADER.....        | £2.50 | □ PERILOUS PIT.....         | £1.00 |
| ★ RUBY ROBBER.....             | £2.50 | ★ MUTANT WARS .....         | £1.00 |
| ★ OLYMPIA .....                | £2.50 | ★ BARMY BURGERS .....       | £1.00 |
| ★ WIZARDS LAIR.....            | £2.50 | ★ BORIS THE BOLD .....      | £1.00 |
| ★ STARMAN JONES.....           | £2.50 | ★ DARTS .....               | £1.00 |
| ★ TRUN.....                    | £2.50 | ★ BOMBS AWAY BASIL.....     | £1.00 |
| ★ CAVERNS OF CHAOS.....        | £2.50 | ★ McDOUGALS LAST STAND..... | £1.00 |
| ★ FINGERS .....                | £2.50 | □ MISSION ATTACK.....       | £1.00 |
| ★ GIS A JOB .....              | £2.50 | □ BROCKS KINGDOM.....       | £1.00 |
| ★ SWORD AND SOURCERER... £2.50 |       | □ DO·DO .....               | £1.00 |
| KAMA KA .....                  | £2.50 | ★ COPTA SNATCH.....         | £1.00 |
| <hr/>                          |       | □ STAR DEFENCE .....        | £1.00 |
| ★ KUNG FU .....                | £3.50 | □ DESPERADO DAN.....        | £1.00 |
| ★ TEMPLE OF DOOM.....          | £3.50 | □ LASER RUN .....           | £1.00 |
| ★ BOULDER CRASH.....           | £3.50 | ★ STAR SWOOP.....           | £1.00 |
|                                |       | ★ FRUIT MACHINE .....       | £1.00 |

Please Add 50p for Post and Packaging on each game up to four games

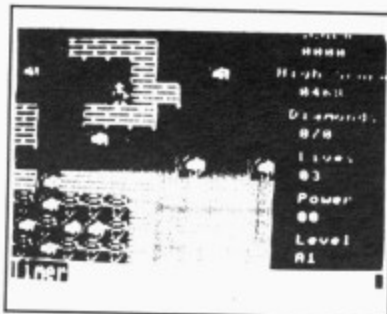

**BOULDER CRASH** — Boulder to the right and left infact every where, nows your chance to be a Diamond Miner a thing you've always nodout wanted. This game was a hit on all other computers now you have it.  
Arcade Action **£5.00**

NEW

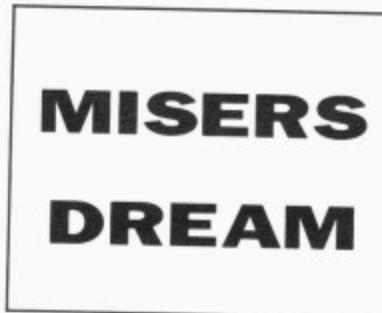

From The Author of  
**"EDDIE STEADY GO"**  
**£4.00**

NEW

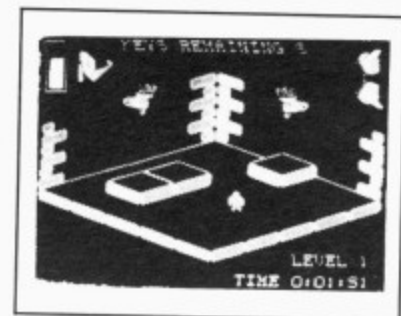

**TEMPLE OF DOOM** — Jones must collect all the keys from this castle to escape four floors of wandering thats if you can last the test of time.  
3D Arcade Action **£5.00**

Blaby Computer Games  
Lutterworth Road  
Blaby, Leicester  
Telephone: 0533 773641

- ★ Denotes Five Star Review
- ☆ Denotes Four Star Review
- Denotes Three Star Review

Send S.A.E. for Catalogue

DR33



## Second language

I HAVE a Dragon 64 computer and am interested in using the second Eprom facility for an alternative built-in language. If this is possible, could you explain how to select the second on-board Eprom and say where it lies in the address space.

Russ Taylor  
Chepstow  
Gwent

IT WOULD be possible to replace the second Basic Eprom (used for Dragon 64 Basic) with a new language eprom which you would have to write and blow yourself. The second Eprom is selected by making bit 2 of \$FF22 an output and then setting it low. The original rom can be reset by setting this line high. The new rom appears in the address space \$8000 to \$BFFF. The following machine code will select the second rom and enter it at address \$8000 with interrupts disabled.

ORCC	# 255
LDA	\$FF23
ANDA	# \$FB
STA	\$FF23
LDB	\$FF22
ORB	# 4
STB	\$FF22
ORA	# 4
STA	\$FF23
LDA	\$FF22
ANDA	# \$FB
STA	\$FF22
JMP	\$8000

## How to justify

I HAVE a Dragon 32 and printer and want to try some word processing. I've thought of buying a piece of commercial software, but have decided to try writing a simple WP myself. The first problem I have come up against is how to right justify a line to 51 characters. I would imagine that I need to use a lot of LEFT\$ and RIGHT\$ commands, but I can't quite see how.

Would it be possible for you to write a short routine to perform right justification on a string?

Sandra Robinson  
50 Kennington Way  
Orpington  
Kent



THE following subroutine can be used within your word processor to right justify lines. The line length is set up in the variable LN in line 500. The string to be justified should be in AS when the routine is called, it will be returned justified in AS.

```
500 LN=51:P=51
510 DF=LN-LEN(AS):IF
INSTR(AS,"")=0 THEN 570
520 IF DF=0 THEN 570
530 FOR J=P TO 1 STEP -1:IF
MIDS(AS,J,1)=" " THEN
AS=LEFT$(AS,J)+MIDS(AS,J):DF=
DF-1:GOTO 550
540 NEXT J
550 P=J-1:IF P<1 THEN
P=LEN(AS)
560 GOTO 520
570 RETURN
```

## Input using?

IN THE same way as Dragon Basic has a PRINT USING facility to give formatted output, I would like to know if there is such a thing as INPUT USING which would provide an input mask for text and number input?

A.M. Stein  
48 Suffolk Road  
Seven Kings  
Ilford  
Essex

THERE is no built-in 'input using' command on the Dragon, but it would be relatively simple to provide this in Basic. As an example, look at the routine below which will take numerical input as formatted in the string FS and return the value in V. This could be expanded and improved to include error traps and all the useful format functions available with Print Using.

```
100 CT=0:MS=""
110 IS=INKEYS:IF IS="" THEN 110
120 IF IS=CHR$(8) AND CT>0 THEN
CT=CT-1:MS=LEFT$(MS,CT):
?CHR$(8); " ";CHR$(8):GOTO 110
130 IF IS=CHR$(13) THEN 180
140 IF MIDS(FS,CT+1,1)=" " AND
IS<>" " THEN SOUND 50,1:
GOTO 110
150 IF MIDS(FS,CT+1,1)="£" AND
(IS<"0" OR IS>"9") THEN SOUND
50,1:GOTO 110
160 ?IS;
170 MS=MS+IS:CT=CT+1:IF
CT<LEN(FS) THEN 110
180 V=VAL(MS):RETURN
```

## Double take

I RECENTLY acquired a Dragon 64 with 80 track double sided disc drives and printer. The system works well with the software that I was supplied with, but I have a problem with buying blank discs. A friend of mine has told me that normal discs will not work with double sided drives.

Could you tell me exactly what sort of disc I should buy, as the price varies enormously with the different formats.

Ken Knox  
Fair Oak  
Eastleigh, Hants.

THE 'official' discs you should buy are double sided double density 96tpi discs. These don't usually come cheap and in practice all floppy discs are manufactured by exactly the same process, so you can get away with using 'normal' single sided, double density, 48tpi discs so long as you use a well known brand such as Memorex or Dysan.

## Zilch

MY DRAGON has recently stopped working, when I turn it on the screen just goes green with a cursor. Why does it do this, is it that the adaptor is too close to the computer?

Benedict O'Reilly  
St. Annes  
Redstone Hill  
Redhill  
Surrey

THE problem is unlikely to be caused by the position of your power supply. As you get a steady display, the problem most likely lies in one of three areas, either the RAM, ROM or CPU is probably faulty.

The most common fault with Dragons of this type is with RAM-chips. I suggest you contact one of the repair specialists who advertise in this magazine for a quotation, for instance Pan Electronics at Unit A10, Enterprise Centre, Merthyr Industrial Park, Pentrebach, Merthyr, South Wales, or one recommended locally by a knowledgeable friend.

## Stylograph

I HAVE a CPA80 printer, and am trying to use Stylograph but I have two problems. Firstly, how can I change the character codes of Stylograph, such as underlining, to match those of my printer, and secondly, how can I stop Stylograph from sending a line feed at the end of each line. I've tried typing XMODE /P -lf, but it doesn't work.

Lothar Pilz  
71 Woodville Road  
Mooroolbark  
Victoria  
Australia

STYLOGRAPH can easily be modified to work with any printer codes simply by setting up a suitable 'stylo' file. I've explained how to do this previously, so I won't go into it again here, but see the Stylograph manual for details.

On your second problem, unfortunately Stylograph does not take any notice of the 'XMODE' setting for line feed, and there is no simple solution that I know of. If anyone has 'patched' Stylograph to stop if sending a LF, then please let us all know!

One fudge is to 'spool' your text to a file and then print this out from OS-9 rather than from within Stylograph.

## S.P. ELECTRONICS

CPA 80 Dot Matix Printer, inc. Printer Cable .....	<b>£228.00</b>
Parallel Printer Cable.....	<b>£12.90</b>
Cannon 160 CPS NLQ Printer, inc. Printer Cable .....	<b>£299.00</b>
Green Screen Monitors .....	<b>£85.00</b>
Disk Drives from.....	<b>£120.00</b>

A large range of software available.  
SAE for free list.  
Large range of spares available.

### Also complete Dragon repair service

#### S.P. ELECTRONICS



48 Limby Road, Hucknall, Notts  
(Nottingham 640377)



DR14

HERE'S MY CLASSIFIED AD.  
(Please write your copy in capitals on the lines below)

Name.....  
Address.....  
..... Tele.....

Please cut out and send this form to: Classified Department,  
Dragon User, 12 -13 Little Newport St, London WC2H 7PP.

## DISC DRIVE CONTROLLER FOR DRAGONS

fully compatible with DragonDos  
only £69.95 inc. of VAT & post  
Disc drives also available

*We also repair Dragons — please enquire.  
Please enclose S.A.E. with any enquiry.*

For further details of DOS see Grosvenor Software Ad.

**PNP Communications**  
62, Lawes Avenue, NEWHAVEN,  
East Sussex, BN9 9SB  
Telephone (0273) 514465

DR1

**DRAGON 62** disc drive, Dragon D.O.S. joysticks, games, utilities, telewriter, rainbow writer, D.R.S. editor/assembler, flex OS9. £250 (0278) 787478.

**DRAGON 32**, drive, printer, lightpen, tv, software, books. £250. 01-354 1296 eves/wkds.

**DRAGON 64**, Dragon 32, cumana V2.0 DOS printer N.L.Q., 12 discs, data recorder, word processor, 40 cassettes, full documentation, magazines, boxed, £500. Telephone (0533) 28501

**PRESTOSOFT** compilation, 1 five + programs including 'wiggler, a multi-screen arcade game only £2.75 (0772) 774485

**DRAGON 32** disk drive, joysticks, some games £130 ono workingham (0734) 784673.

**YOUR** basic programs printed for £1.50 send your tape and remittance to martin 9, Gray Crescent Plymouth Devon PL51DA.

**COMPLETE DRAGON 64 SYSTEM:** Single disk drive, commer printer. FLEX OS with Dynacalc spreadsheet, dynacast compiler and many utilities also disk based

business accounts and mailer programmes stop need larger computer. only £179 o.n.o AP Johnson Potters Bar (0707) 52688 work, 52834 home.

**DRAGON 32** boxed, 4 joysticks, cover, 45 games, books magazines incl 8 months subs to Dragon user. £99 ono Tel: Kidlington (Oxon) 08675 78421.

**PRINTER BROTHER M-1009** for Dragon as new with manual £95 phone 01-995 7145 evenings.

**LISTINGS SERVICE** for Dragon users. £1 for two printouts. Vince Gledhill 3 Belgrave Gardens, Ashington, Northumberland NE 639SW.

**DISK** drive with Dargon DOS, complete with manual and telewriter word processor disk. £100. tel. 0225 708989 after 6pm.

**DRAGON LISTINGS** printed. Send program cassett and s.a.e. to Diastar, Sherwood House, 42 Berron Road, Burnham-on-Sea, Somerset, TA8 2EX. Please include cheque or p/o for £0.75 per program made payable to 'Diastar'.

**DRAGON 32** (boxed) with cassette recorder, joysticks, books, user magazine and games tapes. £75. Wimborne, Dorset (0202) 883814.

**SUPER DRAGON** writer II, excellent word processor cartridge used only once, complete with tutorial £30 O.N.O. Paul Thomas, 144 Maesglas, Llan-Doverly, Dyfed, SA20 ODW.

**DRAGON SPARES** — most available SAE for list including Transformers; 74L S783 £10.25, 6809E £3.25, 6847 £2.50, 2764 £2.10, CPU Boards 32K £22, Nick Spiers, 114 Greenway, Tunbridge Wells Kent TN2 3JN.

**UNTESTED.** Complete cased dragons, 32K £38, 64K, Untested. (Could be working!) All inc p/p Phone Nick 0892 44070.

**SOFTWARE!!** forty one original games plus two joysticks — back issues of Dragon User and several books all for £60.

**DRAGON 32** boxed leads Dragon DOS drive seikosha GP500A printer fanfold paper recorder 20 games D/User mags books joystick telewrite

elite calc filmaster rainbow writer spite magic edit + as New Benefleet Essex 0268 756431 £250 o.n.o.

**DRAGON 32** upgraded to 64K, 3 joysticks, 53 games, light pen, books, mags, cassette recorder £110. Delta DOS disk interface £40. 0480 51421 after 6pm.

#### JOYSTICKS

For Dragon/Tandy, top quality Joysticks easier to handle and faster than others costing twice as much, £5.95 each, £10.95 the pair inc. Cheques and POs to: Peritron Dept. CU, 21 Woodhouse Road, London N12 9EN.

**PRINTER TEXAS 810**, 3" to 15" tractor, Hi-Saeed listing' etc, stand, Dragon cable, manual, paper also RS232, £100 or swap for min. A4 width printer with graphes, Graham, Trowbridge, 60552 (wilts).

**WANTED OS9**  
Editor/Assembler preferably with manual 0203 504842.

#### STOP PLAYING GAMES

Use your computer to make money. Turn your hobby into a home-based income. Full and part-time opportunities to cash in this tremendous market. High earnings easy possible. Open to any amateur micro user and gamer. Write for free details.

**Westlink Promotions**  
48 Great King Street, Edinburgh EH3 6QY



# Out on the tiles

Gordon Lee sets 'em up in time for Christmas

FOLLOWING the usual practice of including a mind-bending game in the Christmas edition of Dragon User, here is a colourful but tricky puzzle to exercise your brain! For the original on which this computer version is based, I am indebted to *Games and Puzzles for Addicts* by Roger Millington.

The game is played with sixteen coloured tiles — three tiles each of green, yellow, red and cyan, and four orange tiles. The object of the game is to place these tiles, one at a time, onto a coloured 4 by 4 grid. The grid can be filled in any sequence and the coloured tiles can be placed in any order, subject to the following rules:

- i) A tile cannot be placed on a square of its own colour
- ii) A tile cannot be placed next to a square of its own colour, either side by side or diagonally.
- iii) Only one tile may be placed on each square of the grid.

Note that only the top (exposed) colour is counted, so for example although a red tile cannot be placed next to a red square on the grid, if the square is covered by, say, a green tile, it might then be possible to place the red tile.

If the program listing is run, the computer will draw the initial layout of the grid. The sixteen tiles are shown (reduced in size) on the right of the screen. A tile is placed by moving the two arrows to locate the square to be played on, and then pressing the initial letter of the colour of the tile to be played. The 'arrow up' key moves the 'arrow up' cursor, and the 'arrow left' key moves the 'arrow left' cursor.

Once a move is made the computer checks that it is a valid move, and if so places a tile. Note that the grid has a black square showing in the centre of each compartment to indicate that it is uncovered. Once a tile has been played this square disappears, so you can tell where the tiles have been placed. To place all sixteen tiles correctly, and hence cover the grid, re-

quires a bit of ingenuity, so have some fun! If you get stuck and wish to start again, press Q to quit. Once you have solved the puzzle on the grid shown, you can also try to solve it using a randomly generated grid by pressing R at the beginning of the game. However, when using this feature it cannot be guaranteed that a winning series of moves will be possible.

Our competition this month also has a seasonal flavour. Take the ten digits zero to ten and allocate one digit to each of the

following letters:

A F H M N O R S T and W

This should be done so that the following numbers, as indicated by their letter substitutions, have the required properties.

SANTA is a prime number  
FROST is a multiple of 7  
NORTH is a multiple of 11  
SNOWMAN is a perfect square.

Merry Christmas

```
100 DIM A(5,5),C(5)
110 CLS:PRINT@133,"PRESS A KEY TO BEGIN":PRINT@139,"(Y) TO RANDOMISE"
120 A$=INKEY$:X=RND(10):IF A$="" THEN 130
130 J=1:RESTORE:FOR Y=0 TO 5:FOR X=0 TO 5:READ A(X,Y):NEXT:Y
140 IF A$="R" THEN 390
150 CLS3:FOR X=6 TO 30:FOR Y=4 TO 28:RESET(X,Y):NEXT:Y
160 FOR Y=1 TO 4:FOR X=1 TO 4
170 PX=3*X:PY=(3*Y)-1:C=A(X,Y):GOSUB 420:NEXT:Y:J=0
180 PRINT@451,STRING$(12,163):CHR$(167);
190 C(0)=3:C(1)=2:C(2)=3:C(3)=3:C(4)=4:C$="GYRCD":GOSUB450:X=1:Y=1
200 PRINT@491+X*3,CHR$(125);:PRINT@96*Y+15,CHR$(127);
210 A$=INKEY$:IF A$="" THEN 210
220 A=ASC(A$):IF A=81 THEN RUN
230 IF A<>9 THEN 260
240 PRINT@96*Y+15,CHR$(175);:Y=Y+1:IF Y=5 THEN Y=1
250 GOTO 200
260 IF A<>94 THEN 290
270 PRINT@491+X*3,CHR$(175);:X=X+1:IF X=5 THEN X=1
280 GOTO 200
290 Z=0:FOR F=1 TO 5:Z=MID$(C$,F,1):IF CHR$(A)=Z THEN Z=F
300 NEXT F:IF Z=0 THEN 210
310 C=Z*2-3:IF C=-1 THEN C=0
320 FL=0:FOR X1=X-1 TO X+1:FOR Y1=Y-1 TO Y+1
330 IF ABS(A(X1,Y1))=C THEN FL=1
340 NEXT:Y1
350 IF FL=1 OR A(X,Y)<0 THEN PRINT@465,"INVALID MOVE";:GOTO 210
360 C(Z-1)=C(Z-1)-1:IF C(Z-1)<0 THEN FL=1:GOTO 350
370 PX=3*X:PY=3*Y-1:A(X,Y)=C*-1:GOSUB 420:GOSUB 450
380 PRINT@465,STRING$(12,175);:GOTO 210
390 FOR Y=1 TO 4:FOR X=1 TO 4
400 N=RND(5):N=N*2-3:IF N=-1 THEN N=0
410 A(X,Y)=N:NEXT:Y:GOTO 150
420 PRINT@PY*32+PX,CHR$(129+16*C):CHR$(131+16*C):CHR$(133+16*C);
430 PRINT@ (PY+1)*32+PX,CHR$(133+16*C):CHR$(143+16*C-J):CHR$(143+16*C);
440 PRINT@ (PY+2)*32+PX,CHR$(133+16*C):CHR$(143+16*C):CHR$(143+16*C);
450 RETURN
460 FOR F=0 TO 4:PRINT@94+64*F,MID$(C$,F+1,1);
470 FOR N=1 TO 4
480 IF NK=C(F) THEN Z$=CHR$(143+16*(F*2-1)) ELSE Z$=CHR$(175)
490 IF Z$=CHR$(127) THEN Z$=CHR$(143)
500 PRINT@94+64*F+2*N,Z$;:NEXT:Y:RETURN
510 DATA 2,2,2,2,2,2,2,5,3,5,3,2,2,1,7,0,7,2
520 DATA 2,0,5,3,1,2,2,1,7,0,5,2,2,2,2,2,2,2
```

## Prize

Those of you who can unravel the mysterious words of Gordon Lee this month will be contending for one of 20 copies of the newie from Smithson Computing, 100 Screen Frankie. Flee from Doctor Van Load and his evil sidekick Egor, shoot bats, bolts, feet. Feet?

## Rules

First you slave for hours over a red hot Dragon. Then you pack your solution, a listing of the program you have created to find that solution (no cassettes, please), the benefit of your ancient wisdom in the form of a tie breaker, and your name and address into a modest envelope marked DECEMBER COM-

PETITION, and tramp out across the deep, crisp and even snow to post it to us here.

The tiebreaker? Complete the line 'I want to be perfectly frank....' and if we like it we might send you a Frankie — even if you don't live in Hollywood.

## September winners

The winners of a £3.00 discount voucher from John Penn Software in the September competition are: Fred Williers of Yarnfield, E. Anderson of Telford, Terry Smith of Worcester, H. Grandy of Sheffield, E. Newman of Addlestone, S. Siddiqui of Chiswick, T. Fawcett of Hendon, Simon Aubrey of Swindon, D. Davies of Bristol, P. Kirk of Aberdeen, Frank Appleby of Aberystwith, J. Boddy of Mill Hill, Geoff

Reed of Maidstone, Jonathan Harrap of Wantage, C. Hitchinson of Middlesborough, Phil Sapiro of Liverpool, D. Gray of Middlesborough, Robin Telkman of Sale, A. Thomas of Staplehurst, and A. Henderson of Bromsgrove.

Favourite tiebreaker comes from Mr. Thomas, who states baldly:

'Oh, little flower upon the ground  
I wish you were instead one pound.'  
I couldn't have put it better myself.

## Solution

There are two sets of numbers: 13651919.1365919.136591.13659.139 and 55306341.5306341.530341.50341.5041.541.

# JOHN PENN DISCOUNT STORE FOR THE DRAGON

\* A HAPPY CHISTMAS TO ALL OUR CUSTOMERS \*

## GAMES

THE THIRTEENTH TASK : ADV. (Asc)	£3.00
COLOSSAL ADVENTURE : ADV (Cowan)	£6.00
RING OF DARKNESS (Wintersoft)	£2.00
GORDON BENNETT (Smithson)	£4.99
HARE RAISER DOUBLE PACK (Haresoft) (search for the Golden Hare)	£4.00
BEST OF PCW (Centurion)	£5.00
SUNKEN CITY : ADV. (Silk)	£4.00
BLOCKBUSTER QUIZ (Computerware)	£4.50
SHOW JUMP (Computerware)	£5.50
TIME ATTACK (Tudor Williams)	£5.50
PREDICTOR (Benley)	£4.00
BEANSTALKER (Microvision)	£7.95
TIM LOVES CRICKET (Peaksoft)	£4.00
SAS (Peaksoft)	£2.00
PHOTO FINISH (Peaksoft)	£2.00
BACK TRACK (Incentive)	£3.50
JET SET WILLY (Software Projects)	£6.00
MANIC MINER (Software Projects)	£3.00
OTHELLO (Oasis)	£3.00
INVADER CUBE (Oasis)	£3.00
DOMINOES (Oasis)	£3.00

### AND

CHESS : cart. (Dragon Data) \* £10.00

### CARTRIDGES

£4.00 each

RAIL RUNNER  
GHOST ATTACK  
COSMIC INVADERS  
ASTROBLAST \*  
METEOROIDS  
CAVE HUNTER \*

## UTILITIES/BUSINESS SOFTWARE

OS9 Software (for use with OS9 Operating System, disc drive(s) and Dragon 64)	
DYNACALC	
R.M.S.	£21.00
BASIC 09	£20.00
'C' COMPILER	£21.00
PASCAL	£27.00
STOCK RECODING SYSTEM	£19.00
CHASH BOOK & VAT	£19.00

### Harris Micro Software

BASIC 42	£14.95 (for use with Dr. 64 only)
+ with HELP utility	£19.95
+ with SPOOL utility	£19.95 in DragonDos
+ with HELP and SPOOL	£24.95

(for CumanaDos add £5.00 to above prices)

Sourcemaker (Pamcomms)	£8.00
Sprite Magic (Knight)	£5.00
Graphics System (Salamander)*	£5.00
Hi-Res-Text (cartwright)	£3.00
Dream : Editor/Assembler (Dragon Data) *	£5.00
Personal Finance (Dr. Data) *	£5.00
Graphic Animator (Dr. Data) *	£5.00
Utilities I (Hilton)	£5.00
Disassembler (Hilton)	£5.00
Personal Banking System (Hilton)	£9.95
Shaper (Shards)	£3.50
Electronic Author : word processor (Smithson) cass. £12.95 disc £19.95	
<b>MST Business Software</b>	
Stock Control cass. £3.00 disc £4.00	
Mailer/Address Book cass. £3.00 disc £4.00	

## PERIPHERALS

CUMANA DISC	RRP	OUR PRICE
1 40 track single sided	£149.95	£113.16
1 80 track double sided	£179.95	£167.30
2 40 track single sided	£269.95	£248.25
2 80 track double sided	339.95	£309.16
Interface (CumanaDos)	£75.50	£71.16
Our price includes VAT and carriage (on Cumana products only)	£15.00	
SAM chips (7LS 783)		
2nd. hand re-usable 5" floppy discs	£0.50p each or 10 for £4.00	

## EDUCATIONAL CORNER

Dragon Data series hide & Seek	£2.00 each or two for £3.00
School Maze	
Circus Adventure	
Typing Tutor *	£4.00
<b>Dragon Educational series</b> Let's Count	
Shape Up *	£2.00 each or two for £3.00
Number Chaser	
Facemaker *	
<b>Shards/Cambrian series</b> Fun to Learn *	
Family Programs	£1.50 each or three for £3.00
Monster Maths	
Quiz Pack	
Infant Pack	
Snow Queen	
Ampalsoft : Cheshire Cat series Maths Level I (4-6)	
Maths Level II (6-7)	
'O' Level Maths I Superspy	£3.50 each or two for £6.00
Basic Tutor : Beginner's Level	
Basic Tutor : Advanced Level	

## BARGAIN BASEMENT

£1.50 each : five for £6.00 : ten for £10.00

Please give at least two alternatives when ordering five or more programs.

CHOCOLATE	CITY DEFENCE
DRAGON SELECTIONS	BRID RUNNER
FLIPPER	STALAG/ENO
ULTIMATE ADVENTURE	NIGHT FLIGHT
KATERPILLAR ATTACK	DON'T PANIC
UP PERISCOPE *	OSSIE
MINED OUT	BOPSWIZZLE
NORTH SEA OIL	BC BILL *
AMAZING	DEMON KNIGHT
DETECTIVE	PICTURE PAZZLE
HOME BASE *	CELLS & SERPENTS
MYSTERY OF THE JAVASTAR	DRAGON TREK
UXB	PEDRO
CHAMPIONS	DRAG RUNNER
SUPERSPY	SURPRISE
ALIEN ODYSSEY *	STOCKMARKET
	MOVIE PRODUCER
	PETTIGREW'S
	TRANSYLVANIAN TOWER
	MINIGAMES
	LEGGITT

### HOW TO ORDER

Write to us, or phone with an Access order, quoting the titles, publisher, price, and medium where relevant, of the programs you'd like. Please include 50p for postage/packaging on single orders, and 75p for two or more titles ordered. Postage to Europe is £2.00 and £4.00 to rest of world. Please double these amounts if you would like your order to be sent by air mail.

If possible please give your telephone number, as well as your name and full address.

Cheques/postal order made payable to John Penn Discount Software. All the software and peripherals are subject to availability.

Please allow up to 21 days for delivery, though we try to despatch all orders within 24 hours.

DR35

**J. PENN**  
**DISCOUNT SOFTWARE**  
Dean Farm Cottage, Kingsley, Bordon, Hants GU35 9NG  
Tel: Bordon (04203) 5970





**TURBOCHARGE YOUR DRAGON:**  
With our great value hardware and software:

**DISK DRIVES**

CUMANA 40 track drives  
EXCL. CARTRIDGE:  
SINGLE (180k) £134.95  
DUAL 6360k) £249.95

CARTRIDGES FOR ABOVE  
CUMANA DOS 2.0 £65.00  
Delivery (mainland Britain) £5.00

**SOFTWARE FOR DRAGON 32/64/128  
AND DRAGONDOS/CUMANA DOS 2.0**

Professionally written programs for home, clubs,  
and small business, with random access disk filing  
and our 42 by 24 screen with true lower case.

**MONEYBOX**      **Personal accounts**      **£14.99**  
Controls income and expenses, for bank account, credit  
card etc. Forecasting, budgeting. Optional VAT analysis  
for use as small business cashbook.

**MAILBOX**      **Mailing list**      **£16.99**  
Stores names, addresses and up to 10 user-defined  
fields. Selects records by multiple tests. Prints labels,  
letter-starts, prints or displays reports.

**Sharebox**      **Stocks and shares**      **£16.99**  
Prints or displays share valuations, capital gains,  
dividends and tax credits, income forecast, price  
changes, draws graphs of price trends.

**SALESBOX**      **Sales Ledger**      **£19.99**  
Balance brought forward with 4 debt periods. Can print  
statements, aged debt analysis, daybooks, labels,  
nominal code report. Can link to CASHBOX.

**BILLSBOX**      **Purchase Ledger**      **£19.99**  
Balance brought forward with 4 debt periods. Can print  
remittance notes, aged credit list, labels, daybooks,  
nominal code report. Can link to CASHBOX.

**CASHBOX**      **Nominal Ledger**      **£19.99**  
Double entry system posting debits/credits to up to 999  
accounts. Prints trial balance, balance sheet, profit and  
loss, budgets, forecasts, audit trial. Can read  
SALESBOX/BILLSBOX files.

**STOCKBOX**      **Stock control**      **£19.99**  
Records sales, orders, deliveries. Prints low stock list,  
orders due, valuation, turnover, price list, stock  
movements. Can bulk change prices.

**ORDERBOX**      **Invoicing**      **£16.99**  
Prints invoices etc, on plain or pre-printed paper. Can  
link to SALESBOX or STOCKBOX.

**BASIC 42**

An extended BASIC for the Dragon 64

Run your Dragon in 64K mode, while retaining BASIC  
and DOS. Print on the hi-res screen, using all the  
standard PRINT commands, and a screen layout of  
42 rows by 24 columns. Other features include:

- \* Full upper/lower case/graphics character set
- \* REDEFINABLE characters
- \* Alternative character sets.
- \* Control key for special characters
- \* REPEATING keys
- \* Commands in LOWER CASE (even filenames)
- \* 8 user-defined, independent WINDOWS
- \* 1 fixed, non-destructive window
- \* CATCH command for automatic return to window
- \* INVERTED VIDEO (green on black/black on green)
- \* True UNDERLINING
- \* Extra PRINT commands and functions
- \* ROW and COLUMN commands for easier printing
- \* LIBRARY lists commands and functions
- \* Automatic startup of BASIC program
- \* TEXT command for software compatibility
- \* Takes NO memory from BASIC
- \* Patches for Dragonos 1.0
- \* Can load in extra UTILITIES from disk:

**HELP UTILITY**

Extensions to BASIC 42 includes:

- \* Change CURSOR character
- \* SCROLL disable
- \* PAUSE: single step listing
- \* Enable/disable repeating keys
- \* Enable/disable BREAK key
- \* Improved TRON (including single stepping)
- \* Detailed HELP messages
- \* Expanded ERROR messages

**SPOOL UTILITY**

Use computerwhile printing:

- \* 3.5K print buffer
- \* TYPIST program turns Dragon into typewriter.

**MORE TO COME: you ain't seen nothing yet:**

<b>PRICES: Dragonos disk (Please state version)</b>	
<b>BASIC 42</b>	<b>£14.95</b>
<b>HELP Utility</b>	<b>£5.00</b>
<b>SPOOL Utility</b>	<b>£5.00</b>
<b>Modification for CUMANA DOS</b>	<b>£5.00</b>

Cheques/p.o.s/Further details/dealer enquiries to:

**HARRIS MICRO SOFTWARE**

49 Alexandra Road, Hounslow, Middlesex, Tw3 4HP  
Tel: (01) 570 8335

# FIRE FORCE

The Greatest Hi-Res Graphic Arcade Game  
Ever Written for Your Dragon/Tandy Colour 32K

# IS HERE

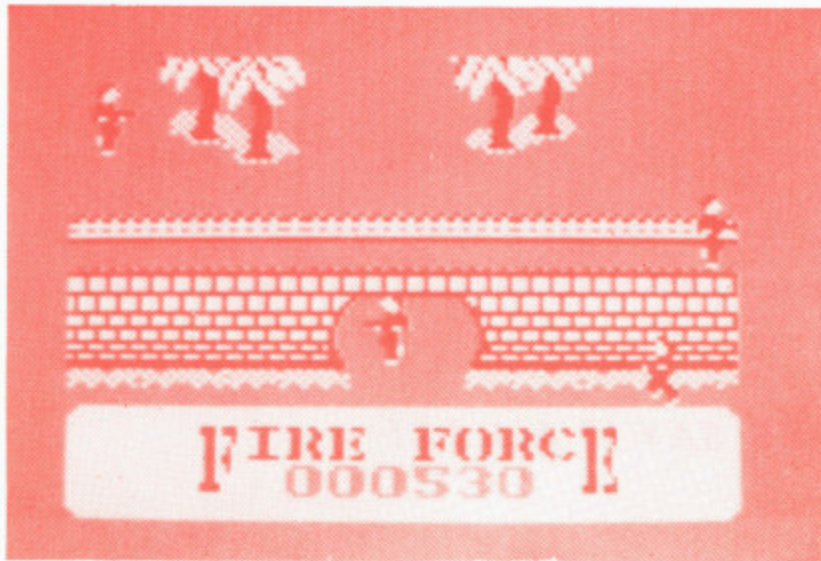
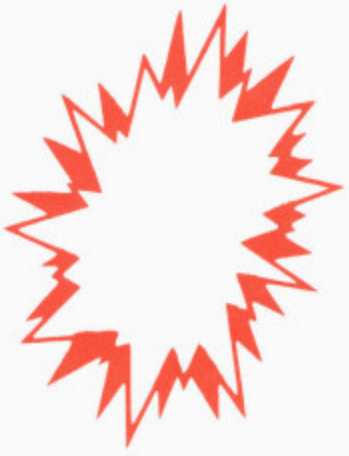

PHASE 1 : LEAD COMMANDO'S IN !!!

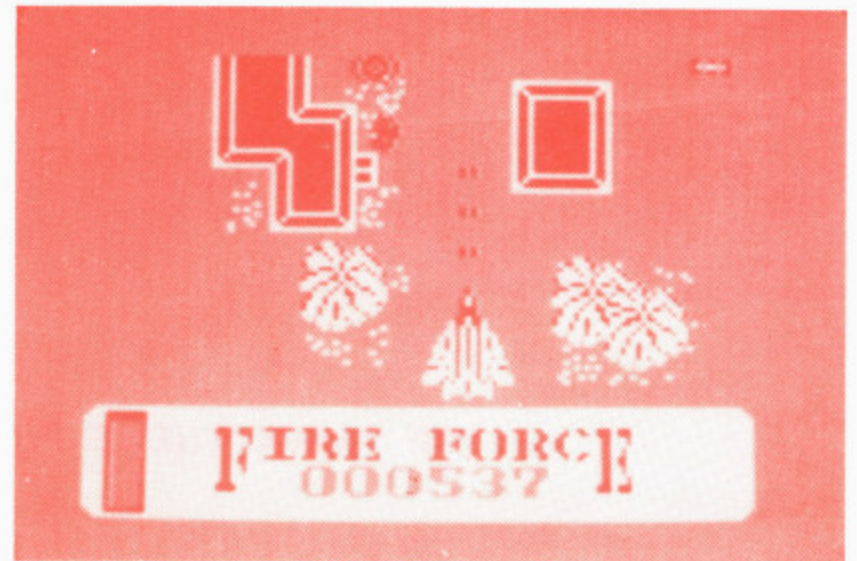

PHASE 2 : FLY PLANE OUT !!!

The year is 1996. The only prototype of the IMFTC X18 'SPIRIT' low level attack plane has been forced down deep in Africa by a foreign power, who are holding it for ransom. YOUR job is to lead a crack COMMANDO assault team (FIRE FORCE) and penetrate the enemy defences and fly this awesome combat vehicle back home.

£9.95



# SHAOLIN MASTER ÷ plus ÷

Probably the BEST KUNG FU game  
on the Dragon/Tandy

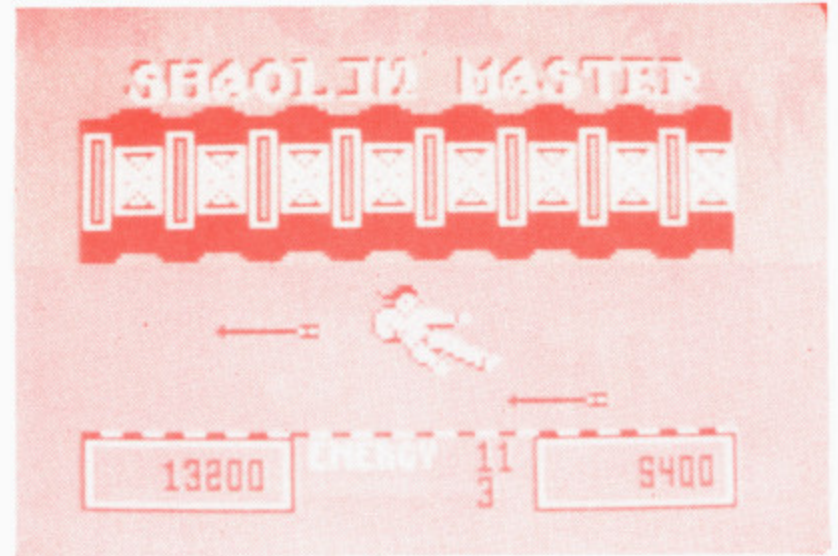
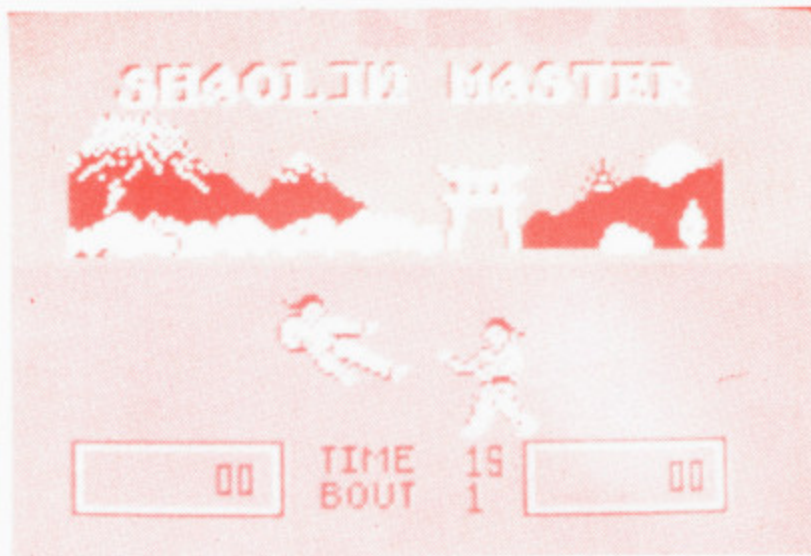

WE THINK THESE PICTURES SAY IT ALL !!!

## TRIVIAL CROSSWORDS

OVER 4000 QUESTIONS

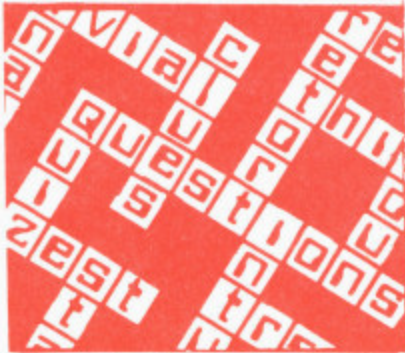

Challenge your family and friends to a contest of general knowledge, mental agility and spelling ability.

There are over 4000 clues, which should keep you busy for hours.

FOR 1 OR MORE PLAYERS

## DUPLIDISK 2

The tape to disk copier you've all been waiting for. If you thought that DUPLIDISK 1 was good, this one is even BETTER. Not only will it transfer even MORE but it is compatible with: - DELTA, DRAGON D.O.S. 2.0 & 4.0, and CUMARNA D.O.S.

## ORDER FORM

- DUPLICAS 5.....£8.45
- DICKIE SPACEMAN.....£6.45
- 6809 EXPRESS.....£6.45
- TERROR CASTLE.....£6.45
- SHRUNKEN SCIENTIST.....£6.45

- FIRE FORCE.....£9.95
- SHAOLIN MASTER PLUS.....£8.45
- TRIVIAL CROSSWORDS.....£6.45
- DUPLIDISK 2.....£8.45
- WEIRDS OF KESH.....£6.45
- DICKIE'S DEN.....£6.45

Please rush me the items I've ticked

I enclose a cheque for £ \_\_\_\_\_

Name \_\_\_\_\_

Address \_\_\_\_\_

Post Code \_\_\_\_\_

Make cheques and P/O's payable to:

**QUICKBEAM SOFTWARE**

Post to

67 old nazeing road  
broxbourne  
herts EN10 6RN