

Wallace  
and Gromit in:  
The right computer! p34



# AMIGA

M A G

# OUTBREAK!

PROTECT YOUR AMIGA FROM  
THE NEW THREAT OF VIRUS ATTACK ...

650Mb OF GAMES, UTILITIES, OBJECTS AND MORE ...

**SUPER CD-ROM II!  
FOR AMIGA & CD32**

On CD-ROM:  
**Exclusive game – Leading Lap SE**  
Fast paced racing game never before released!

**Plus!!!**  
650Mb of utilities, demos, music,  
graphics, games and more ...

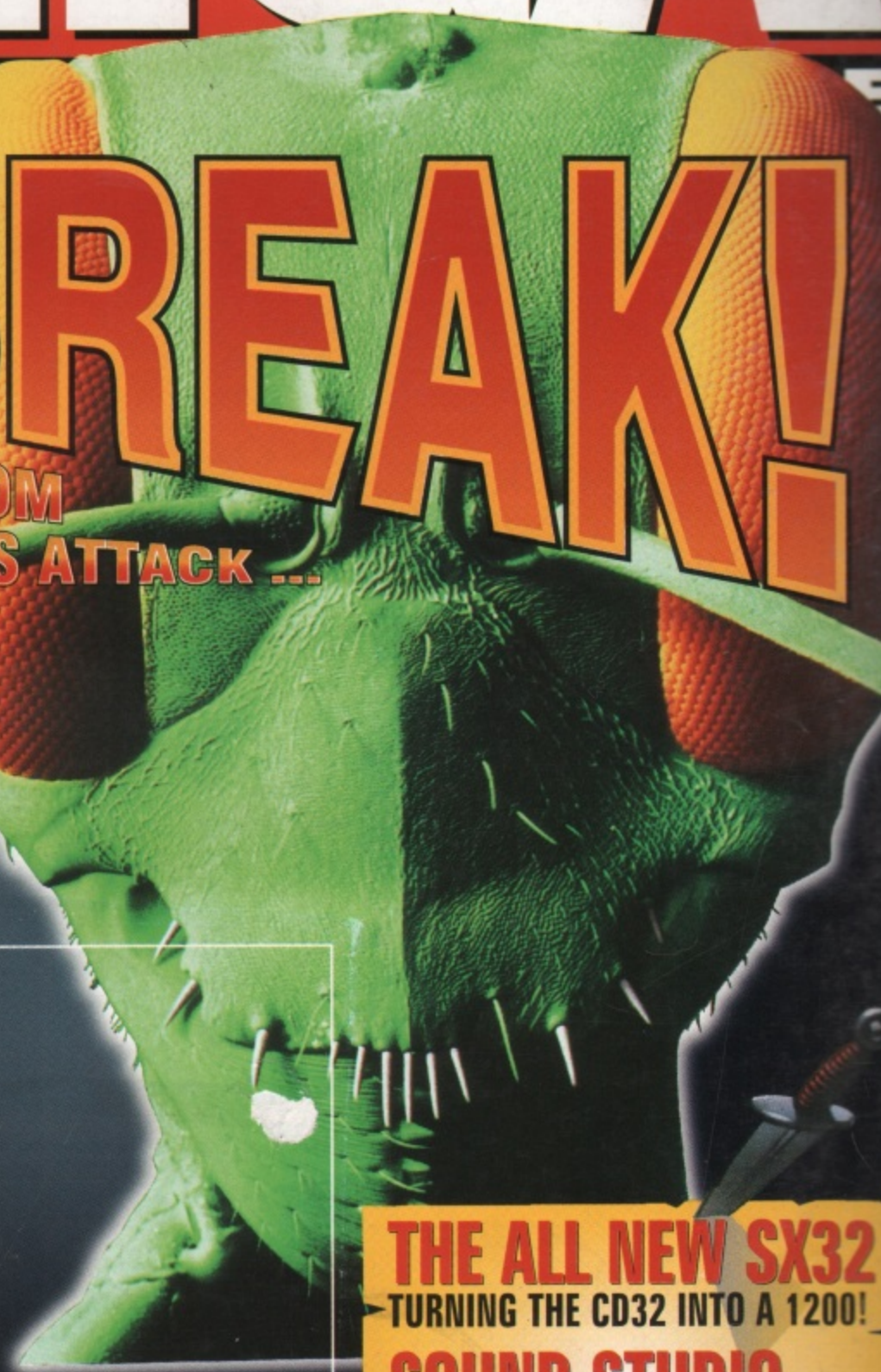

**THE ALL NEW SX32**  
TURNING THE CD32 INTO A 1200!  
**SOUND STUDIO**  
THE NEW HIGH SPEC OCTAMED  
**AND MORE ...**

— APRIL 1996 —

No CD-ROM ? Ask your newsagent now.



CD-ROM edition  
(A 3.5 inch DD  
disk Edition is  
also available)

An EMAP Images Publication £5.95



9 771360 596014  
US\$13.50 • L22,500 • ASCH235 • BFR 520 • HFL 24.9



## XL 1.76MB



XL DRIVE  
**£79.95**

## INT. DRIVES



FROM  
**£30.95**

## SYQUEST EZ



EZ 135MB  
**£239**

## GVP RAM

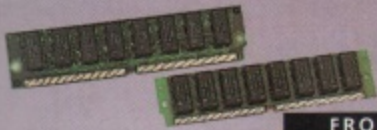

FROM  
**£159**

## 68020EC

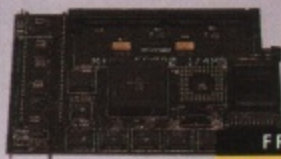

FROM  
**£99.95**

## MEGACHIP



MEGACHIP  
**£159**

## MEMORY

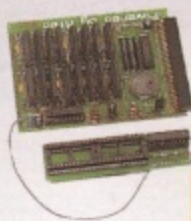

FROM  
**£24.95**

## SUPER XL DRIVE

The Super XL Drive allows you to store 3.5MB on a high density disk.

3.5 SUPER XL DRIVE .....**£129.95**

## 1.76 XL DRIVE

The XL Drive allows you to store a 1.76MB on a high density disk.

1.76 XL DRIVE EXTERNAL ...**£79.95**  
1.76 XL DRIVE INTERNAL .....**£75**  
1.76 XL DRIVE A4000 .....**£75**  
PC880B EXT.POWER DRIVE ...**£49.95**

## INTERNAL DRIVES

PC881 A500 .....**£30.95**  
PC882 A2000 .....**£35.95**  
PC883 A600/1200 .....**£35.95**

## HARD DRIVES

1 GIGABYTE 3.5 SCSI .....**£259**  
1 GIGABYTE 3.5 SCSI EXTERNAL **£335**

### MICROPOLIS

2 GIGABYTE 3.5 SCSI .....**£CALL**  
4 GIGABYTE 3.5 SCSI .....**£CALL**  
9 GIGABYTE 3.5 SCSI .....**£CALL**

### HITACHI

340MB 2.5 IDE .....**£CALL**  
510MB 2.5 IDE .....**£CALL**  
810MB 2.5 IDE .....**£CALL**  
1 GIGABYTE 2.5 IDE .....**£CALL**

### OTHERS

120MB 2.5 IDE .....**£95**

## M-TEC HD

External IDE hard disk for the A500 comes complete with an internal ROM switcher, and upgradable to 4MB RAM

M-TEC AT500 BARE .....**£99**  
PLEASE CALL FOR HD SIZES  
MEMORY REQUIRES 30-PIN SIMMS

## OVERDRIVE HD

External PCMCIA 3.5" IDE hard disk

OVERDRIVE BARE .....**£99**  
OVERDRIVE 420MB .....**£259**

## ZIP DRIVE

ZIP DRIVE 100MB SCSI ....**£179.95**  
100MB DISKETTE .....**£15.95**

ZIP DRIVE REQUIRES SQUIRREL SCSI INTERFACE

## NEW PRODUCT

## SYQUEST EZ135

The Syquest EZ135 drive is an ideal storage device. The EZ Drive stores 135MB on a single 3.5" cartridge and has a seek time of 13.5ms. Comes complete with one 135MB cartridge. (A SCSI interface is required)

SYQUEST EZ135MB .....**£239.95**  
135MB CARTRIDGE .....**£CALL**

## VIDEO BACKUP 3

Backup to 520MB onto a 4hr VHS tape. Version 3 has new backup modes for Amiga's with a 68020 or higher CPU.

VIDEO BACKUP SCART .....**£65**  
VIDEO BACKUP PHONO .....**£60**  
UPGRADE TO VERSION 3 .....**£20**

## FLOPPY EXPANDER

Save 1.5MB on a standard floppy drive and 3MB when used in conjunction with the XL Drive 1.76.

FLOPPY EXPANDER .....**£10**

## DISK EXPANDER

Disk Expander can add upto to 50% to your hard drive capacity and works with all drives including SCSI, IDE, Floppies and even the RAM disk. Disk Expander works on any Amiga with any Kickstart.

DISK EXPANDER .....**£19.95**

## EXTERNAL CASES

SCSI case suitable for CD-ROM/HD/DAT and Optical drives.

5.25" SCSI or IDE CASE ....**£79.95**  
3.5" SCSI or IDE CASE ....**£79.95**

## SX-32

SX-32 is an internal add-on card for your CD32 and features: VGA port, RGB port, parallel port, serial port, external disk drive port (1.76MB), clock, controller for 2.5" hard disk, and a SIMM socket (up to 8MB). Turn your CD-32 into a A1200.

SX-32 MODULE .....**£199.95**

## CHIPS & SPARES

256 x 32 SIMM 72-PIN (1MB) ...**£40**  
512 X 32 SIMM 72-PIN (2MB) ...**£75**  
1 X 32 SIMM (4MB) .....**£125.95**  
2 X 32 SIMM (8MB) .....**£235.95**  
4 X 32 SIMM (16MB) .....**£499.95**  
1 X 8 SIMM 32-PIN (1MB) .....**£30**  
4 X 8 SIMM 32-PIN (4MB) .....**£139**  
1 X 4 STATIC COLUMN A3000 ...**£25**  
1 X 4 DIP .....**£25**  
256 X 4 DIP .....**£5**  
1 X 1 DIP .....**£5**  
CIA .....**£12**  
GARY .....**£19**  
PAULA .....**£19**  
DENISE .....**£19**  
SUPER DENISE .....**£25**  
KEYBOARD IC .....**£12**  
FAT AGNUS 1MB .....**£19**  
FAT AGNUS 2 MB .....**£29**  
PRINTER CABLE .....**£6**  
RS232 CABLE .....**£6**  
SCSI EXTERNAL .....**£15**  
WORKBENCH 3.1 A500/2000 ...**£85**  
WORKBENCH 3.1 A3000/4000 ..**£95**  
ROM SHARE DEVICE .....**£19**  
2.04 ROM CHIP .....**£25**

FOR ANY SPARES REQUIRED PLEASE CALL

## GVP HC-8 SCSI

SCSI hard card which can fit 8MB of RAM on-board.

HC-8 SCSI CARD .....**£99**

## GVP G-LOCK

Award winning Amiga Genlock.

G-LOCK AMIGA GENLOCK ....**£259**

## IO-EXTENDER

Zorro II card that provides an additional serial port, parallel port and connection for optional RS422 and RS232 ports. Call for details

ioEXTENDER .....**£59**

## GVP RAM

Official GVP RAM SIMMS.

4MB GVP RAM .....**£159**  
16MB GVP RAM .....**£549**

## A2000 68060

A 68060 accelerator board for the A2000 running at 50MHz and allowing upto 128MB of user installable memory and a SCSI-II hard disk controller.

A2000 68040 (0MB RAM) ....**£TBA**  
A2000 68060 (0MB RAM) ....**£TBA**  
4MB STANDARD ADD .....**£125.95**  
4MB GVP ADD .....**£159**

## SPECIAL OFFER

### MODEMS

ACEEX V32 BIS 14.4 NOT BT APPROVED **£99**  
X-LINK TRUE V34 28.8 BT APPROVED **£229.95**  
TRAPFAX MODEM SOFTWARE ...**£49**  
ALL MODEMS INCLUDE SOFTWARE AND CABLES

### HI-SOFT

SQUIRREL SCSI INTERFACE ...**£59.95**  
AURA .....**£79.95**  
MEGALOSOUND .....**£29.95**



squirrel scsi interface included where you see this logo

### SURF SQUIRREL

Surf Squirrel offers an even higher SCSI performance, auto-booting, and ultra-fast serial port. Surf Squirrel is the ideal expansion peripheral for your Amiga 1200. Please call for more information.

SURF SQUIRREL .....**£POA**

### SQUIRREL MPEG

Squirrel MPEG allows you to play VideoCD and CDI CD-ROM's, Squirrel MPEG brings high quality digitally mastered images and 16-bit stereo sound to you and your Amiga.

SQUIRREL MPEG .....**£POA**





**CSI**

fit 8MB of  
 .....£99

**K**

ock.  
 .....£259

**ER**

additional  
 connection  
 5232 port.  
 .....£59

**60**

the A2000  
 owing upto  
 memory and a

**ETBA****ETBA****£125.95****£159****FER****£99****£229.95****£49****ND CABLES****£59.95****£79.95****£29.95****terface****ou****REL**

higher SCSI  
 and ultra-fast  
 the ideal  
 our Amiga  
 nation.

**£POA****PEG**

VideoCD  
 PEG brings  
 images and  
 and your

**£POA****RAM EXPANSION**

A 2MB RAM board for the A500 which fits in the trap door slot.

A500 2MB RAM .....£90

**MEMORY CARDS**

512K RAM WITH CLOCK .....£24.95

512K RAM WITHOUT CLOCK .....£19.95

A500 1MB RAM .....£39.95

A500+ 1MB RAM .....£29.95

**MEGACHIP RAM**

Increase your Amiga 500/2000 chip RAM to a total of 2MB. MegaChip does this by using its own 2MB RAM and also now includes a 2MB Fat Agnus. No soldering is required.

MEGACHIP RAM .....£159.95

**A 500 68020EC**

A 68020 EC processor accelerator card for the A500 and A500+, with an option to fit a 68881 or 68882 co-processor (PLCC or PGA). This card can fit upto 4MB FAST RAM and is fully auto-configuring.

NOT COMPATIBLE WITH GVP HARD DRIVE

A500 68020 EC 0MB RAM .....£99.95

A500 68020 EC 4MB RAM .....£239.95

**PRINTERS/MONITORS**

MICROVITEC 1438 14" .....£289

EPSON STYLUS INC.PAPER .....£489

EPSON STYLUS PRO XL A3+ .....£1499

EPSON STYLUS/PRO XL INCLUDE STUDIO II SOFTWARE

STUDIO II SOFTWARE .....£49.95

**VGA ADAPTOR**

VGA ADAPTOR .....£15

**GLIDEPOINT**

Intuitive cursor control at your finger tips 'Tap' for an instant selection. Connects to the Serial port. (This is not a graphics tablet)

ALPS GLIDEPOINT .....£59.95

**POWER TABLET**

Pen and cursor controlled graphic tablet, including cables and software.

POWER TABLET 12 X 12 .....£195.95

INCL. PEN, CURSOR AND POWER TAB S/W

**GURU-ROM V6**

A SCSI driver for all Series II host adaptors and accelerator cards for all Amiga computers. This ROM has a very fast transfer rate of up to 3.5MB/s, maximising your CPU processing time. Guru supports all SCSI device types including hard drives, CD-ROM drives, scanners, Syquest drives etc.Guru ROM is compatible with Amiga OS 1.3 through to 3.1 and is SCSI -1/SCSI-2 compatible. Please call for further information.

GURU-ROM V6 .....£49.95

**POWER SCANNER**

The award winning Power Scanner includes the following features: Scan in 24-bit at upto 200DPI (all Amigas not just AGA)\*, Scan in 256 greyscales at up to 400DPI (all Amigas), Thru'port for printer connection, Fully supports AGA chipset, Display HAM8/24-bit images on a non-AGA Amiga (via image conversion), full editing facilities included. Works with 2.04 ROM or above, min 1MB (recommend 2MB).

POWER SCAN 4 B/W .....£89.95

POWER SCAN 4 COLOUR .....£169.95

OCR (BOUGHT WITH SCANNER) .....£20

OCR SOFTWARE .....£49.95

POWER SCAN 4 S/W ONLY .....£20

PC INTERFACE + COL S/W .....£49.95

PC INTERFACE + B/W S/W .....£39.95

**FLATBED SCANNERS**

24-bit A4 flatbed scanners, complete with software, cables and manual.\*

EPSON GT-5000 .....£489.95

24-BIT, INC. POWERSCAN SOFTWARE

EPSON GT-8500 .....£579.95

24-BIT, INC. POWERSCAN SOFTWARE

EPSON GT-9000 .....£729.95

24-BIT, INC. IMAGE FX REV. 1.5 SOFTWARE

ADPRO SOFTWARE .....£149.95

IMAGE FX 2.0 S/W .....£149.95

**SCANNER SOFTWARE**

FLATBED POWERSCANNER S/W .....£35

**GRAPHIC/VIDEO**

PICASSO II 2MB RAM .....£249.95

INCLUDING TV PAINT JNR.

PICASSO II 2MB RAM .....£399.95

INCLUDING TV PAINT 2

VIDEO DAC .....£25

18-BIT GRAPHICS ADAPTOR

**SCAN DOUBLER II**

ScanDoubler II is a full 24-bit AGA flicker fixer which automatically de-interlaces all AGA screen modes and scan doubles non-interlaced PAL/NTSC modes to allow VGA monitors to display them. Supports VGA, S-VGA and Multiscan monitors. Pixel sharp picture, even at 1440 horizontal resolution and has a standard 15-pin VGA type connector. Comes with composite video/S-VHS outputs.

SCAN DOUBLER II .....£399

**PRO GENLOCKS****TBC-ENHANCER**

Reduction of quality loss when copying, colour and contrast correction, suppression of colour drop-outs, elimination of basically any copy protection. The video signal is edited in professional 4:2:2 studio standard and is synchronized entirely new.

TBC-ENHANCER .....£919.95

**NEPTUNE GENLOCK**

Excellent picture quality, auto fade control, Alpha channel and optional software control.

NEPTUNE-GENLOCK .....£599.95

**SIRIUS II GENLOCK**

Just like the Neptune-Genlock, the new Sirius II combines excellent quality with user friendliness. In addition, this genlock disposes of blue-box keying, bypass, RGB-colour correction, a stereo-audio control with microphone input as well as an integrated test pattern generator for adjustment.

SIRIUS II GENLOCK .....£919.95

**SCANNER**

FLATBED FROM  
**£489**

**POWERSCAN**

FROM  
**£89.95**

**POWERTAB**

POWERTAB  
**£195**

**GLIDEPOINT**

GLIDEPOINT  
**£59.95**

NAME .....

ADDRESS .....

.....

.....

.....

.....POSTCODE .....

TELEPHONE NO. ....

.....

SYSTEM OWNED .....

DESCRIPTION .....

.....

.....

TOTAL AMOUNT (inc. delivery) £ .....

.....

CREDIT CARD NO. ....

EXPIRY DATE .....SIGNATURE .....

.....

DELIVERY 2-3 DAYS £2.50  NEXT DAY £5  SAT £10

MINIMUM DELIVERY £2.50 ALLOW UP TO 7 DAYS FOR CHEQUES TO CLEAR

**phone orders**

We accept most major credit cards and are happy to help you with any queries.

**postal orders**

Ordering by cheque/PO please make payable to Power Computing Ltd and specify which delivery is required.

**warranty**

All Power products come with a 12 month warranty unless otherwise specified.

**technical support**

Help is on hand with a full Technical Backup service which is provided for Power customers.

**mail-order prices**

All prices listed are for the month of publication only, call to confirm prices before ordering.

**export orders**

Most items are available at Tax Free Prices to non-EC residents. Call to confirm prices. BFPO orders welcome.

**mail-order terms**

All prices include VAT. Specifications and prices are subject to change without notice. All trademarks are acknowledged. All orders in writing or by telephone will be accepted only subject to our terms and conditions of trade, copies of which are available on request.

FOR ANY INFORMATION PLEASE CALL

TEL: 01234 273000

FAX: 01234 352207



POWER COMPUTING LTD 44A/B STANLEY ST. BEDFORD MK41 7RW

**P O W E R .**



# contents

CU AMIGA MAGAZINE • APRIL 1996

## Features

### The right computer 34

Aardman Animation's creations have been charming the public since Heat Electric's Creature Comfort ads made them famous to a wider audience. Their new feature film A Close Shave has already been acclaimed a classic and, like A Grand Day Out and The Wrong Trousers it was produced using Amigas.



### Virus outbreak 30

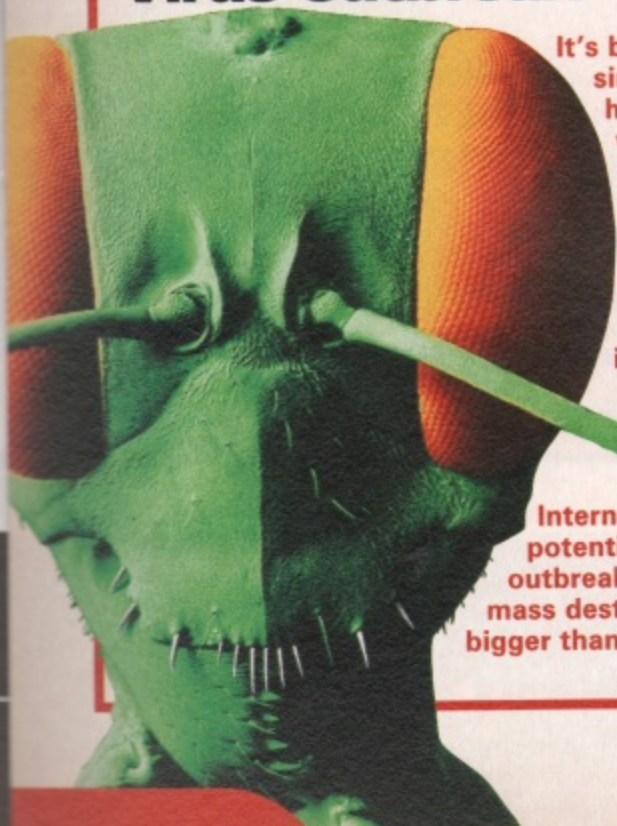

It's been a while since we've heard about viruses, but that doesn't mean they've gone away. Nowadays with the increased use of hard drives, CD-ROMs and the

Internet the potential for an outbreak to cause mass destruction is bigger than ever.

## Games

### PREVIEWS

- **The Chaos Engine 2** 40  
Wahooo! It's almost here at last! We dodge bombs and power cuts to bring you this story from Wapping.
- **At the crossroads** 42  
Intersect developments have promised Amiga game miracles: we check out what's in store.
- **Slamtilt Pinball** 43  
21st Century Entertainment fights back from the mediocrity of Mania with some good-looking tables.

### REVIEWS

- **Watchtower** 46  
Suspiciously similar to Chaos Engine and none the worse for it. A short arcade combat frenzy.
- **World Golf** 51  
Golf for those with excellent eyesight. Turn to page 47 to see what we mean.
- **Premier Manager 3 Deluxe** 51  
The ever popular Premier Manager 3 receives a new season polish up and an editor.

The Chaos Engine 2 40



### PLAYERS GUIDES

- **Vampyra** 52  
More pearls of advice from the adventure temptress with more front than the Brighton pavilion.
- **Snip Tips** 55  
Snippets faster than your average whippet! With more meat on them. Your pedigree chum, Matt, is back.
- **Zeewolf Tips** 57  
The level codes are in Snip Tips but if you're in need of some help on level 10, check this out.

Watchtower 47



Intersect 42



# Cover Disks

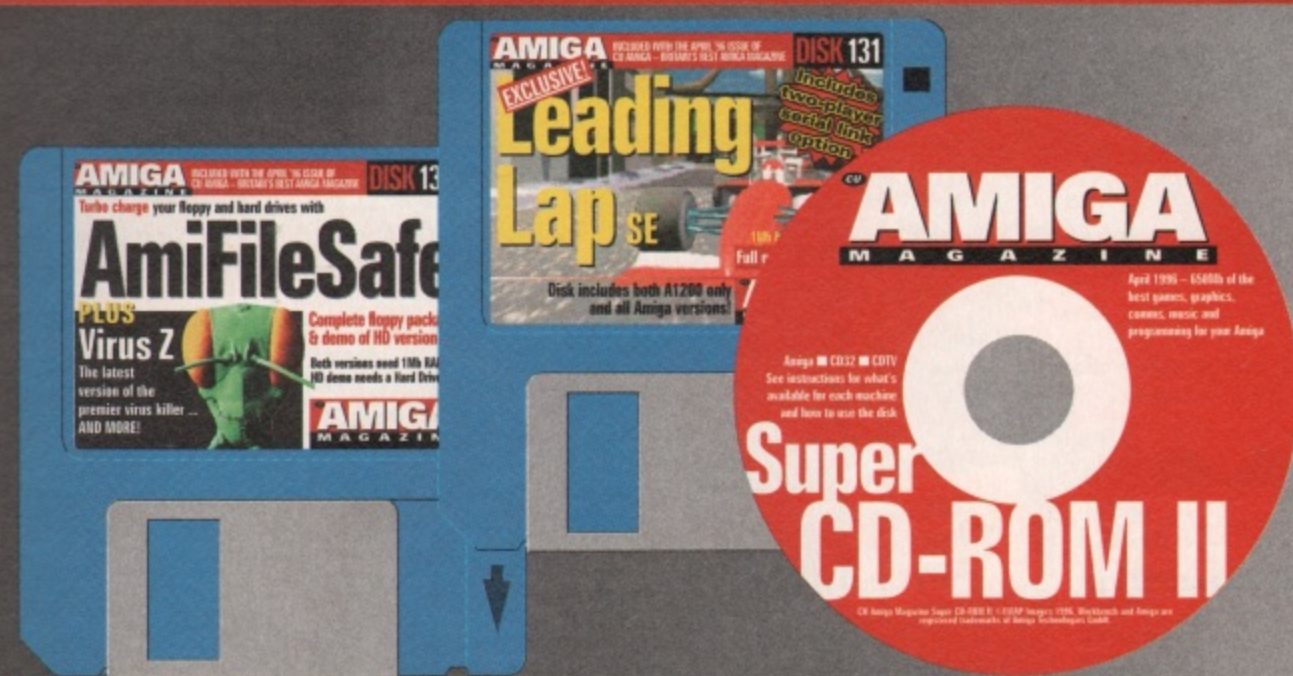

**AmiFileSafe** 9  
A brilliant new disk filing system to speed up your disks and keep your data secure.

**HippoPlayer** 9  
Plays modules from Soundtracker, OctaMED, ProTracker, FastTracker and more. Also displays little twiddly bits.

**Virus Z** 10  
The latest version of the best virus checking software. Sleep easy!

**Leading Lap SE** 12  
Five tracks of fun ... Five racers to choose from ... Serial link option for two player fun ... A500/600 and A1200 versions ... Options galore ...

**CD-ROM II** 16  
A brilliant 650Mb of amazing Amiga software on the CD edition of this magazine awaits you!

## Get Serious

### PREVIEW

● **SoundStudio** 69  
OctaMED's latest version is a break with the past. All new, and previewed.

### REVIEWS

● **Toccata** 62  
Sounds like a brand of Italian ice cream but in fact it's a 16-bit sound card. Nice.

● **SX32** 66  
A neat and inexpensive way of turning your CD32 into an A1200. Keyboardtastic!

● **Aural Synthetica** 70  
Thinking of using your Amiga as a synthesiser? Aural Synthetica could be the answer.

● **Limelight Tyro** 72  
An unusual name, but underneath this flamboyant exterior lies a video titler.

● **HiQ Power Station** 77  
Looking for ways of upgrading your Amiga without clutter? See page 77.

### CD-ROMS

● **CD-ROM Round Up** 78  
Three pages this month, with 8 CDs reviewed. Everything from audio to clip art.



CD-ROMS 78

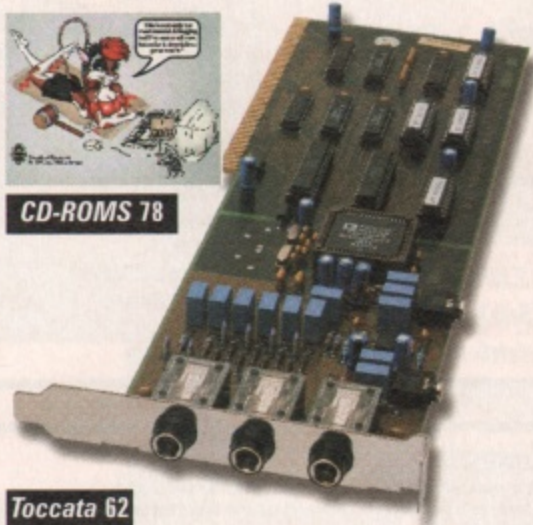

Toccata 62

## Public Domain

● **PD Scene** 83  
This month's Public Domain scene is packed with quality software: some of which is on the April CD-ROM. The highlights are a massive 80Mb demo called DataWorld, a highly rated RPG called Hilt II, smutty Saturday Night Snooker, and demos from a Danish Christmas demo get-together: The Party '95.

● **PD Utilities** 87  
Among the bewildering array of odds and ends sent in for PD utilities there is an odd American Max Headroom-style computer character, a strange self-testing program called Revision Master, some AMOS code and the best ever set of football icons. Check it out.



SoundStudio 66

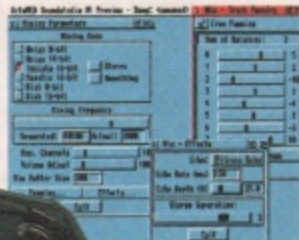

SX32 66



## News 25

CU Amiga Magazine interviews John Smith of Amiga Technologies, to find out just what's happening in the UK Amiga world. Plus more World Of Amiga show news and a computer security report.



## Subscriptions 106

**Massive subscriptions offer! Money off around the world and special six month deals too!**

Get CU Amiga Magazine delivered to your door every month. No more braving the elements to find that your newsagent has sold out! Don't miss these offers.



Workshop

- Imagine 3.0** 92  
Now you've got the hang of textures in Imagine, John Kennedy moves onto the subject of texture mapping.
- VideoStage Pro** 96  
If you've been beavering away on your home videos with VideoStage Pro, here some more essential reference material.
- Graphics Masterclass** 98  
This month's feast of graphics tutorials includes advice on how to mock up photos of UFOs and other phenomena.
- Wired World** 100  
All the latest from the Internet and the wide world of comms, plus of course Net God on his soapbox.
- Sound Lab Q&A** 103  
A special Q&A edition of Sound Lab sees Tony Horgan fielding a batch of popular questions on Amiga audio.
- Frequently Asked Questions** 113  
Networking Amigas is the subject of this month's regular Q&A session, hosted by John Kennedy.
- Q+A Masterclass** 114  
So you want to know all about ARexx then? Following our simple examples, here's the lowdown on how it all works.
- Questions and Answers** 116  
Various technical problems and glitches are solved once again by our technical dream team, Tony and Mat.
- Backchat** 118  
Opinionated readers get to broadcast their own views to the masses in the regular letters page.
- Points of View** 120  
The good, the bad, the trials and tribulations of the Amiga. Find out what Alan Dykes, Lisa Collins, Tony Horgan and Mat Bettinson have to say.

Oldies

- Back issues** 104  
Miss any of the spectacular issues we've done over the last two years? Then turn to 104 for consolation. A quick flourish of your cheque writing hand, or a few seconds relating your credit card details to a nice person at our back issues department could get you a shiny new old issue!

## Editorial



**And so we've reached** April, and things are beginning to brighten up on some fronts. Despite a miserable Christmas and a staff lay-off that had us all worried Amiga Technologies have reaffirmed their commitment to the UK market, as you will read in the news section this month. It's a commitment that has short, medium and long term

aspects and should see the market remaining on track, perhaps even picking up, throughout this year.

You will have noticed, as of last issue and from now on, we were forced to put up the cover price to £4.50. CU Amiga Magazine is a high cost publication and unfortunately the returns from advertising which have traditionally helped pay the way have dropped significantly in the last 12 months. As I've stated before we've tried to avert price rises for as long as possible, but the inevitable must happen sooner or later. Which makes our new subscriptions offers all the more attractive. At £36 in the UK this equates to just £3.00 an issue, and massive reductions are also available to overseas readers. Half year subscriptions are now available too, and though these are not discounted, please take into account that you do get the magazine delivered to your door, and you're only committing for six months. There's never been a better time to subscribe.

Alan Dykes, Editor

## Advertisers' Index

1ST COMPUTER CENTRE	20 & 21	0113231444	HI SOFT	44 & 45	01525 71818
17 BIT SOFTWARE	73	01924 366382	MARPET	33	01423 712600
ACTIVE SOFTWARE	74 & 75	01325 352260	MEGATRONIX	56	01384 77172
ANALOGIC	68	0181 546 9575	OWL ASSOCIATES	53	01543 250377
BLITTERSOFT	8	01905 261466	PD SOFT	58 & 59	01782 466933
CARE ELECTRONICS	85	01923 894064	PLEXUS MEDIA	81	0345 660015
CENTURION PD	38	01274 677673	POWER COMPUTING	L.F.C., I.B.C., O.B.C.	01234 843388
CU AMIGA CLASSIFIEDS	108-111	0171 972 6700	POST HASTE	76	01227 764204
DART	76	0116 2470059	PREMIER MAIL ORDER	105	01268 277172
DATTEL	48 & 49	01782 744707	RESPONSE ADVERTISING	53	01423 530691
EFFIGY SOFTWARE	38	01526 834020	SELECTAFONT	53	01702 292835
EMERALD CREATIVE	29	0181 715 8866	SIREN SOFTWARE	7	0161 796279
EPIC MARKETING	54, 86	01793 400988	SOFTWARE 2000	64 & 65	01374 678068
EVERGLADE	56	01667 454 933	SPECIAL RESERVE	14 & 15	01279 600204
EXCLUSIVE PD	89	01705 642409	UNITED PD	85	01938 529594
FAST COMPUTER SERVICES	76	0171 252 3553	V12 PD	82	01507 450114
GORDON HARWOODS	11, 50, 60	01773 836781	VISAGE COMPUTERS	22	0115 94445201
GREYTRONICS	71	0181 686 9973	WIZARD DEVELOPMENTS	24	01322 272908
G.T.I.	37	0049 617185937			

## Editorial

EDITOR: Alan 'Snowboarding' Dykes  
 DEPUTY EDITOR: Lisa 'Q has copied me!!!!' Collins  
 TECHNICAL EDITOR: Tony 'On the Moon' Horgan  
 "THE NAME'S ROM ... CD-ROM": Mat 'All hours' Bettinson  
 ART EDITOR: Helen 'Danners' Danby  
 DESIGNER AND OFFICE MOTIVATOR: Anthony 'Cardiff' Collins  
 TECHNICAL CONSULTANT/BIKE HEAD: John 'Kawasaki' Kennedy  
 GAMES CONSULTANT: Matt 'My hair fell down' Broughton  
 CONTRIBUTORS: Vampyra, Andy Mitchell, Martin Davies, Norman Harris, Andy Leaning, David Cassidy, The Village People, Eric 'Chris' Idle  
 PHOTOGRAPHY: Mark Gatehouse  
 COVER IMAGE: Tony Stone  
 SYSTEMS AND REPRO: Sarah-Jane Leavey, Sarah Best, Gary Lord

## Advertising/Marketing & Management

ADVERTISING MANAGER: Justine Carlson  
 SALES EXECUTIVE: Marianna Masters  
 AD PRODUCTION: Tina Gynn, Ryan Boundy, Fiona Conway  
 PRODUCT MANAGER AND MORAL SUPPORT: Vicki 'Tanned' Jacobs  
 PUBLISHING DIRECTOR: David 'Bhangra beat' Kelly  
 EXECUTIVE PUBLISHING DIRECTOR: Graham Taylor

## Contacts

When contacting CU AMIGA MAGAZINE there are two golden rules.  
 1: Send your letters etc to the right department (see below) and please do not send an SAE for reply.  
 2: Please remember that we have to write and produce your favourite magazine every month, so try to keep your correspondence short and to the point. Although we'd love to, we simply cannot reply personally to the hundreds of calls, letters, and faxes we get. Answers have to be through the pages of the magazine only.

**ADVERTISING AND ADVERTISING PROBLEMS:** If you wish to advertise, or have a problem with a company advertising in CU AMIGA MAGAZINE our advertising team will be glad to help. Contact Justine Carlson or Marianna Masters on 0171-972 6700, fax them on 0171 216 6219, or write to them at: ADVERTISING, CU AMIGA MAGAZINE, Priory Court, 30-32 Farringdon Lane London EC1R 3AU.

**READERS' LETTERS AND TECHNICAL PROBLEMS:** For general, non-technical, enquiries send your letters to Backchat. For technical problems send them to Q&A. Both are at CU AMIGA MAGAZINE, Priory Court, 30-32 Farringdon Lane, London EC1R 3AU. Phone: 0171 972 6700, FAX: 0171 972 6703. Please remember that we cannot answer enquiries in detail by phone. If you need advice urgently or have a problem then do call us between 4.30pm and 5.30pm Tuesdays, Wednesdays and Thursdays. We will try to assist you within these hours, but complex questions may be too difficult to resolve over the phone. Because of press deadlines we may have to ask you to call at another time. Alternatively, E-Mail us at backchat@cu-amiga.demon.co.uk or Q+A@cu-amiga.demon.co.uk.

**PD SUBMISSIONS:** We get hundreds of new PD programs every week, but we're still hungry for more. If you've written a PD program that you're proud of send it to the PD ZONE, CU AMIGA MAGAZINE, Priory Court, 30-32 Farringdon Lane, London EC1R 3AU.

**COMPETITIONS:** CU AMIGA MAGAZINE often runs competitions. To enter one of these simply put your name and address on the back of postcard, along with the answers and send them to us at the usual address. Competition entries are only accepted by

post. One entry per person please and the editor's decision is final. Winners will be notified by post. Other rules may be printed from time to time.

**BACK ISSUES:** 01858 468 888. Subject to availability. UK price: £5.25 (inc P&P). ROW (£7.25).

**SUBSCRIPTION DETAILS:** Subscriptions are available from Tower Publishing, Tower House, Sovereign Park, Lathkill Street, Market Harborough LE16 9EF Tel: 01858 468888. Annual subscription rates (inc postage) 12 issues: UK/BFPO £36.00. SURFACE/ROW £64.00 AIRMAIL EUROPE £74.00 AIRMAIL ROW ZONE 1 £116.00. AIRMAIL ROW ZONE 2 £116.00.

**COVER DISK PROBLEMS:** If you have a faulty cover disk then write or return your disk to our 3.5 inch floppy people: CU AMIGA MAGAZINE COVER DISK RETURNS, PC WYSE, DOWLAIS TOP BUSINESS PARK, DOWLAIS, MERTHYR TYDFIL, MID GLAMORGAN CF4 8YU. PLEASE USE THE FORM ON PAGE 16 AND REMEMBER TO PROVIDE DETAILS OF THE PROBLEM.

**COMMS:** You can contact CU AMIGA MAGAZINE, via the Internet/E-Mail on general@cu-amiga.demon.co.uk. Please keep E-Mail brief and to the point.

© EMAP Images 1995/1996. No part of this magazine may be reproduced in any form, either electronic or mechanical, or sold without the express written permission of the publisher. Cover disks remain the copyright of their respective suppliers and may not be duplicated, distributed or sold on without their permission. All material and prices are believed to be accurate at the time of going to press. CU AMIGA MAGAZINE attempts to maintain the highest standards, but cannot be held responsible for any errors, factual or otherwise which may have inadvertently crept into the issue. None of the reviews or previews in any section of this magazine constitute paid for or otherwise solicited advertisements for that product or supplier. CU AMIGA MAGAZINE is an independent publication and the opinions expressed by its reviewers are their own, free of any outside encumbrance.  
 PRINTED IN THE UNITED KINGDOM BY ST IVES PETERBOROUGH ABC: 55,789  
 Jan - Jun 1995.



## DATAFLYER SCSI+

Now includes CD ROM drivers and instructions.

The Dataflyer is a 16 bit SCSI II controller card that converts the signals on the internal IDE interface to also run SCSI devices at the same time as the IDE hard drive.

The Dataflyer SCSI+ will operate upto 5 SCSI devices such as CD-ROMS, hard drives, SyQuest removeable drives, tape back up drives etc.



Unlike other SCSI interfaces, the Dataflyer SCSI+ is compatible with all known accelerators etc and it does not stop you from utilising any of the important expansion ports on your A1200/A600.

The Dataflyer SCSI+ easily installs into the A1200/A600 (simply pushes in, no need to remove the metal shield) and provides a 25 way D connector through the blanking plate at the back of the A1200.

Full instructions and software supplied.

**DATAFLYER SCSI+ ONLY £69.99**

**SQUIRREL SCSI INTERFACE ALSO AVAILABLE £59.99**  
PCMCIA fitting SCSI interface

## 2.5' HARD DRIVES

Our high speed 2.5' IDE hard drives for the Amiga A1200 & A600 computers come complete with fitting cable, screws, partitioning software, full instructions and 12 months guarantee. All drives supplied by us are formatted, partitioned and have Workbench (WB2 for the A600 and WB3 for the A1200) installed for immediate use. Fitting is incredibly simple; if you can plug the mouse into the mouse socket, you will be able to plug the hard drive into the hard drive socket.

PLEASE PHONE FIRST!



**FREE 'HOW TO FIT YOUR HARDDRIVE'**  
video and Stakker disk to increase the drive's capacity with every hard drive ordered.

**85mb £89.99**  
**120mb £104.99**  
**170mb £119.99**  
**250mb £139.99**  
**340mb £174.99**  
**540mb £284.99**

**FREE WHILE-YOU-WAIT FITTING SERVICE FOR PERSONAL CALLERS**

## SCSI CD ROM DRIVES

### MEDIAVISION 'RENO'

Double speed CD ROM DRIVE complete with power supply, SCSI cables, docking station and full instructions. Also includes stereo headphones and carrying case for use as personal CD player.



**RENO CD WITH SQUIRREL £174.99**  
**WITH DATAFLYER £174.99**

**IDEAL CHRISTMAS PRESENT**

## APOLLO A1200 ACCELERATORS

### APOLLO 1220

Amazing power for such a low price. This superb accelerator uses a 68020 running at 28hz and comes complete with a 68882 FPU to enable your A1200 to run at 5 MIPS (million instructions per second)! Uses standard 72 pin SIMMS and includes a battery backed clock. Simple trapdoor fitting.



**APOLLO 1220 ONLY £99.99**  
**APOLLO 1220 +1mb £139.99**  
**APOLLO 1220 +4mb £229.99**

### AIWA ACD-300

Top of the range external CD ROM drive. Suitable for use with any SCSI interface. Ideal with the Dataflyer SCSI+



**AIWA ACD-300 ONLY £167.49 OR**  
**WITH SQUIRREL £209.99**  
**WITH DATAFLYER £209.99**

### CHINON CDROM

Superb high quality, low cost Chinon external SCSI CD ROM drive in a top quality fan cooled case or available as an internal unit.



**CHINON CDS435 INTERNAL £79.99**  
**EXTERNAL £109.99**  
**EXTERNAL WITH SQUIRREL £154.99**

### QUAD SPEED CDROM DRIVE

Amazing value quad speed external SCSI CD ROM drive in a top quality enclosure.

**PANASONIC QUAD SPEED EXTERNAL WITH SQUIRREL OR DATAFLYER ONLY £239.99**

## APOLLO A620

Internally fitting A600 Accelerator features 68020 and FPU both running at 28MHZ. 72 pin simm socket for up to 8 Mb of FASTRAM. Easy fit, makes your 600 faster than a 3000!!

**NEW PRODUCT**

**APOLLO A620 ONLY £134.99**  
**+ 2MB £199.99**  
**+ 4MB £264.99**

**S**  
**siren**

**No.1 FOR MAIL ORDER**

**No.1 FOR AMIGA IN MANCHESTER**

**Order NOW for immediate despatch**

**FREEPHONE 0500 340548**

(credit/switch card sales only)

tel: 0161 796 5279

for enquiries or

fax: 0161 796 3208

Send cheques or postal orders (made payable to Siren Software) or credit card details to:-

**SIREN SOFTWARE,**  
**178 BURY NEW RD,**  
**WHITEFIELD,**  
**MANCHESTER**  
**M45 6QF,**  
**ENGLAND**

Access, Visa, Switch, Delta, Connect etc accepted

### OPEN:

**Monday to Friday 9am to 6pm**  
**Saturday mornings 9am to 12pm**

*Personal callers welcome.*

*Please phone first to check availability of any item.*

### DIRECTIONS:

From the M62 Junction 17 head towards Bury. We are 50 yards on the right hand side after the third set of lights. The door to our premises is next to the florists opposite the Masons Pub.

All prices include VAT. Postage and packing will be charged at £3.50 per order (U.K.), £7.50 Europe and £12.50 rest of the world.



Our new range of Amiga Tower Systems will further enhance the specification of your Amiga. Systems include Shuttle expansion boards, upgraded PSU's and complete PC solutions.

Towers (Dimensions 860x190x430 mm with over ten different styles)	£179.95
PSU's available:	
230W	£ 59.95
250W	£ 74.95
300W	£ 89.95
Shuttle 1200 : Upgrades the A1200 to provide 7 x Zorro III (5 DMA), 6 x PC ISA, 2 x Video, 1 x CPU Expansion Slot and a Real Time Clock.	£309.95
Shuttle 1200PCI : As per Shuttle 1200 except 3 x PC ISA, 3 x PC PCI	£349.95
Shuttle 3000 and 4000 : Upgrades A3000 or A4000 to provide 8 x Zorro III (5 DMA), 6 x PC ISA and 2 x Video.	£159.95
Shuttle 3000PCI or 4000PCI : Upgrades A3000 or A4000 to provide 7 x Zorro III (5 DMA), 3 x PC ISA ISA, 3 x PC PCI and 2 x Video	£189.95



Now available for ANY Amiga! The full Amiga Technologies licensed OS 3.1 pack will bring your Amiga up to the very latest operating system. OS3.1 is more efficient, offers more features (such as CD-Rom file access and control, extra windows handling routines, more control over screen preferences /overscan/sizing etc.) and is necessary for many applications.

OS3.1 A500/600/1500/2000	£89.95
OS3.1 A1200	£99.95
OS3.1 A3000	£99.95
OS3.1 A4000	£99.95



**486DX2/4 Board** : 128Kb Cache, 2 x Serial, 1 x Parallel, Floppy and HDD Controller, Keyboard socket, External Power Connector, PC104 Expansion Port, 128Mb RAM max. Accepts 486DX2/4 Processor at 33 to 100MHz (Not included)

£349.95  
£379.95

**486DX2/4 Eprom Board** : As 486DX2/4 Board plus auto boot Eprom.

**Pentium Board** : 256Kb Cache (Expandable to 1Mb), 2 x Serial, 1 x Parallel, Floppy and HDD Controller, Keyboard socket, External Power Connector, PC104 Expansion Port, 128Mb RAM max. Accepts Pentium Processor 75,90, 100, 120,133 and 133MHz (Not included)

£529.95  
£149.95  
£319.95

DX2/66	£ 34.95	DX4/100	£ 79.95	Pentium P75	£149.95
Pentium P90	£219.95	Pentium P100	£229.95	Pentium P120	£319.95
Pentium P133	£449.95				

**EMPLANT BOARDS AND OPTIONS**

The **EMPLANT** system allows hardware emulation of the Macintosh and PC computer. Please call for latest specification and advice.

<b>EMPLANT BASIC</b>		£199.95
<b>EMPLANT OPTION A</b>	(AppleTalk/Serial)	£239.95
<b>EMPLANT OPTION B</b>	(SCSI Interface)	£239.95
<b>EMPLANT DELUXE</b>	(AppleTalk & SCSI)	£269.95
<b>e586DX/SX PC MODULE</b>	(Includes BIOS)	£ 99.95
<b>EMPLANT MAC PRO</b>	(New advanced Mac emulation)	£ 34.95



**EMPLANT BOARD**  
MAC and PC Emulations

**PICASSO BOARDS AND OPTIONS**

**PICASSO II** is the leading graphics card for any Zorro based Amiga. The Workbench emulation offers 256 colours, even on non-AGA machines (Requires OS3.1) at resolutions up to 1600x1280. Choose colour depths including HiColour (16 bit) and True Colour (24 bit). No Chip RAM limitations and an in-built Amiga video pass-through makes Picasso II the best value graphics card around!

<b>Picasso II 2Mb</b>	£249.95
<b>CyberGraphX Software</b>	£ 34.95



**PICASSO II BOARD**  
The leading Amiga graphics board

**PABLO** is the Video Encoder option for Picasso II, expanding it with two additional video ports, one standard Composite Sync Signal, and one S-VHS (Y-C) compatible port. All PAL compatible video devices can be plugged into Pablo, such as a colour TV or a video recorder.

<b>Pablo Video Encoder</b>	£119.95
----------------------------	---------

**NEW! - BLITTERSOFT LABEL CD-ROMS**

**A superb collection of Amiga 3D objects!**  
Amiga 3D is a condensed version of "LightROM 3" packed full with all the LightWave, Imagine, Real3D and Sculpt 3D objects from the 3CD-ROM set on a single CD-ROM for the cost conscious Amiga 3D artist. Amiga 3D contains over 8,000 3D objects/650 Mb in four different Amiga 3D file formats : LightWave 3D, Imagine, Real 3D and Sculpt 3D. The thumbnail renderings of the Lightwave objects have been removed in order to fit all the Amiga 3D objects onto this CD-ROM. **£ 9.95**



**A superb collection of broadcast-ready backdrops!**  
Desktop Video Backdrops is a collection of hundreds of Backdrops suitable for the Desktop Video Professional. Each backdrop is broadcast-ready and in broadcast resolution. This CD-ROM is compatible with every computer platform. The Backdrops are represented by thumbnail renderings in the INDEXES directory for easy previewing. This collection varies from geometric shapes to floral patterns, perfect for any application, for cable access programs, home video productions, training videos and national broadcasts. **£ 9.95**



**A huge collection of high quality textures!**  
2,500 Texture Treasures contains approximately 2,500 textures for the computer artist in many different categories for print, 2D/3D graphics and animation. Categories Brick, Bumpmaps, Cards, Canvas, Carpet, Cloth, Crimple, Fire, Formica, Granite, Greenery, Images, Laminated, Materials, Metal, Misc., Organic, Panels, Patterns, Rock, Roughs, Skin, Stone, Stucco, Tiles, Wood, etc. All of the textures are represented by thumbnail renderings for easy previewing in the INDEXES directory. **£ 9.95**



**Oh Yes! More WORMS!!!**  
This CD will keep you playing and playing.... Over 1000 brand new levels for this extremely addictive game. An additional bonus to this CD is the inclusion of the patch update to offer enhanced features to the original game. This CD is volume one in the series. **£ 9.95**



**A unique collection of Digital Elevation Maps for Scenery programs.**  
DEM-ROM consists of over 1,000 Digital Elevation Maps from the USGS. These files can be loaded into Vista Pro, Scenery Animator and World Construction Set to create breathtaking scenic stills or exciting animated flights through landscapes. These flights could be saved and loaded into a 3D program as a background image sequence while taking a 3D object such as an aeroplane or a spaceship and rendering it in the foreground to create realistic flights of fancy. These DEM's can also be loaded into any 3D conversion programs such as Interchange, PixelPro, Polyform etc. to create 3D landscapes in LightWave, Imagine, 3D Studio, TrueSpace etc. Complete with thumbnail renderings of the topographical map of all the DEM's. **£ 9.95**



**ARIADNE AND LIANA**

Don't get overwhelmed with the complexity of setting up a network! Use our **Ariadne Ethernet card** compatible with all Zorro based Amiga's. Not only is Ariadne easy to set up (using Envoy software) but it offers two additional parallel ports as well. Supports 10Base-2 (Thin Ethernet coax cable) and 10Base-T (Twisted pair).

**ARIADNE**  
If you require a simple low cost connection between any two Amiga's, **Liana** is exactly what you need! Simply plug the cable between the parallel ports and install the software. You can now share your Amiga's hard drive.

**LIANA**  
**AmiTCP** offers the ability to network your Amiga via Ariadne to a foreign computer (with it's own TCP software).

**AMITCP**

**IMAGE VISION**

**ImageVision** is an exciting new multimedia authoring system which gives you the power to create powerful interactive presentations with ease. It has a unique interface to allow full control over events with an amazing overview of your work. With ImageVision, you can put backgrounds, pictures, animations, sounds and even MPEG into an interactive presentation with ease.

**Script Editor**  
This is the main editor where you build your presentation by placing and linking the icons together in your script. Double-clicking on an icon opens up a configuration window, where you, assign pictures, sounds, animations etc. Several icons and scripts can be opened at the same time, and you can copy icons between scripts.

**Click Editor**  
In this editor you make your buttons interactive to reach other parts of the presentation. No programming skill is required to make a full blown multimedia presentation, where you have full control of the interactive scripts.

**Graphics Editor**  
This is the editor where you can add pictures, texts and symbols to your presentation. Load pictures and brushes and place them on the background and they will be automatically remapped to make full use of the palette. Each picture object can be freely moved, resized and cropped to fit your personal needs. Many advanced text features can also be used.

ImageVision comes complete with a CD-ROM containing hundreds of backgrounds, ready made symbols/bullets, MPEG-clips, music and sounds. Context sensitive Online Help is available at all times and free runtime player. Plug-in architecture allows additional features to be added. Requires AGA Amiga, 2Mb Chip, 1Mb Fast RAM, 5Mb Hard drive space and OS3.0+



**ASIMWARE PRODUCTS**

**AsimCDFs 3.0** is a third generation CD-ROM control software package that seamlessly integrates CD-ROM technology into the Amiga operating system. The AsimCDFs 3.0 package consists of AsimTunes, AsimCDFs, CDTV and CD32 emulation modules, FishMarket and a Preferences Editor. **£ 49.95**

Provides access to ISO 9660, Highsierra and Macintosh HFS CD-ROM formats. Includes FishMarket, a CD-ROM containing the public domain Fred Fish collection. Includes AsimTunes 3.0, an audio librarian/controller providing advanced librarian and playback features. Support for direct digitising from standard audio CD's and playing audio via the Amiga hardware. Includes CDTV and CD32 emulation modules. Integrated support for Kodak and Corel PhotoCD CD-ROM's. Colour WorkBench icons are created for easy identification. Support for resolutions from 192 x 128 up to 3072 x 2048. Preferences Editor for all AsimCDFs settings. Full Arexx command set available for all programs. Localised interfaces for English, French and German languages. Full ATAPI CD-ROM support with A1200/A4000

**Master ISO** allows the user to control a CD-ROM recorder in order to create custom CD-ROM and CD-Audio CD-ROM's. An advanced ISO 9660 build utility which the user to create universally compatible CD-ROM volumes. Amiga specific support also allows filenames, special characters, CDTV and CD32 auto-booting. CD-Audio CD-ROM's can be created with Master ISO, sourcing audio data from 16-bit CDDA, MAUD or AIFF audio files and formatted to the red book standard for universal compatibility with standard CD players. All aspects of the Master ISO are controlled through a powerful graphical interface. **£29.95**

Creates ISO 9660 compatible volumes. Handles ISO 9660 level 1 and level 2 filenames. File can be taken for multiple sources and combined into a single volume. Generates volume image to a DOS file or direct to a SCSI hard drive. Uses AIFF, MAUD and CDDA 16-bit audio files.

Requirements : Workbench 3.0 or higher, Compatible SCSI controller (Warp, Z3 Fastlane, 4091...), 1.9GB of HD space, 1.6MB of RAM. Supported Writers : Yamaha CDR-100, CDR-102, Pinnacle RCD-202, RCD-1000, Philips CDD-521, CDD-522, CDD-2000, Sony CDU-920, HP 4020, Pioneer DW-1600

**AMOS PRO OS DEV KIT**

**AMOS Pro OS DevKit** is the ultimate AMOS Pro extension! It brings you over 600 new commands! You can now program your software with very advanced features.

1. Software with full multitasking!!
2. Intuition (Screens, Windows, Gadgets, Menus, Drawings)
3. Gadtools (Gadgets and Menus)
4. Exec (Memory management, Interrupts, MsgPort, Signals, NCP)
5. Graphics (AGA Support, RTG Support), Drawings, Sprites, etc.
6. Localisation
7. Workbench (AppWindows, AppMenus, AppIcons)
8. Datatypes
9. StoneTracker support
10. ASL (Requesters)
11. Tag list support
12. DOS functions
13. Tooltypes
14. Supports AMOS Pro compiler, examples, demos, AmigaGUIS
15. Requires OS2.0 or better.

Example : Open an AMOS screen on an Intuition screen with FULL MULTITASKING, under AGA with the following simple command  
\_AMOSOPENSCTR[0,320,256,5,DBLPAL];SCR=Param

**AMOS Pro OS DevKit** **£ 29.95**



**WORLD CONSTRUCTION SET**

**World Construction Set** is a 3-D terrain modelling and animation program that offers unlimited flexibility and control. WCS provides a wealth of solutions, whether you are creating for video, print media, commercial or scientific applications, or just for fun. There are too many features to list, but this program is regarded by many as the best scenery generator on any platform. WCS requires OS 2.04 or greater, 4 Mb RAM (8 Mb recommended). Both 68030 and 040 optimised versions are supplied.

**WORLD CONSTRUCTION SET** **£119.95**

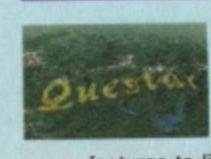

6 Drakes Mews, Crownhill Industry, Milton Keynes. MK8 OER. UK.

01908 261466	Sales	
01908 261477	Technical	
01908 261488	Fax	
01908 261499	BBS	

Order by Access/Visa/Delta/Switch or Postal Order/Cheque. No added surcharges - All prices fully inclusive of VAT. Postage and Packing £7.00 (Next Day) £5.00 (Two Day) and £15.00 (Saturday). Prices and specifications may change without notice. It is advisable to telephone to confirm pricing/specifications/availability before ordering. E&OE. All trademarks acknowledged. All orders subject to our terms and conditions of trading, available on request. Hours of business 9.15am - 5.00 pm Monday-Friday. TRADE ENQUIRIES WELCOME. e-mail : bsoft@mag-net.co.uk Compuserve : 100523.2224 www Site : http://www.mag-net.co.uk/bsoft - All the latest details and pictures online!



# DISK 130

- **AmiFileSafe**
- **VirusZ**
- **HippoPlayer**



## HippoPlayer

HippoPlayer is an intelligent music module player which is capable of loading and autodetecting the format of a wide range of modules, including ProTracker, OctaMED, SID, TFMX, ScreamTracker, FastTracker and more. Modules packed with XPK, Flmp, PowerPacker, Lha, LZX and Zip compression systems are supported. The Reqtools.library file must be in your Libs: drawer for it to work. If you've already installed the rest of the disk then this should already be the case, and if you have a hard drive, you may have it from some previous application's installer. Try running the HiP program and if you need the library you'll be told so, in which case you can run the Install\_Vitals script first. Full documentation is available in the form of the HiP.guide document.

**Keep your data safe as houses with AFS, Virus 2 and HippoPlayer, all on cover disk 130.**

**I**f you don't have CD-ROM capability and have our floppy disk version instead of the CD-ROM one you won't be disappointed. We've got some very handy utilities on there.

## Ami File Safe

Ami File Safe (AFS) is an alternative filing system for your floppy disks and hard drives. Disks formatted with AFS are faster, more efficient and less prone to errors than disks formatted and written with the Amiga's built in filing systems. AFS also allows you to fit more data on your disks.

Cover disk 130 contains two versions of Fourth Level Development's AFS. One is a complete version for use with floppy drives while the other is for hard drives, limited to a maximum partition size of 10Mb.

## Floppy installation

If you are running a floppy-only system you'll first need to make a

copy of your Workbench disk and clear some space on the copy. Rename the copy of Workbench so that it is named exactly the same as the original. Put the original Workbench disk away and work only with the copy for now. Leaving the copy of Workbench write enabled, delete the Tools drawer to free up some space.

Boot from your Workbench copy, insert cover disk 130 and double click on its icon. Open the AFSFloppy drawer and you'll see four icons in a new window marked install\_2.0 and install\_3.0, along with 020 versions of both. The 2.0 and 3.0 refer to your Amiga's operating system (Workbench and Kickstart), while the 020 versions are for Amigas with 68020 or better processors. Double click on one of the icons according to your system.

AFS will now be installed onto your copy of Workbench. If you have just one floppy drive you'll be in for a lot of disk swapping but everything will work out in the end. Time to get a hard drive perhaps? Whenever you want to use

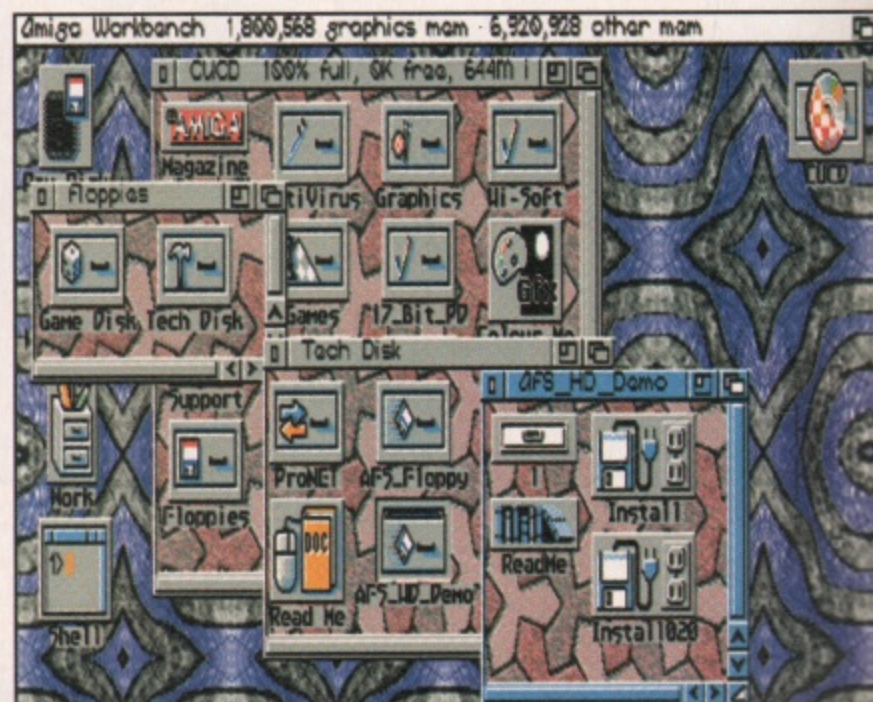

▲ AFS can vastly improve your disk efficiency.



## VirusZ

VirusZ is a neat virus checker that sits in the background of your Amiga's operating system, checking for suspicious activity that could be caused by a virus. It can also be used to check specified disks and files for virus infection. We chose to include VirusZ on disk 130 as its 'brain file' is well up to date and can detect just about all the latest viruses. We can't guarantee that it will catch every virus, as new ones appear all the time, but it's the best way to keep your Amiga safe.

To run it on a floppy-only system you'll need some space free on your Workbench disk. This is because VirusZ needs a library that it expects to find in the Libs: drawer of your Workbench system. If you've already installed AFS Floppy as described on the page opposite you should have enough space on your copy of Workbench. Boot this and then double click the Install Libs icon in the VirusZ drawer. The relevant files will be copied to your Workbench disk. You can now run the VirusZ program straight from the cover disk.

Hard drive users should boot the hard drive and then use the

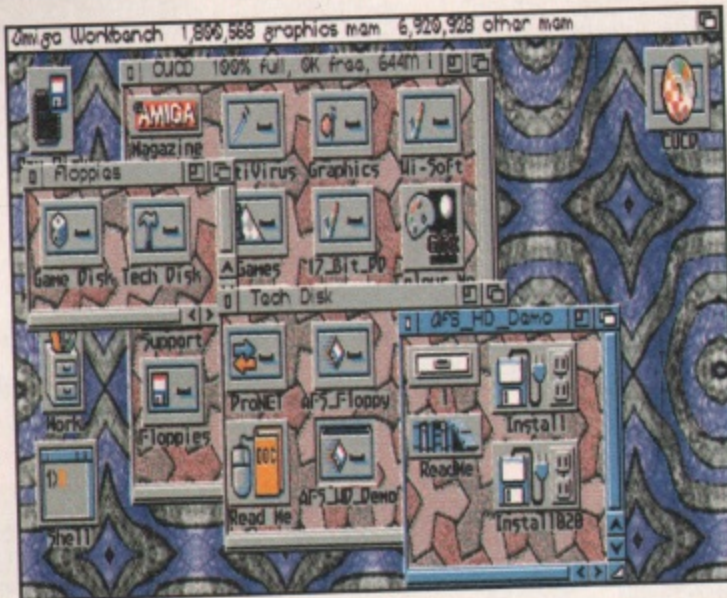

▲ VirusZ is on disk 130 and the CD.

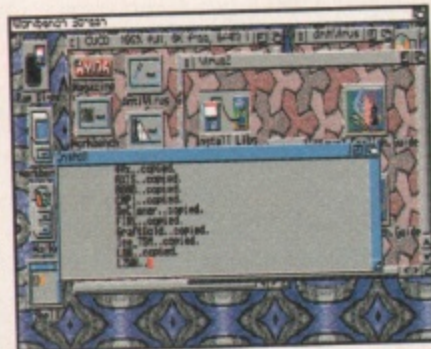

▲ Installation is very simple.

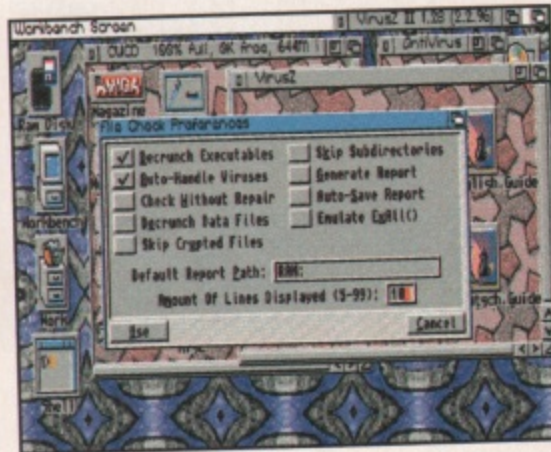

▲ Configure VirusZ to your requirements.

Install Libs icon. If you have the CD edition you'll find VirusZ in the AntiVirus drawer. We recommend you drag the VirusZ icon into the WBStartup drawer, or alternatively copy VirusZ onto your hard drive and call it from the user-startup sequence.

## What to do with VirusZ

Once VirusZ is running you can set a number of options to configure it to your requirements. Click on the VirusZ bar at the top of the Workbench screen so that it becomes active. Now when you hold down the right mouse button you'll see VirusZ menus appear rather than the usual Workbench menus.

Selections from the first menu will carry out tasks, while the second menu is used to set the options for the tasks. From the Prefs/File Check option we suggest you click the Decrunch Executables button and save the changes. This will mean that compressed files will be unpacked and checked during a File Check process. To check a disk or a directory of files, select the File Check option from the

Project menu, choose your area from the file requester (use the All button for speed once you've selected the disk) and click OK. You'll be given a progress report as the program checks all the files. If you have AmigaGuide installed on your machine you can read up on all the advanced options from the VirusZ English.guide document on the disk.

AFS disks you will need to boot with this copy of Workbench.

## Using AFS Floppy

Now it's installed, you won't actually get an AFS disk icon on the Workbench until you have formatted an AFS disk. Because there is no disk icon you can't use the Workbench menus to format an AFS disk - you'll have to use the Shell instead. Enter the following in a Shell window, pressing Return after each line:

```
cd sys:system
resident format
```

The above lines will make formatting disks a lot simpler. Now to actually format an AFS disk, insert a blank into the internal floppy drive and enter the following all on one line and press Return:

```
format DRIVE af0: NAME
afsdisk
```

In the line above, pay close attention to the case of the letters

(capitals where appropriate) and make sure you enter AF0: with a zero, not a letter O. You can now read and write to and from the disk in the internal drive by addressing it as AF0:. You'll notice that an icon called 'afsdisk' has now appeared on the Workbench. When you format another AFS disk, change the 'afsdisk' part of the line above to a different name. This will become the volume name of the formatted disk.

## Hard drive installation

To install AFS onto your hard drive, boot from your hard drive and then insert either cover disk 130 or the CD if you have the CD edition of this month's CU Amiga Magazine. If you want to use AFS on both floppy disks and your hard drive, you'll need to run the floppy installer too. Double click on the relevant icon from the AFS\_Floppy drawer and see the text above marked Using AFS Floppy for more details.

Installation of the AFS HD demo is more complex. Select or

make a suitable partition on your hard drive. All the data in the selected partition will be destroyed when installing Ami-FileSafe, so make sure you make a back-up. Ami-FileSafe must be installed in the I: directory. You can do this by double clicking on the Install or Install020 (For 68020+ machines) icon.

Now you can install Ami File Safe on the RidgidDiskBlock. You can use Commodore's HDToolbox which comes supplied with the Workbench software. We assume here that you will use HDToolbox. If you use another tool you should refer to its documentation.

Select Advanced Options in the the Partitioning window. A number of extra buttons will appear. Click on Add/update... and then click Add New File System. Type in:

**L:HardDiskAFS**

for the name of the file system. Set the Dostype field to 0x41465301 and then select Ok. Go back to the Partitioning window, select the desired partition

and select the Change button. Select Ami-FileSafe (AFS\1). Use all the default options: automount on, block size 512, 2 reserved blocks.

If you are using an older version of HDToolBox and there is not a Change button then click on Custom File System and then type 0x41465301 into the Dostype field. Change the Buffers field to a value between 50-200 depending on how much memory you have free (1 Buffer = 1K).

If you are using an IDE drive then set the Maxtransfer value to 0x1ffff. Now select Ok and the Partitioning menu will appear again. Fill in the name you want the device to have in the Partition Device Name field (e.g. DH1). Set the the Bootable flag if you want to boot from this partition. Go back to the main screen and save the changes.

Ami File Safe should now be installed on the partition. Reboot and format the partition from Workbench. If you have done something wrong then go back and start again. ■



# The World's FASTEST AMIGAS are on this page!

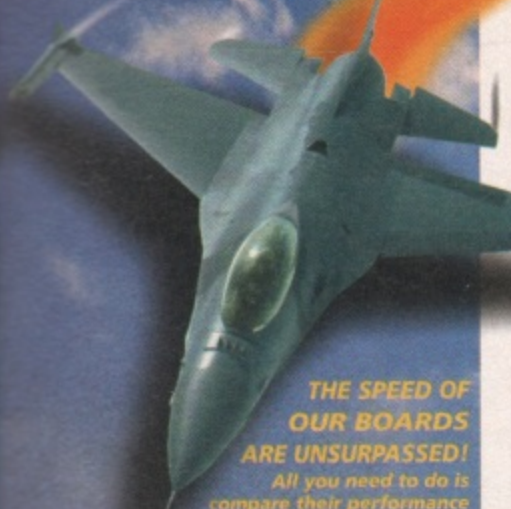

**THE SPEED OF OUR BOARDS ARE UNSURPASSED!**  
All you need to do is compare their performance

Std A500/600/1500/2000	0.55/0.72
Standard A1200	1.33
Standard A4000 '030	4.43
A1200 with 1220/4, '020	5.05
A1200 with 1230/IV, '030 & 4Mb	9.91
Standard A4000, '040	19.10
A1200 with 1260, '060 & 4Mb	37.40
A1500/2000 with 2060, '060 & 4Mb	37.40
A4000 with Cyberstorm, '060 & 4Mb	39.85

## CYBERVISION 64

64-BIT ENGINE A3000/4000 24-BIT COLOUR ACCELERATED GRAPHICS CARD.  
For all Zorro-3 Amigas, this 64-Bit high speed graphics engine/blitzer offers up to 1600 x 1200 pixels in 8-Bit colour or 1024 x 768 pixels in True 24-Bit Colour, with 2Mb of display memory (4Mb user upgradeable).

**Cybervision 64... 2Mb - £299.95**  
**Cybervision 64... 4Mb - £399.95**

### LIMITED OFFER FREE PHOTOGENICS LITE SOFTWARE WITH CYBERVISION 64s

FREE PhotoGenics LITE... Powerful software for image manipulation - the ULTIMATE 24-bit graphics package for A3000 or A4000! Includes 27 effects for processing photos/images such as Emboss, Solarize, Texturize, Add Noise etc. as well as Paint Tools inc. Chalk Pastels, Crayon, Felt Tips & more - Brilliant! (Packaging is shown for illustration purposes only and is not included)



THE WORLD'S FASTEST!... NO QUESTION!

NEW

## CYBERSTORM II

NEW SECOND GENERATION OF THE FIRST EVER 68060 AMIGA ACCELERATOR  
When you fit Cyberstorm II to your A3000, A3000T, A4000 or A4000T you can, for example, render a graphic with Imagine 2.0 software in just 2.45 minutes... Compare that with a massive 10.34 mins on a standard A4000 '040/25! With no jumpers Cyberstorm II is fully plug and play and A4000 users can choose between SCSI-2 and SCSI Fast and Wide options (A3000 users already have SCSI built into their Amiga hardware).

- Up to 128Mb of standard SIMMs can be installed and you can even transfer the 72Pin SIMMs from your Amiga A4000 straight onto your new Cyberstorm.
- Options include a SCSI-2 module, or a SCSI Fast and Wide module (Available in April/May '96)

### Cyberstorm II 68060/50...

50MHz 68060, 0Mb (Expandable to 128Mb) **£699.95**  
SCSI-2 Module **£99.95**  
SCSI Fast & Wide Module (April/May '96) **£149.95**  
SIMM RAM Expansions (Please call for a range of SIMM prices)

Figures shown are in MIPS and taken from comparative performance tests using SysInfo standards (1230-IV, 1260, 2060 and Cyberstorm ratings use 60 Nanosecond SIMMs).

### BLIZZARD 1220/4

28MHz  
68EC020  
A1200 TURBO  
4Mb, 32-Bit RAM  
Expandable to 8Mb

#### Blizzard 1220/4 4Mb Turbo Memory Board

Offers by far the best price/performance ratio of any A1200 32-Bit RAM expansion on the market incorporating everything a good memory board should - such as a Real Time Clock, RAM expandability, optional FPU etc. With its Motorola Processor running the 32-Bit FAST RAM at an amazing 28MHz, the 1220/4 has broken all the barriers! Check the facts for yourself and fit the BEST Amiga A1200 68EC020 Turbo Memory board available.

- Can be disabled in situ for full games compatibility
- Integrated 28MHz 68EC020 Clock Speed Doubler for up to 300% overall performance increase
- Factory Installed & Tested 4Mb 32-Bit FAST RAM
- Expandable to 8Mb with Blizzard Add-4 Board
- Integrated Battery Backed Real Time Clock
- Easy Trapdoor Installation - no modifications required and does not invalidate the Amiga Warranty

(Please note, ANY 68020 board will disable the PCMCIA slot if fitted with over 4Mb)

1220/4 Turbo 28MHz 68EC020	£199.95
4Mb 32-Bit Fast RAM (Expandable to 8Mb)	
Add-4 Board - extra 4Mb for 1220/4	£169.95
4Mb 32-Bit Fast RAM add-on	
Motorola Maths Co-processor	£59.95
68882 PLCC type FPU, 33MHz	

**THE AWARD WINNING A1200 RAM EXPANSION!**

### BLIZZARD 1230-IV

50MHz  
68030  
A1200 TURBO  
ACCELERATOR - 0Mb  
Expandable to 128Mb

#### The Blizzard 1230 MkIV Turbo Accelerator Memory Board

is the highest performing 68030 accelerator available for the A1200! With its 50MHz 68030 and MMU, the new 1230-IV offers EVEN BETTER PERFORMANCE at a LOWER PRICE! With a SysInfo rating of 9.91 (using a 60 Nanosecond SIMM) you can see the 1230-IV is very fast... a performance gain of up to 500% is achieved! Options via its Fast Expansion Bus include Modules such as a SCSI-2 Controller. An industry standard SIMM socket provides for up to 128Mb of auto-configuring 32-Bit FAST RAM (or up to 256Mb with the SCSI-2 option using its extra SIMM socket).

- May be disabled with Simple Keystroke on Boot Up for Full Games Compatibility, even with Badly Programmed or Older Software!
- Battery Backed Self Recharge Real Time Clock
- High Performance Expansion with Full 32-bit wide DMA
- PGA FPU Socket allowing Optional 50MHz, 68882 FPU
- Easy Trapdoor Installation - no modifications required and does not invalidate the Amiga Warranty

1230-IV Turbo 50MHz 68030 & MMU	£179.95
0Mb 32-Bit Fast RAM (Expandable to 128Mb)	
4Mb SIMM RAM Expansion (Fast 60 Nanosecond)	£109.95
32-Bit, 72 pin (Call for Larger SIMM prices)	
Motorola Maths Co-processor	£99.95
68882 PGA type FPU, 50MHz	
SCSI-IV KIT SCSI-2 Module for 1230-IV and 1260	£89.95
(With additional 128Mb SIMM socket)	

**THE WORLD'S FASTEST A1200 '030 ACCELERATOR!**

### BLIZZARD 1260

50MHz  
68060  
A1200 TURBO  
ACCELERATOR & MMU  
0Mb, Expandable to 64Mb

#### The Blizzard 1260 Turbo Accelerator Board

offers Amiga A1200 owners FULL 68060 POWER with a board that simply plugs into the trapdoor slot! Now your A1200 will operate at twice or even three times the speed of an '040 based upgrade and up to five times the speed of a standard A4000! If you want THE FASTEST A1200 available, fit a Blizzard 1260 Turbo to your Amiga now!

- May be disabled with Simple Keystroke on Boot Up for Full Games Compatibility... Even with Badly Programmed or Older Software!
- High Performance Expansion - Full 32-bit wide DMA
- Battery Backed Self Recharge Real Time Clock
- Does not invalidate the Amiga Warranty

1260 Turbo 50MHz 68060 & MMU	£599.95
0Mb 32-Bit Fast RAM (Exp. to 64Mb)	
SCSI-IV Kit SCSI-2 Module for 1260 and 1230-IV (With additional 128Mb SIMM socket)	£89.95
4Mb SIMM RAM Expansion (60ns)	£109.95
32-Bit, 72 pin (Call for larger SIMM prices)	

### BLIZZARD 2060

50MHz  
68060 A1500  
or A2000 TURBO  
ACCELERATOR & MMU  
0Mb - Expandable to 128Mb

#### The Blizzard 2060 Turbo Accelerator Memory Board

offers A1500 and A2000 owners the same specification that the Blizzard 1260 Turbo achieves but also includes built in SCSI-2 So, if you want the fastest A1500/2000 around with FULL 68060 POWER... fit a Blizzard 2060 to your Amiga now!

2060 Turbo 50MHz 68060 & MMU with Built In SCSI-2	£699.95
0Mb 32-Bit Fast RAM (Expandable to 128Mb)	

**EASY TRAPDOOR INSTALLATION...**  
No modification necessary!  
Reliable low heat output!

**1260 & 2060 TURBO BOARDS HAVE A FASTER MEMORY DESIGN THAN ANY OTHER EXPANSION!**

# GH

**GORDON HARWOOD COMPUTERS**  
Gordon Harwood Computers Limited  
Dept. CUA/86 New Street, Alfreton, Derbyshire. DE55 7BP  
**01 773 836781**  
or FAX: 01 773 831040  
Email: gharwood@eworld.com

Please note: Memory, SIMM and FPU prices may change without warning due to exchange rate fluctuations. Please confirm price prior to ordering. CALL TO CONFIRM AVAILABILITY BEFORE MAKING A LONG JOURNEY TO VISIT US. OUR OPENING TIMES ARE... Monday to Saturday, 9am until 5pm



All Blizzard and Cyberstorm products use brand new MOTOROLA 68030 series processors (not second hand as in some of our competitors' boards). They always run WITHIN the electrical timing specification laid down by Motorola to prevent any possible overheating/reliability problems. When you pay for a new 50MHz CPU for example, that's exactly what you get - not a 40, 33 or even a 25MHz CPU 'clocked' to 50MHz! Look out for the MOTOROLA MOTIVATED logo - your guarantee of our commitment to quality and reliability - BEWARE of 'clocked' CPUs!

#### OUR RANGE HAS WON MORE AWARDS THAN ANY OTHER...



#### What the Magazines think...

Blizzard products have consistently achieved the highest magazine accolades and awards!  
Amiga Shopper said "...the Blizzard 1260 is destined to become the ultimate object of desire for A1200 owners" - 91% STAR BUY Award  
Amiga Computing "...If you want the fastest Amiga in the World, get this board!"  
92% BLUE CHIP Rating  
Amiga Format "...Ride on the fastest A1200 in the World..." - 95% GOLD Rating

#### How to Order from GH...

BY PHONE: Simply call our order line. We accept VISA, Mastercard, Access, Switch, Connect, Delta AMEX and Lombar Creditcharge (most 'store cards' are Lombar eg. Dixons, Currys etc.) - WITH NO TRANSACTION SURCHARGES!

BY POST or FAX: Include your name, address and daytime/evening phone/fax number plus order details. If charging a credit/debit card include... number and valid expiry date (and issue number with Switch cards). Make Cheques (please allow 7 days clearance), Drafts or Postal Orders payable to Gordon Harwood Computers Limited.

GH PRICES: Please remember to confirm prices in case you are looking at an 'old' magazine. Prices can change (up or down) before the magazine's cover month has passed. Please confirm before sending orders by post. Prices inc. VAT at 17.5%.

DELIVERY: We offer prompt shipment with fully insured express delivery options throughout the UK, Europe and Worldwide at a very modest cost. If ordering by post please call to confirm delivery charges.

EXPORT: Most items are available Worldwide, and at TAX FREE PRICES to non EC residents and most overseas UK Armed Forces Personnel (with CO's document). Please call us for confirmation of prices and carriage charges etc.

GH WARRANTY: Manufacturers' standard warranties apply or, ask about GH's comprehensive extended options which are always recommended for professional users to minimise costly down time. Ask GH for full details.





# DISK 129

## Leading Lap SE

A game by Reflex  
Interactive/Kellion

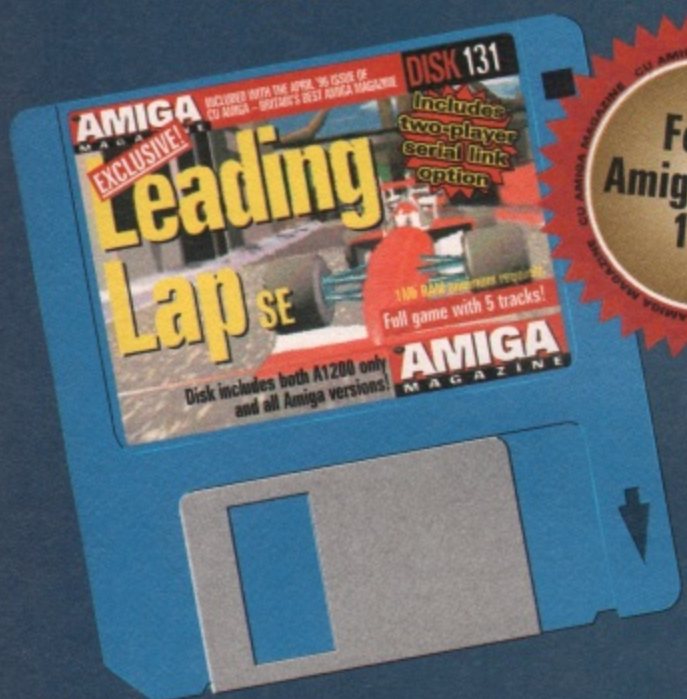

### These are the main controls:

- Joystick forward: Accelerate
- Joystick back: Brake
- Joystick left: Turn left
- Joystick right: Turn right
- Esc: Quit race/Continue
- P: Pause and options
- Space bar: Toggle camera height
- F1-F10: Adjust viewing angles/view other cars
- Return: Return to your car



Chose your driver, choose your car, fire up those engines and get going. This polygon racing sim is yours **EXCLUSIVELY** from CU Amiga Magazine ...

**I**f software houses won't publish games like Leading Lap for you we will. It's not the full commercial release though – how would Reflex Interactive survive if we went around putting their bread and butter on our disk? But it is the full game nonetheless, with five tracks, that's why it's the special edition. We'd sooner bear the brunt of bad feeling in the games industry than see you deprived of it though.

There are two versions on the disk, for both AGA and ECS. The A500/600 version will work on the A1200 and it'll be faster too, but the AGA version does have more sound effects and more detailed scenery. Needless to say the AGA version will not work on an A500/600. You will need to decompress the version of your choice to a separate single disk. This is a simple process. 1. Have a new, blank formatted disk close to hand and turn off your Amiga. 2. Write protect disk 131 and insert it into the internal drive. 3. Turn on your Amiga and wait until a CU Amiga loading screen appears. This will have two disk icons on it. 4. Follow the instructions to press either F1 or F2 to decompress either the AGA or standard version on Leading Lap to your blank disk. 5. Once all files have been decompressed onto the blank disk simply restart your machine with this disk

in the drive and the game will start. Label this new disk "Leading Lap SE". Put disk 131 in a safe place in case of future problems. If you have any difficulty decompressing or loading the disk then turn to page 23 for advice.

### Running Leading Lap SE

Leading Lap SE is simple to load and run, but it'll take some time to get used to the tracks. It requires joystick or joypad, and will not respond to mouse control. Once you've loaded the game you'll enter a menu screen which asks you to Start Season or enter a Grudge Match. If you have a serial null modem cable you can use the grudge match option to play against a friend with another Amiga. More details about this under the heading Serial Play.

Pressing the Start Season option will bring up your choice of driver. There are five to select from and you can find out more about them by pressing the driver stats button on the driver select





## Leading Lap MPV

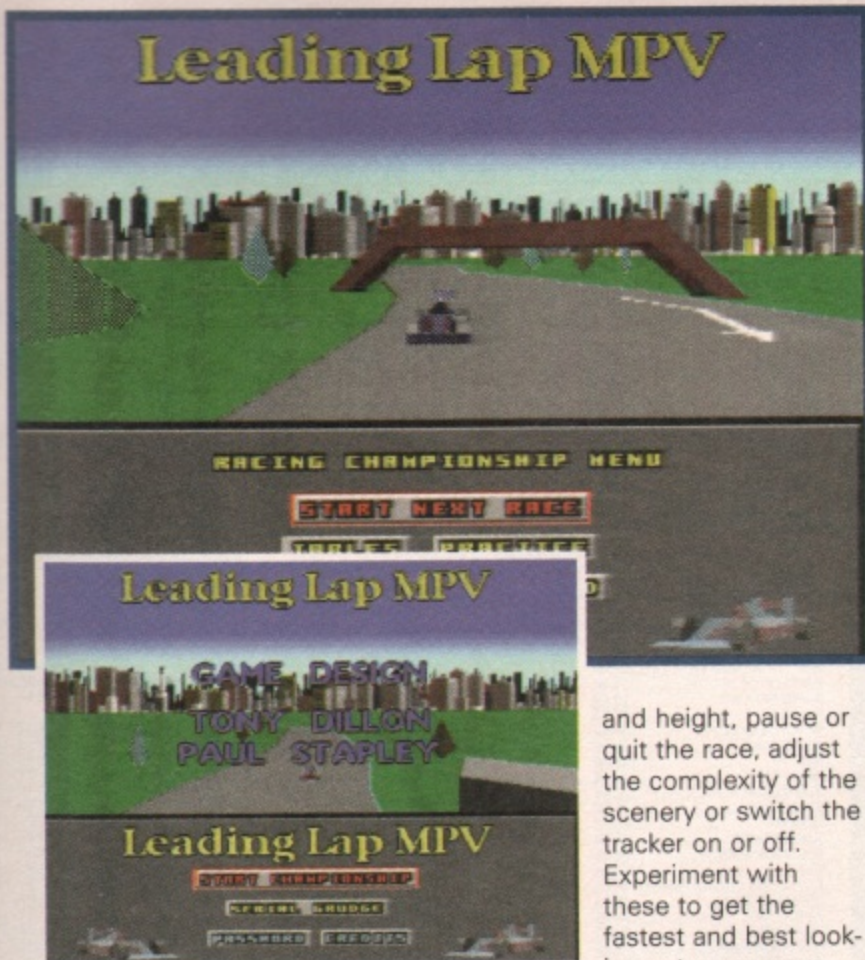

and height, pause or quit the race, adjust the complexity of the scenery or switch the tracker on or off. Experiment with these to get the fastest and best looking set up on your

screen. Once you've chosen your driver press on next. This will bring up your car selection screen. Here you have a choice of three vehicles. Pressing on next after this will bring up the Racing Championship menu. Here you can enter the championship immediately by choosing to Start Next Race, or practice any one of the five tracks in the Practice mode.

### Racing controls

Leading Lap uses both joystick and keyboard during a race. The joystick is the primary control device but using the keyboard you can adjust the viewing angle

individual machine.

### Serial linking ...

If you want to get really competitive you should find a friend with an Amiga and a null modem cable. You can link up two A500s or two A1200s or, say an A500 and an A1200. If you do the latter though you must remember that the person with the A1200 will have an advantage and you must be running the non-AGA version on both machines. This type of link will crash more often than a link between two similar machines.

To link up you need to have the cable plugged into the serial ports

### Problems and the track editor

There are two versions of leading lap on both the cover disk and CD you now own. It is fully functioning in all ways: you can enter competitions, you can race against human competition using a serial link, you can do everything you could in the full version of the game we reviewed three months ago, except race on some of the tracks. This is yours to play for as long as you want, for the cover price of the magazine: there are no catches. But Reflex Interactive, who supplied us with the game, are doing an upgrade offer too, the sort of one you usually see with a utility. This gives you seven more tracks, extra sound effects, a track editor (AGA only) and an objects suite (AGA only) which will allow you to make up your own tracks. This is the difference between Leading Lap MPV as reviewed and Leading Lap SE. If you have any problems with Leading Lap SE or you would like to upgrade to the extra tracks and the editor please write to Reflex Interactive at CU Amiga Leading Lap SE, REFLEX INTERACTIVE, 13 Hawley Crescent, London NW1 8NP. The extra 7 tracks and SFX is available for A500/600 at £4.99 plus 1.95 P+P, while the AGA only track editor, plus the extra tracks, objects and SFX is £12.99 plus £1.95 P+P.

### Compatibility ...

Leading Lap has been tested on Amiga 500, 500+, 600, 1200 and 4000. It works even if there is a hard drive present and works with the Blizzard 1230 accelerator board we use regularly. However, if you have problems with Leading Lap it may have something to do with the peripherals you have plugged in. If so, test it without your RAM or Accelerator, or any other peripherals. It will work! Believe us!

of both Amigas, and then load Leading Lap SE. When you reach the first options screen select Grudge Match and then simultaneously select either Grudge League or Single Match from the next two selections.

If you are properly connected the link will take about 5 seconds to establish. After this one of you should receive a message saying something like "link successful, you are the slave". The other will receive a message saying "link successful, you are the master". It is important that the slave makes their driver and car selection first, otherwise the link has a tendency to crash. Once the slave has made his or her selection the master needs to select drive, then car, then which one of

the five tracks you want to race on. After this the race will begin as normal except you'll both be racing against each other on different Amigas and different screens.

If your link crashes then restart everything all over again, having first checked that your null modem cable is properly connected.

All serial links have a tendency to disconnect from time to time for no apparent reason, but if you play things by the book it shouldn't happen too often. ■

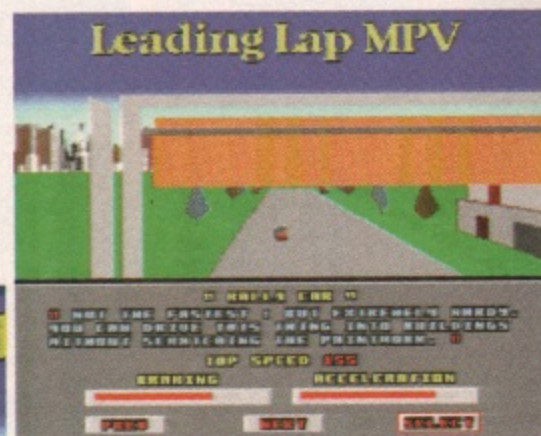

### On the CD

If you have the CD-ROM version of the magazine you will find Leading Lap already uncompressed in the Floppy folder. To run it on an A1200 simply double click on the AGA version to run it on an A500/600 double click on the standard version. If you have a CD32 you will unfortunately not have enough memory to run the full AGA version so double click on the standard version. This is faster anyway, so don't worry. A bonus for CD32 owners is that the joypad operates the various views via its multiple buttons. Try this.



# OUR AWARD-WINNING PENTIUM P100 PC FORMAT'S BEST MULTIMEDIA BUY "A CLEAR WINNER" NOW WITH SIXX SPEED CD ROM (AND COMES WITHOUT ANY INCREASE IN PRICE)

WITH WINDOWS 95 AND TOP 20 SOFTWARE PACK

ALTERNATIVE HOME PACK WITH WINDOWS 95 AND OVER £500 WORTH OF MICROSOFT TITLES AVAILABLE



Don't take our word for it! See the Jan 96 edition of PC Format to compare our P100 with the big names

**SPECIAL RESERVE SIXX MULTIMEDIA PC**  
**MASSIVE 1272 MB HIGH SPEED HARD DRIVE (1.25 GIG)**  
**SUPER HIGH SPEED SIXX CD ROM DRIVE SIX TIMES NORMAL SPEED**  
**GENUINE SOUND BLASTER 16 PRO IDE ASP SOUND CARD, MICROPHONE & SPEAKERS**  
**QUALITY SAMSUNG 14" AWARD-WINNING SYNCMASTER MONITOR**  
**2 YEAR ON-SITE WARRANTY**  
**MICROSOFT WINDOWS 95 PLUS A TOP 20 CD BUNDLE**  
**HOME PACK AVAILABLE**

**TOP TWENTY**  
 Microsoft Works 3 extensive word publisher, spreadsheet and database suite of programs, plus Doom 2 Screen Saver and EIGHTEEN top games. These are all full games, all UK versions and they're the very best in computer entertainment.

**SIXX PENTIUM MULTIMEDIA PC**  
 Pentium P100 or higher CPU on a Pentium PCI motherboard with the latest high performance Intel Triton chipset including 265k asynchronous cache plus EDO memory and Pipeline Burst mode cache support. Samsung 1272 MB high speed hard drive & 1.44 MB Floppy. 256K cache and 8 MB or 16 MB RAM expandable to 128 MB. Fast 1 MB PCI 32-bit graphics (upgradeable to 2MB). EIDE, 6 drive bays, 4 PCI slots and 4 16-bit ISA slots. 14" Syncmaster 0.28 dot pitch SVGA with tilt and swivel. Windows 95 keyboard, mouse and mouse mat.

**FITTED CREATIVE LABS MULTIMEDIA**  
 Latest six speed CD Rom drive, loads your software ultra fast, runs games seamlessly and plays music CD's. Creative Labs Sound Blaster 16 PRO IDE ASP sound card with Advanced Digital Signal Processing. Creative Labs stereo speakers and desk microphone. Extensive utility software including Voice Recognition, Text to Speech, Ensemble Hi-Fi, Wave Studio and Talking Scheduler, plus a CD library of 1000 Creative images, sounds and effects.

**FREE 2 YEAR ON-SITE WARRANTY AND FREE FAST DELIVERY TO MOST UK MAINLAND ADDRESSES**  
 WARRANTY DOES NOT COVER SOFTWARE - FULL DETAILS ON REQUEST. ALL OFFERS SUBJECT TO STOCK. PRICES AND SPECIFICATION MAY CHANGE.

	INC VAT	EX VAT
<b>SIXX PENTIUM MULTIMEDIA PC - WITH EVERYTHING!</b>		
SIXX P100 8 MB + HOME PACK OR TOP TWENTY	1499.99	1276.59
SIXX P120 8 MB + HOME PACK OR TOP TWENTY	1599.99	1361.69
SIXX P133 16 MB + HOME PACK OR TOP TWENTY	1799.99	1531.91
SIXX P150 16 MB + HOME PACK OR TOP TWENTY	1899.99	1617.01
<b>QUAD DX4/100 8MB + HOME PACK OR TOP TWENTY</b>	<b>1199.99</b>	<b>1021.27</b>
<small>(with Quad speed CD and Mini Tower case, 486 PCI Motherboard and Intel DX4/100 processor)</small>		

**PERSONAL LOAN OR CHARGE CARD AVAILABLE SUBJECT TO STATUS - PLEASE ASK FOR DETAILS**  
REGISTERED OFFICE - INTER-MEDIATES LTD, 2 SOUTH BLOCK, THE MALLINGS, SAWBRIDGEWORTH, HERTS, MK21 3PQ. ERRORS AND OMISSIONS EXCLUDED.

**EXTRA OPTIONS - PLEASE ASK**  
 ADDITIONAL FITTED 2ND 1.25 GIG HARD DRIVE ..... 239.99  
 DELETE GRAPHICS CARD AND ADD DIAMOND STEALTH 64 ..... 115.00  
 DELETE SOUND BLASTER 16 PRO AND ADD AWE 32 ..... 120.00  
 ALL PRICES INCLUDE FITTING CHARGE AND VAT

**ALL OUR PRICES INCLUDE VAT**

CHEAP PC UPGRADES	TOP PC CD TITLES
4 MB RAM EXPANSION ..... 75.99	ACTUA SOCCER 8MB ..... 27.99
8 MB RAM EXPANSION ..... 149.99	CANNON FODDER 2 ..... 9.99
CREATIVE LABS QUAD SPEED IDE CD ROM DRIVE ..... 79.99	CAESAR 2 FOR WINDOWS SV/8MB ..... 24.99
CREATIVE LABS QUAD SPEED IDE CD ROM DRIVE ..... 79.99	CHAMPIONSHIP MANAGER 2 8MB ..... 29.99
PLUS ENCARTA 95 ENCYCLOPEDIA ..... 99.99	COMMAND & CONQUER SV/8MB ..... 9.99
	DAY OF THE TENTACLE ..... 34.99
	DESTRUCTION DERBY SV/8MB ..... 34.99
	EF2000 (TFX 2) SV/8MB ..... 34.99
	FIFA INT'L SOCCER 96 SV/8MB ..... 33.99
	FORMULA 1 GRAND PRIX MANAGER ..... 32.99
	MS ENCARTA 96 FOR WINDOWS ..... 39.99
	NEED FOR SPEED SV/8MB ..... 33.99
	REBEL ASSAULT ..... 12.99
	REBEL ASSAULT 2 SV/8MB ..... 34.99
	SAM & MAX HIT THE ROAD ..... 12.99
	SCREAMER SV ..... 22.99
	TFX ..... 11.99
	WORMS ..... 26.99

**01279 600204** **JOIN**  
**Open 10am til 8pm** **No obligation to buy**  
**(5pm on Sundays)** **Annual UK membership £7**  
**No lower age limit**

**PLAYSTATION CD'S**

TITLE	OUR PRICE	SAVE
3D LEMMINGS	34.99	£5
ACTUA GOLF	39.99	£5
ACTUA SOCCER	39.99	£5
AGILE WARRIOR	32.99	£7
AIR COMBAT	37.99	£2
ALIEN TRILOGY	36.99	£8
ASSAULT RIGS	37.99	£2
BATTLE ARENA TOSHINDEN	32.99	£8
D	36.99	£8
DEFOON 5	39.99	£5
DESTRUCTION DERBY	39.99	£2
DISC WORLD	35.99	£9
DOOM	39.99	£5
EXTREME SPORTS	39.99	£10
FIFA SOCCER 96	34.49	£10
GEX	38.99	£6
GUNSHIP 2000	32.99	£7
HI OCTANE	37.99	£7
JOHN MADDEN 96	34.99	£10
JOHNNY BAZZOOKATONE	33.99	£6
JUMPING FLASH	39.99	£5
KRAZY IVAN	37.99	£2
LOADED	39.99	£5
LONE SOLDIER	34.99	£10
MORTAL KOMBAT 3	39.99	£10
NFL QUARTERBACK CLUB	33.99	£6
NHL ICE HOCKEY 96	34.99	£10
OFF WORLD INTERCEPTOR	34.99	£6
PANZER GENERAL	33.99	£6
PGA TOUR GOLF 96	34.99	£10
PSYCHIC DETECTIVE	36.99	£8
RAPID RELOAD	32.99	£7
RAYMAN	37.99	£7
REVOLUTION X	36.99	£8
RIDGE RACER	39.99	£8
RISE 2	36.99	£8
ROAD RASH	34.99	£10
STARBLADE ALPHA	37.99	£9
STRIKER 96	42.99	£7
TEKKEN	33.99	£11
THEME PARK	39.99	£5
THUNDERHAWK 2	32.99	£8
TILT	32.99	£8
TOTAL NBA (BASKETBALL)	38.99	£5
TWISTED METAL	37.99	£2
VIEWPOINT	34.99	£10
WARPAWK	39.99	£5
WING COMMANDER 3	36.99	£8
WIPE OUT	39.99	£5
WORLD CUP GOLF	33.99	£6
WORMS	34.99	£5
X-COM ENEMY UNKNOWN	29.99	£15
ZERO DIVIDE	34.99	£10

**BOOKS**

TITLE	OUR PRICE	SAVE
CANNON FODDER OFFICIAL GUIDE	10.99	
COMPLETE IDIOTS GUIDE TO THE INTERNET	20.49	
DUNGEON MASTER HINT BOOK	3.99	
INDIANA JONES AND FATE OF ATLANTIS HINT GUIDE		
WALKTHROUGH SOLUTION (TEAM WITS AND FISTS PATHS) SPECIAL RESERVE CLUB VERSION	3.99	
INSIDE COMPUSERVE	23.99	
INTERNET FOR DUMMIES	17.99	
SECRET OF MONKEY ISLAND HINT BOOK	9.99	
SECRET OF MONKEY ISLAND 2 HINT BOOK	9.99	
SIMCITY 2000	15.99	
OFFICIAL HANDBOOK	18.99	
THE UK INTERNET BOOK	14.99	
TOTAL! AMIGA DOS	14.99	
TOTAL! AMIGA WORKBENCH	14.99	
UFO (XCOM) STRATEGIES AND SECRETS	12.99	
UK COMMUNICATIONS - THE COMPLETE GUIDE	13.99	

**CD32 CD'S**

TITLE	OUR PRICE	SAVE
A.T.R.	14.99	£15
ALFRED CHICKEN	10.99	£19
ALIEN BREED	20.99	£9
TOWER ASSAULT	22.49	£7
ALIEN BREED 3D	12.99	£17
ARCADE NIGHTS	10.99	£4
ARCADE POOL	9.99	£20
BANSHEE	20.99	£9
BLITZ TENNIS	15.99	£14
BUBBA 'N' STIX	9.99	£20
BUBBLE AND SOUPEAK	16.99	£13
CASTLES 2	9.49	£5
CHAOS ENGINE	9.99	£20
CHUCK ROCK 2	18.99	£8
CORE COMPILATION VOL 3	18.99	£11
BUBBA 'N' STIX, PREMIER, CHUCK ROCK 1 & 2	22.99	£7
ELITE 2 (FRONTIER)	20.99	£9
EVOLUTION	10.49	£19
FEARS	12.99	£17
FIELDS OF GLORY	14.99	£15
FURY OF THE FURRIES	20.99	£9
GLOOM (DOOM CLONE)	9.49	£20
GROOM 2	12.49	£9
GUARDIAN	9.99	£21
GUNSHIP 2000	9.99	£22
HEMLOCK 2	6.99	£19
HEROQUEST 2	12.99	£17
KINGPIN	6.99	£19
LEMMINGS	12.99	£17
LITL' DIVIL	12.99	£17
LOST VIKINGS	12.99	£17
MAN UTD	12.99	£17
PREMIER LEAGUE CHAMPS	12.99	£17
OSCAR & DIGGERS	16.99	£13
PGA EURO TOUR GOLF	19.99	£13
PINBALL FANTASIES	19.49	£10
PINBALL ILLUSIONS	10.99	£4
ROAD KILL	7.99	£12
ROBOCOD (JAMES POND 2)	16.99	£13
SABRE TEAM	10.99	£2
SHADOW FIGHTER	14.99	£25
SIMON THE SORCERER	9.99	£20
SOCCER KID	12.99	£2
SPEEDBALL 2	19.99	£8
STAR LEGACY	19.99	£8
SPER CRUSADER	18.99	£11
SUPER STARDUST	21.99	£13
SYNDICATE	9.49	£20
THEME PARK	21.99	£13
TRIVIAL PURSUIT	9.49	£20
UFO - ENEMY UNKNOWN	21.99	£8
ULTIMATE BODY BLOWS	21.49	£8
BOOY BLOWS & BOOY BLOWS GALACTIC	3.49	£28
WORMS	9.99	£20
ZOOL 2	9.99	£20
ZOOL 2*	9.99	£20

**AMIGA LEADS**

ANALOGUE JOYSTICK ADAPTOR FOR AMIGA. ALLOWS ANY 15 PIN ANALOGUE PC JOYSTICK TO BE USED ON ALL AMIGAS WITH GAMES THAT ALLOW ANALOGUE CONTROL	9.99
ANTI-SURGE 4 WAY TRAILING MULTIPLEG. ALLOWS ANY 4 DEVICES TO BE SAFELY CONNECTED TO ONE MAINS OUTLET AND PROTECTS AGAINST DAMAGING ELECTRICAL SURGES	24.99
FOUR PLAYER JOYSTICK ADAPTOR FOR AMIGA/ST	7.99
HI-FI AUDIO LEAD - AMIGA/CD32 TO STEREO (1.5 METRES, 2 X PHONO PLUGS TO 2 X PHONO PLUGS)	5.99
JOYSTICK EXTENDER CABLE FOR AMIGA (3 METRES)	7.99
JOYSTICK SPLITTER CABLE FOR AMIGA. ALLOWS 2 JOYSTICKS TO BE CONNECTED TO 1 PORT	7.99
MONITOR LEAD - AMIGA CD32 TO PHILIPS CM8833 MKII OR 10845 MONITOR	12.99
MONITOR LEAD - AMIGA TO PHILIPS CM8833 MKII OR 10845 MONITOR	12.99
NULL MODEM CABLE (25 PIN) PORT EXTENSION ADAPTOR FOR AMIGA (PACK OF TWO). EXTENDS JOYSTICK AND MOUSE PORTS BY 21CMS	7.99
PRINTER LEAD (PARALLEL) 1.8 METRES FOR AMIGA, ST OR PC	5.99
PRINTER LEAD (PARALLEL) 5 METRES FOR AMIGA, ST OR PC	9.99
RF LEAD - TV TO CONSOLE OR COMPUTER (2 METRES)	4.99
RF SWITCH (SWITCH BETWEEN TV AERIAL AND COMPUTER WITHOUT DISCONNECTING LEADS)	5.99
RGB EXTENDER CABLE FOR AMIGA 500 OR PLUS. ALLOWS TV MODULATOR TO BE EXTENDED FROM BACK OF MACHINE OR EXTENSION TO RGB MONITOR OR EXTERNAL DISK DRIVE	12.99
ROBOSHIFT INTERFACE FOR AMIGA PLUGS MOUSE & JOYSTICK INTO ONE PORT	9.99
SCART LEAD - AMIGA CD32 TO TV WITH SCART INPUT	10.99
SCART LEAD - AMIGA TO TV WITH SCART INPUT (WORKS WITH ALMOST ALL TV'S)	10.99
TV LEAD - AMIGA CD-32 TO SVHS TV OR VIDEO	9.99

**SATURN CD'S**

BUG	36.99	£8
CLOCKWORK KNIGHT	29.99	£10
CLOCKWORK KNIGHT 2	31.99	£8
CYBER SPEEDWAY	26.99	£13
D	39.99	£10
D	43.99	£6
DIGITAL PINBALL	32.99	£7
FIFA SOCCER 96	37.99	£7
FORMULA 1 GRAND PRIX	33.99	£6
GEX	38.99	£6
HANG ON	33.99	£6
HI OCTANE	36.99	£8
MANION OF HIDDEN SOULS	37.99	£7
MORTAL KOMBAT 2	39.99	£10
MYST	36.99	£8
MYSTERY REALMS OF LORE	33.99	£6
NBA JAM TE	42.99	£7
NFL QUARTERBACK CLUB 96	36.99	£8
OFF WORLD INTERCEPTOR	34.99	£6
PANZER DRAGON	42.99	£7
PEBBLE BEACH GOLF	35.99	£9
RAYMAN	34.99	£10
RISE 2	36.99	£8
ROBOTICA	29.99	£10
SEGA RALLY	43.99	£6
SHINOBI X	29.99	£10
SIM CITY 2000	36.99	£8
THE HORDE	34.99	£5
THEME PARK	37.99	£7
THUNDERHAWK 2	38.99	£8
TILT	32.99	£8
TITAN WARS	34.99	£8
VICTORY BOXING	39.99	£10
VIRTUA COP (WITH GUN)	51.99	£8
VIRTUA COP (NO GUN)	37.99	£7
VIRTUA FIGHTER 2	43.99	£6
VIRTUA RACING DELUXE	29.99	£10
WING ARMS	38.99	£6
WORMS	34.99	£5
X - MEN	39.99	£10
CHILDREN OF THE ATOM	39.99	£10

**JOYSTICKS & MICE**

**QUICKSHOT 137F PYTHON JOYSTICK WITH AUTOFIRE** 10.99

**SAITEK MEGAGRIP 2 JOYSTICK WITH AUTOFIRE** 10.99

**FREEWHEEL STEERING WHEEL FOR AMIGA DIGITAL WORKS AS A JOYSTICK. IDEAL FOR DRIVING GAMES** 12.99

**ECLIPSE MOUSE FOR AMIGA/290 DPI FREE MOUSE MAT** 11.99

**ALFA MEGAMOUSE 400 DPI** 12.99

**AMIGA CD32 FANTASTIC LOW PRICE**

**CD32 CRITICAL ZONE PACK ... 139.99**

INCLUDES ONE JOYPAD, 5 TOP GAMES PLUS OSCAR AND DIGGERS ON CD

**SAVE £90**

**VIEWING PLEASURE AT A PRICE TO SUIT YOU**

**MICROVITEC M1438 14" MULTISYNC MONITOR** 269.99

FREE STEREO SPEAKERS

HIGH QUALITY 0.28 DOT PITCH • DISPLAYS ALL AMIGA SCREEN MODES • SUITABLE FOR AGA SCREENS

**LOOK OUT! SCARTY LOW PRICES**

**WITH 7 GAMES**

**DYNAMICS COMPETITION PRO JOYPAD** 16.99

FOR CD32 AND AMIGA TURBO & AUTOFIRE

**SAVE £25**

**NOKIA 14" NICAM STEREO TV** 214.99

NICAM DIGITAL STEREO

TELETEXT • SCART SOCKET • ADJUSTABLE SOUND DEFLECTORS • REMOTE CONTROL • SQUARE TUBE • HEADPHONE SOCKET







# What's on your



**Mat Bettinson guides you through the 650Mb of goodies on this month's cover CD.**

## Getting started

You can boot this month's cover CD on any CD-ROM compatible Amiga or CD32. Alternatively you can boot from your hard drive first and access the CD from there. If you choose this method, double click the InitCD icon (this is a very small icon in the bottom right of the CD window). This will set up the system so that much of the software can be run straight from the CD. There's no need to do this if you booted from the CD.

You'll notice that the icons are rather attractive but the colours may not be quite right. If this is the case, double click the ColourMe icon. These rather attractive icons were kindly supplied by Tom Ekström from his Iconographics 3.0 set.

All of the main areas can be accessed from the root directory of the CD (the main CUCD window). In general, if you open a drawer and find some icons inside, you should be able to click and run them. On the other hand, if you are presented with a list of filenames and no icons, it's likely that these files must be loaded into an application or handled in some other way (such as the Imagine objects for example which can only be used by loading them into Imagine).

The drawer icons that feature a tick mark all contain demos of existing CD-ROM titles and commercial packages, with a very generous selection of the software for you to try out. These CD previews are themselves contained in drawers marked with CD icons. These CD demos have their own front-ends that are used to access their files.

Now here's a guide to all the major areas of this month's CU Amiga Magazine CD-ROM.

## Magazine

**Contents:** tie-in files for the following magazine departments areas: PD Scene, Wired World, Graphics Masterclass, Q+A Masterclass and more.

The freely distributable software from PD Scene can be found in this drawer. All the software here is stored as DMS archives because it

would not all run from the CD. You'll be prompted for blank disks as you select them. Also see the Misc/The\_Party\_95 drawer for more demos, some of which run from the CD.

Graphics Masterclass contains images for use with this month's tutorial, along with a few from previous issues. You'll find some more in the Images directory which includes some that were missing from our previous CD-ROM edition.

The Wired World directory contains the newest version of Metatool, the MIME encoding/decoding tool as featured in John Kennedy's Wired World tutorial this month. In order to install to your hard drive, simply drag the directory to an appropriate place. The Q+A Masterclass directory contains the ARexx script files as covered by John Kennedy in the Q+A Masterclass tutorial this month. Finally, the Amiga E directory contains virtually all the developers material for Amiga E as cover mounted on the December edition of CU Amiga Magazine. A great many archives have been extracted to this directory so viewing via Workbench will be messy. A directory utility would be best to find the Amiga E support files you need. Documentation for each will also be present in the same directory.



## Floppies

**Contents:** ECS (A500) and AGA (A1200) versions of Leading Lap SE full game. VirusZ anti-virus package, AFS hard drive demo, AFS floppy full version.

Leading Lap SE can be found here in DMS archive format, for both ECS and AGA machines.

The 'Tech disk' section contains the complete Pronet system with full documentation. For more information on the rest of the programs in this drawer, see the floppy disk instruction pages.

Shortly after the CD went to press, we found the VirusZ drawer mistakenly contains Virus Checker and not VirusZ. This is not a problem since VirusZ is also present in the Antivirus drawer off the root of the CD. Installing Virus Checker isn't a bad idea either for double protection. Installation is easy. Just boot from your own Workbench and click on the Install\_Virus\_Checker icon.

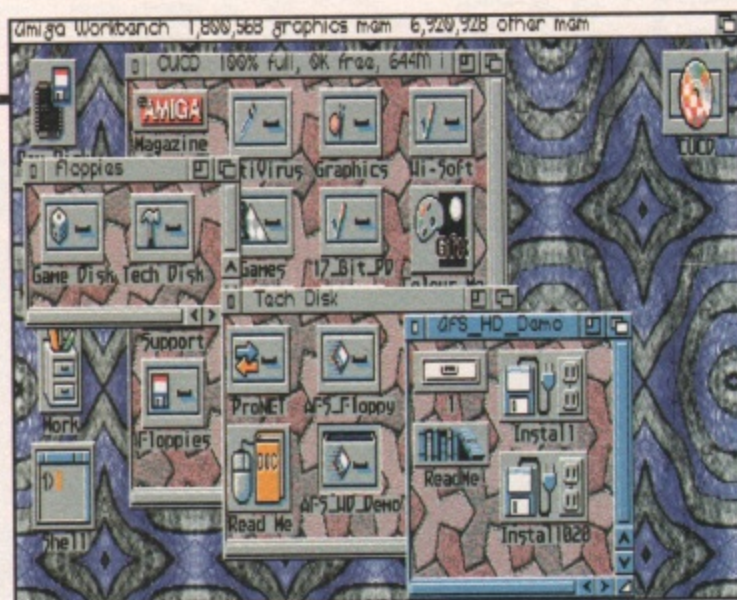



# CD-ROM



## Support

**Contents: Iconographics Icon replacement set, MUI 3.2 (fixed) support GUI system, Delitracker comprehensive module player and Viewtek 2.1 viewer.**

The Support drawer contains a number of programs that are required by the CUCD and its software. First off, the Iconographics package is the top left icon. Click on Install\_Icons to install these icons onto your Workbench, or the IGfx\_Preview icon to show a picture of an example Iconographics Workbench. The IconInstaller program is a manual installation method using a drag and drop interface.

Magic User Interface 3.2 (MUI) is an extension of the Workbench system and is required by some software. If you didn't boot the CD, you'll have to click on the InitCD icon in the root directory to temporarily run MUI from the CD. If you intend to install MUI it would be a good idea to drag the MUI drawer onto your own HD as it will run much quicker.

The SuperViewCD drawer contains an exclusive CD demo of the wonderful multi viewer/converter package called SuperView. SuperView uses special loader and saver libraries to load virtually any type of picture and save out as any other type of picture. What's more, it can display on virtually any display system from the Amiga's native ECS and AGA chip-sets to graphics boards and RTG systems such as CyberGraphX. Read the docs to gain more information and if you think it suits you, click the Install\_SuperView icon to install to your HD.

Delitracker\_II contains the Amiga's most powerful and comprehensive module playing utilities around. It handles virtually every type of module and can play from Fast RAM and even 14-bit playing and headphone mixing. Reading the documentation is highly recommended. Delitracker is activated by the Johan Alpmar ProTracker and the ScreamTracker jukebox icons in the modules section of the CD.

Finally, ViewTek is a picture viewer able to handle most types of files. It's simple to use and downgrades high-colour pictures such as 256 colour GIFs/IFFs and JPegs to ECS HAM6 screen modes on non-AGA machines.

## AntiVirus

**Contents: Virus Checker and VirusZ anti-virus package complete with VList list of fake-virus infected archives and files.**

To tie in with our AntiVirus feature in CU Amiga Magazine this month, the top two virus checkers are included so that you may rest easy against the threat of a damaging virus attack. It's best to boot from your hard drive if you want to install these. To install Virus Checker, click on the Install\_Virus\_Checker icon.

Before you can run VirusZ you'll need to click on the Install Libraries icon. Now drag the entire VirusZ directory onto your hard drive. Now you can put either or both of the virus checkers in your WBStartup drawer to have them permanently resident. Check page 10 for further VirusZ instructions.

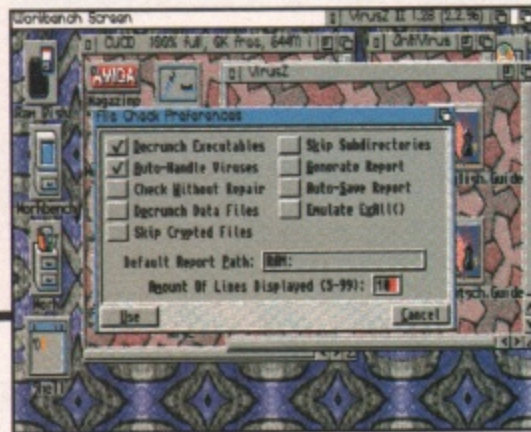
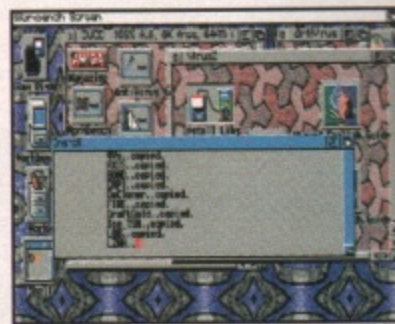

## Games

**Contents: Worms Special section, Blitzbombers demo, Watchtower demo, Nemac IV demo + many full PD/Shareware games.**

Click on the Worms Special icon and you'll find a number of support files for Worms and a preview of a forthcoming Worms Enhancer CD-ROM. The maps contained here and in the Custom directory must be copied to your Worms TWCustom drawer on your hard drive or onto fresh disks if you're playing from floppy. Read the documents here to find out more about the Worm map creators.

Next are four large ball icons with CDXL in their names. These are two of the CDXL animations from CD32 version of Worms. The CD32 icons should be clicked on only by users of CD32s and CD32 emulating CD-ROMs. The others should be used by those using SCSI CD-ROMs.

The last directory TWENGLISH, is a complete replacement sample set made by the CU Amiga team. Some of the samples came from smaller replacement sample sets. Many thanks to Jon

Guidry and Richard Smith for their contributions. To install this set onto hard drive, open up your Worms directory. Select the window and choose Window/Show/All

Files from the Workbench menu. Find the drawer called TWENGLISH and rename to TWENGLISH\_OLD. Then simply drag the TWENGLISH drawer from the Worms Special directory onto your Worms directory.

Please not that floppy drive users will need to format a floppy disk with the name TW2. Then drag the TWENGLISH directory into this floppy disk. When Worms is running and asks for the second disk, insert your new floppy disk instead of the original Worms disk two. OK. Now enjoy.

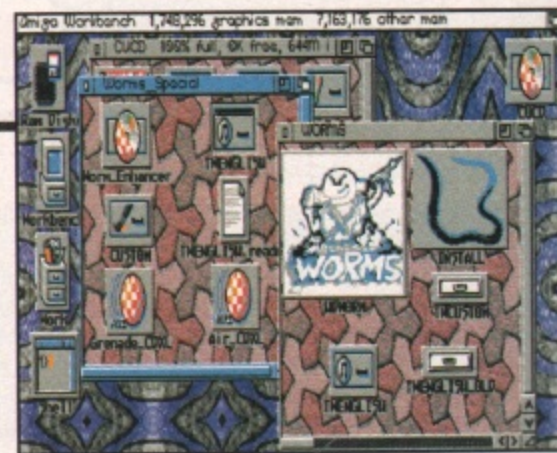



## Sound

**Contents:** OctaMED SoundStudio demo, Audio Lab 16 demo, high quality 8 and 16-bit samples. ProTracker, OctaMED and ScreamTracker modules and jukeboxes.

The Sound drawer contains a save disabled demo of the 16-bit-capable OctaMED SoundStudio (see the preview on page 69). An AudioLab16 2.0 demo is included, which can take digital sample data from audio CDs, provide DSP style effects, process 16-bit samples and more. Tony Horgan has returned with another sound sample collection. The drawers are split into 8 and 16-bit samples. The 8-bit sound samples are a varied bunch including loops, hits, effects and so on. Double click on them to hear them. U4ia/F8 has supplied some original drum loops. For 16-bit audio users there's a complete TR-909 drum kit and some TR-808 bass drums.

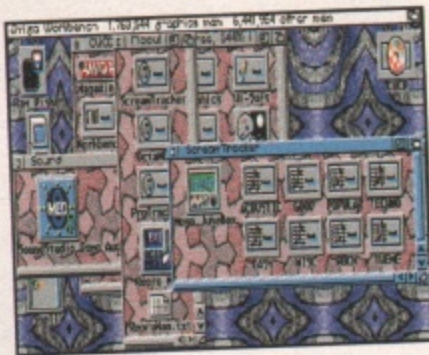

A great deal of modules in many formats are included in the modules directory grouped into ScreamTracker, OctaMED and ProTracker. The ScreamTracker module collection has a special jukebox icon which will launch Delitracker to play from the collection at random. The ProTracker collection has a jukebox dedicated to module author Johan Almar. All of Johan's works that we could find are included, again the jukebox will play from them at random.

The OctaMED directory contains the entire works of Samuel Gilbert AKA Orpheus, plus a few of Tony Horgan's old mods. All these modules have icons to launch DeliTracker. The modules with the '9' postfix are special 9-bit modules and DeliTracker will use its 14-bit noteplayer to render them correctly.

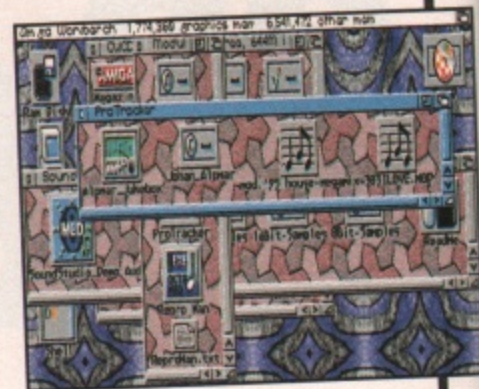

## Graphics

**Contents:** Fresh Fonts I + II CD previews, Amiga3D Imagine objects CD preview, Dust utility for rendering packages.

The CUCD Graphics drawer is loaded with four massive CD previews. Fresh Fonts Vol I contains many megabytes of DMF fonts suitable for PageStream (December's cover disk). The fonts can be loaded straight from PageStream. Fresh Fonts Vol II contains megabytes of IntelliFonts, support for which is built into Workbench and many other Amiga programs.

The Amiga-3D CD preview is an exclusive 20Mb sample of Imagine 3D objects from the BlitterSoft Amiga-3D CD. The objects have no icons and so you will have to access them directly from Imagine. However, using the Hi-Soft MagicLink's demo might give you a better idea of what each object looks like.

The IML drawer contains a massive back archive of Internet Imagine Mailing List archives as large text files and AmigaGuides. You will need to use a text viewer or Amiga Guide utility to view them. They are an excellent reference for troubleshooting with Imagine.

The Dust drawer contains a powerful package for producing 'particle' effects for Imagine and other types of rendering package. Dust will run from the CD fine but it's recommended that you drag the drawer across to a hard drive partition if you intend to use it regularly. Again comprehensive documentation is provided on the CD for the package and in the case of Dust, it's an essential read. Click on some of the faces for some example images of what Dust can do.

Texture\_Portfolio represents the final CD preview, this time from Ground Zero PD, and is a selection of high quality JPEgs 24-bit textures which can be used for several tasks, such as backdrops for multimedia and wrap-on textures for 3D rendering. The collection has icons for each picture which when clicked will activate the ViewTek viewer to display the texture concerned. Clicking on the Portfolio\_Ad icon in the root directory of Texture\_Portfolio will reveal ordering information for the excellent full CD. There are also support utilities for Imagine.

AlfaTexture contains some new third party mathematical textures for Imagine 3.0 and above. AnimFlare is an example project and tutorial for producing animated flare effects and the d2imagine.guide is a comprehensive AmigaGuide Imagine tutorial which if used in conjunction with the Imagine Mailing List archives and Imagine HTML tutorial/reference in the Comms/WWW section provides a massive reference for this excellent rendering package.

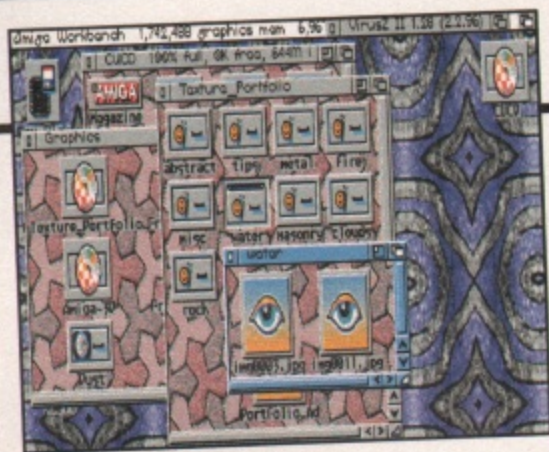

## Hi-Soft

**Contents:** Demos of Cinema 4D rendering package, Magic Link 3D object converter, Disk Magic directory utility, Termite comms terminal package, Twist 2 database and more.

All of the demonstration packages in the Hi-Soft directory at the top right of the CUCD root directory, except Termite, can run directly from the CD. Termite will need to be installed to hard drive. The Twist2-Demo is a demo of the Twist2 database. To activate it click on the Run Demo icon within its drawer. The same goes for DiskMagic, a demo of the top rated directory utility. DiskMagic will need the Setup-DiskMagic icon clicked on before the DiskMAGIC\_Demo icon.

MagicLink-Demo is a demonstration version of a new 3D object converter by Maxon. Again, a simple double-click is all that's required. MagicLink will happily convert between many different types of objects and even provide a preview picture. Hand in hand with Magic Link comes the Cinema4D-demo. Be sure to read the Cinema4D-Tutorial.txt file which also details the features missing from the demonstration version. After running Cinema4D, select Project/Load and pick one of the provided projects to give C4D a spin.

## Misc

**Contents:** BlitzBasic 2.1 and Dice 3.0 programming language demos, AGA experience CD preview, AIBB benchmarking tool, Digital Universe demo (MUI) and ImageVision demo.

This directory contains two complete demo programming environments for Blitz Basic 2 and Dice C 3.0. Digital Universe is a demo of an astronomy package similar to Distant Suns and will be reviewed next issue. ImageVision\_Demo is a demo of a multimedia authoring package from BlitterSoft also to be reviewed next issue.

The Everybody's Girlfriend drawer has a compressed audio sample of David Pleasance, ex MD of Commodore UK, playing flamenco guitar on the ParaMiAmiga track off the album Everybody's Girlfriend.

The AIBB drawer contains the AIBB benchmarking utility. There are lots of modules of various Amiga system benchmarks which can be loaded into AIBB for comparison. The\_Party\_95 drawer contains a large number of The Party 95 demos, many of which can be run directly but some may need to be copied onto floppies or hard drive. Playing the DataWorld animation is essential but you'll need the right libraries installed.

Lastly, a CD preview of Sadness Software's AGA-Experience CD-ROM is included. To access this simply click on the AGA-Experience icon to open the drawer and then the CLICKME! icon to activate the GUI front end.

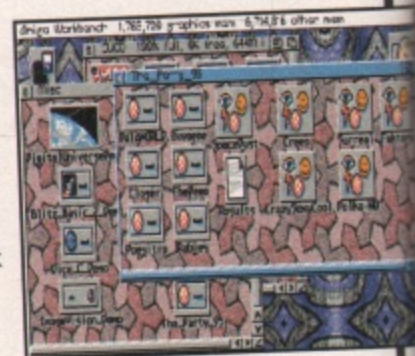



## Comms

Contents: Zeus BBS demo, Thor mail and news browser, AWeb WWW Browser demo and CU Amiga home page + World of Info CD preview.

This directory is dedicated to communications and Internet related material but contains plenty of interest to non modem users. Firstly there's an entire archive of Jason Compton's Amiga Report electronic magazine. You'll find this in the Amiga Report drawer. To view each magazine, simply click on the icons. Next up are a couple of demonstration packages which must be installed to your hard drive. These are the Thor Internet Mail and News browsing software and the Zeus BBS package. In both cases, opening up the windows will reveal an install icon. This will activate the Commodore Installer.

This drawer marked WWW is dedicated to the World Wide Web. All you need to do to check out this wonderful entity is to open the WWW drawer and click on the AWeb icon. Presuming that you have a GIF datatype installed on your Workbench or you booted from the CD then AWeb should fire up right away and you should see the CU Amiga banner.

If you don't see the banner then enter the following commands in the AmigaDOS shell, hitting return after each line and being sure to get all the characters correct including spaces:

```
cd cu:cd:workbench/devs/datatypes/
copy #? Devs:DataTypes/
cd cu:cd:workbench/classes/datatypes/
copy #? Sys:Classes/DataTypes/
```

After that, reboot your Amiga and try again. AWeb should now activate and display the CU Amiga 'home page' correctly. What you see is similar to AmigaGuide. You can scroll around the page and where any text is in blue, this is a link and you can click on this to move off to that location. Of course AmigaGuide doesn't give you pictures in the page either. We've compiled quite a collection of WWW pages for you to 'surf around' to give a taster of what you could experience with a WWW Browser on the Internet where there are millions of WWW pages all around the world and they can be navigated around in the same easy point and click fashion.

Further down the CU Amiga home page, you'll see a small index. The first 'link' is to the documentation for the demo WWW Browser you are using, AWeb. The second is some pages created by CU Amiga Magazine writer John Kennedy. John has included some of his previous articles. The third item is deceptively small for the material contained within.

It's another CD preview but this time it's a CD entirely made up of HTML page - WWW encyclopedia. Daniel Amor kindly donated the Oceania pages to give a taster of this useful CD resource. Ordering information is contained in the pages.

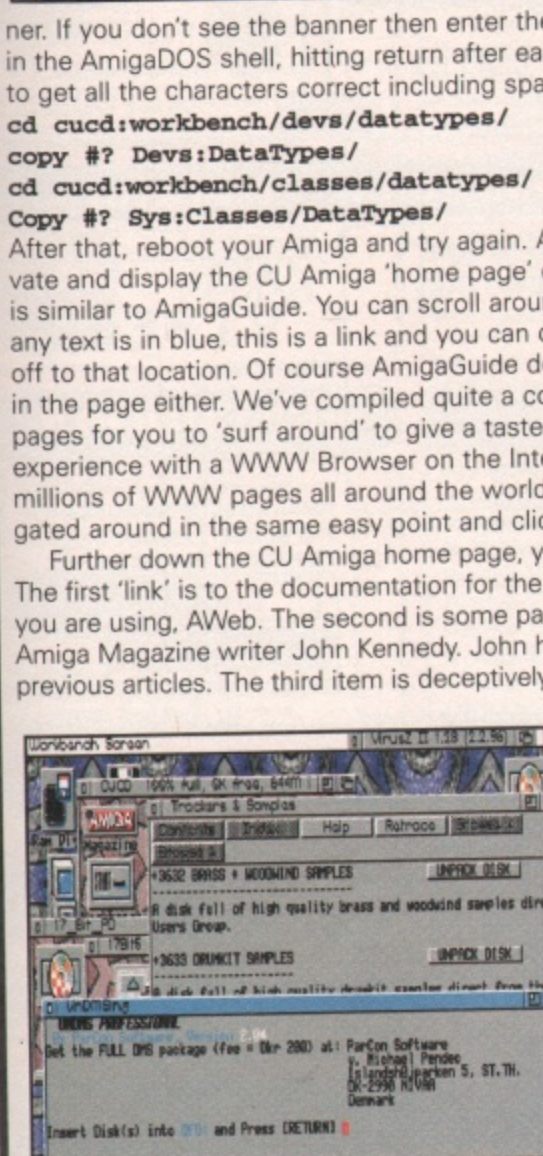

## 17 Bit PD

Contents: 3 massive CD previews of top PD/Shareware collections. 17 Bit Phase 5, Nothing but GIFs and LSD 3.

Using the three 17 Bit Software CD previews is simple. For 17Bit5, just open the directory and double click on the Fifth\_Dimension icon. An AmigaGuide document will appear. When you find your way to the listings of files, if the filename is an AmigaGuide button, the archive is present on CUCD and all you need to do is click on it to extract to floppy disk, RAD or any other floppy compatible device.

17BITGIF is a preview of the Nothing But GIFs CD. Simply click on the WELCOME icon. Each directory of pictures has a number of indexes to give you a quick impression of each picture. Just clicking on the index or the pictures will activate a viewer to display the picture. As with all the 17 Bit PD CD previews, if the filename is not an AmigaGuide button then the file is not present on CUCD but only on the full CD. Click on the 17bitad.iff icon in the 17\_Bit\_PD drawer for ordering information on the full version of the CDs.

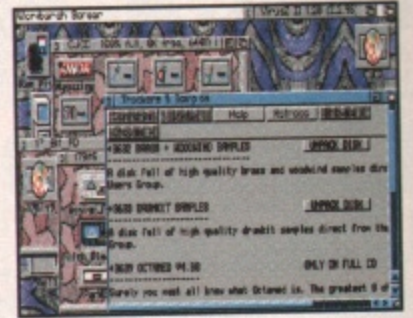

## Epic

Contents: CD previews of Sci-Fi Sensations and Special-FX vol 1.

Within the Epic drawer is a CD Preview of Epic Marketing's Sci-Fi sensations and a preview slideshow of their Special-FX multimedia title. Unfortunately the Sci-Fi Sensations CD preview GUI front end won't work if you don't boot from the CD. This can be solved by performing the following line in the AmigaDOS Shell before activating Sci-Fi Sensations: **Assign Libs: CUCD:Libs ADD**

Enter this line exactly as show, complete with all the spaces and hit Return at the end. You can now exit the Shell. After entering the SCI-FI\_SENSATIONv2 drawer, you'll need to click on the Click Me 1st icon and then the amiga\_menu. If all has gone according to plan, a GUI interface should appear which will let you move around the various material and generally just click to view or hear the files.

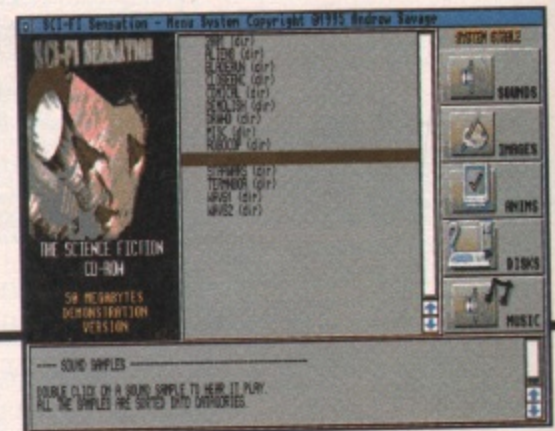

## Many thanks to ...

Though there's no icon, if you're interested in the trials and tribulations that our cover CD compiler Mat Bettinson went through during the making of CUCD, direct your text viewer to a text file in the root of CUCD called Mat.readme. Mat would like to thank all the people that provided the material, knowledge and support which enabled CUCD to come into being. CU Amiga Magazine hopes that a cover-mounted CD can become a regular event, so if you have any material for a future CD or some suggestions of what you'd like to see on the next CD, drop us a line. The Gigabyte hard drive is already reformatted for CUCD2. However, we're sure you'll still be discovering hidden wonders on CUCD when the next CD edition of CU Amiga Magazine hits a newsagent near you.



Late Night Opening  
Wednesday & Thursday  
till 7.30pm

Open Sunday  
11am to 4pm



**FIRST**  
COMPUTER CENTRE

### HOW TO ORDER LOW COST DELIVERY

Order by telephone quoting your Credit Card Number. If paying by cheque please make payable to: **FIRST COMPUTER CENTRE**. In all correspondence please quote a Phone Number, Post Code & Dept. Allow 5 working days cheque clearance.

**SHOWROOM ADDRESS:**  
DEPT. CU, UNIT 3, ARMLEY PARK COURT, STANNINGLEY RD, LEEDS, LS12 2AE.

● 2-4 Week Days £3.50  
● Next Week Day £5.95  
● Saturday delivery £10.00

Delivery subject to stock availability

● All prices include VAT @ 17.5%  
● Large showroom with parking  
● Multi-million pound company  
● Overseas orders welcome  
● Educational purchase orders welcome

**OPEN 7 DAYS A WEEK**

Prices are correct at the time of going to press. Please check our latest prices before ordering. All sales are subject to our standard terms & conditions (copy available upon request). E&OE.

Lombard Tricity low rate finance now available, call.

Telephone **0113 2319444**  
24 HR MAIL ORDER SERVICE FAX: 0113 231-9191  
NEW! BBS Sales & Technical line Tel: 0113 231-1422

E-Mail [firstnet.co.uk](mailto:firstnet.co.uk)  
[www.firstnet.co.uk/firstcom](http://www.firstnet.co.uk/firstcom)

**AMIGA REPAIR CENTRE**

We offer a FREE quotation on your Amiga or any peripheral (monitors, printers etc.) & delivery tariff of just £5.00 is charged or alternatively you can visit our showroom. We can also arrange a courier pickup at an additional cost of £11.00.



### Hardware

**UK'S cheapest Amiga's A1200 MagicPack**

Includes: Wordworth V4SE, Datastore, Organizer, TurboCalc 3.5, Personal Paint V6.4, Photogenics 1.2SE, Pinball Mania & Whizz.

**£349.99**

**Amiga A1200 Magic Pack Inc. 170Mb HD & Scala MM300**

Includes same software pack as Magic Pack, But also includes Scala MM300 (Req. 4Mb).

**£469.99**

**Amiga A1200 Surf Pack Inc. 260Mb HD & 14.4 Modem**

Includes: All the Magic Pack software, plus the latest Comms and internet access software designed for the Amiga. All this for only

**£559.99**

**AMIGA M1438S Monitor Only!! \*£275.99** When bought with a computer

**First Starter Pack**

- A1200 dust cover
- 10 x DSDD disks + labels
- Top quality joystick
- Deluxe mouse mat
- 3 x A1200 games

All for only **£19.99**

**A4000T**

68040-25 **£2089.99**  
68060-50 **£2359.99**

**Chaos Software Pack**

Pack consists of Nick Faldo's Golf Pinball Fantasies Syndicate Chaos Engine

Only!! **£19.99**

### CD ROM Drives

**RENO Portable CD ROM**

- SCSI-2 connector
- 330Kbit data transfer
- Battery or Mains powered
- Kodak multi-session CD
- Stereo headphones supplied
- 18min Access Time
- Audio CD operation bottom

Req. SCSI interface

**£129.99**

Prima shareware CD ROM  
Valued at £10 free with Reno drive

**Amiga Technologies 1241 Q-Drive Quad Speed**

Quad speed external CD-Rom Drive, for A1200, via PCMCIA.

only!! **£239.99**

No additional interface required.

**Internal SCSI CD ROM drives**

- A4000 compatible CD ROM drives
- Toshiba 5401B x4 Speed **£153.99**
- Toshiba 3701B x6.7 Speed **£19.99**

Toshiba drives are shorter than std. drives & so fit inside the A4000 case.

**SCSI Controllers**

- Squirrel SCSI-II interface **\*£45.00**
- \*When bought with any HD/CD ROM drive, £54.99 if bought separate
- Surf Squirrel SCSI-II interface **\*£79.95**
- GVP 4008+ / Oktagon SCSI-II controllers **£99.99**

SCSI-II RAM interface cards for big box Amiga's, A4000/A2000 etc.

### Hard Drives

**3.5" Hard Disk Drives with A1200/600 install kit**

(We recommend 3.5" drives be fitted by qualified computer engineers)

inc. software, cables and instructions

630Mb...**£185.99** 850Mb...**£199.99**  
1.08Gig...**£249.99** 2.1 Gig...**£379.99**

**External Hard Drives for all SCSI aware Amiga's**

500Mb **£199.99** 1.0Gig **£299.99**  
2.0Gig **£639.99** 4.0Gig **£1069.99**

inc. High quality SCSI-II Quantum specification with a 10ms access time, Internal PSU, SCSI ID selector, Cooling fan, and HD prepping/partitioning software. Requires SCSI interface, i.e. Squirrel/GVP additional adaptor may be req. @ £15.95

**2.5" Hard Drives for A600/A1200 with installation kit**

inc. software, screws, cables and instructions

Seagate Fujitsu CONNER

80Mb.....**£89.99** 130Mb...**£109.99**  
170Mb...**£114.99** 250Mb...**£139.99**  
340Mb...**£179.99** 510Mb...**£234.99**  
810Mb...**£349.99** 1.0Gig...**£419.99**

**3.5" Hard Drive install kit £18.99**

Includes set up software, cables and full instructions, no Hard Drive.

### Monitors

**AMIGA M1438S**

Amiga Branded Monitor

Same specification as the Microvitec 1438, but also has Stereo speakers.

**£295.99**

**Microvitec 1438 monitor**

without speakers **£264.99**

Extra adaptor may be req. £6.99

**Amitek 1084 S** **£199.99**

14" Colour CGA Stereo Monitor, Composite Video, Digital RGB, Analog Inputs.

**Monitor dust cover** **£6.99**

### Disk Drives

**Zip Drive**

- Includes Zip Tools software
- 1 X 100Mb cartridge
- Additional 100Mb Zip cartridges **£15.99**

**£199.95**

SCSI Interface required

Additional adaptor may be needed at £15.95

Zip tools available separately **£16.99**

**Syquest EZ-135** **£234.99**

additional media **£15.99**

**Amiga External drive** **£49.99**  
**A1200/600 internal drive** **£39.99**  
**A500/500+ internal drive** **£39.99**

### Squirrel I/face

Hi speed serial port

SCSI-II interface

Autobooting HD

from **\*£79.95**

\*if purchased with any monitor, if purchased separately **£99.95**

**Squirrel SCSI-II interface**

from only **\*£45.00**

\*if purchased with SCSI device **£54.99**

\*if purchased separately

### SupraFAX Modem

**SupraFAX Modem 288**

- Up to 115,200bps (v42bis)
- Silent & Adaptive Answer
- V34 Standard
- NComm Software
- Class 1 & 2 Fax
- Unique LCD Display
- Flash ROM
- 3 Year Warranty

only **£199.99**

**28,000 Data/14,400 Fax**

**SupraExpress 288**

only **£174.99**

- Up to 115,200bps (v42bis)
- LED Display
- V34 Standard
- NComm Software
- Class 1 Fax
- 3 Year Warranty

Supra modems are not BAST approved, however they perform as well & often out perform BAST approved modems. Supra Modems have a 5 year limited warranty

### Robotics WE ARE PREFERRED USER DEALERS

**Sportster Vi** **New**

- Class 1 Fax
- Personal Voice Mail
- Fax on Demand
- Call Discrimination

**BAST Approved**

- 14,400 Data/14,400 Fax **£111.99**
- 33,600 Data/14,400 Fax **£193.99**

**Courier V34+**

If you thought V33bis was fast try V34

**£287.99** BAST Approved

**33,600 bps.**

### RAM Expansion/Accelerators

**PRIMA A1200 RAM Expansion**

- A1200 1 MB RAM Special price!! **£69.99**
- A1200 2 MB RAM **£99.99**
- A1200 4 MB RAM **£124.99**
- A1200 8 MB RAM **£199.99**
- A1200 1MB/33Mhz Co Pro **£99.99**
- A1200 2 MB/33Mhz Co Pro **£124.99**
- A1200 4 MB/33Mhz Co Pro **£159.99**
- A1200 8 MB/33Mhz Co Pro **£235.99**

- 1 Mb 72 Pin SIMM **£29.99**
- 2 Mb 72 Pin SIMM **£59.99**
- 4 Mb 72 Pin SIMM **£69.99**
- 8 Mb 72 Pin SIMM **£145.99**
- 16 Mb 72 pin SIMM **£315.99**
- 1 Mb 30 pin SIMM **£33.99**
- 256x4 DRAM (each) **£6.99**

### Accelerator Cards

**POWER VIPER**

**Viper II-50** **£199.99**

Up to 128Mb RAM, FPU Socket & RT dock

**Viper II-28** **£119.99**

Up to 128Mb RAM, FPU socket & RT Clock

**A500/600 RAM Expansion**

- PRIMA A500 512k RAM no clock **£19.99**
- PRIMA A500+ 1 Mb RAM **£29.99**
- PRIMA A600 1 Mb RAM no clock **£29.99**

Part exchange available on your old memory. Call for pricing.

### Printers

**Canon**

- Canon BJ30 **£184.99**
- Canon BJC70 Colour **£289.99**
- Portable colour printer, 30 page ASF built in
- Canon BJC200ex **£207.99**
- High quality mono printer, virtual 720 dpi
- New!! Canon BJ210 **£229.99**
- Mono printer, 720x360dpi, colour upgradeable
- Canon BJC4100 Colour **£289.99**
- High quality colour/flat mono printing 360 dpi
- Canon BJC610 Colour **£410.99**
- 720 x 720 dpi, near photographic quality

**CITIZEN**

All Citizen printers have a 2 year warranty

**ABC Colour printer**

Simple (as easy as ABC) to use 24 pin printer. Comes as standard with 50 sheet Auto sheet feeder. Tractor feed optional at £34.99

**Citizen Printiva 600c** **£399.99**

600 dpi colour, 1200 dpi mono printer. Dedicated Amiga driver software, use's advanced Micro Dry print Technology.

**HEWLETT PACKARD**

- HP340 Portable **£224.99**
- Colour upgradeable portable printer
- HP600 **£232.99**
- Colour upgradeable mono inkjet/ Col. Kit £61.99
- HP 660 Colour **£319.99**
- New colour inkjet from HP.
- HP850 Colour **£416.99**
- 600x600 dpi up to 6 pipjm mono, 3pipjm colour
- HP 5L Laser printer **£449.99**
- 4 pipjm 600 dpi
- HP 5P Laser printer **£715.99**
- 6 pipjm 600 dpi

**EPSON**

- Stylus Colour II **£335.99**
- 720 dpi, 4ppm Black, 2ppm Colour.
- Stylus Colour IIs **£249.99**
- 720dpi, 2.5ppm Black, 1ppm Colour.
- Stylus 820 **£219.99**
- 720 dpi, 3.5ppm Black, Colour Upgradeable.
- Stylus Pro **£485.99**
- 720x720 dpi, Photo-Real quality output.

**OKI**

People to People Technology

**Authorised OKI dealer**

- OL600ex **£379.99**
- LED laser printer, 6 pipjm, 1Mb of Ram.
- OL610ex **£479.99**
- LED laser printer, 6 pipjm, 2Mb of Ram.

**Miscellaneous**

- Printer Switch Box 2 way **£12.99**
- Printer Switch Box 3 way **£17.99**
- Printer Stands (Universal) **£4.99**
- 1.8 Metre printer cable **£4.99**
- 3 Metre printer cable **£6.99**
- 5 Metre printer cable **£8.99**
- 10 Metre printer cable **£12.99**
- Parallel port ext. cable **£9.99**

### Consumables

**Ribbons**

- Citizen Swift/ABC mono **£3.99**
- Citizen Swift/ABC colour **£12.99**
- Star LC90 mono ribbon **£4.99**
- Star LC10/100 mono **£3.69**
- Star LC10/100 colour **£7.99**
- Star LC240c colour **£13.99**
- Star LC240c mono **£8.99**
- Star LC240 mono **£5.99**
- Star LC24-10/200/300 Colour **£13.99**
- Re-Ink Spray for mono ribbons **£11.99**

**Ink Cartridges**

- Canon BJ10/Star S148 **£19.99**
- Canon BJ200/230 **£13.99**
- Canon BJ30 (3 pack) **£13.99**
- Canon BJC 70 mono (3 pack) **£12.99**
- Canon BJC 70 colour (3 pack) **£16.99**
- Canon BJC 4000 colour (single) **£16.99**
- Canon BJC 4000 mono (single) **£7.99**
- Canon BJC 4000 mono high cap. **£28.99**
- Canon BJC 600e mono high cap. **£10.49**
- Canon BJC 600e colour **£8.99**
- Citizen Printiva Std. colours **£6.49**
- Citizen Printiva Metallic colours **£16.49**
- HP Deskjet 660 double mono **£25.99**
- HP Deskjet 660 colour **£15.99**
- Epson Stylus mono **£36.99**
- Epson Stylus colour **£179.99**
- Epson Stylus Col. II/S/820 Mono **£179.99**
- Epson Stylus Col. II/S/820 Colour **£179.99**
- Epson Stylus 820 colour upgrade **£94.99**
- Star S144 mono/colour (single) **£8.99**

**Covers**

- All printer dust covers **£5.99**

**Paper**

- Fanfoid (tractor feed) 500 sheets **£4.99**
- Fanfoid (tractor feed) 1000 sheets **£8.99**
- Fanfoid (tractor feed) 2000 sheets **£17.99**
- Single sheet 500 sheets **£4.99**
- Single sheet 1000 sheets **£8.99**
- Single sheet 2000 sheets **£17.99**
- Epson Stylus 720 dpi paper pack **£12.49**

**Disks**

- Bulk DSDD**
- 10 x £3.49 **100 x £29.99**
- 30 x £9.99 **200 x £54.99**
- 50 x £15.99 **500 x £118.99**
- Branded DSDD**
- 10 x £4.99 **100 x £35.99**
- 30 x £12.99 **200 x £63.99**
- 50 x £25.99 **500 x £142.99**
- Bulk DSHD**
- 10 x £3.99 **100 x £33.99**
- 30 x £11.99 **200 x £59.99**
- 50 x £17.99 **500 x £134.99**
- Branded DSHD**
- 10 x £5.99 **100 x £47.99**
- 30 x £15.99 **200 x £84.99**
- 50 x £25.99 **500 x £190.99**
- Disk labels x500 **£6.99**
- Disk labels x1000 **£9.99**

**Premier-Ink Cartridge Refills**

Save a fortune in running costs with your ink! bubble jet. Compatible with the HP Deskjet series, Canon BJ10/200/300/300/300/330, Star S148, Citizen Project and many others.

Full range of colours available.

- Single refills (22ml) **£6.99**
- Twin refills (44ml) **£12.99**
- Three colour kit (66ml) **£19.99**
- Full colour kit (88ml) **£27.99**
- Bulk refills (125ml) **£24.99**

Printer repair specialists call for quote



44  
-9191  
-1422  
N  
621  
x write  
9.99  
5.99  
ware  
do disc, no  
349.99  
\*£45.00  
\*£79.95  
£99.99  
New!  
£79.95  
with any modern  
£99.95  
£199.99  
T dock  
£119.99  
T Clock  
Expansion  
lock £19.99  
£29.99  
lock £29.99  
Top Quality  
Prices  
in your old  
casing.  
sks  
100 x £29.99  
200 x £54.99  
500 x £118.99  
SDD  
100 x £35.99  
200 x £63.99  
500 x £142.99  
SHD  
100 x £47.99  
200 x £84.99  
500 x £190.99  
x500 £6.99  
x1000 £9.99

## Video

**Quantum romba**

**VIDI Amiga 24 (RT)+**  
Colour Real Time Amiga video capture system

- Composite & SVHS inputs.
- Time Lapse remote grabbing.
- BMP, TIFF & PCX File Support.
- Load/Save 24 Bit ILM & Anims

**£139.95**

**VIDI Amiga 24 (RT) Pro**  
Professional Colour Real Time Amiga video capture system

- Composite & SVHS inputs.
- 16.7 million colour grabbing.
- BMP, TIFF, PCX, ANIM, ILM.
- Processing controls & effects

**£224.99**

**Pro-GRAB SVHS 24RT Plus**

- Compatible with VHS & SVHS.
- Save & load in multiple file formats
- Support for virtual memory
- Additional teletext facilities
- Large preview window

Reg. kickstart 2.04 & 1.5Mb free memory

**for only..... £129.95**

## Genlocks

**hama**

**Genlock 290**

- Full fading of mixed graphics
- 2 ergonomically designed faders
- High quality output signal
- Independent power supply

**£639.99**

**Genlock 292**

- Full fading of mixed graphics
- Fade to black of output signal
- Demonstration software inc.
- Independent power supply

**£264.99**

**A-Cut**

- Video edit controller
- Works on Kickstart 2.0 and above
- Scenes defined, sequenced/exchanged
- Independent power supply

**£164.99**

**Fusion Genlock**

- Comes with Scala HT100
- 92% Amiga Shopper June 95
- Composite only Genlock

**Only!! £95.99**  
Entry level Genlock

## Graphics

**New!! Epson GT-5000**

- A4 Flatbed scanner
- 300 dpi optical scan resolution
- Inc. PC Editing & OCR software

**£437.99**

**Art Department Pro Scanner Controller**

- Bidirectional Parallel cable
- Amiga driver software
- Total WYSIWYG control
- Can be used without Art Dept Software

With Scanner Without Scanner  
**£89.99 £99.99**

• If cable req. separately £39.99

**Tabby**

The amazing new graphics tablet for the Amiga developed with First Computer. 94% rated in Amiga Shopper. Requires 2.04WB or above.

**only £59.99**

**Power Scan v4.** £89.99  
256 g/scale on AGA Amigas, 64 g/scale non AGA

**Power Scan Col.** £174.99  
24 bit colour scanner, 16.7 million colours

## Graphics Software

**D Paint V**  
Award winning Paint & Animation package.  
**£59.95**

**Art Department Pro.**  
Image processing software  
**£129.99**

**Scala MM211**  
**£139.99**

- MM300 £224.99
- MM400 £274.99

**Photogenics v1.2**  
24 bit graphics manipulation  
**Special offer only!! £47.99**

**New!! Cinema4D**  
**£169.99**  
Amiga Ray-Tracing software  
Req. 3Mb of RAM, and Kickstart 2 or higher.

## Music

**Technosound Turbo 2 Pro**  
8/12 bit Stereo Sampler plus many more advanced features  
A bargain at only **£27.99**

**Mega-Lo-Sound**  
8 bit direct-to-disk sampler  
Great value at only **£25.99**

**ProMIDI Interface**  
• MIDI in, MIDI thru & 2 x MIDI out  
• Compatible with all MIDI software  
**only!! £19.99**

- 2 x 3metre MIDI cables £9.99

**AURA**  
100% **£74.99**  
Octamed compatible  
12/16 bit stereo direct-to-disk PCMCIA sampler

**New**  
**Octamed 6 Official CD**  
**£24.95**  
Latest version of the best music making program for the Amiga. Over 600Mb of Midi files, Samples.

## Wordprocessing

**Final Writer 4**  
Word Processor/Publisher  
Latest version of this award winning software  
**only!! £72.99**

**Final Writer Lite**  
Word Processor  
Requires Kickstart 2.04 or above, 2Mb of Ram and 1 Floppy Drive, Hard Drive installable if desired.  
**£39.95**

**Mini Office Integrated Package**  
• Wordprocessor  
• Spreadsheet  
• Database  
• Graphics  
• Disc Utilities All in one package  
**£38.99**

**Wordworth Ver. 5**  
• Any Amiga 2.04 or higher  
• 3Mb of Memory  
• 2xFloppy drives or HDrive  
**£74.99**

## Home Office

**Final Data**  
• Requires Workbench 1.3 or above, 1Mb of memory & 1 floppy drive.  
**£39.95**

**Twist 2**  
Relational Database  
• Requires Workbench 2.1 or above & 2Mb of memory  
**£74.99**

**Final Calc**  
• Requires Workbench 2.0 or above, 2Mb of memory min., H.Disk with 5Mb of free space  
**£94.99**

**Home Finance**  
**Money Matters 4** **£49.99**  
Utilities

**Opus 5** **£49.99**

**DiskMagic** 92%  
**£34.95** CU Amiga

## Miscellaneous

**Vista Pro 3**  
Landscape Artistry software  
Accurately recreate and explore real world landscapes in vivid detail  
**£27.95**

Also  
Makepath £8.99  
Terraflo £8.99  
Vista Pro 3 Lite £24.95

**Distant Suns 5**  
Desktop Planetarium  
Req. Kickstart 2.04 or above  
2Mb of RAM and a Hard drive  
**£27.95**

**Studio 2** **£49.95**  
Print software for optimised performance, includes Epson Stylus and Canon print drivers.

**GP Fax** **£49.95**  
Use your Amiga modem as a fax machine

**GBRoute Plus** **£44.95**  
Amiga Route Planner. Winner of the "Best Amiga Utility Software" award. Works on all Amiga's with at least 1Mb of Memory.

## Peripherals

**Mega Mouse+ 400 dpi** **£12.99**  
**Mega Mouse 400 dpi** **£11.49**  
**Amiga Mouse 560dpi** **£12.49**

**Mousemat 4mm** **£3.99**  
**AlfaData Trackball** **£34.99**  
**Zip Stick joystick** **£9.99**  
**Gravis Amiga joystick** **£19.99**  
**ZyFi-2 Speakers** **£26.99**  
**ZyFi Pro Speakers** **£57.99**  
**Roboshift mouse/joystick switch** **£9.99**  
**Amiga Contol Pad** **£9.99**

**Amiga Modulator** **£34.99**  
**Amiga PSU** **£34.99**

**Kickstart 2.04/2.05** **£24.99**  
**CIA 8520A I/O chip** **£18.99**  
**FPU 25mhz PLCC** **£34.99**  
**FPU 33mhz PLCC** **£39.99**

**Turbotech R/T clock cartridge** **£118.99** Special Offer all Amiga's

## Cables

**Amiga-CD32 Serial Network cable** **£24.95**  
**Amiga Parnet Parallel Network** **£14.95**  
**Modem Cable 9-25/25-25** **£9.95**  
**Null Modem Cable** **£9.95**  
**Amiga-VGA Monitor** **£12.95**  
**Amiga-TV Cable** **£2.45**  
**Amiga-CM8833 Monitor** **£9.95**  
**Amiga-Scart Cable** **£9.95**  
**Printer Cable (1.8 metre)** **£4.95**  
**Disk Drive/Monitor Ext.** **£14.95**  
**Analogue PC J.stick Adapt.** **£7.95**  
**Mouse/Joystick Extension** **£4.95**  
**Mouse/Joystick Autoswitch** **£9.95**  
**MIDI Cables (3 metre x2)** **£9.95**  
**Centronics-Centronics** **£9.95**  
**SCSI D25-50 way Cent.** **£11.95**  
**SCSI D25-50 way Micro-D** **£15.95**  
**SCSI Adaptors from..** **£15.95**  
**SCSI Terminators from...** **£19.95**  
**Internal SCSI Cables from...** **£9.95**  
**2.5" IDE Hard Drive Cable** **£5.95**  
**Amiga-3.5" Hard Drive** **£18.95**

## Amiga CD ROM's

Delivery £1 per title or £3.50 for 4+

17 Bit The 5th Dimension	£17.49	Grafix Sensations	£17.49
17 Bit Collection (Double)	£24.99	New!! Groliers Encyclopedia 2	£19.95
17 Bit Continuation	£14.49	Illusions in 3D	£8.99
17 Bit Phase 5	£14.49	New!! Light ROM 3	£40.99
17 Bit/LSD compendium 1 or 2	£16.99	Light Works	£29.99
17 Bit/LSD compendium 3	£16.99	Magic Illusions	£11.49
<b>Aminet 8 or 9 or 10</b>	<b>£12.49</b>	New!! Meeting Pearls 3	£8.99
<b>Aminet collection (Aminet 1-4)</b>	<b>£24.49</b>	MultiMedia Toolkit 2 (2xCD's)	£19.95
<b>Aminet collection 2 (Aminet 5-8)</b>	<b>£24.49</b>	New!! Network 2 CD	£12.49
New!! Amos Users CD PD Ver 2.	£16.99	New!! NFA AGA Experience	£17.99
Animations (Double)	£17.49	New!! Octamed 6 CD	£24.95
New!! Artworx	£8.99	New!! Prima CD Vol. 1	£9.99
New!! Assassins 2 (Double)	£17.49	New!! Sci-fi Sensations	£17.99
BCI Net 1/2	£8.99	Space And Astronomy	£16.99
New!! C64 Sensations	£16.49	New!! Speccy Sensations II	£17.49
CAM (Double)	£22.49	The Beauty of Chaos	£13.49
CDPD 1,2,3 or 4	£8.99	Ten on Ten pack (10xCD's)	£37.99
Demo CD 2	£8.99	New!! UPD Gold CD (4x CD's)	£24.99
New!! Eric Schwartz CD	£24.99	New!! World Of Pinups 2	£14.99
New!! Encounters UFO Phenomenon	£14.99	WPD Hottest 5	£17.99
Fractal Universe	£17.49	Weird Science Fonts/Clipart	£8.99
New!! Global Amiga Experience	£24.95	Weird Science Animation	£16.99
Goldfish 1/2	£24.99	New!! World Info 95	£34.99
		New!! XiPaint V3.2	£39.95
		New!! Zoom II	£18.99

**FREE!! Prima Shareware CD-ROM worth £10 with every order of CD-ROM software over £30**

## Blitz Basic

**Blitz Basic 2.1**  
Popular BASIC programming language for all Amiga's  
**Special offer**  
**£29.99**

## Citizen ABC

As easy to use as ABC  
24 pin colour printer  
Usual price **£145.99**  
**Limited special offer price only!! £135.99**

## Turbotech

**Turbotech Real/Time Clock cartridge**  
Usually **£17.99**  
**Special offer price**  
**£14.99**

## FirstNet

Yorkshire's Premier Internet provider  
One time connection fee of £29.38 and then just £14.69 a month thereafter, 15:1 User Ratio, Excellent Bandwidth, Web space available.  
Call for further details



# VISAGE COMPUTERS

27 Watnall Road, Hucknall  
Nottingham NG15 7LD  
Tel: (0115) 964-2828  
Tel/Fax: (0115) 964-2898



## STORAGE

### HARD DRIVES

WESTERN DIGITAL

3.5" E/EIDE

635MB	£159.99
850MB	£179.99
1 GIG	£199.99
1.2 GIG	£239.99
1.6 GIG	£329.99

Seagate

3.5" E/EIDE

850MB	£179.99
1 GIG	£199.99
1.2 GIG	£219.99
2 GIG	£329.99

HITACHI 2.5" IDE

340MB	CALL
540MB	£239.99
810MB	£329.99
1 GIG	£499.99

LOW PRICES

### Quantum

3.5" E/EIDE

540MB	£Call
635MB	£159.99
850MB	£179.99
1 GIG	£199.99

### A500 ALFAPOWER

210MB	£179.99
270MB	£199.99
420MB	£229.99
540MB	£249.99

Externally cased Hard drives for the A500/500+. Can be populated with upto 8MB of RAM.

All 3.5" IDE Hard drive require an adaptor cable when fitted into an A600/1200 (£15.00 when purchased with a drive) £19.99 when purchased separately

If you have found a cheaper price elsewhere in the magazine, call us and we will do our best to beat it.

### A1200 OVERDRIVES

270MB	£199.99
540MB	£219.99
635MB	£229.99
1 GIG	£269.99
1.2 GIG	£299.99

## STOP! AND THINK

Before you purchase your hard drive from elsewhere just look at what you get **FREE** with our drives!!!

\* Drives are formatted & installed with Workbench.  
\* 100MB of top quality Public Domain software including:-  
Compugraphic fonts & clipart, Lightwave & Imagine objects, top demos & music modules, essential utilities, games and lots more

## AMIGA

### 1200 "Magic"

The awesome new AMIGA 1200 "Amiga Magic" pack is here, Software pack includes...  
Photogenics 1.2 SE, Personal Paint 4.6, WordWorth 4, Datastore 1.1, Digita Organiser/Print Manager, Turbo Calc 3.5, Pinball Mania/Whizz, PLUS **FREE** Mousemat & Dustcover



Only ...£389.99

Add £10.00 for a CHAOS Pack, Pack includes:- Nick Faldos Golf, Chaos Engine, Pinball Fantasies, Syndicate

### 4000 Tower

25Mhz 68040 CPU, 1.2GB SCSI-2 HD/6MB RAM AT/IDE HD Interface, SCALA MM300.

£2149.99

Call for details - prices on 060 version.



## AMIGA M1438s

High resolution colour multisync monitor for all the Amigas, Built in stereo speakers.

£289.99



### A500/A600 RAM

A500 1/2MB N/Clock	£19.99
A500 1/2MB W/Clock	£24.99
A500+ 1MB	£29.99
A600 1MB N/Clock	£29.99
A600 1MB W/Clock	£39.99

### MITSUMI FX400

Internal IDE CDROM unit for the A4000 (requires tandem CDROM controller) Super-fast 600Kb/Sec transfer rate.

FX400 CDROM	£119.99
FX400 Plus Tandem CDROM controller card	£179.99

### CDROM DRIVES

#### AIWA CDROM

External SCSI CDROM for the A1200. Plugs into the PCMCIA port, Fast 300Kb/Sec transfer rate, Connect up to six other SCSI peripherals, Dual speed.....CALL

#### STUDIO 2 PRINTER S/W

Professional print studio for the Amiga. Enhance the output of your printer inc. 720DPI on Epson Stylus Colour, Only.....£49.99

### PRINTERS

#### EPSON

Stylus Colour - II inkjet printer offers photographic like quality when used with optional 720DPI printer driver (coated paper required). Built in auto sheetfeeder,

New low price



From only.....	£299.99
Coated 720DPI paper (200 Sheets)	£22.99

### MODEMS

#### EXTERNAL

BABT approved FAX/Modem, Complete with all leads, PSU and Comms software, Low Price 14,400 .....£109.99 V34 - 28,800 .....£179.99

#### LOGIC3 SCREENBEAT SPEAKERS

SB 3 (10W)	£15.99
SB 25 (25W)	£29.99
SB PRO 50 (50W)	£39.99
SB PRO 80 (80W)	£89.99
All speakers come with cables	

### ACCESSORIES

#### 240 CAPACITY DISK BOX

The Logic3 stackable storage box holds up to 240 disks, Only.....£12.99 ASK FOR QUANTITY PRICES

#### ALFA DATA PRODUCTS

Megamouse-400dpi	£12.99
Megamouse-3 Button	£14.99
Auto J/Mouse switcher	£14.99
AT-Bus2008/IDE	£79.99
AT-Bus2008/SCSI	£109.99
AlfaPower/A500/IDE	£89.99
Tandem Controller	£59.99

## APOLLO ACCELERATORS

### APOLLO 4040/4060 APOLLO 1220

The new Apollo A4000 Accelerator fits into the CPU slot of the A4000 (A3000/T). Fully upgradable to the Motorola 68060 CPU (Call for prices & availability). Comes in 33, 40 & 50Mhz versions, 4 x 72pin SIMM for A3000 Desktop) & SCSI-2 controller

The 1220 combines the best Price/Performance ratio for any Amiga 1200 accelerator. With a 68020/28Mhz and 28Mhz 68882 FPU, 1 x 72pin SIMM socket (1 or 4MB). Real-time battery backed clock

Only .....£99.99  
4 Mb Version.....£199.99

040/40Mhz	£699.99
060/50Mhz	£899.99

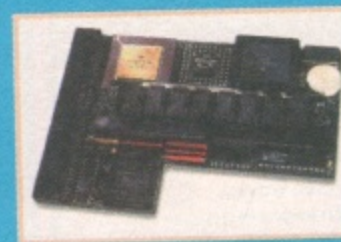

620

The worlds first accelerator for the A600 is here... 25Mhz 68020 CPU, 68882 FPU, 1 x 72pin SIMM socket (1, 2, 4 or 8MB). Requires internal fitting

£139.99

Accelerator card for the A1500/2000. Available in 25 & 50Mhz versions, complete with 68882 FPU & SCSI-2 interface. Not compatible with GVP cards

From £299.99

2030

## HOW TO ORDER

BY POST: Please make cheques and Postal Orders payable to "Visage Computers" Please allow 5 Working days for cheques to clear

WE ACCEPT ALL MAJOR CREDIT CARDS INCLUDING SWITCH & VISA

BY PHONE: Credit/Debit card orders taken from 9.30am - 5.30pm Monday to Saturday

DELIVERY CHARGES  
NEXT DAY ....£6.95  
STANDARD...£3.95

CALL (0115) 964-2828 OR (0115) 964-2898 TO PLACE YOUR ORDER



# cover disks

## How to Load...



### Cover disk 130

This month's 'technical' cover disk 130 will not autoboot. To access the programs you will first need to boot from your Workbench disk or your hard drive. See page 9 for instructions on installation and use of the software on disk 130.

### Cover CD

The special CD edition of this month's CU Amiga Magazine comes with a full Amiga CD-ROM instead of floppy disks. Unlike the CD that came with

the November 1995 issue, this CD has been designed to work with all Amigas with a CD-ROM drive and the CD32. You can boot directly from the CD by inserting it into the drive and resting the Amiga or CD32.

### CD32 Notes

While this CD will boot up on a CD32, due to the limited resources of a standard CD32, not all of the software will be compatible. However, much of the software can be run directly from the CD. You will need a mouse and preferably a keyboard to get the most from the CD but you may find you can browse through the contents using the joyypad controller.

### Accessibility

We wanted to make this CD as accessible as possible and so we decided to include most of the software in uncompressed form, ready to run straight from the CD wherever possible. Archives are used in some of the demos of commercial CDs, such as the 17 Bit Phase 5 drawer which contains a number of DMS files that need to be expanded to floppies. However, on the whole you'll find the software is ready to go with no messing around.

Anything you see that has an icon can be run, viewed, played or otherwise accessed by double clicking. In contrast, if you open a drawer and find a list of filenames with no icons, this is because they are data files which need to be loaded into some other application. The icon depicting a disk and three arrows is used for DMS archives. When you double click on these you'll be asked to insert blank disks into the internal floppy drive, onto which the programs will be expanded.

### Hard drive users

If you decide to boot from your hard drive first, remember to double click the InitCD icon in the bottom right corner of the CD window. This will make sure the software knows where to look for all of its support files. Installing the software onto your hard drive is a simple enough job in most cases. If there is no hard drive installation icon for the software you want to install, read the documents in the relevant drawers for clues, and if all else fails, simply copy the contents of the drawer across to your hard drive. You may also need to copy some libraries from the Libs drawer of the CD to the Libs drawer of your hard drive.

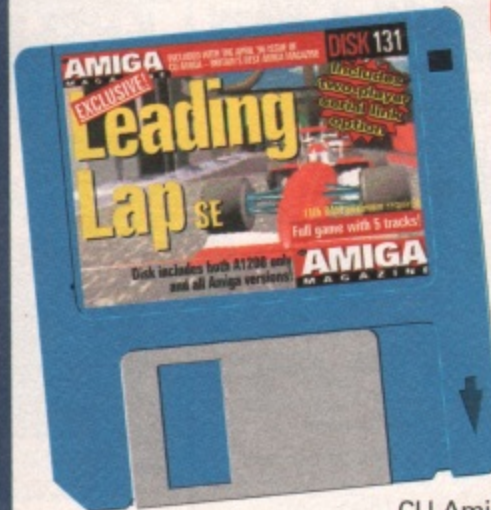

### Cover disk 131 Leading Lap

There are both A500 and A1200 versions on this disk. You will need to decompress either version to a separate single disk. This is a simple process. (1) Have a new, blank formatted disk close to hand and turn off your Amiga. (2) Write protect disk 131 and insert it into the internal drive. (3) Turn on your Amiga and wait until a

CU Amiga loading screen appears. This will have two disk icons on it. (4) Follow the instructions to press either F1 or F2 to decompress either the AGA or standard version on Leading Lap to your blank disk. (5) Once all files have been decompressed onto the blank disk simply restart your machine with this disk in the drive and the game will start. Label this new disk "Leading Lap SE". Put disk 131 in a safe place in case of future failure.

### IF YOUR DISK WON'T LOAD

We go to great trouble to ensure that the CU Amiga Magazine cover disks will work on common Amiga models. However, if you do experience problems follow this simple guide.

We also vigorously virus check our cover disks on a branded virus checker. If some escape our attention we cannot assume responsibility for it.

- 1: Remove all unnecessary upgrades and peripherals, such as printers and modems. Some trapdoor expansions can also cause problems.
- 2: Follow the instructions on this and previous pages exactly.
- 3: If you still experience problems loading the disk call the PCWise helpline on 01685 350 505 between the hours of 10am and 12noon Monday to Friday.

If they advise that the disk is faulty, fill in your details in the form below, and send this form, along with the faulty cover disk and a 28p stamped self addressed envelope to:

CU Amiga Magazine Disk Returns, PCWise Dowlais Top Business Park, Dowlais, Merthyr Tydfil, Mid Glamorgan CF48YU.

NAME: .....

ADDRESS: .....

TYPE OF AMIGA OWNED: .....

DISK NUMBER: .....

DESCRIBE EXACTLY WHAT HAPPENS WHEN YOU TRY TO LOAD THE DISK:

.....

.....

.....

.....

.....

.....

.....

.....

.....

.....







030/40  
40MHz '030  
OF ACCELERATION

33MHz  
FPU

£179.99

£239.99

£289.99

£389.99

£589.99

OPTION

030/40 CAN  
BE ORDERED VIA OUR  
CSI-II INTERFACE  
TO 6 SCSI  
DIRECT ACCESS TO  
PROCESSOR AND  
DATA-FAST ACCESS.  
VARIABLE IS ALSO  
AVAILABLE WITH THE VIPER-II  
D.

NEW



# News

## AT Promises Future

DIRECTORY OPUS HAS  
THE MOST POPULAR  
AMIGA. WITH THE  
ITION CONTINUES.  
EFFICIENT THAN EV  
USES THE POWER OF  
TASKING DESIGN LIK  
OPUS 5 IS NOW TH  
D DRIVE AND FILE  
ILITY EVER!

E MEANINGFUL  
LIANT ENSURES  
R CONTROL.  
WINDOWS AND  
PHICS ♦ MULTIPLE  
FORMING OTHER  
FORM MULTIPLE  
♦ ADVANCED FI  
PORT ♦ EXTENSIV  
AREXX SUPPORT  
H!

49.99

E

OUNTS PACKAGE  
OFFER - £119.99  
AM REQUIRED  
IGA FORMAT

AMIGA FORMAT  
9.99  
ALL PRINTER

TIMATE A1200

ORTH OVER £50  
ORTH OVER £50  
ORTH OVER £50  
99  
99

DUCTS

RD  
NTS

ON INTERNET  
D-D.DEMON.CO.U



AMIGA

hard drive. Because of its plug in and go capability he believes that this will appeal to a wider audience than the standard A1200 Magic Pack did. Here's what we asked and what he said:

**Q Why did Amiga Technologies close down the Maidenhead Operation and lose so many staff?**

**A** One thing that was always on the cards was that Maidenhead was going to be temporary. It was always our intention that we would use the strengths of our parent company Escom. Hence the end of January we moved. As far as the redundancies are concerned there are a mixture of things. First, some of the staff would simply not have relocated from Maidenhead to Stanstead, as it is a significant distance to travel. Couple this with the less than expected turnover that we got at Christmas and that's why we didn't bring all the staff here.

**Q Do you think that the Amiga scene in Britain has been affected by the loss of so many staff?**

**A** It's not good for anyone when you lose staff, I accept this. But at the end of the day one has to cut the cloth accordingly. You can see these premises, they're tremendous and I can rely on a lot of help from the [Escom] people here. I still have the back-up in Germany, who are beginning to take a more active role in publicity in the UK, and we're also going to

do the show, which as you know we're sponsoring. What I'm saying is that we want the Amiga to move forward, we want it to have the desirability it's always had, and if this confidence has been dented slightly, well that's life. But it is my belief that with the excellent features that we've got planned [Surfer Pack, Q-Drive etc] that in the very near future the Amiga will start to get back into the public eye in the very near future, in the manner that we would all like it to be.

**Q Is the UK market still viewed by the parent company as being an important market?**

**A** Yes of course. They have been more proactive in the German market, as you said in your last month's issue, and certainly this paid off there. They're now starting to look at things here in the UK, and are doing the Amiga World Show to help motivate the user base in the UK. We really should be 50/50 with Germany. In real terms 80% of all Amiga business should be done between the UK and Germany, 40% each. By the end of this year this is what we believe we will be able to achieve.

**Q What assurances can you give the UK reader of CU Amiga Magazine that Amiga Technologies isn't retreating from the UK market, that it still has a strong future in the UK?**

**A** One thing is certain: 40% of Amiga Technologies' business can be done in the UK, and any businessman worth his salt would not

want to lose an opportunity like that. It's going to take us time to get back to the dizzy heights though. Let's face it, at Commodore we had eight years of Amiga and that's a long time to develop a product. Irrespective of who's in charge in the UK the guys back in head office in Germany want to see the Amiga succeed here. This commitment will be shown by new products during 1996, like the Q-Drive and Surfer Pack which we are releasing and continued development this year and in 1997.

**Q If Christmas didn't go as well as you expected, how do you view survival this summer?**

**A** Very shortly we will be releasing the Q-Drive. We believe this sort of add on peripheral shows that we are very serious about our machine and this is the right time to launch it. You yourselves are producing a CD-ROM magazine and this proves it. We are also launching the Internet bundle called the Surfer Pack. These are the kind of products that show the strengths of the Amiga. They show its variety and they show its professionalism. We know it's a good games machine, but we also know that it has so much else to offer and this is the long term message we want to get across.

**Q We've always criticised the relaunched Amiga for not being powerful enough. In between PowerPC and the current machines do you still have plans for an upgraded A1300?**

Please add £5 to your order. All products are subject to change without notice. Specification may change.



■ **A** Well, Amiga Technologies in Germany are working towards an 030 based machine. We want to produce an Amiga which falls in between the 020 A1200 and the bigger A4000Ts. Remember that the arrival date for the PowerPC Amiga is spring 1997, and that's without any slippage [a nice way of saying delayed]. No, we want to see the product strengthened and we have plans.

■ **Q** Will it have a CD-ROM drive and Hard Drive?

■ **A** I don't want to give too much information away at the moment because nothing is set in concrete. I would say a hard drive is necessary, and a CD-ROM drive should be an option, as it is with the current A1200. We have big hopes for the Q-Drive, as I have said this is the way the market is developing.

■ **Q** But software developers need to know whether it will have these facilities or not so that they can develop for it.

■ **A** We will renew our efforts to talk to software houses and I personally have already had some positive advances.

■ **Q** When will we see the A4000T in the UK?

■ **A** We had the first significant shipment of A4000Ts last week (mid February) into Anglo/SDL. In time we will get more fluid supplies. I don't know all the reasons for its delay but one of them certainly is the CE mark. I know they had to make a few minor tweaks

to get the machine to conform to the EC's new strict regulations.

(CE stands for controlled emissions. As of 1st of January all new products sold in the European Community must conform to very strict radiation emission standards. These apply to all peripherals attachable to the machine as well as the unit itself. The testing is expensive and lengthy. Because the A4000T was largely US developed, this had to be undergone before it could be sold here.)

## Silent Paws Update Oh Lordy! Its Valhalla 3

If you saw our article on the Silent PAWS laptop Amiga in the February 1996 issue, and were interested, then the World Of Amiga show in Novotel on April 13th, 14th could be the place to go. Sources in America have claimed that Shawn Ralph, the machine's developer is hoping to demonstrate one of the prototypes here in the UK during the show to gauge potential in Europe. If this is the case it will be the first time the machine has been displayed outside North America since its inception. Although expensive, it does provide Amiga on the move capability. The A1200 version of the computer seemed bulky from the photos we saw: the A600 version was much more PC laptop in size. As far as we can see the best way forward for this machine has to be to go as small as possible. This means either a custom motherboard has to be designed or, in the short term, to possibly use the comparatively tiny CD32 motherboard, with an SX32 (see page 66) daughterboard. This is what we'll be putting to Silent PAWS if they turn up. Why not join us?

"It's a bird", "it's a plane", "it's a door", aggh! Those samples again! The notorious Valhalla series, with its high and low pitched sample voices, its holes in the floor and its none too logical puzzles was a source of constant amusement, despair and argument here in the office. You either loved the game or hated it - there was no middle ground. But enough people out there must have loved the original and its follow-up The Lord Of Infinity, because a new version, Valhalla And The Fortress Of Eve is on its way.

The game will follow the fortunes of the young prince of the original game and promises more of the same in terms of gameplay and even more

sampled text. Indeed, for those sick of the samples Vulcan is now incorporating a full text only option. The new game will be sold at Vulcan's good value direct-from-publisher Mini Series price of £14.99. Contact Vulcan Software on 01705 670269.



## A World of New Kit

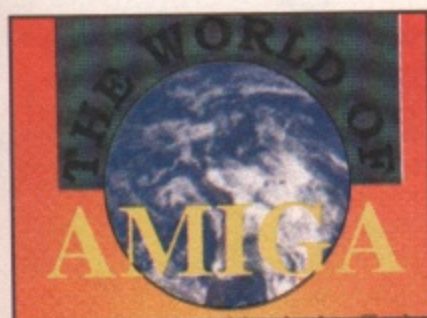

The World Of Amiga show in April seems set to be the launch pad for a whole range of new Amiga products.

Not only will Amiga Technologies have their Surf Pack and the Q-Drive on display (at long last), they'll hopefully also have the first UK A4000Ts and possibly news on PowerPC and the new Workbench.

From other developers the news is just as good with HiSoft working like mad to display their Surf Squirrel and Squirrel MPEG. Both of these are set to take the Amiga by storm like HiSoft's original Squirrel did last year. HiSoft will also be demonstrating

the Terminate TCP (which has Mat Bettinson in a sweat already) and add ons for the superb Cinema 4D from Maxon.

Also displaying new products, including last month's highly rated Wordworth 5, will be Digita. Digita will have the cut down SE version of WW5 on display for Amigas with just 2Mb and a single disk drive, alongside Organiser 2 and Datastore 2.

The Organisers of World Of Amiga haven't got a full list of exhibitors for the show just yet, but Power Computing, Silica, Harwoods and other hardware retailers and developers are all expected to take part.

Booking for the show is available on the following phone number: 01369 706346.

For more information see the advertisement on page 95.

We'd like to wish the show all the support it deserves. We intend to be there, so we hope to meet you there. Let's keep the Amiga alive and support this show.

## Worms, Worms and More Worms

Team 17 have announced that they intend doing an AGA upgrade for Worms to take advantage of the A1200's superior graphics display system. It will be more colourful and the variety of levels will be greater than in the original version. Although the game engine will remain the same the update disks will fall into the £15 bracket and so will still be top value for Worms nuts we reckon. It's due to arrive around the end of March, at the same time as Alien Breed 3DII: The Killing Grounds. Call Team 17 on 01924 267776 for more details.

Blittersoft have also announced a Worms CD packed with hundreds of custom levels levels, samples and speed updates. It's due in mid March, so watch their ads for details. Blittersoft are available on 01908 261466.





# Blittersoft Go Hard Stateside

Blittersoft have announced a new range of hardware and software products for the Spring. These include new tower casings for the A500, A1200, A3000 and A4000 ranges. Equipped with Zorro II and III, PCI slots and other expansion features they will pitch in competition with both the Micronik Tower and Hi-Q's Power Stations (see page 77), for expanding users existing systems. Because of the provision of PCI slots Blittersoft are claiming that PC boards will be available for the tower systems giving you both an Amiga and a PC in the one case, unlike Hi-Q's Siemese Twin system which uses a separate standalone PC and SCSI unit connected via a Squirrel to a standard A1200.

Blittersoft have also announced that they've taken over the distribution of Canadian company AsimWare Innovations CD-ROM software. The products concerned are AsimCDFS 3.0, a control program for CD-ROM drives with PhotoCD, music control and sampling and CD32/CDTV emulation and MasterISO, an Amiga specific CD-ROM mastering program. Call Blittersoft on 01908 261466.

## Guildhall Educational NFA Reply

Guildhall Leisure has taken over distribution of 10 out of 10 Educational software. 10 out of 10 produce educational products for both Amiga disk and CD-ROM for ages 3-16. These include subjects like Maths, History, Geography and a narrow range of languages including French, German and, of course, English. Up to date national curriculum is claimed. For more information contact Guildhall Leisure on 01032 890000.

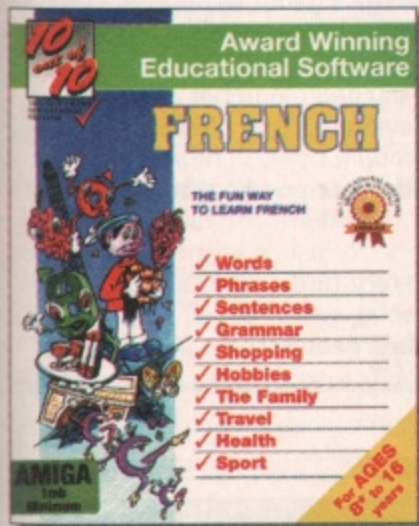

## PageStream 2.2SE

Emerald are doing an offer on PageStream 2.2SE, which makes it available for £49.95. Those not already equipped with this superb package should investigate it now.

Upgrades to version 3.0 from this version will be available soon. Emerald can be contacted on 0181 715 8866.

Last month on Public Domain utilities page we ran an article on some suspected pirate numbers and BBSes on a disk that we'd received from NFA and asked them to contact us. We promptly received a phone call from NFA and asked them to send in their reply so here it is:

"I'm sorry you feel NFA are a bunch of pirates. Due to the article you wrote the morale of several members of the group has been seriously damaged.

"The vast majority of NFA members are very much against piracy. There will always be a pirate element in a group no matter how hard you try to keep it clean.

"We do not promote pirate BBS sites. There may be members in the group who are currently trading pirate software. If there are I would ask them to contact our UK HQ for a chat.

Since publication of your article I have received several calls from people trying to obtain "warze" from our main distribution site.

"The last thing I need sitting on my hard drive in the morning is copyright material.

"I really do not have a lot more to say on the subject, I will be extra careful in future, as when I checked my system there were several archives with cracked keyfiles that I had not checked properly (which were promptly removed). All I can say is that we do try to keep the group legal and will continue to do so." Signed NFA management.

The North American scene of late has been one of cautious optimism, with the Amiga Atlanta 10th Anniversary Banquet as a high and the shutdown of a large Amiga company a low. Let me explain.... writes **Jason Compton**

The Amiga Atlanta user group's party brought Amigans from across the country to the Terrace Garden Inn in fashionable Buckhead, Atlanta, Georgia. The meal was standard-issue banquet chicken but the conversation was all Amiga. The banquet brought in faces from the group's past and present, just as it brought in luminaries from the Amiga's history. Dale Luck and RJ Mical from the original Amiga Corporation kept the audience entertained with tales of the design of the original chips, the legendary joyboard that spawned Guru Meditation, and their own experiences with Commodore. Legends of the industry Dave Haynie and Fred Fish addressed the crowd on their exploits, and I myself was asked to give a piece on the Amiga's future. But there wasn't anything I could say that the audience couldn't see for themselves, particularly when you take into account who was in the audience.

Motorola sent a PR contingent, complete with a PowerPC604 machine (running Windows NT, but they were at least fairly apologetic about this) and loads of consumer and developer goodies to give away. Newtek also sent close to a dozen people, including company president Tim Jenison, who capped off the evening with a rallying speech about the future of the Amiga and his personal confidence in Amiga Technologies' management.

The future isn't what it used to be for Canada's Wonder Computers, who as you may recall from our last issue had just come off of two store openings in the summer and the successful World of Amiga Toronto show. Unfortunately Wonder's accounts were called in by their bank and the company is presently in bankruptcy proceedings. It is the hope of Wonder CEO Mark Habinski that he will be able to raise enough capital to re-purchase the assets from the bankrupt Wonder and form a new corporation. While the North American market itself will be able to sustain the (at best) stall in Wonder's operations and would survive (at worst) its failure to return, it has been a blow to customers who relied on their service, as well as retailers who not only relied on their business, but have considerable accounts and merchandise behind Wonder's locked doors.

In the face of AmiTCP's recent move to commercialism and the release of Net 225 (and its subsequent bundling with Amiga Technologies' Surferpack), Oregon Research is moving ahead with its plans to release a competing networking system. Dubbed Termite TCP after their popular terminal program, Termite's release date and price are as of yet unknown. At the same time, US-headquartered developers, Omnipresence, seem to be close to sealing a publishing deal for their IBrowse Web browsing software. While a firm statement was not available at the time of press, latest reports from Omnipresence management indicate that HiSoft of the UK will get the nod.

## 25p A Megabyte

As well as announcing that they too will be selling the SX32, Eyeteck of North Yorkshire are currently promoting a hard drive and multimedia authoring kit based around Optonica's MME Experience kit. The Hard Drive is a slimline 3.5 inch unit that Eyeteck claim will need no modifications to the standard A1200 to install. It's a 1.083 Gigabytes (over 1000Mb!) model and should be enough for most multimedia applications. The drive, an

installed registered copy of MME and other shareware and PD utilities comes at £229.95. For more information contact Eyeteck on 01642 713185.





Matt Broughton's



# Games in view

**H**ello and welcome. Now you may remember me threatening to gloat at you following a recent trip to New York but considering the fact that it rained and snowed for the entire time, it hardly seems worth it. You'll no doubt also be glad to hear that on returning from my trip, I contracted pneumonia and spent the following weeks locked in a small room with only a large duvet for company. Still, at least I'm alive.

Let's start with some positive stuff. Time, I feel, to catch up with the game that I've been looking forward to since before we sold *The One* ( grrr, grrr!) Yep, **Blitz Bombers** is still on its way, and baring a bit of legal 'calm down, calm down!' between the **Leading Edge** boys and 'another company' - who are a bit worried about the similarity between *Blitz Bombers* and one of their major titles - it should be with us within the next two months.

The company in question aren't actually being very difficult at all, and with any luck, the most it'll mean to the final game will be a possible change to the look of the main 'bomber' character.

Another interesting twist to the tale (according to 'Mr PhD' himself, 'Dr Nigel' Hughes) is that one of the gang recently found a load of music on an Amint CD that they'd previously been presented by THEIR musical man under the pretence of it being his original work! I know - some people will try anything! Still, a couple of the actual composers have already been contacted and it looks as though the end result of this particular problem will just involve writing a couple of new level tunes.

Other than that, everything has come along wonderfully since we last looked, with a one-player game element having been implemented, where each level has a 'goal' as well as bad-dies to kill. It's all pretty simple

**Same old picture I'm afraid, but that's what happens when you go off on holiday and it snows continually. Still, at least I had the Amiga games scene to look forward to on my return.**

stuff like collecting keys and finding the exit, but should add to the longevity as a single-player game.

Future projects from the boys also look pretty interesting, with a decent 3D *Blitz Bomber* engine already doing the rounds - giving the game we know and love a more **Gloom**-like perspective.

One problem with this has come from not being able to see bombs around corners, but the team are hoping to compensate for this with clever use of lighting effects to 'give the bombs away' as well as the possibility of being able to see the tops of bombs from a distance. Interesting stuff, non?

The only other major foreseeable problem is that, while a split-screen is possible, there's no way we can expect a four-way cut. This will probably lead to further developments in the one-player game design.

And finally from the boys, having written so many *Blitz* applications for themselves during the writing of *Blitz Bombers*, there's now a good chance that they'll be making some of their programmes available to the public. Look out for *Blitz* support software in the near future.

Even more good news. Do you remember **Legends**? If you don't let me recap. **Krisalis** planned to release this promising RPG but shelved. Well, it looks like **Guildhall Leisure** will be releasing it soon. So we've got that to look forward to.

Another snippet of good news is that despite the recent disappearance of softco **Rasputin**, top-fun platformer **Ruffian** will still be getting a release - albeit one through mail order - complete with a couple of tweaks such as new and improved

music, improved level designs, and the facility to customise the main controls. Hurrah.

There is a demo of the updated version of **Ruffian** on the CD-ROM covermounted on the CD edition of this magazine. So if you have the CD-ROM edition cheers, if not you'll have to wait a bit.

Some sad news though. This week, however, sad news concerning **21st Century**. Yes, though we've been seeing each other for quite some while now, the spark has gone from our relationship, and they've just rung to say that they need a bit of time and space to think things over.

My gut feeling, however, is that they're about to chuck us. So it's back down the games disco to try and pick up a new chick, but at least there's still **Slam Tilt** to look forward to before the big heave-ho.

It would appear that the only games we're likely to see from the 21st-ers in the future would be budget releases of old games - and even that would

more likely than not be processed through an affiliated label such as **Hit Squad** or **KIXX**. Still we'll wait and see. How many times have we heard that from companies only for them to come back onto the games scene with an Amiga game just a few months later.

A particularly unfortunate bit of news this month, comes from long-time Amiga supporters, **Kompart**, where the loss of the **Blue Byte** label (early last year) appears to have done more damage in the longrun than they realised, with the company going into voluntary liquidation.

**Kompart** have proved extremely important to the Amiga's game scene over the past year, especially with its publishing arm, **Black Legend**, who managed a number of European developers and ultimately brought us such hits as **Tactical Manager** and **Football Glory**.

And there you have it - just time to glance at the HMV charts before turning into a pizza. Be seeing you... ■

**Matt Broughton**

## HMV GAMES Amiga Top 10

No	TITLE	PUBLISHER
1	<b>Sensi World of Soccer 95/96</b>	<b>Virgin</b>
2	<b>Worms</b>	<b>Ocean</b>
3	<b>Player Manager 2: Extra Time</b>	<b>Virgin</b>
4	<b>Alien Breed 2</b>	<b>Ocean</b>
5	<b>Super Stardust</b>	<b>Ocean</b>
6	<b>Project X</b>	<b>Ocean</b>
7	<b>Kid Chaos</b>	<b>Ocean</b>
8	<b>Fantasy Manager 95/96</b>	<b>Hit Squad</b>
9	<b>Ultimate Soccer Manager</b>	<b>Daze</b>
10	<b>PGA European Tour Golf</b>	<b>Electronic Arts</b>



# All The Latest Amiga Software

# EMERALD Creative Technology

Call Us Now On 0181-715 8866

## Hardware

### Disk Drives Etc.

Squirrel SCSI interface.....	£59.95
Omega Zip Drive inc. Squirrel etc.....	£call
A500 Internal Floppy Drive.....	£38.95
A600 & A1200 Internal Floppy Drive.....	£38.95
2.5" IDE Cable.....	£8.95

### Ram Cards

A500 with 0.5Mb.....	£15.95
A500+ with 1Mb.....	£19.95
A600 with 1Mb.....	£24.95
A1200 unpopulated.....	£59.95
A1200 with 2Mb.....	£129.95
A1200 with 4Mb.....	£179.95
A1200 with 8Mb.....	£299.95

### Video

Pro Grab 24RT+ SVHS.....	£125.95
PCMCIA Adaptor for Pro Grab.....	£34.95
Rendale 8802 Genlock.....	£164.95
Rendale 9402 SVHS.....	£279.95
Vidi 24 RT.....	£144.95
Vidi 24 Pro RT.....	£219.95

### Other

Tabby Graphics Tablet.....	£57.95
----------------------------	--------

## Utilities

### Software Development

Blitz Basic 2.1.....	£32.95
Dice C Compiler v3.01.....	£98.95
DevPac 3.....	£59.95
Gamesmith.....	£89.95
HiSoft BASIC 2.....	£59.95
HiSoft Pascal.....	£79.95
Intos.....	£28.95

### Disk Utilities

AmiBack.....	£29.95
AmiFileSafe User.....	£28.95
AmiFileSafe Pro.....	£68.95
CD Write.....	£42.95
Directory Opus 5.....	£49.95
Disk Expander.....	£29.95
Disk Magic.....	£34.95
Gigagem.....	£47.95
Infonex 2 (Infonex + Datanex).....	£28.95
Video Back-up System Phono.....	£54.95
Video Back-up System Scart.....	£57.95

### Communications

GP Fax.....	£44.95
Termite.....	£33.95

### Miscellaneous

Maxxon Magic.....	£23.95
Studio II Print Manager.....	£48.95

## Productivity

### WP & DTP

Final Writer 4 New Version.....	£79.95
Final Copy 2.....	£49.95
Mini Office.....	£37.95
Pagestream 2.2 SE.....	£49.95
Wordworth 3.1SE.....	£47.95
Wordworth 3.1.....	£74.95

### Databases

Digital Datastore 3.....	£45.95
Digital Organiser v2.....	£39.95
Final Data 3.....	£39.95
GB Route Plus.....	£31.95
Mailshot Plus.....	£35.95
Music Librarian.....	£22.95
Plants For All Seasons.....	£22.95
Twist 2.....	£89.95

### Finance

Cashbook Combo.....	£59.99
Counting House.....	£49.95
Day By Day.....	£24.95
System 3.....	£39.95
System 3E.....	£49.95
Digital Home Office.....	£39.95
Money Matters 4.....	£34.99

Personal Finance Manager +.....	£19.95
---------------------------------	--------

### Spreadsheets

Final Calc.....	£94.95
DG Calc.....	£26.95
Turbocalc 2.....	£49.95

## Music & Video

### Music

Aura 12 bit Sampler.....	£79.95
Megalosound Sampler.....	£29.95
Technosound Turbo 2 Pro Sampler.....	£26.95
Music X 2.....	£49.95
Pro Midi Interface.....	£19.95
Little Gem Micro Mixer.....	£66.95

### Video Titling

Big Alternative Scroller 2.....	£49.95
Rendale 8802 Genlock.....	£169.95
Rendale 9402 SVHS.....	£285.95

## Education

### Languages

Beginners to GCSE.....	
Micro French.....	£22.95
Micro French CD.....	£27.95
Micro English.....	£22.95
Beginner to GCSE & Business.....	
Micro Spanish.....	£22.95
Micro German.....	£22.95

### Integrated Science

Micro Science.....	£22.95
--------------------	--------

### Maths

Primary Maths Course 3-12.....	£22.95
11-Years to GCSE.....	
Micro Maths.....	£22.95
Micro Maths CD.....	£27.95
A Level.....	
Mega Maths.....	£22.95

## Books & Videos

### Books

A1200 Insider Guide.....	£12.95
A1200 Next Steps.....	£12.95
Amiga Basic - A Dabhand Guide.....	£17.95
Amiga Disks & Drives Insider Guide.....	£12.95
Assembler Insider Guide.....	£13.95
Amiga Total! Workbench <b>New</b> .....	£19.95
Amiga Total! Dos <b>New</b> .....	£21.95
Amiga Total! Assembler <b>New</b> .....	£21.95
Amiga Total! Beginners <b>New</b> .....	£19.95
Mastering Amiga Programming Secrets.....	£19.95
Mastering Amiga Arexx.....	£17.95
Mastering Amiga Printers.....	£17.95
Mastering Amiga Dos 3.0 Reference.....	£19.95
Mastering Amiga Dos 2 Vol2.....	£17.95
Mastering Amiga Dos Scripts.....	£19.95
Secrets of Frontier Elite.....	£8.95
Secrets of Sim City 2000.....	£9.95
UK Comms.....	£19.95
Workbench 3 A-Z Insider Guide.....	£13.95

### Book & Video Packs

A1200 Beginner's Pack.....	£36.95
Workbench 3 Booster Pack.....	£36.95

### Videos

Intro to the A1200 - Tutorial.....	£14.95
Intro to the A1200 - A Deeper Look.....	£14.95

## Graphics

### 3D & Rendering

Cinema 4D <b>New</b> .....	£179.95
Essence vol 1 + Forge.....	£79.95
Essence vol 2 + Forge.....	£79.95
Imagine 3.0.....	£99.95
Pixel 3D Pro II.....	£94.95
Real 3D v3.....	£319.95
Terraform for Vista.....	£9.95
Vista Pro 3.0.....	£27.95
Vista Lite.....	£24.95

### Painting

DPaint 5.....	£64.95
---------------	--------

Personal Paint 6.3.....	£39.95
-------------------------	--------

Photogenics.....	£47.95
Pro Vector 3 Stylus Pro Pak.....	£174.95
TV Paint 3.6.....	£329.95

### Image Processing

Art Department Professional v2.5.....	£139.00
Image FX 2.....	£189.95
Morph Plus.....	£89.95

### CAD

X-CAD 2000.....	£22.95
X-CAD 3000.....	£119.95

### Personal Suite

Includes:	•Personal Paint
	•SBase Personal
	•Personal Write
	•Personal Fonts Maker 2

PLUS DirDiff • 27 High Quality Kara Colour Fonts • Nearly all of Eric Schwartz's outstanding animations • Amiga Dos Manual • Arexx Manual • "How To" Amiga Guide • PNG Toolkit • Masses of pictures and anims • 20 classic books (Dickens etc.) • And still loads more!

All on one CD for just £49.95 !!!

## Beef Up Your Sound!



The Little Gem Micro Mixer! This 2 channel, stereo mixer features independent Hi and Lo EQ, panning, and volume for each channel. Little Gem greatly enhances all your sound input and output - samples, Mod files, even games - it's ideal for desktop video and music, and it's a great price too!

Little Gem £66.95

## Run PC Software on your Amiga!



PC Task 3.1 allows you to run software designed for IBM PCs and compatibles on your Amiga! PC Task 3.1 emulates a 80286 based PC (including the FPU), so you can run Windows 3.1 and applications like Microsoft Word and Excel. It'll even run Wolfenstein 3D. On an AGA Amiga you can run SVGA screen modes, and for basic tasks it doesn't need stacks of Ram. If you just want to run Dos, PC Task will run quite happily in just 1Mb of Ram. If you want to run Windows, you still only need 6Mb! PC Task gives you two computers for little more than the price of one!

PC Task 3.1 £59.95

## Do you want an Amiga DTP package that doesn't need loads of memory, an accelerator and a hard drive? How about Pagestream 2.2 SE!

All of that famous Pagestream ease-of-use, and functionality all in one box for under fifty pounds! Pagestream 2.2 SE takes DTP into a new dimension - one where you only need Workbench 1.3, 1.5Mb of Ram, and only one floppy drive. Just take a look at these features:

- Typography**  
Pagestream 2.2 SE allows you to use Comugraphic, Intellifont, PostScript and DMF fonts, with all the standard DTP features including tracking, leading, paragraph indents, hyphenation and more!
- Graphics**  
Pagestream 2.2 SE has a powerful toolbox with a good assortment of drawing and editing tools. You can import pictures and drawings from many other programmes and print them in full colour.
- Fast Printing**  
Pagestream 2.2 SE comes with an assortment of printer drivers. Print at lightning speeds to PostScript and non PostScript printers including dot-matrix, inkjet and laser printers. You can even create colour separations!

Pagestream 2.2 SE £49.95

## Disk problems? Hard drive looking doubtful? You need Ami-Back!



The Ultimate In Disk Backup For Only £29.95!

Ami-Back is the solution of choice for all your data backup needs. Designed to be both powerful and flexible, Ami-Back gives you complete control over the backup process. There is no other Amiga backup program that can come even close to offering the features, ease of use, and reliability of Ami-Back. And yes, Ami-Back even supports Amax, Unix and MSDOS partitions, and DAT and tape drives!

When ordering don't forget to include the carriage charge! Charges within the UK are £3.50 for first class post, which usually arrives the next day. Orders over £100 are sent registered post at £4.50. Next day courier service within the UK mainland & subject to availability is £6.00. Hardware is sent by Next Day Courier. Call for prices overseas, islands & Scottish Highlands.

You can pay by Credit Card (Visa, Mastercard, Access, Delta, Switch and American Express) - we only bill your card when we despatch the order, not before - or by Cheque: Please make cheques payable to Emerald Creative Technology Ltd.

All pricing includes VAT. We reserve the right to change prices - you will be informed of any change when ordering. Faulty goods will be replaced or repaired if returned within 30 days of purchase. Postage won't be refunded on returned goods. We will refund if we can't repair goods. It is the responsibility of the customer to check product compatibility with existing equipment before buying. E&OE



Rapid House, 54 Wandle Bank, London SW19 1DW Fax: 0181-715 8877, eMail: EmeraldCT@eWorld.com





# OUTBRE

## PROTECT YOUR AMIGA FROM THE NEW THREAT OF VIRUS ATTACK ...

**With new technology comes a new threat from viruses. We explore just how big is the problem, how has new technology affected its penetration of the Amiga market and how to protect against it ...**

### What is a virus?

For those new to, or unfamiliar with the term, don't panic. A virus is not alive, it's only a computer program. However, that's not to say it's not dangerous – or even that it doesn't exhibit life-like symptoms. For example, like a real life virus, a virus computer program replicates itself at every opportunity, writing copies of itself to every disk it comes into contact with. Each of these copies is the same as the original, and will continue to try spreading like wildfire.

Some viruses hide in the boot sectors of floppy disks. The boot sectors are special because when the Amiga is reset and a floppy disk present, it automatically loads in these boot sectors and runs the data they contain as a program. Normally this program triggers the loading of the Workbench or loads a game, but if a virus is stored there, it will be loaded into memory and executed. As the Amiga is an excellent multitasking system it can lurk for ages, waiting for a new disk to be inserted so it can copy itself to its bootsector. This is how they spread.

If the newly inserted disk is a game with a custom bootblock, the virus can overwrite it and therefore make the

**Y**ears ago viruses were rife on floppy disks but the amount of damage they caused was largely limited. A hard reset would solve most problems on a floppy disk based system as the viruses could only thrive on disk or in RAM. Now though, hard drives are increasingly commonplace, CD-ROMs come with 650Mb of files and the 'net is a gigantic breeding ground. The amount of damage to be caused has multiplied.

A virus can be a big problem, or it can be an insignificant one. In a worst case scenario, it can destroy your software collection, re-format your hard drive and even potentially damage a video monitor. Plenty of scare stories abound and newspapers love to run half-fact half-myth stories and this high tech scourge is ideal press fodder.

Although viruses were big news on Amiga some years ago it's now other systems that are being targeted. Even Bill Gates' new 'safe' operating system Windows '95 was soon at risk; suddenly word processing documents began to act independently and databases lost their data.



# AK!

game useless.

Unfortunately a virus can do even more damage: some are programmed to perform various nasty acts after a certain amount of time. Some viruses will corrupt or format a hard disk for example, some will put up irritating messages on the screen or make the mouse pointer vanish.

## A bit sneaky

Some strains of virus don't require booting though and can sneak into your system in various other ways. Some disguise themselves as normal programs in your c: directory, some misuse the operating system's disk validation system.

The most common way in which viruses used to be spread was through pirated games and demo disks - disks which needed to be booted. Often, users would perform a warm reset (Control-Amiga-Amiga) after loading a demo or game and

then pop in a disk to do something else: instant infection. It has also been known for a virus to pop up on magazine cover disks: I was caught out once with the Saddam virus when compiling a disk for an Amiga magazine (not this title, of course) about four years ago. It was an unpleasant experience, I can promise you.

## On the 'net

With the rise and rise of comms in general and the Internet in particular, the opportunities for viruses to spread is ever greater. The Aminet is the definitive Amiga software site on the Internet - if you upload a program there, it can be used by thousands of users all over the world in hours. Needless to say that the keepers of Aminet make stringent anti-virus tests. Bulletin Boards are an

excellent source of software, but can also be potential risks. Many boards cater for a variety of machines, and many are run on a PC. The PC sysops may not have the tools at his disposal to check Amiga format uploads for nasty extras, so be extra careful when using download programs. DMS files are risky, as they contain a snapshot of an entire disk, including the bootblock data.

## On disks

CU Amiga Magazine tests its disks thoroughly with Anti Virus software every month and it's just as well. Although people who supply us with software for disks have no idea whatsoever that they are carrying a virus, some of them do. This is easily controlled with standard disks, though you do have to make sure that you have proper up to date software to check for brand new viruses. But with CD-ROMs it can turn into a nightmare. Although Mat checked the contents of this month's CD-ROM (see special edition magazines) as each component was put on the disc, when it was fully compiled another check revealed two viruses: 'Ebola' and 'Happy New Year 1996'.

VirusChecker, the program. Mat normally uses to check for them did not discover these, but after having some minor problems with various files he checked the disc with Virus Z, (on this month's disk) and there they were. At this stage they had infected several hundred files, multiplying like wildfire. Virus Z located and recovered most of the files, clearing up the infection.

Luckily Ebola and Happy New Year 1996 are not dangerous, they are not intended to do any harm, only to inflate the egos of their creators. But because of the way they were programmed they caused hang ups or gurus in some of the items on the disk. However they could have been worse. The trick is to use the most up-to-date software and even try running your disks through more than one virus checker, just to make sure. It's a timely coincidence that we were running this feature at exactly the same time as we discovered these viruses: we're always vigilant with our disks and haven't had any problems for nearly a year before this.

## Good news

The good news is that clearly, the virus threat has diminished from a few years ago, when every magazine Q&A post-bag was full of distraught users asking why their disks had been re-named 'Lazarus' (a perfect example of how a non-existent virus got the blame). Raising the awareness of users and good anti-virus tools have made a difference and virus related disasters are

## What they say:

Personally I have only ever caught two viruses and these were both before I was on the net. However, having said that, I normally always have the latest version of VirusChecker running in the background, unless I do a minimum boot, which is usually only to run LightWave, and definitely no Net access, as Rexx and Amitcp are not started either. I think most legitimate ftp sites run careful checks on all uploaded software, aminet certainly does ...  
Laurie  
(A Usenet user)

The only problem I have had with a virus was when my parents brought back some pirated software from Singapore. It was a Saddam virus which was fairly easy to get rid of with VirusChecker. I tend not to rush off and get the latest version of a software release as soon as it appears and I also limit myself to Aminet. I know that corrupted software has appeared on Aminet but they seem to be pretty good at removing it when it's pointed out to them.  
Ian  
(A Usenet user)

## Free love, Safe Hex

Safe Hex International (SHI) are an international group, dedicated to trying to stop the spread of computer viruses. In their own words, SHI is a grass roots movement, started in 1987 with Amiga computers. Today they are an organisation with around 600 members, who are all more or less involved with the project. It's a non-profit making organisation and their motto is 'Safe Hex'. The facilities they provide include a virus bank containing more than 1800 Amiga and PC viruses for supporting good shareware

antivirus programs (helping people get money lost by virus infection back by programming anti virus products) and releasing the newest and the best virus killers around from well known programmers worldwide. There are more than 35 PC and Amiga 'Virus Centers' worldwide where you can get virus help by phoning their Hotline, or by contacting them on the SHI World Wide Web site at <http://www.aal-borges.dk/~i1g/SHI.HTM>

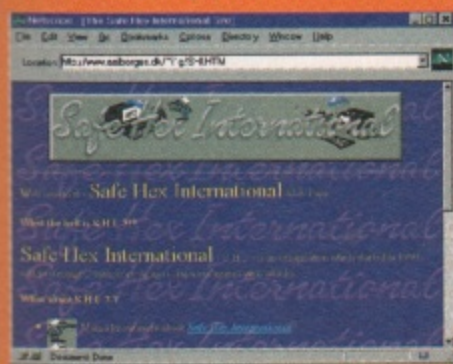



relatively uncommon today.

In a perverse way the lack of new Amiga viruses can actually be seen to be a bad sign about the state of the Amiga. No-one is praising virus programmers, but the fact that most have turned their attentions to the PC is indicative that the Amiga is not as 'hip' as it once was. Let's just hope that when things start rolling again we will leave virus writers behind.

Don't get complacent though. As mass storage media and the 'net take off on the Amiga the threat is still ever present. As 'Happy New Year 96' proves there are still people out there programming them. An even bigger threat lurks on old disks and untested programs from BBS systems. It can only take one virus on a disk you forgot to test to infect your entire collection, and potentially wipe out years of work. Be vigilant!

## How to prevent an attack

The best cure is not to catch a virus in the first place and the only way to be safe is to leave your Amiga switched off and never insert a new floppy disk in the drive or use a modem. But hey, it's not an ornament! Everybody uses disks and a lot use modems, so here are some handy hits for safer hex.

- Don't touch pirated software. Not only is pirating software illegal and damaging to the Amiga market as a

## Recommended anti-virus programs

These programs make use of the special SHI anti-virus libraries, and are therefore recommended. You can obtain them from the Aminet (either the Internet version, the CD-ROMs or any BBS which keeps the CD-ROMs on-line) or from public domain libraries.

- **Virus Checker** by Johan Veldthuis
- **Virus Scanner** by Gabriele Greco
- **Fides Professional** by John Lohmeyer
- **Fides Checker** by John Lohmeyer
- **DMS** by Michael Pendec, ParCon Software
- **D-Copy** by Stefan Bernbo
- **X-Xopy** by Cachet Software (commercial)
- **Disk Ute Copy** by Alchemy Software.
- **Xtruder (a BBS!) virus killer** by Martin Wulffeld
- **Harboot virus analyser** by Martin Harbo
- **Bootwriter** by Ralf Thanner
- **MT-Copy** by Gert-Jan Strik

whole, but it is the prime way in which viruses are spread.

- Use the most up-to-date Virus software you can find. Use it frequently. If you have a hard drive, keep it running all the time.
- Be especially careful about using public domain or shareware software you have downloaded yourself. Test the files with a virus checker
- When using a hard drive you may want to deactivate it when using software you are wary of. You can do this from the boot-up menu (hold down the two mouse buttons).
- Make regular back-ups. Be careful to make several generations of back-ups in case you unwittingly back up

infected files and overwrite your older (but un-infected) back-up.

- Keep the write protect tabs on your floppies open to stop anything writing to your disks without your knowledge.
- Switch your Amiga off between games, and keep the power off for at least 30 seconds to make sure nothing is left lurking in memory.
- If you use electronic mail, beware of warning messages about certain viruses (for example, Good Times) asking you to spread the word. In this case, it's the idea of the warning message itself which is the virus as it is spread around the world by worried users keen to warn their friends. ■

**John Kennedy**

## What they say:

**Chris Wiles of Active Software (CD retailer and 'net enthusiast)**

**Q** Are Amiga viruses as big a worry as they were?

**A** Not really – the 'hype' or worry that surfaced with virus problems has died in the last two years. Beginners and new users always worry, however. They imagine that a virus has entered a disk when they encounter a problem – be it a read/write error, non-dos disk or simply the fact that a program is not installed correctly.

There is very little chance of finding a virus. Probably about one in every 1000 disks you bought may have a virus, maybe less.

Despite general opinions, major Public Domain libraries are usually very virus-free. Simply because programs are checked by BBSes, the Internet, submitters and then the library that receives them.

There are two ways of preventing virus attack: 1. Always keep your write-protect tab UP on a floppy disk 2. Keep a virus checker in your WBStartup drawer on bootup

**Q** Has the Internet made any difference?

**A** There are very few virus problems on the Aminet – not sure about the Internet in general. The guys behind the Aminet and the Aminet CD's (and, indeed most CD's!!) check and double-check every file for every kind of virus. There will be problems on the Internet - but if you take the recommended precautions – you will be safe.

**Q** Does fewer new viruses mean that the Amiga is doing badly as a computer?

**A** I think that the Amiga has 'had it's day' from virus makers. Most are corrupt individuals who like to attack the masses. They target business users, console makers etc. I believe 'they' would love to get a uncontrollable virus into a console game, mass market PC game etc ... once it has installed to your hard drive then the destruction starts.

The Amiga is much more an enthusiasts model at the moment. In

the future this may change with the 're-invention' of the OS and main CPU (RISC), but for now PC is the target.

**Q** Have CD-ROM compilations made the threat of viruses better or worse?

**A** Bizarrely a mixture of both. Better as there is generally much more control. As stated before, the Aminet CD's (as an example) are tested and re-tested for viruses, so the chance of finding a virus on one of those CD's will be minimal. It has made it worse due to the fact there are SO many files present on the CD and therefore increases the chance of finding a virus.

For instance, if a company decided to throw together a games CD in record time (i.e. started in August for October release) they will not have time to test the CD properly, never mind test and re-test for viruses. That could be a worry.

There are many smaller companies trying to jump on the CD bandwagon as quickly as possible – my message is just make sure your CD's are as free from viruses as possible.

Here are some examples of viruses on Amiga

ABCAEK/Odie-CC  
W/MicroMaster  
AIDS  
HIVAlien  
New Beat  
ASS Virus Protector  
Bamiga  
Sector  
Belgium  
BGS9  
BGS9-Mutant  
Big BossBlackflash  
Blade Runners  
BLFBlizzard  
Butonic  
Byte Bandit  
ErrorByte  
Parasite  
Byte Parasite  
Byte Voyager  
Byte Warrior  
CCCP  
Centurion  
Centurion  
DenizDestructor  
Dirty Tricks  
Disaster Master  
Disaster  
Gadaffi  
Glasnost  
Sachsen  
Saddam Hussein  
Scarface  
Sinister Syndicate  
Logo  
StarFire/NorthStar  
Australian Parasite  
The Incognito  
Warsaw X-Copy



No 57 & 58, Top Floor  
Glasshouses Mill  
Nr Pateley Bridge  
Harrogate  
North Yorkshire  
HG3 5QH

# Marpet

Tel: +44 (0) 1423 712600 Fax: +44 (0) 1423 712601

Leading manufacturers of RAM expansions to all major distributors and dealers, are offering a WINTER SALE!! of all their products, SLASHING up to 20% off recommended retail prices.

Why not purchase your requirements direct from the manufacturer?

We guarantee despatch within three days

Don't hang around. ORDER NOW!!

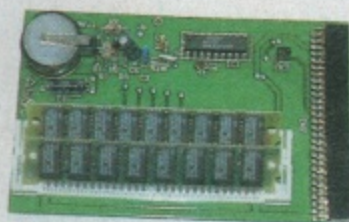

RRP Our price

A500 Expansion to 1Mb.....£19.99 ...£16.99  
Also available with clock .....£24.99 ...£20.99

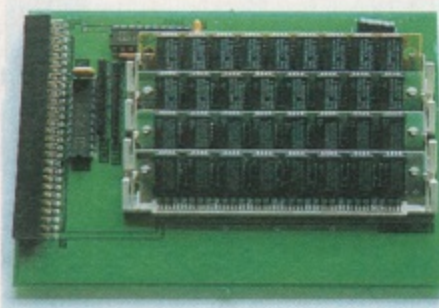

A500 Plus  
Expansion  
to 2Mb

RRP £29.99  
Our price £21.99

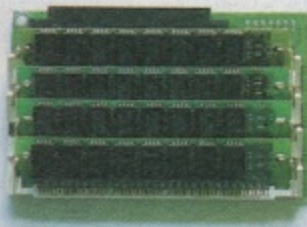

RRP Our price

A600 Expansion to 2Mb ...£29.99 ...£24.99  
Also available with clock £39.99 ...£32.99



RRP Our price

External Drive .....£59.99 ...£43.99  
(All Amigas)

All prices include VAT and P&P

## A1200 Ram Accelerator

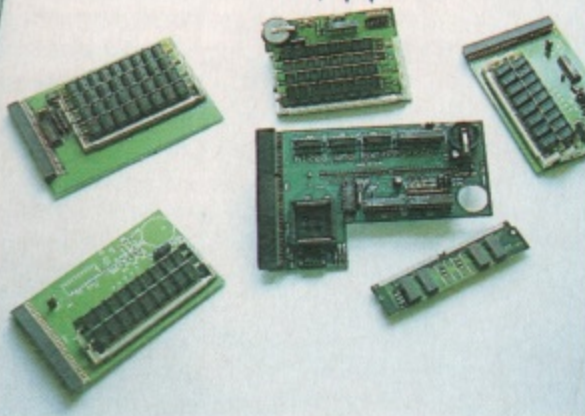
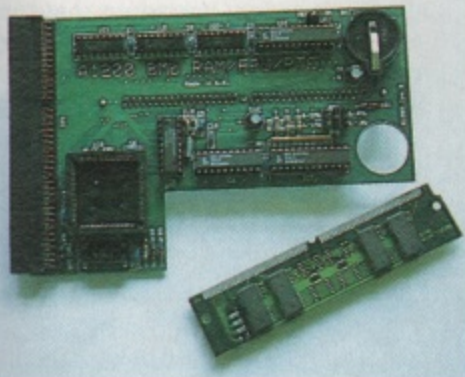

Uses 32bit, 72 way Simms  
Built in real-time clock  
Optional maths co-processor  
Various configurations

	RRP	Our Price
0Mb .....	£59.99	£49.99
1Mb .....	£99.99	£85.99
2Mb .....	£129.99	£110.99
4Mb .....	£189.99	£147.99
8Mb .....	£309.99	£267.99
33MHz F.P.U. ....	£49.99	£38.99
(and crystal)		

Also S-port (connect CD32 to Amiga). With CD and networking software £21.99

A1200 internal real-time clock £10.99

Ring for best prices on 30 and 72 way SIMMS, hard drives, modems, mice etc and we will try to beat any genuine deal.

ACCESS/VISA welcome. 3 YEAR WARRANTY ON ALL OUR PRODUCTS!!!

01423 712600/fax 712601



# Wallace &

## in The right computer

**W**hat do the Crunchie Ad, Frank the Tortoise and the superb Wallace and Gromit animations all have in common? Apart from the fact that they all came from the Aardman Animations stable, they were all done on the Amiga. Not a lot of people know that. We spoke to Glenn Hall, Aardman Animations' Technical Director to find out more.

**Nick Park's latest Wallace and Gromit animation has won yet another host of awards. The Amiga helped make it possible. (We're so proud.)**

**It is the Animator's first choice. We will stay with the Amiga just as long as we can keep them going.**

**Q. When did you get involved in work on the Wallace and Gromit series?**

**A** In 1986. Nick Park, had joined Aardman from the National Film School, and was trying to get his film finished. Peter Lord and David Sproxton, far sighted folk that they are, let Nick finish his film in the studios. It took another three years, and in the end A Grand Day Out was finished, and subsequently got an Oscar nomination. That year, also brought the studio its first Oscar for Creature Comforts.

**Q. What role does Nick Park have in putting his work together and does he have much**

**influence over your work in the making of the Wallace and Gromit films?**

**A** In the production of the recent film A Close Shave, Nick led a whole team of animators. He wrote the script with Bob Baker, the Bristol based writer who famously invented K9 in Dr Who, and drew the storyboard. He oversaw every single model, animated a huge amount of it all himself, and spent loads of precious time helping the other animators to get the look of the film the same all the way through. For Nick it is total involvement, and I as long as I have known and worked with him, I have never known him loose his cool. He is a great guy to work for, and when he and Peter Lord work together, really exciting things happen.

Yes he has influence, in the same way that all the animators in the studio do. It is very important that the equipment and ways of working are driven by the animators themselves, so I spend a lot of time finding out what they want, and how they want it to work, then we try to make it happen.





# ... Grommit



also fit an ISA BUS PC, this connects via its own CVE cable (component video exchange) to the PAR card itself. The capture card has excellent quality video, can handle composite, S video and beta video. A full set of processor amps gives total control over the signal and the PAR is connected directly to an associated hard disc which can support two IDE drives. This system can thus grab video in real time, store it in full colour and give immediate replay. Handily, the software control can support single frame grabbing, and this is the mode we use.

The hard bit for us came when Commodore hit problems. We have bought every new system we could get our hands on, and a fair few secondhand, including an old A3000 that

**■ Q So what equipment do you use then?**

**■ A** We use Amiga 4000s with 230Mb HDD and 6Mb RAM. We also use Microvitec 1438 monitors and have standardised them for all our computers including PCs and some Apple Macintoshes. The crucial piece of equipment is the Personal Animation Recorder from Digital Processing Systems. We also use Directory Opus and Sunrise 19.

Also, we've modified the Panasonic AVE series frame by fitting our own set of remote controls, the Digipod. These allow the controls to be very robust so they can be actually placed on the set.

**■ Q Why did you decide to use Amigas?**

**■ A** After testing various systems, we found that the DPS Personal Animation Recorder on the Amiga worked best for us. It has its origins as a render store for LightWave and the newTek toaster, and as such was a unique combination. It was very cost effective and available. Before we chose the PAR we also tried out similar products on the Mac. We had the very first Digital Film from SuperMac Technologies and we also bought a Radius Video Vision studio, which we still use and have just updated. The PAR is different as it is essentially a hardware product, and

the video system sits entirely above the computer bus. This means that the attached PAL video monitor gives a full screen picture. We use two cards, both from DPS. The first is a capture card AD 350, which usefully will

**Who the hell does Glenn Hall think he is? A right Aardman**

Many thanks to Glenn Hall who after several attempts to avoid being blown up whilst attending recent Government programme in London took time out to answer these questions.

**So How did he get involved in all of this?**  
 "I started in electronic engineering, working mainly in theatre and television lighting and control systems, including the first computer controlled lighting systems. This took me into the area of working in manufacturing and designing lighting equipment, and thus into process control for theatre and manufacturing. Around this time I was lucky enough to work on feature film special effects, including some Pink Panther films. 1980 brought me to Bristol, where I joined the Drama Department at University of Bristol, where I taught stage lighting and theatre crafts, and then one day I met David Sproston from Aardman Animations. I was doing a fair amount of freelance work then, including film work and Aardman made a commercial, their first, featuring dancing bones to make a computer keyboard. They rented the University theatre in the long summer

break to shoot the commercial. I got involved and this led to my working on the seminal pop video for Peter Gabriel, Sledgehammer. Believe it or not that was shot in six days, with the wide angle scenes shot at the university theatre. After that I joined Aardman full time in 1986, with a brief to extend the use of motion control and computers in the film making process. Next up was the creation of the famous skeleton for the Scotch Video Tape, which saw Aardman working with Bill Mather, who went on amongst other wondrous spots, to create those dancing milk bottles."

The programme Glenn was attending, Information Society Initiative, is being set up by the government to help small and medium sized companies get the best benefits from the new IT and trading on e World Wide Web. The government have put £35 million behind this and Aardman Animations is featured as one of the five case studies to show how IT has worked for them. We will be doing a feature on this soon, meanwhile you can find out more on <http://www.isi.dti.gov.uk>





still does good duty. We also have a few that are PC based – we had to do this when we just couldn't get any Amigas.

**■ Q. How does an animation get from being just an idea to animated picture?**

**■ A** Well it starts off with a script and then taking that script through to a storyboard. We look at the ideas to see how it can be done. When the storyboard is done, and has been agreed upon with the advertising agency (if it is a commercial), then the modelmakers and set builders start work. The technical team begin work on special rigs to hold the models, or to move pieces. Sometimes I make computer controlled systems to link the whole thing together. Most of our work involves motion control, using computer based systems to move the camera, and this has to be done in small sections. Extra systems, often based around Toshiba PLCs (Programmable Limit Controllers) are used to keep everything in synch.

A voice track is recorded and this is broken down into phonetics by a film editor. The animators use this as a guide to get the lip synch right. The camera department assembles all the equipment and tests it, then the camera assistant on the job will do a final film test on the set before the shoot starts properly.

**■ Q. Where does the Amiga come in?**

**■ A** We set up a model and view it with a Mitchell 35mm camera which is fitted with CCD video assist. We grab a single frame into a Panasonic frame store then grab a frame into the PAR. Then we move the model and compare the frame using the digital frame store, so you can mix between the current frame being worked on and the last frame shot. If it is OK on the video screen, we take a PAR frame and then play the sequence on the PAR in real time. If all that is OK, then we take the frame on film and do it all again and again and again 25 times per second of finished film. This mostly takes around 10 to 12 minutes per frame.

**■ Q. Will you stick with the Amiga in future?**

**■ A** It is the animators first choice. Until very recently, when DPS brought out a new version the Perception Video Recorder that runs with Windows NT, it remains the essential tool for us. We will stay with the Amiga just as long as we can keep them going.

**■ Q. What future projects do you have lined up**

## Oscar, oscar

Aardman Animations was formed in 1972, by two schoolkids David Sproxtton and Peter Lord. Their home made animations were spotted by a BBC TV producer who promptly gave them a spot on Vision On. From here they developed the unforgettable Morph series. The company grew and grew and, now based in Bristol, has won numerous awards. There are too many to mention here but some of its most noted successes include the Creature Comforts, Crunchie ad, Sledgehammer video, Lurpak ads (little man with trombone) and the infamous Wallace and Gromit series: A Grand Day Out, The Wrong Trousers and A Close Shave.

At the recent BAFTA awards, held in London in February of this year, A Close Shave won a host of awards including: best film over fifteen minutes, best scenario, public choice award for favourite film and public choice award for funniest film.

**■ A** All sorts really. Nowadays there is too much work for one person, so the whole team work together. With many projects either shooting or in development at the same time, it is

**‘After testing various systems, we found that the DPS Personal Animation Recorder on Amiga worked best for us.’**

all a lot of work, and we have a great deal of fun putting it all together. We also get a lot of visitors, and we try to spend time with college students, and even on the phone to help budding animators where we can.

**■ Lisa Collins**









# Pinball Prelude

Fast  
Fun

and

AMIGAS

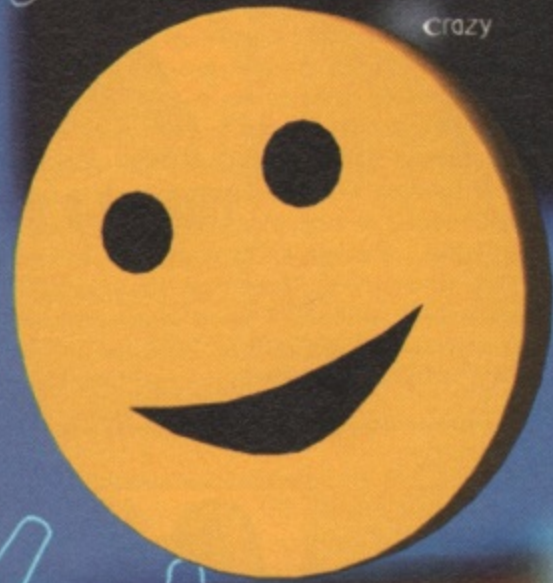

**Centurion PD**  
01526 834020

Now Hard Disk  
Installable For All Amigas

**effigy**  
SOFTWARE

**CENTURION PD**  
QUALITY PD/CD & SHAREWARE

ONLY  
40P EACH  
IF YOU SUPPLY THE DISKS

OR 75p PER DISK IF WE SUPPLY  
THE DISKS

WE HAVE 1000'S OF AMIGA  
TITLES TO CHOOSE FROM

POSTAGE RATES  
UK=75p OTHERS=1.00 UK  
OUTSIDE OF THE UK=2.50

WE OBTAIN ALL THE LATEST  
PD TITLES SO IF YOU CAN'T  
SEE WHAT YOU WANT THEN PLEASE  
GIVE US A CALL WE MAY HAVE IT

WE SUPPORT THE MIDNIGHT EXPRESS BBS +44 (01384) 865626

& THE AURORA BBS +44 (01942) 511252 - ORDER HOTLINE TEL:

+44 (01274) 677673 9am - 6pm (Answer Machine After This)

## LATEST GAMES

( ) DENOTES NUMBER OF DISKS (AGA) = A1200 ONLY (2,4) = W/B2+

G015 SHEPHERD	G175 ROCKETZ II (AGA)
G070 STAR TREK (3)	G176 CYBERGAMES (2)
G072 STRIKE BALL	G177 EGG SCRAMBLE
G076 USA 94 (N1.3)	G178 COARSE ANGLER (2)
G075 SCOTT'S F/BALL MNGR	G179 ALIEN BASH II
G085 100 PD GAMES (7)	G180 THE LAST SOLDIER (2)
G090 SOCCER CARDS	G181 LEGIONS OF DAWN
G096 HUGO (3)	G182 BLACK DAWN 5
G097 STARBASE 13	G183 MORTAL KUMQUAT III
G102 DONKEY KONG	G184 DARK ANGEL
G105 KARATE CHAMP	G185 SUPER SKIDDY TNGS 3
G107 MARIO IN WILAND	G186 SUPER ELF SQUAD
G110 ALL ROUNDER CKT	G187 FEARS DEMO (AGA)
G114 TOP OF THE LEAGUE	G188 CITADEL DEMO
G115 HIGH OCTANE	G203 TRAP EM
G123 GREEN 5	G204 GALLEONS
G124 DELUXE GALAGA	G205 EMOTIONAL CONFLICT
G128 POKER MANIA	G206 LEDGEND/POUND ISLE
G129 MANGLED FENDERS	G207 PUSH AND SHOVE
G135 CHANEQUES (2)	G208 LGE CHAMP SPEEDWAY
G136 TEAM TETRIS 1.36	G210 PREM LEAGUE MANAGER
G137 SUPER OBLITERATION (W/2+)	G211 CHMP MGR EDITOR 2.4
G141 DR STRANGE 2	G213 DOGENSTEIN (AGA)
G142 MASH	G214 CARDZII
G143 JUMP EM	G215 CENTREFOLD SQRS (18)
G144 SUPER COMBAT 3 (2)	G217 VISAGE (AGA)
G145 SKID RACER	G218 POWEROIDS (020)
G150 R3	G219 FUNHOUSE III
G151 DUCK DODGERS	G220 NESQUICK
G152 DELUXE PACMAN (ECS)	G221 FUNHOUSE II
G153 BRATWURST (AGA)	G222 ASI W/BENCH GAMES 9
G154 TRONICS	G223 ASI W/BENCH GAMES 8
G155 DELUXE PACMAN (AGA)	G224 BURGER BAR
G156 CODENAME NANO	G225 DAMAGE WOLF
G158 KLONDYKE (AGA) (3)	G226 DENTAKU (AGA)
G159 PUCMAN	G227 TAG
G161 BOOMIN ECK	G228 WHEELBARROW
G162 APPLEJACK (AGA)	G229 MOVIE MAKER II (2)
G163 GLADIATORS OF DAGANON	G230 STRIKE COMMANDER
G164 DIGITAL NINJA	G231 CHARLIE CHIMP
G165 TOP SECRET	G232 ATOMS
G166 IN DEAD OF THE NIGHT (3)	G233 DRAGON TILES (AGA)
G170 MARATHON MAN (AGA)	G234 WOOGLIES
G171 KILL THE LITTLE DUDES	G235 BIKER BABES
G172 ALIEN SPACE	G236 KNOCK OUT (1200)
G173 MADONNA	G237 HELSINKI FORCE (3)
G174 COSMIC RACER	G238 PENGUINS

## GAMES CONT.

G239 MACHO KILL
G241 ELDRITCH (1200)
G242 SPATIAL HYPERDRIVE
G244 BLOODBALL
G245 MASTERBLAST 2.2
G247 MARTIAL SPIRIT
G248 BEETLE (NOT 600)
G249 GLOOM DELUXE DEMO (AGA)
G251 SILLY SOCCER
G252 COIN MANIA
G253 NICKY II
G254 ULTIMATE MANAGER 1.1
G290 TOOBIS
G291 HILT II
G292 MORTON STRIKES BACK
G294 RACING MANIACS
G295 KNIGHTS (A1200)
G296 PENGU
G297 FRIDAY NIGHT POOL
G246 C64 & 100 GAMES (6)
G116 WIPEOUT
G134 MR MEN OLYMPICS (2)
G157 SUPERMEGA FRUITS
G168 SENSIBLE MASSACRE II
G198 SUPER SKODA CHALLENGE
G194 GNU C CHESS
G199 TETRIS PRO

## EDUCATION

E001 AMIGA TUTORIAL
E002 ARTISTIX
E003 AMIGA FRENCH VERB
E004 BASIC TUTOR
E005 COLOUR IT
E006 CHEMESTHETICS
E007 C-ENCYCLOPEDIA (12)
E008 COMMUNICATE
E009 DINOSAURS
E010 DINOWARP
E011 DIPAINIT III TUTOR
E012 DUNKS DTP
E013 DISCOVERY / ATOM (2)
E014 EASYSPELL II
E015 EUROMAPS
E016 FRACTIONS / SILLOUHETTES

## EDUCATION CONT

E017 GUIDE TO LWR / BACK PAIN
E018 GCSE MATHS MODULE 1
E019 HOW EARTH BEGAN (2.04+)
E020 HIGHWAY CODE TUTOR
E021 INSIDE / OUT GAS TURBINE
E022 INSIDE / OUT PETROL ENG
E023 INSIDE / OUT STEAM ENG
E024 IQ TEST
E025 INVASION MATHS
E026 KIDS PAINT
E027 LANGUAGES (1.3 ONLY)
E028 LEARN / PLAY I
E029 LEARN / PLAY II
E030 MR MEN (1.3 ONLY)
E031 MIND
E032 MR ROBOT SPEAK / SPELL
E033 MATCH WITH HUMPTY
E034 NODDYS PLAYTIME DEMO
E035 NOAHS AMIGA GUIDE
E036 OCTAMED TUTOR
E037 QUIZBASE
E038 ROCK A DOODLE
E039 SPANISH (A1200 ONLY)
E040 STORYLAND II
E041 SIMON / SPACE MATHS
E042 SING NURSERY RHYMES (2)
E043 STARLAB
E044 TREASURE SEARCH
E045 TALKING COLOUR / BOOK
E046 WORLD DATABASE II
E047 WORDS II
E048 W / WAR II
E049 WORLD GEOGRAPHY
E050 W / B II TUTOR
E051 SPANISH / FRENCH / GERMAN
E052 BACK TO SCHOOL I
E053 BACK TO SCHOOL II
E059 BACK TO SCHOOL III
E055 EDUCATION COLL (5)
E060 JACK FROST
E061 DESERT STORM
E062 RED PLANET
E063 KEYQUICK
E064 GCSE MATHS PAPERS (1.3)
E065 GUIDE TO W / B III
E066 TYPING TUTOR (AGA)

## LATEST UTILITIES

MJ40 HIPPOPLAYER 2.11
U185 WORDS 2.3 (GOLD ED)
U186 APEX SLIDESHOW MAKER
U187 SUPER CRUNCHERS
U188 ANIM PRO (2)
U189 COLOUR-A-MORPH
U191 VIRUS WORKSHOP 5.6
U192 MESSYSID V3.0
U193 THE BEST LOTTERY PROG
U194 TEXT ENGINE 5.0 (WB2+)
U195 WORD PUZZLE PRO
F013 PAGESTREAM / SETR FNNTS (5)
U197 EXECUTIVE V1
U198 MCP 1.05
U199 ELECTRIC DIG DSNDR (WB2+)
U200 COP THE LOT PRO V3
SS59 COOKIE SLIDESHOW AGA (2)
U92 G BLANKER 3.6 (020)
U96 T.U.D.E V1 .0D
U107 GOLD ED 3.0 (020)
U117 SCOUT (MUJ)
U120 DOS MAN
U122 DIARY 2000
U133 AMITCP V3.0 (2)
U134 ZXAM V2.0 AGA
U138 SHAPESHIFTER 3.08 (4MB)
U141 EASYCALC V2.0B
U144 ESSENTIAL AMINENT 8
U146 SUPER DMS
U159 MUI V2.3
U160 INTERNET UTILS 2
U161 ASI MULTIVISION 9
U163 ASI MULTIVISION 10
U164 ASI DISK HELPER 9
U166 ASI DISK HELPER 10
U169 AMIGA FAX 1.42 (WB2+)
U170 STOCK CONTROLLER PRO 1.2
U177 GRAPHICS W / BENCH AGA (4)
U178 VIRUS CHECKER 7.17 (WB2+)
U180 A BACKUP 500 (WB2+)
U216 VIDEO TRACKER
U09 GARDEN DESIGNER
U226 CITIZEN PRINT MANAGER 2.1
U225 PRINT STUDIO
U85 PRO GAMBLE 2.1
U106 IMAGE STUDIO 2.0 (2)

## MUSIC DEMOS

DM08 SPACEBALLS WAYFERER
DM46 SPACEBALLS SOTA.
DM53 100 TOP DEMOS (6)
DM54 JESUS ON E'S (2)
DM55 SONGS RACK (AGA)
DM59 ROOTS II (AGA) (020)
DM60 TEMPLE OF DECEASE AGA
DM61 DRUGSTORE (2)
DM63 LECH (AGA)
DM64 ZOOTJE (AGA)
DM65 GREENDAY (AGA) (2)
DM67 IMPOSS / POSSIBILITY (2)
DM68 GRAPEVINE 21 (2)
DM69 ITCHY AND SCRATCHY II
DM70 DAS OMEN (AGA)
DM71 HOUJOBB JAMMIN (AGA)
DM72 ANIMATUNES (AGA) (2)
DM73 MOMENTS (AGA)
DM74 GEN X (AGA) (2) (4MB)
DM75 ALIEN INSPIRATION (AGA)
DM76 BIG TIME SENSUALITY AGA (2)
DM77 ITCHY AND SCRATCHY 4
DM78 ALIEN (AGA)
DM79 HUMAN (AGA)
DM80 VIVAT SLOVAKIA (AGA) (2)
DM82 STILLETTO (AGA)
DM84 POLKA BROS ULVEN (AGA)
DM88 BRAINCCELL (AGA)
DM99 FANATIC (AGA) (2)
DM97 SILENTS (AGA)
DM96 DOMINATION (AGA)
DM95 RAZOR (AGA)
DM93 NO NAME (AGA)
DM94 NFA THE WORD 8 AGA (2)
DM105 C42 AGA
DM106 FRUIT KITCHEN AGA (2)
DM85 BAYGON (AGA)
DM86 SURF JAZZ WAVE AGA (2)
DM87 BATMAN (2)
DM90 RAW 9
DM92 ZYNOISIS (AGA)
DM91 TIME (AGA) (1.5MB)
DM107 THE FLINTSTONES (18+)
DM02 ROBBOCOP
DM09 RED DWARF
DM14 TOP GUN

SEND BLANK DISK & SAE FOR LATEST CATALOGUE DISK OR FREE WITH ORDER.  
WE STOCK: FRED-FISH LSD TOOLS BUSINESS  
ASSASSINS GAMES ARUG MUSIC UTILS  
SCOPE NEW ZEALAND SLIDESHOWS  
TBAG SPECTRUM GAMES CLIPART

AMIGA A1200 "MAGIC PACK"  
OR WITH 170MB HD & SCALA  
CITIZEN ABC COLOUR PRINTER  
AMIGA POWER SUPPLY  
EXTERNAL DISK DRIVE WITH V-CHECKER

SAVE 45.00.....354.99  
SAVE 30.00.....469.99  
.....144.99  
.....34.00  
.....59.00

U204 STAR PRINT STUDIO  
U210 PANASONIC PRINT STUDIO  
U153 PRINTER DRIVERS  
U205 DJ PRINT  
U158 POWER LOGO

## PRINTER UTILS

U23 PRINT STUDIO  
U13 PELICAN PRESS (3)  
U220 CITIZEN PRINT MGR  
U220 EPSON PRINT DRIVES  
U222 PRINT DVR GENERATOR

(DEPT CU) 24 WASTWATER DRIVE, WOODCREST, BRADFORD, WEST YORKSHIRE BD6 2TN. ENGLAND. PLEASE ADD THE CORRECT POSTAL COSTS IN ORDER TO AVOID ANY DELAYS (SEE TOP FOR RATES).



# ScreenScene



It's all gone a bit pear shaped at the moment as you will see from the vast, dark empty spaces opposite. We find ourselves sandwiched in between Christmas and Easter with this issue and thus our games pages may be described as at best sparse, at worst rather empty.

But we're not complaining. We did get an exclusive look at one of the hottest games of the year, now in the final throes of development: Chaos Engine 2, while Lisa travelled to the snowy south west for an exploratory visit to the bustling development basement of Intersect Developments. She came back goggle eyed. Find out why on page 42.

Watchtower is the lead review this month and by all accounts it's a decent shoot 'em up in the Commando mould, though its looks are definitely all Chaos Engine. World Golf is a miniature Sensible Golf, if such a thing were possible while Premier Manager 3 Deluxe updates an already good game. There's also all the usual tips and cheats in Vamp and Snip Tips with the added bonus of Zeewolf 2 help.

News just in from Time Warner Interactive should please SWOS fans: they are doing a special offer on the 95/96 edition of the game. Basically if you've bought the first version you can upgrade to the current season's one for £9.99, postage inclusive. All TWI asks you to do is provide proof of original purchase by sending them the bar code from the old Sensible World Of Soccer box along with a cheque or postal order for the above amount made out to Time Warner Interactive. Make sure to include your full name, address and postcode printed clearly, otherwise you'll never get your game! Send these to Time Warner Interactive, Customer Service SWOS Offer, 2 Carriage Row, 183 Eversholt Street, London NW1 1BU. Then enjoy your game.

Watchtower p47

Chaos Engine 2 p40



Slam Tilt Pinball p43



Intersect P44

## Previews

<b>The Chaos Engine</b>	<b>40</b>
<b>At the Crossroads</b>	<b>42</b>
<b>Slam Tilt Pinball</b>	<b>43</b>

## Reviews

<b>Watchtower</b>	<b>46</b>
<b>World Golf</b>	<b>51</b>
<b>Premier Manager 3 Deluxe</b>	<b>51</b>

## Tips & Guides

<b>Vampyra</b>	<b>56</b>
<b>Snip Tips</b>	<b>59</b>
<b>Zeewolf II Tips</b>	<b>57</b>



# The Chaos Engine 2

■ Due: May ■ Developer: The Bitmap Brothers ■ Publisher: TWI © 0171 391 4300

**M**r and Mrs Bitmap must have had very active bedtimes in the sixties and seventies. I counted at least 15 young men in their office, mostly around the same age. This puts most Catholic families to shame in my opinion. To name but a few, there was Simon Bitmap, Steve and his brother Steve Bitmap, Mark Bitmap, Richard Bitmap, even their sister Abi Bitmap. And these are just the brothers working on Chaos Engine 2. Sister Abi set up my interview.

But I jest. They are not in fact related at all. Despite my disappointment on this score I had a good chat with Chaos Engines' figurehead, the inimitable, and follicularly challenged, Simon Knight. Bitmap Brothers' Colonel Saunders without the beard. To my immense surprise, when I arrived in The Bitmap's Wapping office for my exclusive demo and interview, Simon was showing it to somebody else! Another magazine? Had I been cheated? No, some geezer had just walked in off the street and they thought he was Alan Dykes. Haven't they heard it's dangerous to talk to strangers these days (much less an Irishman)?

The Chaos Engine 2 was first revealed in Spring 1995. Before this there were only rumours that a new version was being done,

**Is your life too calm, too peaceful, too bloomin' boring, in fact. You need some excitement, what you want is a bit of chaos to shale things up. Well, you could get it sooner than you think...**

but the first one was so successful, a follow up was inevitable. The plot of the game revolves around a chap called the Baron's quest for the Chaos Engine, the machine at the heart of the first game, which got blown up and spread to the four parts of time. Now the Baron wants it back in one piece and he has hired mercenaries to do the job for him.

In the first game two player mode was a cooperative affair, fighting side by side to defeat the enemy. Even in one player mode you had assistance from the computer who played the second character for you. In this game however the emphasis is on competition. The screen is horizontally split which means that each character can operate totally independently. The idea is to collect pieces of the Baron's puzzle, kill as many baddies as possible

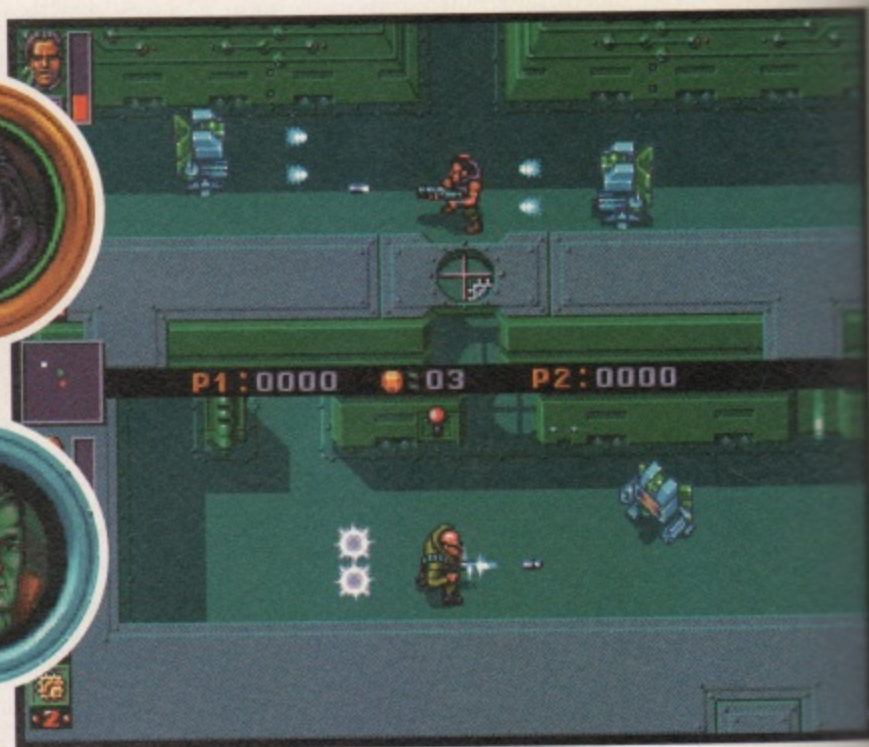

and make it to the end of the level first. The key to the change in emphasis is that you actively try to kill the other character and steal their keys etc, to defeat them. Each level has to have one winner.

This can be done in two player

mode or as a single player. In the latter form you can retain the split screen, in which case you'll be able to see the other character's movements, or else return to the old style single screen. The computer characters have their own advanced intelligence and the Bitmaps claim that this will adapt to the experience and style of each individual human player.

The team working on Chaos 2 includes Simon himself who is the game designer, Steve Kelly who has done most of the in-game programming Mark Vick and Dave Trevelyan who have programmed the intelligence for the computer controlled characters, Steve Cargill who has been doing support and systems programming, Richard Joseph who



▲ Both screens operate independently, allowing one player to see what the other is up to.



▲ Not only does the other character have improved AI, the enemies do too.



▲ Above, on the Aztek level the Mercenary has just been downed and has lost all his belongings.





▲ Brigand beats Navie in all out war shocker! In either one or two player mode the object is to beat your opponent to the exit.

was contracted from outside to do the music and SFX, Gary Carr who did the monster sprites artwork and Dan Malone who did the backgrounds and main characters. It's been in development for nearly two years now, so we asked Simon and Steve Kelly how they were getting along.

**Alan:** What is the object of the game?

**Simon:** 'The object of the game is to succeed to the detriment of the other player, in all aspects, in solving puzzles in winning the levels, in getting more experience.'

**Alan:** How complicated has the AI become?

**Simon:** 'The original system we devised works quite well, but the hardest thing is to create a consistent challenge. It's very easy to make him intelligent so that he can win every time, because he knows the level, the hardest thing is to make him play in a responsive way to make it fun even for players that aren't really good'

**Alan:** It looks similar to number one, what are the big differences?

**Simon:** The graphics are similarish, we've used the same viewpoint and it's based around the same characters, but there are now more animation frames for each character and the baddies have all been updated too. But the game has changed a lot. It's changed in pace, it's changed in objective, apart from the visuals there aren't many similarities at all.'

**Alan:** Are you still enjoying programming on the Amiga or

are the Bitmaps deserting the Amiga like so many others?

**Simon:** 'This project is something new, something out of the ordinary and it is nice to do this on a machine you're familiar with. This allows you to experiment much more in terms of the game engine and intelligence. You're not spending your time learning how to control the equipment, you're actual spending your time developing the game, which is what we really wanted to do. Also, when we started it was at the point when there wasn't really a clear path, so we're happy finishing things off here, and we're certainly enjoying it. We have looked into doing Z on the Amiga [the Bitmap's current PC product], obviously it's



quite difficult because there's a lot going on in Z and it was designed as a PC game from the outset. Basically this really depends on the state of the market.

**Alan:** If you had to recommend a specification for the new Amiga, that would allow you to produce more games, what would it be?

**Steve:** More memory, decent sized internal hard disk and a faster processor. With something like Chaos engine 2, an accelerator doesn't help at all, but with a



project like Z it would be necessary. We've been developing Chaos Engine 2 on the A1200, but there is an A500 version in development to, although this is lagging behind.

It looks a bit different because of the graphics, but the gameplay and speed are very similar to the A1200 version.

**Alan:** What didn't you like about the scientist? Why have you cut the game down to four characters?

**Simon:** The decision was mostly made by Dan, based on the graphics, I mean the scientist/preacher was an obvious one to go because of the similarities. Basically though we needed the space because of all the extra animation frames, we needed all the memory available just to use four characters. Also, in terms of providing a real difference between them it's very difficult to get the intelligence right so that they all play differently.

Doing four enabled us to give them very different playing styles.

**Alan:** What are you programming it in?  
**Steve:** In a mixture of C and assembler. Rob Trevelyan who did the intelligence for Speedball 2 and for Chaos Engine on the SNES programmed it for us on this one, using C but creating a language of its own which the rest of us could then use and modify.

The version I saw was very near completion. We played through two of the four worlds, Aztec and Future world, and the graphics were great looking. The new sprite animations are pretty impressive too and the split screen system worked well. In total there will be five levels on each world and each has very specific features and enemies. I'm pretty excited about The Chaos Engine 2, so hopefully we'll have a review for you next month!

**Alan Dykes**



▲ As you progress through Chaos 2, your character gains experience.



▲ Steve Bitmap, Steve Bitmap, Simon Bitmap and Nick Bitmap trying not to look like brothers.





# Intersected Development

**Problem: no good Amiga games around. Solution: make your own. That's what these guys did ...**

**W**ouldn't have one [a PC] in the house," laughed Intersect Development's Frank Tout at the suggestion that he might have used PCs at some point whilst working on their current store of Amiga games. Dedicated Amiga enthusiasts, this two-man team (the other half being Trevor Mensah) prides itself on only using Amigas for all its work. Intersect Development are an inspiration in these slightly

murky times for the Amiga games market. First because they only use Amigas to produce quality games and second because their loyalty to the Amiga is self evident as they are determined not to let it die. So we were only too delighted, despite the bitter weather, to take our chances on British Rail and travel down to their Torquay office (ie, home) to see what they had lined up.

We're not talking multi-national software company set up with Intersect Development, but they still produce the goods anyway. The set up is simple. Frank works, on his



▲ Neyok's title screen was rendered in LightWave and the screenshot doesn't do it justice here. Sorry folks.



▲ Here are some exclusive shots of the later levels of Atrophy. CU Amiga Magazine always gets there first.

A1200 from his flat in Torquay while Intersect's other half, Trevor, works on the code in Liverpool where he is currently studying computing. They exchange ideas and material via mail, which is how they met originally. Frank, who has been with Commodores since the C64 days, started corresponding with Trevor when he wrote to him to get the source code for a game that he'd written for AmigaNuts.

## Games galore

The first project we were shown was Atrophy. You may remember that we previewed this scrolling shoot 'em up in March and were impressed by what we saw. It was interesting, therefore to see how it had developed in the later stages. The scrolling shoot 'em up, which will have six levels when finished, is now nearing completion. All it's waiting on is a tidy up on the collision detection front. Obviously proud of the game, Franks states that: "What we like about it [Atrophy] is that it is so smooth, everything happens at 50 fifty frames a second compared to other games which, invariably happen at 25."

Next up, we were given a sneak preview of another game

which is in the latter stages of development: Tilly. A puzzle game which will comprise of a massive 100 levels and an editor so when you

exhaust these you can start on your own. It looks fairly basic, a little spherical chappy races around a maze set up, teleporting here there and everywhere in a bid to collect as many pick-ups (the usual sort: treasure chest, pieces of fruit, cuddly toys, OK maybe not) as possible.

The four other games we talked about; Neyok, Phasic Distortion, Alternate Futures and Dominions are currently in the early stages of development. Neyok and Alternate Futures will both be sci-fi based platform games. Neyok, Frank says will be "somewhere along the lines of Shadow of the Beast". It is actually New York in a future world where the earth has been wiped after nuclear burn out and it's up to the hero to leap through three "huge" platforms to save the world. Alternate Futures continues along the same vein, only the story centres around a scientist getting lost







in his time machine and being transported back in time rather than forward. Phasic Distortion, a triple playfield, eight way scroller, is back to a maze/puzzle-type setup where you have to race around collecting prototypes. Finally, Dominions, with 256 hi-res graphics, is a move towards RPGs. It will be a series of three point and click games featuring a hero called Gary Somerton caught in a "no man's land".

All these games will be AGA only as Intersect feel that they couldn't achieve the same quality on non AGA machines.

▲ Tilly is looking like it will be finished before Atrophy. However, there isn't a publisher for it yet.

### How do they do that?

How, you might ask do two men, one based in Liverpool, the other Torquay manage to keep ideas and productivity going? It's quite simple really, according to Frank: "It's all thanks to the unique game engine we have developed which makes it simple to get a game idea into action. The engine is central to everything we do, we

write a game around it because it can do what we want without taking up too much time."

So what other software do they use? LightWave, DPaint, and Personal Paint are used for the graphics and ProTracker for the sound. Tony Horgan paled at the suggestion that someone should use something other than OctaMED though. Frank replies that: "A guy called Lee Smith did all the music for Atrophy using



▲ Tilly will have a 100 levels and just when you thought you'd finished there's an editor to make even more.

ProTracker. OctaMED is too slow for playing back, we couldn't have put it in the game as it takes too much time and we'd end up having glitches and stuff like that."

We left Frank furiously working away on getting Atrophy and Tilly finished so we should a review copies very soon. At the time of going to press OTM hope to Atrophy on the shelf by April. ■

Lisa Collins

# Slamtilt Pinball

■ Due: March ■ Publisher: 21st Century  
Entertainment ☎ 01235 851852

Is there something about Scandinavia that encourages great pinball games on computer? Unless I'm greatly mistaken they are not very well known for their pub pinball tables. But, considering how cold it gets up there, and how expensive pub drinks are, it's perhaps not surprising they don't go out. What was surprising though was that 21st Century and Digital Illusions parted company after three very successful games. 21st then linked up with a company called Spidersoft to do Pinball Mania. This was bundled with the Magic pack but looked unfinished, unpolished and generally disappointing.

It was with much relief then that Helen from 21st popped



into the office a couple of weeks ago with Slamtilt. Four tables from Scandinavia yes, but not from Digital Illusions. The new programmers are Liquid Design and by the look of these tables, they've matched, if not surpassed Illusion's mastery.

The four tables are based around Demons, Space, Mean Machines and Pirates, and the sheer quality of the graphics matches Pinball Illusions.

This game is much deeper and faster than Pinball Mania was, but added to the table-top wizardry are some very comprehensive animations and rigorous



appears to go much further than any other pinball game I've seen before. But I haven't had an

opportunity to test it for more than an hour, so I can't comment on the difficulty or effectiveness of this approach at the moment.

Of course it could be argued that there are enough Pinball

games on Amiga already; surely there's only so many variations you can have on a theme? OK, so how many platform games have there been? Case rested.

I just hope that Slamtilt lives up to the promise it showed in this preview, if it does it should appeal not only to the hardened pinball player but to anyone interested in a good, new, playable arcade game. We'll find out next month. ■

AD

sub games. High scores and much of the gameplay revolves around reading this animation panel and using its features. This



# We must be Nuts!

## FREE INTERNET ACCESS FOR A MONTH WITH BOTH SQUIRREL INTERNET PACKS

### SQUIRREL SURF PACKS

Squirrel  
Surf Packs  
from £199

HiSoft have two amazing offers that will allow you to surf the internet for a whole month free. The £199 Starter Surf Pack is the ideal system for the beginner taking their first steps on the information super highway. The £299 Super Surf Pack is designed for the user who wants to cruise the information highway in style. If within your free month you do not wish to continue your internet experience, you are free to return\* the pack to HiSoft for a



Surf Squirrel makes connecting a modem, CD-ROM, hard disk or Jaz drive.

refund. Should you wish to continue access after your free access period, we can offer you further access from just **£10 per month**.

So why not start surfing with one of HiSoft Systems's Surf Packs? Designed for both the beginner and expert alike, the Squirrel Surf Packs include all the software, hardware, and documentation to get you quickly, and easily, onto the information super highway.

Ordering a Surf Pack couldn't be easier, simply phone our freephone order hotline on **0500 223660** and quote SS14 to order a Starter Surf Pack or SS28 to order a Super Surf Pack.

Both Surf Packs require an A1200 with a hard disk and a minimum of 4Mb of memory, should you require either extra memory or a hard disk, then check out the amazing offers at the bottom of this page.

#### Internet access includes:

- Full internet access with email, ftp, telnet, WAIS, gopher and world wide web.
- 100% UK coverage for local call internet dial-up. Contact us for an access number local to you.
- Usenet news feed - participate in the thousands of usenet news groups.
- 500Kb of Web space- create and maintain your own World Wide Web page.
- Other services available including ISDN, additional web space, mail filing, message forwarding (alert pager/mobile when message arrives) and message forwarding (send email to pager/mobile).

#### Starter Surf Packs contains:

- 14.4k modem which supports all the major standards up to V32bis.

#### Super Surf Packs contains:

- 28.8k modem which supports all the major standards up to V34.

#### Both Surf Packs Comprise:

- The excellent Surf Squirrel with its SCSI and high speed serial interface.
- TCP/IP Internet access software.
- Additional utilities for email, ftp, IRC, telnet, gopher and the amazing IBrowse world wide web browser.
- 1 month free internet access (UK).
- Full 12 month guarantee
- 30 days free technical support.

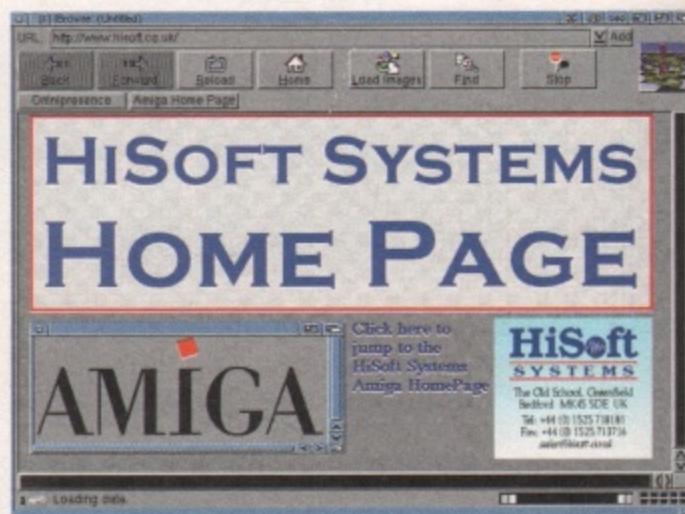

Surf the net with IBrowse, the excellent web browsers included in both Squirrel Surf Packs

\* Pack must be returned with all packaging and in full working condition. You may be liable for damaged or incomplete returns.

Scoop  
Purchase!

### RAM Upgrades

HiSoft can now offer  
Amiga owners excellent  
prices for RAM upgrades.

72pin 60ns SIMMS -  
suitable for all  
A1200/A4000 RAM &  
accelerator boards,  
except GVP.

4Mb SIMM £99.95  
8Mb SIMM £159.95

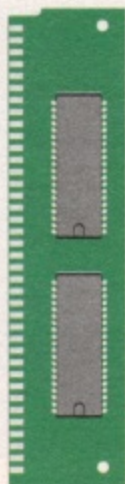

### Squirrel Storage Systems

#### 2.5" IDE

64Mb £59.95  
170Mb £124.95  
540Mb £249.95

#### SCSI Internal (add £70 for external units)

270Mb £119  
420Mb £179  
840Mb £229  
1Gb £299

#### CD-ROMs (add £60 for external units)

Sony 2.4 Speed £79  
Toshiba 4.4 Speed £179

#### Removable Drives

Iomega Zip Drive £199  
Iomega Jaz Drive £599

Other capacities  
are available,  
phone for details.





## SUPERDOUBLE CD PACK

Includes 2 free CDs

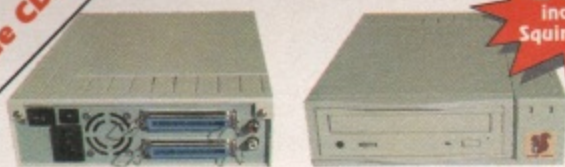

**£189**  
includes  
Squirrel SCSI

The superb SuperDouble CD-ROM is back! Using an excellent 2.4 speed drive from Sony, this CD-ROM provides outstanding performance at an amazing price. With a 360Kb/s data transfer rate and a 230ms access time, the SuperDouble CD-ROM provides all the speed for the power user.

The SuperDouble is fully compatible with the new Squirrel MPEG card, supporting the industry standard VideoCD (White Book) format.

The SuperDouble CD-ROM pack includes the award-winning AGA Experience CD-ROM - rated 93% in issue 79 of Amiga Format. This CD-ROM is crammed full of pictures, utilities, demos, animations and tools for AGA Amigas. The SuperDouble pack also includes the latest Aminet CD-ROM. This disk is brimming with the latest PD, shareware, utilities, demos and picture files from the Aminet archives on the internet.

A full classic Squirrel is also included in the pack. This allows easy connection of any SCSI peripheral to the A1200. The package has all the necessary drivers and software for easy connection of hard drives, CD-ROMs and removable disk drives, such as the Zip™ Drive, to your Amiga.

Jaz is a revolutionary 1Gb removable hard disk system for any Amiga with SCSI. Like a Zip drive on steroids, Jaz provides astonishing performance. Offering data transfer rates of up to 6MB/s and access times of under 12ms.

For full information on this amazing SCSI peripheral contact HiSoft Systems.

- 1Gb Carts
- 6MB/sec

# jaz



**£599**  
plus P&P

## Cinema4D™

Professional Ray-Tracing and Animation for your Amiga



Cinema4D is the easy-to-use ray-tracing and animation system for your Amiga. Equipped with an intuition-based multi-tasking editor, Cinema4D is replete with every conceivable option including window-based real-time interactive modelling, direct modelling in 3D, basic and complex primitives with infinite variations, easy object manipulation, floating toolbars, user-defined menus, object and texture lists, definable object hierarchies, optimised versions for 68020 (A1200 etc.) & FPU's, and much more!

The Cinema4D animator brings you even closer to the world of "virtual reality", breathing life into objects and scenes. Whether you have your spaceship dock with a spacestation, or take a tour around the darkest dungeon - with Cinema4D it's so simple. Just a few mouse clicks and you



**£199**

will have your objects move realistically through time and space.

Cinema4D also includes MagicLink, the flexible object converter. MagicLink converts all popular object formats (Imagine, Sculpt, DXF, Reflections, etc.) to Cinema4D format & back.

**Order Hotline** ★  
**0500 223660**

To order any of the products shown on this page (or any other HiSoft title) - just call us, free of charge, on **0500 223660**, armed with your credit or debit card; we will normally despatch within 4 working days (£4 P&P) or, for only £6 within the UK, by guaranteed next day delivery (for goods in stock). Alternatively, you can send us a cheque or postal orders, made out to HiSoft. All prices include VAT. Export orders: please call or fax to confirm pricing and postage costs. © 1995 HiSoft. E&OE.

All prices include UK VAT @ 17.5%

## SQUIRREL MPEG



The SCSI MPEG Player for your Amiga, Atari, Macintosh & IBM-PC Compatible

Bring the cinema into your home and onto your computer with Squirrel MPEG™. Playing the popular VideoCD and CDI CD-ROMs as well as raw MPEG streams, Squirrel MPEG brings high quality digitally mastered images and 16-bit stereo sound to you and your Amiga.

Squirrel MPEG is a SCSI peripheral that can be used in conjunction with any SCSI controller, such as the Classic Squirrel™ or Surf Squirrel™, and any VideoCD compatible CD-ROM. Squirrel MPEG can also be used as a stand-alone unit, with a SCSI CD-ROM, as an addition to your TV, Video and Hi-Fi setup.

Available from March 1996, Squirrel MPEG is the latest in an established line of ground-breaking products, for you and your Amiga, from HiSoft Systems.

## Studio V2 Professional

The original colour management system for your Amiga

**£49.95**

Studio 2 brings professional colour management to the Amiga, ensuring that the colours on your screen match the colours on your printer.

Use Studio 2 to get the most out of your printer. With its powerful Workbench drivers, you will get outstanding printed results from your applications, every time.

Studio 2 is also directly supported by the popular printer manufacturers, and always includes drivers for their latest printers.

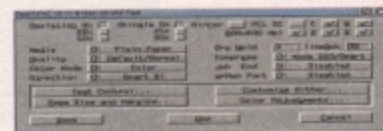

Set every conceivable print option from the Studio preference program

## DiskMAGIC

Easy File & Disk Management

**£39.95**

Constantly doing battle with the Shell/CLI? Stop this futile struggle with DiskMAGIC, the easy-to-use file and disk management utility from HiSoft.

DiskMAGIC simplifies every task you perform, from the copying of disks and files, to the viewing of pictures and anims. In fact, after using DiskMAGIC, you'll wonder how you ever used your Amiga without it.



# HiSoft SYSTEMS

The Old School, Greenfield  
Bedford MK45 5DE UK  
Tel: +44 (0) 1525 718181  
Fax: +44 (0) 1525 713716  
email: hisoft@cix.compulink.co.uk



Zip is a trademark of Iomega Inc



# Watchtower

■ Price: £25.95 ■ Publisher: OTM © 01827 312302

If you wanted tips on the following game, just try the age-old advice "If it moves, shoot it". This would also be a good time to find a friend, 'cause you're gonna need as much help as you can get!

**U**pon loading Watchtower, the immediate thought that springs to mind is "Cwor, this don't 'arf look like Chaos Engine!" – and quite rightly so. The graphics certainly owe more than just a passing nod to the Renegade classic. However, after a few minutes playing you realise that Watchtower's contents is more akin to elderly titles such as Commando and Rambo, not to mention the Sensi Classic, Cannon Fodder.

The game's creators have mercifully spared us a twenty page plot, instead opting for the more easily digestible "You're one well-hard geeza up against the enemy army in its entirety" theme — and before you know it, you're off up the screen armed only with a pea-shooter and a handful of grenades.

The game itself is split into six missions, each with a different objective and a different setting



▲ Collect any uncovered coins for some extra points.

(eg desert, enemy base, urban). The truth, however, is that the game play is pretty much unchanged throughout, with only graphical changes and the odd new enemy type making the different levels identifiable. Whether you're on level two or five, you can bet your granny's spare teeth that most of your time will be spent shooting hostile enemy soldiers and blowing up installations, tanks, aircraft, and... well, pretty much anything that'll react to a well



placed grenade really. The aforementioned explosive apples come in limited supply, so crates and boxes must be blown open along the way as you search for fresh supplies and point-rewarding items. The programmers have obviously spent time perfecting their explo-

sion graphics – and very nice they are too – but this is more than just a special effect, as it can also be exploited by the player. How? Well let's just say that any enemy units near exploding items, er... 'fly away to meet their maker'. Hurrah!

## Guns, guns, and more guns

As previously mentioned, the player starts off with a full complement of grenades (the maximum allowed being nine) and the standard issue pistol, namely the Desert Eagle Magnum .44. Unfortunately, this has a fairly low damage rating, a pretty pathetic range, and a limited rate of fire, so you'll need to find some crates as soon as possible and blow them apart in the hope of finding a better weapon. There are a number of guns to be found, but due to weight, only one type of gun can be carried at any point. It is therefore down to the player to



▲ I realise that most of our readers don't even talk to humans, but if you've got a mate, why not play the two-player game?

become familiar with each gun's attributes and on-screen appearance so that you don't accidentally swap, for instance, an M60 machine gun – with excellent range and rate of fire – for a rocket launcher that, while having the best range possible, can only fire one rocket at a time.

Other toys to play with include AK-47 Kalashnikov, Israeli UZI Sub-Machine gun, M16 Assault Rifle, Minigun, and a Flame Thrower with continuous flame and high damage – grrr! Of course, as well-armed as you are, you can expect to encounter enemy soldiers with the same level of weaponry as yourself, and what with you starting each new mission back with the pistol, well, let's just say that complacency isn't advisable.

As well as engaging enemy troops, you can also expect to come up against some fairly serious military hardware in the form of tanks, supply trucks, and even bombers that fly across







▲ Before each mission you're shown your position on the overall campaign world map, along with a truncated brief (ie kill everything).



▲ Blowing these crates has revealed exactly what the doctor ordered — more grenades!

the screen dropping their deadly payload right on the old noddle. Fortunately, careful rationing of the ever-popular grenades will ensure that you're always in a position to reply to such challenges in kind. The level designs are well thought out, so ambushes are frequent enough to keep the player on his toes, while narrow (not to mention well protected) bridges call for some sharp shooting

skills. As well as a large number of obstacles that can be blown to clear a path, there are also buildings and installations that must be worked around as the screen scrolls slowly to reveal new areas on the map. As if that wasn't enough, later levels are covered in land mines, but thanks to the fact that many of the enemy soldiers are not only single-minded but pretty damn thick, they can be tricked into clearing routes through such deadly grounds (and a very good impression of chopped tomatoes they do too!).

Distinguished Service Cross, or a United Nations Medal. One to avoid, however, is the Purple Heart as this is generally only awarded to those who have died as a result of standing in front of enemy snipers shouting "come and get it big boy". You can also impress your friends and family with promotions throughout the campaign — right through from Private to Brigadier General.

### And the final verdict is...?

To be honest, as simplistic as Watchtower is, it's actually pretty good fun. It's certainly of the 'old school' as far as game play goes — but as long as it's still fun, who cares? The comparisons to Chaos Engine only really go as far as the presentation, the fact that you can have two players trundling around at the same time, and the graphical representation of the extremely questionable coins that appear throughout the game as point bonuses. Other than that, it's all very basic in as much as you just wade through the levels killing everything that crosses your path.

At times the screen can get a tad crowded, as large numbers of soldiers all appear at once, adding to the on-screen confusion with bullets spraying in all directions (though I'm sure you'll be glad to know that only once in my entire testing sessions did I encounter any slowdown). The only other comment worth noting with the screen is that you have to sometimes wait for the scrolling to catch up with your position, otherwise you'll be standing on the edge of the screen just as a new soldier appears, which is — needless to say — a bit of a git.

The choice of weapons is impressive, although once you get yourself a decent weapon with a good range and

fair damage, there's no real need to swap around. As for the grenades, well... they're great! I would say, though, that due to the game's general difficulty (ie bloody hard for the most part!) a few more grenades wouldn't have gone amiss.

And that's about it really. The three difficulty levels don't appear to do much more than make the soldiers tougher (not in intelligence, but where one bullet would suffice on the easy level, you'll need two for the medium level) while the six levels are progressively more busy and generally nasty. As for whether you're getting twenty six quid's worth of value, well... that's really down to how much you personally go for 'bread and butter' arcade games. My personal advice would be to give Watchtower a go, because while it ain't Earth-shattering, it's not at all bad. ■

**Matt Broughton**

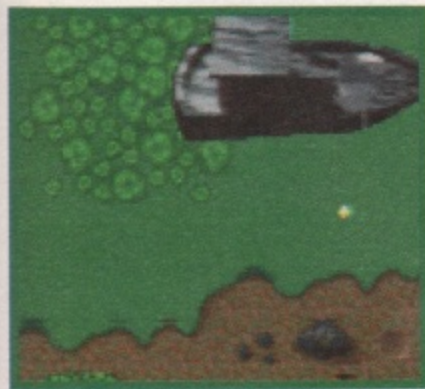

### Reap the many rewards

As you progress through the missions your performance is evaluated, and if you've been a good boy, you could even find yourself being awarded with a nice badge or even a shiny medal. How does a Legion of Merit grab you? Or perhaps a Medal of Honour, a Silver Star, a Bronze Star, a



▲ Hurrah! I'm great I am.

## WATCHTOWER

- workbench version.....3.0
- number of disks .....3
- RAM .....2MB
- hard disk installable .....yes

graphics.....	70%
sound.....	68%
stability.....	73%
playability.....	75%

**OVERALL**  
A tad basic, but pretty entertaining.

# 78%



# DATEL



# 01782 744707

## 24hr Mail Order Hotline

# DIRECT

buying direct from the manufacturer means both low prices and a service second to none!



FAX 01782 744292

## PROFESSIONAL MIDI KEYBOARD & INTERFACE DEAL!

Full size velocity sensitive Midi keyboard PLUS Midi Master professional Midi interface. Total Package!!

### ONLY £99.99

KEYBOARD + MIDIMASTER + FREE MIDI CABLES

### MIDI MASTER PROFESSIONAL MIDI INTERFACE

NEW LOW PRICE

FULL FEATURE MIDI INTERFACE

MIDI MASTER AVAILABLE SEPARATELY £19.99



- ▲ Full specification Midi In, Midi Thru and Three Midi out sockets.
- ▲ Stylish case to match Amiga colours
- ▲ Fully Opto Isolated.
- ▲ Compatible with ALL leading music packages.



### FULL MIDI SPECIFICATION:

- 49 Standard size, velocity sensitive keys with 10 velocity curves.
- Supports all assignable Midi controller messages.
- Supports all program numbers & bank change messages.
- Programmable channel pressure & velocity.
- Pitch bend wheel.
- 6 user programmable "Program & Bank Change" memory.
- 805x208x87mm.
- Transpose up to full range of 109 keys.
- Standard MIDI out 5 pin Din.



DIGITIZING TABLET NOW ONLY £99.99

AS AN ALTERNATIVE TO THE STYLUS INPUT THE GENIUS TABLET ALSO HAS OPTIONAL FOUR BUTTON PUCK.



GENIUS PUCK £29.99

- ▲ With the Amiga Genitizer Graphic Tablet you can streamline the operation of most graphic or CAD programs.
- ▲ The Genitizer Graphic Tablet utilises latest technology to offer up to 1000 dpi resolution at the tip of a stylus.
- ▲ Complete 9"x6" digitizing area plus super accurate stylus combine to enable fast, accurate and easy control.
- ▲ Works by "mouse emulation" so the Genitizer will work with most packages where mouse input is the usual method-Deluxe Paint, Photon Paint, CAD Packages, etc.
- ▲ Supplied with template for Deluxe Paint..
- ▲ This is the input method used on professional systems.

- ▲ Fast input of drawing by "tracing" is made easy - plus "absolute reference" means you can move around the screen many times faster than by a mouse.
- ▲ The Genitizer fits in the serial port of your Amiga 500/500+/600/1200/1500/2000 and "co-exists" with mouse.
- ▲ Unlike a mouse, the tablet gives absolute co-ordinates so that tracking and menu selections are possible from the tablet face.

FREE PC INSTALLATION PACK IF YOU BUY A GENIUS TABLET SYSTEM FOR YOUR AMIGA YOU WILL ALSO RECEIVE SOFTWARE AND MANUALS FOR INSTALLATION ON A PC ABSOLUTELY FREE!

### MAGNETIC CARD READER

Explore the data hidden on Credit Cards, Debit Cards, Security & Membership Cards etc.



Simply swipe your card and read the contents Reads tracks 1,2 and 3 Plugs into your Amiga Joystick Port.

### MAGNETIC CARD READER

£59.99 Complete system

### HIGH RES HANDY SCANNER

FREE PHOTON PAINT



- ▲ An easy to handle Scanner featuring 105 mm scanning width & 400 dpi resolution enables you to scan graphics/text into your Amiga 500/500+/600/1200/1500/2000..
- ▲ Includes hard disk transfer to run under Workbench.
- ▲ Adjustable switches for brightness/contrast levels.
- ▲ Geniscan gives you the ability to scan images, text or graphics & even offers 200 Dpi Dual Scan Mode..
- ▲ Scan Grey Software included to convert half tone images to true Grey scales. Includes editing, zoom & processing features.
- ▲ Save images in suitable format for most leading packages including PHOTON PAINT, DELUXE PAINT, etc.
- ▲ View window and position control panel.
- ▲ Powerful partner for DTP that allows for cut & paste editing of images etc.

### HANDY SCANNER

£79.99 With FREE PHOTON PAINT

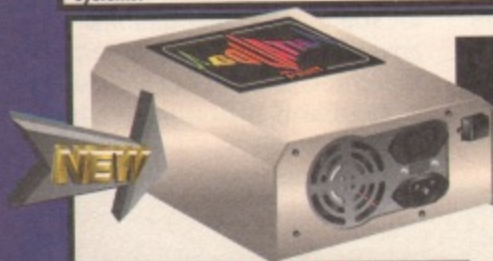

### GOLIATH POWER SUPPLY

£44.99 3 times the power of a standard power supply

## GOLIATH

### GOLIATH HAS THE POWER

Goliath is a direct power supply replacement with a difference! If you have an Amiga with a large harddrive, extra memory, accelerator board or indeed any powerful add-on then a standard Amiga power supply just cannot cope. The Goliath packs more

- ▲ Fan cooled.
- ▲ Heavy duty case.
- ▲ Switch mode electronic system.
- ▲ Full 200 watt output.
- ▲ On/Off switch.
- ▲ 13 Amp uk approved mains lead.
- ▲ Direct plug-in replacement.
- ▲ Also available for cd 32.

### AMAZING 200 WATTS OUTPUT!

## THE ANSWER TO ALL YOUR DISK BACKUP PROBLEMS



SYNCR0 EXPRESS is a sophisticated hardware and software package that works by directly controlling your second drive as a slave device ignoring the Amiga's own disk drive controller. This way SYNCR0 EXPRESS delivers power to backup programs, when other backup systems fail.

- ▲ The most powerful disk backup system ever conceived.
- ▲ Very simple to use requires no user interface.
- ▲ Powerful "SYNCR0 MODE" actually synchronises your drives to achieve even greater backup power!
- ▲ Menu driven selection of start/end track. Upto 85 tracks.
- ▲ Totally "transparent" hardware switches out automatically when not in use.

### SYNCR0 EXPRESS

£34.99 For A500/600/1200

NOW VERSION 5.0

WARNING 1988 COPYRIGHT ACT

It is illegal to make copies, even for your own use, of copyright material, without the given permission of the copyright owner, or the licensee thereof.



# Pro ACTION REPLAY

Designed and Manufactured by DATEL ELECTRONICS

# FOR THE AMIGA A1200



# DATEL DIRECT

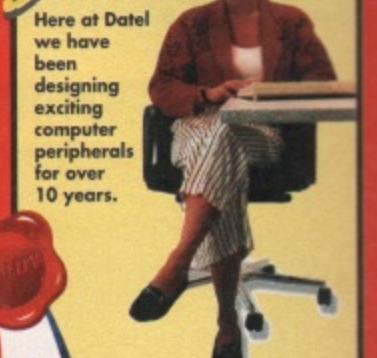

Here at Dattel we have been designing exciting computer peripherals for over 10 years.

By dealing direct with the manufacturer you can be sure we offer the latest products at the keenest prices.

Our sales and technical staff will be pleased to advise you and we will deliver your order to your door within days. Why not give us a try.

## AMPLIFIED STEREO SPEAKERS

YOUR AMIGA HI-FI STEREO SOUND. WHY PLAY THIS THROUGH A SMALL TV SPEAKER WHEN YOU CAN HAVE FANTASTIC HEAD-BANGINGLY GLORIOUS ARCADE STEREO?

**10 WATTS**  
**£14.99**

Logic 3  
MAGNETICALLY SHIELDED

▲ Blasts out 10 watts of power!  
▲ Clip onto your TV/ Monitor.

**50 WATTS**  
**£34.99**

Logic 3  
MAGNETICALLY SHIELDED

## AMIGA VIDEO INTERFACE

This Amiga video interface allows you to output S-VIDEO or COMPOSITE PAL from your Amiga.

- ▲ Connects to Amiga monitor port. Thru connector allows standard Monitor to be connected simultaneously
- ▲ Separate output gives S-VIDEO or COMPOSITE PAL output (please state which required)
- ▲ Ideal for many video applications including titles etc.
- ▲ Allows Amiga to be used with any SCART TV if you don't have an Amiga monitor

**VIDEO INTERFACE**  
**£34.99**

**DATEL DIRECT**

GOVAN ROAD,  
FENTON INDUSTRIAL ESTATE,  
FENTON, STOKE-ON-TRENT,  
ST4 2RS, ENGLAND

**01782 744707**

## NOW PLAY YOUR FAVOURITE GAMES TO DESTRUCTION!

**ACTION REPLAY GIVES YOU THE POWER TO FREEZE ANY PROGRAM AND TAKE TOTAL CONTROL!**



**A1200 ACTION REPLAY**  
**£59.99** Amiga1200

Very simple to use - Just press the freeze button to take total control of the frozen program in memory.

- NEW** Save the entire program in memory to disk or even hard disk. The saved program will reload and run from the point where it was frozen. Perfect to transfer disk games to hard drive to load in seconds!! \*
- NEW** Game trainer feature gives you the power to find cheats within any game. Infinite LIVES, ENERGY, LEVELS etc. Ultimate GAME BUSTING POWER.
- NEW** Screen Grabber option lets you freeze and save screen to disk. Pictures saved in IFF format suitable for all leading graphics packages.
- NEW** Powerful monitor functions give you all the tools to freeze and hack the program in memory. Full 68020 assembler/disassembler. Breakpoint & trace- single step commands Remember that ACTION REPLAY lets you view the program in it's frozen state- no other toolkit can offer this feature.
- NEW** Powerful hardware features custom logic and on-board scratch ram so **No AMIGA MEMORY IS USED.**
- NEW** Works with up to 8 megs of Amiga RAM!
- NEW** Very simple to install... Just plug into A1200 trapdoor.

**HARD DISK SUPPORT**

## TRANSFER YOUR DISK PROGRAMS TO HARD DRIVE!

\*Works with most games.

**01782 744707**  
**24hr Mail Order Hotline**



**8 BIT SOUND SAMPLER**

**FULL 8 BIT SAMPLING AT A NEW LOW PRICE**

- ▲ Full 8 Bit Sound Sampling System. For A500/1500/2000/2000+
- ▲ Fits into Printer Port.
- ▲ Complete Hardware/Software package including Sound Sampler

**8 BIT SOUNDSAMPLER**  
**£19.99** Amiga 500/ 500PLUS Amiga 1500/2000

**Competition PRO CD 32 JOYPAD**

**CD 32 JOYPAD**  
**£16.99**

- ▲ TURBO FIRE
- ▲ SLOW MO & AUTOFIRE
- ▲ 8 WAY SUPERSWITCH.

**AMIGA HYPERPAD**

**AMIGA HYPERPAD**  
**£12.99**

- 2 BUTTONS EACH WITH SPEED CONTROL
- PERFECT FOR REAL ARCADE STYLE GAMES
- AUTOFIRE SPEED SELECT

**INTERNAL MIDI CARD**

**FULL FEATURE MIDI INTERFACE**

- ▲ INTERNAL MIDI CARD FOR A2000 & 1500
- ▲ Full feature Midi Interface - Midi In, Midi Thru and Three Midi outsockets
- ▲ Opto Isolated.

**INTERNAL MIDI CARD**  
**£19.99** Amiga 2000 & 1500

**REPLACEMENT DISK DRIVE**

- ▲ Top quality external 3.5".
- ▲ Quiet operation.
- ▲ Small footprint slimline design.
- ▲ Built-in anti-click feature.
- ▲ Daisy chainable via thru port.
- ▲ No need for external PSU.

**REPLACEMENT DISK DRIVE**  
**£49.99** Direct Plug-in Replacement

**3.5" INTERNAL FLOPPY DRIVE**

**INTERNAL DRIVE**

Amiga 500/ 500PLUS	Amiga 600/ 1200
<b>£39.99</b>	<b>£49.99</b>

**ACTION LINE BBS**

5 NETWORKED PC'S WITH OVER 10 GIGS OF DATA

ACTION LINE is the biggest and best BBS yet! Over 10 GIGS of data. Loads of game cheats, FC, shareware, images, chat, adverts. Large AMIGA only section - Plus much, much more! All speeds to v32 FAST.

**INSTANT DOWNLOAD NUMBER**  
**0891 516353**  
No subscription- Just pay for the call!

**01782 744707**  
24hr Mail Order Hotline  
**FAX 01782 744292**

**CALL 01782 744707 and we will ship your order same day\***

- ▲ Please add £2.00 per order.\*
- ▲ For next day delivery add £5.00
- ▲ For export orders we will quote shipping at cost via UPS.

**01782 744707**  
24hr Mail Order Hotline  
**FAX 01782 744292**



# GH

offers you our  
**LOWEST Prices Ever**

**AND... GH PERSONAL FINANCE - JUST 10% DEPOSIT WITH NOTHING MORE TO PAY FOR 6 MONTHS!**

PERSONAL FINANCE DEFERRED PAYMENT PLAN FOR PERSONAL INDIVIDUALS VISITING OUR SHOWROOM AVAILABLE ON PURCHASES OVER £500... PAY A MINIMUM OF 10% DEPOSIT NOW, THEN NOTHING MORE FOR 6 MONTHS! During that period you can settle IN FULL (without finance charges) or continue your agreement with normal interest arrangements (ie. Direct Debit APR 27.8%/2.07% per Month, Payment Book 32.4%/2.37% per Month). And... for the first 6 months you'll also receive FREE Agreement Life Cover. Written details available on request.

Subject to status and an £18 arrangement fee. Please contact us prior to visiting for Easy Application requirements.



### AMIGA TECHNOLOGIES

**AMIGA 260Mb HD SURFER PACK £569.95**  
A1200 + 260Mb Hard Drive + 14400 Internal Modem (with Internet Web Surfer, Tele Conferencing, E-Mail & STP File Transfer sw), Wordworth V4SE, Dastore 1.1, Organiser 1.1, Turbocak 3.5, Personal Paint V6.4

**AMIGA MAGIC PACK £394.95**  
A1200, Wordworth V4SE, Dastore 1.1, Organiser 1.1, Turbocak 3.5, Photogenics 1.2SE, Personal Paint V6.4, Pinball Mania, Wizz & Print Manager

**AMIGA 170Mb HD MAGIC PACK £494.95**  
A1200 + 170Mb Hard Drive plus the "Magic Pack" software (shown above) and Scala MM300

**Amiga 1438s Monitor £294.95**

### PROGRAB

**ProGrab 24RT Plus £129.95**  
**ProGrab PCMCIA Interface £34.95**  
**Sampler Stereo £19.95**  
**Stereo Hi-Fi Sampler Use with ProGrab via PCMCIA or use any other sampler software £24.95**  
**Teletext Decoder £44.95**

### GENLOCKS

**ProGen Plus Genlock £149.95**

### CD32 PRO MODULE

**CD32 Pro Module - Upgrades CD32 to Amiga A1200 spec inc... RGB Monitor Connection, Real Time Clock, Parallel and Serial (25 Pin) Interfaces, Socket for PLCC FPU, IDE HD Bay & Controller, External Floppy Drive Connector, PS2 Simm Socket, PC-AT Keyboard Socket, Allows simultaneous use of FMV card £239.95**

### BLIZZARD

**1220/4 - 28MHz - A1200 £199.95**  
**Add 4 - 4Mb Board for 1220/4 £169.95**  
**33MHz PLCC FPU for 1220/4 £59.95**  
**1230 MkIV - 50MHz - A1200 £179.95**  
**50MHz PGA FPU for 1230 MkIV £99.95**  
**1260 - 68060 Turbo - A1200 £599.95**  
**2060 Turbo inc. SCSI-2 - A1500/2000 £699.95**  
**SCSI-IV Kit - SCSI-2 for 1230 MkIV & 1260 £89.95**

### CYBER PRODUCTS

**CyberVision 64 - 2Mb - A3000/4000 (& T's) £299.95**  
**CyberVision 64 - 4Mb - A3000/4000 (& T's) £399.95**  
**CyberStorm II 68060 - A3000/4000 (& T's) £699.95**  
**SCSI II Kit - For CyberStorm II £99.95**  
**SCSI Fast and Wide Module £149.95**  
**SCSI II Kit - For CyberStorm II (Available - April/May 1996) £169.95**

### SIMM MEMORY

**4Mb SIMM 70ns £102.95**  
**4Mb SIMM 60ns £109.95**  
**8Mb SIMM 70ns £198.95**  
**8Mb SIMM 60ns £229.95**  
**16Mb SIMM 70ns £351.95**  
**16Mb SIMM 60ns £389.95**

### AMIGA MEMORY BOARDS

**Pro RAM 512K with Clock £29.95**  
**500 Plus 1Mb £29.95**  
**600 1Mb (No Clock) £29.95**  
**600 1Mb with Clock £39.95**

### SCANNERS

**Epson GT 5000 £CALLI**  
**Epson GT 8000 £CALLI**  
**UMAX 56e £CALLI**

*Additional Scanning Software Required*

### FLOPPY DRIVES

**Amitek External 1.76Mb £84.95**  
**Amitek External 880K £59.95**  
**Amitek Internal 880K for A500/500+ £39.95**  
**Amitek Internal 880K for A600/1200 £44.95**

### AMIGA INTERNAL HDs

**Self Fit 2.5" A1200 IDE Hard Drives...**  
**540Mb Self Fit HD £249.95**  
**810Mb Self Fit HD £329.95**  
**1Gb (1000Mb) Self Fit HD £399.95**  
**GH Fitting Service - We collect your A1200, fit the HD and Re-Deliver £CALL**

### CD ROM DRIVES

**NEC External Twin Speed & Squirrel £169.95**  
**D2 External Quad Speed & Squirrel £289.95**

### DOT MATRIX PRINTERS

**Citizen ABC Colour inc. Cable £149.95**  
**Citizen ABC Sheet Feeder £34.95**  
**Citizen ABC Tractor Feed £34.95**

### INKJET PRINTERS

**Canon BJ30 inc. Cable & Driver £184.95**  
**Canon BJC70 inc. Cable & Driver £289.95**  
**Canon BJ200ex inc. Cable & Driver £209.95**  
**Canon BJC610 inc. Cable & Driver £409.95**  
**Canon BJC4000 inc. Cable & Driver £289.95**  
**HP DeskJet 340 inc. Cable & Driver £224.95**  
**HP DeskJet 600 inc. Cable & Driver £239.95**  
**HP DeskJet 660 inc. Cable & Driver £319.95**  
**Epson Stylus Colour II inc Cable £269.95**  
**Epson Stylus Colour II inc Cable £334.95**  
*(Studio II required for 720dpi printing on Epson Stylus IIs)*

### PRINTER CONSUMABLES

**Citizen 9 Pin Mono Ribbon £3.95**  
**Citizen 24 Pin Mono Ribbon £3.95**  
**Citizen 9/24 Pin Colour Ribbon £12.95**  
**Epson Stylus Colour - Mono Cartridge £13.99**  
**Epson Stylus Colour - Colour Cartridge £29.95**  
**Epson Stylus Colour II - Mono Cartridge £17.99**  
**Epson Stylus Colour II - Colour Cartridge £24.95**  
**HP DeskJet 300/500 - Mono Cartridge £23.95**  
**HP DeskJet 300/500 - Colour Cartridge £26.95**  
**HP DeskJet 600/660 - Mono Cartridge £23.95**  
**HP DeskJet 600/660 - Colour Cartridge £25.95**  
**HP DeskJet 340 Portable - Mono Cart. £20.95**  
**Canon 600E - Black Hi Capacity Cart. £10.45**  
**Canon 600E - Cyan Cartridge £9.45**  
**Canon 600E - Magenta Cartridge £9.45**  
**Canon 600E - Yellow Cartridge £9.45**  
**Canon 600E - C, M, Y, K, 4 Pack £35.45**  
**Canon BJC4000 Black Tank £6.95**  
**Canon BJC4000 Colour Tank £13.95**  
**Canon BJC4000 Black Cartridge £24.95**  
**Canon BJC4000 Colour Cartridge £29.95**  
**Canon BJ10/BJ200 Black Cartridge £16.45**  
**Canon BJ30 Cartridge £32.95**  
**Canon BJ30 Tank - 3 Pack £13.95**  
**Canon BJC70 Colour Cartridge £37.95**  
**Canon BJC70 Colour Tank £16.95**  
**Canon BJC70 Black Tank £11.95**  
**Canon 800/820 Black Cartridge £16.95**  
**Canon 800/820 Cyan Cartridge £21.95**  
**Canon 800/820 Magenta Cartridge £21.95**  
**Canon 800/820 Yellow Cartridge £21.95**

### MODEMS

**US Robotics Sportster 14.4 (NCOM) £139.95**  
**US Robotics Sportster 28.8 (NCOM) £194.95**  
**Motorola Modem 28.8 (NCOM) £179.95**

### MICE/TRACKBALLS/JOYSTICKS

**Mega Mouse II 400dpi - 2 Button £10.95**  
**Mega Mouse II Plus 400dpi - 3 Button £12.95**  
**Alfa Data Optical Mouse £28.95**  
**Alfa Data Trackball £32.95**  
**Python Joystick £10.95**  
**Zipstick Joystick £11.95**  
**Saitek Megagrip II £10.95**

### FLOPPY DISKS

**10 - Bulk Unbranded 3.5" DD £3.95**  
**50 - Bulk Unbranded 3.5" DD £15.95**  
**10 - TDK/Sony 3.5" DD £6.95**  
**50 - TDK/Sony 3.5" DD £29.95**  
**10 - TDK/Sony 3.5" HD £6.95**  
**50 - TDK/Sony 3.5" HD £29.95**

### AMIGA BOOKS

**Total ARexx £21.95**  
**Total Amiga Workbench £19.95**  
**Total Amiga DOS £21.95**  
**Total Amiga Assembler £24.95**  
**Total Amiga C £21.95**  
**Total Amiga Beginners £19.95**

### AMIGA SOFTWARE

**Worms £21.95**  
**Colonisation £25.95**  
**Approach Trainer £26.00**  
**Sensible Soccer 95/96 £24.95**  
**Championship Manager II £CALL**  
**FIFA Soccer £24.95**  
**ZEE Wolf II £24.95**  
**All Terrain Racing £21.95**  
**Alien Breed Tower Assault £14.95**  
**Alien Breed 3D £24.95**  
**Theme Park AGA £32.95**  
**Space Hulk £14.95**  
**Leading Lap £CALL**  
**Zuas Legacy £CALL**  
**Photogenics £54.95**  
**Studio II £49.95**  
**Dev Pac 3 £69.95**

### SOFTWOOD PRODUCTS

**Final Calc £99.95**  
**Final Writer 4 £74.95**  
**Final Writer 4 Lite £39.95**  
**Final Data 3 £39.95**  
**French Dictionary (FW 4 Full ONLY!) £19.95**  
**German Dictionary (FW 4 Full ONLY!) £19.95**  
**Norwegian Dictionary (FW 4 Full ONLY!) £19.95**  
**EPS Clip Art Packs... £29.95**  
**Accepts £29.95**  
**Animal 1 £29.95**  
**Animal 2 £29.95**  
**Birds £29.95**  
**Business 1 £29.95**  
**Business 2 £29.95**  
**Education £29.95**  
**Fish £29.95**  
**Flowers £29.95**  
**Food £29.95**  
**Holiday £29.95**  
**Insects £29.95**  
**Nautical £29.95**  
**Sampler £29.95**  
**Sports £29.95**  
**Tools £29.95**  
**Travel £29.95**

### ACCESSORIES

**Zi-Fi Pro Speakers £54.95**  
**Amitek Amiga Modulator £34.95**  
**Amiga Power Supply £34.95**  
**Mouse Mat £4.95**  
**Parallel Printer Cable - 1 Metre £4.95**  
**Mouse Mechanic - Mouse Cleaner £4.95**

GH is a family business established in 1955, supplying systems since 1982. With over £40 million worth of units supplied, and a quarter of a million happy customers, our trading record leaves others standing!

**SO, HOW DO YOU DECIDE WHERE TO BUY YOUR AMIGA EQUIPMENT?**

That's the question we asked in a recent survey. When given a choice of ten categories, customer TOP THREE priorities were...

**No. 1 PRICE**  
At GH you'll get the BEST overall deal... Look at our prices, combine them with our service, and you'll see we're Number 1 for... **No's 1, 2 & 3!**

**No. 2 SERVICE**  
This is OUR No. 1 priority for YOU!

**No. 3 PRODUCT CHOICE**  
Everything for your Amiga. If it's not listed just phone and tell us what you need!

**HOW TO ORDER FROM GH...**

**PHONE GH...**  
We accept all major credit/debit cards with NO TRANSACTION SURCHARGES.

**POST OR FAX...**  
Please include your Name, Address and preferably a daytime and/or evening telephone/fax number with your requirements. If using a debit/credit card include its number and valid from/expiry date (and issue number with Switch cards). Make cheques payable to Gordon Harwood Computers Limited.

**GH PRICES...**  
Prices include VAT, at the standard rate of 17.5%, for all UK and EC customers. UK overseas Armed Forces Personnel may be exempt VAT - please ask for details.

**DELIVERY...**  
We offer prompt shipment with fully insured express delivery options throughout the UK, Europe and Worldwide at a very modest cost. If ordering by mail, please call to confirm delivery charges.

**GH WARRANTY...**  
Manufacturers' standard warranties apply or, ask about GH's comprehensive extended options. Please ask GH for full details.

Whilst our standard warranty cover is comprehensive, we also offer enhanced and extended warranties too. If you require a fast collection service for minimal down time... ask for details then choose an option that suits your particular needs best. Our 'Gold Service' is priced from as little as £10!

**Lifetime Warranty Plan** for equipment used at home (ie not on commercial premises)... Add an extended warranty to any hardware from GH. Take up to 5 yrs cover and at the end of that period extend again on an annual basis, you get a lifetime peace of mind. Schemes even cover for accidental damage as well as break down. Fully transferrable should you wish to sell your equipment so enhancing resale values. Even available on certain hardware purchased elsewhere. Please GH for details.

Manufacturers' specifications and GH prices are correct at time of going to press, however, they may fluctuate and we therefore reserve the right to amend them - confirm prices before ordering. This advertisement is an invitation to visit, not an offer to sell. Goods are not supplied on a trial basis. All transactions are subject to Harwood's Terms and Conditions of Sale, a copy of which is available on request. EGO.E.

**VISIT THE GH SHOWROOM...**  
where our massive range of Amiga hardware, software and accessories are all available OFF THE SHELF!  
We're open Monday to Saturday 9.00am until 5.00pm

**HOW TO FIND US...**



**VISIT OUR SHOWROOM...**

**ALL PRICES INCLUDE VAT AT 17.5%**

If you can't visit us personally, why not ask for an Application Pack for a convenient, flexible **GH BUDGET ACCOUNT CARD**. No Deposit and repayments over convenient periods can be arranged by mail. Once established, you can purchase with your new card and leave existing credit card limits intact!

We supply all Government and Education Departments along with Major PLCs. Call GH now for a rapid response to your Quotation requests!

Why don't you use our new... **GH Email Internet address gharwood@eworld.com**



For your protection all Credit Cards are Security Checked

# Harwood Computers

## 01 773 836781

Dept. GUA/A2, New Street, Alferton, Derbyshire. DE55 7BP FAX: 01 773 831040



# Premier Manager 3 Deluxe

Price: £TBA Publisher: Gremlin © 081 988 8888

**G**remlin's Premier Manager series has been on the go for donkeys years and is one of the most popular footy games ever. We haven't seen anything from this Sheffield based software house for nearly a year now so a parcel thus post marked and obviously filled with a box created a bit of a stir. The last item they sent us was Premier

Manager 3 Multi Edit, a support program for the PM3 series. Just what could this be?

Not to be outdone by SWOS, Player Manager and Ultimate Soccer Manager Premier Manager 3 has had the latest teams and league structures bolted on to bring it bang up to date with the 1995/1996 season. The basic game remains the same though and they've been good enough to supply the original manual.

In fact the packaging is pretty comprehensive: it's nice to see that Gremlin aren't trying to do what is definitely, possibly, maybe, their last Amiga game on the cheap ... though the fact that they claim to have sold over half a million of the various versions of this one program so far may have something to do with this too.

The Multi Edit software

released last year is included in this version too. This means you're getting two programs. The Multi Edit is not a data or update disk, it is designed to operate separately, creating save games for the full program. This it does well, allowing you to create your own scenarios and even edit the on-screen text and messages.

Premier Manager 3 stands the test of time. As a comprehensive football management sim it is still one of our office favourites, alongside On The Ball and Ultimate. When originally launched we felt that it was a little too like PM2 for comfort, and if anyone took our advice at that stage then now might be the time to upgrade as the Multi Editor does make this package more interesting. The only problem marking this game is the fact that Gremlin have supplied it to us with no fixed price. If someone sells it for under £20 and you're in



the mood for an upgrade it's good value. At £25 or more you might do well to wait and see if Domark's Championship Manager 2, the only genuinely new sim on the way, has the necessary oomph to tackle you by the short and curlies. ■

AD

C037  
A500  
A500+  
A600  
A1200  
A1500  
A2000  
A3000  
A4000

83%

# World Golf

Price: £14.99 Publisher: Apex Systems © see text

**Q**uote of the month: "I played the cover disk demos of Sensible Golf, and frankly, I wasn't impressed." So writes Mr David Kirk of Apex Systems. Of course, the difference between Mr Kirk and most unimpressed readers, is that he actually did something about it - he went and wrote his own version. Oh yes ...

It is indeed true, for here before us we find World Cup, an

interesting little offering that comes courtesy of mail order only for the bargain price of £15. There are five famous courses to choose from (Castle Pines, Gleneagles, Little Aston, Muirfield Village, and Wentworth), 63 individually skilled computer opponents to challenge, and the option of up to four human players. There's also an auto-caddie option, where the computer points you in the right direction and selects the correct club for you.

The game format is nothing particularly new, with the good old power-bar making an appearance and, on the whole, it all holds together well. The presentation is nice and clear, the sound effects are as effective as I guess it's possible to be with a big empty field, and everything works as well as you'd expect. It's just that it's a bit unremarkable.

The graphics are simple, but

don't really offer the player much in the way of reward, while the gameplay is a bit too basic to warrant any striking comment. It really is just a straight forward cross between Sensi Golf and the millions of other golf games we've seen over the past few years.

Because it's so plain, there's nothing to rave over and, similarly, nothing to really moan about. The only possible complaint (and where perhaps Mr Kirk should have a look at Sensi) is that the scale doesn't change when you get onto the green, making accurate targeting and power selection a lot less controllable. There's also a problem when, if you are right by the hole but technically off the green, it defaults to irons, leaving you to misjudge and tonk the ball over the other side again (and I don't remember golf



balls bouncing like ping pong balls either!)

As for Mr Kirk saying that he made this game because he was disappointed with Sensi, well, I think it's a 'people in glass houses' situation. Should you fancy a copy of World Golf, you'll want to send £14.99 to Apex System, 8 Gosling Gate Road, Goldthorpe, Rotherham, South Yorkshire S63 9LU. ■

MB

C037  
A500  
A500+  
A600  
A1200  
A1500  
A2000  
A3000  
A4000

62%





VAMP

She's mean, moody and magnificent and knows more about things that go 'bump' in the night than she should. If you are at your wits end with an adventure problem turn to Vampyra for help.

## Dungeon Master II

I am having trouble getting the last Clan piece from the revolving table in the castle between the spooky trees. Each time I go near the table it revolves and moves the piece to the opposite side of the table. How can I get to it?

Jim Laver, Hatfield.

*Would it help if I pointed out that this table is like all the tables which you found in the shops? Think back to how you got the table in the shop to revolve and give you what the shopkeeper had placed at his side? Stupid boy!*

## Maniac Mansion

I have a walk-through guide for Maniac Mansion and all was going well until it said 'walk to the hatch in the man-eating plant room and use the plant to climb into the room above'. After this I was to use the telescope in the room above but I can't get through the hatch as the plant stops me. Could you put me out of my misery?

Craig Ashton, Leicester.

# Adventure Helpline

*Your walk-through was probably written by the same person who wrote the recipe for Dragon Stew. It says, 'first catch and kill a dragon'. The trick is to first make the plant grow by using a jar of pool water on it. Next use a can of Pepsi on it to kill it stone dead.*

## Police Quest II

I'm stuck in Cotton Cove with my partner Keith and Officer Gelespi. There is also a girl present and I've talked to her about the blood. I would like to know how to get past Bains who appears from nowhere when I go up river. When I get killed I get the message: 'make sure sights are set properly and aim gun at the target.' What does this mean?

K. Dodd, Park Village.

*Well you are suffering from one of two options. Either you couldn't hit a cow's bum with a banjo while holding its tail or the sights on your gun need adjusting. Let's be charitable and guess that you haven't been to the shooting range today and adjusted your sights. In fact I'll bet a sloppy kiss to a pint of your blood that that's the answer to your problem. In this game you must go to the shooting range every day and successfully reset your sights or you will die later on.*

## Operation Stealth

I bought Operation Stealth two months ago and I'm finding it extremely difficult. I have passed through the four labyrinths and have ended up stuck in an office. I have no clue what I'm going to do next. I have a little box, a watch, an electric razor, an electric cable and a pen. Can you help me?

Alexandre Valerio, Portugal.

*I'll assume that you are in the*

*Palace. If this is true and you are in the office with the statue, then your next move is to 'operate' the arm of the statue to reveal a safe. You can now use the little box on the safe, and operate the on/off button to switch it on. Operate the up and down arrows until the first light on the box illuminates. Operate the validation button on the safe. Operate the up and down buttons until the second light on the box lights up. (Do this again for the third and fourth numbers). Operate the on/off switch on the box to switch off and take it. Operate the validation button on the safe again and it will open.*

## Drakkhen

I have the eight tears from the Drakkhen Princes and Princesses but there is mention of a ninth hidden tear. Where is it?

Alan Goodridge, Barnsley.

*I cannot tell I lie, I don't know. Maybe a reader could help if they knew. However, I do know quite a few clever tricks for this game, so I thought at least I would help you as much as I could. When you create a character and it asks for a name use 31415927<Return>. Now type SUPERVISOR<Return>. Continue as normal and you will get a very powerful character. Once you have done this you can press F10 during the game and your Magic and Hit Points will go to maximum. Even better, press and hold F9 while you right-click at the bottom of the dialogue window. This calls up Supervisor mode. You could now summon any monster by 'clicking' on their names but I wouldn't recommend that! Release F9, press and hold F8 while you again click in the same place and your character will be miraculously changed into a super-hero. A bit like me really.*

## Monkey Island II

I need help to get a map piece which I believe is under the cottage on the small island off Phatt

Island, but the bloke upstairs is giving me grog that makes me incapacitated. I have tried emptying my mug on the tree but the guy keeps refilling it with his own. I can't think how to win this so-called competition. Please help?

C. Dutton, Clwyd.

*If I had a penny for each time someone tried to get me 'incapacitated' by forcing me to drink too much I would be a rich girl. Happily it's me who usually ends up drinking from the 'mugs' who try. The trick is not to let the guys realise that you have an empty glass, because they just fill it up again. What you must do is empty your mug on the tree, then quickly fill it up with near-grog which isn't alcoholic.*

## Simon The Sorcerer

Can you tell me how to pick up the woodworms so I can get the staff?

Lauren Eames, Gillingham.

*You don't pick up the woodworms you foolish child, you talk to them and they tell you things. Which reminds me, do you know why girls are called birds? Because they pick up worms. ■*

If you've got a little problem with your favourite Role Playing Game and would like Vamp to help you out, drop her a line at CU Amiga Magazine, Priory Court 30-32 Farringdon Lane, London EC1R 3AU.



A TRIED AND TESTED CURE FOR INSOMNIA. IS TO GET PLENTY OF SLEEP.



# LOWEST PRICED TOP QUALITY RIBBONS, INKJETS, TONERS & DISKS

## Printer Ribbons

BLACK				BLACK					
10ff	2+	5+	10+	10ff	2+	5+	10+		
Amstrad DMP 2000/3000	2.80	2.65	2.45	2.25	Panasonic KXP 1123/1124/1140	3.46	3.31	3.11	2.91
Amstrad DMP 4000	3.66	3.51	3.31	3.11	Panasonic KXP 1060/1180/901/992	2.89	2.74	2.54	2.34
Amstrad PCW8256/8512/LQ3500	2.85	2.70	2.50	2.30	Panasonic KXP 2123/2180	4.95	4.80	4.60	4.40
Brother M1008/1024/1109/1209	3.90	3.75	3.55	3.35	Seikosha SL9092/95	5.70	5.55	5.35	5.15
Citizen 120D/LSP10/5with 249	2.85	2.70	2.50	2.30	Star LC10/20/100	2.29	2.14	1.94	1.84
Commodore MPS 1220/1230	4.50	4.35	4.15	3.95	Star LC200	3.00	2.85	2.65	2.45
Epson LQ100	4.10	3.95	3.75	3.55	Star LC24-10/200	2.86	2.71	2.51	2.31
Epson LQ400/500/800/850	3.45	3.30	3.10	2.90	Taxan Kaga KP810/815/910/915	3.14	2.99	2.79	2.59
Epson FX/MX/RX/80/FX/LX/800	2.90	2.75	2.55	2.35	<b>COLOUR</b>				
Epson FX/MX/RX100/FX/MX1000	3.36	3.21	3.01	2.81	Citizen Swift 24	11.95	11.80	11.60	11.20
Epson LX80/86/90	2.12	1.97	1.77	1.67	Panasonic KXP2123/2180	10.63	10.48	10.28	9.88
Mannesman Tally 80/81	3.90	3.75	3.55	3.35	Star LC10/20/100	6.00	5.85	5.65	5.25
NEC Pinwriter P2200	3.03	2.88	2.68	2.48	Star LC200	9.78	9.63	9.43	9.03
OKI ML182/183/192/193/195	3.17	3.02	2.82	2.62	Star LC24-10/200	9.63	9.48	9.28	8.88

Ring for Ribbons Not listed

## Ring us and WE WILL BEAT all other Ribbon prices

3.5" Disks & Disks Boxes		Inkjets, Ink Refills & Toners	
DS/DD	DSHD		
10 Disks	£5	£6	100 Cap. Lockable Disk Box
25 Disks	£10	£11	£5.99
50 Disks	£16	£18	with orders of £10+
100 Disks	£29	£33	
250 Disks	£65	£76	
500 Disks	£125	£148	

Preformatted (MS DOS) disks available at 2p extra/disk  
All disks Certified 100% Error Free and INCLUDE FREE Labels.

Miscellaneous Items		CPU & Monitor Dust Cover	
Roll 100 3.5" Disk Labels	8.99	CPU & Monitor Dust Cover	6.49
3.5" Disk Cleaning Kit	2.99	Monitor Dust Cover	4.99
Parallel Printer Cable (1.8m)	3.99	80 Column Printer Dust Cover	3.99
Mouse Mat	2.99	Amiga 500 Dust Cover	3.99
		Amiga 600 Dust Cover	3.99
		Amiga 1200 Dust Cover	3.99

All Prices INCLUDE VAT (@ 17.5%) & UK Delivery

**01543 250377** **01543 250377**

Ring us or send cheques to:  
Owl Associates, Dept 431, Owl House,  
5 The Brambles, Lichfield, Staffs WS14 9SE

E& OE

# HOW TO ATTRACT GIRLS

EVERYTHING you need to know!

Two unique new illustrated guides, reveal all the secrets and techniques that can bring you sex-cess with women - OR YOUR MONEY BACK!

## 1. HOW TO PICK UP GIRLS

REVEALS: • The best pick-up techniques. • Over 100 fantastic opening lines • How to instantly attract girls you have only just met. • A simple rule that will triple the number of dates you get. • Fool-proof conversation techniques. • How to win over "hard to get" girls. • How to date exceptionally beautiful girls. • How to be so great on dates girls will want to be with you again and again - and much, much more!

£12.95 postpaid.

44 Soft cover, 72 pages

## 2. HOW TO SUCCEED WITH GIRLS

REVEALS: • More brilliant "pick-up" techniques and opening lines. • How to become "sexually attractive". • Secrets that girls will never tell. • What really turns a woman on. • The art of seduction revealed. • What you need to know to be "G.I.B." (Great in Bed). - and much, much more!

£12.95 postpaid.

44 Soft cover, 64 pages

User reports confirm success:

"Just two days after receiving your guides I picked up the most beautiful girl I had ever spoken to in my life. It was something that one week earlier would have been impossible."  
- D.S., London

"My only disappointment is that it's available to other men and I can't keep what I've learnt all to myself!"  
- D.B., Hemel Hempstead

**MONEY BACK GUARANTEE: If your not 100% delighted you may return either guide for a full no-questions-asked refund!**

Credit card holders may phone **01534-61 71 81** (24-hr answerphone)  
**CASUTI LTD., PO BOX 115, 20 BRITANNIA PLACE, ST. HELIER JE4 8QQ**

YES! I want to be successful with girls. I understand that if I'm not 100% satisfied with the goods I receive I may return them in good condition for a full refund. On that basis please send me:

HOW TO PICK UP GIRLS - Price £12.95 inc. p&p.  HOW TO SUCCEED WITH GIRLS - Price £12.95 inc. p&p.

I am ordering both of the above at the special combined price of just £20 inc. p&p.

I enclose a cheque/PO for £..... payable to CASUTI LTD. (foreign orders add £3) or debit my ACCESS/VISA/MASTERCARD

Acc. No. \_\_\_\_\_ Expires \_\_\_\_\_

Name \_\_\_\_\_ BLOCK CAPITALS PLEASE

Address \_\_\_\_\_

Post Code \_\_\_\_\_

**CASUTI LTD., PO BOX 115, 20 BRITANNIA STREET, ST. HELIER JE4 8QQ**  
All orders are discreetly despatched under plain cover.

# Pic 'n' Mix GRAPHICS



Why be tied to taking "Pot Luck" when buying ClipArt? Now YOU can select your own preferences from the comfort of your own home. Choose from over 3000 images in over 40 Categories. Give yourself a break and TRY BEFORE YOU BUY! Available in Formats suitable for all Amiga Programs (Hi-Res Bitmapped or Scaleable) All images are 8 to 256 Colours....suitable for both Colour and Mono Printers. All clips are artist drawn.....no scanned or traced images here!



## INK JET REFILLS

REFILLS (Microfiltered Non-Clog Formula) all Colours from 87p per refill COMPATIBLE CARTRIDGES As good as original...but cheaper! from £4.99

We have been supplying our Customers with Refill Inks for many years, and most of our sales are re-orders. We demonstrate the quality of our Inks by providing a FULL COLOUR PRINTOUT with every Information Pack. Who else does this?

# SELECTAFONT

# Pic 'n' Mix FONTS

- BEEVOUSE CHILLI
- CHINESE BUBBLES HEADHUNTER STEEL
- INDIANAJ KEYBOARD STAR
- BLOCK WHARMBY
- WOBBLE STARS
- ZARROW CARPE
- SWING POSTCY
- Tiptopet SUBTLE
- Open No RANSOME
- PEACE OREGONWET
- SALTER Miami
- ORIENTAL SHANGHAI SHRAPNEL
- Medusa STENCIL STRETCH
- TOYBLOCK WEDDIE WASHBOOK!
- POWERLINER WEDDIE WHAT A RELIEF

Unlike some of the cheap and cheerful Font CDs and Disks doing the rounds, our Fonts WORK! Select from over 4000 Fonts in both TRUE TYPE or POSTSCRIPT (ATM) and leave the rest up to us!

For Bulk Buyers we offer some very special deals with Fonts from 7p each

We have been in business since 1991 and pioneered the Pic n Mix concept. Our service is unique with a TECHNICAL HELPLINE for all of our valued Customers

For your FREE 46 Page Information Pack, either Write, Phone, or Fax us.

SELECTAFONT (Dept CU)

84 Thorpe Road, Hawkwell, Nr Hockley, Essex. SS5 4JT

FAX: 01702 200062



PHONE: 01702 202835



# EPIC MARKETING SOFTWARE

 <p>Basically this is a 3 disk compilation of tools which should really have been on Workbench. eg: Virus Killer, Fast text editor and displayer. Menu system, File manager. A few Workbench games and more. Only £7.00</p> <p><input type="checkbox"/> <b>SCF7-3. STUFF COMMODORE FORGOT</b></p>	 <p>Text Engine is the easiest to use Wordprocessor package available on the Amiga. It even includes a competent Spell check feature. Suitable for all Amiga's. Only £3.00</p> <p><input type="checkbox"/> <b>TXE3-1. TEXT ENGINE</b></p>	 <p>News maker is a simple to use colour Desktop publishing package. Import your own graphics, text etc. Compatible with all popular printer makes.</p> <p><input type="checkbox"/> <b>NRL4-1. NEWS MAKER</b></p>	 <p>Create your own fascinating 3D magic eye images with ease. This package includes The Random Dot Stereogram generator and a number of ready to use images. Only £3.00</p> <p><input type="checkbox"/> <b>RDS3-1. MAGIC EYE KIT</b></p>
 <p>Professional graphics converters, can convert graphics between the Amiga, PC, Mac &amp; Atari ST. Supports GIF, TIF, IFF, PCX, BMP etc. Kickstart 2 or above recommended. Only £5.00</p> <p><input type="checkbox"/> <b>GFC5-2. GRAPHICS CONVERTERS</b></p>	 <p>A six disk collection of Video titling tools, video wipes, fonts, Video titlers, Subtitle generator, Video backdrops etc.... Suitable for use stand-alone or in conjunction with Scala etc.... Only £12.00</p> <p><input type="checkbox"/> <b>VID12-6. VIDEO TITLING TOOLS</b></p>	 <p>A collection of essential hard drive maintenance tools. Like: disksave 2, HDbackup, HD Menu system, Virus Checker, and dozens more.</p> <p>Only £5.00</p> <p><input type="checkbox"/> <b>HDT5-2. HARDDISK TOOLS</b></p>	 <p>A powerful set of cataloging tools. Catalogue your Record, CD, Video and disk collection with ease, and search on any aspect or field. Suitable for use with Kickstart 2 &amp; 3 only. Only £5.00</p> <p><input type="checkbox"/> <b>CTG5-3. CATALOGUERS</b></p>
 <p>Little Office consists of a powerful Wordprocessing package, a spell checker, A diary system, a name and address database, and a powerful spreadsheet. Kickstart 2 or above. Only £7.00</p> <p><input type="checkbox"/> <b>IFC7-3. LITTLE OFFICE</b></p>	 <p>Around 50 scalable compugraphic fonts for use with Wordworth2&amp;3, Pagestream, Workbench 2&amp;3. High quality printout from 5point upto 100point. Only £7.00</p> <p><input type="checkbox"/> <b>PSF7-3. COMPUGRAPHIC FONTS</b></p>	 <p>If you've just got a new A1200 hard disk then to prep &amp; install it correctly you'll need the correct software. This software comes supplied on 2 disks. If your gonna do it, do it properly. Only £7.00</p> <p><input type="checkbox"/> <b>AHD7-2. A1200 HARD DISK INSTALLER</b></p>	 <p>Dozens of easy to follow recipes. If your a budding Ian Beele or Floyd then this gourmet cookbook is just the thing for you. You'll be a professional in no time. (Be sure you test your cooking on your In-laws first!) Only £3.00</p> <p><input type="checkbox"/> <b>GCB3-1. GOURMET COOKBOOK</b></p>
 <p>If you've just purchased your Amiga you may be a bit bogged how you use it properly. Well this five disk set take you through the CLI/Shell, Workbench step by step showing you every thing you need to know. Only £9.00</p> <p><input type="checkbox"/> <b>ABG9-5. AMIGA BEGINNERS GUIDE</b></p>	 <p>Mono Pagesetter clipart contains hundreds of great mono clipart images for use in any version of Pagesetter. Subjects include: Animals, People, Transport, Hi-tech, Computers, Sports, etc.... Only £3.00</p> <p><input type="checkbox"/> <b>MPC3-1. MONO PAGESSETTER ART</b></p>	 <p>An essential collection of disk recovery &amp; salvage tools for any Amiga. Weather a floppy or your Harddisk has conceived an error this package will see you alright. Easy to use. Only £5.00 KS 2 +</p> <p><input type="checkbox"/> <b>DRT5-2. DISK RECOVERY TOOLS</b></p>	 <p>It's time to put on your shorts and dig the garden. NOT. Now the best way to get out of doing this is to use the excess that you are far to busy designing the garden to actual do it. Only £3.00</p> <p><input type="checkbox"/> <b>GRN3-1. 3D GARDEN DESIGNER</b></p>
 <p>A collection of over 100 popular and more unusual printer drivers. Supports the canon, Panasonic, Star, HP, range of printers aswell as hundreds more.... Very easy to use installation procedure. Only £3.00</p> <p><input type="checkbox"/> <b>DRV3-1. PRO. PRINTER DRIVERS</b></p>	 <p>Miscellaneous colour clipart images. Around 100 in all covering: cats, dogs, cars, trees, planes, boats etc.... Suitable for use in any Paint or Desktop Publishing package. Only £9.00</p> <p><input type="checkbox"/> <b>CCP9-5. COLOUR CLIPART</b></p>	 <p>Word finder Plus is the most powerful AMiga crossword solver available to date. Can solve anagrams, crosswords etc. contains a dictionary of over 50,000 English words, and you can easily add your own. Only £5.00</p> <p><input type="checkbox"/> <b>WFP5-2. WORD FINDER PLUS</b></p>	 <p>There are over 1000 Amiga viruses currently "doing the rounds". So catching one isnt a hard thing to do. This collection of Virus killers is updated regularly. So you can be sure you'll be able to detect and kill all known viruses. £4.00</p> <p><input type="checkbox"/> <b>VIP4-2. VIRUS KILLERS</b></p>
 <p>Over 130 top quality colour images from the Lion King cartoon film. Each image is stored as ready to use IFF so can be imported into ANY paint or Desktop publishing package. Only £6.00</p> <p><input type="checkbox"/> <b>LKA6-3. LION KING CLIPART</b></p>	 <p>Magic Workbench is an innovative replacement Workbench. Gives you a completely new 8 colour updated Workbench. A hard disk is highly recommended. Various extras disks are available separately. Only £3.00</p> <p><input type="checkbox"/> <b>MWB3-1. MAGIC WORKBENCH</b></p>	 <p>Essential for Beginners is a collection of files essential for the smooth uninterrupted use of your Amiga. All the most asked for libraries and Viewers are included like More, Muchmore, PPMore, etc. Only £2.00</p> <p><input type="checkbox"/> <b>EFB2-1. ESSENTIAL FOR BEGINNERS</b></p>	 <p>If you've got a temperamental Amiga the The Engineers Kit is what you need. You can test your Drives, Your Hard disk, Memory, Keyboard, Sound chips, graphics chips, Mouse, joysticks etc.... Only £3.00</p> <p><input type="checkbox"/> <b>ENK3-1. ENGINEERS KIT</b></p>
 <p>The disk doubler can literally double the space available on your hardisk. If you've got an 80mb drive you'll end up with over 130mb. runs on any Amiga silently in the background. Only £5.00</p> <p><input type="checkbox"/> <b>EPU5-2. DISK DOUBLER</b></p>	 <p>An updated 2 disk version.... Contains dozens of DIY hardware kits, like how to fit your A1200 into a mini tower PC case, build your own sampler, memory expansion, CD32 Link lead etc, etc. Only £4.00</p> <p><input type="checkbox"/> <b>HWP4-2. HARDWARE PROJECTS</b></p>	 <p>Three Stratrek games. Includes: Stratrek the Arcade game, Stratrek TNG, and the Original Stratrek. Decompresses to SIX disks. Only £6.00</p> <p><input type="checkbox"/> <b>STG6-3. STARTREK GAMES</b></p>	 <p>Play hundreds of classic Spectrum 48 games on your Amiga. This very easy to use Emulator will run on every Amiga. The faster your machine the faster/smoother the games run.... Games include: Skool daze, Manic miner, Little computer people, Monty mole, Stratrek, The Sentinal, etc.... Pack1. (SPE5-3) <b>Specy em &amp; 50 games.</b> Only £5.00 Pack2. (SPG15-7) <b>100 classic games.</b> Only £15.00 Pack3. (SPG35-33) <b>400 classic games.</b> Only £35.00 Pack4. (SEH40-1) <b>Specy em, 50 games and tape deck interface.</b> Only £40.00 (CD119) <b>Specy CD 3000+ games</b> Only £17.00</p> <p><input type="checkbox"/> <b>SPECCY EMULATORS</b></p>
 <p>The Professional mono clipart collection consists of 10 disks featuring hundreds of VERY high quality mono images. Subjects are included like: Xmas, Animals, Transport, People, Eyecatchers etc. Only £13.00</p> <p><input type="checkbox"/> <b>GFX13-10. PRO. MONO CLIPART</b></p>	 <p>Contains Three superb easy to use Typing tutors for the Amiga. Suitable for the complete beginner or anyone who at the moment types with one or two fingers... Only £3.00</p> <p><input type="checkbox"/> <b>TYP3-1. TYPING TUTORS</b></p>	 <p>Play your old Commodore 64 games on your Amiga. Includes around a dozen of the most loved C64 games and the latest and fastest available C64 emulator. Remember the good old days! Only £5.00</p> <p><input type="checkbox"/> <b>CBM5-2. C64 EMULATOR &amp; GAMES</b></p>	 <p>Startrek Magic Workbench backdrop. An interesting 2 disk collection of Magic Workbench Startrek 8 colour backdrops. If you love Startrek you'll love these. Only £5.00</p> <p><input type="checkbox"/> <b>STB5-2. STARTREK MAGIC WB</b></p>
 <p>The Ultimate Chess &amp; Tutor 2, suitable for any 2mb+ Amiga. Contains tons of inbuilt speech, and great graphics. Suitable for the learner of semi-pro. Only £7.00</p> <p><input type="checkbox"/> <b>JIT7-3. CHESS &amp; TUTOR 2</b></p>	<div style="text-align: center;"> <h2>THE EPIC COLLECTION</h2> <p>Amiga CDROM Version 2</p> <p>Contains Virtually every one of these advertised titles plus thousands more of our most popular floppy based software titles on one giant CD-ROM. Now you can purchase the entire Epic collection in one go. This compilation contains hundreds of megabytes of Amiga software. Features a superb new multimedia Amiga front-end. Categories include: Colour, Bitmap, Compugraphic fonts &amp; Adobe fonts, Graphics converters, Music tutorials, Beginners guide, 3D stereogram generators, Sound FX and samples, Virus Killers, Hard disk installer &amp; tools, Various Hardware projects, Hundreds of games including Shoot'em ups, Mind teasers, Puzzle, card, arcade, board games etc *Supplied with printed Index.</p> <p style="text-align: right;">(CD100x) Only £19.99</p> </div>		 <p>Classic card games consists of around a dozen superb card games like Poker, Solitaire, Craps, Montana, Pontoon, Blackjack, Klondike, Spades, Golf, Rummy and more.... Only £10.00</p> <p><input type="checkbox"/> <b>CRD10-4. CLASSIC CARD GAMES</b></p>
 <p>With this language tutor you could learn to speak either SPANISH, FRENCH, GERMAN, ITALIAN OR JAPANESE. Easy to use, and easy to understand???? all languages inc. Only £8.00</p> <p><input type="checkbox"/> <b>LTP8-4. LANGUAGE TUTORS</b></p>			 <p>A new replacement 2 disk Workbench that features: Startrek icons, Backdrops, and amusing sound samples whenever you do anything wrong. Suitable for Kickstart2&amp;3 machines. Only £5.00</p> <p><input type="checkbox"/> <b>TNG5-2. NEXT GENERATION WB</b></p>
 <p>Hundreds of Very high quality professionally finished colour clip fonts for use in any Paint package. Excellent for Video work, demo making etc. Only £5.00</p> <p><input type="checkbox"/> <b>CCF5-2. COLOUR CLIP FONTS</b></p>	 <p>A collection of Lottery Winners. Help your self beat the Lottery with this superb disk. Every week let your computer generate the Winning? numbers. If you play the Lottery then get this disk..... Only £5.00</p> <p><input type="checkbox"/> <b>LWP5-1. LOTTERY WINNERS</b></p>	 <p>Arcade classics V2 contains variations of classic games like: Space Invaders, Frogger, Missile command, Asteroids, Q-Berts, Omega race, Centrepede etc. Suitable for any Amiga. Only £5.00</p> <p><input type="checkbox"/> <b>ARC5-2. ARCADE CLASSICS 2</b></p>	 <p>Around 100 high quality Amiga Bitmap fonts. Suitable for use with almost any Amiga package, including DPaint, Workbench, etc. Font sizes start at 6pt upto 50pt. Only £7.00</p> <p><input type="checkbox"/> <b>FANTASTIC FONTS</b></p>
 <p>Get your finances in order with this unique collection of home finance software. Keep track of your monthly out-goings: Petrol, Gas, Electricity, Mortgage, Rent etc.... Only £7.00</p> <p><input type="checkbox"/> <b>FIN7-3. HOME FINANCE</b></p>			 <p>Around 100 high quality Amiga Bitmap fonts. Suitable for use with almost any Amiga package, including DPaint, Workbench, etc. Font sizes start at 6pt upto 50pt. Only £7.00</p> <p><input type="checkbox"/> <b>FNT7-3. FANTASTIC FONTS</b></p>

**Order line:**  
**01793 514188**  
 Fax Orders: 01793 514187  
 UK Office, Open Monday-Saturday. EPIC 138-139 Victoria Rd, Swindon, Wilts. UK  
 P&P in UK = 50p total, Overseas P&P = £1 per title, Catalogue disk available @ £1.00

**EPIC MARKETING (AUSTRALIA)**  
 The Epic Collection version2 CDROM (order code: CD100x) is also available from our Sydney based office for just \$40 + \$2.00 P&P.  
 Send your order to:  
**EPIC. 36 Forest Road, Heathcote, NSW. 2233. Australia.**  
 Tel: (61) 620 9509  
 Fax: (61) 620 6077  
 For a CDROM Price list please send a SAE. Please make cheques payable to EPIC MARKETING

**PRIORITY ORDER FORM**

NAME \_\_\_\_\_  
 ADDRESS \_\_\_\_\_  
 \_\_\_\_\_  
 \_\_\_\_\_  
 MACHINE \_\_\_\_\_  
 PAYMENT METHOD \_\_\_\_\_  
 CREDIT CARD DETAILS \_\_\_\_\_  
 EXP DATE \_\_\_\_\_

PLEASE SUPPLY		PRICES INC
ITEMS	QTY	£
TOTAL GOODS VALUE		£
POST & PACKING		£
AMOUNT ENCLOSED		£



# Snip tips



Don't forget, every printed hint gets a free game from the Hit Squad label. Aren't they super?



**Poor Matt hasn't been very well this month, but he's dragged his limp and lifeless body into the office (where he fits in nicely in that condition) just for all you needy readers**

## RoadKill A1200

### Guildhall Leisure

Richard Donnellan from Oldham has found a way to make an easy billion or so in this top racing game. Get a password code such as **LQPONTULRI** (this will get you into the second scenario) and switch the sixth and seventh letters. For example, **LQPONTULRI** will now become **LQPOUNTLRI**. Enter the new password and you should complete level 2-1 with around \$4,000,000,000. You can also try this out with the other password codes - although it works with some and not others.

## Zeewolf 2 Binary Asylum

The up to date stuff is now flooding in thick and fast and J Mc Mahon from Lanarkshire starts us off with level codes for this top flight sim:

Mission	Code
2	Requin
3	Wolfram
4	Fullmoon
6	Ouragan
9	Stag
11	Kraken
14	station
16	GBULL
18	STATIPAUSE
20	DO IT NOW

... And Chris Hands, Shropshire also helps out with even more level codes for Zeewolf 2.

23	SHIPDECK
24	GLOBOFF



▲ Up-to-the-minute cheats for an up-to-the-minute game Zeewolf 2, yee haa! My prayers are answered

26	BEHAVE
28	SHADOW
29	MAX FUEL
30	PELPAY
31	DOMINO
32	STEERDART

## Alien Breed 3D

### Team 17

"Not enough of the recent stuff eh", writes Mick Slingsby of Leicester as he defiantly sends us in his level codes for Alien Breed 3D. Thank you Mick and thanks also to Darren White for his help. Anyway here they are:

Level 2	CMOFFJENPPHFFFFF
Level 3	MIOEDEOPPPFFFFFF
Level 4	KPKOFOPHOEHFFFF
Level 5	NLIAMBOOPHHFFFN
Level 6	FOIINMPCNFFFFFF
Level 7	CCCGIDOPPFEEFFFF
Level 8	PPKKIKKPNAANEOMD
Level 9	LLKOHBLPNAANEOMD
Level 10	BMAGHMLPNAANEOMD
Level 11	HCIGGHLPNAANEOMD
Level 12	LNIECOLPNAANEOMD
Level 13	OLKOPFKPNAANEOMD
Level 14	EOIGLMKPNAANEOMD
Level 15	LKKOPPKPNAANEOMD
Level 16	GNAEPPKPNAANEOMD

## Streetfighter II

### US Gold

Select a one-player game and position the selection box over Blanka but DO NOT press fire.

Instead slowly type the word **PATIENCE**

and you should hear a digitised

voice say 'Cheat'. Now select your character and start the game.

Note that you do not have to choose Blanka as your fighter.



When fighting press F10 at any point during the game to replenish all your energy. Also pause the game and type 7KIDS to be able to play a two-player game against a friend as the same character. Well done Mr Mark Wadham from Cornwall. Incidentally, does anyone remember the old game that used the cheat 7KIDS? Hmm.

## Lotus Esprit Turbo Challenge

### Gremlin

Mr Wadham once again provides the bread ... Enter the following names in a two-player race for automatic qualifying:

- 1) FIELDS OF FIRE
- 2) IN A BIG COUNTRY

Also, for a hidden sub-game enter these two names:

- 1) MONSTER
- 2) SEVENTEEN

## k240

### Gremlin

On the main asteroid screen press the return key and type in 'Loadsadosh' pressing the return key after it for a small sum of money. This can be used as many times as you like to amount to a large sum of money. Cheers to Mark Draper, Stockport for that.

## Road Rash

### Electronic Arts

Mark Wadham, strikes gain. Just type in the following code to receive \$7,815,000:

00001 04310 MSOPC 17PFM

## Worms

### Team 17

Here are few tips from David Minnis, Humberside for that all format favourite game involving hermaphrodites with weapons.

### Sheep mode:

Type 'TOTAL WORMAGE' (two words) on the main screen and



▲ Meet the talking prince in level two, three and four in this adventure from Vulcan.



▲ This game needs no introduction ... and we've got a chockload of cheats for it.

you get a banana bomb, three sheep and a minigun to start with.

### Secret move:

Stand next to a worm (not your own) and then press away, away, towards, towards then do a prod and you get a secret move.

### Two versus two mode:

Select your four players, then select two of them again (they get circles instead of stars) you are now ready to play team worms.

### Changing friction and gravity on custom screen mode:

The standard file name for a custom map is 'name.wxyz.wrm' where w=gravity (1-5), x=friction (1-5), and y and z are sea and colours, respectively.

## Valhalla: Before The War

### Vulcan Software

Here's a few level codes from Linda Soul, Cricklewood, to keep you going...

- 2) PUMEL
- 3) BOMAL
- 4) SAMOL



# EVERGLADE

TEL: 01463 240168

68 TELFORD STREET  
INVERNESS IV3 5LS  
OPEN 9.00am - 5.30pm MONDAY - SATURDAY



## AMIGA DISCOUNT SOFTWARE

	A500	A1200	CD32		A500	A1200	CD32		A500	A1200	CD32
1ST SAMURAI	7.99			FIFA INTERNATIONAL SOCCER	19.99			RUGBY LEAGUE COACH	9.99		
688 ATTACK SUB	10.99			RIGHTER BOMBER	8.99			SABRETEAM	20.99		24.99
A320 APPROACH TRAINER	26.99	26.99		FOOTBALL GLORY	10.99			SENSIBLE GOLF	14.99	14.99	
ACID ATTACK COMPILATION: GUARDIAN, ROAD KILL, & SUPER SKIDMARKS			19.99	GLOOM	12.99		12.99	SENSIBLE WORLD OF SOCCER 95/96	17.99	17.99	
ADAMS FAMILY	8.99			GLOOM DATA DISK	12.99			SHADOWLANDS	10.99		
ALIEN BREED II	19.99	19.99	20.99	GLOOM DELUXE	19.99		18.99	SHAQ FU	19.99		21.99
ALIEN BREED SPECIAL EDITION	9.99	9.99		GLOOM 2				SHUTTLE	12.95	12.95	
ALIEN BREED TOWER ASSAULT	16.99	16.99	20.99	GRAHAM GOOCH 2ND INNINGS	4.99			SIMON THE SORCEROR	20.99		
ALIEN BREED 3D	19.99	19.99		GRAHAM GOOCH DATA DISK 94/95	4.99			SIMPSONS	8.99	8.99	
ALIEN BREED 3D II (030 required)	21.99	20.99	20.99	GUARDIAN	8.99	8.99	8.99	SLEEPWALKER	8.99	8.99	
ALL TERRAIN RACER	19.99	19.99	18.99	HARD NOVA	8.95	8.95		SPACE HULK	10.99	10.99	
AMIDYA	8.99			HOOK	8.95	8.95		SPERIS LEGACY	19.99	19.99	
ARABIAN NIGHTS	8.99	9.99		IMMORTAL	10.99			SPACE HULK	10.99	10.99	
ARCADE POOL	19.99	19.99	14.99	IMPACT	4.99			STAR CRUSADER	19.99		
ARCHER MACLEANS POOL	10.99	10.99		INDIANAPOLIS 500	10.99			STRIKE FLEET	10.99		10.99
BEHIND THE IRON GATE	16.99			JIMMY CONNORS	10.99			SUPER FROG	21.99	21.99	21.99
BATTLE OF THE ASHES	4.99			JIMMY WHITE WHIRLWIND SNOOKER	10.99		10.99	SUPER SKIDMARKS	12.99		12.99
BIRDS OF PREY	12.99			JOHN MADDEN FOOTBALL	10.99			SUPER SKIDMARKS DATA DISK	12.99	12.99	
BLACK CRYPT	10.99			LUNGLE STRIKE	10.99		21.99	SUPER LEAGUE MANAGER			8.99
BULTZ BASIC 2.1		25.99		LURASSIC PARK	10.99		10.99	SUPER STARDUST			21.99
BULTZ BOMBERS		19.99		KGB	12.99		12.99	SUPER TENNIS CHAMPIONS	12.99	12.99	
BODY BLOWS				KID CHAOS	19.99		20.99	SUPREMACY	10.95	10.95	
BODY BLOWS GALACTIC		21.99		KID PIX	10.99			SYNDICATE	12.99	12.99	
BREATHLESS		26.99		KING PIN	10.99		12.99	TACTICAL MANAGER	10.99	10.99	
BUBBLE & SQUEAK	9.99	9.99	8.99	LOMBARD RAC RALLY	6.99			TEAM 17 COLLECTION VOL. 1	19.99	19.99	
BUDOKAN	10.99			LURE OF THE TEMPTRESS	12.99	12.99		TERMINATOR 2	9.99	9.99	
CAMPAIGN	9.95	9.95		MAN LTD THE DOUBLE	19.99		19.99	TEMPTRESS	8.99	8.99	
CANNON FODDER	12.99	12.99		MAN UNITED PLC			4.99	THE GAMES 'ESPANA'	10.99	10.99	
CANNON FODDER II	17.99	17.99		MERCENARY	4.99			THEME PARK	22.99	22.99	
CARDIAXX	8.99			MICROPROSE GRAND PRX	10.99	10.99		TINY TROOPS			19.99
CHAMPIONSHIP MANAGER 2	19.99	19.99		MIG 29 SUPER FULCRUM	10.95	10.95		TOTAL FOOTBALL	20.99	20.99	
CITADEL		21.99		NBA JAM T.E.	21.95	24.95		TRACKSUIT MANAGER 94/95	17.99		
COLONIZATION	22.99	22.99		OBSESSION	12.99		19.99	TREBLE CHAMPIONS 2	12.99		
COLLOSSUS CHESS X	4.99			ODYSSEY	12.99		19.99	TURBO TRAX	14.99		
CRAFT FOR AMOS	16.99	16.99		PGA EUROPEAN TOUR GOLF	19.99	21.99		ULTIMATE BODY BLOWS			12.99
CYBERCON 3	10.99	10.99		PGA TOUR GOLF	12.95	12.95		VIRTUAL KARTING	13.99		
DELUXE PAINT V.	59.99			PINBALL PRELUDE	19.99	19.99		WEMBLEY INTERNATIONAL SOCCER	12.99	12.99	8.99
DELUXE VIDEO III	46.99			POPULOUS! PROMISED LANDS	12.99	12.99		WEMBLEY RUGBY LEAGUE	9.99		
DEMOMANIAC	22.99	22.99		POPULOUS II	12.99	12.99		WORMS	18.99	18.99	19.99
DESERT STRIKE	12.99	12.99		POWERMONGER WWI DATA DISK	12.99	12.99		WORMS DATA DISK	12.99	12.99	
DREADNOUGHT	16.99			PRO TENNIS TOUR	6.99			XTRME RACING			19.99
DUNE I	12.95	12.95		PROJECT X SPECIAL EDITION	10.95						
DUNE 2 BATTLE FOR ARRIKIAS	12.95	12.95		PRIMAL RAGE	19.99						
EPIC	12.95	12.95		RUSHOVER	8.99						
EXILE	9.99	12.99	12.99	RUTTY SQUAD	21.99						
EXTREME RACING	19.99			QWAK	9.99						
F17 CHALLENGE	10.99			REACH FOR THE SKIES	12.99	12.99					
F29 RETALIATOR	10.95			REALMS	10.99	10.99					
FANTASY MANAGER '95/96	8.99	8.99		RISKY WOODS	10.99						
FEARS	12.99		19.99	ROADKILL	8.99	8.99	8.99				
				ROBOCOP 3	10.99	10.99					

COMPETITION PRO CD32 PAD 15.99  
SX1 .....189.99

AMINET 8 .....12.95  
AMINET 9 .....12.95  
AMINET 10 .....12.95  
AMINET 11 (PRE ORDER) .11.95

EDUAINMENT  
10/10 EARLY ESSENTIALS 9.99  
10/10 JUNIOR ESSENTIALS 9.99  
10/10 MATHS (NUMBERS) 9.99  
10/10 MATHS (ALGEBRA) 9.99  
10/10 MATHS (GEOMETRY) 9.99  
10/10 MATHS (STATISTICS) 9.99  
10/10 ESSENTIAL MATHS 9.99  
10/10 ENGLISH 9.99  
10/10 STRUCTURED SPELLING 9.99  
10/10 FRENCH 9.99  
10/10 GERMAN 9.99  
10/10 ESSENTIAL SCIENCE 9.99  
10/10 DINOSAURS 9.99  
10/10 DRIVING TEST 9.99

SPECIAL OFFER  
BUY ANY 3 10/10  
PRODUCTS FOR £25.00

CDS - ALL £4.99  
CENTREFOLD SQUARES  
BOMBER BOB  
CRICKET CAPTAIN  
IGSAW PUZZLE MANIA  
LEEDS UNITED  
FOOLS ERRAND  
GENESIS  
BRIDES OF DRACULA  
IGSAW PIN UPS  
GEARWORKS  
STEVE DAVIS SNOOKER  
FORMULA 1 G/ PRX CIRCUITS  
FAERY TALE ADVENTURE

AMIGA ACCESSORIES  
Mock-E-Mouse / Cybershot Twin Pack .....£14.75  
Mock-E-Mouse gives joystick control to all mouse functions.  
Cybershot converts any standard Amiga joystick into a 'Deadly'  
Autofire Stick.  
DUST COVERS  
A1200 .....£3.95 CD32 .....£3.95

JOYSTICKS  
Jupiter Stick .....£7.99  
Hyper pad .....£9.99  
MICE  
Alpha Data 400p.i. mouse .....£12.95  
Amiga/ST switchable mouse .....£9.99  
DISK DRIVES  
Power Computing 1.76 MB High Density drive .....59.99  
DISKS  
DOUBLE DENSITY: 10 FOR £2.25,  
50 FOR £9.00, 100 FOR 20.00

ITEMS SUBJECT TO AVAILABILITY. PRICES SUBJECT TO CHANGE WITHOUT NOTICE P&P IS FREE.  
Europe add £2 per title. Rest of World add £3.50 per title.

# MODEMS AND INTERNET PACKAGES FROM £49.99

## GET YOURSELF CONNECTED

Whether you want to make new friends, swap ideas and programs, or do some serious research, a modem will open the door to an exciting new world where almost anything is possible. A modem has already become an important part of many Amiga user's computer setup. New software can be received in minutes, the benefits are immense. You only need to flip through the pages of this very magazine to see mention of modems and the Internet, and here's your chance to join the swarming crowds with one of these excellent modem packages!

**"BEGINNER PACK"**  
9600bps

This is our best selling pack and consists of a high quality desktop 9600baud modem, all connecting leads, PSU, NComm software, an invaluable 'Archivers' disk, plus handy help/advice sheets, as well as full access to our BBS, where you can download 1000's of latest files for your Amiga!

**£49.99**

**"NOVICE PACK"**  
14,400bps

For the more adventurous, or those who wish to get involved in the Internet, this pack comes recommended. A faster 14,400 modem, as well as all the extras from the previous pack, PLUS additional information on the Internet - and of course, full access to our BBS

**£99.99**

**"LIGHTNING PACK"**  
33,600bps

For big-time Comms users, this pack will most certainly be of interest. 33,600bps is currently the highest speed in modem technology, with the US Robotics Courier V34+ FaxModem. This nifty unit can transfer upto 1MB of data in less than four minutes! Please call for info!

**£239.99**

All our packs come complete and ready to use straight away. You will be able to log onto our BBS, Midnight Express, and download as many files as you wish (full logon instructions included). Please call with any questions you may have!



SALES/ENQUIRIES: 01384 77172



Megatronix Software, 21 Tiled House Lane, Brierley Hill, West Midlands, DY5 4LG



# Zeewolf 2 tips

Some people have been having trouble with this great helicopter sim from Binary Asylum. Here's a guide to the first really difficult level.

## LEVEL 10

Like Cannon Fodder, Zeewolf 2 is not all about flying through each mission blazing away like a madman (or woman). Your Zeewolf becomes increasingly vulnerable on later levels as enemy weapons systems get more sophisticated and ammo levels are low to start with. Level 10 is a case in point. Zeewolf 2 has a staggered difficulty level which leads you into the game with a false sense of security. When you hit level 10 it seems like a dead end for a while; until you get the hang of how to do things in the right order. Although you start off with what seems like nowhere near enough ammo to finish the mission, if you use enemy fire the right way you will find plenty of surprises under the domes.



**10-1** Ready for lift off. Go left to the small island and collect the shells and missiles from the Camel there. This should get you worried; there's only 17 shells and one missile! Now fly right to the main island and, whatever you do, do not waste shells on anything. If you are attacked, lose them. You cannot afford to spend any ammo at this point.



**10-4** Now land on the other side of the Dome, just about in his sights. He will continue to attempt to shoot you but the Dome is in the way, so he'll blow it up first. It only takes 20 or so shells to destroy a Bear so as soon as the Dome blows up take off, destroy him and then land and pick up 400 or so shells from the Camel.

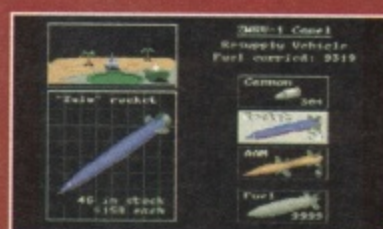

**10-5** It's a good idea to leave some ammo behind: if you get shot down you will still be able to go back and get more. Otherwise you're back to 50 shells and you haven't a hope in hell of finishing the level. Now destroy the domes in the bottom left and bottom right hand corners of the base. These will reveal more ammunition.

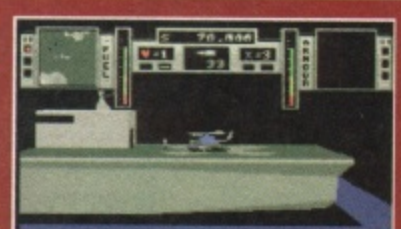

**10-8** Shoot up some of the floors with your Zeewolf, but use the Pelican to shoot out the doors of each building, releasing the soldiers. Then load 'em up and airlift 'em to the carrier. If you have ammo left in the Pelican fly northwards from the carrier and cause as much damage to the air base as possible. Zeewolf should then still be well armed and ready to kill.



**10-2** Although the mission involves picking up troops from damaged buildings there are rather a lot of them so you'll want to use the Pelican, not your Zeewolf. The surroundings are too dangerous at first so you've got to take out the base's defenses, especially the three AA emplacements on the edge of the island. First though scavenge for more ammo.



**10-3** The only way to stock up on ammo is to blow up the green domes on the four corners beside the the high rise buildings, but you don't have enough firepower to destroy even one. The trick is to use the enemy. The Camel under the top right dome, contains 600 shells. Go and buzz the Bear guarding it and get him to shoot at you.



**10-6** The dome in the top left corner is also partially protected by the four missile emplacements so, although the method is the same, you have to be careful of fire from both sides. Also this Bear seems reluctant to destroy the dome, but persevere and don't use too much ammo. The helicopter base you've got to destroy to complete the mission will need loads.



**10-7** Now take out the three missile emplacements at low level with several salvos of missiles and guns blazing. YOU DO NOT want to get caught in any crossfire from these, they will take either chopper down in three seconds. If you're feeling lucky you could get these emplacements to knock out a few floors of the nearest skyscraper for you.











# Pro-GRAB... Rapid Frame Grabbing on your Amiga

Now compatible with both VHS and S-VHS!



The revolutionary S-VHS ProGrab™ 24RT Plus with Teletext is not only the best way to get crisp colour video images into your Amiga, from either live broadcasts or taped recordings, it also costs less than any of its rivals. This real time PAL/SECAM/NTSC\* 24-Bit colour frame grabber/digitiser has slashed the price of image grabbing on the Amiga and, at the same time, has received rave reviews for its ease of use and excellent quality results. ProGrab™ has earned honours from just about every Amiga magazine and Video magazines too! And... with ProGrab™ you needn't be an expert in Amiga Video Technology, a simple 3 stage operation ensures the right results - Real Time, after time

### STAGE 1...

Select any video source with S-VHS or composite output. This could be your camcorder, TV with SCART output, satellite receiver, domestic VCR/player or standard TV signal passing through your VCR/player... the choice is yours

Grab images with your camcorder including S-VHS...

or, Take a signal from a TV with SCART output...

or, Use the signal from your satellite receiver...

or, Grab TV or video pictures from your VCR's video output including S-VHS.



### STAGE 2...

With ProGrab's software, select an image you wish to capture using the on screen preview window and Grab (because the hardware grabs frames in real time, there's no need for a freeze frame facility on the source device). Once grabbed, simply download and view the full image on your Amiga screen. ProGrab also includes a Teletext viewing and capturing facility from either TV or satellite sources.

### STAGE 3...

Use the 'grabbed' image with your favourite word processor, DTP or graphics package.

ProGrab really does make it that simple!

**ProGrab™ ...**  
Supports all recent Amigas and is also fully AGA Chipset compatible. You can render images in any Workbench screen mode resolution including HAM8 mode (Amiga RAM permitting).

**ProGrab™ ...**  
Saves and Loads images in IFF/ILBM, IFF/ILBM24, JPEG, BMP, PCX, and TARGA file formats. ProGrab saves animations as Anim5 files and animations with sound (requires PCMCIA interface and separate sound sampler) as Anim5 + 8SVX files.

A range of image processing effects, palette computing routines (AGA only) and dithering methods are also new to ProGrab Version 2.5.x. Photogenics fully supports ProGrab with a custom 'Loader' to enable grabs directly from within the program - saving YOU time!

**ProGrab™ ...**  
Software has built in mono and colour animation facilities. The number of frames is dependant upon your Amiga's RAM.

**ProGrab™ ...**  
Release 2.5.x software now includes...  
• SUPPORT FOR VIRTUAL MEMORY  
Allows the highest resolutions - Even with low memory Amigas (All Hard Drive Systems without the need for an MMU, requiring just 1Mb. Hard Drive Space).

• ADDITIONAL TELETEXT FACILITIES  
With either Terrestrial or Satellite TV signals.  
• LARGER PREVIEW WINDOW  
Double Resolution and 4 times the area available with previous ProGrab software.

• INTERNATIONAL SUPPORT  
Now works with composite PAL, SECAM and NTSC Straight from the box!

(\*Standard ProGrab hardware is PAL/SECAM/NTSC compatible. Interface mode options are available with PAL & SECAM only. NTSC Only models are available to special order which then support the interface mode fully. Please ask us for full details.)

For just **£129.95...**

- ProGrab is supplied with everything you'll need +...
- ProGrab™ 24RT Plus Digitiser
  - Latest ProGrab Version 2.5.x Software
  - Mains Power Supply Unit
  - Parallel Port Connecting Cable
  - User Manual
  - Input sockets for Composite and SVHS.

PCMCIA Interface for A1200 and A600 - Only **£34.95**

ProGrab's optional PCMCIA Interface includes the latest version software and extends performance for serious/professional users - offering the following benefits...

- Faster Downloading Times (up to FIVE times quicker)
- Improved animation speeds of up to 11fps (mono) and 3.5fps (colour)
- Sound sampling and animation capabilities (separate sound sampler required)
- Saving of animations direct to your Amiga's hard drive
- Freeing of your Amiga Parallel Port for use by a printer or other parallel peripheral device

\* ProGrab™ supports any Amiga with Kickstart 2.04 or later & a minimum of 1.5Mb. free RAM.

+ A video source cable will be required to match your own equipment set up - Ask for details.

**Pro-GRAB™**  
SVHS 24RT Plus

Camcorder User commented... "If you're looking for a high resolution 24 bit digitiser then, at this price, ProGrab 24RT represents great value for money."



ProGrab™ - Voted as **The Best Video Hardware** product for the Amiga. This is especially pleasing because the award comes from the Amiga Shopper magazine's readers...  
Our Satisfied Customers!

ProGrab™ - Amiga Shopper **95% STAR Buy** and remarks like... "Sharp, crisp and faithful to the original colours, we were mighty impressed" and... "Highly Recommended. Whether you are a Videographer or a Graphic Artist, look to the ProGrab 24RT Plus. It's a winner"



ProGrab™ - Amiga Format **93% Gold Rating** and comments... "ProGrab 24RT Plus is quite simply the digitiser to get", "Incredible value for money - no other digitiser offers so much for so little" "Offers far more features than any other digitiser near the same price"

CU Amiga said ProGrab™ is...  
"Just the job for beginners and semi-professionals on a tight budget" and, "Very hard to beat. For the money, nothing can touch it"



Get your hands on NEW ProGrab Plus - Post or FAX your requirements (Quantity Trade Prices Available) on the order form provided OR, if you'd simply like further information please contact...



**GORDON HARWOOD COMPUTERS**

Gordon Harwood Computers Limited.  
New Street, Alfreton, Derbyshire DE55 7BP.  
FAX: 01 773 831040 or...

TELEPHONE  
**01 773 836781**

Mr/Mrs/Miss/Ms:	Initial(s):	Surname:
Address:		
County (Country):	Postcode:	
Daytime Phone:	Evening Phone:	
ProGrab Plus™ @ £129.95	£	:
PCMCIA Interface @ £34.95	£	:
V 2.5.x S/W (User Upgrade) @ £4.95	£	:
Optional FAST Courier Delivery @ £6.95	£	:
TOTAL	£	:
Overseas Customers... Please call for prices, shipping etc.		
Card holder's signature:		
Card No	<input type="text"/>	<input type="text"/>
Expiry Date	<input type="text"/>	<input type="text"/>
Valid From: (Switch Only)	<input type="text"/>	<input type="text"/>
Issue Number: (Switch Only)	<input type="text"/>	<input type="text"/>
Department:	<input type="text"/>	<input type="text"/>
I enclose a Cheque/Bank Draft/Postal Order for £ : made payable to GORDON HARWOOD COMPUTERS LIMITED		





# Get Serious

What's in store in this month's serious reviews section? Let our technical editor reveal all. (No, thanks - ED)

## Horgan's Organ



In terms of hardware and software reviews, this month, there's a

definite swing towards sound and music this month, with a no-nonsense test of the Toccata 16-bit sound card, a preview of OctaMED SoundStudio (the review will be along shortly) and Aural Synthetica to boot!

There's plenty of healthy activity in other areas too, with the SX32 CD32 upgrade, a new video titler in the shape of

Limelight Tyro and another solution for A1200 owners with big ideas in the shape of HiQ's Power Station.

Only last month I was getting all dewey eyed about the lack of innovation on the PD demo scene, when what should turn up but a corking batch of audio-visual weirdness from The Party 95 demo competition. This competition was held on December 95 in Denmark and demo creators around the world entered theirs in a bid to see whose was the best! You'll find a selection of the best of these on the CD edition of this month's magazine, including the amazing 80Mb Dataworld extravaganza (yes, 80Mb!). It feels good to be able to indulge in the sort of luxuries a cover-mounted CD allows!

All this, plus an extra large CD-ROM roundup. Enjoy!

Tony Horgan  
Technical Editor

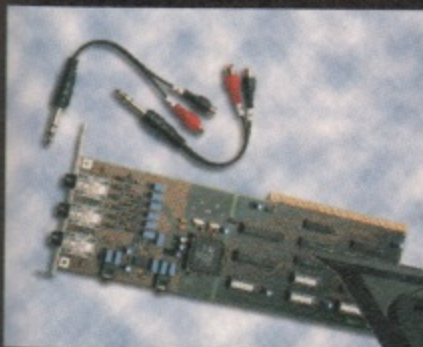

Toccata p66

SX32 p66



## Toccata

62

Given the chance, who wouldn't upgrade their Amiga to full CD quality 16-bit audio spec? Toccata offers exactly that. Can it pull it off?

## SX32

66

With all that power under the bonnet of a CD32 it seems a shame to reduce it to a games machine. With the SX32 you can transform it into a virtual A1200.

## OctaMED SoundStudio

69

Bringing the state-of-the-tracker art into a new era, OctaMED SoundStudio could be the best thing to happen to Amiga audio. Find out more in our exclusive preview.

## Aural Synthetica

70

From the developer of Aural Illusion, Aural Synthetica is a complete modular synthesiser system for your Amiga. All the fun of analogue synths without the cables?

## Limelight Tyro

72

There are times when the all singing multimedia package is just too complex for your simple video titling requirements. It's time for Limelight Tyro.

## HiQ Power Station

77

Face it, the A1200 isn't exactly well endowed when it comes to drive bays and SCSI support. The Power Station offers a possible solution.

## CD-ROM round up

78

You want CD-ROM reviews? You got 'em! Three pages of the latest releases, with everything from sound samples to software archives start on page 79.

## PD Scene

83

Starring the best bits from The Party '95 demo competition, PD Scene also has plenty to offer the cash-strapped Amiga gamer.

## PD Utilities

87

A real diverse bunch of tools and miscellaneous bits are on offer in this month's bargain bucket that's commonly known as PD Utilities.



# Toccata

- Price: £299 ■ Developer: MacroSystem ☎ +49 2302 949490
- Supplier: White Knight Technology ☎ 01902 822 321

**I**t's been the dream of many Amiga users that one day their beloved Paula chip will be superseded by some state of the art audio hardware with a minimum of 16-bit bandwidth to play with, perhaps even 24 or 32 bits. Until that dream becomes reality there will be a place for third party audio upgrades, such as Toccata from German developers MacroSystem.

## Digital video

Toccata is a card for all Amigas with Zorro slots running OS 2 and above. It can sample and replay a single channel of 16-bit stereo digital audio at frequencies up to 48KHz, working from Fast RAM or directly from a hard drive (or any device with a fast enough transfer rate, such as a Zip). It's been designed for use in multimedia and audio mastering work, in which case the card acts as a digital recorder, rather than a sampler in a musical context. Specifically it hooks up to

**Give your Amiga the luxury of 16-bit audio with a nice new Zorro card.**

MacroSystem's V-Lab Motion video card to create a complete digital video editing system.

## Ins and outs

There are four inputs and one output on the board. The rear panel has three 6.5mm stereo jack sockets, two of which are line level inputs, the remaining one is the line level output. Located on the inside edge of the card are two 3.5mm jack sockets, one set up for line level input, the other for mic input. There's an option to mix the input with the Toccata output. The idea behind this is that you can have your Amiga's standard audio channels piped

through the card, so you don't need a mixer. The relative levels of the channels can be controlled from a software mixing desk.

## Supplied software

Two disks of software are supplied with the Toccata. The basic Toccata control tools include a mixing desk front end that allows you to set the relative volumes of the inputs and output, the sampling rate, and the sample bandwidth (8 or 16-bit). From here you can also select A-Law or  $\mu$ -Law compression, which allows for near 16-bit sound quality using roughly the same amount of disk space as an 8-bit sample. For example, 8-bit bandwidth has a noise ratio of 48dB, 16-bit has a noise ratio of 96dB, while A-Law or  $\mu$ -Law can achieve a 70dB noise ratio. This optional compression is handled on the fly in real time during recording and playback.

Simple recording and replaying tools are also included which can also be remotely controlled via ARexx. Finally there are some bits and pieces for anyone who wants to develop their own software to control the card.

Samplitude is the main editing software. This allows sampling direct to disk and comes with a good selection of basic editing functions, but is light on effects processing tools. Fortunately both Samplitude and the Toccata Tools can be used to control the board simultaneously. For example, you can monitor an incoming signal prior to sampling from within Samplitude, drag the screen down and adjust the input gain levels from the Toccata Tools panel, with the results taking immediate action. There's also a playlist section which can be used to string together a sequence of samples.

MacroSystem are currently working on new software that will feature simultaneous recording and playback through the card, along with 'multiplexing' routines that allow for a number of channels to be output at the same time.

## Sound quality

On the surface it would seem that the sound quality should be equal to a well recorded CD and that is generally the case. If you're used to wrestling with the

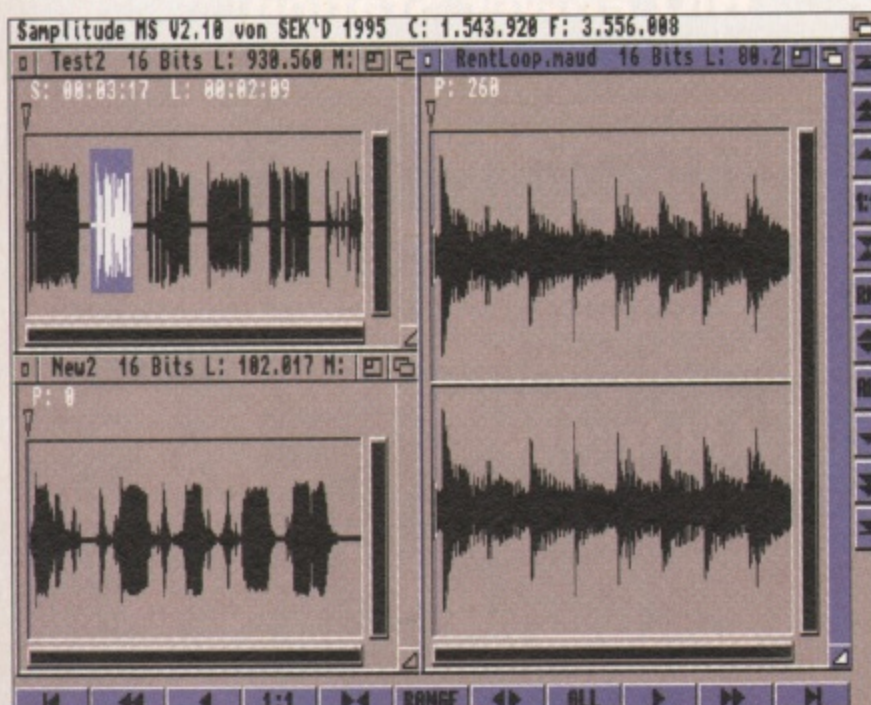
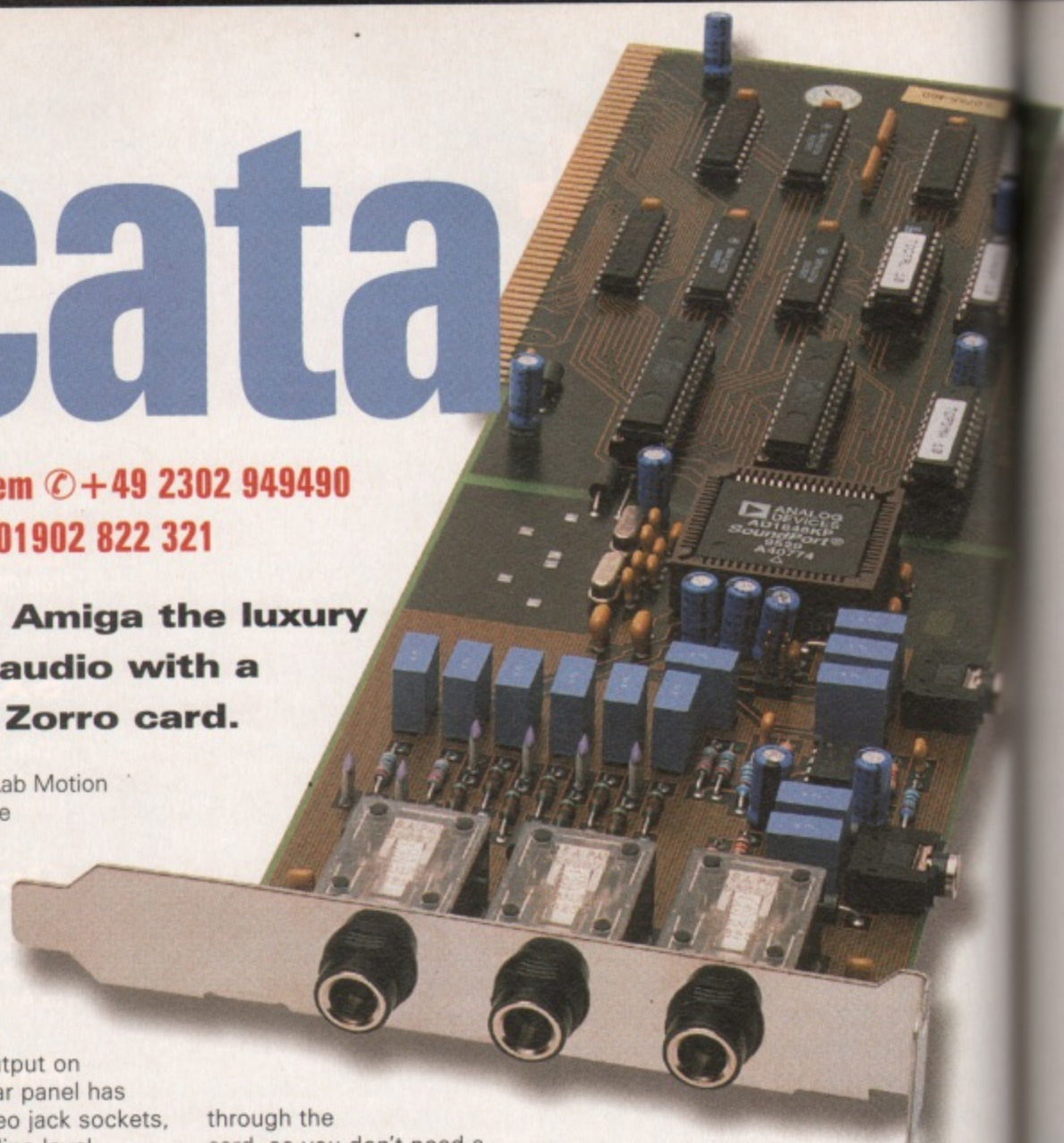

▲ Samplitude MS 2.1 comes bundled with Toccata, offering hard disk recording and sequencing features, along with a good selection of basic sample editing functions and support for plenty of sample formats.



noise and distortion inherent in 8-bit samples, moving up to 16 bits is a real pleasure. For example, 16 bits give ample bandwidth for you to use subtle effects such as reverb without introducing a load of 'stepping' noise, as the steps are much finer. For the same reason, you can sample a long 808 bass drum, filter out any top end noise, and you'll be left with a very clean pure bass sound. Try that with an 8-bit sample and you'll be stuck with a phasing high frequency content on the decay tail.

### Good potential

Frequency response seems to be up to scratch, although in our tests the bottom end of some samples lacked a little definition in places when compared back-to-back with the source CD sound. There is a slight click every time the Toccata begins to play a sample and another straight afterwards. This isn't too intrusive if you are mixing it with Amiga audio and would not matter too much if you were using the card to spool one continuous long sample in an audiovisual context. This does not happen for each sample when using SoundStudio's mixing mode, as the Toccata is only 'opened' at the start of the song and 'closed' at the end. See the Third Party Support panel for more details on this. Overall the sound quality is excellent.

One of the reasons Toccata has not been widely used as a musical tool in the past is that it can only replay sounds at one of 14 preset sample rates ranging from 5513Hz to 44100Hz (CD rate) and 48000Hz. Therefore there are not enough steps in

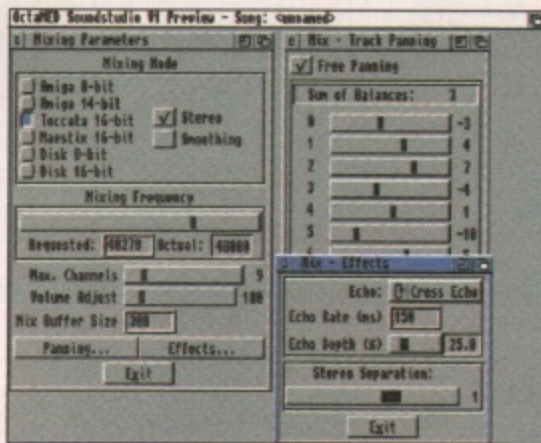

▲ 48KHz 16-bit output and stereo panning for each track is possible with Toccata and the new OctaMED SoundStudio.



▲ Amplitude offers a range of sampling formats, recording to either RAM or a hard drive.

between to be able to replay a tuned instrument sample as a melody, although the new SoundStudio works around this. However, with sample rates that include 32000Hz (the same as the Akai SO1 entry level MIDI sampler), 44100 (the rate used for mastering CDs) and 48000 (another popular rate) it has many potential uses for digital mastering and editing samples from external sources. This could be very handy considering the editing software on many hardware samplers is very basic.

### Conclusion

Toccata is more versatile than it first seems. If you're on the lookout for a 16-bit sampler you've probably already got a good idea of what you want it to do, whether it's hard disk audio mastering, realtime music applications, audio for video and

### Third party support

Although Toccata was designed mainly for multimedia users rather than musicians, it is now well supported by OctaMED SoundStudio. One of the new features of SoundStudio is its ability to retarget its tracks of samples to alternative output devices. Instead of driving the Paula chip directly, it can now process all of the sample data as the module plays, mix the combined result into a stereo signal and push it out through the Toccata's 48kHz 16-bit output.

Up to 32 tracks of samples can be played at once and each track can be panned to its own independent stereo position. Realtime Echo effects are also available. The resulting sound quality on an Amiga equipped with a 50MHz 68030 processor sounds very slightly grainy compared to a high quality standard four channel Amiga module. The quality you get will depend on the speed of your Amiga and the amount of available RAM.

SoundStudio also allows you to play a single channel of stereo or mono 16 bit Toccata samples in normal four-channel mode. The Toccata output is much cleaner in this mode. However, in this mode the replay pitches of the Toccata samples are limited to those listed in the specifications box elsewhere on these pages. In effect this means that in this mode you cannot play melodies with Toccata instrument samples, as there is not enough flexibility in the replay rates.

Back on the multimedia side, there's support from MediaPoint, Scala and Bars and Pipes. The ARexx ports of the Toccata software also means that you can use it with programs that don't have built-in Toccata features.

multimedia or editing samples for use with external MIDI gear. It's capable of handling all of those jobs competently, some better than others. It's already proven itself as a worthy companion to V-Lab Motion but its increasing support from third party software developers has opened up its potential market to thousands of Amiga musicians (there's even a Toccata driver available for DeliTracker). While technically it doesn't compare very favourably to the current PC sound card market (dominated by multitimbral boards with onboard effects and more), in which light may look a little overpriced with just a single stereo output channel, it's in a very different marketplace so direct price to power comparisons aren't really relevant.

This won't solve all your audio problems overnight but it's quite a capable system for a number of specific audio applications, including digital audio mastering for example. For digital video work it's by far the best value audio solution, and the excellent support from OctaMED SoundStudio also makes it a tempting proposition for musicians. With more powerful software on the way from MacroSystem, the future looks very bright. ■

Tony Horgan

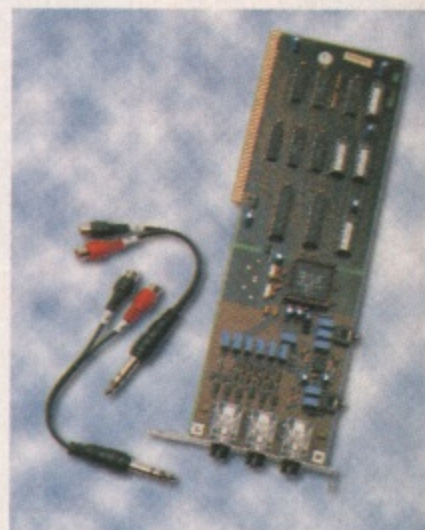

▲ Toccata comes with a minimal selection of leads to allow connect to your sound source and amplifier or mixer.

### Technical specifications

Inputs:	3 stereo line, 1 stereo microphone
Outputs:	1 stereo
Modes:	8 bit, 16 bit, A-Law, $\mu$ -Law (all mono or stereo)
Input impedance (line):	47k
Input impedance (mic):	47k
Output impedance:	470
Input Amplitude (line):	0.3 - 3V
Input amplitude (mic):	10 - 300 mV
Max output amplitude:	2.2V
Dynamic range:	95dB approximately
Frequency response:	10Hz - 20kHz (0dB level, +0/-0.5dB)
Sample frequencies:	5513, 6615, 8000, 9600, 11025, 16000, 18900, 22050, 27429, 32000, 33075, 37800, 44100, 48000 Hz

### TOCCATA

A500	<b>system requirements:</b> Amiga with Zorro slots, OS 2 or above, 1Mb Chip RAM, 2Mb fast RAM hard drive.
A500+	
A600	<b>ease of use</b> .....90% Simple installation, good controller software supplied.
A1200	<b>performance</b> .....80% Basic specs but third party software gives it a big boost. Fine for video work.
A1500	<b>value for money</b> .....70% Not an awful lot for your money considering there is just one stereo output.
A2000	
A3000	<b>OVERALL</b> Competent in a variety of audio applications.
A4000	<b>82</b> <sup>0/10</sup>



# SOFTWARE 2000

**We stock over 6500 QUALITY PD & SHAREWARE**

**How to order** To order any disk just write the disk title and the disk code, EG U01 Agene. Some titles have a number in ( ) this means the title comes on (x) number of disks. To order **PACK** just write down the pack TITLE name will do.

**ALL DISKS ARE COMPATIBLE WITH ALL AMIGAS UNLESS STATED**

AGA Disk means for A1200/A4000 only

**Price.....99p per disk**

Please add 70p to total for postage & packaging  
Pack price as stated. All Orders Same Day Despatches  
For the very latest catalogue disk please add 70p

**MAKE CHEQUE/POSTAL ORDER PAYABLE TO: SOFTWARE 2000 SEND TO (ADDRESSES TOP RIGHT)**

**DEPT (CU) 8 Falcon Wilnecote Tamworth B77 5DN ENGLAND**

**DEPT (CU) 9 Wills Street Lzells Birmingham B19 1PP**

**TEL: 01827 287377 TEL: 0374 678068**

**PLEASE SEND YOUR ORDER TO EITHER OF THESE DISTRIBUTORS YOUR ORDER WILL BE SAME DAY DESPATCH VIA FIRST CLASS POST**

**PER DISK + CHOOSE 1 FREE DISK WITH ORDER OF 10 OF MORE DISK**

**OVERSEAS POST & PACKAGE RATE (Europe add 25p per disk for P&P) (Worldwide add 50p per disk P&P)**

**TEL OR FAX: 01827-287377**

## SOFTWARE 2000

# FREE

## MOUSE MAT worth £2.99

FREE MOUSE MAT worth £2.99 with every order £12 or over. To claim your free mouse mat just cut & return this token with your order + enclose an extra 38p stamp to cover the mouse mat postage & package. Offer only available with this token (limited 1 mouse mat per order exclude any other offer)

**You may choose 1 FREE disk if mouse mat not required**

### \*\*\*\*\*AMIGA ESSENTIAL\*\*\*\*\*

**DISK CLEANING KIT** Complete with disk & cleaning fluid **£2.99**

**Quality MOUSE MAT** 10 blank disks & 10 labels **£4.99**

**50 disk protector sleeve** **£0.99**

**\* special offer £1 off if you order 5 or more pd disks**

### music

M001 BEASTY BOYS - We Want Some Pussy songs  
M002 MICHAEL JACKSON - song BAD  
M003 DO THE BART MAN  
M005 100 CDS TUNES (not A1200)  
M006 BAT-DANCE REMIXED  
M017 SUNS & ROSES - YOU'RE CRAZY  
M018 THE XMAS SONGS (disk) very funny  
M025 MUSIC FOR NOTHING-OFRE STRAITS HIT song  
M027 BLUES HOUSE (2 disks)  
M034 C&A GAMES MUSIC  
M115 MAHONEY & KAKTUS - 40 tunes compilation  
M125 ADAMS FAMILY  
M147 BANGLES - Walk Like An Egyptian  
M150 TIFFANY I Think We've Alone Now  
M171 MADONNA - Like a Virgin  
M175 JANET JACKSON - RHYTHM NATION  
M177 PET SHOP BOYS  
M184 SAM FOX - (PLEASE ME)  
M186 MADONNA - (RESCUE ME)  
M188 JOE LA TAXI  
M189 MICHAEL JACKSON (SMOOTH CRIMINAL)  
M194 JESUS ON ETS (2 disks)  
M025 RAVE - more Rave  
M026 A TO Z OF C&A GAMES MUSIC (4) brilliant  
M014 DICK TRACY (2 disks)  
M035 STAR TREK & STAR TREK NEXT GENERATION (2)

### \*\*\*\*\*AMIGA ESSENTIAL\*\*\*\*\*

### VIDEO TITLER/TOOLS

V0181 VIDEO NOTE database for your video collection  
V021 VIDEO APPLICATION (2 disks) many video titer prog  
V022 VIDEO TOOL (3) loads of video titles. Recommended  
V023 TELESUBTITLE - new video titer  
V024 VIDEO MAKE V4.33 The latest in video  
V025 DESKTOP VIDEO 1 & 2 (best video titer tool)  
V026 CATALOGUING SYSTEM. Diverse of functions  
V027 TELE TITLER (2 disks) more VIDEO TITLER-BEST  
V028 VIDEO TITLER (2) Easy to use Video Titer  
V029 VIDEO TITLER (2) Easy to use Video Titer  
V030 VIDEO TITLER (2) Easy to use Video Titer  
V031 VIDEO TITLER (2) Easy to use Video Titer  
V032 VIDEO TITLER (2) Easy to use Video Titer  
V033 VIDEO TITLER (2) Easy to use Video Titer  
V034 VIDEO TITLER (2) Easy to use Video Titer  
V035 VIDEO TITLER (2) Easy to use Video Titer  
V036 VIDEO TITLER (2) Easy to use Video Titer  
V037 VIDEO TITLER (2) Easy to use Video Titer  
V038 VIDEO TITLER (2) Easy to use Video Titer  
V039 VIDEO TITLER (2) Easy to use Video Titer  
V040 VIDEO TITLER (2) Easy to use Video Titer

## TOP VARIOUS UTILITIES

U024 D-LOCKS protect your disks & files  
U027 ULTRAPART & SURF part & 3D model program  
U028 CAN DO program for 3D modelling  
U029 DARNSTAR no 2 (not 2-5) loads of models  
U032 DISK MAG CREATOR create a disk magazine  
U033 NORTH C compiler (2) built programming language  
U034 ED 1.2 editor/word processor file made very easy  
U035 TETRA COPY copy texts while copying disk, great  
U036 MOST USED UTILITIES (2) very useful util collection  
U037 PROFESSIONAL (2) word processing programs  
U038 C-MANUAL 2 (4) Teaches you how to program in C  
U039 PAINT AND ANIMATE still the best  
U040 SCRYPTURES V4.01 display your own bioscripts  
U041 PROFFER V4.01 V1.6 complete Assembler language  
U042 UNLIMITED DISK CREATOR all tools are here  
U043 M COMPUTER AID DESIGN - Was commercial product  
U044 WPCLOSER 4.0 file file manager. Excellent  
U045 SD 3 copyletters/word processor file using a mouse  
U046 AMOSPART V1 good paint package, lots of features  
U047 GRAPHIC UTIL (3) loads of graphic converter tools  
U048 FREE COPY back up commercial games  
U049 SLIDE SHOW CONSTRUCTION KIT easy to make  
U050 ARCHIVER UTILS lots of functions  
U051 HACKER'S TOOLS many useful tools  
U052 THE A.T. COPIER (not WB1) 13 disk copier  
U053 FRACAL UTIL loads of fractal programs, brilliant  
U054 FRACAL UTIL loads of fractal programs, brilliant  
U055 COPY & CRACK TOOLS back up your software  
U056 MESSY DISK & rewrites PC/MAC etc files  
U057 AUTO DISK LOGGERS catalogue your disk  
U058 GRAPHIC UTIL (3) loads of graphic tools  
U059 GRAPHIC UTIL (3) loads of graphic tools  
U060 SCENERY MAKER more landscape generators  
U061 EMULATOR COLLECTION (8) lots of emulators  
U062 FREE COPY back up commercial games  
U063 MODEL 3D brilliant 3D object designer  
U064 MULTI VISION (2) disk files utilities  
U065 HACKER'S TOOLS many useful tools  
U066 POOL TOOLS - predict horses with the best chance  
U067 RACE RATER similar to above, but both  
U068 START CAT 2 - create startup disk, easy  
U069 SEEKER find files on floppy & hard drive  
U070 R.P.D (2) adventure creator  
U071 DISK REPAIR KIT salvage & repair damaged disks  
U072 WORLD SCRIPT programs ASCII files  
U073 NOCOMM II more modern software - packer util  
U074 UNCOPY fantastic disk copier  
U075 FRASGARDER (2) fractal generator  
U076 SOUND TRACKER V2.5 music maker  
U077 SPEED BENCH (not WB1.3) create auto boot WB  
U078 NB 2 very popular copier  
U079 HATCHER (not WB1.3) create auto boot prog  
U080 SYSPROF find & print info on your Amiga sys  
U081 FONT FARM font creator/wordgen new fonts  
U082 ANIMATOR (not WB1.3) create animation  
U083 FINAL FRONTIER (2 disks) Star Trek magazine  
U084 FINAL FRONTIER (2 disks) Star Trek magazine  
U085 FINAL FRONTIER (2 disks) Star Trek magazine  
U086 PROTRACTOR V2 Best music writer program  
U087 PROTRACTOR V2 Best music writer program  
U088 WORK STATION (2 disks) WB1.3 only WB replacement  
U089 HARD DISK UTIL file collection of Hard Disk util  
U090 EASY PRINT (AS00) only lots of printing util  
U091 WORK MATE 15 brilliant disk util collection  
U092 THE MUSIC CONSTRUCTION KIT (state Amiga owned)  
U093 THE MUSIC CONSTRUCTION KIT (state Amiga owned)  
U094 THE MUSIC CONSTRUCTION KIT (state Amiga owned)  
U095 THE MUSIC CONSTRUCTION KIT (state Amiga owned)  
U096 THE MUSIC CONSTRUCTION KIT (state Amiga owned)  
U097 THE MUSIC CONSTRUCTION KIT (state Amiga owned)  
U098 THE MUSIC CONSTRUCTION KIT (state Amiga owned)  
U099 THE MUSIC CONSTRUCTION KIT (state Amiga owned)  
U100 THE MUSIC CONSTRUCTION KIT (state Amiga owned)

## PUZZLE GAMES II

Massive collection of all the very best puzzle games ever released including some of the classics like Rubic-cube, Picture-Puzzles etc... much too many to list. Very popular

**5 disk pack only £4.99**

## ARCADE GAMES II

COLLECTION OF THE VERY BEST SHOOT EM UPS MUST FOR ANY GAMES PLAYER

**5 disk pack only £4.99**

## BOARD GAME II

The very best board games ever released. This pack contains the very latest CHESS, CHECKER, SCRABBLE, MONOPOLY & DOMINOS

**recommend 5 disk pack only £4.99**

## Printer Pack

5 disk pack with all the latest printing programs specially designed for printing out high quality documents, text & pictures etc. and it is essential to all Amiga owners (ver handy). Easy to use

**Print for any Amiga owner with printer**

**Printer Pack (5 disks) only £4.99**

## 101 GAMES

Price only £10.99

Brilliant collection of over 100 of the very best of PD games includes WARZONE 2, Tetris, Monopoly etc. Much too many to list. Very easy to use system. Most of games come with full playing instructions

**MUST FOR ANY GAMES PLAYER**

COMPATIBLE WITH ALL AMIGAS

All games are available from us easy to use menu & most games come with full playing instructions

## 101 GAMES PK 3

new 101 pack 3 contains over 100 games, run on all Amigas only £11.99 offer buy any 2 pack together & receive a free £4 token for use with next order

**\*this offer cannot be used with any other offer current & subject to condition apply**

G875 RAG TO RICHES - like MONOPOLY  
G876 WIZARD OF WINDS - like MONOPOLY  
G877 WIZARD OF WINDS - like MONOPOLY  
G878 WIZARD OF WINDS - like MONOPOLY  
G879 WIZARD OF WINDS - like MONOPOLY  
G880 WIZARD OF WINDS - like MONOPOLY  
G881 WIZARD OF WINDS - like MONOPOLY  
G882 WIZARD OF WINDS - like MONOPOLY  
G883 WIZARD OF WINDS - like MONOPOLY  
G884 WIZARD OF WINDS - like MONOPOLY  
G885 WIZARD OF WINDS - like MONOPOLY  
G886 WIZARD OF WINDS - like MONOPOLY  
G887 WIZARD OF WINDS - like MONOPOLY  
G888 WIZARD OF WINDS - like MONOPOLY  
G889 WIZARD OF WINDS - like MONOPOLY  
G890 WIZARD OF WINDS - like MONOPOLY  
G891 WIZARD OF WINDS - like MONOPOLY  
G892 WIZARD OF WINDS - like MONOPOLY  
G893 WIZARD OF WINDS - like MONOPOLY  
G894 WIZARD OF WINDS - like MONOPOLY  
G895 WIZARD OF WINDS - like MONOPOLY  
G896 WIZARD OF WINDS - like MONOPOLY  
G897 WIZARD OF WINDS - like MONOPOLY  
G898 WIZARD OF WINDS - like MONOPOLY  
G899 WIZARD OF WINDS - like MONOPOLY  
G900 WIZARD OF WINDS - like MONOPOLY  
G901 WIZARD OF WINDS - like MONOPOLY  
G902 WIZARD OF WINDS - like MONOPOLY  
G903 WIZARD OF WINDS - like MONOPOLY  
G904 WIZARD OF WINDS - like MONOPOLY  
G905 WIZARD OF WINDS - like MONOPOLY  
G906 WIZARD OF WINDS - like MONOPOLY  
G907 WIZARD OF WINDS - like MONOPOLY  
G908 WIZARD OF WINDS - like MONOPOLY  
G909 WIZARD OF WINDS - like MONOPOLY  
G910 WIZARD OF WINDS - like MONOPOLY  
G911 WIZARD OF WINDS - like MONOPOLY  
G912 WIZARD OF WINDS - like MONOPOLY  
G913 WIZARD OF WINDS - like MONOPOLY  
G914 WIZARD OF WINDS - like MONOPOLY  
G915 WIZARD OF WINDS - like MONOPOLY  
G916 WIZARD OF WINDS - like MONOPOLY  
G917 WIZARD OF WINDS - like MONOPOLY  
G918 WIZARD OF WINDS - like MONOPOLY  
G919 WIZARD OF WINDS - like MONOPOLY  
G920 WIZARD OF WINDS - like MONOPOLY  
G921 WIZARD OF WINDS - like MONOPOLY  
G922 WIZARD OF WINDS - like MONOPOLY  
G923 WIZARD OF WINDS - like MONOPOLY  
G924 WIZARD OF WINDS - like MONOPOLY  
G925 WIZARD OF WINDS - like MONOPOLY  
G926 WIZARD OF WINDS - like MONOPOLY  
G927 WIZARD OF WINDS - like MONOPOLY  
G928 WIZARD OF WINDS - like MONOPOLY  
G929 WIZARD OF WINDS - like MONOPOLY  
G930 WIZARD OF WINDS - like MONOPOLY  
G931 WIZARD OF WINDS - like MONOPOLY  
G932 WIZARD OF WINDS - like MONOPOLY  
G933 WIZARD OF WINDS - like MONOPOLY  
G934 WIZARD OF WINDS - like MONOPOLY  
G935 WIZARD OF WINDS - like MONOPOLY  
G936 WIZARD OF WINDS - like MONOPOLY  
G937 WIZARD OF WINDS - like MONOPOLY  
G938 WIZARD OF WINDS - like MONOPOLY  
G939 WIZARD OF WINDS - like MONOPOLY  
G940 WIZARD OF WINDS - like MONOPOLY  
G941 WIZARD OF WINDS - like MONOPOLY  
G942 WIZARD OF WINDS - like MONOPOLY  
G943 WIZARD OF WINDS - like MONOPOLY  
G944 WIZARD OF WINDS - like MONOPOLY  
G945 WIZARD OF WINDS - like MONOPOLY  
G946 WIZARD OF WINDS - like MONOPOLY  
G947 WIZARD OF WINDS - like MONOPOLY  
G948 WIZARD OF WINDS - like MONOPOLY  
G949 WIZARD OF WINDS - like MONOPOLY  
G950 WIZARD OF WINDS - like MONOPOLY  
G951 WIZARD OF WINDS - like MONOPOLY  
G952 WIZARD OF WINDS - like MONOPOLY  
G953 WIZARD OF WINDS - like MONOPOLY  
G954 WIZARD OF WINDS - like MONOPOLY  
G955 WIZARD OF WINDS - like MONOPOLY  
G956 WIZARD OF WINDS - like MONOPOLY  
G957 WIZARD OF WINDS - like MONOPOLY  
G958 WIZARD OF WINDS - like MONOPOLY  
G959 WIZARD OF WINDS - like MONOPOLY  
G960 WIZARD OF WINDS - like MONOPOLY  
G961 WIZARD OF WINDS - like MONOPOLY  
G962 WIZARD OF WINDS - like MONOPOLY  
G963 WIZARD OF WINDS - like MONOPOLY  
G964 WIZARD OF WINDS - like MONOPOLY  
G965 WIZARD OF WINDS - like MONOPOLY  
G966 WIZARD OF WINDS - like MONOPOLY  
G967 WIZARD OF WINDS - like MONOPOLY  
G968 WIZARD OF WINDS - like MONOPOLY  
G969 WIZARD OF WINDS - like MONOPOLY  
G970 WIZARD OF WINDS - like MONOPOLY  
G971 WIZARD OF WINDS - like MONOPOLY  
G972 WIZARD OF WINDS - like MONOPOLY  
G973 WIZARD OF WINDS - like MONOPOLY  
G974 WIZARD OF WINDS - like MONOPOLY  
G975 WIZARD OF WINDS - like MONOPOLY  
G976 WIZARD OF WINDS - like MONOPOLY  
G977 WIZARD OF WINDS - like MONOPOLY  
G978 WIZARD OF WINDS - like MONOPOLY  
G979 WIZARD OF WINDS - like MONOPOLY  
G980 WIZARD OF WINDS - like MONOPOLY  
G981 WIZARD OF WINDS - like MONOPOLY  
G982 WIZARD OF WINDS - like MONOPOLY  
G983 WIZARD OF WINDS - like MONOPOLY  
G984 WIZARD OF WINDS - like MONOPOLY  
G985 WIZARD OF WINDS - like MONOPOLY  
G986 WIZARD OF WINDS - like MONOPOLY  
G987 WIZARD OF WINDS - like MONOPOLY  
G988 WIZARD OF WINDS - like MONOPOLY  
G989 WIZARD OF WINDS - like MONOPOLY  
G990 WIZARD OF WINDS - like MONOPOLY  
G991 WIZARD OF WINDS - like MONOPOLY  
G992 WIZARD OF WINDS - like MONOPOLY  
G993 WIZARD OF WINDS - like MONOPOLY  
G994 WIZARD OF WINDS - like MONOPOLY  
G995 WIZARD OF WINDS - like MONOPOLY  
G996 WIZARD OF WINDS - like MONOPOLY  
G997 WIZARD OF WINDS - like MONOPOLY  
G998 WIZARD OF WINDS - like MONOPOLY  
G999 WIZARD OF WINDS - like MONOPOLY  
G1000 WIZARD OF WINDS - like MONOPOLY

## EDUCATION

**E011 EDUCATION PACK 1** packed with dozen of educational programs ranging from maths, science to educational games recommended suitable for any Amiga. 5 disk pack only £4.95

**E012 EDUCATION PACK 2** pack with lot of ed program ranging from maths to games recommended  
E013 DISCOVERIES teach you all about Discoveries  
E014 KING JAMES BIBLE (2 disks) (2) excellent  
E015 STORY LAND II interact puzzle games rec  
E016 LANGUAGE TUTOR teach you 4 language  
E017 TALKING COLOURING BOOK very nice  
E018 ASTROLOGY (not WB1.3) excellent  
E019 SIMON & SPICE MATHS maths & simon games  
E020 CHESS HELPER help teach how to play  
E021 BASIC TUTOR learn about Amiga basic prog  
E022 AMIGA TUTORIAL 7 part tutorial  
E023 COURSE TUTOR learn about Amiga  
E024 GUIDE TO LOWER BACK PAIN tutorial the spine & how to avoid back pain (recommended)  
E025 KID ALPHABET display all alphabet letter  
E026 MATHS MASTER teach you more on maths  
E027 STEAM ENGINE V2 graphic & tutorial  
E028 GAS TURBINE ENGINE tutorial & amig graphic  
E029 STEAM ENGINE tutorial & amig graphic  
E030 STEAM ENGINE explain the meaning of dream E051  
E031 INVISIBLE WORLD brilliant recommended  
E032 FISH TANK turn your Amiga into a FISH TANK  
E033 DEMOLITION MISSION simple game for kid  
E034 WORD POWER solve crossword puzzle set good.  
E035 WORD POWER simple game for kids  
E036 APPL EASY learn about apple  
E037 CROSS MAZE & CRYPTOPKING 2 excellent kid games E050  
E038 VERB QUIZ find the word & it's related. Br  
E039 KING JAMES BIBLE (2 disks) (2) excellent  
E040 TARTARUS excellent in a minute  
E041 GALLOWAY's a game of hang man  
E042 MATH DRILLS teach all basic math skill Ygood  
E043 EPOCH learn about your Amiga  
E044 WORLD-WAR II graphics tutorial on WORLD-WAR II relate program or simulate Starboard/molecule  
E045 SCIENCE an excellent collection of science ideal for all who are studying or studies in science recommended. The pack come on 4 disks  
E046 KIDPROF teach children paint programme  
E047 ASTROLOGY PACK This is a mixing collection of programs with all the information you need to create certain or star position set for anyone who studies astrology or hobby. great (4DISK)  
E048 PICTURE & LETTER learn to write - first step  
E049 AMIGA BEGINNER GUIDE tutorial on Amiga  
E050 NOOBY PLUMBA intro to Amiga  
E051 KID PIX more excellent paint programs  
E052 D.T.P FOR easy to use, excellent  
E053 SING A RHYMES (not WB1.3)  
E054 HIGH WAY CODE TUTOR (highway code E006  
E055 READ & LEARN (2) THREE LITTLE PIGGY story  
E056 BACK TO SKOOL vol 1 collection of the best  
E057 BACK TO SKOOL vol 2 in education programs  
E058 BACK TO SKOOL vol 3 & games. RECOMMEND

**E100 LITTLE TRAVELLER** world with world wide  
E101 WORLD GEOGRAPHY world with world wide  
E102 DISCOVERY V2 (not WB1.3) excellent  
E103 DESK TOP GUIDE TO MUSIC/DISK & tutorial  
E104 TRUMPET FIREWORK ALPHABET Very entertaining learn your child the ALPHABET  
E105 HOW TO DRAW (not WB1.3) (2) Excellent  
E106 MR MEN OLYMPIC (2) very easy to complete  
E107 CLUT TV DATABASE (2) lots on early TV series  
E108 HOW TO DELIVER (NOTO 2) (2) excellent program your own  
E109 THE EARTH (BIGAN) how the BIG BANG explode and the life & galaxy  
E110 THE EARTH (BIGAN) how the BIG BANG explode and the life & galaxy  
E111 THE EARTH (BIGAN) how the BIG BANG explode and the life & galaxy  
E112 THE EARTH (BIGAN) how the BIG BANG explode and the life & galaxy  
E113 THE EARTH (BIGAN) how the BIG BANG explode and the life & galaxy  
E114 THE EARTH (BIGAN) how the BIG BANG explode and the life & galaxy  
E115 THE EARTH (BIGAN) how the BIG BANG explode and the life & galaxy  
E116 THE EARTH (BIGAN) how the BIG BANG explode and the life & galaxy  
E117 THE EARTH (BIGAN) how the BIG BANG explode and the life & galaxy  
E118 THE EARTH (BIGAN) how the BIG BANG explode and the life & galaxy  
E119 THE EARTH (BIGAN) how the BIG BANG explode and the life & galaxy  
E120 THE EARTH (BIGAN) how the BIG BANG explode and the life & galaxy  
E121 THE EARTH (BIGAN) how the BIG BANG explode and the life & galaxy  
E122 THE EARTH (BIGAN) how the BIG BANG explode and the life & galaxy  
E123 THE EARTH (BIGAN) how the BIG BANG explode and the life & galaxy  
E124 THE EARTH (BIGAN) how the BIG BANG explode and the life & galaxy  
E125 THE EARTH (BIGAN) how the BIG BANG explode and the life & galaxy  
E126 THE EARTH (BIGAN) how the BIG BANG explode and the life & galaxy  
E127 THE EARTH (BIGAN) how the BIG BANG explode and the life & galaxy  
E128 THE EARTH (BIGAN) how the BIG BANG explode and the life & galaxy  
E129 THE EARTH (BIGAN) how the BIG BANG explode and the life & galaxy  
E130 THE EARTH (BIGAN) how the BIG BANG explode and the life & galaxy  
E131 THE EARTH (BIGAN) how the BIG BANG explode and the life & galaxy  
E132 THE EARTH (BIGAN) how the BIG BANG explode and the life & galaxy  
E133 THE EARTH (BIGAN) how the BIG BANG explode and the life & galaxy  
E134 THE EARTH (BIGAN) how the BIG BANG explode and the life & galaxy  
E135 THE EARTH (BIGAN) how the BIG BANG explode and the life & galaxy  
E136 THE EARTH (BIGAN) how the BIG BANG explode and the life & galaxy  
E137 THE EARTH (BIGAN) how the BIG BANG explode and the life & galaxy  
E138 THE EARTH (BIGAN) how the BIG BANG explode and the life & galaxy  
E139 THE EARTH (BIGAN) how the BIG BANG explode and the life & galaxy  
E140 THE EARTH (BIGAN) how the BIG BANG explode and the life & galaxy  
E141 THE EARTH (BIGAN) how the BIG BANG explode and the life & galaxy  
E142 THE EARTH (BIGAN) how the BIG BANG explode and the life & galaxy  
E143 THE EARTH (BIGAN) how the BIG BANG explode and the life & galaxy  
E144 THE EARTH (BIGAN) how the BIG BANG explode and the life & galaxy  
E145 THE EARTH (BIGAN) how the BIG BANG explode and the life & galaxy  
E146 THE EARTH (BIGAN) how the BIG BANG explode and the life & galaxy  
E147 THE EARTH (BIGAN) how the BIG BANG explode and the life & galaxy  
E148 THE EARTH (BIGAN) how the BIG BANG explode and the life & galaxy  
E149 THE EARTH (BIGAN) how the BIG BANG explode and the life & galaxy  
E150 THE EARTH (BIGAN) how the BIG BANG explode and the life & galaxy  
E151 THE EARTH (BIGAN) how the BIG BANG explode and the life & galaxy  
E152 THE EARTH (BIGAN) how the BIG BANG explode and the life & galaxy  
E153 THE EARTH (BIGAN) how the BIG BANG explode and the life & galaxy  
E154 THE EARTH (BIGAN) how the BIG BANG explode and the life & galaxy  
E155 THE EARTH (BIGAN) how the BIG BANG explode and the life & galaxy  
E156 THE EARTH (BIGAN) how the BIG BANG explode and the life & galaxy  
E157 THE EARTH (BIGAN) how the BIG BANG explode and the life & galaxy  
E158 THE EARTH (BIGAN) how the BIG BANG explode and the life & galaxy  
E159 THE EARTH (BIGAN) how the BIG BANG explode and the life & galaxy  
E160 THE EARTH (BIGAN) how the BIG BANG explode and the life & galaxy  
E161 THE EARTH (BIGAN) how the BIG BANG explode and the life & galaxy  
E162 THE EARTH (BIGAN) how the BIG BANG explode and the life & galaxy  
E163 THE EARTH (BIGAN) how the BIG BANG explode and the life & galaxy  
E164 THE EARTH (BIGAN) how the BIG BANG explode and the life & galaxy  
E165 THE EARTH (BIGAN) how the BIG BANG explode and the life & galaxy  
E166 THE EARTH (BIGAN) how the BIG BANG explode and the life & galaxy  
E167 THE EARTH (BIGAN) how the BIG BANG explode and the life & galaxy  
E168 THE EARTH (BIGAN) how the BIG BANG explode and the life & galaxy  
E169 THE EARTH (BIGAN) how the BIG BANG explode and the life & galaxy  
E170 THE EARTH (BIGAN) how the BIG BANG explode and the life & galaxy  
E171 THE EARTH (BIGAN) how the BIG BANG explode and the life & galaxy  
E172 THE EARTH (BIGAN) how the BIG BANG explode and the life & galaxy  
E173 THE EARTH (BIGAN) how the BIG BANG explode and the life & galaxy  
E174 THE EARTH (BIGAN) how the BIG BANG explode and the life & galaxy  
E175 THE EARTH (BIGAN) how the BIG BANG explode and the life & galaxy  
E176 THE EARTH (BIGAN) how the BIG BANG explode and the life & galaxy  
E177 THE EARTH (BIGAN) how the BIG BANG explode and the life & galaxy  
E178 THE EARTH (BIGAN) how the BIG BANG explode and the life & galaxy  
E179 THE EARTH (BIGAN) how the BIG BANG explode and the life & galaxy  
E180 THE EARTH (BIGAN) how the BIG BANG explode and the life & galaxy  
E181 THE EARTH (BIGAN) how the BIG BANG explode and the life & galaxy  
E182 THE EARTH (BIGAN) how the BIG BANG explode and the life & galaxy  
E183 THE EARTH (BIGAN) how the BIG BANG explode and the life & galaxy  
E184 THE EARTH (BIGAN) how the BIG BANG explode and the life & galaxy  
E185 THE EARTH (BIGAN) how the BIG BANG explode and the life & galaxy  
E186 THE EARTH (BIGAN) how the BIG BANG explode and the life & galaxy  
E187 THE EARTH (BIGAN) how the BIG BANG explode and the life & galaxy  
E188 THE EARTH (BIGAN) how the BIG BANG explode and the life & galaxy  
E189 THE EARTH (BIGAN) how the BIG BANG explode and the life & galaxy  
E190 THE EARTH (BIGAN) how the BIG BANG explode and the life & galaxy  
E191 THE EARTH (BIGAN) how the BIG BANG explode and the life & galaxy  
E192 THE EARTH (BIGAN) how the BIG BANG explode and the life & galaxy  
E193 THE EARTH (BIGAN) how the BIG BANG explode and the life & galaxy  
E194 THE EARTH (BIGAN) how the BIG BANG explode and the life & galaxy  
E195 THE EARTH (BIGAN) how the BIG BANG explode and the life & galaxy  
E196 THE EARTH (BIGAN) how the BIG BANG explode and the life & galaxy  
E197 THE EARTH (BIGAN) how the BIG BANG explode and the life & galaxy  
E198 THE EARTH (BIGAN) how the BIG BANG explode and the life & galaxy  
E199 THE EARTH (BIGAN) how the BIG BANG explode and the life & galaxy  
E200 THE EARTH (BIGAN) how the BIG BANG explode and the life & galaxy  
E201 THE EARTH (BIGAN) how the BIG BANG explode and the life & galaxy  
E202 THE EARTH (BIGAN) how the BIG BANG explode and the life & galaxy  
E203 THE EARTH (BIGAN) how the BIG BANG explode and the life & galaxy  
E204 THE EARTH (BIGAN) how the BIG BANG explode and the life & galaxy  
E205 THE EARTH (BIGAN) how the BIG BANG explode and the life & galaxy  
E206 THE EARTH (BIGAN) how the BIG BANG explode and the life & galaxy  
E207 THE EARTH (BIGAN) how the BIG BANG explode and the life & galaxy  
E208 THE EARTH (BIGAN) how the BIG BANG explode and the life & galaxy  
E209 THE EARTH (BIGAN) how the BIG BANG explode and the life & galaxy  
E210 THE EARTH (BIGAN) how the BIG BANG explode and the life & galaxy  
E211 THE EARTH (BIGAN) how the BIG BANG explode and the life & galaxy  
E212 THE EARTH (BIGAN) how the BIG BANG explode and the life & galaxy  
E213 THE EARTH (BIGAN) how the BIG BANG explode and the life & galaxy  
E214 THE EARTH (BIGAN) how the BIG BANG explode and the life & galaxy  
E215 THE EARTH (BIGAN) how the BIG BANG explode and the life & galaxy  
E216 THE EARTH (BIGAN) how the BIG BANG explode and the life & galaxy  
E217 THE EARTH (BIGAN) how the BIG BANG explode and the life & galaxy  
E218 THE EARTH (BIGAN) how the BIG BANG explode and the life & galaxy  
E219 THE EARTH (BIGAN) how the BIG BANG explode and the life & galaxy  
E220 THE EARTH (BIGAN) how the BIG BANG explode and the life & galaxy  
E221 THE EARTH (BIGAN) how the BIG BANG explode and the life & galaxy  
E222 THE EARTH (BIGAN) how the BIG BANG explode and the life & galaxy  
E223 THE EARTH (BIGAN) how the BIG BANG explode and the life & galaxy  
E224 THE EARTH (BIGAN) how the BIG BANG explode and the life & galaxy  
E225 THE EARTH (BIGAN) how the BIG BANG explode and the life & galaxy  
E226 THE EARTH (BIGAN) how the BIG BANG explode and the life & galaxy  
E227 THE EARTH (BIGAN) how the BIG BANG explode and the life & galaxy  
E228 THE EARTH (BIGAN) how the BIG BANG explode and the life & galaxy  
E229 THE EARTH (BIGAN) how the BIG BANG explode and the life & galaxy  
E230 THE EARTH (BIGAN) how the BIG BANG explode and the life & galaxy  
E231 THE EARTH (BIGAN) how the BIG BANG explode and the life & galaxy  
E232 THE EARTH (BIGAN) how the BIG BANG explode and the life & galaxy  
E233 THE EARTH (BIGAN) how the BIG BANG explode and the life & galaxy  
E234 THE EARTH (BIGAN) how the BIG BANG explode and the life & galaxy  
E235 THE EARTH (BIGAN) how the BIG BANG explode and the life & galaxy  
E236 THE EARTH (BIGAN) how the BIG BANG explode and the life & galaxy  
E237 THE EARTH (BIGAN) how the BIG BANG explode and the life & galaxy  
E238 THE EARTH (BIGAN) how the BIG BANG explode and the life & galaxy  
E239 THE EARTH (BIGAN) how the BIG BANG explode and the life & galaxy  
E240 THE EARTH (BIGAN) how the BIG BANG explode and the life & galaxy  
E241 THE EARTH (BIGAN) how the BIG BANG explode and the life & galaxy  
E242 THE EARTH (BIGAN) how the BIG BANG explode and the life & galaxy  
E243 THE EARTH (BIGAN) how the BIG BANG explode and the life & galaxy  
E244 THE EARTH (BIGAN) how the BIG BANG explode and the life & galaxy  
E245 THE EARTH (BIGAN) how the BIG BANG explode and the life & galaxy  
E246 THE EARTH (BIGAN) how the BIG BANG explode and the life & galaxy  
E247 THE EARTH (BIGAN) how the BIG BANG explode and the life & galaxy  
E248 THE EARTH (BIGAN) how the BIG BANG explode and the life & galaxy  
E249 THE EARTH (BIGAN) how the BIG BANG explode and the life & galaxy  
E250 THE EARTH (BIGAN) how the BIG BANG explode and the life & galaxy  
E251 THE EARTH (BIGAN) how the BIG BANG explode and the life & galaxy  
E252 THE EARTH (BIGAN) how the BIG BANG explode and the life & galaxy  
E253 THE EARTH (BIGAN) how the BIG BANG explode and the life & galaxy  
E254 THE EARTH (BIGAN) how the BIG BANG explode and the life & galaxy  
E255 THE EARTH (BIGAN) how the BIG BANG explode and the life & galaxy  
E256 THE EARTH (BIGAN) how the BIG BANG explode and the life & galaxy  
E257 THE EARTH (BIGAN) how the BIG BANG explode and the life & galaxy  
E258 THE EARTH (BIGAN) how the BIG BANG explode and the life & galaxy  
E259 THE EARTH (BIGAN) how the BIG BANG explode and the life & galaxy  
E260 THE EARTH (BIGAN) how the BIG BANG explode and the life & galaxy  
E261 THE EARTH (BIGAN) how the BIG BANG explode and the life & galaxy  
E262 THE EARTH (BIGAN) how the BIG BANG explode and the life & galaxy  
E263 THE EARTH (BIGAN) how the BIG BANG explode and the life & galaxy  
E264 THE EARTH (BIGAN) how the BIG BANG explode and the life & galaxy  
E265 THE EARTH (BIGAN) how the BIG BANG explode and the life & galaxy  
E266 THE EARTH (BIGAN) how the BIG BANG explode and the life & galaxy  
E267 THE EARTH (BIGAN) how the BIG BANG explode and the life & galaxy  
E268 THE EARTH (BIGAN) how the BIG BANG explode and the life & galaxy  
E269 THE EARTH (BIGAN) how the BIG BANG explode and the life & galaxy  
E270 THE EARTH (BIGAN) how the BIG BANG explode and the life & galaxy  
E271 THE EARTH (BIGAN) how the BIG BANG explode and the life & galaxy  
E272 THE EARTH (BIGAN) how the BIG BANG explode and the life & galaxy  
E273 THE EARTH (BIGAN) how the BIG BANG explode and the life & galaxy  
E274 THE EARTH (BIGAN) how the BIG BANG explode and the life & galaxy  
E275 THE EARTH (BIGAN) how the BIG BANG explode and the life & galaxy  
E276 THE EARTH (BIGAN) how the BIG BANG explode and the life & galaxy  
E277 THE EARTH (BIGAN) how the BIG BANG explode and the life & galaxy  
E278 THE EARTH (BIGAN) how the BIG BANG explode and the life & galaxy  
E279 THE EARTH (BIGAN) how the BIG BANG explode and the life & galaxy  
E280 THE EARTH (BIGAN) how the BIG BANG explode and the life & galaxy  
E281 THE EARTH (BIGAN) how the BIG BANG explode and the life & galaxy  
E282 THE EARTH (BIGAN) how the BIG BANG explode and the life & galaxy  
E283 THE EARTH (BIGAN) how the BIG BANG explode and the life & galaxy  
E284 THE EARTH (BIGAN) how the BIG BANG explode and the life & galaxy  
E285 THE EARTH (BIGAN) how the BIG BANG explode and the life & galaxy  
E286 THE EARTH (BIGAN) how the BIG BANG explode and the life & galaxy  
E287 THE EARTH (BIGAN) how the BIG BANG explode and the life & galaxy  
E288 THE EARTH (BIGAN) how the BIG BANG explode and the life & galaxy  
E289 THE EARTH (BIGAN) how the BIG BANG explode and the life & galaxy  
E290 THE EARTH (BIGAN) how the BIG BANG explode and the life & galaxy  
E291 THE EARTH (BIGAN) how the BIG BANG explode and the life & galaxy  
E292 THE EARTH (BIGAN) how the BIG BANG explode and the life & galaxy  
E293 THE EARTH (BIGAN) how the BIG BANG explode and the life & galaxy  
E294 THE EARTH (BIGAN) how the BIG BANG explode and the life & galaxy  
E295 THE EARTH (BIGAN) how the BIG BANG explode and the life & galaxy  
E296 THE EARTH (BIGAN) how the BIG BANG explode and the life & galaxy  
E297 THE EARTH (BIGAN) how the BIG BANG explode and the life & galaxy  
E298 THE EARTH (BIGAN) how the BIG BANG explode and the life & galaxy  
E299 THE EARTH (BIGAN) how the BIG BANG explode and the life & galaxy  
E300 THE EARTH (BIGAN) how the BIG BANG explode and the life & galaxy

**WE ALSO STOCK THE ENTIRE COLLECTION OF LSD TOOLS 1-150 SCOPE 1-220 FRED FISH 1-1000 ASSASSIN GAMES 1-200 ETC**



## VARIOUS PACK

Any pack comes on 5 disks  
Only £4.95 per pack

- COLOUR FONTS pack (1 or Pack 2)
- MONO FONTS Pack (1 or Pack 2)
- High quality fonts for use with DPaint of Personal Paints
- VARIOUS CLIPART pack (1,2,3 or 5)
- COLOUR WORLD MAP (Pack 1,2 or 3)
- High quality world map
- COMPUTA-GRAPHIC FONT (Pack 1,2,3,4 or 5)
- High quality font for WORDSWORTH or any DTP
- IMAGINE VARIOUS OBJECT (Pack 1,2 or 3)
- REAL 3D VARIOUS OBJECT (Pack 1,2 or 3)
- NIGHTWAVE VARIOUS OBJ (Pack 1,2 or 3)
- TRUE FONT FOR ABOVE (Pack 1,2 or 3)
- Please state for which pack above)

We also stock many more packs. Please Phone

## COMMODORE C64 V3

The very latest version. Now you can play real Commodore C64 games on your Amiga All pack below are complete & ready to play directly on your Amiga. Printed instruction provide

**C64 & 45 original games.....£4.99**  
**C64 & 100 original games.....£8.99**  
**C64 & 200 original games.....£16.99**

Ps. C64 & 100 games pack got 88% review in Amiga Shopper Issue 54

## ZX SPECTRUM 48K

Now You Can Play 100s + 100s Of Spectrum 48K Gameson Your Amiga. Any Pack Below Is Complete & Ready To Run On Your Amiga. Full Printed Instructions Provided

SPECTRUM & 50 GAMES PK1 ONLY £4.99  
 SPECTRUM & 100 GAMES PK2 ONLY £7.99  
 SPECTRUM & 200 GAMES PK3 ONLY £11.99

**SPECIAL OFFER**  
 Take All 3 Packs Above & 50 New Spectrum Games For Only £19.99

More spectrum games available  
 <-----screen shot from AMIGA

## Special offer

C64 & 45 games pack  
 Spectrum V2 & 50 games  
 Vic20 & 30 games  
**All 3 packs for only £9.99**

SEE LEFT FOR DESCRIPTION

# 1000

## SPECTRUM GAMES pack

See left for details. This pack comes on very large number of disks. (p. £29.99)

# NOW ONLY £29.99

+ £2.45 for parcel postage (this is due to the large number of disks in this pack)

## AGA A1200 & A4000 ONLY

THIS LISTING ARE FOR USE WITH AGA AMIGA

AGA201 EXTENSION DEMO Stunning demo, fast landscape anim  
 AGA202 KLONDIKE DELUXE AGA (3D) the best A1200 cardgames  
 AGA203 FRACTAL GENERATOR fractal in 256 colour  
 AGA204 WORKBENCH HACK many hacktoyt/blanker act  
 AGA205 NEW SUPER KILLER know know & kill over 316 type of  
 AGA206 MUST FOR ALL A1200 OWNER  
 AGA207 MINDWARP very first demo for the A1200  
 AGA208 MINDWARP DELUXE AGA (3D) the best A1200 cardgames  
 AGA209 FAMOUS lady as cards face 18 + only  
 AGA210 SLEEPLESS NIGHT 3  
 AGA211 PLANET GROOVE Truly A1200 Demos  
 AGA212 MOTOR INVADER 2 (2D) Brilliant INVADER game  
 AGA213 POINT OF SCALE Great A1200 only demos  
 AGA214 CHROMAS- Fairly good demo.  
 AGA215 WORLD OF MANGA (4DISK) magnificent Japanese comic  
 AGA216 show include Japanese Check ect recommend  
 AGA217 MAGIC WORKBENCH improve the look of your WB5 add  
 AGA218 function to your WB really BRILLIANT  
 AGA219 WB 3 UTILITIES load of Wb 3 only utilities  
 AGA220 U-CHESS the best chess program games sofar but require  
 AGA221 graphics, Brilliant graphic  
 AGA222 WORKBENCH 3 SCREEN Great back drop  
 AGA223 ADULT SLIDE Vol 1-9 (2 disk each) "see below  
 AGA224 BODY SHOP VOL 1-7 (2 disk each) "see below  
 AGA225 FITCHICK vol 1-3(2disk each) "see below order any disk  
 AGA226 just state disk code & volume no? (remember 2 disk per vol-  
 AGA227

AGA224 KNOTTY-Stunning AGA sliding pictr puzzles  
 AGA240 LOTTERY WINNER hope fully will improve your chance of  
 winning a jack pot.GOOD LUCK  
 AGA241-258 AGA GAME-GALORE AGA 01-18 lot of games  
 AGA251 PACKMAN AGA -the best pacman yet  
 AGA252 ROCKET PD - Super thrust cnebrantial graphic for 1 or 2  
 player  
 AGA253 REAL DEMO stunning special effect  
 AGA254 DIRT AGA Brilliant 256 colour effect.  
 AGA255 DELIGHT EXPLORE excellent demo  
 AGA256 KEFEREN AGA Demo lot of effect  
 AGA257 MINOMIST RAVE great rave music.  
 AGA258 OXYGENE Fantastic demo  
 AGA259 INTEL-OUT another very good demo  
 AGA260 SOMEJUSTICE4 Demo of the monthbrilliant what effect.  
 AGA261 RECOMMEND  
 AGA262 TO THE DEATH very good STREET-FIGHTER clone with  
 very good graphic.  
 AGA263 GEORGE GALAXO (2disk) brilliant/level shoot/platform  
 game. RECOMMEND  
 AGA265 MISSILE OVER ZENON (2disk) Brilliant 3D missile com-  
 mander with fantastic graphic  
 AGA266 TEAM-HOI DINO PLATFORM excellent dropplatform  
 Note: this disk was a commercial games  
 AGA274 MUSIC 2 SURVIVE 2disk & excellent music master piece.  
 well worth getting  
 AGA271 RAVE MAXIMUM OVERDRIVE II (2disk)  
 AGA278 CHANNEL 2 ISSUE 1 (AGA) (2disk)  
 AGA base disk magazines. RECOMMENDAGA disk magazine  
 topic demo music  
 AGA285 WORKBENCH BACKDROP VOL 3  
 AGA286 DE-LUXE MONOPOLY- Board game.V addicted  
 AGA289 DONKEY KONG Arcade classic conversion  
 AGA297 BOMB PAC Extremely good to play  
 AGA298 ROCKET 2 set deep underground brilliantgraphic, even bet-  
 ter with 2 player  
 AGA299 SCRABBLE-Now fully run on all Amiga  
 AGA300 MAGIC WB V2. Demo of version 2  
 AGA302 TUTANKHAM II(2) 18hr-Egyptian MUMMY  
 AGA303 PAMLA ANDERSON (2) 18+ only BayWatch Babe  
 AGA304 BODYSHOP V8 (3) more bikini beauties  
 AGA305 TIMEZONE (2) V.Good graphic adventures.  
 AGA307 DENTAWOLF dooms demo  
 AGA308 NAXOS -Really show what AGA graphic co do  
 AGA310 FEARS (2d)- dooms clone demo  
 AGA312 JINX (2d) Fantastic arcade puzzle  
 AGA313 RAM JAM THE TASTE DEMO very wicked demo.  
 AGA315 ILEX MYSTIC. New AGA demos  
 AGA320 KLONDIKE 3 (4disk) Hid require & 2meg+we also have a  
 list of 25 cards for above.  
 AGA321 HOT-BABE 1 (1) MUST BE OVER  
 AGA322 HOT-BABE 2 (2) 18  
 AGA323 HOT-BABE 3 (2) BEFORE  
 AGA324 HOT-BABE 4 (2) ORDER ANY  
 AGA325 HOT-BABE 5 (2) OF THE HOT-BABE PACK  
 Hundred of quality Magic wb icon & back drop  
 AGA388 DESK-TOP MAGIC- 32 animated screen blanker  
 AGA389 WAR OF THE WORLDS- full 3D games  
 AGA390 FEAR 2. Brilliant 3D graphic games like  
 AGA391 P8SST Amiga version of Spectrum games  
 AGA392 CHLD MURDER(4)Horror graphic adventure  
 AGA393 FEAR II -Brilliant 3D game play just likeDOOM on the PC  
 Guaranteed you impress.  
 AGA393 PC EMULATOR V3- Latest PC emulator  
 AGA400 HYPER RACE (2) Super racing games  
 AGA410 CINDY CRAWFORD (3) new  
 AGA411 ELLE MACPHERSON (3)  
 AGA412 CLAUDIA SCHIFFER (3)  
 AGA413 BIG GIRLS (2)  
 AGA414 GIRLS GIRLS (2)  
 AGA415 NIKY TAYLOR (2)  
 AGA417 KYLIE MINOUGE (3)  
 AGA418 FEMALE BODY BUILDER (3)  
 AGA419 EXCELLENT CARD GAMES 3 latest  
 AGA420 POKER & BLACK JACK DELUXE (3)MEG  
 AGA421 COLOUR WB make your WB more colourful  
 AGA422 RIDGE RACER Demo on the Amiga,  
 AGA423 DRUG STORE DEMOS (2disk)  
 AGA424 DREAM WALKER (2) Demos  
 AGA425 MYSTIC DEMOS(2) 95 excellent demos  
 AGA426 ORIGIN 2 (2 DISK). Amazing

AGA290 A1200 FIX DISK COLLECTION 1  
 AGA291 A1200 FIX DISK 2 COLLECTION 2  
 AGA292 RELOCKIT V1.4a latest, run A500 SOFTWARE  
 AGA293 A1200 FIX DISK VOL 3 (new July 95)  
 AGA294 disk above are design to make any old A500-A600  
 Amiga program/games ect to run on your A1200/A4000  
 MUST FOR ALL AGA AMIGA OWNER. RECOMMEND

AGA297 A1200 UTIL -AGA TESTER, SYSINFO act  
 AGA298 ACTION REPLAY V4 Complete ACTION REPLAY.  
 AGA299 MADFIGHTER 2 brilliant street fighter clone  
 AGA300 AGA BLITZ SCREEN BLANKER  
 AGA301 FAST GIFF 2 display GIFF pic in Workbench.  
 AGA302 AGA DIAGNOSTIC - NEW system tester  
 AGA303 BLACK BOARD AGA decent image processor  
 AGA304 QUICK GRAB AGA -grab AGA screen PICTUREAGA110  
 AGA305 BEYONDS 1 (3) stunning 256 COLOUR fantasy art.  
 AGA306 smell like CHANEL NO5 brilliant demora trace picture  
 AGA307 release on the A1200  
 AGA308 MAGIC FACTORY 1 STAR TREK (5 disk)  
 AGA309 AGA UTIL V1&2 (2) AGA util compilation  
 AGA310 AGA UTIL V3 &4 (2) more of above  
 AGA311 MULTIBOOT- 4 various version A500 EMU  
 AGA312 OFFICIAL WORKBENCH 3 HARDDRIVE INSTALLER  
 AGA313 WB3 HARDDISK PREF & INSTALLER installing  
 AGA314 CROSS DOS PLUS v5.1 read/write PC files  
 AGA315 SUPER LEAGUE 3 -latest manager games  
 AGA316 SPEAK & SPELL - educational software for kid  
 AGA317 BIG TOPS (18 + only)P8Mmm  
 AGA318 KELOG LAND -brilliant platform games  
 AGA319 ACTION REPLAY V5 - NEW UP DATE TO V4  
 AGA320 GIGER TRIZ new STREET-FIGHTER 2 clone  
 AGA321 FATAL-BLOW new STREET-FIGHTER 2 clone  
 AGA322 CINDY CRAWFORD V81 (2 disk) latest release  
 AGA323 INFESTATION (3 disk) The ultimate AGA demo  
 AGA324 CINDY CRAWFORD Vol II (2disk) amazing  
 AGA325 VIDEO TRACKER AGA-ultimate demo maker  
 AGA326 MAGIC WB EXTRA vol 1 & 2 (2disk)  
 AGA327 GIF BEAUTIES VOL (11-18) 8 more girls disk  
 AGA328 FRIDAY AT 8 another brilliant AGA demos  
 AGA329 ASSASSIN MULTIVISION AGA pic viewing util  
 AGA330 ALIEN FRENZE 2 player blessing +power up  
 AGA331 BIG TIME SENSUAL (2disk) SPACE BALL 2  
 AGA332 MASQUERADE 2disk brilliant puzzle games.  
 AGA333 RAM JAM 94 it cat be done (2disk)  
 AGA334 EXPLICIT 2 DEMO new effect weldone.  
 AGA335 COMPLEX ORIGIN 2disk require 2 diskdrive  
 AGA336 TREASURE OF TUTANKHAMUN- education tool  
 AGA337 LOVE 2 disk-stampy brilliant DEMOS  
 AGA338 AGA UTIL 7 & 8 (2 disk) More USEFUL util

## SOFTWARE2000 DOUBLE CD CONTAIN

# OVER 1965 DISKS

This is the big one! Nearly 2000 original disk from the SOFTWARE2000 library included on a Double CD set.  
 For the list just take a look at this Double advert for example of titles & packs which can be found on these CDs.  
 No lucky dip or unknown software. Full description on every disks/titles. Very easy to use menu-system on both CDs.  
 This unique menu system lets you explore the contents of both CDs without disc swapping.... Excellent. See below.

**EXAMPLE OF DISK CAN BE FOUND ON THE DOUBLE CD SET**

294 VARIOUS UTILITIES DISKS,	118 EDUCATIONS DISK,
252 ANIMATION DISKS,	133 DEMOS,
181 AGA DISKS,	225 MUSIC DISKS,
92 TOP SAMPLE AND FX DISKS,	18 DEMOS (Adults only)
<b>402 +VARIOUS GAMES DISKS - With an estimate of around 1000 Amiga games,</b>	
<b>50 LATEST MAGIC WB &amp; BACKDROP</b> Versions for all Amigas also includes	
<b>100's of Imagine Obj, 600 Amiga fonts, 100's quality B&amp;W &amp; colour clip art &amp; many more</b>	

**ALSO INCLUDED ON THE CDS ARE**

# OVER AROUND 1000 & 700-1000

**NEW Spectrum Games** (Play direct from CD) **NEW C64 Games Files** (EMULATOR INCLUDED)

Both Never been released on any CD Rom

**Now Only ONLY £24.99**  
 +70p for P&P

UPDATE & RELEASE 1-OCTOBER 95 AVAILABLE NOW

- Over 600MB per CD
- Menu Compatible with All Amigas
- No duplicate of data
- Very Easy to use Menu

RRP £34.99 NEW PRICE

## Available Now

Below 3 all new games pack release due to the ever popular. With any of these games packs, You know exactly what sort of games you're buying.

Like our previous packs, each pack comes on 5 disks and using the latest disk packer we can put up to 5 games disks on to one disk. So you get up to 25 top games for only £4.99. All games & instructions will auto run when you click on icon.  
 \* All Games pack contain different games \* Compatible with ALL AMIGAS

**Board Games Pack 3 (5 disks) £4.99**  
**Arcade Games Pack 3 (5 disks) £4.99**  
**Puzzle Games Pack 3 (5 disks) £4.99**  
**Card Games Pack 3 (5 disks) £4.99**

**Non CD rom Owner**  
 This pack is ideal for any Amiga owner who does not own a CD Rom drive and want large amount of the very latest software at minimum cost.

These packs will be 100% update with all new or different software on the 1st of every month, all software is packed using UHA which have a ratio of approx 3-1, (upto 10 disks worth of software from the 10 disk pack).  
 Highly recommend as you will get 3 x more software per disk

**Various latest Games (10 disks) only £9.90**  
**Various latest Utilities (10 disks) only £9.90**

## NEW TITLES

G938 ULTIMATE TOUR TENNIS (2 disk) Excellent tennis games  
 G939 DARK ANGEL - (not WB 1.3) Superb arcade adventure  
 G940 RAISE THE TITANIC - Good 3D Adventure game  
 G941 PHANTOM - excellent shoot games (DEFENDER 96)  
 G942 MACDONA-LAND - Brilliant game similar to ZOOL (not A1200)  
 G943 JOUST III - Brilliant C64 games with update Amiga graphic  
 G944 DELUXE GALAGA V2.6 - Ther Very Latest Galaga. Hi Recommend  
 G955 LAZER RACE - Good Tron type extremely addicted to play  
 G956 TRAIN-DRIVER SIMULATION - The most realistic train sim  
 G957 MASTER-BLASTER - Kill various monsters with bombs  
 G958 KNOCK-OUT - Mini destruction derby, very addictive  
 G959 DUNGEON HERO - 3D Graphic adventure similar to DOOM  
 G960 MORTAL KUMQUAT 3 - Weird but fun beat-em-up  
 G961 CODE NAME NANO - Superb Thrust clone (NANO FLY 2)  
 G962 MICRO MARKET V3 - Get rich by buying shares. Great games  
 G963 POKER-MANIA - if you like poker than this is for you  
 G965 LETHAL FORMULA - Adventure similar to Monkey Island  
 E253 BEGINNER TYPING TUTOR  
 E254 WORD PUZZLE PRO - Create Crossword puzzle or solve puzzle  
 E255 KID DISK 7 - Another very fine education program  
 E256 EARLY LEARNER (age 3-5) teach your kids how to read  
 E257 A-Z COUNTRY OF THE WORLD  
 E258 UK COUNTIES - Similar to above but this is based entirely on ENGLAND, WALES, SCOTLAND & NORTHERN ISLAND  
 E259 BASIC ELECTRONIC V1.5 (2 disk) for Electronic fan  
 E261 MASSIVE GUIDE TO THE INTERNET V2.3  
 AGA429 POWERDROID-96 - New Asteroid with brilliant graphics  
 AGA430 ULTIMATUM - The ultimate 3D Tank Battle  
 U1010 WB2 INSTALLER - install A500/A600 workbench to HD  
 U1011 TURBO-CAT PRO V1.2 (not WB 1.3) create catalogues  
 U1012 TUBE-ENGINE V5 (not WB 1.3) The very latest word processor with spell checker. This is the full version highly recommend  
 U1013 DIARY-2000 - use just like the real diary  
 U1014 TOTAL EXLIPS - Disk Magazine 1  
 U1015 NEW CHEAT DISK V2.1 (2 disk) include some games Fix  
 U1016 ULTRA ACCOUNT - Another very good account program  
 U1017 PRO LOTTERY 96 - The very latest & best lottery program  
 U1018 PRO GREY HOUND - Like ProGamble but for dog  
 U1019 AUTO STEREO GRAM V4 - Latest Magic eye generator  
 U1021 ELECTRONIC ADDRESS BOOK  
 U1022 PRO-FOOTBALL 1.1 (2) - Football predictor like ProGamble  
 U1023 SHAPDE - Remind important date  
 U1024 SHAPDE-SHIFTER V3.3 The very latest Mac emulator  
 U1025 MESSY SID 3 - The latest PC->AMIGA disk converter  
 U1026 HD GAME INSTALLER 4 - install loads more games to HD  
 U1027 SOFT-MEMORY - Double your computers memory. This version does not require HD or MMU. Give this a try Recommend  
 U1028 MAGIC-USER-INTERFACE V3.1 update to version 2.3  
 U1029 ORIC 48K EMULATOR (Not 1.3) At last it work  
 U1030 MSX II Emulator v2.1 (WB3.0) MSX computer on  
 U1031 900 AMIGA GAMES HIT & CHEAT V4 (2 disks)  
 U1032 VIRUS CHECKER V8.2 (not WB 1.3) Latest

## LOTTERY WINNER

EXCELLENT COLLECTION OF VARIOUS LOTTERY WINNER PREDICTION PROGRAM  
**HIGHLY RECOMMEND Pack only £4.99**

## UFO THE CLOSE ENCOUNTER

100's of real life documents of UFO sightings, photographs & Animal mutilation and many more.  
 Very interesting read 6 Disk set only £5.99

## UFO - ALIENS MULTIMEDIA

100's of documented cases on UFO sightings, abductions, Cattle mutilation & many more. Many with photo to back up the claim. Some are so secret only released recently by law  
**9 disk pack only £8.99**

## CARD GAMES PACK II

FOR ALL CARD GAMES FANS.  
 You Like Poker, Black Jack, Spade, Poolbill, Solitaire, Skatje, Kocroche etc then this pack is a must.  
**Only £4.99**  
 This pack contains 5 disks

## BUSINESS SOFTWARE

U007 TEXT PLUS 2.2e easy to use word processor  
 U023 BANKING Home account program  
 U027 LABEL DESIGNER design your own labels  
 U028 CAL V 3 Excellent Database prog. RECOMMEND  
 U037 DESKTOP FILING THE best P&D DTP available  
 U038 BUSINESS CARD MAKER (not A1200) brilliant  
 U040 600 BUSINESS LETTER very handy. Out it now  
 U041 BUSINESS 81 - can Print in colour  
 U042 DATA BASE WORKSHOP (2) brilliant P&D  
 U043 SCHEDULE SHEET Very easy to use spreadsheet  
 U045 QUICK REPORT MAKER - can Print in colour  
 U046 RM DATABASE powerful database + full DOC  
 U048 AMBASE - Professional file based database yet  
 U049 TEXTURA Can edit several documents at once  
 U052 PENNY WISE very powerful database  
 U053 VISUALC Great database lots o functions  
 U054 TEXT-SCHEM V3 - full feature wordprocessor  
 U0543 LITTLE OFFICE - database/wordprocessor/spreadsheet  
 U0545 HOME BUSINESS - easy to use database  
 U0546 PERSONAL FILE V2.2 ZOURNAL - easy to use database  
 U0547 MICRAPP REPORTER - easy to use database  
 U0549 JOURNAL full feature account prog. Excellent  
 U0550 COBAN NOTE BOOK database & word map  
 U0551 DATA BASE - compilation - best seat to state  
 U0558 MORTGAGE CAL calculate mortgage repayment rate etc  
 U0559 ACCOUNT MASTER V2.6 new account program  
 U0560 HOUSE INVENTORY - ideal for home insurance  
 U0561 ADDRESS PRINT V2.1 stores & print addresses  
 U0567 TEXT PLUS V4.0 pro requires HD & 2meg  
 U0568 INVENTORY 5.0 at least 36,000 word spellchecker  
 U0572 EDWARD PROFESSIONAL truly the best wordprocessor  
 U0573 CYCICAL - amazing spreadsheet max 92983 cells  
 U0574 PAY ADVANCE ANALYZER - money prog  
 U0580 PAY ADVISOR 3 account program  
 U0581 LABEL MAKER - print labels ect. new  
 U0582 THE MORTGAGE ACCOUNT program  
 U0583 LOANS ACCOUNT  
 U0584 CONFIRM One of the best invoice makers  
 U0585 ACCOUNT MASTER V2.2 (new) program is up to 1000 entries per account

## LITTLE OFFICE 2

New Release includes  
 530 Business Letters  
 Word Processor  
 Calendar  
 Name & Address Database  
**All this for only £1.99**  
 COMPATIBLE WITH ALL AMIGA

## Harddrive & disk drive space doubler

Up to 1.6 this doubles the size of your HD or DISK Drive storage capacity. RECOMMEND

## 18 DEMOS MUST BE 18 OR OVER

X80 CINDY CRAWFORD (2)  
 X74 MADONA (SEX) (3)  
 X01 SHOWER GIRL  
 X03 BODY TALK (2)  
 X09 MARIE WHITTAKER  
 X24 SABRINA SPECIAL  
 X25 DIE FILKINGER  
 X26 MADONA EARLY DAY  
 X28 KATHY LLOYD  
 X30 MEGA-MAID  
 X31 CALENDER GIRL  
 X32 MAY FAIR  
 X33 UTOPIA (4 DISK)  
 X46 GIRLS OF SPORT  
 X49 PAGE 3 GIRL  
 X70 GON GON GIRL  
 X71 TINA SMALLHOT  
 X91 CINDY CALENDAR 95  
 X96 HOT BABE 1  
 X97 HOT BABE 2  
 X98 HOT BABE 3  
 X99 HOT BABE 4  
 X100 HOT BABE 5  
 X101 BIG GIRL II  
 X102 FEMALE BODY BUILDER  
 X103 GIRLS GIRLS  
 X105 ELLE MACPHERSON  
 X106 CLAUDIA SCHIFFER

## HARDWARE PROJECT III

Build dreams of project. Includes an A500 for less than £15 (incl. 1.5 HD in your AMR & A1200. Put your A500/400/1200 in a basement for less than £50. Use 1.44 PC disk one on your Amiga. Add in Packed Modem to your Amiga & many many more this could save you £25. (not for beginners) 3 disk pack only £5

## MAGIC WB & EXTRA DISK

This is the cheapest way to obtain Magic WB extra. Each pack below will fit 12 disks when unpacked. Very easy to unpack via click a few buttons

MAGIC WB EXTRA PACK (01-12) 12 disks	£6.99
MAGIC WB EXTRA PACK (13-24) 12 disks	£7.99
MAGIC WB EXTRA PACK (25-36) 12 disks	£7.99
AGA21 MAGIC WB V1.2 THE LATEST MAGIC WB FOR A1200	£1.99
U995 MAGIC WB 1.3 this is for the A500 1.3/A500plus & A600	£1.99

## Magic BackDrop

This is a great way to obtain Magic WB extra (WB2 users require MCKDFP to use the backdrops)

Various Back Drop 1 (8)	£1.99
Various Back Drop 2 (8)	£1.99
Sexy BACKDROP	£1.99
NEW AMIGA LOGO 80	£1.99
Magic Scenery 80 (8)	£1.99
Glamour Face	£1.99
All New BackDrop 90 (8)	£4.99



# SX32

If you've bought a CD32 but feel limited. Why not turn it into an A1200? The SX32 provides the solution ...

■ Price: £199/£299 ■ Developer: DCE Computers ■ Supplier: Visage ☎ 0115 964 2828

**W**hen the CD32 was launched it was intended to be a true blue, straight down the line, no frills games console. It was 32-bit, had a CD-ROM drive and was allegedly the future of gaming. But it was something else too. Underneath that dark grey exterior, that toilet seat lid, behind the facade of Joystick one and Joystick two ports lay the guts of a standard, 2Mb AGA Amiga 1200.

On the back of the CD32 there is a little screw-on door. Go on, take a look. This door opens to reveal a large empty space with a 72 pin connector built in. In the old days of exuberant optimism this port was most famous for allowing the Commodore FMV card to be attached, with all the Start Trek, Terminator and Jurassic Park CD film hilarity this entailed. Unfortunately the big C didn't get very far with the FMV card before going bust: it barely got past prototype stage. Some say this was a good thing, Phil Collins was about to release a 'Best Of' album on Video CD around the time they went belly up. What was that about clouds and silver linings?

## SX1 shortfalls

However, it had one other expansion: Paravision's SX1. This was a large metal box similar in colour to the CD32, with a socket which could be attached to its 72 pin connector and it was designed to fit flush with the back of the console, forming a sort of L shape. It was a God-send for those who needed a computer as well as a console, especially those who like their games to look better than average - it had an RGB port. It also had serial and parallel ports, a floppy disk drive port, facility for a standard PC keyboard and space for an internal IDE hard drive. However, the SX1 must have been designed with the CD lid closed all the time, because whenever you perform the simple task of flipping the CD lid open it jogs the SX1 slightly which could cause problems, such as instant crashes. The other disadvantage is that

it plugs onto the side of the CD32, making for a rather awkward sprawling desktop setup.

## SX32 solutions

The SX32 is designed by rival German company CDE to overcome these problems and it does so in the most logical way: using all that empty space I talked about inside the CD32. It attaches to the same port but the circuit board is housed inside the CD32 instead of the SX1's external metal casing. Like the SX1 there is also provision for a hard drive to be fitted and this is inside too.

All that sticks out of the back of your CD32 is a 1 centimetre protrusion painted in the usual brand of attractive Commodore Grey. This houses the five sockets that connect the SX32 to the outside world. These are Serial, Parallel, Disk Drive, RGB and, unusually, VGA. Unlike the SX1 the

serial port is standard Amiga 25-pin as opposed to the PC 9-pin standard.

The inclusion of a VGA output is useful for direct connection to a VGA monitor but the outputs are not buffered which means that it's not really practical to use the RGB and VGA outputs simultaneously. Technically, if you wanted to you could view what's on your CD32 using the composite output too and the RF.

It's also worth noting that you will need a PC monitor capable of handling the Amiga's horizontal and vertical scan rates if you intend to use the VGA output, which, in the case of the AGA CD32 is 15-30 KHz and 48-73Hz respectively. This means that many PC VGA monitors will not work and you should be aware of this if you own one and think that the SX32 would slot in nicely in front of it.

## Starting up

Installing the SX32 is a tad more complicated than the SX1, mainly because you have to unscrew and open up the CD32. This voids the warranty but



▲ The SX32 makes very little cosmetic difference to your CD32, but once you add peripherals the scene changes drastically. A disk drive is pretty essential (the slimline BFC HD model used above suits the CD32's colour too), as is an A4000 keyboard and a mouse. Visage will supply a keyboard and disk drive (not this one) as part of an expanded package.



you'll be lucky if you've still got one at this stage, so this is not much of a problem. Technically speaking if you were only installing the board without a hard drive, you could just jam it in; but this is no way to treat £200 worth of kit. With the cover off the CD32 it simply and easily slots into the 72-pin connector and the circuit board sits on top of the metal shielding covering the CD32's circuitry. Rubber feet are at both ends of the board to allow it to rest securely on here. You can then replace the top of the console and, hey-presto, everything's back to normal.

One of the other top class reasons for having an SX32, apart from the keyboard, mouse and Workbench it gives you access to is that it enables you to insert RAM and a hard drive. 4-8Mb of 72-pin Simm inside it will not only help you down the path of productivity but it will speed your games up in a way you never imagined - even standard CD32 games. It really helps games like Alien Breed 3D, which are almost too sluggish for words on the standard CD32.

### Accelerator?

One of the biggest improvements the SX32 could have had over the SX1 was provision for an accelerator. You can add up to 16Mb of RAM but there's no substitute for an upgraded processor as well. This is where an SX32 equipped CD32 really falls short of its A1200 cousin. You're limited to the standard 14MHz 68020 and there's no way out. Even taking size limitations into account a motherboard upgrade to the 28MHz 020 currently used in 1220

accelerators would have been welcome. But sadly none of this has happened.

### Getting connected

I tested the SX32 with all manner of software, both from CD, disk and Hard Disk. And it worked perfectly with everything. Unlike an A1200 with a CD-ROM drive you really do have the best of both worlds here: all CD32 and Amiga CD-ROM titles will work, without exception. And like an A1200 you can connect a printer, run business software, use a modem and surf the net; the choice is yours. But the inevitable trade off is that some applications do require acceleration to run at an acceptable speed and there is only so much speed that extra fast RAM will give you.

Also, you must remember that it's not just an SX32 you need, you'll also have to invest in a keyboard, a mouse, an external disk drive and Workbench software. If you already have an Amiga of some sort you'll have the mouse and Workbench and maybe an external drive but the keyboard isn't as straightforward as it was in the SX1. With that unit you could use an old standard PC AT keyboard. These cost £15-£25 new and I've picked one up before for a fiver secondhand (with a PC believe it or not!). The

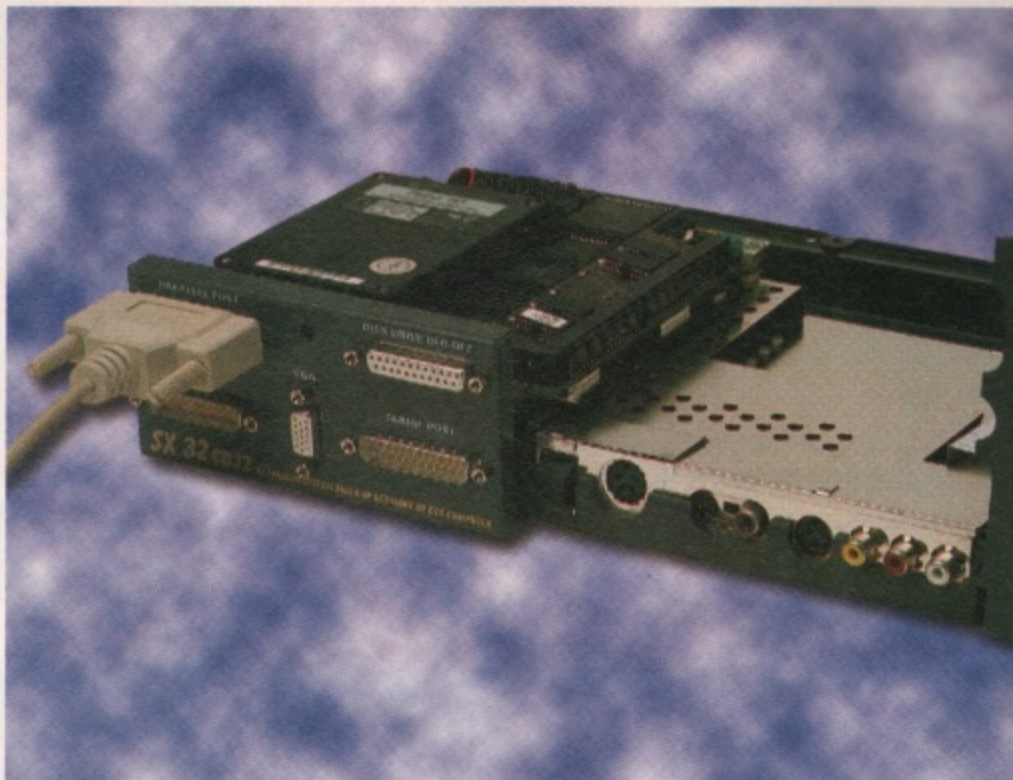

▲ See how neatly the SX32 fits inside the CD32's box. Ours has a hard drive and 4Mb RAM, which really does make a difference to this modified CD32 or, indeed, any A1200. Provision for an accelerator and PCMCIA would have been real icing on the cake.

SX32 has no separate keyboard input so you have to use the PS2-style port on the CD32 itself (beside the joystick ports). PC PS2 keyboards will plug in fine but won't work, so the only option is to purchase a rare and very expensive replacement A4000 model. Bummer.

Luckily Visage intend supplying the SX32 with both an external drive and a compatible keyboard, but not Workbench, which is proving difficult to source. You can still run autobooting disks and many CDs boot into Workbench and you can continue to use this. But there is no substitute for the real thing and sooner or later you'll need part of the Workbench system that's not on whatever you're booting off. The keyboard and external drive bump the price up to £299, so hunt around for an old A4000 keyboard first if you're serious.

So is it better than the SX1 then? Well it depends on your priorities. Scanning the ads (and I can only find one for the SX1 in last month's mag) I make it slightly cheaper than this unit at the moment. It costs £8 less than Visage are quoting for the SX32 and although a decent disk drive will set you back the best part of £50 for either peripheral, using the AT port you will save more than a couple of quid on a cheap PC keyboard. On the other hand you might want something that actually fits snugly inside your CD32, rather than a cumbersome external box, and one which has a standard Amiga serial port as opposed to a PC one. You might also want a real

Amiga keyboard with the proper keymaps and names, not some cheap, confusing alternative (an AT jacked Amiga keyboard will almost be as expensive as an A4000's). The difference in price is, in the final analysis, only one of around £20-£30. Both SX1 and SX32 are up to the task of turning a toy into a valuable computer tool, the SX32 just does it in a neater way. ■

Alan Dykes



▲ Alien Breed 3D is just one of the CD32 games which benefit from the speed boost of fast RAM.

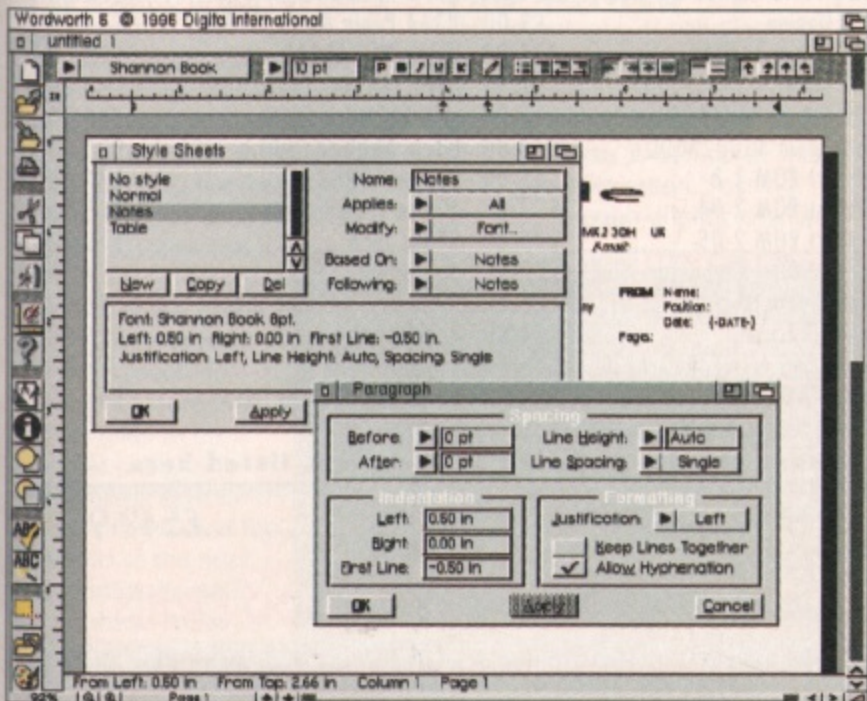

▲ A word processor and a printer will make you realise just how much your console has turned into a real computer. You can now use serious applications off disk or CD, surf the net, or program your own games.

<b>SX32</b>	
CD32	<b>system requirements:</b> Will only work with CD32. Keyboard, external disk drive and mouse are necessary. Accepts up to 16Mb RAM on 72 pin single or double sided SIMMS and a hard drive.
A500	
A500+	
A600	<b>ease of use</b> .....93% Easy to set up and then as easy to use as an A1200 - with the CD-ROM bonus.
A1200	<b>performance</b> .....87% Greatly increases the CD32's performance but provision for an accelerator upgrade would have made it a Super Star.
A1500	<b>value for money</b> .....85% Good value if you have a CD32 and want a computer with CD capability for just £300.
A2000	
A3000	<b>OVERALL</b> With acceleration this would eclipse the standard A1200.
A4000	<b>86%</b>



# REPAIRS WHILE-U-WAIT!!

## COMPUTERS AND MONITORS

That's  
a promise  
for computers!!

### Attention Dealers

Ring/Fax Now for best trade prices and terms on Repairs, Spares, Floppy Drives, Hard Drives, CD Rom Drives and Memory Upgrades.

- FAST TURNAROUND
- 90 DAYS WARRANTY ON ALL REPAIRS!!
- £10 EXTRA CHARGE FOR WHILE-U-WAIT SERVICE
- COURIER CHARGES £6.00 + VAT EACH WAY
- A1500/A2000/A3000/A4000.....£QUOTATION

## NEW LOW FIXED PRICE

**A500, A500+ & A600**

**£39.95**

**A1200**

**£49.95**

### 2.5" HARD DRIVES

For A600 & A1200

80Mb .....£69.95 170Mb .....£99.95 340Mb.....£169.95  
120Mb .....£79.95 250Mb.....£129.95 510Mb.....£249.95

All hard drives are pre-formatted, partitioned with Workbench loaded and include 2.5" IDE cable and software  
2.5" IDE Cable and Software (if bought separately) .....£9.95

### ACCELERATORS

Apollo 1220 . £99.95

Apollo 1232 . £199.95

SIMMS ..... £POA

### MODEMS

X-Link

14.4k . . . £129.95

X-Link

28.8k . . . £219.95

## FOR BEST AFTER-SALES SERVICE

### MEMORY UPGRADES

<b>A500</b>	Upgrade to 1 Meg	<b>£13.95</b>	<b>A500+</b>	Upgrade to 2 Meg	<b>£19.95</b>
<b>A600</b>	Upgrade to 2 Meg	<b>£19.95</b>	<b>UNBEATABLE PRICES</b>		
<b>A1200</b>	0Mb	2Mb	4Mb	8Mb	
	£49.00	£104.95	£149.95	£279.95	
	33MHz FPU plus Crystal ..... £39.95				

**GUARANTEED  
SAME DAY DISPATCH**  
(Subject to availability)

### INTERNAL FLOPPY DRIVES

A500/A500+ ..... £29.95 A600/A1200 ...£34.95

### CHIPS ♣ SPARES ♣ ACCESSORIES

1 Meg Fatter Agnus .....£19.00	8520 CIA A600/A1200 .....£14.50
2 Meg Fatter Agnus .....£24.00	8374 Alice A1200 .....£30.00
8362 Denise .....£9.00	8364 Paula A600/A1200 .....£16.50
8373 Super Denise .....£18.00	Video DAC A1200 .....£19.00
5719 Gary .....£7.50	A600/A1200 Keyboard .....£60.00
8520 CIA A500/A500+ .....£15.00	Lisa A1200 .....£35.00
8364 Paula A500/A500+ .....£12.00	Gayle A600/A1200 .....£25.00
Kickstart ROM 1-3 .....£15.00	Budgie A1200 .....£30.00
Kickstart ROM 2-04 .....£22.00	Mouse (290dpi) .....£15.00
Kickstart ROM 2-05 .....£29.00	SCART lead .....£15.00
A500/A500+ Keyboard .....£50.00	Mouse Mat .....£4.00
6570 Keyboard Chip .....£20.00	10 Boxed Branded Disks .....£6.00
68000 Processor .....£8.00	Printer Cable .....£6.00
Power Supply A500/A600/A1200...£35.00	100 Disk Box.....£7.00
Exchange A2000/A1500 Power Supply ...£70.00	Squirrel SCSI Interface .....£59.00

\* All chips are available ex-stock  
\* Please call for any chip or spare not listed here

**AMITAR CD ROM DRIVE**  
Including Squirrel SCSI Interface  
**QUAD SPEED**  
**£249.95**

### Genlocks

Hama 292 . . £280.00  
MiniGem  
L500 . . . . .£69.95  
L1500 . . . . .£169.95  
L2000S . . . £349.95

**Now Available**

A1200 without hard drive .....£299.95

A1200 with 170Mb hard drive ...£379.95

A1200 with 340Mb .....£449.95

A1200 with 510Mb .....£549.95

**\* Call for more good deals**

**ANALOGIC Analogic Computers (UK) Ltd**  
Unit 6, Ashway Centre, Elm Crescent,  
Kingston-upon-Thames, Surrey KT2 6HH

Open Mon-Fri 8-00am-5-30pm, Sat 9-00am-5-00pm Fax: 0181 541 4671  
\*\* NEW OPENING TIMES \*\* NEW OPENING TIMES \*\*

**Tel: 0181 546 9575**

\* All prices include VAT \* All prices subject to change without notice \* Fixed charge for repair does not include disk drive/keyboard  
\* We reserve the right to refuse any repair \* P&P charges £3.50 by Royal Mail or £6.00 + VAT for courier \* Please allow 5 working days for cheque clearance  
\* All sales are only as per our terms and conditions of sale, copy available on request.

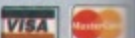



# OctaMED SoundStudio

**A new generation of trackers is about to arrive, bringing Amiga audio bang up to date, starting with SoundStudio.**

**S**oundStudio 1.0 is set to be the first release of a next generation of OctaMED sequencers. Although it may look just the same at a glance, the menus have some powerful new features. How do you fancy 64 tracks of samples, each with its own stereo pan position, with optional delay and echo effects? That'll do nicely thanks.

## Retargetable audio bonus

The key to SoundStudio's stunning new features is its own kind of 'retargetable audio'. In the same way that retargetable graphics systems allow you to direct graphic output to any one of a number of display boards, SoundStudio supports six different audio output options. Normal four-channel trackers traditionally take advantage of the Amiga's built-in sample replay functions, using the Paula chip directly to replay samples from Chip RAM. While this is very efficient in terms of speed, barely taxing the CPU, it does have limitations, such as allowing no more than four samples to be played at once, with two samples sent to the left channel and the other two to the right.

SoundStudio gets around these limitations by inserting a new signal processing stage before the sound is output. In effect, the

sample data is read from anywhere in memory, including Fast RAM and then it's processed according to the user's settings, during which the samples are mixed, given a stereo pan position, echoes are added if required and then the final stereo signal is output to the chosen destination. The destination can be the Amiga's standard audio output (both 8-bit and 14-bit output is supported), a Toccata 16-bit output, a 16-bit Maestix output, or even sent straight to a hard drive as a continuous stereo 8 or 16-bit sample.

## No limits

The advantages of handling the sample manipulation with software routines are manifold. For example, the Amiga cannot play samples in reverse as standard. This is no longer a limitation. Passing samples through effects routines is

now possible, and although at the moment this is limited to delays and echoes, in future this may be expanded to include phase and chorus effects. We may even see synthesiser options such as resonant filtering (as already featured in Musicline Editor).

Output quality will depend on the speed of your Amiga. Faster processors can mix the tracks at a higher rate, thus including more of the original sample information and introduce less noise. The system comes into its own on a fast Amiga (50MHz 030 or better) with a 16-bit output device, such as a Toccata card. A stock A1200 will struggle to achieve good reproduction of the higher frequencies which start to sound scratchy as if low sample rates are being used. Good news: the notation editor is back! It vanished when OctaMED

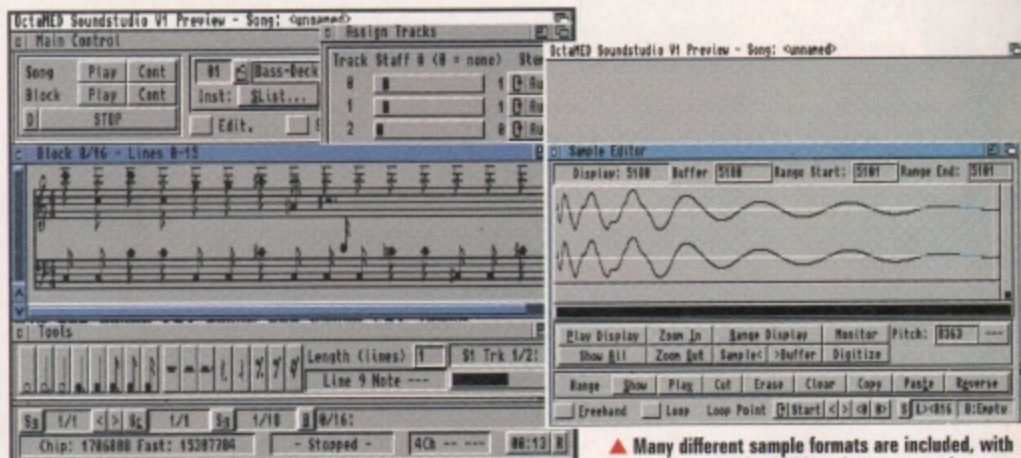

▲ The notation editor makes a return in a new improved form after its absence from the last two major OctaMED revisions.

▲ Many different sample formats are included, with plenty of support for 16 bit and stereo sounds.

when OctaMED morphed from its custom GUI of version 4 to the windows and menus of version 5. A notation display isn't very well suited to a tracker editor (much of the tracker information is impossible to display using traditional stave notation) but some still find it reassuring to be able to view their melodies in this way. It also gives you the chance to output your modules as hard copy via a printer.

## So good, so far

We had hoped to bring you a full review in this issue but it's still in development, so we'll have to wait a little longer for a full analysis. It's looking good so far and if author Teijo Kinnunen can pull it off, it could be the best reason yet to keep your Amiga at the heart of your sequencing set-up for years to come. ■

Tony Horgan

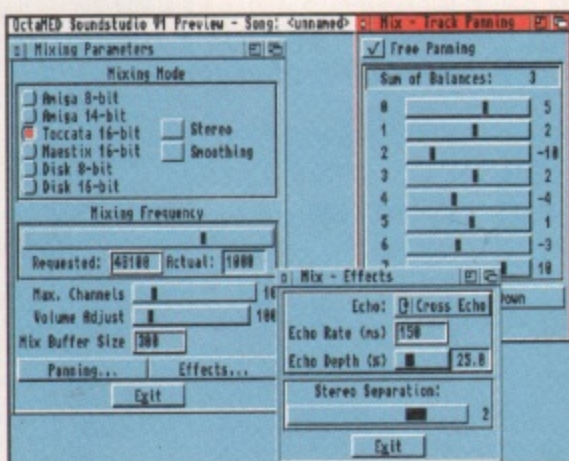

▲ These are the most impressive new controls - SoundStudio's unique retargetable audio features that break away from previous limitations.

## It's on the CD, it is

The CD edition of this month's CU Amiga Magazine includes a non-save demo of OctaMED SoundStudio. You can run it straight from the CD (you'll find it in the Sound drawer). A generous selection of multi-channel Screamertracker (3SM) modules have also been included, which can be loaded into SoundStudio. This is an early preview version, so everything won't be fully working at this stage. Have fun!





# Aural Synthetica

■ Price: £35.50 ■ Developer: Blachford Technology ■ Supplier: Seasoft Computing ☎ 01903 850378

Turn your Amiga into a sprawling modular synthesiser with this new sample generation system.

**I**f you make modules with your Amiga, you're bound

to have longed for a synthesiser at one time or another. Maybe you've even given in and bought one. The trouble with working solely with samples is that if you don't have the required sample, there's nothing much you can do about it; you'll just have to make do with what you've got. This is where Aural Synthetica comes into the picture. It's like a software version of a module synthesiser, but rather than working in realtime, it renders its sounds as samples, which you can then use in your chosen tracker or sequencer.

## Twiddly bits

Sample synthesis programs have been around for quite a few years, but none has gone to the same lengths as Aural Synthetica. It gives you a massive range of buttons and sliders to push and pull however you see fit. Once you think you've got a recipe for an earthshaking sound, you hit the render button and wait for the sound wave to wend its way through the sequence of oscillators, modulators, filters and other 'components'. Once it's all finished

you end up with a 16-bit 44kHz sound sample which you can play, or save out to disk as an SAFF, AIFF, WAV, MAUD or IFF sample.

There's an impressive amount of operators to tinker with. You can use up to 18 oscillators along with stacks of other twiddly bits. The patch programmer section offers almost limitless possibilities if you want to explore them. If the synthesis was carried out in real time it would be quite fun to experiment with all the different settings, but the time it takes the render the sounds can be off-putting. If you're not sure what you're doing you can spend all day generating useless sounds. Having to wait for your changes to be rendered before hearing them, can make learning the ropes a slow process.

On the other hand if you do know all about modular synthesis, you could generate some excellent sounds without too much bother.

## The sounds

On the disk there are 51 patches for use as examples. These are a big help in understanding the workings of the program, as you can modify them and compare the originals with your versions. Most of these are weird sound effects,

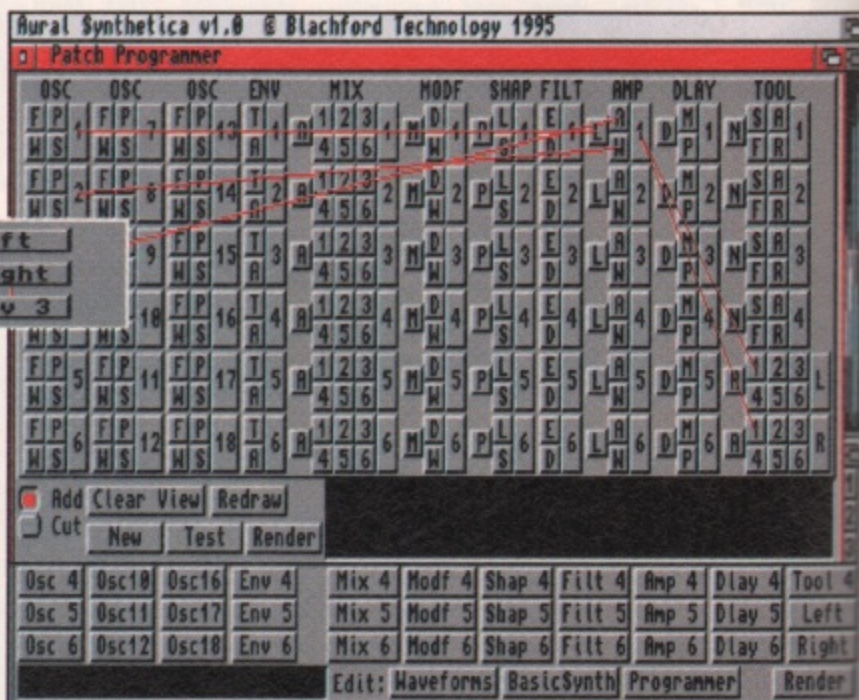

▲ See, it's quite simple really! Aural Synthetica allows you to create your own 'patches' as if you were using one of those old analogue modular synthesisers.

although there are a few that could be used as instruments. On the whole the examples are very impressive, especially if you like abrasive abstract techno sounds.

## Conclusion

There are a number of improvements and bug fixes I'd like to see in the program. 'Error in patch' messages are common after loading and hitting render, when a reload proves there was clearly nothing wrong. If you try to save a sample to a disk that is full, the program gives no indication that it hasn't saved the file, or that the disk is full. A low grade quick-render option is also required, due to the long rendering times, even on fast Amigas.

Even with these faults and oversights, Aural Synthetica is a very

interesting and potentially useful program. It can create some decent noises and if you know what you're doing there's plenty of scope for building your own completely original sample sets. Unless you're very patient you'll need a fast Amiga though. To give you some idea, with a 50MHz 030 you can expect to wait around 30 seconds to render a typical two second sample. Rendering times vary depending on the settings. Hours of fun for season synth fans. ■

Tony Horgan

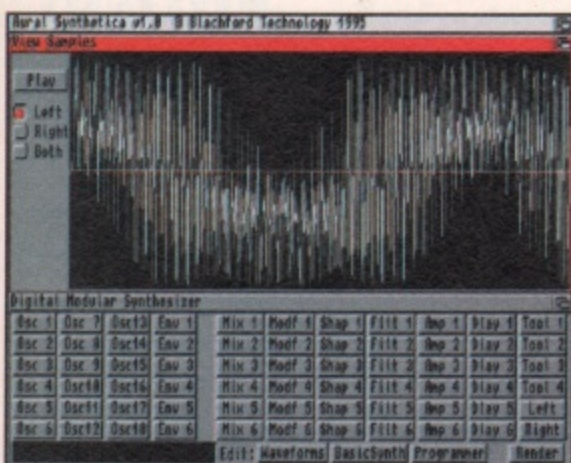

▲ The top window is the rendered sample. The buttons below give access to the multitude of operators and options.

## Understanding synths

Modular synthesis is a fascinating but baffling subject. Understanding the concepts of oscillators, frequency modulators and the like can be an uphill struggle and you really need a good analogue synth with plenty of knobs and sliders to get a feel for what each part does and how it affects the others. The Aural Synthetica manual takes you through the stages of making your first sound, while the AmigaGuide document goes into more depth on the subject.

## AURAL SYNTHETICA

**system requirements:**  
OS 2 or above, 2Mb RAM. Accelerator recommended.

**ease of use** ..... 75%  
All accessed through a GUI but confusing to synth novices.  
**performance** ..... 80%  
Rendering is slow, but the results can be very impressive.  
**value for money** ..... 80%  
At the attractively low end of the price scale.

**OVERALL**  
Potentially potent sound creation tool.

**78**





TDK DISKS AT BULK PRICES

# GREY-TRONICS LTD



LOWEST PRICES

BEST SERVICE

RAPID DELIVERY

**SALES FREE CALL 0500 737 800**  
**OTHER ENQUIRIES 0181 686 9973 / 0181 781 1551**

**3.5" DISKS**  
**100% CERTIFIED ERROR FREE DISKS & LOCKABLE BOXES**

TDK DS/DD	DS/HD	
50 3.5" Disks .....£16.99	.....£18.99	+ 100 cap lockable box.....Add £4.00
100 3.5" Disks .....£27.99	.....£28.99	+ 100 cap lockable box.....Add £4.00
150 3.5" Disks .....£38.99	.....£41.99	+ 2 x 100 lockable box.....Add £8.00
200 3.5" Disks .....£48.99	.....£51.99	+ 2 x 100 lockable box.....Add £8.00
300 3.5" Disks .....£73.99	.....£76.99	+ 3 x 100 lockable box.....Add £12.00
400 3.5" Disks .....£98.99	.....£101.99	+ 4 x 100 lockable box.....Add £16.00
500 3.5" Disks .....£123.99	.....£126.99	+ 5 x 100 lockable box.....Add £17.50
1000 3.5" Disks .....£229.99	.....£234.99	+ 10 x 100 lockable box.....Add £30.00

**FREE LABELS + FREE DELIVERY BY PARCEL FORCE**

**MAGIC PACK INCLUDES**

- \* Amiga A1200 Computer - 2Mb RAM
- \* 3.5" Floppy Disk Drive Built-in
- \* Wardwath v4 SE - Word Processor
- \* Digital Datasort v1.1 - Database
- \* Digital Organizer c1.1 - Personal Organizer
- \* Turbo Calc v3.6 - Spreadsheet
- \* Personal Paint v6.4 - Paint Package
- \* Photogenics v1.2 - Pixel Editing
- \* Whizz - 3D Platform Game
- \* Pinball Mania - Pinball Arcade Game

**STANDARD PACK 2Mb - NO HD** **£369 inc. VAT**

**170Mb HARD DRIVE PACK** **£469 inc. VAT**

**NEW A1200 SUPER PACK** **£545**

Inc. 240Mb Hard Drive + 14400 Ext. Modem Comes with Magic Pack software but pre-installed on HD. SHOULD BE BACKED UP. USER AS NO ORIGINALS ARE SUPPLIED.

**Optional Extra... CHAOS SOFTWARE PACK**

Includes 4 EXCELLENT Titles:  
 CHAOS ENGINE - AGA .....£25.99  
 SYNDICATE .....£34.99  
 PINBALL FANTASIES - AGA .....£29.99  
 NICK FALDO'S GOLF - AGA .....£24.99

**ONLY £12** When Purchased with A1200 As long as stocks last (Combined original RRP) .....£125.99

**RAM UPGRADES & ACCELERATORS**

A1200 2Mb RAM	.....£109.99
A1200 4Mb RAM	.....£142.99
A1200 8Mb RAM	.....£242.99
33 MHz PLCC FPU	.....£42.00

**APOLLO A1200 ACCELERATOR**

Apollo 1220 28MHz 68020 6882	.....£98.99
Magnum 030/40/OFPU 2Mb	.....£199.99
Magnum 030/40/OFPU 4Mb	.....£219.99
Magnum 030/40/OFPU 8Mb	.....£309.99

**A500/500+/600 UPGRADES (inc clock)**

A500 up to 1Mb	.....£24.99
A500+ up to 2Mb	.....£28.99
A600 up to 2Mb	.....£39.99

**AMIGA 4000 TOWER**

A4000T 040 25Mhz	£2099	£2231
A4000T 060 50Mhz	£2359	£2525

SPECIFICATIONS: A4000 Tower, 6Mb Memory, 1.7Mb Floppy Drive, 1.2 Gig SCSI Drive, Scala 300 Preinstalled

**ACCESSORIES**

**AMIGA CABLES**

Amiga to TV Scart	.....£10.99
Amiga to Sony TV	.....£10.99
Amiga to Amiga (Parrot/Null modem)	.....£10.99
Modulator overhang lead 23M/23F	.....£11.99
Joystick Splitters	.....£5.99
Automatic Mouse/Joystick Cable	.....£13.99
Joystick Extension Lead 10ft	.....£5.99
Printer Lead	.....£4.00

**DUST COVERS**

Amiga 1200/500/500P/600	.....£4.00
Commodore/Philips Monitors	.....£4.00
Star/Citizen/Panasonic Printers	.....£4.00

**ACCESSORIES**

Amiga Disk Drives Free Direct Opus 4.12	.....£42.99
Amiga Mouse (Top Quality)	.....£11.50
Internal Drives A500/A500+ A600/A1200	.....£34.00
TV Modulator (2 yrs warranty)	.....£34.00
Deluxe Mouse Mat	.....£1.99
1000 Labels	.....£8.99
3.5" Disk Head Cleaner	.....£1.99
Python 1M Joystick	.....£8.75

**ADD £2 FOR DELIVERY**

**HARD DRIVES**

**EXTERNAL OVERDRIVE HARD DISK**  
 Provides games and data portability to A600/A1200

External casing	.....£68.00	560Mb	.....£234.99
<b>INTERNAL 2.5" + CABLE + SOFTWARE</b>			
80Mb 2.5"	.....£69.99	250Mb	.....£127.99
120Mb 2.5"	.....£88.00	340Mb	.....£174.00
170Mb 2.5"	.....£124.99	510Mb	.....£249.00

**INKJET CARTRIDGES AND REFILLS**

HP Deskjet Black Dual Capacity Cartridge	.....£22.99
HP Deskjet Black Refill	.....£7.99
HP Deskjet 500 C /560 C Colour Cartridges	.....£25.99
HP Deskjet 500 C/560 C Colour Refill	.....£16.99
Canon BJ 10/200 Black ink Cartridges	.....£16.99
Canon BJ 10/200 Black ink Refill	.....£9.99
Citizen Project IIC Colour	.....£34.00
Citizen Project IIC Mono	.....£20.50

**NEW PRINTERS**

**PANASONIC 2135**  
**24 PIN COLOUR**

**£164.99**

All printers free lead & delivery

**CD-ROM DRIVES**

Overdrive Double Speed CD	.....£174.99
Overdrive Quad Speed CD	.....£234.99
Amiga CD32 + 7 games + kit to connect to A1200	.....£205.00

**TOP QUALITY RIBBONS**

**BLACK**

Amstrad DMP 2000/3000	.....£3.00
Amstrad DMP 4000	.....£3.66
Amstrad PDM/8256/8512/855000	.....£3.00
Amstrad 9512	.....£3.50
Citizen 1200/LSP10/5with 24/9	.....£2.85
Epson LQ100	.....£4.10
Epson LX80/86/90	.....£2.50
Epson LQ400/500/800/850	.....£3.45
Epson FX/MX/RX80/LX800	.....£3.45
NEC Pin Writer P2200	.....£3.50
Selkotha SSP1200/1600/2000	.....£4.00
Panasonic KOP1123/1124/1180	.....£3.30
Panasonic 2135	.....£8.25
Panasonic KOP2123/2180	.....£4.00
Star LC10/20/100	.....£2.99
Star LC200	.....£3.50
Star LC2410/24200	.....£3.00

**COLOUR**

Citizen Swift 24	.....£12.99
Panasonic 2135/2123/2180	.....£13.99
Star LC10/20/100	.....£7.00
Star LC200	.....£12.30
Star LC2410/24200	.....£12.50

**ADD £2 P&P**

**DOT MATRIX 24 PIN COLOUR**

PANASONIC 2135 inc sheet feeder	.....£164.99
Citizen ABC colour	.....£144.99

Add £15 for black ribbon (Dot Matrix only), dust cover, printer stand, 500 A4 paper when purchased with printer.

**INK JET - DESKTOP & PORTABLE**

Hewlett Packard 600 mono ink jet	.....£230.00
Hewlett Packard 660 colour ink jet	.....£325.00
Hewlett Packard 850 colour ink jet	.....£414.99
Canon BJ30 mono inc. sheet feed	.....£184.99
Canon BJ70 colour ink jet	.....£289.99
Canon BJC210 mono ask colour opt.	.....£226.99
Canon BJC4100 colour ink jet	.....£289.99
Canon BJC610E colour ink jet	.....£412.99
Citizen Project IIC colour	.....£249.99
Citizen Printiva 600 colour NEW	.....£389.99
Epson stylus colour IIS	.....£275.99

**GENLOCKS**

**FUSION VIDEO GENLOCK**

It is a high specification video genlock that is ideal for both the first time user (for adding titles, graphics & effects to home movies) & the semi professional user (wedding videos, corporate presentations...)

**FREE Scala HJ100** (enables you to add special effects and overlay text onto your video. **£98**)

**AMIGA CD32**

CD32 Machine	.....£174.99
7 games pack only	.....£174.99
SX1 Modular Expansion	.....£197.99
Keyboard for CD32	.....£37.99
Disk Drive for CD32	.....£42.99
CD32 to Amiga 1200 inc software	.....£29.99
CD32 to Scart	.....£11.99
Competition Pro Pad	.....£15.99

**Add £2 p&p for accessories**

**FAX / MODEM**

	Modem only	+GP Fax e/w
Tornado 14.4k int	.....£89.99	.....£129.99
Tornado 14.4k ext	.....£104.99	.....£144.99
Tornado 28.8k ext	.....£189.99	.....£229.99
Tornado 28.8k int	.....£169.99	.....£209.99

**MONITORS**

Amiga M14385	.....£287.99
Microvitec 1438+speakers	.....£264.99
Amitek 10845	.....£198.99
Hitachi or Panasonic Monitor/TV	.....£174.99

U.K. & INTERNATIONAL DELIVERY SERVICES - (BFPO ORDERS WELCOME + SURCHARGE)

LAND AIR SEA

ALL PRICES INCLUDE VAT & DELIVERY (except otherwise stated). Delivery within 3 days (UK MAINLAND ONLY). ADD £10.00 FOR NEXT DAY DELIVERY. CALL OR SEND CHEQUES/POSTAL ORDERS TO:

**GREY-TRONICS LTD, UNIT 1015 WHITGIFT CENTRE, CROYDON, SURREY CR0 1UU**

SALES HELPLINE: 081-686 9973 (Mon-Fri 9-5pm) FAX: 081-686 9974

All offers subject to availability. E&OE. Prices/Pack details may change without notice. Please allow 6 working days for cheques to clear.

**Mon-Sat: 9-6pm Thurs: 9-8pm Sun: 11-5pm**



# Limelight Tyro

■ Price: £65.80 ■ Developer: Future Software Systems ■ Supplier: Future Software Systems ☎ 01628 24318

**A**s established software packages get increasingly powerful, complex and more expensive, the market for a low-end introductory alternative starts to open up. While Limelight Tyro doesn't aim to compete with the likes of Scala, MediaPoint or VideoStage Pro, it does have a few tricks of its own to help win the approval of the less ambitious videographer.

Like most video titlers, Limelight Tyro uses a two-tier screen layout, one for the screen you are putting together and another laid over the bottom which houses the control panel. This allows you to have an interlaced display screen with a more comfortable non-interlaced control panel both visible at the same time.

There are three modes in which the program can be used, from novice to advanced. In novice mode, the menus only reveal a few of the total available selections, with more on offer in intermediate mode and the whole lot available in advanced mode. It's a kind of 'blinking' system that is supposed to lead you gently into the program without confusing you with a mass of options from the start. You might expect this sort of approach with some kids' educational software, but I'm not sure of its worth in a 'grown up' product such as this.

There is also no direct way of jumping from one menu to any other. With around a dozen menus in Tyro this often means that you have to move through

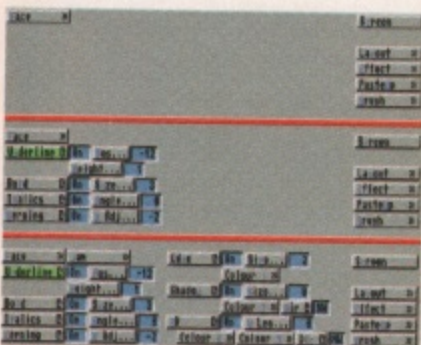

▲ Your range of options changes depending on the user level you decide to run Tyro in. From the top we have: Novice, Basic and Advanced.

## A new entry level video titler which claims to offer some powerful features but can it deliver the goods?

several menus to get to where you want.

### Features

Limelight Tyro is a fairly basic video titler. The first step is to enter some text. This can be done via the keyboard or by using the mouse to click on a graphical representation of the keyboard that appears on the control panel. Although this seems pointless, it may be useful in very unusual such as when the program is running on a CD32 system with no keyboard, or if your keyboard was faulty. There's also a disconcerting time lag between you typing the text and the letters appearing on the screen. They do appear instantly in the text box on the control panel but on the main screen, it takes a little longer to draw the characters, giving the impression that you've misspelled your words.

Style changes can be made to the text once it's on the screen. The usual selections of colour, bold, underline, italic, spacing and kerning are available, with a 3D drop shadow option and a further shadow which uses a dithered pattern to produce a semi transparent shadow that is effective even when using a genlock. Bitmapped and Compugraphic fonts can both be used at any selected size.

Colour IFF backdrops can be loaded into your pages. Tyro automatically alters the screen mode to match the imported image. You're free to use overscan modes on any Amiga and AGA modes are also supported.

### Transitions

When it comes to transitions, Tyro provides line and screen effects. While there is a good selection of wipes and fly-ons to choose from, there is nothing outstanding and there are occasional glitches with the more processor intensive

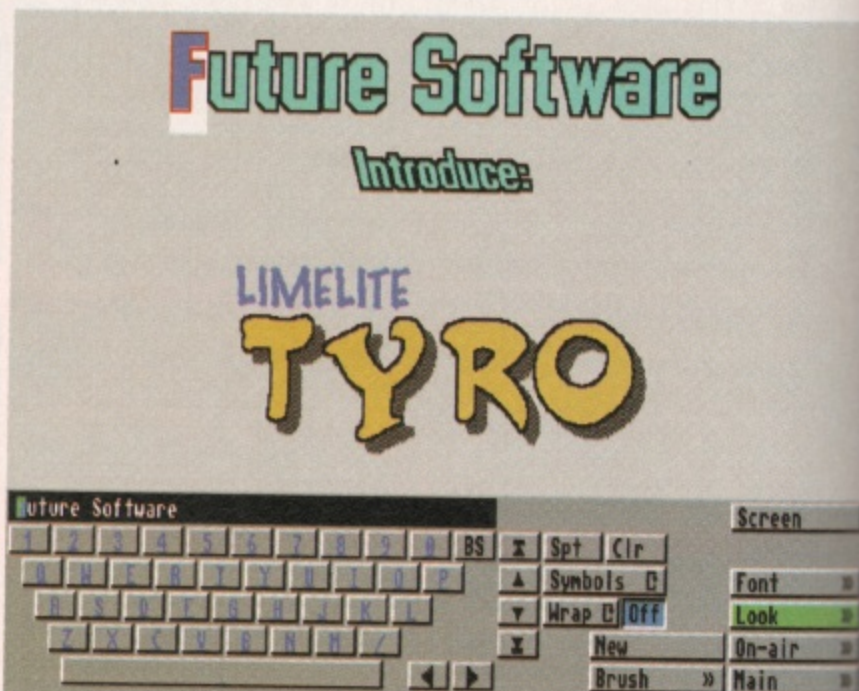

▲ Quite why you would prefer to enter text in using the mouse rather than typing it in on the keyboard I'm not sure. You can cycle through various keyboards for lower case letters and symbols.

ones. I couldn't achieve the videographer's favourite vertical scroll without each page stopping for a split-second although the horizontal crawl works well.

If you are using a genlock to transfer your titles to video then there is one special feature. Connect an RGB monitor to your genlock and you can set in motion Tyro's On-line and Off-line feature. While in Off-line mode your video passes straight through the genlock without any graphics showing. This allows you to construct and preview your graphics on the RGB monitor without fear of them being recorded. When you are ready to introduce your titles into the video, just switch to On-line. And all this happens without the need for additional hardware or switching on your genlock. This feature would especially appeal to a studio using a live video feed with the need to create titles on the fly, but this isn't really the beginner's territory that Tyro is aimed at.

If you have a low end machine with no hard drive you will have missed out on last month's VideoStage Pro cover disk, in which case Limelight Tyro should fit the bill, but don't expect it to add too much pizzazz to your productions. ■

**Norman Harris**

LIMELIGHT TYRO	
A500	<b>system requirements:</b> Any Amiga with Workbench 2.04 or later, 2Mb RAM. Workbench with AGA Chip Set and 4Mb RAM recommended.
A500+	
A600	<b>ease of use</b> .....70% Not the easiest of programs to get on with. A more graphical maneal might help.
A1200	<b>performance</b> .....70% Adequate for the home video buff but don't expect it to add much glitz.
A1500	<b>value for money</b> .....68% Not a bad price but not an absolute bargain either.
A2000	
A3000	<b>OVERALL</b> Adequate entry level titling program.
A4000	<b>70</b>



# 17 BIT SOFTWARE

1st Floor Offices, 2/8 Market Street  
Wakefield, West Yorkshire. WF1 1DH

- TEL: 01924 366982 FAX: 01924 200943
- EMAIL: sales@bit17.demon.co.uk
- WWW: <http://www.demon.co.uk/bit17>

Office Hours Mon - Sat 9:00 To 5:30  
Answerphone At All Other Times

## POSTAGE RATES

- [UK] Disk Orders 50p CD's 75p Each.
- [EU] Disk Orders 10% CD's £1.00 Ea.
- [OE] Disk Orders 20% CD's £1.50 Ea.

## MAX POSTAGE PAYABLE

- [UK] Disk Orders 50p CD's £1.50
- [EU] Disk Orders 10% CD's £4.00
- [OE] Disk Orders 20% CD's £6.00

ALL ORDERS SENT 1ST CLASS POST / AIRMAIL

ALL OUR AMIGA PD  
DISKS ARE ONLY

**£1.00**  
EACH

WE WILL

**PRICE MATCH**  
ANY STOCK CD FOUND  
CHEAPER ELSEWHERE

### 17 Bit 5th Dimension



£19.99

Contains our most recent PD from disk 3351 to 3870. Something here for everyone!

"Up to 17 Bits high standards....  
Covers every aspect of Amiga PD...  
**8/10 Amiga Computing Issue 94**  
"The selection of software is excellent...  
Highly recommended". "Top grade stuff"  
**88% CU Amiga DEC 95.**

### Encounters



£14.99

Everything you could possibly want to know about UFO's, Coverups, Top Secret Projects, Conspiracies and MUCH, MUCH more!

"If you have a keen interest in ufology or are looking for some convincing evidence, look no further." "Cover every budding ufologists dreams..."

**91% Amiga Computing FEB 96**

### Nothing But GIFS AGA

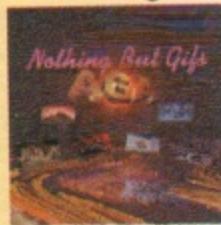

£19.99  
CD32 OK!

Fed up with CD's that promise super quality pictures which turn out to be poor 32 or even 16 colour scans? This CD contains only the BEST, all AGA only, 256 colour pictures which cover many areas. Ideal for DTP & clipart but simply amazing to look at! EVERY image included was hand selected for quality. Guaranteed!

### Anime Babes



£19.99  
CD32 OK!

This CD contains well over 5000 GIF images in the hand drawn Japanese ANIME tradition. All the images contained are of an ADULT nature and therefore, this title cannot be supplied to anyone under 18. All images can be viewed direct from the CD via a custom menu on PC, Amiga & CD32

### ArtWorx £9.99



Thousands of colour images created by computer artists from all over the world. A must for users with a colour printer! Makes ideal colour clipart!

### F1 Licenceware CD £29.99



Contains the complete collection of F1-001 to F1-100. This CD is worth well over £500 if the titles included were purchased separately. Superb value!

**WE OFFER AN UNCONDITIONAL 30 DAY MONEY BACK GUARANTEE ON EVERY CD WE STOCK! IF YOU ARE NOT ABSOLUTELY DELIGHTED WITH YOUR PURCHASE SIMPLY RETURN IT FOR A FULL REFUND**

### Official Octamed 6 £29.99



Includes the latest version of the best music making program for the Amiga along with 600MB of modules, midi files and samples. Also inc. full Walkabout collection!

**AMINET 10 IN STOCK NOW!**  
**£14.99**

- 4040 WORM MAPS Extra Maps For Team 17's Worms.
- 4039 VMM V3.3 Virtual Memory Manager
- 4038 SWAZBLANKER V2.40 AGA Only Screenblinker
- 4037 SUPERVIEW V5.32 Multi Format Picture Viewer
- 4036 TERM V4.5 Libs, Docs, Extras & Locale
- 4035 TERM V4.5 030 VERSION Ok on 020 / 030 / 040 / 060
- 4034 TERM V4.5 000 VERSION For A500+ & A600
- 4033 (AB) IMAGE STUDIO V2.3.0 Latest Image Processing
- 4032 MASTER BLASTER V2.21 5 Player Dynablaster Clone
- 4031 VIRUS WORKSHOP V5.8 Superb Virus Killer
- 4030 SHAPE SHIFTER V3.3 Mac Emulator
- 4029 ROBS HOT VIRUS KILLERS 3 More Superb Killers
- 4028 PATCHES DISK #2 Photogenics & Final Writer 4 Etc.
- 4027 (AB) AMIGA FRONTIER #4 Amiga Diskmag
- 4026 SPECTRUM SOLUTIONS #1 Speccy game Solutions
- 4025 LSD LEGAL TOOLS TNG 009
- 4024 LSD LEGAL TOOLS TNG 008
- 4023 LSD LEGAL TOOLS TNG 007
- 4022 LSD LEGAL TOOLS TNG 006
- 4021 AMIGA GAME SOLUTIONS (Adventure & RPG)
- 4020 PEANUTS CLIPART Black & White
- 4019 ASTERIX CLIPART Black & White
- 4018 LSD LEGAL TOOLS TNG 005
- 4017 LSD LEGAL TOOLS TNG 004
- 4016 CRON UTIS Amicron, Crontask, Cybercron Etc.
- 4015 WILLIES WEIRDY NIGHTMARE F1 Licenceware Demo
- 4014 AQUAKON F1 Game Demo (2 Meg Chip)
- 4013 PUNTER V3.1 Horse Racing Game (F1 Demo)
- 4012 GRAC V2.0 F1 Licenceware Demo
- 4011 (ABCD) CHARLEY CAT ANIM Camera-Raderie 2.5MB
- 4010 (ABCD) ULTIMATE LIBRARIES Collection Of Libraries
- 4009 THIRD DIMENSION #21 3D Construction Kit Mag
- 4008 TOTAL SPECIES Arcade Adventure game
- 4007 SHANGHAI COLLECTION Includes 5 Variations

### Grolier Enc.



£26.99

### Aminet Set 2



£24.99

### LSD 3



£19.99

### Adult Sens. 2



£19.99

### SCI FI Sens.



£19.99

### Aminet Set 1



£24.99

### Arcade Clscs



£14.99

### Software 2000



£29.99

### Phase 4



£9.99

### EuroScene 2



£14.99

### Network CD 2



£14.99

### Gateway CD

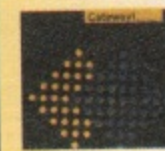

£9.99

### MULTIMEDIA 2



£22.99

### Assassins 2



£19.99

### Amos Release 2



£19.99

### GoldFish 3



£24.99

### LightRom 3



£39.99

### AGA Experience



£19.99

### Meeting Pearls 3



£9.99

### Aminet 9



£12.99

Visit Our WEB For A COMPLETE CD List With FULL Descriptions Or Download A CAT Disk!

**WWW: <http://www.demon.co.uk/bit17>**



# GET STARTED

## Multimedia At Its Best!

- ✓ Simple and Easy-to-use
- ✓ Educating and Informative
- ✓ Entertaining and Exciting
- ✓ Powerful and Amazing!



## Main Contents List:



### The History of the Amiga

Who invented it? The old Commodore, its bosses, ideas, mistakes etc. The Escom rival and much more.

### Amiga Environment

What is your Amiga? Why is it so special? What is the scene? Who are Amiga Technologies and what do they do?

### Amiga Hardware

Inside, outside, ports, chips all explained

### Workbench and DOS

What is it? Using it. Data and file management, Workbench environment tips, the CLI, advanced WB and CLI tricks

### Programming

AMOS, Blitz, assembly, C, Amiga E and AREXX examined

### Become an Artist Overnight

Raytracing, 3D, animation, bitmap drawing analysed

### Become an Amiga Music Maestro

Octamed explained, MIDI discussed, musicians interviewed

### Getting Your Words into Print

Word processing, Desk Top Publishing, Printers, Clipart etc

### Surfing the Super Information Highway

Intro to the Internet, Surfing the Internet, WWW design, Amiga Internet Providers, Amiga Internet software. The Amiga Technologies Internet pack taken for a test drive.

### General Arena

Emulation, Operating Systems, Storage Systems, Amiga in Business, Multimedia etc etc etc

### The Amiga Future

Where is the Amiga going? Amiga Technologies' plans, Amiga visions, possible industry comments. Amiga "Visions" - the companies that will bring us innovative products in 1996. We interview Intersect Developments, Fields of Vision and more.

### And Finally

Credits, thanks and anything we have forgotten!

The world's first truly AGA multimedia, interactive compact disc. Designed for beginners, new users through to intermediate (and higher!) levels, it helps an Amiga user understand more about their computer and what it is capable of. Covers many subjects from raytracing to the Internet and from programming to music. Many 'well-known' experts and Amiga-buffs are contributing to this CD. They offer help, answers, tips, tricks and more. Want to know how the experts create a WWW page? Global Internet show how! Stuck using Internet software? John Kennedy explains all. Also contains forums, opinions and a look to the future with top Amiga developers. Comes with a FREE bonus beginners section with commercial programs, commercial demos and all the PD you need to Get Started, all ready-to-run. If you have an AGA Amiga with a CD player, then get this. PC multimedia CD's are here!



Above are four screen grabs from an early version of the Get Started CD interface: The main page, the colour windows, the floating dictionary and an animation example.



## And Starring!

Key and Gareth Craft  
Steve Bye  
Ed Wiles  
Larry Hickmott  
Peter and David Clarke  
Simon & Co.  
Mark Thomas  
Danny Amor  
Jason Jordache  
Dale Hemenway  
David Taylor  
John Kennedy  
Jeremy Ford  
Justin Joyce  
Andrew Campbell  
Richard Bannister  
Spencer Jarvis

- Amiga MIDI  
- AMOS Programming  
- Octamed in Depth  
- DTP, Printers, Clipart  
- 3D Animation  
- 3D Architecture  
- WWW Design/future  
- The CD and German Mkt  
- Bitmap Graphics  
- Animation  
- Storage, Emulation  
- Internet etc etc etc!  
- PD Section  
- Amiga DTV  
- AMOS 'Hands-on'  
- Music (Soundstudio)  
- Imagine 'Hands-on'

- MIDICraft  
- F1 Licenceware  
- Octamed Expert  
- LH Publishing  
- The Room Upstairs  
- V.S.I.  
- Global Internet Ltd  
- Freelance Writer  
- Freelance Artist  
- Dalemation  
- Freelance Writer  
- Paragon (Freelance)  
- Ground Zero Software  
- Axiom Video Services  
- AMOS Programmer  
- MED Users Group  
- Imagine Users Group



## Also!

- Full version of DOpus v4
- Full version of Octamed v5.04
- Other full programs (TBC)
- 'Test Drive', exclusive version of Wordworth 3
- Limited Version of PPaint v6.4
- 'Get Connected' to the Internet - all you need, all ready to go!
- Essential PD to Get Started!
- Exclusive stuff from various user groups and companies!

## ADVANCED AMIGAGUIDE - AAG

- **Fast Rendering of 8 bit (256 colour) Images**  
practically instantaneous display of 256 colour pictures even on stock 020 Amiga. There can be more than one 256 image displayed at one time with the palette shaver.
- **Is a Stand-alone Platform Unlike Other "Hypertext" Products (HTML Language etc)**  
does not need other programs such as MUI or AmiTCP to run
- **Allows Text, Picture and Gadget Links as Opposed to it's Pre-desessor**  
click on a picture or animated gadget and move to another page. Retrace back to your original position.
- **Allows the use of Sub-Modules Runnable as Commands**  
for instance, play and show an animation as a command by clicking on a button! The commands can allow you to "link" to anything and anywhere. Click a link and enable the dictionary etc.
- **Multiple Fonts & Add Colour from 256 Colour Palette**  
you can use as many different fonts as you like. Just use the normal Amiga bitmap fonts in any size! You can also add colour to the text from a palette of 256 colours. Highlight a word - add colour. Highlight different links - add colour!
- **Super Bitmap Window**  
cater for AmigaGuide files which take up more lines than is available
- **Downward Compatibility**  
is able to read old AmigaGuide format (and soon HTML pages)
- **Drawing Tools**  
AAG allows you to create lines, boxes, circles and colour them by using simple commands such as @DRAW 10-40,25-60 or @LINE 10,30,35 - using co-ordinates and lengths.

Advanced AmigaGuide (or AAG) is the language that resides behind the Get Started interface. It offers many enhanced and powerful features over the old AmigaGuide language. To the left of this box is a list of the features AAG contains. AAG could be used in a multimedia product, interface front-end, on-line help program, disk magazine and much more. Contact us for licence details. AAG should be available by May/June 1996.

## AAG - GUI OS VERSION

Advanced AmigaGuide (AAG) can be a direct replacement for the current AmigaGuide. In a native OS GUI version it looks very similar to the existing format, however it is very different. The language allows more flexibility such as the co-ordination of text, images and gadgets in upto 256 colours and can add more powerful features such as HTML decoding or use of multiple fonts on a page. AAG can also read old AmigaGuide files. It also uses the same techniques for writing ".GUIDE" files (see second picture): @NODE, @LINK, @COMMAND etc are the same as the old format, but new commands have been added such as @IMAGE, @REM, @MOD, @SECTION, @PAGE, @COLOUR, @BOX, @DRAW, @LINE, @GOTO, @CENTRE etc etc. This allows the user to quickly understand the simplicity of writing the documents/pages.

## 'ALL YOU NEED' SECTION

The 'all-you-need' section contains a carefully selected collection of read-to-run material: This section encompasses full (or limited) commercial programs such as Octamed v5.04, Personal Paint 6, Directory Opus 4 and Wordworth 'Test-Drive' with commercial demos and superb public domain as chosen by Ground Zero. There are exclusive collections from M.U.G., the Imagine Users Group, MIDICraft, AMOSzine authors and Cloanto. The PD contents are highlighted and examined within the Get Started interface. There is also a superb "Get Connected" area: all you need, ready-to-run/install (all explained in the Get Started interface!) to get onto the Internet. Global Internet will be providing the access, so immediate 'net surfing! There are many reasons to buy Get Started - it's like 3 CD's in 1! Multimedia CD, Internet Software CD, Commercial Software CD.

The Get Started CD should be available from most good CD mail order and high street Amiga retailers. All rights reserved. Contents may be subject to change.

**Out March 1996** German version due early April.  
**[AGA Machines] £29.99**

## ZOOM



It's HERE! Zoom release 2 - now in ready-to-run and DMS format! Do you want the latest PD CD-Rom that contains the latest PD to January 1996? Contains the greatest and latest PD from two superb PD libraries. The interface must be the most easy to use CD interface on any CD. Coded by the co-author of the superb new Get Started CD - just point, read about the disk and click to extract. Superb and very easy to use. The contents have also been updated so you get all the latest PD until early January 1996 and loads more as listed opposite. Comes with an on-line help routine, multitasking search routine and hotkeys function. If you want 650MB's of the latest PD, then look here! Two formats - ready-to-run and the DMS format (for shops etc). The pictures below show the enhanced DMS interface in action.



Superb value CD-Rom at only **£19.99 NEW!**

## NEW - RELEASE VER-

- ✓ **New Search Routine**  
the multi-tasking search/find will seek file names or number
- ✓ **New 'Hot-Keys' Function**  
just press 'S' for search or 'E' for extract, 'Help' for help!
- ✓ **Restyled, Remastered**  
new help and information guide, restyled artwork! Superb!
- **Greatest & latest PD from early 1995 - January 1996: Utills, games, demos, slideshows, education, disk mags and more!**  
- including most of this advert and loads of great PD software
- **NEW! 100 Klondike/Card Games Deluxe Cardsets**
- **NEW! The complete Active Software Pro Pack collection**
- **NEW! All the Professional Sound Samples [50 Disks]**
- **NEW! Over 25MB+ of read-to-view/use Magic WB icons etc**
- **NEW! Special "programming" themed area**

## NEW! READY TO RUN & DMS

NEW to ZOOM release 2 is the easy-to-use, ready-to-run format as first demonstrated in NFA AGA Experience. Allows the direct use of PD straight from the CD-ROM!



## F1 LICENCEWARE volume one - F1-01 to F1-100



Sick of the run-of-the-mill old PD CD releases containing collections from pre-1995? This CD contains the complete collection of F1 Licenceware titles from F1-001 to F1-100. Over 100 titles or more than 200 disks! This CD is worth well over £500, if the disks were bought separately. There is something for everyone on the CD - games, utilities, tools, professional clipart and music, beginners guides, educational programs and much more. Some superb material is contained within this CD-Rom: Blackboard v3 (image manipulation), Ultimate Quiz 2 (general quiz), Word Plus Pro (originally valued at £15!), Fortress (strategy God game), Relics of Deldroneye (voted best PD game ever by Amiga Format), ERIC (voted second best PD game ever), Powerbase (database program), GRAC (superb 'Monkey Island' style adventure game creator with 000's of copies sold on floppy), Introduction to WB (best selling F1 Title), Absolute Beginners Guide to AMOS, Junior Artist (kids paint package) or Tots Time (one of many kids educational programs). Use some of the professional music within your games, with no extra charges. What about the clipart for your DTP documents? AMOS programmers have a field day with this CD - AMOSzine, guide to AMOS and AMOS supplements. Something for everyone. With a very easy to use AmigaGuide© interface with 80% of the programs running straight from the CD. Remember that the programs are commercial, with copyright owned by F1 Licenceware. **All programmers receive a royalty for every CD sold.** **£32.99**

**COMMERCIAL SOFTWARE - NOT PD!**



## TEXTURE PORTFOLIO

£29.99

The collection of textures has taken a staggering 5 years to complete. Phantasmagoria are a professional graphics company, based in Bristol. They have been providing textures and backgrounds for video, ray-tracing etc. This CD consists of 500+ 24Bit backgrounds and textures, it includes the very high quality 24Bit JPEG files for video, graphics and multimedia work, Targa's for PC raytracing and GIF format for video tiling applications. The various sections include Abstract - Phantasmagoria, Abstract - Oil Paints, Abstract - Mixed, Animal Skins, Clouds, Fire, Food, Masonry, Rock, Metal (6 sub-sections), Water, Wood Bark, Wood Grain, Miscellaneous. No wasted space on this CD-Rom - a collection of extensive tutorials. This CD comes with a full colour multi-page reference booklet for every single texture. An ideal complement to a raytracing CD such as Light Rom 3 etc. **Please note that all these textures are exclusive to this CD-Rom and cannot be found on any other collection.**

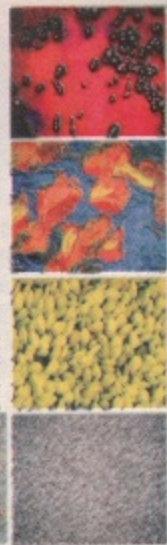

## LIGHT ROM VOLUME 3

£38.99

Light Rom 3 is the most ambitious issue to date, consisting of 3 CD Rom's! Rom 1 is filled with thousands of Lightwave objects and scene files, building upon previous issues. Rom 2 contains huge collections of 3D objects in different file formats including Imagine (175MB's), 3D Studio (100MB's), Sculpt (30MB's) and Real 3D (7MB's). It also includes 700 textures in the JPEG format and a Video Toaster directory with wipes and CG fonts. Rom 2 also has a collection of 3D landscapes in the Lightwave, Imagine and 3D Studio file formats and a collection of useful Amiga and PC PD programs. Rom 3 is a "DEM ROM", a bonus CD-ROM containing over 1000 digital elevation maps for use with VistaPro, Scenery Animator and World Construction Set (available from Blittersoft) on any platform. All Lightwave objects, textures and DEMs on this collection are represented with thumbnail renderings. Michael Meshew, the author of Light Rom 1, 2 and 3, has produced a CD that offers the World artistic talent for a reasonable price.

**SALE** Texture Portfolio & Light Rom 3 for £49.99

## NEW! SPACEBALLS present.....

# SCENE STORM



Scene Storm is a glorious feast of tempting eye candy produced by the legendary SPACEBALLS. Amazing graphic and audio delights to show your friends what the Amiga can really do! This CD is packed with every major scene production from 1995, including all the releases from The Party 5 held in Xmas 95. Exclusive Digital Candy material is also included, ranging from music competition entries to a complete Development suite. Scene Storm features an easy to use Magic Workbench interface that is simple to set up and a joy to use. Much of the contents of Scene Storm are presented as ready-to-run files through custom designed icons. No more trawling through archives and filling your hard disk with files. Includes: Productions from over 20 Scene Parties held throughout the world in 1995. All the best demos and intros from the last year, slideshows, music disks, the most popular disk mags and charts. Exclusive modules taken from the coolest demos as well as entries from Digital Candy BBS Music Competitions. A complete development suite that will allow you to learn how to code your own demos. Development utils are included along with exclusive and easy to follow source code. All purchasers of Scene Storm that own a modem can register to qualify for 3 months free downloading of the latest scene files from Digital Candy Bulletin Board. This would normally cost £15. This BBS is classed as the 'scene' board in the UK! Place your pre-order now as this will be the hottest selling CD throughout Europe!

**ECS/AGA MIXED AVAILABLE END OF FEBRUARY £19.99**

## NFA AGA EXPERIENCE

## ENCOUNTERS

NFA have been serving the Amiga 'scene' recently with an amazing amount of effort. Well known in the UK for their Bodyshop series, excellent AGA-only Word disk magazine and programs such as 'Balls', 'Boomin Eck' and 'enLock' present their first CD for the Amiga. Unlike other scene releases, this contains AGA PD from the last 3 years of which 90% will run straight from the CD! Contains the best WBS+ utilities and creative software (100MB), the greatest AGA games (100MB), high quality AGA slideshows (150MB), the most outstanding AGA demos (200MB), entertaining and informative disk magazines and the best of the rest including the licenced Amiga Reports and all the Amiga 'Doom' clones. NFA have also compiled loads of exclusive wares for the CD: slideshows, Klondike cards and more. All this and contained in superb exclusive raytraced iconified drawers set within a Magic Workbench environment makes the CD an absolute pleasure to use! This has got to be the most comprehensive CD-Rom for any AGA user. Want to show off the power of your new AGA machine you received at Xmas? Get this if you do!

A first for the Amiga. The UFO phenomenon has hit the computer with this excellent release. Forget the X-Files, UFO's are for real - here is the evidence! The most comprehensive UFO compilation ever. UFO and 'the unknown' fans will not be disappointed with this release. Based on AmigaGuide it allows the interaction of text files and images on every possible UFO story. Received over 90% in a recent Amiga Computing review. The only Amiga CD source for UFO and the unknown related subjects. Buy your copy before stocks run out!

**SALE £15.99**

**SALE £12.99**

## THE AMINET COLLECTION

Aminet 6	June 95	£-----	AMINET COLLECTION VOL.1	£22.99
Aminet 7	August 95	£11.99	The Aminet Collection is a superb set of four CD's for any Amiga user. Contains Aminet 1-4, PD from '93 to December '94, 4 GIG's of data!	
Aminet 8	October 95	£11.99	AMINET COLLECTION VOL.2	£24.99
Aminet 9	December 95	£11.99	Aminet Set 2 contains all the Aminet uploads since release 1. PD from December 1994 to November 1995. Gigabytes (four CD's) of games, utilities, demos, pictures, animations, tools, modules and more. Also contains 300 books from the Project Gutenberg CD-Rom.	
Aminet 10	February 96	[Out Now] £11.99		
Aminet 11	April 96	[Pre-Order] £11.99		
Aminet 12	June 96	[Pre-Order] £11.99		

**AMINET SERIES BI-MONTHLY SUBSCRIPTION SERVICE**  
Every time an Aminet CD is released (usually bi-monthly) we will send it to you for £11.99 - pay by credit or debit card. Card debited on despatch.

**AMINET SET 2 OUT NOW**

## OCTAMED 6 CD-ROM

Octamed is the most easy-to-use, powerful and effective music sequencer on the Amiga. Designed for the beginner right through to a music expert, Octamed will allow you to play up to eight channels of sound on any Amiga. By using a fast processor (D30) you can even use high-quality samples across all eight channels - effectively doubling the normal sound output (normally four channels). Octamed also has a built in sound sampler/editor, custom sound generator and MIDI support. This CD also contains over 600MB's of modules, the entire Walkabout sound sample collection and much more. Documentation comes in a on-line format and a laser printed, full-featured accompanying manual by Ed Wiles.

**new release! INCLUDES MANUAL! £29.99**

## SCI-FI SENSATIONS vol.2

SCI-Fi Sensations is an exciting new CD-Rom containing over 1000MB's of science fiction images, music, animations, 3D objects for Imagine and Lightwave, sound FX, documents/text, themtunes, information and SCI-Fi games. Categories include Babylon 5, Star Trek (the Original, TNG, Deep Space Nine, Voyager and the films), Batman, Dr. Who, Thunderbirds, Robocop, Bladerunner, Aliens, 2001, Battlestar Galactica, TRON, Total Recall and many other films. All the information is ready to run from the CD. Amiga, PC and MAC. New version 2 is now available containing more SCI-Fi data than ever before.

**new version 2!! DOUBLE CD-ROM £18.99**

### MEETING PEARLS 3

Contains 10MB of packing tools, 21MB of network tools, 29MB of development tools, 13MB of graphics programs, 13MB of AmigaTCP data, 60MB of CD-Rom databases, 96MB pasTEX, 30MB of HTML data etc. A very easy to use CD along with a special edition version of CD-Write to edit your CD!

**new!! £8.99**

### MEETING PEARLS 2

Carrying on the excellent tradition this entire CD is run from HTML 'internal' style pages. More utilities, games, tools, music and MIDI, FAQ's, PasTEX files and MB's of other data. This CD is similar to the Aminet series except it could be classed as more technical.

**SALE £7.99**

### C64 SENSATIONS

This CD gives you almost 10000 C64 Demos and over 600MB of software. Mega demos, games, utilities for the Amiga and PC computers. Latest versions of emulators for both machines the commercial version of A64 v3 for the Amiga. Superb collection for Amiga and PC.

**£16.99**

### TEN ON TEN PACK

Almathera collection consisting of ten CD's. They are: Team Yankee, Pandora's CD, World Vista Atlas, Illustrated Shakespeare, CDPD1, CDPD2, Demo 1, Comics and Networking, Fonts & Clipart and Photo Library CD. A superb value CD collection.

**SALE £32.99**

### WS ANIMATIONS

A double CD animation extravaganza! All the animations are ready to run from the CD, through an Amiga Guide file system. Some stunningly large animations, some over 5MB in size. Suitable for both the Amiga and PC.

**SALE £14.99**

### WS FONTS

Another popular World Science compact disc. This CD contains 2000+ Adobe and CG fonts, some PS fonts, 500+ bitmap, 180 coloured, 240 IFF, 139 Pgs, 24 Prodraw, 500 Trustype, 132 PCX, 300 GDOs and more!

**£7.99**

### NETWORK KIT

Do you have one of the 'old' CD32's lying around in your house? Well, why not connect it to your Amiga and use it as an external CD drive. All you need to make the connection - the CD, disk (for the computer) and the cable. An A1200 is recommended.

**£37.99**

### ASSASSINS 2

Following on from the tradition of the first CD this contains loads of new public domain games from 1994 and 1995. Entire Assassins collection upto 250, 60 utility disks and loads more games runnable from a superb custom written interface. Parrot and net provided for connection to host computers.

**SALE £15.99**

### TURBO CALC v2.1

A superb spreadsheet package now available on CD-Rom. Excellent formatting capabilities, more than 100 functions, macro and AREXX abilities, 100 instructions, sheet size limited by memory only, import of foreign spreadsheets and a comprehensive help guide manual.

**new!! £9.99**

### LSB VOLUME 3

MB's of data, most of which have never before been included on a CD-Rom at release! Software in both ready-to-run and archived format: demos, disklags, comms and compiling, anims and pictures, music modules, original clipart, source code, games, utils, etc.

**SALE £14.99**

### WS CLIPART

Must be nearly third in the most popular CD ever produced. Contains megabytes of B/W IFF bitmaps, colour IFF, proclips, EPS, Pagesetter, Pgs, IMG, Corel Draw and coloured brushes for Deluxe Paint. Bargain! This CD-Rom is suitable for Amiga, PC and MAC computers.

**£7.99**

### AMOS vol.2

This is an update to the first AMOS CD - the official library disks upto 638, general megabytes of B/W IFF bitmaps, colour IFF, proclips, EPS, Pagesetter, Pgs, IMG, Corel Draw and coloured brushes for Deluxe Paint. Bargain! This CD-Rom is suitable for Amiga, PC and MAC computers.

**SALE £15.99**

### SOUND WORKSHOP

Over 1 Gigabyte of data on this double CD. Includes MIDI files in various formats (MIDI, MM), hundreds of MB's of music to listen to or change/edit for your own applications. Over 5000 modules, 1000 VDC files, 1000 WAV files, 1000 samples.

**SALE £14.99**

### 17BIT CD 5

Following on from successful Phase 4 CD-Rom this CD contains hundreds of megabytes of data from 17Bit Software. The 5th disc in this series contains only the very best software including demos, games, utilities, graphics, artwork, disk magazines, music modules and much more.

**£18.99**

### WORLD INFO 95

Thinking about going abroad this year? Unsure about where to go? This is a virtual guide around the world. Explore different countries, learn different facts and information. You need a WWW browser and a machine capable of running in 256 colours for this CD.

**SALE £18.99**

### SPECCY 2

Multi-platform CD with emulators for Amiga, Atari ST, Mac and PC. Loads of FAQs (Speccy related), games lists, wallpaper (BMP) pictures for Windows and (JPG) for Amiga. Over 100 different Speccy computer screens and loads of tape covers. Stuffed with over 150MB's of Spectrum games for a myriad of computers. sof. 280 files.

**SALE £15.99**

### GIGA GRAPHICS

Giga Graphics is the ULTIMATE collection of graphics for the AGA Amiga. Over 10000 images on this quad-pack CD. All images are in 24 Bit and 8. Superb price for 4 CD's suitable for all AGA Amiga owners. What a picture of a landscape? What about a animal?

**SALE £29.99**

### AMIGA EXPERIENCE

Demo and full versions of Amiga software. Includes full version of Scala v1.13, Imagine v2, Vista Pro v1, The Edge v1.721, X-Copy, Carissa v1.1 and demo versions including image FX 2, Intersplay, Turbo Calc v3, InfoNEXUS v2.5. All these are ready to run.

**SALE £18.99**

### LIGHT WORKS

A superb compilation brought to you by Tobias J. Richter, known for his amazing spaceships of famous science fiction films. The objects are complex, highly detailed and seem very real due to the superb surface texture techniques used. A superb collection.

**SALE £24.99**

### ADULT SENSATIONS 2

This CD is for adults only. New material such as new images, sounds, games, etc. If this material offends you in any way please refrain from purchasing the CD. Proof of age (18+) only needed when buying this CD. No proof = no CD. We do not condone or supply hard core material.

**new!! £18.99**

### 3D ARENA

A superb 3D CD that contains many objects for Imagine, Lightwave and Real 3D for the Amiga and PC computers. One exclusive aspect for this CD is the 24Bit Cub's objects/images for Lightwave. You'll only find them on here! Also attribute files, tutorials, utilities.

**£19.99**

### CD BOOT v2

This allows you to use any CD32 game on your A1200 or A4000. You can create a corrie file for every game. Comes with a complete English based manual and can run around 98% of CD32 games.

**£24.99**

### SOUNDS TERRIFIC

This CD contains over 1.2 Gigs of sound and music data. It will form part of any professional musician's library or amateur's collection. 4,600 modules, 14,000 samples, 568 Soria scores, 4500 instruments, 302 octamed modules and more!

**SALE £14.99**

### COLOUR LIBRARY

1700 colour files with categories such as Animals, Boats, Buildings, Cars, Cartoonists, Cats, Computers, Dinosaurs, Dogs, Fantasy, Fish, Flags, Insects, Maps, Medical, Military, Misc, Painting, Photo, Places, Planes, Sci-Fi, Sea, Space, Sport, Star Trek, Swimsuit, Trains, Wars! You asked for a colour clipart CD - here it is! Colour clipart for nearly every occasion.

**new!! £8.99**

We stock many other compact discs. If you do not see what you want listed call us for possible availability. Remember we will match and try to beat any compact disc price listed within this magazine. Call for details!

## END OF SEASON EXTENDED SALE

Look out for the **SALE** sign. Offers end on the 22nd of April 1996. Normal prices (call) resume after this date. Please check availability before ordering.

Send your order to:  
Active Software, PO Box 151,  
Darlington, County Durham,  
DL3 8YT, ENGLAND.

01325 352260  
sales@active2.demon.co.uk

When ordering add 75p for postage. Orders outside UK add £1.00 on every CD for postage. Make cheques/P.O.'s payable to Active Software and send to the address below. You can pre order Get Started by credit card only - your card will not be debited until despatch of the CD-Rom. ZOOM release 2 is now available and in stock for delivery.







# Hi-Q PowerStation

■ Price: £299.95 ■ Developer: HiQ Ltd ■ Supplier: HiQ Ltd ☎ 01525 211327 <http://www.hiq.co.uk>

**Anyone wishing to expand their A600 or A1200 to have CD-ROM and SCSI capability should take a look at this effective device.**

**T**wo problems face the A600/1200 owner wanting to expand their machine: one concerns where to store the drives and the other concentrates on how much electrical power you'll need. These worries mainly effect external devices such as CD-ROMs and other SCSI devices. Hi-Q have partially come to the rescue with their PowerStation, which, although a simple device, can be highly useful for those intending to connect some real hardware to their A600/1200.

## Squirrel driven

The PowerStation consists of a rather nice PC tower case, a SCSI extension cable and an internal SCSI ribbon which terminates in a connector for the extension cable. The theory is that

you use Hi-Soft's Squirrel PCMCIA SCSI interface fitted to your A1200 (or A600 for that matter) and attach the extension cable to the Squirrel's SCSI connector. Most SCSI devices can be fitted into the tower case, attached to the internal ribbon and driven by the Squirrel.

The PowerStation has a healthy 200W power supply in the case. This not only runs any SCSI peripherals connected, it has an Amiga cable too, so there's no need to buy a Goliath to power your accelerator and internal HD. Hi-Q want part of the stock power supply (AKA The Brick) back in exchange though, since Amiga Power leads are in short supply. You simply snip the connector end of the lead and send it to them. The transformer itself can then be used as door stop; a task it's more suited to than attempting to power an expanded Amiga.

Your monitor can also

be plugged into the pass-through power socket on the rear of the tower so that with a simple push of the button, Amiga, drives and monitor are all powered on or off. Darned handy.

## Audio freaks

The most common configuration available from Hi-Q is the Tower, as reviewed here, fitted with a Sony 2.4 speed (breaking the tradition of drives being even multiples of single speed units). This mechanism featured in a pack from Hi-Soft reviewed previously. It's proved to have excellent access time and a healthy rate of transfer as well as facility to be able to send audio data down the SCSI bus. Audio freaks will love this feature as the highest possible quality samples can be obtained with no extra hardware. A very respectable and cost-effective mechanism to have built in, HiQ chose well with this Sony mechanism. Also included with the CD-ROM are two sets of RCA/Phono jacks which allow the CD audio to be mixed into your Amiga audio through the loop.

Annoyingly, the tower has a panel which covers the drive bays. This would have to be left open to get regular access to the CD drive. If not concerned with appearance the user might prefer to remove it all together.

The tower, unfortunately, is a little too deep for my liking. It will use quite a lot of desk space but being equipped with 2 full 5.25" drive bays and two centred 2 3.5" drive bays, it does at least have the requisite storage. The innards of the tower generally have everything that's required. A healthy length of internal SCSI cable with 5 x 50 way SCSI connectors fitted will be more than enough for any drives internally. The connector at the rear of the tower also has a passthrough connector so that external devices could still be looped through such as

the Zip drive which is still not available in an internal form.

## It all depends

Whether the PowerStation is a worthy purchase depends on how many SCSI devices you want to connect. If all you want is a beefier power supply and a CD-ROM with SCSI capability then a Goliath and Hi-Soft CD bundle is £235, which is more than £50 cheaper than the PowerStation. However, if you wanted to add a SCSI hard drive, it would be difficult and messy to do without the Tower. You'd need an external box and power supply, which would probably cost about the same as the PowerStation but wouldn't have as many future expansion options. In this case I'd recommend the PowerStation.

The PowerStation is an effective highly expandable system that's well constructed if a bit large. Although Amiga owners just wanting one or two SCSI devices in the foreseeable future might be better served by an external box, the PowerStation is a good option for anyone needing to add several internal SCSI devices. Such a set-up with a SCSI HD, CD-ROM, Internal ZIP (when available) and perhaps coupled with the forthcoming Hi-Soft Surf Squirrel (extra SCSI speed and high speed serial) would be an admirable Amiga system indeed. Recommended. ■

**Mat Bettinson**



Hi-Q PowerStation	
A500	<b>system requirements:</b> A1200 or A600 only
A600	<b>ease of use</b> ..... 90% Just plug in the extension cable. Anyone can fit an internal HD to a tower case.
A1200	<b>performance</b> ..... 86% Does what it needs to. Uses up a lot of desk space though.
A1500	<b>value for money</b> ..... 82% Most of the cost is made up from the CD-ROM mechanism.
A2000	<b>OVERALL</b>
A3000	Recommended beefy expansion solution. <b>84</b> %
A4000	



# CD-ROM

We've gone CD-ROM crazy this month. There's a special bumper edition of choice shiny discs for you to look at.

## Round Up



### F1 Licenceware Volume 1

Licenceware software is really cheap commercial mail order software. The 'ware' part of the name comes from the idea that it's like pre-registered shareware. The range of software covers games, education and utilities, along with a few music-related disks.

The games are generally sub-standard AMOS creations but there are a few highlights, such as Relics of Deldroneye and Giddy. The utilities section is made up of disk magazine creators, a video titler, a game map editor, a database, a picture converter and

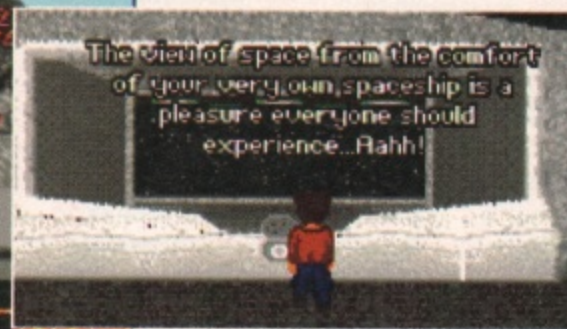

presented with a non-DOS disk containing software that may have no quit option can be infuriating. This is an exceptional case and much of the software can be run straight from the CD, but system-friendliness seems not to have been a high

priority in most cases. Finally there's the miscellaneous drawer which is filled with disk magazines and quiz programs.

While there are some goodies on the CD, much of the software will not satisfy the demands of 'power' users. The need to unpack to floppies on many occasions and then be

Available from: **F1 Licenceware, 31 Wellington Road, Exeter, Devon EX2 9DU. Tel: 01392 493 580.**

**Price: £29.99 plus 50p P+P.**

**60%**

### Danny Amor's Online Library Vol 1

If you haven't already checked out the World Wide Web pages on this month's cover CD, do so immediately! Right, now you've done that, you'll be familiar with the idea of using a web browser to view documents on a local drive. It works well and it's a lot cheaper than doing it over a phone line!

Danny Amor's Online Library is using the same system to present his 200 plus books on this CD. The selection takes in a range of public domain publications, including of course The Bible, along with lots of reference material from various sources, such as the CIA, which



supplies encyclopedic information on every country in the world with population figures, financial status and all that kind

of stuff. There's also some classic fiction from Charles Dickens, Robert Louis Stevenson, Tolstoy, Mark Twain, Jules Verne, HG Wells and Antonella D'Addeo. Some of the volumes are text-only but there's also quite a bit of illustration to keep your mince pies stimulated. (bit of cockney thrown in for the Londoners, I like it - Ed).

There's not enough room on the CD for it to be anything like

a fully featured library but there is a wide enough variety of topics. It doesn't seem to be aimed at anyone in particular. Maybe a more focused selection would help aim the CD at a particular audience. Even so, it's quite an impressive presentation all the same.

Remember you'll need a web browser in order to use this CD.

Available from: **GTI, Zimmersmühlenweg 73, 61440 Oberursel, Germany (see adverts for UK suppliers).**

**Price: TBA.**

**80%**



## Nothing But GIFs

While some graphics collections are filled out with scraps from the bottom of the public domain barrel, Nothing But GIFs offers a wide range of high quality images. As you've already guessed, all the pictures are in 256 GIF format. The sizes vary but most are around 640x512 pixels, which is just right for high resolution interlaced screens. The pictures are separated into three main sections: drawn, digitised and rendered.

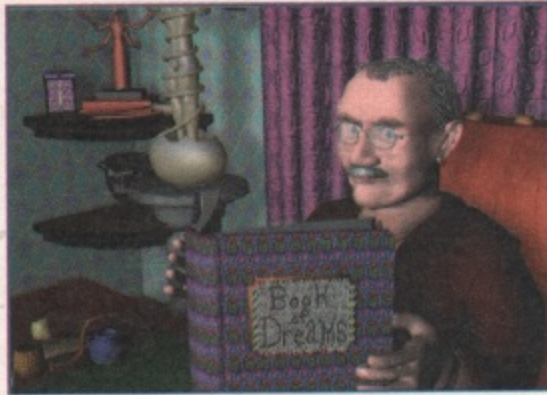

The first section is made up of pictures from demos and what look like DPaint doodles. The largest area of the disc is taken up by the digitised pictures, which are split into animals, buildings, glamour, landscape,

miscellaneous, people, plants, space and transport sections. Finally there's the rendered area, which holds all of the 3D ray-traced and fractal-generated images.

There's an AmigaGuide index included on the disc to make viewing as easy as possible. There are also index pictures in each drawer, made up of thumbnail versions of the images for quick reference. If you're looking for a good photo library CD, Nothing But GIFs will do just fine.

**Available from: 17 Bit Software, 1st Floor Offices, 2/8 Market Street, West Yorkshire WF1 1DH. Price:**



**£19.99 plus 75p P+P.**

**89%**

## Texture Portfolio

One of the best features of this CD is the printed index booklet that comes with it. It's a collection of 24-bit texture and back-drop images, each of which is pictured in the booklet along with its filename. It's high time that CD-ROM producers started producing proper documentation for their discs, as it makes using them so much easier.

The images are duplicated in three formats (JPEG, TARGA and PICT) and most are digitised from

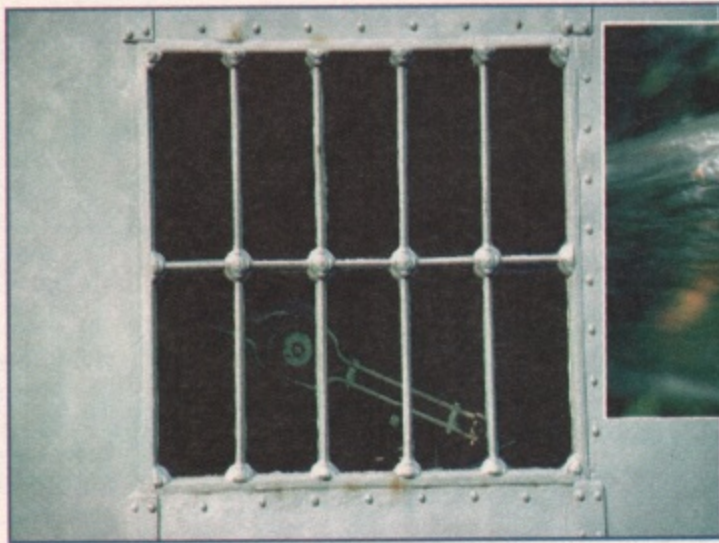

photographs. Each one is segregated into one of the following areas: abstract, animal, clouds,



fire, food, masonry, rock, metal, water, wood and miscellaneous. Although the

duplication of the images means that there aren't as many files as there might be on rival CDs,

they're all very clean and you won't find any fillers.

Whether you want textures for 3D rendering or back-drops for general graphics and video work, Texture Portfolio has plenty to offer.

**Available from: Ground Zero Software, 4**

**Chandos Road, Redland, Bristol BS6 6PE. Tel: 01179 741 462.**

**Price: £29.99 plus 75p P+P.**

**91%**

## Workbench Add-On

The theme here is productivity, or to be more precise, how to increase it. Workbench Add-On covers most of the areas you'll find on the Aminet and Fred Fish CDs (comms, mods, text, development tools, sound, games, fonts, utilities, disk tools, games etc) but in this case it's mostly ready to run rather than archived. Magic User Interface is included, and is required to make full use of the CD.

Sensible emphasis has been placed on registering the shareware software on the disc, to the extent that the accompanying booklet has a number of registration forms complete with

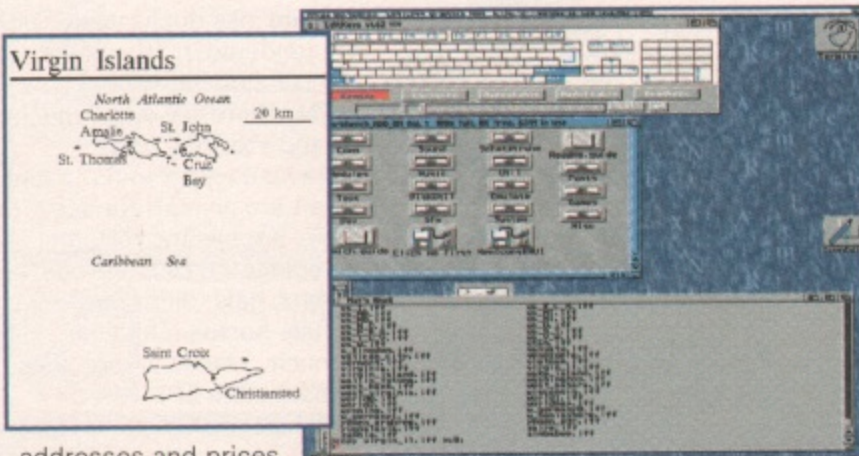

addresses and prices, in both English and German. It's good to see such a responsible attitude, as without shareware registrations, there

would be no shareware to put on the CD in the first place. One of the best aspects of

this CD is the generous amount of sound samples and music modules. The samples can be auditioned straight from the disc but unfortunately many of them replay at the wrong speed. Even so, the overall quality of this CD is exceptionally high and there are quite a few 'original' samples, rather than the same old ones that crop up on most CDs. Well worth a look.

**Available from: GTI, Zimmersmühlenweg**

**73, 61440 Oberursel, Germany.**

**Price: TBA.**

**84%**



## Aminet 10

File	Dir	Size	Age	Description
1 rave.t.lha	mods/techn	352K	32	RAVE-Tools The New Chapter
2Control.lha	mods/techn	13K	62	Mad tekno tune
2ndcele.lha	mods/techn	178K	5	ProTrackerV3.15-Module
2 rave.t.lha	mods/techn	384K	32	Rave Tools - The New Chapt
3 rave.t.lha	mods/techn	162K	32	Rave Tools - The New Chapt
4yourind.lha	mods/techn	95K	18	Rave module
5HouseMeganix.lha	mods/techn	422K	12	Great Tekkno Modul by The
5Ravers Mix.lha	mods/techn	469K	36	Great Tekkno Modul by D.A.
6idick.lzh	mods/techn	46K	22	MOD By JayFx/BlackOut
6idickLaneshad.lha	mods/techn	111K	75	Techno mod by Mark Knight
6idick.lha	mods/techn	73K	8	ProTracker 2.3 module
6idick.lha	mods/techn	283K	75	Techno mod by Orpheus
6idick.lha	mods/techn	94K	86	A ProTracker module by Tra
6idick.lha	mods/techn	35K	75	Techno mod by Zodiac
6idick.lha	mods/techn	151K	44	Techno mod
6idick.lha	mods/techn	188K	27	ProTracker .MOD (Dark Ind
6idick.lha	mods/techn	115K	75	Techno mod by Mr.Urk
6idick.lha	mods/techn	127K	4	Techno mod by Time Guardia
6idick.lha	mods/techn	223K	6	Techno mod by Optic
6idick.lha	mods/techn	178K	14	House-Trans-Mod By Pirat/
6idick.lha	mods/techn	566K	43	Ambient module (QuadraCome
6idick.lha	mods/techn	149K	184	ProTracker Module "Anthem"
6idick.lha	mods/techn	81K	2	Mod.anti-razist by claps!
6idick.lha	mods/techn	146K	2	Technopop module by Hotman
6idick.lha	mods/techn	222K	36	Great Tekkno Modul by TITA
6idick.lha	mods/techn	90K	23	Babdobbel dobbelin Hardco
6idick.lha	mods/techn	159K	14	Acid-Breakbeat-Mod By Pira
6idick.lha	mods/techn	55K	7	Rave/Techno module (4 voic
6idick.lha	mods/techn	538K	6	Techno mod by Vinnie

Here it is, the latest grab bag from the Amiga's definitive on-line shareware archive. It's all here: demos, utilities, software, pictures and a special focus on music modules. The format is just as before, with most of the files stored as LHA archives. Fortunately these can all be accessed from an intelligent AmigaGuide document, which automatically plays modules, displays pictures and unpacks archives as necessary. Not everything works straight from the guide, but it's a good system in general. Highly recommended as always.

**Available from: Exclusive**

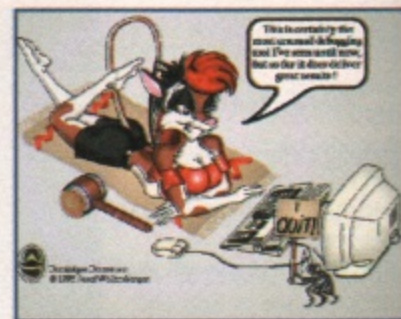

**PD, First Floor Offices, Coltsfoot Drive, Waterlooville, Hants PO7 8DJ.**  
**Price: £12.99 plus 75p P+P.**

**90%**

## The Epic Collection

Epic have their own unique approach to PD and shareware, often compiling their own themed packs of disks to complement the rest of their library. The Epic Collection is their PD library compressed into DMS files and put onto a CD-ROM.

The DMS files must be unpacked onto floppies before use. This is the only way to archive some demos, but it's a pain to have to go via floppies if all you want is to access some files or utilities. As there are very few demos or archives with alternative disk structures, it's shame you don't get the chance to unarchive to a specified drive.

However, the software included on the disc is varied, fun and

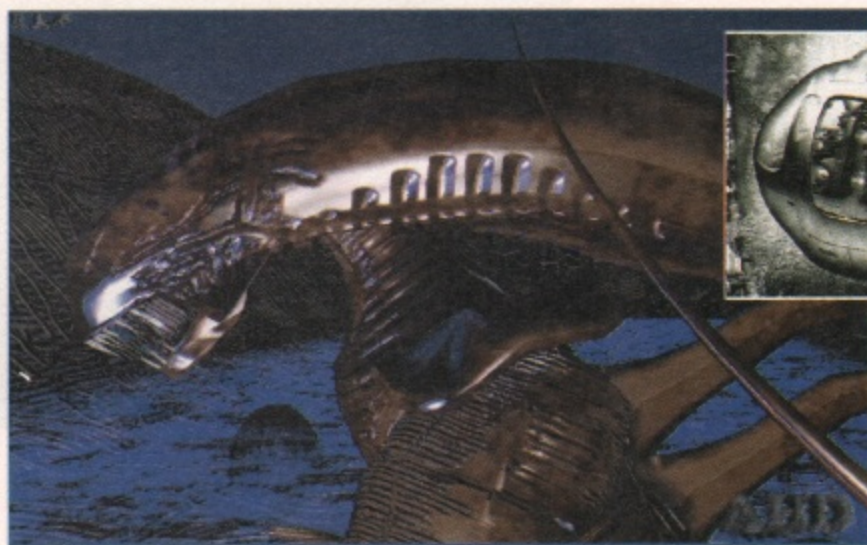

often quite useful. The front end is attractive but uses a system of dual selection windows, making

it easy to accidentally decompress the wrong disk. The lack of quit and screen cycle

gadgets is also irritating but if you're not used to using Workbench then this may not be so much of a problem. All in all, a bit of a mixed bag but there are plenty of gems to be found,

whatever your interests may be.

**Available from: Epic Marketing, Victoria Centre, 138-139 Victoria Road, Swindon, Wiltshire SN1 3BU. Tel: 0500 131 486.**

**Price: £19.99 plus £1 P+P.**

**78%**

## Phase 2



The Phase series of clip art and font CDs has proven itself to be a most reliable source of graphics for video, DTP and general

graphics work. Phase 2 uses the same format as the others, dividing its clip art into mono IFF, colour IFF and EPS, while its

image bank has duplicates of all files rendered in 16 colours, 256 colours and HAM-6 mode. There are also Type 1, CG and ProDraw fonts. Subjects covered in the mono clip art are animals, fantasy, music, people and religion. The colour IFF clips include birds, cars, cats, dinosaurs, dogs, fish, horses, The Lion King, music, planes and reptiles. Then there's the EPS section with animals, buildings, computers, food, logos, office, people, transport, USA and the world.

As for the images, we get animals, balloons, Blake's 7, cars, Conan, Dragon Lance, fantasy,

horses, natural, planes, racing, renders, reptiles, snow scenes, space, Star Trek, trains and backdrops for video work. Added to that you also get some bonus bits, including all the PageStream 3 updates, the Opalvision 2.3b update and utilities, Typesmith 2.5a update and more.

**Available from: EMC Computergraphic, 8 Edith Road, Clacton on Sea, Essex CO15 1JU. Tel: 01255 431 389.**

**Price: £24.99 plus £1 P+P.**

**89%**



# AMIGA CDROMS COMPACT disc

 <p>Contains Thousands of Workbench icons and backdrops. Workbench3 recommended. £10</p> <p><b>PRO ICONS 2</b></p>	 <p>Compiled over the last 5 years this CD contains only the very best quality textures. £26</p> <p><b>TEXTURE PORT.</b></p>	 <p>Allows you to Virtually write to any CD ROM on any drive. Quite useful for some things. But generally a waist of time. £40</p> <p><b>CD WRITE</b></p>
 <p>Over 600mb of new material all DMSed onto a superb CD, compiled by Active PD. £17</p> <p><b>ZOOM</b></p>	 <p>Around 2000 high quality "Girly" pictures. Includes viewer for Amiga. Adults only £18</p> <p><b>SEXY SENSATION</b></p>	 <p>A TEN CD set of colour textures, this collections a real bargain. Basically £2 a cd. You can't go wrong. £20</p> <p><b>MEDIA CLIPS</b></p>
 <p>Contains hundreds of great AGA cards for use with Klondike AGA. suitable for any Amiga. £10</p> <p><b>KLONDIKE GOLD</b></p>	 <p>Features around 40,000 clipart images, virtually every subject imaginable. £16</p> <p><b>WORLD OF CLIPART</b></p>	 <p>The Guinness Disc of World records is a superb multimedia Amiga presentation. £19</p> <p><b>DISC OF RECORDS</b></p>
 <p>Complete with CD ROM, floppy disk, and connecting CD32 lead to any Amiga. NEW super fast transfer version. £34</p> <p><b>GD32 NETWORK 2</b></p>	 <p>Thousands of Adobe, Bitmap and compugraphic fonts. There's something for everyone. £8</p> <p><b>WS FONTS</b></p>	 <p>Contains around 1,000 ready to run games on one CD ROM. excellent value for money. £18</p> <p><b>ASI GAMES 2</b></p>
 <p>The Grolier electronic encyclopedia. Based on the hugely popular PC version, now available for the Amiga. £25</p> <p><b>GROLIER 2</b></p>	 <p>A Double CD ROM featuring Hundreds of great Animations all viewable direct from the CD. £18</p> <p><b>WS ANIMATIONS</b></p>	 <p>Professional fonts &amp; clipart CD is possibly the best selection of fonts (Adobe&amp;compugraphic) your ever likely to find. £8</p> <p><b>PRO FONTS</b></p>
 <p>Compiled by 17bit Software this CD ROM has been praised by most magazines for it's original and upto date information. £19</p> <p><b>LSD TOOLS 3</b></p>	 <p>Includes animations, music, games, pictures, text files, and more all with the SCI-FI nature. £18</p> <p><b>SCIENCE FICTION</b></p>	 <p>Contains hundreds of "secret" documents about UFOs, UFO abductions, the FBI, etc. £15</p> <p><b>ENCOUNTERS</b></p>
 <p>Features: Space Invaders, Galaxians, Centerpede, Q-Bert, Pacman, Defender, Frogger, Lode runner etc. £13</p> <p><b>ARCADE CLASSICS</b></p>	 <p>Includes video backdrops, Video fonts, Video titling tools and more. £13</p> <p><b>DESKTOP VIDEO</b></p>	 <p>Features around 3,000 all-time classic spectrum 48 games. runnable on any true Amiga. £18</p> <p><b>SPECTRUM CD 2.1</b></p>
 <p>Features 600mb of DMS based disks, for sheer value this cant be beat. £7</p> <p><b>HOTTEST 4</b></p>	 <p>A four CD set of around 10,000 colour images, all stored as IFF. You can load them straight into almost any AGA package. £29</p> <p><b>GIGA GRAPHICS</b></p>	 <p>Anything and everything to do with AGA amiga's. Very AGA demo based. but still good. £15</p> <p><b>AGA EXPERIENCE</b></p>
 <p>A double CD featuring samples and thousands of music modules and music tools and players. £18</p> <p><b>SOUND LIBRARY</b></p>	 <p>Aminet 10 is the latest tools CD compiled from the Aminet. Very easy to use. £13</p> <p><b>AMINET 10</b></p>	 <p>Adult Sensation2 contains around 4,000 pictures, sounds, animations, jokes etc. For Adults only. £17</p> <p><b>ADULT 2 (18)</b></p>
 <p>A double CD ROM of around 10,000 colour clipart images. suitable for any Amiga. £18</p> <p><b>GIF LIBRARY</b></p>	 <p>Four CD ROM collection of games, demos, utils, patches etc. great value!!! £25</p> <p><b>AMINET SET2</b></p>	 <p>Features over 300 gory animation sequences, pictures, sounds and stories. (very gruesome) £19</p> <p><b>HORROR CD (18)</b></p>
 <p>Contains almost 100 variations of the Worlds best loved game. all runnable from CD. £9</p> <p><b>TETRIS CD</b></p>	 <p>Contains over 4,000 high quality colour GIF images for use in almost any graphics package. (OVER 18) £16</p> <p><b>ADULT SENSATION</b></p>	
 <p>Includes emulators for Atari, C64, Spectrum, Mac, Sinclair QL, Amstrad etc, etc. £18</p> <p><b>EMULATORS</b></p>	 <p>Contains all of the latest floppy disks from the 17bit software collection. Very easy to use. £19</p> <p><b>5TH DIMENSION</b></p>	
 <p>A four CD collection of DMS files. Includes Animations, Fish disks, Music, Demos, Clipart etc. £28</p> <p><b>UPD GOLD (4CD)</b></p>	 <p>Contains Pictures, Animations, tools, demos, Blal, Blal, Blal! £10</p> <p><b>PEARLS 3</b></p>	

## COMPLETE CD-ROM LIST

WEIRD SCIENCE CLIPART	£8
GIFS GALORE	£19
PRO PCX-IFF CLIPART VOL1	£8
GOLD FISH DISKS1-1000	£25
ADULT SENSATION (18)	£16
MEETING AT PEARLS 2	£10
C64 SENSATIONS	£18
ZOOM!!!	£17
GUINNESS DISK OF RECORDS	£19
PROFESSIONAL UTILITIES 1500	£8
SOUNDS TERRIFIC (2CD)	£19
PRO. IFF & PCX CLIPART 2	£18
MEDIA CLIPS (10 CDROMS)	£20
AMINET 7	£13
LSD COMPENDIUM VOL3	£19
PRO BACKDROPS & ICONS 2	£10
LIGHTROM VOL1	£poa
AMIGA TOOLS ONE	£20
GFX SENSATION	£15
17 BIT COLLECTION (2 CDROMS)	£28
ADULT SENSATIONS 2 (18)	£19
UPD GOLD COMPENDIUM	£28
GOLD FISH 2 (2CDROMS)	£poa
COVERGIRL STRIP POKER(18)	£13
HORROR SENSATIONS (OVER18)	£19
GROLIER ENCYCLOPEDIA V2	£25
PRO FONTS AND CLIPART	£8
HOTTEST 6	£poa
WEIRD SCIENCE FONTS	£8
POWER GAMES	£8
17 BIT PHASE 4	£10
LSD COMPENDIUM VOL1	£14
17 BIT CONTINUATION	£10
CD32 NETWORK V2 (CD&LEAD)	£34
SPACE AND ASTRONOMY	£19
AMINET SET ONE (1-4)	£25
ARCADE CLASSICS	£13
LIGHTWORKS BY T.RICHTER	£poa
CD WRITE (HD REQ)	£40
AMINET 6 (JULY 95)	£13
GIF SENSATION (2CD)	£18
THE COLOUR LIBRARY	£9
WORLD OF CLIPART (2CD)	£16
LSD COMPENDIUM VOL2	£17
MULTIMEDIA TOOLKIT 2	£20
SOURCE CODE CD	£19
SHUTTLE ENCYCLOPEDIA	£19
EMULATORS UNLIMITED	£18
SCI-FI SENSATIONS	£18
LUCKY DIP VOLUME 2	£5
SUPER CARS	£5
ASSASSINS GAMES VOL 2	£19
NETWORK CD V2 (CD ONLY)	£15
AGA EXPERIENCE	£15
SEXY SENSATION (18)	£18
AMINET SET 2 (VOL5-8)	£25
MAGIC WB ENHANCER	£10
17BIT 5TH DIMENSION	£19
AMINET 9 (DECEMBER 95)	£13
THE ERIC SCHWARTZ ARCHIVE	£25
ENCOUNTERS (UFOS)	£15
AMINET 10	£13
SPECCY SENSATION PART2.1	£18
ILLUSIONS 3D	£5
HOTTEST 5	£10
LIGHT ROM VOL2	£poa
SOUND LIBRARY (2CD)	£18
GIGA GRAPHICS (4CD)	£30
POV-RAY	£19
WORLD INFO '95	£30
MEETING PEARLS 3	£10
DESKTOP VIDEO CD	£13
INTERNET INFO	£19
WS ANIMATION (2CD)	£18
3D ARENA	£20
ESSENTIAL UTILITIES	£7
AMINET 8 (OCT95)	£13
LOCK'N'LOAD 2	£poa
NOTHING BUT TETRIS CD	£9

# PLEXUS MEDIA DISC SUPPLIERS

TO ORDER BY POST SIMPLY SEND YOUR ORDER WITH PAYMENT EITHER BY CHEQUE, POSTAL ORDER OR CREDIT CARD. UK ORDERS PLEASE ADD £1.00 PER TITLE FOR P&P. OVERSEAS ORDERS PLEASE ADD £2 PER CD. GOODS ARE NOT SOLD ON A TRIAL BASIS, SOME ITEMS MAY NOT YET BE RELEASED. ALL SALES ARE SUBJECT TO OUR NORMAL CONDITIONS. EXOE

LO-CALL Lines open 10am-4pm Monday-Friday  
**0345 66 00 15**  
 Plexus Media. PO BOX 637, SWINDON, WILTS. UK





# V12-PD

Dept CU1  
PO Box 14  
Lincolnshire  
LN11 8LF  
United Kingdom  
01507 450114

**20 PD DISKS FOR A TENNER FROM A LIBRARY OF 13,000+, TRADE PRICES ON ALL SERVICES AND BULK DEALS. CD'S AND HD'S AVAILABLE NOW AT MUCHO CHEAP PRICES TOO!**

**OUR CATDISKS CAN BE DOWNLOADED RIGHT NOW FROM MIDNIGHT EXPRESS BBS, THE UK'S COOLEST AND BEST BBS ON 01384 826282 RIGHT NOW, AND RIGSBY'S BBS ON 01530 260160, OR HAIR OF THE DOG BBS ON 01344 4425553!**

**OPEN SOON, V12-PD'S OWN BBS, ON THE SAME NUMBER AS OUR PHONE LINE, BUT RUNNING FROM 8PM-9AM, WE ARE CURRENTLY HAVING A LINE INSTALLED TO MAKE IT A 24 HOUR BBS, TRY LOGGING ON TODAY, WE MAY BE OPEN ALREADY AND YOU'LL BE MISSING OUT! IT'S CALLED GLAMOURPUSS BBS, AND TAKES ALL SPEEDS UPTO 28.8K, CONTACT US FOR THE BEST AMIGA ONLY FILES TO DATE, 4 GIGABYTES ONLINE, AS WELL AS CD'S AND SERVICES ON OFFER LIKE FAXES OUT. GENEROUS UPLOAD/DOWNLOAD RATIOS AND WE'RE THE SYSOPS SO YOU CAN RING FOR A CHAT TOO!**

## SPECIAL OFFERS, EXTREMELY LIMITED, RING NOW.....

NOW AVAILABLE, HARD DRIVES (3.5 INCH IDE) ARE IN FROM OUR MATES ACROSS THE POND, ONLY LARGE SIZES CURRENTLY AVAILABLE, 540MEG TO 1.3 GIG, BUT VERY CHEAP AND 100 MEGS OF FREE PD INSTALLED ON IT, AS WELL AS FULL PARTITIONING/MAGIC WB ETC, WE ARE SELLING THESE VERY CHEAPLY AND THEY ARE VRAND NEW MODELS WITH FULL GUARANTEES.

2.5 - 3.5 CABLES AVAILABLE, FITTING IS ALSO POSSIBLE. RING FOR LATEST PRICES AND MORE DETAILS! THESE ARE CHEAPER THAN ANY OTHER AD IN THIS MAGAZINE, WE THINK!

NOW ON OFFER! V12-PD CD VOLUME 1, COMPATIBLE WITH ALL AMIGA CD DRIVES RUNNING WORKBENCH 1.3 - 3.1, CONTAINS ABOUT 1000 OF V12'S LATEST PD DISKS, ALL RUNNING THROUGH A CUSTOM, MULTITASKING GUI MENU SYSTEM CODED BY FREAK OF NFA (SUPERB LOOKING) WE HAVE LIMITED COPIES AVAILABLE AS OF PRESS DATE AND THEY CAN BE ORDERED FOR THE FIRST TIME OFFER PRICE OF 15.99! TRADE PRICES ON OFFER NOW!

OTHER SERVICES INCLUDE MEMBERSHIP, FLATBED SCANNING, DIGITIZING, SOUND SAMPLING, MEMBERSHIP, PD SWAPS, FOREIGN PD AVAILABLE IN LARGE NUMBERS, BRAND NEW AND DIRECT FROM THE AUTHORS! OUR MEMBERSHIP FOR ONE YEARS CATDISK UPDATE (24 DISKS!) IS ONLY £6.00, GET THE LATEST PD AVAILABLE WITHIN MINUTES OF IT BEING RELEASED, AND OUR FAB DISKS FOR A YEAR WITHOUT BOTHERING TO ASK FOR IT EACH MONTH. PLATINUM MEMBERSHIP IS £15.00, AND ENTITLES YOU TO 10% OFF PD, A YEAR'S CATDISKS AS THEY'RE RELEASED, 30% OFF SCANNING, 30% OF BLANKS AS PD, 25% OFF SCANNING, 30% OFF SAMPLING, ETC, ETC, ETC! DON'T MISS IT, OR YOU'LL CRY FOR DAYS!!!

## V12-PD WELCOMES ALL LOYAL AMIGA USERS OUT THERE!

WELCOME TO THE PD WORLD OF THE AMIGA, IT'S A SECRET INDUSTRY, FILLED WITH SPIES, MYSTERY, INTRIGUE, AND A MISS MARPLE IN EVERY VILLAGE! WE LIKE TO THINK WE'RE THE BIG CHEESES AROUND THE PD WORLD, NOT LEAST COS WE SMELL A BIT CHEDDARY.....

ONCE AGAIN, THE V12-PD LIBRARY GROWS INTO FURTHER GARGANTUAN PROPORTIONS, WITH NOW 13000 DISKS ON OFFER TO EVERYONE, AS WELL AS ANY CD YOU'D CARE TO MENTION. OUR NEW CD IS NOW AVAILABLE, CONTAINING 11000-12000 IN OUR CATDISKS, AS WELL AS MORE STUFF TO HAVE A SNUFFLE THROUGH THAN EVEN THE LARGEST SNUFFLERS COULD DEAL WITH IN A HURRY! EVERY TITLE HAS OUR TYPICALLY WITTY AND INTELLIGENT (?) DESCRIPTION ATTACHED TO IT ON THE MENU, AND FULL SEARCH/GOTO FACILITIES MAKE IT A DREAM TO USE. IT IS FULLY CONFIGURABLE TO BE ONLINE ON A BBS, SO BBS'S CAN GET 1 GIG OF NEW DATA IMMEDIATELY WITHOUT NEED FOR A NEW HARD DRIVE! YOU CAN IGNORE IT IF YOU WANT TO, BUT IF YOU DO IT'LL FEEL WORSE THAN A SHARP BITE ON THE BUM! JUST SO AS YOU KNOW.....

OK, WE'VE RAISED OUR PRICES. I HEAR YOU SAY, "OK, WHY'VE YOU DONE THAT, MISSUS, I AIN'T PAYING THAT!", WELL, THERE'S A GOOD REASON. WE RECENTLY DECIDED THAT AS PEOPLE NOWADAYS DON'T TREAT SOME PD AS 'THROW-AWAY TEMPORARY ENTERTAINMENT' WE WANTED TO MAKE SURE OUR PD WOULD LAST LONGER THAN A BAD SMELL IN A SMALL LIFT, SO WE HAVE MOVED OUR DISKS WE USE FOR TITLES UP TO FULL 70% CLIP GRADE A DISKS, WHICH OBVIOUSLY COST MORE FOR US TO BUY, NOW UNLESS YOU WANTED TO SEE US IN THE POORHOUSE, WE REALLY HAD TO PUT UP THE PRICES, AS THE SMALL INCREASE TO EACH CUSTOMER IS VERY IDDY-BIDDY, BUT IF WE FOOTED THE DIFFERENCE IT WOULD RUN INTO THOUSANDS A WEEK! I MUST STRESS THAT NOW V12'S PD AND BLANKS ARE FULL 100% GUARANTEED GADE A FINE STEAK, NOT THAT THE ONE'S WE WERE USING WERE POOR, BUT WE DECIDED AS WE CAN SEND YOU REALLY NICE ONES FOR A PITTANCE MORE, YOU'D PREFER IT.

PLEASE NOTE THAT FOR 20 DISKS OR MORE, THE PRICE IS NOT ALTERED, DUE TO BULK DISCOUNTS FOR US, AND WE'VE PASSED THAT BENEFIT STRAIGHT ON TO YOU, SO WE'RE STILL THE CHEAPEST LARGE SCALE FULL TIME LIBRARY AROUND. OH YES WE ARE, ALSO TAKE INTO CONSIDERATION THAT V12 IS ONE OF A VERY SMALL NUMBER OF LIBRARIES TO USE GRADE A DISKS, ALMOST ALL LIBRARIES STILL USE GRADE B'S, SO GET GOOD QUALITY GRADE A'S AT A CHEAPER PRICE THAN B'S AND REALLY BENEFIT!

OUR PD IS CHEAP, IT'S VERY CHEAP. IN FACT HERE ARE OUR PIDDY PRICES:

1-5 DISKS = 70P EACH  
6-9 DISKS = 65P EACH  
10+ DISKS = 55P EACH  
20+ DISKS = 50P EACH

P+P IS ONLY 50P ON ANY SIZE ORDER! DISKS ARE 25P EACH INCLUDING P+P IF YOU SUPPLY THE BLANKS

THEREM THAT DIDN'T HURT TOO MUCH, DID IT? AND JUST COMPARE OUR NEW GRADE A PD DISKS TO ANYTHING ELSE YOU'VE EVER BEEN OFFERED IN A DARK ALLEY AT 2 IN THE MORNING, WE'RE STILL THE CHEAPEST, AND WE'RE STILL THE BEST! BUT I WON'T WITTER ON ABOUT ALL THAT, I'M HERE TO TELL YOU EXACTLY WHAT'S GOOD ABOUT V12-PD! V12 IS NOW A WELL ESTABLISHED PD LIBRARY, YOU CAN BE SURE THAT IF YOU PICK THIS MAGAZINE UP IN SIX MONTH'S TIME, WE'LL STILL BE HERE SELLING GOOD OL' BILLY JOE JIM BOB PD TO DELIGHT YOUR GOOD OL' GRANPA AND THE 96 COUSIN'S WHO ALL LIVE RATHER ODDLY IN A ONE ROOMED MAISONNETTE.

OK, GOOD THINGS ABOUT US THEN, WELL, WE'RE CHEAP, THAT YOU KNOW ALREADY, BUT WE ALSO HAVE THE BEST CATDISK ON THE PLANET BY A VERY WIDE MARGIN, JUST TAKE A LOOK AT SOME OF THE THINGS OUR CATDISK CAN DO FROM THE PRESS OF A KEY OR THE CLICK OF AN ICON: 2 DISKS THAT SELF BOOT TO INDIVIDUAL CUSTOM MENUS WITH INDIVIDUAL EFFECTS, MUSIC AND LAYOUT, FULLY INSTALLABLE TO RAM DISK OR PARTIALLY INSTALLED FOR LOWER MEMORY SYSTEMS, FULLY INSTALLABLE TO HARD DISK ON ANY SYSTEM, SPEEDS OF OVER 300K A SEC WHEN INSTALLED USING CRUNCHED ASCII FILES, ANIMATION, HIRES INTERLACED INTRO SCREENS WITH SOUND EFFECTS ON EVERY MACHINE INCLUDING THE LOWEST POSSIBLE SPECS EVEN WHEN HD INSTALLED, FULLY MULTITASKING WHEN INSTALLED, SEARCH FACILITY, GOTO FACILITY, MUSIC (YOU CAN TURN IT OFF, DON'T WORRY!), AUTOMATIC WORKBENCH VERSION DETECTION INCLUDING THREE DIFFERENT VERSIONS OF THE CATDISK OPTIMIZED FOR ALL THREE MAIN SYSTEMS (1.3, 2.0, 3.0) ALL PACKED AND READY TO RUN ON ONE FLOPPY! ALL IN ALL, THE CATDISK IS SUPERB, AND HAS TAKEN 16 MONTHS OF DEVELOPMENT TO REACH THIS STAGE, SO YOU SHOULD GET A COPY TODAY, WITHOUT HESITATION. IT'S ALSO ONE OF THE VERY FEW CATDISKS AROUND TODAY THAT THE LISTINGS ARE IN ALPHABETICAL ORDER FOR EASE OF USE.

SO, WE HAVE AN ALL SINGING, ALL DANCING CATDISK TO SHOW OFF, AND RIGHTLY SO, BUT WHAT ABOUT THE LISTINGS OF TITLES IN OUR LIBRARY ON IT? IT HAS FULL DETAILS OF THE CONTENTS OF EVERY COLLECTION WE STOCK, YES, EVERY UTILITY ON EVERY FRED FISH DISK IS ON THERE (A MUCHO BIG TASK, SENOR!), EVERY GAME ON THE ASSASSIN'S DISKS IS LISTED, YOU DON'T MISS OUT ON ANYTHING! THE DESCRIPTIONS ARE TAKEN AFTER TESTING THE DISKS ON 4 DIFFERENT SET UPS, AND IT INCLUDES FULL COMPATIBILITY LISTINGS FOR EVERY ONE OF OUR 13000 TITLES. SO WHAT WE'RE TRYING TO SAY IS, WE'RE DEDICATED TO THE AMIGA, WE WORK VERY HARD TO PRODUCE SUCH A STAGGERING FEAT OF INFORMATION, AND WE WANT YOU TO SEE IT, SO IT'S ALSO EXTREMELY CHEAP. HOW CHEAP? NOT TELLING! NAAH, ONLY KIDDING, IF YOU WANT OUR LATEST DOUBLE DISK CATALOGUE, SEND JUST 3 FIRST CLASS STAMPS TO THE ADDRESS ABOVE, AND ALL WILL BE REVEALED WHEN THE LITTLE WHITE JIFFY FROM THE HALLOWED HALLS OF V12 COMES SAILING THROUGH YOUR DOOR!

AS THIS ADVERT WENT TO PRESS WE WERE FINDING OUT PRICES ON HARDWARE FOR SALE, IF YOU WANT ANYTHING, AND WANT IT CHEAP AND BRAND NEW WITH A FULL GUARANTEE, THEN GIVE US A RING FIRST, COS YOU MAY BE PAING WAY TOO MUCH ELSEWHERE. WE CAN GIVE FREE ADVICE WITH ANY SALE, AND ANY PD SOFTWARE THAT WILL ENHANCE YOUR BUY AS WELL, SO GIVE US A CALL ON 01507 450114 FOR A SUPERB DEAL ON ANYTHING FROM MOUSE MAT'S TO CD-RECORDERS.

NEW PACKS WE'VE PUT TOGETHER FOR YOU ARE THE FOLLOWING:

AMIGA: FROM BEGINNER TO WINNER (10) = 5.00 INCL P+P TEN DISKS OF TUTORIALS AND UTILITIES ON EVERYTHING, FROM WORKBENCH, TO PRINTING, ARTWORK, ANIMATING, MUSIC, INTERNET AND COMMS, RAYTRACING, YOU NAME IT, IT'S HERE.

PD GOLD VOL 1 + 2 (8) = 4.50 INCL P+P THE BEST GAMES AVAILABLE ON THE AMIGA PD SCENE, INCLUDES THE LEMMINGS CLONE, CHANEQUES, THE WORMS CLONE, MASH, A SUPER PLATFORMER CALLED NICKY 2, A BRILLIANT SHOOT EM UP CALLED MISSILES OVER XERION, THE BEST PD SHOOT EM UP EVER, DELUXE GALAGA V2.5, AND A SUPERB ROLE PLAYER, DUNGEONS OF AWALON 2. RECEIVED OVER 90% IN REVIEWS IN 4 MAGS, GAME OF THE MONTH IN 3 OF THEM!

MR MAISTRO MUSIC VOL 1 (10) = 5.00 INCL P+P CONTAINS THE BEST MUSIC PROGRAM IN PD, QUADRO COMPOSER V2.1, AND 6 DISKS OF MODULES, AS WELL AS 3 DISKS PACKED WITH A HUGE RANGE OF SAMPLES TO PLINK PLONK WITH!

AMIGA'S PINK PILL PACK (10) = 5.00 INCL P+P 10 DISKS OF SYSTEM CHECKERS AND ENHANCERS, VIRUS KILLERS, LATEST VERSION OF DISK SALLY AND VIRUS CHECKER, VIRUS WORKSHOP, MEMORY CHECKERS AND CLEARANCE, DEFRAGMENTERS FOR HD'S, HD INSTALL SET UP, EVERYTHING YOU NEED TO KEEP THE AMIGA HEALTHY! SPECIFY WHICH AMIGA.

PIXEL PERFECTION VOL 1 (10) = 5.50 INCL P+P A SUPERB GRAPHICS POACK, WITH ART UTILITIES GALORE, CONTAINS CONVERTERS, MANIPULATORS, RIPPERS, FULL PAINT PACKAGES, AND OVER 250 CLIPART IMAGES OF A VERY VARIED NATURE!

VIDEO MANIACS PACK 1 (12) = 6.00 INCL P+P A SUPERB PACK FOR VIDEO TITLING, DISK PRESENTATION OR INTROS, INCLUDES 3 DISKS OF UTILS FOR ANIMATING, TITLING, CONVERTING, ETC, AND 9 DISKS OF VIDEO TYPE FONTS, LARGE, BOLD, COLOURFUL, APPROX 500 IN ALL!

COMPUGRAPHIC FONT BACK 3 (15) = 7.00 INCL P+P APPROX 170 COMPUGRAPHIC RESCALABLE FONTS ON 15 DISKS, SUITABLE FOR WORDWORTH ETC, SUPERB QUALITY AND A GOOD PRICE, MISSUS!

GLAMOUR GIRLS 1 (12) = 6.00 INCL P+P [AGA] 12 DISKS OF AGA GIRLS, INCLUDING SOME FAMOUS NAMES, OVER 18'S ONLY! SUPERB QUALITY PICS!

ALSO AVAILABLE, BULK PD IN 500 PACKS FOR 120.00 AND 1000 PACKS FOR 200.00! WE WILL SELL IT CHEAPER THAN MR DIM ON THE DIMMEST DAY OF HIS DIM LIFE!

TO GET YOUR PACKS, SIMPLY WRITE THE NAMES DOWN ON A PIECE OF PAPER, AND SEND A CHEQUE FOR ANY YOU REQUIRE. THE CATDISK IS FREE WITH A PACK TO SAVE YOU EVEN MORE! CHEQUES AND POSTAL ORDERS ACCEPTED, AS WELL AS PHONE BANKING. FOR AN ORDER OVER THE PHONE, PLEASE HAVE YOUR CHEQUE BOOK READY FOR THE ACCOUNT NUMBER, VISA NOT REQUIRED, BUT A CHEQUE BOOK IS!

GREETINGS GO OUT TO DEAN KELLY OF MIDNIGHT EXPRESS BBS, ROB DAVAILL, STEFAN MANSIER OF HOLLAND, COCA COLA, FREAK OF NFA, MICHAEL CARTER, ROBERT WILKINS, NEIL PAINTER, AND A SPECIAL HI TOPHIL AT SADDLETRAMPS PD. IF THERE'S ANYONE ELSE THAT WANTS A GREETING, LET ME KNOW WHY YOU DESERVE ONE AND WE'LL PRINT THE BEST HERE EACH MONTH, NO, I AIN'T JOKING, GET YOUR NAME IN AN AMIGA MAG FOR THE FIRST TIME EVER!

## FLATBED SCANNING SERVICES

FLATBED SCANNING IS NOW AVAILABLE TO A PROFESSIONAL STANDARD, WITH DPI UPTO 2400 X 2400 DPI, EVERY FILE FORMAT FROM ILBM TO JPEG, AND EVERY RESOLUTION FROM LORES-NTSC TO SUPERHIRES-FULL OVERSCAN PAL AND CUSTOM RESOLUTIONS BEYOND THAT. WE OFFER THIS SERVICE OUT TO ANY PD COMPANY, OR ANY AMIGA BASED COMPANY AT DISCOUNT TRADE PRICES, AND ALSO TO ANY AMIGA OWNING INDIVIDUAL AT THE VERY LOW PRICES, RING US FOR DETAILS, WE ARE AT LEAST 3 TIMES CHEAPER THAN DEDICATED SCANNING BUREAUS. ANY AMIGA COMPANY WHO WISHES TO OFFER OUR SERVICE CAN ARRANGE AN AGREEMENT WITH US FOR SOME SERIOUS DISCOUNTS, SO MAKE THOS SCANNING DREAMS COME TRUE! REMEMBER ALSO, OUR DIGITIZING SERVICE, WHEN ALLIED WITH SCANNING, CAN OFFER COMPUTER REPRESENTATION OF ANY OBJECT, ANY PICTURE UP TO ABOUT 4 SQUARE METRES(!) WITH NO LOSS OF QUALITY. PLEASE RING FOR FURTHER DETAILS.

**We stock all the collections including Assassin's 1-250, Fred Fish 1-1000, Scope 1-220, Amigan, Arug, New Zealand, Imagine Object collection, Clipart collection, Barbie, Amos, Legal Tools 1-149 and thousands more. we now also sell CD's cheaper than everyone else, every Amiga CD available is, emm, available from us!**

**13000+ titles, that's more than a library with less than that!**



# PD Scene



A plethora of divine cheapness, in quality form, awaits you. Dave Cassidy takes a look at the holy world of new Public Domain software.



### On the CD

Check out the CD edition of this month's issue of CU Amiga Magazine for the best of this month's Public Domain, including the amazing Dataworld.

### Dataworld AGA demo

A storming 80Mbs of animation makes up this rather tasty demo. It was an entry in The Party 95 demo competition held in Denmark at the end of last year, where it won second prize in the Wild Demo section.

It's a series of expanded 3D animations with a techno soundtrack. Featuring abstract morphs, stomach-churning camera rolls and loads of lens flare it's quite a treat. As it's so big you won't find it listed in PD library catalogues and you're unlikely to want to spend all day downloading it from the net or a BBS. Here's the good news: it's on this month's cover CD! If you have the CD edition of this magazine you'll find it ready-to-run in the public domain section.

Once you've watched it through a few times you can try using the anim player (YP) from the shell to play the anims. Read the documents on the CD for details.

**Available from:** Our cover CD. Not available on floppy disk.



### Demo of the Month

### Hilt 2 game

Strategy games are rarely my favourites, but Hilt 2 really enveloped me. It's simple enough to get to grips with, you control up to six characters who must venture through various worlds in order to destroy the enemy. To do this you must solve puzzles and cunningly use your forces to out-wit your computer opponent. Each move consists of any combination of possible actions, such as walking, using computers, firing weapons and so on.

The range of possibilities within the game seems to be endless, and there's plenty of depth, especially with the prospect of extra mission disks becoming available. This is an extremely well executed game - as the polished graphics and sound testify - and fully deserves your attention.

**Available from:** 5th Dimension Licenseware, 1 Lower Mill Close, Goldthorpe, Rotherham, South Yorkshire S63 9BY. Tel/Fax: 01709 88812 7. Price: £3.95 including P+P.

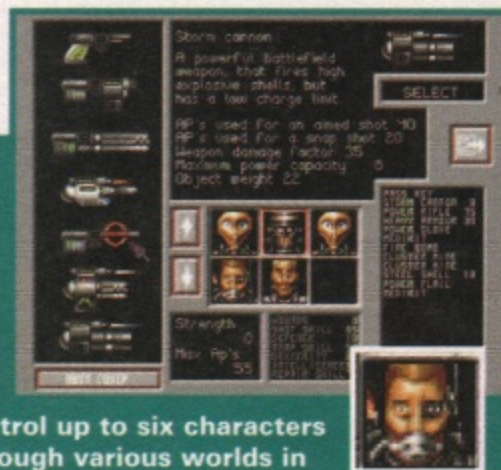

91%

### Blobble game

Simple gameplay is the key here. All you have to do is guide a spherical chap around tiled areas, collecting tokens, points and letter bonuses. Tiles with cracks in them make life complicated, as do tiles which allow movement in only one direction. The graphics and sound are of a fair standard and the controls are sensitive enough to keep you busy.

**Available from:** Freestyle PD, 108 Woodside Way, Short Heath, Willenhall, West Midlands WV12 5NH.

Tel: 01922 710985. Price: £1 plus 50p P+P.



84%



## Contentious game

This is one of those split screen two-player games where you have to find and kill the other player. The playing areas are fairly large, but because the maze is so big, finding your opponent becomes as much a game of luck as tactics. You need some breadcrumbs to hand so you can leave a trail. Failing that it's pure luck.

Contentious is two player only, which limits its appeal, but with a cool theme tune (that for the life of me I can't name) and a built-in level construction kit, there's loads of longevity for those with fellow death-wishers they'd care to share the fun with.

**Available from:** 5th Dimension Licenseware, 1 Lower Mill Close, Goldthorpe, Rotherham, South Yorkshire S63 9BY. Tel/Fax: 01709 88812 7. Price: £2.95 including P+P.

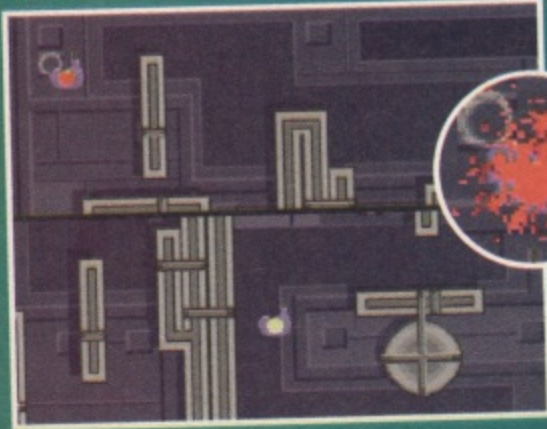

75%

## Bomb Mania game

This is an interesting twist on Dynablast, in which you have to kill all the nasties on the level and collect the goodies by laying bombs over the playing area whilst avoiding blowing yourself up! One or two players can participate in the various worlds, with custom worlds also promised shortly.

Bomb Mania is well worth a look if you're into simple concept games that offer innovative twists on tried and tested concepts.

**Available from:** Freestyle PD, 108 Woodside Way, Short Heath, Willenhall, West Midlands WV12 5NH. Tel: 01922 710985. Price: £1 plus 50p P+P.



85%

## Galerie AGA demo

The atmospheric music contributes a lot to Stellar's entry to The Party '95, with light-sourced terrain spins, including light flares taking the first honours. Concentric rings spin in multiple planes and then we're taken into warping tunnels and spinning vectors. It's fairly short, but well constructed overall, although very noticeable glitches can be seen occasionally.

**Available from:** Freestyle PD, 108 Woodside Way, Short Heath, Willenhall, West Midlands WV12 5NH. Tel: 01922 710985. Price: £1 plus 50p P+P. Requires hard drive and 2Mb Fast RAM.



80%

## Voyage In A Storm AGA demo

With four disks you'd expect something fairly brilliant and that's just about what you get in this production from Impulse. It kicks off with a zooming, rotating texture-mapped polygon which is smooth even on a fairly basic 030 system. The music grabs your attention and syncs in perfectly with a superbly smooth run down an alleyway with curved walls - not so easy to achieve. Complex realtime Gouraud effects follow, with some simply gorgeous still graphics and another amazing module featuring a melodic vocal track. A landscape flyover finishes the whole deal, so you can sit back and watch the usual scroller, catching your breath.

The Party 1995, held at Christmas, seems to have produced a fair selection of demos, and this is certainly one of the better ones. If you've got the hardware, check it out.

**Available from:** Freestyle PD, 108 Woodside Way, Short Heath, Willenhall, West Midlands WV12 5NH. Tel: 01922 710985. Price: £4 plus 50p P+P. Requires hard drive and 2Mb Fast RAM.



93%

## Crazy Sexy Cool AGA demo

Einstein's tongue kicks off this Essence production and the superb quality of the graphics shown here is maintained throughout. A laid back acid jazz/trip hop concoction keeps the action shuffling along at a steady pace, as effects such as texture-mapped polygons, Gouraud-shaded torts with phong twists and light-sourced animated polygons sweep across the screen. It doesn't smack you between the eyes but takes you on a relaxing journey through some of the better code currently doing the rounds.

**Available from:** Freestyle PD, 108 Woodside Way, Short Heath, Willenhall, West Midlands WV12 5NH. Tel: 01922 710985. Price: £1 plus

50p P+P. Requires hard drive and 2Mb Fast RAM.

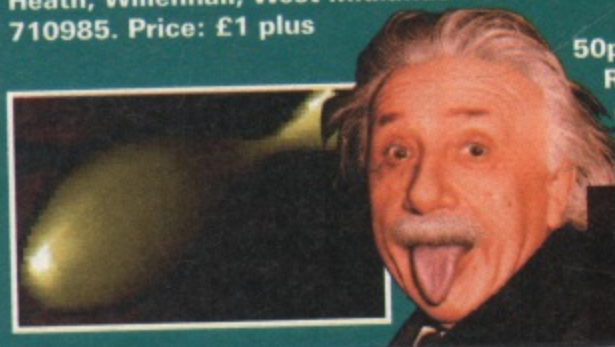

81%



# United Public Domain Distributors

Save **£2.50** On PD purchases over £10 with this voucher

For example: 10 x PD inc postage, normal price: £10.50. With voucher price Only £8.00 inc. Discount must be claimed with your order! Please cut out and include, or send a copy, or even a drawing we don't mind! Phoning in your order? No problem simply claim the discount when ordering.

**HARD DRIVE UTILITIES**  
 PU 686 HD GAMES INSTALLER Installs: Aladdin AGA, Alien Breed 2 AGA, Jungle Strike, MK2, and more  
 PU 772 HD GAMES INSTALLER 3 Inc: Steel Sky Flashback, Sensi Soccer, Skidmarks 2, and more.  
 PU 898 HD GAMES INSTALLER 4 Arcade Pool Assassin, Dizzy, KO3 (AGA) Zool (AGA) and more  
 PU 917 LEMMINGS to HD, SETTLERS EDITOR Backup, fix, etc  
 PU 064 HARD DRIVE UTILITIES Backup, fix, etc  
 PU 548 REORG V3.11 Disk organiser/optimizer  
 PU 574 DISK SALVAGE v211.3 Recover old files  
 PU 576 HD CLICK v2.7 Menu system for HD  
 PU 721 EPU STACKER v1.70 Increase HD storage  
 PU 668 SECURITY v3.71 Protect your HD  
 PU 425 MAGIC WORKBENCH Attractive WB  
 PU 536 M/W EXTRAS PU 704 M/W EXPANSION  
 PU 824 R. McVEY ICONS Fab 16 col icons for above  
 PU 835/56 MAGIC WORKBENCH EXTRAS Vols 1-12 Lots of fab icons, etc for Magic Workbench! (24 disks!)  
 PU 859 MAGIC SELECTOR Random set-up MWB  
 PU 890 MR BACKUP PROFESSIONAL V2.1  
 PU 828 MAGIC USER INTERFACE v2.3 (MUI)  
 PU 871 ASSIGN MANAGER Help with those assigns  
 PU 901/2 MAGIC TREK (2) Lots of Startrek backdrops  
 PU 933 DATATYPES Loads of datatypes

**GENERAL UTILITIES**  
 PU 172 WORDPOWER Solves anagrams crosswords etc  
 PU 204 GATORS TUTORIAL Super D'Paint hints and tips  
 PU 207 SID2 + MULTIDOS Transfer files, Amiga and PC  
 PU 230 PRINTER DRIVERS Inc Seikosha, Star, & Citizen  
 PU 293-317 HAM RADIO SET 25 disks for only £15.00  
 PU 367 ESSENTIAL PRINTING UTILS Banners, labels, etc  
 PU 697 TUDE The ultimate degrader and enhancer disk  
 PU 683 CAPTIONATOR v2.0 TV titler, New fs, fonts, etc  
 PU 659 SCION v3.13 Genealogy program  
 PU 728 ICONTOOLBOX v2.12 Icon creation utility disk  
 PU 761 MAGIC WORKBENCH 1.3 Now for 1.3 (HD)  
 PU 762 PC TASK v3.10 Latest version of this PC emulator  
 PU 769/71 MAGIC EYE (3) Make your own magic stereograms  
 PU 776/7 INTERNET ARCHIVE (2) Programs for Internet  
 PU 778 INTERNET UTILS 2 More useful programs  
 PU 799/801 TERM V4.3 (3) Comms program  
 PU 821 GENTREE v1.5 A new genealogy program  
 PU 822/3 GRAPHICS CONVERTORS (2) Many are archived  
 PU 828 MAGIC USER INTERFACE v2.3 (MUI)  
 PU 860 PROTTTLER V2 Useful video titler program

PU 874 BLITZBLANKER V2.5 Very nice screenblanker  
 PU 897 MAGNIFICAD CAD package  
 PU 924 MORSE CODE TUTOR v1.2 Learn morse code  
 PU 927 EFF INTERNET GUIDE Beginners guide to the net

**BUSINESS**  
 PB 019 BUSINESS LETTERS Examples of tricky letters.  
 PB 020 TEXT ENGINE 4.1 Possibly the best 'PD' Wordpro.  
 PB 025 FORMS UNLIMITED Nice program to create Forms  
 PB 030 THE MONEY PROGRAM Attractive budget prog  
 PB 038 BUDDBASE Good database. Great docs for beginner  
 PB 046 PERSONAL DIARY Simple electronic diary  
 PB 054 ACCOUNT MASTER Integrated home finance pack  
 PB 074 REMDATE v2 Address & phone, Calendar, etc  
 PB 075 INVOICER v2.1 Creates invoice from database  
 PB 078 TEXTPLUS v5 Archived for the Hard drive  
 PB 079 PHONE LOCATOR Find the area of any phone  
 PB 088 EASYCALC v2b Good spreadsheet. Latest version

**EDUCATION**  
 PE 007/8 LEARN & PLAY (2) Word/number games for ages 5-10  
 PE 027 AMIGA BEGINNER Help and info on the Amiga  
 PE 035 KIDS DISK 1 Alphabet & Colours, for pre-school  
 PE 053 HIGHWAY CODE Helps you to pass your test  
 PE 054 ARTISTIX Super art package for kids  
 PE 058 WORD FACTORY Brilliant spelling program  
 PE 077 GCSE MATHS Several lessons and questions  
 PE 109 SPELLTRIS (n1.3) Educational Tetris Game  
 PE 110/1 TREK GUIDE Loads of StarTrek info in Hyperbook  
 PE 135 BEGINNERS GUIDE TO WORKBENCH 3 Tutor  
 PE 136 DPAINT GUIDE Deluxe Paint 4 hints and tips  
 PE 142 KIDS DISK 7 Puzzles for the young on holiday theme  
 PE 155 BEGINNERS TYPING DISK Typing exercises  
 PE 157 NIGHT SKY Brill map of the sky. Names the stars!

**GAMES**  
 PG 124 TOTAL WAR A good game of RISK on the Amiga  
 PG 255 KINGDOM AT WAR Battle with knights to rule land  
 PG 260/1 18th HOLE GOLF Nice graphics, good golf game  
 PG 314/5 MR MEN OLYMPICS (2) Frantic joystick waggler  
 PG 319 PROFESSIONAL BINGO Prints cards, calls numbers  
 PG 325 MEGABALL 3 AGA Best PD Breakout  
 PG 345 SICKBALL II Its the freestrik ping pong game ever!  
 PG 326 DART'S GAME Nice darts game written with Amos  
 PG 333 ICERUNNER (Disable CPU A1200) Like LoadRunner.  
 PG 334 GORF Invaders & Galaxians. Copy of the arcade  
 PG 344 EXCELLENT CARDS Includes 4 patience games  
 PG 383 ZOMBIE APOCALYPSE 2 (AGA) Brilliant & gory  
 PG 399 BACMAN AGA Very Good AGA Pacman

PG 401/2 STARWOIDS (2) Wow! Skillful moonlander/gravity game  
 PG 404/5 WRESTLING (2) Brill sound fx and action packed  
 PG 464 DANGER MOUSE A DM 'Hunchback' game  
 PG 467/8 CYBERTECH AGA Very impressive like Alien Breed  
 PG 486 DYNAMITE WARRIORS 2 Very good Dynablasters  
 PG 489 SUPERMEGA FRUITS A brill fruit machine  
 PG 506 XENEX Its like Asteroids but a little special  
 PG 508 ULTIMATE QUIZ Quiz. More questions available  
 PG 514 DELUXE GALAGA v2.4 Brilliant SEU. classic game  
 PG 530/1 CHANEQUES Super Lemmings clone. GET IT, (2)  
 PG 533 INDYCAR CHALLENGE (n1.3) Racing management  
 PG 534 ASI XMAS SPECIAL 2 excellent platformers  
 PG 565 APPLEJACK Its Mr Do, almost exact copy. Excellent  
 PG 576 POKERMANIA Superb poker machine with extras  
 PG 596 JET SET WILLY 3 (AGA) Super typical Spectrum  
 PG 600/1 SKIDMARKS CARS (aga) 4 New skiddy cars  
 PG 619 RASH PANIC Just like the old arcade Space Panic  
 PG 620 DERRING DO Best Mr Do clone so far  
 PG 624/7 CHILD MURDERER (AGA) Text+graphic adventure  
 PG 648 EXCELLENT CARD GAMES III (AGA) Great  
 PG 650 DELUXE PACMAN (AGA) Excellent Pacman!  
 PG 682 FRIDAY NIGHT POOL A great pool simulator  
 PG 683/4 DATAFORM (2) Nice graphical adventure game  
 PG 689 MORTAL KUMQUAT 3 (n1.3) Great Beat em up  
 PG 690 MANGLED FENDERS Stock car racing  
 PG 691 MASTERBLASTER 2 Best Dynablasters?  
 PG 700 DELUXE GALAGA v2.6 (n1.3) Super classic shoot up

**MUSIC UTILITIES**  
 PT 093 OCTOMED TUTOR A simple to follow tutor  
 PT 174 OCTAMED V4 Music package. Latest PD version  
 PT 178 OCTAMED 6 DEMO Latest version. Demo  
 PT 229/30 XMAS MODULES Lots of Christmas tunes

**LOTTERY PROGRAMS**  
 PU 756 BALLS (AGA) Most & least popular. Keeps track ton  
 PU 757 NATIONAL LOTTERY (Liberty Software) Shareware, scientific picker, powerful user editing system  
 PU 758 PRO LOTTERY (Shareware) Pick random numbers, Also includes interesting 'random' vs 'average' info  
 PU 775 LOTTO LUNACY Best pure PD lottery available?  
 PU 899 SUPER LOTTERY Yet another good lottery predictor  
 PU 935 LOTTERY PRO And another. Look good too

**FONTS FOR WORDWRITH**  
 Compographic font disks which can be used with Wordworth, Professional Page, and Page Setter. There are an average of 16 fonts per disk, and 33 disks in all. Available separately at normal PD price or why not get the full set for just... £24.99

**HORIZON SOFTWARE**  
 TOUCH TYPING TUTOR Best tutor around £3.50  
 A-CHORD Guitar chord tutor £3.50  
 FAST FRET Speed your fingers. Various scales £3.50  
 DRAGON TILES Brill Shanghai/Majong game £3.50  
 WINNING POST Horse racing inc commentary! £3.50  
 LETS LEARN 2 Educational games pack £3.50

**UPD COLLECTION ON CD**  
 Back in stock, complete UPD library on 4 CDs. All disks stored in DMS format. A complete library for only £25.99

**ASI GAME COMPILATIONS**  
 The best selection of PD games ever. A list of the very best.  
 PLEASE NOTE: The odd game will not work on certain Amigas  
 ASI 14 China Challenge, Columns  
 ASI 27 Assorted card games  
 ASI 36 Wonderland, Donkey Kong  
 ASI 46 Checkers, Ouch!, City, Amiga Q  
 ASI 60 PipeMaster, Hunter, Chinese Checkers  
 ASI 65 Paranoids, Chess, Word Puzzles  
 ASI 70 Wangle & the best Tetris  
 ASI 71 Numerix, Battleships  
 ASI 89 Megaball 2.1, Chuedo  
 ASI 96 Dungeon Flipper, Backgammon  
 ASI 158 Scrabble, Toad, VChess2  
 ASI 168 Dyna-Warriors, Ludo  
 SPECIAL Any 6 of the above... £5.00  
 OFFER All 12 of the above... £8.00

**ORDERING DETAILS**  
 Send your order plus your name, address, (BLOCK CAPITALS PLEASE!) and a cheque or P/O to either of the PD libraries in this advert. Cheques should be made out to that company. For super fast results you may phone in your order with your ACCESS or VISA card number. Delivery should be NEXT DAY!  
 PD PRICES All PD now only £1.00 (minimum order £2.00 inc postage)  
 POSTAGE Please add 50p to the total price, to cover postage and packing (UK only)  
 OVERSEAS ORDERS WELCOME  
 EU: Add 25p per disk post. World: 50p per disk.

**LAST MINUTE BARGAIN**  
 A500 or A600 (State which) dust covers only 99p

## CATALOGUE

Our PD collection is now HUGE!! For a full catalogue just send 3 x 25p stamps. Includes a full list of Education, Demos, Utilities, Music Utilities, Business, Animations, Demos, Games, Assassins Games Compilations, Music, Fonts, Business, Clipart, Education, & more!

## NEW OWNERS PACK Only £5.00 inc

Compiled for the new Amiga owner or anyone wanting to discover the wonderful world of Amiga PD Pack contains: Word processor, Database, Virus Killers, Disk Copier, Selection of great games, A stunning demo Plus our latest catalogue (8 Disks) (Please state Amiga model)

**NBS PD**  
 132 GUNVILLE ROAD  
 NEWPORT, IOW  
 PO30 5LH  
 TEL 01 983 529 594  
 FAX 01 983 821 599

**BLITTERCHIPS PD**  
 CLIFFE HOUSE, PRIMROSE ST.  
 KEIGHLEY  
 BD21 4NN  
 TEL 01 535 667 469  
 FAX 01 535 667 469

## FLEXIDUMP 3

NO MORE BANDING  
 NO MORE WHITE LINES  
 COLOUR GRAPHICS LIKE  
 YOUVE NEVER SEEN BEFORE

Yes its true the new flexi 3 will remove banding & white lines from dot matrix & bubblejet printers  
 Now you can have laser quality on dot matrix printers.

Other new features include:-

- \*Balance control for picture enhancement \*
- Select area to be printed\* Select size to be printed \*
- Page Control\* Colour Seive \* InkCorrection \*
- Automatic poster mode for larger than A4 \*
- Gamma correction \* Spooler for colour letter heads etc \*
- Colour separation \* Now with Anti-Aliasing to get rid of jagged edges \*
- Large range of dithering (dot pattern) \*
- Variable levels of shingling to totally remove banding/white lines.\* Colour catalogue function will print a miniature of each picture. Configurable between 1 to 8 across. \* Star, Citizen, Panasonic, NEC, Epson, Cannon, Hewlett Packard and just about any dot matrix or inkjet bubblejet/Laserjet printer.

ONLY £39.95 CARE SPECIAL £29.95  
 UPGRADE FLEXIDUMP TO FLEXIDUMP 3,  
 ONLY £14.95 INC. RETURN MASTER DISK

How to order: Enclose cheques/PO made payable to: CARE PRODUCTS or use Access/Visa

## CARE PRODUCTS

Dept CUA, 15 Holland Gardens, Garston, Watford, Herts WD2 6JN Fax 01923 672102

ORDER LINE ON 01923 894 064

ALL PRICES INCLUDE VAT AND CARRIAGE

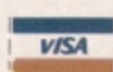

## COLOUR PRINTER RIBBONS

Just take the top off, take out the old ribbon and reload it with a new one. Full instructions supplied.

	Complete Ribbon	One Reload	Five Reloads
Citizen Swift/ABC/224	£11.95	£6.99	£29.95
Panasonic KXP2123/2124/2180	£9.99	£6.99	£29.95
Panasonic KXP2135	£9.99	£6.99	£29.95
Star LC200 9 Pin	£9.64	£5.99	£23.95
Star LC24-10/20/200	£9.64	£6.99	£29.95
Seikosha SL95	£14.95	£6.99	£29.95
Star LC24-30/LC240	£8.99	£4.95	£19.99

## INKJET REFILLS

For HP DESKJET 500,510,520,550,500C,500C,550C,560C  
 EPSON STYLUS 800,1000, CANNON BUBBLEJET, BC-01, BJ105/EX/SX, BC02, BJ200, BJ130, BJ300, BJ330  
 OLIVETTI JP150,250,330, CITIZEN PROJECT  
 6 Refill Kit 120ml pure black .....£16.99  
 CANNON BJC 600, BJC4000 .....£16.99  
 20 Refill Kit 120ml pure black .....£16.99  
 EPSON STYLUS four refills 120ml pure black .....£16.99  
 TRICOLOUR REFILL KITS FOR: HP DESKJET RANGE, CANON BJC600, BJC4000 etc 10 Refills of Yellow, Magenta & Cyan 180ml .....£24.99  
 EPSON STYLUS TRICOLOUR refill, 4 refills of Yellow, Magenta & Cyan 180ml .....£24.99  
 Print Head Recovery Fluid for unblocking nozzles .....£5.95

Important: Please state type when ordering.

## SPECIAL RE-INK

For Panasonic 1080/81, 1124, 1180, 2123, 2135, Star LC200 9 Pin, Epson LQ100, Oki 182/390. Black bottle will re-ink 100+ ribbons ..... £9.95

## BLACK PRINTER RIBBONS

Just take the top off, take out the old ribbon and reload it with a new one.

Citizen Swift/ABC/120D 5 black reloads ..... £9.99
Star LC10/20/100 5 black reloads ..... £4.99
Star LC24 Range 5 black reloads ..... £9.99
Seikosha 1900/2400/SL95/96 5 black reloads ..... £9.99
Epson FX80/LQ800 Range 5 black reloads ..... £11.99
Star LC24-30/LC240 5 black reloads ..... £14.99

## T-SHIRT PRINTING RIBBONS

PRINT ON NORMAL PAPER IRON ON T-SHIRT

4 Colour Citizen Swift/ABC/240 ..... £19.99
4 Colour Citizen Swift (Reload) ..... £9.99
4 Colour Star LC10 ..... £10.99
4 Colour Star LC200 9 Pin ..... £12.99
4 Colour Star LC200 9 Pin (Reload) ..... £7.99
4 Colour Star LC200 24 Pin ..... £19.99
4 Colour Star 24 Pin (Reload) ..... £9.99
1 Colour Star LC10 ..... £9.99
1 Colour Star LC200 9 Pin ..... £9.99
1 Colour all Star 24 Pin ..... £9.99
1 Colour Epson FX80/LQ400/MX80 ..... £9.99
1 Colour Epson LX80 ..... £9.99
1 Colour Panasonic KXP 1080 ..... £9.99

Wide range of other ribbons available.

## COLOUR KITS FOR MONO PRINTERS

Ever wished you'd bought a colour printer instead of a mono one? Wouldn't it be nice to print out pictures in colour? Now you can with Amiga "Flexicolor Kit". Each Amiga Flexicolor Kit comes complete with everything you need to print in colour, including superb software. The colour kit is simple to use, the ribbons fit exactly the same way as your black ribbons so it will not affect your guarantee. Also on all models listed below paper alignment is automatic, you do not have to manually align. PRINTS AS GOOD AS COLOUR PRINTER. If your printer is not listed below please phone. Amiga Flexicolor kits for Star LC10, LC20, all Star 24 Pin Panasonic 1080/81/1123/1124, Epson FX80, LQ800 etc. Citizen 120D+, NEC P6, P6+. Please note colour kits come complete with coloured ribbons. (Anti Banding now included in software) COMPLETE KIT £39.95



# EPIC MARKETING

## CD ROM SOFTWARE



Emulators Unlimited contains Software emulation tools for the Amiga & PC. Spread over the two platforms are emulators for: Apple, BBC, Commodore 64, Commodore VIC20, Amstrad CPC, Apple Mac, Gameboy, Atari ST, MSX, Apple200, Atari 800, Atari1040ste, Sinclair QL, Unix and more. Also features hundreds of games, tools etc for most of the emulators.

**EMULATORS UNLIMITED** (CD117) £19.99



Sound FX Sensation is an original new CD that contains hundreds of megabytes of high quality samples. A superb CD for game makers, demo makers, or even film makers. Hundreds of Sound FX subjects include Animals, Wild life, Nature, Explosions, Creatures, Scary stuff, Science fiction samples, House hold noises, car crashes, and hundreds more.

Suitable for use on any Amiga configuration. Available April / May 1996

**SOUND FX SENSATION** (CD165) pre-order price £14.99



Adult Sensation is possibly the Amiga's largest selling adult title. It features over 4,000 high quality 256 colour images of the "adult" nature. Image viewers and converters are included for every configuration of Amiga. (OVER 18 ONLY)

**ADULT SENSATION** (CD001) £19.99



Adult Sensation 2 not only contains 4,000 new colour images but also includes tons of adult related samples, adult music modules, tons of adult stories, adult animations, black&white 70's photos, adult games and more. (OVER 18)

**ADULT SENSATION 2** The new batch (CD115) £19.99



Available now, this CD contains around 2,000 especially chosen high quality GIF Images. Viewers & graphic converters are included for easy and quick access to any of the pictures on any Amiga. (OVER 18 ONLY)

**SEXY SENSATIONS** (CD169) £19.99



This CD actually contains over 2,000 true 3 Dimensional colour images. 3D viewing software and top quality 3D glasses are also supplied. Includes superb new Multimedia interface. Available Now!

**ADULT SENSATION 3D** EXCLUSIVE! (CD145) £19.99

Special.... Adult Sensation 1&2... just £29.99. order CD180  
Coming Soon.... Adult Animations, (AS4)



World of Clipart is a double CD-ROM containing around 40,000 mono and colour clipart images contained in over 100 categories in IFF, GIF, PCX, CDR, EPS, TIF, & BMP. Tools for converting images to another format are included for both the PC & Amiga. Subjects include:

- Animals, Anatomy, Babies, Men, Women, Trees, Reptiles, Insects, Xmas, Religious, Planes, Vehicles, Ships, Toys, Zodiac signs, Eye catchers, Humour, Cats, Dogs, Computers, Technology, Sealife, Space, Symbols, Royalty, Dinosaurs, Plants, Nature, Ads, Tools, Astrology, Hands, Birds, Business, Office, Workers, Cartoon, Lion King, Education, Food, Gardening, Holidays, Houses & Buildings, Helicopters, Children, Banners, Medieval, Military, Monsters, Music, Sports, Transport, Trains, War and more.

Rated 94%

**WORLD OF CLIPART Plus** DOUBLE CD (CD77) £17.99



This CD contains information that NOBODY wants you to know about, and includes tons of megabytes of text documents and photographs relating to UFO sightings and abductions etc since 1941 as well as hundreds for "classified" documents.

**ENCOUNTERS** Rated 91% (CD179) £14.99



This NEW CD rom contains Thousands of all-time classic Commodore 64 games and emulator to run them.... Available shortly. Order now as stocks are bound to go quickly.

**C64 GAMES CD** (CD182) £29.99



SCI-Fi Sensation is an exciting new CD-ROM containing over 1.3GIG of SCI-FI images, animations, 3D objects, Sound FX, Documents, Themetunes, Scripts & SCI-FI games. Subjects included are: Babylon5, Startrek (The original, TNG, Deep Space 9 and Voyager), Batman, Dr Who, Thunderbirds, Robocop, Sea Quest DSV, Bladerunner, Aliens, Terror hawks, 2001. Blake7, Battlestar Galactica, Tron, Total Recall, 2010, Space 1999 etc.

\*Buy SCI-Fi Sensation from us and you are guaranteed to always receive the latest version. CU Amiga: 91% AU: 93%

**SCI-FI SENSATION v2** DOUBLE CD (CD118) £19.99



CHOOSE ONE OF THE FOLLOWING CDROM TITLES FREE! WITH ALL ORDERS OVER 25.00

**FREE**

- FCD54. ILLUSIONS 3D
- FCD74. ESSENTIAL UTILITES
- FCD12. HOTTEST 4
- FCD47. PRO FONTS & CLIPART
- FCD163. LUCKY DIP VOLUME TWO
- FCD181. TERRA SOUND LIBRARY

**FREE PHONE 0500 ONE FREE ONE 486**  
At the time of ordering please request your free CD preference.



If your into Horror then this original CD ROM will please you no end. It contains Thousands of gruesome images, tons of gory animations. Bloody games. Spine tingling horror type sounds, Horror stories, Eariee music modules. Pictures & animations from hundreds of horror films and heaps of real-life blood'n'guts. (Adults only)

**HORROR SENSATION** NEW (CD144) £19.99



John Paternak's "Movie Maker" series takes you step by step through the professional techniques of Special FX, Horror and Action film making. Explained in every detail are all the camera angles, editing techniques, prop building, make up etc, all using easily available domestic equipment and materials. This Multi-media AGA Amiga title Contains video footage, stills and around 60minutes of audio.

**MOVIE MAKER SERIES** (CD184) Special £29.99



Actual Amiga Screen shots

**SPECIAL FX Vol:1 CD**

John Paternak's "Movie Maker" series takes you step by step through the professional techniques of Special FX, Horror and Action film making. Explained in every detail are all the camera angles, editing techniques, prop building, make up etc, all using easily available domestic equipment and materials. This Multi-media AGA Amiga title Contains video footage, stills and around 60minutes of audio.

**NEW**



Arcade Classics is an original collection of ALL your old arcade favourites, Including Amiga & PC veriations of: PACMAN, SPACE INVADERS, ASTERIODS, MISSILE COMMAND, PENGO, FROGGER, LOAD RUNNER, GALAXIANS, DONKEY KONG, NUMEROUS TETRIS GAMES, BATTLE-ZONE, TEMPEST, COMBAT, TRON, SPACE WARZ, THRUST, Q-BERT, HUNCHBACK, MOON PATROL, TRAIL BLAZER, BREAKOUT, CENTREPEDE, CYCLES, BEZERK, SNAKE, SCRAMBLE, PING PONG, BREAKOUT, NUMEROUS C64 CONVERSIONS, A COLLECTION OF JEFF MINTER GAMES AND HUNDREDS MORE. Over 600mb of unforgettable retro-gaming. Keyboard recommended.

**ARCADE CLASSICS** Rated 87% AC (CD76) Now £14.99



Contains our most popular floppy based software titles on one giant CD-ROM. Now you can purchase the entire Epic collection in one go. This compilation contains hundreds of megabytes of Amiga software. subjects include: Professional mono clipart, colour clipart, numerous 3D objects for Imagine & Lightwave, Colour, Bitmap, Compugraphic fonts & Adobe fonts, Graphics converters, Music tutorials, Beginners guide, 3D stereogram generators, Hundreds of Sound FX and samples, Virus Killers, Hard disk installer & tools, Various Hardware projects, Hundreds of games including Mind teasers, Puzzle, card, arcade and board games and more.\*Supplied with Index book.

**THE EPIC COLLECTION v2** NEW!!! (CD100X) £19.99



Retro gaming at it's best. Around 3000 all-time classic spectrum game files on one CD-ROM. Emulators included for any Amiga.. Games include Manic Miner, Skool daze, Monty mole, Startrek, Thrust, Jet Set Willy, The Hobbit, Strip Poker, Danger Mouse, The Sentinel, Micro Olympics, Under Wurld, Uridium, Atic Atac, River raid, Barbarian, Hunchback and around 3000 other classic spectrum game files including multi-load games. Speccy '96 also contains hundreds of documents containing instructions for most games aswell as hundreds of speccy game cheats. Okay with any CDROM drive connected to an Amiga.

Rated: AF GOLD 95% - CUAMIGA 91% - AUI Over 90% - AC over 90%

**SPECCY SENSATION '96** (CD119) £17.99



The largest collection of Magic Workbench Icons, Backdrops and tools ever compiled. Includes well over 5,000 Icons, Over 600 selected Magic WB backdrops, and megabytes of WB desktop enhancer tools/utilities. Suitable for any Kickstart2/3 based Amiga.

**MAGIC WORKBENCH ENHANCER** (CD152) £9.99



Over 7000 royalty free colour images. Subjects include: cats, aviation, animals, people, hi-tech, space, cars, trains, textures, nature, sports, pinups (18), boats, flowers, plants, seasons, birds, technology, raytraced, cartoons, fantasy, art, reptiles etc, etc.

**GIF SENSATION** DOUBLE CD (CD128) £24.99



This CD contains almost 100 variations of the worlds most addictive and loved game. Nearly all the games are ready to run directly from CD, and archived versions are also included.

**NOTHING BUT TETRIS** (CD148) £9.99



Lucky Dip volume 2 contains stacks of games, demos, clipart, fonts, music, tools, graphics utilities, Animations, Sound FX, Samples, and loads more. (now with Amiga front end) A bargain!

**LUCKY DIP Volume 2** (CD163) £5.99

**UK FREE PHONE Order line:**  
**0500 131 486**

Overseas Order / Enquiry line. 01793 514188 Fax: 01793 514187

UK & EUROPE Open Monday-Saturday, EPIC - 138-139 Victoria Rd, Swindon, Wilts. UK  
P&P in UK = £1 per title, Overseas P&P = £2 per title, E&OE

**EPIC MARKETING (AUSTRALIA)**

If you live in Australia or New-Zealand you can now purchase any of the above CD ROM titles from our Sydney based premises. Send your orders or enquiries to:

**EPIC. 36 Forest Road, Heathcote, NSW. 2233. Australia.**

Please make cheques payable to EPIC MARKETING

For a Price list please send a SAE. For prices in Australia \$99 simply double the UK £99 prices listed.

**PRIORITY ORDER FORM**

NAME \_\_\_\_\_

ADDRESS \_\_\_\_\_

MACHINE \_\_\_\_\_

PAYMENT METHOD \_\_\_\_\_

CREDIT CARD DETAILS \_\_\_\_\_

EXP DATE \_\_\_\_\_ CD-CU1.qxd

PLEASE SUPPLY PRICES INC VAT		
ITEMS	QTY	£££
TOTAL GOODS VALUE		£
POST & PACKING		£
AMOUNT ENCLOSED		£



# PD Utilities



Tony Horgan rummages through his Public Domain mail bag and pulls out a selection of weird and wonderful utilities for you to take your pick from. Footy, cookery, music, it's all here.



## DMC disk mag creator

Nothing to do with the Disco Mixing Club, this DMC stands for Disk Magazine Creator and is designed to help you build your own floppy publications. I was expecting DMC to consist of a main editor/construction program from which you would collate and combine the various pages but it's not really that kind of a system. All of your pages must be written in a text editor and coded by hand to indicate font colours and so. Similarly, the article lists for the index pages must be coded from within your text editor with directions to further text and IFF graphics files. For example, the colour palette is defined by a list of six three figure hex values that must be entered into one of the configuration text files, eg. 5A2, 0FB, 19E, CCA, B15, 234. Simple eh? Yeah, right!

You can also use your own graphics for the control panel. When you've arranged all of your files on the disk and named them correctly, DMC will load them automatically when it is launched. Files compressed with CrunchMania are automatically decompressed.

There's no place for confusing formatting codes in an authoring package. They are fine as an optional extra but this should be handled by an editor program with a graphical front end, complete with buttons and menus for defining links, text styles and so on. Across between Scala and a DTP package is what's required. However, DMC will find its takers, and some will no doubt put it to use and produce fully-fledged publications, but don't expect too much.



### DMC GOLD RELEASE INTRODUCTION

- READ ME FIRST - VERY IMPORTANT
- THESE OPERATIONS
- ABOUT DMC
- INSTALLATION
- FORMS TO USE
- IMPORTANT ADDRESS NOTICE
- SOURCE CODE OFFER
- USE TO CHECK PROGRESS

Available from:  
F1 Licenceware,  
31 Wellington  
Road, Exeter,  
Devon EX2 9DU.  
Tel: 01392 493  
580. Price: £6.99  
plus 50p P+P.

55%

## World of Football Icons

### AGA icon pack

Football crazy, football mad? If so, you'll probably jump at the chance to plaster your Workbench with this set of footy-themed icons.

Every team from the English League is included, from the Third Division up to the Premiership. There are pictures of the teams' shirts, complete with the sponsorship logos. You also get foreign club teams and the world's national teams. There's an extra section called Football By Another

Name, which has similar icons for rugby and American football teams. The series, includes icons based on Star Trek, sci-fi, sports, glamour and other subjects.

Available from: TMC,  
22 Warrender  
Crescent, Dunbar, East  
Lothian  
EH42 1LU.  
Price: £1  
including  
P+P.



81%

## Steve Headroom talking head

Here's a strange one. Steve Headroom isn't really a utility but it's quite interesting all the same. Steve is a character who bears a strong resemblance to Max Headroom, right down to the weird scrolling backdrops. He's been programmed with a vocabulary of digitised words, from which he constructs random sentences that still make some kind of sense.

What's the point? There isn't one, apart from to keep you entertained at times of boredom, or perhaps to comfort lonely Amiga users. I like it anyway, even if the deadpan intonation of the voice starts to grate after the first 30 seconds.

Available from: 17 Bit Software, 1st  
Floor Offices, 2/8 Market Street,  
Wakefield, West Yorkshire WF1 1DH.  
Tel: 01924 366982. Requires 2Mb Chip  
RAM. Price: £2.00 plus 50 P+P.

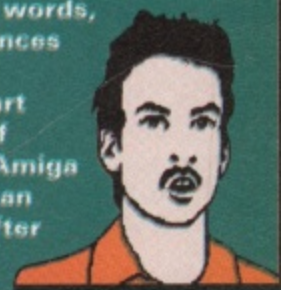

80%



## Granny's Cookbook 1 recipe book

If you happen to have your Amiga set up in the kitchen, a recipe book might come in handy, you never know.

Granny's Cookbook Volume 1 has suggestions for ten varieties of home-made biscuits, presented as a slideshow of IFF screens. Highlights include chocolate chip cookies, Dutch kisses and coconut cookies. Give it a shot if you're bored of those old fashioned paper cookbooks.

**Available from:** Classic Amiga PD, 11 Deansgate, Radcliffe, Manchester M26 9YJ. Tel: 0161 723 1638.

Price: £2.00 including P+P.



*Is this mouthwatering good  
You'll hear you say!*

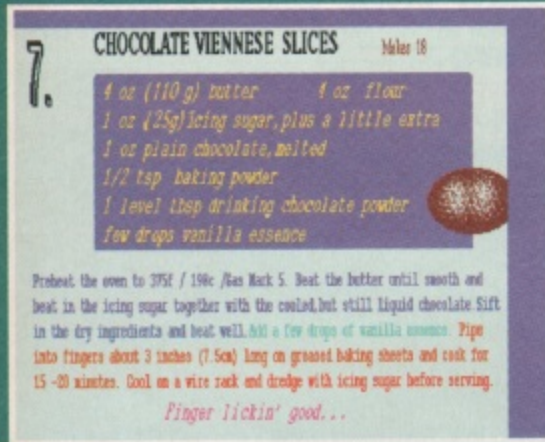

*Finger lickin' good...*



78%

## The Hit Kit 2 sound tools

Maybe this should be renamed The Hit and Miss Kit (boom boom!). It's a collection of sound utilities, as follows. PlayMod is a ProTracker module player that's useful due to its low memory overheads. Interplay 4 is a CD player with a few handy buttons and functions. VSound is a crude oscilloscope that can run in a Workbench window or on its own screen. PWSInfo is a system information diagnostic tool.

JustPlay is another small module player. SNED allows you to edit the instrument names of a module. MIDIPlay refused to work from the disk, but I presume it plays MIDI files when it works. MusicDots is a little AMOS program which creates 'music' (random ping sounds) as little dots bounce around the screen. Multisample is a handy if limited sample conversion tool. Mod2Smp converts modules to samples (in theory, but it didn't work with any I tried, not helped by the lack of docs). APercKey is a potentially useful sample triggering device that desperately needs a graphic interface (at the moment it requires the user to enter a long winded config file in order to get any sound at all).

So there you have it. If anything tickles your fancy you now know where to get it.

**Available from:** Roberta Smith DTP, 190 Falloden Way, Hampstead Garden Suburb, London NW11 6JE. Tel: 0181 455 1626. Price: 90p plus 50p P+P.



78%

## Sauce and Code 3 AMOS tutorials

Presented in the format of a disk magazine, Sauce and Code is a collection of AMOS programming tutorials and examples. All of the examples are geared towards writing demos and games, many of which come with source code to be loaded into AMOS, text explanations and in a few

cases, executable files that can be run straight from the front end. The subjects covered in this issue include text scrollers, text effects, screen zooms and warps, and a sprinkling of other assorted visual tricks.

If you're into AMOS and have aspirations that exceed the limits of the manual, Sauce and Code is well worth a look.

**Available from:** Roberta Smith DTP, 190 Falloden Way, Hampstead Garden Suburb, London NW11 6JE. Tel: 0181 455 1626. Price: 90p plus 50 P+P.

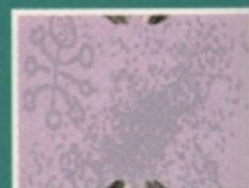
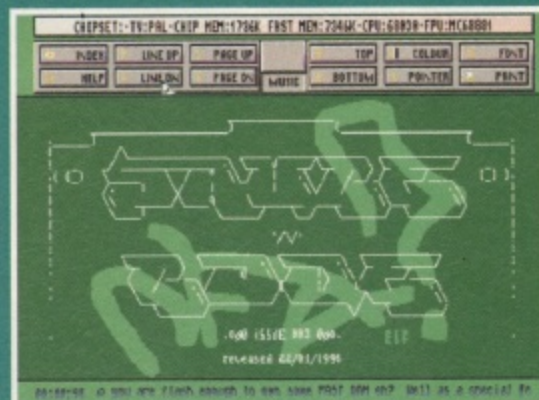

80%

## Revision Master education

Unless you're some kind of specky swot, when it comes to



revising for exams, you need all the help you can get. Revision Master is a question and answer quiz designed to probe your cranium and test your knowledge of a specialised subject. Rather than attempt to cover everything from political history to home economics with a massive database of questions, it suggests that you (or a friend) build up your own bank of questions to suit your subject. I would imagine preparing the questions yourself would have limited value but if you could find someone to do it for you it could be quite useful.

As a bizarre form of bonus disk filler you also get a small animation of a galloping horse, scanned from photos taken by Eadweard Muybridge during the 19th century (try using it as an anim brush).

**Available from:** Roberta Smith DTP, 190 Falloden Way,

Hampstead Garden Suburb, London NW11 6JE. Tel: 0181 455 1626. Price: 90p plus 50p P+P.

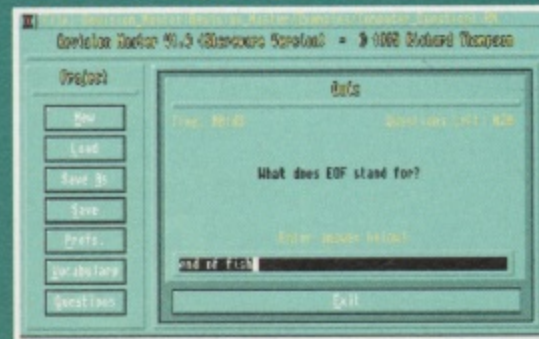

76%







# THE AMIGA GALLERY

**Wanted: art gallery entries. Please send to usual address.**

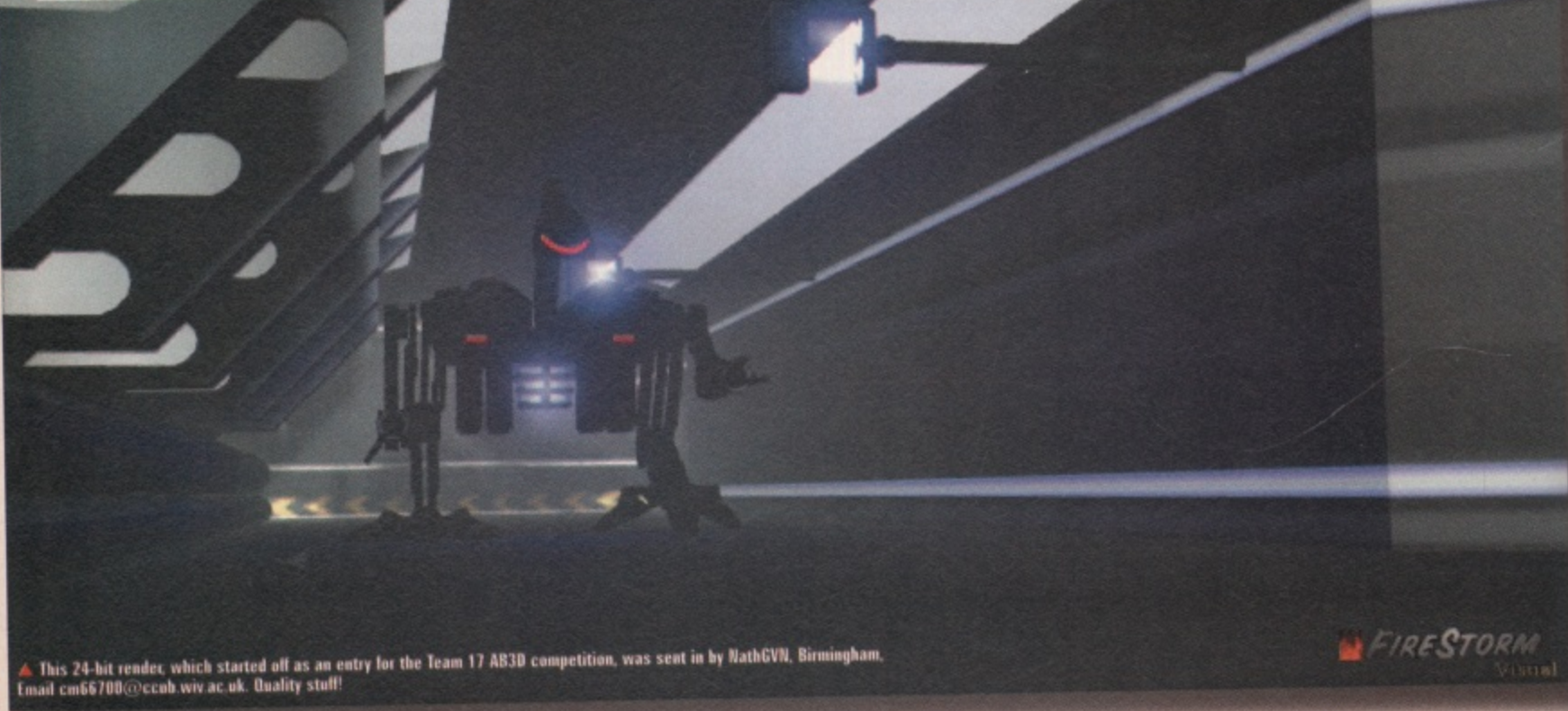
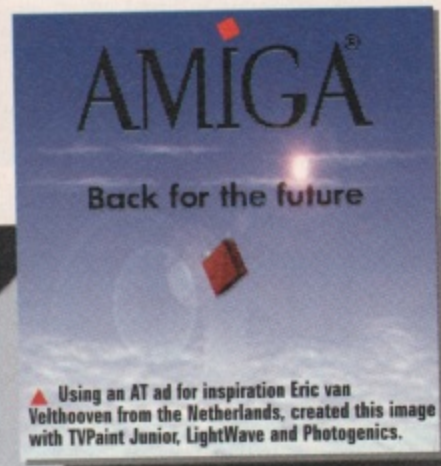
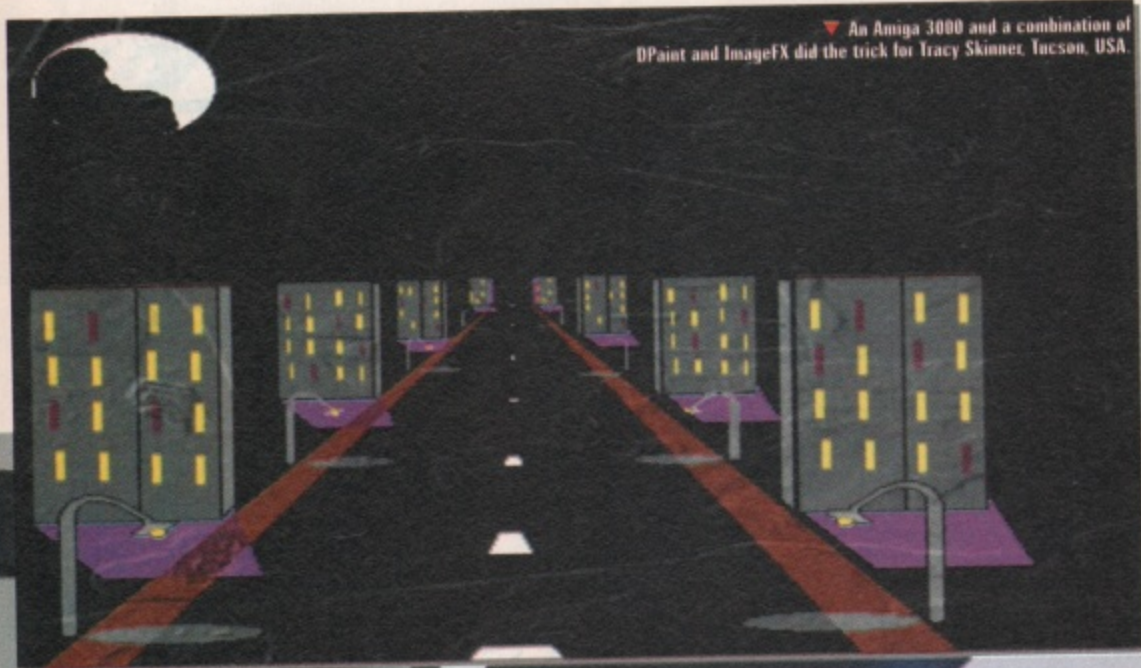



# AMIGA

## workshop

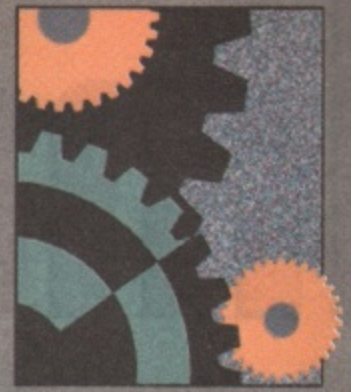

Last month's four-man points of view generated a lot of interest so, this issue, by popular demand, it's three men and one woman's point view. There's also the usual helping of superb tutorials including Imagine and last month's VideoStage Pro cover disk. And check out our superb new worldwide cut price subscription offers and the all new six month option. Unbeatable value for all!

### IMAGINE 3.0 92 ●

How do you add intricate detail in one easy step, in Imagine? With a brush map of course. It's easy when you know how.

### VIDEOSTAGE PRO 96 ●

We kick off our March cover disk 128's tutorial with a look at what this excellent video titling package can do.



VideoStage Pro p96

### GRAPHICS MASTERCLASS 98 ●

Michelle Pfeiffer and Jeff Goldblum get it together in this month's graphics masterclass to produce some interesting results.

### COMMS 100 ●

It's all about Mime this month. No, it's got nothing to do with wearing stripy tops and black leggings, it's how you can add stuff such as animations to your Email.

### NET GOD 102 ●

CU Amiga Magazine's undercover internet spy is on the case finding out what is happening out there in the wired world.



Net God p102

### SOUND LAB 103 ●

It's a sound lab with a difference this month. Tony Horgan has decided to do a one-off frequently asked questions on Amiga sound. So it's an ASFAQ.

### SUBSCRIPTIONS 106 ●

There are pounds to be saved worldwide now, we've introduced special offers across the board. And there's six month subscription offers as well!

### POINTS OF VIEW 120 ●

The CU Amiga Magazine team mount their collective soapbox. Four opinions for the price of one, not bad eh?



Points of View p120

## Regulars

### FAQ 113

Man cannot survive alone but computers can. However, it can be fun if you link two or more Amigas together. Your common queries answered.

### Q&A MASTERCLASS 114

Arex is still here. Following on from last month's look at its internal workings, this month John Kennedy explores exactly what it does.

### Q+A 116

Just to prove Q&A is a two way street we've got some reader solutions to other readers' problems.

### BACKCHAT 118

Happy people, sad people, angry people: it takes all sorts to make up a universe and it looks like they've all written into our letters page.



# Imagine 3.0

**PART**  
**2**

**Brush maps are a quick and very easy way of including intricate detail in an object. Learn how to incorporate them into yours.**

**B**rush maps are the secret to creating realistic-looking objects. With brush maps you can swiftly add tiny details without causing a huge delay to your rendering times. For example, imagine the time it would take to create the objects necessary to model a computer board full of connecting circuit lines. However, with one brush map you can create the entire object in moments.

Brush maps can be used to apply wallpaper to a room or chunky stone tiles to a swimming pool floor. Once you start creating brush maps you'll be addicted as they allow so much detail to be created in such little time.

Creating the right brush map takes a lot of time, but the end effects will be worth it. With lots of experimentation you will soon build up

your own library of special maps for every occasion. Let's begin ...

**Here's how**

Using a paint program (here, Personal Paint) draw a simple pattern. Then cut it out as a brush and save it. Think of this image as a sheet of wrapping paper: we are now going to create an object and wrap it up.

Thankfully Imagine can wrap objects a lot better than I can wrap presents. **See figure 1.**

Open a new project and go to the Detail Editor. Create a Primitive Sphere. Select the Sphere (click in the centre or press F1) and increase the scale. Whilst it is still selected, pick ATTRIBUTES from the pull-down menu. Click on ADD BRUSH. **See figure 2.**

Load in the brush that you created with the paint program. Copy the settings (apart from the name) and in particular check that the Wrap X and Wrap Z boxes are marked. **See figure 3.**

Perform a Quickrender of the object. Notice how the pattern is wrapped tightly around the sphere, not quite like wrapping paper (which would be bunched up at the top and bottom) but spaced out properly. This is what the Wrap X and Wrap Z options achieved. **See figure 4.**

It is essential to appreciate the three main ways of mapping a brushmap onto a shape.

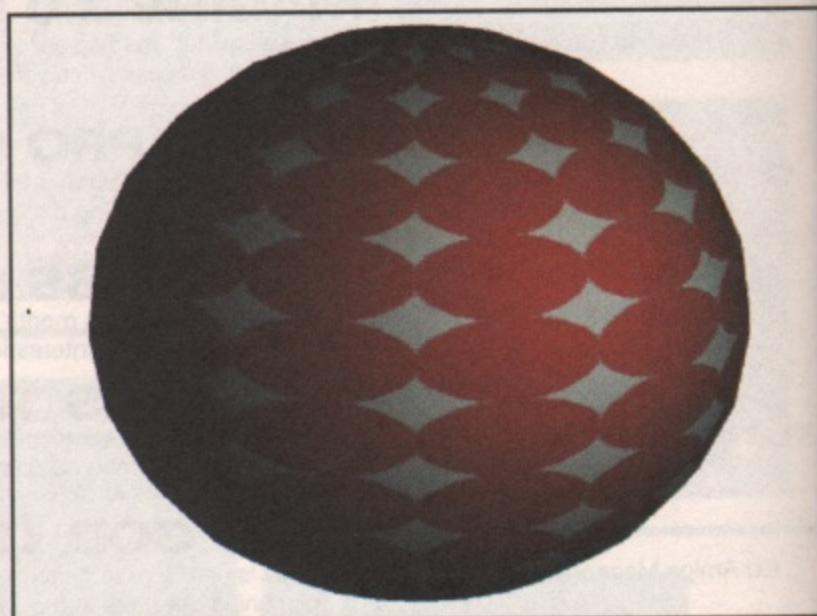

▲ Figure 4: perform a quick render to wrap the pattern around the sphere.

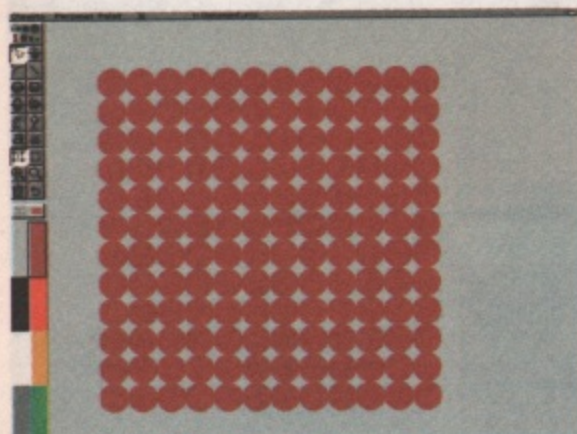

▲ Figure 1: cut out a simple object as a brush.

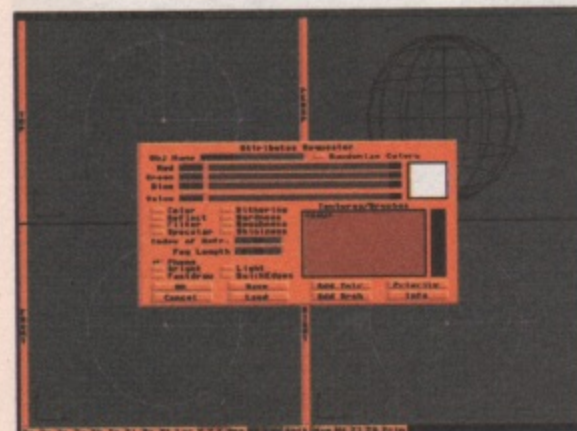

▲ Figure 2: in the detail editor click on 'Add Brush.'

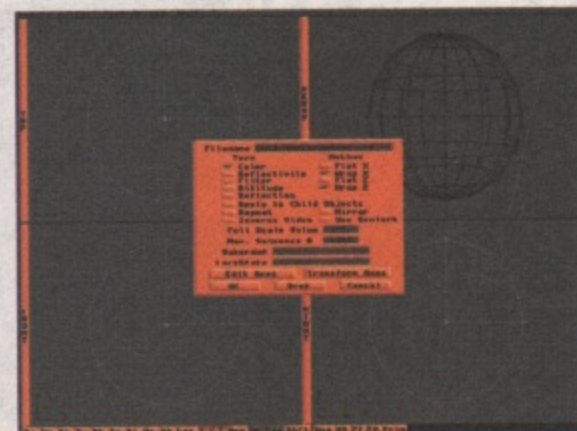

▲ Figure 3: loading in the brush that we created in our paint program.

Imagine will normally do most of the work in wrapping but you need to give it a hint about the general shape of the object. You can of course ignore these settings for special effects but stick with them for the moment.

The three main shapes are a Cuboid, a Cylinder and a Sphere. You can see from the diagram which mappings need to be altered depending on the shape.

For example, if you wanted to create a planet you would draw the surface (or scan it in from a book) and wrap it around a sphere with Wrap X and Wrap Z switched on. **See figure 5.**

**A bit tricky**

Let's move on to something slightly trickier. Let's say, for example, you wish to place a mapping onto an object in a particular place: not entirely covering it. A good example would be placing an insignia on an aircraft

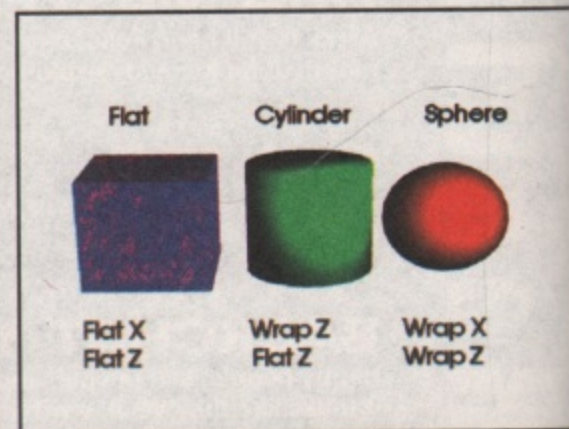

▲ Figure 5: there are three main shapes – cuboid, cylinder and sphere.





▲ Figure 6: here's our 'friendly' decal.

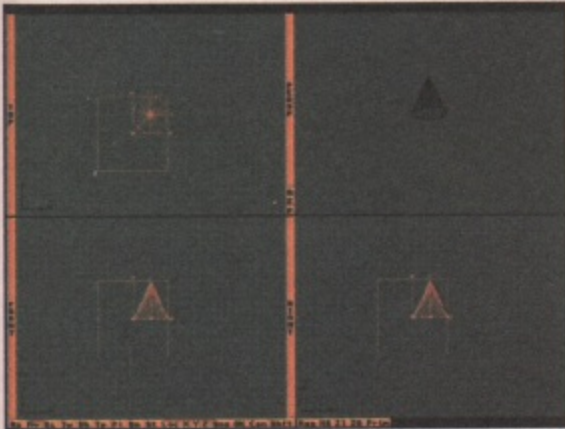

▲ Figure 7: in 'Edit Axis' the top right square is the map image.

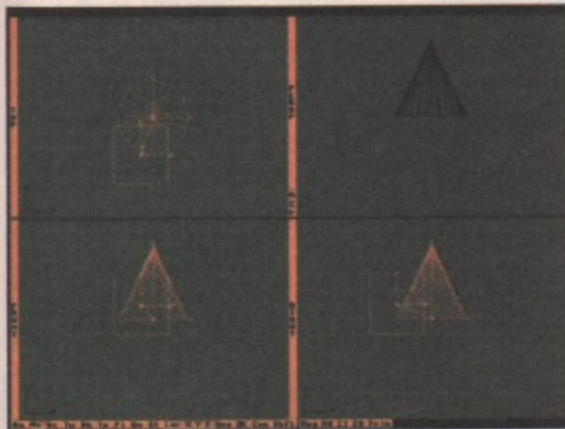

▲ Figure 8: you can also rotate brush maps if you want.

wing. This time the Wrapping format isn't quite as important as the position and shape of the image.

Creating this effect is possible because Imagine treats the brushmaps in much the same way as objects: you can move, stretch and manipulate the map in many ways.

Paint a small image and imagine this to be the 'decal' which we will place on our model. Make it small but detailed so you can tell which way it should be. See figure 6.

Now return to Imagine's Detail editor and create a cone or any other primitive shape. This is our model to which will apply the decal. Get a saucer of warm water ready to make the decal slide off the paper backdrop and try not to cover the fuselage with polystyrene cement as this makes it go all cloudy (oops... only joking, remember those days all you air fix fanatics out there?). Open the attributes requester and add a Brush as before.

This time we'll be keeping it flat, so don't touch the Wrap buttons. Instead click on the 'Edit Axis' button. You'll see the window disappear and instead there will be a grid overlaid on the cone. See figure 7.

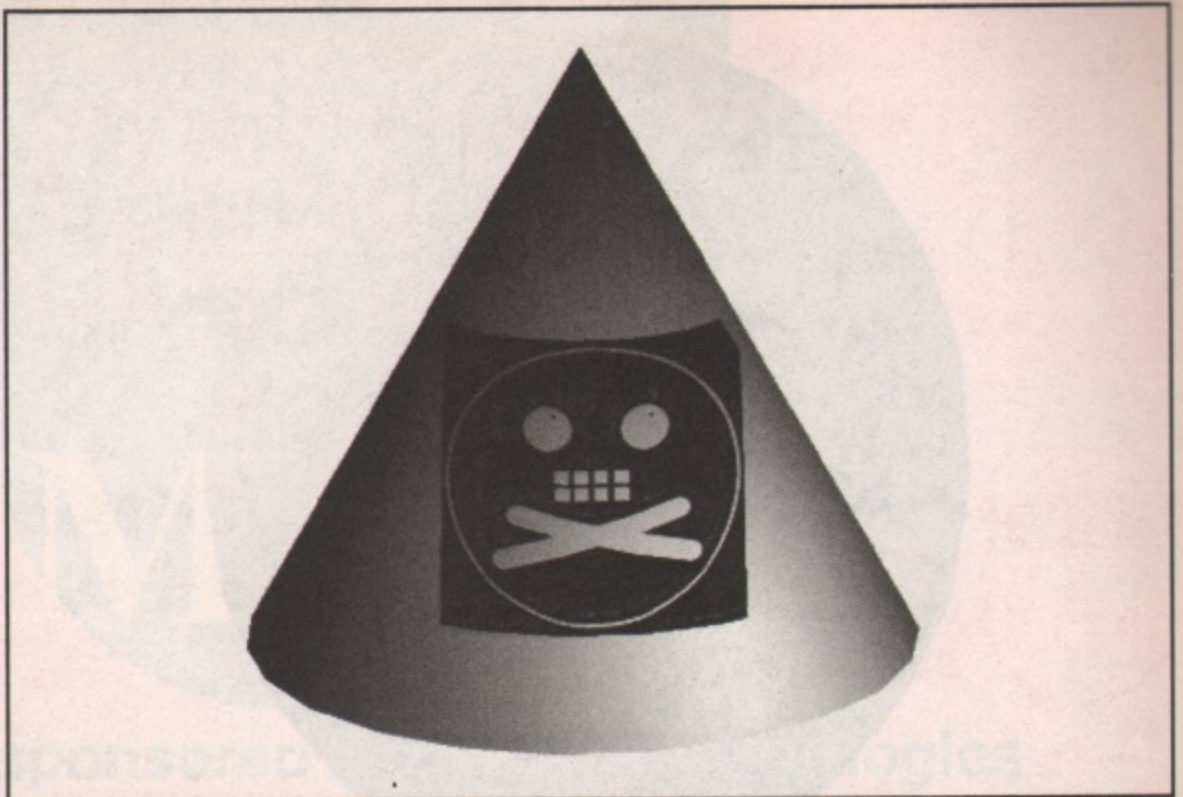

▲ Figure 9: our decal and object combined to make an unusual sight.

The top right quarter of the grid represents the map image. Use Scale and Move to alter the size and shape until it looks something like the image shown here. You can always click cancel if you get lost, and then start again. Alternatively you can click on the 'Transform Axis' button and enter the new size and position by hand. Don't forget that you can rotate brush maps too if you wish. See figure 8.

When you render it, you'll see that the decal has been changed to cover only a small part of the object. See figure 9.

## Mapping techniques

So far the maps we have been dealing with have concentrated on controlling an object's colour. However, as you will have seen from the brush map attribute menu there are several other ways in which maps can be applied.

### 1. Colour Map

As we have seen, the colour map simply paints the object with the colour in the map. In this case, I have created a very fetching repeating square motif using different shades of gray (and some graduated tones too). OK, it's dull but you will see what a difference it makes when we apply the other mapping techniques. See figure 10.

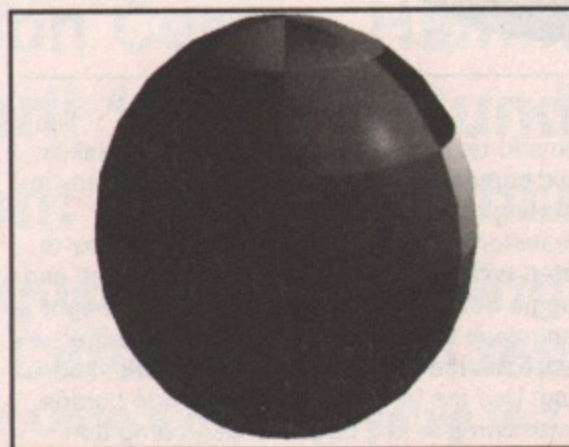

▲ Figure 10: here's the colour map in fetching shades of grey.

### 2. Reflectivity Map

The colours in the brush cause the object to selectively reflect its surroundings. In order to see anything happen you will need to include a Global Reflection image - do this from the Global settings in the Action editor. The white parts of the map cause the reflection to be strongest, the black parts don't reflect anything at all. See figure 11.

### 3. Filter Map

The colours in the brush make the object transparent. This can be applied to make

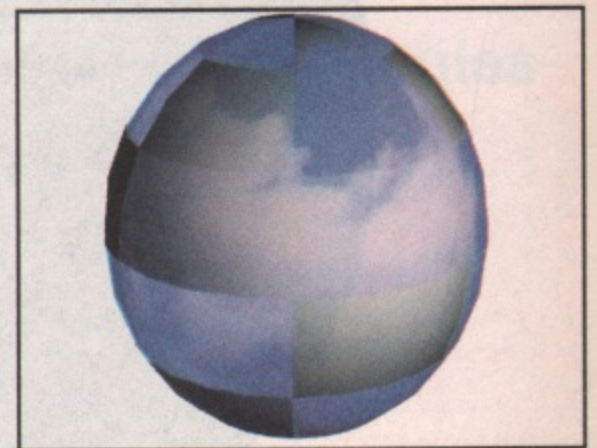

▲ Figure 11: the white parts of the reflectivity map are strongest.

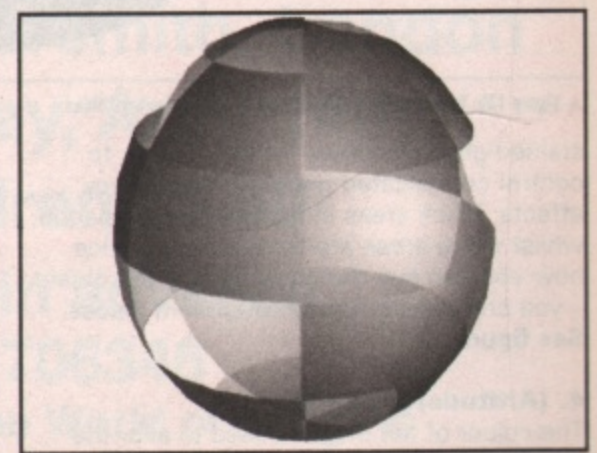

▲ Figure 12: the filter map is ideal for a stained glass window effect.



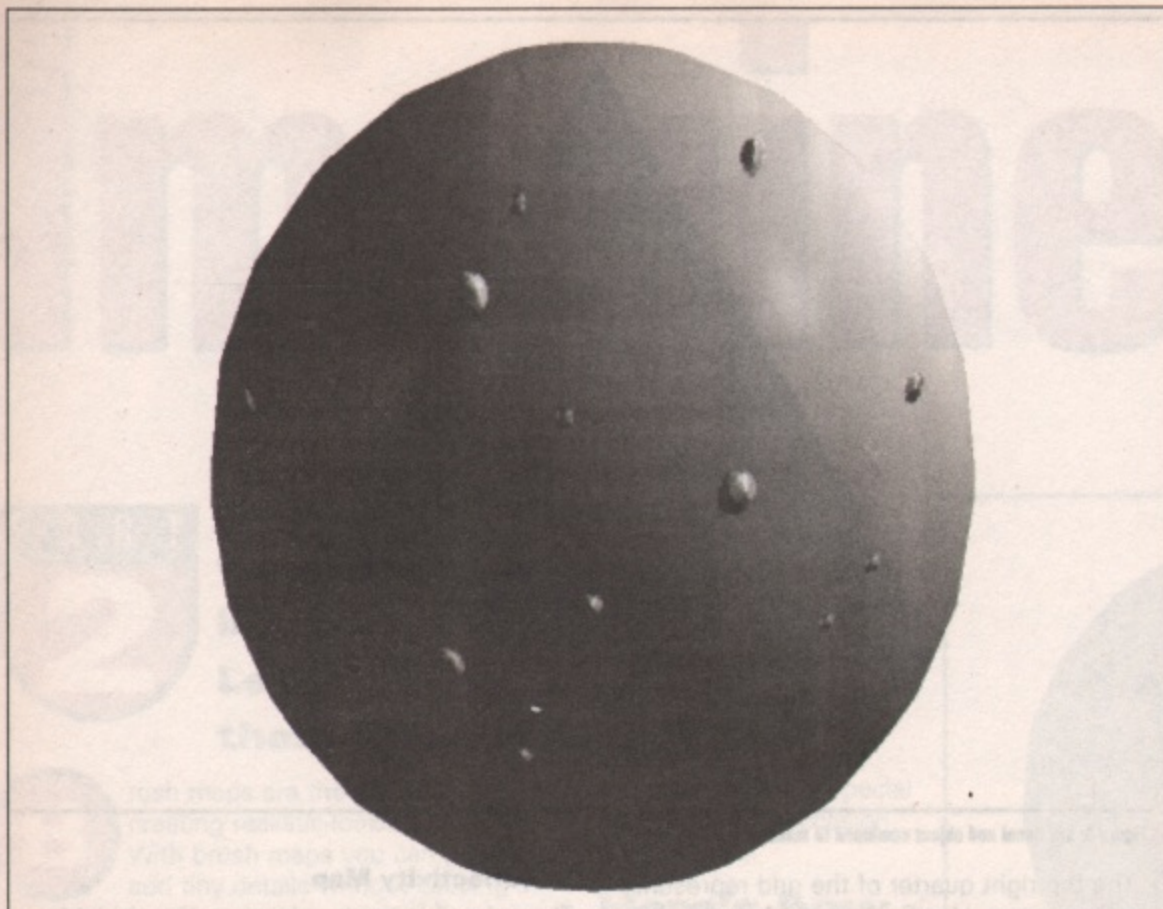

▲ Figure 13a: you put your left bump in, right bump out .... The altitude map is where you can add texture, such as bumps, to an object.

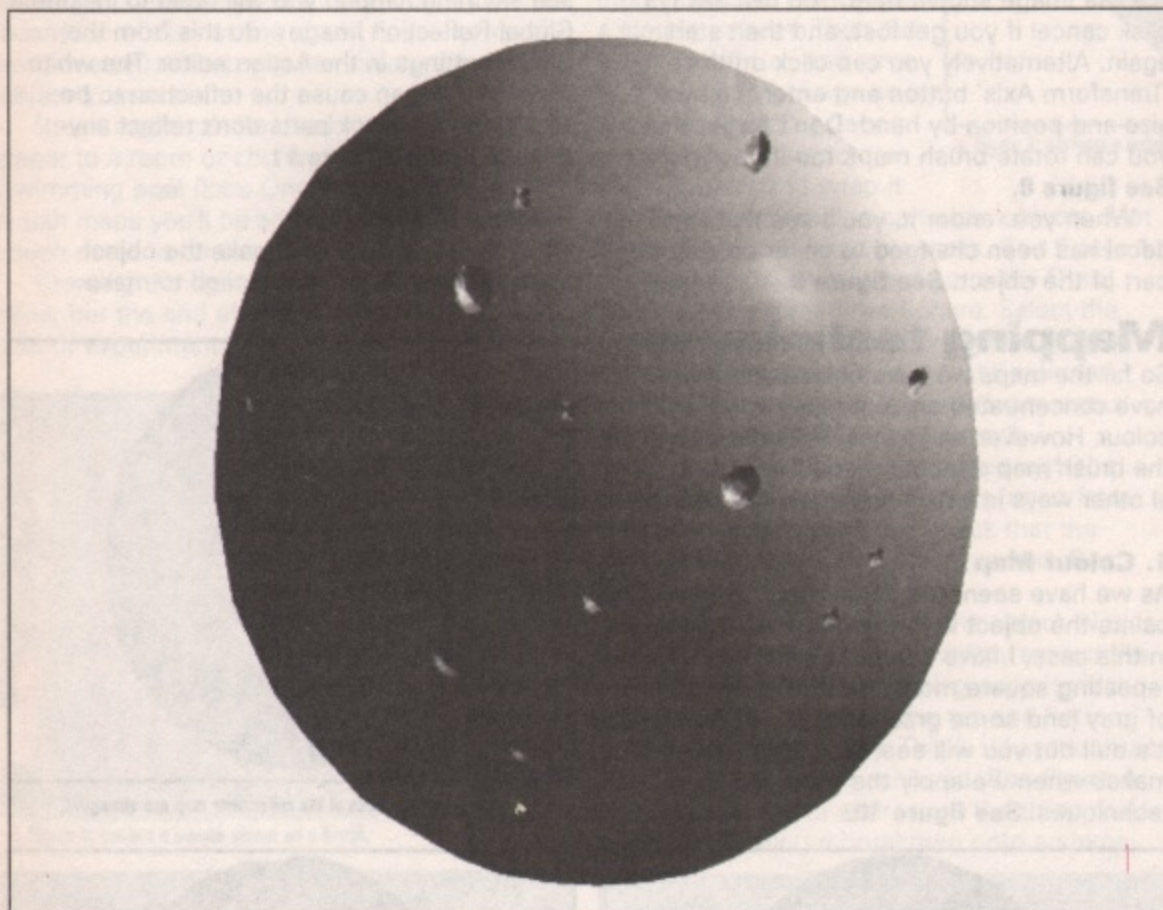

▲ Figure 13b: To create bumps that bump in use the Inverse Video.

stained-glass windows for example or to control complicated graded transparency effects. Black areas in the image are opaque, whilst white areas are transparent. Notice how you can see the other side of the object – you are looking right through it in places. See figure 12.

#### 4. (Altitude) Bump Map

The colour of the brush is used to alter the height of the object. This is an excellent way

to add texture to an object, although it takes experimentation to get it right – particularly in setting the height on the bumps (use Transform to set the Y value to about nine to start with). In this case the square pattern and some dots have been used. Placing the light source in the right place makes a big difference, as the bumps will show up with shading. Use the Inverse Video to provide bumps with bump in and bumps which bump out. See figures 13a and 13b.

## Brush Map Hints

- Spend a great deal of time working on the brush maps as they will make all the difference to the final model.
- Use 24-bit images as brush maps if you can, as they will give best results.
- Use the smallest images you can as each brush map needs to be held in memory. If your finished render is 320 by 256 pixels, it makes no sense to create a 1024 by 1024 24 bit brush map. You'll run out of RAM!
- Remember that Imagine3 allows you to apply many maps to the same object. This means you can apply a texture, some decals and a bump map all to the same object.
- If you can't draw, remember that you can always scan or digitise brush maps instead. You can also buy disks full of suitable textures in IFF or JPEG format. (JPEGs will need to be converted to IFFs before use)
- When applying bump maps, try using the blur feature in many image processing packages to smear the details out. This can give better results.
- Imagine 3 can deal with multiple brushmaps. For each frame in an animation you can map a different image onto an object. If you can digitise some frames from video this is a great way to create a rendering television set.

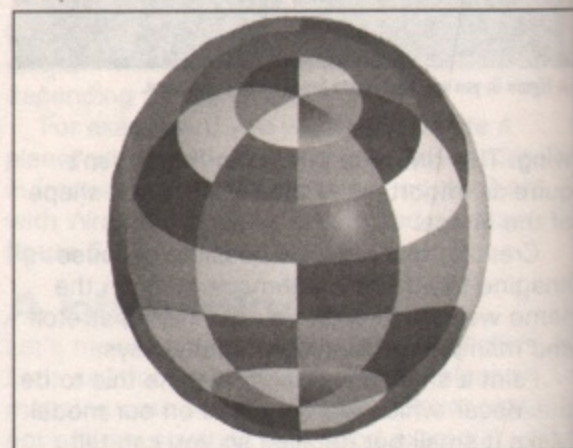

▲ Figure 14: the reflectivity map adds varying reflections to an object.

## 5. Reflection

This is very similar to a Reflectivity Map, except the brush is treated as though it were in the space surrounding the object, where it will be reflected in it if the object is itself reflective. Go on, try it for yourself but remember to change the attributes of the object so that it is reflective or you won't see anything! This technique is potentially useful if you need to add different reflections to different objects in a scene: for example, if you are making a very flash company logo effect. See figure 14. John Kennedy



THE WORLD OF  
**AMIGA**

An exhibition sponsored by Amiga Technologies  
Witness the dawn of a new age in computing

# THE AMIGA IS BACK!

## So on with the show

Be the first to see

- All the latest developments from Amiga Technologies
- The first major launches in two years

☆ Games Arcade ☆ Competitions Galore ☆ Retail Area

☆ Presentation Theatre ☆ ICPUG Free Advice Centre

☆ High End Applications ☆ Save £100s on special offers

**Novotel Exhibition Centre, Hammersmith, London**

**Saturday, April 13th and Sunday, April 14th**

**Admission: Adults £7 Children £5.50**

**Avoid the queues by booking in advance**

**Credit Card Hotline 01369 706346**

**Cheques and Postal Orders made payable to The World of Amiga at  
PO BOX 9, Dunoon, Argyll. PA23 8QQ**



# VideoStage Pro

**PART**  
**1**

Continuing on from last month's feature we take a further look at what you can do with our cover disk 128 VideoStage Pro. Making your own video presentations has never been so easy.



**WARNING!! This image contains HOT Video Colors**

Free Chip Memory: 1786584 ( 1651288)  
Free Fast Memory: 5798136 ( 5632312)  
PAL 320 x 256 x 5

OK

HELP

▲ 'Hot' colours that would overload a composite video signal are automatically detected by VideoStage Pro.

**L**ast month we covered the excellent visual presentation system for video work, VideoStage Pro. We also covered most of its main attributes in our walk through guide to creating presentations with it. This tutorial will look at some of other features that we haven't yet covered with this great program.

## On-line help

On-line help is available at any time when using VideoStage Pro - press the Help key to call it up. The relevant page of the help document will be displayed, depending on which part of the program you are using at the time. To view the entire help document, click on the Help button at the top and then navigate your way around it using the AmigaGuide controls.

## Hot colours

Some colours when displayed on video produce a blurred look that will detract from the appearance of your work. These are bright, rich colours such as pure red. They're called 'hot' colours because they seem to burn into the video screen and leave a brief after image. Technically they are colours which would require illegal voltage levels in order to be represented in NTSC or composite PAL video.

VideoStage Pro checks for occurrences of hot colours. For example, when you load in a picture file, after you click on the Add Text/Objects button, you will be in the Text Entry panel. If there are hot colours in the image the Hot Colour indicator in the Text Entry panel should display Red, indicating the presence of hot colours.

To see which colours are hot, click on the Backdrop button or press F8. Now click on the Palette button (near the right edge of the panel). You'll now be presented

with the Colour Adjustment window, from which you can highlight the hot colours by clicking on the Flash button. You can change any of the hot colours using the RGB sliders to reduce their intensity. Click on an area of the picture to select the required colour to be altered, or select it from the palette.

## ARexx scripts

If you find that VideoStage doesn't do everything you'd like it to do, you can use ARexx scripts to remotely control other programs or video devices from within VideoStage.

To call an ARexx script all you need to do is drag the ARexx Event icon onto the relevant part of the storyboard and then select the ARexx script that you want to execute. This means that you could, for example, replay OctaMED MIDI sequences by using an ARexx script to tell the OctaMED Player to start playing the current song. In this case you would of course need to have both ARexx (Rexx Mast) and the OctaMED Player running as well as VideoStage Pro. Check the documentation on your ARexx compatible software for specific details on how to control them using ARexx scripts.

## Using genlocks

You can use any Amiga genlock with VideoStage Pro, but there's also specific built-in support for the GVP G-Lock and the SuperGen from Digital Creations. The program is normally set up for use with a generic (normal) genlock. This can be changed to either of the aforementioned genlocks from the Settings control panel.

To use the special genlock features, drag a Genlock Event icon onto the storyboard and click on it to bring up its options. The first option window will appear.

There are two times associated with a given genlock event, the start and end time. The end time is the start time plus a duration. This is due to the fact that some settings can be altered over a time interval, giving a sort of transition between the computer graphics and the live video coming into the genlock. The start and duration can be entered in this window and/or altered on the timeline. Bitplane keying (making certain areas transparent) is carried out at the start time only. You can also specify single colours or ranges of colours to be made transparent and/or opaque to the genlock. When more than one colour is involved, the range will be made transparent and/or opaque over

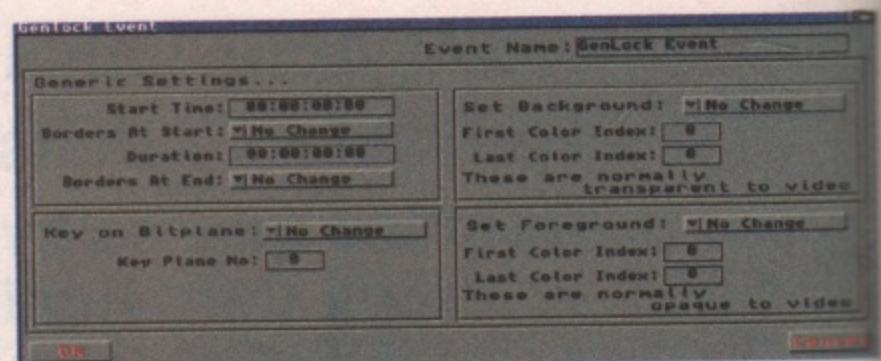

▲ If you have a genlock you can make use of the advanced palette control options for maximum control.



On the left

On the right

Coffee  
Homebrew  
Party invites

Rob McBride  
Mat Bettinson  
Anthony Collins

This is centered

▲ Text can be imported with ready-made formatting codes which saves you arranging things from VideoStage.

```
CygnusEd Professional V3.5 Copyri
Scratch:Text/CodedText.txt
#FONT 32 VSRavenB.font
#SHADOW 0
#BOLD 0
#OUTLINE 1
#COLOR 1

#SETX 50
#JUSTIFYLEFT
#SETY 10
On the left
#SETX 590
#SETY 10
#JUSTIFYRIGHT
On the right

#COLOR 4
#FONT 46
#JUSTIFYCC
#SETX 320
#F 1
#FONT 24 VSFinch.font

Coffee Rob McBride
Homebrew Mat Bettinson
Party invites Anthony Collins

#JUSTIFYCENTER
#ITALIC1
This is centered
□
```

▲ This is the original text file that was imported into VideoStage Pro to generate the screen at the top of the page. The lines starting with a '#' sign are the formatting codes. See the panel for more details on the codes.

the time range. This allows you to have a picture gradually changing from opaque to transparent, or vice versa.

If you're using a G-Lock or SuperGen, you'll also see a second window, which will be different depending on which genlock you have selected.

The G-Lock window allows you to specify the video and audio source at both the start and end time. Remember that your G-Lock software must also be running for this to work.

For SuperGen users, the

second window gives options for specifying the cross fade options of the genlock. This is done by entering the transparency of the computer graphics as a percentage, both at the start and end time, with 0% indicating all computer graphics, 100% indicating all video, and 50% an equal mix of the two. Enter a value of -1 for no change. Remember that you can change which part of the Amiga graphics acts as the background colour from the previous window. ■

Tony Horgan

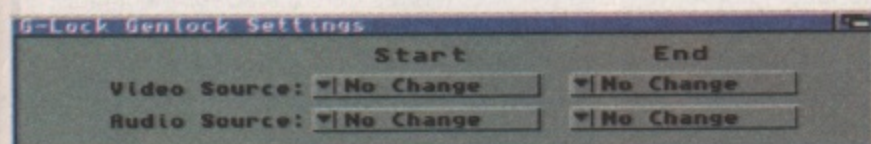

▲ There are specific options for both the G-Lock and SuperGen genlocks.

## Coding text files

You'll probably remember from last month that you can import text files straight into VideoStage pages. What's more, you can even include all of the text formatting information within the text file, so as soon as it's imported it arranges itself neatly on the screen.

Adding the formatting codes from within the your text editor can be a lot quicker when you're working with large lists of credits.

The codes you enter in the text document relate to all the text on the lines below. For example, if you wanted to change the text to italics, you would enter "#ITALIC 1" on the line above the part you want to italicise. In this case the '#' sign indicates that a code will follow, 'ITALIC' is the code, and '1' means 'on' ('0' would mean 'off'). Not all codes need to be followed by a number.

These are the available codes for justification (note the American spelling: center).

```
#JUSTIFYLEFT
#JUSTIFYRIGHT
#JUSTIFYCENTER
#JUSTIFYCC
```

The following codes set the X and/or Y location of the text. Note that the Y value is for the top of the text, not the bottom nor the baseline. Replace 'value' with the position given in pixels:

```
#SETX value
#SETY value
```

Before you make changes to the fonts, you can select which of the two fonts you are addressing using the following code, where a value of 0 (zero) refers to the left font and 1 refers to the right font.

```
#F value
```

Now you can define the style of the font. All of the following use a value of 0 to represent off, and 1 to represent on.

```
#ITALIC value
#BOLD value
#UNDERLINE value
#OUTLINE value
```

The shadow option can have one of three value settings: 0 (off); 1 (cast shadow); 2 (drop shadow).

```
#SHADOW value
```

Font size and name can be set with the following code. Size should be specified in 'point' units while the name should correspond to the font name in the fonts drawer (eg. #FONT 8 Topaz.font).

```
#FONT size name
```

The three colours of the text can also be specified. The values correspond to the colours of the palette, so if the third colour in the palette was red, a value of 3 would lead to red text.

The following codes relate to the main colour, outline colour and shadow colour respectively (remember to use the American spelling: color).

```
#COLOR value
#OCOLOR value
#SCOLOR value
```

These codes can be used in any order and embedded throughout the text, so multiple font changes are possible.

## That's all folks!

That concludes our look at VideoStage Pro. If you still need more information, remember that the on-line help is available at all times. Next month we continue our focus on desktop video with a look at Scala, the top presentation package currently bundled with all new Amigas.



# Graphics Masterclass

**What do you get when you cross Michelle Pfeiffer's eyes with Jeff Goldblum's face? Find out in this month's bit of graphical wizardry.**

**T**his month's graphics masterclass moves off in a new direction, on a mission to turn your Amiga into a state of the art graphics workstation. With a combination of hot software like Photogenics and Image FX linked to the Amiga's AGA chipset or even a 24-bit graphics board, you can do just about anything and that's just what we aim to prove.

## UFO sightings

Fact or fantasy? In this case it's fantasy. Whether you believe in the possibility or not there's plenty of mileage to be had when it comes to mocking up pictures of UFOs and other phenomena.

I'm not suggesting that you use your Amiga to make up some pictures and sell them to a popular publication for pots of cash, but ...

The picture we have here may not be the most convincing flying saucer shot you've ever seen but then again most of them are usually blurred and distorted more than this. Even so, if you were to take it seriously and spend some time

on it, I'm sure you could come up with a photo-realistic image using the same techniques.

There are two main components in the image: the spaceship and the background picture. The spaceship was rendered with Imagine, using an object that comes with a little spot-light already attached. You'll find this in the Imagine drawer if you have the CD-ROM edition of this magazine. This was rendered with no fancy textures, but you could add something like the DeathStar texture for a neat panelled metal

surface. In order to make the saucer blend into the background as naturally as possible, the light source was carefully aligned to match the lighting of the background picture. It was then rendered in 24-bit colour on a

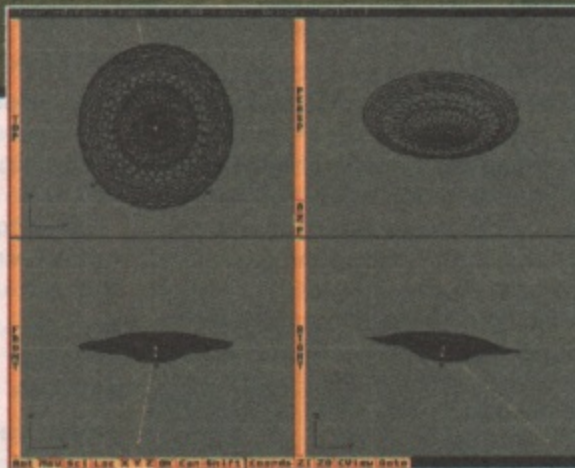

▲ Here's our Stonehenge UFO getting ready to make its debut. It's all symmetry man.

large screen and saved out to disk.

Next it was loaded into Image FX to be added to the Stonehenge backdrop. Using the automatic background detection mode, it was cut out, scaled and pasted down onto the backdrop. If you prefer to use Photogenics, the Compose function does the job just as well.

Finally it was touched up from within Photogenics with some motion blur, blending and a few dots were added for the lights. All that remains is to send it off to *Gullible Alien Theories Monthly* along with a story about how you were abducted just after you took this photo a pagan summer solstice ritual.



## Sexy eyes

Who do you think this is? The eyes are those of Michelle Pfeiffer and rest is the face of Jeff Goldblum. This is a simple example of a subtle rub through effect. It was created with Photogenics, although the same result could be achieved with Image FX. The two source images are from the Nothing But GIFs CD-ROM and were chosen because both faces fitted the frame of the picture in a similar way.

However, a rub through alone still highlighted the different positions of the features (the eyes appearing above the others). To correct this, one of the pictures was cropped and scaled to match the other. This is simple to do with Photogenics, as you can see both pictures at once, each in its own window. Image FX requires you to switch buffers to compare them (use the J key to speed things up).

All that remains now is to select a subtle brush type, such as the default Airbrush from Photogenics, draw over the features and marvel as the second face appears like a spooky ghost!



## Spiritual harmony

There's no reason to become locked into the habit of producing rectangular 640 x 512 pixel pictures, just because that's the shape of your monitor. This picture, for example, could be reproduced as a poster or wall

hanging, or even used as a scrolling backdrop in an Amiga demo or video presentation.

Photogenics was the tool used to create it. The first Buddha image came from the Nothing But GIFs CD and originally had a blue sky backdrop. This was painted solid 100% blue with a number of Fill processes and then saved out.



Next a blank page was created (solid 100% blue), the same width as the Buddha picture but a lot taller. The Buddha was pasted onto the bottom, and then the entire backdrop was filled using the Gradient Tint option. At this point you may encounter some problems. Filling the majority of a 640 x 1200 pixel 24-bit image requires quite a lot of RAM and even on a 10Mb machine a few tricks had to be employed to get it to work. With undo buffers turned off and other

software closed down, it performed the fill eventually. As you work, memory gets fragmented, so sometimes it's a good idea to save your image, turn the machine off for a few seconds, then power up again.

The finishing touch was the planet in the sky. This was added using the Compose function, with the Brightness Key switched on. A few pixels of the planet image seemed to be corrupt, but a quick smoothing over with the Blur function was enough to sort them out.

## These pictures are on the CD



If you have the CD-ROM edition of this magazine, you'll find all these pictures along with the source

images and 'work in progress' snapshots in a drawer called Magazine/GraphicsMasterclass.



# Wired World

## PART 9

**A picture's worth a thousand words ... so why limit your Email to text? With Mime you can include graphics, sounds - even animations.**



If you been using electronic mail or lurking around in the Usenet newsgroups, you will probably have come across files which have been uuencoded. Uuencoding is a method of converting a standard binary file, for example a program or IFF image, into a mass of text. The text can then be sent via Email or included in a news posting.

Uuencoding is required because text systems only use 7 bits out of 8 to store the various letters and punctuation symbols. If you sent a program and missed out one bit in eight, whatever arrived at the other end would be totally useless.

Multipurpose Internet Mail Extensions (Mime) is an attempt at making this uuencoding process as simple as possible. It too encodes binary files into text format but this time uses a slightly different standard called Base64. However, the important thing is the way in which the Mime mailing program works.

### The ultimate

Unlike the traditional uuencode way, the user does not need to play around with messy CLI only

utilities. Instead, they only need drag a file or two into a special window and it is converted automatically. Each file is converted into a Mime 'partial' and included in the mail message. Even more impressive is what happens when the message reaches its destination. If set up properly, an image will automatically be displayed and a MED tune automatically played, making it the ultimate way to exchange data by electronic mail.

### A must have

To use Mime on the Amiga, you'll need a program called MetaTool. MetaTool was written by Ellis Pritchard and is available from the Aminet. I'm assuming that you already have an Email system operating on the Amiga and therefore have experience with either a Mailkick or AmiPOP program for sending and receiving mail. For example, if you are a Demon

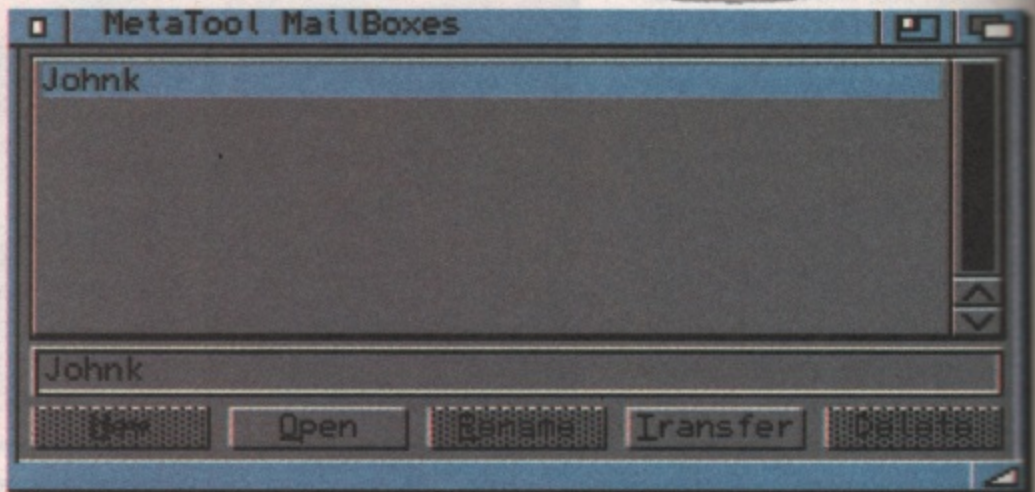

▲ MetaTool organises the mail into different mailboxes. The name comes from the USERNAME environmental variable.

customer you'll be using the SendMail program for handling the mail transfer.

Before you can start using MetaTool, you will need to make sure that you have set up some environmental variables. These sound horrendous but it only means that you need to include the settings for your user name, domain name and host name. The user name will be the name of your internet postbox and this will be the first name you picked when you signed up with your service provider. The domain name is the section you didn't pick yourself after the @ sign in your Email

address and the host name is the part you chose. For example, my Email address is 'johnk@infosys2.thegap.com' and so I set up the variables as in figure 1. If your address was 'brian@toastrack.demon.co.uk' then you would set the variables like figure

Figure 1

```
setenv USER Johnk
setenv DOMAINNAME thegap.com
setenv HOST infosys-2
```

2. You can either type these directly into the Shell every time you re-boot your Amiga, or save yourself a lot of time and include

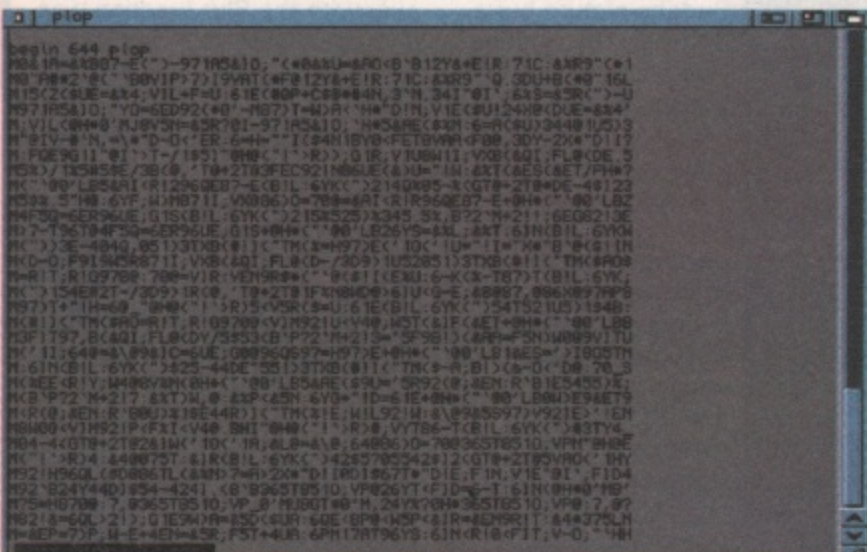

▲ When you uuencode a file it is converted into text. You can't read it, but you can uuencode it to bring back the original file.

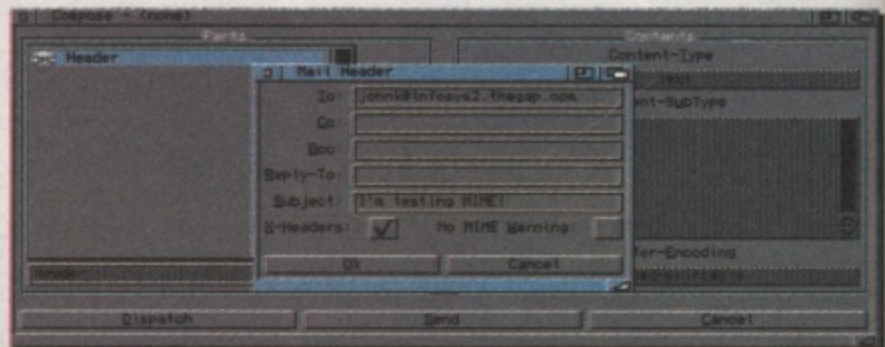

▲ You can send copies of your mail message to others by including names in other fields. Here I'm letting some people know that I'm testing Mime.



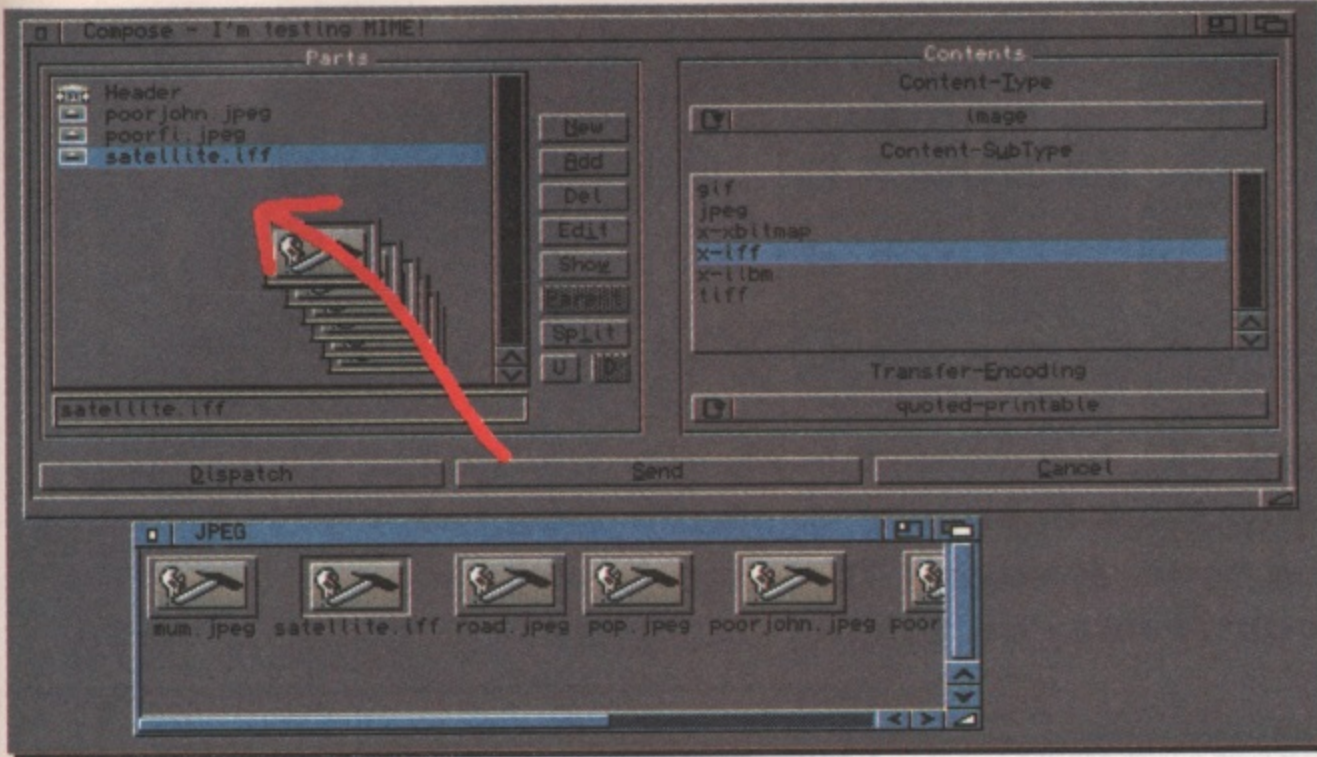

▲ You can drag-and-drop files or create them from scratch and use a file requester.

Figure 2

```
setenv USER brian
setenv DOMAINNAME demon.co.uk
setenv HOST toastrack
```

ready to send a Mime message. Press Right Amiga-N to create a new message. You see the compose window appear and there will already be

to send the message over the Internet.

You can also create parts of the message manually, without dragging and dropping. Click on the NEW button and you can select the type of the object you

want to send. You will then be given a file re-

Figure 3

```
text/x-aguide; MultiView %s; label="An AmigaGuide file"; edit="emacs %s"
```

them in your s:user-startup file. You may find that they have been created for you when you installed AmiTCP: you can check by typing setenv by itself and see watch to see if USER, DOMAINNAME and HOST whizz past.

You'll also need to use everyone's favourite Graphical User Interface, Magic User Interface. If you are a heavy Internet user you will probably already have MUI installed to let you run AMosaic or IBrowse.

Starting MetaTool should be painless if you remembered the right setenv commands. You'll see your 'majl box' included in the list. Open it up and you are

one element in the list on the left. This is the 'header' and you should select it and press the EDIT button. Now you can enter the Email address of the recipient and any subject the message may have.

### Drag 'n' drop

The easiest way to create a message is to drag and drop icons into the window. Create a text file and save it. Then find the icon and drag it into the window. You can drag and drop IFF images, LHA files or just about anything you can imagine. MetaTool will package them all up and when you click on SEND or DISPATCH it will use the mailer program you have running

quester so you can select the file. When you receive a Mime message, you can view it in MetaTool simply by clicking on the constituent parts in the message list. But how does the Amiga know what to do with each type of file? This is the tricky section but it's the only way to really harness the power of the Mime system.

### MimeTypes

To alter what happens to existing files or to add support for your own specific application programs, you will need to enter the murky

world of the files called 'mailcap' and 'mime.types'. Both are in the MetaTool drawer and you should edit both with a standard text editor. Before you start message about with them, it might be a good idea to make a copy.

The first file, mime.types, is to help MetaTool work out what sort of file you have just dropped on top of it. By default it will recognise many graphics formats, as well as the Amiga specific AmigaGuide format. Here is how the AmigaGuide format is included: **text/x-aguid guide GUIDE** It's nothing too amazing: the file is obviously text based, so the definition begins with 'text/'. It's not a standard extension so there is an 'x-' added to make this clear. Then we have the possible file extension names in upper and lower case.

The mailcap file tells MetaTool what to do when a Mime file is received. Figure 3 shows how it mentions AmigaGuide files: The matching line in the mailcap file tells MetaTool that when a x-aguide file is shown, the Amiga must use MultiView. That's what the section 'MultiView %s' means, as the '%s' will be replaced with the filename.

The last part of the line tells MetaTool what to do when the file is edited. In this case, the emacs program is spawned. You may not have emacs on your Amiga and you may want to edit this line to reflect your own choice, such as CygnusEd or GoldEd.

You can extend this system yourself to both control what application is triggered to take card of an incoming partial and to add support for many other file types. As long as both your system and the system of whoever you are sending the message to have suitable entries in mime.types and mailcap you should be able to send anything by Email. ■

John Kennedy

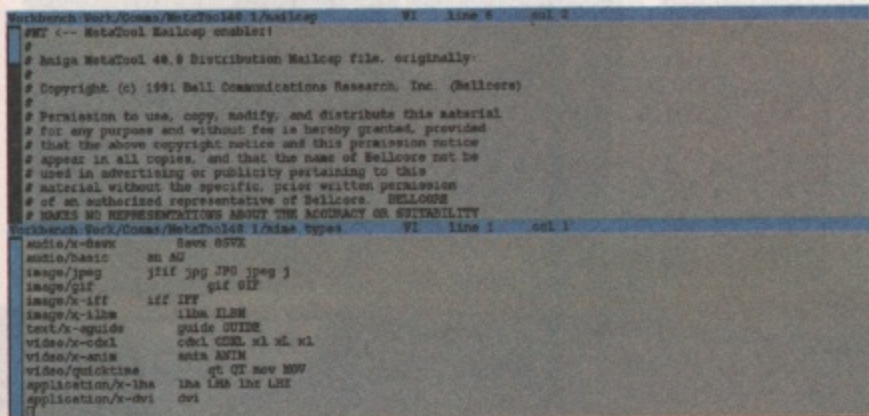

▲ Mailcap and meta.types are the two magic files for determining what happens when you send and receive Mime mail.



▲ Cruel but funny - Mime can be used to send pictures as easily as text. I don't think I'll be forgiven for a while when my subject claps eyes on this image of her.



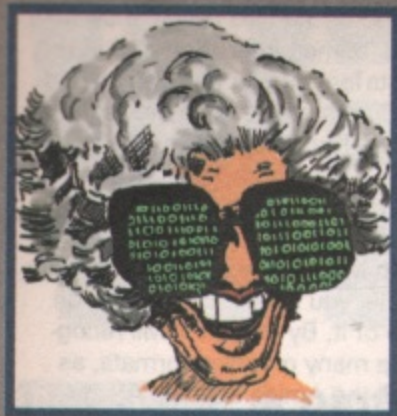

## Net God speaks

AT's Surf Amiga Pack is currently only on sale in Berlin as a marketing exercise before it is released to the rest of the world. Soon to be released to the rest of us via the normal Amiga distribution channels, it's caused quite a debate.

The main cause for concern is because it consists of a stock 2Mb A1200 bundled with software largely reliant on MUI. Anti MUI types moan about the fact that MindWalker (formerly the Voyager browser), AmiRC and AmFTP are all reliant on MUI. Whilst MUI advocates criticise the decision to supply a machine with only 2Mb specification. Although I can see valid points on both sides I fall into the latter group (because IMHO MUI is a good thing). However, getting on the Internet on a 2Mb machine was going to be hard enough but with MUI ... Let's just say that I'm eagerly awaiting the software suite so that I can witness AS225, MUI and Mind Walker actually running in 2Mb of memory. It seems to me that AT can't have it both ways. They can't argue that the Amiga is so efficient that it'll function with 2Mb of RAM whilst simultaneously bundling next generation resource hungry software. The sooner we have a 4Mb base specification the better.

# Surf's up!

**Big, big, big news this month: the Amiga Technologies Surf Pack is on sale. In Berlin. Don't worry it'll be with us soon. However, it's already whipping up a storm of controversy on the net ...**

### Aminet goes down

The chief Aminet site at Washington University in St. Louis USA has crashed spectacularly due to a hard drive failure in the middle of February, at the time of writing of this article. Ordinarily, a simple fault that could be repaired quickly, it's a different matter when you're talking about 64 Gigabytes of hard drives going down. The system was still down at time of going to press. Only when we at CU Amiga are without our regular Aminet feed do we appreciate exactly how wonderful a thing the Aminet is. Blank lines are piling up on the recent lists and Amiga PD/shareware junkies the world over are wishing Wuarchive a speedy recovery at the earliest opportunity. Wuarchive, please come back to us!

### New network provider

IMM Studios have announced a move into Internet providing. An internet 'Cybermall' is to be launched soon selling a range of Amiga hardware and software including the A4000T thereby allowing customers to view before they buy. After sales technical support will also be on offer. The Amiga network consists of many Amigas from the A1200 to an A4000/060 specially used for CD32 Scala presentations which are implemented and then pressed onto CDs for interactive touch screen kiosks. IMM say many more projects are due to come on-line in the next month. At the moment no dial in access is available although users are able to hire web space for personal design or contract IMM to design WWW pages for them. You can contact them on <http://www.immstudios.com/amilon>

### Non MUI WWW wins favour

As the rant on the far left explains MUI has a lot of fans and a lot of enemies. The current crop of WWW browsers on the Amiga, both on general release and in Beta, use MUI to formulate the complex GUIs needed for such features as Forms etc. Lately, however, a new Dutch browser by the name of AWeb has been in Beta testing. It's simple non-MUI interface and its stable nature (unlike much of the crash prone competition) has found favour among many users. An official AWeb demo can be found on CU Amiga's CD complete with documentation in HTML format. There's also quite a bit of other WWW pages present so check it out in the Comms drawer if you have the CD issue. AWeb's author, Yvon Rozijn, is continuing development on AWeb and hopes to make a general HTML-2 release in March (the CD version is limited to local access). For further information contact: <http://huizen.dds.nl/~aweb/>

### Termite TCP at WOA London

Oregon Research, the company responsible for the Termite terminal package, has announced plans to show a new TCP/IP package at the World of Amiga show in London on April 13th-14th. Oregon say the package was written from scratch to provide a TCP/IP package which requires no knowledge of networking or communications and features completely automatic installation and connection to Internet services. The ensemble of provided clients and utilities is not yet determined nor has a retail price been set. Oregon say they originally planned to release the

package at WOA but this has been delayed due to illness.

### Hi-Soft distribute IBrowse

The MUI based WWW Browser, IBrowse, is probably the most fully featured browser currently available on the net. The authors have always aimed to release it commercially but only recently have announced that Softwood will distribute it in the US and Hi-Soft in the UK. A demo beta of IBrowse is available at <http://www.omnipresence.com/ibrowse/>



▲ The new Amiga surfer pack: the cause of much on-line controversy.



# Sound Lab

## FAQ Special



**Q.** Why can't I use stereo samples in Amiga trackers like OctaMED and Protracker?

**A.** A stereo sample is two mono samples and trackers work on the basis of four mono channels. The Amiga has only two stereo channels and you can't play a stereo sound through a mono channel. However, if different samples are played on each side of these two stereo channels, then four different sounds can be produced simultaneously.

**Q.** My Amiga 1200 uses 32-bit technology, so why can I only play 8-bit samples?

**A.** Most of your Amiga uses 32-bit components, but the Paula chip, which handles the sound among other things, has 8-bit architecture. Unfortunately this was not upgraded when the rest of the Amiga architecture jumped to 32-bits.

**Q.** Why doesn't my Amiga appear to slow down, even when it's playing a high quality music module?

**A.** The audio hardware gets on with the business of playing samples without having to trouble the CPU while it does so, leaving the CPU free to handle all of its other tasks, hence there's no noticeable slow down.

**Q.** Some module players claim to play modules in 14-bit resolution. How come?

**A.** The Amiga's sound channels have 8-

We get asked all kinds of questions about Amiga sound. Here are some of the most common.

bit resolution with an extra four bits per channels for the volume information. These bits are combined resulting in a total of 14-bit output.

**Q.** Why do none of the Amiga music programs allow you to play samples in reverse?

**A.** They use the Amiga's built-in sample replay functions, which do not include reverse sample replay. However, OctaMED SoundStudio will allow this when it is released.

**Q.** I want to play very large sound samples straight from my hard drive. Is this possible?

**A.** Yes. Technosound Turbo II Pro will record and replay samples as large as your spare hard drive space. There are also PD tools that do the same thing, such as HD Frequency. OctaMED SoundStudio also promises this.

**Q.** I want to load modules from demos into my tracker to find out how they were made. Can I do this with single file executable demos or demos that use a strange disk format?

**A.** Yes. You need a 'ripper'. There are many rippers available in the public domain. You load the demo, then quit or reset and run the ripper program. This searches the memory for modules and saves them out to disk if it finds any.

**Q.** When I sample sounds from my hi-fi I

always get some interference. Where does this come from and what can I do about it?

**A.** This could be generated by a number of things: your monitor or TV, extra peripherals you may have plugged into your Amiga, or even an internal hard drive. Disconnect everything and try sampling with the absolute minimum set-up, then add more to the system until you find what is making the noise.

**Q.** What's the best sampler to use?

**A.** Most 8-bit samplers are very similar in design and there's little to choose between them. CU Amiga Magazine's preference is Megalosound from HiSoft. DSS8 Plus, available from Power Computing, is another good one.

**Q.** What's the best 16-bit sampler?

**A.** The best value 16-bit sampler is Aura from HiSoft. Toccata (see review this issue) from MacroSystem is preferred by many and has good support from OctaMED SoundStudio. The Sunrize AD516 is the best you can buy and is used by many professionals for digital audio-visual work.

**Q.** Will 16-bit samplers replace my Amiga's four 8-bit channels with four 16-bit channels?

**A.** Aura adds a stereo 12-bit channel, Toccata adds a stereo 16-bit channel, and Sunrize AD516 adds two stereo 16 bit channels. This is in addition to

the original Amiga audio channels which remain available exactly as they always were.

**Q.** What is the difference between a tracker and a sequencer?

**A.** A tracker works primarily with Amiga samples. Notes are entered onto a scrolling numeric display, with optional commands entered to alter the way samples are played. They normally have an integrated sampler and sample editor section. Some, such as OctaMED, can also play and record MIDI instruments. A sequencer is geared towards recording and playing MIDI instruments, normally with limited facilities for replaying Amiga samples. Many 'traditional' musicians find the style of a sequencer much easier to use than a tracker. To generalise, notes are programmed into a tracker, but played into a sequencer.

**Q.** What is the best tracker available?

**A.** There are two main contenders: ProTracker and OctaMED. There are also many other similar trackers, all of which are PD or shareware, each with its own particular strengths.

**Q.** What is the best sequencer around?

**A.** This is another two horse race. In this case the horses are Bars and Pipes Pro and Music X 2.0. Bars and Pipes offers a lot more power and flexibility, thanks to its modular system that allows plug-ins to be written for linking to a variety of hardware and software, such as AD516, Triple Play Plus (48-way MIDI interface), One Stop Music Shop (Proteus synth on a Zorro card), Toccata and more. Music X scores with its relative simplicity, some unique working methods and because it has been around long enough to build up a large following. ■ Tony Horgan.







POSTAGE & PACKING  
 UK - INCLUDED  
 EUROPE - £ 2.00  
 REST OF WORLD - £ 3.50

# Premier Mail Order

TEL: 01268 271172  
 FAX: 01268 271173

Please Send Cheques/POs Made out to Premier Mail Order or Visa/Mastercard/(Switch + Issue No) & Expiry Date to:  
 Dept: CU04 9-10 THE CAPRICORN CENTRE, CRANES FARM ROAD, BASILDON, ESSEX SS14 3JJ  
 Mon-Fri 9am-7pm Sat&Sun 10am-4pm. Please note: Some titles may not be released at the time of going to press.  
 Most titles are despatched same day, but can take up to 28 days. VAT IS INCLUDED on all titles. E&OE

500 1200 CD		500 1200 CD		500 1200 CD		500 1200 CD																																									
Attack Sub	10.99	Heart of China	12.99	Subversion	8.99	<b>JUNIOR ADVENTURES</b>																																									
Tank Killer	12.99	Help! Compilation - Sensible Soccer Euro	12.99	SUBWAR 2050	12.99	Robin Hood (8+)	13.99																																								
Approach Trainer	26.99	Champs, Push Over, Road Rash, Cool Spot, The Humans, Desert Strike	17.99	Super League Manager	19.99	Scrooge - Xmas Carol (8+)	13.99																																								
Attack Compilation - Guardian, Roadkill	11.99	History Line 1914-18	12.99	Super Stardust	22.99	Skeleton Krew	7.99 4.99																																								
Super Skidmarks	19.99 19.99	Hook	8.99	Super Streetfighter 2	20.99	The Three Bears (5-10)	13.99																																								
BLITZ COMPILER	29.99	Hudson Hawk	6.99	Super Street Fighter 2 Turbo	20.99 20.99	Wind In The Willows (6+)	13.99																																								
Hodams Family	8.99	Immortal	10.99	Super Tennis Champ	17.99	Wizard Of Oz	13.99																																								
Haddin	19.99	Indy Jones - Atlantis Adv.	12.99	Superfrog	12.99	<b>JOYSTICKS &amp; ACCESSORIES</b>																																									
Indy Breed 3D	22.99 22.99	Indianapolis 500	10.99	Supremacy	10.99	AAR ANALOG ADAPTER REQUIRED																																									
Indy Breed 3D 2-Killing Grounds	22.99	Insight Dinosaurs	14.99	Syndicate	12.99	10 Capacity 3.5" Disk Box	1.99																																								
Indy Olympics	19.99	Intelligent Strategy Games Chess, Bridge, Go, Backgammon, Checkers, Renju, Gomoku, 4 in A Line, Chinese Chess	19.99	Tactical Manager	19.99	50 Capacity 3.5" Disk Box	5.99																																								
Indy Terrain Racer	19.99 19.99 19.99	International One Day Cricket	9.99	TACTICAL MANAGER 2	19.99	100 Capacity 3.5" Disk Box	7.99																																								
Indy Agassi Tennis	19.99 19.99 19.99	IntOS - AMOS	16.99	Team Yankee	12.99	4 Player Joystick Adapter	4.99																																								
Indy Another World	12.99	ITS Cricket	18.99	Test Match Cricket	7.99	Accelerator 68020 EC Bare for A500+	95.99																																								
Indy Boya	8.99	James Pond 3	8.99	Terminator 2	6.99	AMITEK FUSION GENLOCK	94.99																																								
Indy Arabian Knights	8.99 9.99 12.99	Jimmy White's Snooker	12.99	The Clue	19.99 17.99	Analogue Joystick Adaptor	4.99																																								
Indy Arcade Pool	8.99	John Madden Football	10.99	The Games	10.99	Automatic Joystick/Mouse Splitter	14.99																																								
Indy Archer Macleans Pool	10.99	Jungle Strike	21.99 21.99	THE KILLING GROUNDS	22.99 22.99	CH FLIGHTSTICK (ANALOGUE)	29.99																																								
Indy Archery	19.99 19.99	KGB	12.99	THEME PARK	4.99	Competition Pro Joypad for CD32	13.99																																								
Indy Award Winners 2	19.99	Kick Off 3	9.99	Thunderhawk	12.99	External 880K Floppy Drive	59.99																																								
Indy B 17 Flying Fortress	12.99	Kick Off 3 European Champs	9.99	Tiny Troops	22.99	FreeWheel Steering Wheel	12.99																																								
Indy Banshee	19.99 19.99 19.99	Kid Chaos	19.99 19.99 21.99	Top 100 Games	9.99	Gravis Analogue Joystick	29.99																																								
Indy Base Jumpers	9.99	Kingpin	10.99 12.99 12.99	Total Football	22.99	Internal 880K Floppy Drive A500	47.99																																								
Indy Battlechess	19.99	Kings Quest 1, 2, 3, 4 or 5	12.99	Touring Car Challenge	12.99	INTERNAL 880K FLOPPY DRIVE A600/A1200	49.99																																								
Indy Battle Isle '93	17.99	Kings Quest 6	22.99	Tower Assault	13.99 13.99 22.99	Mouse	10.99																																								
Indy Behind The Iron Gate	16.99	Last Ninja 3	9.99	Tower of Souls	19.99 19.99	Mousehouse	1.99																																								
Indy Big Sea	19.99	Leading Lap	19.99 19.99	Traps & Treasures	17.99	Mousemat	1.99																																								
Indy Birds of Prey	12.99	Legends of Valour	12.99	Treble Champions 2	7.99	Joystick/Mouse Extension Cable	6.99																																								
Indy Black Crypt	10.99	Leisure Suit Larry 1 or 2 or 3	12.99	Triple Action - Vol 6 - Super Tetris + Airball + Time Bandit	9.99	Joystick Y Splitter	4.99																																								
Indy Blastor	17.99	Lemmings 1	19.99	Turbo Trap	19.99	Logic 3 Delta Ray Autofire JY156	10.99																																								
Indy BLITZ BASIC 2.1	22.99	Lemmings 3	19.99	Turning Points	12.99	Logic 3 Quatro GT Autofire JT155	10.99																																								
Indy Blitz Bombers	19.99 19.99	Links - The Challenge	12.99	U.F.O.	12.99 12.99	Logic 3 Quatro JT154	8.99																																								
Indy Blitz Tennis	19.99	Lion King	19.99	Ultimate Body Blows	22.99	Logic 3 Alpha Ray - Autofire	10.99																																								
Indy Body Blows Galactic	22.99	Lombard RAC Rally	6.99	Ultimate Golf	8.99	Logic 3 Sigma Ray - Autofire	12.99																																								
Indy Bravo Romeo Delta	8.99	Lotus Trilogy - Lotus 1,2,3	9.99	Ultimate Soccer Manager	19.99 19.99	POWER SUPPLY UNIT	39.99																																								
Indy BREATHTLESS	26.99	Lure Of The Temptress	12.99	Uncovered	17.99	Quickjoy Hyperpad SV136	8.99																																								
Indy Brutal Paws of Fury	19.99 19.99	M1 Tank Platoon	12.99	Virocop	17.99 17.99	Quickjoy Pedals SV129	9.99																																								
Indy Brutal Football	13.99 19.99	Manhunter "New York"	12.99	VIRTUAL KARTING	19.99	Quickjoy II Turbo SV124	10.99																																								
Indy Bubble & Squeak	17.99 19.99 19.99	Manhunter "San Francisco"	12.99	Vital Light	19.99	RAM Board - A1200 - Bare	59.99																																								
Indy Budokan	10.99	Martians Marvelous Adv	19.99	Watch Tower	19.99	RAM Expansion 4 MEG 72 Pin SIMM	119.99																																								
Indy Burntime	17.99 17.99	Master Axe	19.99 19.99 19.99	Wheel Spin	19.99	RAM Expansion 8 MEG 72 Pin SIMM	239.99																																								
Indy Campaign 2	12.99	Megatraveller 1 or 2	12.99	Wild Cup Soccer	17.99 17.99 8.99	RAM Expansion 16 MEG 72 Pin SIMM	445.99																																								
Indy Cadaver/Pay Off	12.99	Messengers Of Doom	19.99	Wing Commander	12.99	Saitek Megagrip 2 Autofire MX220	10.99																																								
Indy Cannon Fodder 2	19.99	MICROPROSE GOLF	12.99	Winter Gold	12.99	Saitek Megagrip 7-MX732 (Analog)	13.99																																								
Indy Cannon Fodder	12.99	Midwinter Warriors	19.99 19.99	Wizard	10.99	Screenbeat 3 Speakers SB203	12.99																																								
Indy Cardbox	8.99	Midwinter	10.99	World Class Leaderboard	10.99	Screenbeat 4 Speakers SB204	11.99																																								
Indy CHAMPIONSHIP MANAGER 2	19.99	Midwinter 2	12.99	World Cup Golf	29.99	Screenbeat 5 Speakers SB205	11.99																																								
Indy Champ Manager End Of Season	11.99	Mighty Max	17.99 19.99	WORLD CUP YEAR '94	19.99	Screenbeat 25 Speakers SB 225	21.99																																								
Indy CIVILISATION	12.99	Military Masterpieces	19.99	World Of Ciplart	9.99	Screenbeat Pro 50 Speakers SB250	32.99																																								
Indy Classic Collection - Dolphins - Flashback, Cruise For A Corpse, Another World, Future Wars, Operation Stealth	16.99	Mini Office	35.99	World Of Games	9.99	Screenbeat RCA Adapter Cable	1.99																																								
Indy Classic Golf - Lucas Arts - Monkey Island, Indy Jones & Last Crusade Adv, Loom, Zak McKracken, Maniac Mansion	19.99	MONKEY ISLAND 1 OR 2	12.99	World Of GIF	9.99	Screenbeat Power Supply	7.99																																								
Indy ClockWiser	9.99 9.99 9.99	Morph	17.99	World Of Pinups Vol 1	12.99	Suncom Analogue Edge II (Analog)	14.99																																								
Indy Club Football	9.99 9.99	Mr. Nutz	27.99	World Of Pinups Vol 2	12.99	Suncom Flight Max (Analog)	27.99																																								
Indy GOALA	19.99	Music X 2.0	24.99	World Of Photo	9.99	Suncom FX2000 (Left & Right Handed)	17.99																																								
Indy Colonels Bequest	10.99	MULTI MEDIA EXPERIENCE	24.99	World Of Sound	9.99	Thrustmaster XL Joystick	27.99																																								
Indy Colonisation	22.99	Mutant League Hockey	17.99 17.99	World Of Video	9.99	<b>Amiga CDROM</b>																																									
Indy Combat Classics 1 - F15 II, 688 Attack Sub, Team Yankee	19.99	Napoleonics	12.99	World Of Football	19.99	<b>Glamour Titles - Over 18 Only</b>																																									
Indy Complete Chess	22.99	Navy Moves	6.99	World Of Golf	17.99	Asian Dream Girls 1 or 2	14.99																																								
Indy Core A1200 Bundle - Skeleton Krew, Banshee, Heimdal 2	12.99	Nigel Mansells W/Champ	8.99	World Of Soccer	7.99	Asian Pleasures 1 or 2 or 3 or 4	29.99																																								
Indy Core CD32 Bundle 1 - Banshee, Heimdal 2, Universe, Skeleton Krew	22.99	Odyssey	17.99	Worlds at War	6.99	Coloureds & Asians	10.99																																								
Indy Core CD32 Bundle 2 - Bubba n Stix, Premier, Chuck Rock 1+2	16.99	ON THE BALL-WORLD CUP EDITION	9.99 9.99	Worlds of Legend	12.99	European Dream Girls 1 or 2 or 3	14.99																																								
Indy Cosmic Spacehead	17.99	On The Ball-League Edition	19.99 22.99	WORMS	19.99	Hot Pie	9.99																																								
Indy Covergirl Poker	12.99	Operation Hammer	8.99	Wreckers	8.99	Hot Spot Women 1 or 2 or 3	15.99																																								
Indy Craft for AMOS	17.99	Operation Stealth	11.99	WWF 1 or 2	16.99	Photo Studio	15.99																																								
Indy Cruise For A Corpse	12.99	Oriental Games	8.99	X-IT - Zonked	19.99	Pin Up Girls Vol 2	16.99																																								
Indy Cybercon 3	10.99	Ostrun Europa	8.99	XP 8	6.99	Pixels of Passion 1 or 2 or 3	29.99																																								
Indy Cyberspace	22.99	Overdrive	8.99	Z-Out	6.99	Scandinavian Cover Girls 1 or 2 or 3	15.99																																								
Indy D Generation	12.99 17.99	Overlord	22.99	ZEE WOLF 2 - WILD FIRE	25.99	<b>3.5" Blank Discs</b>																																									
Indy Dark Seed	12.99 19.99	Patrician	12.99	<b>SPECIAL OFFERS</b>		<table border="1"> <thead> <tr> <th colspan="2">TDK</th> <th colspan="2">PRECISION</th> <th colspan="2">UNBRANDED</th> </tr> <tr> <th>Low</th> <th>High</th> <th>Low</th> <th>High</th> <th>Low</th> <th>High</th> </tr> </thead> <tbody> <tr> <td>10</td> <td>5.99</td> <td>6.99</td> <td>3.99</td> <td>5.99</td> <td>3.50</td> <td>4.99</td> </tr> <tr> <td>20</td> <td>11.50</td> <td>13.50</td> <td>7.50</td> <td>11.50</td> <td>6.50</td> <td>9.50</td> </tr> <tr> <td>50</td> <td>27.50</td> <td>32.50</td> <td>17.50</td> <td>27.50</td> <td>16.25</td> <td>22.50</td> </tr> <tr> <td>100</td> <td>52.50</td> <td>62.50</td> <td>32.50</td> <td>52.50</td> <td>29.99</td> <td>42.50</td> </tr> </tbody> </table>		TDK		PRECISION		UNBRANDED		Low	High	Low	High	Low	High	10	5.99	6.99	3.99	5.99	3.50	4.99	20	11.50	13.50	7.50	11.50	6.50	9.50	50	27.50	32.50	17.50	27.50	16.25	22.50	100	52.50	62.50	32.50	52.50	29.99	42.50
TDK		PRECISION		UNBRANDED																																											
Low	High	Low	High	Low	High																																										
10	5.99	6.99	3.99	5.99	3.50	4.99																																									
20	11.50	13.50	7.50	11.50	6.50	9.50																																									
50	27.50	32.50	17.50	27.50	16.25	22.50																																									
100	52.50	62.50	32.50	52.50	29.99	42.50																																									
Indy Deluxe Paint V	59.99	PGA European Tour	19.99 21.99 21.99	Body Blows	12.99 12.99	<table border="1"> <thead> <tr> <th colspan="2">RECYCLED DS/DD Low Density</th> </tr> <tr> <th>10</th> <th>2.99</th> </tr> <tr> <th>20</th> <th>5.50</th> </tr> <tr> <th>50</th> <th>12.50</th> </tr> <tr> <th>100</th> <th>22.50</th> </tr> </thead> </table>		RECYCLED DS/DD Low Density		10	2.99	20	5.50	50	12.50	100	22.50																														
RECYCLED DS/DD Low Density																																															
10	2.99																																														
20	5.50																																														
50	12.50																																														
100	22.50																																														
Indy DELUXE VIDEO 3	66.99	PGA Tour Golf	12.99	Bubba n Stix	4.99	<b>PD &amp; Shareware</b>																																									
Indy Demomaniac	17.99	Pinball Dreams & Fantasies	22.99	Chuck Rock	4.99	<b>BUSINESS</b>																																									
Indy Desert Strike	12.99	Pinball Fantasies	19.99 24.99	Chuck Rock 2	4.99	B001 A-Genie (1 meg)	1.25																																								
Indy Dogfight	12.99	Pinball Illusions	19.99 19.99	ClockWiser	8.99	B002 Business Card Maker	1.25																																								
Indy Dune 1 or 2	22.99	PINBALL MANIA	19.99	Cool World	8.99	B003 Database Master	1.25																																								
Indy DUNGEON MASTER 2	12.99	Player Manager 2	13.99	Corporation	4.99	B004 Ami Cash	1.25																																								
Indy Elite	19.99	PLAYER MANAGER 2 EXTRA	13.99	Crystal Dragon	12.99	B005 Amibase Prof	1.25																																								
Indy Elite 2 - Frontier	19.99	Pole Position	19.99 19.99	Dennis	4.99	B006 600 Business Letters	1.25																																								
Indy Embryo	17.99	Police Quest 1 or 2 or 3	12.99	Dragonstone	4.99	B007 Text Engine	1.25																																								
Indy Emerald Mines	12.99	Populous & Promised Lands	12.99	Fly Harder	12.99	B008 PC Task	1.25																																								
Indy Empire Soccer '94	19.99	POPULAR 2	12.99	Football Glory	8.99 8.99	B011 A-Graph	1.25																																								
Indy Epic	12.99	POWERBASE V3.5(DATABASE)	12.99	Heimdal 2	4.99	B013 Analytic ALC	2.50																																								
Indy European Champions	10.99	Powerdrive	19.99 19.99 19.99	Heimdal 2	4.99	B015 Stock Analyst	1.25																																								
Indy EXILE	9.99 19.99 19.99	Powerhouse	22.99 22.99	Heimdal 2	4.99	B016 Little Office	1.25																																								
Indy Exterminator	17.99	Powermonger & D/Disk	12.99	Jaguar XJ220	4.99	B017 Budgets V1.34	1.25																																								
Indy Extractors	19.99	Prem Man 3 Multi Edit Sys	10.99	J Nicklaus Designer Clip Art	7.99	<b>EDUCATIONAL</b>																																									
Indy EXTREME RACING	19.99 19.99	Prime Mover	17.99	Jetstrike	9.99 9.99 9.99	E002 The Bible (4 Disks)	4.99																																								
Indy Eye Of The Beholder 1 or 2	12.99	PRIMAL RAGE	19.99	Last Ninja 3	9.99	E003 World Databank	1.25																																								
Indy FORMULA ONE GRAND PRIX	12.99	Project X	10.99	Mean Arenas	12.99	E004 GCSE Maths	1.25																																								
Indy F1	12.99	Pro Tennis Tour	6.99	MICROPROSE GOLF	12.99	E006 Total Concepts	1.25																																								
Indy F1 World Champ Edition A500+	19.99	Pushover	8.99	Morph	7.99	E007 Bank Talk	1.25																																								
Indy F15 Strike Eagle 2	12.99	Pussies Galore	16.99 16.99	Myth	12.99	E008 Dunks DTP	1.25																																								
Indy F17 Challenge	10.99	Putty	8.99	Naughty Ones	12.99	E009 Colour The Alphabet	1.25																																								
Indy F19 Stealth Fighter	11.99	Putty Squad	19.99 19.99	Out To Lunch	12.99	E010 The Highway Code	1.25																																								
Indy F117A Stealthfighter	12.99	Qwak	9.99	Powergames	12.99	E011 Junior Maths	1.25																																								
Indy F29	10.99	Quest For Glory 1 or 2	12.99	Sabre Team	12.99	E012 Electronic Train Set (1 MEG)	1.25																																								
Indy FEARS	19.99 19.99	RBI Baseball 2	6.99	Sensible Soccer 92/93	12.99	E013 Learn & Play 1	1.25																																								
Indy Fields Of Glory	12.99 12.99 12.99	Reach For The Skies	12.99	Sensible Soccer International	12.99	E014 Learn & Play 2	1.25																																								
Indy FIFA Soccer	19.99	Realms	10.99	Shadowfighter	9.99 9.99	E015 Treasure Hunt	1.25																																								
Indy Final Over	10.99	Red Baron	12.99	SIMON THE SORCEROR 1	12.99 12.99 12.99	E016 Wrathful One	1.25																																								
Indy Fire Force	19.99	Rise Of The Robots	17.99 12.99 12.99	Steve Davis Snooker	4.99	E017 Story Land 2	1.25																																								
Indy Flashback	12.99	Risky Woods	10.99	Syndicate	12.99	E018 Wotstname	1.25																																								
Indy F Sim 2 Hawaiian Scenery	13.99	Roadkill	9.99 9.99	Tornado	9.99 9.99	<b>CREATIVE</b>																																									
Indy FOOTBALL STATISTICIAN PRO	26.99	Road Rash	10.99	Total Carnage	12.99	C002 Label Designer	1.25																																								
Indy Future Wars	10.99	Robocop 3	10.99	Torvak	4.99	C003 Super Fonts	1.25																																								
Indy Gamer Gold Collection - Bump N Burn + Jetstrike + Nick Faldo's Golf	19.99	Robinson's Requiem (A500+)	22.99 22.99 22.99	Universe	4.99	C005 Deluxe Paint Tutor	1.25																																								
Indy Gearworks	7.99	Rome AD92	12.99	Vikings	8.99	C006 Shadow Demo Maker	1.25																																								
Indy Global Effect	8.99	Rugby League Coach	19.99	Warzone	4.99	C007 Clip Art	1.25																																								
Indy GLOOM	19.99 19.99	Ruffian	13.99	WEMBLEY INTERNATIONAL SOCCER	7.99 7.99	C008 Illinois Labels	1.25																																								
Indy Gloom Data Disk	12.99	Sensible Golf	19.99	Wembley Rugby League	7.99	C011 Word Power	1.25																																								
Indy Gloom 2	19.99	SENSIBLE WORLD OF SOCCER 95/96	16.99	Wolfchild	4.99	C012 Font Farm	1.25																																								
Indy Gloom Deluxe	19.99	Settlers	19.99	Wonderdog	4.99	C013 Wine Maker	1.25																																								
Indy G Gooch-Second Innings	11.99	Shaq Fu	19.99 21.99	World Class Rugby 95	8.99	C014 Assassins	1.25																																								
Indy G Gooch-Test Match Special	19.99	Shuttle - S/Flight Sim	12.99	Zool	8.99	C016 Garden Designer	1.25																																								
Indy G GOOCH-WORLD CLASS CRICKET	9.99	Sierra Soccer	16.99	<b>EDUCATIONAL</b>		C017 X Beat	1.25																																								
Indy G Gooch - 94/95 Data Disk	4.99	Skidmarks	12.99	All Dogs Go To Heaven	7.99	<b>UTILITIES</b>																																									
Indy G Gooch - Battle for the Ashes	4.99	SKIDMARKS 2	19.99	Better Spelling (8-10)	13.99	U003 The Workshop	1.25																																								
Indy GROLIERS ENCYCLOPEDIA	22.99	Skidmarks 2 Data Disk	12.99	Better Maths (12-16)	13.99	U006 Address Book	1.25																																								
Indy Gremlin Four Pack - Lotus, Premier Manager 2, Space Crusade, Zool																																															





# QUIDS IN!

**Save pounds! Avail of our special offers and subscribe today to make sure that you don't miss out on what we've got lined up this year!**



**CU Amiga Magazine is the ultimate Amiga package, bringing you:**

## **The best tutorials**

Our in-depth features and step-by-step tutorials cover all the latest Amiga developments and programs. Plus there's the added bonus of new promotions including covermounted manuals with some of our hottest cover disk programs.



## **The best cover disks**

Only CU Amiga brings you exclusive and complete versions of Amiga's most desirable utilities. Imagine 3.0, PageStream 2.2, Amiga E and VideoStage Pro are just some of the great programs we've covermounted in the past six months.



## **The best previews and reviews**

CU Amiga Magazine is the choice of the world's top Amiga developers. That means we get exclusive previews and reviews of the latest and most exciting Amiga products. We were the first to bring you news on the Escom takeover, Team 17's top selling game Worms and much, much more.



**Special offer now open to readers worldwide**

## **HOW TO ORDER**

Tick which box applies to you on the form opposite, then fill in the rest of the form and send it along with payment to: CU AMIGA MAGAZINE, SUBSCRIPTIONS DEPARTMENT, EMAP CONSUMER MAGAZINES, LEICESTER LE87 4AB, UK. Free postage is available in the UK. UK subscriptions should send the completed form with payment to: CU Amiga Magazine, subscriptions department, EMAP Consumer Magazines, FREEPOST (LE5981) Leicester LE87 4AB.

**Or call the subscriptions Hotline on 01858 468888** (9.00am to 5.30pm)



# CU Amiga Magazine

As a special offer we've slashed the prices of our year's subscription rates worldwide and introduced a six month subscription option. What a bargain!

Six month subscriptions now available



## CU Amiga subscription priority order form

Please enter my subscription to CU Amiga Magazine.

Please tick/delete as required.

**Rates** - 12 issues including postage

- £36.00 UK 12 ISSUES FOR PRICE OF EIGHT (\*UK only, offer code: A1p)
- £58 (was £64) REST OF WORLD SURFACE MAIL
- £60 (was £74.00) EUROPE/EIRE AIR MAIL
- £78 (was 116.00) REST OF WORLD AIR MAIL ZONE 1
- £78 (was 116.00) REST OF WORLD AIR MAIL ZONE 2

**Rates** - 6 issues including postage (offer code: A1q)

- £27.00 UK
- £43.50 REST OF WORLD SURFACE MAIL
- £45 EUROPE/EIRE AIR MAIL
- £58.50 REST OF WORLD AIR MAIL ZONE 1
- £58.50 REST OF WORLD AIR MAIL ZONE 2

### Method of payment

Cheque/Postal Order/International Money Order payable to EMAP Images Ltd.

Access/Visa number.....Expires.....

Signature.....Date.....

Title.....Initials.....Surname.....

Address:.....

.....Postcode.....

Day time telephone no.....

**IMPORTANT:** 12 issues for the price of 8 offer available to UK residents only. Please allow 28 days for fulfilment from receipt of order.

Tick this box if you do not wish to receive any direct mail that EMAP Images Ltd feels may be of interest to you. Offer closes 30th April 1996. Source code:IA1u  
Note: Zone 1: Middle East, Africa, USA, South America, Hong Kong, Singapore, Pakistan, Indonesia; Zone 2: Australia, China, Japan, Pacific.



**PD AMIGA**  
**TOP QUALITY PD PROGRAMS AT LOW PRICES**



**FULL BRANDED DISKS**  
**LOTS OF SPECIAL OFFERS**  
**CALL FOR CAT. DISK**  
**(01698) 265 634**

**PENGUIN PUBLIC DOMAIN**

ART-ANIMATION-MUSIC  
 PLAYABLE DEMOS - FONTS  
 GAMES COMPILATIONS  
 CLIPART-ASSASSINS  
 MISCELLANEOUS-GAMES  
 DEMOS-MUSIC UTILITIES  
 EDUCATION-FINPACK 1-36  
 SCOPE 1-220-FRED FISH 1-1000  
 T-BAG 1-77 - SLIDESHOWS  
 UTILITIES-HAM RADIO  
 BUSINESS-JAM 1-10

**50P EACH**

POST AND PACKING FREE.  
 RING OR SEND FOR A FREE CATALOGUE

0589 722502

**AMIGA**

PO BOX 179  
 READING  
 BERKSHIRE  
 RG30 3DD  
 ENGLAND

**CLASSIC AMIGA**  
**PD Software**

Phone for a **FREE catalogue disk**  
**0161 723 1638**  
SHOP OPEN  
**12-9pm DAILY**  
**CD ROMS NOW AVAILABLE**

**11, DEANSGATE RADCLIFFE Manchester**

**ONLINE PD**  
**FREE 3 DISK CATALOGUE LISTING 10,000+ PD TITLES**  
**TEL: 01704 834335**



FRED FISH 1-1000  
 ASSASSINS GAME DISKS 1-255

OR SEND SAE

Every 10 disks ordered choose 1 **FREE**

Online Pd, Dept CU4,  
 1 The Cloisters, Halsall Lane,  
 Formby, Liverpool L37 3PX

**KEW = II**  
 SOFTWARE Est. 1989

THE BEST IN QUALITY PD & SHAREWARE  
 SUPPLIED ON BRANDED DISKS ONLY!

The LEADER -  
 OTHERS CAN ONLY FOLLOW!

FREE FRIENDLY HELP BY POST or PHONE ANYTIME!  
 FREE CLUB MEMBERSHIP  
 PICK YOUR OWN PROGRAMS!  
 BY NAME, NUMBER AND SIZE!  
 IT'S EASY!  
 500K makes 1 bootable disk!  
 800K makes 1 non bootable disk!

CATALOGUE WITH FULL DESCRIPTIONS & INDEX ONLY £1  
 Phone for the LATEST PROGRAMS!  
1-3 disks £1.50, 4 or more ONLY £1.25

P.O BOX 672  
 South Croydon  
 Surrey CR2 9YS  
 Tel: 0181 657 1617

**FREE P&P**

**STORK PD**  
**Tel: 01302 830 720**

**fast - friendly - efficient**

We are here for you, and what we haven't got we will soon get for you!

With disks from as little as 50p why pay more?

Just send 2 first class stamps for our catalogue disk

**STORK PD**  
 Dept. CU, 15 Rands Lane,  
 Armthorpe, Doncaster,  
 South Yorkshire DN3 3DZ

**ARNOLD COMPUTER SUPPLIES**

Blank Disks £15.00 per 50 inc. labels  
 DSHD Disks £22.50 per 50 (Pre-formatted)

**PD LIBRARY NOW OPEN!**  
 Please send 4 1st class stamps for catalogue.  
 Free local delivery and installation (10 mile radius)  
 Many more items stocked.  
 Please phone or fax for latest prices.  
**Barry Voce 0115 926 4973**  
**Fax 0115 956 1663**  
 11 Champion Street  
 Arnold, Nottingham, NG5 8GR

**Q. What's plastic, 3.5 inches and costs just 45p?**  
**A. A public domain disk from**

**NO MERCY SOFTWARE**

That's right, 45p per disk from 1-499 (bulk PD prices from 22p each - send for info)  
 Choose any PD list from any Amiga mag, then order from us, or send £1 or 4x1st class stamps for our catalogue disk and a FREE util or game (please state)  
 Cheques payable to:

**NO MERCY SOFTWARE**  
 3 HILL SIDE, GT. THIRKLEBY, THIRSK,  
 NORTH YORKSHIRE YO7 2AX  
 Phone 01845 526412 (between 6-8pm only)  
 0421 493916 (mobile)

**DELTRAX PD(CU)**  
 36 BODELWYDDAN AVE,  
 OLD COLWYN, COLWYN BAY,  
 CLWYD LL29 9NP  
 TEL/FAX 01492 515981

**AMIGA & IBM PC**  
 HARDWARE  
 PERIPHERALS  
 CD ROMS  
 COMMERCIAL SOFTWARE  
 VERY COMPETITIVE PRICES  
 PUBLIC DOMAIN/ SHAREWARE

**ONLY 95p PER DISK**

PLUS 60p P&P PER ORDER  
 STATE WHICH **FREE** PRINTED CATALOGUE YOU REQUIRE

**AMIGAHOLICS PD**

THE 100% AMIGA PD LIBRARY, WE STOCK; DEMOS, MUSIC, ANIMS, MUSIC UTILITIES, SLIDESHOWS, GAMES, LSD LEGAL TOOLS, UTILITIES, ASSASSINS GAME DISKS, FRED FISH, FONTS, CLIP-ART AND MUCH MORE.

**THIS MONTH'S TOP TEN**  
 MAGIC WORKBENCH 1.3 - Magic W/Bench for any Amiga  
 CARDZ - Use AGA Klondyke cards on ECS Amigas  
 SKIDMARKS 2 AGA CARS (2D) - 4 Extra cars for Skidmarks AGA  
 ARTCORE - Brilliant 3D Art Gallery/Slideshow Demo  
 JASON ART - Superb hand draw art  
 'SETTLERS' EDITOR - Have super fishermen, find all the gold etc.  
 'F1 G.P.' EDITOR - Latest version, '95 teams & frame accelerator  
 SCORCHED TANKS - Battle against a friend or computer  
 'DOG COGS' MUSIC DEMO - Great AGA demo (3D)  
 MYSTIC 'IMPOSSIBLE POSSIBILITY' - 2 Disks AGA demo

SPECIAL PD STARTER PACK FOR NEW 'A1200' OWNERS  
 THE VERY BEST OF P.D. GAMES & UTILITIES ETC.  
 EIGHT DISKS FOR ONLY £5.00  
 INCLUDES CAT DISK + P&P

DISKS FROM TOP TEN ONLY 80p EACH INCL. P&P

WE NOW DISTRIBUTE 'INFINITE FRONTIER' PRODUCTS INCL. THE 'FINAL FRONTIER MAG' No.9 AT £5.00 AND ALSO 'HOLODECK' AND 'ILLUSIONS' SLIDESHOWS AT £3.00 EACH (2 DISKS)

SEND 2 X 1ST CLASS STAMPS OR SAE FOR CAT DISK, WHICH INCLUDES GAMES AND MUSIC - PD DISKS FROM 50p

FREE P & P ON ALL ORDERS  
 Send cheques, PD's to  
 AMIGAHOLICS PD DEPT. CU  
 236 CHESTER ROAD NORTH  
 KIDDERMINSTER  
 WORCS DY10 1TE

**PD POWER**

WE STOCK OVER 10,000 DISKS

**PD FROM ONLY 25p**

For **FREE** CATALOGUE DISK + **FREE** GAME + **FREE** COPIER AND MORE

Please SAE to:  
**PD POWER (DEPT CU)**  
**15 LOVETOT AVENUE**  
**ASTON**  
**SHEFFIELD S31 OBQ**

**SOFTSELL**  
**AMIGA CLUB**  
 FULL PRICE GAMES FOR HIRE  
 RETURN POSTAGE PAID

Send a stamped SAE for a catalogue  
**Softsell (CU),**  
 16 Church Street,  
 Trowbridge, Wilts,  
 BA14 8DW



# BUILD MUSCLES FAST!

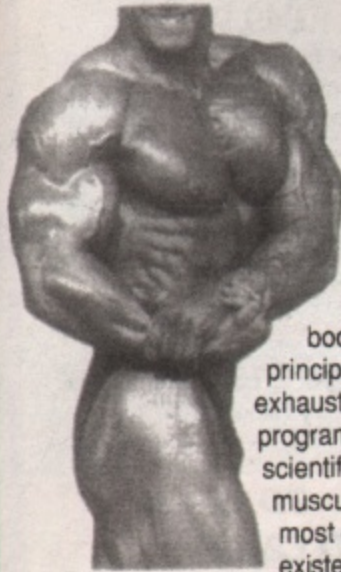

NEW! Fastest way to build muscles and strength without weights - EVER! Just 35 minutes daily in the privacy of your home will develop an amazing physique.

**MUSCLE DYNAMICS** is a new body building system based on principles developed after years of exhaustive research. It is a total exercise programme involving the very latest scientific breakthroughs in the field of muscular development. It is the fastest, most effective way to build muscles in existence.

Noticeable results in 28 days guaranteed.

Send for **FREE** Information Pack.

MUSCLE DYNAMICS, P.O. BOX 70, DOUGLAS, IM99 1EH.  
Tel: 0624 801023 (24 hrs)

MUSCLE DYNAMICS, P.O. BOX 70, DOUGLAS, IM99 1EH  
Yes! I want to build muscles fast. Please rush me a **FREE** information pack!

Name.....BLOCK  
Address.....CAPITALS  
Postcode.....PLEASE  
(A stamp for reply appreciated)

## KOBRAHSOFT QUALITY PD

Don't get bitten by buying cheap, poor quality P.D. we sell the best. If we haven't got what you want, please tell us and we will get it. We have over 8000 titles available, so we should have something to interest YOU! We pride ourselves on our speed of delivery - we try and send out every order on the same day it is received - no waiting for DAYS. We accept payment by cheque, P.O. and Access and Visa. To give you an idea of what we stock:-

### UTILITIES

MIDPLAY - plays music modules  
MOST V1.56 - Text Viewer  
INPUT LOCK V1.1 - Security Lock  
CHARACTER GENERATOR  
D.M.S. V2.03 - Data cruncher  
MDSPOOLER V1.2 - DIR Utility  
CD PLAYER V1.1 - Plays your CD's  
A BACK UP V4.03 - Back up utility  
ADAM V3.0 - Calculator  
VIRUS CHECKER - Detects viruses  
CALENDAR - Super Calendar Prog  
POWERCALC V1.5 - Draws graphs  
TURN V4.0 - Latest Comms program  
POWERPLAYER V4.0 - Music Util  
RECALL V2.3 - Diary program  
SCHEDULER V1.2 - Organiser

### GAMES

MISSILES OVER XERION  
NIBBY 2  
MUTANT PENGUIN  
MULTI TETRIS  
TIME RUNNERS 17  
RUNNERMINE 6  
MORTON STRIKES BACK  
SPIDERMAN 2  
DEADLOCK 8  
SPACEBALLS  
DONKEY KONG  
FLIGHT OF THE INTRUDER  
MEGABALL  
STEWARDS ENQUIRY  
GALAGA 92  
DEFENDER

We have hundreds more games and utilities and also:-  
DATABASES, GRAPHICS, ANIMATIONS, SLIDES, MUSIC AND SOUND DEMOS, EDUCATIONAL PROGRAMS, FONTS, CLIPART, BUSINESS PROGS. We also stock a wide range of Spectrum and Sam Utilities.

Prices:- Disk£1 each, or send £1 for CAT disk or order to:-  
KOBRAHSOFT, Pleasant View, Hulme Lane, Longton, Stoke-on-Trent. ST3 5BH;  
or phone 0178 230 5244. We also take Access and Visa.  
P+P U.K. 25p; others 50p

## HORNESOFT PD

ESTABLISHED 1990 MON - SAT 9.30AM - 7PM  
TEL/FAX 0114 296 7825  
DEPT (CU) 23 STANWELL CLOSE, WINCOBANK, SHEFFIELD S9 1PZ

### PD PRICES (PER DISK)

1 - 5 .....65p  
6 - 9 .....60p  
10 + DISKS ...50p

or send your own disks and pay just 30p per disk

### OVER 16000 DISKS AVAILABLE

for our catalogue disk send 2x1st class stamps  
WE STOCK F1 & 5D LICENCEWARE  
or ask for a free cat disk when ordering game below!

BLACKDROWN II - £2.95 (5D LICENCEWARE)

Great Dungeon style game.  
Complete version now on 5D Licenceware.  
Price includes postage and a FREE catalogue disk

CREDIT CARD HOTLINE: 0114 296 7825

## FREE FREE

GAMES CHEATS 1.4 EMULATOR

ON ALL ORDERS

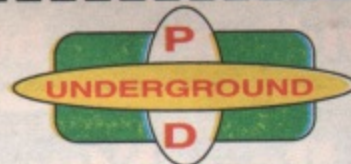

## FREE FREE

LIBRARY DISK POST & PACK

ON ALL ORDERS

### PLATFORM GAMES

- Q 1036 A12 NEQUICK
- Q 1296 HARRY HADDOCK
- Q 1320 CAVE MAN NOT 1.3
- Q 1322 NICKY 2 NOT 1.3
- Q 1321 AIR TAXI NO 1.3
- Q 1330 CAPTAIN BONUS
- Q 1233 ROACH MOTEL
- Q 1221 DUDES NOT 1.3
- Q 1225 BOUNCER NOT 1.3
- Q 1218 TRAP-EM NOT 1.3
- Q 1217 DUCK DODGERS
- Q 1365 A12 ORANGE MAN
- Q 1339 THE TIME LORD

### SPACE BLASTERS

- Q 911 SOLO ASSAULT
- Q 906 OBLITERATOR
- Q 498 THE LAST REFUGE
- Q 1139 TRACER NOT 1.3
- Q 1192 A12 D.N.X. 2 DISK

### ARCADE GAMES

- Q 1308 PSSST A1200
- Q 1295 A1200 APPLEJACK
- Q 1319 PEPSI NOT 1.3
- Q 1327 A12 ROCKET V2
- Q 1281 A1200 FUN HOUSE
- Q 1316 FRACUS
- Q 1328 GEEK!
- Q 555 HUGO V2.5 DISK
- Q 976 BEAVIS & BUTTHEAD
- Q 273 KELLOGG EXPRESS
- Q 1207 SHOOT BADDIES
- Q 1168 S.TANKS V1.8
- Q 1237 ARTILUS NO 1.3
- Q 1363 PUNICA
- Q 1368 ALIENS F.F.
- Q 1367 THE STIMPSONS
- Q 1374 A12 MARATHON
- Q 1338 STRIKE COMMAND

### P.D. VERSIONS

- Q 025 HUNTER PLUS
- Q 022 GODS-TMACHINE
- Q 026 ROBOCOP-T/RECALL
- Q 815 LEMMING'S PACK
- Q 023 RICK DANGEROUS
- Q 941 FATAL BLOWS
- Q 938 MARTIAL SPIRIT
- Q 290 FIGHT WARRIORS
- Q 1068 2DSK CYBERGAME
- Q 1238 WEAPON MASTERS

### COMBAT GAMES

- Q 011 ASTEROIDS
- Q 693 MISSILE COMMAND
- Q 778 OVERLANDER
- Q 692 SPACE INVADERS
- Q 841 COOKIE
- Q 308 DONKEY KONG
- Q 1336 A12 AUTOS 2 DISKS
- Q 974 F1 EDITOR 945
- Q 951 FLAMMING ENGINES
- Q 469 THE ROAD TO HELL
- Q 1059 MANSELL NOT 1.3
- Q 1055 2DK HYPERACE A12

### SIMULATORS

- Q 1325 A12 TANKS 2 DISKS
- Q 1329 BASEBALL GAMES
- Q 926 HELICOPTER
- Q 332 SEALANCE-SUB
- Q 333 BATTLE CARS V2
- Q 1273 A12 TRAIN DRIVER

### SPORT GAMES

- Q 1014 CRAZY GOLF
- Q 366 GOLF 18TH 2 DISK
- Q 822 CRICKET AMOS V2
- Q 630 TEN PIN BOWLING
- Q 104 FUTURE FOOTBALL
- Q 1171 2 DSK CRS-ANGLER
- Q 1373 ICE HOCKEY
- Q 1317 A12 GON FISHING
- Q 1251 PLAY TENNIS

### HINTS & CHEATS

- Q 418 1000 CHEATS
- Q 931 BACKDOOR V3
- Q 821 PASSWORD MANIA
- Q 813 GAME TAMER V4.5
- Q 820 MEGA CHEATS
- Q 681 SIERRA SOLUTIONS
- Q 1118 UP TO DATE V1
- Q 1358 GAME SOLUTIONS
- Q 1328 ADULT JIGSAWS
- Q 1324 A12 B-FEST 2 DISKS
- Q 1307 TERRORLINER V3
- Q 997 2 DSK ADVENT V1
- Q 1001 2 DSK ADVENT V2
- Q 101 TERROR LINER V1
- Q 712 TERROR LINER V2
- Q 1081 ADULT TETRIS
- Q 1176 A12 NUMBERS V2
- Q 1248 STRIP POKER
- Q 1145 A12 NUMBERS V1
- Q 1335 ADULT DROIDS

### MANAGER GAMES

- Q 876 SCOTTISH LEAGUE
- Q 404 METROS MANAGER
- Q 321 AIRPORT
- Q 322 MICRO MARKET
- Q 443 SLAM BALL
- Q 817 BLOOD BALL
- Q 1033 TAZ QUIZ NOT 1.3
- Q 1031 TREK TRIV 5 DISK
- Q 716 POP MUSIC QUIZ
- Q 309 THE QUIZ MASTER
- Q 462 WHEEL OF FORTUNE
- Q 1037 MARBLES GAME
- Q 1035 ATOMIC GAME
- Q 603 EXIT 13
- Q 442 REVERSI V2
- Q 119 DRAGON'S TITLES
- Q 112 DRAGON'S CAVE
- Q 1369 BOOM'N ECK!

### QUIZ GAMES

- Q 1033 TAZ QUIZ NOT 1.3
- Q 1031 TREK TRIV 5 DISK
- Q 716 POP MUSIC QUIZ
- Q 309 THE QUIZ MASTER
- Q 462 WHEEL OF FORTUNE
- Q 1037 MARBLES GAME
- Q 1035 ATOMIC GAME
- Q 603 EXIT 13
- Q 442 REVERSI V2
- Q 119 DRAGON'S TITLES
- Q 112 DRAGON'S CAVE
- Q 1369 BOOM'N ECK!

### LOGIC GAMES

- Q 660 KORG 01W 8 DISK
- Q 218 HOUSE 2 DISK
- Q 206 SELECTION 7 DISK
- Q 647 SOUND FX 3 DISK
- Q 619 DRUMS 2 DISK

### SAMPLES - MODS

- Q 660 KORG 01W 8 DISK
- Q 218 HOUSE 2 DISK
- Q 206 SELECTION 7 DISK
- Q 647 SOUND FX 3 DISK
- Q 619 DRUMS 2 DISK

### TETRIS - COLUMNS

- Q 294 KLACK-TRIS COLUMNS
- Q 107 TWIN-TRIS TETRIS
- Q 390 DIZZY DIAMONDS
- Q 293 DR. MARIO COLUMNS
- Q 617 NUMBER-TRIS
- Q 826 MEGA-BLOX TETRIS
- Q 013 TET-TREN TETRIS
- Q 597 TETRIS PRO
- Q 611 HOT-BLOX TETRIS
- Q 657 ZYNYX COLUMNS
- Q 1240 ROCK - SLIDER
- Q 1215 A1200 BLITRIS
- Q 1352 THE AGE OF ROCK
- Q 1371 A12 STEP FIVE

### PAC-MAN GAMES

- Q 230 SUPER PAC MAN
- Q 008 ORIGINAL PAC MAN
- Q 592 PAC MAN RETURNS
- Q 252 YUM YUM PAC MAN
- Q 397 DELUXE PAC MAN
- Q 1096 PUC MAN
- Q 1138 A12 CYBER MAN
- Q 1346 WABES PAC MAN

### BREAK-OUT & PONG

- Q 1323 CIRCUS NOT 1.3
- Q 003 MEGABALL V1
- Q 459 MEGABALL V2
- Q 559 MEGABALL V3 NOAS
- Q 007 BATTLE PONG
- Q 421 REBOUNDER PONG
- Q 731 HAUNTED MINES
- Q 254 EMERALD MINES
- Q 121 MARATHON MILES
- Q 351 ROYAL MINES
- Q 391 DIZZY LIZZY MINES
- Q 480 BLUE DIAMONDS

### PUB-CLUB GAMES

- Q 560 DARTS NOT 1.3
- Q 1304 CHECKERS V2
- Q 598 PIN BALL NOT 1.3
- Q 222 FRUIT MACHINE
- Q 010 POKER ARCADE
- Q 375 CARDS SOLITAIRE
- Q 1073 CARDS PACK
- Q 1246 AMIGA CRIBBAGE
- Q 1190 2 DSK HOT HANDS
- Q 1362 PUB DARTS TOUR

### BOARD GAMES

- Q 910 NEW MONOPOLY STAT
- Q 631 SCRABBLE
- Q 476 CHESS GAMES
- Q 1331 BURGER BAR
- Q 1300 2 DSK MOVIES A12
- Q 1284 2 DSK BLACK DAWN 5
- Q 116 STAR TREK 2 DISK
- Q 297 NEIGHBOURS 2 DISK
- Q 1136 A12 FEARS V2
- Q 1266 3 DSK PANIC SOS
- Q 1209 LOST PRINCE
- Q 1180 A12 I-DEMON 4 DISK
- Q 1359 A12 ALIEN SPACE

### AMIGA LEISURE

- Q 205 AMIGA PUNTER
- Q 228 PERM CHECKER
- Q 886 LEAGUE EDITOR
- Q 1210 LOTTO LUNATIC
- Q 1262 LOTTERY PROF
- Q 1302 AGA DUNGEONS
- Q 1087 SHAKKA LAOKA
- Q 1130 ROOTS 18 V2
- Q 1274 CONTROL 2 DISK
- Q 1206 JAZ WAVE 2 DISK
- Q 1186 NOSTROMOS 12
- Q 1270 DOOM RAVE
- Q 1204 TAZ INTROS
- Q 1184 BOSNIS METAL
- Q 1220 AMIGA JAMMIN
- Q 1165 VENTILATOR

### AMIGA MEGADEMOS

- Q 460 TEKNO RAVE
- Q 1015 2DSK TAZ QUEEN
- Q 1120 2DSK TAZ QUEEN 2
- Q 1104 2DSK OXYGENE
- Q 1084 ASCII NOT 1.3
- Q 1287 FASTJETS NO 1.3
- Q 740 4 DISK MANGA
- Q 507 5 DISK WEIRD/SCI
- Q 780 2 DISK KING TUT
- Q 1271 PIXEL STORMS
- Q 1213 SCOOPEX ARTCOORE
- Q 1193 LEMMINGTONS

### AMIGA SLIDE SHOWS

- Q 704 REVELATIONS
- Q 061 PAT NAGEL'S GIRLS
- Q 918 ERIC'S GIRLS 2 DISK
- Q 936 AVIATION HISTORY
- Q 1111 SDSL BOLDLY GO
- Q 1060 SDSL LION KING
- Q 1040 3DSK AGA GLAMOUR
- Q 080 VIRTUAL WORLDS
- Q 084 PUGGS IN SPACE
- Q 233 COOL COUGAR
- Q 651 FAIRLIGHT 242
- Q 302 ODYSSEY 5D NOT A12
- Q 831 RED DWARF
- Q 475 BAIT MASKING
- Q 463 MR POTATO HEAD
- Q 474 MISS MAMISSELLE A12
- Q 865 TAROT MASTER 2 DISK
- Q 861 AMY AT THE MOVIE
- Q 271 NEWTEK V2.2 DISK
- Q 347 NEWTEK V3.2 DISK
- Q 187 ANIMATION STUDIO

### AMIGA VIDEO

- Q 329 VIDEO INSCRIPT
- Q 790 VIDEOTRACKER 5 DISK
- Q 148 S-MOOVIE
- Q 220 FUNK KEYBOARDS
- Q 431 RAVE KEYBOARDS
- Q 661 MED WORKSHOP 4 DISK
- Q 202 MED V3.2
- Q 204 SOUNDTRACKER
- Q 729 DRUM MACHINE
- Q 787 SONIC DRUM KIT
- Q 866 OCTAMED TUTOR
- Q 738 OCTAMED V2
- Q 136 THE ART OF MED
- Q 192 THE COMPOSER
- Q 618 MUSIC DATABASE
- Q 981 AUDIO ENGINEER
- Q 1268 HIPPO PLAYER

### CLASSIC-POP

- Q 1029 COTTONEYE SONG
- Q 201 PIANO CLASSICS
- Q 234 VIVALDI 2 DISK
- Q 342 AMIGA-DEUS
- Q 213 DIGI CONCERT V2
- Q 620 BAGPIPE MUSIC
- Q 750 DOOP DOOPY DOOP
- Q 248 EXPRESSION V2
- Q 473 RHYTHM'S DANCER
- Q 1357 2 MEG DACO VI
- Q 660 KORG 01W 8 DISK
- Q 218 HOUSE 2 DISK
- Q 206 SELECTION 7 DISK
- Q 647 SOUND FX 3 DISK
- Q 619 DRUMS 2 DISK

### AMIGA EMULATION

- Q 423 2 DISK SPECTRUM
- Q 889 PC EM 2 DISK
- Q 327 ACTION REPLAY
- Q 300 RELOKICK 1.3
- Q 955 RELOKICK 1.4A
- Q 414 SKICK 1.3-3.0
- Q 380 NIBBLER (NIB)
- Q 727 MULTI TASK (MT)
- Q 158 X.COPY PRO
- Q 357 COPY AND CRACK
- Q 325 LOCK PICKER V2
- Q 416 MAVERICK V5
- Q 1252 LOCK PICKER
- Q 1348 C COPY NOT 1.3
- Q 191 HD CLICK MENU
- Q 779 WB 3 INSTALL
- Q 780 WB 2 INSTALL
- Q 621 HD STACKER
- Q 665 MR BACK UP PRO
- Q 490 8 DISK MAGIC WB
- Q 533 HD SUPERLOCK
- Q 957 GAME INSTALL V2
- Q 1141 GAME INSTALL V3
- Q 1199 GAME INSTALL V4

### HARD DRIVES

- Q 243 AWARD MAKER 4 DISK
- Q 065 AMIGA FONT 7 DISK
- Q 100 PRINTER DRIVERS
- Q 048 PRINTING STUDIO
- Q 345 BANNER MAKER
- Q 057 TEXT ENGINE V4
- Q 393 LABEL DESIGNER
- Q 394 INVOICE PRINT
- Q 749 FORM PRINTER
- Q 832 DATABASES 2 DISK
- Q 092 ACCOUNT MASTER
- Q 240 ADDRESS BOOK
- Q 691 DAILY DIARY
- Q 470 LITTLE OFFICE
- Q 244 SPREADSHEET
- Q 535 UK S.T.D CODES
- Q 1121 REM-DATE
- Q 637 8 DISK COLBRUSH
- Q 633 7 DISK CLIP ART
- Q 901 9 DISK WORLD MAP
- Q 172 15 DISK PORTFOLIO
- Q 558 7 DISK CLIP ART
- Q 702 COMMS TUTORIAL
- Q 413 N.COMMS V3
- Q 079 OPTICOMMS V2
- Q 1032 MAX BBS PROG
- Q 1303 DOS - MANUAL
- Q 288 A-BASIC TUTOR
- Q 190 PCQ PASCAL
- Q 306 UNDERSTAND AMOS
- Q 722 TONS OF AMOS
- Q 1067 AGA DATATYPES

### DO IT YOURSELF

- Q 1097 2DSK HELM
- Q 239 SLIDESHOW MAKER
- Q 381 ADVENTURE MAKER
- Q 808 MAKE A DISK
- Q 242 MENU MAKER
- Q 585 2 DISK PARNET
- Q 1154 HEDLEYGUIDE A12
- Q M.U.I. NOT 1.3
- Q 1030 A12 DIONIC TOOLS
- Q 612 4 DISK TOOL KIT
- Q 166 SYSTEM TESTER
- Q 467 FILE UNDELETE
- Q 194 DISK OPTIMISE
- Q 356 ENGINEERS KIT
- Q 245 FIX DISK
- Q 168 HARDWARE MANUAL
- Q 766 GEOGRAPHY
- Q 532 MATHS 5 DISKS
- Q 844 ENGLISH 4 DISK
- Q 486 LANGUAGES 4 DISK
- Q 270 PLANETS 6 DISK
- Q 304 ENGINES 5 DISK
- Q 059 AMIGA TUTORIAL
- Q 1269 DPAIN 4 TUTOR
- Q 937 A1200 / 800 TUTOR
- Q 1361 2 DISK INTERNET
- Q 1360 AMIGA GUIDE

DISK COST £1.25 EACH, NO MINIMUM ORDER, ALL VIRUS FREE AND USER FRIENDLY.  
All games are on 1 disk and run on all Amiga's unless otherwise stated  
PICK AN EXTRA DISK FOR FREE WITH EVERY EIGHT DISKS YOU PURCHASE

UNDERGROUND PD, 54 CARMANIA CLOSE, SHOEBOURNE, ESSEX SS3 9YZ. TEL: 01702 295887

Name: ..... Amiga Model: .....

Address: .....

Postcode: .....







(CU01) 31 Wellington Rd, Exeter, Devon, EX2 9DU  
Tel: 01392 493580 Office hours Email steve @ ll/w.demon.co.uk



**F1 CD ROM VOL. 1**

Contains the F1 library from disks 1-100 (not 41) with extra inclusive titles. All programmers receive a royalty - £500 worth of EXCLUSIVE-FULL COMMERCIAL SOFTWARE for only £29.99. Rated 92% Amiga Shopper

**AMOS PRO COMPILER V2**

Exclusively licensed from Europress Software for a limited period only. The complete APC package with manual but without the box for £14.99. Comes with update for Pro to V2. Works on any Amos, EasyClassic & Pro. Previously sold at £34.95. BUY NOW WHILE AVAILABLE. Special offer get the Amos AGA extension of the new USA Intuition extension together with the compiler for only £16.99 (please state which extension, if any)

**GRAC V2.0**

F1's most popular title EVER. Massive update. With printed manual. Create your own Monkey Island style graphic adventure games. You don't need to be a programmer to enjoy creating your own games. Comes with complete game written with Grac. £8.99

**MAGIC PAINT BOX**

Without a doubt the BEST kiddies paint program on the Amiga. Rated 96% in AS and virtual AF Gold. Complete with manual. Over 80 kid-friendly options and tools. Save and print your work. Only £8.99

**DMC GOLD**

With printed manual, friendly mag creator, no programming required. £8.99

RELICS OF DELDRONEYE 11 A completely new Adventure game. It's massive! 6 disks. RATED 89% £7.99

**NEW F1 RELEASES:**

- Balanacy £3.99 A brilliant new arcade puzzler from France.
- Total Domination £4.99 A Dune 11 type war strategy game
- Lozobase £3.99 Well we had to get one sooner or later!
- Tell The Time £3.99 Really good educational prog for under 5's.
- Tour Through Time £5.99 Excellent, multimedia presentation for 7-14yrs
- Strategy Games £5.99 Three good strategy games in on pack.
- Word Puzzle Pro £4.99 Create your own Crosswords and WordSearches

Please add 50p post/packing to any size order. F1 products also available from selected dealers

Stacks more high quality and exclusive titles are listed in our FREE cat disk. Just call/write for a FREE copy NOW.

MOST GOODS DISPATCHED SAME DAY AS ORDER RECEIVED

# BUS STOP PD

UTILITIES	GAMES	SLIDES	MUSIC	5TH DIMENSION LICENCEWARE
MAGIC DOPUS SPONDULIX MONITORS DISK 600 LETTERS BELLES PAINT STAKKER FILEMASTER 3 MIDIPLAY 500+ EMULATOR REMDATE TEXTMASTER AUTOSTEREO FINAL WRAPPER 3 BLACKBOARD LIONKING CLIPS (3) 1000 HD PREP AMOS AQUIRE (4) DCA COPY MODEM UTILS LC GRAPH 71 UTILS MESSY SID 2 LOCKPICK 2 OCTAMED 2 MINIMORPH VIDEOTRACKER DISK MANAGER 4 UK CODES DISK MAG CREATE SUPERSLIDE D COPY 3.1 SPECTRUM V1.7 SPECTRUM GAMES (8) SUPERVIEWER 2.4 SID V2 S/TRACKER MOODS (10) BITMAP FONTS (5) DMS PRO V2.2 CG FONTS (4) QUALITY CLIPS (5) OCTAMED MOODS (5) KIRKS SAMPLES (3) HOUSE SAMPLES (3) ADOBE FONTS (1)	PUNTER COURSE FISHING (2) WRESTLING (2) CHECKER CHALLENGE CROAK 2 FRIDAY NIGHT POOL INNER DEMONS (4) BLACK DAWN 2 TOP HAT WILLY CATAPULTS QUIZ CHALLENGE BAT DOG BRIDGE MAJONG SHOOT OUT PROJECT BUZZBAR DAY AT THE RACES CHEESE BUS STOP BLOX BLACK DAWN COBBLERS DECENDER PENGU 2 SUPERMEGAFRUITS DARTS 105 GAMES (7) ROAD TO HELL MYSTERY 2144AD DELUXE MONOPOLY STARSTRIKE ANT WARS (2) CASHFRUIT ARTILLERUS SQUIGS SLAMBALL BILLY BURGLAR ALL ROUNDER BINGO CALLER STRIKE DEFENDER SOP N PLOP SUNNY BLASTER WARRIOR EXTREME VIOLENCE	MANGAJIN (3) MUSCLEMANIA AKIRA & X MEN REVELATIONS IRON MAIDEN (4) SUPERBIKES (2) LAUREL AND HARPOY CALVIN HOBBS WATERSHIP DOWN CATS k d lang WILDLIFE BELINDA CARLISLE CHER SHARON STONE CARTOON CAT WOMAN KIM WILDE THE PRISONER WWF & TENNIS FAST CARS ROCK ALBUM  <b>GLAMOUR</b> PLEASE STATE OVER 18 TINA SMALL MADONNA - SEX KATHY LLOYD MARIA WHITTAKER (3) STRIP SLOTTOR UTOPIA (4) CLASSIC GIRLS (4) BEYOND FORCE (2) SEXY DREAMS SLAYER STARS (3) MAYFAIR (3) ERIKA ELENIAK (5) CELEBRITY SPECIALS (5) BO DEREK GIRLS ON FILM SHOWERING GIRLS BUST UP CALENDER GIRLS MADONNA EARLY	DESTROY FASCISM BLACK TRIANGLE (2) SCOTT JOPLIN k d lang DANCEMIX STILETTO (2 MEG) WOO OLD BULLS NAMALM DEATH JARRE LIVE MAD PREACHER CYBERPUNK (2) LED ZEP LAWNMOWER DETH YAMMA YAMMA LSD STORY (3) 9 FINGERS (2) TOTALLY TECHNO SWEET CHILD DEBUSSY SADNESS PT1 242 JUNGLE COMMAND ALTERN 8 RAGGA SYKO  <b>ACCESSORIES</b> P&P INCLUDED 100 Cap Box £7.40 100 4 Colour Labels £2.50 Disk Drive Cleaner £3.29 8mm Mouse Mat £3.29 500+800 & 1200 Dustcovers £2.99  <b>QUALITY BLANK DISKS</b> 10 Cap Box £1.49 1 - 50 50p each 51 - 100 45p each 101 - 200 40p each 201 - 500 35p each 500 - 1000 29p each 1000+ 24p each	PRICE PER TITLE £2.95 JUMP EM ANTZ BLOX DISK SYSTEM CATALOGUER 3 LOTTERY SYSTEM SCAM MAPPER  <b>CULT TV/BIZARRE</b> JAMES BOND (3) RED DWARF QUIZ DR WHO (2) DR WHO QUIZ X FILES GUIDE STAR TREK GUIDE (6) STAR TREK PARCOIES DARK PORTAL (2) PROJECT UFO (8) ALIENS MULTIMEDIA (9) THERAPST MINGSHU FISH TANK SIM BIRTHRIGHT HUMAN ALFA (2) (WB2+) PARANORMAL (2) (WB2+) STRANGE (2) (WB2+)  <b>GAMBLING</b> POOLS TOOLS RACE RATER DIVIDEND WINNER PRO GAMBLE BOOKE BEATER PROTEUS PRO LOTTERY COP THE LOT  CATALOGUE - 50P LISTING OUR VAST LIBRARY. CLR LICENCEWARE ETC

**AMIGA MAGAZINE** 0171 972 6700  
MARIANNA MASTERS

## WHAT DO YOU GET FOR £53

FREE TYPESETTING  
FREE COLOUR  
FREE COPY OF THE MAGAZINE  
MORE TECHNICAL COVERAGE  
MORE SOFTWARE COVERAGE  
MORE PUBLIC DOMAIN COVERAGE  
MORE PROMOTIONS  
BETTER COVERDISKS  
ABOVE ALL

THE BEST VALUE FOR MONEY PACKAGE IN THE AMIGA MARKET  
NO 1 FOR CLASSIFIED ADS!

# "HOW MUCH?"



**PHILIPS COLOUR MONITORS**

**£134** inc. next day delivery

The Problem: Eastenders or Street Fighter?  
The Solution: A Dedicated Amiga Monitor.



**PHILIPS 9-PIN NLQ PRINTERS**

**£79** inc. next day delivery

Hard on copy. Soft on wallet.

**icrotrade**

**Dept. CU, The Redwood Building, Leighton Road, Buttington, Welshpool SY21 8HE**  
**Tel: 01938 556575/556623**

**Monitor specification:** Phillips HCS35 Video monitor with speaker - compatible with AMIGA, NES, SNES, MEGADRIVE III, ATARI ST & COMPOSITE VIDEO (price includes video lead). **Printer specification:** Phillips NMS 1436 9-pin NLQ matrix printer, Epson/IBM compatible, 120CPS draft, tractor/single sheet fed, supplied with lead.

Note: all equipment advertised is second-user and has been fully refurbished, tested and repackaged in our warehouse facility and carries a 90 DAY WARRANTY.  
Delivery included, prices applies to UK only. **Ordering:** please place orders by post ensuring that you specify item(s) required & your computer type.  
Cheques or postal orders only please, made out to "Microtrade". Items subject to availability.



ISSUE 4 HAS ARRIVED

# MAXIMUM







# Frequently asked questions

## Everything you ever wanted to know about networking ...

**Q. What's the easiest way to connect two Amigas?**

**A.** The simplest way is to use a Null modem cable to link up their serial ports. You can then run a comms program on each Amiga (for example, Term or NComm) and use the X, Y or Z Modem protocol to transmit files.

**Q. Is this how networked games work?**

**A.** Yes, nearly all networked games on the Amiga work using a Null modem cable connected between the two machines.

**Q. Games aside, is there a better way?**

**A.** Yes. The serial port isn't amazingly fast. OK, if you connect two Amiga 1200s fitted with HiSoft's new Surf Squirrel PCMCIA device, things will be a lot faster but there is still a better way of linking the machines: the parallel ports for example.

**Q. What software do I need for linking Amigas with the serial ports?**

**A.** You can use ordinary terminal emulation software such as NComm or Termite on the Amiga, and Terminate on the PC. Then set the baud rates and other settings to be the same and use Zmodem to copy the files across. You could also use the program 'TwinExpress' which is available from the Aminet and PD libraries. It makes sending files a lot simpler by running a custom utility on each machine.

**Q. Can I link two Amigas via their Parallel**

**ports and use the comms software as before?**

**A.** No, you can't. Parallel ports are not designed with communications in mind and so you will need special software. The best known system is ParNet and the best distribution is called ParBench. Setting up ParNet can be very hard and the ParBench system includes an official Commodore Installer system to make it a lot easier. Ask your PD library for ParBench or get it yourself from Aminet.

**Q. Apart from speed, why is ParNet better than a serial link?**

**A.** ParNet provides true networking features (although not terribly advanced ones). This means when the Amigas are linked there is a new device on each machine called NET: and this is a link into the remote hardware. It means that one Amiga could use the hard drive or CD-ROM drive of a second Amiga.

**Q. What sort of cable do I need for this?**

**A.** You need a special cable and instructions for constructing it are given in the ParNet archive. You must not connect a standard parallel port to parallel port cable, as this will damage the Amigas. You must make (or buy) a cable designed for use on the Amiga.

**Q. Can I network a CD32 in this way?**

**A.** Yes, although there are various reasons why this is tricky. It's best to buy a CD-ROM and lead kit already made up,

from a dealer such as Brian Fowler Computers.

**Q. Is there another way of linking Amigas via parallel ports?**

**A.** Yes, you can use a commercial system called Liana. Liana comes with a special parallel cable but the software support is offered through 'Envoy'. Blittersoft sell Liana in the UK.

**Q. I've heard of Envoy, what is it?**

**A.** Envoy is the standard Amiga networking package, written by an ex-Commodore employee. It is a commercial product, currently at version 2. It is more advanced than ParNET and offers a lot of features, such as the ability to share printers, full security and inter-network routing. It also is 'hardware independent' in that it doesn't mind which hardware the network uses, as long as there is a suitable driver.

**Q. Is Envoy available for other hardware?**

**A.** Yes, as long as there is a suitable driver, called a SANA2.driver. This is an Amiga standard for networking support. For example, the AmiTriX networking system uses the floppy disk port and it can run Envoy as well. Envoy will also run over Ethernet.

**Q. What is Ethernet and can I use it?**

**A.** Ethernet is a fast networking standard used on PCs and other computers. It allows transfer speeds of up to 10Mbit/second over various types of cable. Many machines can be linked together over Ethernet. It is possible to buy Amiga specific network cards for Amigas with Zorro slots

(Blittersoft sell the Ariadne card). It's also possible to buy a GoldenGate 2 card and fit a PC Ethernet card (EyeTech sell the GG2 in various bundles).

**Q. Can I use Ethernet on an Amiga without Zorro slots?**

**A.** There are no A1200 Ethernet cards currently advertised in the UK, although there are rumours of some available in the US. Sadly, although PCMCIA and Parallel port Ethernet adapters are available for the PC, no one has created a version for the Amiga.

**Q. Can I link my Amiga to a PC network?**

**A.** If you have an Ethernet card, yes, you can set up both the Amiga and the PC to use the TCP/IP transmission protocol and link the machines in that way. This makes it possible to run Telnet, FTP and even X Windows systems. If you don't have an Ethernet card, there are still ways to link up the Amiga at least in theory. One approach would be to use a SLIP or PPP connection into an Amiga running Windows95 or a version of Unix such as Linux.

**Q. How advanced is a TCP/IP network?**

**A.** In terms of filesystem support, not very. You can copy files using FTP but if you have used this you'll appreciate that it is basic to say the least. One possible solution is to use a Novel style network system, but details of Novel support on the Amiga is sketchy to say the least. More promising is the version of a program called SAMBA which has appeared on Aminet. This aims to mount PC Windows Workgroups on the Amiga and vice versa, which would be a very flexible method of working. ■

**John Kennedy**



# Masterclass AREXX

**PART 2** We've looked at what Arexx is all about, now we're onto to bigger things such as how it works.

**F**or those of you unfortunate enough to have missed last month's issue let me recap: ARExx is a very useful programming language. What can you do with it? Write programs is the obvious answer, and by golly that's what we'll do. ARExx looks a little like the well-known programming language BASIC, but it is considerably more flexible. Not only does it include many powerful commands but it can control other programs and be expanded to include support for, as an example, standard Windows and Menus.

## What makes her tick?

Last month we saw how to install ARExx and run a simple program. Now we'll look at some more programming examples to get an idea as to the way in which ARExx works. First, let's examine the SAY command as it can be slightly trickier than you might expect. The best way to discover its secrets is to enter the following program and execute it. To do this, create a text file which contains the listing, save it and then use 'RX' followed by the filename. Do not simply type this into a Shell, as it won't work. (see example 1)

### Example listing 1

```
/* Say examples */
SAY Hello world
SAY "Hello World"
SAY 'Hello World'
SAY "Hello" "World"
SAY "Hello"||"World"
SAY ``Hello World''
```

When you run the program with RX you'll see something like figure 1 (top left):

The first thing to note is that the program, like all ARExx programs, starts with a comment. If you leave the comment out the program

▲ Figure 1: The best way to get to grips with the SAY command is to run the above program with RX.

won't run. Now we come to six different ways of putting text on the screen. The first method uses no form or quotes – only text. You can see that ARExx displays it as upper case.

The subsequent examples use quote makes. You can use either single or double, as long as you are consistent: the first two quoted examples will produce identical results. You can also see that splitting the words into two and adding quotes to each automatically adds a space. If you don't want a space, use the concatenate command ( || ) which joins the two text strings together without introducing any extra characters. Finally, if you want to include quotation marks, use a different sort – imagine the outmost pair being removed.

With output mastered, we can now learn how to make programs more interactive by getting input from the user. The simplest way

### Example listing 2

```
/* Pull examples */
SAY "Hello, what's your name?"
PULL name
SAY "Nice to meet you" name
SAY "How old are you?"
PULL age
IF age > 28 THEN SAY "Wow, that's old..."
ELSE SAY "That's not very old."

EXIT
```

▲ Figure 2: here we can see that the first pull takes in the name while the second pull takes in the numeric value which in this case is age.

▲ Figure 2a: (Oi – Lisa), I am not 31 do you hear. I'm a spritely 27 years old and don't you forget it.

to do this is with the PULL command, which waits at the Shell for something to be entered, (see example 2, figure 2 and 2a)

The first PULL takes in a text string and converts it into upper case (we don't ask for this to happen, it just does). The second PULL takes in a numeric value. There is no distinction between the text and number PULLs as far as we are concerned, it's up to ARExx to keep track of which is text and which is a number. The IF-THEN-ELSE statements do a little processing and that is all there is to it.

## Variables

We can't go much further without touching on the concept of variables. Variables are locations in the Amiga's memory which store specific values and are referenced by a special name.

For example, when we asked for your age using PULL, ARExx creat-



ed a variable and stored a number in it. ARexx deals with variables in a very flexible way: when it comes across some text which doesn't mean anything to it, it assumes it's a variable. If the variable hasn't been used before (that is, it hasn't been initialised) then it has as a value its own name in upper case.

This is why our very first example, SAY Hello world, did what it did. ARexx thought "Hello" and "World" were two variables and so printed them. As the default contents of a variable is its own name in upper case, the program display "HELLO WORLD".

Now here is an example of how you can make variables which store more than one value. Lets say we need to store the names of five different types of fish, for the start of an excellent Fish Database program. We could use five separate variables and get the names like this:

```
.. PULL first-fish
PULL second-fish
PULL third-fish
PULL fourth-fish
PULL five-fish ..
```

and so on. However, this would make the

### Example listing 4

```
/* More Variable examples */
age. = "Unknown"
age.john = 28
age.brian = 15
age.mary = 25
age.anne = 34
SAY "Enter a name, please:"
PULL name
IF age.name = 'Unknown' THEN SAY "Sorry, I don't know " name
ELSE SAY "That person is" age.name "years old"

EXIT
```

program rather lengthy. It would also be very hard to expand the program at a later date to include more than five fish.

A better way is to use a compound variable - a variable which has a single base name but stores different values depending on the associated name appended with a full-stop. Erm... here, look at example 3.

When it is run, you should enter five fishy types. The program automatically creates and assigns variables called "fish.1", "fish.2", "fish.3" and so on because the ".i" is actually the loop counter which counts from 1 to 50. Notice the second part of the program goes through the fish names itself, looking for a match. Imagine how hard this would be if there were fifty fish to process... (see figure 3).

Don't think that you have to use numbers to reference the values which a compound variable can store all the time though.

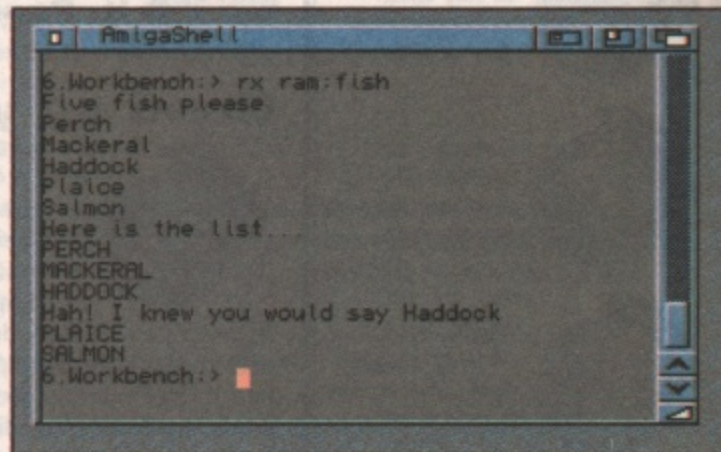

▲ Figure 3: compound variables are handy when it comes to dealing with lists of items which you want to store and maybe add to later.

### Example listing 3

```
/* Variable examples */
SAY "Five fish please"
DO i = 1 TO 5
  PULL fish.i
END
SAY "Here is the list..."
DO i=1 TO 5
  SAY fish.i
  IF fish.i = "HADDOCK" THEN SAY "Hah! I
  knew you would say Haddock"
END
EXIT
```

Example four is an interesting little listing. It creates a miniature database of ages for four people and then asks you to pick a name (see example 4).

Of particular interest is the fact that when no extra reference is given, there is an automatic default value present (which we call "Unknown") and this can be tested for (see figure 4).

Next month, we'll be concentrating on making use of ARexx with existing programs: creating your own user-defined Macros to do exactly what you want with minimal effort. ■ John Kennedy

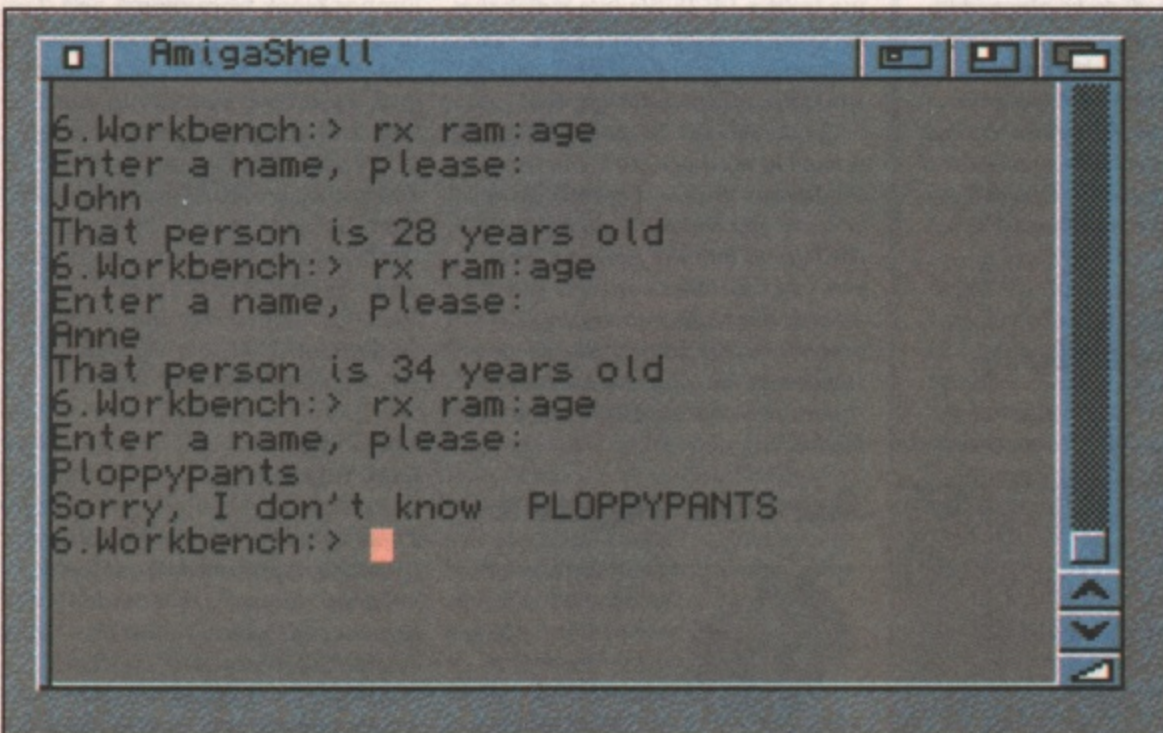

▲ Figure 4: Here in our database of four people, there is an automatic default value 'unknown' which comes into play when it doesn't recognise a reference.

### It's all there on the CD

If you've got this month's CD-ROM edition you should be delighted with all the top stuff we've managed to cram on there: games, utilities, pictures, demos and lots more. We've also tried our best to include most items relevant to this month's workshop section.

And the Arexx Masterclass is no exception. You will find these listings included on the CD-ROM on the cover of this month's CD-ROM edition. Go to the drawer called Magazine/Arexx Masterclass and you should find the tutorial stuff there. You will also find some programs from previous ARexx Masterclass features: please read the text file before running them!



## Logos, meanings and mysteries:



CD32 queries, ParNET and various other CD ROM-related problems.



All about upgrading RAM, operating systems and processors.



Plug-in hardware of any kind: scanners, disk drives etc.



Answers to queries on particular pieces of software.



Music, sampling, MIDI and anything that makes a loud noise.



Miscellaneous tools to keep your Amiga running smoothly.



Form-feeds, page-breaks, preferences and lots, lots more!



Monitors, TVs, modulators, screen-modes and all that stuff.



Pixels, sprites, animation, pictures. In one small word: graphics.



Spreadsheets, databases, organisers, accounts ...



Everything you need answering about the internet



Not everything fits into a pigeonhole, but anything you like fits in here.



**They're back, and they're ready for action. CU Amiga's moderately handsome yet still intelligent dynamic duo are ready to battle with your hardest technical problems and dilemmas.**



**Lisa, tired of chasing Tony around the office for Q&A, let him have it. Poor, poor lad ...**



**On seeing Tony's fate. Mat quickly scribbled down the answers before taking the first plane back to Aussie.**

## Good on ya



I have an A600 with a 40Mb hard drive, a Citizen ABC printer and a Power Computing quad speed CD-ROM drive. I've now decided to take the plunge and upgrade to an Amiga Technologies A1200. I am going to buy one from a friend who wants to sell his so he can buy an A4000. What do I need to get to enable my current A600 peripherals to work with the A1200.

**Richard Jones  
Perth**

*Congratulations on deciding to upgrade, you'll have a great time with the A1200. Your hard drive, assuming it's an internal one, will work fine on the A1200 - just follow the fitting instructions in our May '95 issue. Likewise your Citizen printer just needs to be plugged in and you'll be pumping out colour pictures to your heart's content.*

*The CD-ROM drive will also work happily on the A1200 without modification, just slide the Squirrel interface into the PCMCIA slot as you do on the A600 and it'll work fine.*

## Adorage aggravation



Many thanks for your answer to my Adorage SSA demo query, 'Adorage blues' in CU Amiga,

February issue. Unfortunately, I am still unable to use the program and shall therefore put it on ice until you are able to assist me further.

Using Opus5, I set about transferring IconX from my

Workbench C directory to the C directory on my Adorage working disc. I was presented with the error message 'As Error Occurred Copying IconX DOS Error: Disk is full.'

When I checked the available space on the Adorage working disk it was 967b. The IconX file however, says it needs 1452b. My 1200 has 240Mb hard disc and 4Mb expansion board. Please help. What do I do now?

**Roy Firth  
No address supplied**

*My, you are demanding aren't you. Firstly let's clear up a slight misunderstanding you seem to have.*

*The problem you're having is that there isn't enough space on the floppy disk that Adorage is on, the amount of hard drive space or RAM in your computer will have no bearing on this.*

*As to your current problem, trying to fit a 1452b file into a disk that only has 967b left won't work, your only solution will be delete some of your files off the Adorage disk.*

*To do this use DOpus and try removing the Logo\_1FF file from the Images drawer. This will however leave you without a foreground file to load into the program when creating animations (unless you already have some others) so it's probably worth copying the file to somewhere on your hard drive first. Again, you can use DOpus to do this.*

## Auntie Agnus



I read with great interest your reply in February issue to a letter from Derek Bailey asking about upgrading an old A2000 from 512k of chip ram to 1Mb of chip ram. You

asked if a reader could help with the various modifications needed to increase the Chip memory for Amiga motherboards. I carried out a similar modification on my B2000 (rev 4.4) last month, here's how I did it ...

Having installed the 1Mb agnus you need to alter two jumpers on the motherboard, so open the A2000 and take off the PSA and drive mount once again. You should find two solder pads labelled J500 under where the PSU would be if you hadn't just removed it. There's a trace of solder joining the two pads and you have to cut it so that the jumper is open. Shame Commodore didn't put some pins and a jumper block there, I used a scalpel.

Next find jumper J101 which is near the power connector and a load of upright cylinder things. J101 has three pins two of which are covered by a jumper block. You need to move the jumper block from pins 1 and 2 to pins 2 and 3.

Put your Amiga back together and, assuming everything went well and you manage to boot up, open a shell and type 'avail'. You'll now see that the maximum chip ram is now 1047552 bytes (I don't know what happened to the other kilobytes but there you go). Time for that Hi-Res Interlaced Overscanned Magic Workbench you couldn't have before ...

**Martin Bahn  
East Yorkshire**

*Thanks for that handy tip Martin, it's much appreciated. We should point out, however, that we don't recommend readers follow this course of action unless they're familiar with the insides of the Amiga and are very careful doing it - getting it wrong will clobber your Amiga good and proper! We do not*



want to be held responsible if you damage your system, so get a pro to do it.

## CIA shock



I recently fitted a new Canon BJC bubble jet to my A500 and since doing so the mouse has

stopped working. It moves left and right but no longer goes up or down. It's really annoying. Can you give me any hints as to what's gone wrong.

**Patrick Divan  
Bristol**

*It's very simple, there are two chips inside your Amiga, collectively known as CIA chips and it looks like they're dead, no more, kaput! This can happen by plugging in the printer while the Amiga is on. These two chips control the mouse port, joystick, disk drive, serial interface and printer and by attaching the printer without turning the Amiga off you've damaged them.*

*There are two solutions, one buy a new chip: try calling one of the Amiga repair centres such as Silica: when we last checked they cost about £20.*

*Alternatively, try swapping the two CIA chips around. To do this open the Amiga, remove the metal shielding and locate them - they're labelled CIA ODD and CIA EVEN. Gently lift them out and swap them over, if you're lucky the mouse will work. You may lose some other functions though, the disk drive for instance, but as you have a hard drive this might not be a major problem until you get a replacement set of chips.*

## The future's so bright ...



I've just returned to the Amiga after several years away from it. Previously I had an A500 Plus,

now I've just bought an A1200 from my local Escom store, and having had a quick glimpse through the pages of CU Amiga Magazine I have only one thing to say - the Amiga is far from being on its last legs as some people seem to think.

The power of the peripherals now available (SCSI CD-ROM drives, 040 accelerators) and the amazing applications around (FinalWriter 4, WordWorth

5, FinalCalc etc) make the products that used to be out when I had my A500 look really sad by comparison.

However, this is getting away from my real reason for writing, namely, will the Lexmark 1050 colour printer work on the A1200? A friend is selling his PC system when he moves to the USA shortly and I can buy the printer off him cheap.

**Paul Winters  
Glasgow**

*We're in total agreement with your comments about the current Amiga. Although Commodore are no more, and we're still waiting on hardware news from Amiga Technologies, the software now coming out is certainly the highest quality it's ever been.*

*Unfortunately the Lexmark printer needs Microsoft Windows to work properly and as a result won't work with the Amiga. However, if you look around you'll find many other printers of equally good quality available that will, look out for anything that's Epson compatible as a good starting block for Amiga compatibility.*

## Which CD-ROM drive is best?



A friend of mine has told me that computer CD-ROM drives are simply normal HiFi compact disc

players that have been modified. Is this true and if it is how can I adapt the compact disc player on my stereo to work with my A1200.

Does the 'digital out' socket on the back the unit have something to do with this? If I can adapt it, which CD drive do you recommend I buy?

**Adrian Poole  
Staffordshire**

*Unfortunately you can't adapt your HiFi CD player to work on the Amiga. The digital out port on your CD is intended for use with amplifiers that support Digital input - producing better quality amplification and sound reproduction. It's also possible that VideoCD boxes will be released that take this Digital output and convert it into sound and pictures for displaying on a TV, although this is becoming less likely as time goes by.*

*As for the best dedicated Amiga CD drive checkout Power Computing or Hisoft Squirrel based systems, both of which are very impressive units.*

## The great CD32 FMV debate

I would like to thank you for supporting our favourite computer over the last couple of very turbulent years. I am pleased to say that CU Amiga Magazine is currently my favourite magazine.

However, I feel that I must put Tony Horgan right on a Q&A letter in your February issue. A Mr K Walsh wrote in to say that he had a CD32 FMV card without its adaptor.

On close inspection of the whole module you will find that it actually consists of a shielded circuit board (the metal bit) and a loopback section with the CD32 coloured plastic around it. These can be separated and hence the loopback is lost. Just to help, the loopback has two stickers on the inside of it (only really visible with the actual card removed). The first has REV A and a barcode on it while the other has CDGS LOOPBACK and a barcode with the following number below it; 8515293365480001000565. I have written to AT about this.

My advice to Mr Walsh is to contact them at their new address and see if they can source a loopback connector for him.

**Sven Harvey, West Midlands.**

*Thanks Sven, it's always good when readers come up trumps with a bit of handy information. If any other readers out there feel that they can help out on any of the other problems that they read in these pages please write in.*

## I'll be back, for sure

I am writing in response to my phone call to you about my letter printed (Q+A February edition 'CD32 FMV cart') and your reply which you printed and repeated back to me on the phone. I have the FMV card, I rang Amiga Technologies as you said and they said I was right, it is a real one.

However, it's just that mine does not have the 150-way female connector. Anyway they could not help me. I'm not waiting for a fresh batch of SX1s from the USA. I'm now flogging my card, someone out there with an SX1 will do.

My only options are to either get a 12" laserdisk player or wait for DVD due out soon! It's a shame I cannot utilise my CD32 to its potential, what a waste of a good machine.

**K. A. Walsh  
London**

*Okay, fair enough, you seem to have been right all along. Obviously what has happened is that the unit you have was retro-fitted with an gender adaptor which has since parted company with the main cartridge. Had you bought this from a shop, we would suggest that you return it and demand a refund, but we understand this was bought second hand from a private seller, so you probably won't have much luck on that score.*

*It is a shame that the CD32 FMV module never really took off in a big way, but with AT's plans for using CD32 technology in 'set-top' home video boxes, maybe something will emerge in future.*

*As for laserdiscs you could buy one, but it's possible that DVD might kill them off in the long run making your investment worthless and, unfortunately, although DVD is definitely a very good option official units either computerised or in a standard TV/HiFi format won't be released until this autumn, and even then they'll be well above the price you can get FMV units for but Hisoft's MPEG is on the way too.*

## Send your Q&A problems to...

You can send your technical problems [or answers - Ed] to CU Amiga by the following means:

By letter to Q&A, CU Amiga, Priory Court, 30-32 Farringdon Lane, London, EC1R 3AU.

Email: Q+A@cu.amiga.demon.co.uk.

Sadly we can't personally answer Q&A problems, so please don't send SAEs or phone us.





# Backchat

**Forget the cold weather, people are getting hot under the collar in this month's reader's debate. Want to turn up the heat? Join in and write in.**

## Put your money where your mouth is

How am I and other members of the Amiga-using public supposed to believe that the Amiga is still going strong and will survive the competition from Mega Drives, SNESes, Saturns, Play Stations and PCs? It's very disheartening when you walk into any high street computer shop and find that the Amiga software display has been relegated to the darkest corner at the rear of the shop. And if that is not a big enough insult these shelves are only stocked with old releases. How can the Amiga be expected to survive without the support from the retailers?

**Andrew Redd, Essex.**

*A good point. The only way around this seems to be to keep going into these shops and asking for Amiga hardware and software products. Then maybe retailers might wake up and realise that there is a huge market out there for Amiga products. It's not just Amiga users who are annoyed with this situation, software companies are also finding it increasingly irritating. Peter Calver from Audiogenic whose excellent game Super Tennis Champs is hardly*

*anywhere to be seen in the shops is incredibly frustrated by the situation. He urges people to "vote with their wallets" which means that if we show that we mean business and we actually want to spend money in their shops this might get them moving. Or failing that contact the software companies direct for their product.*

*You've raised a valid point in your letter and we are hoping to look at this matter and clear it up in depth next issue. In the meantime turn to our points of view pages where Lisa Collins has asked around to find out what some retailers' policies are concerning the Amiga.*

## The price is right

I'd like to add some more points to a reply I read in your magazine concerning the price of the Amiga. Although you agreed with the letter's author that the price was high you said it was justified. I agree. Here, in Germany, the Amiga only costs 650DM which is outstanding value for money compared to other current computers. Also, the software that is being shipped with stock A1200s is brilliant. I mean: look at PCs. Do they have anything like Scala or WorkBench? Can they

immediately generate titles for their home-videos without any additional hard or software? No, not at all. So why complain about the price?

I think that people are complaining now about the current price of the Amiga because for some time, due to Commodore's closure and other difficulties, A1200s (and CD32s) were sold for a lot less than their normal retail price. The price for A1200 (with a HD and 4Mb RAM all in one) at 980DM is brilliant and it is a very affordable price for a computer. The A4000's price however ...

**Marc, Germany.**

## Cobblers

Call me a miserable old git, boring old fart or whatever else but I think the net wedding feature (February 96 CU Amiga Magazine) was the most crap, infantile, pathetic piece of journalism I have ever read. I'll never forget Mat Bettinson's worldly wise "super highway" quote: "You may not take it seriously but you should it happened, it's real." - Cobblers.

I realise that you have to cater for younger purely games playing readers but I am sure you do not not want every other type of Amiga user to desert to other publications. They will with too much of this type of article, it was the pits.

Unfortunately, I have no doubt that this letter will be ignored or publisher with some smart alec reply. Be warned though, you are surely aware of the media perceptions that for every person that bothers to phone or write about something then hundreds or thousands think the same but never get around to doing anything about it. On the plus side ProCalc was the best cover disk I've ever found on any magazine.

**RD Armour-Chelu, Kent.**

*Why do you assume that the piece was aimed at younger readers? It was a topical article which was informing us about something which is really happening. It was the first wedding to take place on the net and we were there to report it, what's infantile about that? As for your warning that every letter represents thousands of unwritten ones - we've received tons of phonecalls and letters congratulating us on this article and only one criticising it - yours. Since our article similar reports have appeared in national newspapers and on television.*

## The dog's ...

I enjoyed your net wedding article (Feb 96). It's nice to see some romance on the net. I'm tired of hearing all these stories about the net being a cesspit of paedophiles and porno freaks.

**Barry MacDonald, Bracknell.**

### THE FAR SIDE

By GARY LARSON



"We're screwed, Marge. Big AI was our star attraction, the king of the show. ... And now he's gone."

### THE FAR SIDE

By GARY LARSON



Carlton falls for the old rubber-scalpel gag.



## Letter of the month

### The way forward

This letter is aimed at users who have been reluctant about upgrading and who complain about the lack of interest of software developers. I bought one of the early A1200s after owning an A500 for a few years. Then I bought a hard drive a while later. The point is, that one single peripheral completely transformed my Amiga into a genuinely productive and useful machine.

I used to think that a hard drive would just make file access faster and prevent me from stacking up floppy disks, but it is so much more useful. For instance I simply couldn't run programs like Real 3D, Imagine or play games like Worms, Alien Breed 3D etc. without one. Amiga Technologies should really not be selling Amigas without hard drives, although the Amiga philosophy has always been one of affordable entry models which grow gradually with users' needs.

Hard drives are essential, if you intend to use your Amiga for any serious application and quite a few games rely on hard drives to make them playable. I would seriously avoid any games which I knew were not HD installable. Piracy is not an excuse against games not being installable. If Amiga floppy users want more games like Alien Breed they should give a hard drive serious consideration. After all, a 3.5" IDE will squeeze into an A1200.

There is no longer any reason for not buying a HD. HD prices have fallen by a ridiculous amount in the last year. Looking through your mag: 850Mb costs less than £200, even 420Mb is only £125 – this is the same price as only three or four Amiga games (two or three console games).

To anyone who complains that the A1200, with its 020 processor is now behind the times, the answer is simple, save up some

money and buy an accelerator – which are also dropping in price these days. There are bound to be some affordable second-hand 030s for sale, with a lot of serious users looking for 040/060s. Even buy 4Mb of Fast RAM. It may sound a little harsh, but when you consider people spend probably £1000s on PCs, to upgrade a basic A1200 to a very usable Amiga set-up costs around £450 (or much less when buying second-hand). i.e. a 50MHz 030 + 4Mb fast RAM + 420Mb 3.5" HD. Even a small second hand HD, which would cost little more than the average game, would make a world of a difference, although as is often said repeatedly – upgrade to the largest you can afford, or at least three or four times as much HD space as you think you need now. You'll regret it otherwise. I know, I out-grew my 120Mb HD very quickly a few years ago.

Now that games producers have started to develop for accelerators, there seems to be a new lease of life in the Amiga as a games machine. The CU demo of XTreme Racing really flies along on my 040 and it's great to play AB3D in all its glory. I don't think this kind of software will continue to be produced for long, unless a lot of people upgrade and buy the new software. The 'RAMming it home' article (CU Feb 96) makes a lot of sense. Let's hope that both users and the industry are listening.

### Forces combined

I noticed the interesting Breathless/Power Computing offer in your magazine. I think it's time software, hardware manufacturers, the magazines and AT themselves all pulled together more to stress the upgrade issue. It would be worth including details of games which benefit from memory and accelerators with the hardware and details of the hardware available with the games. This sort of co-operation

makes sense. I mean, where better to advertise your accelerator than inside the box of a game which would benefit from one?

Maybe all the magazines and Amiga Technologies should start a major survey of Amiga users. Discover how many have expanded systems, and what their configuration is. Things have changed a lot for the Amiga both hardware and software-wise since Commodore went under, not to mention the radical changes in the console and PC markets. In addition, the survey would pool the ideas of everyone who supports the Amiga and show to software houses that the Amiga is still worth investing in. A carefully designed survey organised by AT, in co-operation with the magazines – or wider press might benefit the Amiga immensely – it can't do any harm! I can't remember the last time I saw an Amiga survey, but things have changed so much lately, surely another one is due.

### Bad attitude

Recent stories about the attitude of some Escom salespersons concerning the Amiga are quite worrying. I hope AT will take steps to ensure Amigas are promoted properly, especially since every other platform is on display. Shop displays, are what catches the consumer's eye. How many more people are likely to discover the Amiga if it is not on display?

Finally, if software houses make a hard drive and extra memory/processor obligatory for every release from now on (assuming the software was of a high quality, like the 'Doom-clones' rating 90%+) and there was a kind of hardware/software co-operation, how many people could honestly refuse to upgrade their system?

**Gerard Callaghan, Missouri, USA.**

### Rammed home

I'd just like to mention a few things about your Points of View article in the Feb 96 issue of CU.

Alan Dykes was going on about the min. spec of miggys, pcs and macs. He stated that the min. spec on the miggy was 2Mb RAM and no hard disk (or thereabouts). However, in my experience, I've found that the majority of Amiga users (in comms anyway) have around 6Mb RAM and at least 1/2 Gig HD. It's pretty rare to find someone that has a base level machine or at least a base level w/hd.

I totally agree with everything Alan said in that article. But why don't developers just auto config their software a bit like expansion boards. XTR does it with no apparent speed loss ... a friend and I ran it on both our A1200s at the same time and hardly noticed any difference. He has 2Mb chip no fast and 214Mb HD. I have 2Mb chip, 4Mb fast and 1/2 Gig HD.

**Peter Kirby, Barnet.**

### A pat on the back

I would just like to thank you for your magazine CU Amiga. I have found it to be useful as well as fun. The magazines here in the USA all

seem to think everyone reading them already knows all there is about the Amiga. Your projects have gone a long way to help me understanding the Amiga and computers. Now that the machine is once again in production, I hope to see more good things from you. Keep up the good work.

**Tom Gower, Texas, USA.**

### Double pat

Since my son had his A600 a couple of Christmases ago we have regularly bought and read various Amiga mags. These are all kept in a box under his computer desk. Looking back through the mags it was interesting to note that the one we have purchased most is CU Amiga Magazine. I think this is probably due to the consistently good balance and content of articles, reviews, technical help etc and the quality and usefulness of the cover disk. It is also a change for a magazine to invite personal contact with its readers rather than just taking the £4 or so with a don't call us and we won't call you attitude.

Recently I had cause to contact your advertising department for help with a problem regarding one of your previous advertisers. I

had returned a faulty drive and was having difficulty getting either a replacement or a refund. Finally, and only after your intervention I received a refund slip. This was only after they had been phoned by your Marianna Masters. I don't know what she said to them but it did the trick. Thanks.

**Ken Dryden, Cambs.**

### Firm sale? We say NO!

As I am on a tight budget, I have been forced to stop reading CU Amiga Magazine as it has now gone firm sale. I cannot commit to paying out the monthly sum of £4.50 just in case I'm broke. Why oh why is it now firm sale?

**K Simmons, Bristol.**

*Firm Sale means that a newsagent has to buy a magazine and bear the cost if it doesn't sell. The opposite, SOR (sale or return) means newsagents return unsold copies of magazines to the distributor. CU Amiga Magazine is distributed by a company called Frontline, the country's premier magazine distributor. They definitely handle CU Amiga Magazine on an SOR basis. If you have problems getting the mag write to Mark Cowie, CUA, Frontline, Park House, 117 Park Road, Peterborough PE1 2TS.*



# Points of view

## CD-ROM - saviour of the Amiga scene

by **Tony Horgan**

Many people both inside and outside of the Amiga scene are surprised at the way the market has stood up over the past couple of years. Amiga users have always been a discerning bunch; they know what they want from their computer and won't be taken in by media hype and advertising alone, which explains why they bought Amigas in the first place, and is part of the reason they have not abandoned the platform.

**Every so often, the state of the art moves on, leaving a wake of washed up and redundant technology.**

Even so, every so often the state of the art moves on, leaving a wake of washed up and redundant technology, which is where many think the Amiga should be floundering. It's managed to stay on the boat partly due to its very

■ Tony Horgan is CU Amiga Magazines' technical Editor

loyal user base, but also thanks to the fairly recent introduction of affordable CD-ROM technology which has revolutionised the Amiga scene.

CD-ROM is the perfect medium for mass distribution of the Amiga's unique shareware scene. CD is the international standard medium for both computer data and music, which has led to very low duplication costs that mean CDs can be sold for as little as a fiver, or even less. With third independent organisations such as the Aminet playing a pivotal role in the compilation, management and distribution of the best Amiga-specific shareware, backed up by hundreds of themed CD compilations from other producers, the Amiga is free to exist, in some form, with or without support from the established commercial software producers.

However, while this has kept the Amiga scene going through what could have been very lean times, we still need to continue development of the core commercial applications - the likes of Wordworth, PageStream,



Photogenics, Personal Paint and the merry band of 3D rendering systems. If the financial backers of these packages pull out of the market, all will not be lost, for then it will be the turn of the shareware developers to pick up the gauntlet and keep on keeping on, running the show on their own terms.

## Have money, will travel. But where to?

by **Lisa Collins**

I am sick and tired of the amount of letters we are starting to receive which end with those three little words: "disgusted and disillusioned". What is causing this heightened level of unhappiness? The apparent lack of availability of Amiga hardware and software.

I found tales of incompetent shop assistants advising Amiga enthusiasts

if Escom took him up on this generous offer. Also, recent rumours that Escom shops had received a memo telling them to remove all their Amigas from their premises were a little more than disconcerting.

Judging from sackloads of mail we receive, there's a huge army of frustrated Amiga users out there armed with cash to spend on upgrades, new machine and software but don't know where to get the goods.

In next month's issue Alan and I will trail the country to find out what is going on, who is stocking what and where. In the meantime let me try to clear this confusion up.

Despite rumours to the contrary, Escom have confirmed that they are going to continue to stock Amigas and are committed to promoting them in their shops. Also, although reported to be stocking Amigas, Dixons and Currys, however, "do not stock Amiga products and have not done so for at least two years", according to Helen Sargent, Corporate Affairs Manager.



HMV's Oxford Street branch according to Trish Saunders "will stock all Amiga software and, whereas other smaller branches will have a limited amount of Amiga products, you will be able to order a particular game through us (HMV) if not available." I hope that helps, until next month ...

■ Lisa Collins is CU Amiga Magazines' Deputy Editor

to buy a rival piece of hardware and little or no shelf space for Amiga games very worrying. One man in Bury St Edmunds even went as far as to offer his services, for free, to help his local Escom shop display the Amiga's talent. We've yet to find out



## Cover disks are saving the market not killing it



by Alan Dykes

Before Jonathon Anderson left Amiga Technologies at Christmas he stated his belief that magazines cover mounting full commercial software harms the Amiga. His point of view is shared by many in the software industry and, indeed, by many readers too: Every piece of software we cover mount is supposedly putting a nail in the Amiga's coffin – apparently no-one is buying new software because they already have all they need from our front cover. Oh yes. But does anyone remember whether there was some software in the Magic Pack by Amiga Technologies? Obviously not, it could have destroyed the market!

Let's straighten this matter out. There is still a healthy market for word

processors, databases, spreadsheets, rendering software etc, and why? Because we've been promoting them all through the ups and downs of the last two years. My theory is that if people hadn't got this software from magazines, if they hadn't been offered cheap upgrades from cover mounted software, the market would be in a worse state than it is in at the moment. Buying commercial software on the front cover of CU Amiga Magazine (or any of our competitors, or in the Amiga Magic pack with its superb utility suite), makes you realise just what's available and just how good it is. Programs like PageStream 2.2, Image FX and Imagine have encouraged many, who previously may not have considered investing in this sort of software to upgrade, to continue to use their Amigas for serious applications.

What about games? We have not cover mounted a commercial release yet. You have never seen a 'worth twenty five quid' badge on a games disk, on any Amiga magazine I believe. That's because we (and the other magazine publishers) have an agreement with the games publishers not to do so. This agreement dates back years and no-one has yet broken it. But consider this: where has it got us? This 'NO COMMERCIAL GAMES!' crusade has not succeeded in saving the games market from a situation where a title like Leading Lap was not going to be released – despite good

scores in all the magazines it was reviewed in.

My indignation is tempered by the fact that the two markets (games and technical) are admittedly different. The technical market is upgrade led. People with version 1 of a program inevitably upgrade to version 2 and so

**Name me more than a handful of games where the sequel was better than the original and I'll eat my Doctor Martens!**

on. They want the improvements and they want them now! But name me more than a handful of games where the sequel was better than the original and I'll eat my Doctor Martens. The games market is not upgrade led, so the argument above holds more water in this climate.

As a magazine we cannot afford to pay the full development costs of a piece of software, not at £4.50 an issue. But we do showcase the best new software, either by putting an older full version of a utility or a demo of some software on the front cover. Don't forget though, these programmers, publishers and developers still have to make money from you going out and buying these products and upgrades!

■ Alan Dykes is  
CU Amiga Magazines' Editor

## Workbench 4 – just begging for it!



by Mat Bettinson

The commonest problems we hear of are anonymous crashes, gurus and such forth. AmigaDOS will help out under some conditions to indicate which program is failing but conversely there are plenty of errors which can't be tracked down with any method

other than an exhausting process of elimination. I have found it difficult to create a reliable complex automatic Internet system on an Amiga that doesn't crash at some stage in the night.

Of course the problem isn't the Amiga's fault as such and Commodore provided tools to help programmers find illegal memory accesses. These tools, known as Enforcer and MungWall, require a Memory Management Unit or MMU to trap and document errant memory accesses (crashes are usually caused by programs writing to parts of memory that are otherwise engaged).

The trouble is the Amiga doesn't come with an MMU as stock, least of all something like Enforcer built-in. Currently, the most reliable operating systems are Unix variants and for this reason they are responsible for running most of the Internet. The feature of Unix that makes this reliability possible is known as Memory Protection, something that the new Workbench 4 is begging for. This means that tasks are

controlled by an MMU so that they can not access memory outside the areas they have allocated. The net theory as a task might crash itself but it can't crash the machine. Interestingly, this is why some Unix ports to the Amiga aren't nearly as reliable as this Unix counterparts. In short, Unix can handle the buggy code but AmigaOS can not (AMosaic

**Currently the most reliable operating systems are Unix variants and for this reason they are responsible for running most of the internet.**

for example). If the future Workbench 4 has the strong features of previous incarnations coupled with memory protection and other modern OS features, it would truly be a force to be reckoned with.

■ Mat Bettinson is CU Amiga  
Magazines' technical Staff Writer



# Next Month

# In **CU AMIGA** Magazine.

Don those  
virtual  
wetsuits ...  
the surfpack is here!



To reserve CU Amiga Magazine hand this form to your newsagent

Dear Newsagent,

Please reserve me a copy of the May issue of CU Amiga Magazine.

Please reserve CU Amiga Magazine for me until further notice.

Thank you.

My name is .....

My address is .....

..... Postcode .....

CU AMIGA Magazine is distributed by Frontline



## PLUS:

- The Amiga Technologies Q-Drive
- A4000 Tower System
- Chaos Engine 2
- Worms AGA
- Alien Breed 3DII

## May Issue on sale 14th April 1996



# CD-ROM



**DUAL-SPEED**  
**£179\***

**QUAD-SPEED**  
**£249**

## POWER CD-ROM

The Power CD-ROM for the Amiga 600/1200 plugs directly into the PCMCIA port and provides a direct SCSI-I and SCSI-II interface, allowing up to six additional devices to be connected. What's more the Power CD-ROM features a 'Hot-plug' which allows you to connect and disconnect the CD-ROM and any other additional devices even when the Amiga is switched on.

**FREE CD'S**  
**Diggers/Oscar**  
**Chaos Engine**

The CD-ROM drive comes with a SCSI interface, PSU, manual, audio lead, mains lead and software which includes Audio CD, CD32 Emulator, MPEG Film Decoder and Photo CD.

### REAR OF CD-ROM

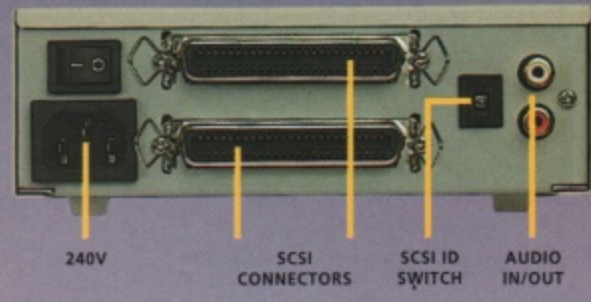

- AMIGA 600/1200**
- x2 SPEED CD-ROM INC. SQUIRREL . . . **£179**
  - x4 SPEED CD-ROM INC. SQUIRREL . . . **£249**
- AMIGA 4000**
- DUAL SPEED CD-ROM EXT. . . . . **£139**
  - QUAD SPEED CD-ROM EXT. . . . . **£199**
  - AMIGA 4000 SCSI-INTERFACE . . . **£129**
  - SCSI CABLE . . . . . **£10**



**80-WATT**  
**£54**

## CD-ROM'S

- AMINET SET 1 (4 CD'S) . . . . . **£25**
- AMINETSET 2 . . . . . **£25**
- AMINET 6 . . . . . **£12**
- AMINET 7 . . . . . **£12**
- AMINET 8 . . . . . **£12**
- AMINET 9 . . . . . **£12**
- MEETING PEARLS 2 . . . . . **£10**
- MEETING PEARLS 3 . . . . . **£10**
- AMIGA TOOLS 3 . . . . . **£25**
- XIPAIN T V3.2 . . . . . **£35**
- CD-WRITE . . . . . **£39**
- CD-BOOT 1.0 . . . . . **£29**

FOR ANY CD-ROMS NOT LISTED  
PLEASE CALL 01234-273000

\*DUAL SPEED CD-ROM CASING  
DIFFERS FROM ONE SHOWN  
SCSI INTERFACE REQUIRED FOR A4000

# FALCON

**68040RC 25MHZ**  
**£399.99**

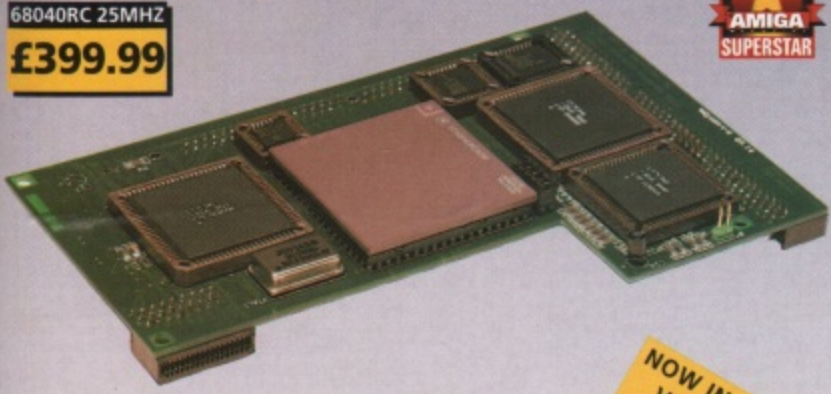

**1.5 Times more powerful than the Amiga 4000/040**  
**RAM Access 3.5 times quicker than the Amiga 4000/040**  
**Easily upgradable to the 68060 Processor**

**68040/060**

- FALCON 68040RC 25MHZ . . . **£399.95**
  - FALCON 68060RC 50MHZ . . . **£649.95**
  - 4MB SIMM . . . . . **£89.95**
  - 8MB SIMM . . . . . **£189.95**
  - 16MB SIMM . . . . . **£399.95**
  - FALCON NO CPU . . . . . **£389.95**
  - SCSI ADAPTOR . . . . . **£29.95**
- All Falcon's come complete with a cooling fan

## VIPER 28MHZ

The Viper 28 can have up to 128MB RAM installed, full Kickstart remapping, optional SCSI-II adaptor, on-board battery backed clock, 68882 co-processor optional, instruction and data burst modes.

- VIPER 28 MKII BARE . . . . . **£119.95**
- VIPER 28 MKII 2MB . . . . . **£179.95**
- VIPER 28 MKII 4MB . . . . . **£199.95**
- VIPER 28 MKII 8MB . . . . . **£299.95**
- VIPER 28 MKII 16MB . . . . . **£489.95**
- VIPER MKII SCSI ADAPTOR . . **£69.95**

## VIPER 50MHZ

The Viper 50 can have up to 128MB RAM installed, and the same features as the Viper 28.

- VIPER 50 BARE . . . . . **£199.95**
- VIPER 50 2MB . . . . . **£269.95**
- VIPER 50 4MB . . . . . **£289.95**
- VIPER 50 8MB . . . . . **£389.95**
- VIPER 50 16MB . . . . . **£599.95**

## CO-PROCESSOR

FPU's complete with crystal. Please state for Blizzard compatibility.

- 20MHZ FPU PLCC . . . . . **£20.95**
- 33MHZ FPU PLCC . . . . . **£39.95**
- 40MHZ FPU PLCC . . . . . **£60.95**
- 50MHZ FPU PGA . . . . . **£89.95**
- VIPER MK1 SCSI-ADAPTOR . . **£79.95**
- 4MB SIMM . . . . . **£89.95**
- 8MB SIMM . . . . . **£189.95**

## PC1208

A1200 8MB RAM card which uses 1 x 32 SIMMs and is PCMCIA friendly.

- PC1208 BARE . . . . . **£55.95**
- PC1208 1MB . . . . . **£85.95**
- PC1208 2MB . . . . . **£119.95**
- PC1208 4MB . . . . . **£145.95**
- PC1208 8MB . . . . . **£249.95**



**NOW IN STOCK**  
**VIPER MK1**  
**SCSI-ADAPTOR**  
**£79.95**

**STARTING FROM**  
**£119.95**

FOR ORDER FORM SEE DPS ADVERT

TEL: 01234 273000 FAX: 01234 352207  
POWER COMPUTING LTD 44A/B STANLEY ST. BEDFORD MK41 7RW

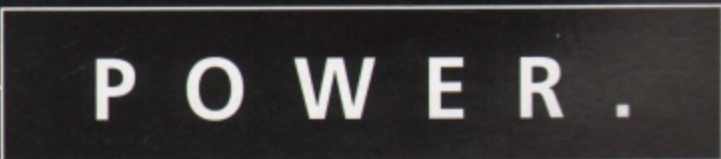

ALL PRICES INCLUDE VAT. SPECIFICATIONS AND PRICES ARE SUBJECT TO CHANGE WITHOUT NOTICE. ALL TRADEMARKS ARE ACKNOWLEDGED. ALL ORDERS IN WRITING OR BY TELEPHONE WILL BE ACCEPTED ONLY SUBJECT TO OUR TERMS AND CONDITIONS OF TRADE, COPIES OF WHICH ARE AVAILABLE FREE OF CHARGE ON REQUEST.





# BREATHLESS

CATCH YOUR BREATH. IT MAY BE YOUR LAST...



FREE DELIVERY  
**£29.99**

"Breathless has boldly taken the Amiga where no Amiga has gone before." *AMIGA FORMAT MAGAZINE*

"At the moment there's nothing like it. This game plays as well as it looks" *92% CU AMIGA MAGAZINE*

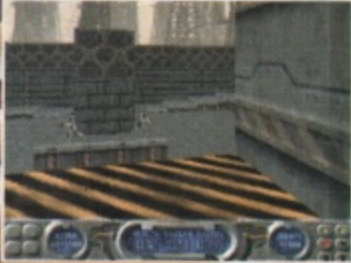

ORDER HOTLINE  
**01234 273000**



256 AGA COLOURS • 3D RAYTRACED GRAPHICS • 360° FIRST PERSON PERSPECTIVE  
20 AWESOME LEVELS • MULTIPLE WEAPONS SYSTEMS • REALISTIC LIGHTING EFFECTS  
ATMOSPHERIC SOUND & MUSIC • HD INSTALLABLE • AVAILABLE FOR THE A1200/4000

POWER COMPUTING LTD 44A/B STANLEY ST. BEDFORD MK41 7RW

PLEASE RUSH ME A COPY OF 'BREATHLESS'

NAME \_\_\_\_\_  
ADDRESS \_\_\_\_\_  
TEL NO. \_\_\_\_\_  
POSTCARD \_\_\_\_\_  
I ENCLOSE A CHEQUE/PO FOR £ \_\_\_\_\_  
PLEASE MAKE CHEQUES PAYABLE  
TO POWER COMPUTING LTD