

Special pa

CU AMIGA

M A G A Z I N E

WORTH £50!

MOVIESETTER

Full program
and free 100
page manual!

PLUS

FIFA SOCCER DEMO!

CREATE YOUR OWN MOVIES!

GOLD DISK PRESENTS

AMIGA INCLUDED WITH THE APRIL '95 ISSUE OF CU AMIGA - BRITAIN'S BEST AMIGA MAGAZINE **DISK 104**

Now everyone can create movies - all you need is your Amiga! **FULL PROGRAM & MANUAL**
All Amigas with 1Mb

MovieSetter

WIN! A CAMCORDER

PLUS: Complete MovieSetter clipart & Directory Opus Configuration File **AMIGA** MAGAZINE

AMIGA INCLUDED WITH THE APRIL '95 ISSUE OF CU AMIGA - BRITAIN'S BEST AMIGA MAGAZINE **DISK 105**

Try before you buy... **adidas**

FIFA INTERNATIONAL SOCCER

PLAYABLE DEMO! **It's brilliant!**

Superb playable demo of EA Sports' top-rated isometric footy game! **AMIGA** MAGAZINE

NO BOOK OR DISKS ATTACHED? ASK YOUR NEWSAGENT



GORGEOUS!

Animation made easy

Stop frame • Grabbing • Titling • Special effects



POWER CD-ROM

Super fast CD for A600/A1200

- Games:
- ATR
 - Turbo Trax
 - Super League Man.
 - Dawn Patrol
 - Baldies preview



April 1995 £3.95
US\$7.95 CAS\$9.95 DM20 PTA995 L13600
ASCH170 An EMAP Publication.

UNLESS STATED ALL PRICES INCLUDE VAT



"THE" CD ROM BASED A1200 SYSTEM

SUPER AMIGA CD SX-1 BUNDLE
ALL THE POWER AND FLEXIBILITY OF AN AMIGA A1200 COMBINED WITH THE CAPABILITIES OF A CD32.
COMPRISES
• CD32 CD CONSOLE
• SX-1 EXPANSION MODULE
• EXTERNAL 3.5" DISK DRIVE
• KEYBOARD, MOUSE, JOYPAD
PLUS MICROCOSM, CANNON FODDER, LIBERATION, PROJECT X, ULTIMATE BODY BLOWS, OSCAR AND DIGGERS (DOES NOT INCLUDE MOUSE MAT, MONITOR OR WORKBENCH DISKS)

UPGRADEABLE BY ADDING
• EXTRA 4 MEGABYTES OF RAM FOR SX 1 (129.99)
• INTERNAL 2.5" HARD DRIVE (A1200 VERSION)
• FULL MOTION VIDEO (STD CD32 FMV CART)

SUPER AMIGA CD SX-1 BUNDLE 2/0 480.00



AMIGA CD32

CD BASED CONSOLE WITH A1200 32-BIT POWER. 262,144 COLOURS FROM A PALLETTE OF 16.7 MILLION, 2 MB RAM, FAST 14 MHz 68020 PROCESSOR. PLAYS AUDIO CD'S VIA ON SCREEN DISPLAY AND DIGITAL VIDEO CD'S WITH OPTIONAL FMV ADAPTOR. FULLY EXPANDABLE WITH OPTIONAL SX-1 MODULE TO ALLOW KEYBOARD, DISK DRIVES AND OTHER AMIGA PERIPHERALS TO BE CONNECTED

AMIGA CD-32 CRITICAL ZONE PACK 220.00
WITH MICROCOSM, CANNON FODDER, LIBERATION, PROJECT X, ULTIMATE BODY BLOWS, OSCAR, DIGGERS AND ONE PAD

... VERY SPECIAL DEAL ...
ADD A PLUS THREE PACK ONLY WHEN YOU BUY A CD32 OR SUPER AMIGA

PLUS 3 PACK FOR CD32 ... 29.99
CONTAINS ONE COMMODORE CONTROL PAD, ELITE 2 AND TRIVIAL PURSUIT CD'S



COMMODORE CONTROL PAD FOR CD-32 13.99



DYNAMICS CONTROL PAD FOR CD-32 16.99



SX-1 EXPANSION MODULE FOR CD-32 194.99
TRANSFORMS CD-32 INTO A FULLY FUNCTIONAL A1200 COMPATIBLE COMPUTER ALLOWING CONNECTION OF EXTERNAL FLOPPY DRIVE, INTERNAL AND EXTERNAL IDE HARD DRIVE, KEYBOARD, MODEM/SERIAL DEVICES, PRINTERS, RGB MONITORS AND UP TO 8 MB MEMORY

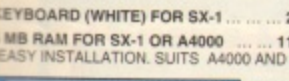

KEYBOARD (WHITE) FOR SX-1 29.99



4 MB RAM FOR SX-1 OR A4000 119.99
EASY INSTALLATION. SUITS A4000 AND SX-1

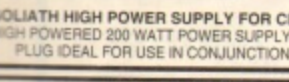

PREMIER COMBI CENTRE FOR CD-32 & SX-1 45.99
STRONG STAND FOR CD-32 AND SX-1 EXPANSION UNIT ALLOWING A NEAT AND TIDY SYSTEM SETUP. MONITOR STAND AND SLIDING SHELF FOR DISC LOADING. EASY SELF ASSEMBLY

GOLIATH HIGH POWER SUPPLY FOR CD 32 49.99
HIGH POWERED 200 WATT POWER SUPPLY, FAN COOLED HEAVY DUTY, DIRECT PLUG IDEAL FOR USE IN CONJUNCTION WITH SX-1 EXPANSION MODULE

TRAP DOOR MEMORY EXPANSION
512K AMIGA RAM + CLOCK FOR A500 OR A500+ 24.99
1 MB A500 PLUS RAM UPGRADE + CLOCK 35.99
1 MB A600 RAM UPGRADE + CLOCK 44.99
4 MB RAM BOARD FOR A1200 WITH CLOCK 179.99
4 MB + FPU RAM FOR A1200. FAST 33MHz FLOATING POINT MATHS & GRAPHICS ACCELERATION. COMPATIBLE WITH OVERDRIVE HARD DRIVES 235.99

LEADS
PROBOSHIFT INTERFACE FOR AMIGA OR ST 29.99
PLUGS MOUSE AND JOYSTICK INTO ONE PORT 13.99
SCART LEAD - AMIGA CD32 TO TV WITH SCART 9.99
SCART LEAD - AMIGA TO TV WITH SCART INPUT 9.99
TV LEAD - AMIGA CD-32 TO SVHS TV OR VIDEO 9.99

POWER SUPPLY
GOLIATH HIGH POWER SUPPLY FOR AMIGA HIGH POWERED 200 WATT POWER SUPPLY FOR ANY AMIGA. IDEAL FOR AMIGAS WITH HARD DRIVES, EXTRA MEMORY, ACCELERATOR BOARD OR ANY POWERFUL ADD ON 49.99
ZYDEC AMIGA POWER SUPPLY SPECIAL COOL RUNNING TRANSFORMER 32.99

COMPUTER CARE
DUST COVER FOR 80 COLUMN PRINTER (CLEAR) 5.99
DUST COVER FOR A1200 (CLEAR PVC) 5.49
DUST COVER FOR A600 (CLEAR PVC) 5.49
DUST COVER FOR A500 OR ATARI ST (CLEAR PVC) 5.49
DUST COVER FOR MONITOR (CLEAR PVC) 6.99

CONTROL CENTRES
PREMIER UNI-CENTRE FOR AMIGA. STRONG UNIVERSAL STAND FOR COMPUTER, MONITOR STAND AND SHELF FOR EXTERNAL PERIPHERALS 39.99
PREMIER UNI-CENTRE PLUS (EXTRA WIDE) 44.99

DISK DRIVES
EXTERNAL 3.5" DRIVE FOR ANY AMIGA OR SX-1 49.99
SONY/CITIZEN MECHANISM. 880K FORMATTED, QUIET, HIGH QUALITY, SLIM LINE COLOUR MATCHED METAL CASE AND LONG REACH CABLE

SOUND SAMPLER
TECHNOSOUND TURBO 2 REAL TIME SPECIAL EFFECTS. WORKS WITH ANY AMIGA. 1 MB RAM REQUIRED. 29.99

FRAME GRABBER
PROGRAB 24RT COLOUR DIGITISER. 24 BIT REAL TIME FRAME GRABBING SYSTEM. DIGITISES SINGLE FRAMES OR ANIMATIONS FROM VIDEO SOURCE. SUPPORTS 24 BIT FILE AND AGA SCREEN MODES 126.99

SCANNER
ZYDEC HANDY SCANNER FOR ANY AMIGA. 100-400 DPI HIGH QUALITY RESOLUTION, 64 SIMULATED GREYSCALES, INCLUDES DAATASCAN PRO SOFTWARE. 99.99

COMPLETE MULTIMEDIA 486 DX2/66 PC 4/560
999.99
EX VAT PRICE
INCLUDING MEMBERSHIP AND 24HR DELIVERY (SUBJECT TO STOCK)
(1174.99 INC VAT)

THIS PC HAS EVERYTHING - FULL SPEED FULLY UPGRADEABLE - FUTURE PROOF



TRUST 486 PC MINI TOWER
• MIDI TOWER CASE WITH FOUR DRIVE BAYS
• INTEL 486 DX2/66 PROCESSOR (UPGRADEABLE TO PENTIUM)
• FAST 13 MS 560 MB HARD DRIVE
• 4 MB RAM UPGRADEABLE TO 64MB
• FAST 32 BIT GRAPHICS ACCELERATOR TO SVGA
• 1 MB VIDEO RAM UPGRADEABLE TO 2 MB
• 256K CACHE FOR FULL DX2/66 POWER
• 3 LOCAL VESA BUS SLOTS AND SIX ISA SLOTS
• SAMSUNG 14" LOW RAD 0.28 DOT PITCH SVGA MONITOR (2 YR ON SITE WARRANTY)
• 102 KEY KEYBOARD, MOUSE & MAT
• CREATIVE SOUND BLASTER 16 VALUE SOUND CARD (300 COMPATIBLE)
• PANASONIC 563 DUAL SPEED CD ROM DRIVE
• STEREO SPEAKERS
• MS WINDOWS 3.11 AND MS DOS 6.22
• MS WORKS 3 INTEGRATED OFFICE SUITE
• MS MONEY HOME ACCOUNTS PACKAGE
• MS ENCARTA 95 FABULOUS ENCYCLOPEDIA ON CD
• MS DANGEROUS CREATURES
• MS SCENES SCREEN SAVER
• FOUR CLASIC GAMES - MS GOLF, CIVILISATION, ELITE 2 AND LEMMINGS.
• 24 MONTHS WARRANTY
• 24 HOUR DELIVERY TO UK MAINLAND SUBJECT TO STOCK

TRUST OPTIONS (PRICES EXCLUDING MEMBERSHIP)
OPTION 4 • WITH 4 MB RAM CHIP (3 SPARE RAM SLOTS) 996.59 1170.99
OPTION 8 • WITH 8 MB RAM CHIP (3 SPARE RAM SLOTS) 1102.97 1295.99
OPTION 16 • WITH 16 MB RAM CHIP (3 SPARE RAM SLOTS) 1273.18 1495.99
NEC QUAD SPEED CD ROM DRIVE OPTION AVAILABLE - JUST ADD £75 (INCLUDING VAT) TO ABOVE PRICES

OVERDRIVE V.11 CD ROM FOR A1200 189.99
EXTERNAL CD ROM DRIVE COMPLETE WITH INTERFACE (PLUGS INTO PCMCIA PORT). RUNS MOST EXISTING CD-32 SOFTWARE, PHOTO-CD, CD AUDIO AND CD+G DISCS. DOUBLE SPEED MULTI-SESSION DRIVE UNIT WITH MOTORIZED TRAY LOADING. COMPLETE WITH INTERNAL POWER SUPPLY AND UTILITIES/DRIVERS DISK. AMIGA AND CD AUDIO CAN BE MIXED. 1 YEAR WARRANTY. PLEASE NOTE SOME THIRD PARTY TRAPDOOR ACCELERATORS CAN DISABLE THE OVERDRIVE CD. WE ONLY SELL COMPATIBLE BOARDS.

MASSIVE 560 MB FOR 269.99
OVERDRIVE V.6 HIGH SPEED HARD DRIVES FOR A1200 AND A600
"THE FASTEST DRIVE EVER REVIEWED BY CU" 3.5" QUALITY IDE HARD DRIVE. AVERAGE ACCESS TIME 12MS. STYLED TO MATCH AMIGA. EASY INSTALLATION - PLUGS INTO PCMCIA SLOT. AQ TOOLS AND 1 YEAR WARRANTY (NOW FOR A600 TOO)

INTERNAL HARD DRIVES FOR AMIGA A1200, A600 & SX-1
HARD DRIVES: HIGH SPEED 2.5" DRIVE. 15 MS ACCESS TIME (APPROX). 1 YEAR WARRANTY. KIT COMPLETE AND EASY TO FIT. DRIVES FULLY PREPARED NOTE THAT OPENING YOUR AMIGA MAY INVALIDATE THE WARRANTY.

MICROVITEC 1438 MULTI-SYNC MONITOR 282.99
FOR AMIGA A1200/A4000 OR PC. WITH STEREO SPEAKERS AND AMIGA ADAPTOR. 0.28 DOT PITCH RESOLUTION, 15 PIN RGB DIN PLUG. SUITS ALL AMIGA AGA AND ALL PC SCREEN MODES TO SVGA. 1 YEAR WARRANTY.

QUICKSHOT SOUNDMATE 4 STEREO SPEAKERS FOR AMIGA, CD-32 OR PERSONAL STEREO. VOLUME AND BALANCE, BASS AND TREBLE BOOST, 4W+4W MUSIC 17.99
SCREENBEAT 3 STEREO SPEAKERS FOR AMIGA, CD32 OR PERSONAL STEREO 14.99
SCREENBEAT MAINS ADAPTOR FOR SCREENBEAT SPEAKERS 7.99

HEAVY discounts HUGE range
10am to 8pm Daily
FREE - 16 page colour catalogue - just phone
01279 600204
Order by fax on 01279 726842 - we'll fax back to confirm receipt

WE ONLY SUPPLY MEMBERS BUT YOU CAN ORDER AS YOU JOIN
Members receive our 48-page Colour Club Magazine bi-monthly. Each issue reviews a selection from our extensive range and includes at least £30 worth of coupons for additional savings on top products. Members are under no obligation to buy anything

MEMBERSHIP FEES
ONE YEAR (6 MONTHS) UK 7.00 (4.00) EC 9.00 (6.00) WORLD 11.00 (7.00)
One year price includes six issues of Special Reserve magazine with £180 of XS Coupons

All prices include VAT and 2-3 working day carriage to UK mainland
Software and peripherals are sent by post, hardware by White Arrow
Allow one or two days for processing and despatch of stock items
We issue confirmations of all orders received

Overseas orders must be paid by credit card
Hardware items (battery or mains) are only supplied to the UK mainland
Overseas surcharge £2.00 per software item or 25% on other items

HADE

(BLOCK CAPITALS please)
Name & Address

Postcode

Phone No Machine

Enter membership number (if applicable) or **NEW MEMBERSHIP FEE (ANNUAL UK 7.00)**

Please use this box to add any optional fast delivery charge
1st Class Post 40p per posted item or £10 hardware

ALL PRICES INCLUDE UK POSTAGE & VAT £

Cheque/P.O./Access/Mastercard/Switch/Visa

CREDIT CARD EXPIRY DATE SIGNATURE SWITCH (ISSUE NO)

Cheques payable to: **SPECIAL RESERVE at P.O. BOX 847, HARLOW, CM21 9PH**
Inevitably some games listed may not yet be available. Please phone to check availability. Prices and offers may change without prior notification. SAVE = Saving off full retail price. PRICES CORRECT AT TIME OF GOING TO PRESS. 24.02.95 E & O.E. Inter-Medias Ltd, 2 South Block, The Maltings, Sawbridgeworth, Herts. CM21 9PG.

Special Reserve The Discount Club
HUGE range of hardware, software, books, peripherals and leads for PC, CD Rom, Amiga, CD32, Sega, Nintendo, Atari, Apple, Sony, Philips and 3DO. All official UK products, all at HEAVILY discounted prices
Order by post, or by phone or come to one of the Special Reserve
OPEN 10am to 8pm CLUB SHOPS 7 DAYS A WEEK
43 Broomfield Rd **CHELMSFORD** near the bus station
The Maltings **SAWBRIDGEWORTH** near the train station
Over 250,000 people have joined Special Reserve

CITIZEN ABC 24 PIN COLOUR PRINTER
FREE PRINTER LEAD 144.99
FREE EASYSTART SOFTWARE 123.40 EX VAT
24 PIN, 80 COLUMN, 192CPS/64LQ, 5LQ/1 DRAFT FONT, 2 YEAR WARRANTY THE EASY TO USE PRINTER
ABC MONO PRINTER 124.99

GOOD BUDGET COLOUR
CITIZEN PROJET IIC COLOUR INKJET PRINTER 239.99
300 DPI RESOLUTION, 50 NOZZLE, 80 COLUMN, 120 CPS LQ, 3 COSTEABLE FONTS, LOW RUNNING COSTS AND EASY TO USE. 2 YEAR WARRANTY

ALL PRINTER PRICES INCLUDE CARRIAGE VAT AND FREE PRINTER LEAD PLUS DIGITA PAK
WORDSWORTH SPECIAL EDITION & HOME ACCOUNTS FOR ANY AMIGA ONLY WHEN YOU BUY A PRINTER ... 14.99

CANNON BJC-4000 COLOUR INK JET PRINTER. 64 NOZZLES, 8 PPM 334.99
CANON BJ-200 BUBBLE JET PRINTER. 248CPS, 8 TYPEFACES 229.99
CITIZEN TRACTOR FEED KIT FOR CITIZEN ABC PRINTER 36.99
CITIZEN DOT MATRIX PRINTER DRIVER KIT FOR AMIGA 12.99
DUST COVER FOR 80 COLUMN PRINTER (CLEAR PVC) 5.99
PRINTER STAND FOR ANY PRINTER 8.99

COMPREHENSIVE RANGE OF RIBBONS IN STOCK - PLEASE PHONE

contents

CU AMIGA • APRIL 1995

Cover Feature

Gorgeous Animation 22

Discover new tricks to make stunning animations with your Amiga!



We spill the beans on a world of exciting animation techniques. With the help of this month's brilliant **MovieSetter** cover disk and other art common programs, we show you how to create stop frame animations, science fiction mini movies, techno visual effects, professional logos and impressive combinations of live video and cartoon action! Turn to page 22. Now!



PD special p77

There's loads of good public domain software around, so we've devoted nine pages to this seemingly bottomless source of virtually free fun. We've got charts covering all major areas including demos, games, applications, utilities, graphics, sound and education, plus reviews of the best of the latest disks!

Get serious

- Twist Database** 96
 Fancy storing some data? Andy Leaning checks out Digita's new database.
 
- A500 Upgrades** 98
 The A500 is still alive and kicking, and to prove it we've got a round up of hot new high performance peripherals.
- Photogenics 1.1** 100
 The 24 bit paint package gets a new revision. Andy Leaning has a tinker with the new bells and whistles.
- Power CD-ROM** 102
 At last the Zappo has competition. Will the Power CD-ROM clean up in the A600 and A1200 CD-ROM market?
- Studio II Professional** 104
 Improve your print quality with this new printer driver.
- Squirrel** 106
 HiSoft's SCSI interface opens up a world of storage possibilities: hard drives to CD-ROMs, floptical drives ...
- ACEEX DM02814 Modem** 108
 Everyone wants a piece of the Internet action, but you won't get far without a fast modem.
- Mamba TV Modulator** 108
 Replacement TV modulators have been hard to come by, but now Amitek have a new one on the market.
 

Cover disks

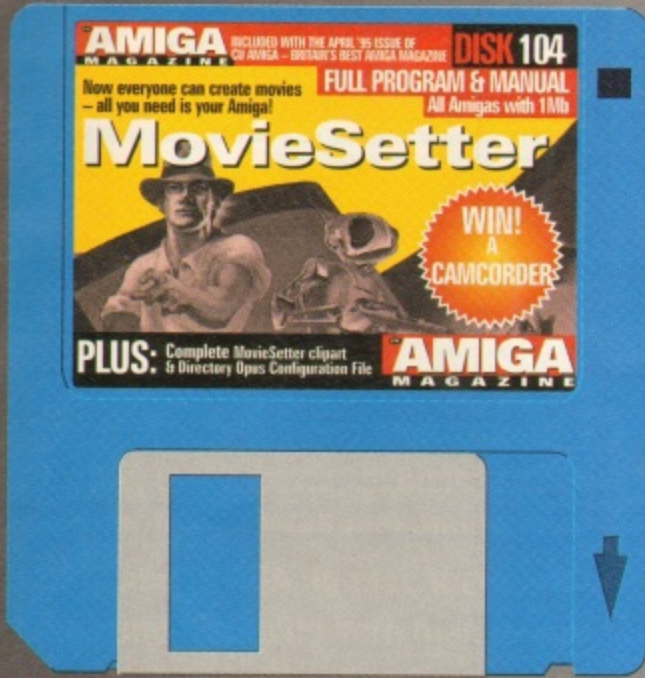

Disk 104 Page 10

MovieSetter: the full working version of this brilliant animation package, including extra clip art, full manual and a new module for *Directory Opus*.

Disk 105 Page 12

FIFA Soccer comes to your Amiga! Test it out for yourself in this playable demo of the action packed 3D arcade footy simulation.

Games

PREVIEWS

- **Baldies** 40
The funniest egotist sim yet? Check it out.
- **Ultimate Soccer Manager** 42
There's more to football than Match Of The Day.
- **Tactical Manager II** 42
Even more sheepskin jacket football action.
- **Speris Legacy** 44
Team 17's *Zelda*-like adventure gets its first airing.
- **Leading Lap** 44
Get your go faster stripes ready for this polygon racer.

REVIEWS

- **Ruffian** 49
Check out Grandslam's latest platformer.
- **ATR** 50
Racing around Wakefield's toughest tracks.
- **Dawn Patrol** 52
A good history lesson or a good game? Find out.
- **Shadow Fighter A1200** 56
The best fighting game has gone AGA at last.
- **ITS Cricket** 56
International Test Cricket from Australia.
- **Voyages Of Discovery** 58
Passing ships in the night.
- **Turbo Trax** 61
Snow, sand, mud and fast cars.
- **Super League Manager** 63
Audiogenic's realistic management sim.
- **X-it** 66
Alien experiment goes wrong.

- **Benefactor** 67
Superb platform *Lemmings*.
- **XTractors** 67
The new diggers.
- **Skeleton Krew** 70
More 'Supergooscope'.
- **Dragonstone** 70
Core's adventure with a big sword.
- **VFM** 71
Bargain basement games.



PLAYERS GUIDES

- **Vampyra** 73
Solutions from the woman who knows.
- **Lords Of The Realm** 74
Find out how to become king in part one of our players guide.
- **Dreamweb** 75
Can you defeat the dark forces of the Dreamweb or will it gain control of you?



Competitions

- **Canon camcorder competition!** 20
Your chance to win an amazing Canon video-camera.
- **Six A1200s must be won!** 36
Part 2 of this superb comp.
- **Zeewolf 2 Competition** 46
Design a level and win £200.
- **Win a Power CD-ROM** 103
There's two of these superb drives up for grabs.



- **CD32 Akira** 66
So much potential, so little gameplay.



Editorial

What have I got to smile about in such a smug manner? You might well ask. The answer is that I've seen the future. Not that I'm going to win the lottery or anything, nor do I have any inside betting information on who is going to take over Commodore. No, I've seen what the games and productivity software that is being produced for the Amiga over the next six months is like, and it's good news. Check out our preview pages for titles like *Baldies*, *Team 17's Speris Legacy* and *Leading Lap*. Check out our news pages for a first report on a superb new spreadsheet from Softwood and a ProGrab update from Harwoods. With these and other new products



such as the imminent release of a new version of *Blitz Basic* from Acid, *DPaint 5* (at last) from EA and coin-op conversions like *Super Streetfighter II* and *Primal Rage* on their way it looks like being another good year.

I hope you like the second in our frequent series of full manuals, cover mounted for your convenience. We cannot do this sort of thing all the time, but the reader response to both the *X-CAD* guide and the *ComicSetter* manual was so good we just had to repeat the offer. While other magazines are padded out with page after page of 'Special Offers', designed to help you part with more money, we like to give you a pat on the back now and again, give you something more than the rest of the pack. And speaking of the rest of the pack, I saw an international 'Amiga' magazine recently with a completely disproportionate amount of PC and non-Amiga product reviews and advertisements gracing its pages. That's one sure way to kill a market guys. Kick it while it's down, that's the spirit.

Advertisers' Index

1ST COMPUTER CENTRE.....38	0113-2319444	MICROPROSE.....15	
17 BIT SOFTWARE.....86	01924-366982	NOBLE HOUSE.....83	
ACTIVE SOFTWARE.....80, 81	01325-352260	OCEAN MEDIA.....OBC	
ANCO SOFTWARE.....34, 35	01322-292518	OWL ASSOCIATES.....101	01543-250377
BLACK COU NTRY MICROS.....112	01562-720214	POST HASTE.....60	01227 764204
BRIAN FOWLER COMPUTERS.....57	01392-499755	POWER COMPUTING.....13, 62, IBC	01234-843388
CARE ELECTRONICS.....83	01923-894064	PREMIER MAIL ORDER141	01268-271172
CU AMIGA CLASSIFIEDS.....130,131,132,133	071-972 6700	SEASOFT.....122	01903-850378
DART COMPUTER SUPPLIES.....101	0116-2470059	SELECTAFONT.....112	01702202835
DELTRAX PD.....88, 89	01492-515981	SILICA SYSTEMS.....29, 43, 47, 65	0181-3091111
DIRECT SOFTWARE.....97	01908-379550	SOFTWARE 2000.....92, 93	01374-678068
ELECTRONICS ARTS.....7		SOFTWARE FIRST.....21	01268-725500
EPIC MARKETING.....68, 69, 94, 113	01793-490988	SOFT XPRESS.....111	01908-277177
EXCLUSIVE PD.....76	01705-642409	SOFTWOOD PRODUCTS.....30, 31	01773-836781
FAST COMPUTER SUPPLIES...112	0171-252 3553	SPECIAL RESERVE.....IFC	01279-600204
FLASHTECH.....48	01736-331999	THE ONE AMIGA.....136	0171-972 6700
FREESTYLE PD.....112	01922-710985	VIRUS FREE PD.....114	01793-490988
GORDON HARWOODS...8, 9, 37, 45	01773-836781	VISAGE COMPUTERS.....64, 105	0115-9444501
GREYTRONICS.....59	0181-686 9973	WALKABOUT MUSIC.....112	01726-813807
HI SOFT AVA.....17	01525-718181	WEIRD SCIENCE.....108	0116-2340682
IMPRESSIONS SOFTWARE.....53		WHAT HOME ENTERTAINMENT...129	0171-972 6700
INDI DIRECT.....54, 55	01543-419999	WIZARD DEVELOPMENTS.....72	01322-272908
KTS PD.....76	01702-542434	WIZARD GAMES.....101	01723-376586

Editorial

EDITOR: Alan 'New York' Dykes
DEPUTY EDITOR: Lisa 'Very cold' Collins
TECHNICAL EDITOR: Andy 'Other projects' Leaning
REVIEWS EDITOR: Tony 'Dalek' Horgan
GROUP ART EDITOR: Jeff '50 a day, at least' Zie
DESIGNER: Helen 'I'm interviewing people tomorrow' Danby
TECHNICAL CONSULTANT: John 'Brilliant screen shot' Kennedy
CONTRIBUTORS: Peter Lee, Andy Mitchell, Vampyra, André Digard, Nik Lines, Rik Skews, Tony Dillon, Jimmy Conway, Andy Nuttall, Matty B, Michael Traquir, Foz
PHOTOGRAPHY: Mark Gatehouse and his minions **ILLUSTRATION:** Seb Quigley
IN-HOUSE REPROGRAPHICS & SYSTEMS: Sarah-Jane Leavy & Nick Claridge

Advertising

Ad MANAGER: Justine Carlson
SENIOR SALES EXEC: Chris Perera
AD PRODUCTION: Tina Gynn and Vicky Jacobs
PRODUCT MANAGER: Fiona 'Er, got a game Alan' Malloch
PROMOTIONS: Nigel 'Polo' Taylor
MARKETING CONTROLLER: Mark 'Adieu' Swallow
EDITORIAL DIRECTOR: David Kelly
MANAGING DIRECTOR: Terry Pratt

Contacts

When contacting CU AMIGA there are two golden rules.
1: Send your letters etc to the right department and please do not send a stamped self-addressed envelope.
2: Please remember that we have to write and produce your favourite magazine every month, so try to keep your correspondence short and to the point. Although we'd love to, we simply cannot reply personally to the hundreds of calls, letters, and faxes we get. Answers have to be through the pages of the magazine only.

ADVERTISING AND ADVERTISING PROBLEMS
 If you wish to advertise, or have a problem with a company advertising in CU AMIGA our advertising team can help. Contact Chris Perera on 071-713 5289, or write to them at CU AMIGA Advertising, Durrant House, 9 Herbal Hill, London EC1R 5EJ.

READERS' LETTERS AND TECHNICAL PROBLEMS
 For general, non-technical, enquiries send your letters to Backchat, for technical problems send them to Q&A. Both are at CU AMIGA, Priory Court, 30-32 Farringdon Lane, London EC1R 3AU.

PD SUBMISSIONS
 We get hundreds of new PD programs every week, but we're still hungry for more. If you've written a PD program that you're proud of send it to the PD ZONE, CU AMIGA, Priory Court, 30-32 Farringdon Lane, London EC1R 3AU.

COMPETITIONS
 CU AMIGA runs massive competitions almost every issue. To enter one of these simply put your name and address on the back of postcard, along with the answers and send them to us at the usual address. Competition entries are only accepted by post. One entry per person please and the editor's decision is final. Winners will be notified by post. Other rules may be printed from time to time.

SUBSCRIPTIONS and BACK ISSUES
 If you're fed up with hunting around for CU AMIGA every month there's an easier way of getting your favourite monthly - see page 124 for details. The subscription hotline and back issues number is 0858 468888.

SUBSCRIPTION DETAILS:
 Subscriptions are available from Tower Publishing, Tower House, Sovereign Park, Lathkill Street, Market Harborough LE16 9EF Tel: 0858 468888. Annual subscription rates (inc postage) 12 issues: UK/BFPO £47.40. SURFACE/ROW £55.00. AIRMAIL EUROPE £60.00. AIRMAIL ROW ZONE 1 £90.00. AIRMAIL ROW ZONE 2 £96.00.

COVERDISK PROBLEMS
 If you have a faulty cover disk then write or return your disk to our 3.5 inch people: CU AMIGA COVER DISK RETURNS, DISKXPRESS, UNIT 7, WILLOW COURT, BOURTON INDUSTRIAL PARK, BOURTON-ON-THE-WATER, GLOUCESTERSHIRE, GL54 2HQ.

COMMS
 You can contact Andy Leaning, via the Internet/Email CUAMIGA@cix.compulink.co.uk. Please keep email brief and to the point.

Special thanks to: Canon UK for the excellent camcorder equipment used in the feature.

© EMAP Images 1994. No part of this magazine may be reproduced in any form, either electronic or mechanical, without the express written permission of the publishing director. PRINTED IN THE UNITED KINGDOM ABC: 105,412 Jan - June 1994.

Extra

News 18

DPaint is released at last, there's a new spreadsheet from Softwood, a six speed CD-ROM drive is announced, Arcane get the a Conan licence and Black Legend set up a help line.

Sensible World Of Soccer 126

Fancy yourself as a world class manager? Fancy a trip to a European football game of your choice?

Subscriptions 124

Subscribe now, save money and get a free gift!

Workshop

Directory Opus 116

Andy Leaning continues his monthly tutorial on the fabulous Feb. '95 coverdisk.

Modeler 3D 118

More Leaning help for potential 3D geniuses.

ProCalc 119

Find out more about the best spreadsheet available.

Photogenics 120

Peter Lee starts off the newest tutorial in the magazine, showing you how to get the most from Almathera's stunning 24-bit paint and animation package.

Buyers guide 123

Nervous about mail order? Let our expert help you out.

Questions And Answers 134

Tony and Andy give you good advice.

Frequently Asked Questions 137

High density and PC disks - are they compatible.

Amiga Masterclass 138

Data compression techniques.

Tony Horgan's Sound Lab 140

The talking Amiga.

Backchat 142

Letters. What did you think?

Points of View 146

Andy Nuttall, the greatest actor of them all, talks about his favourite subject: Games. Or the lack of good ones.

DELUXE PAINT® V

THE DIRECTOR'S CUT

When you're creating a new version of an acknowledged classic, how do you go about improving it? By including and improving every feature possible, that's how. DeluxePaint® V has 30 new features and enhancements over DeluxePaint IV and IV AGA. In fact, there are more features and flexibility here than in any other Amiga paint and animation program.

DeluxePaint V gives Amiga 1200 and Amiga 4000 owners access to over 262,000 apparent colours (using HAM8 modes) in multiple screen resolutions. All Amiga owners can now create, edit and save true colour 24BIT RGB pictures and animations in any screen mode. That means greater colour control and better definition for all your graphics and animations.

Automate any feature or perform complex functions at the press of a key thanks to ARexx and Macro record and playback. DeluxePaint V supports painting and animation in every screen mode, from 2 colours to 16.7 million colours. Texture background and media types give drawings and paintings a real world/media look, while multiple palette and variable frame anims provide unparalleled control of frame colour and animation speed. There's video overscan support for desktop video recording and editing, plus a huge crowd of extras.



DELUXE PAINT V - ONE SEQUEL THAT WAS WELL WORTH THE WAIT



For more information about DeluxePaint V, please call 01753 546 465, or write to Electronic Arts, P.O. Box 835, Slough, Berkshire SL3 8XU.

• DeluxePaint is a registered trademark of Electronic Arts. • DeluxePaint® V by Lee Özer and Dallas Hodgson ©1985, 1994 Electronic Arts • **Supports:** Amiga 500, 2000, 3000, 1200, 4000 (AGA required for 256 color and HAM8 support) • **RAM Requirements:** 2MB, 4MB highly recommended for 24Bit True Color RGB support, ARexx support • **System Requirements:** Amiga DOS 2.04 or greater

APPEARING ON AN AMIGA NEAR YOU FROM MARCH 1995

"Why not FAX our Sales Team for a Quick-Quote!"



"Call us, we're always keen to offer GREAT DEALS on everything for your Amiga!"

LOW PRICES, EXCLUSIVE PRODUCTS... EXPERT ADVICE and MUCH MORE FROM THE UK'S FAVOURITE

170Mb Self Fit Hard Drive
GH Prices start from as little as...

£164.95

If you prefer we can fit your new hard drive for you!

GH AMIGA A1200 INTERNAL DRIVES... are all standard 2.5" IDE devices (self fit or fitted) as designed by CBM. We do NOT use cheaper alternative 3.5" units which can overload the Amiga's circuit board and create incompatibility problems when using expansion boards! You should check with other suppliers if THEY use quality 2.5" IDE units when you make price comparisons! ESSENTIAL Hard Disk Manual FREE with every GH 2.5" IDE Hard Drive!

A1200 INTERNAL HARD DRIVES



INTERNAL FITTING FOR YOUR AMIGA A1200

FREE... ESSENTIAL GH HARD DRIVE MANUAL

CAPACITY	Self Fit	Fitted
170Mb Internal	£164.95	£189.95
200Mb Internal	£219.95	£244.95
250Mb Internal	£264.95	£289.95
400Mb Internal	£274.95	£299.95
500Mb Internal	£439.95	£464.95

JUST LOOK AT THE BENEFITS OF OUR FITTING SERVICE... ONLY GH CAN OFFER YOU ALL THIS AT SUCH LOW PRICES!

AMIGA DEALER

LOOK HERE! WE'VE GOT 170Mb DRIVES AT UNDER... **£165!**

THE UNIQUE GH FITTING SERVICE... Why not let our engineers collect your Amiga and fit your drive for only £25 extra!

- The price includes...
- Collection of your Amiga
 - Fitting by experienced GH technicians
 - Formatting with W/Bench
 - HD configuration and installation of back up and repair software
 - FULL 1 Year GH Gold Collection Warranty
 - Courier return to you

OVERDRIVE 35 EXTERNAL HARD DISK DRIVES



SIMPLY... PLUGS INTO THE PCMCIA PORT OF AN A1200

340Mb External Hard Drive

Super Prices start from Only... **£239.95**

Designed to match your Amiga - Looks and works Great!

OVERDRIVE 35 EXTERNAL HARD DRIVE 'Plug and Go!'

Simply plug this great Hard Drive into the PCMCIA slot of your Amiga 1200! Fitting doesn't involve taking your Amiga apart. Retains full CBM warranty. Casing matches the Amiga's, pre-formatted, tested and ready to use. Just 'Plug and Go'. All models up to 500Mb. are at Super Low Prices!

CAPACITY	GH Price
340Mb External	£239.95
400Mb External	£269.95
500Mb External	£279.95

Full 12 months warranty on HD. Doesn't invalidate CBM warranty!

SIMPLY... PLUGS INTO AN A500/+



External HD's... External IDE Case that Plugs into the either A500 or 500+. You can add either TWO 2.5" or ONE 3.5" IDE Hard Drive! Allows up to 680Mb configuration!!! Auto-Boot, Auto-Config, c/w manual & software. Ideal with Supra Turbo!

200Mb External	£299.95
250Mb External	£349.95
400Mb External	£359.95
500Mb External	£519.95



SUPRA 28MHZ ACCELERATOR
For A500 or 500+
£129.95

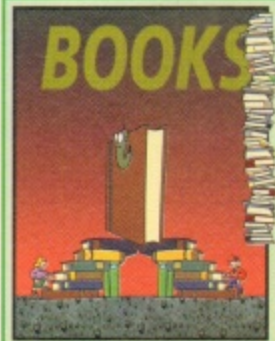

Please phone and ask about more books in the comprehensive GH Bookshop range!

AMIGA BOOKSHOP - Just a Small Sample of the GH stock...

Amiga Workbench 3 A-Z	£14.50	Mastering Amiga DOS Scripts	£18.95
Amiga 1200 Insider Guide	£14.50	Mastering Amiga AREXX	£19.50
Amiga Assembler Insider Guide	£14.50	Mastering Amiga Printers	£18.50
Mastering Amiga DOS...		Amiga Disks and Drives	£14.50
Version 2, Volume 1	£18.95	A1200 - Next Steps	£14.50
Version 2, Volume 2	£18.50	A1200 Beginners Pack	£37.95
Version 3 Reference	£19.50	(2 books, video & tutorial disks)	
Version 3 Tutorial	£19.50	NEW...Secrets of Frontier Elite	£9.95
NEW...Amiga Desktop Publishing	£14.95	NEW...Workbench 3 Booster Pack	£37.95
NEW...Fonts & Clip Art	£9.95		

AMIQUEST EXTERNAL HARD DRIVES



SIMPLY... PLUGS INTO THE PCMCIA PORT OF A600's & A1200's

COMPACT AND PORTABLE DESIGN!

OVERDRIVE

170Mb External 'Portable' HD
GH Prices start from just... **£234.95**

Units with REAL Portable Power!

So small it can be transported with ease for Portable Power!

AMIQUEST A600/1200 PORTABLE EXTERNAL HARD DISK DRIVES

No taking your Amiga apart... just plugs into the PCMCIA slot of your A600/A1200 computer. Fantastic 2.5" IDE device that's small & easy to fit. Faster access times than internal units. Use as a second HD (for backups etc.). Full 12 months warranty.

Doesn't invalidate your CBM warranty!

CAPACITY	GH Price
170Mb External	£234.95
200Mb External	£294.95
250Mb External	£324.95
400Mb External	£349.95
500Mb External	£514.95

AMIGA COLOUR MONITORS



Amiga Displays

Monitor & TV Monitors for better displays from **£159.95**
You'll see the difference!!!

MICROVITEC 14" COLOUR MONITOR 0.28 Dot Pitch, Hi-Res Colour (requires separate speakers), Ideal for Amiga, Acorn, ST, PC-SVGA, etc. Cable Included FREE!	PHILIPS CM8833 14" COLOUR MONITOR One of GH's best selling monitors ever! We have secured... LIMITED STOCKS of this great all round display. Plugs straight into your Amiga with the cable supplied FREE by GHI!	PHILIPS PRO2000 17" COLOUR MONITOR/TV 2000 Character Resolution 17" FST High Definition & FastText TeleText! Includes Remote, Loop Aerial, Headphone Socket, front panel Audio/Video input, SCART Socket (for direct connection) with FREE Leads!	PHILIPS ENTRY LEVEL 14" COMPUTER TV Ideal first time display and TV too! Infra Red Remote, front panel Audio/Video input sockets (for camcorder etc.), SCART Socket for direct computer connection, FREE Amiga Leads!
Microvitec 14" Monitor Only... £299.95 (Requires Speakers)	Microvitec 14" Monitor & Sound... £329.95 (Includes Speakers)	CM8833 14" GH Best Seller £234.95 (Internal Speakers)	Pro 2000 17" Larger Quality! £239.95 (Internal Speakers)
		Philips 14" GH Best Budget Buy £159.95 (Internal Speaker)	

Viper 68030 Turbo NEW LOWER PRICES FOR VIPER TURBO ACCELERATORS

25MHz: 68030-MMU - 0Mb	£149.95
40MHz: 68030-MMU - 0Mb	£249.95



0.5Mb for A500 with Clock	£32.95
1Mb for A500+ with Clock	£39.95
1Mb for A600 with Clock	£39.95

Finance Facilities Available on all HARDWARE items. Why not apply for a GH Credit Charge Card (subject to status). Ask for an Application Pack. Full written details available on request.

BUY FROM GH WITH ABSOLUTE CONFIDENCE! "As a family business established in 1955, we've supplied computers for the past 12 years. With over £32 million worth of units sold, and more than 215,000 happy customers, our trading record is second to none! Why don't you try us for your next Amiga product and find out just why we are the UK's Favourite Amiga Dealer! Phone us now - you'll be pleased you did!"

GH AMIGA PRINTERS

"We've selected some of our **Best Sellers** and held the prices **LOW!** Of course with GH you will receive a **FREE Cable** and with **Dot Matrix** models you also get a **FREE Dust Cover!**

Epson Stylus 800



EPSON STYLUS 800
720 dpi COLOUR INKJET
Exciting and revolutionary **NEW HIGH QUALITY INKJET PRINTER!** Boasting incredible 720dpi resolution max. output, the Stylus 800 is unique! Take a look at recent mag. reviews and glowing reports! If you need the ultimate low cost inkjet proofing device - This is the one for you!
(Works with current drivers but requires a new one that takes advantage of the 720dpi resolution - available soon!)

Epson Stylus Colour

Excellent and Truly Unique Budget Inkjet 720dpi Printer

ONLY... **£429.95**
INCLUDES SHEET FEEDER



CITIZEN PRINTER RANGE

A great range of Dot Matrix Printers...

Citizen ABC - 24Pin

Choose either Mono or Colour!
Budget MONO... Great Value COLOUR...
ONLY... **£129.95** **£154.95**

Citizen 90, 9Pin Colour

One of our Best Selling COLOUR Printers...
ONLY... **£164.95**

Citizen 200, 24Pin Col.

Super Print Quality at a special low price
ONLY... **£184.95**

Citizen 240, 24Pin Col.

Super Quality Print and Feature Packed...
ONLY... **£224.95**



CANON BUBBLEJET RANGE

If you prefer BubbleJet (inkjet) then think Canon!

Canon BJ10sx Mono

Low cost A4 Printer with 360dpi resolution
JUST... **£189.95**

Canon BJ200 Mono

Low cost A4 Printer with 360dpi resolution
JUST... **£249.95**

Canon BJ230 Mono

Superb A4/A3 Printer with 360dpi resolution
JUST... **£329.95**

Canon BJ600 Colour

Fully featured A4 Printer with 360dpi resolution
JUST... **£459.95**



BRAND NEW HP 320 MONO INKJET PRINTER
Replaces the popular 310 model and now has 600 x 360dpi resolution. Ask for details of the optional colour kit!



HP 320 Mono
Low cost A4 Printer with 360dpi resolution
JUST... **£229.95**
Optional SHEET FEEDER Only... **£61.95**
Optional COLOUR KIT Only... **£39.95**

CONSUMABLES/ACCESSORIES

Canon
INKJET CARTRIDGES:
BJ10ex/sx **£18.95**
BJ200/230 **£18.95**
BJ600 Black **£6.95**
Cyan, Magenta, or Yelo **£8.95**
BJC600 Pack - inc. Cyan, Magenta, Yelo, Black **£32.95**
BJ800 Black **£16.95**
Cyan, Magenta, or Yelo **£21.95**
BJ10ex SHEET FEEDER **£84.95**
(Black/White available state which you need when ordering)

CITIZEN
RIBBONS:
120D Mono **£3.95**
90/C Mono **£3.95**
90/C Colour **£15.95**
24/200/240 Mono **£3.95**
Colour **£15.95**
9/24Pin 80 Col. Colour Kit **£37.95**
(NB: This is not suitable for Citizen 124 Printers)
32K RAM BUFFER - 24/24E **£13.95**
32K RAM BUFFER - 200/240C **£19.95**
128K RAM BUFFER - 200/240C **£32.95**
80 Col. AUTO SHT. FEEDER **£84.95**
(Please state your printer model when ordering)

hp
INKJET CARTRIDGES:
DeskJet BLACK (Double Life) **£23.95**
DeskJet TRI COLOUR **£27.95**
PaintJet BLACK **£26.95**
PaintJet TRI COLOUR **£38.95**
PAPER - Single Sheet **£18.95**
PAPER - 'Z' Fold **£20.95**
TRANSPARENCY FILM (50Sht) **£49.95**

EPSON
Stylus COLOUR
INKJET CARTRIDGES:
Stylus 800 BLACK **£19.95**
Stylus 800 TRI COLOUR **£34.95**
PAPER **£18.95**
Stylus 800 **£21.95**

CITIZEN
ABC PRINTER ACCESSORIES:
COLOUR KIT **£24.95**
TRACTOR FEED **£39.95**

PHONE US FOR OTHER PRINTERS AND EVEN MORE ACCESSORIES AND CONSUMABLES AT GREAT PRICES!!!

harwood computers

THE GH ADVANTAGE...
Remember when you buy from GH we look after you... Our policy gives you...
FREE UK Mainland collection and re-delivery for any major hardware item that may develop a fault in the first year, access to our special Help-Line option to extend most product warranties for a period of your choice and...

MUCH MORE!
Why not ask about our 'LifeTime Warranty Plan', you'll be amazed at the LOW COST! Even if you purchased hardware elsewhere you may still be able to take advantage of this unique scheme. Call us now you'll be pleased you did!



DIAL -A- DEAL **01-773-836781** or



FAX US FOR A 'QUICK-QUOTE' ON... **01-773-831040**

AMIGA EXTERNAL FLOPPY DISK DRIVES

POWERDRIVE 880K - 3.5" EXTERNAL DRIVE
Anti Click, Anti Virus, Throughport, Sony Mechanism, can be upgraded to 1.7Mb Spec. With FREE Blitz & Expander software to give 1.4Mb per disk!
Cyclone compatible. Full 2 year warranty.
£57.95
Great Value

POWERDRIVE 1.7Mb HD 3.5" DRIVE
A massive 1.7Mb capacity is now available on every Amiga disk! Inc. FREE Head Cleaner
£69.95
BIG Capacity

AMITEK 3.5" DRIVE £62.95
Built-in Anti Virus checker and FREE Disk Head Cleaner!

CYCLONE SOFTWARE £14.95
Fully compatible with either of the two Powerdrive models shown in this advert

We also supply other Disk Drives (not listed above) both internal and external at GREAT PRICES!
Phone GH and ask for details

SUPRA FAX MODEMS

NOT BART APPROVED

Supra 144LC
V32 Bis - Transmit & Receive Faxes at up to 14400bps! Includes a cable to your Amiga (Fax s/w available, see panel below)
£139.95
GH Value
Modem to Modem s/w inc.

Supra 288
Feature packed! Can operate up to a FAST 28800bps! Includes a cable to your Amiga (Fax s/w available, see panel below)
£229.95
GH Value
Modem to Modem software included

GP FAX SOFTWARE £49.95
Required by Supras for Fax transmission and receipt.

AMIGA ACCESSORIES

AMIGA MICE:
HQ Microswitched, smooth 400dpi Resolution MEGA MOUSE **£11.45**
HQ Optical Microswitched mouse **£28.95**
Alpha Data Mouse Pen **£32.95**
HQ Microswitched Trackball **£29.95**
Auto Mouse/Joystick Switcher **£17.95**
Mouse Mechanic - mouse cleaner **£4.95+p&p**

AMIGA MIDI INTERFACE:
Midi interface Sport **£24.95**

AMIGA JOYSTICKS:
Zipstick Autofire **£11.95** The 'BUG' **£14.95**
(Full range of Quickjoy and other joysticks - PHONE!)

AMIGA DISK PRODUCTS:
TDK 3.5" DS DD - 10 **£6.95** 50 **£29.95**
TDK 3.5" DS HD - 10 **£8.95** 50 **£39.95**
Certified Bulk Disks with labels:
10 with library case **£4.95**
50 Disks - No Library Cases... **£19.95**
100 Disks - No Library Cases... **£35.95**
250 Disks - No Library Cases... **£79.95**
3.5" Essential Disk Head Cleaner - **£2.95**
PHONE FOR LOTS MORE ACCESSORIES TOO!

AMIGA SOFTWARE

Listed is a small selection of our vast range of Amiga software. Phone us for more!

PAGESTREAM 3 **£229.95**
NEW... FINAL DATA - Database **£39.95**
PEN PAL Vers. 1.5 **£34.95**
FINAL COPY II Release 2 - Supports AGA **£49.45**
FINAL WRITER Release 3 - Supports AGA **£74.95**
MINI OFFICE **£39.95**
SCALA HT100 **£35.95**
DELUXE PAINT 4.1 **£64.95**
DELUXE PAINT 4 - AGA **£74.95**
VISTA PRO 3 **£29.95**
VISTA PRO LITE **£29.95**
ART DEPARTMENT PRO 2.5 **£149.95**
REAL 3D CLASSIC **£74.95**
REAL 3D Vers. 2.4 **£399.95**
NEW... TURBO CALC V2 **£62.95**
BRILLIANCE 2 **£49.95**
IMAGINE 3 **£109.95**
NEW... IMAGINE 3 ENHANCER CD **£49.95**
X-CAD 2000 **£24.95**
X-CAD 3000 **£227.95**
GB ROUTE + **£36.95**
DISK EXPANDER **£32.95**
NEW... PC TASK V3 **£64.95**
NEW... PHOTOGENICS - AGA ONLY **£52.95**
NEW... INTOS (Requires AMOS) **£24.95**

SOUND SAMPLERS...

NEW... Techno Sound Turbo 1 only... **£24.95**
NEW... Techno Sound Turbo 2 only... **£34.95**
NEW... Megalow Sound only... **£29.95**

MOUSE MECHANIC...

Keep your mouse in tip top condition the easy way.
Very Effective!
£4.95
+p&p

"...at GH, we'll look after you..."

SERVICE, SUPPORT and WARRANTIES: GH's One Year GH Gold Warranty gives you complete peace of mind (new for faulty goods exchange for 30 days, service for first year - we collect & redeliver free), with enhanced/extended options available as you prefer.

BY PHONE: We'll help with any queries and when you're ready to order we accept Visa, Mastercard, Access, Switch, Connect, Delta and Lombard Creditcharge (most 'store cards' are Lombard Creditcharge and we happily accept them).

BY POST or FAX: When ordering include your name, address and preferably a contact phone number with your order requirements. If charging a credit/debit card include its number and expiry date (and issue number with Switch cards).

PRICES: Please remember to confirm prices in case you are looking at an 'old' magazine. Prices can change (up or down) before the magazine's cover month has passed. Please confirm before sending orders by post.

EXPORT: Most items are available at TAX FREE PRICES to non EC residents & overseas UK Armed Forces Personnel (with CO's document). Please call us for confirmation of prices and carriage charges.

FREE UK DELIVERY: We despatch promptly & offer FREE delivery of all orders throughout Mainland UK. If your order is urgent we have priority despatch options with expedited delivery available.

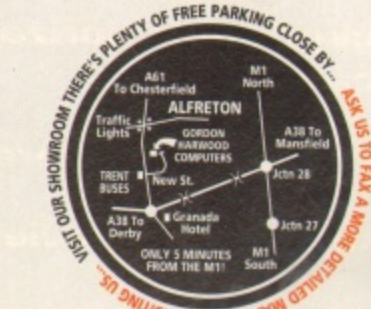

"Why not pay a visit to our Amiga Showrooms?"

We're Open...
Mon-Sat 9am til 5pm
Wed 9am til 1pm



"Confirm you're getting the BEST DEAL - call the UK's FAVOURITE AMIGA DEALER!"

"Got a technical problem?" "Need an Upgrade?" "Want a new peripheral fitting?"
LOOK NO FURTHER... GH engineers can do the job - that's guaranteed

gordon harwood computers limited

the UK's favourite Amiga Dealer!

GORDON HARWOOD COMPUTERS LIMITED
(Department CUA/A3)
NEW STREET ALFRETON
DERBYSHIRE DE55 7BP
Telephone: 01-773-836781
Facsimile: 01-773-831040

DISK 104

MovieSetter



Create stunning animations with this month's fantastic cover disk: **MovieSetter**.

You'd have to be very silly not to notice that this month's cover of CU Amiga Magazine is carrying something a little special. Not just the amazing MovieSetter from GoldDisk but also a complete 100 page manual. With this feature packed program you can create animations and mini-movies using your Amiga, and add a whole new dimension to home videos. Amongst the many features included are:

- **Frame accurate editing**
- **Backgrounds can be 'wiped' onto the screen**
- **Add, move, or delete characters with a mouse click**
- **Scroll backgrounds horizontally and vertically**
- **Playback of digitised stereo sound**
- **Freely distributable MoviePlayer included**

Follow the easy tutorials in the manual and our in depth animation feature (on page 22), and in no time at all you'll be using MovieSetter to create animation wonders that Hollywood's best would be envious of.



▲ With a little imagination, your Amiga and this month's exclusive cover disk you could create stunning animations.



▲ Load the demo and click on the Play button to watch it.

So how do you use *MovieSetter*? Well it's dead easy. Firstly follow the cover disk loading instructions on page 16. You should now have two disks ready – the main program disk and a clip art disk.

Insert the program disk into the drive and turn on the Amiga. Now double click on the icon for the *MovieSetter* program disk and then on the

icon for the *MovieSetter* program. It will now load.

Move the mouse to the drop down menu called Production and click on the third option down, Load. A requester will pop up asking if you are sure you want to do this, in case you had a previous movie open which would be erased if you simply loaded another movie. Click on OK. After a short period a requester will appear allowing you to select a movie, or a production as it is referred to in *MovieSetter* lingo. Double click on the Productions drawer and then click on the file Demo. After a few minutes you'll be prompted to insert the second disk – several other disk swaps will be needed, so follow the on screen prompts.

As the demo file loads a window will appear showing you the parts of the production being loaded.

In a few minutes you'll see a background with a requester appear. The requester has arrows pointing to the left and right and a series of numbers underneath it. In the manual this is referred to as the Player Control Window.

To see the movie click on the play forward button, this is the fifth icon from the left on the Player Control Window. The movie will now play until the end or you can stop it any time by pressing the mouse button.

In our free manual you'll find details on how to change this movie, add extra frames, deleting and moving the character around and much, much more. *MovieSetter* is a tremendously powerful program, and is widely recognised as being the best animation creator available for the Amiga.

But there's more

You aren't just limited to creating Amiga-only pictures with *MovieSetter*. Following our animation feature this month you can hook up your Amiga to videos and camcorders with a genlock, and create high quality films. These can then be combined with *MovieSetter* to produce fantastic introduction sequences and special effects that'll make you the envy of video producers everywhere.

More Clip art

If you've got a CD-ROM drive for your Amiga and are looking for more clip art to use with *MovieSetter* check out this months subscription offers. One of the many free gifts you can chose is a CD disc overflowing with clip art – worth £19.99. Go on, you know you want to!

Win a Camcorder!

If you're feeling lucky why not turn to the news pages in this issue and enter our massive competition to win a free camcorder. With this and a genlock you'll be well on your way to creating great movies.

Extra, Extra!

As if having a 100 page manual, *MovieSetter*, a disk of clip art for *MovieSetter* and an exclusive demo of *FIFA International Soccer* wasn't enough we've gone even further.

Also on disk 104 you'll find two drawers, one labelled *Directory Opus Configuration* and one labelled *ProCalc Sample File*.

Directory Opus

The first of these contains a new configuration file for *Directory Opus*. To use this simply load *Directory Opus* as normal from our February cover disk. Put the disk into the drive. Enter the *Directory Opus Configuration* screen and load the new configuration file using the Open menu option. This shows how buttons can be altered to suit your tastes.

ProCalc

Readers following our *ProCalc* tutorial (page 119) can save themselves some work and load the spreadsheet used in the tutorial file from the cover disk. Simply load *ProCalc* as

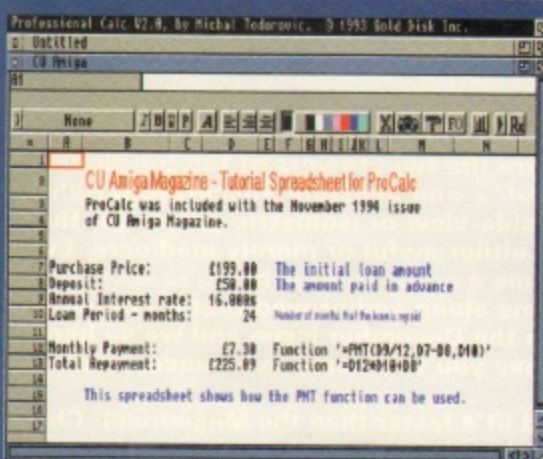

normal (supplied with the November '94 issue of *CU Amiga Magazine*) and select the Open option and highlight the file in the *ProCalc* drawer of the cover disk. Now turn to the tutorial for an explanation of what's going on.

Quick Start

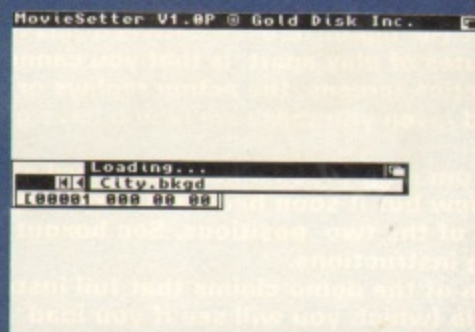

We know you're just itching to try out *MovieSetter*, so here for experienced users is a quick start guide. If you're unfamiliar with the Amiga simply follow the tutorial on this page or in the manual supplied.

1. Load *MovieSetter* from the disk.
2. Load the Demo file from the Productions drawer on the *MovieSetter* program disk. You'll be prompted to insert the second disk so have it ready.
3. A requester will appear, as seen above, showing which parts of the movie are currently being loaded.
3. Once the complete movie is loaded you can try out *MovieSetter* and watch this quick demo.
4. Click on the play button in the Player Control Window – it's the fifth icon in on the floating toolbar.

You'll now see the demo playing. *MovieSetter* provides an immense range of functions to allow you to manipulate and change movies and animations. For a comprehensive guide to these follow the 100 page manual supplied free with this issue.

DISK 105

FIFA International Soccer

By Electronic Arts

Yes, it's finally here, the demo you've all been waiting for and we've got it - FIFA International Soccer. Get stuck in.

The Amiga is best known and loved for the two footy games that are the twin towers of the top-down view genre; *Kick Off 2* and *Sensible Soccer*. And rightly so, most of the side-view or isometric games for the machine are either awful or merely mediocre. Even the mighty *Kick Off* has come a cropper after being re-invented in this way. Then FIFA came along and proved that it could be done. We gave it 89% back in the December issue and we've been waiting, gasping even, to give you this demo ever since. And now it has arrived.

Check out that speed (it's faster than the Megadrive). Check out those animations. Marvel at the post goal scoring celebrations. The demo is for one player only and you'll need to use both joystick and keyboard. To load the game simply insert the disk into DF0: and re-start your Amiga. The EA Sports opening screen will come up and then, once you press fire, you will immediately go into a 2 minute game, USA versus England, with you playing the boys in White. Simply choose which side of the coin you want and if you win, which half of the pitch. The big difference between this demo and the full game, two minutes of play apart, is that you cannot access the statistics and tactics screens, the action replays or change the teams. If we had given you these we would have given away the whole game!

Playing from top to bottom might look a little awkward at first because of the isometric view but it soon becomes very easy, and in fact is almost the better of the two positions. See boxout entitled Control for playing instructions.

Although the title screen of the demo claims that full instructions are on the read-me file (which you will see if you load workbench and then insert the disk and click on it) this file actually contains Electronic Arts' copyright instructions and not game instructions. Just in case you thought you were missing a little something.



Controls

FIFA International Soccer supports one or two button joysticks, a CD32 controller (red and blue buttons) or Megadrive multi-button controller. On one button joysticks C corresponds to fire, so you need to use Z and X on the keyboard. On two button joysticks or controllers, the second button (blue on the CD32 controller) replaces Z.

GENERAL CONTROLS

Kick off: **Z, X** or **C**.
Penalties: **B** to change players, **Z** or **C** to fire.

OUTFIELD PLAYER WITH BALL

Shot at goal: **C** up close or **X** further out.
Medium, long directional pass: **C** or **X**
Chip: **Z**

OUTFIELD PLAYER WITHOUT BALL

Sliding tackle, header, bicycle kick or barge: **Z**
Change control to player nearest the ball: **X**
Tackle: **X**
Shoulder charge: **C**

GOALKEEPER

Throw ball to nearest player: **Z**
Toggle direction box on/off: **X**
Kick ball towards direction box: **C**



Next Day **£5.00**

2-3 Days **£2.50** Saturday **£10.00**

Deliveries are subject to stock availability

Allow up to 7 days for cheques to clear



TELEPHONE **01234 273000**

POWER COMPUTING LTD

44a/b Stanley St. Bedford MK41 7RW

Tel **01234 273000** Fax **01234 352207**

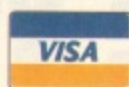

A4000



Keyboard is extra

TOWER CASES

The A1200 Tower comes complete with 3 x 5.25" drive bays, 5 x 3.5" drive bays, real time clock, 5 x Zorro slots, 4 x PC slots and a keyboard interface.

The A4000 Tower comes complete with 6 x 5.25" drive bays, 5 x 3.5" drive bays, real time clock, 7 x Zorro slots and 5 x PC slots.

Both Towers are easy to install.

TOWER A1200£499

TOWER A4000£429

EXTENDED KEYBOARD .£29.95

PSU 230watt£99.95

PSU 250watt (available 3/95) .£129.95

VIDEO DAC 18-BIT

Video Dac 18-bit is a graphics card which allows the Amiga to display 262,144 colours simultaneously. The software can display images or animations created and saved with any other 24-bit program.

Video Dac 18-bit plugs externally into the RGB connector with thru' port capabilities, allowing the use of digitizers such as Videon, or a genlock recording with your VCR any image you created in 262,144 colours.

Video Dac 18-bit is able to split the screen and display images/animations at different resolutions or colours at the same time.

- Medium Res:** 320 x 256 PAL
320 x 200 NTSC
- High Res:** 320 x 512 PAL
320 x 400 NTSC
- Overscan:** 384 x 576 PAL
334 x 482 NTSC
- Max Res:** 768 x 576 PAL
668 x 482 NTSC

All resolutions display 262,144 colours

The free bundled software saves your images in the following formats: IFF, IFF24, RGB and Anim, plus a series of dithering modes to enhance the overall quality of the images.

VIDEODAC£39.95



ACEEX MODEMS

Aceex Fax Modems feature: Full Hayes compatibility, error detection + correction, modem cable and manuals included, NComm Telecommunications software, Auto dial, Auto answer and leased line support.

ACEEX v32 BIS 14,400 bps£169

ACEEX v32 BIS FastFax 28,800 bps £229

TRAPFAX Fax Modem Software .£49



GRAPHIC SYSTEMS

Microgen genlock allows you to overlay professional looking graphics onto your home-made movies. Microgen comes complete with titling software and hardware controlled fades.

MICROGEN SVHS Genlock .£179.95

MICROGEN VHS Genlock .£99.95

Videon 3.0 unlocks the Amiga's graphic potential. Digitize and display all 4096 colours in high resolution mode and the stunning 29,791 colours mode. Digitize in 24-bit, directly from a VCR, Video Camera, LaserDisc, etc.

VIDEON 3.0£139.95

Maxigen 2 is a very high quality genlock for over-laying graphics onto VHS or SVHS. Full hardware fades, colour composition controls and excellent keying quality.

MAXIGEN 2 Genlock£299.95

GENLOCKS/DIGITIZERS



TANDEM CD-DE

This card allows you to connect a CD-ROM drive to your Amiga 2000/3000/4000, Syquest 3.5" and IDE HD's. Complete with cables, software and manual. ROM 2.04 or above.

TANDEM CD-DE CARD£69

OCTOGEN SCSI-2

SCSI-2 controller card for the Amiga 1500/4000 Upgradable to 8MB of RAM.

OCTOGEN 2008£129

VGA ADAPTOR£15

HISOFT PRODUCTS

SQUIRREL SCSI INTERFACE Connect SCSI peripherals£59.95

AURA 12/16-bit direct- to -disk sampler A600/1200£79.95

MEGALOSOUND 8-bit direct- to -disk sampler, all Amiga's£29.95

VIDEOMASTER AGA Realtime video with sound + stills A600/1200 **£59.95**

VIDEOMASTER AGA RGB VideoMaster AGA plus ColourMaster **£99.95**

VIDEOMASTER Realtime video with sound + stills A500/A500+ . . .£52.95

VIDEOMASTER RGB VideoMaster plus ColourMaster A500/A500+ **£89.95**

COLOURMASTER RGB splitter for VideoMaster£52.95

PROMIDI INTERFACE Amiga Midi interface£19.95

PICASSO II

Picasso II is a 24-bit graphics card offering true retargetable graphics on any Zorro based Amiga. Picasso resolutions are available from the standard ScreenModes program, all useable by OS friendly programs. The new Chunky option offers incredible speed with a 256 Workbench which is many times faster than AGA! All screens are stored in fast RAM, removing 2MB Chip RAM limitations. PicassoMode allows the creation of custom screens quickly and simply. Picasso II comes with TVPaint Junior and drivers for ImageFX, AdPro, ImageMaster, Real 3D and GIF, IFF, JPEG and MPEG viewers. Also included is the MainActor animation program.

PICASSO II£299.95 WITH TV PAINT 2.0 £329.95

PABLO Video Encoder . .£129.95

Name	
Address	
Postcode	
Telephone	System Owned
Description	
Total Amount (inc. delivery) £	
Payable to Power Computing Ltd	
Credit Card No.	
Signature	
Expiry Date	
Delivery	2 - 3 Days £2.50 <input type="checkbox"/> Next Day £5 <input type="checkbox"/> Sat £10 <input type="checkbox"/> Minimum Delivery £2.50

All products have a 12 month warranty unless otherwise specified
Trade and Educational orders welcome - Worldwide distribution available

All prices include VAT. Specifications and prices are subject to change without notice, all trademarks are acknowledged. All orders in writing or by telephone will be accepted only subject to our terms and conditions of trade, copies of which are available free of charge on request.

Valhalla - Before the War

Disk 103 Solution



Last month we cover mounted a demo from the last level of **Before The War**, the follow up to 'The first ever Amiga talking adventure'. We promised you a solution too. Try this ...



You will start the game in a room with a light bulb, a book and a chest. For the purposes of this demo you will not need the book so don't worry about picking it up.

Start off by picking up the light bulb then walk into the next room. Look at the fat monk who's sitting in between the two chests. Infinity will say 'It's a Holy Monk' and the monk will reply 'The Lord be with you'. Operate the floor tile on the left with the hole in it. Underneath you will find a laurel wreath. Pick up the laurel wreath and walk further to the left where you will find another torn tile just in front of a lamp. Operate this and take the apple that was underneath it.

Now continue left down the upper corridor (the lower one is guarded by a knight who will not let you pass). Operate the lever in the wall on Infinity's right hand side and go through the door. Up a short passageway you will find a third floor tile that's hidden beneath a book. Pick up the book, operate the floor tile and pick up the vanish spell that's hidden underneath it. Take this and return to the lamp, almost right beside the knight. Try inserting the light bulb into the lamp.

Each time you put the light bulb

in the lamp it lights up, the knight then travels over to the lamp and removes the bulb before returning to his original position. You will not be able to sneak past him so the only way to get by is to use the vanish spell. Put the vanish spell on the floor between the knight and the lamp before putting the light bulb in the lamp. When he shuffles over to remove the bulb he has to stand on the spell and vanishes.

After this happens go down the passage the knight was guarding and pick up the piece of paper that says 'And also with you'. Go and stand opposite the monk and look at your piece of paper. This will cause Infinity to read it, and these prove to be the magic words. The monk opens the chests, allowing you to take a bottle of stamina potion and a flower.

Now travel back to the place where you found the vanish spell. You will see a river on the left hand side. If you have already tried to negotiate this you will have died. Begin to walk down this river, but just before your stamina runs out (the bar on the right hand side of the screen) top up your stamina by selecting it from the inventory menu and drinking it. At the end of the river you'll find the 'Tomb of the King's Knight Caesar Petal', put your laurel wreath and flower on

here and take the bottle of stamina that appears in their place. Pick up the key that's beside the tomb and go back along the river, using your new stamina bottle in the same manner as before.

Go back to the monk's chamber. At the opposite end of this you will find a locked door. Insert the key and operate the lever. Enter the next room where you will notice a courtier who has got hiccups. Ignore him and turn right into the next room where you will find a pianola. Go down the corridor opposite the pianola and operate the first floor tile. Take the rosary beads you find underneath and return to the monk's chamber. Drop the rosary beads into the fountain of confession and take the prayer book which appears there.

Go left again, past the corridor where you found the book and the vanish spell. You will pass a courtier who has a hoarse throat. Ignore him. In the next room you'll find another tomb. Drop the book and the apple on the 'Tomb of the King's Knight Eve Holywoods'. Take the stick that appears and return to the place where you found the rosary beads. Travel down the passageway until you find a hole in the wall, insert the stick, pull the lever and open the door. Hey presto! That's the end of the demo. ■



▲ This knight's tomb will allow you to make up a stamina potion, provided you've collected the right ingredients. Don't forget the key.

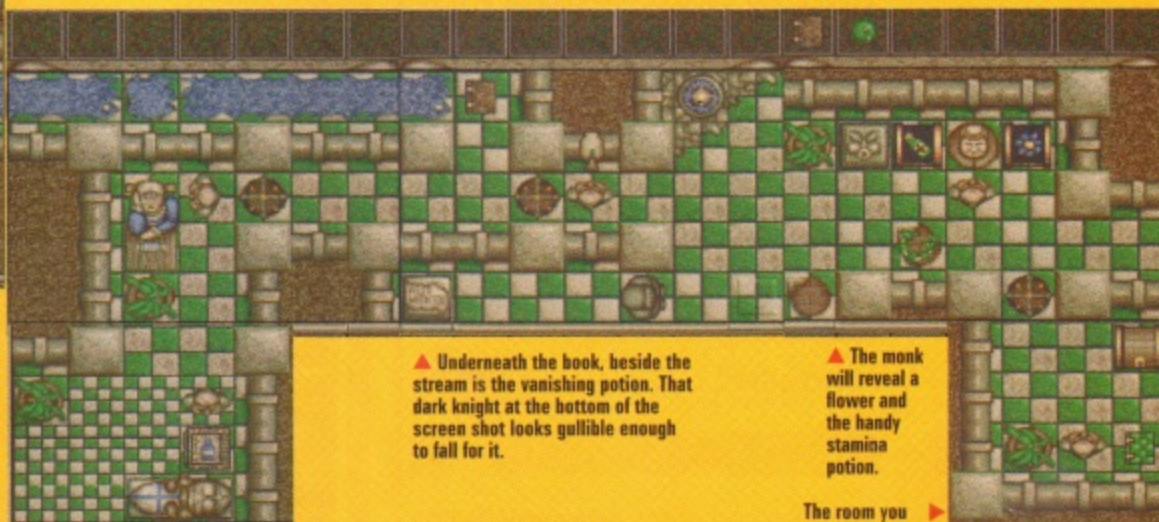

▲ This dead knight will yield the stick which is the key to finally finishing this demo.

▲ Underneath the book, beside the stream is the vanishing potion. That dark knight at the bottom of the screen shot looks gullible enough to fall for it.

▲ The monk will reveal a flower and the handy stamina potion.

▶ The room you start off in. This is where you pick up the bulb.

P I Z Z A



T
Y
C
O
O
N

Do you want to know what's cooking?

Do you knead to make some dough?

Then get a piece-of-the-action with **Pizza Tycoon**.

A business simulation to get your teeth into.

Order up **Pizza Tycoon** from us.

Because at MicroProse, we deliver.

AVAILABLE FOR IBM PC COMPATIBLES AND AMIGA A500 / A1200

MICROPROSE

cover disks

How to load...



Make a back-up!

Before doing anything else, make a back-up copy of the cover disks! This will save you much heartache if you accidentally erase or damage your disks. If you are unsure about doing this follow our guide below.

Making a back-up is easy. Take a spare blank disk and use either *Directory Opus* from our February issue or use the Diskcopy function from the Workbench.

Directory Opus

Click on the Diskcopy option from the Function menu. Requesters will appear prompting you for the source (cover disk) and destination (your blank disk) disks. Insert them as requested. It will copy it for you.

From the Shell

Boot with your Workbench disk and load the Shell program. This can be found in the System drawer - double click on it. Now type in the following line.

diskcopy from df0: to df0:
Then press return. You'll then be prompted for the source disk. Insert disk 104 or 105. After a short time you'll be asked to insert your blank disk. On some Amigas you'll need to swop disks a few times

Once finished type in:

endcli

Press return. This will close the Shell window, and your copy will be ready. So you now have our permission to enjoy it.

IF YOUR DISK WON'T LOAD

We go to great trouble to ensure that the CU Amiga Magazine coverdisks will work on common Amiga models. However if you do experience problems follow this simple guide.

- 1: Remove all unnecessary upgrades and peripherals, such as printers and modems. Some trapdoor expansions can also cause problems.
- 2: Follow the instructions on this and previous pages exactly.
- 3: If you still experience problems loading the disk call the DiskXpress helpline on 0451 810 788 between the hours of 10am and 5pm Monday to Friday.

If they advise that the disk is faulty, fill in your details in the form below, and send this form, along with the faulty cover disk and a 28p stamped self addressed envelope to: CU Amiga Magazine Disk Returns, DiskXpress, Unit 7, Willow Court, Bourton Industrial Park, Bourton-on-the-Water, Gloucestershire GL54 2HQ.

NAME:
ADDRESS:
TYPE OF AMIGA OWNED:
DISK NUMBER:
DESCRIBE EXACTLY WHAT HAPPENS WHEN YOU TRY TO LOAD THE DISK:
.....

WRITE PROTECT YOUR COVER DISK



Here's a question: how can the *MovieSetter* program disk, clip art disk and *FIFA Soccer* all fit onto two floppy disks? Well, using state-of-the-art compression technology, a little bit of magic, and the very best spot welding equipment we've managed it.

And, because we love you dear reader, we've also made it wonderfully simple to decompress the programs and data on the disks.

LOADING MOVIESSETTER

Before doing anything else make a back-up copy of disk 104 - see the panel titled 'Make a back-up'. Now make sure you've got two blank disks handy. You don't need to format them, as the decompression software will do this automatically. Now follow these simple instructions.

1. Insert disk 104 in your Amiga and switch it on.
2. Double click on the CU AMIGA disk icon.
3. Double click on the *MovieSetter* icon in the disk window.
4. After a short time your Amiga will ask you to insert a disk in DF0: - the internal disk drive. Replace the cover disk with your first blank disk. This disk must be write-enabled (the notch in the top right hand corner is closed).
5. Press the Return key.
6. Replace the cover disk when asked to do so.

MOVIESSETTER CLIP ART DISK

To decompress your *MovieSetter* clip art disk, follow the instructions above, but at stage 3 click on the clip art icon instead of the *MovieSetter* icon. When asked to insert a spare disk use your second blank disk.

Now refer to the manual on the front cover of this magazine for loading instructions. Our animation feature starting on page 22 also shows you how to get more out of this powerful, fun filled program.

LOADING FIFA SOCCER

If you fancy a spot of football you can either put on your football boots and wander down the local park or use our cover disk. Using our cover disk is simpler and a lot less tiring. To play the game simply insert cover disk 105 into the internal drive of your Amiga and turn it on. The game will then load. See page 12 for playing instructions.

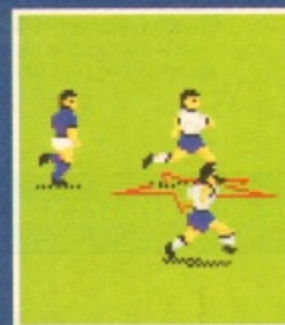



NICE ONE SQUIRREL!

Amiga Format 93% **CU Amiga 94%**
Amiga Shopper 95% **JAM** "The best piece of hardware I've ever bought for my A1200 ... well done, HiSoft!"

As you can see, the Amiga press has gone nuts over our new Squirrel SCSI interface for the A600/A1200. In case you've missed these reviews, the Squirrel SCSI is a plug-and-play add-on that allows you to connect up to 7 SCSI peripherals to your Amiga. Just think of it, CD-ROM, Hard drive, Scanner, DAT, Optical, SyQuest, Tape Streamer - all on line at the same time! No wonder we named it after that famous storage-hungry animal! To go with Squirrel, here are some great value devices...

SCSI CD-ROM Drives



SuperDouble - int £129, ext £189
SuperTriple - int £189, ext £249

Not all CD-ROM drives are the same. Our SuperDouble and SuperTriple drives are fast, modern devices supporting all the SCSI features that you'll need, based on quality units from the world's leading manufacturers of CD-ROM, Sony & Toshiba.

Both drives are cased in extremely stylish enclosures with all SCSI connectors and offer fast access times, stereo headphone sockets with volume control, phono line output, PhotoCD™ multi-session support, CD32 emulation, CD-DA compatibility with the convenience of tray-loaded action. The SuperDouble™ CD-ROM drive offers 360Kb/sec transfer while the SuperTriple™ attains 510Kb/sec, both far faster than any competitive drive for the Amiga. **90% Amiga Format**

These are the drives we use for developing and testing the Squirrel hardware and software - need we say more?

SyQuest Drives



88Mb - int £269, ext £329
270Mb - int £419, ext £479

Introducing removable SCSI drives for your Amiga. Based on reliable, proven SyQuest™ mechanisms, these 88Mb and 270Mb units offer transportable, compact, high performance and, above all, expandable storage for all your computing needs. SyQuest is the world leader in this technology across computer platforms which means that you can transfer work between Amiga, Macintosh™ and PC, with ease. We recommend the CrossDOS and CrossMac software packages to simplify portability - call for pricing. Our drive prices include 1 free cartridge.

SCSI Hard Drives



270Mb £169, **540Mb** £239
730Mb £279, **1Gb** £479
 Add £60 for external units

Hard drives are becoming more and more affordable and we can now offer some tremendous prices on a range of superb quality, Quantum drives in a range of capacities.

These drives offer fast seek times (14ms @ 270Mb, 11ms @ 540/730Mb, 9ms @ 1Gb), large caches and high speed data transfer rates (1.5Mb/sec with Squirrel). All units can be supplied for you to fit in your own case or pre-installed in one of our professional Squirrel Storage Cases. The Squirrel does not auto-boot external hard disks but you can do this from floppy or from internal IDE hard disk.

We can supply all leads, terminators etc. Please feel free to discuss your exact requirements with our friendly, technical staff.



Squirrel Storage Systems



All our Squirrel Storage Systems come either bare (int - ready for installation internally within a suitably-equipped Amiga or other computer) or fully-cased (ext) with integral power supply, SCSI in/out, SCSI ID selector and audio out (for CD-ROM). The cases we supply are high quality, shielded, snap-together enclosures, each with 40W power supply - the back panel of the 5.25" case is shown above. These SCSI enclosures are available at **£69.95** each (please specify 3.5" or 5.25" when ordering).

The neat Squirrel SCSI interface is shown on the right. The unit simply plugs into the PCMCIA slot, comes complete with all the software you need together with a cable which terminates in a 50-way Amphenol plug to attach to your first SCSI device.



the Squirrel SCSI interface

Twist 2

Twist 2 is the new, friendly, relational database for all Amigas. Twist's range of power features such as its integrated forms designer, its varied & multi-level querying, its N:1 1:N & N:M relations coupled with its un-cluttered, well-designed user interface make it ideal for both the first-time and the seasoned database user.

Twist 2 is the only database you will ever need - a product that expands to meet your requirements as they grow. So, before you buy another database, why not take a look at the Twist demo disk?



AURA

The latest of our highly acclaimed sound samplers for the A600/A1200. Aura offers high performance 12/16 bit quality with direct-to-disk sampling plus a host of software features. Octamed 5.04 up compatible.

96% Amiga Shopper 90% AUI

GAMESMITH

Professional game development is made easy with the new GameSmith Development System. Over 3 years in the making, GDS gives you the low level power to create the masterpiece of your dreams in a single, easy-to-use, comprehensive environment, using C or assembler. Comes complete with junior versions of Dice C and Devpac 3. **90% AUI 92% CU Amiga**

Termite



Afraid of becoming a hedgehog on the Information Super Highway? Don't worry, Termite is so easy to use that even a first time user will feel at home. Yet it has all the power and flexibility to satisfy the most seasoned modem warrior!

Termite is packed with features and comes with its superb Button Bar already set up for instant access to CIX and many BBSs. **88% Amiga Computing 95% AUI 88% CU Amiga**

Ordering Information

All HiSoft products (see the complete list below) should be available through your favourite Amiga dealer. If you have difficulty in obtaining any title you can order directly from HiSoft - just call us free on **0500 223660**, armed with your credit or debit card; we will normally despatch within 4 working days or, for an extra £6, by guaranteed next day delivery (for goods in stock). Alternatively, you can send us a cheque or postal orders. All prices include VAT. Export orders: call or fax to confirm pricing and postage costs. © 1995 HiSoft. E&OE.

HiSoft products for your Amiga: Squirrel SCSI interface - £69.95, Squirrel Storage Systems - as above, Aura 12/16 bit sampler - £99.95, Megalosound 8 bit sampler - £34.95, ProMidi interface - £24.95, HiSoft Devpac 3.14 - £79.95, HiSoft BASIC 2 - £79.95, HighSpeed Pascal - £99.95, Gamesmith - £99.95, Termite - £39.95, Twist 2 database - £99.95, Maxon Magic - £29.95, Upper Disk Tools - £14.95, VistaLite inc MakePath/TerraForm £39.95 and much more. **Coming soon: DiskMagic (disk tools) and Cinema4D.**

HiSoft SYSTEMS

The Old School, Greenfield
 Bedford MK45 5DE UK
 Tel: +44 (0) 1525 718181
 Fax: +44 (0) 1525 713716



News

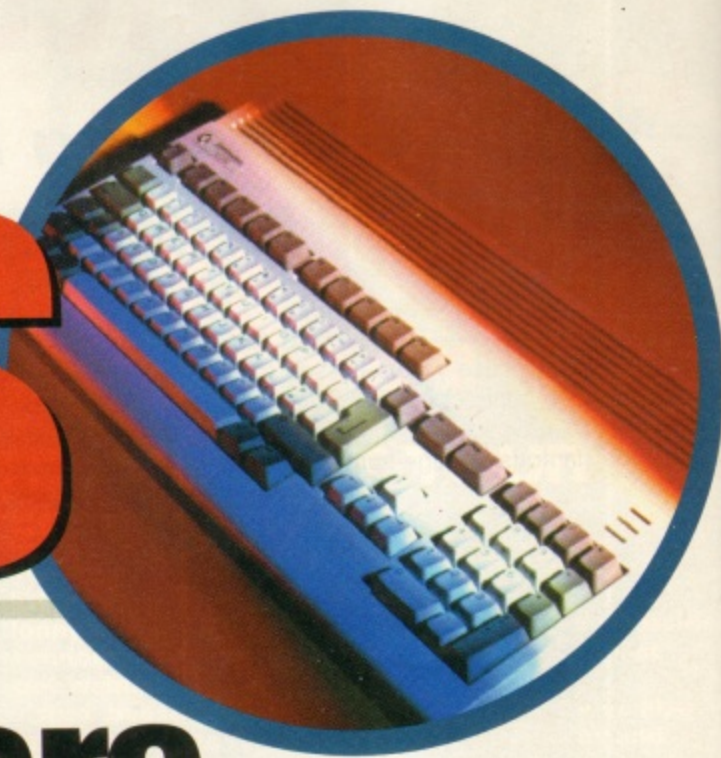

DPaint 5 Is Here

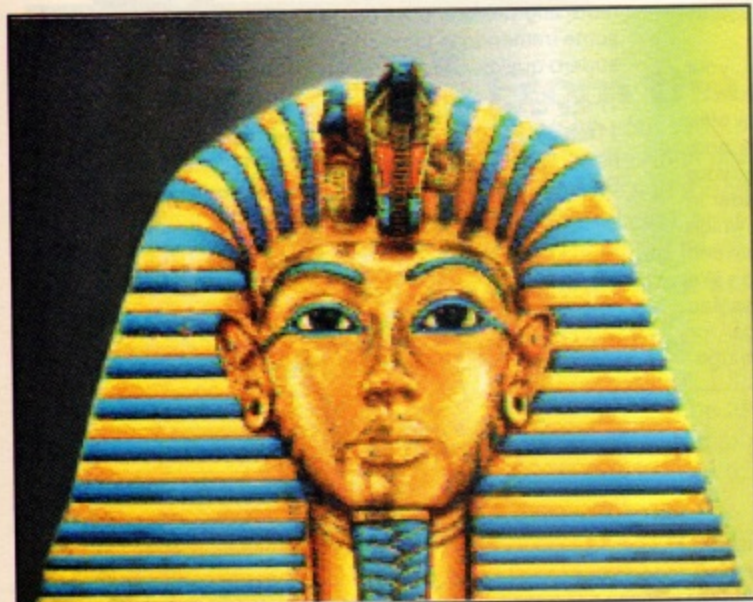

▲ After a long wait DPaint is on its way to a shop near you.

After much delay Electronic Arts are finally shipping *DPaint 5*. The latest version of their best selling Amiga graphics package will be available by the time you read this. EA picked CU Amiga Magazine to exclusively preview the new version last October, including a cover disk and since then dealers and end users alike have been clamouring for it.

Amongst the many new features are full internal 24-bit image handling, natural media painting tools, texture backgrounds, improved animation support, full *ARexx* support and macros.

Until the summer of 1994 *DPaint* was bundled with every Amiga, becoming the most used graphics package on all ver-

sions of the machine. The last version released, *DPaint IV AGA* came out over a year ago in the Winter of 1993. Since then several more powerful rivals have appeared, with *Brilliance* and more recently *Photogenics* costing less and offering more features.

Next month CU Amiga Magazine will bring you a definitive head-to-head round up of Amiga paint packages, including *DPaint 5*. If you want to try it out in advance why not check out our preview version on the cover disk of the October '94 issue of CU Amiga Magazine (call our back issues department on 0858 468888). *DPaint 5* costs £89.99 and is available from Amiga dealers or Electronic Arts on 01753 546 465.

New Spreadsheet

SoftWood, developers of the Amiga's best word processor - *FinalWriter*, are to release a spreadsheet. Called *FinalCalc* it should be available in early May.

From what we've seen *FinalCalc* looks like being a pretty powerful program, and certainly has all the features needed to be a market leading product. Although final pricing and features weren't set at the time of going to press, it is known that it will offer several new innovations. These include multi-layer spreadsheets, animated graphs and the ability to scale a document to fit on a printed page.

CU Amiga Magazine hopes to have a review of *FinalCalc* next month. SoftWood are on 01773 521606.

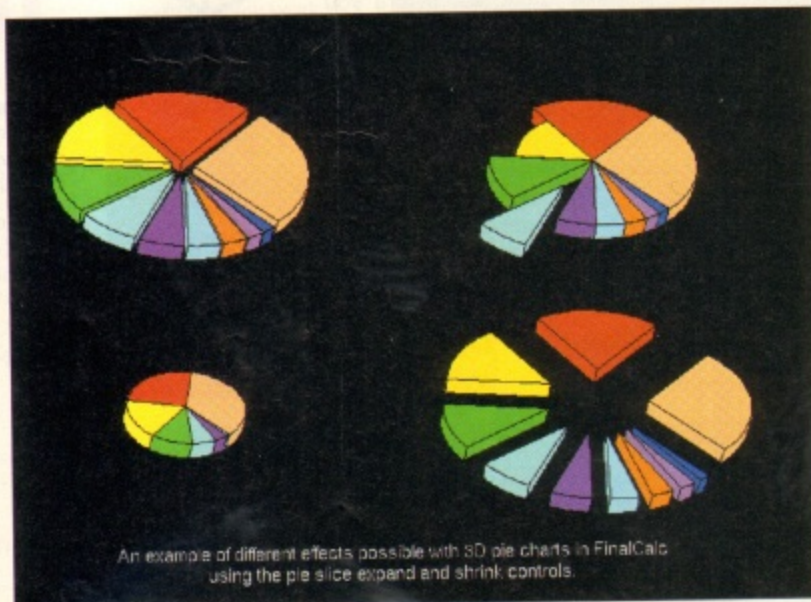

Six Speed Drive

A CD manufacturer has developed what is claimed to be the world's fastest CD drive. The Plextor 6PLEX is a six speed drive, current CD drives are mainly double speed while quad speed mechanisms are still relatively uncommon.

The 6PLEX drive has data transfer rates of just over 900Kb/second, compared to 300Kb/second for double speed drives such as the new Power CD. The drive should be available in early April with prices of about £400.

Doom Clone!

T A French teenager has created what looks like being the first proper Doom-style game for the Amiga. Titled *Fears* the game offers full screen texture mapped, first person perspective graphics.

The object of the game is pretty similar to the original best selling PC *Doom* game. You explore an dungeon collecting keys and other objects to allow you to move on to other floors. Also living in the dungeon are a collection of monsters which you have to (surprise, surprise) dispatch with an assortment of weapons, including shot guns, bazookas, and a chain gun.

We've seen early versions of the game and its certainly the best looking *Doom* clone yet, with full screen graphics featuring texture mapping and fluid movement in place. Guns and monsters are also present, although these were still being worked on when we saw it.

There are other *Doom* clones planned for release. Of these *Alien Breed 3D* from Team 17 looks the most promising. *Fears* is set for an April release and we hope to have a full preview of it next month.

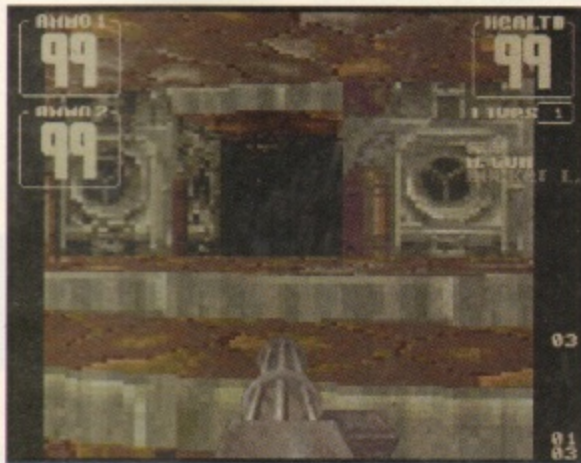

ProGrab Gets Thinner

G Gordon Harwood Computers have released a PCMCIA interface for the ProGrab 24RT colour video digitizer and upgraded the software. The new software is available to existing ProGrab users (available as an upgrade for £3.95) and provides a virtual memory capability on Amigas with hard drives. This will allow Amigas to grab images at the sort of resolutions which would previously have required lots of RAM.

The PCMCIA interface, which comes with the Version 2 software, provides faster performance - reportedly up to five times greater, the ability to sample sound (via a parallel port sampler), improved animation support, shows teletext pages on Amiga screens and saves teletext data in ASCII. It costs £29.95, in addition to the normal ProGrab hardware which costs £129.99.

Gordon Harwood are on 01773 836781.

Barbaric Activity

Fresh from their *Turbo Trax* programming adventures Arcane Developments are devoting their time to developing a Conan game based on the Hiburia Chronicles series of books. It will have no association with the Arnold Schwarzenegger movies however. *Conan The Conqueror* will be set in the dungeons of a castle called Belverus and the player will have to guide him through the catacombs of said dungeon to escape. The gameplay will be along the lines of *Darkmere* but, according to Arcane's Steve Iles, the graphics will be something special. Coding is currently being carried out by a relatively new Finnish company, Monoceros, and the game design and overall graphics are being monitored by Arcane. Due out in May, more next month.



Help Is At Hand

Got a problem with your Amiga? Want to know how to convert something to PC? Don't know where to turn? Well, help is now only a phone call away. Black Legend have set up a dedicated support board for anyone who has an Amiga-related technical query. Also, any would-be games programmers can now send in their games and receive some helpful advice and criticism from the experts. All you have to do is get on the blower and call 0392 493 816 or you can contact their Sysop, Kevin Gearing, on the same number via the internet. Couldn't be easier. ■

Pirate Jailed!

FAST, the Federation Against Software Theft, carried out a search of the premises of a Lincoln software pirate and recovered pirated software worth approximately £330,000. The pirate, Timothy Paul Stothard, pleaded guilty to the sale and possession of pirated software and was jailed for six months, his equipment was also confiscated. ■

PM On NET

10 Downing Street, official residence of the Prime Minister, will soon be available on the Internet. Trials are already running to test the possibility of Email and world-wide-web pages linking 10 Down Street to voters. Distribution of policy documents is also being looked at. ■

Calling All Technical Writers

If you have a degree in English, and have a detailed knowledge of the Amiga then we want to hear from you. CU Amiga Magazine is looking for new freelance technical writers. You must be able to write clearly and entertainingly, love the Amiga and ideally have a specialist knowledge of at least one type of Amiga application: graphics, sound, comms, programming etc. Owning a modem would also be preferable.

In return we can offer you competitive freelance rates and access to the very latest Amiga software and hardware.

If you're interested in writing for the UK's leading Amiga magazine send two reviews of serious software titles to the following address: Writer Submissions, Andy Leaning, CU Amiga Magazine, Priory Court, Farringdon Lane, London EC1R 3AU.

All submissions will be treated with confidentiality and successful correspondents will be notified by post.

Kung Fu Fighting

Dust down your black belt and get ready for *Brutal*, the new martial arts beat 'em up from Gametek. And before the 'oh no not another violent game on the Amiga' brigade go up in arms, *Brutal* doesn't feature any mindless violence. The leading characters are cute cartoon chaps such as Kung Fu Bunny. So instead of 'rip your spine out' death moves, you'll be knocking your opponent's head out of shape in Rodger Rabbit fashion. *Brutal* is being designed to support the PF Magic AT&T modem device so you will be able to hook up and start earning enough points to improve your belt grade and special move ability with people all over the country.



Platinum Games

Empire are releasing three of the most popular games ever in one compilation: David Braben's *Frontier*, Sid Meier's *Civilization* and Psygnosis' massively successful *Lemmings*. Due out in March, but too late to hit our reviews section, keep an eye out for this compilation. If you haven't already got some of these games (and we'll be surprised if you don't) then don't wait for the review - go out and buy it. It's a sure bet and a bargain compilation.

For more information contact Empire on 0181 343 7337.



WIN A FABULOUS CANON CAMCORDER

Yes that's right, CU Amiga Magazine has joined forces with Canon, one of the UK's leading camcorder manufacturers, to bring you this canny Canon compo.

And it's not just any Camcorder either, it's an 8mm Canon UC600. This beast provides an awesome array of features for its price. Amongst its impressive specifications are the ability to zoom up to 12 times, full transport control (fast forward, rewind etc), built-in character titling, video lighting and autofocus. And to top it all off there's stereo recording as well!. In short it's a power packed camcorder!

But the Cannon UC600 isn't just packed with technology; it's packed with microtechnology - the UC600 is one of the lightest and most compact camcorders we've seen, weighing just 900 grams. It's just perfect for sneaking into weddings, parties and family occasions. But it can also be used to create your own movies.

Add a genlock and you can link it to your Amiga giving you the facility to edit, add titles, special effects and logos to your videos. Turn to page 22 for our top tip guide to video effects that are possible with your Amiga, a genlock and a camcorder.

To stand any chance of winning you'll need to correctly answer the following three questions. To enter, write the answers, your name and address on the back of a postcard or a sealed envelope and send it to: CUNNING CANON CAMCORDER COMPO, CU Amiga Magazine, Priory Court, 30-32 Farringdon Lane, London EC1R 3AU.

1. What type of Amiga peripheral is needed to link a camcorder to your Amiga?
2. How much does the UC600 weigh?
3. Does the UC600 record sound in mono or stereo?



Rules:

The editor's decision is final and no correspondence will be entered into. The winner will be notified by post, within 30 days of the closing date. Closing date 25th April 1995. Only one entry per person - others will be ceremonially burned. No employees of EMAP Images or Canon may enter.

WORTH £900!

Gorgeous

Stunning Amiga Animation Made Easy

Your Amiga is an animation workstation. Whether you've got a 1Mb A500 or a turbo speed A4000, the power to create amazing animations and films is right at your fingertips! With this month's MovieSetter cover disk, some well known software and your Amiga, you've got all you need to get started. It doesn't matter if you're no Walt Disney - there's so much more to animation than Mickey Mouse cartoons, and we're going to prove it! Over the next couple of pages, we're going to reveal how you can do all of this and more with your Amiga ...



STOP FRAME ANIMATION ★ 'ROGER RABBIT' STYLE LIVE ACTION WITH CARTOON ANIMATION ★ TRIP-O-MATIC PARTY VISUALS ★ MASSIVE ANIMATIONS FAR EXCEEDING RAM CAPACITY ★ PROFESSIONAL-LOOKING ANIMATED LOGOS ★ STYLISED VIDEOS ON LOW-END AMIGAS

Animation!

Getting set-up

You've already got the most important part of your animation workstation: your Amiga. If you've got a home video recorder, then you've got the basics of a powerful system. Depending on what exactly it is you want to do with your animations, any or all of the following bits of kit will come in very handy. Not all of this gear is essential, though!

- video digitiser
- genlock
- camcorder
- chromakey
- video mixer
- hard drive
- RAM expansion
- additional VCR

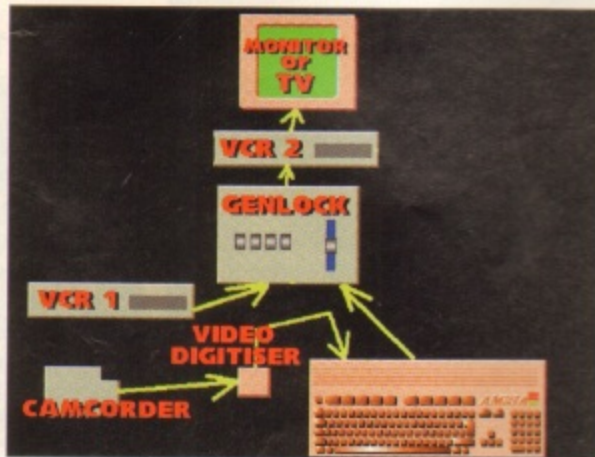

The heart of the system is the Amiga. In this case, the Amiga is used to grab images and animations from the camcorder, via the video digitiser. The genlock overlays the Amiga graphics onto the video pictures coming from VCR 1. The combined video is then sent through to VCR 2, which makes the master recording, and sends out the final picture to the TV or monitor.



Recommended software

All of that hardware is no use without the right software. You've got a head start already with this month's *MovieSetter* cover disk. In addition, you'll also find that some combined paint and animation software is essential. *Deluxe Paint* has traditionally been a favourite for this, although it's now challenged by *Brilliance* and *Personal Paint*. Both *Brilliance* and *Personal Paint* have the advantage of supporting animations with multiple palettes (a different palette for each frame), unlike the current release of *Deluxe Paint*. However, *Deluxe Paint 5* is due for release any day now, which will support multiple palette animations.

Multiple palette animation support is not vital if you're creating your own animations from scratch, using computer generated or hand drawn cells. But if you

want to incorporate digitised animations in your work, it's essential, for the simple reason that digitised animations are nearly always saved out with multiple palettes.

Deluxe Paint 4 AGA is the most widely used graphics and animation program on the Amiga, partly because of its combination of power and ease of use and partly because it's been around longer than the others.

Among its strongest points is its ability to handle any screen mode from low resolution in 2 colours, up to super high resolution in HAM-8 (256,000 colours) on AGA machines and HAM-6 (4096 colours) on other Amigas.

Animations are fairly simple to create, thanks to basic tweening and morphing features.

On the other hand, in many respects it's the slowest of the three options here.



▲ *Brilliance* is very adept at remapping brush palettes so it's very handy at combining parts of different images.

Brilliance 2 scores for its superior speed, whilst retaining almost all of the features of *Deluxe Paint 4 AGA*, along with the same 'hot keys'. This is very handy for anyone who's used to using *Deluxe Paint*, and doesn't want to learn a new set of keyboard shortcuts. It handles the

re-mapping of brush palettes very well, so combining parts of different images or animations is rarely a problem.

Personal Paint 6.1 doesn't attempt to do everything that *DPaint* and *Brilliance* do. Instead, it has a few of its own tricks up its sleeve, such as image processing, very useful facilities for converting

animations to different screen modes, and automatic loading of JPEG compressed files. There's also a good storyboard option for when you're working on animations. However, *Personal Paint 6.1* doesn't work in any more than 256 colours.



Roger Rabbit on Your Amiga



Who Framed Roger Rabbit was one of the most remarkable animation films ever made, seamlessly combining footage of live actors with hand drawn cartoon animation. Stacks of time, money and expertise was ploughed into the production to ensure that the viewer believed Roger Rabbit was really there with the actors, interacting with them and all of the surrounding objects. Well, you too can create your own Roger Rabbit-style film, with no more than this month's MovieSetter cover disk, your Amiga, a VCR, a genlock and a camcorder!

How it's done

The theory behind it is actually very simple. The effect is made up of two basic components: the footage from the camcorder, and the cartoon animation from the Amiga. The two parts are mixed together with a genlock.

A genlock combines computer graphics and video pictures in a special way. Unlike a normal video mixer, which merely fades from one video picture to another, a genlock is 'intelligent', in that it can read the graphics signal from the Amiga, and separate the parts that are drawn in the 'background' colour. This means that the genlock can then make these parts transparent, while the rest of the graphics are displayed at full strength. The signal from the camcorder (or any other video source) is seen through the transparent parts of the computer graphics. This gives the effect of the computer graphics appearing over the top of the video picture. As we want to overlay cartoon animation from the Amiga on top of pictures from a camcorder or VCR, a genlock is the perfect tool.

Doing it for real

Before you set out shooting your video or creating your animation,

you should first make up a story board. A story board is something like a comic strip – a series of sketches depicting all the scenes and actions you want to include in the film. Without a story board, coordinating both the animation and the video footage would be a nightmare, and getting the two to match up would be almost impossible!

Start off with just a single scene that has very simple interaction between the actor and the cartoon character. This is actually quite a tall order for the actor, as it involves sharing a scene with a non-existent co-star. One of the simplest ways to get used to interacting with a cartoon character is to have a brief conversation with an imaginary friend. Avoid any contact between the actor and the cartoon character at this point (such as a handshake for example), which is quite advanced stuff. Get your actor to sit on a sofa and exchange a few comments with the imaginary friend. The camera operator can be the voice of the cartoon character. Use a fixed camera position for the whole shot, otherwise you'll have terrible trouble combining the computer animation without it looking obviously separate.

Now you've got the video footage of your actor talking into thin air, you can start drawing the

cartoon part. There's little point in tackling the cartoon part first, as you need the video footage as a position and scale guide for the cartoon character. Connect your Amiga and your video tape to a genlock, and view them both through your TV or monitor. Load up your preferred paint and animation software, and play the video tape. Adjust your genlock so that you can see the video pictures and the controls of the animation software. You can now mark out guidelines by tracing over the video picture. For example, in the sofa conversation scene, it would be a good idea to mark the levels of the seat and arm rest. You should also make a rough trace around the actor. Use the pause button on the video if necessary.

The next thing you should take note of is where the actor appears to be looking. This is a crucial detail, which can make or break the illusion. If the actor seems to be looking above, below, or through the cartoon character, the whole scene will be spoilt.

At last you can start to animate your cartoon overlay, helped by the guidelines you traced earlier. You'll need to refer back to the video tape quite often to make sure it's all fitting in properly. Most camcorders and VCRs won't allow you to

remain in pause mode indefinitely, as it can damage the tape and the heads, so you'll have to trust the guidelines most of the time, and make occasional checks by playing the tape through now and then.

Synchronisation

Synchronising the animation to the video will be one of the biggest hurdles. If your character is a human, it could be tricky to time the animation so that its mouth moves in time with the conversation recorded on the video. One way around this is to use a character that looks less like a human, such as alien. An alien doesn't even need to have a mouth – you could make him talk out of a bugle on the side of his head if you wanted (although to keep the thread, the person supplying the alien voice would have to reflect this). Alter the frame rate of your animation to get the two parts running in time.

Once you've got the hang of that, you can go on to more complex movements. If you want your cartoon character to interact with real life objects (opening a door for example), then you'll need a second actor to stand in for the cartoon character. You can then draw the cartoon character over the top of the second actor.



▲ Combining Amiga-generated cartoon animation with live video is a simple affair.



▲ The foxy lady is animated with this month's cover disk MovieSetter, and then mixed with video footage.



▲ You don't even need to do any fiddly cut-outs, as the genlock handles that automatically.



▲ Have a go yourself – with a bit of work, you could be on your way to a job at Disney!

Abstract Visuals

Abstract and experimental animation is one of the most exciting areas of computer film making. In the past, animators have been limited to using imagery from the real world, or that which could be created by traditional drawing and painting techniques. Computer and video technology has done away with all that. Now you can work with purely synthetic images, generated by the computer, and enhanced with simple video mixing tricks.

Your Amiga is a visual synthesiser, capable of rendering amazing graphics and animations. Bend the rules, tweak the nose of convention, and what's more, have a go at some of the ideas on this page.

The easy option

Make your own party video tapes by simply recording the best sections from your favourite PD demos onto a home VCR.

Many VCRs allow you to record a soundtrack onto the tape without affecting the visuals. This is called over dubbing, and if your VCR supports it, you can then add your choice of music to the video, by recording straight from a CD, tape, vinyl or your Amiga.

Video feedback

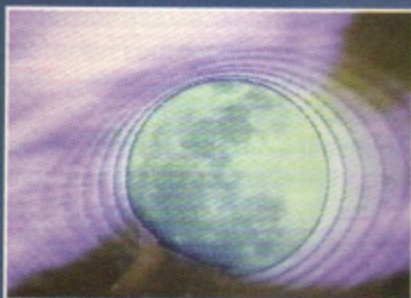

Audio feedback is what you get when an electric guitarist holds the guitar up to the speaker. The whistling sound is created by the pickup on the guitar being vibrated by the sound waves coming from the speaker. These vibrations are sent from the pickup through the system to the speaker, and back out again, causing a loop.

Video feedback works in the same way. The loop is made when you point the video camera at the TV or monitor that's displaying the picture from the camera. This effect comes into its own when you add your Amiga and a genlock to the loop. Using a picture or animation with plenty of transparent background space, point the camera at the monitor, and adjust the zoom and position. Zoom right in, and you'll fill the background with a magnified pattern of the cells that make up the monitor screen. Tilt the camera to one side, and you'll get a rolling, spiralling trail coming from the main image.

If you get the position just right, you can create a wonderful flare effect, with parts of the image's edge appearing to melt away, floating smoothly off the screen. Unlike the static feed-

back you get by facing two mirrors towards each other, this technique is fully animated, and very hypnotic, which unfortunately doesn't come across very well in still pictures! For some good examples of video feedback, take a look at the Global Chaos video from Hex, which is available from HMV and other good record and video suppliers.

Colour cycling

It's easy to make your own colour cycled animations. *DPaint* is the best tool for the job, especially if you want to do some kaleidoscope screens. These instructions refer to *DPaint* specifically.

There are basically two types of colour cycled animations. One way is to set up a palette that consists of all the same colour, except for one. Set up the colours as a 'range', and turn on colour cycling draw mode by pressing F7. Now you can paste down a series of frames from an anim brush in a sequence. When you press the TAB key, the colours will be cycled, giving the effect of movement. This has the advantage of using just one frame, and so requires very little memory.

The other method involves setting up a range of colours that fade into each other. Turn symmetry mode on, select dotted draw with a big brush, and doodle around. Now hit the Tab key and enjoy the multi-colour pulsations.

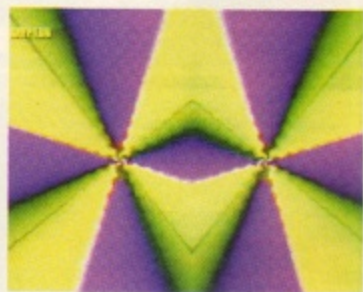

3D ray tracing

Your imagination and patience are the only limiting factors with this one. There's just so much you can do with 3D animation. Despite the recent hype surrounding *LightWave 3D*, it's not the only worthy 3D ray tracing package.

Imagine and *Real 3D* are both excellent systems. In fact, the lower-spec packages are more suitable for certain jobs, as they won't use as much memory, and can be quicker to use due to a reduced amount of options and features.

We've all seen the spiny, throbbing, shiny balls that are popular with many techno video artists, but there's so much more that can be done. Why limit yourself to producing something that's either a simulation of the real world, or completely abstract? Why not combine the two?

You could even make a 3D model that looks just like you, with your actual features mapped onto the face! Take a camcorder, and digitise your face. Now use this as a texture map which you can wrap onto the face of your 3D humanoid.



Stop Frame Animation

Stop frame animation is the technique used in films such as *The Wrong Trousers*, and the children's programmes *Trumpton*, *Chigley* and *Camberwick Green*. It's also how the monsters are animated in the old *Sinbad* films, and the classic *100 Million Years BC*. Best of all, you can make your own stop frame animation sequences with your Amiga!

The idea behind stop frame animation is very simple. The impression of movement is created by taking a series of photographs, and moving the subjects in the scene very slightly between each shot. Each shot will only be visible for a split second, so you need to be prepared to spend plenty of time on your film. It's a slow process but the results can be very rewarding.

Traditionally a film camera would be used and advanced one frame at a time, but you can use a camcorder and a video digitiser. This approach has plenty of advantages. Every frame will be stored in memory (or preferably on a hard drive),

which means that you can edit them using your normal graphics software.

Animating human characters is tricky in any kind of animation. If you don't feel up to making your own human dolls, try using objects or characters with fewer moving parts. In our example here, we've recreated a scene from *Dr Who* using model daleks. These are nice and easy to animate, as they stand up on their own (unlike an *Action Man* in mid-step), and just glide around the floor with no actual walking action to contend with. The arms of Davros, their leader, can be moved a little at a time, along with the dalek's rotating heads and sink-plungers.

Painting your own backdrops is fine if you're handy with your water-colours, but don't worry if not. The backdrop we used was a roll of kitchen foil (did you guess?).

For the final showdown, our resident raygunner was added to the animation with a chromakey. A chromakey lets you replace all areas of a video picture that use a specified

colour. In this case, the hero was filmed against a blue backdrop (a large bed sheet actually). This was then fed into the chromakey, along with the animation running off the Amiga. The controls on the chromakey were set so that the blue part of the video footage was replaced by the Amiga animation. This has the effect of overlaying the character onto the dalek scene. After a running through the sequence a few times to get an idea of the position, the lasers were added to the Amiga animation. Then the two parts were played back once again for the final effect.

Storage

Animations are very memory-intensive. However, you don't need to be limited by RAM size. If you have a hard drive, you can save out each frame as it's created, and then play the animation back directly from the hard drive. Using the public domain utility *BigAnim*, enormous animations can be played from a hard drive on an Amiga with small RAM capacity.

Stylisation

If you find yourself getting short of RAM, one solution is to reduce the amount of colours in your animations. A 256 colour anim will be far larger than one that uses 32 colours. Don't let this hold you back - use it to your advantage. If it's done right, an animation using very few colours can actually look pretty good. In fact, there are expensive video effects units that produce very similar results. Your audience will assume that you chose to affect the animation in this way.



▲ Some of the best sci-fi films use models for their special effects.



▲ Terminator 2 used stop-frame animation with computer graphics.



▲ In our scene, we've used tin foil for a cheap and easy backdrop.



▲ Each frame was subtly altered and digitised with Pro Grab 24 RT.



▲ The frames are then played back as a rolling animation.



▲ Finally, live action was added with a chromakey.

Logos and Branding

If you want to get on in the animation business, you'll need to make a name for yourself. Logos are a key part of forming an identity that embeds itself in the heads of your audience.

Since the arrival of cable and satellite TV, there are more TV channels available than ever before. To remind you which channel you're watching, most programmes now include a small logo in the corner of the screen. You know when you're watching SKY Sports, because there's always that little logo in the corner. The breakfast TV companies have their own logos in the form of clocks, and the Saturday morning kids' show Live and Kickin' has a constant reminder, even throughout the cartoons and other sub-programmes.

These logos are very easy to create. The key to a good logo is clarity. It's going to be very small, no more than a couple of inches across, so make it bold and simple. If your production company has a name of more than two words,



decide which is the most important word in the name, and make that bigger than the rest.

For example, 'CU Amiga Magazine TV' is a bit long, and trying to give each word equal priority would lead to them all being too small to read. Instead, we decided that the keywords are Amiga and TV.

In a bid for world media domination, we also wanted to keep strong links with the magazine, so the CU Amiga Magazine 'mast-head' was used as a basis for continuity.

This idea can be extended to full screen animated logos. Classic examples of these are the MGM



▲ Globes are good for logos, as they lend the company an international world-beating air.

Lion, the BBC spinning globe, and the Channel 4 logo.

In this example the 2D logo has been bent around a picture of the world. This could be done with 3D rendering software, which would

allow the logo to spin around the globe. However, this example is just a single frame. The original logo was bent into shape with *DPaint*, and then pasted over the globe.

Rounding it off

What the hell, why not finish your animation with one final logo? It's these parting shots that are often most effective in embedding your name into the viewer's mind. Rotating 3D lettering is all very impressive, and very simple to do in any 3D rendering package. If you want to stand out from the crowd, you might be better off going for something a bit more original.

There are no hard and fast rules that say what makes a good end piece. The Raygun Productions screen below gets the message across with a double hit: once with the title, and a second time with the ray gun itself. The image of the ray gun is likely to stay in the mind, and serve as a reminder of the name. Without this visual hook, the viewer might not even notice the screen, let alone remember it.

Still images are fine, but animations can be more effective. Our imaginary production company Time Bomb Films uses a short sequence that helps you remember the name. Rather using a realistic time bomb, with fiddly wires, explosives and a clock, a cartoon-style bomb has been used. In the few seconds of the short animation, a realistic-looking time bomb could be mistaken for a clock-radio, whereas everyone knows what a cartoon bomb looks like. The explosion is also a neat way of cutting into the next programme, or just fading to a black screen.

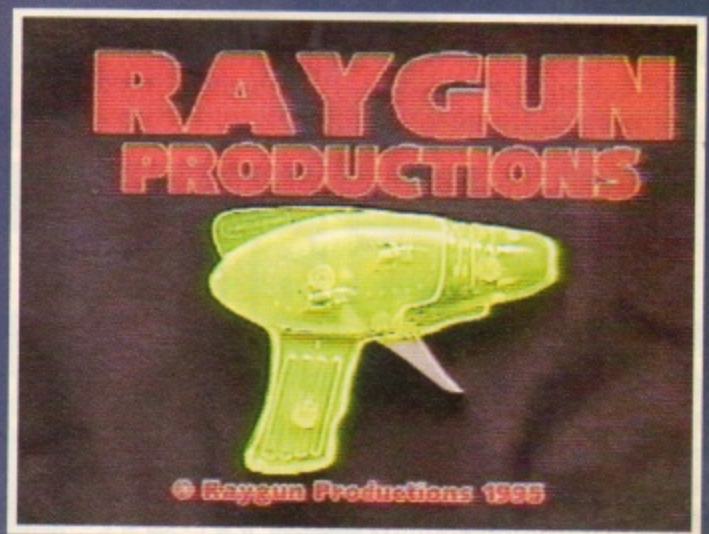

▲ Give your productions unique branding by inventing your own logo. Placed at the start and end of your films, this can engrain your name into the viewer's memory.

Time Bomb Films



Time Bomb Films



Time Bomb Films



Time Bomb Films



Buyers Guide

Hardware:

Pro Grab 24 RT

Real time video digitiser. Pro Grab 24 RT is available in standard form, compatible with all Amigas running Workbench 2.0 or higher. Single frames or animations are grabbed from a composite video source (camcorder, VCR etc) in 24 bits, for saving in any Amiga screen format, or 24 bit JPEG, IFF, Clipboard, Pro Grab or Anim5 format. An additional £29.95 buys an optional PCMCIA interface for increased grabbing rates on A600s and A1200s.

Available from: Gordon Harwood Computers, New Street, Alfreton, Derbyshire DE55 7BP. Tel: 01 773 836781. Prices: Pro Grab 24 RT: £129.95. Optional PCMCIA interface: £29.95. Optional SVHS connector: £4.95.

Vidi 12/24/24 Pro RT

Range of real time RGB video digitisers. Vidi 12 RT works in 12 bit colour, Vidi 24 RT works in 24 bit colour, and Vidi 24 RT Pro offers higher resolution grabbing at 720 x 576 pixels. Picture quality tends to be superior to composite video grabbers.

Available from: Rombo, 2B Young Square, Brucefield Industrial Park, Livingston,

Scotland EH54 9BX. Tel: 0506 414631. Prices: Vidi 12 RT: £69. Vidi 24 RT: £149. Vidi 24 RT Pro: £249.

Amitek Fusion Genlock

Simple but effective composite video genlock. Includes a fader, RGB Amiga input, RGB monitor output, composite video in and out, and three operation modes (video, graphics and combined). *Scala HT 100* titling software comes free.

Available from: Silica, Silica House, Hatherly Road, Sidcup, Kent DA14 4DX. Tel: 081 309 1111. Price: £99.99.

G-Lock

Professional level genlock featuring composite video, SVHS and RGB inputs and outputs, real time colour effects and sound mixing and software-controlled operation.

Available from: Silica, Silica House, Hatherly Road, Sidcup, Kent DA14 4DX. Tel: 081 309 1111. Price: £269.

Rendale Super 9402 Genlock

SVHS genlock featuring two 'key-hole' modes that make different parts of the Amiga graphics transparent (note: this is not the same as a chromakey effect). A rotary fader allows fading to black, or between

either source. SVHS input and output give good picture quality.

Available from: Marcam Ltd, 62 Tenter Road, Moulton Park, Northampton NN3 6AX. Tel: 01604 790 466. Price: £299.

MicroStudio 2000

Excitingly powerful all-in-one genlock, chromakey and effects processor. Includes four built-in wipe effects, chroma and luma keying, audio mixing and EQ. Watch for a full review, planned for the May 1995 issue of CU Amiga Magazine.

Available from: CTV Multimedia, Litton House, 52-56 Buckingham Street, Aylesbury, HP20 2LL. Tel: 01296 330670. Price: £ 1,100.

Software:

Deluxe Paint 4 AGA

The latest version of the Amiga's favourite paint and animation software. Allows paint and animation in any screen format, although multiple palette anims are not supported. This is rectified in Version 5, due for release any day now.

Available from: Electronic Arts, 90 Heron Drive, Langley, Berks SL3 8XP. Tel: 0753 549442. Price: Deluxe Paint 4

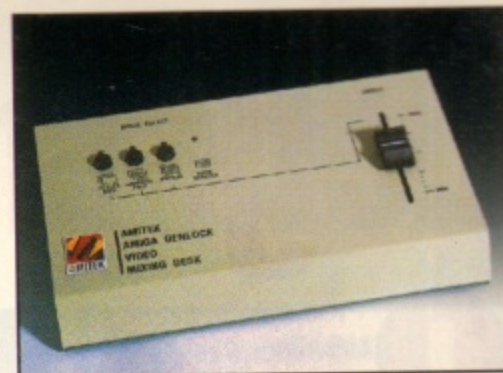

▲ The Amitek Fusion genlock - an effective composite video genlock.

AGA: £49.99. Deluxe Paint 5: £89.99.

Brilliance 2.0

Direct rival to DPaint. Additional features include multi-palette animations support, and generally improved speed.

Available from: Emerald Creative, Rapid House, Wandle Bank, London, SW19 1DW. Price: £45.95.

Personal Paint 6.1

Similar to DPaint and Brilliance, but includes more image processing options and file conversion facilities. Limited to 256 colours.

Available from: Ramiga, Stablau, 'Rin, Pentrefoelas, Clwyd LL24 OHT. Tel: 0690 770304. Price: £69.95.

Photogenics

24 bit graphics package (no animation). Lots of professional features. More useful for image manipulation and composition, rather than creating pictures from scratch.

Available from: Almathera, Challenge House, 618 Mitcham Road, Croydon, Surrey CR9 3AU. Price: £54.95.

Video Standards

VHS

The first home video system, and quite poor by today's standards. The tapes are large and bulky, and the vertical image resolution is a paltry 240 lines. It suffers from poor frame rate accuracy and crosstalk (black and white lines close together causing coloured bands to appear).

VHS-C

The smaller cassettes used in some camcorders are called VHS-C. They can be used in special adaptor cassettes to allow replay in normal home

'full sized' players. The picture quality is fine for home use, but still far from professional quality.

VHS-HQ

A slightly improved version of VHS. Modern systems are of this type, which is slightly better than standard VHS.

8mm

The very small tapes used in some camcorders are of the 8mm system. The tape is a metal compound which gives a better quality picture. The resolution is still only about

260-280 vertical lines. The main problems with 8mm are that you can't replay 8mm tapes in a VHS machine (only watch or re-record the signal), and the audio signal is embedded as part of the video signal which means there is no way of dubbing on a separate sound track on after the recording has been made. 8mm is still a good choice when selecting a camcorder because the cameras will be smaller and cheaper, and the quality is marginally better than VHS or VHS-C.

SVHS

SVHS looks physically identical to VHS, but works in completely different way. The

colour and brightness signals are separated and recorded separately on the tape. This keeps noise effects such as 'crosstalk' to a minimum and gives a much better picture as a result. SVHS equipment is the best consumer level kit available today (400-420 lines of resolution), but is also very expensive. SVHS-C is a compact version for use in camcorders.

Hi8

Hi8 is like 8mm, but in the same way as SVHS, separates the luminance and chrominance information for a better quality image. Hi8 equipment is expensive and hard to come by.

QUALITY AMIGA PRODUCTS

24-BIT GRAPHICS FOR A1500/2000/3000/4000

2Mb PICASSO II

NEW!



- 24-bit graphics card
- Resolutions up to 1600x1200
- Up to 16.7 million colours
- Emulator integrated into system
- Supports Workbench 2.x and beyond

Software included: Setup/Installation TV Paint Junior MainActor Pro

RRP £299
 INC VAT - VID 2200
FREE DELIVERY

PRO 3D DESIGN FOR ALL AMIGAS

PIXEL 3D PRO v2.0

NEW!



SAVE £20

- 3D text creation
- Object creation, editing & handling
- Supports AGA
- Object format conversion - all popular formats
- Complete bitmap and postscript font support
- Colour view modes
- Adapts to larger screen sizes

RRP £149
£129
 INC VAT - ASP 4000
FREE DELIVERY

ULTIMATE 3D GRAPHICS & ANIMATION FOR ALL AMIGAS

LIGHTWAVE 3D - PAL VERSION 3.5

SAVE £50

- 24-bit graphics
- 16 million colours
- Resolutions up to 16,000 x 16,000
- Fast photorealistic rendering
- Texture mapping
- Procedural texturing
- Full ray tracing
- Motion blur
- Field rendering
- Customised lens flares
- Interactive wireframe editing with real-time feedback

RRP £499
£449
 INC VAT - ASL 6472
FREE DELIVERY

LIGHTWAVE 3D VIDEO TUTORIALS

VDO 6000 - LIGHTING & CAMERA TECHNIQUES
 VDO 6010 - MAPPING, MORPHING & BONES
 VDO 6020 - SURFACES & TEXTURES
 VDO 6030 - MODELER PART 1
 VDO 6040 - MODELER PART 2

Explains how to give your animations depth & realism. Teaches you how to twist, bend & deform objects. Explores the power & realism of surface & texture. Explains the basics of custom 3D modelling. Techniques on how to shape and modify objects.

FREE DELIVERY
SAVE £50

£49.95
 INC VAT EACH - SEE LEFT
SPECIAL PACK ALL 5 VIDEOS
£199.95
 INC VAT - VDO 6050
FREE DELIVERY

SUPER ANIMATION FOR ALL AMIGAS

ANIMATION WORKSHOP v2.0

NEW!



SAVE £10

- Create, play, add sound process, edit and manipulate animations
- Builds animations as you work
- Uses ADPro or ImageFX when image processing is required
- Supports AGA modes, ANIM5/7/8 formats

RRP £79
£69
 INC VAT - ASA 5800
FREE DELIVERY

IMAGE MANIPULATION FOR A1200/A4000

PHOTOGENICS

NEW!



SAVE £5

- 24-bit graphics and manipulation package
- Supports popular image formats inc. JPEG, GIF and IFF
- Multiple image editing
- Real-time HAM8 display
- Open design allows you to add your own loaders, savers or effects

RRP £54
£49
 INC VAT - ASP 3000
FREE DELIVERY

IMAGE PROCESSING FOR ALL AMIGAS

IMAGE FX v2.0

NEW!



SAVE £50

- 24-bit image processing
- Various Real-time painting tools
- Image thumbnails
- Enhanced text handling
- Expanded image compositing
- AutoFX
- ImageFX browser
- Soft edge and anti-aliasing

RRP £249
£199
 INC VAT - ASI 2132
FREE DELIVERY

SOFTWARE OFFERS LIMITED STOCKS

	RRP	SILICA
AMOS PROFESSIONAL	£34.95	£31
AMOS PRO COMPILER	£34.95	£31
BRILLIANCE V2.0	£89.95	£59
CANDO V2.5	£129.95	£99
DATASTORE	£69.99	£49
EASY AMOS	£34.95	£30
EDGE 1.7 - PRO	£49.95	£49
GB ROUTE PLUS	£49.95	£44
KINDWORDS 3	£29.95	£14
MAVIS BEACON II	£29.95	£29
MAXIPLAN 4	£29.95	£29
VISTA PRO 3.0	£29.95	£29
WORDWORTH 3.1SE	£69.95	£49

PUBLISHING PROGRAM FOR ALL AMIGAS

PAGESTREAM v3.0

- Precise typographic control
- Import text and graphics
- Draws boxes, lines etc
- Automatic text flow
- PostScript, Compugraphic Intellitext & PageStream format fonts
- Textgraphics writing palette
- Gradient/radial/shape fills

SAVE £100
£199
 INC VAT - ASP 0981
FREE DELIVERY

PRINTER CONTROLLER FOR ALL AMIGAS

STUDIO PROFESSIONAL II

NEW!



- 24-bit graphics
- 16.7 million colours
- Workbench drivers for most printers
- Prints pictures from disk using very little memory
- Supports nearly all graphics formats
- Latest dither technology
- Professional Colour Management system

£49
 INC VAT - ASS 8800
FREE DELIVERY

INCREASE THE SPEED OF YOUR AMIGA FOR A1200

A1230-II ACCELERATOR & RAM BOARD

- 40MHz and 50MHz 68030 processor options
- Built-in memory management unit (MMU)
- Kickstart remapping technology (50MHz model)
- Memory disk management software
- Optional 68882 maths co-processor
- 32Mb RAM capability

FPU OPTIONS
 40MHz 68882 OR 50MHz 68882
 UPG 1982 OR UPG 1996
SAVE UP TO £130
£100 INC VAT

	4Mb RAM	8Mb RAM
40MHz 68030 NO MMU	£299	£499
50MHz 68030 WITH MMU	£449	£649

INC VAT - UPG 1244 INC VAT - UPG 1248 INC VAT - UPG 1540 INC VAT - UPG 1580
FREE DELIVERY

PAINT PACKAGE FOR ALL AMIGAS

PHOTON PAINT V2.0

Illuminate the power of your Amiga with this comprehensive graphics drawing package.

- Full selection of drawing tools
- Contour mapping & 3D objects
- Comprehensive 160 page manual

SAVE £80
£9.95
 INC VAT - KIT 4822

THE SILICA SERVICE

Before you decide WHEN to buy, we suggest you consider WHERE to buy and protect your investment with a purchase from Silica. With our unrivalled experience and expertise, we will provide all the extra help, advice and new product information you may need both now and in the future. Visit one of our stores, or return this coupon now and begin to experience the "Silica Service".



DEBENHAMS
 STORES NATIONWIDE

- ESTABLISHED 17 YEARS:** We have a proven track record in professional computer sales.
- PART OF A £50M A YEAR COMPANY:** With over 300 staff - We are solid and reliable.
- EXPERIENCED STAFF:** All fully trained in "Customer Care".
- TECHNICAL SUPPORT HELPLINE:** FREE help and advice from a team of experts.
- A FULL PRODUCT RANGE:** All of your computer requirements from one supplier.
- WE PRICE MATCH:** On a "Same product - Same price" basis.
- FREE CATALOGUES.**
- PAYMENT:** We accept most major credit cards, cash, cheque or monthly terms (APR 23.8% - written quotes on request).
- VOLUME DISCOUNTS AVAILABLE:** Business, Education and Government. Tel: 0181-308 0888.
- MAIL ORDER:** FREE DELIVERY in UK mainland on orders over £40+VAT. Small administration charge (£2.50+VAT) on orders under £40+VAT.
- 21 STORES NATIONWIDE:** *Mini Stores carry a selected range only but products can be ordered in the stores via Mail Order.

MAIL ORDER 0181-309 1111 PLUS TECHNICAL AND HEAD OFFICE

SILICA, SILICA HOUSE, HATHERLEY ROAD, SIDCUP, KENT, DA14 4DX

PLUS BRANCHES AT:

BRISTOL	Debenhams - (2nd Floor), St James Barton	0117-929 1021
CARDIFF	Debenhams - (1st Floor), St David's Way	01222 341576
CHELMSFORD	Debenhams - (2nd Floor), 27 High Street	01245 355511
CROYDON	Debenhams - (2nd Floor), 11-31 North End	0181-688 4455
GLASGOW	Debenhams - (2nd Floor), 97 Argyle Street	0141-221 0088
GUILDFORD	Debenhams - (2nd Floor), Millbrook	01483 301300
HARROW	Debenhams - (2nd Floor), Station Road	0181-427 4300
HULL	Debenhams - (2nd Floor), Prospect Street	01482 325151
IPSWICH	Debenhams - (2nd Floor), Westgate Street	01473 221313
LONDON	Silica - 52 Tottenham Court Road	01703-580 4000
LONDON	Debenhams - (2nd Floor), 334 Oxford St	0171-580 3000
LUTON	Debenhams - (1st Floor), Arndale Centre	01582 21201
MANCHESTER	Debenhams - (2nd Floor), Market Street	0161-832 8666
PLYMOUTH	Debenhams - (2nd Floor), Royal Parade	01752 266666
ROMFORD	Debenhams - (2nd Floor), Market Place	01708 766066
SHEFFIELD	Debenhams - (2nd Floor), The Moor	0114-276 8611
SHEFFIELD	Debenhams - (L. Ground), Meadowhall Ctr	0114-256 9779
SIDCUP	Silica - Silica House, Hatherley Rd	0181-302 8811
SOUTHAMPTON	Debenhams - (1st Floor), Queensway	01703 223888
SOUTHEND	Keddies - (2nd Floor), High Street	01702 462426
THURROCK	Debenhams - (1st Floor), Lakeside Centre	01708 863587



COMPUTER SHOPPER
 1994 Awards
WINNER
 Best Software Delivery Service



COMPUTER SHOPPER
 1994 Awards
NOMINATION
 Best After Sales Service

To: Silica, CMUSR-0495-236, Silica House, Hatherley Rd, Sidcup, Kent, DA14 4DX

PLEASE SEND ME AN AMIGA CATALOGUE

Mr/Mrs/Miss/Ms: Initials:

Surname:

Company (if applicable):

Address:

Postcode:

Tel (Home):

Tel (Work):

Which computer(s), if any, do you own?

236A

SoftWood Software will go down in history, the best there's been... for ages.

The way we all communicate today has gradually evolved from early cave paintings by Prehistoric man, through Egyptian Hieroglyphics and eventually on to a method of symbols representing both letters and numbers. Early inscriptions in stone gave way to clay tablets, papyrus, parchment and ultimately paper, and the Greek alphabet became the basis of most of today's languages.

Books were created by hand until the mid 15th century when crude printing processes were first introduced. Albeit with continual refinements, printing methods have, until very recently, remained the only way to distribute the written word and hence a host of information throughout the world.

The biggest leap forward has been achieved in the last ten years!

Through the adoption of computer generated text as a new standard, complicated layouts and designs can now be generated and printed at the touch of a few keys right on your desktop. And it doesn't stop there.

Archiving and record keeping works hand in hand with these new methods of processing text and allows far faster data retrieval than ever before. This latest technology has not just revolutionised the world of print, but has opened the floodgates to an explosion in communication possibilities throughout the world.

At SoftWood, our constant aim is to bring you these powerful, up to date technologies with the best possible software for your specification of Amiga.

Our word processing packages have repeatedly won the favours of magazine reviewers, who have awarded

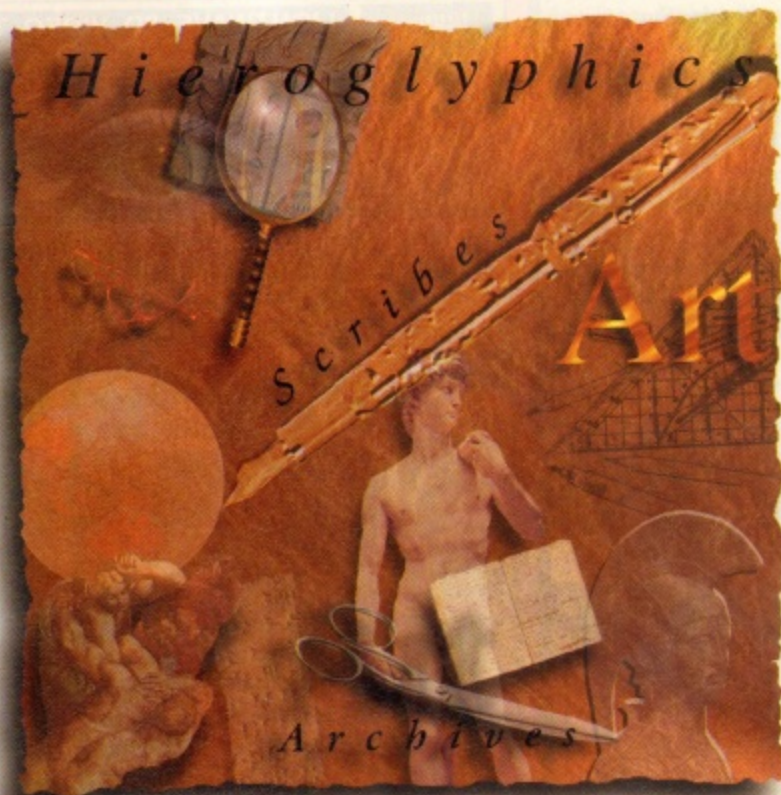

SoftWood products their highest accolades, all over the world. We are continually updating and improving those products and adding new ones, such as Final Data™, and soon, Final Calc™ to our range. Our efforts are bringing the revolution into your home or office... and onto your Amiga.



Word Processing/Publishing...

Whatever specification Amiga you own, SoftWood have the perfect solution for your requirements.

Final Copy II™ Release 2 is at the peak of achievement when running a floppy based Amiga configuration, whilst Final Writer™ Release 3 is the only hard drive compulsory Amiga word processor - it leaps a stage ahead and doesn't make any compromises to be floppy disk compatible. Whichever you choose, you'll be

assured of the latest in WYSIWYG technology and reap the benefits of still unsurpassed, easy to use, Amiga software from SoftWood.

Our new Database...

Final Data™, is designed in the true SoftWood tradition and brings you a program that is not only extremely powerful, but also very easy to use. Indeed, you can learn to set up your Final Data™ database, enter your information and print the results in a matter of minutes... not hours. You'll soon be generating all kinds of reports and label print runs to suit your kind of work.

LATEST NEWS from SoftWood... Final Calc™

Final Calc™ is the answer to every Amiga Spreadsheet users dreams. With its flexible modes of operation, Final Calc™ is the only Spreadsheet that can start with a minimum range of features (ideal for the beginner), but progress to offer power beyond the levels found not just on any other Amiga Spreadsheet, but almost any Spreadsheet on any computer system. Multi-layer sheets, advanced PostScript outputting facilities with flexible font handling, complete document scaling options, a vast choice of Graph styles including 3D and animated (to show calculation result/progressions) are just some of its comprehensive and unique features.

Final Calc™ is due for release in Spring 1995, so look out for the magazine reviews. If you want to know more now, simply cut the coupon (on the right) for your free advance information.

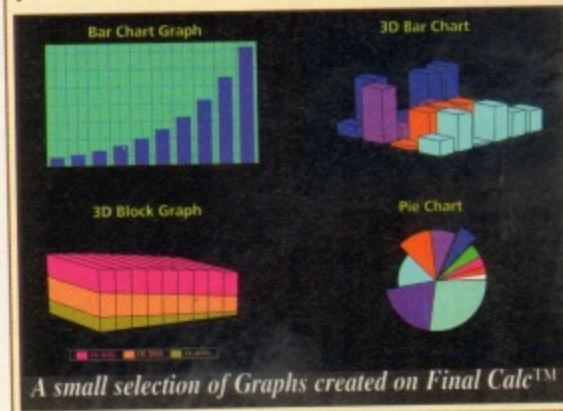

SoftWood

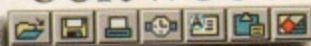

bringing the revolution into your home or office... and onto your Amiga.

SoftWood Products Europe, New Street, Alfreton, Derbyshire. DE55 7BP. Telephone: 01 773 521606 Facsimile: 01 773 831040

Final Copy II™

Release 2

Designed to get the most out of an Amiga floppy drive based system, *Final Copy II™* offers more than just word processing (at which it naturally excels) and opens up a world where 'how the document looks' is as important as 'what the document says'.



Compatibility: Floppy or Hard Drive Systems

Final Copy II™ is ideal for that quick letter but also boasts features which are powerful enough to help you produce end results normally associated with expensive Desk Top Publishing packages... easy to achieve, without the fuss!

Unique features such as **FastDraw™** on screen drawing tools (to generate boxes, borders, lines and arrows etc.) and **Perfect Print™** (an advanced system that enables you to print the same Postscript™ outline fonts to any printer in both landscape & portrait modes) ensure that *Final Copy II™* is the leader in its class. You can easily generate multiple newspaper style snaking columns, import any graphic objects or pictures (and place them anywhere on your page), scale or crop those graphics and also auto flow text around them. You can even

print text over graphics and the output is always of the highest quality. *Final Copy II™* offers the perfect balance between word processing and more advanced page layout creation - in one great program.

Ease and speed of use with total control of the final printed presentation is available on your floppy based Amiga system right now for only **£49.95 inc. p&p.**

Final Copy II™ requires any Amiga floppy or hard drive system with a minimum of 1Mb. free RAM (A600 hard drive computers need 1.5Mb). Twin floppy drives are recommended for total flexibility with no installation or multiple disk swaps required.

Help on memory: our products are the most economical in their use of memory. Like others, we quote the minimum memory required to load our software but we also like to make it clear that all graphical software requires more memory - dependent on the functions being used.

Final Writer™

Release 3

Hard drive compulsory, this new program is for power users wanting the ultimate performance. As with *Final Copy II™*, excellent output is guaranteed utilising **PerfectPrint™** and you'll also benefit from a host of other advanced features including...

- **Text Blocks™** which position text at any size, angle and position on the page.
- **Touch Tools™ & PowerUserBars™** giving 'one touch' control - just click on a button... define, change and save such attributes as text position, font size, font styles (bold, italic, underline etc.), justification, bullets, line spacing, indents etc.
- **FastDraw Plus™** allowing more versatile on screen drawing tools which include options like rotation.

Final Writer™ can also import, scale, crop, view on screen and output structured PostScript EPS clip-art images (we even include 100 free) to any printer. With PostScript printers your options include... thumbnails, crop marks, scaling and halftoning.

Add ARExx/Macros, floating palettes, undo/redo (both text formatting and graphics), table of contents, auto indexing, table of illustrations, bibliography generation, new drag & drop

text, spelling while you type, dictionary hyphenation, foreign

language dictionaries, auto save, polygon graphics irregular shape generation, plus lots more and *Release 3* takes your Amiga further than ever before!

Amiga word publishing power, only **£74.95 inc. p&p.**

Release 3 includes 100 quality clip art files and 120 outline fonts and, when you register with SoftWood, we send you a further 50 Bonus Fonts Free too!

Final Writer™ Rel 3 requires any Amiga running Workbench 2 or 3 with a hard disk drive and a minimum of 2Mb. free RAM.

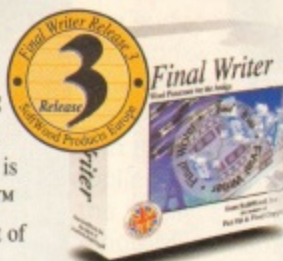

Compatibility: Hard Drive Systems Only



Final Data™

New Release

Final Data™ has been designed by SoftWood to be by far the **EASIEST TO USE** Database for your Amiga. Many users dislike the involved "two stage" process conventional databases force you to follow.

To set up a *Final Data™* database, you won't be confronted by an array of unfamiliar commands, simply define a column for each sort of information you want to keep eg. christian name, surname, house name or number street, town, county, postal code and phone number etc. Incidentally, you can add or remove columns at any stage during your working session. Your new database will appear as a table with rows and columns allowing you to view whole ranges of data at the same time. Column widths can

always be adjusted, to suit your requirements, by simply dragging their borders with the mouse. Data is then entered into "cells" and *Final Data™* even detects entries of invalid dates etc. and displays an alert message for your attention. Screen totals are available as options on all amounts and calculations (numbers can also be formatted with currency signs and commas - again you can decide).

Final Data™ is ideal for label printing and even has built-in routines that remove all the complexities from this often involved task. You can always utilise the "Print Merge" feature found in *Final Copy II™* and *Final Writer™* - simply select the program you are using and *Final Data™* does the rest automatically for you. The program is also capable of reading any database created in *Pen Pal™*, *MiAmiga File* and *File Ilsg™* as well as standard ASCII files found in many other common programs. Above all you'll be able to start using *Final Data™* immediately.

An easy to use yet extremely powerful method for keeping all your records in order from SoftWood Direct at only **£39.95 inc. p&p.**

Final Data™ requires any Amiga system with a minimum of 512K free RAM operating under Workbench 1.3 or higher.



Compatibility: Floppy or Hard Drive Systems

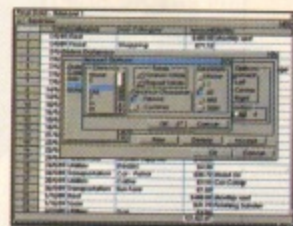

Mr/Mrs/Miss/Ms: _____ Initial(s): _____ Surname: _____

Address: _____

County (Country if overseas): _____ Postcode: _____

Daytime telephone: _____ Evening telephone: _____

Please rush me... **ADVANCE INFORMATION ON NEW... Final Calc™** (Please Tick if required)

Please charge my credit/debit card as detailed below and rush me my new SoftWood software (Please Tick as required)...

Final Copy II UK £49.95	<input type="checkbox"/>	Final Copy II Overseas £59.95	<input type="checkbox"/>	(Card Authorisation Signature:)
Final Writer UK £74.95	<input type="checkbox"/>	Final Writer Overseas £84.95	<input type="checkbox"/>	
Final Data UK £39.95	<input type="checkbox"/>	Final Data Overseas £49.95	<input type="checkbox"/>	
Credit/Debit Card No.: _____				

Credit/Debit Card Expiry Date: _____ Issue No. (Switch Cards Only): _____

Cheque/Bank Draft/Postal Order for £ _____ payable to SoftWood Products Europe... (Please Tick if enclosing cheque/draft/PO)

Order by Phone: 01 773 521606
Order by Fax: 01 773 831040

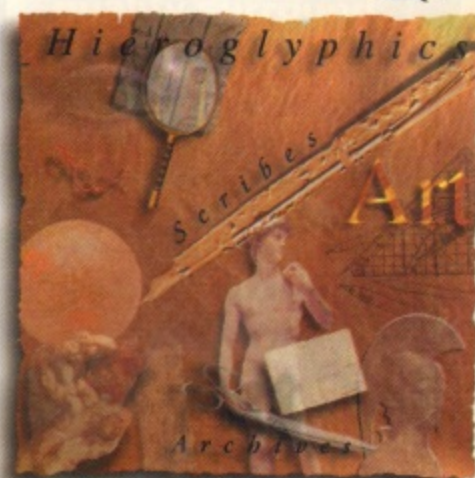

SoftWood Direct



Future of the Amiga

Continuing our celebration of the Amiga's tenth anniversary we take a speculative look forward and consider what delights the future may hold for the Amiga.

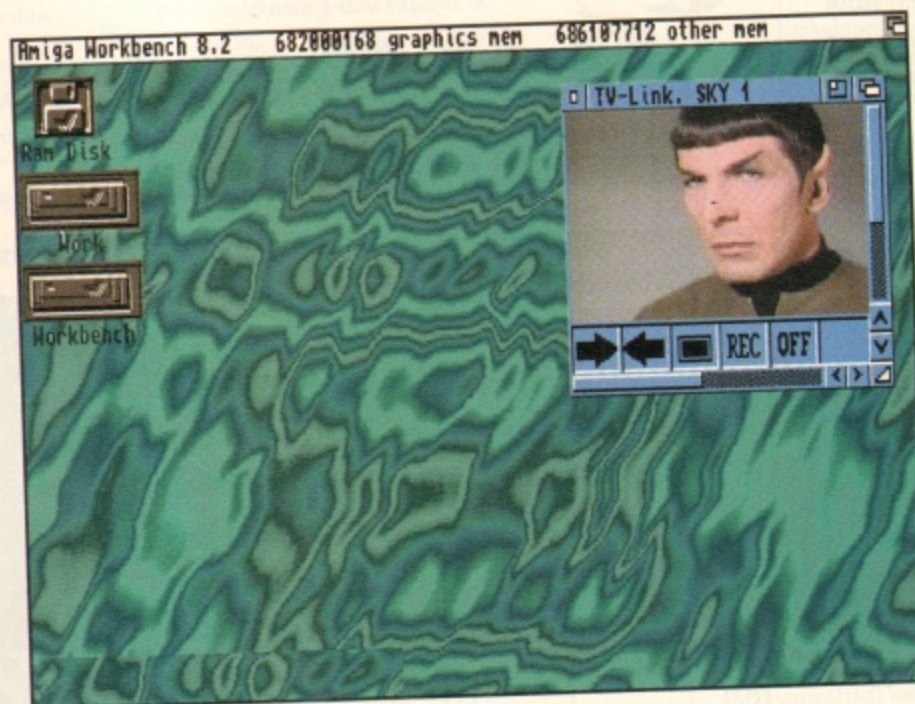

▲ Video tape could soon be a thing of the past. Future Amiga technology could allow downloading of movies direct to hard drive, or even writable CDs.

The Amiga is already an incredibly powerful machine, but compared to the next generation of Amigas, even the versatile, super-fast A4000 looks limited. Our whole perception of 'the home computer' is going to change beyond all recognition, and the Amiga will be a major force in this metamorphosis.

David Pleasance and his team have already gone on record to state that the future Amiga will be based around a RISC processor. The move from 680x0 processor to a RISC-based system will be the key factor that allows the Amiga to turn its hand to all manner of applications in both the entertainment and professional fields. Such power and diversity will also ensure the Amiga adds to its vast numbers of hobbyist and semi-professional users. The integrated all-in-one form of the A1200 will disappear. In its

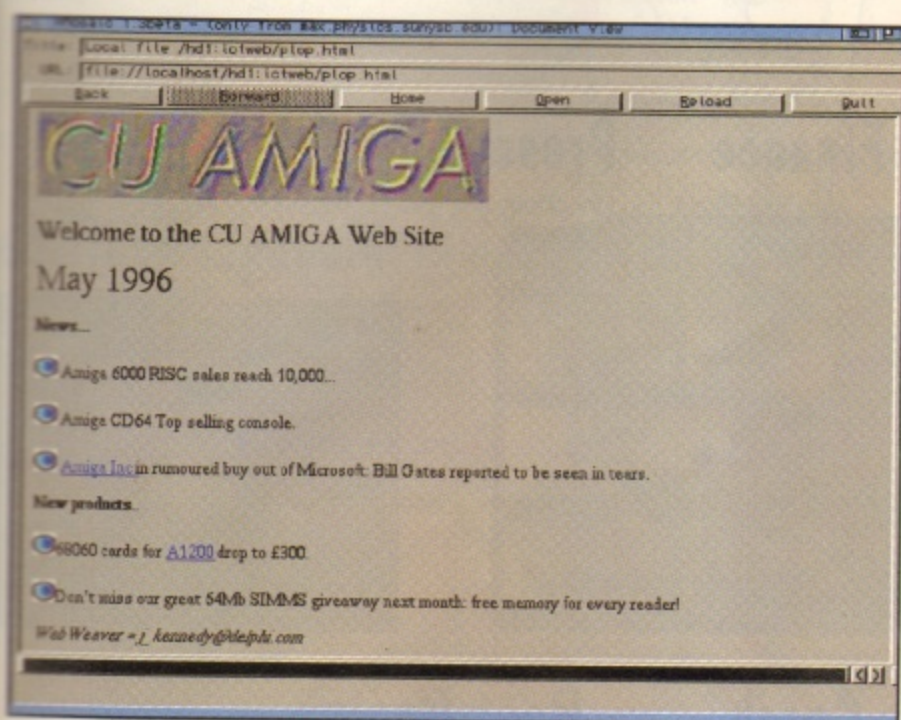

▲ Current state-of-the-art Internet front ends will look prehistoric compared to the systems now in development. Digital communication is set to become as simple and easy as making a telephone call.

place will be a 'set-top box', which will typically sit on top of a TV (like a satellite receiver), or else could be integrated with the hi-fi system. This will be controlled by a keyboard and infrared controllers. This arrangement will provide greater interaction with TV and other audio visual equipment. The Amiga set-top box will link up with your video so you can watch all your favourite films. You will probably even have the option of downloading any film you want through a 'video on demand' system. This system will also be able to decode and display lyrics, captions, subtitles and other information transmitted with films and TV programmes. And of course it will all be wonderfully easy to control through the workbench using a friendly icon system.

Interactive shopping

Your Amiga will also be able to help you with your shopping. Suppose you're watching a trailer for a new album and decide you'd like to hear a few tracks. No problem, click on an icon and the tracks are downloaded and played. If you like it, a further icon is on hand to allow the complete album to be ordered, paid by credit card and downloaded instantly. Other shopping services will also be available in a similar manner. Holiday booking, home banking, and educational services are just some of the other potential services.

Initially, payment will probably

be made through credit cards. But digital cash and smart cards are already in operation in Wiltshire as part of a trial by National Westminster Bank, where money is transferred electronically.

Video on demand systems are not that far off either. BT, for instance, is running trials of such systems in Ipswich and Colchester. All the Amiga will have to do is provide the hardware that receives and decodes the video signal. MPEG is the current favourite compression technology for video data, and the Amiga already has a headstart with its CD32 VideoCD/MPEG compatibility.

One of the current proposals is that video will be delivered via the telephone network, hence the BT involvement. For this reason it's likely that the next generation Amigas will have a high speed modem built-in. With a modem there's a perfect opportunity to include Internet access of some kind, possibly with a telephone socket on the back. Workbench will come with simplified Internet access software built-in, a variant of AMOSAIC. With video and telecommunications capability built in, video phones and video conferencing capabilities are also a strong possibility.

Of course the Amiga won't just be a glorified video player and Internet system. The Amiga as a home computer will still exist. But the hardware and operating system will have changed completely. It's

likely to have a two-tier user interface. On the surface will be a simplified front end for those who don't want to get their hands dirty – a kind of ultra-friendly point and click system to handle all of the general applications that might be used by the family, such as the downloading of films, shopping, direct access to major applications such as word processors, and an easy single-button link to the Internet. This will be controlled by a simple TV-remote style pad.

Along with this, there will also be an expert mode, which will give more experienced users the chance to use the whole power of the system, with an advanced Workbench-style interface, controlled by the infrared keyboard and its built-in trackball.

Surround sound

Surround sound is likely to be a standard feature of the future Amiga. 16-bit CD sound may be good by today's standards but Dolby-S surround sound is where future games technology is heading. Developers are already experimenting with surround sound for the existing Amigas.

What would we do with surround sound? Well an obvious choice is first person perspective game environments where your viewing screen looks straight ahead, but you will also be able to hear movement to your side and behind you. For this, high speed texture mapping and polygon hardware is definitely needed. David Pleasance has confirmed that the next generation of Amiga will have such hardware. If it's done properly, this could double as an engine for games like *Daytona*, whilst making realtime 24-bit 3D ray tracing a realistic prospect.

Resolutions will also increase. If high definition TV can survive the current war of conflicting standards, before the public get bored of it, then this could mark the end for dedicated monitors in the home. One enormous pulsating screen will then become the main display for both TV and computer.

CD-ROM

Naturally the above technology will result in very large files. So a large scale storage medium is going to be needed. CD-ROM would be ideal but it's too slow, and as yet you still can't save data to CDs. CD drive speeds are doubling every six months, and prices are falling. Couple this with the fact that writable CDs will soon be available, and that CD capacity is set to increase, and you'll see that it is

the obvious choice for future storage and will undoubtedly be built-in.

All this glorious hardware will result in some amazing applications. If Amiga developers follow trends on other platforms (PC and Mac) then it's likely that most current powerful applications (*PageStream*, *FinalWriter* etc) will be replaced by "pick and mix" software. This software will provide the shell of an application into which you plug modules. You could, for instance, have a module for text editing, spell checking, DTP page layout tools, and image processing functions. By only buying what you need you get the power you want without paying for redundant features doubling up features across several applications. Also, because it is a single application with plug in modules, this approach has the tremendous advantage of having one common file format, instead of trying to match several from different packages. Naturally this will require a major change of thinking on the part of software houses. It could also do with involvement from Commodore or whoever eventually owns Amiga.

So that's one vision of the future. Whether all of these wonderful features see the light of day remains to be seen. The various worlds of computers, communications, music and video entertainment are all forming into one big audio-visual pandora's box, which is getting deeper and more mysterious every day. So long as Amiga technology gets back on its feet, it could well lead this expedition into the electronic future, while the PC and Mac try to keep up with the pace. ■

Andy Leaning

FIVE THINGS OF THE FUTURE

1. Sixteen bit CD quality surround sound.
2. CD-ROM drive as the storage medium.
3. Built-in Internet access hardware and software.
4. Ultra high resolution displays on high definition TV.
5. Video on demand access.

Action on the pitch...

JOINING...

Your appointment as Player Manager brings gasps in the national press. Will you be able to handle the pressure cooker atmosphere of the manager's office and still do your duty for England?

Archives
Finance
Press Office
Board Room



Manager's Office



Physio

Coach

Boot Room

PLAYING...



Player Manager 2 is the only management game which gives you the chance to play on the field. As an international star you're already a proven matchwinner who can influence and inspire those around you. Play in your favourite position or control the player nearest the ball, but remember ultimately it is the right managerial decisions that get results.

Nearing 30, the legs won't carry you forever. The road to the top is hard and you will have to give way to younger players eventually and watch them from the dugout. One thing is for sure, you'll never be too far from the action.

COACHING...

Coaching and training are an integral part of Player Manager 2. Training realistically affects your players' performances. Skills such as shooting, tackling and close control can improve drastically with the right training, but will deteriorate just as quickly with neglect. By varying your training patterns, bringing in specialist coaches, initiating new tactics you can change the way your team play.

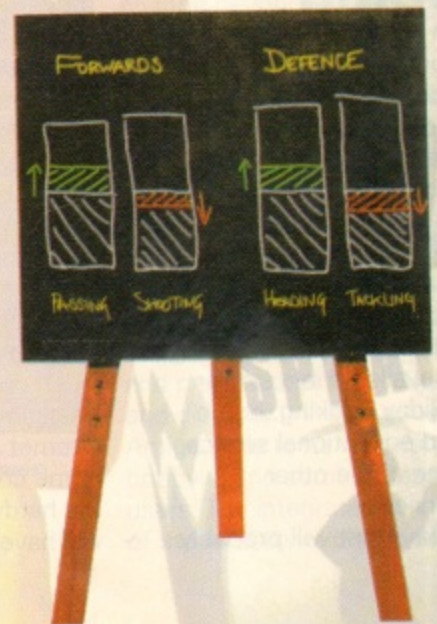

ANCO

For more detailed information please write to Anco, Unit 7, Millside Industrial Estate, Lawson Road, Dartford, Kent DA1 5BH

PLANNING...

A good manager is a master tactician. The inclusion of a Ray Trace gives Player Manager 2 the most powerful tactics designer ever. Applying the Ray Trace you can pinpoint player limitations, determine the best positions for your key players, refine systems and design the right tactics for the right matches. Then it's all down to your players.



SIGNING...

16 year old school boys are much of a muchness. A good manager can spot young talent, train, coach and nurture it to produce international players. The same potential stars in the wrong hands can be wasted, misused and end up as a 4th division nobody. Can you spot the talent amongst the turkeys?



DEALING...

A shrewd manager knows how to wheel and deal and make a killing in the transfer market. Player Manager 2 has a lively, ever changing transfer market, you can buy domestically or like Ferguson, Dalglish and Keegan before you enter the European transfer market and bolster your squad with foreign talent.

WINNING IDEAS.

Player manager 2 is a comprehensive management simulator which tests your management skill where it counts - **ON THE PITCH.**

Player Manager 2 is due for release on AMIGA in APRIL and PC CD ROM in MAY.

Action off it!

**PLAYER
Manager 2**

Happy Birthday Amiga!

6 AMIGA 1200s MUST BE WON!

Last month we took a look back at the history of the Amiga, from the A1000 to the A4000. The people involved, the new launches, the evolution of Workbench and more. We also printed the first part of this superb competition to win one of six A1200s. In this month's feature we've concentrated on the possible future of this great machine, so now, with the final three questions for the competition, is your big chance to get your hands on one of these super upgrades.

Just to recap, the questions asked last month were: 1. The Amiga was originally known by a different name before its release. What was this name? 2. Name the man widely regarded as 'the father of the Amiga' who died in June of 1994. 3. Name the famous 'pop' artist who helped launch the Amiga in 1995.

You should have the answers to the above questions already (they were all in last month's feature) so all you have to do now is answer the following questions based on our vision of the future of the Amiga:

1. What sort of chip should the next generation of Amiga have at its heart?
2. What compression technique, suitable for video, does the Amiga and CD32 already use?
3. What large scale storage medium is destined to become standard equipment on all Amigas?

Winners will be picked within one month of the closing date of this competition (April 20th 1995) and will be notified by post. One lucky winner, however, will go even further and win a full 12 month subscription to CU Amiga Magazine, a free gift of their choice from the list on our subscriptions page (p124) and a chance to meet the CU Amiga Magazine team. We will present you with your prizes, discuss groovy Amiga topics of your choice and generally show you a good time courtesy of EMAP Images.

In order to sort out who will win this extra prize please complete the following tie breaker in no more than 25 words:

I want an Amiga 1200 because ...

How to enter

Write the six answers and your tie breaker quote on the back of a post card or sealed envelope and send it to us at the following address:

AMIGA 1200 COMPETITION,
CU Amiga, Priory Court, 30-32
Farringdon Lane, London
EC1R 3AU.

RULES

1. Employees of EMAP Images or Commodore can not enter.
2. Multiple entries will be thrown in the bin.
3. The closing date for entries is 20th April 1995.
4. Competition entries will only be accepted by post.
5. The winners will be notified by post within 30 days of the competition closing date.
6. The editor's decision is final and no correspondence will be entered into.

Flight of fantasy?

No... with a Blizzard or Cyberstorm Accelerator, your Amiga will fly!

If you've ever sat and waited for your Amiga to catch up, you'll know that an extra boost of power would be just the ticket.

But, the only problem is the cost... isn't it?

Well not any more. When you compare our cost per MIP with other boards you'll be surprised at just how little you'll have to pay to enhance the performance of your Amiga computer.

Then, the sky's the limit!



BLIZZARD 1220/4 4Mb TURBO

The multi award-winning 1220/4 offers by far the best price/performance ratio of any A1200 32-Bit RAM expansion on the market. Of course the 1220/4 also incorporates everything else that a good memory expansion should too, such as a Real Time Clock, further RAM expandability, optional FPU etc. as well as offering a Clock Speed Doubling Circuit which runs the 32-Bit FAST RAM at an amazing 28MHz. Not only does the 1220/4 give Amiga A1200 owners all this, but the price has broken the sound barrier too!

- Integrated 28MHz 68EC020 32-Bit RAM Clock Speed Doubler for up to 300% overall performance increase
- Factory Installed/Tested 4Mb of 32-Bit FAST RAM
- Expandable to 8Mb with Add-4 Board
- Integrated Battery Backed Real Time Clock
- Easy Trapdoor Installation, retains CBM Warranty
- Can be disabled in situ for full games compatibility

1220/4 Turbo £229.95

4Mb 32-Bit Fast RAM 28MHz 68EC20 CPU

Add-4 Board (extra 4Mb for 1220/4) £169.95

4Mb 32-Bit Fast RAM add-on

Motorola FPU &Call

68882 PLCC 25/33MHz

The Blizzard Performance Advantage...

Just look below to see how well your Amiga really could fly!

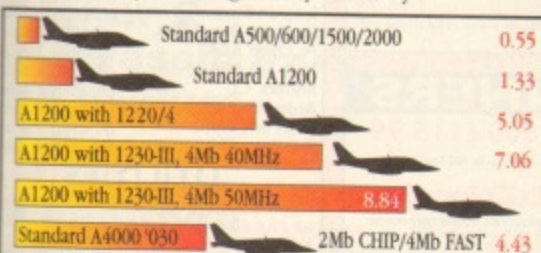

NEW...

BLIZZARD 1230-III TURBO ACCELERATOR MEMORY



The NEW BLIZZARD 1230-III TURBO ACCELERATOR MEMORY BOARD is the highest performing 68030 accelerator for the A1200. With its rapid 40 MHz 68EC030 CPU, or faster still 50MHz 68030 with MMU, it offers up to 500% performance increase overall. The 1230-III has further expansion options with its integral Fast Expansion Bus for Add-on Modules such as the SCSI-2 Controller (due for release early '95). With its industry standard SIMM socket it provides up to 32Mb of

auto-configuring 32-Bit FAST RAM.

- PGA FPU Socket up to 50MHz
- Instruction & Data Burst Modes*
- Automatic, Kickstart Re-Mapping (can be disabled if required)
- Battery Backed Self Recharging Real Time Clock
- Easy Trapdoor Installation

1230-III Turbo 0Mb, 40MHz 68EC030 £189.95

1230-III Turbo 0Mb, 50MHz 68030 & MMU £229.95

SCSI-II Module for 1230-III &TBA

Motorola FPU 68882 PGA 25/30/50MHz &Call

4Mb SIMM RAM Expansion 32-Bit, 72 pin £129.95

LARGER SIMMS AVAILABLE &Call

FASTLANE Z3 SCSI CONTROLLER

Lightning FAST DMA SCSI-II interface for Amiga A4000 owners. Expandability up to 64Mb. of 32-Bit Fast RAM. Doesn't require any 'Buster Chip' upgrades. Use with hard drives, CD Rom etc

£299.95

BLIZZARD 4030 ACCELERATOR

FULL 50MHz 68030 with MMU ACCELERATOR for Amiga 4000 030's. Replaces the A4000's CPU and offers an FPU option. Approx. 50% overall performance increase when fitted with 50MHz 68882 PGA FPU.

From £219.95



CYBERSTORM 060 A4000 ACCELERATOR

Upgrade your A4000 030 or 040 with the new CYBERSTORM MODULAR ACCELERATOR, and you'll have "The Worlds Fastest Amiga". With its new 50MHz 68060 CPU (due February '95), it provides up to 10 Times the performance of standard A4000/030s (82.2 MIPS, compared to 15.4 MIPS!). Optional SCSI-2 and Ethernet I/O Module. Call and request our 4 page technical brochure. &PHONE

NEW... CYBERVISION64

GRAPHICS BOARD

For all Zorro-3 Amigas this 64-Bit high speed graphics engine/blitter has up to 1600 x 1200 pixels in 8-Bit colour or 1024 x 768 pixels in 24-Bit True Color, 2Mb of display memory (4Mb user upgradeable). Call and request our technical brochure. **Just £299.95**

gordon harwood computers
the UK's favourite Amiga Dealer

POST, FAX or PHONE YOUR ORDER TODAY!
Tel: 01 773 836781
Fax: 01 773 831040

Mr/Mrs/Miss/Ms: Initial(s): Surname:

Address:

County (Country) Postcode:

Daytime Phone Evening Phone:

Items required: Card holder's signature:

Card No.:

Expiry Date: Issue No.(Switch Only): Department: CUA

Cheque/Bank Draft/Postal Order for £ : payable to Gordon Harwood Computers Limited...

(All prices are UK including VAT and postage. Overseas customers please call to confirm pricing before ordering)

Gordon Harwood Computers Limited. New Street, Alfreton, Derbyshire DE55 7BP. Tel: 01 773 836781 Facsimile: 01 773 831040

AMIGA SCREENSCENE

MAGAZINE



I just hate being wrong. Nothing in this world is predictable and I'm not a soothsayer but when I say something and it doesn't happen it makes me mad. Unfortunately that's what went wrong with last

month's 'Next Month' page. There is hardly a single thing on it that actually arrived on time to put into this issue, and thus it was almost a waste of two pages.

Unfortunately we cannot fulfil promises unless other people do. But we can fulfil one promise, and do so every issue: We will always provide you with the best games news, previews and reviews available.

This month we whet your appetite for the games of the future with previews of Baldies, Speris Legacy and Leading Lap while our reviews section contains ATR, Dawn Patrol, Ruffians and Turbo Trax plus the A1200 update of the superb Shadow Fighter. We've also brought back games tips due to popular demand, with part one of hints and solutions to Lords Of The Realm and Dreamweb.

Alan Dykes
Editor



PREVIEWS

- Baldies40
- Ultimate Soccer Manager42
- Tactical Manager 242
- Speris Legacy.....44
- Leading Lap44

REVIEWS

- Ruffians49
- ATR50
- Dawn Patrol52
- Shadow Fighter A120056
- ITS Cricket56
- Voyages of discovery58
- Turbo Trax61
- Super League Manager63
- X-IT66



CD32 REVIEWS

- Akira66
- Benefactor67
- Extractors67
- Skeleton Krew70
- Dragonstone70

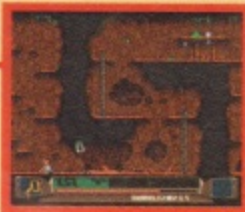

BUDGETS & COMPILATIONS

- VFM71
- Ishar 2
- Jurassic Park
- Stardust

TIPS

- Vampyra73
- Lords of the Realm74
- Dreamweb75

Tactical Manager 2



■ Due for release: April ■ Publisher: Black Legend ☎ 0438 84003



ou just can't get away from them. Footy manager games are the 2 Unlimited of the Amiga game charts: their fans can't get enough of them, and everyone else thinks they're nothing more than a single idea that's endlessly re-worked and



re-released. Here at CU Amiga Magazine we have scholars from both schools of thought. As usual, the footy manager fans in the ranks are getting a bit excited about this one, as it's the sequel to last year's 87% rated *Tactical Manager*.

Among the new features promised for *TM2* is a higher difficulty level. But there's more to a football manager's job than finances and talent scouting. There's team morale for one thing. If you leave players out of the team for too long, they get all upset, and start playing badly in the event that you decide to put them on as a sub.

The intelligence of the computer teams is to be improved, both in terms of tactics and team

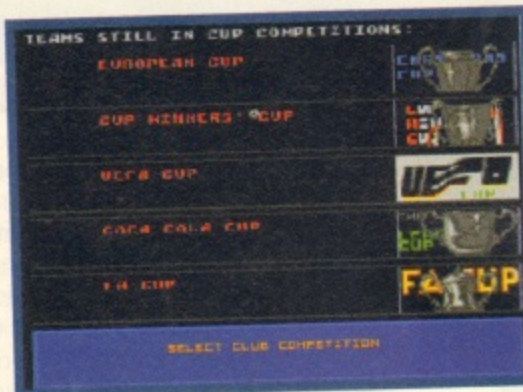

selection. League cup winners get a stab at playing in Europe, plus the opportunity to trim away some of the lesser players in exchange for extra cash. Fixtures will also be shuffled around from one season to the next, to ensure a predictable pattern doesn't form

too easily.

TM2 looks like its shaping up to be as good if not as better than *TM1*. We can't wait for it arrive here at the CU Amiga offices. We should have a full review next month. For more information on *Tactical Manger 2* contact Black Legend 0438 840003.

LC

Ultimate Soccer Manager

■ Due for release: April ■ Publisher: Impressions ☎ 0171 373 7435



It may seem strange that yet another football management game has been unleashed onto the public and even more unusual that it comes from a company such as Impressions which is perhaps better known for its strategy games. But it's not that bizarre, footy fans, because strategy is at the heart of this management game. If you play the Business Game option you can develop your

own business empire as well as managing your team and this is where the strategy element comes into play. You can either employ the by-the-book method of building up your empire by using your hard-earned money wisely to slowly build up money-spinning enterprises such as shops, fast food joints, car parks, access roads, merchandising goods, ticket prices, training grounds and so on. Or you can pump ill-gotten gains into your empire and risk the peril of an FA investigation by dabbling in match rigging, (ie you can bet *against* your own team to bring those pounds in) doling out backhanders to get those star players and generally greasing palms all round to make sure that you get the cash you need.

As well as the above strategy element, *USM* also promises to push itself away from the plethora of football management games by



featuring 3D graphics such as a fully rendered football stadium.

An overhead-view game, it will also have lots of other features such as: full match reports with comments from managers and spectators, a tactics screen, a team editing screen, talent scouts, bank loans and overdraft facilities, training, press conferences, a TV information service, sponsorship, advertising, and some nice graphs and statistics to let you know how your finances are developing. Due to be released in April, *USM* looks pretty good but the proof of the pudding is in the belching up afterwards or something like that so we'll have to wait until next month for a full review. Until then ...

LC



SILICA ARE NOW IN 18 BRANCHES OF
DEBENHAMS
 SEE BOTTOM PANEL FOR DETAILS

NEW! AMIGA CD32

CRITICAL ZONE PACK - WITH 7 CD TITLES

32-BIT SYSTEM PLUS! 7 CD TITLES

- 32-BIT POWER
- BUILT-IN DUAL SPEED CD-ROM DRIVE
- 16.8 MILLION COLOURS
- ALSO PLAYS AUDIO CDs
- 11 BUTTON CONTROLLER
- TITLES AVAILABLE FROM £14.99
- OPTIONAL SX1 COMPUTER MODULE
- OPTIONAL FULL SCREEN VIDEO CD MODULE

PACK INCLUDES:

CD ³² GAMES CONSOLE	RRP	£249.99
CANNON FODDER	RRP	£29.99
DIGGERS	RRP	£29.99
LIBERATION	RRP	£34.99
MICROCOSM	RRP	£44.99
OSCAR	RRP	£29.99
PROJECT X	RRP	£12.99
ULTIMATE BODY BLOWS	RRP	£29.99
TOTAL VALUE:		£462.92

£239

INC VAT - CCD 3450

FREE DELIVERY IN UK MAINLAND



NORMAL RRP
~~£249~~

MORE THAN JUST A GAMES CONSOLE...

COMPUTER UPGRADE

Turn the CD³² into a fully functional Amiga 1200 compatible computer.

SX1 MODULE	KEYBOARD	DISK DRIVE
£199	£39	£59
INC VAT - CCA 0100	INC VAT - PKE 0120	INC VAT - DRV 1150

14" STEREO COLOUR MONITOR

Sharpen your output with this high quality 14" RGB & Composite, Stereo Monitor

RRP ~~£299.74~~ **£219** INC VAT

MON 8833 - Requires cable CAB 5224 - £5.95

WATCH MOVIES

With the addition of a simple plug-in cartridge the CD³² can be turned into a fully featured Video CD player. Allows you to play blockbusting movies (full screen) with digital quality picture and sound.

£199 INC VAT

EXPECTED DURING 1995 - CCA 0320

A COMPLETE RANGE OF SOFTWARE

JUST SOME OF THE 100+ TITLES AVAILABLE ON CD FOR THE AMIGA CD³²

NEW! ALIEN BREED - TOWER ASSAULT ARA 5611 - £29.99	ARCADE POOL ARA 7681 - £14.99	BANSHEE ARB 1211 - £29.99	NEW! BENEATH/STEEL SKY ARB 4751 - £29.99	THE BIG ARD 4481 - £14.99	ELITE 2 ARE 4041 - £22.99
FIELDS OF GLORY ARF 3581 - £34.99	GUARDIAN ARG 8761 - £34.99	INT SENSIBLE SOCCER ARI 3081 - £24.99	JETSTRIKE ARJ 3841 - £25.99	OTHER TOP TITLES	
NEW! JUNGLE STRIKE ARJ 7851 - £27.99	LITTLE DRILL ARL 4091 - £29.99	PGA EUROPEAN TOUR ARP 3201 - £27.99	PHOTOCD LITE ARP 3741 - £19.99	CHAOS ENGINE ARC 4451 - £21.99	GUNSHIP 2000 ARG 8601 - £22.99
RISE OF THE ROBOTS ARR 4641 - £34.99	SIMON THE SORCERER ARS 4351 - £39.99	SUPER STARDUST ARS 7831 - £29.99	TOP GEAR 2 ART 5421 - £29.99	LABYRINTH OF TIME ARL 0121 - £21.99	SEEK & DESTROY ARS 4351 - £19.99
				SOCCKER KID ARS 6571 - £19.99	SPEEDBALL 2 ARS 6681 - £14.99
				SUBWARS 2050 ARS 6901 - £29.99	SUPERFROG ARS 6951 - £14.99
				THEME PARK ART 4051 - £34.99	VITAL LIGHT ARV 4631 - £14.99
				WORLD CUP GOLF ARW 7961 - £29.99	

17 YEARS SERVICE TO YOU

THE SILICA SERVICE

Before you decide WHEN to buy, we suggest you consider WHERE to buy and protect your investment with a purchase from Silica. With our unrivalled experience and expertise, we will provide all the extra help, advice and new product information you may need both now and in the future. Visit one of our stores, or return this coupon now and begin to experience the "Silica Service".

DEBENHAMS
STORES NATIONWIDE

- **ESTABLISHED 17 YEARS:** We have a proven track record in professional computer sales.
- **PART OF A ESOM A YEAR COMPANY:** With over 300 staff - We are solid and reliable.
- **EXPERIENCED STAFF:** All fully trained in 'Customer Care'.
- **TECHNICAL SUPPORT HELPLINE:** FREE help and advice from a team of experts.
- **A FULL PRODUCT RANGE:** All of your computer requirements from one supplier.
- **WE PRICE MATCH:** On a "Same product - Same price" basis.
- **FREE CATALOGUES.**
- **PAYMENT:** We accept most major credit cards, cash, cheque or monthly terms (APR 23.8% - written quotes on request).
- **VOLUME DISCOUNTS AVAILABLE:** Business, Education and Government. Tel: 0181-308 0888.
- **MAIL ORDER:** FREE DELIVERY in UK mainland on orders over £40+VAT. Small administration charge (£2.50+VAT) on orders under £40+VAT.
- **21 STORES NATIONWIDE:** *Mini Stores carry a selected range only but products can be ordered in the stores via Mail Order

MAIL ORDER 0181-309 1111 PLUS TECHNICAL AND HEAD OFFICE

SILICA, SILICA HOUSE, HATHERLEY ROAD, SIDCUP, KENT, DA14 4DX

PLUS BRANCHES AT:

BRISTOL	Debenhams - (2nd Floor), St James Barton	0117-929 1021
CARDIFF	Debenhams - (1st Floor), St David's Way	01222 341576
CHELMSFORD	Debenhams - (2nd Floor), 27 High Street	01245 355511
CROYDON	Debenhams - (2nd Floor), 11-31 North End	0181-688 4455
GLASGOW	Debenhams - (2nd Floor), 97 Argyle Street	0141-221 0088
GUILDFORD	Debenhams - (2nd Floor), Millbrook	01483 301300
HARROW	Debenhams - (2nd Floor), Station Road	0181-427 4300
HULL	Debenhams - (2nd Floor), Prospect Street	01482 25151
IPSWICH	Debenhams - (2nd Floor), Westgate Street	01473 221313
LONDON	Silica - 52 Tottenham Court Road	0171-580 4000
LONDON	Debenhams - (2nd Floor), 354 Oxford St	0171-580 3000
LUTON	Debenhams - (1st Floor), Amdale Centre	01582 21201
MANCHESTER	Debenhams - (2nd Floor), Market Street	0161-832 8666
PLYMOUTH	Debenhams - (2nd Floor), Royal Parade	01752 266666
ROMFORD	Debenhams - (2nd Floor), Market Place	01708 766066
SHEFFIELD	Debenhams - (2nd Floor), The Moor	0114-276 8611
SHEFFIELD	Debenhams - (1st Floor), Meadowhall Ctre	0114-256 9779
SIDCUP	Silica - Silica House, Hatherley Rd	0181-302 8811
SOUTHAMPTON	Debenhams - (2nd Floor), Queensway	01703 223888
SOUTHEND	Keddies - (2nd Floor), High Street	01702 462426
THURROCK	Debenhams - (1st Floor), Lakeside Centre	01708 863587

SILICA

To: Silica, CMUSR-0395-231, Silica House, Hatherley Rd, Sidcup, Kent, DA14 4DX

PLEASE SEND INFORMATION ON AMIGA CD³²

Mr/Mrs/Miss/Ms: Initials:

Surname:

Company (if applicable):

Address:

Postcode:

Tel (Home):

Tel (Work):

Which computer(s), if any, do you own?

231C

E&OE - Advertised prices and specifications may change - Please return the coupon for the latest information.

Leading Lap

■ Due for release: April ■ Publisher: Black Legend ☎ 0348 840003

Polygon racing games, have suddenly become very popular again thanks to some superb arcade games and *Leading Lap*, the product of a



newly formed software development team, Kellion, is obviously hoping to cash in on the trend. And guess what the name of this new development company stands for? Mr. Kelly and Mr. Dillion. The latter being our very own ex-games editor. Reputations are on the line!

So far, it looks as if we won't be disappointed. According to Kellion a mysterious Mr S has developed a unique 3D editor code called 'Reflex' and *Leading Lap* is the first of a trio of games to be designed using it.

One of the game's unique features promises to be the way the steering wheel and the viewing screen have been configured to move in synchronisation, as if you were actually driving. It is designed to intelligently guess which direction you would really look out of the vehicle and adjusts your viewpoint accordingly. To make this extra realistic the game is being designed to work with the CyberMaxx Virtual

Reality headset

Another original feature is the introduction of the concept of 'illegal' races, in which you can race through a city with no planned route, just a road map with the start and the end clearly marked out. It will be up to you to decide which route you want to take and risk the perils of traffic jams, buses, old ladies crossing the road, anything that you would expect driving through a real city. Just to add to the mayhem, there are plans to add hidden levels and *Spyhunter*-like extras (ie go through a certain gate and you turn into a speedboat).

The game will start on the race track, move onto open country, desert and finally the land of illegal races, the city. In all the game should span 25 tracks and you are given 15 attributes which you can use to customise your car with. So far it all

sounds great, we have a full review next month. ■

LC

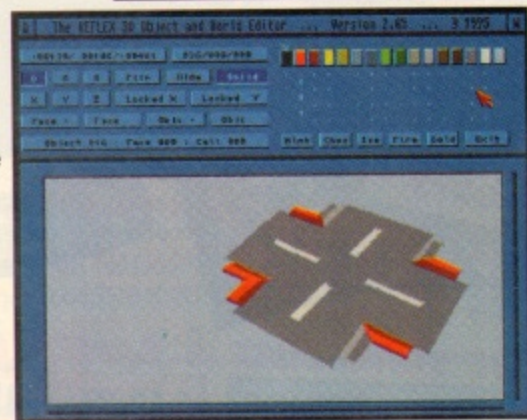

Speris Legacy

■ Due for release: June ■ Publisher: Team 17 ☎ 01924 267 776

Team 17 are continuing their assault on the Amiga market, even over the summer months, with this unusual adventure game. I say unusual because the style of graphics and gameplay is more akin to what you would see on a Nintendo than any Amiga game. It's a (very) *Zelda*-like adventure with cute graphics and involves wandering

around villages, forests and castles killing tons of strange enemies, talking to people and solving puzzles.

The central character is a boy called Cho who is in the unhappy position of having to avenge a friend's death at the hands of his brother, a greedy and power hungry maniac named Gallus, who's determined to take over the lands of Speris. Starting off not knowing where to look Cho has to ask questions of everyone he meets, some of whom will require a bribe.

There are 12 different locations Cho can visit to piece together the mystery, but getting from one to another will require a little brain power utilisation and a lot of button pressing.

Enemies come in all shapes and forms:

snakes, large barging green things (for I cannot describe them as anything else at the moment), cannon, pacman-like creatures and more. Once these enemies pass into the next world, after being swatted by Cho's trusty little sword, most will release jewels which can be collected.

The menu system, brought up by pressing the space bar, includes instructions for picking up things or using them, or examining an object in Cho's inventory. But the only way to solve puzzles is to interact with other characters and this is done by speaking to them. And boy does Cho like speaking ... the menu brought up by using this command presents one with up to six questions, and the game has been intelligently programmed so that if a character says something that either raises another question or answers an existing one the menu will increase

or decrease correspondingly.

Cute as hell, fast and playable (at this stage anyway), *Speris Legacy* looks like being a fun title. Watch out for a full review soon.

AD



Amiga Frame Grabbing has just taken a Fall... in Price, but definitely not on quality!

NOW WITH NEW VERSION 2.0 SOFTWARE... AND OPTIONAL PCMCIA INTERFACE FOR EVEN BETTER PERFORMANCE, PLUS SECAM SUPPORT (and NTSC due soon)



Grab images with your camcorder.

Take a signal from a TV with SCART output



Use a satellite receiver as your output device.

Grab TV or video pictures from your VCR's video output

The revolutionary new ProGrab™ 24RT with Teletext is not only the best way to get crisp colour video images into your Amiga, it actually costs less than any of its rivals. Whilst this real time 24-Bit colour frame grabber/digitiser has slashed the price of image grabbing on the Amiga, it hasn't been at the expense of quality. Indeed, ProGrab™ has been bestowed the Amiga Format Gold Award and received many rave reviews for its ease of use and excellent quality results.

With ProGrab™ you needn't be an expert in Amiga Video Technology either. Simple 3 stage operation ensures the right results Real Time, after time.

STAGE 1...

Select any video source with composite output. This could be your camcorder, TV with SCART output, satellite receiver, domestic VCR/player or standard TV signal passing through your VCR/player... the choice is yours.

STAGE 2...

Using the ProGrab™ software, select an image you wish to capture in the on screen preview window (because the hardware grabs a frame in real time, there's no need for a still frame facility on the source device) and, grab! ProGrab™ even includes a Teletext viewing/capturing facility from either TV or satellite source devices. Once grabbed, simply download the image to your Amiga for full screen viewing.

STAGE 3...

Use the saved image in your favourite Amiga word processing, desktop publishing or graphics software packages.

ProGrab™... supports all recent Amigas and is also fully AGA Chipset compatible. You can even work in the new graphics modes up to 1472 x 512 pixels in HAM 8 (Amiga RAM permitting). Images are digitised in 24-Bit, 16.7 million colours.

ProGrab™... supports IFF, ILBM, ILBM24, Clipboard, JPEG, ProGrab™ File or Anim5 File output formats.

ProGrab™... software has built in mono and colour animation facilities. The number of frames is dependant upon your Amiga's RAM.

For just £129.95

ProGrab™ is supplied with everything you'll need...

- ProGrab™ 24RT Digitiser (with power & input signal leads)
- ProGrab™ 24RT Software
- Parallel Connecting Cable
- Mains Power Supply Unit

ProGrab™ accessories can extend performance even more for the serious/professional user.

Available accessories include...

- **Optional PCMCIA Interface only £29.95 for A600/A1200's** for even FASTER operation...
 - Faster Downloading Times (up to FIVE times quicker)
 - Improved animation speeds of up to 11fps (mono) and 3.5fps (colour)
- New sound sampling and animation capabilities (separate sound sampler required)
- Save animations direct to your Amiga's hard drive
- **Optional S-VHS Connection Lead only £4.95** (Only necessary if your output device doesn't have a standard phono composite video out socket)



ProGRAB 24RT

ProGrab™ really does make it that simple!

Even better performance using ProGrab™ Version 2.0 upgraded software.

- Support for Virtual Memory on all hard drive system Amigas (without the need to fit an MMU). Allowing use of the highest resolutions - even with smaller memory Amigas in low memory situations; requiring only 1Mb of hard drive space.
- Additional Teletext - with terrestrial TV signals as well as satellite
- A Larger preview window option with double the resolution and 4 times the area of the previous version
- Composite PAL, and now SECAM (French TV system) video inputs with NTSC compatibility due to be released soon.

FREE with all new ProGrab™ orders and available to all existing users as a software upgrade.

To get **your** hands on ProGrab™, call our sales line on...
01 773 836781



...or Post/FAX your requirements on the order form provided.

gordon harwood computers
the UK's favourite Amiga Dealer

Gordon Harwood Computers Limited,
New Street, Alfreton, Derbyshire DE55 7BP.
Tel: 01 773 836781 Facsimile: 01 773 831040

Mr/Mrs/Miss/Ms:	Initial(s):	Surname:
Address:		
County (Country)		
Daytime Phone		Postcode:
Evening Phone:		
Please rush me... <input type="checkbox"/> ProGrab Frame Grabber @ £129.95 inc. p&p £ _____: _____		
For a software upgrade @ £4.95 inc. p&p please tick here <input type="checkbox"/>		
<input type="checkbox"/> Optional PCMCIA Interface @ £29.95 inc. p&p £ _____: _____		
<input type="checkbox"/> Optional SVHS Connector @ £4.95 inc. p&p £ _____: _____		
<input type="checkbox"/> Optional FAST Courier Service Delivery £ 6 : 95		
Card holder's signature: _____		
(Overseas Customers - Please Call for Prices etc.) TOTAL £ _____: _____		
Card No.:	<input type="text"/>	<input type="text"/>
Expiry Date:	<input type="text"/>	Issue No.(Switch Only): <input type="text"/>
Dept: C 112		
Cheque/Bank Draft/Postal Order for £ _____: _____ payable to Gordon Harwood Computers Limited...		

Leading Lap

■ Due For release: April ■ Publisher: Black Legend ☎ 0348 840003

Polygon racing games, have suddenly become very popular again thanks to some superb arcade games and *Leading Lap*, the product of a



newly formed software development team, Kellion, is obviously hoping to cash in on the trend. And guess what the name of this new development company stands for? Mr. Kelly and Mr. Dillion. The latter being our very own ex-games editor. Reputations are on the line!

So far, it looks as if we won't be disappointed. According to Kellion a mysterious Mr S has developed a unique 3D editor code called 'Reflex' and *Leading Lap* is the first of a trio of games to be designed using it.

One of the game's unique features promises to be the way the steering wheel and the viewing screen have been configured to move in synchronisation, as if you were actually driving. It is designed to intelligently guess which direction you would really look out of the vehicle and adjusts your viewpoint accordingly. To make this extra realistic the game is being designed to work with the CyberMaxx Virtual

Reality headset

Another original feature is the introduction of the concept of 'illegal' races, in which you can race through a city with no planned route, just a road map with the start and the end clearly marked out. It will be up to you to decide which route you want to take and risk the perils of traffic jams, buses, old ladies crossing the road, anything that you would expect driving through a real city. Just to add to the mayhem, there are plans to add hidden levels and *Spyhunter*-like extras (ie go through a certain gate and you turn into a speedboat).

The game will start on the race track, move onto open country, desert and finally the land of illegal races, the city. In all the game should span 25 tracks and you are given 15 attributes which you can use to customise your car with. So far it all

sounds great, we have a full review next month. ■

LC

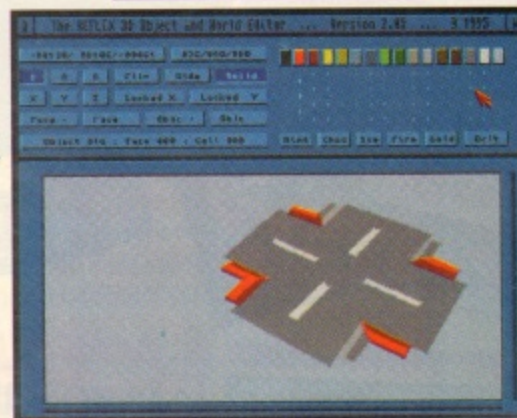

Speris Legacy

■ Due for release: June ■ Publisher: Team 17 ☎ 01924 267 776

Team 17 are continuing their assault on the Amiga market, even over the summer months, with this unusual adventure game. I say unusual because the style of graphics and gameplay is more akin to what you would see on a Nintendo than any Amiga game. It's a (very) *Zelda*-like adventure with cute graphics and involves wandering

around villages, forests and castles killing tons of strange enemies, talking to people and solving puzzles.

The central character is a boy called Cho who is in the unhappy position of having to avenge a friend's death at the hands of his brother, a greedy and power hungry maniac named Gallus, who's determined to take over the lands of Speris. Starting off not knowing where to look Cho has to ask questions of everyone he meets, some of whom will require a bribe.

There are 12 different locations Cho can visit to piece together the mystery, but getting from one to another will require a little brain power utilisation and a lot of button pressing.

Enemies come in all shapes and forms:

snakes, large barging green things (for I cannot describe them as anything else at the moment), cannon, pacman-like creatures and more. Once these enemies pass into the next world, after being swatted by Cho's trusty little sword, most will release jewels which can be collected.

The menu system, brought up by pressing the space bar, includes instructions for picking up things or using them, or examining an object in Cho's inventory. But the only way to solve puzzles is to interact with other characters and this is done by speaking to them. And boy does Cho like speaking ... the menu brought up by using this command presents one with up to six questions, and the game has been intelligently programmed so that if a character says something that either raises another question or answers an existing one the menu will increase

or decrease correspondingly.

Cute as hell, fast and playable (at this stage anyway), *Speris Legacy* looks like being a fun title. Watch out for a full review soon.

AD



Amiga Frame Grabbing has just taken a Fall... in Price, but definitely not on quality!

NOW WITH NEW VERSION 2.0 SOFTWARE... AND OPTIONAL PCMCIA INTERFACE FOR EVEN BETTER PERFORMANCE, PLUS SECAM SUPPORT (and NTSC due soon)



Grab images with your camcorder.

Take a signal from a TV with SCART output



Use a satellite receiver as your output device.

Grab TV or video pictures from your VCR's video output

The revolutionary new ProGrab™ 24RT with Teletext is not only the best way to get crisp colour video images into your Amiga, it actually costs less than any of its rivals. Whilst this real time 24-Bit colour frame grabber/digitiser has slashed the price of image grabbing on the Amiga, it hasn't been at the expense of quality. Indeed, ProGrab™ has been bestowed the Amiga Format Gold Award and received many rave reviews for its ease of use and excellent quality results.

With ProGrab™ you needn't be an expert in Amiga Video Technology either. Simple 3 stage operation ensures the right results Real Time, after time.

STAGE 1...

Select any video source with composite output. This could be your camcorder, TV with SCART output, satellite receiver, domestic VCR/player or standard TV signal passing through your VCR/player... the choice is yours.

STAGE 2...

Using the ProGrab™ software, select an image you wish to capture in the on screen preview window (because the hardware grabs a frame in real time, there's no need for a still frame facility on the source device) and, grab! ProGrab™ even includes a Teletext viewing/capturing facility from either TV or satellite source devices. Once grabbed, simply download the image to your Amiga for full screen viewing.

STAGE 3...

Use the saved image in your favourite Amiga word processing, desktop publishing or graphics software packages.

ProGrab™... supports all recent Amigas and is also fully AGA Chipset compatible. You can even work in the new graphics modes up to 1472 x 512 pixels in HAM 8 (Amiga RAM permitting). Images are digitised in 24-Bit, 16.7 million colours.

ProGrab™... supports IFF, ILBM, ILBM24, Clipboard, JPEG, ProGrab™ File or Anim5 File output formats.

ProGrab™... software has built in mono and colour animation facilities. The number of frames is dependant upon your Amiga's RAM.

For just £129.95

ProGrab™ is supplied with everything you'll need...

- ProGrab™ 24RT Digitiser (with power & input signal leads)
- ProGrab™ 24RT Software
- Parallel Connecting Cable
- Mains Power Supply Unit

ProGrab™ accessories can extend performance even more for the serious/professional user.

Available accessories include...

- **Optional PCMCIA Interface only £29.95 for A600/A1200s** for even FASTER operation...
 - Faster Downloading Times (up to FIVE times quicker)
 - Improved animation speeds of up to 11fps (mono) and 3.5fps (colour)
 - New sound sampling and animation capabilities (separate sound sampler required)
 - Save animations direct to your Amiga's hard drive
- **Optional S-VHS Connection Lead only £4.95** (Only necessary if your output device doesn't have a standard phono composite video out socket)

To get your hands on ProGrab™, call our sales line on...

01 773 836781



...or Post/FAX your requirements on the order form provided.

gordon harwood computers
the UK's favourite Amiga Dealer

Gordon Harwood Computers Limited,
New Street, Alfreton, Derbyshire DE55 7BP.
Tel: 01 773 836781 Facsimile: 01 773 831040



ProGRAB 24RT

ProGrab™ really does make it that simple!

Even better performance using ProGrab™ Version 2.0 upgraded software.

- Support for Virtual Memory on all hard drive system Amigas (without the need to fit an MMU). Allowing use of the highest resolutions - even with smaller memory Amigas in low memory situations; requiring only 1Mb of hard drive space.
- Additional Teletext - with terrestrial TV signals as well as satellite
- A Larger preview window option with double the resolution and 4 times the area of the previous version
- Composite PAL, and now SECAM (French TV system) video inputs with NTSC compatibility due to be released soon.

FREE with all new ProGrab™ orders and available to all existing users as a software upgrade.

Mr/Mrs/Miss/Ms:	Initial(s):	Surname:
Address:		
County (Country)		Postcode:
Daytime Phone		Evening Phone:
Please rush me... <input type="checkbox"/> ProGrab Frame Grabber @ £129.95 inc. p&p		£ _____
<input type="checkbox"/> Optional PCMCIA Interface @ £29.95 inc. p&p		£ _____
<input type="checkbox"/> Optional SVHS Connector @ £4.95 inc. p&p		£ _____
<input type="checkbox"/> Optional FAST Courier Service Delivery		£ 6 : 95
(Overseas Customers - Please Call for Prices etc.)		TOTAL £ _____
Card No.:	<input type="text"/>	<input type="text"/>
Expiry Date:	<input type="text"/>	Issue No.(Switch Only): <input type="text"/>
Cheque/Bank Draft/Postal Order for £ _____		payable to Gordon Harwood Computers Limited...

For a software upgrade @ £4.95 inc. p&p please tick here

Card holder's signature: _____

Dept: C112

Zeewolf 2

Design a level and win £200

Zeewolf, Binary Asylum's top chopper shoot 'em up was a stunning first game from a new software development company. It combined gorgeous graphics with top gameplay (on an A1200 anyway) and made its unique mark on the world of wildlife conservation by naming the various air, sea and land craft you encounter in it after a menagerie of wild beasts, and encouraging you to blow each and every one of them up.



Not happy with making a whole dung pile of cash with the first game those canny Somerset lads have planned an even better one for the sequel. Problem is, they're so busy spending their massive bonuses that no-one has the time to design the game, and that's why they're turning to you, the Amiga public to help them out. After all if you're going to buy the game you might as well tell them exactly what you want.

No seriously, Binary Asylum realise that there are a lot of potential game designers, coders and artists out there, looking for recognition and a chance to be part of something really big. That's why they're offering you the opportunity to design your own level of *Zeewolf 2*. You could win £200 and the accolade of being included in the credits of a top-selling full price game. Of course you also get your name printed in this very mag, a full credit to your achievement.

To enter the competition you

have to plan a level around the islands shown (right). The level can be based on any of the mission concepts in *Zeewolf*, ie escort, rescue, airlift, seek and destroy (or any other you can come up with), and using the land, air and sea craft also featured in the game.

You'll need to make two copies of the map provided (right). On the first map you should locate the units, using shapes or colours to differentiate what they are and who they belong to (remember, some of them could be friendly units). Mark these clearly because if Andy and the boys at Binary can't understand what's going on they'll chuck it in the bin.

Next up is the fun bit. Remember Dad's army? Remember all those arrows prancing around Europe to the tune of 'Who do you think you are kidding Mr. Hitler ...' at the beginning of the show? Well you've got to draw them, lots of them. Basically this is the map where you show what actually happens on the level. Where units move to, what flight paths they have, what areas the enemy hippos and sharks patrol, where your rocket launchers and radar guidance systems should be placed etc. When you've finally got it right, think of a particularly gruesome or funny name for it - the Binary boys are well known for their joviality and sense of irony, and it might just catch their attention. ■

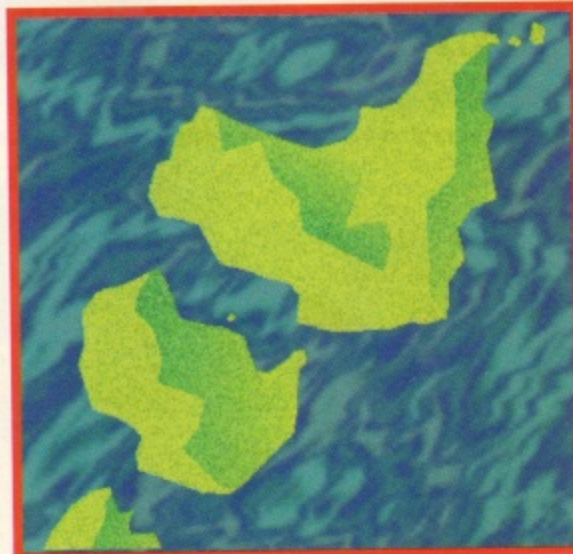

WHAT YOU COULD WIN

If your entry is successful will be included in *Zeewolf* with full credit given in the game and in *CU Amiga Magazine*. The best level will win £200 and a copy of the final game. Any other level judged good enough to be incorporated in the game also win a copy of the game and have their name included in the credits.

HOW TO ENTER

You can enter the competition as many times as you like, but remember, if any of your entries are unclear or don't make sense, they will not go forward for judging. Make two very large copies of the map given above and mark the first one with the combat units, buildings and emplacements you intend to use, the second with their movement. Use different colours and shapes to signify friendly or enemy units and different types of craft. Write out a separate, detailed plan and description of what is happening. Finally, when you've got all of this together post it to us at the following address:

My level of Zeewolf 2, CU Amiga Magazine, Priory Court, Farringdon Lane, London EC1R 3AU.

Rules: Unusually, multiple entries ARE allowed! Even more unusually the Editor does not have the final say - Binary Asylum does, and of course, due to the nature of the game, correspondence will be entered into. However, as usual, no employees of EMAP Images or Binary Asylum may enter. Closing date for receipt of entries is 30 April 1995.

QUALITY PERIPHERALS FOR THE AMIGA



Designed to bring you high quality and performance at affordable prices, Amitek peripherals offer outstanding value-for-money. They are built to ensure easy fitting and trouble free operation - making them a pleasure to use. Amitek products are also thoroughly tested and very reliable, so reliable that we are pleased to offer a full two year warranty on most of the Amitek products detailed here.

HAWK RAM UPGRADE & MATHS ACCELERATOR OPTIONS FOR THE AMIGA 1200



INSTALLATION OF A HAWK RAM BOARD INCREASES A1200 SPEED BY UP TO 3x

- Plugs straight into A1200 trapdoor - No soldering required
- Upgradeable FAST RAM board to 1, 2, 4 or 8Mb
- Uses industry standard socketed SIMMs for easy upgrades
- Optional Floating Point Unit - 33MHz or 40MHz PLCC 68882 co-processor
- Comprehensive manual with illustrations
- Works with all A1200 and A1200HD computers
- Does not invalidate your A1200 warranty
- 2 year warranty

Operation	Amiga 1200	40MHz FPU 4Mb RAM
INCREASES OPERATION BY UP TO 40x	1.0	40.27

In FLOPS (FLO Point operations per Second) Figures from A35 version E.1

1Mb RAM FPU	2Mb RAM FPU	4Mb RAM FPU	8Mb RAM FPU
£99	£129	£189	£329

OPTIONAL FLOATING POINT UNITS
Available with above RAM upgrade boards

33MHz PLCC FPU + CRYSTAL	£59
40MHz PLCC FPU + CRYSTAL	£99

1Mb SONY 3 1/2" DELUXE FLOPPY DRIVE FOR ALL AMIGA COMPUTERS



'Amitek's new disk drive combines an elegant design, high build quality and smooth performance in a very affordable package. Highly recommended'. Jason Holborn - Leading Amiga Journalist

- DELUXE FEATURES**
The Amitek drive has many deluxe features not included in other drives - check out the competition!
- ANTI-CLICK**
This feature stops your drive making whirs and clicks when the drive is empty and searching for a disk.
- ANTI-VIRUS**
This switchable mode stops track 0 viruses infecting the disk while in the drive. Unlike many other drives which have virus killers, this mode can be disabled, allowing some fussy copy protected software to run.

	ANTI-CLICK	ANTI-VIRUS	ROBUST STEEL CASE	QUALITY SONY MECHANISM	TOP RATED CU-AMIGA MAY '94 90%	2 YEAR WARRANTY
AMITEK	✓	✓	✓	✓	✓	✓
CUMANA	-	-	-	-	-	-
ZAPPO	-	-	✓	-	-	-

- High Quality 3 1/2" SONY MECHANISM
- 2 YEAR WARRANTY
- STRONG METAL CASING
- BUILT-IN ANTI-CLICK FEATURE
- SWITCHABLE ANTI-VIRUS MODE
- ENABLE/DISABLE SWITCH
- 75MS ACCESS TIME
- DAISY CHAINABLE VIA THRU PORT
- LOW POWER USAGE
- EXTERNAL PSU NOT REQ'D

EXTERNAL DRIVE
£59
INC VAT - DRI 1159
FREE DELIVERY IN UK MAINLAND

FUSION VIDEO GENLOCK FOR ALL AMIGA COMPUTERS



- High Quality Graphics And Video Mixing Desk
- FREE Scala HT100 Program Disk
- Add Titles And Special Effects To Videos
- Ideal For Home and Semi-Professional Users
- Supports All Standard Amiga & AGA Graphics
- Input And Output Composite Video Signals
- Switches Between Video Only, Computer Only And Mixed Graphics
- Hardware Fade Between Graphic And Video
- RGB Thru - Saving The Genlock From Being Unplugged When Not In Use
- Optional Chroma Key Unit Available Early '95
- Comprehensive 16-Page Manual Plus Full Colour Sleeve

FREE!
SCALA HT100
HOME VIDEO TITLING PROGRAM
WORTH £49
INC VAT

GENLOCK
£99
INC VAT - VID 2100
FREE DELIVERY IN UK MAINLAND

MAMBA MODULATOR FOR ALL AMIGAS



The Amitek Mamba External Modulator, makes an ideal replacement modulator for all Amiga owners. Everything needed is supplied. Like all Amitek peripherals, it comes with an easy to follow manual.

RAM UPGRADES

CODE	DESCRIPTION	INC VAT
RAM 0505	A500 - 512K (No Clock)	£20
RAM 0510	A500 - 512K (With Clock)	£25
RAM 0520	A500PLUS - 1Mb RAM	£30
RAM 0605	A600 - 1Mb (No Clock)	£30
RAM 0610	A600 - 1Mb (With Clock)	£40

POWER SUPPLY

This power supply is an ideal replacement unit, which can deliver 1.0 Amp on 12V and 4.5 Amps on 5V. More than enough power for a seriously expanded Amiga!

POW 0510 AMITEK POWER SUPPLY UNIT £29 INC VAT

LOADER 1Mb INTERNAL FLOPPY DRIVES



These internal Amitek Loader replacement drives are ideal for users who wish to replace their existing internal drive.

The packs feature a high quality internal 1Mb, 3 1/2" drive mechanism for the Amiga 500/500PLUS or Amiga 600/1200. All you need to fit your drive is included, plus easy to follow fitting instructions and 12 months warranty.

A500/A500PLUS INTERNAL DRIVE
£34
INC VAT - DRI 3600

A600/A1200 INTERNAL DRIVE
£44
INC VAT - DRI 3605

THE SILICA SERVICE

Before you decide WHEN to buy, we suggest you consider WHERE to buy and protect your investment with a purchase from Silica. With our unrivalled experience and expertise, we will provide all the extra help, advice and product information you may need both now and in the future. Visit one of our stores, or return this coupon now and begin to experience the "Silica Service".

DEBENHAMS
STORES NATIONWIDE

- ESTABLISHED 17 YEARS:** We have a proven track record in professional computer sales.
- PART OF A £50M A YEAR COMPANY:** With over 300 staff - We are solid and reliable.
- EXPERIENCED STAFF:** All fully trained in "Customer Care".
- TECHNICAL SUPPORT HELPLINE:** FREE help and advice from a team of experts.
- A FULL PRODUCT RANGE:** All of your computer requirements from one supplier.
- WE PRICE MATCH:** We will normally price match any local high street store within a 3 mile radius on a "Same Product - Same Price" basis.
- FREE CATALOGUES.**
- PAYMENT:** We accept most major credit cards, cash, cheque or monthly terms (APR 23.8% - written quotes on request).
- VOLUME DISCOUNTS AVAILABLE:** Business, Education and Government. Tel: 0181-308 0888.
- MAIL ORDER:** FREE DELIVERY in UK mainland on orders over £40-VAT. Small administration charge (£2.50-VAT) on orders under £40-VAT.
- 21 STORES NATIONWIDE.** *Mine Stores carry a selected range only but products can be ordered in the stores via Mail Order

MAIL ORDER 0181-309 1111
PLUS TECHNICAL AND HEAD OFFICE

SILICA, SILICA HOUSE, HATHERLEY ROAD, SIDCUP, KENT, DA14 4DX

PLUS BRANCHES AT:

BRISTOL	Debenhams - (3rd Floor), St James Barton	0117-929 1021
CARDIFF	Debenhams - (1st Floor), St David's Way	01222 341576
CHELMSFORD	Debenhams - (2nd Floor), 27 High Street	01245 355511
CROYDON	Debenhams - (2nd Floor), 11-31 North End	0181-688 4455
GLASGOW	Debenhams - (3rd Floor), 97 Argyle Street	0141-221 0088
GUILDFORD	Debenhams - (3rd Floor), Millbrook	01483 301300
HARROW	Debenhams - (2nd Floor), Station Road	0181-427 4300
HULL	Debenhams - (2nd Floor), Prospect Street	01482 325151
IPSWICH	Debenhams - (2nd Floor), Westgate Street	01473 221313
LONDON	Silica - 52 Tottenham Court Road	0171-580 4000
LONDON	Debenhams - (2nd Floor), 334 Oxford St	0171-580 3000
LUTON	Debenhams - (1st Floor), Armdale Centre	01582 21201
MANCHESTER	Debenhams - (3rd Floor), Market Street	0161-832 8666
PLYMOUTH	Debenhams - (3rd Floor), Royal Parade	01752 266666
ROMFORD	Debenhams - (3rd Floor), Market Place	01708 766066
SHEFFIELD	Debenhams - (3rd Floor), The Moor	0114-276 8611
SHEFFIELD	Debenhams - (L. Ground), Meadowhall Ctr	0114-256 9779
SIDCUP	Silica - Silica House, Hatherley Rd	0181-302 8811
SOUTHAMPTON	Debenhams - (1st Floor), Queensway	01703 223888
SOUTHEND	Keddies - (2nd Floor), High Street	01702 462426
THURROCK	Debenhams - (1st Floor), Lakeside Centre	01708 863587

SILICA

To: Silica, CMUSR-0495-213, Silica House, Hatherley Rd, Sidcup, Kent, DA14 4DX

INFORMATION ON AMITEK PRODUCTS

Mr/Mrs/Miss/Ms: Initials:

Surname:

Company (if applicable):

Address:

.....

.....

Postcode:

Tel (Home):

Tel (Work):

Which computer(s), if any, do you own?

.....

213L

EBOE - Advertised prices and specifications may change - Please return the coupon for the latest information.

FLASH TECH

BREAD STREET, PENZANCE, CORNWALL, TR18 2EQ
TELEPHONE 01736 331999 FAX 01736 331777

HARD DRIVES

2.5"

3.5"

IDE

80MB £99

130MB £99

120MB £139

365MB £149

170MB £149

540MB £189

260MB £189

1000MB £329

AMIGA HEAVY DUTY POWER SUPPLY £39

CALL FOR SCSI DRIVE PRICES

ALL DRIVES CARRY A 2 YEAR WARRANTY

CABLE KITS AND FULL INSTRUCTIONS ARE AVAILABLE

2.5" £5 3.5" £13

SALES: 01736 331999 (4 LINES)

NO MONIES WILL BE ACCEPTED UNLESS WE HAVE THE DRIVES
IN STOCK

ALL PRICES INCLUDE V.A.T. PLEASE ADD £10 CARRIAGE
PAYMENT BY CHEQUE OR P.O. MADE PAYABLE TO FLASHTECH LTD.

ALL PRICES SUBJECT TO CHANGE WITHOUT NOTICE E&OE

Ruffian

Price: £TBA Publisher: Grandslam © 081 680 7044

No, nothing to do with England supporters on tour.

Ruffian is a rather apt name for this platformer from Grandslam because the game's hero is indeed a bit of ruffian – he spits and he does moonies whenever he gets bored. Charming. So what's this rather uncouth chappie doing in a game? Well, he has been sent on a mission by a witch doctor to free a whole load of pixies who have gone and got themselves enmeshed inside some carnivorous plants (though on screen the plants look more like huge balloons). Your job as Ruffian is to free each pixie before they are digested by the plants and go to that great pixie land in the sky.

Gameplay

How do you free the pixies? By spitting at them of course. You begin each level with a certain amount of pips that you can eject from your mouth as a weapon and throughout the level there are numerous icons that will give you even more pip ammunition. There are the usual bits of fruit, loaves (you the know the kind of thing), dotted around each level as pick-



▲ Watch out for grape ape lurking around below.

ups to enhance your strength. And the witch doctor has kindly left you lots of magic potions around which give you extra powers such as the ability to jump higher, rapid fire spray, invincibility for few seconds, whirlwind power and quakes to kill all the baddies for a few seconds.

Have I not mentioned baddies? There are plenty, mainly in the shape of big hairy apes which tend to kill you on contact, so it's best to avoid them altogether by leaping over them. Other evil doers include slippery snakes that delete your energy and lizards who enjoy flicking their tongue at you. These and most of the baddies in the game can be easily avoided though.

The trickiest part of *Ruffians* is freeing all the pixies within the allotted time span. At the start of each level you are given a set amount of pixies to free and a time span to do it in. The bottom of the screen shows how much energy you have and how much time you have left. From there on it's a question of racing around trying to find the hidden ones.

Grandslam have kindly provided a

'helping hands' option which are little hand icons that point you in the direction, telling you where some of the pixies are. When you have finally freed all the pixies the same pointy hands direct you towards the exit. You can of course turn this option off, if you want to make things more difficult. You can also vary Ruffian's speed from the option screen if you wish, either making him run along manageably



or speed like a tornado through the whole level.

Conclusion

In all, *Ruffian* is an enjoyable game. The concept itself is not revolutionary but the central character is a loveable, cheeky sort of chap who gets really impatient at being left alone while you go and make the tea and waves at you or even moons at you. In game control is quite simple. Holding the fire button



down you can position Ruffian's head and then release it so he will spit in the direction you what him to. There is a difficulty curve in the game as well. As you progress through the

game you have to collect more pixies and kill more baddies at the same time. The graphics are pretty good too and as the game progresses each level becomes more detailed. The sound effects are pleasant, but the intro tune seemed slightly incongruous with jungle scenery. A more thumping rhythm would have suited the theme, instead of the 70's disco-tune along the lines of 'we fade to grey' that is used. Still, *Ruffian* is a pleasant enough platformer and well worth a look at. ■

Lisa Collins



▲ Can you spot Ruffian cleverly disguised as a tornado in this screenshot?



▲ Monkeys can be used to catapult you to high places if you drop them on the right spot.

RUFFIAN	
A500	workbench version.....1.3+
A500+	number of disks.....3
	RAM.....1Mb
	hard disk installable.....No
A600	graphics.....80%
A1200	sound.....75%
A1500	lastability.....80%
	playability.....85%
A2000	OVERALL
A3000	Good fun, but not exactly ground-breaking.
A4000	83%

ATR

■ Price: £29.99 ■ Publisher: Team 17 © 01924 267776

That's All Terrain Racing to the uninitiated. CU Amiga Magazine gets into top gear for Team 17's overhead racer.



neglected title out around the same time as *Stardust* was Team 17's *Overdrive*. An overhead racer,

inspired by the likes of classic arcade titles like *Super Sprint*, *Overdrive* was a decent game but that wasn't enough and for whatever reason it ended up being, by Team 17's standards at least, a



▲ Obliterate your opponent with a missile in the Micro Machines styled two-player battle mode.

failure. Undeterred, however, the Yorkshire-based team have developed *All Terrain Racing*, which

thankfully for my creaking fingers has been snappily abbreviated to *ATR*.

Three racing terrains await initially; Sport, Canyon and Forest. Further terrains like the moon become accessible once the seven levels in each of the first three terrains have been completed, so over forty levels await in total. Each of the levels has its own hazards and pitfalls, with the snowy forest levels, featuring dangerous patches of ice to watch out for, while the snaky canyons force the player's car through small tunnels where the view is obscured. All these levels look a treat thanks to the highly-detailed graphics. *ATR* runs comfortably on a bog standard A500. Sadly the sound FX don't quite match up to the

visuals while the tunes are a little weedy for a race game.

In one or two-player mode the player must take on five computer opponents and finish in the top three positions to progress. Each position has a cash reward so it pays to finish as high as possible in each race. Money can be spent in a shop that pops up before each race. All the usual power-ups can be bought here, like better tyres for a stronger grip and improved gears for faster accelerating. There's also a special power-up available. This varies from race to race but includes delights like power steering. Ignoring the specials, each power-up has five power levels and obviously the maximum one costs a packet, for example, but they become essential as the game progresses because the courses start to become extremely tortuous. Without the likes of decent tyres finishing in last position is almost a certainty in the later stages of the game.

Thankfully numerous power-ups litter the course but these only last for the duration of that particular race. Nonetheless they can mean the difference between topping the league or ending up in the scrapyard.

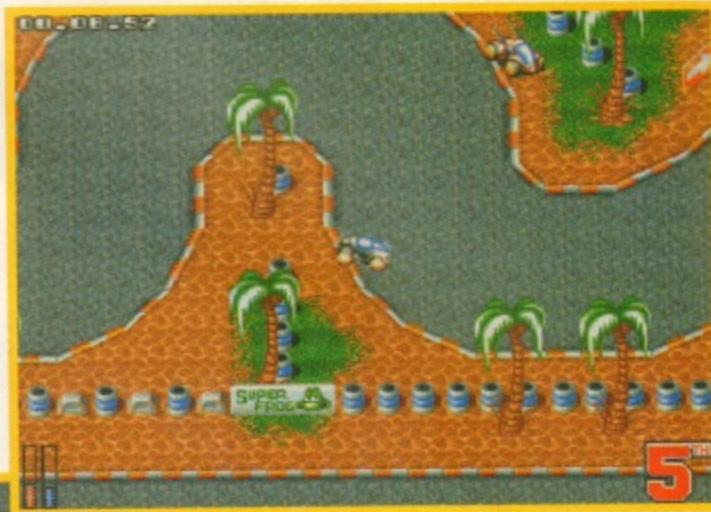

▲ The courses are littered with shortcuts which can shave precious seconds off a lap.

Pick your car

At the start of the game the player is given a certain amount of money to spend on power-ups, but first a car is needed. Three types are available; 4X4 Jeep, Hydra Buggy and Formula Special. The 4X4 Jeep is the cheapest and recommended for beginners, but it suffers from being reasonably slow. Equally the Formula Special is fast, expensive and best suited to experts. The Hydra Buggy is arguably the best all rounder, being cheap enough to allow a decent range of power-ups to be bought at the start of the game and both controllable enough for beginners and fast enough for the more expert player.

As well as the standard one and



▲ The cars handle very realistically. For instance, slipping on this ice is almost a formality.



▲ Graphically ATR is one of the best games seen in recent months but the sound and music could do with beefing up a bit considering the racy pace of the game.





▲ Customise the vehicle to your heart's content in the shop, assuming you have the readyies that is.

▲ Some of the canyon levels are very tough as the tunnels block the view of your vehicle for a while.

two-player modes there's also a battle mode which can be played against either the computer or a human opponent. This is similar in concept to Codemasters' multi-player classic *Micro Machines*. Like *Micro Machines* once the lagging player has trailed back off the screen he'll be zipped up to the leader and the leader rewarded with a point. Completing a lap first results in a two point bonus. Optional missiles are also available and making contact with one on an enemy is worth one point. The overall winner is the person who reaches the allotted number of points. Setting this number is one of the numerous preferences that can be altered before a race commences. Trust me it's a lot simpler than it sounds and while playing points are the last thing on your mind - you're too busy trying to stay on the track, get and keep the lead and ram your opponent.



▲ Hitting obstacles like cones slows the vehicle down big time, so er ... don't hit anything, basically!



▲ Car enhancing power-ups litter the course. They're free so grab them while you can. Unfortunately they only last for the duration of that particular race.

Essentially *ATR* is a revamped version of *Overdrive* with the criticisms which that game attracted ironed out plus plenty of new features and an excellent two-player mode. *ATR* feels more like a true racing game than *Overdrive* ever did, partly because of the speed the cars move at, but more because of the way they handle realistically control-wise and the way they react to background scenery.

Whereas *Overdrive's* tracks seemed to be made of tarmac no matter where they were set, *ATR's* are more convincing. Slipping around snowy track is all too real, especially when you lose control on the ice. There are also *Skidmarks* style obstacles which *Overdrive* lacked in the main and these add not only to the skill required to play the game but also give it a random element. In *Overdrive* once someone took the lead it was nearly impossible to lose it as there was little in the way of hazards to knock them off their stride. *ATR* has that random element and without complete control and total commitment it's easy to screw up on a bump, total the vehicle and end up in fifth place, in a matter of seconds.

Loving care

This is clearly a game that has been playtested to death, the care and attention within it shines out. I love the way that you don't complete all the levels on a particular terrain at once, only three of them. This stops boredom caused by repetition, which with something like snow based levels can be a problem no matter how good the graphics are. In *ATR's* case the graphics are some of the best seen on the

Happy Shopper

Welcome to our showroom. I think I have just what you're looking for. Now let me see, ah what about these three lovely little beauties ...

The 4X4 Jeep: Cheap but a bit on the slow side, this has plenty of potential to be upgraded. One for the driver who has just passed their test perhaps.



Ultra Buggy: An ideal combination if you want my opinion. Good price, good performance and it leaves you with money to upgrade with.



Formula Special: One for the connoisseurs I believe. High price but what a performance! Needs an expert driver to show it at its best though.



Amiga for some time. I do have one niggle though. The missiles in the two-player battle mode are plain annoying. Getting ahead is a matter of skill and being rewarded with a projectile up the backside from the vehicle tailing is unfair. It's like a jealous child destroying the toy another child has because they can't have it themselves. The difficulty curve is also a bit off-key, most of the early levels are a breeze but the later ones are difficult and require a vehicle with plenty of upgrades to have any chance of success in navigating the twisty nightmares.

Overall though, *ATR* is another class Amiga title from Team 17 and offers enough new features (even if the later tracks are like *Overdrive's*!) and all important playability to be recommended to newcomers as well as original *Overdrive* purchasers. ■

Rik Skews



▲ There's always a safe route around obstacles so try and take it. Taking the longer route might slow you down, but not as much as hitting an obstacle will.

All Terrain Racing

A500	workbench version.....	1.3+
A500+	number of disks.....	2
	RAM.....	1Mb
	hard disk installable.....	no
A600	graphics.....	90%
A1200	sound.....	81%
A1500	lastability.....	83%
	playability.....	86%
A2000	OVERALL	85%
A3000	Overdrive -	
A4000	with go	
	faster stripes!	

Dawn Patrol - is it a good flight sim, a history lesson or both? We find out

It seems that Rowan Software is single handedly attempting to keep the flight sim genre alive and kicking on the Amiga. First they released *Reach for the Skies*, then a couple of months back it was *Overlord* and now comes *Dawn Patrol*. *Reach for the Skies* and *Overlord* played well so does *Dawn Patrol* match that tradition?

Well, if a game was marked on options alone then the answer would most definitely have to be an emphatic yes. *Dawn Patrol's* 150 plus scenarios cover the air wars from the earliest days at the start of the First World War, right through until the bitter and bloody end. It's not just air to air combat that's covered though, ground attacks and the more mundane aspects of war such as destroying air balloons are also featured.

Realism

Clearly a lot of time has been spent making the missions as realistic and accurate as possible and repeated playing teaches you a great deal about early air combat.

For instance, playing the Allies in some of the early missions (whose first combat aircraft featured guns on the top wing making aiming almost impossible)

Dawn Patrol

■ Price: £34.99 ■ Publisher: Empire © 0181 343 7337



Being bombarded with information continues apace throughout the game with impressively researched and thoroughly detailed accounts of the pilots and the battles themselves for each of the missions on offer in the game. The problem is that this information tends to get in the way of the action.

I don't know about you, but if I want to read brilliant research material I get a book with which I can sit down in a comfortable chair and burrow through it. I don't want to sit in front of a glaring monitor clicking through page after page of weeny text when I'm trying to play a game. This information interferes with the structure of the game because no sooner have you completed the series of missions for one pilot, than you're ploughed straight into the next. A severe lack of immersion or feeling of progress in the game is the result because just as you become used to the idiosyncrasies of the

plane and period that you're flying in, bam, you're whizzed off to the next.

It's a lot like being trapped in a string of episodes from BBC2's cult sci fi programme *Quantum Leap* where physicist Sam leaps from person to person

makes it easy to see why the average life expectancy of a pilot was measured in hours rather than days or weeks. Certain mission parameters like how many and what type of enemy planes are encountered can be altered too and this helps to increase the game's longevity.

Other options such as invincibility, super engines and unlimited ammo are also available for the more arcade orientated gamer, but *Dawn Patrol* is definitely a game for the flight sim fan as the multiple keys required for mastery of each aircraft demonstrates.

Presentation

Empire also deserve special praise for the presentation of *Dawn Patrol*, which is amongst the best I've ever encountered in any computer game. First off is the chunky box, complete with a dramatic painted image of a dogfight. Once inside there's a satisfying manual and technical supplement, but far more interestingly there's a limited edition book from the Famous Flyer's series. Manfred Von Richthofen: The Man and the Aircraft He Flew follows perhaps the most famous of pilots' exploits, from his early days to becoming the World War One Ace of Aces, a title earned for rather happily shooting down more enemy planes than any other pilot.



▲ Dawn Patrol features all the usual views which can be zoomed in and out of to your heart's content.

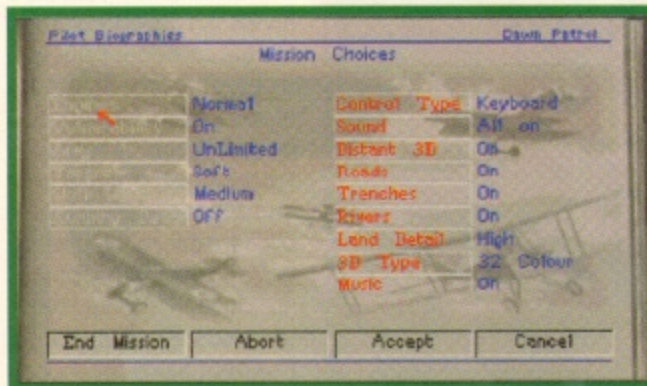

▲ Even when you're in the midst of a mission a number of game parameters can be changed.



▲ Not a good moment for the gun to jam. Time to frantically hit the reload button methinks.



▲ Turning down the graphical detail keeps the game flowing at a sensible speed even on an A500.

without ever becoming fully accustomed to where he is. In my opinion strategy-based games need a sense of progress that missions, sub-missions and the ability to save games offers.

Your failure or success has no effect on the game. Either way you're free to play the mission again or move on to the next. For me this resulted in the feeling of 'so what' if I failed.

Good reading material but ...

As a piece of reference material *Dawn Patrol* is exceptional, especially for a computer title, but as a game? Well, it's fun to play for sure, but I felt there was no sense of progress in the game and didn't get very involved in it. It's something that I'd return to, but only for a quick blast, which surely isn't the aim for a flight sim.

Still, it's not all bad by any means. Although limited in their scope, most of the missions are fun and I like the way that you can choose to play as either a German or Allied pilot as well as alter at what height and whereabouts the battle takes place. And graphically this is impressive for an Amiga flight sim, certainly

more so than *Overlord* and particularly when played on an A4000.

Dawn's Patrol's main problem though is one of simple economics. For the same price you could pick up a copy of the definitive Amiga flight sim, MicroProse's classic *Knights of the Sky*, as well as a decent book about First World War air combat and at the end of the day I'd recommend that. ■

Paul Springett



▲ The amount of information contained within the text is astonishing, it's just a shame the actual gameplay is so average.

DAWN PATROL

A500	workbench version.....	1.3+
A500+	number of disks.....	3
	RAM.....	1Mb
	hard disk installable.....	yes
A600	graphics.....	81%
A1200	sound.....	57%
A1500	stability.....	78%
	playability.....	71%
A2000	OVERALL	74%
A3000	Great for reference, but only OK to play.	
A4000		



▲ Arrgh, good bye cruel world. Now where did I put the fire extinguisher, parachute, inflatable mattress etc ...

AN EARLY BATH FOR THE OPPOSITION!

Experience the nail-biting tension of a real manager in revolutionary interactive animated matches!

Play it dirty! Rig matches, place bets and offer bungs!

Complete feedback from press, agents, chairman and fans.

See your stadium develop in superb 3D splendour.

Ultimate Soccer manager

Arrives in May on A500, A1200, PC, PC CD-ROM

DON'T MISS OUT!

INDI DIRECT

CALCULUS Stores

OPTIONS

Buying Mail Order is convenient and the prices are great. But sometimes it is important to actually see the product and take it away the same day. That's where our new Options scheme comes in. iNDi Mail Order or a visit to one of our Calculus Stores, the choice is yours. The same quality Service and with this Exclusive reader offer, Calculus will match any iNDi Mail Order price on the Spot. Add No Deposit Credit and Nothing to pay for 6 Months and we believe that this is the most exciting offer anywhere.

ORDER ANY iNDi ADVERTISED PRODUCT OVER £100, USE IT FOR 6 MONTHS BEFORE YOU PAY A PENNY

Option 1

BUY TODAY FROM EITHER iNDi OR CALCULUS. PAY BY CHEQUE OR CREDIT CARD
TO OBTAIN iNDi PRICES YOU MUST SHOW A COPY OF THIS ADVERT

Option 2

BUY TODAY FROM EITHER iNDi OR CALCULUS WITH NOTHING TO PAY FOR 6 MONTHS THEN CHOOSE TO PAY OVER 6 TO 36 MONTHS.

INSTANT CREDIT AVAILABLE FROM NEARLY 100 OFFICES NATIONWIDE

CREDIT CARDS



EXPRESS CHEQUE CLEARANCE

Simply write your cheque guarantee card number, name and address on the back of your cheque and we will normally be able to despatch your order the day that we receive your cheque. Cheques, received without a cheque guarantee card number, will normally clear within a maximum 7 working days.

CUSTOMER CARE

The substantial volume of sales calls coming into our office has resulted in delays in the crucial area of customer care. To ensure that all customer queries are handled speedily and efficiently a new customer care department has been established. Our new department will be happy to assist you on their new number
Mon - Fri 10am-4pm

01543 419999

9am - 6pm Monday to Friday 9.30am - 3.30 Saturday

* APR 29.8% Subject to Status.

ZAPPO AMIGA 1200 CD ROM DRIVE LIMITED EDITION PACK



Quote

"Whatever your CD-ROM needs, the Zappo Drive can handle it." Amiga Format
"More stunning than a phaser gun in Star Trek." A must for 1200 owners. CU Amiga

We understand that some non standard Accelerator boards may cause problems when using the Zappo CD ROM. Please confirm compatibility at the time of order as iNDi cannot accept responsibility for this problem

GREAT GAMES WORTH £60.00

- * Brutal Football "It is first rate ... it'll keep you in stitches for months" 94%
 - * Alien Breed "A supreme challenge to new and old players alike" 90%
 - * Qwak "The most playable Amiga game ever" 92%
 - * Project - X "Incredible graphics, awesome speech... a true classic" 92%
 - * F17 Challenge "fast moving graphics, excellent gameplay... a game to be reckoned with" 84% (Min 3Ms Memory Required)
- PLUS a superb multi button, joystick worth £14.99
ZAPPO CD ROM DRIVE Limited Edition

£225.99

AMIGA OPTIONS!

The Amiga was a great product but technology marches on. Have you compared the cost of a full Amiga System against a Multimedia PC. Did you know that Calculus will give you a trade in deal for your Amiga 500/600/1200/ Monitor etc against a brand new PC.

NEW COST COMPARISON

- | | | | |
|---------------------------|----------------|--|----------------|
| * Amiga 1200 | £349.99 | * Hyundai SX 33 PC | £349.99 |
| * 540 Mb Smart Stor | £299.99 | * 540 Mb Hard Drive | £299.99 |
| * 1230 Board / 2Mb memory | £329.94 | * 4 Mb Memory | £329.94 |
| * Zappo CD ROM | £225.99 | * CD ROM Drive | £225.99 |
| * Microvitec Monitor | £285.99 | * 16 Bit Sound Card | £285.99 |
| | | * Stereo Speakers | £285.99 |
| | | * 14" SVGA Monitor | £285.99 |
| | | * 8 CD ROM Software Titles | £285.99 |
| | | * World Cup Golf | £285.99 |
| | | * All New World of Lemmings | £285.99 |
| | | * Ecstasia | £285.99 |
| | | * Extractors | £285.99 |
| | | * The New Dictionary of the Living World | £285.99 |
| | | * Novastorm | £285.99 |
| | | * Comptons 1995 Interactive Encyclopedia | £285.99 |
| | | * Virtuoso | £285.99 |

Total **£1141.97**

Call into your local Calculus Store for an Amiga Trade in Price. NO DEPOSIT. NOTHING TO PAY FOR 6 MONTHS

Total **£1126.83**

FREE Zapsac or Zappo T Shirt (whichever when ordering)

ZAPPO Smart Stor plus

Plugs into the PCMCIA Slot of the Amiga 600 & 1200 and is ready to go. Excellent build quality at an amazing price. **12 Months Warranty**

270Mb---**£199.99** 340Mb---**£239.99**
540Mb---**£299.99**

DRIVES HAVE COME DOWN SO iNDi PASS THE ADVANTAGE ONTO YOU

2.5" EXTERNAL HARD DRIVE PRICES

The massive reduction in hard drive prices has forced us to reconsider our position and stock 2.5" drives

170Mb **£349.99** 260Mb **£249.99**
420Mb **£299.00** 540Mb **£399.99**
Complete with installation disk and lead.

ZAPPO 1200 EXTERNAL FLOPPY DRIVE



You've seen all the reviews on this popular and affordable second Amiga drive. "Compatible with all Amigas Quality 9 out of 10." Exceptional value for money. Amiga Computing

£44.09

MICROVITEC MONITORS

This superb monitor offers a high quality 0.28 dot pitch and low radiation total MPR-II compliance. Complete with external Stereo Speakers and includes all leads - this is the monitor that we have all been waiting for.

External Speakers Included



£285.99

SHARP MONITOR / TV

The superb Sharp 14" Monitor / TV provides a real alternative to a Commodore Monitor with full function remote control 39 channel electronic auto search tuning, digital on screen display and 1.5 watt Mpo audio output. All you need to know is the low low price. The Sharp Monitor / TV is the product for you complete with scart socket and connectivity cable and including 12 months Warranty.



£159.99

ALPHASCAN PLUS 256 GREYSCALE

£124.99

ALFASCAN - PLUS 256 GREYSCALE & ALFA COLOUR 256K COLOUR HAND SCANNER

This Superb A4 Amiga Scanner voted "Amiga Shopper Best Buy", arrives complete with Merge IT and Micrograph OCR Software. Merge IT allows the simple, quick merging of two on-screen images and Micrograph OCR turns your Amiga into an efficient text reading system. Amiga 500/500 plus /A600 /A1200 /A1500 /2000 /3000 /4000 * Minimum 1Mb memory * Minimum 2Mb memory & a Hard Disk to run OCR option. * Kickstart, Workbench V1.2 or higher.

WITH OCR SOFTWARE

Optical Character recognition allows you to edit Scanned Documents. Perfect for Word Processing Applications

ALPHA COLOUR WITH 256 COLOUR HANDSCANNER

£294.99

* A copy of this advert to is required to obtain our Mail Order Prices at Calculus Stores. Valid only for the month of Publication. Some Calculus Stores may not carry the full Indi Range. Phone to avoid disappointment. Insured deliveries by securitor. Hardware £7 +Vat per box, Saturday £15 + Vat, software £5 +Vat for 1st item. £2 for each subsequent item Saturday £10 per Bos Uk Mainland

MAIL ORDER SALES HOTLINE 0543 419999

All trademarks are acknowledged. E&OE APR 29.8%



INDI & CALCULUS

DIRECT Stores

OPTIONS

INCLUDES WORDWORTH THE ULTIMATE WORD PROCESSING PACKAGE

NEW Panasonic KX-P2135

A 24 Pin Quiet colour printer, designed for those who need low cost professional quality output, giving all your documents and presentations eye catching colour. The NEW KX-P2135 incorporates a 20 page built in sheetfeeder, a flat belt push tractor feed to facilitate easy loading together with a noise level of only 46.5dBa (43.5dBa in super quiet mode)

- * Quiet Printing 46.5 dBA - 43.5 dBA SQ Mode
- * Multiple font capabilities including 3 draft and 7 letter quality
- * Tractor feed
- * 2 paper paths
- * 7 Colour printing
- * 250 cps Draft Micron, 83 cps LQ
- * 1 Year Warranty

FREEPHONE
0800 444220
for your FREE Amiga
Driver Disk



£159.99

Please note all Panasonic Dot - Matrix printers are supplied with a tractor feed, FREE of Charge. Other Companies can charge approximately £50 extra for this feature.

Panasonic KX - P4400

New KXP4400 Ultra - Compact LED LAZER QUALITY Page Printer the printer that fits virtually anywhere. Ultra small footprint (12.7cm x 38.8cm x 29.4cm ex trays) At under 6.5 kg this printer travels with you. They also feature energy efficient power save.

- Page Printer standard Specification**
- * 4 pages per minute of laser quality output * 100 sheet, multi purpose paper tray (A4, letter, legal and executive) * 1 Mb Ram expandable to 5 Mb
 - * 1600 copies per toner. * 1 Year On Site Warranty * 28 Bitmapped fonts
 - * HP Laserjet IIP



£351.32

Canon PRINTERS

NEW Canon BJ-200ex

The NEW BJ-200ex has print speeds of over 3ppm, it incorporates and in built 'smoothing' function giving and effective resolution of upto 720 x 360 dpi! At the faster speeds of 204cps HQ, and 248cps HS. The BJ-200ex still maintains the whisper quiet operation of 42 dBA, and of course the built - in 100 x A4 automatic sheetfeeder.

Canon BJC-4000

* Colour desktop bubble jet with Separate CMYK ink tanks *360 DPI, 720 with black only *248 cps HS, 173 CPS HQ.(BC-20 opt.)496 CPS HS, 346HQ * Prints on media * Built in Sheetfeeder *Windows compatible * 8 standard typefaces * 1 year Canon Warranty

NEW £235.00

£374.99

ROMBO

MEGAMIX. Low cost, hi spec digital effects cartridge plugs into the printer port of the Amiga. Allows stereo sampling from almost any musical source. **PRICE £26.99**

TAKE TWO. Animation package is a must for computer artists and enthusiasts of all ages. As used in Rolf Harris Cartoon Club. **PRICE £34.99**

VIDI AMIGA 12. The ultimate low cost colour digitiser for the Amiga. "the best value full colour digitiser on the market". - Amiga Format. **PRICE £69.99**

ROMBO VIDI AMIGA 12 (RT)

Based on the best selling Vidi Amiga 12. This all new version offers real time colour capture from any video source. Full AGA chipset support as standard for all A1200/A4000. **PRICE £129.99**

ROMBO VIDI AMIGA 24 (RT) Plus FREE Power Supply

For the more serious user, this 24 - bit version will again capture from any video source with true photo realistic images! A staggering 16.8 million colours can be utilised with incredible results. Full AGA chipset support. **PRICE £219.99**

SCOOP PURCHASE

Top Quality 100% Error Free

BULK DISKS

50 Disk Pack £12.99 Disk Labels 500 Pack £4.99

PRINTER ACCESSORIES

- 1) Printer Dust Cover Tailored dust cover for the Panasonic KX-2123 printer **INDI PRICE £8.99**
- 2) Paper Pack -500 sheets of quality A4 paper **INDI PRICE £9.99**
- 3) Continuous Paper 2000 sheets 1 part listing paper **INDI PRICE £19.99**
- 4) Parallel Printer Cable -Used for connecting Amiga to Panasonic printers **INDI PRICE £8.99**
- 5) Panasonic Colour Ribbon -Colour ribbon for KX-P2123 **INDI PRICE £12.99**
- 6) Panasonic Black Ribbon Black ribbon for KX-P2123 **INDI PRICE £6.99**

MBX 1230 XA 50 MHz 50 MHz 68030 & MMU

- * Allows your A1200 to run 1.52 times faster than a A4000 / 030
- * Easy trap door installation (No soldering required) * Fast RAM upgradable to 128 Mb (72 pin 32 bit) * On board battery backed clock
- * Does not interfere with PCMCIA port

50mhz £199.99 50mhz +50mhz FPU £229.99

AMIGA REPLACEMENT FLOPPY DRIVES

Amiga 500 / 500+ **£34.99**
Amiga 600 / 1200

Commodore 601

Trapdoor upgrade for the Amiga 600, 512K. **£19.99**

Do You Own An AMIGA A1500 / A2000 / A3000 Or A4000

2091 SCSI CONTROLLER CARD

- * 6.6 Roms for use in the A4000 * Upto 2Mb of 16 bit dips can be fitted
- * Any 3.5" SCSI Hard Drive can be fitted
- * Install software for SCSI Hard Drive Any other standard SCSI device can be added
- * Tape streamer * SCSI Scanner
- * External Hard Drive

£69.99

256K DRAM memory **£4.49**

SX-1

CD 32 EXPANSION MODULE

The Amazing SX - 1 Module simply slots into the back of your Amiga CD32 and a whole world of expansion opens up for you. Add a keyboard, floppy drive or even fit a superfast hard drive. Instantly your CD32 is no mere console, it's a real computer.

FREE FRED FISH SX-1 EXPANSION MODULE

£194.99

EXPANSION OPTIONS

BLACK KEYBOARD £37.99

ZAPPO FLOPPY DRIVE £44.09

SX1 Compatible

SX-1 SUPER BUNDLE

- * SX-1 Expansion Module
- * Black Keyboard
- * Zappo Floppy Drive

£259.99



CALCULUS STORES NATIONWIDE

- SOUTH AYLESBURY**
39 Friars Square Centre
TEL: 0296 436811
- MAIDENHEAD**
6 Nicholson Walk
TEL: 0628 770768
- HEMEL HEMPSTEAD**
Marlowes Centre TEL: 0442 250035
- FARNBOROUGH**
1 Princes Mead Shopping Centre
TEL 0252 377722
- MIDLANDS BURTON-UPON-TRENT**
The Octagon Centre, New Street
TEL: 0283 517505
- COVENTRY**
24 Orchard Walk Shopping Centre
TEL 0203 520778
- SUTTON COLDFIELD**
80 The Parade
TEL: 021 3554839
- TAMWORTH**
34 Ankerside Shopping Centre
TEL: 0827 67776
- WALSALL**
48 Park Mall Saddler Centre
TEL: 0922 21700
- NORTH ALTRINCHAM**
59 George Street.
TEL: 061 929 7433
- DONCASTER**
11 South Mall Frenchgate Centre
TEL 0543 418666
- LEEDS**
11 Bond Street Centre
TEL: 0113 2454098
- NORTHWICH**
85 Witton Street
TEL: 0606 47883
- HULL**
11 Princes Quay
TEL: 0482585100
- OLDHAM**
The Spindles TEL: 0616270822
- PRESTON**
St George's Centre
TEL: 0772 259494

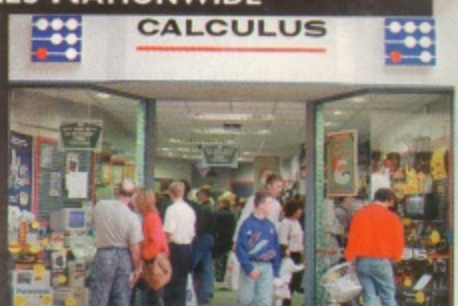

OUR CALCULUS STORE IN MAIDENHEAD

SHEFFIELD
67 The Moor Sheffield
TEL: 0114 2721192

WARRINGTON
52 The Mall Golden Square
TEL: 0925 575055

WIGAN
18a The Galleries Shopping Centre
TEL: 0942 323913

INDI DIRECT MAIL recognises all Trade Marks and Copyrights All prices are correct at time of going to press. E & OE. Some Calculus Stores may not carry a full range of Indi products. Phone to avoid disappointment.

MAIL ORDER SALES HOTLINE 01543 419999



Shadow Fighter

■ Price: £29.99 ■ Publisher: Gremlin Graphics ☎ 0742 753423

The *Mortal Kombat 2* hype machine was definitely in full flow at Christmas. The second coming of Kitana and Co outsold Gremlin's *Shadow Fighter* in the shops, despite the fact that it didn't really deserve to. OK, if you read our February issue you'll notice that *MK2* scored an incredible 95% while *Shadow Fighter* scored 93%, but this reviewer still thinks that it's better. The difference in scores does not reflect the true long-term playability of *Shadow Fighter*. If I had reviewed *MK2*

instead of the console obsessed crusty who did so it would have scored less, *Shadow Fighter* would have been top of the pile!

Rant over, the reason for this review is that a shiny new A1200 version of the game has arrived in the office. It's basically the same game, with 17 fighters, of which you can choose from six in single player mode or 15 in two player. The only two non-selectable characters are Pupazz the practice dummy and the Shadow Fighter himself. There are tournament, single fight, practice and Vs (two player modes), three difficulty levels, 'stun', and 'blood' options.

Upon loading up *Shadow Fighter* A1200 I was hard pressed to immediately tell the difference between it and the older version. The concept is identical, the copy protection is, the music is and the amount of disks (four) is too. It plays exactly the same as well, so I had to get out my old A500 *Shadow Fighter* to

make a genuine comparison.

Although there were a few noticeable differences at first it was only when identical matches, with identical characters and backgrounds were compared side by side on screen that they were easily identifiable. The backdrops have been improved by the additional colours, though not as much as you'd expect, while the sprite outlines have been smoothed out and their colours enriched. The fluidity of their movement has also been



improved, though it's still not quite up to arcade standard.

In the final analysis *Shadow Fighter* is still top of my list of Amiga beat 'em ups. If you've got an A1200 and you've already bought the non AGA version then for God's sake don't buy this one

– the differences are not really worth it. If, on the other hand, you don't actually have *Shadow Fighter* then I would advise you to get it. It's excellent.

AD

CD32
A500
A500+
A600
A1200
A1500
A2000
A3000
A4000

93%

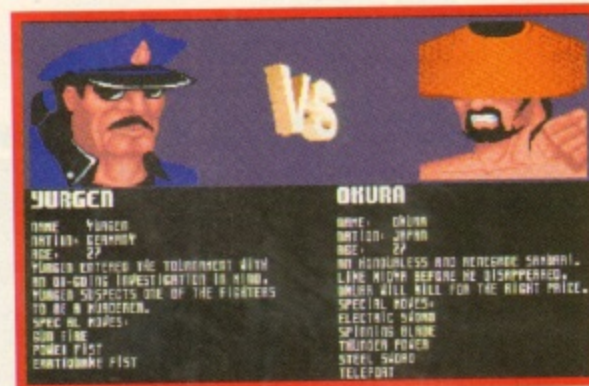

International test series cricket

■ Price: £26.99 ■ Publisher: Grandslam ☎ 0181 680 7044

I Audiogenic have, up until now, been the only company to offer the Amiga users anything in the way of cricket simulations, but thanks to an Australian development team and Grandslam, that's about to change.

The first thing that grabs you about *ITS Cricket* is its choice of

presentation. Opting for a more realistic style, digitised graphics and sampled sound effects are utilised, and though it gives the game a somewhat unique feel, it somehow lacks polish. The animations are too jerky to warrant their use over traditional sprites, and the samples tend to just drop in and out without too much care for continuity, sound quality or volume.

However, the gameplay within *ITS* does offer interesting control systems for both bowling and batting sides. Bowling is controlled by mouse, with a number of options such as over or around wicket deliveries, along with leg-spin, off-spin, straight, etc. depending upon the currently active bowler.

Batting is via the joystick (which allows two-player games to flow,

only stopping to swop joystick for mouse after the full innings) with a *Mortal Kombat*-like combination of firing and directions to execute any of the twelve strokes available. Other than that, batting is all down to good timing (and luck) while any really good shots are rewarded by Ozzie commentators' grunts of approval.

The fielding is the weakest aspect of play, with a clumsy mouse selector first picking a fielder, and then where you want him to run. Once the ball is collected, the cursor then freaks out, making it deliberately difficult for you to throw back to the wickets.

I've yet to be impressed by a



cricket game, and *ITS* was no different. It's a shame the presentation, in my opinion, is so unattractive because the control system is quite nice. I can't see anyone getting excited by this other than the real cricket fanatics.

MB

CD32
A500
A500+
A600
A1200
A1500
A2000
A3000
A4000

57%

BRIAN FOWLER

Commodore
AMIGA

Computers Ltd

11 North Street, EXETER, DEVON, EX4 3QS

AMIGA

We're Backing Amiga!

Amiga 1200, CD³² and A4000

are in extremely short supply. Phone for latest news, prices and availability.

We have available now memory expansions, accelerators, hard disks (SCSI and floppy disk drives, multi-io cards, laser printers (impact, inkjet, laser), printer and monitor shares anything you want to accelerate your Amiga? Talk to us, we know the answers!

Want to accelerate your Amiga? Talk to us, we know the answers!

brian_fowler@cix.compulink.co.uk

CD32 Expansion Modules

Add Memory, Floppy Drives, Hard Drives, Keyboard, Printer --- turn your CD32 into a real Amiga!

Great Value at £199.95

Studio II

The Ultimate Utility for Amiga Printing
Now In Stock at only £49.95

Retina BLT Z3
Superb 24 bit video card
4MB version
Only £449.95

Other Cards available ...
Piccolo,
Picasso, EGS
--- you name it!

AMIGA

Imagine a drive which is almost as fast as a hard drive, but which takes disks similar to a floppy drive

Imagine filling this hard drive, and then simply replacing the cartridge and instantly having another 105 or even 270 Megabytes of storage available

Imagine saving your work to cartridge, and being able to read the data on any similarly equipped Amiga, PC or MAC

Now you're thinking SyQuest

From
£199.95

compuserve 100072,1536

Microvitec 1438
14" Colour Multisync Monitor. All Amiga modes.
£299.95

* OR *
Phillips 8833
Monitor. A Classic for only £229.00

CD32 Connection Kit MarkII
Network to any Amiga or PC

With SERNET - "Just Click and Go"

We have been selling Kits successfully since October 93! If you want one that works, talk to us!

Only £34.99

Upgrade from Connection Kit Mark I available --- Only £16.99

AMIGA

Contact us if you want an Emplant board or a new mouse or the latest DTP software or a second joystick for your CD32 or a PARNET cable or a CD full of fonts or one full of clip art or CDPD 4 or the latest AMINET CD or a CD32 keyboard adapter or a SCSI controller or a VLAB digitiser or Flowcharting software or anything AMIGA!!!

Turn your 4000/030 into a 4000/040 for only £399.95

Turn your 4000 into a 4000 Tower! - Phone for details. (Also available for 1500/2000, 3000 and 1200!)

Hard Drives

Fujitsu 528MB IDE	£235.00
Fujitsu 528MB SCSI 1/2	£250.00
IBM 1000MB	£500.00
Larger Drives	EPOA

SCSI Controllers

GVP 4008	£129.00	DKB 4091	£299.00
----------	---------	----------	---------

SCSI CD DRIVES

NEC	£179.95	SONY	£179.95
Nakamichi 7 CD Drive	£349.95		
... and lots lots more ...			
External SCSI cases with PSU available from £69.95.			
SCSI Towers from £99.95			
We stock most SCSI cables, and can manufacture custom cables to your requirements here in Devon.			

Fax Modems complete with software. Join the Comms revolution!
From £189.95 (BT Approved).
Very Fast 28800bps modems now available.

Can't see what you want? Just ring (0392) 499 755 --- we have lots more than we can show here!

Fax us on (0392) 423480

Compare Our Prices! We don't charge extra for Credit Cards or Standard Delivery.

What You See Is What You Pay !!!

How To Order

By Post

Send your Cheque/Postal order to the address above. Clearly state your name, address, telephone number and the product(s) you require. Prices can change so please phone to confirm price and availability. Please allow seven working days for your cheque to clear

By Phone

For an even faster service telephone our sales hot line and quote your credit or debit card number. Friendly and expert buying advice is available at all times.

(0392) 499 755

Monday - Saturday 9.30am-5.30pm

0392 499 755



Prices Correct At Time Of Going To Press. E&OE. Please Phone To Confirm Latest Prices.

bfc027

All Prices Shown Include VAT. Standard Delivery Is Free. No Hidden Extras.

Voyages of Discovery

■ Price: £25.99 ■ Publisher: Black Legend ☎ 0438 840003

After Ascon's success with *The Patrician*, Black Legend are hoping to create more than a drop in the ocean with *Voyages Of Discovery*.

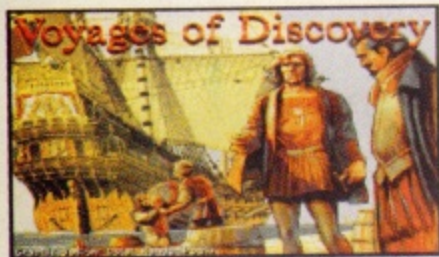

In its native Germany *Voyages Of Discovery* is known as *Kristopher Kolumbus* and the game coincided with last year's anniversary of the famous Italian explorer's discovery of the new world for the Spanish crown. Here in blighty, a year later it has been re-named *Voyages Of Discovery* because, unlike Germany, Britain has its own famous explorers, one of whom, James Cook, is actually in the game. Unfortunately, a game called

James Cook would hardly catch the eye these days, especially since he inconveniently died in the Pacific three hundred years ago, without setting up any publicity or sponsorship deals.

You start off in *Voyages Of Discovery* by choosing a famous explorer to play, or at least his face; you can change the name to whatever you want. There are five explorers in the game, Columbus, Cook, Le Maire (Dutch), Bougainville (French) and Vasco De Gama (Portugese). Up to four human players can participate, or any combination of human and computer players up to five. The game generates a 'new world' every time you start from scratch and the first thing you see is a colourful little island surrounded by water and encapsulated by a sea of blank grey. You begin the game with one ship, which you must man, arm and equip and then set sail into the deep grey yonder.

The playing map is basically a gigantic grid and your ship or ships have limited movement each turn. As they penetrate square by square into the grey zone it slowly becomes newly discovered sea and, hopefully, land. The idea is to discover new lands, subjugate the natives, then colonise and exploit them. The money earned through trade is then used to colonise and exploit other lands.

It's not all plain sailing though (ho, ho): with up to four other



▲ Excellent!

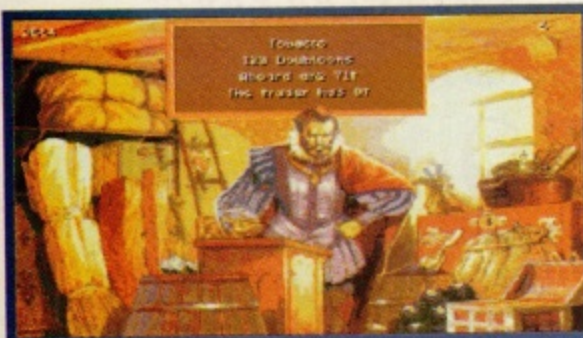

▲ Tobacco plantations are a very good investment.



▲ What's the name of this bank? Barings? I see. I'd like 5,000 Feb 1995 doubloon futures at 4 yen a piece please.

opponents your ships, plantations and colonies can be taken over by enemies or pirates and attack and defence becomes very important later on in the game.

Ships can be bought second hand or constructed, but become extremely expensive after a while, as do mercenaries.

Time does not stand still and while you're pootling around the ocean playing Captain Bligh, technology is advancing at a fantastic rate. At the start of the game you can buy a 'Caravelle', or small trading ship for the eight grand mark, but a couple of years later this line is discontinued and you'll have to pay between three and six times as much for newer ships. Mercenaries also get more expensive as guns are introduced.

All of these technological advances are necessary though. Ships need to be bigger to travel further, carry larger loads and be better armed, while mercenaries need to have the latest equipment or you run the risk of a rout by enemy forces.

Although each new game has a different map, the home port screens remain the same for each of the featured characters. There are five of these static screens, which are livened up by the need to scroll (smoothly) left to right and back to access the different activity areas. Brief animations also add to



the atmosphere. Each port has a Historian's office, a Pub (used for recruiting sailors, soldiers and pirates), a bank (which enables you to borrow money and transfer it to and from your ships), a shipyard (for building new ships and repairing existing ones) and a trader, who buys and sells food, water, trinkets, cannon balls, tobacco, wood etc.

Voyages Of Discovery is playable trading sim once you get used to it, but there are times when it seems rather dull and lifeless. In concept it's rather like a cross between *The Patrician* and *Dune II*, but without the instant addictivity of either. Worth getting though if you're home, dry and can't get any more hours out of *The Patrician*. ■

Alan Dykes

VOYAGES OF DISCOVERY

A500	workbench version.....1.3+	
	number of disks.....4	
A500+	RAM.....1Mb	
	hard disk installable.....yes	
A600	graphics.....	85%
A1200	sound.....	67%
	lastability.....	76%
A1500	playability.....	80%
A2000	OVERALL	78%
A3000	Colourful and	
	playable, but	
A4000	lacks lastability.	



CRAZY DISK PRICES!! GUARANTEED

GREY-TRONICS LTD



LOWEST PRICES

BEST SERVICE

RAPID DELIVERY

SALES FREE CALL 0500 737 800
SALES HELPLINE 081 686 9973 / 081 781 1551

DISKS DISKS DISKS

100% CERTIFIED ERROR FREE

+ LOCKABLE BOXES

	Grade A+	Grade B	
50 3.5" DS/DD	£15.99	£15.49	+ 100 cap lockable boxAdd £4.00
100 3.5" DS/DD	£24.99	£24.49	+ 100 cap lockable boxAdd £4.00
150 3.5" DS/DD	£38.99	£38.49	+ 2 x 100 lockable boxAdd £8.00
200 3.5" DS/DD	£48.99	£47.99	+ 2 x 100 lockable boxAdd £8.00
300 3.5" DS/DD	£73.99	£69.00	+ 3 x 100 lockable boxAdd £12.00
400 3.5" DS/DD	£98.99	£92.00	+ 4 x 100 lockable boxAdd £16.00
500 3.5" DS/DD	£123.99	£110.00	+ 5 x 100 lockable boxAdd £17.50
1000 3.5" DS/DD	£229.99	£205.00	+ 10 x 100 lockable boxAdd £30.00

FREE LABELS + FREE DELIVERY BY PARCEL FORCE

NEW PACK

AMIGA CD32

7 GAMES PACK - FREE DELIVERY



- SX1 Modular Expansion£187.99
- Keyboard for CD32£36.99
- Competition Pro Pad£15.99
- CD32 to Start£11.99
- CD32 to Amiga 1200 inc. software£34.99
- Disk Drive for CD32£48.99
- CD32 Lens Cleaner£9.99
- CD32 HiFi Lead£11.99

£229.99

Add £2.00 p&p for accessories

3.5" DELUXE LOCKABLE BOXES

- 50 Capacity£4.05
- 100 Capacity£4.99
- Add £2.00 P&P

3.5" STACKABLE BOXES

- 100 Cap drawer£9.99
- 80 Cap Box Boxes.....£9.99
- Add £2.00 P&P

AMIGA 1200 PACKS AMIGA 600 PACKS

CALL FOR LOWEST PRICES

SMART BUY

- * STARTER PACK £14.99 For: 10 disks, Mouse Mat, Microswitch Joystick, 50 cap storage box, Disk cleaner
- * Games for A1200 USERS ONLY WHILE STOCKS LAST

- SYNDICATE£9.99 PINBALL FANTASIES£9.99
- CHAOS ENGINE£5.99 NICK FALDO'S GOLF£9.99
- All above 4 games £24.99 Add £3.20 P&P

ACCESSORIES

- 3.5" Disk Head Cleaner£1.99
- Mouse Mat£1.99
- 1000 Labels£6.99
- Amiga Disk Drives (Cumana/Amitek/Zappo)£54.99
- Manhattan Mouse Amiga/Atari£12.50
- Universal Printer Stand£4.99
- Add £2.00 For Delivery

TOP QUALITY RIBBONS

	Black	Compatible	Colour	Branded
Panasonic KXP1124/1123/1180/1080	8.50	3.30	N/A	N/A
Panasonic 2123/2180/2135	8.15	4.00		
Citizen 1200/Swift 9/24	N/A	2.70	13.60	
Citizen Swift 90/200	N/A	2.70	13.60	
Star LC10/20	N/A	2.95	10.99	
Star LC200	N/A	3.50	12.30	
Star LC2410/24200	N/A	3.50	12.50	
Epson LX400/LQ100	N/A	4.00	N/A	

Add £2 for Delivery

ZAPPO SMART STOR HARD DISK

Provides games and data portability to A600/A1200.

- 260Mb£209.99
- 540Mb£309.99

AMITEK HAWK RAM BOARD

- 2Mb Ram£127
- Alternative£120
- 4Mb Ram£187
- Alternative£180

Call for GVP A1230 II 40MHz & 50MHz Accelerators

ZAPPO CD ROM FOR A1200 WITH 5 GAMES

Brutal Football - Alien Breed - F17 Challenge - Qwak - Project X

- +Free Pad£219.99

AMIGA CABLES

- Amiga to TV Scart£10.99
- Amiga to Sony TV£10.99
- Amiga to Amiga£10.99
- Modulator overhang lead 23M/23F£11.99
- Joystick Splitters£5.99
- Automatic Mouse/Joystick Cable£13.99
- Joystick Extension Lead 10ft£5.99
- Printer Lead£4.00
- Python 1M Joystick£8.75
- Maverick 1M Joystick£10.99

DUST COVERS

- Amiga 1200/500/500P/600£4.00
- Commodore/Philips Monitors£4.00
- Star/Citizen/Panasonic Printers£4.00

INKJET CARTRIDGES & REFILLS

- HP Deskjet Black Dual Capacity Cartridge£22.99
- HP Deskjet Black Dual Capacity Refill£15.99
- HP Deskjet 500 C /560 C Colour Cartridges£25.99
- HP Deskjet 500 C/560 C Colour Refill£16.99
- Canon BJ 10/200 Black ink Cartridges£16.99
- Canon BJ 10/200 Black ink Refill£9.99

Add £2 for Delivery

PRINTERS

PANASONIC 2135 24 PIN COLOUR

ALL PRINTER FREE LEAD
& DELIVERY

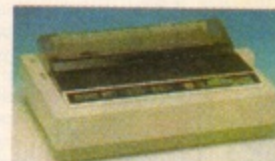

£159.99

- Panasonic 2135 24 pin Colour inc. sheet feeder£159.99
- Panasonic 2023 24 pin mono Free sheet feeder£149.99
- Panasonic 1150 9 pin mono£119.99
- Panasonic KXP 4400 Laser quality£375.00
- Canon BJ105X ink jet£179.99
- Canon BJ200 ink jet£229.99
- Canon BJ400 colour£374.99
- Citizen ABC 24 pin colour£149.99
- Citizen Swift 200 24 pin colour£179.99
- Citizen Swift 240 24 pin colour£214.99
- Citizen Project II inkjet colour£259.99
- Hewlett Packard 320 colour inkjet£249.99
- Hewlett Packard 320 inkjet£224.99
- Hewlett Packard 520 inkjet£249.99
- Hewlett Packard 560 colour inkjet£429.99
- Star LC100 9 pin colour£124.99
- Star LC240 24 pin colour inc. sheet feed£179.99

Add £12.50 for (Word Processor or Ribbon) dust cover, printer stand, 500 A4 paper when purchased with printer

MONITORS

Philips 8833/II

£215.00

As long as stocks last



- Microvitec 1438 (Free speakers)£294.99
- Philips 8833/II£215.00
- Sharp TV/Monitor£169.99

SPECIAL OFFER

HOW TO FIND US



ALL PRICES INCLUDE VAT & DELIVERY (unless otherwise stated). Delivery within 3 days (UK MAINLAND ONLY). ADD £8.00 FOR NEXT DAY DELIVERY CALL OR SEND CHEQUES/POSTAL ORDERS TO:

**GREY-TRONICS LTD, UNIT 1015 WHITGIFT CENTRE,
CROYDON, SURREY CRO 1UU**

SALES HELPLINE: 081-686 9973 Mail order prices only FAX: 081-686 9974

All offers subject to availability. E&OE. Prices/Pack details may change without notice. Please allow 6 working days for cheques to clear.

U.K. & INTERNATIONAL DELIVERY SERVICES - (BFPO ORDERS WELCOME + SURCHARGE)



LAND



AIR



SEA

SOFTWARE

Some of the following games titles are limited offers at the time of going to press. Order early to avoid disappointment. We stock all the latest titles which we offer at appx. 30% OFF R.R.P.

EDUCATIONAL

Table listing educational software titles and prices, including 10/10 Early Essentials, 10/10 Essential Maths, and ADI English series.

Table listing educational software titles and prices, including Triple Action 1-5, Asgard Winners, and Sim Classics.

Table listing educational software titles and prices, including Mavis Beacon Typing 2, Mega Maths, and Micro English.

CD32 SOFTWARE

Table listing CD32 software titles and prices, including Arabian Nights, Arcade Pool, and Banshee.

VISA, MASTERCARD, EUROCARD, P.O. despatched same day! Please allow 4 working days for cheques to clear. CHEQUES/P.O. payable to POST HASTE, 11a, Burgate Lane, Canterbury, Kent. CT12HH. Overseas Orders add £2 postage for Software. Hardware-overseas postage charged at cost. Prices are subject to alteration.

POST HASTE

11a, Burgate Lane, Canterbury, Kent. CT1 2HH TRY US.. WE LIVE UP TO OUR NAME.. RING NOW!!! TEL. 01227-764204 9.30am to 7.00pm



(Answerphone outside normal hours) Any 3 titles £4.99 or less for £10.00 Any 3 titles £7.99 or less for £20.00 Any 3 titles £9.99 or less for £25.00

GAMES

Table listing games titles and prices, including 688 Attack Sub, A Train + constr Set, Action Stations, and Addams Family.

Table listing games titles and prices, including Jack Nick Golf, Jaguar XJ220, James Pond (Not 1200), and JETSTRIKE.

SERIOUS VIDEO & MULTIMEDIA

Table listing serious video and multimedia titles and prices, including Adorage, Big Altern Scroller 2, Broadcast Titler 2, and Scala HT100.

ADVANCE BOOKINGS

We accept advance orders for new releases. You can order with peace of mind as we will despatch on day of release. Your account will not be debited until date of release.

Table listing advance bookings for Disk Expander, GB Route Plus, Video Back Up, Icon Paint, and Maxxost Magic.

HARDWARE

Table listing hardware items and prices, including A1200 Basic Pack, A1200 Innovations Pack, Amitek 2MB Hawk Board, and Amitek 4MB Hawk Board.

Table listing hardware items and prices, including Combat Classics 3, History Line Campaign, Team 17, and The Greatest.

TOP TITLES SPECIALS

Table listing top titles specials and prices, including Armour Geddon, Death Mask, Jungle Strike, Kick Off 3, Euro. PGA Tour, and Premier Manager 3.

Table listing top titles specials and prices, including MR NUTZ, Nick Faldo Golf, Operation Stealth, and Outrun (Not A1200).

Table listing top titles specials and prices, including Quest for Glory 1, Quest for Glory 2, Railroad Tycoon, and Rainbow Islands.

Form for CU AMIGA APRIL ORDER FORM, including fields for Name, Address, Tel. No., Cheque/Credit No., Expiry Date, Description of, Customer Ref.No., Machine, and Titles.

PROGRAMMING

Table listing programming titles and prices, including Easy AMOS, AMOS Professional, AMOS Pro Compiler, and Kraft for AMOS.

MUSIC

Table listing music titles and prices, including Bars & Pipes Pro 2, Deluxe Music C.Set 2, Megalosound Sampler, and Technosound Samples V2.

MISCELLANEOUS

Table listing miscellaneous titles and prices, including PC Task, Directory Opus 4, Dir. Works 2, and On the Ball (League).

A1200 SOFTWARE

Table listing A1200 software titles and prices, including Air Bucks 1.2, Aladdin, ALFRED CHICKEN, and Banshee.

Table listing hardware items and prices, including 50 Blank disks, MONITORS, Philips 66-33-2, Commodore 1942 Multisync, and PRINTERS.

Table listing hardware items and prices, including Overkill, PGA European, Pinball Fantasies, Pinball Illusions, and Premier Manager 3.

You name it!... We do it!... Just phone and we'll quote! WE STOCK ATARI ST, IBM/PC, CDROM, MAC, SNES WE STOCK SEGA, LYNX, JAGUAR, 3DO, C64 CARTR. MAIL & TELEPHONE ORDERS ONLY!... NO PERSONAL CALLERS! Allow up to 10 days delivery Out of Stock items. All trade subject to our terms & conditions available o/r

Turbo Trax

■ Price: £29.99 ■ Publisher: Arcane/Kompart © 0438 840004

Originally due for release last year, has the extra time helped make Turbo Trax the most playable racing game yet?



Apart from Acid's *Roadkill* we haven't seen many Amiga car racing games recently (if you discount *Powerdrive* which was pretty miserable). When they do arrive along though they always seem to become best sellers, ranking up there alongside football titles. This Spring sees three long-awaited games being released in quick succession – Team 17's *All Terrain Racing*, Acid Software's *Super Skidmarks 2* and Arcane's *Turbo Trax*. The competition is hot.

With *Turbo Trax* Arcane has



▲ The desert track. The green computer opposition just love to get in the way.



▲ The amount of detail is impressive on all tracks. Above is the ice track with 4x4 trucks.

been trying to produce something which not only looks graphically polished but also has original gameplay features and realistic controls, this has resulted in a long and turbulent development process, with several major graphics

and game engine overhauls in the last 12 months.

The game itself involves racing one of three types of cars around desert, forest, city and snow covered tracks in a time challenge against computer opponents or in a head-to-head with another player. Two player mode uses either a serial link and two machines or, with one machine, a full screen two player 'catch up' mode, similar to *Micro Machines* and *ATR*, where the losing player gets transported back to the centre of the screen with a time penalty deducted from their score.

Arcane have certainly achieved good results in the graphics department. The vehicles; a jeep, a rally car and an Indy car, are viewed from above, rather like *Roadkill*, and are small but very neatly drawn. The wheels give a strong impression of motion (though they are a tad too shiny for my liking) and collision detection is superb – these cars really do bounce off roadside obstacles in a realistic, if heavily sprung and seriously armour plated, way. The faster you hit an object the bigger the crash. The angles of deflection have been well mapped out too, and the clouds of smoke or dust emanating from the cars' tyres add atmosphere.

Crashing into objects lowers the traction of the wheels and damages the car, but there are repair pickups along the track to ease this problem. There are also spinning dollar icons which, when added to your prize money, allow you to



maximise the car's performance by buying upgrades between levels in the ubiquitous shop. These upgrades govern the speed and traction of the car, so you can buy new engines, high octane fuel, better power steering or tyres.

The other major on-track pickup, and the source of the game's name, are the turbo boosters that are liberally scattered around the er, trax. If you intend to end up in the first three places you'll need to pick up most of these. In normal mode the cars travel at a manageable pace, but once you hit a turbo the speed doubles, along with the excitement, and the effect lasts for a number of seconds. Not quite

long enough to get you to the next turbo, but far enough to get you away from the opposition. Unless you crash that is, or run over the edge of the road into the sand or grit of the trackside, in which case the turbo will dwindle to nothing.

One of the more innovative things about *Turbo Trax* is the view of the car. Rather than constantly centring the sprite, Arcane have gone for what they call a 'helicopter view'. This allows the car to be offset in such a way that you can see more of the track ahead than you can behind. In most cases almost three quarters of the track is ahead of the car and this largely dispenses with the need for arrowed directions on the road.

Turbo Trax is a competent, exciting racing game. The graphics are colourful, polished and very detailed in both the intro screens and menus and the game itself, and this combined with the overhead



▲ The shop allows you to upgrade your car for speed and traction. Collect as many coins as possible for the maximum upgrade.

view of the car makes it a convincing and enjoyable bash. The cars get rather slow if you belt them off the wall a few times and under these circumstances if you hit a turbo you'll spin all over the place, because of the consequent loss of traction, but overall control has been well implemented. An A1200 only version of *Turbo Trax* is also planned with more speed and AGA graphics; this could be even better. ■

Mark Davies



TURBO TRAX	
A500	workbench version.....1.3+
A500	number of disks.....2
A500+	RAM.....1Mb
A500+	hard disk installable.....No
A600	graphics.....93%
A1200	sound.....79%
A1500	lastability.....83%
A1500	playability.....86%
A2000	OVERALL
A3000	A solid, good looking racing game.
A4000	86%

Next Day **£5.00**

2-3 Days **£2.50** Saturday **£10.00**

Deliveries are subject to stock availability

Allow up to 7 days for cheques to clear

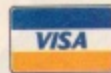

TELEPHONE 01234 273000

POWER COMPUTING LTD
44a/b Stanley St. Bedford MK41 7RW
Tel **01234 273000** Fax **01234 35220**



VIPER

68030



FROM
£115.95
UP TO 128MB
ON-BOARD
(VIPER 2)

VIPER 68030 SERIES

- RAM Up to 8MB (Viper 1)/128MB (Viper 2)
- Full Kickstart Remapping
- Optional SCSI-II adaptor
- On-board battery backed clock/68882 Co-processor
- Instruction and data burst modes

Viper -1 28MHz

PGA/PLCC, FPU upto 50MHz

Bare Board ... **£115.95**

4MB Viper ... **£249.95**

8MB Viper ... **£399.95**

Viper -1 33-42MHz

PGA/PLCC, FPU upto 50MHz

Bare Board ... **£169.95**

4MB Viper ... **£299.95**

8MB Viper ... **£439.95**

Viper -2 28MHz

PLCC only, FPU upto 40MHz

Bare Board ... **£135.95**

4MB Viper ... **£269.95**

8MB Viper ... **£419.95**

Viper -2 40MHz EC

PLCC only, FPU upto 40MHz

Bare Board ... **£199.95**

4MB Viper ... **£329.95**

8MB Viper ... **£469.95**

Viper Co-processors

28MHz FPU ... **£25**

33MHz FPU ... **£50**

40MHz FPU ... **£70**

50MHz FPU (PGA) ... **£100**

Viper Options

SCSI-II Adaptor ... **£79**

4MB SIMM ... **£139**

8MB SIMM ... **£299**

Other SIMMS ... **£POA**

Complete with Crystal, Blizzard Board compatible

VIPER 68030

68030 40MHz RC or 50MHz RC with MMU, RAM upto 128MB, FPU-PGA only.

Bare 40MHz **£229.00**

40MHz-4MB **£379.00**

40MHz-8MB **£499.00**

Bare 50MHz **£249.00**

50MHz-4MB **£399.00**

50MHz-8MB **£519.00**

POWER 1208

- A1200 RAM board
- PCMCIA friendly
- Uses 1 x 32 SIMM
- Amiga Format Gold award
- Expand upto 8MB



2MB **£139.00**

4MB **£189.00**

8MB **£329.00**

XL 1.76MB

The XL Drive 1.76MB measures half the height of a standard external floppy drive and allows you to store a massive 1.76MB on a high density disk. The A4000 internal drive fits perfectly underneath the original drive and no case cutting is required.

EXTERNAL **£59.95**

INTERNAL **£55.95**

A4000 INT. **£55.95**

£59.95
STORE
1.76MB



£49.95
INC. FLOPPY
EXPANDER

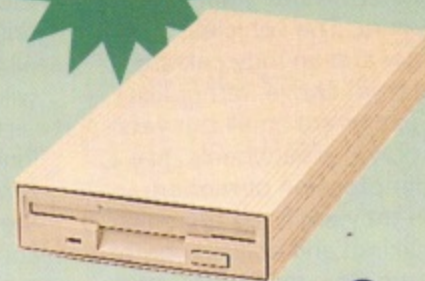

POWER DRIVE

The Power Drive now includes Blitz Amiga and Floppy Expander, free. Floppy Expander allows you to compress files on floppy disks by up to 50%. Other features include: Anti-Click, Anti-Virus, Isolation Switch, 2 Year Warranty, Thru'port, Cyclone Compatible Chip, Backup Hardware and Blitz Compatible feature.

EXTERNAL **£49.95**

CYCLONE S/W ONLY .. **£10.00**

INTERNAL DRIVES

Our internal drives use the same drive mechanisms as the Amiga to ensure complete compatibility.

PC881 A500 **£30.95**

PC882 A2000 **£30.95**

PC883 A600/1200 **£35.95**

£30.95
A500
INTERNAL



All products have a 12 month warranty unless otherwise specified

Trade and Educational orders welcome - Worldwide distribution available

All prices include VAT. Specifications and prices are subject to change without notice, all trademarks are acknowledged. All orders in writing or by telephone will be accepted only subject to our terms and conditions of trade, copies of which are available free of charge on request.

Super League Manager

■ Price: £29.99 ■ Publisher: Audiogenic © 0181 424 2244

With a large kung fu kick, Audiogenic's latest leaps into the cluttered football management market.



▲ Check out how your players are performing via the ratings screen.

Super League Manager's focus is on playability and fun, rather than realism. As the recently appointed manager of shabby Folkford United, currently bottom of an imaginary fourth division, the aim is to progress through the leagues and eventually win the first division title. Should you achieve this difficult feat three times in a row the job of managing the national side

might be fired your way. As well as the management section, the A1200 version also includes an arcade game which allows the manager to further influence a match by taking control and playing. In fact the arcade game included is Audiogenic's footy title from last year, *Wembley International Soccer*. A500 owners have a similar option by using their copy of *Emlyn Hughes International Soccer*, but don't worry if you don't own a copy, as Audiogenic will provide one free of charge.

Deskbound

The majority of the game takes place around the manager's desk. The different icons represent the various sections of the game and are accessed by clicking on them with the manager's arm. All the regular management options are here, such as buying and selling players, as well as the more mundane aspects like keeping a check on the club's finances and making sure the loan agreements are large enough to buy new players.

Despite the importance of the transfer market in football management games, the one in *Super League Manager* is weak. For instance, players appear to play well or badly with no in-between. If they are playing badly it might be because they're unhappy from rotting in the reserves, not being paid enough or simply because they are inept. Whatever, there's no way of finding out

unless you take the risk and buy them. Players have no skill ratings either, the only information available is what position they are best suited to and their approximate value. The manual suggests this is because players don't have ratings in real life. True, but a manager will know his team inside out and be aware of the best players in other teams, otherwise he wouldn't be employed. Training has similar problems. Players suffer if you don't vary their training schedules but surely someone who's a striker should concentrate on fitness and shooting for the majority of the time? Repetition and practice helps create discipline which is the hub of any successful team.

Presentation

Browsing through the Gazette is arguably the best option. Brilliantly presented, the Gazette has plenty of potential transfer gossip, the latest job vacancies and match reports and player ratings for the most recent games. Excellent stuff. Indeed the whole game is a class act when it comes to presentation. The graphics are of a high standard for a management game and the FX are excellent, from the wonderfully tacky hold music when waiting on the telephone to the slurping sound of a drink being knocked back.

Unfortunately though, *Super League Manager* suffers from a number of annoying features which considerably lowered my opinion of the game. For instance, the tea lady is fond of clogging up the in-tray with complaints if you don't drink her beverages. Although amusing at first it quickly becomes irritating, especially when trying to scan through messages quickly because the phone is

ringing. What's worse is that drinking a beverage requires the drink to be clicked on a few times which I imagine represents someone sipping their way through. Arggggh! The tea lady also has a habit of complaining to other players which can affect your standing with them. This is just plain stupid and very annoying. Another irritation is found in the arcade section. Although not the greatest of games it would be much better if it could be selected whenever desired rather than having to rely on whether Match of the Day were showing it or not.

Super League Manager is fun but too basic to be considered a serious challenger in the football management genre and not playable enough to win over arcade fans. I'd rather have a more statistically heavy football management sim like *Championship Manager* or a premium arcade footy game like *Sensible World of Soccer*, not an average mixture of both and I'm afraid you'll feel the same way. ■

Rik Skews



▲ Keep a track on potential purchases by putting a scout on them.



▲ GOAAAAAAAAAAAAAAAAAAAAAAAAAAAAAAAAAAAAAL! Hurrah!

SUPER LEAGUE MANAGER

A500	workbench version.....1.3+	
	number of disks.....2	
A500+	RAM.....1Mb+	
	hard disk installable.....no	
A600	graphics.....	76%
A1200	sound.....	77%
A1500	lastability.....	72%
	playability.....	71%
A2000	OVERALL	71%
A3000	Good but needs more statistics for longevity.	
A4000		

CITIZEN COLOUR PRINTERS

FREE! FROM SILICA

- DELIVERY** - On orders over £40, next day - anywhere in the UK mainland
- 2 YEAR WARRANTY** (Excluding consumables)
- PRINTER KIT** With Citizen dot matrix printers from Silica
- WINDOWS 3.1** Free Windows 3.1 driver with Printer Kit
- HELPLINE** Technical support during office hours

FREE! PRINTER KIT WORTH £57.58



FREE PRINTER KIT INCLUDES:

- 3 1/2" Disk with Amiga Print Manager
- 3 1/2" Disk with Windows 3.1 Driver
- 1.8 Metre Parallel Printer Cable
- 200 Sheets of Continuous Paper
- 50 Continuous Tractor Feed Address Labels
- 50 Continuous Tractor Feed Disk Labels

AMIGA PRINT MANAGER
For faster printing from your Amiga, with clearer images and more vibrant colours. Available free of charge as part of the Silica Printer Kit.

KIT VALUE £57.58 INC VAT



FREE! PRINTER KIT
SEE LEFT

2 YEAR WARRANTY

- 24 pin - 80 column
- 192cps Draft (12cpi) 64cps LQ (12cpi)
- 8K Printer Buffer
- 5 Fonts - 2 Scalable
- Parallel Interface
- Graphics Resolution: 360 x 360dpi
- Epson & IBM Emulation
- Autoset Facility
- Quiet < 48dB(A)
- Built-in 50 Sheet Automatic Feeder
- "EASYSTART" S/W - Windows Driver - Amiga Driver
- Optional 128K RAM, Colour Kit, Tractor Feed
- FREE Silica Printer Kit
- 2 Year Warranty

FREE DELIVERY IN UK MAINLAND

24 PIN 192 CPS 80 COLUMN
COLOUR KIT OPTIONAL EXTRA - SEE BELOW

IDEAL FOR THE FIRST-TIME USER

EASYSTART SOFTWARE



ABC - MONO PRINTER

OPTIONAL COLOUR KIT
£21.28 + VAT = **£25** INC VAT
PRA 1237

SAVE £5 COLOUR KIT ONLY £20 WHEN PURCHASED WITH PRINTER

RRP £189.00
PRINTER KIT ... £49.00
TOTAL VALUE: £238.00
SAVING: £119.70
SILICA PRICE: £118.30

£118.30 PRI 2411 + VAT =
£139
INCLUDING VAT
FREE DELIVERY

COLOUR PORTABLE 126 CPS



FREE COLOUR RIBBON

- Citizen Portable Thermal Notebook Printer II
- Fast LQ Output - 126cps (12cpi)
- 18K Printer Buffer & 5 Fonts
- Parallel Interface
- Graphics Resolution: 360 x 360 dpi
- Epson, IBM, NEC and Citizen Emulations
- Drivers for MS Windows 3.1, MS Word and WordPerfect
- Prints on 8 1/2" Paper
- Built-in Auto Sheet Feeder - 5 Sheets
- Spot Colour & Black Ribbons Supplied
- Battery Optional (included)
- 2 Year Warranty

RRP £229.00
FREE RIBBON £5.99
TOTAL VALUE: £234.99
SAVING: £39.99
SILICA PRICE: £194.99
PRI 2104 + VAT =
£229 INCLUDING VAT

FREE DELIVERY
SPECIAL OFFER! NOTEBOOK PRINTER II BATTERY WHEN PURCHASED WITH PRINTER Ref: PRA 1148 - Normal price £44.99 INC VAT **£20** INC VAT
SAVE NEARLY £40

INKJET 180 CPS 80 COLUMN

- Citizen Projct II Inkjet - 80 column
- 180cps Draft (10cpi)
- 120cps NLQ (10cpi)
- 50 Nozzle Head
- 50K Printer Buffer
- 3 Fonts Built-in
- 1 x IC Card Slot
- Optional HP Compatible Font Cards
- Parallel Interface
- Graphics Resolution: 300 x 300dpi
- HP Deskjet Plus (PCL3+) Emulation
- Automatic Sheet Feeder
- Includes Enhanced Windows 3.1 Driver
- Quiet - 46dB(A)
- 2 Year Warranty



FREE DELIVERY IN UK MAINLAND

FREE CABLE

PROJET IIC COLOUR

£228.94 PRI 2097 + VAT =
£279
INCLUDING VAT
FREE DELIVERY

RRP £279.00
FREE CABLE £8.47
TOTAL VALUE: £287.47
SAVING: £58.53
SILICA PRICE: £228.94

24PIN FAST DOT MATRIX 270 CPS 80 COLUMN

- Citizen Swift 200C - 24 pin - 80 column
- 270cps SD (15cpi), 216 cps Draft (12cpi), 72cps LQ (12cpi)
- 8K Printer Buffer - 40K maximum
- 7 LQ Fonts
- Parallel Interface
- Graphics Resolution: 360 x 360dpi
- Epson, IBM, NEC P20 & CEL Emulations
- Quarter Printing Facility
- Auto Set Facility Bi-directional Interface, Auto Emulation Detection
- Ultra Quiet Mode - 43dB(A)
- Colour Printing Standard
- FREE Silica Printer Kit
- 2 Year Warranty

FAST COLOUR
24-PIN DOT MATRIX



STAR BUY

2 YEAR WARRANTY

SWIFT 200C COLOUR

FREE! PRINTER KIT
SEE ABOVE

FREE DELIVERY IN UK MAINLAND

RRP £279.00
PRINTER KIT £49.00
TOTAL VALUE: £328.00
SAVING: £175.66
SILICA PRICE: £152.34

£152.34 PRI 2495 + VAT =
£179
INCLUDING VAT
FREE DELIVERY

THE SILICA SERVICE

Before you decide WHEN to buy, we suggest you consider WHERE to buy and protect your investment with a purchase from Silica. With our unrivalled experience and expertise, we will provide all the extra help, advice and new product information you may need both now and in the future. Visit one of our stores, or return this coupon now and begin to experience the "Silica Service".

Silica

DEBENHAMS
STORES NATIONWIDE

- ESTABLISHED 17 YEARS:** We have a proven track record in professional computer sales.
- PART OF A £50M A YEAR COMPANY:** With over 300 staff - We are solid and reliable.
- EXPERIENCED STAFF:** All fully trained in "Customer Care".
- TECHNICAL SUPPORT HELPLINE:** FREE help and advice from a team of experts.
- A FULL PRODUCT RANGE:** All of your computer requirements from one supplier.
- WE PRICE MATCH:** On a "Same product - Same price" basis.
- FREE CATALOGUES.**
- PAYMENT:** We accept most major credit cards, cash, cheque or monthly terms (APR 23.8% - written quotes on request).
- VOLUME DISCOUNTS AVAILABLE:** Business, Education and Government. Tel: 0181-308 8888.
- MAIL ORDER:** FREE DELIVERY in UK mainland on orders over £40+VAT. Small administration charge (£2.50+VAT) on orders under £40+VAT.
- 22 STORES NATIONWIDE:** *Mini Stores carry a selected range only but products can be ordered in the stores via Mail Order.

MAIL ORDER 0181-309 1111
PLUS TECHNICAL AND HEAD OFFICE

Silica, Silica House, Hatherley Road, Sidcup, Kent, DA14 4DX

PLUS BRANCHES AT:

BRISTOL	Debenhams - (1st Floor), St James Barton	0117-929 1021
CARDIFF	Debenhams - (1st Floor), St David's Way	01222 341576
CHELMSFORD	Debenhams - (2nd Floor), 27 High Street	01245 355511
CROYDON	Debenhams - (2nd Floor), 11-31 North End	0181-688 4455
GLASGOW	Debenhams - (1st Floor), 97 Argyle Street	0141-221 0088
GUILDFORD	Debenhams - (2nd Floor), Millbrook	01483 301300
HARROW	Debenhams - (2nd Floor), Station Road	0181-427 4300
HULL	Debenhams - (2nd Floor), Prospect Street	01482 325151
IPSWICH	Debenhams - (2nd Floor), Westgate Street	01473 221313
LONDON	Silica - 52 Tottenham Court Road	0171-580 4000
LONDON	Debenhams - (2nd Floor), 334 Oxford St	0171-580 3000
LONDON	Harrods - (2nd Floor), Knightsbridge	0171-730 1234
LUTON	Debenhams - (1st Floor), Arndale Centre	01582 21201
MANCHESTER	Debenhams - (2nd Floor), Market Street	0161-832 8666
PLYMOUTH	Debenhams - (2nd Floor), Royal Parade	01752 266666
ROMFORD	Debenhams - (2nd Floor), Market Place	01708 766066
SHEFFIELD	Debenhams - (2nd Floor), The Moor	0114-276 8611
SHEFFIELD	Debenhams - (1st Ground), Meadowhall Centre	0114-256 9779
SIDCUP	Silica - Silica House, Hatherley Rd	0181-302 8811
SOUTHAMPTON	Debenhams - (1st Floor), Queensway	01703 223888
SOUTHEND	Keddiess - (2nd Floor), High Street	01702 462426
THURROCK	Debenhams - (1st Floor), Lakeside Centre	01708 863587

Silica

To: Silica, CMUSR-0495-215, Silica House, Hatherley Rd, Sidcup, Kent, DA14 4DX

PLEASE SEND INFORMATION ON THE CITIZEN RANGE

Mr/Mrs/Miss/Ms: Initials:

Surname:

Company (if applicable):

Address:

Postcode:

Tel (Home):

Tel (Work):

Which computer(s), if any, do you own?

COMPUTER SHOPPER
1994 Awards WINNER
Best Software Delivery Service

COMPUTER SHOPPER
1994 Awards NOMINATION
Best Software Delivery Service

215J

X-IT

■ Price: £19.99 ■ Publisher: Psygnosis © 0151 709 5755



▲ Frying tonight. step on the wrong block and you'll have an electrifying experience.

taking over the Earth and need a human guinea pig to test the intelligence of their intended victims.

As Bill (the unlikely hero) you must negotiate level after level of sneaky puzzles in your attempts to save the World. Basically a puzzle game, *X-IT* is a race against the clock, in which the sole object of each level is to reach the exit.

This may sound a tiny bit easy, and it would be if it was not for the fact that every room is littered with holes, which makes your short journey to freedom all the more difficult. To

help you combat these perilous pitfalls, you have at your disposal ... blocks.

"BLOCKS!" I here you cry, yes blocks. No ray guns here I'm afraid, just good old fashioned blocks. These blocks must be pushed into the holes closing them up and allowing you safe passage to exit. Ingenious I'm sure you'll agree, but that's not all, some of the

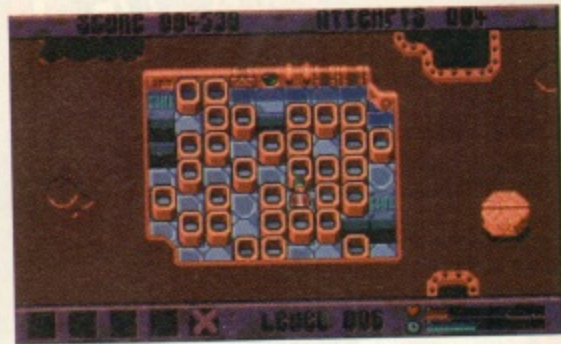

blocks are heavy, some are light, some slide, some melt, but all have the common goal of helping you reach the exit.

The first thing that struck me about *X-IT* is how easy the first 15 or so levels are – then it became very difficult. It didn't feel as if there is any real learning curve to the game. I ended up wishing that the aliens had not kidnapped me.

MT

CD32
A500
A500+
A600
A1200
A1500
A2000
A3000
A4000

58%



Life is a funny thing, one minute you're walking down the street minding your own business, the next you're thrown into some kind of man-sized rat maze. What? you mean this has never happened to you? Well you can't have played *X-IT*, because if you had you would know that aliens are thinking of

Akira

■ Price: £29.99 ■ Publisher: ICE © 0453 756 993



When Manga originally released the *Akira* film, it was received with critical acclaim for its stunning animation, and equally amazing plot. Now with hundreds of Manga films available, the announcement of an Amiga *Akira* game came as no surprise.

The game follows the plot of the film, in which a gang of teenage bikers stumble across a small boy on the run from the government. The little lad, known only as Number 26, is in fact a mutant, and has amazing super-human powers.

If I said *Akira* on the Amiga was disappointing it would be a massive understatement. It really



▲ Looks like Herbie goes askew in this screenshot. Spitting is not nice, you know.



▲ Like wow man, what a fab and groovy machine on two wheels you've got there.



▲ What's this? How did that toboggan-shaped thing get in here?



▲ The evil one-eyed monster prepares to meet his doom.

is terrible. I found the controls were slow and clumsy, and the character animation very wooden.

I also found fault with the gameplay – it was limited at the best of times. The early levels have you riding around on a motorbike, bumping into traffic cones which boost your speed. Hello! Mr. programmer, I don't want to ruin the illusion for you, but if you were to ride your motorbike into a traffic cone at 100mph, rather than speeding up, I think you'd be more likely to perform a triple front somersault with a half twist. The music and sound effects also failed to impress me.

In case you hadn't guessed by now, *Akira* is big disappointment. It was always going to be hard to produce a game anywhere near good as the film, but there's no excuse for releasing something which in my opinion is awful. Just when movie tie-ins were getting really good. ■

MT

CD32
A500
A500+
A600
A1200
A1500
A2000
A3000
A4000

18%

Benefactor

■ Price: £29.99 ■ Publisher: Psygnosis ☎ 051 709 5755

Red and yellow and pink and green, orange and purple and blue, I can see a rainbow, see a rainbow, see a rainbow too". That was the song the happy people of Lullyat known as the Merry Men used to sing everyday, because they knew that the amazing rainbow which surrounded their planet was the source of their happiness, and that the fantastic machine which generated that rainbow was the most fantastic and wonderful thing ever created.

But as in real life, happiness is short lived, and so came the day that the inhabitants of Minniat decided to pay their neighbours on Lullyat a little visit. All was going well on the Merry Men's tour, until they came to the Rainbow Temple where the Marvellous Rainbow Machine was housed.

The people of Minniat did indeed agree with the Merry Men that the Rainbow Machine was a masterpiece. So much so, that the very same night they stole it, along with the Merry Men who were guarding the Rainbow Temple.



You play the part of Ben.E.Factor (Benefactor), ex-marine, who now devotes his life to helping people, and you've intercepted the captured Merry Men's S.O.S signal, so off you must go to rescue them and the Rainbow Machine.

Benefactor is splendid game which bears (graphically anyway) a striking resemblance to *Lemmings*. The game itself requires you to find the keys which will unlock the doors to the Merry Men's cells. Once rescued, you and



the Merry Men must make it to the teleporter in order to escape.

Benefactor is full of cunning puzzles, and lovely animations, which makes it one of the best platform-based puzzle games out at the moment. ■

MT

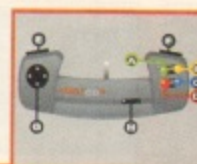

Drop objects
B Short diagonal jump
Roll
Pick up objects
E Map scrolls left
F Map scrolls right

88%

Extractors

■ Price: £29.99 ■ Publisher: Millennium ☎ 081 988 8888

Five men at your beck and call, rushing here, there and everywhere at your command – sounds like heaven to me. And I also get to choose which assortment of chaps I want on my team. No, I'm not talking about a Blind Date for polygamists, it's *Extractors* from Millennium.



In the game you've the option to choose your five man team from three different races: Habbish – who are very intelligent but tend to get bored and sit down for no reason, Boids – who have good stamina, heal quickly, but are not so good at digging and finally Raldein – who are fast diggers but tire easily. A combination of all types is best. The plot is simple: you've got to lead your band of merry men across 30 levels destroying all the shield generators that are guarding the planet in order to reclaim it.

There are plenty of nasty creatures and henchmen trying to thwart your mission and your spaceship isn't the best, so you've got spend your time mining for fuel to make sure it can get you to the next level. You're not totally on your own though. Pick up enough precious stones and you can trade them in the shop for lots of goodies such as high-tech mining equipment, a first aid kit, weapons and maps to name a few.

In-game control is easy enough. There's an

icon bar at the bottom of the screen which you can use to get your diggers to dig, pick up, drop, teleport back to the spaceship and so on.

Extractors is an ideal game if you have a lot of patience and enjoy long term strategy. I unfortunately am extremely impatient and spent most of my time getting annoyed with the little blighters who kept wandering off, drowning, getting bored, and getting on my nerves generally. However, that's just me. It is well put together with nice graphics but unfortunately I found the gameplay a bit too boring to keep me hooked for a long time. ■

LC

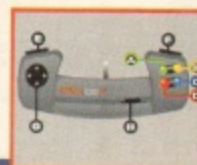

Pause
B Pause
Call up menu
Selection
Scrolls left
Scrolls right

75%

AMIGA SOFTWARE



VIRUS KILLER
A Virus killer is an essential purchase in these days where there are hundreds of Amiga viruses. Make sure your software collection is free from all known viruses.
£4.00

VIP4-2. VIRUS KILLERS



Wookbench 3 is good but Commodore forgot to include a few things, like a virus killer, a decent Text editor, a few leisurely games, more datatypes, a tiny clock, a file copier, a decent disk copier, a hard disk menu system and a few other things.
Only £7.00

SCF7-3. STUFF COMMODORE FORGOT



Star Trek the game is a superb interactive action/strategy game where you take control of all key personnel on the bridge. Great gfx & gfx.
Only £6.00

STG6-3. STAR TREK - THE GAME



Now the winter's here, it's a good reason not to have to do the garden - because you'll be too busy designing it.
Only £3.00

GRN3-1. 3D GARDEN DESIGNER



A two disk collection of various Scala background textures. Wood, paper, etc. Gives your Scala production a more professional finish.
Only £6.00

SCA6-2. SCALA BACKDROPS

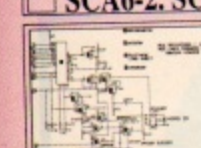

Make your own hardware and save £££s. Sound samplers, memory expansions, Bridgeboards are all here. Includes complete diagrams.
Only £4.00

HWP4-2. HARDWARE PROJECTS 2



Forty top quality compugraphic fonts for use with WB2/3, Pagestream, Wordworth, D Paint 4 etc, etc.
Only £7.00

PSF7-3. COMPUGRAPHIC FONTS



Four all time classic board games. Scrabble, Cluedo, Snakes and Ladders, and Monopoly. Great fun for all the family.
All for only £10.00

BDG10-4. BOARD GAMES



This is the most powerful Amiga disk duplicator available. The manufacturers claim it will copy every Amiga disk known to man. Includes s/w & hardware
Special Price £29.95
* Unboxed version now being supplied

SXCP30-1. XCOPY PRO.



Fifty stunning AGA images in 256 colours, on 10 disks. All of which will blow your mind.
Only £15.00

GRL15-10. BATHING BABES AGA



News Maker allows you to create great looking documents. Try Desk Top Publishing for yourself and see just how brilliant it really is on the Amiga.
All for only £4.00

NRL4-1. NEWS MAKER



Features all you need to crunch, archive & decrunch any file or disk. Includes DMS the Disk masher, Powerpacker, LHA etc.
Only £5.00

CRM5-2. CRUNCH MANIA



Over 1000 Top Amiga game cheats on five disks. Includes all popular titles like: Monkey Island, Project X etc, etc.
Only £9.00

CHT9-5. 1000 GAME CHEATS



Over 70 top quality imagine objects on five great disks. Subjects include: Vehicles, Animals, Star Trek and loads more miscellaneous objects.
Only £10.00

IOD10-5. IMAGINE OBJECTS 2



Hundreds of general knowledge questions. Subjects include: Sport, Films, Music, Science, Geography. Test your knowledge with this excellent Trivia game.
Only £5.00

QUZ5-2. QUIZ MASTER



Run PCAT software on your Amiga. Supports VGA on the A1200 or A4000. Works with your Hard Disk, Floppy Drive, Serial, Parallel & mouse ports. Runs Windows etc.
£69.95

PCT70-1. PC TASK 3 AT



A superb three disk set of frustrating mind teasers. Over 10 brilliant Puzzle games. You'll be hooked in minutes.
Only £7.00

MTG7-3. MIND TEASERS!!



A complete Word Processing package. Features all standard options like: cut paste, tab, spell check etc. A very easy to use package.
Only £3.00

TXE3-1. WORD PROCESSING

FREE!!!
FREE BOX OF TEN BLANK DISKS WITH EVERY ORDER OVER £25
Don't forget to ask for them



Create your own fascinating Random dot Stereograms, very easy to use.
Only £3.00

RDS3-1. RDS Professional



Get your finances in order with this excellent package. Take a closer look at your bank accounts, find out where all your money goes every month.
Only £7.00

FIN7-3. FINANCE



A two disk set of extra backgrounds, icons etc. for use with Magic Workbench. Requires KS2/3.
Only £5.00

MWE5-2. MAGIC WB EXTRAS



The most professional word search, crossword solver available on the Amiga. Includes a dictionary of over 58,000 words, and you can add your own.
Only £5.00

WFP5-2. WORD FINDER PRO.



If you're new to the Amiga, then you may be having problems with missing Libraries on your workbench that are needed to run particular software. Order this now and solve those problems.
£2.00

EFB2-1. ESSENTIAL FOR BEGINNERS



A selection of tools for degrading your A1200 down to a 500. Very easy to use, but extremely effective way of running old games etc.
Only £4.00

DEG4-2. A1200 DEGRADERS



A new set of 4 disks containing numerous printer tools. Includes: printer drivers, label maker, address programs, print manager, and other useful tools.
Only £7.00

PRT7-4. PRINTER TOOLS 2



Over 3,500 top quality Amiga icons for use in workbench. A bargain at just.
£5.00

AIA5-4. ICON ARCHIVE



If you want to be a budding Ian Beale or Floyd then THE GOURMET COOK BOOK is a good way to get started. Over 50 recipes included.
Only £3.00

GCB3-1. THE COOK BOOK



Over 130 stunning full colour Lion King clipart images for use in any Paint or Desk Top Publishing package.
All 3 disks only £7.00

LKA6-3. THE LION KING Clipart

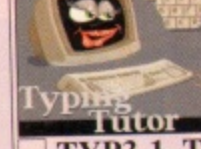

Learning to type can be a difficult task, but not when you get a copy of our classic typing tutors. Includes three programs to help you learn to type.
Only £3.00

TYP3-1. TYPING TUTOR

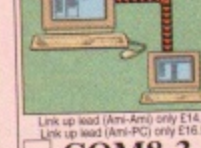

Whether you want to link two Amigas together, or 2 PCs or Amiga to PC, then this package will suit you. Easy to install.
Only £8.00

COM8-3. NETWORKING

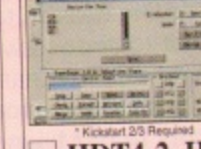

An essential purchase for all Hard Disk owners. Includes backup tools, file managers, virus tools and loads more.
Only £4.00

HDT4-2. HARD DISK TOOLS

Priority Order Form

Name
Address.....
Amiga model Payment
Credit Card No
Exp.

All clipart images are stored as IFF so they can be used in any Amiga DTP or paint package. Packs ITX 12-6 & HWP4-2 require some knowledge of LHA, which is supplied with these titles.
Kickstart 2/3 means you require an A500+, A600, A1200 or any machine fitted with Kickstart 2 or 3.
AGA means you will require either an A1200 or A4000 to use that particular title.

Order Value

Amount of Packs XXX10-5. PACK TITLE Individually priced	QTY	
		= £
Other Items		= £
Total goods value		= £
Postage & Packing <small>Please add a total of 50p for P&P in the UK</small>		50p in the UK. = £
Amount enclosed		= £
ALL TITLES ADVERTISED ARE IN STOCK READY FOR DESPATCH		

Ordering by post
Simply send us a written order with a list of the disks you require, or simply tick the boxes of the titles you require, fill in your name and address, remove or photocopy this page and send it along with full payment to: Epic Marketing, 138-139 Victoria Rd, Swindon, Wiltshire, SN1 3BU.

Collecting disks
PD disks can be collected same day, but if your order is quite large, please phone in a few hours previous to pick-up.

Overseas Orders
Overseas orders are welcome, but please add £1.00 to each title ordered, & a minimum of 5 titles apply.

Postage & Packing
Please add a total of 50p to your order if in the UK for floppy disk orders. Add £1.00 per CD in UK. Overseas please add £1.00 to each pack ordered for 1st class delivery and £2.00 per CDROM title ordered.

Compatibility
All titles advertised should work on any Amiga unless stated. AGA means that it only works on A1200/A4000. KS2/3 means that title requires an A500+/A600/A1200.

Ordering by phone
To place an order over the phone simply call any time between 9.30 & 5.30pm Monday to Saturday with your credit card details and the disks you would like to order. (Orders can usually be placed up to 6pm every evening).

IMAGINE
HINTS, TIPS & TUTORIALS
This 40-page book will give you hundreds of helpful hints & tips for Imagine users.
FREE COMPANION DISK
Containing Objects, Textures etc.
Only £7.95 + P&P

CD 32 LINKUP
Connect your CD32 to your Amiga for easy transfer of ALL CD Rom discs.
Complete with leads + CD Rom boot software
CDL35-1. Only £34.95 + £1.00 P&P



Order hotline: 0793 490988 Fax: 514187

MGB3-1. MEGABALL AGA

Megaball V3 is most definitely the best ever "Break-out" game available. Superb AGA graphics, music and gameplay make this an all time classic.

Only £3.00

ENG9-5. INSIDE ENGINES

Inside Engines is a compilation of in-depth animation sequences showing you the workings of all the most popular engine types.

Only £9.00

ENK3-1. ENGINEER'S KIT

The complete system analyser. Test your drives, memory, keyboard, mouse, expansions and all your custom chips etc.

Only £3.00

CDPD IV COLLECTION

Thousands of useful tools, demos, games and graphics. Imagine objects, and loads more.

Only £19.95

GG10-4. 101 GAMES

Over 100 all time classic games including: Breakout, Pacman, Space Invaders, Snakes, loads of puzzle games and more.

Only £10.00

GFX13-10. PRO CLIPART

Hundreds of high quality professional clipart images. Subjects include: Transport, People, Computers, Xmas and loads more. A much wider scope.

Only £13.00

SAM7-5. IFF SAMPLES

Hundreds of high quality IFF samples, including: drums, guitars, bass, vocals and beats. Perfect for Music X, Med or any tracker clone.

Only £7.00

ADULT SENSATION CD

Over 3,000 AGA pictures of beautiful ladies. Stunning images in up to 256 colours. Complete with powerful picture viewer.

Only £19.95

ILR3-1. ROBOT OBJECTS

Features numerous Lightwave & Imagine objects of Robots and Robot related items. Requires min 2Mb RAM.

Only £3.00

SPE5-3. SPECCY EMULATOR 2 £5.00

Play 100s of all time classic Spectrum games on your Amiga. Inc: Jet Set Willy, Attic Atak, Star Trek, Uridium and loads more

Only £5.00

ARC6-4. ARCADE CLASSICS

Features 4 all time classics. New & old versions of Pacman, Space Invaders, Asteroids and Galaxians. Remember the good old days for now only £5.00.

SPECCY SENSATION CD

NEW! NEW! Features the Spectrum Emulator and over 500 all time classic Spectrum games on one CD ROM.

Only £19.95

WGB5-2. WORKBENCH BACKDROPS

A selection of superb girly pictures to place in the background of your Workbench.

Only £5.00

DRV3-1. PRINTER DRIVERS

A selection of printer drivers including all popular printers such as: Hewlett Packard, Star, Panasonic, Epson, IBM, OKI, Seikosha, Postscript etc.

Only £3.00

AHD7-2. HARD DISK INSTALLER

An essential tool for installing workbench on your new hard disk. Easy to use either on the A600 or A1200.

Only £7.00

AMINET 4 CD ROM

Thousands of archived tools, including: patches, Dir tools, music, graphics, AGA tools, workbench tools. It'll take you months to sift through this lot.

Only £19.99

IFC7-3. LITTLE OFFICE

Whether you run a small business or just need to go computerised then this superb easy to use integrated package is what you want.

£7.00

VID12-6. VIDEO STUFF

Contains a selection of Video titlers, Video wipes & backdrops. Great for creating professional home movies. All you need.

Only £12.00

CTG5-3. CATALOGERS

Organise your entertainment media with this set of cataloguing tools. Video, CD and disks are all catered for.

Only £5.00

ABS6-4. BETTING SHOP

If you like to have a little flutter then this is for you. Contains a number of brilliant gambling games. Includes Roulette, Craps, Fruit machine, etc.

Only £6.00

BTS4-2. BIG TIME SENSUALITY

This is the most impressive AGA demonstration available. If you want to impress someone, then this is what will do it. Features a brilliant Bjoerg soundtrack.

Only £4.00

ABG9-5. BEGINNER'S GUIDE

If you've just purchased your Amiga you may be a bit bogged how to use it properly. Well this five disk set takes you step by step through every basic thing to know.

£9.00

GFC5-2. GFX CONVERTER

Convert graphics formats between PCX, GIFF, IFF, TIFF etc. Easy to use...

Only £5.00

DSP10-1. DELUXE STRIP POKER 2

Play Poker with some of the most lovely ladies in the world. Great fun for all the family, NOT! Includes superb graphics and digitised speech.

Now Only £10.00

ITX12-7. IMAGINE TEXTURES

Large range of Textures for use in Imagine. Render your objects in a variety of shades, colours and textures. Compatible with all Amigas.

Only £12.00

CRD10-4. CARD GAMES

A collection of Amiga card games including: Poker, Craps, Solitaire etc. Great fun for all the family.

Only £10.00

LPW5-1. LOTTERY WINNER PRO.

LOTTERY WINNER PROFESSIONAL can predict the National Lottery results with as little as only a couple of months back data. The more data you input the more accurate the results.

Only £5.00

JIT4-1. CHESS & TUTOR

Whether you're a complete beginner at chess or a champion, JI CHESS has something for you. Superb graphics and speech make this a great software title.

Only £4.00

CPY5-2. DISK COPIERS

A compilation of very powerful disk copiers, make backups of your software collection with ease.

Only £5.00

TTU3-1. 203 UTILITIES

Over 200 Workbench 2 or 3 utilities/tools, including: text editors, virus killers, disk editors, sound & graphic tools and loads more.

Only £3.00

THE NATIONAL LOTTERY

CCP9-5. COLOUR CLIPART SET

A new collection of 5 brilliant disks crammed with colour clipart images. Subjects include: Cats, dogs, plants, animals, comical, vehicles, ships etc.

Only £9.00

FNT7-3. FONTS & EDITOR

Seventy bitmap fonts for use in almost any package including Deluxe Paint. Also features a fantastic font editor for designing or customising your own fonts.

Only £7.00

ATC5-2. POWERTOOLS

A new collection of tools for WB 2/3 machines. Includes: virus killers, editors, sound tools, gfx tools, HD tools, and loads of other stuff. It'll take you ages to go through this lot.

£5.00

CF8-1. CENTREFOLD SQUARES

Another great puzzle game for adults. A pint of the best, a packet of peanuts and a good game of Centrefold Squares. "What a life!"

Now Only £8.00

EDU9-4. EDUCATIONAL

A collection of great fun educational games for children under 7. Maths, spelling, speed, etc. are all included in this excellent compilation.

Only £9.00

TET9-5. TETRIS MAYHEM

Tetris is the most addictive game in the world, and that's a fact. This is a compilation of five of the best. Best graphics, best sound and best playability.

Only £9.00

MPC3-1. PAGESETTER ART

A range of clipart for use with PageSetter. Dozens of subjects including: People, Vehicles, Animals, Computers, Sport etc, etc.

Only £3.00

PSW10-4. PASSWORD

Stop other people from accessing your floppy or hard disks, by putting a customised password on your disk. Also contains file encryption tools.

Only £10.00

ENCRYPTOR

Skeleton Krew

■ Price: £29.99 ■ Publisher: Core Design ☎ 01322 297797

The year is 2062, and Monstro City is at the mercy of evil kryogenics experimenter Moribund Kadaver. Ever since his monolithic kryogenics plant opened at the edge of the City, the populace of Monstro have been terrorised by a strange and hideous mutant known only as Psykogenix.

When news of the goings on reached the Military Ascertainment Department (MAD), special operatives were dispatched to Monstro to give the mutants a damn good drubbing... only one returned. His last few breaths tell of a terrible Psyko Machine being created by Moribund Kadaver in secret his lab, DEAD 1.

So MAD decide to get nasty, and send in the Skeleton Krew, a trio of hard core mercenaries who live for causing death and destruction. This is where you get the opportunity to take control of either Spine, Joint, or Rib in their attempts to stop the psychopathic Kadaver.

Skeleton Krew is an isometric shoot em up, where the aim of the game is quite simply to kill everything that moves. Each level has

hordes of mutants hell bent on tearing you to shreds.

Fortunately, you have at your disposal two different type of gun, the first a straight forward energy blaster allowing you to pick off the monsters at long range, the second being high powered energy mines which are devastating for those more intimate encounters.

Skeleton Krew is a brave attempt at producing a really instinctive shoot 'em up, but unfortunately the game is let down a tad by gameplay that could have been better. For example, every level is the same old thing, "oh look there's a monster BANG!", this gets incredibly boring FAST. The graphics, while being well drawn are very jerky, and some of the animation on the sprites is left wanting in some areas.

Skeleton Krew would have been a great game if some variety had been added to the gameplay, and if more time had been spent ironing out some of the game's little niggles, such



as the sprite animation and scrolling. Heaven knows why our editor gave it such a high mark last month. ■

MT

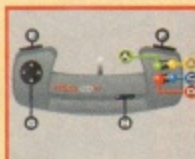

48%

Dragonstone

■ Price: £29.99 ■ Publisher: Core Design ☎ 01322 297797

Nice graphics, pity about the gameplay' is a phrase that seems to have been banded about concerning Core Design's latest RPG. I agree that the graphics are wonderful. Areas such as the woodlands and the village are beautifully detailed with lush greenery, chatty villagers, mysterious magicians, sparkling



ponds and such like. And there are plenty of good sound effects as well. The birds tweeting away in the woodlands, for example, add a great deal to the ambience.

However, I beg to differ with the attack on gameplay. Starting off in a woodland, you are a brave warrior armed only with a sword, left to your devices to work your way through the game, which involves lots of puzzle-solving and plenty of battling against goblins and snotty green monsters.

The main reason for *Dragonstone's* failing in the gameplay department seems to have centred around the fact that when you are attacked by goblin type creatures they drain you of your energy so quickly that you die within seconds. I found this to be quite true the first few times that I attempted to play *Dragonstone*. However, when I consulted the manual's handy hints section it said that holding down on the fire button and releasing carefully-timed

blows worked better than mindless hacking and slashing which is what I had been doing. Bearing this in mind I went back to the game and hey, guess what, it worked for me. Holding down on the fire button for long enough also released handy psychic bolts which didn't use up much of my energy and stunned my opponents long enough for me to kill them.

But there were times when I was clubbed to death by a greeny oaf without even getting a chance to retaliate which just left me feeling like chucking the games across the room. However, if you enjoy RPGs and are blessed with a nimble finger which are must to get away from irritating goblins that lurch at you, then you do far worse than buying a copy of *Dragonstone*. ■

LC

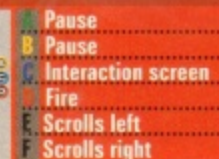

75%



Ishar 2

£12.99 Daze Marketing 0171 372 7435

The *Ishar* trilogy is one of the top RPG series ever released on the Amiga, and *Ishar 2* is widely regarded as the best of the three.

For those who like stories with lots of unpronounceable names, here's the plot in brief. The land of Kendoria is peaceful again. Krogh, offspring of Morgoth, has been defeated and the fortress of Ishar has become a safe haven for all of Arborea.

As the new ruler of the Ishar Fortress, you maintain law and order, and enjoy many years of peace and prosperity. Unfortunately, though, that's about to come to a strange and sudden end. The old and wise alchemist Jon sends you message warning you of a forthcoming danger to the land of Arborea, which marks the start of your quest to save Ishar, and all of Aborea.

The control system is very user friendly, with its simple icons. The screen is split up into different sections with a picture of all the characters currently under your control, as well as the main game window where all the action takes place.

Movement is controlled from a compass, and there's a map of the area that can be called up at anytime. *Ishar* is a great RPG which is very instinctive and easy to get into. Your mission to save Aborea is a bit vague which may annoy some people, but this just gave me a greater sense of freedom in the game.

The graphics are surprisingly detailed, and the sound does its job well. *Ishar 2* is possibly the best game of its type on the market at the moment. Now re-released at this budget price, it's even more attractive than ever. *MT*



88%

Stardust

£12.99 Daze Marketing 0171 372 7435

It might seem strange that everyone should get so excited about an *Asteroids* game these days, but *Stardust* is a bit special. It's one of those games that's obviously been created by a team who love their work. Where others would have cut corners, Bloodhouse have lavished time and expertise onto the game, and the results are impressive.

Blasting rocks into smaller rocks until they disappear is the aim of the game. This time around though, the rocks are great big chunky lumps of granite, spinning wildly across the screen. Motherships and other alien craft put in occasional appearances to keep the pace up. The only thing missing is a decent cannon on the player's ship. Unlike the original machine gun from *Asteroids*, this one is a bit of a pea-shooter.

Every game needs a "good bit", and *Stardust's* good bit is the tunnel sequence, in which you fly down a 3D shaft, blasting away at the debris that's thrown at you. It's a bit like *Microcosm*, only you don't need a CD32 to play it! If you like a bit of techno, you'll love the soundtrack, which is riddled with squiggly TB 303 riffs and pounding bass. Fab.

The trouble is, it can seem a bit like one of those posh birthday cakes you see in baker shops. There's plenty of flashy icing and decoration on top, but once you get past the marzipan you find it's filled out with old fruit cake. If you like fruit cake, that's fine, but don't expect a moist fondant fancy. *MT*



80%

The basic premise behind the title is that you as Doctor Alan Grant, have been stranded on Isla Nebula with Dicky Attenborough's niece and nephew and there are lots of wild dinos running around. Of course you've lost the kids so you've got to find them again and get off the island without getting eaten.

Believe it or not *Jurassic Park* is not a platform game. Ocean have a long reputation for movie licence platformers, but they've gone for a scrolling shoot 'em up here. You start off armed with a lightning bolt projector, which kills small dinosaurs instantly, but will take longer to kill or stun larger creatures. This weapon has unlimited ammo, but as you progress you can pick up more powerful guns, which need ammunition.

There are terminals which provide maps of the island, show the location of dinosaurs and allow you to open and close gates to the various enclosures which form the 'levels' of the game. Some features of these terminals will not work all the time and you will have to return to them once you've completed tasks to find out where to go and what to do next.

The graphics look quite good and most of the larger dinosaur sprites are convincing in a shoot 'em up kind of way, mimicking characters like the spitting dino from the movie, but once you start moving about it all falls apart. The sprite animation is OK, even good on some of the creatures, but the main character is too slow and shaky and the scrolling is very jerky. It's a bit like watching and playing a potentially good game with one of your mates holding the monitor and shaking it about. The music and sound effects are a redeeming factor, and the game is quite difficult too, but ultimately it's just not rewarding to play. *AD*

58%

Jurassic Park

£14.99 Ocean 0161 832 6633



Jurassic Park is proof positive that a big film licence does not necessarily mean a great game - though it can mean that a mediocre game sells an awful lot of units.



AMIGA

PRODUCTS FROM

WIZARD DEVELOPMENTS

SALES HOTLINE
01322-272908



- COMPATIBLE WITH ALL AMIGAs
- HIGH QUALITY SONY® DRIVE
- ROBUST METAL CASE
- ANTI-CLICK AS STANDARD
- SWITCHABLE ANTI-VIRUS
- ENABLE/DISABLE SWITCH
- LOW POWER CONSUMPTION
- THRU PORT FOR EXTRA DRIVES
- 2 YEAR WARRANTY

1MB FLOPPY DRIVE

FOR ALL AMIGAs

MONEY BACK GUARANTEE
2 YEAR WARRANTY
FREE UK DELIVERY

AMIGA 1MB DRIVE
CODE: W100

£49.99

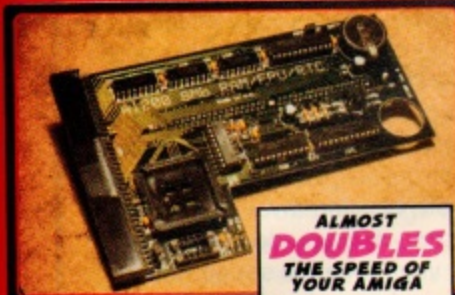

- WORKS WITH ALL AMIGA 1200s
- AVAILABLE WITH 0, 2, 4, 8MB OF 32-BIT RAM INSTALLED
- USES STANDARD 72-PIN SIMMS
- OPTIONAL PLCC TYPE FPU (FLOATING POINT UNIT)
- BATTERY BACKED CLOCK
- INSTALLS IN MINUTES
- FINGER CUT-OUT FOR EASY INSTALLATION

A1200 8MB RAM BOARD WITH CLOCK & OPTIONAL FPU

33MHz FPU
£49.99
CODE W233
COMPATIBLE WITH THE WIZARD AND AMITEK HAWK BOARDS

0MB	£59.99	CODE W200
2MB	£119.99	CODE W202
4MB	£179.99	CODE W204
8MB	£299.99	CODE W208

ALMOST **DOUBLES** THE SPEED OF YOUR AMIGA



- 28.8K OR 14.4K BAUD V32, V22BIS, V22, V23, V21
- BAPT APPROVED REQUIRED FOR USE ON A BT LINE
- MNP 2-5 AND V42, V42BIS
- SYNC & ASYNC OPERATION
- GROUP 1-3 FAX TO 14.4K
- FULLY HAYES COMPATIBLE
- MODE DESCRIPTIVE LEDS
- 2 YEAR WARRANTY

X-LINK TURBO MODEMS

FOR ALL AMIGAs

2 YEAR WARRANTY
FREE UK DELIVERY
MONEY BACK GUARANTEE

SUPPLIED WITH CABLE & S/W (N-COMM FOR AMIGA)
GP FAX OPTION FOR JUST £35 SEND A RECEIVE FAXES DIRECTLY FROM YOUR AMIGA - NORMALLY £39.99

14.4k	£139.99	CODE W504
28.8k	£249.99	CODE W505

GP FAX - Amiga S/W Special price when bought with a modem **£35** CODE W302



- ULTRA SMOOTH 400DPI RESOLUTION
- MICRO-SWITCHED BUTTONS
- AMIGA/ST SWITCHABLE
- IDEAL REPLACEMENT FOR YOUR NORMAL AMIGA 260DPI MOUSE

MICE & MATS

FOR ALL AMIGAs

MONEY BACK GUARANTEE
2 YEAR WARRANTY
FREE UK DELIVERY

ULTRA SMOOTH QUALITY OPTICAL MECHANISM
NO BALL TO CLEAN/REPLACE
MICRO-SWITCHED BUTTONS
GRID MOUSE MAT INCLUDED
AMIGA/ST SWITCHABLE

OPTICAL MOUSE	£19.99	CODE W151
HIGH QUALITY MOUSE MAT	£2.99	CODE W152

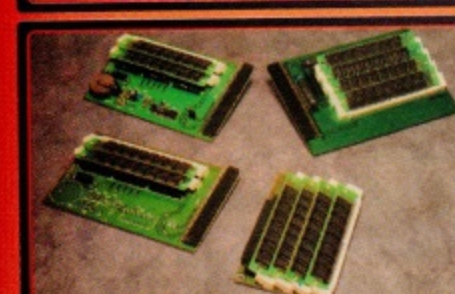

- HIGH QUALITY - LOW PROFILE DESIGNS
- LOW CHIP COUNT TO IMPROVE RELIABILITY
- ALL BOARDS INSTALL IN MINUTES
- 2 YEAR WARRANTY

A500/600 RAM BOARDS

MONEY BACK GUARANTEE
FREE UK DELIVERY
2 YEAR WARRANTY

	A500 512k	A500+ 1Mb	A600 1Mb
NO CLOCK	£19.99 CODE W401	£29.99 CODE W403	£29.99 CODE W404
WITH CLOCK	£24.99 CODE W402		£39.99 CODE W405

DIR. OPUS 5
SIMPLY THE BEST FILE MANAGEMENT SYSTEM AVAILABLE ON THE AMIGA. VERSION 5 - DUE LATE DECEMBER - BREAKS NEW BARRIERS IN POWER FEATURES AND OPTIONS. CALL FOR VERSION 4 TO 5 UPGRADE DETAILS.
£49.99
CODE W300

EASY LEDGER 2
FULLY INTEGRATED ACCOUNTS SYSTEM WITH GENERAL LEDGER, DEBTORS LEDGER, CREDITORS LEDGER, STOCK CONTROL/PRICE BOOK & JOB COSTINGS. IDEAL TO RUN A SMALL BUSINESS WITH AN AMIGA. WB2+ 2MB AND HARD DISK REQUIRED. AMIGA FORMAT GOLD - 94%
£199.99
CODE W301

GP FAX
ALLOWS YOU TO SEND AND RECEIVE FAXES USING YOUR MODEM. EVEN ALLOWS YOU TO PRINT FROM YOUR APPLICATION (FINAL WRITER, WORDWORTH, PAGESREAM ETC.) DIRECTLY TO THE FAX DEVICE. MODEM REQUIRED
£39.99
CODE W302

HYPERCACHE 2
IF YOU HAVE GOT A HARD DISK YOU MUST GET THIS! IT ALLOWS YOU TO DEFINE SOME OF YOUR RAM AS A CACHE AND CAN INCREASE THE SPEED OF HARD DISK READING & WRITING BY UP TO 2200%. ALSO WORKS ON FLOPPIES & CD-ROMS WB 2+ REQUIRED.
£24.99
CODE W303

IMAGE FX 2
QUITE SIMPLY THE BEST GRAPHICS PROGRAM ON THE AMIGA WITH HUNDREDS ON NEW FEATURES LIKE LIGHTNING BOLT GENERATORS IN VERSION 2! VERSION 1.5 AT A NEW LOW LOW PRICE.
VERSION 1.5 **£99.99**
CODE W304
VERSION 2.0 **£189.99**
CODE W305

28 DAY MONEY BACK GUARANTEE If your not 100% satisfied with your purchase, you can return the product within 28 days of receipt for a refund.

Please send me the following (please quote the codes shown in advert).

Product Code	Description	Price

Name _____
Address _____
Post Code _____ Phone No. _____

CHEQUES SHOULD BE MADE PAYABLE TO WIZARD DEVELOPMENTS.

01322-272908
BETWEEN 9AM AND 6PM, MONDAY TO FRIDAY, TO PAY BY ACCESS OR VISA. TO PAY BY CHEQUE OR POSTAL ORDER PLEASE RETURN THE ORDER FORM TO - WIZARD DEVELOPMENTS, PO BOX 490, DARTFORD, KENT, DA1 2UH

WHY BUY FROM WIZARD ?

- LEADING EDGE PRODUCTS AT DOWN TO EARTH PRICES
- OUR BUYING POWER ENSURES AGGRESSIVE PRICES AND FAST DELIVERY
- WE PROVIDE PRODUCT LIFE-TIME SUPPORT
- TRAINED STAFF TO PROVIDE THE HIGHEST LEVEL OF SALES AND TECHNICAL SUPPORT
- ALL PRICES INCLUDE UK CARRIAGE
- THE PRICES SHOWN ARE WHAT YOU PAY

Access VISA

All prices include VAT and carriage within the UK mainland. All products are subject to availability. E&OE. Advertised prices and specification may change without notice. Please allow 21 days for delivery - subject to stock availability. Please allow 7 working days for cheque clearance.

Adventure Helpline



V A M P

VAMPYRA – THE 'RAVE FROM THE GRAVE' – HAS GOT ALL OF THE ANSWERS. IF YOU'RE STUCK, THIS GIRL KNOWS HOW TO GET YOU GOING.

Innocent Until Caught

I bought *Innocent Until Caught* three months ago. I gave the woman her vase and I've given the biker his silver ornament, so I have lots of money. I have tried everything, but I can't get past the robot and I can't get the hat from the tramp in the alley.

Ronnie Dunsmore, Glasgow.

The secret of success with the tramp is to dazzle him with the flashbulb of a camera. You'll get this useful item from the pawnbroker if you give him the ticket which you get from the man seated in the bar. Coping with the robot is a little more difficult because you need to build a remote control unit, which is done by simply dropping a circuit board onto a radio. Providing you have the screwdriver from the vending machine, (loosen it with some oil) you can give the robowaiter a quick screw in exchange for his circuit board. Using the circuit board with the radio, (which is found lying around on the railway platform) you have the power to control the robot guard.

Operation Stealth

I am on Doctor Why's helicopter with the girl. I secure the bomb with an elastic band then Glames and the girl jump into the water. However, no matter what I do they always get eaten by sharks.

Oystein Kristiansen, Norway.

What do you expect them to get eaten by – oysters? If you want to go jumping out of helicopters I suggest that you first take the precaution of taking a lifeboat with you. While you were running around the corridors of the secret hide-out beating up guards and being a macho man, you should have taken some time out to search the garbage near the water fountain. 'Operate' the garbage and you'll find the inflatable item no man should be without – an inflatable dinghy. While you are falling from the helicopter you should 'inflate

your mate' and then you'll be sure of a happy landing!

Beneath A Steel Sky

I have got down through the club and into the sewer, but then the trouble starts. I've looked everywhere, but I can't find anything to kill the monster which is there. I can't even get out again.

Matthew White, Salisbury.

Sooner or later most people end up somewhere in the dark with a monster they can't get rid of. Like most monsters, this one does its evil work in the dark, so you must bring a bit of light to bear on the subject.

Near the entrance hole is a light socket which is waiting for you to insert the light bulb. Insert the bulb which you found on level one and this will solve your problem.

Leisure Suit Larry II.

I really do need your help with LSL2. Please tell me how to get past the two KGB guards in front of the airport, as they always capture me when I go near them.

Dave McLean, Thetford.

Pick a pretty flower from the jungle, and when the Hari Krishna freaks approach you, thrust the bloom into their hands. They'll be so surprised that they'll let you past.

I do a similar trick with rugby players. Sing them a dirty song, then vomit in their laps, and you'll be amazed at how surprised they look.

Kings Quest VI.

I need help with *Kings Quest VI*. I don't know how to cast the Paint Spell or how to get past the archer at the gate.

Peter Simpson, Broxburn.

First you'll need a black feather which you can find at the bottom of the Logic

Cliffs (seems logical to me). Next you'll need a teacup full of swamp ooze. Finally you'll need to add some gooey water from the River Styx which gurgles through the Realm of the Dead. Mix the horrid mixture with the black feather, then use the brush which you can get from the pawn shop to paint the picture of a door on the side of the castle. Finally, cast the spell to make a door appear.

The answer to the archer is pretty easy, you just need to have the shield. Of course you haven't got that or you wouldn't be stuck.

Look for the shield in the catacombs. From the entrance go:- N, N, E, E, N. Pick up the skull. Then go S, W, W, N, W. Step on the correct tiles to get across this room – you can work this out from the poem on page 35 of the game's hand book, or do it through trial and error. The shield is in the room just north of here. ■



FINAL THOUGHT:
"DROP ME A LINE AND I'LL GLADLY GIVE YOU A HELPING HAND."

GOT A PROBLEM WITH AN ADVENTURE GAME? VAMPYRA HAS THE ANSWER. GET YOUR CONUNDRUM ONTO PAPER, AND SEND IT IN TO DEAR VAMPYRA, CU AMIGA MAGAZINE, 30-32 FARRINGTON LANE, LONDON EC1R 3AU.

Lords of the Realm

PART
1

Have those rampaging peasants eaten all your sheep? Maybe you need some good advice.

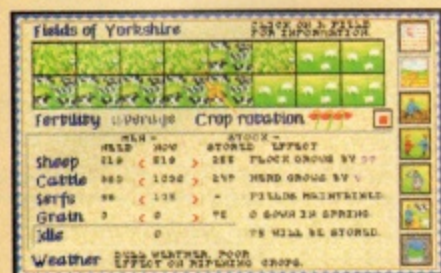

couple of seasons. Adjust the food bar so that stored grain is the first thing to go, then sheep and then cattle. A trader will probably appear in your county during the first few rounds, and on easier levels you will have quite a few crowns so buy cattle, bringing the amount stored up to one tenth of your human population. That way the peasants will not eat any grain or livestock; dairy produce will feed them all. Once the peasants are healthy and the the amount of hearts is rising you can make moderate increases in taxes. This should pay for more sheep and cattle.

The most important thing to look at when starting out on any difficulty level is the state of the peasants and fields. Check how many hearts you have and whether this total is going up or down, then see how healthy your population is. If they are sick they will just get worse, you will lose population and you will not be able to create an army. Start off by cultivating grain and and cattle and recovering lost fields. Cattle are of prime importance because dairy produce feeds people in the ratio of one cow to ten people.

Doubling or trebling the people's rations will make them healthy in a

You could sell all of your grain and buy cattle instead – as long as you are able to keep the 1:10 ratio intact, the dairy produce will feed everyone. This will free up a lot of people for land reclamation, mining, forestry and building. But don't discount grain farming, when your population gets big it can be profitable.

Seasons

There are two seasons that are extremely important in Realm agri-

culture: Autumn and Winter. Autumn deserves attention for grain farming. Make as many of your peasants available as possible by cutting down to the bare minimum for cattle and sheep tending, while reducing field maintenance to a level where if you take one more peasant off duty you will lose a field. This will ensure maximum harvest. In winter you will need to concentrate labour on planting for the spring. It is a good idea to allocate more fields to grain, cattle and sheep at this stage too – if there is a flood or drought you won't lose everything.

Sheep are potentially your biggest revenue earner at the beginning of the game – they will yield wool in the spring and this can be sold as a product at market without reducing food stores. They also breed in great numbers in the winter months if you assign enough peasants to them, so do this, even to the detriment of sowing grain. If you can get hold of 100 sheep by autumn time you will be on target for an increase of 10-20 lambs over winter and 120 bales of wool in the spring, worth around 2000-3000 crowns – and that will buy a lot of food and mercenaries.

Intensive sheep farming in all of your counties at the beginning of the game will bring down the price of wool eventually so you'll need to concentrate on something else when this starts to happen, like mining or grain. If you really want to stick to sheep then you'll need to stop selling wool every year. By doing this, in a typical supply and demand scenario, the price of wool will eventually creep back up, making it economically viable again.

Armies

Mercenaries are useful and relatively cheap, but don't be tempted to hire too many at the start, and never use a large army for defence, even if you



▲ When you've taken over half of the country bards will make up a new song about your skill as a ruler. Other Lords will be out to get you.



▲ Buy plenty of swords for your peasant army.

can afford it. They will eat your realm into bankruptcy. As soon as you raise an army move it out of your county and let it live off someone else's produce.

You will never win the game with mercenaries though. Sooner or later you will have to raise and arm a peasant army. This is actually a superb way of controlling your counties' populations too. Raising an army of 49% of a county's population will be unpopular and reduce the people's happiness but, provided you increase rations or buy them beer, they will recover quickly and there will be a lot fewer mouths to feed in the long term.

Weapons are expensive but essential if you want a real army, not just a rabble with butter knives and bent pitchforks. This is where your wool exploits will come in useful; sell wool and buy weapons, then equip as much of the army as possible and bulk it out with peasants. ■



▲ OK, I realise that you're going to think I'm a bit perry, but check out those 1002 bales of wool! Sell that and you've got 10,020 Crowns, bringing your total to 18,903 Crowns.

Next month

Next month we'll deal with siege warfare and what to do when you've got half of the country and

Dreamweb Tips

Here's the first part of the solution to Empire's top-rated heavy on the murder adventure game, Dreamweb.

PART 1

Eden's Flat

In Eden's flat go to the desk and take the wallet. Exit the room by heading right and examine the microwave. Open it, take the key and place it in Ryan's inventory. Call the lift, enter it and use the controls to the right of the doors. You're now in Eden's garage. Examine the car, take the screwdriver and wrench. Leave the garage via the doors to the south. Proceed left. On the travel screen select Ryan's Flat. Head north until Ryan reaches two doors. Enter the left door by entering the code 5106 (which you can discover either inside your wallet or in the Dairy of a Madman which comes with the game).



Ryan's Flat

In Ryan's bedroom pick up the knife on the bed. Pick up the network cartridge marked 'important', nearest to the network machine. Examine the network interface by the window, open it and put the network cartridge inside. Now examine the network monitor and use it. Once the machine has booted up type LIST and press ENTER. Type LOGON RYAN and enter BLACKDRAGON as the password (again listed in the Diary of a Madman). Type LIST CARTRIDGE and then READ PRIVATE. Take down the door codes of Eden and your best mate Louis. Feel free to read more of the net stuff but there's isn't any essential info listed as yet.



Louis' Flat

Select Louis' flat from the travel screen. Upon arriving you'll be mugged. You can't stop this, but don't worry, the muggers are only after your trainers. You can't leave the area until Ryan has suitable replacements. So, go south, the door here is Louis'. Enter by inputting the code 5238. Inside Louis' flat open the toilet doors and talk to Louis. Pick up and wear both the trainers. Open the cupboard with the drinks machine on top, take the red pool card and place it into your inventory. Examine it. You now know where the pool hall is and will be able to go there. Leave Louis' flat and return to the travel screen or for a laugh try using one of the dodgy cigarettes lying on the floor.



Sparky's Bar

Open your wallet, take the cashcard out and place it in Ryan's inventory. Select Sparky's Bar from the travel screen and enter it. Walk to the seat in front of Sparky, examine it and then use it. Talk to Sparky, then examine the credit card reader with the credit card in your inventory. Check your balance by using the card. Talk to the man next to you who will tell you about rock star David Crane, who's staying at the hotel, which you can now go to. But not yet! Leave the bar, return to the travel screen and proceed to the pool hall.



The Pool Hall

Enter the lift in the pool hall and use the controls. Talk to the bartender, and he'll tell you where you can buy a gun to kill David Crane. Walk left until the end of the corridor and go through the door directly to the south by entering the code 5222. Now you're in Silverman's office. Put Ryan's credit card in the reader on Silverman's desk and then take the gun from the desk. Don't try anything clever with the gun or you're history! Return to the travel screen.



The Regency Hotel

Talk to the receptionist. Use Ryan's credit card on the reader and watch out for the security pass that appears in front of the receptionist. Take it. Enter the lift by using the security pass and then use the lift controls with the room key. Exit the lift and go left and down. Find the axe by examining the firepoint and then opening it. Take the axe. Go back into the lift and use the controls with the knife you picked up from Ryan's flat. Examine the wire and use it with the knife again. Examine the handle and use it. Now you're on top of the lift. Examine the lift doors and use them with the axe. Outside the lift use the axe as soon as the watch icon changes to a hand. The guard will shoot but miss you, so select the gun from your inventory screen and use it immediately. Now walk left and down and examine the gun. Watch the sexy bit and then waste David Crane. Don't waste any time or another guard will shoot you.



The Dreamweb

You're now in the Dreamweb, talk to the monk. Exit by using the first door on the right at the bottom. Use the key from the microwave in the plinth and Ryan will wake up in a skip in the alley. Walk right and down. Return home and use the network monitor. Type LIST NEWSNET, READ TVSPECIAL and EXIT. Here you'll get all the information about the General, the second person Ryan must kill. Join us next month as the General and few more besides get their cards.

There's a whole world of free software out there! The Amiga public domain scene is unique. To many, it's the lifeblood of the Amiga itself. Whether you're into demos, graphics, music, programming, games, or whatever, there's always something for you in the public domain. The best thing is, it all costs virtually next to nothing! This month we've scoured the globe to bring you a guide to the world's best PD.

Varieties of PD

PUBLIC DOMAIN

Software that can be copied free of charge.

FREWARE

Can be copied and shared as long as no profit is made.

SHAREWARE

Like freeware but you must 'buy' the software for a small fee, often around £10.

LICENSEWARE

You cannot copy the software and all profits go to the author.

Public Domain Special

We start with three pages of charts, taking into account everything from the last year or two. Then we've got our usual reviews of current disks. It's all topped off with a round up of the latest public domain CD-ROM discs. Turn to page 87 for addresses and prices of all suppliers.

Top 10 Games

1. Spectrum AGA Emulator

Not a game in itself, but the emulator comes with plenty of classic Spectrum games on disk for your Amiga. On-Line PD. 1 Disk.

2. Donkey Kong

Good old Donkey Kong, the original platform game, converted faithfully to your favourite computer. Software 2000. no. G334. 1 disk (not A1200).

3. Galaga Deluxe

Another classic from the arcades of yesterday, and a decent shoot 'em up in its own right. KT's PD. 2 disks.

4. The Unusual World of Doctor Strange

Space Panic gets an overhaul with a Frankenstein-style setting. 17 Bit Software. 1 disk.

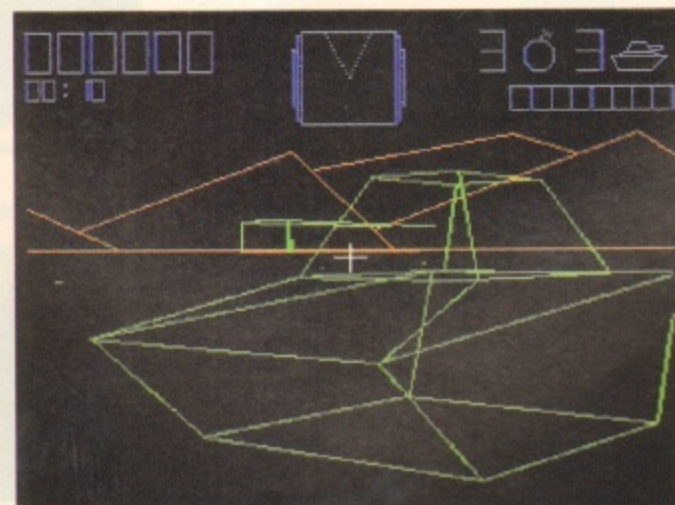

▲ If it's classic games you want, you'll find plenty in the public domain, including *Battle Zone*, *Space Panic*, *Lunar Lander*, *Donkey Kong*, *Galaga*, *Pong* and more!



▲ Satisfy your for lust for gambling without losing a penny, with *Super Mega Fruits*.

5. Starvoids

Mix *Thrust*, *Asteroids* and *Oids* with the plot from *Star Wars* and you get a top shoot 'em up called *Starvoids*. On-Line PD. 2 disks.

6. Wayne's World Pong

The simplest video game ever gets a new lease of life with some Wayne's World sound effect samples.

7. Speedtris

One of the best versions of *Tetris*, including a simultaneous two-player mode, and a few other new twists. F1 Licenseware. 1 disk.

8. Magnetic Fields Tanks

Battle Zone with few new additions, but it's still a slippery-smooth 3D shoot 'em up. On-Line PD. 1 disk.

9. Super Mega Fruits

Fruit machine simulator with awful sound effects, but could be a cheap distraction for fruity addicts. On-Line PD. 1 disk.

10. Tony and Friends in Kellogg's Land

Cute platform game featuring characters from your favourite breakfast cereals. It's PD and copyright-free according to the supplier. Do Kellogg's know? Mr K Dagnall. 1 disk.



▲ Brain State In a Box.



▲ More visual trippery from Brain State in a Box.



▲ Arte – scary pictures and contorted visual effects.

Top 20 Demos

All the following demos are for AGA Amigas only, unless otherwise stated.

1. Switchback

Top-notch swirly graphics climaxing in a lunch-revisiting roller-coaster ride. Decent music too! Freestyle PD. 2 disks.

2. Brain State in a Box

Trance-inducing colour zooms and smooth flight sequences that loop into infinity, with user-interaction on the A4000. Visage Computers. 1 disk.

3. Some Justice 94

Jungle remix of the classic hardcore tune with fab vocals, a massive bassline and brilliant synchronised visuals. Watch your bass bins! Roberta Smith DTP. 1 disk (state whether standard A1200 or accelerated).

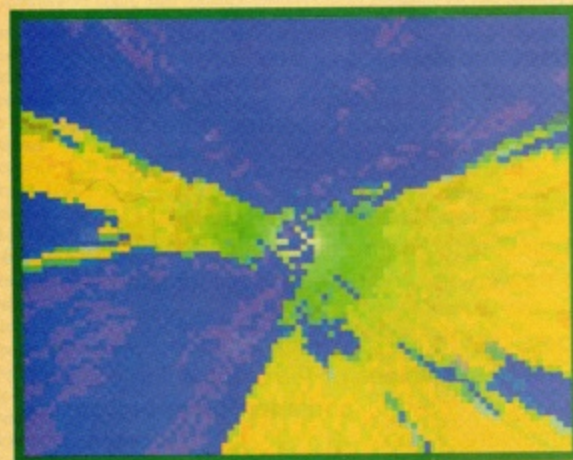

▲ Some Justice 94 in full tunnel effect, complete with funky breaks.



▲ Zootje – Hu hu, hu hu, hu hu, hu hu...errrr...yeah! Bring on the ostriches!

4. Animatunes

Paranoid cartoon sequence followed by an excellent tunnel with a jazzy organ soundtrack. Freestyle PD. 2 disks.

5. Nine Fingers

Clever digitised dancers and a bouncy techno soundtrack. Looks a bit cheesy now, but fun all the same, and works on all Amigas. KT's PD. 2 disks.

6. Mina Omistan

A raw music video on a disk, with digitised video clips and lots of intentional distortion.

7. Gevalia

A barrage of slippery graphics perfectly synchronised to a funky soundtrack. Compatible with all Amigas. 17 Bit Software. 1 disk.

8. Zootje

Ostriches, Beavis and Butthead, and more ostriches. Stupid, childish, and lots of fun. Freestyle PD. 1 disk.

9. CCCP

Ominous sounds and visuals with a Big Brother/ Communism theme and a techno soundtrack, compatible with all Amigas. 17 Bit Software. 1 Disk.

10. Big Time Sensuality

A big clean sample of Björk's best single to date accompanies plenty of slithery graphic effects.

11. Friday at Eight

The Polka Brothers supply a frenzied disk of in-ner-face graphics synced to a jiggly tune. Seasoft no. 1802. 1 disk.

12. Roots

Psychedelia of the highest order, with an assortment of other visuals to mess with your head, and a soundtrack with swearwords. Freestyle PD. 1 disk.

13. Arte

Dali-style pics break up the exquisite sequences of slimy colours, tunnels and plasma, along with some funky guitar. 17 Bit Software. 1 disk.

14. Psychedelic

The title speaks for itself really. Among the brain-melting effects are the rotating zooming plasma, the tunnel and the colour wheel. Visage Computers. 3 disks.

15. Twisted

Four disks of fun including digitised animations, cartoons, a video wall, plasma, a tunnel and all that kind of stuff. 17 Bit Software. 4 disks.

16. Full Moon

A flight round a mountain range, a touch of *Doom*, and loads of wobbly bitmap contortions. Visage Computers. 1 disk.

17. Ray World

3D city! Stacks of vector graphics effects and pre-rendered animations. 17 Bit Software. 3 disks.



▲ Phwoooooaaarrrr!



▲ The aptly-named 'Psychedelic' with its spinny colour wheels.



▲ Nine Fingers – stylised video of people dancing. It's good, honest!

18. Mindflow

A long trippy fractal zoom and plenty of contorted bitmap effects.
17 Bit Software. 1 disk. Requires 2Mb Fast RAM.

19. Nexus 7

Red hot blobs of molten goo, a cute anglepoise lamp, and a picnic hamper of bitsize supporting effects.
Visage Computers. 1 disk.

20. Ariel Ultra

The Polka Brothers slip in a record fourth entry to the chart (they're also responsible for Gevalia, Friday at Eight and Twisted). Good speedy fun.
Visage Computers. 1 disk.



▲ More fractal landscapes. Brilliant!

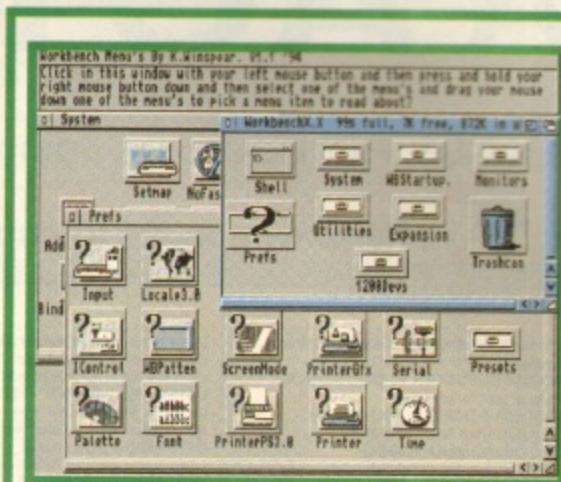

▲ Improve your productivity with our choice of PD utilities.

5. Guitar Chord Directory

Even Stairway to Heaven gets a bit boring after a while. Time to learn some new chords! 1 disk.
Robert Stanley Licenseware £5 inc. P&P.

Graphics Applications

1. Blackboard 3

A great introduction to image processing, despite the lousy interface.
F1 Licenseware. £5.99 inc. P&P. 1 disk.

2. Imagestudio

More image processing. Makes a brilliant sidekick to Blackboard.
Andrew Dean Licenseware £10 inc. P&P. 1 disk.

3. Main Actor

Superb animation utility that can also convert between different animation file formats.
KEW=II Software. Shareware £3 inc. P&P. 1 disk.

4. Viewtek

Graphics file viewer par excellence. Works with most normal graphics files including JPEGs, IFF-24bit, GIF and Animations. Pieces of Eight Freeware £1 plus 50p P&P. 1 disk.

5. QuickGrab

The main screen grabber we use for this magazine. Will grab almost any Workbench-launched screen, but won't grab most games.
Pieces of Eight Freeware £1 plus 50p P&P. 1 disk.

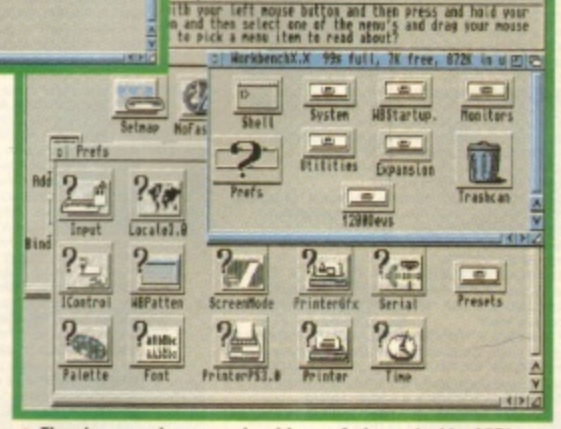

▲ There's so much you can do with your Amiga and a bit of PD!

Sound

1. OctaMED V2.0

Extremely powerful music sequencer that seamlessly combines Amiga samples and MIDI music.
Seasoft. 1 disk.

2. ProTracker 3

OctaMED's more widely-used rival. Includes most features of OctaMED 2 but no MIDI sequencing.
Software 2000. 1 disk.

3. X-Beat Pro V3

Excellent 4 track drum machine with optional bassline sequencer. Very easy to use.
Battle Axe PD. 1 disk.

4. Sound Machine

Converts the PC standard WAV and VOC sound sample formats to IFF for use with the

Amiga, and vice versa. Very handy for use with PC-orientated CD-ROMs.
Valley PD. 1 disk.

5. Urban Shakedown Samples

Six disks of high quality dance samples, including loops, breakbeats, vocals, synths, drums and effects. The best.
NBS. 6 disks. £6.95 plus 50p P&P.

Education

1. Kid's Disks 1-6

Fun, friendly and enjoyable. Better than most commercial efforts.
Duncan Moran Freeware. 6 disks for £6 inc. P&P.

2. Fast Fret

Every guitarist's dream. Learn to play at lightning speed. 1 disk.
17 Bit Software. Licenseware £3.50 plus 50p P&P.

3. Introduction to Workbench and AmigaDOS

Beginner's guide to using the Amiga.
F1 Licenseware. £4.99 inc. P&P. 1 disk.

4. Typing Tutor

Teach yourself to type the easy way. 17 Bit Software. Licenseware £3.50 plus 50p P&P. 1 disk.

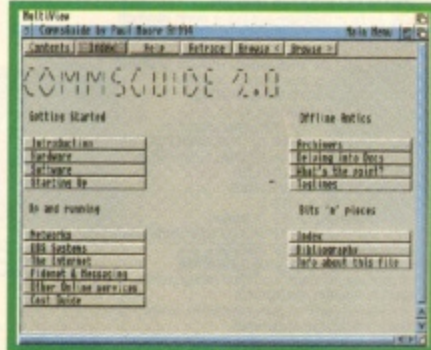

▲ Navigate the comms jungle with CommsGuide.

Banish boredom... ... write a book

Once upon a time in a house by a forest lived a girl. She was called Red Riding Hood.

▲ Create your own picture books for fun. See Kids Disks 1-6 above.

Programming

1. GNU C, C++ and Obj. C

The most comprehensive PD programming language ever. Only experts need apply. Requires 16Mb hard disk space and at least 4Mb memory. Pieces of Eight. 10 disks. £10 plus £3.50 P&P.



▲ A funky ripple effect, yesterday.

2. DICE C

The most popular PD C language. Ideal for newcomers to C. Roberta Smith DTP. 2 disks. Shareware £1.80 plus 70p P&P.

3. Menus and More

Multimedia for the masses (see this month's PD utilities). 1 disk. Pieces of Eight Shareware. £1 plus 50p P&P.

4. C Manual

Everything you ever wanted to know about C but were afraid to ask. Deltrax PD. 12 disks. £13.60 inc. P&P.

5. The C Manual

Teaches you how to program in C (not the same as above!). A little rough but good for beginners. Pieces of Eight. 4 disks. £4 plus £1 P&P.

Comms

1. Comms Guide 2

A must for anyone new to comms. A shining example of how to use AmigaGuide.



▲ Importing pictures in ImageStudio.

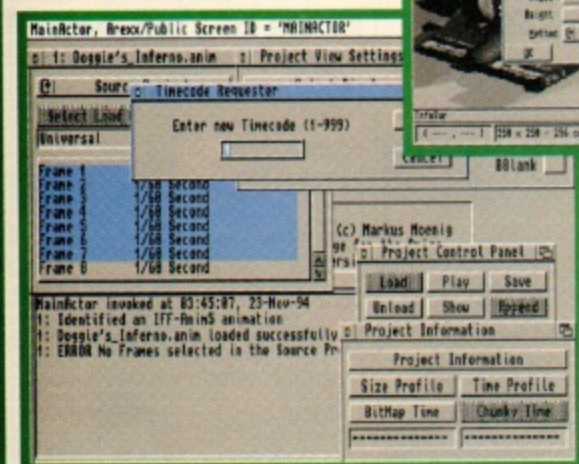

▲ The MainActor animation package.

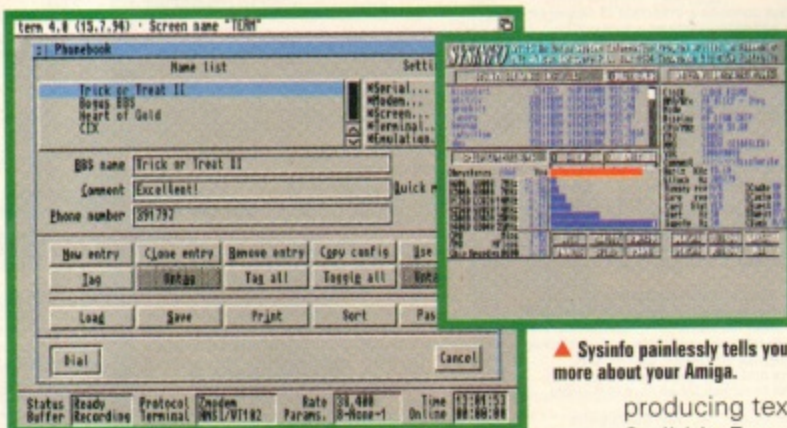

▲ Term, one of the top Comms packages available from PD libraries.

Paul Moore freeware. £1 plus 50p P&P. 1 disk.

2. Amiga Point

Instant FidoNet access for beginners (see this month's PD Utilities). Pieces of Eight Shareware £1 plus 50p P&P. 1 disk.

3. NComm 2

Good modem software for beginners. Simple to set up, easy to run. Scribble PD Shareware. £1 plus 75p P&P. 1 disk.

4. Term 4.1

Heavyweight modem software. Needs a multi-scan monitor, hard disk and lots of memory to work at its best.

OnLine PD. 4 disks. Shareware £3 plus £1.50 P&P.

5. PGP

Security software the CIA wanted banned. Essential if you're on the Internet. 17 Bit Software. £1.50 plus 50p P&P. 1 disk.

Small Utilities

1. LHA

The most popular compression program for the Amiga. AmigaNuts. Shareware £1.25 plus 60p P&P. 1 disk.

2. SysInfo

Compare the speed and memory of your machine against others in the Amiga range. 17 Bit Software Shareware. £1.50 plus 50p P&P. 1 disk.

3. DMS 2

Compresses a whole disk into a single file. We use it for our cover disks. Pieces of Eight Shareware £1 plus 50p P&P. 1 disk.

4. CacheFont

Keeps track of your fonts, and saves time when selecting new fonts. Scribble PD Shareware. £1 plus 75p P&P. 1 disk.

5. Snoop DOS 3

Displays the names and locations of programs and libraries as they are loaded by Workbench. Useful for de-bugging and trouble-shooting. Scribble PD Shareware. £1 plus 75p P&P. 1 disk.

Applications

1. GoldEd

The Text editor of choice for programmers. Doubles up as a word processor. Pieces of Eight. 3 disks. Shareware £3 plus 75p P&P.

2. Final Wrapper

Macros for *Final Writer* for producing text spirals etc. Scribble Freeware. £1 plus 75p P&P. 1 disk.

3. Disk Salv

Repairs damaged disks. Very handy. KEW=II Shareware. £1.50 inc. P&P. 1 disk.

4. Text Engine 4.1

Word Processor for beginners. Includes spell checker. Pieces of Eight Shareware. £1 plus 50p P&P. 1 disk.

5. Magic CX

Various bits and pieces: new commodities exchange, screen blankers, a calendar, pop up menus etc. Roberta Smith DTP Shareware 75p plus 75p P&P. 1 disk.

6. ParBench

Allows you to link two Amigas together using a parallel cable. 17 Bit Software Shareware £1.50 plus 50p P&P. 1 disk.

7. A Backup

Backup your hard disk to floppy. Keeps important files safe. Roberta Smith DTP Shareware 75p plus 75p P&P. 1 disk.

8. Account'Ability 2

Simple accounts system for the home or a small business. Jack Pritchard Shareware. £1.50 inc. P&P. 1 disk.

9. Re-Org

Optimises and speeds up your disks. Pieces of Eight Shareware. £1 plus 50p P&P. 1 disk.

10. M-Tool Read and write.

LHA archived files from a Directory Opus-style front end. Pieces of Eight Shareware. £1 plus 50p P&P. 1 disk.



▲ GoldEd, the programmer's text editor.

GAMES

GRAVITY FORCE 2 +Y
Game of the year '84 !!
STARBASE 13 (2) +Y
Brill point'n'click
ROCKETZ AGA Y
Excellent shoot em up
MEGABALL AGA Y
Arkanoid clone
MECHFORCE +Y
Strategy game
MOOSE DRIVE +Y
Good overhead racer
SOCCER CARDS +Y
Footy game
HIGH OCTANE +Y
Fast racing game
18TH HOLE GAME (2) +Y
Great golf game
ZOMBIE APOCALYPSE +Y
Shoot em down!
FIGHTING WARRIORS +Y
Streetfighter clone
DITHELL IN SPACE +Y
Good platformer
OSWALD +Y
Nice jumping game
DONKEY KONG +Y
Classic Arcade game
GORF +Y
Good game
STARIANS +Y
Spacey shoot em up
ICE RUNNER +Y
Good platformer
ORC ATTACK +Y
Fight them off
MADFIGHTERS Y
Beat up your opponent
ORBIT (2) +Y
Brill space flight sim
GALACTIC PREDATOR +Y
Action packed
CROBOTS +Y
Robot war game
FANTASY FOOTBALL LEAGUE +Y
Excellent management sim
THE SHEPHERD +Y
Play god
ROAD TO HELL (2) (1.5 MEG) +Y
Good top view racer

**Huge selection of
18+ titles in stock.
Full listing in catalogue**

UTILITIES

VIDEOTRACKER +
Everything for making demos
VIDEOTRACKER AGA Y
The AGA version
RDS +Y
Create random dot s/grams
TEXTENGINE 4.1 +Y
Best PD wordprocessor
X-COPY PRO +Y
Disk copier
LITTLE OFFICE +Y
W/P, S/sheet, D/base etc
IMAGE STUDIO (WB 2+)
pic converter / manipulator
BLACKBOARD +Y
Pic converter / manipulator
PC TASK 2+Y
PC emulator
DELITRACKER +Y
Music player
RELOKICK +Y
Degradar
MAGNUM +Y
Disk mag creator
FAST INTRO MAKER +Y
DESKTOP VIDEO STUFF +Y
Useful utils
GATOR GRAPHICS +Y
Graphics tutorial
GFX CONSTRUCTION KIT +Y
Great gfx aid
MINIMORPH +Y
Fast morpher
PLASMA CLOUDS 256 Y
Plasma creator
VECTOR DESIGNER +Y
DISKMASTER 3 +Y
Dopus clone
ACTION REPLAY 1.5 +
Software version of cartridge
ACTION REPLAY V4 Y
AGA version
CRACK'N'COPY +
CRACK'N'COPY AGA Y
AGA EMULATOR (not 1200)
MAGIC WORKBENCH (not 500)
TERM +Y
Great comms program
INSCRIPT +Y
Video titler

NOBLE HOUSE

48 EDNAM DRIVE
GLENROTHES,
FIFE
KY6 1NB

IMAGINE

FEMALE (OBJECTS)
Four models of female walking ready to
animate
57 CHEVY (WB2+) (OBJECT)
HUMANS (OBJECTS)
2 male/2 female
CAR (OBJECT) - BMW, 32 DODGE
STARTREK (OBJECTS)
SCI - FI (OBJECTS)
IMAGINE TUTORIAL +Y
All you ever wanted to know about
imagine. Hints / Tips projects / step by
step etc
SPACE FONT TOOLS
Ex commercial program for manipulat-
ing fonts. Italicize condense etc (great)
IMAGINE UTILITIES
ISL, Wrappen, Igensurf, Showobj
TEXTURES 1 - Wood and Misc
TEXTURES 2 - Stone
TEXTURES 3 - More Stone
TEXTURES 4 - Organic + Util to con-
vert JPG to IFF & GIF
WORLD
Insects + Ape + Land + Plants includes
Shelly, a utility to create shell like
objects for imagine/lightwave/real 3d
etc.
Sold as separate disks or buy all 14 for
only £10.00

EDUCATION

COLOUR IT +Y
Colouring book
STORYLAND 2 +Y
Excellent reasoning adventure
DUNKS DTP +Y
DTP for kids
LITTLE TRAVELLER +Y
World facts
JAPANESE +Y
Learn Japanese
I.Q. TEST +Y
GARDEN DESIGNER +Y
3D design
CROSSWORD CREATOR +Y
FOOTY +Y
Pools checker
COMMUNICATE +Y
8 Languages
TOME OF MYTHS (2) +Y
Excellent hyperbook
LANGUAGE TUTOR +Y
4 Languages
D-PAINT TUTOR +Y
WORLD WAR 2 +Y
Hyperbook
WORLD GEOGRAPHY +Y
Maps & text
GCSE MATHS +Y
KIDS GAMES +Y
MR MEN +
Learn to read

CLIPART

COLOUR CLIPART (3)
GAME CHARACTERS (COL)
DISNEY CLIPS (COL)
DANDY AND BEANO
WOMEN CLIPART (2)
VIZ CLIPART
SPORTS (2)
MUSIC
FRAMES / BORDERS
FOOD / DRINK
TRAVEL
WEDDINGS
LANDMARKS
TRANSPORT

SLIDES

BABYLON 5 +Y
BEAUTIES +Y
BO DEREK +Y
BODYSHOP 4 AGA (2) Y
BODYSHOP 5 AGA (2) Y
BODYSHOP 6 AGA (2) Y
CALENDER GIRLS +Y
CELEBRITY SPECIALS (5) +Y
CHER +Y
CINDY CRAWFORD (2) +Y
CLAUDIA SCHIFFER +Y
ERIKA ELENIAC +Y
FOOTY +Y
ERIKA AGA Y
FENNTASTIC 1 +Y
FENNTASTIC 3 +Y
FENNTASTIC 6 +Y
FIT CHIX AGA (2) Y
FIT CHIX 2 AGA (2) Y
FIT CHIX 3 AGA (2) Y
GIRLS ON FILM +Y
GIRLS OF SPORT +Y
GLADIATORS +Y
INSIDE SPORTS (2) +Y
KATHY LLOYD +Y
KYLIE +Y
MADONNA (3) +Y
MAGNIFICO 1 +Y
MAGNIFICO 2 +Y
MANGA AGA (4) Y
MARVEL +Y
NAKED DREAMS +Y
SHARON STONE +Y
STREAKER +Y
STUNNERS +Y
SUPER GIRLS 3 +Y
SWIMSUIT BABES AGA (3) Y
UNPLEASANT WAYS TO DIE +Y
WRESTLEMANIA 7 (2) +Y
ZERO HOUR MODELS +Y

+ 500+/600 compatible Y 1200 compatible () Number of disks
1 - 5 disks £1.50 per disk 6 - 14 disks £1.25 per disk 15+ disks £1.00 per disk
UK postage FREE Europe postage £2.00 R.O.W. postage £3.50
Payment in £'s sterling only. Cheques/PO's payable to Noble
Fast turnaround. All orders sent by 1st class post. Write for FREE catalogue disk.

COLOUR KITS for MONO PRINTERS

Ever wished you'd bought a colour printer instead of a mono one? Wouldn't it be nice to print out pictures in colour? Now you can with Amiga "Flexicolor Kit". Each Amiga Flexicolor Kit comes complete with everything you need to print in colour, including superb software. The colour kit is simple to use, the ribbons fit exactly the same way as your black ribbons so it will not affect your guarantee. Also on all models listed below paper alignment is automatic, you do not have to manually align. PRINTS AS GOOD AS COLOUR PRINTER. If your printer is not listed below please phone. Amiga Flexicolor kits for Star LC10, LC20, all Star 24 Pin Panasonic 1080/81/1123/1124. Epson FX80, FX100, LQ800 etc. Citizen 120D+, NEC P6, P6+. Please note colour kits come complete with coloured ribbons.

COMPLETE KIT £39.95

FLEXIDUMP 3

NO MORE BANDING
NO MORE WHITE LINES

Yes its true the new flexi 3 will remove banding & white lines from dot matrix & bubblejet printers
Now you can have desk jet quality on dot matrix printers.

Other new features include:-

- * An extended range of special Dithering Patterns.
- * User selectable levels of Anti-Aliasing to remove those jagged edges and smooth.
- * Compatible with the new screen modes.
- * Deskjet 500C/310C users can now have a colour picture with true black - The colour results with this new version will astound you.
- * Suitable for Citizen, Epson, Hewlett Packard, NEC, Panasonic, Seikosha, Star and just about any dot matrix or inkjet/bubblejet/laserjet printer.

STILL ONLY £39.95

GOT THE CU COVERDISK FLEXIDUMP OR AN
OLD VERSION THEN UPGRADE FOR
ONLY £14.95

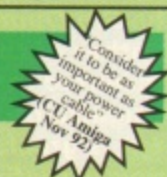

T-SHIRT PRINTING RIBBONS

PRINT ON NORMAL PAPER IRON ON T-SHIRT

4 Colour Citizen Swift.....	£29.95
4 Colour Citizen Swift (Reload).....	£14.95
4 Colour Star LC10	£14.95
4 Colour Star LC200 9 Pin	£19.95
4 Colour Star LC200 9 Pin (Reload).....	£12.95
4 Colour Star LC200 24 Pin	£29.95
4 Colour Star 24 Pin (Reload)	£14.95
1 Colour Star LC10	£11.95
1 Colour Star LC200 9 Pin	£11.95
1 Colour all Star 24 Pin	£11.95
1 Colour Epson FX80/LQ400/MX80.....	£11.95
1 Colour Epson LX80.....	£11.95
1 Colour Epson FX100.....	£11.95
1 Colour Panasonic KXP 1080.....	£11.95
Heat transfer pens 5 large red/ orange/ yellow/ green/ blue, Large pens have a marker size nib	£14.95 a set
Heat transfer Pens 5 small red/ orange/ yellow/ green/ blue, small pens have a fine nib	£12.95 a set

ALL PRICES INCLUDE VAT AND CARRIAGE

BLACK PRINTER RIBBONS

Don't throw away your plastic printer ribbon cases when the ribbon wears out just take the top off, take out the old ribbon and reload it with a new one. Black reloads from as little as 99p each

SPECIAL RE-INK

For Panasonic Printers, Star LC200 9 Pin, Epson LQ100, OKI 182/390
Black Bottle will re-ink 100+ ribbons.....£9.95

COLOUR PRINTER RIBBONS

Don't throw away your plastic printer ribbon cases when the ribbon wears out. Just take the top off, take out the old ribbon and reload it with a new one. It's simple. Full instructions supplied. (We stock Reloads for most colour printers)

Reloads for:	
Star LC200 9 Pin 4 Colour (Normal Ink)	
1 Reload - £5.99	5 Reloads - £23.99
Star 24 Pin 4 Colour (Normal Ink)	
1 Reload - £6.99	5 Reloads - £29.95
Citizen Swift /ABC etc 4 Colour (Normal Ink)	
1 Reload - £6.99	5 Reloads - £29.95
Seikosha SL 95/96 4 Colour (Normal Ink)	
1 Reload - £6.99	5 Reloads - £29.95
Panasonic 2123/2180/2135 4 Colour (Normal Ink)	
1 Reload - £6.99	5 Reloads - £29.95

Ink ribbons also available in Gold, Silver, Magenta, Orange, Purple, Brown, Green, Blue, Red for a wide range of printers.

HP DESKJET/CANON BUBBLEJET REFILLS

"CARE THREE PACK" will refill HP51608A Cartridge 3 times.
The Canon BC-01/SJ48 Cartridge 3 times. Three Pack available in
Yellow, Magenta, Cyan, Red, Green, Brown, Purple, Black
£14.98m each.

"TRI-COLOUR PACK" 3 Yellow, 3 Magenta, 3 Cyan refill £17.95
available for Bubblejet and Deskjet

"CARE SIX PACK" will refill HP51608A cartridge 6 times. The
HP51626A High Capacity 3 times. The Canon BC/01 Cartridge 6
times.

Please state type when ordering
6 BLACK REFILLS ONLY £24.95
GOT A BLOCKED NOZZLE? DON'T THROW AWAY YOUR
CARTRIDGE - NEW "INK MAGIC" PRINT HEAD RECOVERY
FLUID
18ml BOTTLE £5.95

How to order: Enclose cheques/PO made payable to: CARE ELECTRONICS or use Access/Visa

CARE ELECTRONICS

Dept CUA, 15 Holland Gardens, Garston, Watford, Herts WD2 6JN Fax 0923 672102

ORDER LINE ON 0923 894 064



Over the next two pages you'll find reviews of the best new serious PD disks.

PD Utilities

Spellbinder's Magic Pack workbench enhancements

This is a neat collection of six disks covering every aspect of updating your Workbench. The set is aimed squarely at hard disk users. It's all based around that modern essential, *Magic Workbench*. The pack starts by offering you loads of replacement icons and backdrops. It really does make your Workbench look ten times better than before. Far more relaxing on the eye and enjoyable to navigate.

There are also several extras in the pack which make it even more useful. There's *SmallMagic* which has all the standard *MagicWB* icons, but resized for use with an ordinary monitor. The standard *MagicWB* icons are designed for use with multiscan monitors and can look a bit odd on an ordinary screen.

There's *Magic Selector*, a fun utility to change the Workbench backdrop and sounds every time you boot up. Then there's Button Menu which creates a kind of tool bar from which you can run programs a great time saver. It has the added advantage that it can be switched off. Lastly there's *MagicCX*. This one's a bit special. It adds a whole host of new facilities to your Workbench. There are simple things like a calendar, a mouse accelerator, "click to front" windows and a clock. There are also more sophisticated things like the fractal screen blanker and a disk formatting system. Spellbinder's *Magic Pack* works quite happily on any hard drive-equipped OS 2+ Amiga.



Available from: Pieces of Eight, 30 Hanover Buildings, Southampton SO1 1JU. Tel: 01703 399234. Price: £6 plus £2 P&P.

90%

Big Dummies Guide to the Internet comms guide

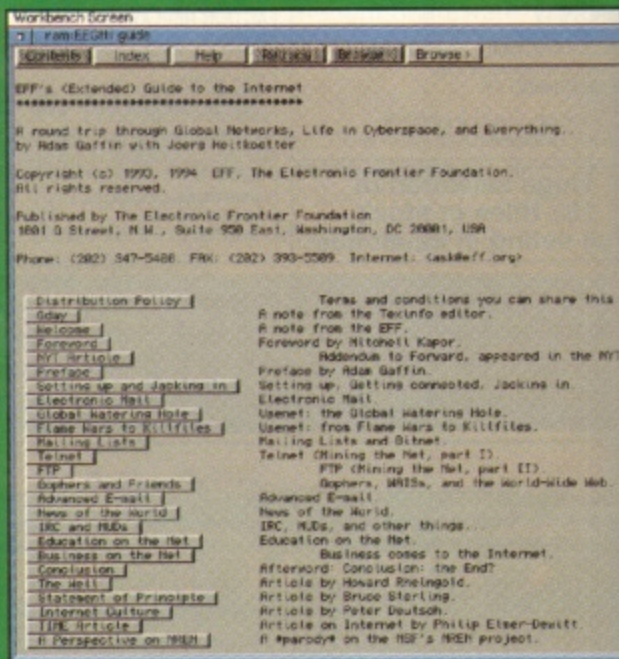

▲ Just some of The Big Dummies Guide To The Internet. A worthy if wordy read if ever there was one.

The *Big Dummies Guide To The Internet* is another of those manuals for the Internet, presented in a hypertext format, using the AmigaGuide Workbench 3 utility. The concept is great, and the AmigaGuide programming is proficient. The text is informative and often useful.

There are two major problems, however. The guide is just too big to negotiate easily, and has next to nothing on how to set up your software. Even though in some places the text is a bit long winded, I would rather see too much text than not enough. It definitely needs more information on setting up for Internet access, as this is the hardest part of getting on the Net.

It really needs someone who knows how to set up Amiga Internet software. On the whole, BDG is promising but doesn't quite deliver the goods. It's still worth reading if you're interested.

Available from: 17 bit Software, 1st Floor Offices, 2/8 Market Street, Wakefield, West Yorkshire WF1 1DH. Tel: 0924 366982. Price: £1.50 plus 50p P&P.

80%

Hardware Projects

Diy electronics

This disk makes a nice change. It's all about making your own leads, peripherals and adapting ready-made stuff for your Amiga. Amongst the many projects there's a sound sampler, a MIDI interface, a VGA monitor adaptor and a 3.5" IDE hard drive cable. It even shows you how to fit a 3.5" IDE drive into an A1200.

I didn't try to build any of the projects, though the IDE cable proved to be the same as the one I already have, and the projects all seem genuine enough. But be warned, tampering with your Amiga hardware can be dangerous. One slip of the soldering iron could spell the end for your beloved machine.

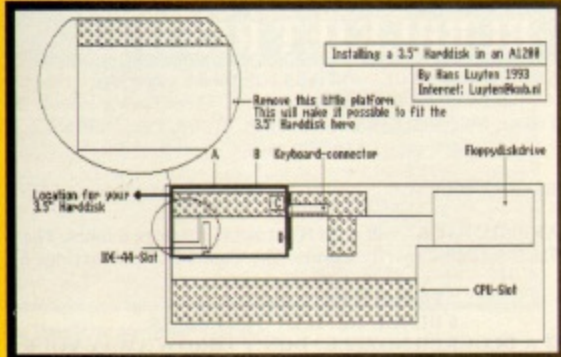

This disk is just the ticket if you enjoy building your own stuff. There are 14 projects, which should be enough to keep you occupied for a while.

Available from: Saddle Tramps PD, 1 Lower Mill Close, Goldthorpe, Rotherham S63 9BY. Tel: 01709 888127. Price: 95p plus 50p P&P.

80%

Tiny Toons Clip art cartoon pictures

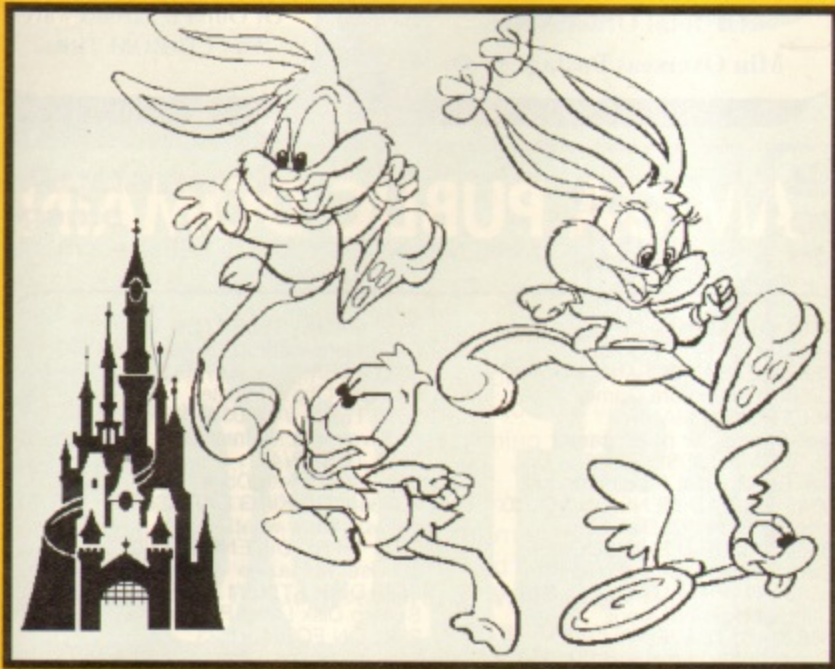

▲ Don't you just love them? Quick! Where's the hammer?

This disk had a lucky reprieve, as the colour clips on the disk I loaded first are dreadful. Because of this I almost binned it there and then. Fortunately, the black and white clip art is well worth a look.

Whether they're for your own productions or just for the kids to colour in, the pictures should come in very handy. It's difficult to tell whether they've been drawn or scanned, but either way, the quality is high enough for use in a number of amateur and professional applications.

Available from: OnLine PD, 1 The Cloisters, Halsall Lane, Formby, Liverpool L37 3PX. Tel: 01704 834335. Price: 75p plus 75p P&P.

80%

Meny Menu System menu options system

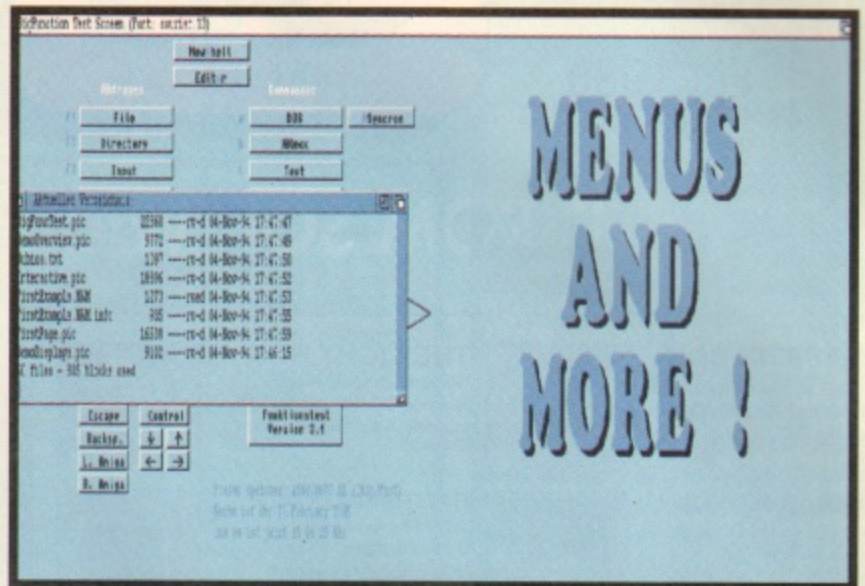

This is a system for making your own push-button menus although it's limited to using standard Amiga buttons. This can make your menus look more professional, an import factor in presentation, but it's a limit all the same. The program is controlled by a script, which means you have to learn to program it. Meny's one outstanding advantage is that it is only 11K in size.

There's also an AmigaGuide replacement program on the disk called Hyper. It's a reasonable little program in that it looks a bit better than the original and can load PowerPacked guide files. Worth remembering if you're hard up for space.

Available from: Freestyle PD, 108 Woodside Way, Short Heath, Willenhall, West Midlands WV12 5NH. Tel: 01922 710985. Price: £1.50 including P&P.

60%

The Ultimate Degradar

If you have an AGA machine and some old software which is incompatible, this is the beast you need. Options include disabling Fast memory and rebooting your system as a 1.3 machine. You can also get your Chip memory to act as Fast memory, disable caches, switch off various parts of the AGA chipset and change the monitor types.

It won't get everything to run, but it's still easily the best degrader available. Available from: Freestyle PD, 108 Woodside Way, Short Heath, Willenhall, West Midlands WV12 5NH. Tel: 01922 710985.

Price: £1.50 including P&P.

70%

Icon Tool Box workbench icon utility

This one's a bit of an oddball. The program is designed to manipulate icons, though not as you might expect. It has no editor for instance. It makes up for that minor omission in spades with some really outrageous features instead. The heart of the program revolves around converting icons back and forth from IFF files. It's a simply brilliant idea as it means you can use things like digitised pictures or your favourite artwork.

The program also has many other features that include converting an entire directory of icons, and changing just an icon's picture whilst preserving its attributes (e.g. tooltypes and window size). It even has an option to wrap an icon or picture around a sphere.

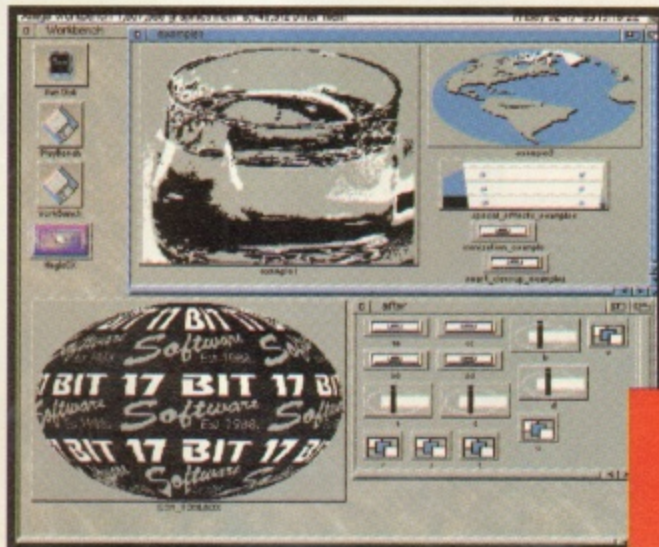

Available from: 17 bit Software, 1st Floor Offices, 2/8 Market Street, Wakefield, West York shire WF1 1DH. Tel: 0924 366982. Price: £1.50 plus 50p P&P.

80%

Amiga Point 2.1

fidonet comms utilities

Calling all modem users! This is instant FidoNet. Unless you know exactly what you're doing and have large amounts of dull minded persistence, setting up your Amiga to be a FidoNet "point" is a right royal pain. Until now.

Once you've installed the system, it'll ask you a few questions which you'll need to get your "node manager" (the bloke who runs the local bulletin board) to answer, and that's it. No fuss, no bother.

Stuart Grier, John Keniry and Harry Genery are hereby nominated as heroes of the Amiga comms world. This is comms for the masses, exactly as it should be.

Available from: Pieces of Eight, 30 Hanover Buildings, Southampton SO1 1JU. Tel: 01703 399234. Price: £1 plus 50p P&P.

95%

PD Scene

Take your pick from this month's selection of PD disks - all for your entertainment.

Aquanaut game

From the author of *Giddy* and *Morton Strikes Back*, *Aquanaut* is a slick shoot 'em up, along the lines of the classic 8-bit hit *Cybernoid*. It's set in sub-aqua scrolling maze, filled with fish, mines and an assortment of nasty aliens. Extra weapons can be picked up to help you through the trickier sections. The only thing that lets it down is the lack of urgency. If you want, you can play the game at a snail's pace, as the aliens don't come at you until you're right next to them. Apart from that, it's a lovely game, and I wouldn't have a word said against it.

Available from: **F1 Licenceware, 31 Wellington Road, Exeter, Devon EX2 9DU. Tel: 0392 493580. Price: £3.99 including P+P.**

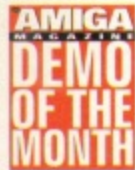
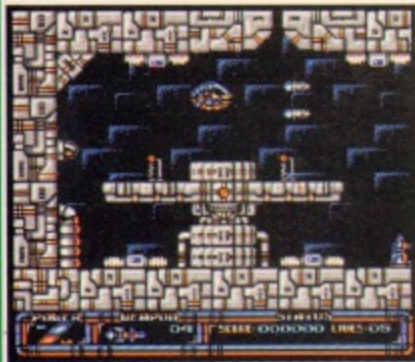

Say Demo and other utils utility compilation

This just missed the deadline for the utilities section, so we've squeezed it in here instead. The best part of this utility compilation is the speech synthesiser *Say Demo*, a simple program that speaks whatever text you type into it. Although it makes some attempt to speak with expression it still sounds computerised but it's still great fun to mess around with.

The disk also includes a dice simulator and a Connect 4 game. The dice simulator generates numbers using dice graphics and the Connect 4 game is a competent version of the game. This disk comes as part of a three-disk collection, which also includes a kid's paint package, a Pong game and a joystick tester. Worth a look for the speech toy.

Available from: **Andrew Fisher, Ingleside, 60 Burgh Lane, Mattishall, E Dereham, Norfolk, NR20 3QR. Price: £5 including P+P.**

85%

85%

Ilyad AGA demo

There's plenty of good 3D graphics in this 4-disk, but there doesn't seem to be any link. If you've got 3Mb of hard drive space, an AGA Amiga and 4Mb of Fast RAM, you can sit back and watch a stream of pre-rendered and realtime generated 3D space scenes. There's a soundtrack that threatens to get the pulse racing, but never quite manages it. 3D fans should check it out all the same.

Available from: **Freestyle PD, 108 Woodside Way, Short Heath, Willenhall, West Midlands, WV12 5NH. Tel: 01922 710985. Price: £3 plus 75p P+P.**

85%

Disk Magazines

Raw issue 7

Opinionated and heated debate seems to come high on the agenda with most disk mags covering the Amiga demo scene, and there's no shortage of it in the latest issue of *Raw*.

A lot of the articles are awkward to read, as they've been written by people whose native language may not necessarily be English but it's all been translated into English. Most of it is quite vehement, so it makes it all the more interesting reading for anyone on the scene.

Available from: **Freestyle PD, 108 Woodside Way, Short Heath, Willenhall, West Midlands, WV12 5NH. Tel: 01922 710985. Price: £75p plus 75p P+P.**

Upstream issue 10

More chat, news and opinions from the demo scene, in a similar style to that of *Raw*. There's aren't so many articles in *Upstream*, but there's still enough to keep you busy for a while.

Available from: **Freestyle PD, 108 Woodside Way, Short Heath, Willenhall, West Midlands, WV12 5NH. Tel: 01922 710985. Price: £75p plus 75p P+P.**



79%



76%

Cybersphere game



Breakout. Need I say more? Well, it's not exactly *Breakout*, it's more like *Arkanoid*, the updated version in which you don't just bounce a ball off a load of bricks, but you also get a few bonus pickups. The only thing that lets this down is the lack of speed, which makes it a bit too easy. A good 'un for the kids though.

Available from: **Freestyle PD, 108 Woodside Way, Short Heath, Willenhall, West Midlands, WV12 5NH. Tel: 01922 710985.**

Price: £75p plus 75p P+P.

72%

PD CD-ROMS

One of the best ways to get your PD fix is from CD-ROM compilations. Here are six of the best and two of the rest.



Gold Fish 2

The Gold Fish CDs are caviar compared to the fish paste of other CD-ROMs. Volume 1 scored the highest mark in our CD round-up last month (84%) thanks to its friendly storage system (all disks are stored in both compressed and uncompressed format) and the fact that it contains every Fred Fish disk from 1 to 1000. Volume 1 also has a simple text search system for finding particular programs.

Volume 2 compares very well. It's a completely new set of programs, utilities and tools. This time it's the Fresh Fish collection from volumes one to seven. It's much of the same type of stuff as on the first disc.

A real bonus is its simple program name and program type search system that allows you to locate bits and bobs easily. The Gold Fish 2 compilation lives up to expectations and is more than worth the asking price of £29.99 - recommended.

PD Soft. Price: £29.99

85%



Power Games

Packed with over 500 games this single CD offers something for game players of every kind. All the games are PD, and there doesn't seem to have been any quality control exercised here, so among the better games, there are plenty of complete turkeys. Even so, there's enough variety to cater for fans of all genres.

A collection of demos and hints and tips for commercial games can also be found on the disc, and although many of them are quite old, they're bound to come in handy at some time.

Twenty quid for 500 games is a bargain, and even if you only end up playing a handful of those on the disc you'll still have saved money. The number of good games and the commercial game hints combine to raise this CD above the quality of many PD compilation CDs.

PD Soft. Price: £19.99

79%



Ultimedia 1 and 2

For anyone requiring lots of images and sound files, this CD pack will be a boon. For £30 you get two CDs packed with animations, textures, pictures, and sound files. The quality of the images and sound files is impressive, particularly the photos. There are a few niggles, though. Whilst the pictures are grouped under sensible headings (animals, landscapes etc) the individual files have meaningless names such as 'IMFF0006.GIF'.

Also many of the images and all of the sound files and animations are in non-Amiga file formats. Animations are stored in .FLI format, sounds are stored as .WAV files and many of the pictures are in the GIF format. There are conversion utilities on the disc, but it would have been far better had they been converted by the CD compilers. Even so, £30 gets you two CDs stuffed with high quality pictures, which can't be bad.

PD Soft. Price: £29.99

85%



Clip art .GIF Professional

Although the back cover of this CD is adorned with pictures of 'babes' in various states of undress, there are actually relatively few pictures of girls on the disc itself - although there are still more than on other clip art CDs. All the pictures use no more than 256 colours, and come in GIF format, but unlike the Ultimedia collection there aren't any utilities to read or convert the GIFs to IFFs. Unless your graphics package can read GIFs, they'll need to be converted before you can use them.

Much of the material on the CD is pretty ropey, both in terms of subject matter and picture quality. However, you're bound to find quite a lot of useful stuff in a collection of this size. Most of it is fairly well organised into descriptive directories, which makes it easy to find what you're after. At £19.99 it's more than worth having if you need a collection of colour clip art.

PD Soft. Price: £19.99

82%



Get your utilities here. Any type of utility you can think of is bound to be crammed onto this disk. What a bargain!

Aminet Set 1

For £27.99 you get four CDs of software and data - that's 2600Mb of Amiga programs and files! And they are all from the public domain. Practically every type of Amiga utility is on here, along with bucket loads of images, textures, games, programming utilities, sound files, hardware drivers, animations - well you get the idea. No matter what you do with your Amiga, you'll find something here.

Accessing the individual programs and files is a cinch, and finding what you're looking for is made easy by a helpful disc index on the outside of the packaging and simple search software on the discs. For CD owning Amiga users this is an absolute must. It's quite simply the best value CD compilation around, and is a gold mine for Amiga owners.

PD Soft. Price: £27.99

92%



This baby's jam packed with some rather handy sounds. Unfortunately some of the samples are not such great quality.

Sounds Terrific

Packed with audio samples, Amiga musicians will love this two-disc set. Various file formats are used. You'll find a mix of *OctaMED* and *SoundTracker* modules, MIDI files, IFF, VOC and WAV samples, Sonix Scores, and more. There are plenty of player and conversion utilities. Sound quality varies from one sample to the next. As with most CDs, much of the data is complete crap, although there's enough good stuff to make it worthwhile.

What's frustrating is that many of the sounds are potentially very useful, but have been sampled so badly that they're a waste of space.

If you don't have access to a sampler, or you haven't got the knack of grabbing your own clean samples, then this is well worth a look. However, anyone accomplished at sampling would do better to get hold of some audio sample CDs.

Weird Science. Price: £19.95

75%



Lots of fun and games on this Public Domain CD from PD Soft. Hottest 4 manages to carry a whole bunch of stuff. You have to use DMS though.

Hottest 4 Professional

The fun side of public domain is reflected on this CD - demos, disk magazines, games, slide shows, pictures and sound. There's a truck load of games, and quite a few of them are AGA, many of which are quite good. These are accompanied by numerous Workbench 3 programs, some reasonable pictures and samples.

This rather good compilation is let down by the fact that all the files are in the DMS format, meaning you'll have to de-compress them first. This is a necessary evil, as much of the software uses non-standard disk formats, but it's not helped by the fact that you need to use either the CLI or a directory utility (like *DOPus* on CU Amiga Magazine's Feb cover disk) in order to de-compress them. All in all this is a good disc held back by a poor front end.

PD Soft. Price: £19.95

60%



Assassins! Ultimate Games Compact Disc

Assassins Collection

Assassins regularly release compilations of PD games on floppy disks. Some are good, some are awful. Now they've shovelled the whole lot onto a CD.

The front end is well implemented, allowing you to chose the type of game from a list (platform, shoot 'em up etc). Then a screen appears showing the type of controller needed (mouse, joystick and possibly CD32 controller) which is useful, and saves you messing around with the wrong controls once the games have loaded. You can also transfer games from a CD32 to a normal Amiga using a ParNET link. The best games disc so far, but don't expect a million and one classics.

Weird Science. Price: £19.95

80%

Public Domain and CD-ROM Suppliers

- **17 BIT SOFTWARE**
1st Floor Offices, 2/8 Market Street, Wakefield, West Yorkshire WF1 1DH. Tel: 0924 366982. Prices: £1 per disk, plus 50p P+P.
- **ACTIVE SOFTWARE**
PO Box 151, Darlington, Co. Durham, DL3 8YT. Tel: 01325 352260
- **AMIGANUTS PD**
3 Spring Road, Bittern, Southampton, SO19 2BH. Prices: £1.25 per disk plus 60p P+P.
- **ANDREW DEAN**
14 Fielding Avenue, Poynton, Stockport, Cheshire SK12 1YX. Prices: (Image Studio) £10 including P+P.
- **BATTLE AXE PD**
Unit D5, High Tech House, Blackfars Street, Norwich, Norfolk. NR3 1SF.
- **BUSTOP PD**
2 Wycliffe Terrace, Gilmorton Road, Lutterworth, Leics, LE17 4HN. Tel: 0455 554 982.
- **DELTRAX PD**
36 Bodelwyddan Avenue, Old Colwyn, Colwyn Bay, Clwyd, LL29 9NP. Tel: 0492 515981.
- **DUNCAN MORAN**
24 First Avenue, Colwyn Bay, Clwyd LL28 4DQ. Prices: (Kids Disks 1-6) £6 including P+P.
- **EPIC MARKETING**
Victoria Centre, 138-139 Victoria Road, Swindon, Wilts, SN1 3BU. Tel: 0793 490988.
- **FREESTYLE PD**
108 Woodside Way, Short Heath, Willenhall, West Midlands, WV12 5NH. Tel: 01922 710985. Prices: 75p per disk plus 75p P+P.
- **F1 LICENSEWARE**
31 Wellington Road, Exeter, Devon EX2 9DU. Tel: 0392 493580. Prices: various, enquire when ordering or see reviews.
- **JACK PRITCHARD**
5 Parklands Close, Gosport, Hampshire PO12 4XJ. Prices: (Account'Ability) £1.50 including P+P.
- **KEW=II SOFTWARE**
PO Box 672, South Croydon, Surrey, CR2 9YS. Tel: 081 657 1617. Prices: (Main Actor) £3 including P+P.
- **KT'S PD**
Dept CU, 75 The Drive, Rochford, Essex, SS4 1QQ. Tel: 0702 542434 Prices: 90p per disk plus 75p P+P.
- **NJH PD**
12 Meesons Mead, Rochford, Essex, SS4 1RN. Tel: 01702 546796.
- **NOBLE HOUSE**
48 Ednam Drive, Glenrothes, Fife, KY6 1NB.
- **ONLINE PD**
1 The Cloisters, Halsall Lane, Formby, Liverpool L37 3PX. Tel: 01704 834335. Prices: 75p per disk plus 75p P+P.
- **PAUL MOORE**
62 Braeside Avenue, Milngavie, Glasgow G62 6NN, Scotland. Prices: £1 per disk plus 50p P+P.
- **PENGUIN PD**
PO Box 179, Reading, Berks, RG3 3DD.
- **PD SOFT**
1 Bryant Avenue, Southend-on-Sea, Essex. SS1 2YD. Tel: 0702 466933.
- **PIECES OF EIGHT**
30 Hanover Buildings, Southampton SO1 1JU. Tel: 01703 399234. Prices: £1 per disk plus 50p P+P.
- **REDLAW RESOURCES**
74 Durban Road, Patchway, Bristol, BS12 5HQ. Tel: 0117 976 0600
- **ROBERT STANLEY**
13 Canterbury Avenue, Willenhall, West Midlands WV13 1JG. Prices: (Guitar Chord Directory) £5 including P+P.
- **ROBERTA SMITH DTP**
190 Falloeden Way, Hampstead Garden Suburb, London NW11 6JE. Tel: 081 455 1626. Prices: various, enquire when ordering or see reviews.
- **SEASOFT COMPUTING**
(cu) Unit 3, Martello Enterprise Centre, Courtwick Lane, West Sussex, BN17 7PA. Tel: 01903 850378. Prices: £1.50 plus 50p P+P.
- **SCRIBBLE PD**
2 Hillside Cottages, Burstall, Suffolk IP8 3DY. Tel: 0473 652588. Prices: £1 per disk plus 70p P+P.
- **SOFTWARE 2000**
Dept CU, 48 Nemesia, Amington, Tamworth, B77 4EL. Tel: 0827 68496. Prices: 99p plus 70p P+P.
- **VALLY PD**
33 Smiley Road, Hordan, Peterlee, Co. Durham SR8 1NZ
- **VISAGE**
18 Station Road, Ilkeston, Derbyshire, DE7 5LD. Tel: 0115 944 4501 Prices: £1 per disk plus £1 P+P.
- **WEIRD SCIENCE**
1 Rowlandson Close, Leicester, Leics, LE4 2 SE. Tel: 0116 234 0682.

THE EPIC SENSATION



CHES & TUTOR
A complete chess program with integrated tutorial. (includes speech)
Order code J1T5-2



DISK EXPANDER
Doubles the available space on your hard drive.
Order code EPU5-2



WB3 BACKDROPS
A great selection of superb Girly pictures to place in the background of your Workbench. Give it that personal touch.
Order code: WGB5-2



COPY THAT FLOPPY
A set of the most powerful disk copying tools available on the Amiga.
Order code :CPY5-2



LUCKY DIP CDROM
A mixed bag of Modules, tools, Objects, SFX, GFX tools, Demos, Games and loads more. A bargain at just £5 +£1P&P
Order: CDLDR49



BANSHEE CD32 VERSION A1200 VERSION
State of the art 4 disk vertical scrolling shoot'em up with superb sound & graphics, and unbeatable playability. Rated over 90% in most magazines. *Only available when purchased with at least two other titles.
Order code: BAN5-1

ONLY £5 each



CENTREFOLD SQUARES
A great game for Adults!!!
Order code: CFS5-1

FREE BOX OF TEN TDK DISKS WITH EVERY PURCHASE OVER £25.00



IMAGINE HINTS & TIPS
Imagine Hints, Tips, and tutorials is the perfect companion for imagine users. Includes a 40 page book plus a free companion disk.
Order code: HTT5-1

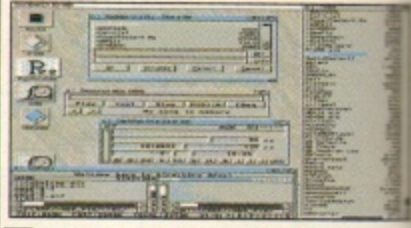

AMIGA POWER TOOLS
new collection of tools for Workbench 2 & 3. Includes Hard disk tools, Virus killer, sound & graphics tools, text editor and loads more.
Order code



LOTTERY WINNER PRO.
Lottery Winner Professional attempts to predict the National Lottery draw with as little as just a few months data. Every week you input the winning numbers and lottery winner will predict the following weeks numbers. (OFFICIAL FULL LICENCED VERSION)
Order LWP5-1



ARCADE CLASSICS 2
8 All time classic arcade games. Pacman, Frogger, Asteroids, Space Invaders, Centipede, Missile Command, Q-Bert, & Omega Race.
Code ARCS-2



MAGIC EYE CONSTRUCTION
Create your own fascinating Magic eye images on your own computer. supplied complete with viewer and examples. Great fun for the family.
Order code RDS5-



GRAPHICS CONVERTERS
The complete graphics manipulation package for Workbench 2 & 3 machines
Order code GFC5-2



HARD DISK TOOLS
An essential purchase for Hard drive users. Includes HD Backup, Salvage, menu system and more.
Order code HDT5-2



CATALOG SYSTEM
The complete cataloging system for Disks, games, CD's, videos etc
Code CTG5-3



WORD FINDER PRO.
This is the most powerful Word search / Cross word solver available. Over 58,000 word dictionary, and you can add your own.
Order code: WFP5-2



STARTREK TNG
A superb new Workbench enhancer kit that turns your Workbench into a virtual bridge. ENGAGE!. Includes samples, tools, and images.
Order code: TNG5-

Victoria Centre,
138 Victoria Rd,
Swindon, Wilts.
SN1 3BU. UK

Main Order Hotline.
01793 490988

Order Hotline.
01793 514188

PRIORITY ORDER FORM
Name _____
Address _____
Amiga Model _____
Payment Method _____
Credit card number _____
Exp date _____
ALL TITLES ARE COMPATIBLE WITH ALL AMIGA'S UNLESS STATED.

ORDER VALUE	
Please send me..	
Total goods value	£.
Postage & Packing	£.
Amount enclosed	£.

OVERSEAS ORDERS
Overseas orders are welcome, but there is a minimum order of 3 titles, and please add £1.00 per item.
COLLECTING YOUR ORDER
You are welcome to collect your order from any time between 9:30am - 5:30pm Monday - Saturday.
ORDERING BY POST
Simply send us your order, listing the items you require, the total cost, and your name & address with payment either by cheque or Postal Order.
ORDERING OVER THE PHONE
Call any time between 9:30 & 5:30 Monday - Saturday with your Credit card details and the items you would like to order.
POSTAGE & PACKING
UK & Mainland, add a total of just 50p Overseas. Please add £1.00 per title.

LICENCED SOFTWARE
Most titles advertised here are Licenced exclusively and so are not available from other software outlets.
CONDITIONS OF SALE
Goods are not sold on a trial basis. E&OE. Your statutory rights are not affected.
TECHNICAL SUPPORT
With a dedicated Technical supports line we offer 30 free technical support to all our customers on all our ware titles.
SATISFACTION GUARANTEED
We now have a powerful new order processing system which ensures that over 90% of orders are processed in 48hours. And with over 90,000 satisfied customers can be sure of a good service and fast delivery.
PRODUCT KNOWLEDGE
8 full time Knowledgeable staff to assist you.

Get Serious

LEANING OVER THE EDGE



CD-ROM has definitely arrived on the Amiga. The Archos Overdrive CD has proved tremendously popular, and our new regular CD-ROM reviews section (this month included as part of our PD feature) has gone down

a real treat if your letters are anything to go by. But now we're starting to see other CD products appearing.

The first of these is the wonderfully impressive Power CD-ROM from Amiga stalwarts Power Computing. Reviewed on page 102 this great CD drive is going to be an enormous success judging by the enthusiastic reaction it received in the CU Amiga Magazine offices.

Giving access to the rapidly growing library of Amiga CD discs and allowing many CD32 games to be played, it's likely to draw many new A600 and A1200 owners to the CD format.

But the Power CD-ROM wouldn't have been possible if it wasn't for another development. The HiSoft Squirrel will probably do more for the Amiga than any other peripheral yet. With it A1200 and A600 owners will be able to add hard drives, CD drives, SyQuests and tape back-up systems to their machines with the minimum of fuss. Find out more on page 106.

It's a shame there isn't an easier way of adding CD-ROM technology to the A500 at the moment (although my industry sources tell me it shouldn't be too long before a new CD drive is announced).

But in its place there are many other types of expansion you can fit, and best of all they're all relatively low priced.

On page 98 we take a quick look at some of these expansions, including new hard drives, RAM upgrades, and accelerators. If you're an A500 owner you can't afford to miss it!

Joining this lot are in-depth tests of a new database from HiSoft (see page 96) and a high speed 28,800 baud modem from Power Computing, reviews of a new modulator and an update of the immensely popular graphics package Photogenics. ■

It's your favourite techie section of your favourite Amiga magazine! We've got a load of goodies for you this month, whatever you use your Amiga for: there's a new CD-ROM drive, an update of Photogenics, a round-up of A500 expansions and plenty more beside, read on ...

- **Twist Database** 96
Databases are like buses: you see none for ages, and then three come along in a row! Twist is hot on the bumper of *Final Data* and *Datastore*.
- **A500 Upgrades** 98
Want to upgrade your A500? Andy Leaning takes a look at some low cost, high spec A500 expansions.
- **Photogenics 1.1 Upgrade** 100
Photogenics has been upgraded. Find out what's in the new version.
- **Power CD-ROM** 102
Power Computing's stunning new CD drive for the A600 and A1200.
- **Studio Professional** 104
Improve your print quality with this new printer driver software.
- **Squirrel** 106
Connect hard drives, CD mechanisms, tape drives and more to your Amiga with the amazing Squirrel SCSI interface for the A600 and A1200.
- **ACEEX FaxModem** 109
Another 28,800 baud super fast modem lets you speed onto the information super highway.
- **Mamba Modulator** 109
Need a replacement modulator or want to use your A4000 with a TV? The Amitek Modulator will solve your problems.
- **Art Gallery** 110
Art from Australia gets a special feature in this month's graphics showcase.

A500 UPGRADES PG 98



MAMBA MODULATOR PG 109

Twist Database

■ Price: £74.99 ■ Developer: Mermaid Group ■ Supplier: First Computer Centre ☎ 0113 231 9444

If you need to develop a better relationship with your database this product from Mermaid could be just the job.

Like all other databases that we have looked at over the past few months, *Twist* allows you to store whatever information you want about an object, present it on screen in a pretty manner and produce reports about what you have and haven't got.

However, *Twist* adds another dimension to these functions: relationships. Simply speaking, a relationship links fields and records from separate databases together by using a unique 'key' from one database to the other. The theory is that only need to store information about one thing in one place, keeping everything nice and simple, and reducing data duplication.

For example, say a company wanted to store information about its orders. An order is made up of a customer and some goods, but a customer may want to order from the company more than once and the goods will certainly be ordered by more than one customer. In a traditional card file database, all the information for each individual order is stored in one file (ie customer, address, product, quantity etc). Using a relational database means that the information about the customer is in one place, while the product information is somewhere else. The two components are pulled together to form an order by using unique customer and product reference numbers.

Still with me but can't see the point? Well, if a customer wants to make another order, his or her data does not need to be re-entered. Every time an order for a particular product is taken, data about the



product is pulled from the relevant database. Size is also a major factor. Using this system an order has only three numbers associated with it: the order number, customer number and product number.

To enhance the Supermodel database Andy Leaning used last month (*Datstore* review CU Amiga Magazine March 1995), something like a calendar database could be added. This could contain information on the price of the calendar and bring up information on the models contained within it for each month by adding a model code to the models database and accessing this from the calendar database.

Features

Twist has all the standard features of most databases. Fields (or slots of information) about an object are created and then arranged into a form which can also have boxes, text, graphics and any type of picture or text file that your datatypes will support. Graphics can also be displayed by relating a field in the current database form to one from another database form. In the example given above (see screenshot) the *LightWave* picture's filename was inside actually inside the the products database and was displayed on the customer one by

entering the number '37' into the issue number box.

A nice feature of *Twist* is that pictures in a database can be set to only display when clicked on – a process sometimes known as 'greeking'. This speeds up the process of calling up a file. It's also worth mentioning that *Twist* allows complete control over fonts, colour and style for each bit of information on the screen, too.

Fields can be flagged with a number of options, such as mandatory, unique and index and have a validity check performed on them too. Overall its field handling is pretty powerful.

Data entry is nice and simple. Entities can be created, deleted, duplicated or edited easily. Data can also be displayed in list format too – not just as forms. This has the advantage of allowing more than one entity to be displayed at the same time (as it is in the screenshot).

Twist also has its own 'query' language – a simple programming routine allowing you to build up complex reports based on information in the database. This is a moderately powerful beast which should mean that any report required can be generated with sufficient patience. I'd have preferred to have seen the industry

standard SQL query language used (which isn't too hard to implement) but the provided language seems quite adequate.

Documentation

The manual that comes with *Twist* is excellent in some places, lacking in others. It would be exceptionally useful to give more information on relational databases as I feel some users could be flummoxed by this. A vital point to remember when designing this type of database is to plan everything completely, before you start implementing it, otherwise you'll find sooner or later that you need to add another field to one database but can't because another database is using it! It's very easy to get this planning wrong: the detail involved is a scary topic, well beyond the scope of this review, but is essential if you are to make the most of *Twist*.

Twist is easy relatively easy to get to grips with using, exceptionally friendly (it reminds you of this fact by printing it the title screen), powerful, has a full *Arexx* port and can be run on any screenmode (useful for graphics card owners).

Compared to other databases, the richness of adding relationships seems worth a few pounds more, but don't forget to invest in some paracetamol if you intend to use this function. ■

Nik Lines

TWIST DATABASE	
A500	system requirements: Workbench 2.1+, 2Mb memory. Hard drive recommended.
A500+	
A600	ease of use87% Very easy for standard DB stuff. Relational model could cause headaches.
A1200	performance90% With an in-built caching system, it's extremely fast!
A1500	value for money89% Cheap for what it does. More manual would have been nice.
A2000	
A3000	OVERALL Easy to use, powerful and cheap.
A4000	89%

The A500 is still going strong. If you want to upgrade yours to 90s' standards, there are plenty of options ...

A500

RAM upgrades

Adding extra RAM to your A500 opens up stacks of new opportunities. Multi-tasking comes into its own when you have enough memory to run three or four major applications simultaneously.

Animations can stretch to previously impossible lengths, sounds are granted higher sample rates, and you can actually use the RAM disk without instantly running out of space!

Thankfully there's no shortage of RAM upgrades for the A500 and A500 Plus. Leafing through the pages of CU Amiga Magazine you'll find plenty of them advertised.

Most of these plug into the trapdoor slot under the A500. Typically they come with 512k or 1Mb of Fast RAM pre-fitted. A battery backed clock is also a common option, although you'll pay slightly more for it. A clock is useful for hard drive users especially, as it tags the date onto each file you save.

The Wizard Developments RAM boards provide all of these features and also have a two year warranty. Their prices start at £19.99 for an A500 512k card. Wizard are on 0322 272908.

If you need to increase your graphics handling or sound sampling capacity, Fast RAM will help, to make a big difference you need to add some Chip RAM. The Amiga's custom graphics and sound chips can only directly access Chip RAM. A standard A500 comes with 0.5Mb of Chip RAM. The A500 Plus has 1Mb of Chip RAM. Adding Chip RAM is a bit more fiddly than Fast RAM, as it involves replacing one of the chips on the Amiga motherboard (the Agnus or Fat Agnus chip).

Power Computing make the MegaChip 2, which can increase your Chip RAM to a total of 2Mb. For anyone

used to the constraints of graphics and sampling on a 1Mb A500, 2Mb of Chip RAM is a real godsend. Replacing the old Agnus chip with the MegaChip 2 is easy enough. There's no soldering involved, but you will need a steady hand. The MegaChip 2, also compatible with the A2000, is priced at £159. Power Computing are on 0234 273000.

Hard drives

Fitting a hard drive to your Amiga will dramatically improve its performance. Programs and files will load far quicker than from floppy and you won't need to keep swapping disks. There are still several A500 hard drives available, and all are reasonably priced.

One example is the rather innovative MTEC AT-500 hard drive. This metal-cased unit offers RAM expansion, a hard drive and optional ROM switcher, to allow

Kickstart 1.3 machines to swop between 1.3 and 2.04 ROMs.

Up to 8Mb of Fast RAM can be added inside the case using standard SIMM RAM chips, for which two sockets are provided. There's also a chip socket into which you can fit a 2.04 ROM. On the front of the unit is a switch allowing you to change from the 1.3 ROM inside the Amiga to the 2.04 ROM in the hard drive. You'll need to buy the 2.04 ROM separately, as it's not supplied.



▲ M-TEC's innovative hard drive also includes a RAM expansion and operating system upgrade.

Upgrades

Workbench 3.1

If you've got an A500, one of your main priorities could be upgrading the operating system. Adding the latest version of Kickstart and Workbench, 3.1 (or simply Workbench 3 as it is often referred to), will transform your Amiga into a new computer. The Amiga operating system is a combination of Kickstart (which comes on a ROM chip) and Workbench (which comes on floppy disks). Matching versions of both are needed in order for the system to work properly.

Moving up to Workbench 3 has many benefits, such as giving your A500 compatibility with the latest software (*Photogenics*, *DPaint 5* etc), faster performance, built-in PC disk compatibility, a utility called *Multiview* to

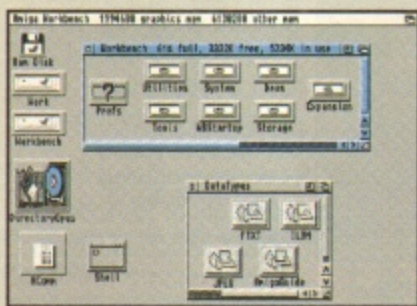

display graphics and play sound files, hypertext on-line help and more. You should also consider that most developers are now writing their software to work with and take advantage of Workbench 3.

Power Computing can supply a complete Kickstart and Workbench 3.1 upgrade for the A500, priced at £84.95. Power are on 01234 273000.

the back to allow additional drives to be 'daisy chained' onto them, so you can have up to eight attached at once.

Amiga 3.5" drives start at around £49, and go up to £99 for the feature packed models. There are several types available. Amitek have a very popular model, offering anti-virus, anti-click, and a disable switch for £59. Power Computing also sell a range of drives, including high capacity models that can store a massive 1.76Mb and 3.5Mb per disk (although they need special disks). Power Computing are on 01234 273000. Amitek drives are available from most dealers, including Silica on 0181-309 1111.

Accelerators

The best way to speed up all of your Amiga applications is with an accelerator. This replaces the brain of the Amiga with a faster version.

The hard drive interface is IDE, and interfaces for both 2.5" and 3.5" drives are provided. Power Computing can supply it with a variety of different hard drive sizes. The unit we reviewed had a 364Mb drive installed.

The instructions that came with our review model were pretty sketchy. However, these are being re-done, and the new improved instructions should be available by the time you read this. Power Computing also have a good phone-in after sales service, so their technical team should be able to help you out of any difficulties.

The hard drive wasn't secured properly inside the case of our review model, but Power Computing tell us this was a one-off, and is not the case with units sent out to customers. That said, it's still a nice unit. Simple and easy to use. Power are on 01234 273000.

Floppy drives

A second or third floppy drive will make a lot of operations faster. You

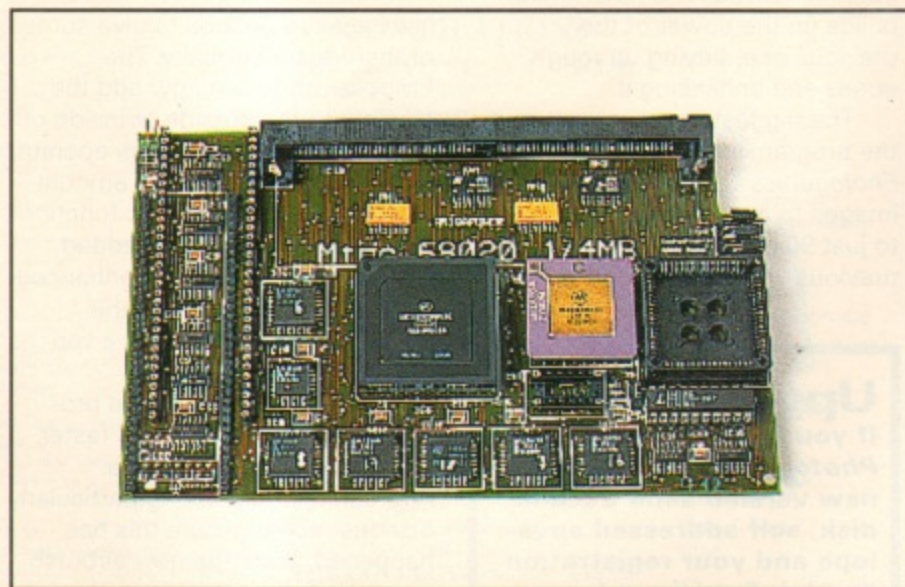

▲ Super power! Give your A500 A1200 processing power with this 68020-based accelerator from Power Computing. In addition to the 68020 CPU it also has a maths co-processor and optional RAM upgrade.

can keep the Workbench disk in the internal drive and your data and program disks in the external drives, which cuts down on a lot of the disk swapping involved with many programs.

You're not limited to having just one external floppy drive. Most Amiga drives have a connector on

Power Computing now sell a 14MHz 68020 accelerator with a 68881 maths co-processor, which also doubles up as a 1Mb or 4Mb RAM upgrade using SIMMs. This boosts performance to roughly double that of a normal A500. The on-board maths co-processor and RAM (if fitted) increase this still further.

Made by the same company that produce the MTEC hard drive, the M-Tec 68020i works on either the A500 or A500 Plus, but it's nowhere near as easy to fit as their hard drive. You need to open the Amiga, remove the existing CPU from its socket, plug the expansion card into the empty socket and then place the original CPU back into a socket on the expansion card.

Once again, the instructions are very basic, but Power do supply extensive aftersales back-up should problems occur.

The speed increase is very apparent once you've fitted the board. Workbench and applications fly, and many games improve as well. It's worth pointing out that this enhancement gives the A500 the same CPU and speed as an A1200.

Recommended for those who are confident with a screwdriver. Power Computing are on 01234 273000. ■

Urgent upgrades

So which upgrade should you get first? To soup up a basic A500, a RAM upgrade is a good starting point. The more RAM you add the better, and right now prices for 512k and 1Mb upgrades are very low.

The next priority for anyone using a variety of new applications is a Workbench upgrade. However, if you only use your Amiga for games, there's little point. In some cases, a hard drive or accelerator could be more beneficial, if most of your software is compatible with your current operating system.

Next month we'll have a range of reader offers on several of these upgrades, so start saving now.

Photogenics 1.1a



■ Price: £57.45 ■ Developer: Almathera ■ Supplier: Almathera ☎ 081 687 0040

In just a few months Photogenics has become the number one graphics package on the Amiga. But never a company to stand still, Almathera have released an upgrade. So what makes the new version so special?

In December CU Amiga Magazine exclusively previewed a new program called *Photogenics*. What we found was an innovative paint and image processing program. Since then it has



▲ The emboss operator has been improved and can now add the emboss shadow to the inside of any lines as well as the outside.

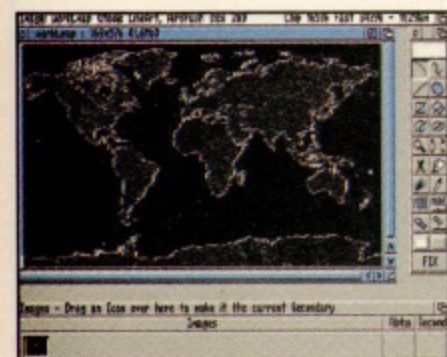

▲ Lineart now has the ability to invert as well as its usual functions.

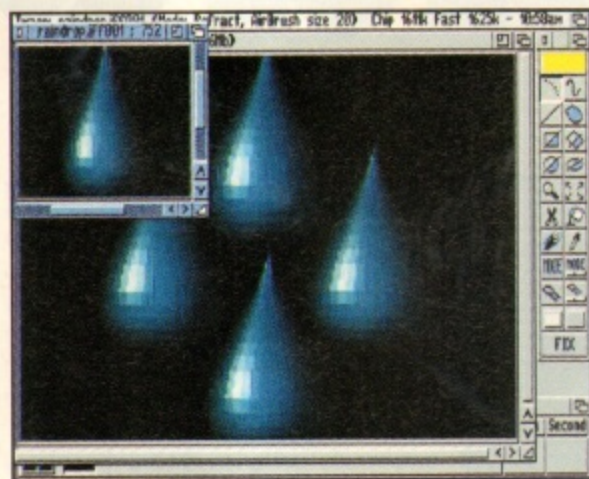

▲ The refract mode in operation, this takes a picture, splits into four and then puts it back together offsetting each of the four copies from the original.

gone on to become the Amiga's top graphics title.

There were minor irritations with the first version of *Photogenics* but nothing major, and certainly no more than any other new software package, so why did Almathera feel the need to issue an update?

The answer can be found in the way changes have been made between versions 1 and 1.1. There are relatively few new features, instead existing capabilities have been enhanced. The new version builds on the power of the previous one, tidying up rough edges and enhancing it.

The biggest improvement is in the program's rotation capabilities. *Photogenics 1.1* can now rotate images to any angle, as opposed to just 90 degree increments of the previous version.

Upgrading

If you already own *Photogenics* and want the new version send a blank disk, self addressed envelope and your registration number (you must have previously sent in your registration card) to Almathera.

Almathera is continuing to work on the program adding still more features, in fact a new version was in the works as I write this. We'll keep you posted.

Gimme five

The number of paint modes has also been significantly increased. Five new modes have been added: a median stellate which turns the picture into a bright pattern of stars, a flip operator, which takes the picture and reverses it either vertically or horizontally, refract which splits the picture up into four sections and rebuilds it placing each section

back in place but offset from the original, and last, but not least defocus. Like existing modes these can be applied to the entire picture or painted on using a brush.

In addition to these new modes several old ones have been merged and retitled in a way which makes them easier to locate and use. For example, heavy blur is incorporated into blur, while the limitmin and limitmax have now simply become limit.

The final changes to modes involve extra options to give some of them extra flexibility. The Emboss mode can now add the shadow to the outside or inside of an area, while the defocus operator allows you to specify the amount of defocus and the lineart function now has an invert mode added. Finally, rubthru has been enhanced by allowing you to offset the pixels from the original by a variable amount.

The overall speed of the program hasn't got that much faster, but specific operators have. Airbrush and blur being particularly obvious modes where this has happened. Also, the new airbrush is wonderfully fast and responsive.

And so ...

Photogenics is now a much more polished program, although the original was already pretty good. With more paint modes and further options for the existing modes and additional file formats it's now without any doubt the best all-round graphics package on the Amiga. It

File formats

The original version of *Photogenics* handled more than enough files for most users. But with in its new incarnation Almathera have taken the opportunity of adding a few extra formats. The complete savers and loaders are shown below.

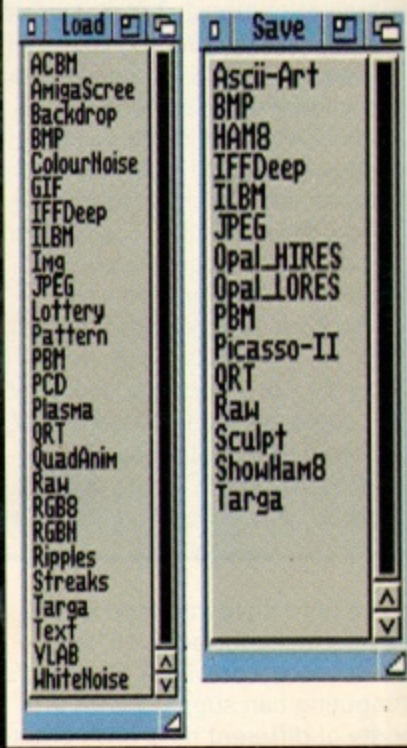

may not offer the sheer power of *ImageFX* but it's more flexible. ■
Andy Leaning

PHOTOGENICS 1.1a

A500 **system requirements:**
Any Workbench 3 Amiga with a 68020 CPU and 2Mb RAM.

A600	ease of use	91%
A1200	performance	92%
A1500	value for money	92%

Some of the requesters have been improved, making operation easier to understand.
Many rough edges have been polished up.
Still good value for money just like the original version!

OVERALL
The best just keeps on getting better.

92%

AMIGA REPAIRS

FIXED PRICE ONLY £42.99 Incl. (A500/+, A600 ONLY)

- * Price includes PART, LABOUR, DELIVERY & VAT
- * 90 Day warranty on all repairs
- * 24 Hour turn-around on most repairs
- * All upgrades purchased from us fitted free with repair
- * Includes FULL DIAGNOSTICS, SERVICE AND SOAK test
- * If drive or keyboard need replacing add £10

Est. 13 Years

AMIGA A1200 Repairs only £52.99 Fully inclusive

SPECIAL OFFERS

A500 Internal Drive	£36.20	A600/1200 Internal Drive	£38.90
A500/600/1200 PSU	£28.50	A500 Keyboard (UK)	£42.10
Fatter Agnus 8372A	£24.30	A500 CIA	£15.00
Super-Denise	£14.40	A520 Xchange Modulator	£18.00

CHIPS		CHIPS		HARD DRIVES	
8371 Agnus (A500)	£12.60	Kickstart 1.2	£4.20	Quality 2.5 inch Int HD	
8372A 1 Meg Agnus	£24.30	Kickstart 1.3	£12.80	Suited for A600 & A1200	
8375 2Meg Agnus	£24.30	Kickstart 2.04	£22.40	60 Mbyte	£135.95
8374 Alice (A1200)	£32.70	Kickstart 2.05	£29.90	120 Mbyte	£195.00
8362 Denise (A500)	£9.60	Kickstart 3 (high)	£25.00	210 Mbyte	£269.00
8373 Super Denise	£14.40	Kickstart 3 (low)	£25.00		
5719 Gary	£7.60	Rom Sharer	£15.00		
8520 CIA (A500/+)	£15.00	NEW Modulators	£29.50		
8520 CIA A600/1200	£15.00	All spares are factory NEW and genuine Commodore parts. All come with 12 months warranty (Except chips)			
8364 Paula (A500/+)	£12.34				

Add £1.00 P&P on chips, £2.50 P&P on drives & PSUs. We reserve the right to refuse repairs

***** ATTENTION ALL DEALERS *****

Our Company offer the most competitive dealer repair service on all home computers, Credit facility available. SEND FOR FREE INFORMATION PACK TODAY

Service HOTLINE (0533) 470059

DART Computer Services (CU)

105 London Road
LEICESTER LE2 0PF



DART
Computer Services

The Guild of Master Craftsmen

A division of D.A. Computers Ltd

LOWEST PRICED TOP QUALITY RIBBONS, INKJETS, TONERS & DISKS

Printer Ribbons

BLACK					BLACK				
	1 off	2+	5+	10+		1 off	2+	5+	10+
Amstrad DMP 2000/3000	2.80	2.65	2.45	2.25	Panasonic KXP1123/1124/1140	3.46	3.31	3.11	2.91
Amstrad DMP 4000	3.66	3.51	3.31	3.11	Panasonic KXP1080/1180/90/1592	2.89	2.74	2.54	2.34
Amstrad PCW8256/8512/LQ3500	2.85	2.70	2.50	2.30	Panasonic KXP2123/2180	4.95	4.80	4.60	4.40
Brother M1009/1024/1109/1209	3.90	3.75	3.55	3.35	Seikoshia SL90/92/95	5.70	5.55	5.35	5.15
Citizen 120D/LSP10/Sweet 24/9	2.85	2.70	2.50	2.30	Star LC10/20/100	2.29	2.14	1.94	1.84
Commodore MPS1220/1230	4.50	4.35	4.15	3.95	Star LC200	3.00	2.85	2.65	2.45
Epson LQ100	4.10	3.95	3.75	3.55	Star LC24-10/200	2.86	2.71	2.51	2.31
Epson LQ400/500/800/850	3.45	3.30	3.10	2.90	Taxan Kaga KP810/815/910/915	3.14	2.99	2.79	2.59
Epson FX/MX/RX80/FX/LX800	2.90	2.75	2.55	2.35					
Epson FX/MX/RX100/FX/MX1000	3.36	3.21	3.01	2.81	COLOUR				
Epson LX80/86/90	2.12	1.97	1.77	1.67	Citizen Swift 24	11.95	11.80	11.60	11.20
Mannesmann Tally 80/81	3.90	3.75	3.55	3.35	Panasonic KXP2123/2180	10.63	10.48	10.28	9.88
NEC Pinwriter P2200	3.03	2.88	2.68	2.48	Star LC10/20/100	6.00	5.85	5.65	5.25
OKI ML182/183/192/193/195	3.17	3.02	2.82	2.62	Star LC200	9.78	9.63	9.43	9.03
					Star LC24-10/200	9.63	9.48	9.28	8.88

Ring for Ribbons Not Listed

Ring us and WE WILL BEAT all other Ribbon prices

3 1/2" Disks & Disk Boxes

	DS/DD	DS/HD	
10 Disks	\$5	\$7	100 Cap. Lockable Disk Box \$5.99 with orders of \$10+
25 Disks	\$10	\$14	
50 Disks	\$16	\$23	
100 Disks	\$29	\$43	
250 Disks	\$65	\$92	

Preformatted (MS-DOS) disks available at 2p extra/disk.

All Disks Certified 100% Error Free and INCLUDE FREE Labels.

Miscellaneous Items

Roll 1000 3 1/2" Disk Labels	8.99
3 1/2" Disk Cleaning Kit	2.99
Parallel Printer Cable (1.8m)	3.99
Mouse Mat	2.99

Inkjets, Ink Refills & Toners

Canon BJ-10/20 Cartridge	17.54 each
Commodore MPS1270 Cartridge	12.13 each
HP Deskjet Cartridge (Double Cap.)	24.24 each
HP Deskjet Tri-Colour Cartridge	28.89 each
HP Thinkjet/Quickjet Cartridge	12.13 each
HP Deskjet Tri-Colour Cartridge Refill	16.00 each
Inkjet Refills (Twin Packs) for Canon BJ-10/20, BJ300, HP Deskjet. Available in Black, Cyan, Magenta, Yellow, Red, Blue, Brown, Light Green, Dark Green and Gold.	
1 Pack \$11.00, 2+ Packs \$10.60 ea, 5+ Packs \$9.95 ea	
HP Laserjet II/III Toner Cartridge	44.51 each
HP Laserjet III/III Toner Cartridge	53.14 each

Ring For Inkjets & Toners Not Listed

CPU & Monitor Dust Cover	6.49
Monitor Dust Cover	4.99
80 Column Printer Dust Cover	3.99
Amiga 500 Dust Cover	3.99
Amiga 600 Dust Cover	3.99
Amiga 1200 Dust Cover	3.99

All Prices INCLUDE VAT (@ 17 1/2%) & UK Delivery

01543 250377

01543 250377



Ring us or send cheques to:
**Owl Associates, Dept 318, Owl House,
5 The Brambles, Lichfield, Staffs WS14 9SE**



E & OE

WIZARD GAMES

1 NORTH MARINE ROAD, SCARBOROUGH, NORTH YORKSHIRE, YO12 7EY. Tel: 0723 376 586

AMIGA GAMES

Adams Family	£5.99	Power Monger and WWI	£11.99
Akira	£19.00	Ruff 'n' Tumble	£17.99
Aladdin (A1200)	£19.99	Reach For The Skies	£11.99
Battle for the Ashes	£7.99	Road Kill A1200	£15.99
Bubble 'n' Squeak	£14.99	Road Rash	£9.99
Bump 'n' Burn	£14.99	Rugby League Coach	£16.99
Campaign 2	£14.99	Sabre Team (A1200)	£9.99
Champ Manager End Of Season D/D	£12.99	Scrabble	£15.99
Clockwise A1200/A500	£8.99	Sensible Soccer	£5.00
Club Football	£20.99	Shadow Fighter	£17.99
Cybercon 3	£8.99	Space Crusade and Voyage Beyond	£8.99
Death Mask (Doom)	£17.99	Skidmarks	£9.99
Dennis A1200/A500	£7.00	Skidmarks Upgrade	£11.99
Desert Strike	£10.99	Super Skidmarks 2	£11.99
Dune 2	£12.99	Simpsons	£6.99
European Champions	£9.99	Sim City Architecture 1	£4.99
F-1 (Domark)	£12.99	Sleep Walker A500/A1200	£7.99
Funschool 2. Under 6-6-8 over 8	£6.99	Soccer Kid A500/A1200	£9.99
Graham Gooch & 2nd Innings	£15.99	Soccer Team Manager	£10.99
Gunship 2000	£14.99	Supremacy	£10.99
Hanna Barbera Animation Workshop	£19.99	Sooty's Fun with Numbers 7Yrs	£7.99
Hero Quest 2	£16.99	Tactical Manager	£12.99
Hero Quest and Return of the Witchlord	£8.99	Thomas Tank Fun with Words 7 Yrs	£7.99
Inter Open Golf A1200	£10.00	Thomas Tank Paint Box	£12.99
International Golf	£10.99	Toki	£9.99
James Pond 3 (A1200)	£13.99	Top Gear 2	£14.99
Jet Strike A1200/A500	£10.00	Tornado A500/1200	£10.99
K240	£17.99	Tornado A1200/4000 Hard Drive Only	£10.99
Kid Pix	£9.99	Track Suit Manager 2	£16.99
Lion King (A1200)	£19.99	Traps 'n' Treasures	£9.99
Man UTD Premier League 94/95	£14.99	Trivial Pursuits	£7.99
Marvins Marvellous Adventures (A1200)	£19.99	Thomas Tank 1 and 2	£12.99
Mavis Beacon Typing Tutor	£15.99	Vital Light	£12.99
Microprose Grand Prix	£14.99	Wemby Int. Soccer	£14.99
MIG-29m Super Fulcrum	£10.99	Wemby Rugby League	£14.99
Monkey Island 2	£12.99	Zool 2 A500/1200	£8.99
Noddy's Big Adventures 3-8 yrs	£16.99	Liberation	£9.99
Noddy's Playtime 3-8 yrs	£16.99	Yo Joe	£9.99
Playdays 3 to 8 yrs	£9.99	Wiz n' Liz	£9.99
P.G.A. Tour Golf + Extra Courses	£12.99	Wiz Kid	£5.99
Premier Manager 3	£15.99		

CD 32

Akira	£19.00	Lotus Trilogy	£12.99
Cannon Fodder	£14.99	Nick Faldo	£14.99
Bubble 'n' Squeak	£10.99	Road of Kill	£15.99
Bump 'n' Burn	£19.99	Ryder Cup Golf	£10.99
Death Mask (Doom)	£15.99	Sleep Walker	£9.99
Grolier Encyclopedia	£19.99	Theme Park	£22.99
Guardians	£14.99	Tower Assault	£19.99
Guinness Book of Records	£12.99	Top Gear 2	£14.99
Humans 1 & 2	£12.99	Trolls	£12.99
Jungle Strike	£17.99	Wemby International Soccer	£19.99
Kid Chaos	£10.99	Zool 2	£10.99
Lil' Devil	£14.99		

COMPILATIONS

THE GREATEST	£12.00
Jimmy White/Dune	
Lure of the Temptress	
EXCELLENT GAMES	£12.00
Shuttle/Populous 2	
Archer Macleans Pool/James Pond 2 (Not boxed)	
KIDS RULE OKAY	£9.99
Postman Pat 3/Popeye 2	
Sooty and Sweep	
BUMPER PACK	£6.99
Jaws/Grand Prix/High Steel/Crossbow	
KIDS PACK	£5.99
Postman Pat/Musters/Count Duckula (Not Boxed).	
SPORTS TOP 10	£14.99
World Rugby/World Soccer/Int Ice Hockey/Int Tennis/Int Truck Racing/World Cricket/Carnage/Tag Team Wrestling/Kenny Dalglish/G Souness.	
THE COLLECTION	£19.99
Cannon Fodder, Settlers, Chaos Engine, T.2.	
CLASSIC ARCADE	£7.99
Pacman, Invaders, Rebound, Galaxy	
BITMAP VOL 1 (not 1200)	£8.99
Xenon, Cadaver, Speedball 2	
COMBAT CLASSICS	£10.00
F/S Strike Eagle 2, Team Yankee, 688 Attack Sub	
COMBAT CLASSICS 3	£21.00
Campaign, History Line, Gunship 2000	

SPECIAL OFFER

Money Matters v3	£29.99
Infofile	£5.99
Includes Database, Accounts, Addressbook, Graphics	

ANY 3 FOR £10.00

Allo Allo	Ultimate Golf
Pegasus	Utopia
Jim Power	Ultimate Ride
Mega Motion	Liverpool
Rampart	Total Carnage
Striker	Puzznic
Surburba Commando	Blues Bros
Dinosaur Detective Agency	Morph A1200
Arnie 2	Crazy Cars 3
Beastlord	Hyperion
BSS Jane Seymour	Super Cars 2
Daily Double Horse Racing	Rick Dangerous
Resolution 101	Shuffle Pack Cafe
Santas XMAS Capers	The 3 Stooges
Times Crosswods	Spike in Transylvania
Huckle Berry Hound	Track Suit Manager
Switch Blade 2	World Champ. Boxing
Space Crusade	Manager
Steve Davis Snooker	Sun Cross Words
Colossus & Chess	Pixie & Dixie
Carrier Command	Zool
Elvira	INT. Soccer

When Ordering Please Give One Alternative Also Which Amiga

CD32

Alfred Chicken	Fireforce	Robocod
Battleroads	Fury of the Furies	Striker
Battlechess	John Barnes	Super Methane Bros
Beavers	Lost Vikings	Summer Olympic
Bubu 'n' Stix	Man UTD	Seven Gates of Jambula
Castles 2+	Mean Arcans	Top Banana
Chuck Rock 1 or 2	Morph	Trivial Pursuit
Chambers of Shaolin	Nigel Mansell	Whales Voyage
D-Generation	Overkill + Lunacy	Zool
Deepcore	Out to Lunch	
Flyharder	Premier	

£8.99 Each or Any 3 for £20.00

Games subject to availability. A phone call reserves your order



Open 6 Days a week

9.00 - 5.30

Price inc. P/P (U.K)



Europe + £2.00 Per Game - Rest of the World £3.00

Shop prices may vary.

Cheques or postal Orders Payable to Wizard Games.

WIZARD GAMES, 1 NORTH MARINE RD, SCARBOROUGH, N.YORKS YO12 7EY

TEL & FAX : 0723 376586 / 503299



Earphone Output: Plugging headphones in here will allow you to use the player as an Amiga controlled audio CD player. However, unlike the phono outputs on the back of the Amiga sound isn't sent through here.

CD Tray: CDs can be booted directly. The drive also plays music CDs, CD32 games, and can read the growing number of CD-ROM reference disks.



Power CD

■ Price: £199 ■ Developer: Power Computing ■ Supplier: Power Computing ☎ 01234 273 000

Looking for a CD drive for your A1200 or A600? You've just found it.

The HiSoft Squirrel SCSI interface was bound to result in a sudden rush of SCSI based expansions for the A1200 and A600. What we didn't expect however is that they would arrive so quickly. Power Computing managed to release such a product almost as soon as the Squirrel became available!

Power's product takes HiSoft's interface and combines it with a standard 'off-the-shelf' CD-ROM drive from Sanyo. This is then boosted with a quality manual and driver software.

The driver software will need to be installed on your Workbench boot disk or hard drive, or else a

dedicated CD boot disk can be created. You can then access the CD-ROM drive as if were any other Amiga 'device', such as a hard drive, RAM disk or a floppy drive. Compared to the system used by the Overdrive from Indi, this approach results in a greater compatibility with CD32 games (see the panel CD32 Compatibility).

The drive offers double speed performance which equates to transfer rates of roughly 300k per second. According to SysInfo, it managed to access 315,203 bytes per second in our tests.

MPEG playback

This is more than satisfactory for copying and loading files, or for

playing animations directly from CD. It's also just about good enough to play MPEG files with the supplied MPEG decoder software. MPEG decoding is usually carried out by dedicated hardware chips (such as the FMV card for the CD32), but software decoders are getting better at pulling audio and video data off CDs to generate full-motion video.

Another interesting feature is that the drive has audio inputs, which it mixes with any sound it's playing from the CD. The combined sound is output through a pair of phono sockets. An obvious trick is to take the Amiga's normal output and link it to the drive's audio input, so you can listen to a music CD and

then play a game, listening to both without needing to mess around changing cables. Unfortunately this combined sound is only output via the phono sockets at the back of the drive and not through the earphone jack on the front.

Another niggle I have is that to change the SCSI ID settings you need to open the case. The ID settings are used by the Amiga to identify which SCSI device is currently being used (remember that SCSI can support up to seven different drives). If you add extra SCSI devices to your system you may need to change this ID number - to avoid conflicts. On many CD drives this ID switch is on the outside, at the back of the unit, for ease of use. Indeed Power Computing's advert in the March issue shows a drive with the switch on the back. It's not a major problem, and won't affect you if you don't intend to

CD32 Compatibility

The Power CD-ROM comes with drivers to emulate a CD32. To test its compatibility, we tried out the following CD32 games.

Compatible Games

- Super Stardust
- Alien Breed Tower Assault
- Gunship 2000
- Brutal Football
- Brian the Lion
- Clockwiser
- Ultimate Body Blows
- Heimdall 2

Incompatible Games

- Skeleton Krew
- Dragon Stone
- Theme Park
- Nigel Mansell World Championship
- Lotus Trilogy

Some of those that did eventually work required a bit of messing around with Workbench first.

add another SCSI device, but if you're regularly doing so it can be very annoying.

Conclusion

Apart from the above niggle, I have no hesitation in recommending this drive. It's a great way of adding CD compatibility to your Amiga 1200 or 600. It's certainly a lot better implemented than the Overdrive CD-ROM, in terms of speed, user interface, and software compatibility. The best Amiga CD-ROM yet. ■

Andy Leaning

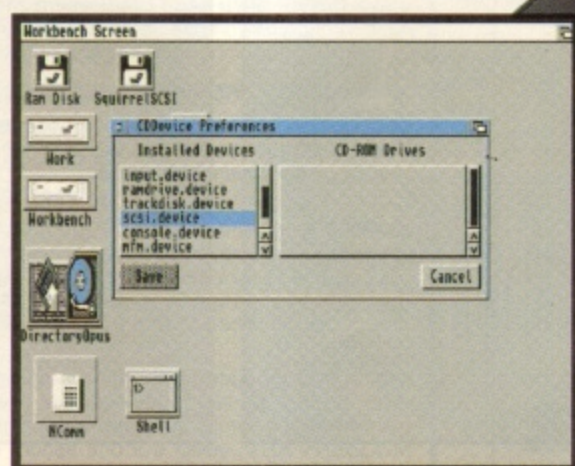

SCSI Interface: The drive connects to the Amiga via HiSoft's Squirrel interface (reviewed on page 106 of this issue). Further SCSI interfaces can be attached via the second SCSI interface. You could also use this drive on a Mac or PC using the SCSI interface.

Audio In/Out: By plugging the Amiga's audio to the phono inputs on the CD drive, and then linking the phono outputs of the drive to your amplifier, you can listen to music CDs and your Amiga's sound simultaneously.

Competition time

As you can probably tell from this review we were very impressed with the Power CD. And so in a fit of generosity we've joined forces with Power Computing to give away two of these brilliant CD drives as competition prizes.

To enter the competition simply answer the following three questions, write the answers, along with your name and address, on the back of a postcard and send it to: I WANT A SPEEDY CD, CU AMIGA MAGAZINE, Priory Court, 30-32 Farringdon Lane, London, EC1R 3AU.

1. How fast is the drive according to Sysinfo calculations?
2. How many other devices can be plugged into the back of the CD drive?
3. Name one of the CD32 games from Team 17 that is compatible with the Power CD?

EMAP Images Publications Ltd may permit other reputable companies to make offers of products or services that may be of interest to competition entrants. If you do not wish to have details given here passed on, please tick the following box.

RULES:- Closing date 25th May 1995, all entries must be received before this date. Entries will only be accepted by post. No correspondence will be entered into. The editors decision is final. The winner will be notified by post. Only one entry per person is allowed. No employees of Emap Images or Power Computing may apply.

POWER CD	
A500	system requirements: A600/A1200 only
A500+	system requirements: any Amiga with a PCMCIA slot.
A600	ease of use92% Couldn't be easier with its slide in CD compatibility.
A1200	performance89% A good CD drive with a very impressive performance.
A1500	value for money90% Pretty good, although CD drive prices will fall in the next few months as more models appear.
A2000	OVERALL
A3000	Good all round performer at a reasonable asking price.
A4000	91%

Studio II Professional

■ Price: £49.95 ■ Developer: Wolf Faust ■ Supplier: Just Amiga Monthly ☎ 0895 274449

Can you really improve your print quality without changing your printer? Apparently so ...

Standard Amiga printer drivers are nothing to write home about. For a long time now the best alternative has been Wolf Faust's *Studio*. Now it has been given a serious upgrade in the form of a colour management system and several other enhancements.

Studio II Professional is both a small step and a giant leap at the same time. The printer drivers themselves are reasonable improvements over Version 1. They are slightly faster, slightly neater. That's no great surprise though. Wolf's *Studio* drivers were already the best available for the Amiga.

The big picture

However, the image printing software has been vastly improved. This is a program separate from the printer drivers, used for outputting images to the printer. The file can be an IFF, JPEG, GIF, TARGA, PGM, PPM or any OS3 datatype. The pictures are printed direct from disk so it needs very little memory to print even the largest image. 1Mb of RAM is enough to print any image, but things run more smoothly with 2Mb or more.

The image printer has a wide range of capabilities. It can print in any size, limited only by the time you're prepared to spend feeding paper into your printer. It can perform a few image processing operations, like blur and negative. It has a total of 54 dither types available (patterns of dots which make up the picture), and there are plenty more features too.

Linked in with the image printing software is the Colour Management System. This ensures that the output produced matches exactly what is

seen on screen. Best results are achieved if you have a colour scanner. This allows you to print the picture, then scan it back in. The program compares the original image with the scanned image and adjusts itself accordingly.

The 207 page manual contains all the information on printers you are ever likely to need (and a fair bit you could probably do without),

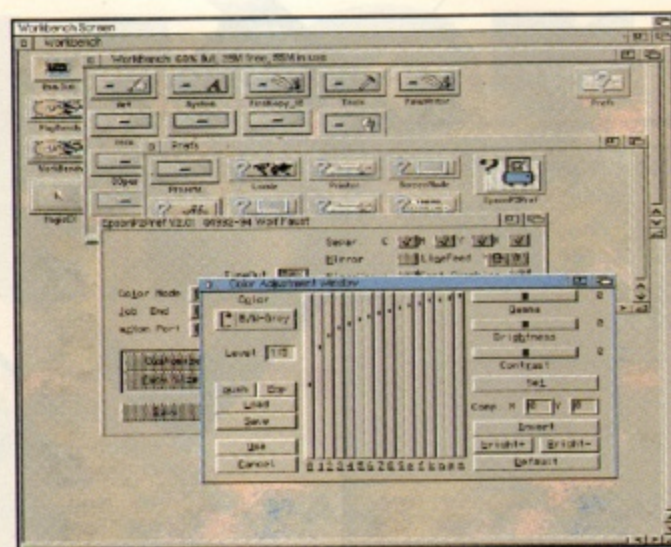

▲ Studio II Professional's printer driver has absolute control over colour output. The sliders shown above can control the amount of colour that is put onto the page.

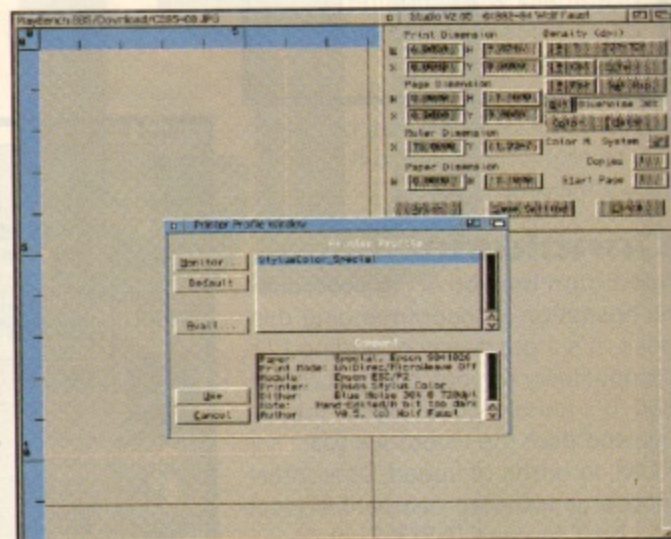

▲ Studio II Professional also has the capacity to produce image printouts of poster size proportions.

covering dithers and colour separation, ink compensation and monitor/ink gamut. It's long, it's tedious but if you really want results it is invaluable. Without it your output will probably be duff.

Conclusion

The results are stunning. It kicks just about any printer into overdrive. The output is 24 bit and it shows. If you compare it with *Studio 1* there is a noticeable difference, and it's streets ahead of the Workbench drivers.

There are only a few things missing from *Studio II*. The colour management system only works with the image printing software, not the printer driver itself. While

the driver could do with an automated colour changing system to match the dithering. It would also be nice if all the dithers were available to the driver and not just the image printing software. Lastly, the preferences programs could do with being a little bit friendlier.

In the final analysis the quality of the printing renders these problems insignificant. At £49.95 it may seem expensive, but you do get good value. It really does make a world of difference. If you have a 24 pin printer, an inkjet or even a laser, check with Just Amiga Monthly to find out if your printer is compatible. ■

André Digard.



Compatible Printers

Here are some of the printers that are compatible with *Studio II Professional*. If your printer is not listed below, call Just Amiga Monthly on 01895 274449 to find out if it's compatible. *Studio II Professional* will not work with 9 pin printers.

Canon.....	BJ series
Canon.....	BJC series
Citizen.....	Swift 240C
Epson.....	LQ series and compatible
Epson.....	Stylus Color (full 720 DPI)
Fargo.....	Primera
HP.....	Laserjet series and compatible
HP.....	Deskjet series and compatible
Panasonic.....	KX-P1124 series
Star.....	LC-24 series

STUDIO II PROFESSIONAL

A500 **system requirements:**
1Mb, Kickstart 2+. Printer: 24 pin, inkjet or laser.

A500+	ease of use60%
A600	A bit of a dog in places. You have to learn a lot to get the best results.
A1200	performance94%
A1500	The best on the Amiga so far. Produces the results you always hoped for.
A2000	value for money83%
A3000	Not cheap, but it delivers the goods - just what you need.
A4000	OVERALL

Clean, accurate results.
The best driver so far. **89%**

How You can be Rich within 3 years

My name is John Scott. Let me briefly tell you my story. Five years ago I was broke, living in a cramped rented flat and driving a rusty old Ford Escort. My clerk's salary was not enough to survive on and I was sliding into debt. I felt like a total failure. Things are very different today, I now own a large five bedroom house, a top-of-the-range Mercedes and a Porsche 911 Cabriolet, and my wife and I usually take three overseas holidays each year (we have just recently returned from a superb two weeks in Thailand).

I went from being broke to a millionaire within 3 years (certification available). I have earned more than £3 million in the past five years – not by dreaming or wishing for wealth but through hard work, trying various techniques – making mistakes along the way, but learning hundreds of little known secrets in the process.

So how come my drastic change in fortune? In the beginning I purchased almost every book available that promised great wealth through plans or schemes that required no work, but I soon discovered the information was worthless. I believe that most people selling plans that promise to show you how to make money using little or no effort make their money on the books and plans themselves – not on the formulas outlined in those books.

Five years ago I was lucky enough to meet and become close friends with an amazing forty-two-year-old self-made multi-millionaire. He taught me that it's not just how hard you work that counts as many people work hard all their lives yet have nothing to show for it. He shared with me his most closely guarded secrets. By closely following his advice I became a millionaire within three years. **You** now have the chance to share in my success because I am making two very special guides, unlike anything else you will have read – or will ever read – available to you!

1. THE STREETWISE WAY TO WEALTH

Some time ago a friend of mine who had recently lost his job, aware of my success, asked me how he could do as I had. I revealed to him my methods. The results were amazing – despite his having no previous business experience he made £5,150 during his first month after following my advice and now earns quite a substantial income. His success made me decide to write a complete step-by-step guide that will enable anyone, regardless of their age, sex or education, to earn an exceptional income – provided they are of at least average intelligence and prepared to work hard and learn new ideas.

I have called this guide 'THE STREETWISE WAY TO WEALTH' (A4 format, 96 pages, illustrated. Price £20 postpaid). It shows how the beginner can start to make serious money – it's a lot easier than you may think and you don't have to quit your job to start. Obviously you will want to test it first. I will show you how to get started in your spare time at home. Don't think for one minute that you can't do it – I'll prove you can. **I will reveal to you the money-making secrets that no one else will tell you.** What I reveal is worth many thousands of pounds and if acted upon will make you financially secure for the rest of your life.

This is not some phoney "get rich quick" scheme of the type commonly available. **The information and secrets I will teach you are those that I have used myself every day over the last five years.** I will tell you exactly what to do and how to do it. I'll even supply you with actual names and addresses of useful contacts.

2. HOW TO LEGALLY AVOID EXCESSIVE TAXES AND BUREAUCRACY

It is hard to imagine any economy without some necessary taxes and regulations. But we are now burdened with so many taxes, controls and regulations that the average businessman's biggest expense is paying off the taxman, while his time is increasingly taken up having to deal with senseless bureaucracy.

'THE FREEDOM HANDBOOK' is your escape route. A massive manual (A4 format, 134 pages, 50,000+ words. Price £29.95 postpaid). It has taken over two years to prepare and reveals such secrets as: how to *legally* avoid confiscatory taxes and bureaucratic interference, open secret bank accounts, hide your assets, protect your privacy, travel the world as an international entrepreneur, obtain a foreign passport, and **much, much more!**

It will also show you: how to get the guaranteed cheapest air tickets, how to fly tourist class but get first-class advantages and how to pay the very lowest rates at top class hotels. You will also be given tips and guidelines for growing in authority and power and ultimately for developing an ability to make money and live freely. 'THE FREEDOM HANDBOOK' is like no other book ever published and there are many people and several organisations who will not like the fact that all of these secrets have now been revealed. To order either or both manuals write "Financial Freedom" on a piece of paper along with your name and address and the titles required. Enclose a cheque/P.O. for the correct amount and send to me c/o my publishers: CASUTI LTD., Dept. CUA, P.O. Box 115, St. Helier, Jersey JE4 8QZ, Channel Islands. Credit card holders may phone (01534) 617181 anytime.

Reply promptly and while stocks last, you will receive with your order **FREE OF CHARGE**, a double length (50-minute) audio cassette in which I personally reveal how to acquire the strength, willpower and energy that will be so important for your future success.

GUARANTEE

If you don't think the material you receive is worth to you at least one hundred times what you paid for it, simply return everything in good condition and my publishers will immediately send you a full refund of your money – no questions asked. What could be fairer than that?

You may ask why I'm willing to reveal all my insider secrets? Well, simply because your success is in no way any threat to my own and of course all those who order my material will be helping to increase my own wealth. Also, many of you will probably seek further consultation and direction from me as your wealth rapidly grows and the consultation fees add to my fortune. But then why should you care if I make a profit so long as I show you how to achieve financial freedom? And I promise I will.

I've said everything I can say, now it is up to you. If you apply my secrets I guarantee that they will bring you wealth. If I'm wrong all you've wasted is a few minutes and a postage stamp. But what if I am right? 30 days from now you can be just another month older or you can be on your way to a better life. You decide.

SWORN STATEMENT: "On the basis of my professional relationship with John Scott over the past five years I can certify that the above statements are true and factual and that his net personal worth is in excess of one million pounds." – M. Thomas, Accountant.

VISAGE COMPUTERS

(DEPT CU1) 27 WATNALL ROAD, HUCKNALL, NOTTINGHAM NG15 7LD

TO ORDER CALL: (0115) 994-4501

BLIZZARD PRODUCTS NOW IN STOCK!!!

THE BLIZZARD 1220/4 TURBO MEMORY BOARD

Plugs into the trapdoor of the A1200. It comes populated with 4MB of 32bit Fast RAM (expandable to 8MB), has a realtime clock and an optional FPU socket. The board's 68020 CPU runs at an amazing 28Mhz which is clocked at a speed of 5.05MIPS (Faster than a A4000/030!!!)

1220/4 Inc
4MB RAM

ONLY
£229.00

4MB RAM
for 1220/4

ONLY
£169.00

NEW THE BLIZZARD 1230 TURBO ACCELERATOR BOARD NEW

Plugs into the trapdoor of the A1200. It comes populated with 4MB of 32bit Fast RAM (expandable to 8MB), has a realtime clock and an optional FPU socket. The board's 68020 CPU runs at an amazing 28Mhz which is clocked at a speed of 5.05MIPS (Faster than a A4000/030!!!)

1230 MkII
0MB RAM

ONLY
£229.00

1230 MkII Inc
4MB RAM

ONLY
£359.00

A1200 32BIT RAM CARDS

These trapdoor RAM cards increase the speed of your A1200 by 22% (when installed with Fast Memory), comes with a real time clock & socket for math co processor (FPU).

0 MB
£69.00

4 MB
£189.00

8 MB
£349.00

NEW A4000 CYBERSTORM NEW

Call for latest information on A4000/040 Cyberstorm and A4000/060 Cyberstorm (82MIPS!!!).

DELIVERY CHARGES

STANDARD (3-4 DAYS)	£3.95
NEXT DAY COURIER	£5.95
SMALL ITEMS	£1.95

All prices include VAT.

MEMORY BANK

The following Memory SIMMS are industry standard 72 pin (70ns). They can be used in the A4000, A1200 RAM boards and the CD32 SX1 expansion module.

4MB	£139.99	16MB	£549.99
8MB	£279.99	32MB	£949.99

COMING SOON !!!

THE APOLLO RANGE OF AMIGA ACCELERATOR CARDS

Apollo A1200 1230/SCSI2

50Mhz 68030 CPU, industry standard 72 pin SIMMS, FPU socket, battery back-up clock, SCSI2 option. Incorporating burst speed RAM for super fast operation.

CALL NOW FOR AVAILABILITY & PRICING

Apollo 2030/SCSI2

25 or 50Mhz 68030 accelerator board for the A1500/2000/3000. Includes SCSI2 interface. Upgradeable to 64Mb using industry standard SIMMS.

Ring now for details on these and other exciting new products for the full range of Amiga computers!!!

HOW TO ORDER (0115) 944-4501

WE ACCEPT ALL MAJOR CREDIT CARDS INCLUDING ACCESS, VISA, SWITCH AND DELTA. CALL THE NUMBER ABOVE TO PLACE YOUR ORDER. TO ORDER BY POST, MAKE CHEQUES PAYABLE TO "VISAGE COMPUTERS". ALLOW 5 DAYS FOR CHEQUES TO CLEAR.



Squirrel

SCSI Interface

■ Price: £29.99 ■ Developer: HiSoft ■ Supplier: HiSoft ☎ 01525 718181

Now you can attach any SCSI device to your Amiga 1200 or 600, including hard drives, tape streamers, floptical drives, magneto-optical drives and more. And a squirrel is responsible for all this.

SCSI Vs IDE

The Amiga 1200 and 600 have built-in IDE interfaces (Integrated Drive Electronics) for the easy fitting of hard drives. So why bother with a SCSI interface?

Well, with IDE interfaces you can only connect a maximum of two hard drives at once. SCSI however will let you connect up to seven different storage devices simultaneously. SCSI hard drives are typically faster than IDE hard drives. Speed differences also depend on individual models, but in our tests, the IDE drives ran at roughly a quarter to half the speed of the SCSI units.

The award for wackiest product name of the year goes to HiSoft. It's a growing trend for expansion manufacturers to name their products after fast, big or aggressive animals. Such names are supposed to suggest that the product has the attributes of the said animal. So the Amitek Hawk RAM board is fast and deadly, whilst the Viper accelerator has the venom of a snake (metaphorically speaking of course). These are fairly

What is SCSI?

SCSI stands for Small Computer Systems Interface. It's one of the only true industry standards in the computer market, with SCSI devices available for the PC, Mac and Amiga.

SCSI is a definition for physically linking storage devices (and other types of peripherals) to computers and other SCSI devices. Where as with other standards you have different shape sockets and pin configurations, SCSI interfaces all look and act the same. You can take a Macintosh SCSI CD-ROM drive, plug it into a SCSI interface on a PC and it'll probably work! No hassle.

obvious names. Now we come to HiSoft's new SCSI interface

You'd want a SCSI interface to be fast, or expect it to be attached to a big hard drive and therefore have a large capacity, so a name like T-Rex would be the order of the day. Why then have HiSoft called their new PCMCIA SCSI interface the Squirrel? Either HiSoft are nuts or their marketing team went into hibernation for the Winter.

Naming conventions aside, the Squirrel delivers something of a first for the A1200 and A600. We've had CD-ROM and hard drives using PCMCIA interfaces, but these have been IDE devices. We've also had SCSI devices connecting via the trapdoor, using the interfaces that bolt onto the GVP A1230-II and the Blizzard 1230-II.

What's exciting about the Squirrel is that it's a SCSI interface that fits into the PCMCIA slot.

Multiple devices

Why is this an improvement over the GVP and Blizzard cards, or the Archos Overdrives? Simple. The Archos drives are just that, drives. Whilst they plug into the PCMCIA slot, they offer no more than a hard drive or CD-ROM drive. Perhaps even more problematic, you can only have either the Overdrive HD or CD-ROM in at one time, not both.

With the Blizzard and GVP interfaces, you can attach up to seven different devices at once (a feature of the SCSI standard), but there are two big disadvantages. Firstly you need to have the corresponding accelerator card in order to attach the interface (adding a minimum of £149 onto the price of the interface

itself). This system involves faffing around pushing cables through the inside of the A1200, and they're not compatible with the A600.

The Squirrel solves all of these problems. As a PCMCIA interface it's wonderfully simple to fit to either the A1200 or A600. Literally lift your computer and slide it in. However, if you need to remove and replace it regularly, the weak PCMCIA connector pins on your Amiga are likely to get bent and snapped very easily. Because it's SCSI, up to seven different storage devices can be used at once. If you want three CD-ROM drives, and four hard drives attached that's not a problem. As an added advantage you're not limited to just hard drives and CD-ROM drives. You can attach tape back up units, SyQuest drives, optical drives, and even scanners with SCSI interfaces.

Performance

So how does the Squirrel perform as a SCSI interface? Admirably is the simple answer. I took the unit and attached a variety of CD-ROM mechanisms, hard drives, and SyQuest drives. Some of these were off-the-shelf SCSI devices, some were previously used with Apple Macs in the CU Amiga Magazine office, and some were PC SCSI units. All worked first time. The supplied driver software spotted them all and allowed us to communicate with them as normal Amiga devices. After that it was just a case of formatting and prepping them using HD Toolbox.

In terms of data transfer rates the Squirrel wasn't the fastest SCSI interface we've seen - this accolade goes to the GVP SCSI interface (as reviewed in CU Amiga Magazine May 1994) - but it's certainly fast enough.

Typical transfer rates clocked in at around 1.5Mb per second for hard drives, which is pretty good. CD-ROM speeds are limited by the speed of the CD-ROM unit. Original CD drives could only manage to transfer 150k per second, current double speed models

SCSI-2?

The Squirrel supports all required SCSI-2 commands. SCSI-2 is the next generation of the original SCSI interface and offers faster performance. Any drives that are SCSI or SCSI-2 compatible will work with the Squirrel. However it isn't compatible with the SCSI-2 Fast or SCSI-2 Wide Fast standards. These are subset developments of the SCSI-2 standard and offer higher transfer speeds.

If you're buying a hard drive or another SCSI device for use with the Squirrel, check that it's fully compatible with the SCSI or SCSI-2 standard. You can get SCSI devices that claim SCSI compatibility but actually aren't fully compatible. Whilst you may not notice the difference initially they may hinder you in future. Typical problems include long startup times, or an inability to transfer audio data over the bus. You might for example only initially buy the unit to play CD32 games, but later decide you want to use it to read audio CD data directly into RAM. You won't be able to do this unless it also transfers audio data via the bus (the PCMCIA connection).

In a future issue of CU Amiga Magazine we'll be bringing you a comprehensive guide to SCSI compatibility and revealing which devices do and don't offer full compliance with the standard. Watch this space.

Alternatives

The only alternative SCSI interface for the A1200 is the GVP A1291 expansion. There aren't any for the A600. This plugs into the GVP A1230-II accelerator and offers very high transfer speeds. You will however need to buy an A1230-II to use it. We rated it at 96% in our May 1994 review. It's available from Silica on 081-309 1111.

If you want to add just a hard drive, consider an internal IDE mechanism. They won't be as fast as Squirrel SCSI based hard drives but they will be cheaper. Alternatively you should check out the Overdrive. It ties up the PCMCIA interface with just one hard drive, but it offers very fast performance. It got an impressive 88% in the March 1994 issue of CU Amiga Magazine. Both internal IDE mechanisms and the Overdrive are available from Gordon Harwood Computers on 01773 836781.

If you want a CD-ROM drive there are two options. First is the Archos Overdrive CD unit. It's simple, effective and capable. Alternatively there's the new Power CD drive from Power Computing (reviewed in this issue on page 102). The Overdrive CD is available from Indi on 01543 419999.

manage about 350k on average, whilst new quad speed drives churn out around 1Mb. So the Squirrel interface, which can handle 1.5Mb per second, has no problem dealing with current or near future CD drives.

devices, the Squirrel is without doubt the most affordable option. ■

Andy Leaning

Conclusion

At £69 it's more expensive than the SCSI expansion for the GVP accelerator (£59) but you don't need to buy an accelerator in the first place to use the Squirrel. However, if you happen to own the GVP or Blizzard card you'll be better off buying their SCSI cards - for both price and performance.

The Squirrel is also the easiest SCSI interface to use and fit - just plug in and go. It performs well too. If you want access to the world of SCSI

What's available?

If you're considering buying the Squirrel you'll naturally want to buy a SCSI device to plug it into. So what exactly is available? HiSoft supply a range of SCSI compatible storage devices for the Squirrel. These range from SyQuest drives (combine hard drive speeds and capacity with the portability and flexibility of a floppy disk) to CD-ROM drives to large hard drives. Prices start at £349 for a SyQuest unit, £229 for a 270Mb hard drive, and £179 for a CD-ROM drive.

Gordon Harwood also have a range of SCSI devices. Call them on 01773 836781 for details.



SQUIRREL

A500 **system requirements:**
Any A1200 or A600

A500+	
A600	ease of use94% It so simple. Slide it in, turn on and away you go.
A1200	performance92% What an excellent performance. Does the job and does it well.
A1500	value for money96% Outstanding, a SCSI-2 interface for £69 - wow - couldn't be better!
A2000	
A3000	
A4000	

OVERALL
Innovative, well designed, excellent performance.

94%

ACEEX DM026 14 Modem

■ Price: £229.99 ■ Supplier: Power Computing ☎ 01234 273000

With the popular media hyping up the Internet at every opportunity it's not surprising that modem manufacturers are having a field day. In the last few months modems have become one of the fastest selling peripherals. But it's not just any old modems that are selling. With costly phone bills in mind, most prospective 'netters are looking for the fastest modem they can afford.

The faster a modem can transmit and receive data, the less time you'll spend on-line, which leads to lower phone bills. The current top speed is 28,800 bps – the ability to send or receive 28,800 bytes every second. Power Computing's ACEEX modems have been popular with Amiga users for a long time, so the new 28,800 bps version could well be a popular upgrade.

Unlike the X-Link modem reviewed last month the ACEEX

model won't win any awards for styling, with its aluminium box, plastic front and rear panels and a few lights. It's designed to lie flat on the desktop, and whilst it can stand vertically on its edge the underside has labels and feet making it look untidy.

Power Computing supply *Ncomm*, the standard software supplied with most Amiga modems. This is an easy and flexible program that provides most of the features you'll need. A point to consider though is that *Ncomm* is shareware, and the version supplied here will not save your personal settings – for this you'll need to register and pay a small upgrade fee. This is the case with other modems that come with *Ncomm*.

In operation it's suitably fast. It complies with V34 standards and offers Group 3 fax compatibility. If you want to join the Internet revolution and need fast high performance you won't be disappointed.



The only negative point about the ACEEX is that it's not BABT approved. This means that technically it's illegal to connect it to the UK telephone system, and it doesn't fully understand UK telephone tones, such as the engaged tone. Power really need to address this problem.

If the ACEEX was BABT approved it would be a great modem. Until then it's good but not fantastic. ■

Andy Leaning

86%

Mamba TV Modulator

■ Price: £34 ■ Supplier: Silica ☎ 0181 3091111

Sometimes the smallest of malfunctions can bring your whole Amiga system to a halt. Sod's law says that this will probably happen just after the warranty period expires.

One of the most common components to pack up is the modulator, the circuit that adapts the Amiga's monitor output to a signal suitable for a UK TV. This is a fairly common problem with A500s, where the modulator is an external box hanging precariously off the rear, and so is subjected to more stress than it should be.

A modulator is also worth considering if you've got an A4000 and want to use it with a

TV as unlike other Amigas the 4000 doesn't have modulation built in.

Amitek's Mamba Modulator is a straight replacement for the standard issue Commodore modulator. Housed in black casing it doesn't really fit in with the Amiga's off-white colouring but still looks rather stylish (in a small black box kind of a way). It has exactly the same inputs and outputs of the normal Commodore modulator, and is also very similarly shaped.

Priced at £34 it's might be considered expensive for what it does, but if you can't use your Amiga because of a faulty modulator it's a small price to pay. ■

Andy Leaning



▲ Amitek's Mamba Modulator is available for £34 from Silica. A vital piece of equipment if you use your Amiga with a TV a lot.

80%

Art Gallery

This month's selection of reader art.

Aussie Corner

There's been a lot of artistic talent flooding into the CU Amiga Magazine offices from the land down under recently. Here are two fine examples of Aussies who know their polygons from their airbrushes.



First up is Gavin Anderson from Osborne, South Australia. Gavin sent in a selection of images which he created on an Amiga 1200 with 2Mb using Caligari, Vista, Fractal Pro, Lyapunov and DPaint IV. All images concentrate on the role of computers in Australian society. The picture Landscape is one of a series exploring the internal landscape of the computer. Telekinesis is intended to draw the viewer into a half way point between the user and computer. And, finally, From Obscurity To Delusion discusses the "location of Australia and the wall which seems to keep us (Australia) from other nations".

From obscurity to delusion

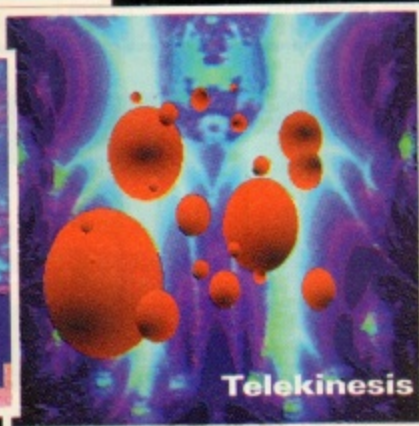
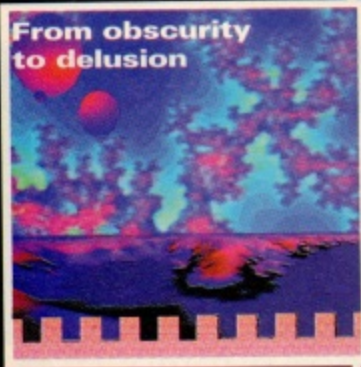

Next we have Paul McMillan from Victoria, Australia who sent in a step-by-step guide on how he created this picture of a Dolphin. The background was created using DPaint's airbrush, shade and polygon tools. The outline of the dolphin was created using the curve tool for the basic shape. Finer details were added using the magnify function with anti-aliasing turned on. Finally, a map of Australia was copied with the help of a grid, then reduced to fit into the picture.



A Dolphin in Port Phillip Bay, Australia

Dream

By Simon Philips, Kent



Created with DPaint on a 1Mb A500.

Inferno

by Adam Palmer, Derbyshire.

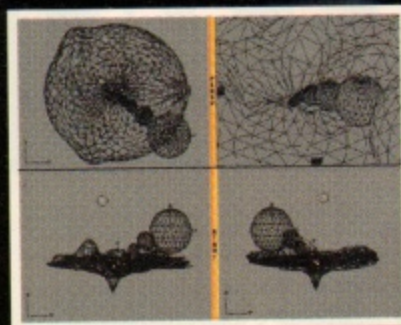

▲ To start with both the balls and mountains were created from sphere primitives in Imagine 2.0. Then the magnetism tool and stone textures were used for the finishing touches to the mountains to give them a special effect.



▲ Once the scene was rendered, the 24-bit image was converted to 256 colours using Rend24 with FS Dither switched on. Adjustments to the colour balance were made with Personal Paint's palette/adjust feature.



Not impressed with earlier results the author decided to abort the current pictures and converted back to the original 256 shades of grey. After a bit of fiddling about with colours and contrast in PPaint, the final effect we see here on the left was created.

HIGH QUALITY SOUND SAMPLES

EXTENDED RANGE OF IFF SAMPLES (Includes new RHYTHM LOOP disks)

Each disk is compiled from a studio recorded master and is sampled on the Amiga at twice the sample rate of P.D. sample disks. They are compatible with all P.D. and commercial tracker and sequencer programs, and are highly regarded by the Amiga Press. "There are a lot of sample libraries around but this one is absolutely brilliant" Amiga Computing 2/93. This collection of disks shows how it should be done... the conventional instrument samples are the best I've heard on the Amiga. CU Amiga 7/92. "Do you want some high quality and wide ranging sounds to use in your compositions? Well then this is the place to look." Rating 87% Amiga Format Special Aug/92. N.B no of samples in brackets

- | | | |
|---|--|---|
| 001 AFRICAN
Talking Drums, Marimbas, Chants etc (53) | 019 PIANOS
Octave Splits, with strings, FX (16) | 020 STRINGS
Cello, Orch. Hits, Sections etc (21) |
| 002 INDIAN INST
Sitar, Bansuri, Chants etc (19) | 021 SYNTH STRINGS
Analog & Digital (19) | 022 CHOIRS
Mixed Choirs, with Bells & Synth (16) |
| 003 INDIAN PERC
Tabla, Bayas, Rhythm Loops etc (35) | 023 ORGANS
Church & Electric (17) | 024 BELLS
Real & Synth with Choir & Strings (20) |
| 004 ARABIC
Ud, Saz, Bendir, Rhythm Loops etc (37) | 025 SOUND FX
Action: Explosions, Gunshots etc (30) | 026 FX PERC LOOPS
Up-tempo effected rhythms (14) |
| 005 FAR EAST
Tibetan Bells, Yangqin, Koto etc (31) | 027 DRUM LOOPS 1
Various styles - pop, breakbeat etc (14) | 028 DRUM LOOPS 2
More pop and breakbeat rhythms (13) |
| 006 EUROPEAN
Balalaika, Choirs, Bodhran etc (34) | 029 TECHN 1
Techno, Industrial & Electronic Loops (17) | 030 TECHN 2
More of the above! (16) |
| 007 OCEANIA
Didjeridu, Chants, Silt Drum etc (23) | 031 ROCK RHYTHMS
Various rock rhythms with effects (19) | 032 WOODWIND
Flutes, Pan Pipes, Clarinets etc (19) |
| 008 AMERICAS
Kena, Berimbau, Pan Pipes etc (30) | 033 BRASS 2
Saxes, Trumpets, Brass Sections etc (15) | 034 PIANOS 2
Multi-Sampled, Soft, FX (17) |
| 009 FX PERC
Power Toms, Snares & Bass, Scratch/Rap (88) | 035 STRINGS 2
Sections, Cellos, Pizzi, Hits, Violin (23) | |
| 010 DRUM KIT
Bass & Snares, Hi-Hats, Cymbals & Toms (63) | | |
| 011 ANALOG PERC
TR-808, CR-78, Loops etc (64) | | |
| 012 LATIN PERC
Tumbales, Congas, Cabasas, Cowbells etc (107) | | |
| 013 GUITARS
Acoustic, Electric & Distorted etc (41) | | |
| 014 BASS GUITARS
Slap, Picked, Fretless, FX etc (44) | | |
| 015 ANALOG BASS
Oberheim, Roland, Korg etc (22) | | |
| 016 DIGITAL BASS
Yamaha DX, Roland, Korg etc (28) | | |
| 017 BRASS
Sections, Saxes, Trumpets etc (24) | | |
| 018 SYNTH BRASS
Analog, Digital & L.A. etc (18) | | |

PRICES: 1-9 Disks £2.50 each, 10-19 Disks £2.00 each, 20 or more £1.75 each, The Complete Set £59.95 P&P: Add £1.00 (any size order). Cheques & P.O.s to: **WALKABOUT MUSIC, Dept CU TRENNOVICK FARM, THE MOUNT, PAR, CORNWALL PL24 2DA. Tel: (0726) 813807**

FREESTYLE PD

FOR THE VERY LATEST IN GAMES UTILITIES AND DEMOS

TEL: 01922 710985

GAMES, UTILITIES, DEMOS, SLIDESHOWS, FONTS, CLIP ART, MUSIC, ASSASSINS GAMES 1-22, LSD TOOLS 1-150 AND FRED FISH 1-1000 CATALOGUE DISK £1.00

PD DISK PRICES
1-20 @ £1.00 EACH 21+ @ £0.75 EACH
2 Free disks with every 10 purchased. P&P 50p per order.
Please send all cheques and Postal Orders to:
FREESTYLE PD (DEPT. CU)
108 WOODSIDE WAY, SHORT HEATH
WILLENHALL, WEST MIDLANDS
WV12 5NH
RECYCLED COVER DISKS - CALL FOR PRICES

BLACK COUNTRY MICRO'S

THE MIDLANDS NO. 1 SERVICE AND REPAIR CENTRE.
FAST AND RELIABLE REPAIRS ON ALL AMIGAS AND PERIPHERALS.
A500/A500+ REPAIRS £45 INC. A600/1200 PLEASE PHONE
(DRIVE OR KEYBOARD REPLACEMENT + £10)
THE MIDLANDS NO. 1 STOCKISTS OF "WIZARD" DEVELOPMENTS RANGE OF PERIPHERALS
CALL FOR LATEST PRICES!!
14.4 MODEMS INC NCOMM AND FAX SOFTWARE £135 INC
CONTACT:-
BLACK COUNTRY MICRO'S
24 DOBBINS OAK ROAD
PEDMORE FIELDS, STOURBRIDGE
W. MIDLANDS DY9 9HX.
TELEPHONE : 01562 720214 (24 HRS)

SELECTAFONT

SEND NOW FOR YOUR FREE 46 PAGE INFO PACK

Over 4000 Fonts now in Stock!

PIC n MIX from over 4000 Fonts in ADOBE or COMPUGRAPHIC Format. Or select from 164 Disks (12 Fonts per Disk)

FASTEST MAIL ORDER COMPANY ON EARTH! (6 hr response)

Fonts from as little as 7pence!

SCALEABLE COLOUR/B&W CLIP-ART

We now have the Worlds largest collection of Scaleable (non jaggy) Amiga Clip-Art. OVER 100 Disks!!!!
Prices start from a measly 1.99 a Disk

Fontbuster 41 DISKS (500 Fonts) £34.99
CLIPBUSTER 23 CLIPART DISKS £24.99

Choose from 4 Different Volumes

TECHNICAL Helpline for all Customers

(ALL Disks have Image Catalogues)

INK-JET/BUBBLEJET SERVICES

Having used Ink-Jets for 4 Years, we feel we are in a unique position to offer a first class service to all of our customers. We only supply PREMIER Ink refills for all printers which we GUARANTEE will give a BETTER quality than from your original Cartridge. We also supply a comprehensive range of Ink-Jet/Bubblejet Consumables including: COLOUR KITS/ORIGINAL CARTRIDGES/CLEANING KITS

Single Refills	£6.99	available in Black/Cyan Magenta/Yellow/ Green/Red/Blue WATERPROOF BLACK	ABSOLUTELY FREE!!! Avery Ink Jet Label Starter Pack for EVERY Premier Ink Customer!
Twin Refills	£12.99		
6 Pack Refills	£24.99		

For a FREE Comprehensive Printout of all Fonts and Details of our other Services
PHONE 0702 202835 24 HR SERVICE
or FAX 0702 200662
or WRITE TO US!
Please include Details of your System set-up and the Software you will be using.

No Silly Info Packs Here!

ACCESS/VISA/BARCLAYCARD
MASTERCARD
CREDIT CARDHOTLINE:
0702 202835
SELECTAFONT (DEPT CU),
84 THORPE ROAD, HAWKWELL
Nr HOCKLEY, ESSEX S85 4JT

POSTCRYPT

QUBIA
RANSOME
SHANGHAI
SHRAPNEL
STAR
STEEL
STENCIL
STRETCH
TOYBLK
WEDGIE
WOBBLER
ZORROW
SWINGER
Tiptopetto
OpenHouse
PEACE
POWERLINER
StarStruck
SALTER

FAST AMIGA REPAIRS

FAULTY TROUBLESOME COMPUTER ??

SEND OR DELIVER TO THE EXPERTS FOR FAST RELIABLE REPAIR OF YOUR BELOVED AMIGA 500

ONLY £44.00 INC,*

FREE GIFT WITH EVERY REPAIR. PLEASE TICK BOX.

WE ALSO REPAIR TO COMPONENT LEVEL
A600, 1200, 1500, 2000, 3000 + 4000
* FREE QUOTATION *

MOUSE MAT	<input type="checkbox"/>
MOUSE HOLDER	<input type="checkbox"/>
DISK CLEANING KIT	<input type="checkbox"/>
ADD £5 REPLACE MOUSE	<input type="checkbox"/>
ADD £5 JOYSTICK SEGA STYLE	<input type="checkbox"/>

DRIVE OR KEYBOARD REPLACEMENT + £10

BARGAIN HARD DRIVES FITTED 85-500mbCall
EXCHANGE SERVICE	
MODULATORS£19.50
PSU£19.50
D/DRIVES£25.50
K/BOARDS£25.50

*COLLECTION AVAILABLE ANYWHERE IN THE UK.

144 TANNER STREET TOWER BRIDGE, LONDON SE1 2HG - TEL: 071 252 3553

FREE!

MULTIMEDIA CD-ROM

NO PURCHASE NECESSARY

FOR ANY AMIGA

To celebrate our 2nd successful year in business we're giving away
10,000 free Multimedia CD-ROM disks.

MULTIMEDIA MANIA CD-ROM

Includes

500 top quality fonts,
1500 of the best clipart images,
200 music modules,
500 instruments,
over 200 soundfx,
100 Video backdrops,
200 textures,
200 3D objects,
100 AGA images,
200 colour clip fonts,
Animations,
graphics tools and lots more

ORDER CODE: CDMMM60

**WORTH
£19.99**

01793 422355

LINES OPEN 6 DAYS A WEEK 9:30AM - 5.30PM

There is a non-refundable £6.00 shipping and admin charge to residents in the UK and £9.00 P&P for foreign orders. Please have your credit card ready. Access, Visa, Mastercard & Eurocard accepted. Fax your order on 01793 514187. Send cheques to: Epic Marketing, PO Box 637, Swindon SN1 3DN. Offer limited to the first 10,000 customers, and only one CD per customer applies. If you wish to collect, you can exchange this advert for your free CD from Epic in Swindon. This offer is run separate from any other offer we are currently running. An up to date CD-ROM list will be sent with your free CD. Please allow 14 days for delivery E&OE

VIRUS FREE PD

Order hotline. **01793 432176**

Only
£2
unless stated a disk



OPEN SIX DAYS A WEEK OVER 80,000 CUSTOMERS
5 YEARS IN THE TRADE
FREE TECHNICAL SUPPORT
FAST DELIVERY
CREDIT CARDS ACCEPTED
OVER 6000 AMIGA DISKS

MOST ORDERS DESPATCHED WITHIN 24 HOURS

- IMAGINE OBJECTS**
- V3930 DINOSAURS & ANIMALS different animals including various Dinosaurs
 - V3931 WWII & MISC AIRCRAFT A number of different air crafts
 - V3932 MODERN AIRCRAFT
 - V3933 STARWARS OBJECTS Loads of different objects from Star Wars trilogy
 - V3934 STARTREK OBJECTS Loads of different objects from the Startrek series
 - V3937 BILLIARD, BUILDINGS Includes various objects including CHESS
 - V4030 WILLIAMS, F1 OBJECT Fantastic 4meg Formula One object

- UTILITIES & TOOLS**
- V3329. **ABASE V1.33.** Very powerfull and flexible database, perfect for anything from a video collection to friends & relatives etc.
 - V3004. **AMIGA TUTORIAL** Great tutorial for beginners to learn a little.
 - V3121. **A600 NUMPAD** Numeric keypad emulator.
 - V3151. **TEXT ENGINE 4** We regard this as the best PD word processor.
 - V3155. **X-KOPIA** Very powerful disk copier. inc various copy modules.
 - V3033. **PRINTER DRIVERS** around 100 various printer drivers for Star, Panasonic, Citizen, etc.
 - V3182-12. **C MANUAL (12 Disks)** Latest version of C the language.
 - V2937. **TEXT PLUS V4.0** Advanced WP package.
 - V2969. **LITTLE OFFICE** Includes Word processor, database & spread-sheet.
 - V2970. **DUNKS DTP** Kids DTP.
 - V3013-2. **COMPUTER EYES FONTS** A 2 disk collection of Amiga fonts.
 - V3084. **CANON STUDIO 1.2** essential for use with th canon BJ printers.
 - V3125. **T.A.C.K.** Animation con kit Allows you to create animations with synchronised sound fx. Brill.
 - V3194. **ENGINEERS KIT.** Fault finder.
 - 3201. **ARESTURE (UNDELETE)** Can undelete (get back) deleted files.

- BUSINESS TOOLS**
- V BANKIN & CLERK Keep account
 - V MINI SPREAD powerfull s-sheet
 - V3311 FILE O FAX get organised
 - V3329 ABASE 1.33 powerfull
 - V3371 ADDRESS PRINT 3.1
 - V3407 EXCEL DATABASE
 - V1938 600 BUSINESS LETTER Over 600 letter templates
 - V3522 ACCOUNT MASTER
 - V3298 GRAMMER CHECKER
 - V3636 TEXT ENGINE 4.1
 - V3032 FANCY DISK LABLER
 - V2906 THE DTP PROGRAM simple to use Desk Top Publisher software
 - V3863 EASY CALC + KS2/3
 - V3877 PAY ADVICE ANALYZER
 - V3803 ADDRESSER The best address database available on the Amiga

- DISK AND FILE COPIERS**
- V3494 MAVERICK COPIER Removes copy protection from hunders of games.
 - V659 TETRACOPY powerfull disk copier, that you can play Tetris whilst copying a disk.
 - V3410 LOCK PICK 2 removes copy protection from over 400 games.
 - V3155 X-KOPIA very powerfull
 - V3070 DISK MATE simple workbench copier
 - V2934 FREE COPY 1.8 removes copy protection from various games
 - V2333 SUPER DUPER Very fast disk copier
 - V1775 PAC COPY play Pacman whilst copying
 - V3576 D-COPY 3.1 THE BEST PD copier available
 - V3550 SAFE II Can copy Amiga & PC

- EMULATORS**
- V2997.A500+IBM EM
 - V3837.BBC EMULATOR A BBC Emulator
 - V4008-3.SPECCY EM V2 Play speccy games on Amiga
 - V3554.PC TASK 2.03 Run PCXT software on the Amiga
 - V3495.KICKSTART 3 EM Run Workbench 3 on A500+
 - V2001.PC EM Good A500 PC emulator
 - V2879.ATARI ST EM For the A500+
 - V3159-2. QL EMULATOR A Sinclair QL emulator
 - V2897.KICKSTART 2 EM For the A500

- BEST AGA STUFF**
- V3432 ACTION REPLAY IV
 - V3356 DEGRADERS
 - V3554 PC TASK V2 (VGA)
 - V3175 UCHESS (4meg)
 - V3153 WB3 BACKDROPS
 - V3375 DOS DRIVERS should give every amiga owner full compatibility
 - V3798-2 FIT CHICKS

- KIDS**
- V3240 FIREWORK ALPHABET
 - V3072 MATHS REFLEX TEST
 - V3065 DIVISION
 - V3026 FOUR STROKE ENGINE
 - V2931 MATHS CALCULATOR
 - V2915 BOOK OF SPELLS
 - V1420 LEARN AND PLAY
 - V2016 MATHS TALK
 - V2065 ALGABRA II
 - V2068 MATHS WIZARD
 - V2135 STORY LAND
 - V2303 KIDS PAINT
 - V3946-2 BACK TO SCHOOL

- DPI SOFTWARE**
DPI Disks cost £3.50 each
- DPi1 WORKBENCH 3 Replacement copy of Workbench 3
 - DPi2 HD INSTALLER Prep & Install software on your A1200 hard drives
 - DPi3 HARD DISK PREP Formatting & prep software for new A1200 hard drives
 - DPi4 PRINTER DRIVERS Over 100 printer drivers for Workbench 3. Includes installation tool.
 - DPi5 ENGINEERS KIT Test your A1200 over Speed test, drive check, custom chip tests etc
 - DPi6 EXTERMIN 8 AGA Virus Killer package Latest version
 - DPi7 CRACK'N'COPY Latest and greatest collection of copiers & cracking tools.

- WORKBENCH ICONS**
- V2527 ICONS FOR ALL 2
 - V3848-3. ICONS PLUS KS2/3
 - V3887 CUSTOM ICONSKS2/3
 - V3773 MAGIC WORKBENCH
 - V4063 16 COLOUR ICONS
 - V4090 AGA ICONS
 - AIA5-4 3500 ICONS £5.00

- DESK TOP VIDEO**
- V654-2 VIDEO Applications
 - V656 TV GRAPHICS
 - V2986 VIDEO WIPES
 - V2989 CAPTIONATOR
 - V3080 VIDEO TITLER
 - V4112-4. SCALA backdrops

A 2 disk set of various tools for Video titling, Wipes, backdrops etc
A set of IFF backdrops for use in Scala or any other video titler
A set of different but original video wipes
Perfect for doing sub-titles/kareoki etc
Possibly the best PD video titler available, excellent results
Excellent backdrop collection for video titlers.

- PRINTER DRIVERS**
- V3033 PRINTER DRIVERS Over 100 printer drivers on one disk, including HP500/500c, HP550, HP Laserjets, Star Printers, Panasonic, Canon, Postscript, Seikosha, Epson, Amstrad, OKI, Commodore etc
 - PDWB (WB with driver installed) We'll install a printer driver of your choice on the version workbench you request, We'll then send you a ready to use full working copy of workbench with a printer driver installed.
all for just £5.00 + P&P

- CLASSIC GAMES**
- V3895 ICE RINNER Loadrunner
 - V3888 MEGABALL AGA 256 colour breakout
 - V3869 PLACEBO INVADRS Colourfull Spaceinv
 - V3870 TECHYON A tron clone
 - V3871 MOOSE DRIVER fast top view racer
 - V3873 DITHEL IN SPACE cute but addictive
 - V3861 NOSTAGIUM the classic C64 uridium i
 - V3858 LCD GAMES 4 classic LCD games
 - V3776 FATAL MISSION 2 Brilliant shoot em up
 - V3777 OPERATION FIRESTORM
 - V3745 HIGH OCTANE Fast car racing game
 - V3667 INSECTOIDS 2 brilliant shoot em up
 - V3668 SHANGHAI '93 A fantastic conversion
 - V3640-2 STARBASE 13

FULL CATALOGUE DISK AVAILABLE FOR JUST £1.00 WITH ANY ORDER

PRIORITY ORDER FORM

1 DISK = £3.00
2 OR MORE = £2 EACH

Name. _____
Address. _____
Amiga Model. _____ Payment _____
Credit Card No. _____
Exp. date _____

ALL TITLES COMPATIBLE WITH ALL AMIGA'S UNLESS STATED

ORDER VALUE	
Please send me	Qty
	=£
Total goods value	=£
Postage & Packing	=£
Amount enclosed	=£

OVERSEAS ORDERS
Overseas orders are welcome, but there is a minimum order of 3 titles, and please add £1.00 per title for first class Air mail delivery.

COLLECTING YOUR ORDER
You are welcome to collect your order from any time between 9.30am-5.30pm Monday-Saturday.

ORDERING BY POST
Simply send us your order, listing the items you require, the total cost, and your name & address or if you wish simply mark off the items you wish to order, fill in your name etc, and send us this page with payment by cheque, Postal order.

ORDERING OVER THE PHONE
Call any time between 9.30 and 5.30pm Monday to Saturday with your credit card details and the items you would like to order. We accept Access, Visa, Mastercard, Eurocard etc, but not Switch.

POSTAGE AND PACKING
UK & Mainland, add a total of just 50p. Overseas please add a total of £1.00 per title

SPECIAL OFFER
AMIGA 1200 DUST COVER
Only £1.99
with any order. Order code XI

AMIGA

workshop



DIRECTORY OPUS 116 ●

Transform our stunning February issue cover disk into a Workbench replacement. Andy Leaning shows how to configure *Directory Opus* to launch programs at the touch of a button.

MODELER 3D 118 ●

Create excellent 3D shapes using our March cover disk.

PROCALC 119 ●

ProCalc's functions are the key to its power. Find out how to get the most from them, and calculate loan interest rates at the same time.

GRAPHICS MASTERCLASS 120 ●

Part one of a brand new series devoted to professional graphics techniques. This month Peter Lee has some tips for anyone using *Photogenics*.

BUYER'S GUIDE 123 ●

Buying from mail order companies.

SUBSCRIPTIONS 124 ●

Don't miss out on the amazing cover disks and features we've got coming in the next few months. Subscribe now.

FREQUENTLY ASKED QUESTIONS 137 ●

Compatibility with PCs and Macs is the subject under the microscope this month. John Kennedy answers your common questions.

SOUNDLAB 140 ●

Get your Amiga talking, singing and generally pretending to be a human, with little more than a sampler and a few good ideas.

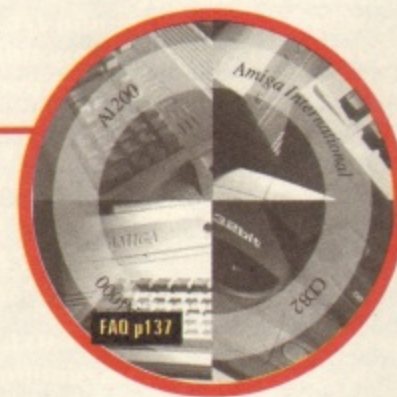
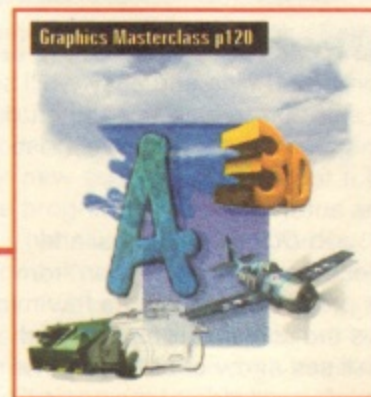

April 1995

This issue sees two new columns. First up is the new Graphics Master class. CU Amiga Magazine has always lead the way with its graphics tutorials, showing you how to get the most out of DPaint and Brilliance. This month heralds a slight change. We've got some of the industry's best professional graphics artists to reveal their own tips, tricks and techniques for producing stunning effects and images. For the first instalment, Peter Lee collaborates with Almathera's top artist to demonstrate some tricks with Photogenics. The second new column sees the return of Andy Leaning's popular Buyer's Guide. If you're thinking about buying from a mail order company in the next few weeks, read this first. Joining these are CU Amiga Magazine's guides to recent cover disks, including Directory Opus, ProCalc, and Modeler 3D. Then there's Tony Horgan's popular SoundLab tutorial, our Masterclass Guides, and reader letters.

Regulars

Q+A 134

Your most technical questions and problems get the CU Amiga Magazine treatment as Andy and Tony tackle another month's postbag.

Q&A MASTERCLASS 138

How do compression programs work, and which is best for you? John Kennedy explains all.

BACKCHAT 142

You're an opinionated bunch, aren't you? Have your say on all things Amiga-wise in the letters page we like to call Backchat.

POINTS OF VIEW 146

Does the Amiga have a future as a games machine? Andy Nuttall, editor of The One Amiga, gives his point of view.

Directory Opus

PART
2

Create a powerful yet simple Workbench replacement with Directory Opus - our

February cover disk.

Directory Opus can be far more than a glorified file manager. With a few mouse clicks, a sprinkling of key presses and a little imagination *DOPus* can almost replace Workbench as a working environment.

This is possible thanks to the powerful re-configuration abilities of *DOPus*. Each of the buttons you see at the bottom of the screen can be reprogrammed to perform a complex range of user-defined commands. It can run any Workbench or AmigaDos program, carry out one of many built-in commands, execute *ARexx* macros and more.

By defining the buttons you can turn *DOPus* into a central control point for all your Amiga work, using it to launch your most commonly used programs with a single mouse click and perform otherwise laborious tasks such as archive extraction and creation. Here's how to go about changing those buttons.

All change

Starting off nice and easy we'll set up a button to load the standard AmigaDos text editor. We'll also set it to load any selected files automatically.

Load *DOPus* as normal and select the configure option from the project menu. After a few minutes the screen will change and you'll see a row of buttons down the left hand side of the screen. You may see the Workbench screen appear while it loads the configuration program. Click on the icon marked 'buttons'.

The window will change again, this time showing the buttons that appear at the bottom of the normal *DOPus* working screen. Below this first bank of buttons is a second bank. These buttons are only available if you hold down the right mouse button, or those that have a little tick in the corner. Directly below these is an empty text box, which is used to display program messages. And finally, below this

box is a third set of buttons. This last bank of buttons are options and commands which allow you to change the buttons. Clicking on these buttons brings up a line of text in the text box describing you what to do, or alternatively a requester may appear asking for information. From here you can swop buttons around, delete them, copy them, add or delete new banks of buttons.

In our case we want to create a new button. Move the mouse over an empty button, one with

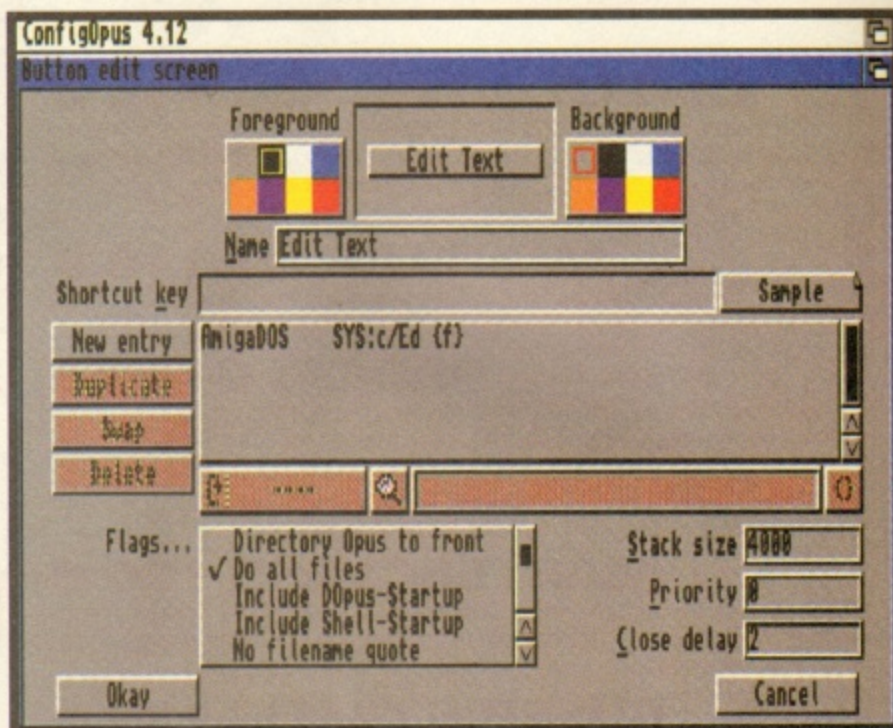

▲ Here we are creating a new button called 'Edit Text' which loads the DOS Ed program.

no text in it, and click once. You'll now see what looks like a very complex requester. But don't worry, there's only a few things we need to do. Firstly in the line labelled 'Name' type in something like 'Edit Text'. This is the name that will appear in the button.

Next click on the button marked New Entry. Another button (just to the right and below) will now be enabled. By clicking on New Entry you have told *DOPus* that you are going to create a new series of commands. The button now enabled allows you to set the type of command and the name of the command to be executed. By clicking on the Command button you can change it to AmigaDos, Workbench, Batch, *ARexx*, and back to Command. These are the different types of functions possible. Command means that what follows is an internal *DOPus*

command. AmigaDos

indicates a CLI command.

As we're going to use the AmigaDos text editor, click on Command until it shows AmigaDos. Now click on the magnifying glass next to this button. This brings up a requester that allows you to specify which program should be used. In this case change to the 'Sys:c/' drawer and click on the 'Ed' program. *DOPus* will now add this command to the text box next to the magnifying glass.

Your text editor may have a different name, so remember to change this if that is the case.

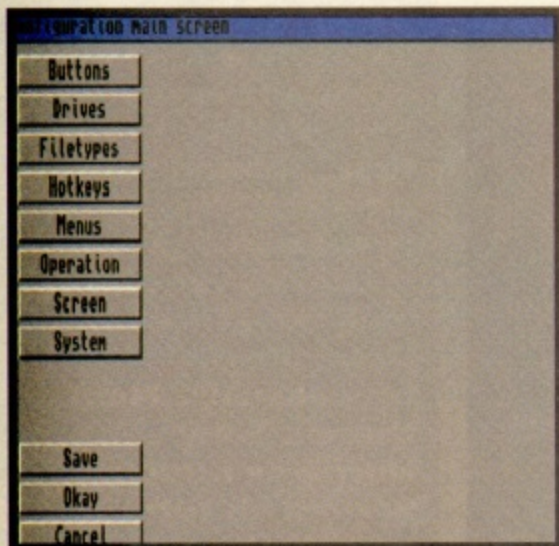

▲ The configure screen, click on the top button to get into the button configuration screen.

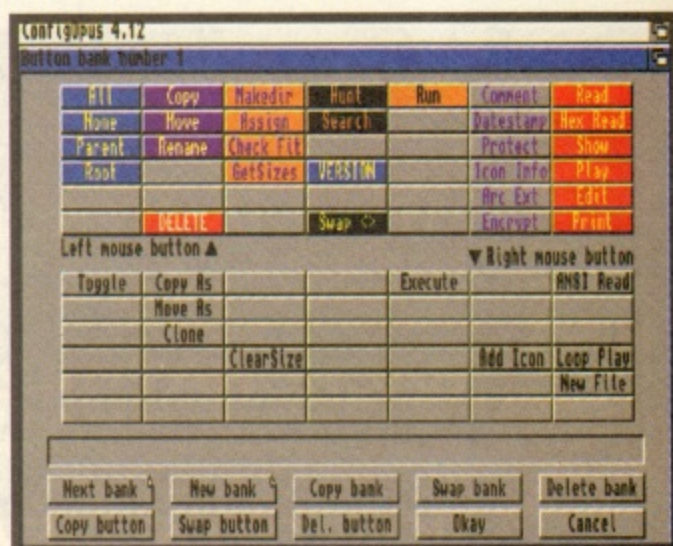

▲ In this window you can make any alteration or adjustment that you like to the buttons.

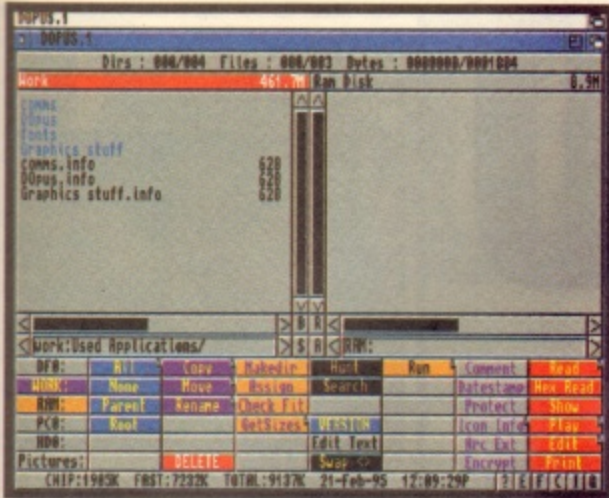

▲ Now the new button 'Edit Text' is now in place.

If you had selected the Command function type, the file requester would be replaced with a list of built-in *DOpus* commands.

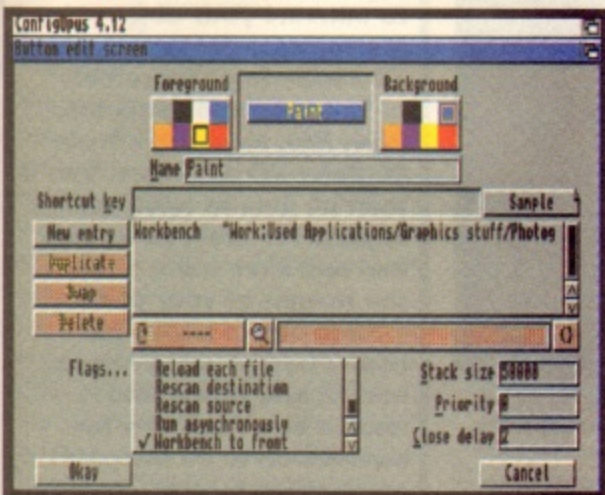

▲ In this screen a button is created which will automatically load an image in *PhotoGenics*.

Now click on the button with the two brackets in it '{ }'. This allows the arguments, such as the current directory and selected files,

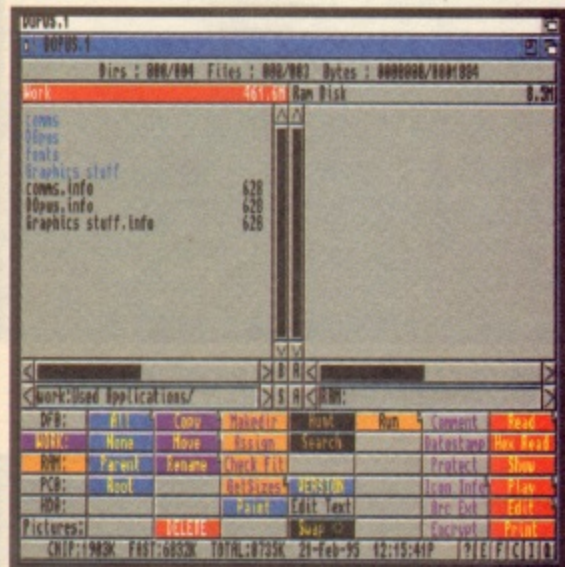

▲ And here's the button ...we've called it 'paint'.

to be passed to the program when it's run. In effect you are building up a command line that *DOpus* will execute each time the button is clicked. In this case you are giving the command line the names of the currently selected files. We

want to pass any highlighted files to the editor, so click on the line which reads '{F} - All selected entries (with paths)'.

Now find the word 'Flags ...'. Next to this is a scrolling list of actions that *DOpus* can perform before and after the main command, defined above. Click on the commands 'do all files', 'run asynchronously' and 'workbench to front'.

Having done all of this click on OK. The screen will revert to the button bank screen. Click on OK again, and finally on OK in the main con-

figure window. *DOpus* will now reload and you should see your Edit Text button displayed. Select a text file and click on this button. The standard Amiga text editor will now appear with the chosen text file loaded automatically.

Try experimenting with the other settings. Using AmigaDos commands and those built into *DOpus*, you can do practically anything you could do with the normal Amiga CLI/Shell, but this way it's much quicker and easier. Remember, pressing the Help key will bring up a quick guide to the current screen. This should help if you get stuck.

Launchpad

That covers replacing the Shell but what if you want to use *DOpus* to launch applications? It's pretty similar to the procedure discussed earlier apart from a few important differences.

The first is that you'll have to change the button showing AmigaDos to WorkBench and change the text field stack size to a larger setting. In the example used for loading *PhotoGenics*, the stack was set to 50,000 rather than 4,000.

I also took the opportunity to change the colour of the button. The two colour pallets at the top of the requester allow you to change the colour of the text (Foreground) and the button (Background).

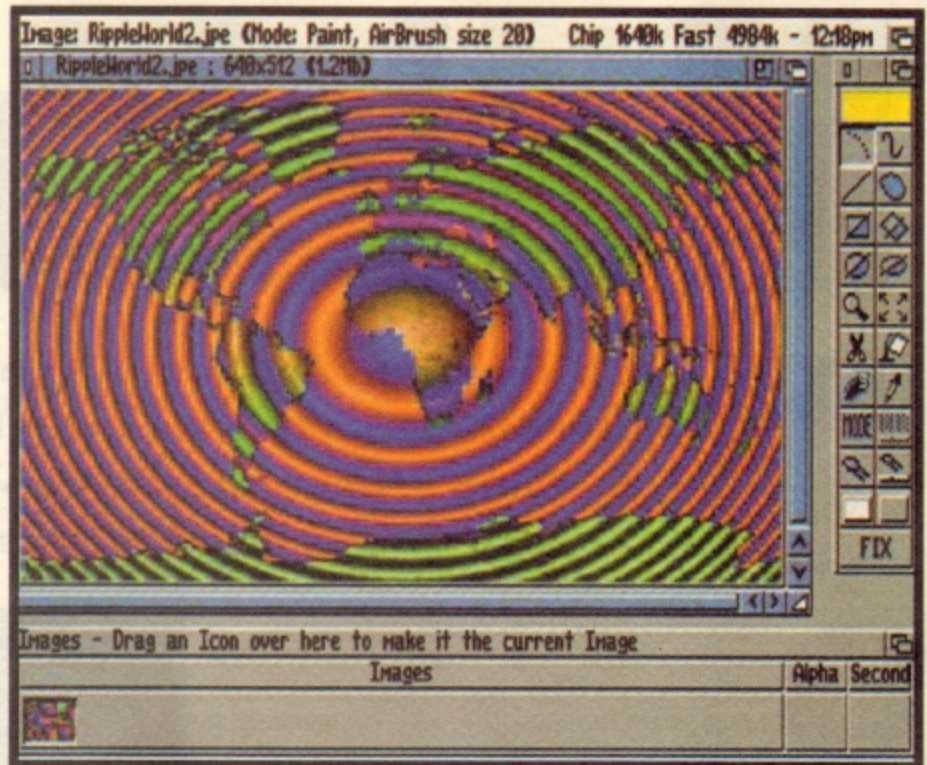

▲ Hey presto, *PhotoGenics* up and running at the touch of a button. No more having to waste time double clicking on icons in Workbench.

Returning back to the main working screen and clicking on the new button will now load the program.

That about finishes it for this month. Next time we'll have a look at changing menus. They work in an identical fashion to buttons - why not have a go yourself. We'll also cover the button arguments and built-in functions in

more detail. There are some really powerful facilities in *DOpus* if you know how to use them, so stay tuned to find out what they are and how to get the best from them. ■

***DOpus 5* is available from Wizzard Developments. Call 0322 272908 for details.**

The system revisited

Last month we looked at one of the possible settings available under the System button. The other buttons in the system window all work in a similar manner. You'll be presented with either text fields or radio buttons allowing you to specify the settings of the programs various functions. Listed below are simple descriptions of the buttons found when clicking on the System button.

AMIGADOS: Change the settings for the launching of external functions.

CLOCKS: Configure the format of the screen and minimised clock.

DETERMINE: How are directories handled.

HOTKEY: Which key sequences used to load up *Directory Opus*.

ICONS: Specify which icons are used by the AddIcon button.

MODULES: To save memory parts of *DOpus* are stored as modules. These are loaded when needed. If you've got enough memory you can preload these modules to save time. This option allows you to set those modules to preload.

SHOW PATTERN: Using standard Workbench wildcards you can define which type of files will be shown or hidden.

STARTUP: Covered last month.

VIEW & PLAY: Modify animation and text viewing and sound playing parameters.

Modeler 3D

PART 1

Last month's Modeler 3D cover disk instructions introduced the basics of 3D modelling. This month we look at some of the program's more advanced features.

This month it's time to take a look at some of the various editing functions of *Modeler 3D*. For more information on the general operating environment, check back to the instructions on page 10 of the March 1995 issue.

We'll start with the modify menu, which is home to a series of enticing options. These options mainly affect the shape of objects allowing you to create varied and diverse shapes as well as cubes, globes and cones.

Mirror duplication

As well as affecting the shape and style of objects, there are numerous options which help speed up

the process of object creation. The mirror command is one. For instance, if you were creating a car object you need only draw one half of the car as the mirror command will do the rest for you. For example, selecting all the points and polygons then clicking on the mirror function produces a mirrored copy of the object. After selecting 'mirror' a cursor with a line will now appear. This determines the axis along which the mirroring will take place. Placing the cursor near the sides of the view will effect a horizontal mirror, while positioning it near the top or bottom will result in a vertical mirror. You'll also be prompted to select the layer in which the mirrored copy will be placed. As mirrored components will usually form part of another object, the default layer is the same as the working layer, so click on OK. You'll now see duplicate but mirrored points and polygons appear.

The translate option allows you to easily change the shape of any given object by moving points in the x, y and z dimensions - (Remember you're dealing with three dimensional shapes). You may find that points disappear when moved. This is because they have moved outside of the viewing area. You can see them by pressing A, which scales the viewing area to show all points and polygons.

Remapping

My favourite function on the modify menu is the Remap tool. This deceptively simple sounding menu option can twist, shear, and distort shapes. Try the following for an example of its power. Create a

globe, following the example we used on the cover disk pages last month, and then call up the Remap requester. Try entering different values into the fields and selecting OK. Use the undo function and try it again, entering different values. After a few trials you should start to realise the tremendous power this command has, not to mention the ease that it brings to creating unique shapes.

The rain drop object rendered here in *LightWave* was created using a globe and setting the Y offset to a value of 2. As a challenge try mirroring this object horizontally, then copy it to layer two and rotate it through 90 degrees. Now move it back to the centre of the working area and copy it back to layer one. The result is an abstract object-looking, which could look quite interesting when rendered and animated. You can see the type of object I have in mind in the *Pixel Pro* screen shot.

Next month we'll look at some more of the Modify operators. ■

Exporting objects

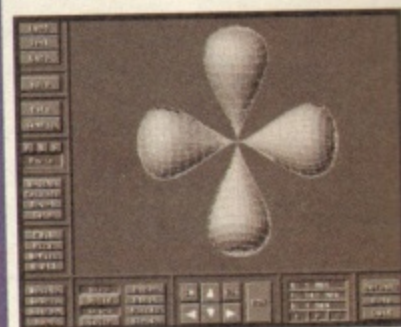

Modeler 3D uses a very similar file format to that of *LightWave*. You can load many objects created with *Modeler 3D* directly into *LightWave*. And, using *Pixel Pro 3D*, you'll also be able to convert your objects into file formats for use in other 3D rendering programs.

To load the objects into *Pixel Pro*, save them from *Modeler 3D* as Binary. You'll then be able to open the objects in *Pixel Pro* as normal and save them out in the format of your choice.

This object above has been created using remap, mirror, and rotate and loaded into *Pixel Pro* for conversion to an *Imagine-compatible* format.

▲ Raindrops keep falling on my head ... OK so it's not that great, but with a little bit more effort it's easy to see that this could be a very convincing raindrop.

Who's on top?

When building complex 3D objects it's often useful to work on just one part of an object, without having to worry about the polygons and points surrounding it. Modeler allows you to do this using a system of layers. You can have up to eight layers, each holding individual points and polygons. Multiple layers can be displayed and saved, and turned off so they become invisible.

To change layers simply click on one of the small boxes (labelled one to eight) in the bottom right-hand corner of the screen. The currently selected layer will be displayed. To view several layers at once, select them whilst holding down the shift key.

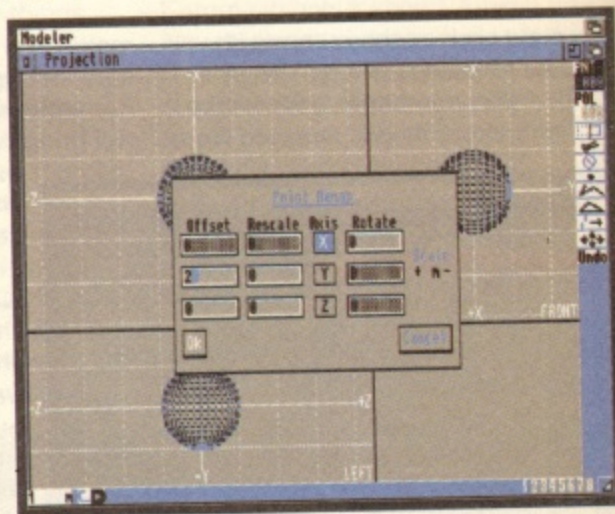

▲ A globe object prior to using the rescale command. These parameters will create a raindrop type shape...

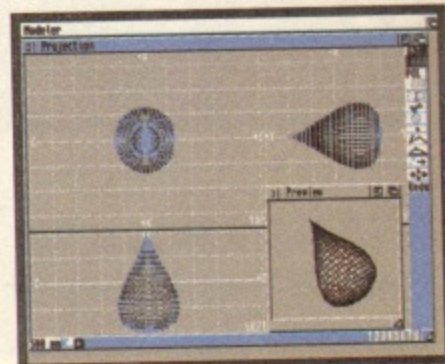

▲ ...after using remap on the globe it changes into the raindrop shape.

ProCalc Tutorial

PART 2 The power of ProCalc can make working out house hold bills a cinch. This month we show you how, using some powerful financial functions.

Last month we covered the basics of functions, operator precedence and logical operations. Now we're going to move on to functions themselves with some examples. This approach shows how the functions work, whilst giving you spreadsheets that you can start using and ideas for other possible spreadsheets.

The first example tackles the age old problem of loan repayments, in this case using ProCalc's PMT function. This returns the amount needed per month to repay a figure borrowed, with a fixed interest rate, over a number of months. Using ProCalc we can build upon this function to quickly try out different interest rates, repayment periods and deposits.

The syntax for the function is

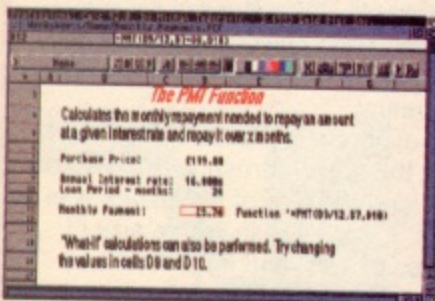

▲ Figure 1: Here we have the PMT function in action — handy for working out any long term repayment plans.

'=PMT(x,y,z)' where x is the interest rate, y is the total amount borrowed and z is the number of months. In the sample shown in figure 1 I've set up three cells to hold these figures. When entering these numbers, remember to only enter the numbers and not the pound sign and percentage symbol (see the panel 'Formats' for more detail). The fourth cell holds the formula, and once calculated shows the amount to repay on a monthly basis.

What if?

You can carry out 'what-if' tests by simply changing the values in the

first three cells. 'What-if' capabilities are one of the primary advantages of spreadsheets and allow you to experiment with different values, asking 'What-if I changed such and such a value?' You could also use 'what-if' to find what starting parameters are needed for a desired result. Suppose for instance you wanted to borrow £199 from a bank to buy Power Computing's new CD-ROM drive, but could only afford to pay back £10 a month. By changing the entries in the first three cells you can try out the different repayment periods needed to reach the £10 repayment amount — a typical what-if test. In our example we find that with an interest rate of 16%, twenty four monthly repayments of just under £10 would be needed.

We can also use ProCalc to find out the total repayments, ie how much the bank will charge you for the loan. To do this, simply multiple the monthly repayments by the number of months — so the formula would be '=D12*D10'.

Another factor you could add might be a deposit. This would let you reduce the monthly repayments by increasing the initial deposit and stretching out the number of months over which the loan was repaid. To add a deposit, type in the figure £50 under the loan amount. Now change the PMT function to '=PMT(D9/12,D7-D8,D10)'. This does the same as the last PMT function, but now we subtract the deposit value (held in D8) from the loan amount. Once again you can carry out 'what-if' tests by changing the initial deposit figure.

Because we've now added a deposit, we'll also have to update the formula to take this into account. To do this change the formula to '=D12*D10+D8'.

The screen shot in the box out titled formats shows these last two amendments. Note how adding a deposit and increasing the number

of repayment months has reduced the monthly repayment amount.

Terms and ...

The opposite function to PMT is TERM. This returns the number of months required to reach a desired amount, by making equal payments to an account paying a compound rate of interest. We could ask ProCalc to figure out how many months we'd have to hand over money for if we borrowed £199 with a given interest rate. Again this could be used in what-if calculations to help plan your future budgets.

The syntax for this function is

'=TERM (payments,interest,value)'. Payments is the amount paid each month, interest is the interest rate, value is the total amount spent. Using this function with the figures used for PMT above, you'd enter '=TERM(10,.16,199)' or to tie it into the cells '=TERM(D12, D9/12,D7-D8)'. In the first case TERM asks how many months will be needed to repay a £199 loan at 16% interest paying £10 back a month. The second result uses the values in the cells, taking into account the deposit. Next month we'll continue our look at functions with some more real world examples. ■

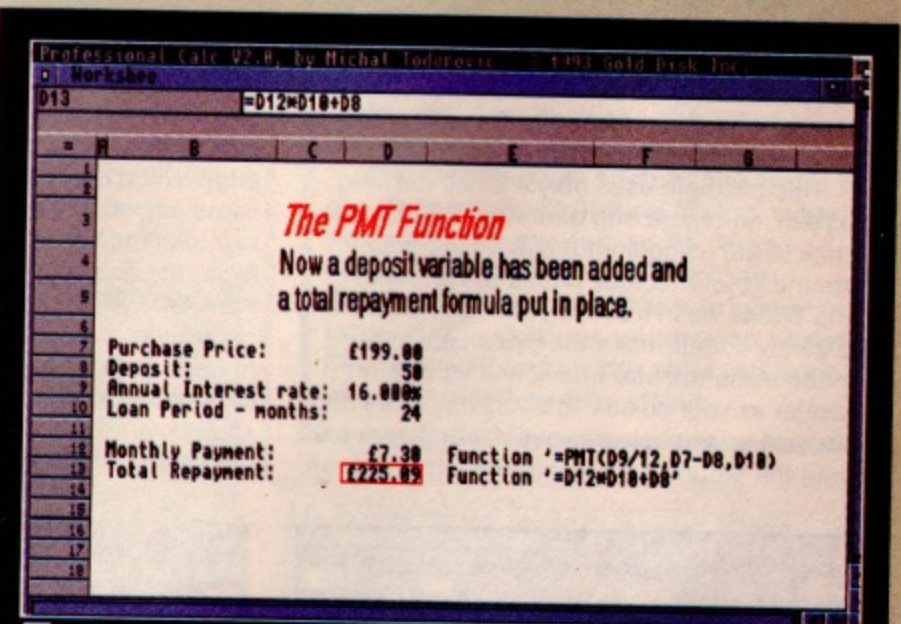

Formats and menus

When entering data into the spreadsheet, you'll probably notice that your screen doesn't look like the one shown here. The obvious difference will be that our numbers have pound signs in front of the prices, and a percentage symbol at the end of the percent number.

You don't need to enter '£' and '%' symbols when typing in numbers, in fact if you do ProCalc won't operate correctly. Instead enter only the numbers. Now move the cursor over the cell with one of the numbers and select the 'Numeric Format/Format' menu. You'll then see another menu pop up which lists a range of possible formats. If the cursor is over a cell containing prices, click on the Currency option, or for percentages click 'Percent'. The '£' and '%' symbols will then be added for you.

Graphics Mas

PART
1

Become a 24 carat 24-bit artist with our easy to follow guide to Photogenics.

Photogenics offers features to Amiga artists that used to be found only in high-spec, high-priced systems. What's more it combines them with a level of sophisticated image manipulation never seen on the Amiga. Over the next few months we'll be running expert tutorials to help you develop your skills with the program, and expand your artistic horizons. *PhotoGenics* is a very versatile program. You

can sketch in pencil, pastels or crayon; dabble in biro or felt-tip or make your pictures spring to life using watercolours. The way the program is structured means you can merge different images, both in terms of graphics or texture, and it makes photo-montage work a dream. In this first tutorial we'll create images using an assortment of drawing mediums and try our hand at merging separate images to achieve special effects.

Tutorial one

Just like the real world, your brush strokes reflect your medium; trying to simulate water-colour washes in 8-bit drawing packages is damn near impossible. But *Photogenics* lets you dilute colours loaded onto the computer brush with infinite precision, through the Settings menu. The pressure of a brush affects the amount of colour laid down, and used in conjunction with the Transparency factor gives a vast range of strokes.

This example uses only a small drawing screen, so create one of around 200 by 200 units large, using light beige as the background colour (colour values of H23, S40 and B194). As in true watercolours, the outline is gently added; draw the eye shape in paint mode using the biro brush, and light Burnt Umber as your colour. To edit a colour's intensity, call up the colour requester and click and drag the Saturation slider to the left to lighten,

or right to darken. The shading under the eye, intended to give the object depth, is added using a wide Pencil brush (size 11 with a pressure of 14% works well), adding a light grey colour with sweeping movements of the mouse. The combination of Pencil and the settings creates a nice streaked grain effect.

You can magnify the image once now, to get closer to the work in hand. Firstly, using a pink wash with high transparency, draw in the pink dot at the corner of the eye, and just edge a little around the inner eye with the same colour. Using the Fill tool, with a very low tolerance level, with a very low tolerance level, fill the inside of the eye. *Note: the Tolerance setting is accessed from the Image/Fill options pull-down menu, and determines how similar adjacent pixels need to be in order to be filled. Set it high and you cover a wide range of similar colours. Likewise a low tolerance level will restrict the number of similar colours affected by the fill option.*

So many options

The menu structure of *Photogenics* is huge. We're talking serious choices here. The screen shots on these pages show the major items which can be active on your drawing screen - but don't panic, you can have as many open or closed as you like. The modes, brush setting and palette menus are the ones used most often, so it's to keep them open at all times. The scope of choices is initially bewildering, but the learning curve is well within the reach of everyone; sometimes it's like being in a sweet-shop - you have to try everything!

One of the beauties of *PhotoGenics* is that you can experiment wildly. Execute an effect in one mode and if it's not up to scratch, you can re-do it without harming your image. Best of all, even the colour of your paint can be altered after it's been applied. This option helps you achieve the exact effect you're looking for.

The blue iris is an open circle, drawn for delicacy with the Crayon brush of size 5, using the violet colour. The pupil is a similar, smaller circle drawn in crayon in black. The highlights on the pupil are plain white, with slight transparency.

Finally the eyebrow is just two strokes of Umber, using the crayon brush with 50% transparency, and the hint of eyelashes was done with the Sponge brush with a size of 5, transparency of 10% and light brown as the colour.



▲ Having drawn the eye's outline and brush-stroked the shadows it's time to fill the eyeball with white.

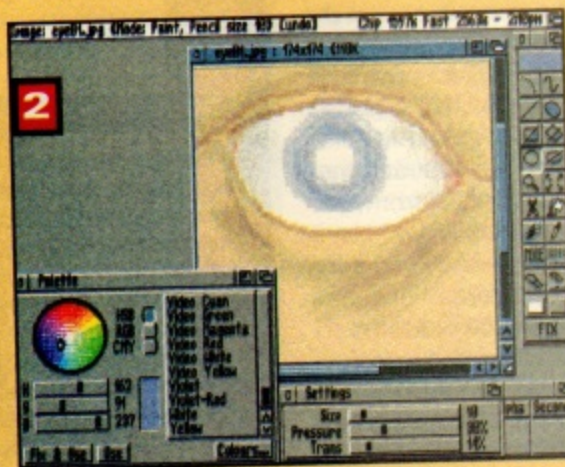

▲ Ol' blue eyes is back - the delicacy of the pupil is one of the trademarks of painting with Photogenics.

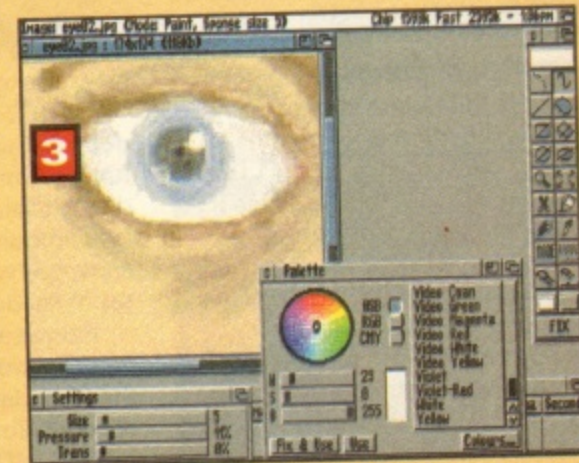

▲ The eye takes on more realism with the addition of the iris, reflective highlights and hints of eyelashes.

terclass

Tutorial two

Using simulated watercolours on canvas we can recreate the brush-strokes of conventional artists on the computer. The only difference is, if we make a mistake, we can rub it out.

The beauty of using water colours, is the way washes of subtle colours interact with the paper and with each other. *Photogenics* recreates this feedback superbly, and does it in a sophisticated but easy way.

Surprisingly enough, I chose to create the tree foliage using the Cloth brush; this is a great brush for random blots of colour, and when it is set larger than normal, it covers a wide area, with good colour fading around the edges. So with a light green as your colour, dab around a new, off-white screen to create the shape of foliage.

Fix the image, and change to a darker green. Decrease the size of the brush by half, and dapple some darker, shady leaves on the tree.

The trunk is purely representational, and was sketched using the Felt Pen brush, set to a size of 4, using burnt umber as the colour.

The water was achieved using the Water colour brush with 60% Transparency. A few streaks is all it takes in this minimalist art form. The far-off snow-capped brown mountain was also drawn in water colours, the snow peak using the Filled freehand drawing tool and white. A violet open rectangle frames the shot nicely.

The text is pure imagination, but it looks authentic. It was drawn using the Calligraphy pen on low transparency. The sweeps of the strokes are visible and a really nice touch.

The finishing touches involve using the Alpha Channel; this is where we store a further image, which can be made to interact with our drawing. The first stage is to make our artwork look as if it were drawn on paper, so we need to mottle it slightly. To do this, from the Loaders menu, select White Noise and accept the defaults. Something resembling TV interference is generated; save this for now, as it will be useful in future work. Move its icon, as displayed in the mini-bar at the bottom of the screen, into the slot marked Alpha. The effect we want to create will be based on this unassuming image

From the Modes menu, select Rub Texture, and execute the effect by clicking on the Fill Paint Layer icon (above left of the Fix icon) on the Toolbar. The texture of the white noise screen is added to the drawing, giving a more realistic look to the image.

But wait – there's more. Fix the image and save it. In the same way as you loaded in the white noise, load the Foil.jpg which came with your program as the Alpha image (you can find it in the Textures directory). From the Modes menu, select RubMix, click on the Fill Paint Layer, and watch as your drawing is transferred to crumpled silk. Beautiful.

Image composition



A powerful feature of *Photogenics* is the 'compose' function. Each part of the image was rendered in LightWave and saved in 24-bit IFF format with an 8-bit alpha channel and composed onto a blank page one by one. This allows you to move, position and scale the images without having to commit to any changes. Once you're happy with the composition, the images can be blended in using any of the brush tools. The airbrush is probably best.

It's also easy to achieve the slightly transparent effect on the text and armoured car. When composing the secondary image, open the brush settings window (the 'V' key is a useful shortcut key for this). The last of the three sliders in this window is the transparency setting. By moving the slider you can increase the transparency of the secondary image.

Another popular trick of the trade is the drop shadow. Simply 'Paint' where you want the shadow to be, then change the mode from 'Paint' to 'Brightness' and adjust the brightness in the mode settings window to about 50. This will darken the selected area to give a shadow-like effect.



▲ The tree is dabbed on using two shades of green, which shows up as many hundreds of shades thanks to transparency.

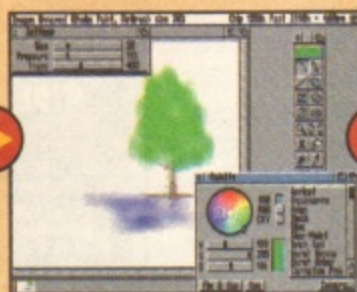

▲ You can add even more detail by using the colour requester to fine-tune those delicate hues.



▲ A subtle pink sunset-type sky and a frame begin to help the image take some form.



▲ This enlarged image shows how finely the colours are laid down on screen.



▲ Use the Calligraphy brush to paint oriental-style characters.



▲ The main image and the Noise Alpha image. Combine them for a strong image.



▲ The finished product, with the RubMix effect making our drawing look as if it were painted on shimmering silk.

(01903) 850378

SEA SOFT



AMIGA PD & SHAREWARE

A1200 ONLY
1885 AGA UTILITIES (3)
Rend24, PPShow, Viewtak, BBlank, ForceVGA, DoubleX, Plasma, Ioon Illusion, Quick Grab, Ham8-JPEG, Clouds etc.
1619 A1200 HD SET UP (1)
A1200 HD prep disk
1273 ASI FIX DISK (1)
Get A500 programs working!
1431 BIG TIME SENSUALITY (2)
Impressive MegaDemo
1358 BIG GIRLS (X) (1)
1732 BODY SHOP 8 (X) (3)
Page 3 style pics
1834 BREATHTAKING DEMO (5)
Megademo needs 4 megs/HD
1875 C CRAWFORD (X) (3)
1881 CLAUDIA SCHIFFER (X) (3)
Excellent pictures of top models
1758 CYBERTECH CORP (2)
Destroy the Aliens if you can!
1384 DIAGNOSTIC PROG (1)
Comprehensive A1200 tests
1660 DIRT (1)
Demo from Mystic
1725 DONKEY KONG (1)
Classic Platform game
1879 ELLE MCPHERSON (X) (3)
1383 ERIKA ELENIAK (X) (1)
Excellent pictures of top models
1376 EXPLICIT 2 DEMO (1)
Some stunning effects
1756 EVIL INSECTS (1)
Stunning puzzle - shoot 'em up
1408 FIT CHICKS VOL 3 (X) (2)
Page 3 style pictures
1340 FULL MOON DEMO (1)
Stunning AGA demo
1802 FRIDAY AT EIGHT DEMO (1)
1663 ILEX DEMO (1)
A must for the Demo collection
EXTRA KLONDIKE CARD SETS
1791 Betty Page (1)
1760 Dungeons & Dragons (2)
1792 Dr Who (1)
1715 Ellie McPherson (X) (1)
1849 Empire Strikes Back (1)
1762 Fast Cars (1)
1862 Hajime (1)
1854 Marilyn Monroe (1)
1852 Return of the Jedi (1)
1851 Sailormoon (1)
1853 Star Wars (1)
1718 Star Trek old series (1)
1784 Star Trek new series (1)
1765 Swimsuits (1)
1642 Dave Sandman (1)
1643 Woman (X) (1)
1763 X-Men (1)

A1200 ONLY
1345 LOCK PICK 2 (1)
Helps install many games on HD
1772 LOTTERY WINNER (1)
Will it help you win a Million?
1775 MAX OVERDRIVE 2 (3)
Breath-taking AGA Demo
1344 MAGIC WORKBENCH (1)
Jazz up your WB - needs HD
1651 MAGIC WB EXTRAS (1)
Extra Magic Workbench Icons
1813 MINI AGA SLIDESHOW 2 (4)
Excellent Raytraced pictures
1655 MISSILES OVER XENON (2)
AGA "Missile Command" game
1754 MAMMA WAS A VAMPIRE (2)
A variety of excellent effects
1711 MONOPOLY (1)
English version board game
1348 MOTOROLA INVADERS (2)
Aga Space Invaders game
1811 MOVIEGUIDE AGA (2)
Learn all about the movies!
1369 NINE FINGERS (2)
A must for all Demo fans.
1798 ROKETZ V2 (1)
Excellent gravity/thrust game
1805 SHARD ART (2)
Excellent Ferrari pictures
1910 AGA SPECTRUM EMULATOR (2)
Latest emulator with 23 games
1714 SOME JUSTICE 94 (1)
Excellent sound track
1865 SOUL KITCHEN DEMO (2)
Brilliant Demo from Silents
1752 SWITCHBACK DEMO (2)
Excellent AGA demo from Rebels
1793 TOOTHBRUSH DEMO (2)
Watch that toothbrush
1773 VIDEO TRACKER AGA (1)
Ultimate demo maker
1839 VIDEO TRACKER EXTRAS (3)
Help with your Demo making
1867 THE WEATHER GUIDE (3)
Full of interesting information
1514 TUTANKHAMUN (2)
AGA Slideshow of the treasures
1757 WIT PREMIUM DEMO (1)
Stunning Demo from Freezers
1797 ZOOTOJE DEMO (1)
Weird - Beavis & Butthead

OCTAMED VS MODULES
1466 BARNEY WARTS 'N' ALL (1)
1925 FADE TO GREY (2)
1461 FRIENDS OF PAULA 5 (1)
1659 FRIENDS OF PAULA 6 (1)
1927 HARMONIOUSLY DIFFERENT (1)
1436 MAKIN TRAX VOL 1 (1)
1928 MUSIC FIRST BLUES (1)
1661 ROBS ROCKERS (2)
1922 TALK TALK VOL 1 (1.5M) (1)
1923 WHAT CAN YOU DO FOR ME (2)
We also stock the entire range of Med Users Group Samples and Mods

SAMPLE ILLUSIONS
A collection of unique sounds created with the Aural Illusion sample processing package and saved as 8-bit IFF samples
6 disks for £5.00

MUSIC UTILITIES
1929 AURAL ILLUSION DEMO (1)
1767 DROP IN THE OCEAN (1)
Demo Midicraft CD & other products
1921 EAGLE PLAYER V1.54 (1)
Multi format music player
1462 MIDI TUTORIAL (1)
Problems with MIDI - Help is here
1463 NO SAMPLER? (3)
Various rippers and other tools
1444 OctaMED V4 MANUAL (1)
1855 X BEAT PRO III (1)
The very latest Drum Machine

NEW TITLES ARRIVE DAILY - THOUSANDS AVAILABLE
PLEASE GIVE US A CALL IF YOU CAN'T SEE WHAT YOU WANT

ONLY £1.00 PER DISK FOR 5 OR MORE

1 disk - £1.50, 2 to 4 disks - £1.25, 5 to 19 disks - £1.00, 20+ disks - 90p
Number of disks shown in brackets
Titles marked # will not work on A500 (V1.2/V1.3)
Titles marked (X) are suitable for over 16s only

SPECIAL VALUE PACKS

IMAGINE OBJECTS
16 Disks packed full of quality Imagine objects covering many subjects.
£12.00

KLONDIKE AGA
Klondike V3+ 10 card sets Airbrush, C64, Puzzled, Trad, Reko, C. Crawford, Faces, Manga, Iron Maiden (A1200 HD Only)
£8.00 for set

GLAMOUR PACK
15 disks packed with AGA beauties from the famous Body Shop collection
£12.00
(A1200 only - not suitable for anyone under 16)

CG FONTS PACK
Over 180 Compugraphic fonts (16 disks) for WB2 & 3, Wordworth 2+, Final Copy, Final Writer, Page Setter 3 etc.
£12.00

OctaMED MODS
Hundreds of modules from the Med Users Group members collection
10 disks per pack, 6 packs currently available
£8.00 per pack

OFFICE PACK
5 essential tools for the small office - Word Processor, Database, Spreadsheet, Forms Designer & Accounts
£4.50

UTILITIES
1766 ACCOUNTS MASTER 3# (1)
Excellent Accounts package
1480 AGENE V4.18 (1)
Genologic package
1475 A.C.C. 1-4 (1)
Best of ACC issues 1-4
1481 600 BUSINESS LETTERS (1)
Example letters to load in WP
1771 CITIZEN PRINT MANAGER (1)
1483 CODE MUNGUS V5.7 (1)
Highway code tutor
1310 COPIERS UNLIMITED # (1)
Excellent collection of copiers
1786 COMPUGRAPHIC FONTS (4)
Vols 17 to 20 of excellent fonts
1916 CRUNCHMANIA # (2)
1216 D COPY V3 (1)
Copying program
1490 DISK MANAGER 3 (1)
Excellent database
1491 EASY CALC PLUS # (1)
Very comprehensive spreadsheet
1647 FINAL WRAPPER # (1)
Final Writer Macros
1918 HD GAMES 2 INSTALLER (1)
Install many games on to your HD including Mortal Kombt etc.
1777 IMAGE STUDIO # (1)
Very latest image processor
1778 IMAGINE BUDDY SYSTEM # (2)
1719 LION KING CLIPART (3)
IFF Colour clipart from Disney
1769 MENU MENU SYSTEM # (1)
Menu system used on TI, AMFM etc.
1919 MSDOS -> AMIGA DOS 2.3 (1)
Adds Msdos commands to your Amiga
1261 N COMM V3 (1)
Modem package
1318 PRINTER DRIVERS (1)
Canon BJ; HP Deskjet; Ricoh LP1200 drivers
1768 SID PROF V2.01a # (1)
The very latest version
1770 SNOOPDOS V3 # (1)
1305 TEXT ENGINE V4.1 (1)
Text Editor/Word processor
1833 THE DESIGNER # (1)
A GUI creator
1920 VIRUS CHECKER V6.50 (1)

GAMES & EDUCATION
1831 APOLLO 11 (2)
Text book about Apollo mission
AS1218 GAMES DISK # (1)
Ace of Rock, Hearts Back Lady, Commando Raid
1527 BACK TO SCHOOL 1-3 (3)
Educational games for kids
1532 CALCULUS COMBAT (1)
Mental arithmetic quiz
946 DINOSAURS VOL 1 (1)
Text book all about Dinosaurs
1636 DR STRANGE (1)
Excellent colourful platform game
1829 DUMMIES GUIDE TO COMMS AND INTERNET (2)
A very helpful guide to the net
1716 GREENS 5 # (1)
Great Flashback game
1522 GCSE MATHS # (1)
Helps with your studies
1517 ILLUSIONS (1)
Excellent Shareware art package
1510 KIDS 1-3 (4)
Excellent educational programs
1827 KIDS DISK 5 (1)
3 educ. programs maths/letters
1828 KIDS DISK 6 (1)
Help Mum with the shopping!
1843 PARANORMAL INVESTIGATIONS # (2)
1521 RUNE MASTER (1)
Learn all about Rune Stones
1717 SCRABBLE # (1)
Traditional board game
1427 STARBASE 13 (2)
Graphic space adventure game
1533 STATES OF EUROPE (1)
Textbook on Europe
1524 THREE LITTLE PIGS (2)
Excellent Talking story book
1517 TOME OF MYTHS (2)
Textbook Classical Mythology
1780 UNKNOWN UFO (6)
Full information about UFOs
1526 WORD FACTORY (1)
Spelling game for young kids
1271 WORLD WAR II (1)
Second World War textbook
1607 WORLD MAPS COLOUR CLIP ART A-Z (9)
IFF pictures to load into DPaint

CLR LICENCEWARE
WE STOCK THE COMPLETE RANGE OF CLR TITLES
CLU03 TYPING TUTOR (£3.95)
Learn to type-Lessons/Speed tests
CLU06 SUPERSOUND V4.7 (£3.95)
Brilliant sampling package
CLU32 POWER TEXT 2 (£3.95)
Word Processor & Spell Checker
CLU43 LOTTERY FORCASTER (£3.95)
CLU44 NATIONAL LOTTERY (£3.95)
Will you win the million!!!
CLE 35 OGI THE CAVEMAN (£3.95)
Commercial quality platform game
CLG 65 WEAPONS MASTER (£3.95)
Impressive Street Fighter clone
CLE 68 BASIC NOTE TUTOR (£3.95)
Learn to read music and music quiz
CLE 65 JUNIOR MATHS (£3.95)
Pre-Early school fun Maths tutor
CLE 67 PHOTO (£5.95)
Comprehensive photographic manual

CLR ENCYCLOPEDIAS
Excellent range of educational disk based encyclopedias, with detailed text, diagrams/photos
CLE01 DINOSAURS 2 (£4.95)
CLE02 GEOLOGY (£4.95)
CLE03 SOLAR SYSTEM (£5.95)
CLE14 ECOLOGY (£5.95)
CLE31 SPITFIRE (£4.95)
CLE33 MESSERSCHMITT BFI09 (£4.95)
CLE35 SOLAR SYSTEM 2 (£5.95)
CLE49 DINOSAURS 3 (£5.95)
CLE54 THE TITANIC (£4.95)
CLE56 CHEMISTRY (£4.95)
CLE58 STARS & GALAXIES (£5.95)
CLE63 TUTANKHAMUN (£4.95)

MEGA MOUSE
Microswitched 400dpi ultra high res
£12.95
BUDGET MOUSE
£9.99

ACCESSORIES
(£1.00 p&p)
MOUSE MAT - £2.99
MOUSE HOLDER - £2.50
HEAD CLEANING KIT - £2.99
MONITOR COVER - £4.99
AMIGA DUST COVERS (state model required) - £2.99
LONG JS EXTENDER - £4.99
SHORT TWIN EXTENDER - £4.99
AMIGA-SCART LEAD - £9.99
PRINTER STAND - £4.99
PRINTER LEAD (1.8m) - £3.99

H/W PROGRAMMERS MANUAL
Vol 5 & 6 now available
£5.00 each
Volumes 1 to 3 - £12.50
Vol 4 - £5.00

AURAL ILLUSION SAMPLE PROCESSOR
32 bit processing, many effects & manipulations, powerful editing functions, compatible with most popular 8/16 bit file formats
£20.00

NOTHING BUT AMOS
Issue 7 of the best selling AMOS disk magazine
£2.50
(£4.50 with support disk)
Issues 1 to 6 also available

MORTON STRIKES BACK AGA - £7.00
Brilliant A1200 only version of this classic style platform game with 80+ colourful levels
NON AGA VERSION - £5.00

STARTER PACK
10 Blank Disk, Mouse Mat, Head Cleaning Kit, 100 Capacity Disk Box, Amiga Dust Cover (state A500/A600/A1200)
£15.00

CD ROMS
CD-ROM prices include p&p (UK only)

17-BIT PHASE FOUR - £19.95
All the very latest from the 17-Bit collection.
ADULT SENSATIONS - £19.95
The perfect companion for all nature lovers
AMINET 5 - £19.95
Latest offerings from the Aminet archive. Hundreds of files of applications, games, mods, demos etc. etc.
ASSASSINS COLLECTION - £19.95
Over 650 games ready to run from an easy to use menu system.
CDPD 4 - £19.95
Fish disks 891 to 1000, AM/FM, GNU C/C++, etc.
DESKTOP VIDEO - £14.95
Stacks of textures, fonts, backgrounds, objects & utils.
EMERALD MINES - £14.95
Over 10,000 levels of this classic game OK on CD32.
GOLD FISH 2 - £29.95
Double CD with the best of Fresh Fish 1 to 6
HOTTEST 4 - £19.95
Latest demos, games, anims etc. from PD-Soft.
ILLUSIONS 3D - £9.95
Loads of Stereogram tools & pics for the Amiga & PC
LSD/17-BIT COMPENDIUM - £19.95
LSD Legal Tools 1 to 149, Pics, Anims & much more (LSD TOOLS 2 AVAILABLE SOON)
MULTIMEDIA TOOL KIT - £19.95
Pics., clip-art, fonts, mods & samples (MULTIMEDIS TOOLKIT 2 AVAILABLE SOON)
NETWORK ROM - £14.95
Various networking tools, Fish, AMOS, T-Bag etc.
PROFESSIONAL UTILITIES - £19.95
Over 1500 disks of applications & utilities from PD-Soft.
PROF. GIF £19.95 PROF. PCX - £19.95
SOUNDS TERRIFIC - £19.95
Double CD with thousands of music files for Amiga & PC.
SPECTRUM SENSATIONS - £19.95
Amiga & PC emulators with masses of Speccy games
WEIRD SCIENCE ANIMATIONS - £19.95
W.S. CLIP ART - £9.95 W.S. FONTS - £9.95

Buy any 2 CD-ROMS and save 10%
Buy 3 for a massive 15% discount

A DROP IN THE OCEAN
This audio CD shows what can be achieved with a modest studio set up and an Amiga. 12 original compositions from the Craft Brothers.
In stock NOW
£10.99

OctaMed V5.01
with 220 page Companion tutorial.
NOW ONLY £19.95
(£1.00 P&P)

T.I.10 - £2.50
Latest issue of the official MED Users Group Disk magazine.
Essential reading for all OctaMED users
(Iss 6 to 9 also available)

MIDI MODULES
High quality Music-X and PC/Amiga MIDI files produced and arranged by K & G Craft
Volume 1 - £15.00
Vol 2 for Keys - £10.00
Dynamite Drums - £10.00
(call for further details)

ETHEREAL - £2.50
Amiga floppy disk version of Dave Sullivan's track for the "Amiga Experiment" CD.
Although the CD may not now be published you can hear Dave's work on this huge OctMED module

TECHNOSOUND SAMPLERS
TURBO - £22.50
TURBO 2 - £27.50
MIDI INTERFACE
£22.50

ASSASSINS GAMES
We stock the complete range of Assassins Games (1 to 226) ask for full list
SPECIAL OFFER - BUY 10 ASI GAMES DISKS FOR £8.00

FI LICENCEWARE
WE STOCK THE COMPLETE RANGE OF FI TITLES
FI 02 CRICKET CRAZY (£3.99)
Fun cricket game
FI 10 KARATE MASTER # (£3.99)
Serious Karate sim (2 Meg chip)
FI 18 RELICS OF DELDRONEYE (£5.99)
Epic adventure game (2 Meg chip)
FI PICK 'N' STICK (£3.99)
"Fuzzy Felt" Art package
FI 28 C.L. INDEX # (£3.99)
Amiga Dox C commands ref book
FI 31 POWER BASE (£3.99)
Powerful, user friendly database
FI 37 SUPER BINGO 2 # (£3.99)
Bingo game (Need 1 Meg chip)
FI 38 AMBASSADOR PRO # (£3.99)
Fruit machine sim (Need 1 Meg chip)
FI 40 HENRY HOUSE (£4.99)
Colourful platform game for kids
FI 42 MAGPIES KIDS CLIP ART (£4.99)
400 high quality scanned/IFF pics
FI 43 MAGPIES CLIP ART (£7.99)
900 high quality scanned/IFF pics
FI 44 BLACKBOARD V3 (£5.99)
Image processor. Needs 2 drives
FI 48 ERIK (£3.99)
Commercial quality platform game
FI 50 BEGINNERS GUIDE TO AMOS (£4.99)
FI 51 WORKBENCH/AMIGADOS# (£4.99)
Text book about Kick V2 or above
FI 56 GIDDY 2 (£3.99)
Sequel to the PD Game Giddy
FI 60 ULTIMATE QUIZ (£3.99)
Well presented Trivia Quiz
FI 61 CAPTAIN CARNAGE (£3.99)
Excellent "Alien Syndrome" game

PARNET
1.8m lead - £10.00
5.0m lead - £15.00
CD2 - AMIGA SERIAL LEAD
£19.95

3.5" DSDD DISKS
100% error free (price includes labels)
10 - £4.50
50 - £20.00
100 - £35.00
EXTRA DISK LABELS
100 - £1.50
500 - £6.00
1000 - £10.00

Please add 50p P&P to orders for P.D./Licenceware only (£1.50 Europe, £3.00 rest of World) or £1.00 if your order includes other items (Europe & Rest of World at cost).
Please make cheques/postal orders payable to SEASOFT COMPUTING and send to:
SEASOFT COMPUTING (CU), Unit 3, Martello Enterprise Centre, Courtwick Lane, Littlehampton, West Sussex BN17 7PA or telephone
(01903) 850378
10.00am to 7.00pm Mon-Fri (to 5pm Sat). Callers by appointment only please

Buyers Guide

PART 1 Buying mail order might seem risky but it needn't be. Andy Leaning kicks off a new series of the CU Amiga Magazine buyers guide.

Shopping for computer peripherals can be a tricky business. Can you be sure you're getting what you want? Is it good value for money? Will the company you buy from be able to support the product? Over the next few issues I'll be giving you all the information you need to shop with confidence.

Obviously there are differences between buying from shops and buying via mail order. If you intend to buy via a mail order company, follow our "Managing Mail Order" guide on this page. This will give you peace of mind and added security when parting with your money. In brief, check the goods you want are in stock before ordering, keep a record of all conversations and correspondence you have with the company, only order using a credit card, and put any complaints you have in writing. If you return the goods, send them via registered or insured post so you're covered against loss.

Most of the time your goods will arrive and everything will be hunky dory, but occasionally problems arise. Maybe your goods don't turn up, or they're faulty when they do arrive.

In such cases there are several solutions to your problems. If the goods don't arrive, call the supplier as soon as a reasonable period of time has passed. Twenty eight days is an accepted period for mail order delivery - there's little point in panicking before this time. When you do contact them, call them and then write. Note down the names of anyone you speak to and if they won't give you their name, ask to speak to the manager.

Next month we'll take a look at what action you can take in the event of goods not arriving. ■



Managing Mail Order

Follow this simple guide when buying via mail order.

1. Check that your chosen supplier has the goods in stock before ordering.
2. Check that the price quoted includes delivery, and any other hidden charges.
3. When placing an order use a credit card. This will give you some protection if things go wrong.
4. Take the names of anyone you speak to or deal with.
5. Record all correspondence and phone calls.
6. If ordering by phone, confirm it in writing, giving details of price etc. But make sure that you state that the letter is confirmation of a previously made order, not a new order!

Advertising Complaints

If you get into trouble, CU Amiga Magazine's advertising team will do their best to help you out. If you experience any problems please contact Chris Perera on 071 972 6700. Alternatively write to him at CU Amiga Magazine, EMAP Images, Priory Court, 30-32 Farringdon Lane, London EC1R 3AU.

CU Amiga Magazine

To the supplier: this order follows your advert in CU Amiga Magazine. Please treat it as a priority order.

Reader: if purchasing by post or fax, complete this form and send it to the company you are ordering from. Alternatively, use it to note down your order when calling.

SUPPLIER

Company

Address

Tel. Number Date of order

CUSTOMER DETAILS

Name

Address

..... Postcode

Daytime phone number

Method of payment:

Postal Order, Cheque, Visa, Access, Amex, other credit card*

Card Number:

Expiry Date:

Start Date:

DESCRIPTION OF GOODS ORDERED

Goods

Delivery Charges

Total Price

Delivery Date Required

Signed

Usually within 28 days

If you intend to send this order form through the post, take a photocopy first.

* If using a credit card other than Visa or Access check that the supplier can accept the card.

DON'T M

Just look at what CU Amiga Magazine

THE BEST TUTORIALS

You want to get the best out of your Amiga, and we help you do it. Here are just some of the features we've run in the last few months:

- **Word Processing** - get the best out of your word processor.
- **Speed** - make your Amiga faster for under a tenner.
- **Pump It Up** - hooking up to your hi-fi & video for brilliant sound and vision.
- **Plus tutorials for all the best software: Photogenics, ProCalc, DPaint and Brilliance, XCAD, OctaMED and more.**

THE BEST COVER DISKS

Over the last six months only one Amiga magazine has brought you the very best cover disks.

CU Amiga Magazine has cover mounted:

- **Full versions of the Amiga's most powerful spreadsheet: ProCalc, the undisputed best utility: Directory Opus, the fun and flexible ComicSetter, and now MovieSetter.**
- **It's also the only magazine which has cover mounted complete manuals and user guides for its programs.**

But it's not just all about cover disks and features - CU Amiga Magazine provides you with everything else you need to know to use and improve your Amiga:

THE BEST PREVIEWS AND REVIEWS

CU Amiga Magazine is the choice of the world's top Amiga developers. That means we get exclusive first previews and reviews of the top new Amiga products:

- **Electronic Arts - Deluxe Paint 5**
- **SoftLogik - PageStream 3**
- **GP Software - Directory Opus 5**
- **Nova Design - ImageFX 2**
- **Almathera - PhotoGenics**

CU Amiga Magazine - the ultimate Amiga package!

**FREE GIFT
WORTH UP
TO £29.95
WHEN YOU
SUBSCRIBE!**

Subscribe now and you'll also receive a fabulous free gift, worth up to £29.95!*



**Clip art
and
Fonts
CD-ROM**

Worth £19.99
Packed with
clipart and fonts
for your Amiga!



**Alien
Breed
Tower
Assault**

A500/A1200 &
CD32. Worth
£19.99/£29.99.

Try out the third instalment of Team 17's superb Alien massacre game.



**Super
Stardust**

CD32 & A1200
Worth £29.99
Amazing
graphics and
great gameplay,

rounded off by Tony Horgan's favourite: the stunning, cunning tunnel sequences.

Or else:

Get two free issues of CU Amiga Magazine and either of the following gifts: A high quality 400 dpi mouse with micro switched buttons, worth £9.95 or 25 A-grade DD blank diskettes, including labels, worth £16.99.

MISS OUT!

as delivered in the last twelve months!



WIESETTER
Program
free 100
manual!
US
FOOTBALL DEMO!

MOVIES!

CU AMIGA SUBSCRIPTION ORDER FORM

Please enter my subscription to CU Amiga.
Please tick/delete as required:

- RATES** - 12 issues including postage
- £47.40 UK
 - £55.00 REST OF WORLD SURFACE MAIL
 - £60.00 EUROPE/EIRE AIR MAIL
 - £90.00 REST OF WORLD AIR MAIL ZONE 1
 - £96.00 REST OF WORLD AIR MAIL ZONE 2

- FREE GIFT** Select 1 gift (*offer only available to UK subscribers).
- Super Stardust A1200 (offer code A1E)
 - Super Stardust CD32 (offer code A1F)
 - Alien Breed Tower Assault A500/A1200 (offer code A1G)
 - Alien Breed Tower Assault CD32 (offer code A1H)
 - 400 DPI mouse + 2 free issues (14 for price of 12) (offer code A1I)
 - DD disk pack (25) + 2 free issues (14 for price of 12) (offer code A1J)

METHOD OF PAYMENT

Cheque/Postal Order/International Money Order payable to EMAP Images Ltd.

Access/Visa number: Expires/.....

Signature:

Date:

Name:

Address:

.....Postcode :

IMPORTANT: *Free gift offer available to U.K residents only.
Please allow 28 days for fulfilment from receipt of order. Your gift will be sent separately from your 1st issue. EMAP Images reserves the right to provide an alternative offer in the unlikely event that your requested gift should become unavailable.

Tick this box if you do not wish to receive any direct mail that EMAP Images Ltd feels may be of interest to you.

Offer closes 19th May1995 Source code: IA1e

*Zone 1: Middle East, Africa, USA, South America, Hong Kong, Singapore, Pakistan, Indonesia. *Zone 2: Australia, China, Japan, Pacific.

SUBSCRIBE TODAY!

SUBSCRIBE TODAY AND ENSURE THAT YOU DON'T MISS OUT ON WHAT WE'VE GOT LINED UP FOR THE NEXT 12 MONTHS! IF YOU SUBSCRIBE NOW YOU'LL GET A FABULOUS FREE GIFT WORTH UP TO £29.95! SO HURRY! THIS OFFER IS AVAILABLE FOR A LIMITED PERIOD ONLY.

HOW TO ORDER: simply select your free gift, fill in the form, and send it along with payment to CU Amiga Subscriptions Dept., EMAP Consumer Magazines, FREEPOST (LE5981) Leicester LE87 4AB. (Free postage within the UK only.)

Or call the **SUBSCRIPTION HOTLINE ON 0858 468888 (9.00am to 5.30pm)**

FANCY A SPELL IN EUROPE? FANCY FOOTBALL LEAGUE

WIN
a trip for two to
a European city
and Football
match of your
choice during
1995!

AMIGA and The One For Amiga (the best Amiga magazine edited by a Welshman) have teamed up with Renegade and Sensible Software to bring you the ultimate magazine football competition. The Fancy Football League, run over the next four months, will test your knowledge of football and footballers to the limit. Hey, even if you know nothing about football it will test your luck to the limit. Anyway, once the men have been sorted from the boys, the real men will be sorted from the just average men until finally a total

super-human football genius (or spawny git) triumphs and wings off to see his (or her, this is an equal opportunities competition) favourite European football team in action on their home ground. But that's not all! Every month there is a team strip (of your choice) up for grabs by the person whose team performs the best! And it's all courtesy of Renegade. Their generosity knows no bounds.

It all starts off this issue with the coupon printed on page 80. All you have to do is choose a team from the 22 top sides we've printed here, within the budgetary constraints that Renegade have set. And they're not as generous with notional money as they are with the real stuff! You've only got £17million to spend - roughly what you would get if you were

JOPS ATHLETIC!

Here's a sample team chosen by Sensi's Jon Hare.

No.	Name	Team	Code	Price
1	Luis Henrique	Atletico Minero	0401	£3M
2	Stig Inge Bjornbye	Liverpool	1216	£650K
3	Paulo Negro	Lazio	1112	£550K
4	Dave McPherson	Rangers	1812	£1M
5	Miguel Lasca	Real Madrid	1914	£750K
6	Vladimir Jugovic	Sampdoria	2127	£1.9M
7	Michel	Real Madrid	1925	£2M
8	Antonio Conte	Juventus	1027	£950K
9	Jason Wilcox	Blackburn	0729	£700K
10	Mark Hughes	Man Utd.	1431	£3.5M
11	Sergio Araujo	Atletico Minero	0431	£2M

THE 22 TEAMS

- AC Milan (Italy)
- Ajax (Holland)
- Arsenal (England)
- Atletico Mineiro (Brazil)
- Barcelona (Spain)
- Bayern Munich (Germany)
- Blackburn Rovers (England)
- FC Porto (Portugal)
- Galatasaray (Turkey)
- Juventus (Italy)
- Lazio (Italy)
- Liverpool (England)
- Mamelodi Sundown (South Africa)
- Manchester United (England)
- Neguya Grempas (Japan)
- Newcastle United (England)
- Paris St-Germain (France)
- Rangers (Scotland)
- Real Madrid (Spain)
- River Plate (Argentina)
- Sampdoria (Italy)
- Tottenham Hotspur (England)

AC Milan (Italy)

1.	Sebastiano Rossi	G	0101	Italy	£1M
2.	Christian Fanucchi	D	0112	Italy	£1.9M
3.	Franco Baresi	D	0113	Italy	£5M
4.	Alessandro Costacurta	D	0114	Italy	£3M
5.	Paulo Maldini	D	0115	Italy	£8M
6.	Roberto Donadoni	M	0126	Italy	£2M
7.	Demetrio Albertini	M	0127	Italy	£2.2M
8.	Marcel Desailly	M	0128	France	£3.5
9.	Gianluigi Lentini	M	0129	Italy	£3M
10.	Dejan Savicevic	A	0130	Yugoslavia	£7M
11.	Alessandro Melli	A	0131	Italy	£5M

Ajax (Holland)

1.	Edwin Van Der Sar	G	0201	Holland	£700K
2.	Michael Reiziger	D	0212	Holland	£800K
3.	Danny Blind	D	0213	Holland	£750K
4.	Frank De Boer	D	0214	Holland	£1.5M
5.	Finidi George	M	0225	Nigeria	£1.3M
6.	Frank Rijkaard	M	0226	Holland	£2.2M
7.	Edgar Davids	M	0227	Holland	£850K
8.	Jari Litmanen	M	0228	Finland	£3M
9.	Marc Overmars	M	0229	Holland	£3M
10.	Patrick Kluyvert	A	0230	Holland	£650K
11.	Ronald De Boer	A	0231	Holland	£1M

Arsenal (England)

1.	David Seaman	G	0301	England	£1.9M
2.	Lee Dixon	D	0312	England	£1.5M
3.	Steve Bould	D	0313	England	£1M
4.	Tony Adams	D	0314	England	£2M
5.	Nigel Winterburn	D	0315	England	£1.3M
6.	David Hillier	M	0326	England	£550K
7.	John Jensen	M	0327	Denmark	£950K
8.	Stephen Scharzz	M	0328	Sweden	£1.5M
9.	Paul Merson	M	0329	England	£2M
10.	Kevin Campbell	A	0330	England	£1.6M
11.	Ian Wright	A	0331	England	£6M

Atletico Mineiro (Brazil)

1.	Luis Henrique	G	0401	Brazil	£3M
2.	Andre	D	0412	Brazil	£2.25M
3.	Neto	D	0413	Brazil	£1.8M
4.	Paulo Roberto	D	0414	Brazil	£2M
5.	Allesandro	D	0415	Brazil	£2M
6.	Valdir	M	0426	Brazil	£3.5M
7.	Cristavo	M	0427	Brazil	£2M
8.	Carlos	M	0428	Brazil	£2.75M
9.	Tononho Perreira	M	0429	Brazil	£3M
10.	Renaldo	A	0430	Brazil	£1.3
11.	Sergio Araujo	A	0431	Brazil	£2M

a factory worker in the midlands who has just won the lottery.

You can spend the money on any player from any of the 22 teams (that's 242 players to choose from, for your information), but you must recruit 11, 'cos otherwise you won't have a football team. Also, you can only recruit a maximum of 2 players from each team supplied. Want a super striker? Go for it. But remember, you have to leave enough money to get the rest of the team together.

How does Fancy League work then?

Every month all 22 teams in the league will play 14 matches (this is the Fancy League, after all!) with each team played by members of Sensible Software, Renegade, CU Amiga Magazine and The One. At the end of the three month period, each team will have played 42 matches, making up a full season.

Each player you have selected scores points based not only on his team's performance, but also on his individual goal-scoring or defending. So, after each match, every player's individual score is calculated, and after 14 matches we'll print all the individual scores.

Using the scores for each of your 11 players, you can then add up your team's total score for that month. You'll be pitting your wits against lots of other managers from around the country, but if you're judged to be one of the top 50 managers in any of the three months, your name, team name and score will be printed in a manager's league table in both CU Amiga Magazine and The One.

All you have to do to enter is write down your choices on the coupon on page 80, then phone the telephone number supplied and carefully tell the computer at the end of the line what your selection is. Alternatively you can post a photocopy of your coupon to the address printed on it. You must keep the original as proof of your entry. Entering the competition is free but the phone call, or the stamps, or the photocopies aren't. The phone call will cost you 36 pence per minute off peak or 48 pence per minute at all other times and the call shouldn't last more than an average of 3 minutes. If you're not responsible for the phone bill make sure you get permission from the person who is before you call The Fancy League line.

Then, beginning with the May issue of CU Amiga Magazine, and continuing for the next three issues, we'll be keeping an eye on the per-

formance of each Fancy League manager (using our wiz computer) and we'll print the top 50 league table. At that stage we'll also announce the winner of the monthly prizes.

A very sensible choice?

Confused? Let us give you an example of a team we prepared earlier (see boxout on opposite page entitled Jops Athletic) with the help of Jon Hare out of Sensible Software. We're certainly not suggesting that you use this team of course, oh no!

RULES AND HOW TO ENTER: Please read this carefully.

1. Each entrant has £17 million in total with which to construct his/her Fancy League team. Any team exceeding this total will be void.
2. Each Fancy League team must comprise the following players: one goalkeeper; four defenders; four midfielders; and two attackers (11 players in total). The players' positions are as specified as: G - goalkeeper; D - defender; M - mid-fielder; A - attacker. Only the positions specified next to the players' names will be accepted. Any team not conforming to the formation above will be void.
3. Each entrant can pick a maximum of TWO players from any single team (i.e. you can't have three Manchester United defenders, or the four Ajax mid-fielders). Any entrant's team comprising more than two players from any one of the 22 Fancy League teams will be void.
4. Once you have selected your team, ring the Fancy Football League Hot-line number on the coupon on page 80. You must have a touch-tone phone to enter this way. If you haven't, you must enter by post - see rule 10 below. Once connected to the Fancy League Registration Line, follow the instructions, speaking clearly when prompted and inputting data such as players' code numbers using the dial pad. You are advised to fill in the form printed on the next page beforehand to cut down the length of your call.
5. The Fancy League Telephone Hotline will be set up to reject any team not conforming to the above rules. Average length of call: three minutes. Calls cost 36 pence per minute off-peak (that's 6pm to 8am Monday to Friday, and all weekend), and 48 pence per minute at all other times. Please check with the person who pays the bill before dialling. Lines will be open 24 hours a day from 21st February 1995 to 3rd April 1995. You must enter your team into the competition by the closing date. Any team entered after that date will be considered void. Multiple entries are allowed.
6. After the closing date, the Fancy League will begin. Each team will play each other twice, making a total of 42 matches.
7. Players will score points for each match they play in as follows: Goalkeepers gain four points (+4) for keeping a clean sheet (not letting in any goals), or lose one point for every goal they concede. Defenders gain four points (+4) for every goal they score, three points (+3) if their team doesn't concede any goals, or lose one point (-1) for every goal their team concedes. Midfielders score four points (+4) for every goal they score. Attackers score three points (+3) for every goal they score. Players who fail to appear through suspension or injury neither gain nor lose points for matches they miss.
8. Every month, for the next three months, both CU Amiga and The One for Amiga will print the results and goal-scorers of matches played during that month.
9. A league table will be printed every month showing the top 50 Fancy League teams and their respective totals. Prizes of a full football strip of your choice will be awarded every month for the manager of the top team.
10. If you do not have a touch-tone telephone, you can also enter by cutting out or photocopying the completed form below, and sending it to: Fancy League Entries, Computerize, Unit 1, Neach Hill, Neachley Lane, Shifnal, Shropshire TF11 8PJ.
11. After each month, the top manager will win the full footy team strip of his (or, indeed, her) choice. At the end of the competition, the manager with the most points will win a fabulous weekend for two people, to the European footballing destination of their choice. In the event of a tie, the team that has scored the most goals will win.
12. EMAP Images cannot be held responsible for any inaccuracies or technical problems which may occur. The Editor's decision is final, and no correspondence will be entered into.
13. EMAP Images reserves the right to cancel the Fancy League competition at any time, for any reason, without liability.

1.	Carlos Busquets	G	0501	Spain	£600K
2.	Albert Ferrer	D	0512	Spain	£2M
3.	Ronald Koeman	D	0513	Holland	£4.5M
4.	Abelardo Fernandez	D	0514	Spain	£1.6M
5.	Guillermo Amor	M	0525	Spain	£1.8M
6.	Miguel Angel Nadal	M	0526	Spain	£5M
7.	Josep Guardiola	M	0527	Spain	£5M
8.	Jose Maria Bakero	M	0528	Spain	£2.7M
9.	Sergi Barjuan	M	0529	Spain	£2M
10.	Hristo Stoichkov	A	0530	Bulgaria	£8M
11.	Romario	A	0531	Brazil	£9M

1.	Oliver Khan	G	0601	Germany	£1.3M
2.	Oliver Kreuzer	D	0612	Germany	£800K
3.	Lothar Matthaus	D	0612	Germany	£4.5M
4.	Thomas Helmer	D	0614	Germany	£3M
5.	Jorginho	M	0625	Brazil	£1.9M
6.	Christian Nerlinger	M	0626	Germany	£1.3M
7.	Markus Schupp	M	0627	Germany	£800K
8.	Mehmet Scholl	M	0628	Germany	£1.8M
9.	Christian Zeige	M	0629	Germany	£1.5M
10.	Jean-Pierre Papin	A	0630	France	£3.5M
11.	Alain Sutter	A	0631	Switzerland	£1.9M

1.	Tim Flowers	G	0701	England	£1.9M
2.	Henning Berg	D	0712	Norway	£800K
3.	Tony Gale	D	0713	England	£550K
4.	Colin Hendry	D	0714	Scotland	£850K
5.	Graeme Le Saux	D	0715	England	£1.6M
6.	Stuart Ripley	M	0726	England	£1.5M
7.	David Batty	M	0727	England	£1.6M
8.	Tim Sherwood	M	0728	England	£1M
9.	Jason Wilcox	M	0729	England	£700K
10.	Chris Sutton	A	0730	England	£6M
11.	Alan Shearer	A	0731	England	£8M

1.	Vitor Baia	G	0801	Portugal	£1.6M
2.	Joao Pinto	D	0812	Portugal	£1.1M
3.	Semedo	D	0813	Portugal	£1.1M
4.	Aloisio	D	0814	Brazil	£950K
5.	Rui Jorge	D	0815	Portugal	£800K
6.	Secretario	M	0826	Portugal	£850K
7.	Vasilii Kulkov	M	0827	Russia	£1.1M
8.	Rui Barros	M	0828	Portugal	£1.5M
9.	Emerson	M	0829	Brazil	£1.1M
10.	Sergei Yuran	A	0830	Russia	£1.1M
11.	Ljubinko Drulovic	A	0831	Yugoslavia	£950K

1.	Gintaras Staucer	G	0901	Lithuania	£500K
2.	Norman Mapeza	D	0912	Zimbabwe	£450K
3.	Mert Korkmaz	D	0913	Turkey	£550K
4.	Yusuf Altintas	D	0914	Turkey	£500K
5.	Bulent Korkmaz	D	0915	Turkey	£550K
6.	Okan Buruk	M	0926	Turkey	£650K
7.	Suat Kaya	M	0927	Turkey	£500K
8.	Tugay Kerimoglu	M	0928	Turkey	£850K
9.	Hakan Sucker	A	0939	Turkey	£800K
10.	Kubilay Turkylmaz	A	0930	Switzerland	£350K
11.	Saffet Sancakli	A	0931	Turkey	£700K

1.	Angelo Peruzzi	G	1001	Italy	£1.8M
2.	Ciro Ferrara	D	1012	Italy	£1.9M
3.	Luka Fusi	D	1013	Italy	£1.1M
4.	Jurgen Kohler	D	1014	Germany	£2.75M
5.	Moreno Torricelli	D	1015	Italy	£750K
6.	Angelo Di Livio	M	1026	Italy	£1M
7.	Antonio Conte	M	1027	Italy	£950K
8.	Paulo Sousa	M	1028	Portugal	£6M
9.	Didier Deschamps	M	1029	France	£1.9M
10.	Roberto Baggio	A	1030	Italy	£9M
11.	Gianluca Vialli	A	1031	Italy	£6M

1.	Luca Marchegiani	G	1101	Italy	£1.9M
2.	Paolo Negro	D	1112	Italy	£550K
3.	Roberto Cravero	D	1113	Italy	£1M
4.	Jose Chanot	D	1114	Argentina	£2.75M
5.	Giuseppe Favalli	D	1115	Italy	£1.5M
6.	Roberto Rambaudi	M	1126	Italy	£1.9M
7.	Aran Winter	M	1127	Holland	£2.75M
8.	Paul Gascoigne	M	1128	England	£7.5M
9.	Roberto Di Matteo	M	1129	Italy	£1.5M
10.	Giuseppe Signori	A	1130	Italy	£7M
11.	Alen Boksic	A	1131	Croatia	£6.5M

1.	David James	G	1201	England	£750K
2.	Rob Jones	D	1212	England	£1.9M
3.	Neal Ruddock	D	1213	England	£1.5M
4.	Phil Babb	D	1214	Ireland	£3.5M
5.	John Scales	D	1215	England	£2M
6.	Stig Inge Bjornbye	D	1216	Norway	£650K
7.	Steve McManaman	M	1227	England	£1.9M
8.	Jan Molby	M	1228	Denmark	£1M
9.	John Barnes	M	1229	England	£2.25M
10.	Robbie Fowler	A	1230	England	£5M
11.	Ian Rush	A	1231	Wales	£4M

Mamelodi Sundown (South Africa)

1	Craig le Grange	G	1301	South Africa	£650K
2	Samuel Kambule	D	1312	South Africa	£300K
3	Johannes Modau	D	1313	South Africa	£350K
4	Lucky Molefe	D	1314	South Africa	£300K
5	Joas Magolego	D	1315	South Africa	£450K
6	Ernest Chirwali	M	1326	Malawi	£450K
7	Rabbie Morope	M	1327	South Africa	£550K
8	Moses Morodi	M	1328	South Africa	£450K
9	Zana Mose	M	1329	South Africa	£450K
10	Lovemore Chafunya	A	1330	Malawi	£450K
11	Bennett Masings	A	1331	South Africa	£550K

Manchester United (England)

1	Peter Schmeichel	G	1401	Denmark	£3M
2	Paul Parker	D	1412	England	£2M
3	Steve Bruce	D	1413	England	£2M
4	Gary Pallister	D	1414	England	£3M
5	Dennis Irwin	D	1415	Ireland	£1.9M
6	Andrei Kanchelskis	M	1426	Russia	£2M
7	Paul Ince	M	1427	England	£5M
8	Roy Keane	M	1428	Ireland	£2.75M
9	Ryan Giggs	M	1429	Wales	£6M
10	Eric Cantona	A	1430	France	£7M
11	Mark Hughes	A	1431	Wales	£3.5M

Neguya Grempas (Japan)

1	Dick Havenaar	G	1501	Japan	£550K
2	Toshiyuki Kosugi	D	1512	Japan	£350K
3	Garca	D	1513	Brazil	£450K
4	Toshihisa Iijoma	D	1514	Japan	£350K
5	Hisataka Fujikawa	D	1515	Japan	£250K
6	Jorginha	M	1526	Brazil	£1.6M
7	Makoto Yonekura	M	1527	Japan	£500K
8	Elivelton	M	1528	Brazil	£1.6M
9	Tetsuya Nakanishi	M	1529	Japan	£350K
10	Gary Lineker	A	1530	England	£2.5M
11	Shigeo Sawami	A	1531	Japan	£550K

Newcastle United (England)

1	Pavel Srnicek	G	1601	Czech	£2M
2	Marc Hottiger	D	1612	Switz	£750K
3	Darren Peacock	D	1613	England	£1.3M
4	Philippe Albert	D	1614	Belgium	£3M
5	John Beresford	D	1615	England	£1M
6	Ruel Fox	M	1626	England	£1.5M
7	Barry Venison	M	1627	England	£950K
8	Robert Lee	M	1628	England	£2.25M
9	Scott Sellars	M	1629	England	£700K
10	Peter Beardsley	A	1630	England	£3M
11	Andy Cole	A	1631	England	£5.5M

Paris St-Germain (France)

1	Bernard Lama	G	1701	France	£1.9M
2	Jose Cobos	D	1712	France	£950K
3	Alain Roche	D	1713	France	£1.3M
4	Ricardo Gomes	D	1714	Brazil	£1.8M
5	Patrick Colletier	D	1715	France	£750K
6	Daniel Bravo	M	1726	France	£800K
7	Paul le Guen	M	1727	France	£800K
8	Vincent Guerin	M	1728	France	£950K
9	David Ginola	M	1729	France	£5M
10	Valdo	M	1720	Brazil	£3M
11	George Weah	A	1731	Liberia	£2.25M

Rangers (Scotland)

1	Andy Goram	G	1801	Scotland	£1.1M
2	Dave McPherson	D	1812	Scotland	£1M
3	Alan McLaren	D	1813	Scotland	£1.1M
4	Basile Boli	D	1814	France	£2M
5	David Robertson	D	1815	Scotland	£1.5M
6	Craig Moore	M	1826	Scotland	£450K
7	Stuart McCall	M	1827	Scotland	£1.3M
8	Pieter Huistra	M	1828	Holland	£950K
9	Brian Laudrup	M	1829	Denmark	£4.5M
10	Ally McCoist	A	1830	Scotland	£3M
11	Mark Hateley	A	1831	England	£2.5M

Real Madrid (Spain)

1	Francisco Buyo	G	1901	Spain	£1.5M
2	Quique	D	1912	Spain	£1.3M
3	Rafael Alcorta	D	1913	Spain	£2.75M
4	Miguel Laso	D	1914	Spain	£750K
5	Michel	M	1925	Spain	£2M
6	Fernando Redondo	M	1926	Argentina	£5M
7	Fernando Hierro	M	1927	Spain	£7M
8	Michael Laudrup	M	1928	Denmark	£5M
9	Rafael Martin Vazquez	M	1929	Spain	£3M
10	Jose Emilio Amavisca	A	1930	Spain	£2.25M
11	Ivan Zamorano	A	1931	Chile	£5M

River Plate (Argentina)

1	Leonardo Aguirre	G	2001	Argentina	£750K
2	Ricardo Altamirano	D	2012	Argentina	£750K
3	Guillermo Rivarola	D	2013	Argentina	£450K
4	Roberto Clerico	D	2014	Argentina	£650K
5	Diego Cocca	D	2015	Argentina	£1.3M
6	Leonardo Astrada	M	2026	Argentina	£350K
7	Julio Toresani	M	2027	Argentina	£750K
8	Berti	M	2028	Argentina	£700K
9	Ramon Medina Bello	A	2039	Argentina	£1.6M
10	Alejandro Aranda	A	2030	Argentina	£1.1M
11	Walter Silvani	A	2031	Argentina	£750K

Sampdoria (Italy)

1	Walter Zenga	G	2101	Italy	£3M
2	Moreno Mannini	D	2112	Italy	£1.5M
3	Riccardo Ferri	D	2113	Italy	£1.5M
4	Pietro Vierchowod	D	2114	Italy	£1.3M
5	Sinisa Mihajlovic	D	2115	Yugoslavia	£1.9M
6	Attilio Lombardo	M	2126	Italy	£2M
7	Vladimir Jugovic	M	2127	Yugoslavia	£1.9M
8	David Platt	M	2128	England	£3M
9	Alberigo Evani	M	2129	Italy	£2M
10	Ruud Gullit	A	2130	Holland	£7M
11	Roberto Mancini	A	2131	Italy	£4.5M

Tottenham Hotspur (England)

1	Ian Walker	G	2201	England	£750K
2	David Kerslake	D	2212	England	£650K
3	Kevin Scott	D	2213	England	£700K
4	Sol Campbell	D	2214	England	£750K
5	Justin Edinburgh	D	2215	England	£500K
6	Darren Anderton	M	2226	England	£1.8M
7	Gheorghe Popescu	M	2227	Romania	£3.5M
8	Jason Dozell	M	2228	England	£850K
9	Ilie Dumitrescu	M	2229	Romania	£2.75M
10	Jurgen Klinsmann	A	2230	Germany	£5M
11	Teddy Sheringham	A	2231	England	£3M



THE FANCY FOOTBALL LEAGUE ENTRY FORM

Use this form to write down your Fancy League team. This will make it easier when phoning through your selection. It also doubles as an entry form if you don't have a touch-tone telephone! Remember, only send a photocopy, not the coupon itself.

TEAM NAME

NUMBER	POSITION	NAME	PLAYER CODE	VALUE
1	GOALKEEPER		
2	DEFENDER		
3	DEFENDER		
4	DEFENDER		
5	DEFENDER		
6	MIDFIELDER		
7	MIDFIELDER		
8	MIDFIELDER		
9	MIDFIELDER		
10	ATTACKER		
11	ATTACKER		
			TOTAL VALUE

Note: You must have 1 goalkeeper, 4 defenders, 4 midfielders and 2 attackers. Players cannot play out of position. Fill out this form carefully before you phone, and make sure that everything is just as you want it. Phone and postal competition entries can be made from 21 February to 3 April 1995.

To Enter Call: 0891 615640

Address: Fancy League Entries, Computerize, Unit 1, Neach Hill, Neachley Lane, Shifnal, Shropshire TF11 8PJ. For postal entries please include a stamped self addressed envelope with your name and full address so that we can notify you of your competition entry number.



Want to improve your listening and viewing pleasure, but don't know your woofers from your tweeters?

Then you need this!

On sale NOW!

'You'll find **WHAT HOME ENTERTAINMENT?** in all good newsagents next to the Hi-Fi Magazines.' **ONLY £2.25**



Why six portable stereos had us dancing in the streets, page 39

WHAT RECEIVED FROM **£2.25**

HOME ENTERTAINMENT?

TELLS YOU THE BEST EQUIPMENT TO BUY AND HOW TO USE IT

PERSONAL CD PLAYERS
Top sounds on the move for under £170

VIDEO RECORDERS
Watch and record TV in stereo with our pick of 7 Nicam VCRs, page 68

PLUS: How to use your VCR to make better home movies, page 73

WIN
Currys home cinema prize worth £5,000 — see page 26

Home cinema made easy

HI-FI STACKS THAT PLAY AND MOVIES TESTED AND IN OUR LABS, PAGE

THE UK'S ULTIMATE SHOPPING LIST
WHAT TO BUY & HOW IT ALL WORKS TOGETHER — OVER 2,500 ENTRIES

DUVER'S

PARADISE ISLE



VAST HARDWARE, SOFTWARE AND ACCESSORY SUPPLIES AVAILABLE FAST

CD32 SPECIAL
£224.99
INCLUDING DELIVERY

CRITICAL ZONE PACK
FOR THIS AND HUNDREDS OF OTHER SPECIAL OFFERS CONTACT PETE AT

70, STANDFAST ROAD, HENBURY BRISTOL AVON
TEL/FAX: 0117 9850011

FORTRESS
AMIGA PD LIBRARY
OVER 16500 DISKS AVAILABLE
ALL AT 95p INCLUDING P&P
Send 3*25p stamps For List Disk

Available are **FULL SETS** of:-
Fred Fish. LSD Legal Tools
Scope Disks Assassins Games
Assassins Utils T/Bag Disks
PLUS
Graphics. Music. Slide Shows.
Games. Clip Art. Fonts, Etc...
Far Too Many To List Them All

Contact:- FORTRESS P.D.
26, SPENCER STREET, KEIGHLEY,
WEST YORKSHIRE. BD21 2BU
Phone:- (0535) 609263

WANTED

Full price Amiga Software in good condition. Send List for Prices Fast Collection and payment.
Working or faulty
Amiga equipment required.
Phone for a price.
Repairs and Spares phone for prices.

OMNIDALE SUPPLIES
8E ROWAN COURT
FRIAR GATE
DERBY DE1 1BU
TEL: 0332 291219

CENTURION P.D.
24 WASTWATER DRIVE, WOODCREST, BRADFORD,
WEST YORKS, BD6 2TN

ATTENTION!!

ALL DISKS ONLY 55p EACH
(For a limited period only)
2 Disk Catalogue ONLY £1.
Includes Free Games
- Free Virus Checker
- Loads of Music Modules
and Complete Centurion PD Lists.
Cheques payable to B. G. Reed (Mrs)
Please add .75p Postage and Packing to all orders.
All orders despatched
First Class same day.
Return Cat Disk for a FREE update.

PENGUIN PUBLIC DOMAIN

ART-ANIMATION-MUSIC
PLAYABLE DEMOS - FONTS
GAMES COMPILATIONS
CLIPART-ASSASSINS 1-220
MISCELLANEOUS-GAMES
DEMOS-MUSIC UTILITIES
EDUCATION-FUNPACK 1-36
SCOPE 1-220-FRED FISH 1-1000
T-BAG 1-77 - SLIDESHOWS
UTILITIES-HAM RADIO
BUSINESS-JAM 1-10

DISK PRICE
1 TO 10 90P
11 TO 20 65P
21 PLUS 50P

POST AND PACKING FREE.
SEND FOR A FREE CATALOGUE



AMIGA

PO BOX 179
READING
BERKSHIRE
RG3 3DD
ENGLAND



AMIGAHOLICS PD

THE 100% AMIGA PD LIBRARY, WE STOCK; DEMOS, MUSIC, ANIMS, MUSIC UTILITIES, SLIDESHOWS, GAMES, LSD LEGAL TOOLS; UTILITIES, ASSASSINS GAME DISKS, FRED FISH, FONTS, CLIP-ART AND MUCH MORE.

HERE'S SOME POPULAR ONES:-
SWITCHBACK - BRILLIANT AGA DEMO (2D)
MEGABALL AGA - BEST VERSION YET
EPOCH MASTER - DIARY, ADDRESS BOOK ETC.
'SETTLERS' EDITOR - DESTROY FOES CROPS ETC.
'F1 G.P.' EDITOR - LATEST TEAM COLOURS ETC.
EDWORD PRO - TEXT PROCESSOR, THE BEST?
SKIZ II - GREAT 4 DISK MUSIC DEMO (4D)

FREE FRIENDLY ADVICE + HELP

SEND SAE FOR CAT. DISK

1 Disk £1.50
Each extra disk £1.00
Order 5 get 1 FREE
Order 10 get 3 FREE
Order 15 get 5 FREE
Order 20 get 10 FREE

FREE P & P
Send cheques, PO's to
AMIGAHOLICS PD DEPT. CU
236 CHESTER ROAD NORTH
KIDDERMINSTER
WORCS DY10 1TE
All Trademarks acknowledged

DISKS FROM 66p INC. P&P

XCAD DIRECT

Compare the features of XCAD 200c with AutoCAD R12 and you will be very impressed! If you can use AutoCAD you'll love XCAD. Also if you can use XCAD you'll have no trouble using AutoCAD - whatever version.
Don't delay buy while stocks last!

XCAD 2000 LATEST RELEASE 3.1 - FULL PRODUCT £34.50
XCAD 2000 - MANUAL ONLY £24.50

ALL PRICES INCLUDE VAT + P&P (UK ONLY)
AND 14 DAYS FREE TECHNICAL SUPPORT

TEL: 01843 292150
FAX: 01843 227262

ALL MAJOR CREDIT CARDS ACCEPTED
All trademarks acknowledged.

ACTIVITY SOFTWARE PD

Now under new expensive management!!

Collective catalogues over
5,000 disks to be
expanded to 10,000 over
the next few months

Introductory Offer 150p per disk

Catalogue disk #1.00 refundable with first order.
120 Sheffield Road, Dronfield, Sheffield S18 6GG.
Telephone or Fax: 0246 290860.

Eastwood
AMIGA PD

All disks 80p inc p&p
Tel 01709 829748

UTILS, DTP, FONTS, W.P.s, A1200 AGA
FRED FISH SCOPE, 17 BIT, LSD, AMINET,
TBAG, GAMES, CLIPART, ASSASSINS,
PAINT CD32 CDTV

SAME DAY DESPATCH
114 FITZWILLIAM RD,
EASTWOOD, ROTHERHAM
S65 1PX

CAT. DISK £1.00 OR BLANK DISK + SAE

DISKS! DISKS! DISKS!

If you can find anyone in this magazine selling GRADE 'A' 3.5" DS/DD disks cheaper than us then phone and

WE WILL BEAT THAT PRICE!!!

Amount / Price
10 - £2.60
25 - £6.25
50 - £12.00
100 - £23.00
200 - £44.00
250 - £54.00
500 - £105.00
1000 - £205.00
1000+ - £Call

Free labels with ALL disks! All disks are 100% error free and carry a one for one replacement guarantee!
Add £1.50 P&P to less than 50 disks.
Add £3.50 P&P to 50 disks or more.
B.P.M DISKS (CU) 8 Magnolia Park, Dunmurry, Belfast, BT17 ODS. Tel: 01232 626694.

Lazycat PD
Public Domain Computer Software



29 Woodville, Barnstaple, North Devon EX31 2FH

CAT DISK 2 X 25P STAMPS. SUPER MEGA FRUITS GAME FREE WITH CAT

ONLINE PD

FREE 2 DISK CATALOGUE LISTING
9,000+ PD TITLES

TEL: 01704 834335 OR SEND SAE

75P
PER DISK

Every 10 disks ordered
choose 1 FREE

Online Pd, Dept CU
1 The Cloisters, Halsall Lane, Formby,
Liverpool L37 3PX

AMIGA POWER SUPPLY

#27.50 + #1.00 p/p
 Direct from manufacturer,
 built to British Standards.
 Official Commodore Part Number.
 Suitable for Amigas up to A1200

Send Cheques to
 BJK Distribution
 120 Sheffield Road, Dronfield
 Sheffield S18 6GG Tel or Fax 0246 290860

CAPRI CD DISTRIBUTION

ALL AVAILABLE TITLES IN STOCK

70 + CDTV TITLES COMPATIBLE WITH CD32
 90 + CD32 TITLES / 30+ VIDEO CD TITLES

GOLDFISH 1&2 £29.99	DEMO MANIA £19.99
GUARDIAN £29.99	ULTIMEDIA 1 & 2 £29.99
BENEATH A STEEL SKY £29.99	PGA TOUR GOLF £27.99
SUPER STARDUST £29.99	TOWER ASSAULT £29.99
JUNGLE STRIKE £27.99	ROAD KILL £29.99
THE LITE ROM £39.99	AMINET 4 £19.99
CAM COLLECTION £24.99	DEATHMASK £29.99
COMPENDIUM DELUXE £19.99	ASSASSINS CD £19.99
17 BIT PHASE 4 £19.99	POWER GAMES £19.99

BACK IN STOCK

GROLIER ENCYCL £99.99	INSIGHT TECHNOLOGY £39.99
DEFENDER CROWN 2 £29.99	GUINNESS RECORDS 2 £39.99

THIS IS JUST A SMALL SELECTION OF THE TITLES & SPECIAL OFFERS WE HAVE. PLEASE WRITE OR RING FOR THE LATEST LIST. WE ALSO STOCK THE COMPLETE ALMATHERA, OPTONICA, PD SOFT & WEIRD SCIENCE RANGES

CAPRI CD DISTRIBUTION
 DEPT ONE2, CAPRI HOUSE, 9 DEAN ST, MARLOW, BUCKS. SL7 3AA
 TEL/FAX 0628-891022
 TRADE ENQUIRIES WELCOME



ASA KEEPING TABS ON ADS

THE ADVERTISING STANDARDS AUTHORITY 2 TORRINGTON PLACE LONDON WC1E 7HW

IF YOU ARE INTERESTED IN ADVERTISING IN OUR CLASSIFIED PAGES PLEASE CONTACT CHRIS PERERA FOR INFORMATION AND RATES



0171 972 6700

GVB - PD

"G.V.BROAD ENTERPRISES."
 AMIGA PUBLIC DOMAIN
 AS LOW AS

60P

1 TO 11 DISKS £1.00 EACH
 12 TO 19 DISKS .75P EACH
 20+ DISKS .60P EACH

ORDERS INCLUDE POST & PACKING

FRED FISH 1-1000 ASSASSINS GAMES 1-220

NO MINIMUM ORDER FOR A CATALOGUE DISK

PLEASE SEND 3 FIRST CLASS STAMPS

TO: GVB - PD DEPT. CUFEB.
 43 BADGER CLOSE, MAIDENHEAD,
 BERKSHIRE. SL6 2TE ENGLAND
 OR PHONE ME ON 0831 649386
 FOR MORE INFORMATION

PD at 35p or 75p! Great products Great prices Great service

CD's from £4.95

Redlaw resources
 CD1200/A570/CDTV/CD32
 A500/A500+/A600/A1200

• STORAGE •

CD Rack, holds 20 CD's in a tiltable slot allowing easy front view selection. For worktop use, with non-slip feet**£4.95**
CD System, stores 20 CD's in two units with touch-release selection. Each horizontal or vertical interlocking unit holds up to 10 CD's each. Wall/shelf-mounting**£7.95/pair**
CD Cases. Replace your broken, cracked or scratched CD cases with these new ones.**95p each or £4.50/pack of 5!**

• CARE •

CD Cleaner, Polisher & Restorer, brilliant new product that will clean, polish, reduce static, prevent skipping & restore original quality of your CD collection. Only ...**£4.95**
CD Lens Cleaner, cleans your vital laser lens with optical brushes. Automatic process plays music while it cleans (!!) and stops when it's finished it's job.....**£11.95**

• PD Catalogue •

Wide range of games, demos, clipart, music, fonts, utils etc listed on disk. Send 3 stamps

Sheer Delight

One very hot CD that requires statement of age to be 18 or over due to the explicit adult photo and sound contents.
 CD1200/CD32 only.
£18.95

• CD Review •

Unique description of all stocked CD's in our CD Review Booklet. Send 2 stamps for your copy (Free with all new CD orders)

• CD's for A570/CDTV/CD1200 •

17-bit I, instant library of 1600 of best of everything	£32.95
17-bit II, 500 more incl 141 Assassins, ARUG, etc	£17.95
17-bit Phase 4, another 500 of everything, 2801-3351	£17.95
Aminet IV, 1.1Gigabytes of latest mixed software!!	£17.95
AMOS PD, 1-621, networks, mag, & 34,000 files!	£17.95
Assassins Games 1-200, 3 guesses as to what this is	£17.95
CDPD II, Fish 661-760, NASA, AB20 & SCOPE	£17.95
CDPD III, Fish -890, fonts, clipart, utils, pics, books	£17.95
CDPD IV, Fish -1000, C-compiler, Internet, ray-trace	£17.95
Clipart CD, 20,000 pics & utils, IFF/EPS/TMG/PS etc	£8.95
DEMO I, games, anims, demos, fonts, art, FX, tunes	£17.95
DEMO II, demos, images, samples, tunes, 100 games	£17.95
Emerald Mines, 10,000 levels of emerald collecting!	£13.95
Euroscene One, prime Amiga demos, party winners	£13.95
Fonts CD, 18,000 files, Adobe/CG/BitMap/IFF/PS etc	£8.95
Insight:Dinosaurs, multi-media dinosaurs reference	£37.95
Insight:Technology, multi-media 'How things Work'	£37.95
Lock-n-Load, 1000, yes count 'em, 1000 great games	£17.95
LSD/17-bit, Legal Tools, AGA anim, utils, games etc	£17.95
Multimedia Toolkit, images, clipart, sounds & utils	£17.95
Network CD, network CD32/CDTV to Amiga, +more	£13.95
Pandora's CD, 2000clipart, sound FX, multi-media	£4.95
Sounds Terrific, 2 CD's, Mods/Midi/FX/Instr/Utils +!	£17.95
Space & Astronomy, 1090 images & lots of fact files	£17.95

Description of all the above CD's free with first order

Access **VISA**

Send Cheques/PO's to: REDLAW RESOURCES, 74 Durban Road, Patchway, Bristol BS12 5HQ. Tel: (0117) 9760600 incl. evenings.
 Please add 75p for postage to all orders. All goods sent 1st class.

LOGOS, MEANINGS AND MYSTERIES:



CD32 queries, ParNET and various other CD ROM-related problems.



All about upgrading RAM, operating systems and processors.



Plug-in hardware of any kind: scanners, disk drives etc.



Answers to queries on particular pieces of software.



Music, sampling, MIDI and anything that makes a really loud noise.



Miscellaneous tools to keep your Amiga running smoothly.



Form-feeds, page-breaks, preferences and lots, lots more!



Monitors, TVs, modulators, screen-modes and all that stuff.



Pixels, sprites, animation, pictures. In one small word: graphics.



Spreadsheets, databases, organisers, accounts ...



Not everything fits into a pigeonhole, but anything you like fits in here.



Send your technical problems to Q+A, CU Amiga Magazine, 30-32 Farringdon Lane, London EC1R 3AU. We'll do our best to sort you out.



TONY HORGAN
"I can't hold this grin much longer, it's no good, I'm definitely gonna crack!"



ANDY LEANING
"I'm Andy, your technical agony uncle. I apologise for the awful yellow T-shirt."

PCMCIA problems



I own an Amiga with a 420Mb Overdrive hard drive and would like to buy a RAM upgrade. I was thinking of purchasing 4Mb of Fast RAM. However, a friend told me that a normal RAM upgrade would conflict with my PCMCIA-connected hard disk. Is this true? I hope not as I want to upgrade my Amiga with some useful fast RAM. Please can you tell me which boards would be appropriate, how much they cost and where I can get them.

I live outside the UK, therefore I can only order stuff by mail so please can you let me know about mail order companies specifically.

Sebastian Klaasen, The Netherlands.

There are some problems with fitting trapdoor RAM expansions and PCMCIA peripherals. However, most of the RAM boards coming out now do not clash with the PCMCIA slot. The only way to be sure that you won't experience problems is to ask the manufacturers of the various boards before you buy them. We use the Power Viper accelerator and RAM board which works fine with our Overdrive.



A PCMCIA slot - most of the RAM boards coming out now will not clash with PCMCIA slots.

Hypercache



When I load your cover disk Hypercache on my A500 with 5Mb, I get the message 'can't open DF0:/summary for

input-object not found.' I thought that I had a faulty disk so I bought a new copy with a new disk. Same problem. Help.

L. Evans, Gwent.

There was a slight mistake in the disk loading instructions. To install Hypercache type the following in the shell:

```
copy DF0:Hypercache/Hypercache
sys:c/Hypercache [return]
copy DF0:Hypercache/Summary
sys:c/summary [return]
```

Now type in Hypercache -v DF0: [return]

It should now work.

SLIP connection



I own an A1200 with a Sportster 28,800 modem using Ncomm software, and have been offered four months free access to the Internet via a SLIP connection. However, the problem is finding the right software to feed my A1200 and my time is running out. I have tried downloading several SLIP programs and they are all either missing instructions or corrupted or sometimes both. Can you explain to me which files I need and how to use them, or better still how about putting them on a future cover disk?

Martin Bosson, West Sussex.

In one of those strange chicken and egg situations the software you need to connect to the Internet is on the Internet. To get it you need to have the software to enable you to download it! Alternatively you can get it from a CD-ROM, as it's included on many including most of the Aminet discs. The only other chance you've got is if you know someone who already has access to the Internet and can download it for you. You'll need TCP/IP and AMOSIAC (the WWW reader) which are held on Aminet sites.

Questionnaire



I have a few questions that I would like answered:

1. I have just upgraded my Amiga 600 to an Amiga 1200. What's the difference between them apart from 2Mb and 32-bit chips?
2. I'm wondering whether to buy either a Zappo CD-ROM or a 2.5" hard drive. Which one is better in the long term?
3. If I bought a CD-ROM can I watch Philips CD-i software such as movies and games on it?
4. Why can't Amiga bring out any games that are interactive like 3D0?
5. Does any other company use the AGA chipset and if so who?
6. Why does everybody slag off the Amiga compared to a PC? In my opinion the PC is crap and has not really changed for the last ten or fifteen years.

Mark Gilmore, Manchester.

1. The difference between an A1200 and A600 other than 32-bitness? Well the A600 is smaller for starters, then there's also a full expansion slot underneath the A1200 the AGA graphics, a numeric keypad and Workbench 3 instead of version 2.
2. Whether to buy a hard drive or a CD drive? It's a question of horses for courses. Adding a hard drive will make your Amiga seem a lot faster, and give you lots of space on which to save files, pictures and sound samples. A CD drive can't save data or programs; it basically offers you access to pre-recorded CDs holding programs, pictures, sound files, etc.

3. CD drives currently have no VideoCD/Philips CD-i compatibility. However several Far East firms have plans to release a box that you can plug into a normal CD player that will then let them play VideoCDs.

If you found a CD drive for the Amiga with a digital out port then you might, in theory, be able to link one of

these boxes to the CD drive. But don't bank on it.

4. The term 'interactive' is misused. All games are interactive, and ironically, those that are touted as interactive involve far less interaction than the simplest platform game! The closest the CD32 has come to an interactive movie was a tame Sherlock Holmes game. The CD32 is quite capable of these games, but they take a lot of work to prepare, and the end result is usually nothing more than an extremely shallow adventure game with nice graphics.

5. Commodore holds the copyright to the AGA chipset and no other company can use it. However, some developers in the USA are starting to use Amiga hardware as the basis for their own video products.

6. Possibly because the PC is better! No, only kidding. Every owner likes to think their computer is better than someone else's. For this reason PC owners slag off the Amiga, and Amiga owners slag off the PC. In truth they both have their advantages. See our article in the February '95 issue for a comparison of the Mac Vs PC Vs Amiga.

Just enough RAM



I am considering buying a RAM upgrade for my A1200. I have an Overdrive, use FinalWriter all the time and am thinking

of buying a scanner in the future. All I want is to be able to stop FinalWriter saying 'not enough memory' all the time and to be able to handle graphics from a scanner. I have a budget of £200 and think that the Hawk from Silica seems a fairly decent board for the money, but there isn't really much to compare it to. Please help.

Ryan O'Neill, Northern Ireland.

The Hawk is a reasonable memory board for the money and you won't be disappointed. It will certainly cut out the error messages you keep seeing.

Q&A responses



In response to letters in the February Q&A in CU Amiga Magazine:

AG Smith:
Lemmings II HD

install works fine. Use the patch on the disk from NAUG but install it manually as the supplied script is wrong.

Lee Arnell: you can connect a CD drive to an A600, using the Squirrel and a SCSI CD drive, although this is rather expensive.

On a personal note, I am having trouble getting ToolsDaemon 2.1 working on my Amiga (600, kickstart

37.00, 2Mb RAM, workbench 2.05 and 64Mb internal HD). It will only start up when a program such as Snoopdos, Dostrace or the Commodities Exchange program is running. Once started though it works fine. What's going on?

Jeff Japes, Northumberland.

Thanks for your answers. You are indeed right that the Squirrel can be used to add a CD drive to the A600. Apparently the Zappo CD drive will also now work with the A600 - although Indi/Calculus the UK distributors have neither informed of this upgrade or sent us a new sample to review.

In reply to your particular problem, ToolsDaemon should work. Have any readers got any suggestions?

Citizen query



I own a Citizen Swift 240c and I am thinking about buying a Citizen PROjet 2. What I really want out of a printer is good colour with no light

or dark lines going through it. I would like quality just like the front covers on your magazines. I don't care about speed or noise, will a Citizen PROjet 2 do this? Finally, if it's not too much trouble, could you please tell me where to get a PD database where you type the info into cells on the screen.

David (no address supplied)

Given that you're considering the Citizen PROjet I've assumed you are intending to spend under £400. This being the case I'm afraid you won't get anywhere near the quality of print you see on our front covers. You'll need to spend around £600 to £800 to get near such quality. However the PROjet will give you a massive increase in quality compared to the 240c.

Spot the difference



I have recently upgraded my A500 with a Fatter Agnus and a 2.05 ROM which came out of a scrapped A600. The extra RAM was

fitted when I bought it. Is there any difference between the 2.04 ROM and the 2.05 ROM? Also would I be better off selling my A500 to buy an A600 with a hard drive, or should I keep the A500 and just get a new hard drive? I'm unemployed so I can't afford an A1200.

Dean Henighan, Somerset.

Your best bet would be to save for an A1200, as most future peripherals and expansions will be developed for the A1200. If you can't wait to save up, stick with the A500. Upgrading the ROMs was a great start, and a hard drive would

also be well worth having. The A600 is a nice computer but it's not nearly as expandable as the A500, which is still well-supported by third-party developers (see pages 94 for a round up of A500 upgrades).

Printer problems



Recently I purchased a Citizen ABC printer to replace my CBMMPS1270 which gave up the ghost. As I only

use my printer for text printing I thought the ABC would be ideal, especially as it is advertised as being 'easy to use', and already has a printer driver.

However, when I tried to print, all I got was a page of text with each line split in half horizontally with about a one and a half inch gap in between. I had already copied the Print Manager onto my copy of PageSetter 3 and selected the ABC printer driver - so I don't know what the problem is.

It's a nuisance having to use the Print Manager, and I would prefer if possible to use a driver in the devs drawer.

However, if by using the Print Manager you get a lot better quality, how do I get it to work, and where am I going wrong?

Also I have bought the Spectrum AGA V1.3 emulator. It is perfect in every way except that it is fairly slow.

Would buying 1Mb or 2Mb of fast RAM speed the games up, and if so by how much?

P. White, West Yorkshire.

From your description I'd speculate that the printer is printing a carriage return and line feed at the end of every line, when it should just be printing a carriage return. You'll find an option in the Citizen Print Manager to switch between these.

Alternatively you could use a normal Amiga printer driver, and although the quality won't be as good it will be close. Adding extra memory will improve the Spectrum emulator slightly.

Hard drive hell



I have an A600 with 2Mb of chip RAM, extra disk drive and a Panasonic printer. I recently had a 170Mb IDE hard

drive installed with 20Mb as workbench and 150Mb as work. I am encountering a problem with duplicating libraries in the libs drawer of my workbench.

For instance: Advantage was installed in a drawer and the libs copied from the disk to the libs drawer of workbench. The spreadsheet runs fine from the hard drive.

When I install another program that requires the libraries copied to

the workbench:libs some of the library names are duplicated and are over written on the ones already in my libs drawer.

This results in the error "something's missing" and then the computer crashes. This is becoming extremely frustrating.

If I rename the libraries will the programs still recognise them? I know little or nothing about programming but I am fairly confident with the Shell.

Glenn Florey, Kent.

I suspect that when you are installing new programs you aren't adding the new libraries to your libs drawer, just replacing the old one with the new drawer. When you then try to load the old program it can't find the libraries it's looking for and therefore crashes.

The way around this is not to copy over the entire libs drawer. Instead merely copy over the contents of the new libs drawer. You can do this by going into the libs drawer of the floppy disk you're copying from and calling up directory. This would be done by typing:-

```
CD DF0:libs
DIR
```

This will then show the libraries needed for this program. Now copy over the individual files into the libs drawer on your hard drive using the copy command. Alternatively use Directory Opus from our Feb. '95 issue which will make life much easier - you won't need to use the Shell. Once you've done this try loading the different programs. They should now all work. ■

NO SAES PLEASE
We regret that we cannot respond to readers' queries by post or over the phone. Please do not include stamped addressed envelopes with your letters, as we simply don't have time to answer the thousands we receive. Responses are only possible through the pages of the magazine.

BIFF!

SHAZAAM!

SUPER STREET FIGHTER 2
hits the Amiga!

TFX
More superer
than Sonic!

KAROW!

OUCH!

LOST EDEN
Would you
Adam 'n' Eve it?

Read The One's
EXCLUSIVE!
deeply probing
Work in Progress!

DENIED!

**FLIGHT OF THE
AMAZON QUEEN**
It's HUGE!

PAT!

BALDIES
Go on, give
'em a good
slap!

THE **ONE**

FREE!

Nelson
Mandela under
each disk!*

April issue: Considerably nicer than
a smack in the face. In all decent
newsagents from 28th March.
You'd be a fool to miss it (doh!!)

*Contents subject to change at the last minute



Frequently Asked Questions

Swapping disks with other computers can be a tricky business. John Kennedy tackles some of the more common problems.

Q. Is it possible to use PC disks with my Amiga?

A. Yes, so long as you have the right software. The Amigas 1200 and 4000 come with a program called *CrossDOS* as part of the Workbench software. *CrossDOS* gives your Amiga a virtual PC disk drive called PC0:. This is the exact same disk drive as DF0: but it can be addressed as either PC0: or DF0:.

Q. I don't have Workbench 3, what can I do?

A. Either upgrade to Workbench 3.1, or buy *CrossDOS* separately. There are also various programs available in the public domain (such as *MessyDOS*) which will achieve the same result.

Q. What's the exact difference between High Density and Double Density disks?

A. Most disks used with IBM-PC clones are High Density floppy disks, and all Amigas (with the exception of some late A3000s and all A4000 models) use Double Density disks.

A High Density disk can be identified by the extra square hole in the corner: it looks like the write protect tab but has no little movable shutter.

You can buy a third party High Density disk drive for use with the A1200, which will store twice as much data per disk.

Q. Is it worth upgrading my A1200 to a High Density disk drive?

A. Only if you have already fitted a hard drive and some extra memory. A High Density disk drive is most useful for backing up hard drives and swapping data with PCs.

Q. Why does the Amiga need extra software to read a PC disk?

A. Disks must be 'formatted' before they can be used. The formatting procedure divides the disks into a number of tracks and sectors. This organisation is necessary for the disk operating system to be able to read and write to and from the disk.

However, the Amiga uses a slightly different formatting method from the PC, and as a result can squeeze slightly more data onto each disk. With hindsight this was probably a mistake, as although physically the disks are identical, the difference in formatting means they cannot be swapped between machines.

Q. How do I use CrossDOS with Workbench 3?

A. To start the *CrossDOS* system working, find the drawer called Storage which is part of the Workbench system. In the drawer named DOSDrivers you'll find an icon labelled PC0:. Double-click on it and a new icon should appear on the Workbench. Copy this icon into Devs/DOSDrivers if you want it to

be present all the time.

Alternatively, opening a Shell and entering "mount pc0:" will have the same effect.

When you read and write to PC0: the data is read and written in the correct format for PC disks. You can even format PC disks in this way, although I have occasionally had problems and find in general it is better (and faster) to format the disks on the PC if at all possible. The Amiga drive DF0: can still be used. If you have an external floppy it is possible to create a PC1: device so that it too can behave like a PC disk drive.

Q. Whenever I copy text files from PC0: I get extra lines appearing.

A. Linefeeds and carriage returns are dealt with differently by Amiga and PC programs. Find the Commodity called *CrossDOS* on the Amiga Workbench. It includes an option to strip the extra linefeeds.

Q. How can I transfer data to and from an Apple Mac?

A. There is no easy way to emulate the Apple method of formatting disks (which causes the disk drive to spin at different rates). The good news is that all Apples come with a program called *Apple File Exchange* which can read PC disks. Newer Macs (with System 7.5) can read PC disks even easier. Hardware Mac emulators (such as the excellent *Emplant*) can use the Amiga disk drives to read and write Apple disks. *Emplant* can also use the AppleTalk networking system, so you could swap files to and from a Mac in this way too.

Q. My Virus checker goes nuts with CrossDos, why?

A. The Virus checking software knows

there is an extra disk drive present (PC0:) but can't read it – and therefore warns that there may be a virus on the loose. You will either have to put up with the warnings or switch off the checker until you have finished using PC disks.

Q. If I can read PC disks, does that mean I can run PC programs?

A. No, so put away that disk with *Doom* on it. Being able to read disks is one thing, using programs written for a different machine is something else.

It's possible to share image files and *Soundtracker* MOD tunes between the PC and Amiga, as these are only data files, but programs are completely different. A PC program expects to run on a PC operating system (such as MSDOS) and requires an Intel (or compatible) processor to be present – as well as a graphics, sound and I/O card with memory at certain fixed locations.

Some programs (such as *PC Task*) will attempt to emulate a PC on an Amiga, by running a program which appears to mimic the Intel processor and other dedicated PC hardware. However, as the Amiga processor is effectively running a program running a program, it's not a very fast process. Don't expect Windows to work very well, if at all.

Hardware solutions such as BridgeBoards (which are fitted into the Zorro slots in an A2000, A3000 or A4000) are now very hard to come by, although they worked extremely well as they included a real Intel processor on-board. These boards even allowed dedicated PC expansion cards to be fitted inside the Amiga. ■



Data Compression

"You can't fit a quart into a pint pot," they used to say. Data compression has changed all that, but how does it actually work?

Data Compression

It might sound impossible, but as anyone who has ever struggled with an archive from a Bulletin Board knows, it is possible to compress a file so that it takes up less space than the original. The Amiga makes use of several data compression systems, and sometimes you'll find them happening automatically. Let's take a look at some of the most common systems. Next month we can look in a little more detail at how they actually work.

File name extensions

- .DMS:** Entire disk crunched with DMS.
- .LHA:** One or more files compressed with Lh or Lha. Use either Lh or Lha to decompress them.
- .ZIP:** One or more files compressed with ZIP. Use UNZIP to decompress.
- .ARC:** One or more files compressed with ARC. Use UNARC to decompress.
- .JPEG:** Image crunched with JPEG compression. Use *Viewtek* or *Multiview* or various graphics software with the JPEG datatype.
- .GIF:** Special 256 colour image which features built-in compression.
- .IFF:** Amiga IFF - used for graphics and sound samples. Use with any Amiga program.
- .ANIM:** Amiga animation file. Display with *Deluxe Paint*, *Viewtek* etc.

MasterClass

```

AmigaShell
LHA Evaluation V1.38 - Copyright (c) 1991,92 Stefan Boberg.
All rights reserved. Not for commercial use.

Usage: LHA [-<options>] <command> [<archive>[.LZH/LHA/RUH]] [<homedir>]
      [<filespec>... ] [<file>] [<destdir>]

      Where <Command> is one of:

a      Add files                      c      Concatenate/Append archives
d      Delete files                   e      Extract files
f      Freshen files                  h      Hunt for diffs arc (-) filesystem
[!q]   List archive (terse)           m      Move files to archive
p      Print files to stdout          r      Replace files in archive
t      Test archive integrity         u      Update archive
[!q]   List archive (verbose)        w      Show archive contents (full)
x      Extract files with full path

      And <Options> is one or more of:

-a      Preserve file attributes      -A      Set archive attributes
-b      Set I/O buffer size (KB)     -B      Keep backup of archive
-c      Confirm files                 -C      Clear arc-bit on extract
-d      Archive date = newest file    -D      Alternate progress display
-e      Archive empty directories    -E      Touch extracted files
-f      Ignore filenotes             -F      Use fast progress display
-g      (Un)Garble with password     -G      Only extract newer files
-h      Disable homedirectories      -H      Write header level (0,1,2)
-i      Read filelist from file      -I      Ignore LHAOPTS variable
-k      Keep partial files           -K      Kill empty directories (move)
-l      Make filenames lowercase     -L      Create filelist
-m      No messages for query        -M      No autoshow files
-n      No byte progress indicator   -N      No progress indicator
-p      Pause after loading          -P      Set task priority
-q      Be quiet                     -Q      Alternate option set introducer
-r      Collect files recursively    -R      Collect archives recursively
-s      Only add files with A flag unset
-t      Only extract new files       -T      Set A flag on added files
-u      Make filenames uppercase     -U      Only extract new & newer files
-v      Set compression speed        -V      Set indicator update rate(bytes)
-w      Set work directory           -W      Enable / set multivolume size(KB)
-x      Preserve and use path names  -X      Exclude filenames
-y      Always append LZH/LHA suffix -Y      Do not append LZH/LHA suffix
-z      Do not compress files        -Z      Store big files w.ratio < 3%
-0      Use LhArc V1 compression (-lh1)
-2      Use LhArc V2 compression (-lh2)

      Alternate options:

-Qa     Use simple console I/O       -Qd     Delete autoshow files
-Qh     Set Huffman buffer size (KB) -Qo     Ignore options after end
-Qp     Ignore delete protection flag -Qr     Skip datestamp check
-Qv     Disable wildcards

Options are case-sensitive and may be specified anywhere on the command
    
```

▲ LHA may look complicated (as this excerpt from its instructions may indicate) but you only need to know that 'LHA x file' decompresses data, and 'LHA a archive files' compresses it.

Amiga IFF images use compression automatically when they are saved and loaded to disk. The technique used is called 'Run Length Encoding' and it's pretty simple to understand. Think of an image which contains a totally white horizontal line from left to right. The saving program has a choice: it can either save the data for each of the pixels in the line individually, or it can count the number of pixels and include a special code in the file which states, "there are 'X' white pixels coming next". With suitable codes, it's possible to compress a pure white image from 10K to just over 580 bytes.

Run Length Encoding works very well for plain images, but not very well for complicated pictures such as digitised frames from video, which generally have many slightly different coloured pixels next to one another.

Delta Compression is especially popular with Amiga animators. An Anim file works by saving the first frame, and then specifies the following frames by their differences

to the frame before it. Some parts of the following frame will be the same as the previous one, so it takes less memory to describe the changes than to describe a whole new screen. This is called a 'delta shift' and it means animations take up a lot less space than if they were stored as individual frames. It also means there is less data to read from disk or RAM and the resulting speed increase can make it possible to play an animation direct from a hard disk.

There are three common Amiga Anim formats: Anim5 which is the most common (used by *Deluxe Paint*), Anim8 which is used by *AdPro* but not much else, and Anim7 which is supported by *Personal Paint 6.1* and *Viewtek*.

Anim7 is the most flexible format, as it runs extremely quickly on Amigas fitted with 68020 or better processors and contains extra

information used to define a separate palette and timing delay for each individual frame.

There are other formats as well, such as SSA which is used by *Clarissa* and is best suited to video work.

JPEG compression is very useful, but not perfect. It examines the image in detail and uses some tricky mathematical processes and filters to decide what information you 'probably' wouldn't miss. If for example, two neighbouring pixels are almost the same colour, it changes them so that they actually are the same colour, hoping that you won't notice. This makes it easier for the image to be stored in a similar fashion to the IFF format, for example "10 red pixels followed by two blue ones ..." When you go to save your JPEG, you are asked to set a quality level. This decides how much the JPEG compression will alter the image. More alteration leads to smaller file sizes.

Complicated images are much, much smaller when compressed with JPEG, although when displayed again it is possible to see some slight degradations. An image such as a snapshot of the Workbench would actually increase in size, so in these cases it's better to stick to IFF and the in-built Run Length Encoding.

It is now possible to buy chips which encode and decode JPEG



▲ The left half of the image has been saved with JPEG quality set to minimum, the right half with quality set to maximum. The left-hand side file takes up 2,800 bytes, the right side takes over 65,000 bytes. JPEG is a constant struggle to find a balance between file size and quality.

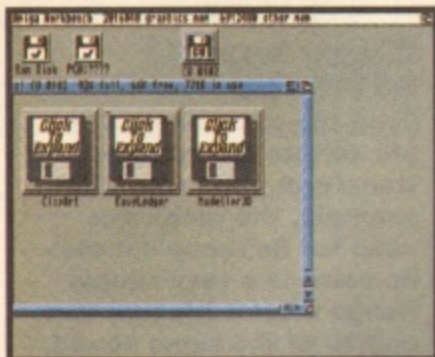

images in real time. For example, both the VLAB Motion and PAR cards contain chips which take an incoming video signal, digitise it and then use JPEG to compress it and store it on disk: all within one 25th of a second.

To replay the images, the JPEG decoder loads each frame and converts it into video – again, at a rate of 25 frames a second.

You might have heard of the MPEG system, especially when it comes to putting films on CD-ROM. The MPEG systems looks at the frames which are coming and those which have been. However, because of the way it works it is difficult to use in a live situation and crunches them into a very small amount of data. As a result it's possible to read them from relatively small CD-ROM disks and display them in real time.

The MPEG decompression chips are actually extremely cheap, but compression hardware is expensive and it is difficult to do well.

Ordinary file compression is big business, and it saves us all a lot of time and money. Modem users compress files before sending them to make sure their system stays on-line for as short a time as possible, and Bulletin Boards compress files so they take up as little expensive hard disk space as possible.

Probably the most common Amiga archiving program is 'Lha' but there are plenty of variations. Other systems such as ZIP and ARC are more common on PCs, although the RAR system is also becoming very, very popular.

When you see a file ending in '.DMS' you know you'll need a blank floppy disk. DMS compresses entire disks to form a single file, which makes distributing programs via cover disk a lot easier. Unfortunately, DMS is not the most flexible of schemes, and many times using Lha and a intelligent decompression script would be a better choice. Next month, I'll look at each of these methods in more detail. ■

THE PATH COMMAND

I've been using AmigaDOS for years, but I'm ashamed to say that it's only fairly recently that I've found a use for the path command. Allow me to share this secret with you ...

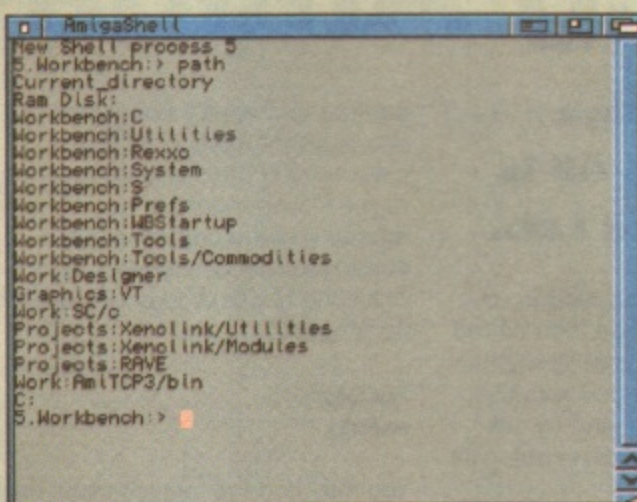

AmigaDOS needs to know where to look for files, and PATH will not only tell you, it will allow you to add new locations as well.

Whenever you enter a command at the Shell, the Amiga looks at several places to see if it can find it and execute it. You can obtain a list of these places, and the order in which they are searched, by entering "path" by itself in the Shell window. This will save you a lot of time and effort and is quite simple to do.

For example, a lot of the paths shown in the picture above are set up by default when the Amiga boots; you can see for yourself how the Workbench disk is searched a lot (which is why on a single floppy, no hard disk system you get a lot of "Insert volume Workbench" messages).

One of the things Path will help you with is a bit of organisation. If you use a program such as LHA or UNZIP a lot, you might be tempted to throw it into the C: directory with the other AmigaDOS commands and forget about it. However, this can clutter up the directory very quickly, slow down operations and make things hard to find.

A better approach would be to create a new drawer called, for example, MyUtilities and then add a path to search to it.

Creating a drawer is easy, although the chances are you won't need a drawer icon for it and the utility programs such as Lha don't have any icons themselves.

For this reason, you might find it more convenient to use the "Makedir" AmigaDOS command, which creates a drawer with no icon. Use makedir like this:

```
makedir workbench:MyUtils
```

Now you can copy all your utility programs into the directory. If you like to "drag and drop" them as icons, use the "Show All.." Workbench menu to make them visible.

Normally, without the presence of the Path command, to use the utilities you would enter something like:

```
workbench:MyUtils/lha
```

This can get a bit tedious. For example, my favourite picture viewing program is *Viewtek*, which I keep in draw on my hard drive. Before Path came along, I'd often find myself opening a Command Line from the Workbench (the old right-Amiga-E hotkey) and entering a path ending in "...vt picture.iff"

Now I have used Path to add this drawer onto the search chain, and all I need do is enter "vt picture.iff". I've calculated this has saved me about one minute 30 seconds a week (as much as that? – Ed).

From the Shell, enter:

```
path workbench:MyUtils
```

If you enter 'path' again by itself, you'll see your new directory has been added to the list. This means you can enter 'lha' without a full pathlist, and the command will run as normal.

The path settings will be lost when you reset the Amiga, so if you create any essential ones make sure to edit the s:user-startup file and add the path statements to the list of instructions which get executed every time the Amiga is booted.

If you create some paths to disks which aren't actually present when you subsequently enter a single "Path" to check on what you have defined, a requester will appear on screen. You can disable it with the use of the keyword QUIET, like this:

```
path quiet
```

You can also remove Paths which you may no longer require, with the REMOVE keyword:

```
path workbench:MyUtils remove
```

Correction: REMRAD

Did I really say last month that the removable Ram disk (RAD:) could only be obliterated from the system by switching the Amiga on and off (in other words not a warm reset)? How careless: I should have mentioned the REMRAD command which returns as much memory as possible to the system.

John Kennedy

Soundlab

The Talking Amiga

Wouldn't it be nice if your Amiga could talk to you? Well it can! All is revealed in this month's Sound Lab.

Talk to your Amiga, and it'll talk back to you. It's true! Your Amiga might not have ears, but it's got the next best thing: a parallel port. Add a sampler cartridge and a microphone, and your Amiga will be able to hear you. Once you've got this far, you can add your own vocals to your music, and even get your Workbench to talk to you.

One of the easiest ways to get your computer speaking to you, is to include a greeting in your Workbench or hard drive boot sequence, so every time you boot up your Amiga, it says "Hi Tony," or something like that.

This is easy to do. First of all you need a sampler cartridge, a microphone, and some sampling software. It's likely that your sampler cartridge will accept a 'line' level signal, but microphones transmit 'mic' level signals. Line signals are more powerful than mic signals. Many home hi-fi systems can change a mic signal into a line signal with the use of a karaoke-style microphone input. If your hi-fi has a microphone input, plug your microphone into it, and connect the headphone socket

to your sampler. The sound from the microphone should then be fed into the sampler. If nothing seems to happen, mess around with the controls on your hi-fi, and try setting the tape section to record, with no tape in the deck.

Sample your choice of phrases, and then save them as IFF files to the SYS: folder of your hard drive or Workbench boot disk. Now you need to get hold of a public domain utility such as *Playsound*, available on many music utility compilations (phone your nearest PD library for details). Copy *Playsound* into the C directory of your boot disk. Next you need to add a line to your startup-sequence. Open a CLI or SHELL window, enter the following line and press Return:

```
ed s/startup-sequence
```

Move down to the line that reads "Loadwb", and insert a blank line just above it. Assuming that you named one of your samples hello, you could add the following to the blank line:

```
playsound hello
```

Press the Escape key followed by the X key, followed by Return, and this will save the startup-sequence with the changes you just made. Alternatively, if you have a newer version of the Ed text editor program, select Save from the Project menu.

Next time you boot your Amiga, you'll be greeted with your sampled speech. If you get the error message 'playsound: unknown

command' then it's likely that you've either misspelled the word playsound in the startup-sequence, or the Playsound file is not in the C directory of the boot disk. If the startup-sequence stops, enter the following to get Workbench booted up properly:

```
loadwb
endcli
```

You may find the speech plays back at the wrong speed. If so, re-load the sample into your sampler software, check that the sample rate is correct, that you are saving as an IFF file, and then re-save the sound.

Built-in speech

All Amigas up until the release of Workbench 3 have a built-in speech synthesiser. Why it was discontinued is beyond me. This is a brilliant toy that can be accessed from a CLI or SHELL window. This uses snippets of spoken sounds to make up words. This means you can type in any word, and the Amiga will speak it. It can understand certain combinations of letters, which it interprets according to its American-English programming. For example, if you were to type in 'apple', it would say 'appal', rather than 'app-lee'. However, its understanding of English word construction is very basic, so in most cases you'll need to enter words phonetically, using incorrect spellings to get the pronunciation right. Also try experimenting by entering things like "ooooooooooooaiiououou" for some amusing results! You'll find the speech synthesiser on the Workbench disks. Workbench 3 owners can use *Say Demo* as reviewed on page 85.

Alarm bells

You can also get your Amiga talking with the Sound Preferences of Workbench 2 and above. Load Workbench, and click on the Prefs drawer, followed by the Sound icon. Click the Make Sound box so that it

Easy vocal effects

Even the most basic sample editors can be used to transform your voice. For example, the technique used for Robocop's metallic voice is a very simple flange effect. It's just two copies of the same sound, with one delayed very slightly. Even if your software doesn't have a built-in flange option, you can re-create this by copying the sample, and then mixing it back onto itself. When you select the mix option, make sure that your cursor is positioned a short way along from the start of the sample wave. This will then add a copy of the sample to the original, with the second copy slightly off-set against the first. Try adding further off-set copies to emphasise the effect.

Pitch-shifting is the easiest way to disguise your voice (just play the sample slower or faster). If you're lucky enough to own an analogue synthesiser with an audio input, you can do all sorts of weird things to your voice. Channel your voice through the resonant filters for freaky results.

Finally, don't forget The Real Time Effects Generator, (CU Amiga's October 94 cover disk) is stacked with voice-changing features.

contains a tick symbol, and the Sound Type button so that it reads 'Sampled Sound'. Now click the Select Sample button, and use the file requester to select your chosen sample from the hard drive or your Workbench disk.

Click on Test Sound to try it out. If it plays at the wrong pitch or speed, adjust the Sound Pitch slider, and test it again. Click on Use, or else Save if you want your changes to be stored for future use.

Now you'll hear your selected sample when you attempt to do something 'illegal' from the Workbench (such as selecting Quit when you have another Workbench-dependant program already running). This can be more useful than it appears. For example, if you set your Amiga going on a task, and wander off to make a cuppa, or sit back and read a magazine, you'll get an audible alarm if the computer runs into an error. ■

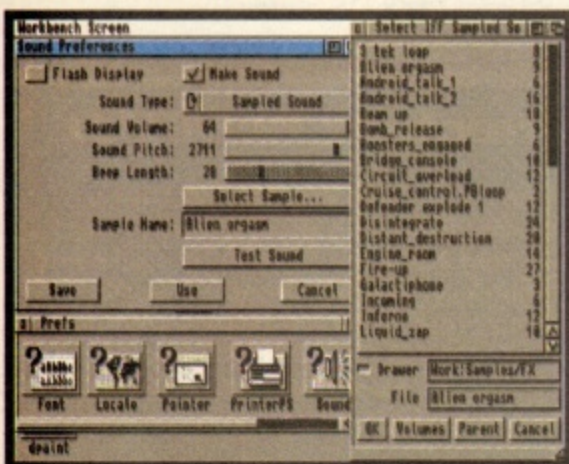

▲ With the help of your Workbench Sound Preferences, you can program your Amiga to warn you of any errors with your choice of sound sample.

Go on, drop us a line,
you know you want to.
Send it to Backchat CU
Amiga Magazine, 30-32
Farringdon Lane,
London EC1R 3AU.

Where's the software?



I've just read a multi-platform magazine and am feeling pretty much disillusioned. *Virtua Fighter* on the Saturn is as good as the arcade version, *Doom* and *Alien*

Vs Predator on the Jaguar are totally awesome, *Super Street Fighter* and *The Need For Speed* on the 3DO are graphically the most impressive games I have ever seen.

After all this, all I saw for the CD32 was a tired old Amiga conversion that could easily be done on a rotting Megadrive. The CD32 might be a great machine but the software support is really not to be taken seriously. With the exception of *Microcosm* and *Megarace*, the CD32 is not out there with the likes of machines such as the Jaguar and Playstation. I see no reason why we can't have any half decent games sprawling with rendered 3D graphics. The CD32 has a fast processor and as the name suggests is 32-bit, but what really separates it from a A1200 is the powerful AKIKO chip which converts IBM 'chunky' graphics to something the Amiga can use and it does it fast.

If any publishers and developers are listening, we want games that tell us what *Doom* or *Daytona* are all about, not another souped up floppy conversion with a rendered intro and digital sound.

Sharad Bachant, Dubai.

We'd love to be able to say that the CD32 can beat the likes of the Jaguar and Playstation, but when it comes to 3D games like *Ridge Racer* and *Virtua Fighters 2*, the fact is that the CD32 doesn't have the power to cope. The processor of the CD32 may be 32-bit, but the Playstation has its own custom chips specifically designed for real time (ie. extremely fast) 3D texture mapping and bitmap scaling. It's custom-designed chips like these that make these amazing games possible. None of us have personally tried to program the CD32's AKIKO "chunky to planar" chip, so we can't be absolutely sure, but all the programmers we have spoken to tell us it's still not fast enough to make much difference. Still, the CD32 is still capable of running some excellent games and programmers are not currently playing to its strengths.

BACK

chat

What chance the Amiga?

Having just invested in a CD32 despite no news on the Commodore situation, I wish to reply/add to the September Letter of the Month. First a short quote from the Team 17 Tower Assault manual: "Copying games is wrong, not that that bothers most people. More importantly copying games means that software houses are finding it increasingly difficult to support the Amiga."

This is a bit worrying. Could I suggest that whoever takes over Commodore considers cajoling the software firms to bring out new games in CD-only form. Push the A1200 with a CD ROM drive for around £400 and you're still onto a winner. Keep 'serious' software on floppy and have the option of a hard disk. Software companies are leaving the Amiga market and if anymore desert we're in trouble. No more talk about boycotting software firms - we need the likes of Team 17 and MicroProse.

If we want people to convert to the Amiga just show them *Tower Assault* on the CD32 (juicy intro etc). However, what chance does the Amiga have if piracy continues - within a few weeks of *Cannon Fodder 2* and *Sensible World of Soccer* being released my son's friend had pirated copies of both from a set up in Italy.

Paul Scott, Antrim, Ireland.

Top tips

In your excellent January 95 issue, you informed a Mr Tim Them ('Time Please' article) that without buying a new RAM upgrade he could not install a battery backed clock. However, Siren Software on freephone 0500 340548 produce a battery backed clock module for £19.99. This will not invalidate your warranty either, as installing simply entails plugging into a socket at the back of the Amiga.

Also, November's 101 tips had many useful tricks but here's one you left out. Removing old disk labels, especially when they are several labels thick, is a legendary problem for all. Simply ripping the label off doesn't work very well. So, to peel a label cleanly off a disk simply leave the disk on a hot water bottle for a couple of minutes. This shouldn't be too hot or your disk might just melt. Anyway the glue melts and allows easy and complete removal of those pesky labels.

Finally, although CU Amiga Magazine is the best consistent quality Amiga mag, the new look CU is pure brilliance. A couple of other magazines rely on a hyped reputation, game reviews taken off the back of a box or pages that resem-

ble an A500's PCB! I've purchased this magazine since the heady days of when an Amiga section was a treat in Commodore User mag. Congratulations on certainly the highest maintained quality text, content, reviews, cover disks and all round general bloody greatness.

Robert Ellis, Gwynedd.

Hold the revolution

It was with great distress that I received a letter from MicroProse today. In a very nice and polite way I was informed that the Amiga is about to miss on what will probably be the strategy game of 1995, *Colonization*. Would you believe that they are actually planning to skip an Amiga version of this wonderful game? Or as the letter stated there are "currently no plans to release *Colonization* on the Amiga format."

Let's make sure they change their plans. All Amiga owners should send Microprose a letter and ask for an Amiga version of *Colonization*. The more the better. Now everyone ought to see what piracy is doing to our wonderful computer. Hardly any really heavy duty programs are released on the Amiga format anymore. If you don't want to end up playing Super Mario clones for the rest of your miserable lives then go out

THE FAR SIDE By GARY LARSON

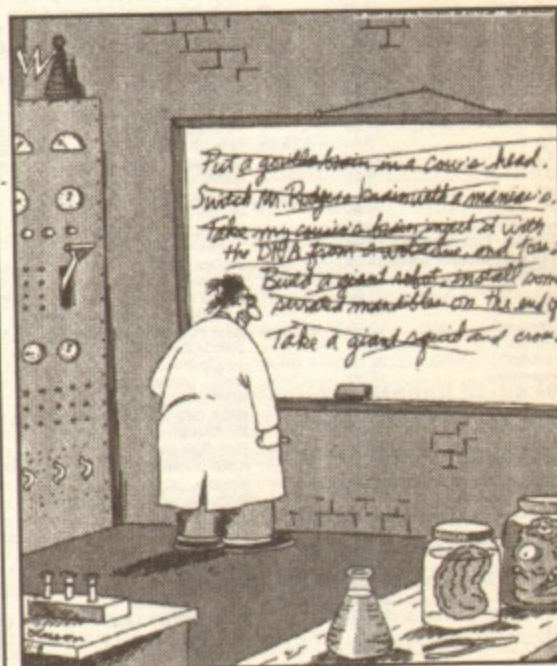

The curse of mad scientist's block

and buy the software. If you don't support the people who produce the kind of program you like, they'll simply stop making them.

Jan-Ivar Hansen-Bergli, Norway.

Good news: CU Amiga Magazine can exclusively reveal that MicroProse are in the process of developing Colonization on the Amiga. So keep 'em peeled. We'll bring you more info when we have it.

PC pooh, pooh

The other day one of my PC owning mates came round to my house. I switched on my Amiga A1200 with 240Mb and promptly loaded the most fabby and impressive game in my collection - *Super Stardust*. He just said, "you think that's good graphics? Hah that's nothing on *Doom 2!*" He left my house with a bloody nose.

After a sulking session I thought, maybe *Stardust* doesn't have the graphics of *Doom 2* but what kind of specs do you need to run it? The minimum is probably something like this; 66 MHz 486 PC and a double speed CD-ROM drive. *Stardust* has gorgeous graphics, tried and tested playability of *Asteroids* and some stunning 3D tunnel sequences and this will work on a £300 unexpanded 1200 with one floppy drive. Even at 14MHz the game runs at a heck of a speed whereas they have *Doom 2*, a very nice game if you have £2,000 worth of PC at your disposal.

Colin Rushton, Lancashire.

Positive feedback

We just found a copy of CU Amiga Magazine at our local book store and thoroughly enjoyed your review of *ImageFX 2.0*. Thanks for the positive comments! Your criticisms are well taken, with a single exception. You mentioned that you reduced our rating percentage due to the lack of a system wide UNDO ability. In truth, our UNDO function has always been universal within *ImageFX* since before *ImageFX 2.0* or even *ImageFX 1.5*. The UNDO system can even UNDO to our virtual memory - removing a restriction other software has of only UNDOing that which can fit within RAM memory. Would it be possible to have this correction noted in your magazine and know the full rating given then? Thanks again for your excellent review.

Kermit Woodall, Nova Design, Inc.Kermit@cup.portal.com.

Thanks for letting us know. The UNDO function didn't work with our original review copy, but we'll be re-rating ImageFX in a forthcoming roundup of all major Amiga graphics packages.

It's a kind of Magic

February's article on speeding up the Amiga was great. Have you tried Magic Menu? This gives you the same 3D effect on the drop down menus plus you can make them appear anywhere on the screen wherever the mouse pointer is. I use Magic Workbench and ToolsDaemon and they all work together fine. My magic menu setup is: standard, 3D centre boxes, use pull down menu in menu bar, otherwise pop-up. Double borders off. Mark sub-menus on.

On page 119 of the mag, there were two

pictures of Workbench with icons at the bottom of the page (much like next step) with no names. Where are they from? Keep up the good work

Martin Randall, mr394@soton.ac.uk.

Thanks for your comments regarding the Speeding Up Your Amiga feature. The program seen in the screen shot on page 119 was ToolsManager - which is available from most PD libraries.

Bring back art gallery

I've just bought a copy of CU Amiga March 95 and although I have no complaints about the magazine I would like to know what has happened to Art Gallery. I always look forward to this feature and so far three of my pictures have been shown in your magazine. I would like to suggest that the best entry in Art Gallery each month be given as a prize as both an incentive and reward for readers efforts. As there is no mention in your magazine as to the disappearance of the Art Gallery I would appreciate it if you could clarify the position of this feature. Thanks for you time and I sincerely hope that Art Gallery will return as soon as possible.

Mr M.R. Edwards, South Glamorgan.

We're glad to hear that you enjoy art gallery so much. Art gallery is back in its rightful place this month. Keep sending your work in.

Pumping it up

I have a couple of comments on the March Pump it up feature. Firstly, just because a TV has a Scart socket don't be fooled into thinking it will work with your Amiga. Toshiba TVs appear to have a different Scart to the Amiga. My local dealer made up a special lead for the Toshiba, which still didn't work with my Amiga. My dealer wanted to alter my set but I gave up on the idea. If you decide to buy a TV primarily for use with your Amiga make it clear that you will not part with any cash until you're sure that it will work with your Amiga.

Secondly, I thought that the reason a 'normal' set up using the TV RF aerial connector was not such as good as quality as Scart was because the Amiga had to convert the signal into RF for the TV to then demodulate before displaying it, therefore losing quality at each stage. If so will using the Scart on the video help? The VCR must still modulate the signal to RF and the TV demodulate in the same way?

Graham Hague, Bedfordshire.

You are correct, there are a few TVs which although Scart compatible, won't work with Scart sources. If you have written confirmation from the supplier that the TV is compatible with your Amiga you should have grounds for a full refund if it turns out not to be. You are partially correct about modulation. However, video circuitry will still be able to improve upon the RF quality. Try it, it works for us.

WRITE TO US NOW!

Send your letters to: Backchat CU AMIGA, 30-32 Farringdon Lane, London EC1R 3AU.

•CU AMIGA reserves the right to edit your letters and assumes that unless stated otherwise all correspondence is for publication.

TEAM TALK

We're such a diverse bunch at CU Amiga, we couldn't agree on anyone 'top' topic to discuss in this month's teamtalk. So here's our personal chart to all things 'top'.

ALAN DYKES



Top Five ... Bagel fillings

1. Salt beef and mustard
2. Chicken tikka
3. Hot chicken curry
4. Sausage, bacon and marmalade
5. ATR or Turbo Trax

LISA COLLINS



Top Five ... Places For Hiding Loot

1. Biscuit tin under the bed
2. Under the loose floorboard
3. The toilet cistern
4. Inside zip-up teddy pyjama case
5. Under the armchair cushion

ANDY LEANING



Top Five ... TV Theme Tunes

1. Star Trek
2. John Craven's Newsround
3. Brookside
4. Casualty
5. Vision On

TONY HORGAN



Top Five ... Excuses For Lateness

1. None
2. Errrrr ...
3. Those flippin' trains
4. Is it Monday already?
5. That lift gets slower every day

HELEN DANBY



Top Five ... Pot Noodle Flavours

1. Sweet and Sour
2. Beef and Tomato
3. Chicken and Mushroom
4. Dillon
5. Cheese and Tomato (now discontinued)

JOHN KENNEDY



Top Five ... Reasons For Marriage

1. Don't know really
2. Lisa wouldn't have me
3. Want some home comforts
4. Not getting enough ...
5. I'm in love (aaaaah)

CU

AMM

M A G A

**IF YOU EV
AMIGA MAG
THIS WI**

May's CU Amiga Magazine cover disk will be worth more than anything we've ever given away before. It will open up new frontiers for expressing your imagination and will be one of the most most important additions to your software collection this year. What is it? Find out on 18th April. It'll be worth the wait.*

*if everything goes according to plan.

NO GAA

Z I N E

EVER BUY AN MAGAZINE AGAIN YOU'LL BE IT!

Newsagent Order Form

CU Amiga Magazine is going ballistic next month and I want a piece of it. Please reserve a copy of the May 1995 issue for me.

Please reserve a copy of CU Amiga Magazine for me until further notice.

My name is:

My Address is:

.....

.....

CU Amiga Magazine is published by EMAP Images Ltd and distributed by Frontline.

Wishful Sinking

The future of Amiga software has never looked rosier - especially through the newly tinted spectacles of games magazine The One's editor Andy Nuttall. Everything is all right, he reckons. Everything is just fine.

The opinions expressed in this column are not necessarily those held by CU Amiga Magazine. If you hold an opinion on the Internet or any other Amiga related topic then email us at CUAMIGA@cix.compulink.co.uk, or the one@cix.compulink.co.uk.



What's all this I hear about 'non-activity' within Commodore? As far as I can remember, there was never that much movement from that company even in its heyday. And the suggestion that its inability to produce more machines is in some way inhibiting the sales of games is hogwash.

Let me explain. If you buy a new Amiga, you're labelled an 'active user', which means in marketing speak that you might go out and buy a new game now and then. Active users remain so for no fixed period of time; maybe minutes, perhaps years, but the general opinion is that the core of active users is constantly reducing in size. Stop making machines and the core market eventually dwindles.

But don't underestimate the size of this core where the Amiga is concerned. There are 2.5 million Amigas in this country, and if even even a small percentage of this number are still buying games, that's a hell of a lot. Sales of Amiga 500 games, almost three years after the machines were last manufactured, proves this. So why worry?

Paper tigers

I'll tell you: poor-quality games. They've always been a pet hate of mine as a reviewer and player, but until now they've never really bothered me. However as releases dwindle slightly, which they invariably do at this time of year anyway, gamers tend to be a little more choosy about what they buy. Those who read the magazine reviews before they go out and spend money, will steer clear of the real stinkers. It's not so much a dying market, it's a

wised-up group of gamers that isn't willing to put up with so much plop any more.

But it's the publishers of bad games who are often the first to leap overboard at the first sign of trouble, their already low sales figures in serious danger of disappearing completely.

Core Design, after gaining an early reputation as one of the best Amiga games publishers, has recently released two, in my opinion, shoddy games: *Skeleton Krew* and *Dragonstone*, while its next game, *Big Red Adventure*, is likely to be its last. Other companies, like ICE (whose latest Amiga game *Akira* is pretty awful, despite the big name licence) are also pulling out of the market along with the odd big player. Why is everyone running away? Why not just produce good games and see good results?

The current bandwagon is being steered by Electronic Arts and Psygnosis, two big-name, big game publishers. EA, after a second sojourn in the Amiga market, has once again decided to stop producing Amiga titles, despite recently purchasing Bullfrog Productions (which has at least one Amiga game still in development). However, because of its US ancestry, and the lack of Amiga presence across the Atlantic, it really comes as no surprise that its Amiga games development has been somewhat shaky.

Shallow grave

Psygnosis, though, is a different story. It recently claimed that *Flink* on the CD32 was its Amiga swan song, which if true would close the lid on a plentiful and reasonably consistent source of Amiga games. Even in this

worst-possible case, though, a spokesperson recently told me that other titles' potential *would* be 'evaluated' for conversion onto the Amiga, and the future will almost certainly hold further *Lemmings* releases.

Attitudes like this, coupled with the recent non-activity of Commodore, have created enough black days in the lives of Amiga gamers to not only send the machine to an early grave but also dig a large adjacent hole accommodating everybody associated with it. Remember what happened to the ST?

But let's get things into perspective. So the big boys are feeling a little edgy producing games for this once-trendy, quirky little machine, from which they have undoubtedly made a fortune over the last ten years. Aaaaahhh. Poor things. It would be nice to think however that these two, Psygnosis especially, would plough in some of the money they earned off the back of the Amiga's early success to help it through this difficult period. But it probably won't happen, especially since Psygnosis was recently bought out by electronics giant Sony.

But somehow this doesn't worry me. Even if Commodore's current situation is never solved, there is still a very large core of active games buyers who are interested in good, new software, and enough good softies who are willing to provide it. Off the top of my head Ocean, Renegade, Team 17, Gremlin, Interplay, US Gold, Black Legend, Acid Software, Bullfrog, Adventuresoft, Sensible Software and Binary Asylum are all planning releases in the near future, while DEM Software and Bomb are two newcomers hoping to make it big on the format. ■

Next Day **£5.00**

2-3 Days **£2.50** Saturday **£10.00**

Deliveries are subject to stock availability

Allow up to 7 days for cheques to clear

POWER

TELEPHONE 01234 273000

POWER COMPUTING LTD
44a/b Stanley St. Bedford MK41 7RW
Tel **01234 273000** Fax **01234 352207**

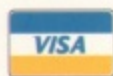

CD-ROM

NEW
CD-ROM
INC. CD³²
EMULATION



£199
x2 CD-ROM

DOUBLE SPEED CD ROM

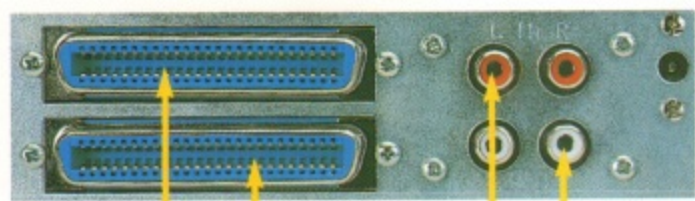

SCSI Connectors

Audio In/Out



£299
x4 CD-ROM

QUAD SPEED CD ROM

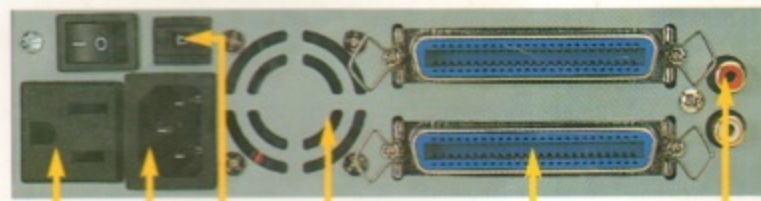

110v

240v

SCSI ID
Switch

Cooling
Fan

SCSI
Connectors

Audio
In/Out

POWER CD-ROM

The new Power CD-ROM for the Amiga 600/1200 plugs directly into the PCMCIA port and provides a direct SCSI-I and SCSI-II interface, allowing up to six additional peripherals to be connected, for example: Syquest Drives, Hard Drives, Flatbed Scanners and Dat Drives. What's more the Power CD-ROM features a 'Hot-Plug' and 'Un-Plug', which allows you to connect/disconnect at any time the Power CD-ROM and any additional devices, even when your Amiga is switched on.

The CD-ROM comes with a SCSI interface, PSU, manual, audio lead, mains lead* and software: Audio CD, CD32 Emulation, MPEG Film Decoder and PhotoCD software.

Amiga 600/1200

Double - Speed
CD-ROM **£199**

Quad - Speed
CD-ROM **£299**

Amiga 4000 No SCSI Interface

Double - Speed
CD-ROM **£159**

Quad - Speed
CD-ROM **£259**

COMPARISON CHART

	POWER	OTHER
DOUBLE SPEED, MULTI SESSION	✓	✓
MAX TRANSFER (INTERFACE)	3MB	1.5MB
CD32 EMULATION	✓	✓
NUMBER OF SUPPORTABLE DEVICES	7	1 OR 2
THRU PORT FOR ADDITIONAL DEVICES	✓	-
HIGH QUALITY METAL CASING	✓	-
FULLY SUPPORTS 'HOT UN-PLUG'	✓	-
AUTOMATIC BOOTING OF CD-ROMS	✓	-
CD + AMIGA SOUND MIXING FACILITIES	✓	✓
COMPATIBLE WITH ACCELERATOR CARDS	✓	?
12 MONTHS WARRANTY	✓	✓
COMPLETE WITH UTILITY SOFTWARE	✓	-
COST	£199	£199

Accessories

Amiga 4000
SCSI-Interface **£129**

Multi-media Speakers
80 Watt **£54**



80 WATT
SPEAKERS
£54

*UK only

Trade and Educational orders welcome - Worldwide distribution available

All prices include VAT. Specifications and prices are subject to change without notice, all trademarks are acknowledged. All orders in writing or by telephone will be accepted only subject to our terms and conditions of trade, copies of which are available free of charge on request.

HIT NAMES - HIT GAMES FOR YOUR AMIGA



"A TOP CLASS SOCCER SIM."

"A must for any football fan."

"Destined to be one of the biggest selling titles of the year."

© 1993 O.G.M.P. All Rights Reserved

1 2 9 9



EUROPEAN
CHAMPIONS



SPACE
HULK



JURASSIC
PARK



HIT SQUAD
2 CASTLE STREET · CASTLEFIELD
MANCHESTER · M3 4LZ
TELEPHONE: 061 832 6633
FAX: 061 834 0650

Screen shots taken from various computer formats

"THIS IS ONE OF THE MOST EXCITING RPG/STRATEGY/SHOOT-'EM-UPS EVER."

"HIGHLY RECOMMENDED."

"...incredibly challenging."

"Buy this game it's smart."

"Plenty of action and gripping play." " ...addictively challenging."

© 1993 Electronic Arts. Warhammer 40,000, Space Marine and the Games Workshop logo are registered trademarks of Games Workshop Ltd. Space Hulk, Death Wing, Genestealer, Assault Cannon and Lightning Claws are trademarks of Games Workshop Ltd. Freeze Time is a trademark of Electronic Arts. Electronic Arts is a trademark of Electronic Arts. Published under license.

1 4 9 9



TRONIC ARTS

"JP IS A BIT OF A CORKER... YOU'LL LOVE THIS."

"A massive and challenging game... Ocean have done themselves proud."

"An atmospheric and addictive game."

TM & 1992 Universal City Studios, Inc. & Amblin Entertainment, Inc.
© 1993 Ocean Software Ltd.

1 4 9 9

