

BYTE

Dual Pentium Pro
Screamers **P.112**

Tools to Direct Your Own
Multimedia **P.122**

Web PC Takes Shape **P.105**

the global authority for computing technology

EXCLUSIVE

INSIDE SUN'S

JAVA CHIPS

HOW WILL THEY TRANSFORM COMPUTING?

PLUS:

- Kill Network Viruses!
- PowerBuilder 5 vs. Centura

BYTE JAVA CHIPS • DUAL PENTIUM PROS • CAIRO, COPLAND, 64-BIT UNIX
NEWS: Hand-Held PCs Are Coming **REVIEW:** Omega Ditto Tape Backup; Cut a Web CD
Volume 21, Number 11



North America



\$3.95 U.S.A./\$4.95 IN CANADA
A Publication of The McGraw-Hill Companies/0360-5280

www.byte.com

LOOKING FOR THE BEST PCs ON THE MARKET?



pentium

MICRONTM
ELECTRONICS, INC.



MILLENNIA™ P166

- Intel 166MHz Pentium® processor
- 512KB pipeline burst cache, flash BIOS
- 12X EIDE CD-ROM drive, 3.5" floppy drive
- 16-bit stereo sound & speakers
- **PCI 64-bit 3D video, MPEG, 4MB EDO**
- Tool-free minitower or desktop
- Microsoft® Mouse, 104-key keyboard
- Microsoft Windows® 95 & MS® Plus! CD
- 5-year/3-year Micron Power™ warranty

- **16MB EDO RAM** • 1.2GB EIDE hard drive
- 15" Micron 15FGx, .28dp (13.7" display)
- Microsoft Works 95 CD

\$1,999 Business lease \$68/month

- **32MB EDO RAM** • 2.1GB EIDE hard drive
- 15" Micron 15FGx, .28dp (13.7" display)
- Microsoft Office Pro 95 & Bookshelf® 95 CDs

\$2,299 Business lease \$78/month

- **64MB EDO RAM** • 3.1GB EIDE hard drive
- 17" Micron 17FGx, .26dp (15.8" display)
- Microsoft Office Pro 95 & Bookshelf® 95 CDs

\$2,949 Business lease \$100/month

- With 133MHz Pentium processor.....subtract \$200
- With 200MHz Pentium processor.....add \$100

MILLENNIA™ P200 PLUS

- Intel 200MHz Pentium processor
- 512KB pipeline burst cache, flash BIOS
- PCI 32-bit Ultra SCSI Fast-20 controller
- 12X SCSI CD-ROM drive, 3.5" floppy drive
- 16-bit stereo sound & speakers
- **PCI 64-bit 3D video, MPEG, 4MB EDO**
- Tool-free minitower or desktop
- Microsoft Mouse, 104-key keyboard
- Microsoft Windows 95 & MS Plus! CD
- 5-year/3-year Micron Power warranty

- **16MB EDO RAM** • 2GB Ultra SCSI hard drive
- 15" Micron 15FGx, .28dp (13.7" display)
- Microsoft Works 95 CD

\$2,899 Business lease \$99/month

- **32MB EDO RAM** • 2GB Ultra SCSI hard drive
- 15" Micron 15FGx, .28dp (13.7" display)
- Microsoft Office Pro 95 & Bookshelf® 95 CDs

\$3,099 Business lease \$105/month

- **64MB EDO RAM** • 4GB Ultra SCSI hard drive
- 17" Micron 17FGx, .26dp (15.8" display)
- Microsoft Office Pro 95 & Bookshelf® 95 CDs

\$4,049 Business lease \$138/month

- With 166MHz Pentium processor.....subtract \$100

HOME MPC™ P133

- Intel 133MHz Pentium® processor
- 256KB pipeline burst cache, flash BIOS
- **16MB EDO RAM** • 1.2GB EIDE hard drive
- 12X EIDE CD-ROM drive, 3.5" floppy drive
- 16-bit stereo sound & speakers
- 28.8 fax/modem, speakerphone, voice mail
- Microsoft® Phone telephony software
- Internet ready: Internet in a Box from CompuServe®/Spry Microsoft Internet Explorer
- Prodigy®, America Online® & CompuServe trial memberships
- PCI 64-bit 3D video, MPEG, 2MB EDO
- 15" Micron 15FGx, .28dp (13.7" display)
- Tool-free minitower or desktop
- Microsoft Mouse, 104-key keyboard
- Microsoft Windows® 95 & MS® Plus! CD
- Quicken® Financial Pak includes: Quicken Deluxe 5.0; Quicken Financial Planner™; Quicken Parents' Guide to Money™; Quicken Family Lawyer™
- Family Pak includes: ABC by Dr. Seuss; Thinkin' Things™ Collection 1; Earthworm Jim™; and Mechwarrior™ 2
- Microsoft Home Pak includes: Works 4.0 for Windows 95; Publisher Deluxe for Windows 95; Encarta® 96; World Atlas; Music Central™ 96; Wine Guide; Arcade 1.0; Scenes—Sports Extremes Collection; Cinemania™ 96; Julia Child Home Cooking; Best of Windows Entertainment Pack; CD Sampler (including Fury™ game demo)
- 5-year/3-year Micron Power™ warranty

\$1,899 • With 166MHz Pentium processor.....add \$200

HOME MPC™ P200

- Intel 200MHz Pentium processor
- 256KB pipeline burst cache, flash BIOS
- **32MB EDO RAM** • 2.1GB EIDE hard drive
- 12X EIDE CD-ROM drive, 3.5" floppy drive
- 16-bit 3D Wavetable stereo sound card
- Advent AV270 2x25 watt stereo speakers
- 28.8 fax/modem, speakerphone, voice mail
- Microsoft Phone telephony software
- Internet ready: Internet in a Box from CompuServe®/Spry Microsoft Internet Explorer
- Prodigy, America Online & CompuServe trial memberships
- PCI 64-bit 3D video, MPEG, 2MB EDO
- 17" Micron 17FGx, .26dp (15.8" display)
- Tool-free minitower or desktop
- Microsoft Mouse, 104-key keyboard
- Microsoft Windows 95 & MS Plus! CD
- Quicken® Financial Pak includes: Quicken Deluxe 5.0; Quicken Financial Planner™; Quicken Parents' Guide to Money™; Quicken Family Lawyer™
- Family Pak includes: ABC by Dr. Seuss; Thinkin' Things™ Collection 1; Earthworm Jim™; and Mechwarrior™ 2
- Microsoft Home Pak includes: Works 4.0 for Windows 95; Publisher Deluxe for Windows 95; Encarta 96; World Atlas; Music Central 96; Wine Guide; Arcade 1.0; Scenes—Sports Extremes Collection; Cinemania 96; Julia Child Home Cooking; Best of Windows Entertainment Pack; CD Sampler (including Fury game demo)
- 5-year/3-year Micron Power warranty

\$2,899 • With 166MHz Pentium processor.....subtract \$100

MILLENNIA TRANSPORT™

- Mobile Intel Pentium processor
- Intel 430MX PCI chipset
- 256KB L2 pipeline burst cache
- 16MB EDO memory (48MB max.)
- 8X modular CD-ROM drive
- PCI graphics accelerator, 1MB EDO memory
- Pick-a-Point™ dual pointing devices integrate both pointing stick and touchpad
- Removable EIDE hard drive
- 3.5" modular floppy drive
- Intelligent modular lithium-ion battery
- 16-bit stereo sound
- Built-in stereo speakers and microphone
- 2 Type II or one Type III PCMCIA slots
- 5-video and NTSC-video outputs
- Headphone, microphone and line-in jacks
- 2 infrared ports, one front, one back
- Parallel, serial, VGA and 2 PS/2 ports
- Dimensions: 11.7" x 9.4" x 2.0", Weight: 6.9 lbs.†
- Nylon carrying case
- Microsoft® Windows® 95 and MS® Plus! CD
- Microsoft Office Pro 95 and Bookshelf® 95 CDs
- Kensington™ security lock ready††
- 5-year/3-year Micron Power™ warranty

† 6.9 lbs. includes 3.5" floppy and one battery
†† Lock secures both Millennium Transport and MicronDock™

OPTIONS

- With 150MHz Pentium processoradd \$200
- With Motorola Montana 28.8 fax/modem.....add \$259
- With 3Com® Ethernet 10BT PCMCIAadd \$149
- With Samsonite® leather carrying caseadd \$99
- With 2nd modular lithium-ion batteryadd \$199
- With primary 2.1GB removable hard drive.....add \$100
- With 2nd hard drive (1.2GB)add \$599
- With 2nd hard drive (2.1GB)add \$699
- With 16MB DIMM module upgradeadd \$349
- With 32MB DIMM module upgradeadd \$749
- MicronDock™ multimedia port replicatoradd \$299
- MicronExec™ desktop packageadd \$799

- 133MHz Intel Mobile Pentium processor
- 16MB EDO memory (48MB max.)
- 12.1" active matrix display, 800 x 600
- 1.2GB removable hard drive

\$4,399 Business lease \$150/month

- 133MHz Intel Mobile Pentium processor
- 32MB EDO memory (48MB max.)
- Motorola® Montana 28.8 fax/modem
- 12.1" active matrix color display, 800 x 600
- 1.2GB removable hard drive
- 2nd lithium-ion battery

\$5,199 Business lease \$163/month

- 150MHz Intel Mobile Pentium processor
- 32MB EDO memory (48MB max.)
- 12.1" active matrix color display, 800 x 600
- 2.1GB removable hard drive
- Motorola® Montana 28.8 fax/modem
- 2nd lithium-ion battery
- Samsonite® leather carrying case

\$5,550 Business lease \$174/month



MILLENNIA™ Pro2 200

- Intel 200MHz Pentium® Pro processor
- Supports dual 200MHz Pentium Pro processors
- 256KB internal cache, flash BIOS
- 12X EIDE CD-ROM drive, 3.5" floppy drive
- 16-bit stereo sound & speakers
- **PCI 64-bit 3D video, MPEG, 4MB EDO**
- Tool-free minitower or desktop
- Microsoft® Mouse, 104-key keyboard
- Microsoft Windows NT® Workstation 4.0 CD
- 5-year/3-year Micron Power™ warranty

- **16MB EDO RAM** • 1.2GB EIDE hard drive
- 15" Micron 15FGx, .28dp (13.7" display)
- Microsoft Works 95 CD

\$2,299 Business lease \$78/month

- **32MB EDO RAM** • 2.1GB EIDE hard drive
- 17" Micron 17FGx, .26dp (15.8" display)
- Microsoft Office Pro 95 & Bookshelf® 95 CDs

\$2,849 Business lease \$97/month

- With 2nd 200MHz Pentium Pro processor...add \$699

MILLENNIA™ Pro2 400 Plus

- **Dual Intel 200MHz Pentium Pro processors**
- 256KB internal cache, flash BIOS
- PCI 32-bit Ultra SCSI Fast-20 controller
- 12X SCSI CD-ROM drive, 3.5" floppy drive
- 16-bit stereo sound & speakers
- **PCI 64-bit 3D video, MPEG, 4MB EDO**
- Tool-free mini-tower or desktop
- Microsoft Mouse, 104-key keyboard
- Microsoft Windows NT Workstation 4.0 CD
- Microsoft Office Pro 95 & Bookshelf® 95 CDs
- 5-year/3-year Micron Power warranty

- **32MB EDO RAM** • 2GB Ultra SCSI hard drive
- 15" Micron 15FGx, .28dp (13.7" display)

\$3,999 Business lease \$136/month

- **64MB EDO RAM** • 4GB Ultra SCSI hard drive
- 17" Micron 17FGx, .26dp (15.8" display)

\$4,949 Business lease \$168/month

- **128MB EDO RAM** • 9GB Fast SCSI-2 hard drive
- 21" Micron 21FGx, .26dp (20.0" display)

\$7,199 Business lease \$226/month



MICRON™

ELECTRONICS, INC.

800-362-7306
http://www.mei.micron.com

900 E. Karcher Road, Nampa, ID 83647 • Mon-Fri 6am-10pm Sat 7am-5pm (MT) • International Sales Hours: Mon-Fri 6am-7pm (MT) • 208-893-3434 • Fax: 208-893-3424

• Purchase Order Fax: 208-893-8992 • Technical Support Available 24 Hours / 7 Days • Technical Support E-mail: techsupport.mei@micron.com

International Sales 208-893-8970 • International Fax 208-893-7393 • Tollfree from Puerto Rico 800-708-1756 • Tollfree from Mexico 95-800-708-1755 • Tollfree from Canada 800-708-1758

©1996 Micron Electronics, Inc. All rights reserved. Micron Electronics is not responsible for omissions and/or errors in typography or photography. All purchases are subject to availability. Prices and specifications may be changed without notice; prices do not include shipping and handling, 30-day money-back policy does not include return freight and original shipping/handling charges, applies only to Micron brand products and begins from date of shipment. All sales are subject to Micron Electronics' current terms and conditions of sale. Lease prices based on 36-month lease. Intel, Intel Inside and Pentium are registered trademarks of the Intel Corporation. Microsoft, Windows, Windows NT and the Windows logo are registered trademarks of Microsoft Corporation. All other service marks, trademarks and registered trademarks are the property of their respective companies. BYT-FM-9611

Circle 173 on Inquiry Card.

WHAT A COINCIDENCE, W

To get an idea of how Micron Electronics™ products have achieved leadership status in the best components available to rigorous performance and reliability tests. The results

FAST 12X CD-ROM

**200MHz PENTIUM®
PROCESSOR**

**32MB ULTRA-FAST EDO RAM
UPGRADABLE TO 128MB**

**HIGH-SPEED 512KB
PIPELINE BURST CACHE**

**EIDE OR ULTRA SCSI
HARD DRIVE**

**ACCESSIBLE
FULL-LENGTH SLOTS**

MASSIVE EXPANSION BAYS

**4MB EDO HIGH-RESOLUTION
3D VIDEO ADAPTER W/MPEG**

**ADVANCED
INTEL 82430HX CHIPSET**



**16-BIT STEREO
SOUND AND SPEAKERS**

**TOOL-FREE CHASSIS
W/SECURITY FEATURES**



THEY HAPPEN TO MAKE THEM.

For reliability, you really have to look inside. We focus on superior engineering, from picking components to the outstanding performance you can count on. Our first-tier reliability status proves it.

RELIABILITY RANKING

1ST TIER



2ND TIER



3RD TIER



Source: PC World Reliability & Service Monitor, May 20 - November 20, 1995



Micron Power™ Warranty & Support

- 5-year limited warranty on microprocessor and main memory
- 3-year limited parts-only system warranty
- 1-, 2- or 3-year optional on-site service agreement for Micron desktop systems
- 30 days of free Micron-supplied software support for Micron desktop systems
- 30-day money-back policy
- 24-hour technical support

The foregoing is subject to and qualified by Micron's standard limited warranties and terms and conditions of sale. Terms and conditions of sale may vary for specific configurations. Copies of the limited warranties may be obtained on our Web site or by calling Micron.

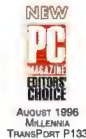

**EDITORS' CHOICE AWARDS
MILLENNIA™ P166 & P133**

**MS WINDOWS® 95 &
MS OFFICE INSTALLED**

MICRON™
ELECTRONICS, INC.







800-362-7306
<http://www.mei.micron.com>

Microsoft Internet Explorer 3.0



Microsoft Internet Explorer

Special Offers

-  The Wall Street Journal Interactive Edition
-  ESPN[®] SportsZone
-  Hollywood Online
-  MTV Online
-  InvestorsEdge
-  And more!



*Connect time charges may apply to all offers.

©1996 Microsoft Corporation. All rights reserved. Microsoft is a registered trademark and the Microsoft Internet Explorer logo and *Where do you want to go today?* are trademarks of Microsoft Corporation. The Wall Street Journal[®] Interactive Edition is a trademark of Dow Jones & Company, Inc. ESPN[®] is a trademark of ESPN, Inc. SportsZone is a trademark of Starwave Corp. MTV is a trademark of MTV Networks, a division of Viacom International, Inc. Hollywood Online is a trademark of Hollywood Online Inc. investorsEdge ©1995 Ethos Corp.

IS YOURS TO DOWNLOAD, ABSOLUTELY **free**,
 COMPLETE WITH **subscriptions**
 TO THE WALL STREET JOURNAL INTERACTIVE
 EDITION AND ESPNET SPORTSZONE,
also free.



STREET JOURNAL.
 INTERACTIVE
 EDITION.

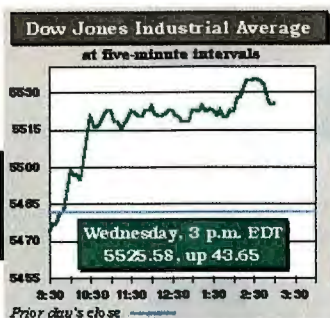

Introducing Microsoft® Internet Explorer 3.0. The new browser that's a step ahead of all the rest. It lets you experience all the coolest content, like sound and animation, that's being developed for the Internet today. It lets you customize the way you access and view the web. And it's yours to download right now, absolutely **free**.* From now through December 31, we have all kinds of special offers that make the experience even better: You get The Wall Street Journal® Interactive Edition, free. It's the web's leading source of business news, with 24-hour updated coverage of world business and deep background on thousands of companies and

topics. You also get a free subscription to the premium areas of ESPNET™ SportsZone,™ the number one destination site on the web, including expert columnists, multimedia highlights, behind-the-scenes reports, in-depth player profiles, and more. Our new browser also gives you free access to "buy, sell, hold" stock recommendations from InvestorsEdge, the Internet's premier financial information service. And there's even special content on MTV™ Online and offers on other sites that can only be seen with it. Just go to www.microsoft.com/ie. Then click one button. And see what a real browser can bring you these days.

Microsoft®

Where do you want to go today? www.microsoft.com/ie

COVER STORY

EXCLUSIVE

JAVA CHIPS

79

By Peter Wayner

Sun's Java chips may run Java code faster than regular CPUs—but will smart compilers soon make these hot chips obsolete?

Tomorrow's CPUs

76

By Alan Joch

They just keep getting faster.

The x86, Faster with Age

89

By Tom R. Halfhill

A guide to the PC chip choices you'll face in the next year.

PowerPC Regroups

101

By Tom R. Halfhill

The PowerPC may break the 300-MHz barrier before the Pentium.

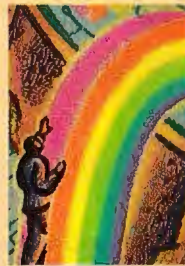

From LAN to WAN with ISDN

104NA 3

By Jeffrey N. Fritz

ISDN can extend your LAN to the Internet, remote users, and enterprise networks. An expert examines the technologies, the pitfalls, and the payoffs.

EDITORIAL

Computing Crossroads

14

By Mark Schlack

Sun's Java chip/Java language combination is the most radical bid for a new computing platform in years.

INBOX

19

BYTE readers write about our Web coverage, NT security, the on-line future, and more.

Inside the NC

105

By Peter Wayner

Are network computers just stripped-down terminals? Not hardly.



Keep Networks Safe from Viruses

167

By Barry Nance

Networks put you at risk from viruses; an enterprise-wide strategy can help keep you safe.

BITS

The Return of Hand-Held Windows

26

Web Info Delivery

27

Cyrix 6x86 Bug

30

Post-Millennium Cruising

30

Plugged-In CD-ROMs

32

FlashPix Graphics

36

Survey: Web Commerce

36

Java Forms

38

Future Notebook Screens

42



New PowerPCs

44

Flying Robots

48

SPECIAL REPORT

Your Next OS

134

By Dick Pountain

Six key issues to consider.

Unix Leads the 64-bit Charge

139

By Laurent Lachal

64-bit OSes are moving from the horizon to the desktop.

Unearthing Cairo

145

By Mark Minasi

Follow the signs to Cairo to get a glimpse of NT's future.

Copland, Revisited

151

By Tom Thompson

A look at the current state of Apple's next OS.

EVAL

Componentized WAV of the Future

49

By Tom Thompson
Digital Harbor's WAV word processor is among the first OpenDoc components for the Macintosh.

Waterproof Color That Lasts

50

By Robert L. Hummel
The Alps MD-4000 prints smudge-proof color images and razor-sharp text. It's also a 600-dpi color scanner.

GroupWise Sends a Message

53

By Steve Gillmor
Novell's Release 5 makes the choice of groupware a tougher decision.



Hybrid Web/CD-ROM: Do It Yourself

54

By Jon Udell
What bandwidth problem? WebCD lets you publish your Web site on CD-ROMs that retain live Internet links.

CORE

OPERATING SYSTEMS

VMS: Alive and Well

59

By Ben Smith
A young horse is fast, but an old horse knows what's going on.

NETWORKS

A File System for the Web

63

By Bob Friesenbahn
A modified version of Sun's NFS can deal with large amounts of Web data.

LAB REPORT

LAB REPORT: HARDWARE



Eight Twin-Engine Pentium Pro Workstations

112

By Maggi Bender,
Dorothy Hudson, Jim Kane,

and John McDonough
Our tests point out the peak performers and the best buys.

LAB REPORT: SOFTWARE

How Multimedia Multitools Compare

122

By David Seachrist
NSTL tests four authoring programs for building mixed-media applications.

WEB PROJECT

On-Line Componentware

129

By Jon Udell
Here's how you can turn your Web site into a flexible software component to build new applications quickly.

COMPARISON

Upgraded C/S Tools: How Much Better?

177

By Mark Hettler
Evaluating new versions of two client/server toolkits: PowerBuilder and Centura Team Builder (the program formerly known as SQLWindows).

REVIEWS

Real-Time RAD

181

By Rick Grehan
Verilog's ObjectGeode does a decent job of marrying real-time control to OO-modeling standards.

Ditto Your Data

184

By Robert L. Hummel
Iomega's Ditto 2GB External drive delivers everything you expect from a portable backup unit: convenience, low cost, ease of use ... and sluggish performance.



CHAOS MANOR

Don't Swap—Network!

185

By Jerry Pournelle
Jerry offers advice on upgrading and engages in another struggle over IRQ assignments, this time under Windows 3.11.

WHAT'S NEW

240

Fractal Design's Expression goes beyond standard vector-drawing packages; Gateway's Solo 2100 S5-120 combines raw power and good looks.



CODE TALK

Visual Age for BASIC...Sort of

248

By Rick Grehan
Visual Age for BASIC has more in common with Visual Basic than with the other Visual Age products.

SERVICE

Reader Service

Inquiry Reply Cards 104A-B, 232A-B

Index To Advertisers

Alphabetical Order 232
Product Category 234
Editorial Index
by Company 236

PROGRAM LISTINGS

FTP: ftp.byte.com
From BIX: Join "listings/frombyte96" and select the appropriate subarea (i.e., "nov96").

**THE BYTE WEB SITE
and THE VIRTUAL PRESS ROOM**
<http://www.byte.com>

BYTE (ISSN 0360-5280) is published monthly by The McGraw-Hill Companies, Inc. U.S. subscriber rate \$29.95 per year. In Canada and Mexico, \$34.95 per year. European surface mail subscriptions \$60, airmail \$85. Non-European subscriptions, \$60 surface mail or \$85 airmail. All foreign subscriptions are payable in U.S. funds that can be drawn on a U.S. bank. Single copies \$3.95 in the U.S., \$4.95 in Canada. Executive, Editorial, Circulation, and Advertising Offices: One Phoenix Mill Lane, Paterborough, NH 03458. Periodicals postage paid at Paterborough, NH, and additional mailing offices. Postage paid at Winnipeg, Manitoba, Canada Post International Publications Mail Product Sales Agreement No. 246492. Registered for GST as The McGraw-Hill Companies, Inc., GST #123075673. **Postmaster:** Send address changes and fulfillment questions to BYTE Subscriptions, P.O. Box 552, Hightstown, NJ 08520. Printed in the United States of America.

WINDOWS

Windows for Tiny PCs . . . 26
CE will bring some Win 95 capabilities to hand-held PCs, PDAs, pagers, and cell phones.

GroupWise Sends a Message 53
Novell's newest version—how's it compare to Microsoft Exchange and Lotus Notes?

The x86 Gets Faster with Age 89
While Intel enhances the Pentium, chip competitors will introduce new x86-compatible CPUs in the coming year.

Eight Twin-Engine Pentium Pro Workstations 112
A 200-MHz Pentium Pro provides great Windows NT performance. Two Pentium Pros are even better.

How Multimedia Multitools Compare 122
A review of four Windows 95-based authoring kits for building multimedia projects.

Your Next OS 134
Points to consider when comparing Windows with other operating systems.

Unearthing Cairo 145
Bits of Microsoft's ambitious project will show up in future versions of Windows NT.

Don't Swap—Network! . 185
Upgrading a CD-ROM under Win 3.11 results in another IRQ struggle at Chaos Manor.

What's New 240
Fractal Design's Expression software brings natural media to vector drawing.

Visual Age for BASIC... Sort of 248
In Codetalk, Rick Grehan looks at IBM's construction kit and discovers where Visual Basic meets OOP.

OS/2

Keep Networks Safe from Viruses 167
DOS-based viruses running on OS/2 and viruses designed to infect native OS/2 executables can create havoc.

MACINTOSH

New PowerPCs Boost Macs 44
BYTE benchmarks show that the latest PowerPC-based Macs offer a performance jolt.

Componentized WAV of the Future 49
Digital Harbor's WAV word processor shows off OpenDoc's potential.

Waterproof Color That Lasts 50
The Alps MD-4000 resin-thermal-transfer printer produces high-quality color images.

The Consumer PowerPC Revisited 67
Motorola's new embedded processor uses a PowerPC core.

PowerPC Regroups . . . 101
The chips will shatter the 300-MHz barrier soon.

Copland, Revisited . . . 151
Apple's next-generation OS promises better performance and new features.

UNIX

VMS: Alive and Well . . . 59
An update on the OS that's probably Unix's closest rival.

Unix Leads the 64-bit Charge 139
While those younger OSes are hanging out in 32-bitland, Unix moves on.

Keep Networks Safe from Viruses 167
The network structure of Unix machines connected to the Internet means the door's open for some viruses.

Real-Time RAD 181
Verilog's ObjectGeode complies with OO standards, but code generation is another thing, our reviewer discovers.

NETWORKS

Eight Twin-Engine Pentium Pro Workstations 112
Some of these speed demons are designed to serve networks.

Your Next OS 133
We take a network's-eye view of the next generation of operating systems.

Keep Networks Safe from Viruses 167
Sharing files on servers and connecting to the Internet present more entry points than ever for viruses.

Upgraded C/S Tools: How Much Better? . . . 177
PowerBuilder goes up against Centura Team Builder in this comparison of client/server development packages.

INTERNET

Web Info the Way You Want It 27
On-line Ginsu knives cut through the jive to carve out what you're searching for.

CD-ROM Weds the Web . 32
A new trend in optical storage: CDs with links to Web sites.

Web-Commerce Polarization 36
Results from the latest BYTE Survey on Internet commerce and privacy. Cookies, anyone?

Sun Gambles on Java Chips 79
We describe the architecture and the technical implications of these radical new processors.

Inside the NC 105
Just what is a Network Computer? Peter Wayner explains why NCs are much more than dumb terminals.

AltaVista	129
Backup	184
Cairo	145
CD-ROM	32, 44, 54, 185
Chips	67, 76, 79, 89, 101
Client/server	177
Componentware	49, 129
Copland	151
Databases	139
Data synchronization	71
Embedded systems	67, 79
Enhanced IDE	112
Groupware	53
HTML	105, 129
HTTP	63, 105
Internet	26, 27, 36, 129
Java	14, 38, 79, 105
Mobile devices	26, 43, 67
Multimedia	122
Multiprocessing 134, 145, 151	
Networking	63, 134, 139, 145, 167
Network Computers	105
OOP	181
OpenDoc	49
Operating systems	59, 134, 139, 145, 151
Parallel processing	71
PCs, dual-CPU	112
PowerPC	44, 67, 101
Programming	71, 122, 129, 177, 181, 248
Printers	50
Real-time applications	181
Robots	48
SCSI	112
Storage, portable	184
Universal Serial Bus	112
Unix	59, 134, 139
Viruses	167
Word processing	49
World Wide Web	27, 54, 63, 122, 129
x86	30, 89, 112

And the

WINNER is...

Pinnacle Micro's
2.6 GB Optical
Storage System



- ✓ Best Overall Removable Media Drive
- ✓ Best High Performance
- ✓ Best Low Cost

Pinnacle's award-winning 2.6 GB Removable Optical Drive

is only \$1695 (MSRP) complete with one optical disk. Based on Pinnacle's unique optical technology, the Vertex™ boasts a 19 msec seek time, a maximum data rate up to 4.3 Megabytes per second, and a fast rotation speed of 3755 RPM. Vertex utilizes removable, high capacity optical media for unlimited storage. Fill up a disk, just pop in another. Data intensive applications such as imaging, networking, digital video/audio, graphics, and data archiving all require the optimum level of data integrity, portability, and fast random access to your information. Vertex can hold up to 2.6 Gigabytes of mass storage on a single cartridge that complies with industry standards for data interchangeability with other 2.6 GB optical drives. Each removable disk is only \$119 (MSRP) and has an estimated shelf life up to 100 years! And now, Vertex-based optical library systems are available in capacities ranging from 40 Gigabytes to 2.5 Terabytes for on-line centralized storage in network environments. Go with the winning removable storage drive from Pinnacle Micro, the optical storage leader.

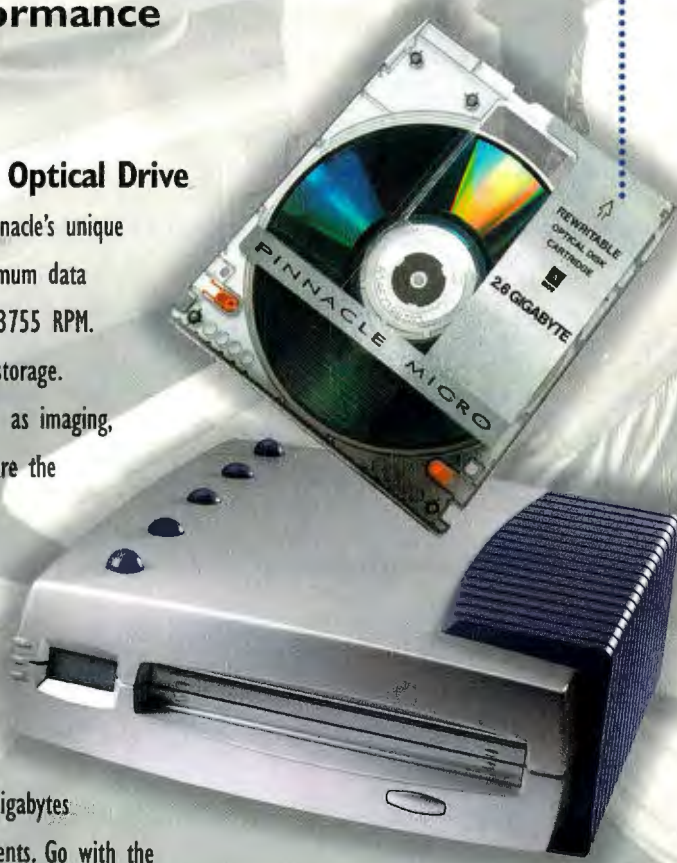

800-553-7070

The Pinnacle Micro logo is a registered trademark of Pinnacle Micro Inc.
All other trademarks are trademarks of their respective owners.

PINNACLE MICRO
THE OPTICAL STORAGE COMPANY

Tel: 714-789-3000 • Fax: 714-789-3150 • <http://www.pinnaclemicro.com>

Circle 155 on Inquiry Card (RESELLERS: 156)

IT'S ONLY LOGICAL THAT INTELLIGENT MANAGEABILITY (NOW, WHAT THE HECK IS IN

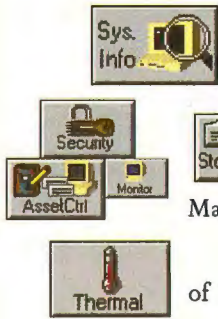

Intelligent
Manageability is kind
of like Extra Sensory

Perception for a computer and every new Compaq Deskpro has it. It lets you know if something's going to happen before it actually does. This way you can manage all of the desktops on your network from one location.

Taking inventory, for instance, of all hardware and software is done simply and efficiently from one Deskpro. Or if a hard drive's about to fail anywhere, you'll know ahead of time. As before, Intelligent Manageability backs up

your data on the network in case of failure; but now, thanks to our new PD-CD drive backup, it also preserves your data locally.

Okay, so our newest version of Intelligent Manageability is smart. But affordable? Considering that the Deskpro line from Compaq starts at around \$1,100*, we think so.

Equally impressive are the high-performance features. Up to Pentium® Pro 200 processors. Choice of PCI graphics. Plus a choice of EIDE and Ultra SCSI hard drives.**

And maintenance? That's easy

*I'm burnt.
I need a vacation.*



because we deliver continually updated support software via our Web site and CDs. And so is upgrading and servicing, thanks to a quick-release CPU hood and accessible components.**

In the end, Intelligent Manageability gives you a lowered cost of



©1996 Compaq Computer Corporation. All rights reserved. Compaq and Deskpro registered U.S. Patent and Trademark Office. Deskpro is covered by our 3-year limited warranty. *Price mentioned is estimated street price with Windows 95. The Intel Inside Logo and Pentium are registered trademarks and the Pentium Processor Logo and the Pentium Pro Processor Logo are trademarks of Intel Corporation. Other products mentioned may be

ILITY ALSO COMES WITH AN INTELLIGENT PRICE.
TELLIGENT MANAGEABILITY?)

Call MIS.



ownership, a three-year warranty and
dedicated toll-free technical support
that's open for business seven days a
week, 24 hours a day. And what could
possibly be more logical than that? For
more, visit us at www.compaq.com or
call 1-800-392-8883.



*The Deskpro line
starts at around
\$1,100**

COMPAQ

Has It Changed Your Life Yet?

Dealer prices may vary. *Features vary by model. Monitor not included. Thermal sensor available only on Deskpro 4000 and 6000. Some features available with Compaq Deskpro and independent software applications. Other features only available trademarks or registered trademarks of their respective companies.

EDITOR IN CHIEF
Mark Schlack

Editor in Chief's Assistant: Linda Higgins

EDITORIAL

EXECUTIVE EDITORS

International: Rich Friedman
New Media: Jon Udell

MANAGING EDITOR

Jenny Donelan

NEWS

Peterborough:

News Editors: David L. Andrews, Martha Hicks

Frankfurt:

Senior Editor: Rainer Mauth

REVIEWS

Director of Reviews: David Essex
Senior Technical Editors: Rick Grehan, Dave Rowell
Technical Editor: Russell Kay

FEATURES

Senior Editor/Features: Alan Joch

Peterborough:

Senior Technical Editor at Large: Tom Thompson

San Mateo:

Senior Editor: Tom Halfhill

Lexington:

Senior Editor: Edmund X. DeJesus

NEW MEDIA

Production Associate: Joy-Lyn S. Blake

SENIOR RESEARCHER

Rowland Aertker

ASSOCIATE TECHNICAL EDITORS

Dennis Barker, Cathy Kingery, Warren Williamson

SENIOR CONTRIBUTING EDITOR

Jerry Pournelle

CONTRIBUTING EDITORS

Dick Pountain, Udo Flohr, Mark LaPedus

CONSULTING EDITORS

Stephen Apiki, Nicholas Baran, Raymond GA Côté, Trevor Marshall, Stan Miastkowski, Barry Nance, Roberta Pournelle, Ellen Ullman, Peter Wayner

EDITORIAL ASSISTANT

June Sheldon

DESIGN

Design Director: Charles Dixon III
Associate Design Director/Design & Photography: Sharon Price
Associate Design Director/Graphics: Joseph A. Gallagher
Designers: Barbara Busenbark, Cindy Sands, Donna Sweeney

FINANCE AND OPERATIONS

Vice President: Claudia Flowers

ADVERTISING PRODUCTION

Advertising Production Manager: Linda Fluhr
Senior Advertising Services Representative: Dale J. Christensen
Senior Advertising Production Coordinator: Lyda Clark
Advertising Production Coordinators: Karen Cilley, Rod Holden
Senior Operations Coordinator: Lisa Jo Steiner
Advertising Graphics Manager: Susan Kingsbury
Graphics Production Coordinator: Christa Patterson

FINANCE

Senior Financial Analyst: Kathleen Deguise
Systems Administrator: Peggy Dunham
Junior Financial Analyst: Diane Henry

CIRCULATION

Director: Susan Blattman
International Circulation Manager: Barbara Copcutt
Subscriptions Manager: Lynn Lagasse
Assistant Subscriptions Manager: Christine Tourgee
Subscription Source Specialist: Carol Sanchioni
Newsstand Manager: Vicki Weston
Assistant Manager: Karen Desroches
Circulation Assistant: Jill Wood

ADMINISTRATION

Human Resources Administrator: Pat Burke
Receptionist: Agnes Perry

MARKETING AND PLANNING

Market Information Manager: Edward Fielding
Market Information Coordinator: Dylan DiGregorio
Marketing Services Administrator: Meredith Bickford

VICE PRESIDENT/PUBLISHER
John M. Griffin

Publisher's Assistant: Donna Nordlund

ADVERTISING SALES

Sales Assistant: Susan Monkton (603) 924-2635

NEW ENGLAND

John Ferraro (617) 860-6221, (212) 512-2555
Jeanne Beeson (617) 860-6349

NEW YORK

Michael Feinberg (212) 512-4811
Jill Pollak (212) 512-3585

MID-ATLANTIC/SOUTHEAST

Neil Helms (770) 242-6298
Paul Franchak (614) 899-4912

CENTRAL U.S.

Lori Silverstein (614) 899-4908
Paul Franchak (614) 899-4912

SOUTHWEST

Bert Panganiban (214) 688-5165
Brian Higgins (603) 924-2596

SOUTH PACIFIC

Beth Dudas (714) 753-8140
Geannette Perez (714) 753-8140

NORTH PACIFIC

Roy J. Kops (415) 513-6861
Lisa Farrell (415) 513-6862

INSIDE ADVERTISING SALES

Assistant: Vivian Bernier (603) 924-2521

BYTE DECK

Brian Higgins (603) 924-2596

EURO-DECK

Mark Stone (603) 924-2533

REPRINT SALES

Susan Monkton (603) 924-2618

INTERNATIONAL ADVERTISING SALES STAFF

Director: L. Bradley Browne (603) 924-2501
Administrative Assistant: Arja Neukam (603) 924-2636
Copyrights Manager: Faith A. Ellington (603) 924-2525
See listing on page 233.

HOW TO CONTACT THE EDITORS

We welcome your questions, comments, complaints, kudos, and submissions.

MAIN OFFICE: One Phoenix Mill Lane, Peterborough, NH 03458, (603) 924-9281.

San Mateo: 1900 O'Farrell St. #200, San Mateo, CA 94403, (415) 513-6912.

Lexington: 24 Hartwell Ave., Lexington, MA 02173, (617) 863-5100.

GERMANY/EUROPE: Emil von Behring Strasse 2, 60439 Frankfurt, Germany, +49 69 5801 123.

ELECTRONIC MAIL: On BIX, send to "editors." All BYTE editors and columnists also have individual mailboxes on BIX for easy access.

MCI: 250-0135 BYTE Magazine. Many editors also have individual MCI addresses in their own names.

OTHERS: Many editors also are reachable through uunet, AppleLink, CompuServe, and numerous other services.

WEB: <http://www.byte.com>
U.S. fax: Editorial: (603) 924-2550

Advertising: (603) 924-7507

U.K. fax: +44 71 495 6734

SUBMISSIONS:

Authors: We welcome article proposals and submissions. Unacceptable manuscripts will be returned if accompanied by sufficient return postage. Not responsible for lost manuscripts or photos.

Vendors: We welcome news of your new products; please call the News department or the Reviews department at the earliest possible date. We cannot be responsible for unsolicited product samples.

ARTICLE REPRINTS: For price quotations on customized reprints of BYTE articles, contact Susan Monkton, reprints manager, at (603) 924-2618. (Minimum quantity: 500.)

SUBSCRIPTION CUSTOMER SERVICE

Inside U.S. (800) 232-BYTE; outside U.S. +609 426 7676. E-mail-based customer service: mpcstsvc@mcgraw-hill.com. Web-based customer service: <http://www.byte.com/admin/mpaddchg.htm>.

International subscribers may also contact our international customer service facility in Galway, Ireland, by calling +353 91 752792 or via fax: +353 91 752 793.

For a new subscription, (800) 257-9402 U.S. only. E-mail: mporders@mcgraw-hill.com or write to BYTE Subscription Dept., P.O. Box 555, Hightstown, NJ 08520. Subscriptions are \$29.95 for one year, \$54.95 for two years, and \$74.95 for three years in the U.S. and its possessions. In Canada and Mexico, \$34.95 for one year, \$64.95 for two years, \$87.95 for three years. Internationally, US\$60.00 for fast surface delivery, US\$85.00 for air delivery. Single copy price is \$3.95 in the U.S. and its possessions, \$4.95 in Canada. Foreign subscriptions and sales should be remitted in U.S. funds drawn on a U.S. bank. Please allow six to eight weeks for delivery of first issue.

PHOTOCOPY PERMISSION:

Where necessary, permission is granted by the copyright owner for those registered with the Copyright Clearance Center (CCC), 222 Rosewood Dr., Danvers, MA 01923, to photocopy any article herein for personal or internal reference use only for the flat fee of \$1.50 per copy of the article or any part thereof. Correspondence and payment should be sent directly to the CCC, 222 Rosewood Dr., Danvers, MA 01923. Specify ISSN 0360-5280, \$1.50. Copying done for other than personal or internal reference use without the permission of The McGraw-Hill Companies, Inc., is prohibited. Requests for special permission or bulk orders should be addressed to Faith Ellington, copyrights manager, (603) 924-2525. BYTE is available in microform from University Microfilms International, 300 North Zeeb Rd., Dept. PR, Ann Arbor, MI 48106 or 18 Bedford Row, Dept. PR, London, WC1R 4EJ, U.K.

Copyright © 1996 by The McGraw-Hill Companies, Inc.

BYTE

A Division of The McGraw-Hill Companies

All rights reserved. BYTE and **BYTE** are registered trademarks of The McGraw-Hill Companies, Inc. Trademark registered in the United States Patent and Trademark Office.

 Member Audit Bureau of Circulation

BIX GLOBAL CONFERENCING SYSTEM. AN ON-LINE COMMUNITY

ACTING MANAGING EDITOR

Peter Olson

INFORMATION ENGINEER

Peter Olson

MEMBER SERVICES MANAGER

Chuck Greenslit

EXCHANGE EDITORS

Amiga Exchange: Joanne Dow
Entertainment and Leisure Exchange: Rich Taylor
IBM Exchange: Barry Nance
Programmers Exchange: Bill Nicholls
Professionals Exchange: David Reed
Tojerry Exchange: Jerry Pournelle
Windows Exchange: Karen Kenworthy
Writers Exchange: Wayne Rash Jr.
Macintosh and Other Exchanges: At Large

BIX is the BIX Information Exchange, your best source for technical advice. BIX is owned and operated by Delphi Internet Services Corporation. Find us on the Web at <http://www.bix.com/> (all browsers are welcome). E-mail our autoresponder at info@bix.com or fax us at 617-441-4902. Dial us by modem at 800-695-4882 or 617-492-8300 (V.34 28.8kbps). Telnet to x25.bix.com or call us (voice) at 800-695-4775 or 617-354-4137. Connect via packet networks to host BIX. Look in the last few pages of this magazine for our advertisement.

The world is changing faster than you think; don't be caught by surprise!

OFFICERS OF THE MCGRAW-HILL COMPANIES:

Chairman and Chief Executive Officer: Joseph L. Dionne; *President and Chief Operating Officer:* Harold W. McGraw III; *Senior Vice President and General Counsel:* Kenneth M. Vittor; *Executive Vice President and Chief Financial Officer:* Robert J. Bahash; *Senior Vice President, Treasury Operations:* Frank D. Penglase; *President, Information Services Group:* Michael K. Hehir; *Vice President, Information Technology and Communications Group:* Kevin C. Harold.

Founder: James H. McGraw (1860-1948).

Deliver Industrial-Strength Decision Support Tools and Watch the Sparks Fly!

Delivering effective decision support for hundreds or thousands of users is definitely not child's play. It takes powerful, mature tools. IQ Software's decision support tools are industrial-strength, best-of-breed products that can be deployed individually or as a total decision support solution.

IQ/Objects™ Robust Query and Reporting

For end-user query and reporting, IQ/Objects is simply unbeatable. This award-winning tool's familiar, easy-to-use Microsoft look and feel belie the awesome power of its true object-based technology. IQ/Objects supports everything from simple ad hoc queries to the most sophisticated cross tabulations. Reusable objects let users combine new queries and reports with previously saved ones to create sophisticated reports easily and quickly. A selection of templates makes it easy to create presentation-quality results in minutes.



IQ/SmartServer™ Three-Tier Architecture

IQ/SmartServer provides production reporting, scheduling and job monitoring facilities. This elegant three-tier architecture implementation harnesses the power of servers (UNIX and NT) to reduce network traffic and deliver a scalable, manageable, high-performance solution. IQ/SmartServer cures fat client performance problems without limiting user access to information.

IQ/Vision™ Multidimensional Analysis

IQ/Vision works directly with relational databases and Arbor's Essbase or can be implemented with its own MDDDB to deliver a complete OLAP solution. For robust multidimensional and drill-down analysis, nothing is easier to use or functionally as rich as IQ/Vision. An intuitive interface displays information in interactive charts or cross tabs, allowing any user to visually slice and dice, drill up and down, nest dimensions, flip axes, and rotate dimensions – all with point and click simplicity.

"IQ/Objects – A breakthrough technology for query and reporting tools."

Aberdeen Group

"IQ Software has brought the power of objects to mainstream business intelligence."

Patricia Seybold Group

"IQ/Vision is an extremely powerful and easy to use OLAP tool that shines with complex data."

Information Week Labs

IQ/LiveWeb™ Web-enabled Decision Support

IQ/LiveWeb links corporate databases and cyberspace, turning your intranet into a source of live database information. With IQ/LiveWeb, users can request and view reports anytime, anywhere using a standard Internet browser. IQ/LiveWeb lets you design and build database reports, charts and cross tabs.

Server-based publishing makes it easy to keep those reports current. Simply tell IQ/LiveWeb the schedule. That's it. IQ/LiveWeb automatically executes your requests, refreshing the information and publishing it to your intranet.

Special Offer! For a limited time, download a fully operational copy of IQ/LiveWeb, valued from \$4,000 to \$20,000, absolutely free. See <http://www.iqsc.com> for details.

Start the sparks flying! Contact us today for details on our industrial-strength tools.

DOWNLOAD
FREE
SOFTWARE



800-458-0386

info@iqsc.com

<http://www.iqsc.com>

European Subsidiaries & Affiliates: UK (44) 1-962-844-777, France 33 (1) 474-903-04, Italy-Dexia Italia (39) 6-517-933. International Distributors: Australia (61) 2-369-1932, 2-975-7669, 2-436-2788, Canada-Information Access (416) 620-5811, Chile (56) 2-341-4785, Hong Kong (852) 2541-9900, Mexico (52) 5-575-6098, Singapore(65) 298-3838, South Africa (27) 11-421-4800, Spain (34) 50-27-55-11. For distributors in all other Pacific Rim countries, call (65) 334-1936; European countries call the UK office, and all others call IQ Software's U.S. headquarters.

Circle 179 on Inquiry Card (RESELLERS: 180).

Computing Crossroads

Will it be Intel inside or Java everywhere?

This month, our Cover Story (which is the State of the Art section) highlights the most radical bid in years for a new computing platform: Sun Microsystems' Java chip/Java language combination. This is not just an alternative to Intel/Microsoft computing, à la the PowerPC/Mac OS package. It's a reinvention of the computer into a more universal, versatile, and interoperable device. The Java model could obliterate many of the distinctions between standard computers, embedded systems, and products still to come, such as intelligent cable boxes and cellular phones.

For years, we've lived with chips that will run almost anything and languages that will run on almost anything. Java chips will give us performance where we need it—running Java applications—while the Java environment will give us interoperability with every other hardware platform.

Sun hopes that electronic designers, corporate information technology (IT) departments, and, ultimately, end users will find this so compelling that they will leave behind the Intel architecture. However, it's a tall order. Look at how hard it's been for the mighty PowerPC troika of Apple, IBM, and Motorola to make headway against the x86 line.

Still, I think Sun will win a significant place with its Java chips. In the last year, we've started to hear some awful gnashing sounds coming from Redmond, as Microsoft grinds off a few gear teeth trying to keep up with the paradigm shift toward the Web. On the hardware side, Intel hasn't made any major adjustments to the infobahn. Check out our story on Intel's road map ("The x86 Gets Faster with Age") on page 89, and the only new signs that you'll see are those for mul-

timedia. Keep those MIPS coming!

There's no question that simpler, cheaper, faster PCs will spread computers to people who have never used them before. As business communications and public commerce march relentlessly toward computerization, the network computer (NC), or Web PC, or whatever you call it, will proliferate (see "Inside the NC" on page 105). Ditto for new devices we haven't named: the wireless gameboy-phonebrowseremotecontrol and such.

But Sun may be ahead of its time. When will the network infrastructure arrive to make fully networked computing possible? It will definitely be a year that begins with 20 before we have the kind of end-to-end digital broadband network we'll need.

So don't put all your money on one horse just yet—you'll need both Java and

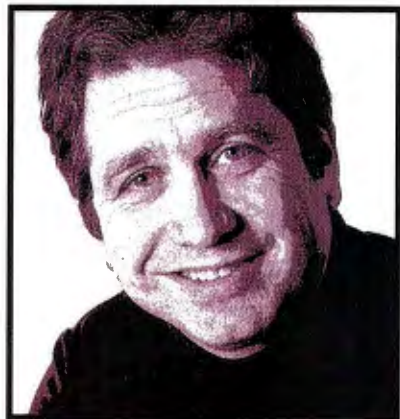

think about computing. Can it be a coincidence that Microsoft has revived its hand-held computer OS project, now called Pegasus? Or that Oracle hopes Intel will buy into its Network Computer concept? That's not the end of it: Look for

It will be a year that begins with 20 before we have the kind of broadband network we'll need.

Wintel for the foreseeable future. Java chips and the Java language will solve some of client/server's thorniest problems. (Do you really want to individually maintain hundreds of PCs that are nothing more than cash registers or data-entry terminals?) The Java duo will also make lots of cool but dumb stuff like cellular phones much smarter.

Yet our familiar OSes and applications make the classic PC—Intel, PowerPC, or whatever—much more flexible than those devices will ever be. Throughout the next decade, I may want a Java unit for the office and a self-sufficient but connectable machine for computing on airplanes or when I'm otherwise outside the wired urban hubs of the world.

Win, lose, or draw in the commercial war, Java has already changed the way we

traditional OS vendors to let you turn the desktop GUI into a screen onto which you project server-based applications, NC-style.

Users' interests lie in being able to flexibly combine the best elements of the Java concept with the best of what we have now. For example, products such as Notes and higher-end database managers can choreograph local and centralized data management. Make that skill widely available to all sorts of applications, and we'll have the best of both worlds.

Mark Schlack

Mark Schlack, Editor in Chief
mschlack@bix.com



**“Open mail.
Tom, the
contract arrived.
I need your
input. Bill.
Send.”**

INTRODUCING DESKTOP COMPUTING WITHOUT THE DESKTOP



I UNDERSTAND Isn't the most natural interface of all your voice? So how come you're still chained to a keyboard? Why don't you just talk to your computer while you get on with the zillion other things that need your attention? Sound impossible? Not anymore, because we've incorporated IBM VoiceType speech recognition technology into the best desktop operating system solution money can buy: OS/2® Warp 4. Which means you can have hands-free e-mail, voice Internet navigation, even dictation into most all your applications. All at the sound of your voice. So now you'll be able to get on with your work while you get out from behind your desk.

With a great new graphic interface, OS/2 Warp 4 is the ultimate network computing solution that lets you connect to almost anything, from just about anywhere. All it takes is a couple of mouse clicks and you're into your drives, printers, networks, servers and Web pages. It even comes with Java™ runtime so you can run Java applets from your desktop without a browser. And now you can also download a native OS/2 Warp 4 version of Netscape Navigator™ from our website at no additional charge.* All in all, whether you're in the office or on the road, there's no better universal client. Wherever you happen to be in the universe.

Solutions for a small planet™ 

GET

a free interactive demo CD that allows you to experience the benefits of “hands-free computing” by visiting our website at www.software.ibm.com/info/w442, or call 1 800 326-2504.

*Beta version. IBM reserves the right to modify or withdraw this promotion at any time. IBM and OS/2 are registered trademarks and VoiceType and Solutions for a small planet are trademarks of International Business Machines Corporation. Netscape Navigator is a trademark of Netscape Communications Corporation. Java is a trademark of Sun Microsystems, Inc. © 1996 IBM Corp. All rights reserved.

**PRESENTING A
STRAIGHTFORWARD,
NO-NONSENSE
COMPARISON OF
DEVELOPMENT
PLATFORMS FROM,
WELL, LET'S SEE IF
YOU CAN GUESS.**

COMPATIBILITY	MICROSOFT® EXCHANGE	LOTUS NOTES®
Platforms	Windows 95® Windows NT™	Windows 95® Windows NT™ OS/2® Novell Netware® IBM AIX® Sun Solaris™ HP-UX™ Apple Macintosh® Digital Alpha
Database/ TP Integration	Microsoft SQL Server ODBC	Microsoft SQL Server™ ODBC™ Oracle® MQSeries™ CICS™ IMS™ HP-UX™ AS/400®
Applications Development Tools	Microsoft Visual Basic	Microsoft Visual Basic® C++ C API Lotus Script® Notes™ Agent Builder Revelation ViP™ Brainstorm VB/Link™ JAVA

Source: Microsoft Website and Lotus Website 8/12/96

For more information (and
a clue as to who paid for
this ad) visit our website
at www.lotus.com/compare.

Radical technology embedded



New 33MHz Intel386™ EX
embedded processor



QNX RTOS with
Photon microGUI™

QNX
The Leading Realtime OS for PCs

New RadiSys R380EX
system controller



The New EXPLR2: All the hottest embedded technologies on one handy eval board!



Combine the latest products from the leaders in embedded PC technology and what do you get? Faster time-to-market. More functionality with less hardware. A longer production life for your product. And a lot less work.

Intel's EXPLR2 makes your design work easy. All the hardware you need is fully integrated, so you can start prototyping right away. Just cut and paste to create your custom system.

The EXPLR2 also comes with QNX, the realtime OS that delivers high-end performance, even on low-cost hardware. QNX gives you a POSIX-certified environment and a full-featured GUI in under 1MB of memory!

Better yet, the design-capture files come included. Commitment. With their long-term commitment to embedded applications, Intel, RadiSys, and QNX Software Systems are the right companies to give your designs a real future. **Radical!**

For your free reference design kit
surf: www.explr2.com
or call: **800 862-1883**
(to order a board, contact your Intel distributor)

Circle 159 on Inquiry Card.

QNX is a registered trademark and Photon microGUI is a trademark of QNX Software Systems. Intel and Intel386 are registered trademarks of Intel Corporation. RadiSys is a registered trademark of RadiSys Corporation.

The Future On-line

I found the vision of the on-line future that Mark Schlack described in "Smart, Fast, and Well Connected" (September Editorial) stimulating and bracing. However, I don't believe that vision will be fully realized until the companies concerned with building the global infrastructure forget the idea, at least for a quarter of a century, of making substantial money out of it. The Internet arose out of a sense of collective experimentation that had little to do with the profit motive. Tim Berners-Lee is not as wealthy as Bill Gates by a long way!

Paul Richards
East Finchley, London

I agree it will take visionaries to make the intelligent network happen, but they won't have to ignore the profit motive. For some time, the telecom industry has been making the transition from hardwired, inflexible switches to a software-defined network, and for their own reasons: efficiency, manageability, expandability, and the ability to sell value-added services. Once the network is programmable, nearly anything is possible. The biggest obstacle will be for carriers to act more from their customers' perspective. —Mark Schlack, editor in chief

Wizard Review

Kudos to BYTE for the crisp and substantive review of

the OS/2 Warp 4.0 beta ("You Talk, Warp Listens," September). I have my sights set on installing Merlin as soon as it arrives, and the article gave me sufficient edge to coordinate my programming strategy starting today. Now I will pass around that issue of the magazine to my 30 OS/2 coworkers, and I will buy future issues.

Mark A. Ehlen
Germantown, MD
me13@cornell.edu

Cover Story Uncovered

BYTE is usually pretty good, but the August cover is misleading. There is no article called "Run Your Business on the Web" but rather something called "Your Business Needs the Web." These are not even remotely the same thing. To run a business you need marketing, production, financial, and personnel strategies. Your article doesn't touch on these. And yes, I really did expect it to, or at least to show examples of businesses that are unique in how they exploit new opportunities enabled by the Web. I don't care what not-for-profit organizations like NASA and Harvard are doing with mammoth budgets and half the brainpower in the free world; show me what economies my business can achieve or how it could be transformed in the short as well as the long term.

Greg Graham
gregg@idacom.hp.com



I did on the development side of BYTE's business. Now I build things and write about what I learned. What cuts through all the Internet hype for me is simply the fact that this has become possible. It's just plain exciting. —Jon Udell, executive editor

Inspiration and Perspiration

Let me be the one-millionth customer to point out that Thomas A. Edison did not exactly work "on his own" in his lab ("The Elements of Design," August). He may have in the early days, before he set up his lab, but not later. He had lots of assistants with whom he interacted and to whom he assigned "polishing up" tasks. Many historians feel that those people received nowhere near the recognition they deserved.

K. Steven Knudsen, Ph.D.
Resolute Research Ltd.
Calgary, Alberta, Canada

You're not quite the millionth customer to point this out. However, you're the first to realize that I was talking

Refreshing!

I get sick of all the hype and misrepresentation about the huge shift that has happened with the Internet. So many articles, so little substance. "Your Business Needs the Web" was different. It was well written, well researched, and informative—a breath of fresh air. I think you actually touched on the real issues, challenges, and exciting prospects facing all us poor slobs who have to implement this stuff.

Ryan Sutter
Ryan.Sutter@mortenson.com

Thanks! Used to be, I wrote about a lot of things that were far removed from what

HOW TO CONTACT US		
ON THE WEB Visit The BYTE Site! Search our archives. Download articles. See industry press releases. Join on-line conferences with other BYTE readers! www.byte.com .	BY E-MAIL Address letters to editors@bix.com. To reach individual BYTE editors, see The BYTE Site on the Web for a directory. Letters may be edited for publication.	SUBSCRIPTION CUSTOMER SERVICE U.S. only: (800) 232-2983; international: (609) 426-7676; or see www.byte.com/admin/mpcstsvc.htm
BY FAX (603) 924-2550	BY POST Editors, BYTE, One Phoenix Mill Lane, Peterborough, NH 03458	For advertising and other noneditorial contacts, see page 10 or click on the Information link on The BYTE Site.

about his early days. I certainly did not intend to rewrite history. It might have made good closure to the article to point out that Edison adopted this administrative model for his research work. The same model is used today, but on a larger scale. —Tom Thompson, senior technical editor

Token Token Ring

In this age of political sensitivity, I was disappointed to see you slip into a minority-unfriendly attitude in "Mainstreaming Pentium Pro" (August). No, you didn't bash a political minority—just a technical one. A significant portion of the networked world uses Token Ring, and we know that "built-in networking" is media slang for "built-in Ethernet," which for us translates into "a tax on minorities." May the Deity, if H/She exists, bless AST for not wasting the electricity and materials for such a device on those of us who live happily without. Otherwise, nice job!
Tim Schultheis
Victoria, MN

OS Insecurity

In "Air-Tight Windows NT" (August), author Jim Reynolds states that the U.S. National Security Agency granted Windows NT 3.5 C2-level approval. What few people know is that this evaluation was limited to a stand-alone computer and did not include network interfaces. If a user hooks up an NT server to a network, the computer can no longer be considered C2-secure until almost all network functionality is disabled. Failure to mention this is

misleading and lures users into a false sense of security. The article also doesn't mention the so-called "boot floppy" vulnerability of Windows NT. By booting from a floppy and using assembly language utilities, a person can bypass NT security and can read, write, and delete files from the hard disk without leaving a trace.

Karl Pottie
Rumbeke-Roeselare, Belgium
karl@vl-brabant.be

The security features I discussed also apply to networked computers. NT is currently undergoing network evaluation (the NSA usually conducts stand-alone and network evaluations separately). But remember, the evaluated configuration, which includes hardware and software, might not match what you have or need. The NSA team was aware of the boot-with-floppy issue; the evaluated configuration prohibited physical access to the floppy. A less stringent need for security might take advantage of the common PC feature that prevents booting from a floppy. Of course, without physical security this solution can be circumvented. The bottom line is that if you can boot a different OS, then none of the security mechanisms of NT work. This is to be expected with any OS. What makes the NT case appear different is the ubiquitous character of the hardware platform and the fact it is generally designed to boot from floppy, unlike older, time-sharing systems such as Unix.
—Jim Reynolds

Xyratex Omitted

While your news story on Serial Storage Architecture ("SSA Products Deliver Bet-

ter Storage," September Bits) was informative, it neglected to mention that Xyratex supplied the pair of eight-SSA-disk desk-side tower units (\$9000) for BYTE's testing of this hot technology. We also manufacture single-SSA-disk desktop models and 16-SSA-disk rack-mount devices and a complete line of test equipment for SCSI, SSA, and Fibre Channel interfaces.

Roger Nixon
Xyratex International Ltd.
71740.3316@compuserve.com

Mr. Nixon is correct. We apologize for the oversight.
—Editors

Apache

I've been reading your Web Project column on Web site management with growing amazement. How can you continue to write about the Web without ever mentioning the world's most popular Web server, Apache? Apart from this glaring deficiency, it's an interesting column.

Ben Laurie
Freelance consultant and technical director
A.L. Digital Ltd.
London
ben@algroup.co.uk

I use Apache on my main conferencing server, a Linux machine, and, in fact, I mention that in this month's Web Project. Currently, I'm experimenting with dual-mode NNTP/Web conferencing, where the primary message base is handled by INN, but a Web view—which now includes posting as well as reading capability—echoes the message base using Apache. The conference, which will now become an ongoing accompaniment to the column, is

at <http://dev4.byte.com/joncon/threads.html> or [news://dev4.byte.com/joncon](http://dev4.byte.com/joncon).
—Jon Udell, executive editor

Java and Forth

After reading your August issue with all those Java articles and code examples, it became very clear that we old-timers can pull our Forth manuals out of storage and put them to use again. If Java basically is Forth, is this a copyright infringement?
Thomas A. Naegele, DO
Albuquerque, NM
tanman@swcp.com

The Java and Forth virtual machines do share many common elements, but the syntax of the Java language is quite different from Forth's.
—Rick Grehan, senior technical editor

Why Not Tao?

In "Weird, Wacky, and Wonderful" (August Editorial), you question whether distributed computing can be made to work. The technology to do this already exists in the form of the Tao operating system, which has been reported on by your own U.K. correspondent, Dick Pountain, in "Parallel Course" (July 1994). The big advantage of the Tao OS's translated system is that the speed penalty is only about 1 percent; this leads inevitably to the fact that it reduces the processor to a commodity item, something that can only benefit the consumer. For more information about Tao's technology, go to <http://www.tao.co.uk/>.
Russel Hughes
rhugesc@cix.compulink.co.uk

Tao Systems is still actively talking to telecom and elec-

3 "Three-peat"

Unprecedented Winner of 3 Editor's Choice Awards in 1996



September 24, 1996
SAG STA Pentium Pro 200



February 20, 1996
SAG STF 166 Pentium



February 20, 1996
SAG STF 150 Pentium

S E R V E R S W O R K S T A T I O N S L A N S R A I D S T O R A G E

Want a custom built system?

Until SAG, that meant high-priced VARs and other costly consultants.

Want to pay less for your system without compromising on quality?

Until SAG, your only options were pre-configured systems and their many limitations. SAG uses only the highest quality components the marketplace has to offer and still provides you with the best cost!



Don't Settle for Less.

We don't build it until you buy it! Now you can have custom quality configurations *without* compromise. All SAG solutions are precision-built and packed with features. We offer the latest in technology, with speed, data integrity, and compatibility in mind. For affordable disk arrays, tape backup solutions and RAID 5 technology, SAG Electronics is the acknowledged "High-End Solutions Company."

The Choice Web Server

Companies like *Business Week Magazine* are choosing SAG Electronics as their high performance web server solution.

Quad Pro 200MHz RAID 5	Dual Pro 200MHz SMP	Pro 200 Workstation	Alpha 433 Power System	Dual Ultra 200MHz
2 Intel Pentium Pro® Processors Exp. to 4	Intelligent Management System reduces cost of ownership. Built-in Expandability with SMP Natoma Chipset	1 Intel Pentium® Pro Processor	256 Bit Bus	1 Intel Pentium® 200MHz Processor, Upgradable to 2 CPUs
64MB of ECC 4 way Interleaved Memory to 1GB	1 Intel Pentium® Pro 200 Processor	32MB of 60 NOS EDO RAM Expandable to 128MB	1MB SRAM Cache	Triton II Chipset
Slots (6) PC; (4) EISA	32MB of 60 NOS RAM Expandable To 512MB	ECC Supported	1 DEC 433MHz Alpha CPU	32MB RAM Expandable to 256MB
Adaptec 3940 UW	ECC Supported	SLOTS: (4) PCI, (4) ISA	64MB RAM to 1GB	Slots (4) PCI, (4)EISA
Quantity: 3, 4.1GB UW Removable HD	Imagine 128 Series II 4 MB VRAM	3GB 5400 RPM 9.5ms HD	8x CD-ROM	Sony 8x CD-ROM
RAID 5 Ultra Wide Controller	Integrated on Board: • Adaptec 2940 UW • 16-Bit Sound Card	Matrix 2MB WRAM Video	ELSA Gloria 8 Video Card	Floppy, Mouse
8x CD-ROM	• Intel 10/100 PCI Ethernet • Asic for Hardware Monitoring	16 Bit Sound Card	4GB 7200 RPM	Imagine 128 Series II 128 Bit "3D" 4MB VRAM Video
#9 2MB DRAM Video	4.1GB Ultra Wide SCSI HD	Sony 8x CD-ROM	SCSI Wide HD (8ms)	2940 UW
8GB DAT Drive	Sony 8x CD-ROM	Keyboard, Floppy, Mouse	Slots (4) PCI, (2) ISA,	2.1GB Ultra SCSI Wide HD (8.5ms)
Quad PCI Ethernet 10/100	Keyboard, Floppy, Mouse	Midtower	Tower 300 Watt	32 PNP Sound
Floppy, Keyboard and Mouse	Tower Case 300 Watt			Midtower Case
12 Bay Tower 450 Watt Power				MAG 170XT Monitor
				\$3530
				Single Processor Motherboard Solution
				\$3280
\$13000	\$3350	\$2159	\$7990	

AT&T on-site and 4 year extended warranties are available. Lease options available. Returns may be subject to restocking fee. RMA# must be acquired. Some devices have not been approved by the Federal Communications Commission. These devices are not, and may not be, offered for sale or lease, or sold or leased until the approval of the FCC has been obtained. GSA Schedule #GS-35F-31103D

SAG ELECTRONICS

High Quality Custom-Configured Systems at Off-the-Shelf Prices

1.800.989.3475

SAG Electronics • 451 Andover Street • North Andover, MA 01845
508-882-2055 Fax 508-889-0180 Hours: 8:30am-7:00pm, Monday-Friday EST
5 Year Limited Warranty
<http://sagelec.com>

We've solved your inter-connecting puzzle.

Avoid the twists and turns in choosing your communications software. FaxFacts is your one stop source for enhanced fax/voice solutions.

- Fax documents from any Windows application
- Complete transaction reporting
- Total network support
- On-line credit card authorization
- Fax over network from multiple workstations

DEMO:
847-923-3030
DOC. NO. 889812

Faxfacts®

by
Copia International Ltd.
Wheaton, Illinois 60187
(800) 689-8898
(630) 682-8898

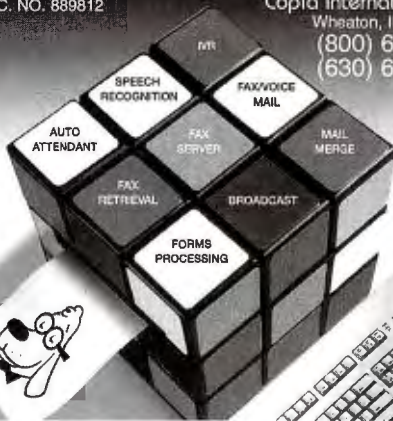

SEE US AT
COMDEX
BOOTH
S4661

Multi-screen Windows NT System

controls from 2 up to 12 monitors using PCI bus based single- or multi-channel graphics boards in a PC.

The NT-Walk product supplies a large virtual screen of multiple monitors for the Windows NT user in a PCI bus based PC system. NT-Walk consists of graphics software drivers and PCI graphics boards. All Windows 3.1, Windows 95 and Windows NT compatible applications can be run on the large screen of multiple monitors.



Resolutions for one channel from VGA up to 1280x1024 or 1600x1200 pixels. Applying 4 graphics channels with 1600x1200 resolution each and 4 monitors in a 2 by 2 configuration can reside a 3200 by 2400 pixel total resolution for example.

Specifications
Compatibility Windows NT Workstation 3.51 or 4.0
Controllers single- or three-channel PCI boards
Accelerators S3 or Weitek
No. of boards from 1 up to 4 in one system
No. of monitors from 2 up to 12 in one system
Resolution from VGA up to 1280x1024 or 1600x1200 each monitor screen
Total resolution sum of all monitor screens
Platform PCI motherboards with Intel processors

DEXON Systems Ltd.
For all technical and commercial questions:
Fax: +36-1393-2618 **Phone:** +36-1393-2617
E-mail: sales@dexon.datanet.hu
Web: http://www.datanet.hu/dexon
Distributors' fax:
USA: +1-310-941-5757
Japan: +81-337-679-709
UK: +44-1959-700-300
All other countries please fax:
+36-1-393-2618

Customized and UNIX based solutions are available.

tronics companies but has yet to name any licensees. That's why we haven't covered the Tao operating system recently. If any deal is announced or new development occurs, we'll be sure to mention it.—Dick Pountain, contributing editor

FIXES

Due to editing errors, we omitted some text in "Cyril 6x86 Matches Pentium," (September Bits). The \$1500 price we cited in the article was meant to refer to the approximate cost of the SCSI controller with 64 MB of memory, not the entire system. The price at the end of

the story is the correct approximate system price. We also said the Cyrix system had 64 MB of RAM. The SCSI controller had 64 MB of memory; the Cyrix system itself had 32 MB of RAM.

The rightmost graph in the figure "SQL Server Performance" on page 162 of the Quad Pentium Pro Server comparison (September) was mislabeled. The scale at the bottom should have read 1 to 4, reflecting the number of processors.

In "Microsoft Catches Up with Netscape" (September), we referred to "Sun's JavaScript." JavaScript is a Netscape product.

COMING UP IN DECEMBER

COVER STORY

The Microprocessor at 25

BYTE examines how, in 25 years, the microprocessor has changed the world. We'll also explore the evolution of microprocessor design and where it's going, and we'll bring you the views of industry luminaries on the impact of future advances in computing technology.

EXCLUSIVE!

Hot New Processor

We take a detailed look at Exponential's PowerPC-compatible bipolar chip, which delivers clock speeds in the range of 500 MHz.

STATE OF THE ART

Next-Generation Internet Applications

As a platform for distributed applications development, the Internet is dynamic but immature. BYTE takes a close look at evolving standards for directory services, e-mail, and security and explains what they'll mean for developers deploying enterprise-wide applications on the Net of 1997 and '98.

HARDWARE LAB REPORT

Network Laser Printers

NSTL tests monochrome laser printers with output speeds of 17 to 32 pages per minute. Here's where to find the one that can meet the needs of large corporate departments and small businesses.

SOFTWARE LAB REPORT

Lotus Notes and Microsoft Exchange

Which of the groupware heavyweights is best for your business? NSTL's in-depth report will help you decide.

What is nStor?



Manageable Fault-Tolerant Storage

Lasting quality and reliability are built into every nStor RAID system. From the easy-to-use Alert Manager software to the redundant hot swap components, data integrity is our first priority. nStor systems are the first to incorporate the SAF-TE (SCSI Accessed Fault-Tolerant Enclosures) standard which is leading-edge technology to protect your investment. In addition, nStor utilities provide unmatched manageability which allows

you to switch RAID levels or capacity on-the-fly. You can also configure a hot spare for automatic data reconstruction without user intervention. So whether you're looking for manageability or reliability nStor RAID systems meet your needs. nStor systems support RAID levels 0, 1, 3, 5 and are compatible with FAST WIDE SCSI. Call for more information or visit us on the web at <http://www.nstor.com/>

	RAID MODEL	NETWORK, WINDOWS NT, DS/2, SCSI COMPATIBILITY	MAX CAPACITY	RAID LEVELS	DRIVES	POWER SUPPLIES	FANS	SAF-TE	ALERT MANAGER
CR2	•	18GB	0,1,3,5	•	•				
CR6e	•	24GB	0,1,3,5	•	•	•	•	•	•
CR8	•	72GB	0,1,3,5	•	•	•	•	•	•



nStor. Formerly Conner Storage Systems

1.800.RAID511 ▼ 407.829.3500 ▼ Europe: +44(0)1234 213571

©1996, nStor Corporation, Inc. All trademarks are of their respective owners. Specifications subject to change without notice.

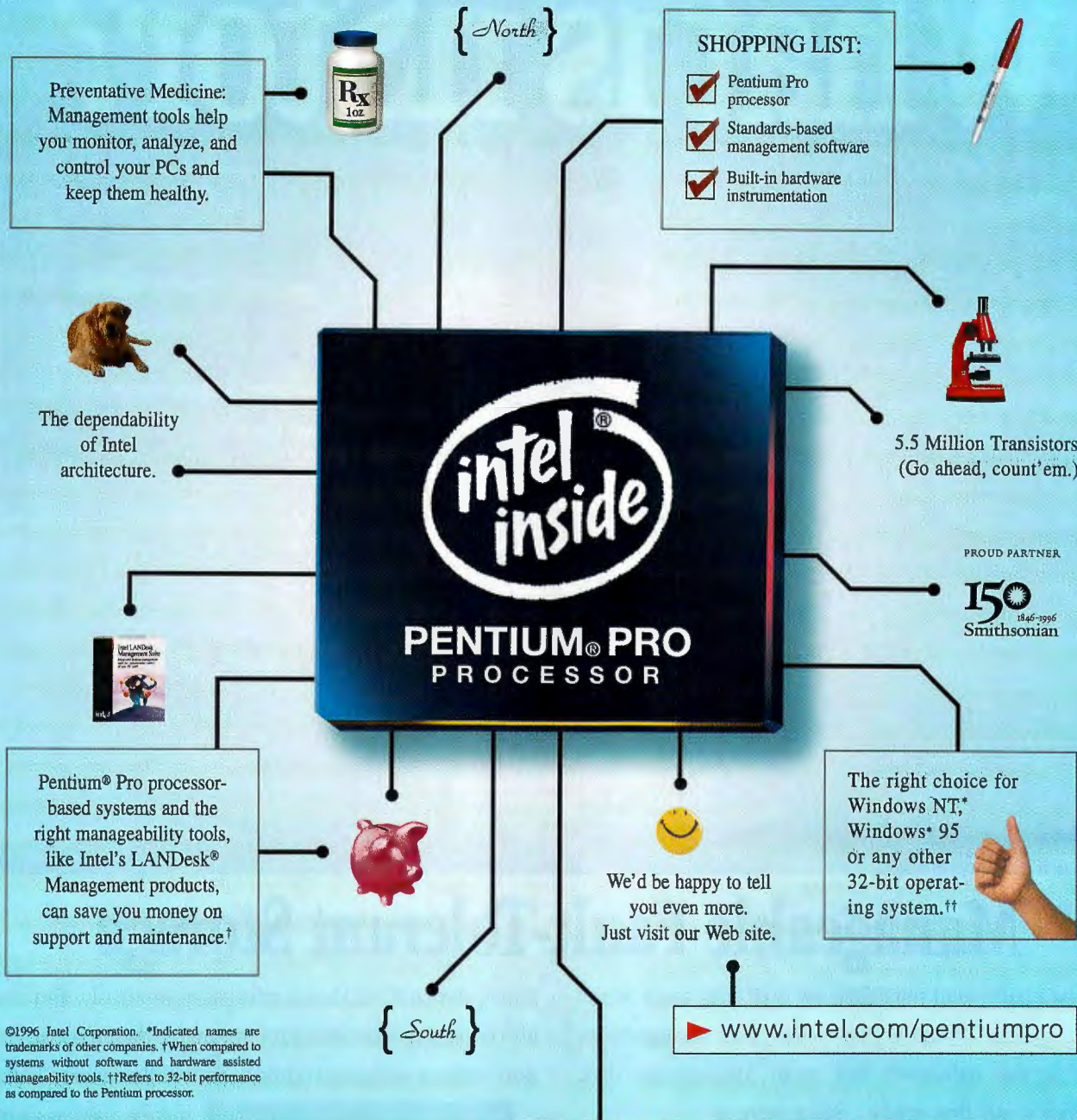

SHOPPING LIST:

- Pentium Pro processor
- Standards-based management software
- Built-in hardware instrumentation

Preventative Medicine: Management tools help you monitor, analyze, and control your PCs and keep them healthy.

The dependability of Intel architecture.

5.5 Million Transistors. (Go ahead, count 'em.)



Pentium® Pro processor-based systems and the right manageability tools, like Intel's LANDesk® Management products, can save you money on support and maintenance.†

We'd be happy to tell you even more. Just visit our Web site.

The right choice for Windows NT,* Windows® 95 or any other 32-bit operating system.††

www.Intel.com/pentiumpro

©1996 Intel Corporation. *Indicated names are trademarks of other companies. †When compared to systems without software and hardware assisted manageability tools. ††Refers to 32-bit performance as compared to the Pentium processor.

Manageab

man"äge·ä·bil'i·ty,

n, the ability to simplify and automate the maintenance and support of business computing with the right hardware and software tools, i.e., Pentium Pro processor-based systems with the right manageability software.

ility defined.

intel®
The Computer Inside.™

Windows for Tiny PCs

Seamless information synchronization with desktop PCs will highlight Windows CE.

If at first you don't succeed, try again. Following an earlier effort to develop an OS for hand-held devices, Microsoft will release an OS called Windows CE this fall. The first products based on the new OS, which is code-named Pegasus, will be hand-held PCs that are about the same size as today's Psion 3A and Hewlett-Packard's 200LX.

Unlike these other devices, however, the new Windows CE hand-held PCs will feature an OS that provides a Windows 95 look and feel. Windows CE will also offer programmers a subset of the Win32 APIs, making it easier for developers

familiar with those interfaces to write applications for these new hand-held PCs. Microsoft says that Windows CE will also be appropriate for such items as cellular smart phones, digital information pagers, and entertainment and multimedia consoles.

The first Windows CE hand-held PCs will likely be released late this year. They will ship with slimmed-down versions of popular applications such as Microsoft Excel and Word, although the CE versions will probably offer only some of the features available in desktop applications. The devices will reportedly let you synchronize information with Schedule

Windows CE Highlights

- Good PC connectivity
- Programming interface based on Win32
- Windows 95 look and feel
- Backed by several hardware manufacturers
- Device price near \$500
- First release slated for this month

Plus and possibly other calendar programs from your desktop.

Microsoft declined to comment in depth on the devices or the OS, but company officials say the hand-held PCs will offer strong connectivity to Windows PCs. Initially, companies such as Casio, Compaq, HP, LG Electronics, NEC, and Philips Electronics will offer them. Compaq, perhaps PDA-shy from its initial work with the abortive WinPad OS, will reportedly resell a hand-held PC made by another company.

Windows CE is a 32-bit, multitasking, multithreaded OS. It is also portable to a variety of microprocessors, such as Hitachi's 32-bit SH3. Processors from NEC Electronics and Philips Semiconductor can also be used in Windows CE hand-held PCs. The OS will be stored in 5.5 MB of ROM, according to reports.

These hand-held PCs will probably sell for about \$500. Whether they will be breakthrough products that breathe new life into the market or just another bust in a field littered with failures remains to be seen. However, even if Windows CE isn't perfect in its first release, it's possible that Microsoft will continue to improve the product until it is as popular in the hand-held PC arena as Windows 95 is on the desktop. **—Dave Andrews**

geek mystique

Surf Now, Fly Later

From 3Com (aka Candlestick) Park to rock concerts, Internet-access terminals are showing up in various mainstream venues. Now they are also arriving in airports and hotels. Atcom/Info, which is a San Diego-based provider of public communication and information resources, will have 10 of its Internet-access kiosks (see the picture) installed at Dallas-Forth Worth International Airport. From there, business travelers will have access to e-mail, the Web, Internet newsgroups, ticketing services, information about local attractions, and other information. Each kiosk will have one sit-



Web Surfing at DFW

down and one stand-up access terminal, plus two stations for phone service. An electronic card-reader slot will accept credit-card payments. GTE, which is installing the terminals, will also provide the ISDN connections.

If you're too busy to stop at the airport to do some Web surfing, or to dash off a last-second e-mail message, perhaps you can do so when you get to your hotel. Atcom/Info is developing Internet-access systems for hotels that will allow busy business travelers to log in on the road even if they have forgotten their notebook. **—D.A.**

Web Info the Way You Want It

The strength of the Internet, its vast collection of information, is a double-edged sword. You can spend hours looking for something without finding it. To address this problem, several new products and services let publishers deliver information over the Internet in a focused way to the people who most need it.

Search tools such as Yahoo and Alta Vista can help you find something more quickly on the Web, but sometimes you still have to browse through many bad hits before you find what you want. Off-line browsers can download information from Web sites while you sleep, but they don't help if your job requires instant access to the latest information. If you've configured your off-line browser to download information at midnight, you may not get an important piece of news that breaks

yeah, but...

The Internet is growing so fast that we can't keep up with it. It's where everything cool in the computing world is happening, and nothing can stop it from growing.

Yeah, but a recent report by Yankelovich Partners (Norwalk, CT), a market research firm, indicates that the Internet is at a crossroads, and that unless the cost of access devices such as PCs and modems improves, the rate of Internet growth will decline. The firm says the annual average growth rate in the number of cybercitizens will decline to 20 percent by the end of the year unless the price to play on the Internet comes down. Another caution flag: Between May 1995 and May 1996, average on-line time fell by 25 percent, from just over 16 hours to 12 hours.

early the next morning for another 24 hours.

New services that address the above problems let information-oriented businesses deliver just the news you care about directly to your PC. Subscribers to these services specify topics they are interested in, such as business competitors or stock prices. When news about those topics breaks, it is sent to your PC.

Pointcast's (<http://www.pointcast.com>) advertising-supported service allows you

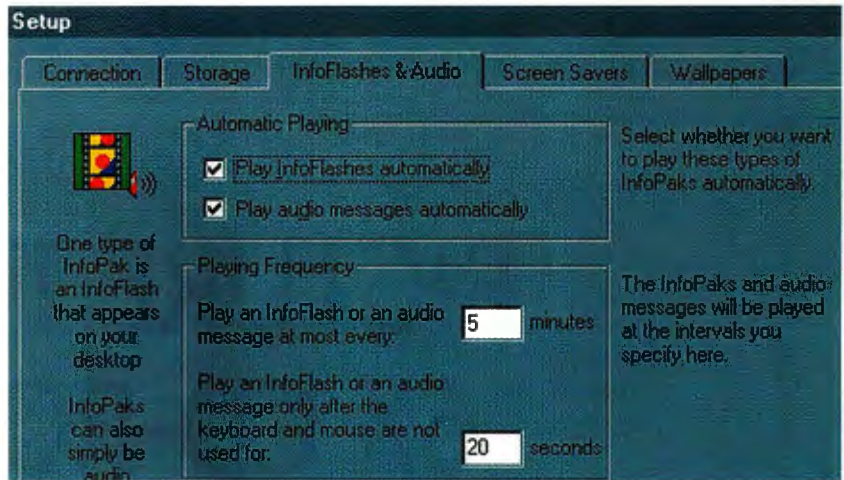

BackWeb can deliver news as an audio message, a news flash, or in an information package.

to customize which kinds of topics you want to know about from a variety of news sources, such as Reuters, newspapers, and others. A new product from Pointcast called Iserver (\$995 per server CPU) lets corporations distribute information more efficiently over an intranet.

BackWeb's (<http://www.backweb.com>) namesake product suite lets content providers create information-delivery broadcasts and send information to a wide audience or just a single end user. The BackWeb server console lets you track detailed statistics of how users interacted with information, and a scripting language allows you to control how information appears at the end user's desk. WavePhone (<http://www.wavo.com>) is also getting into the Internet and intranet real-time news-delivery business to complement its current broadcast services. And NetGuide (<http://www.netguide.com>), an on-line guide to the Web, will deliver content based on your information preferences.

One problem for would-be content providers is that some of these server platforms can cost thousands of dollars. That price is prohibitive for many small-size and midsize businesses, says Ross Rubin, senior analyst with New York City-based Jupiter Communications (<http://www.jup.com>), an Internet consultancy. He also says that a subset of what vendors such as Pointcast are offering may be available in a few years from standards-based Internet e-mail and even sooner from Web-server and database vendors.

John MacFarlane, CEO of software.com (<http://www.software.com>), a provider of standards-based Internet mail servers, agrees. Already, says MacFarlane, the new

IMAP 4 standard lets mail users store Internet mail on servers instead of having to pull them onto a client machine. This lets active agents automatically file mail to the correct folder on the e-mail server. Although this filtering doesn't currently approach the level of functionality offered by services such as Pointcast and BackWeb, MacFarlane points out that the standards will continue to evolve. Also, discussions are under way among vendors to improve the integration among e-mail server and client programs. Improved integration would let someone using a program such as Qualcomm's Eudora create sophisticated filters that work well with any standard Internet mail server. Until then, products such as Pointcast provide a valuable filter for people who want targeted, fresh information updates. —D.A.

Contents

Cyrix/Windows NT 4.0 Bug Update	30
ActiveX Danger	32
Movie Screens for Notebooks	42
Latest PowerPC Mac Benchmarks	44
The Future of Robots	48

**PICTURE THIS:
6X CD-ROM,
11.3" DISPLAY AND
ZOOMED VIDEO.**

**NOW
PICTURE THIS:
\$2499[†]**

ZOOMED
ZV
VIDEO

FULL-MOTION VIDEO
With Toshiba's Zoomed Video technology and a ZV PC Card, you get full-screen, full-motion video and MPEG support without sacrificing system performance.

11.3"
dia.

800 x 600 RESOLUTION
Sure, the screen is huge. And it also has 800 x 600 resolution, which means that every inch of viewing area delivers crystal-clear definition and vibrant colors.

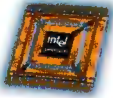

PENTIUM® PROCESSOR
A 100MHz Pentium processor and 40MB of EDO memory can speed up any multimedia presentation. Plus, the 2.9v processor was designed specifically to maximize notebook battery life.

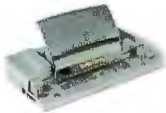

EXPANSION
Satellite Pro's two PC Card slots unlock a world of expansion capabilities. And the optional NoteDock™ I Enhanced Port Replicator offers additional PC Card slots as well as easy connection to your desktop setup.



ADVANCED MULTIMEDIA
With a 6X CD-ROM, microphone, speaker and stereo headset, Satellite Pro offers the most advanced multimedia features you can get at this price.

INTRODUCING THE NEW SATELLITE PRO.™ When it comes to multimedia features, the Satellite Pro offers the big picture at a small price. It all starts with a huge display and full-motion video to make your multimedia presentations look more like feature films. And it's easy to take your show on the road with a 100MHz Pentium processor, up to 40MB of memory and a massive hard drive. Add to that a 6X CD-ROM, integrated AC adapter and PC Card slots and you've got



more than you need to get the job done. So when you want some real portable power, pick up the Satellite Pro. No other notebook can give you so much for so little. For more information visit the Toshiba website at <http://computers.toshiba.com>, or for a dealer near you, call 1-800-457-7777.

Satellite Pro™

420CDT *

- 11.3" dia. color active-matrix TFT display
- 1.3 billion byte (≈1.26GB) hard drive**

420CDS *

- 11.3" dia. color dual-scan DSTN display
- 810 million byte (≈772MB) hard drive

BOTH MODELS

- 100MHz (2.9v) Pentium® processor
- 8MB of EDO DRAM expandable to 40MB
- Modular 6X CD-ROM and 3.5" floppy drive, swappable in the SelectBay™
- MPEG support via ZV Port technology (requires optional PC Card)
- HiQVideo™ graphics controller

- 16-bit Sound Blaster® Pro compatible audio system with microphone, speaker and stereo headset
- Two stacked PC Card slots (two Type II or one Type III)
- IrDA compliant
- Lithium Ion battery
- Integrated AC adapter
- Optional NoteDock™ I Enhanced Port Replicator
- Windows® 95 or Windows® for Workgroups included
- 3-year limited warranty
- Toll-free technical support – 7 days a week, 24 hours a day



In Touch with Tomorrow
TOSHIBA

The World's Best Selling Portable Computers.

©1996 Toshiba America Information Systems, Inc. All prices, specifications and availability are subject to change. †Price is for 420CDS model, price of 420CDT model begins at \$3299. *The 420CDT and 420CDS are sold at selected resellers as the 425CDT and 425CDS with Windows® 95 and additional pre-installed software. **The 425CDT comes with an 810 million byte (≈772MB) hard drive. All products indicated by trademark symbols are trademarked and/or registered by their respective companies. Intel Inside and Pentium Processor Logos are trademarks of Intel Corporation.

Circle 166 on Inquiry Card.

Cyrix 6x86 Bug Puts Brakes on NT 4.0

Cyrix has apparently fixed a bug in its flagship 6x86 processor that results in sluggish performance of Windows NT 4.0, but not before chips affected by the bug reached the market. This bug, uncovered by Microsoft during its prerelease tests of NT 4.0, caused the new OS to crash. To guarantee NT 4.0's stability, Microsoft added code that disables write-back caching in the 6x86's on-board cache. Tests BYTE performed on a Cyrix PC with the 150-MHz 6x86-P200+ processor revealed that applications running under NT 4.0 on a Cyrix chip containing the bug suffered a performance degradation of about 30 percent, compared to later revisions of the 6x86.

Cyrix says it hasn't identified the specific problem in the 6x86 that caused the instability during Microsoft's testing. "We're trying to figure out what exactly is going on," said a Cyrix spokesman.

BYTE has confirmed that a new version of the 6x86 (designated as revision 2.7 by Cyrix) doesn't exhibit the slowdown, indicating that NT 4.0 can distinguish between defective and fixed versions of the chip. If NT 4.0 detects one of the fixed chips, it runs at standard speed with the chip's internal cache fully enabled.

Cyrix would not specify what changes

NT Slow on Some Cyrix 6x86 Chips

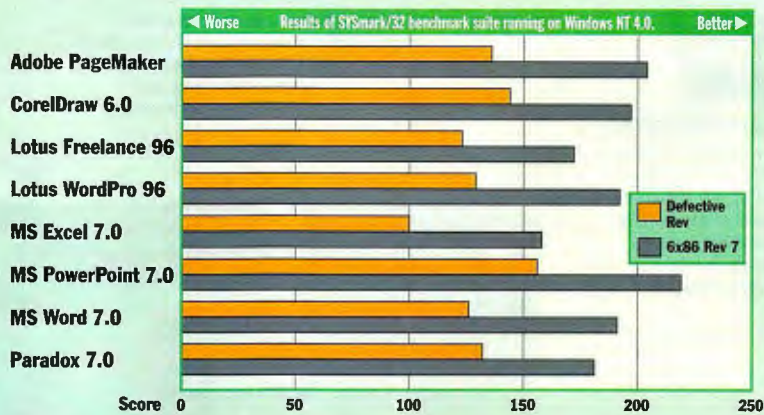

A 100-MHz Pentium PC with 16 MB of EDO memory, a Quantum Fireball 1280A IDE hard drive, 256 KB of L2 cache memory, and an S3 Trio 64V at 1024 by 768 pixels by 256 colors video card, equals 100. Cyrix system tested with 32 MB of RAM.

Real-world applications show the 6x86 slowdown.

it made in the chip or the manufacturing process between revisions 2.6 and 2.7 that may have fixed the problem. Company officials said it is Cyrix's policy not to discuss the specifics of chip revisions.

When asked about the 6x86/NT problem, Microsoft stressed that NT 4.0 is stable on all certified platforms, including all versions of the 6x86. Once Microsoft discovered that a 6x86 couldn't complete the company's so-called stress tests, it alerted Cyrix, and both companies developed a workaround for the problem.

In the workaround, the companies added a series of instructions to NT 4.0 to

identify problematic 6x86es. When a chip with the bug is found, NT 4.0 changes the chip's internal cache operating mode from write-back to write-through. As a result, all memory writes, even those cached inside the chip, force an access to system memory. This change let the 6x86 complete Microsoft's testing, but at the cost of reduced system performance. Cyrix says it is investigating whether a software patch to NT 4.0 will correct the problem. The company also says that other members of its 6x86 family that run at slower clock speeds may be affected by the NT slowdown.

Measured by the SYSmark/32 benchmark suite of eight real-world Windows applications, a 6x86 with its write-back caching disabled turns in poorer NT 4.0 performance than a 133-MHz Pentium. One vendor who sells Cyrix-based systems didn't seem worried by the performance problem. Art Afshar, who is president of Micro Express (Irvine, CA), said that most of his customers buy a 6x86-based PC to run Windows 95 and choose the Pentium Pro to run NT. However, about 25 percent of the people who responded to an article about the Cyrix/NT performance slowdown that BYTE posted to its Web site said they had either bought or were strongly considering a 6x86-based PC as a platform for running NT. Afshar said that the company will replace the chip for customers with slow NT 4.0 performance on a 6x86.

Cyrix recently began direct-marketing

future watch

Cruising Twenty-First Century Style



Smart cruise controls for cars could prevent drowsy drivers in the future from drifting out of their lane or driving too fast around a curve. Today's cruise-control systems let you set a preferred speed at which your car will travel, freeing you from the tedium of stepping on and off the accelerator on long drives. Researchers at the Robotics Institute at Carnegie Mellon University (Pittsburgh, PA) are working on next-generation systems that combine visual sensors and microprocessors. These intelligent systems will change speeds relative to the curvature of the road. They

will also be able to warn you if you are not traveling in the correct lane and alert you to potential obstacles, even ones you can't see. Another possibility is maintaining a certain distance between your car and the one in front of you.

This is one of several new uses of robotics (for others, see this month's interview on page 48). Takeo Kanade, director of the Robotics Institute, says smart cruise-control systems should be ready in about two years. However, before they start showing up in cars of the twenty-first century, car manufacturers and the public will need to accept the concept.

—D.A.



"Optima++ marks a leap forward over traditional C++ tools." *Rich Dragan, Windows Sources - June 1996*

"Powersoft's new development tool makes creating corporate applications with C++ an optimal experience." *Dan Rogers, Software Development, September 1996*

"Optima++ is a powerful product that combines the ease of use of VB's component metaphor with the speed and power of C++." *Steve Jackson, Visual Programmer++, September 3, 1996*

"Powersoft has scored a home run." *Dan Rogers, Software Development, September 1996*

"Optima++ represents a breakthrough in visual programming not only for C++ developers, but for all users of fourth-generation language (4GL) client-server development tools." *Rich Levin,*

"... integration, innovative component-oriented tools; superior execution speed, non-proprietary language." *Peter Coffee, PCWeek, June 10, 1996*

"With Powersoft's Optima++ visual tool, C++ development for Windows has never been easier." *Sean Gallagher, Information Week - May 06, 1996*

"Look, it's VB - No, Wait - C++" *Rick Grehan, BYTE, August, 1996*

"Optima++ provides direct ODBC support, meaning classes and bound controls call the ODBC API directly, without an intermediate layer such as VB's Jet engine or Delphi's IDAPI." *Steve Jackson, Visual Programmer++, September 3, 1996*

"[Optima++] puts the fastest compiler that we've found to date into an environment that is both approachable and productive." *Peter Coffee, PCWeek, March 18, 1996*

"It is definitely..."

"A RAD Tool That Aces The Competition"

Peter Coffee, PC Week, June 10, 1996

- Component-based RAD C++
- Drag-and-drop programming
- Over 220 components and classes
- Build and exploit Powersoft® DataWindow
- Native drivers for Sybase®, Microsoft®, Oracle®, Informix®, DB/2®, and more
- Scalable Sybase® SQL Anywhere™ database
- Exceptionally tight, fast code
- Build and debug CGI, NSAPI and ISAPI custom application servers
- Powersoft ObjectCycle for team developments

Now you can deliver extraordinary solutions — at an extraordinary speed. Optima++™ revolutionizes development by allowing you to quickly build client/server and Internet applications using visual component assembly, drag-and-drop programming and the full power of C++.

For client/server development, the new DataWindow™ control gives you point-and-click database access, powerful extended attributes, and

presentation capabilities made famous in PowerBuilder®. For Internet development, Optima++ delivers visual component assembly and seamless remote debugging so you can create high-performance applications and custom application servers.

Choose the edition that's right for you. Optima++ Developer delivers approachable C++ for client/server development. Optima++ Professional adds powerful features for the corpo-

rate developer including DataWindow technology and Internet development. Optima++ Enterprise takes scalability and performance to the next level with native database drivers and ObjectCycle™ for team project management.

So don't just read about this revolutionary RAD tool. Order yours today and let Optima++ take your development to new heights!

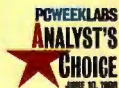

Get Optima++ Developer, Professional, or Enterprise today: 1-800-395-3525 or www.powersoft.com

© 1996 Sybase, Inc. All rights reserved. Sybase, Powersoft, Optima++, DataWindow, ObjectCycle, PowerBuilder, and SQL Anywhere are trademarks of Sybase Inc. or its subsidiaries. All other trademarks are property of their respective owners. Outside the U.S., call 508-287-1500. Optima++ is a product family consisting of three editions. Please check the Powersoft Web site for a complete listing of the features in each edition.

its own brand of PCs built around the 6x86p. When asked if Cyrix would provide a chip that runs at full speed under NT 4.0 to customers who request one, Steve Tobak, vice president of marketing at Cyrix, said that it would offer a software fix if one is available. Or, he added, at the user's option, Cyrix will replace the chip.

—Robert L. Hummel

CD-ROM Weds the Web

Although digital videodisc (DVD), the impending new CD-ROM standard, is currently attracting much attention, another important trend in optical storage is the marriage of the CD-ROM and the Internet's World Wide Web. Hybrid CD-ROMs are titles that include on-line communications, such as links to Internet sites where users can access expanded content. According to InfoTech (Woodstock, VT), a CD-ROM research and consulting firm, hybrid CD-ROMs are expected to account for nearly 10 percent of all CD-ROM titles in print worldwide by 1997.

Hybrid CD-ROMs have numerous advantages. A publisher can put high-quality video clips on the CD-ROM, instead of making you squint at postage-stamp-size, slow video as it transmits over the Internet. Game developers can establish links to Web sites that let you download gaming scenarios or participate in networked multiplayer sessions. Entertainment developers can create titles that have a link to an on-line interview. For example, a new title from the Graphix Zone (Irvine, CA, (800) 828-3838 or <http://www.gzone.com/>) called Herbie Hancock Presents Living Jazz includes links to an FTP site where you can download interviews with jazz greats to your hard drive.

Besides providing advantages to content developers, the emergence of the hybrids is also an opportunity for publishers of toolkits that make it easy to create such CD-ROMs. One such product is the WebCD development program, which is available from MarketScape (Colorado Springs, CO, (719) 593-9890 or <http://www.marketscape.com>). It does much of the work for you by helping you organize your Web content (for more information, see "Hybrid Web/CD-ROM:

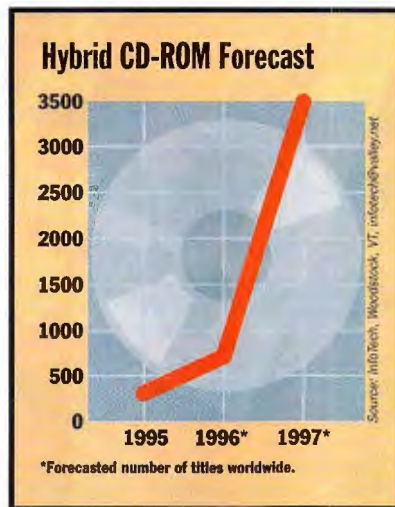

The next big thing:
CD-ROMs with on-line access.

Do It Yourself" on page 54). Companies such as Folio (Provo, UT, (801) 229-6700 or <http://www.folio.com>), whose customers access data stored in proprietary infobases, have introduced Internet-

enabled programs that leverage their core products.

For example, Folio says it will release a new version of its Web publisher that lets Internet users access information contained in Folio infobases. Folio's first Web publisher worked with only one HTTP server. Version 2, which should ship this fall, will run on HTTP servers from Netscape, Microsoft, and others.

Another version of Web publisher, which will follow version 2 and should ship late this year or in early 1997, will add some new features. They include support for document metering, rights management, and other functions currently supported in Folio, company officials say. Folio also provides tools for integrating disparate data stored in Folio infobases and Hypertext Markup Language (HTML) into a hybrid CD-ROM package. Says Ted Pine, chairman of InfoTech, "The Web will become the universal way to look at things, but the data you're browsing may originate from legacy databases."

—D.A.

Bug of the Month

Be Careful Out There!

This month's choice isn't a bug per se, but rather a dramatic example of what can happen when good people download bad ActiveX controls. Fred McLain, CEO of Apropos, a software engineering company, wrote an ActiveX control to illustrate the potential dangers in downloading ActiveX programs. If you're using the final version of Microsoft's Internet Explorer 3 and download his Exploder control, it performs a clean shutdown of your Windows 95 system.

"I'm warning visitors to my Web page [<http://www.halcyon.com/mclain/ActiveX>] that you have to be careful," McLain says. He points out that someone else could just as easily write an ActiveX control that formats your hard drive or does other equally bad things.

Exploder went through the Authenticode process, in which controls are submitted to VeriSign, the digital-authentication com-

pany that is working with Microsoft. With Authenticode, a software publisher signs its code with a unique digital signature, which confirms to users who published the control and that it hasn't been hacked.

Microsoft says Authenticode wasn't designed to guarantee that users won't download malicious code, but that the technology does provide a measure of accountability on the Internet. McLain is not convinced that's enough.

"If I were to put a loaded pistol on the table with a note indicating who owns the gun, that won't prevent a 3-year-old from walking in, picking up the gun, and accidentally shooting himself," says McLain. "The note wasn't enough to prevent the accident." At press time, McLain was putting the final touches on a version of Exploder that does another clean shutdown, this time of Windows NT.

—D.A.



Send yours to edejesus@bix.com!

Introducing bulletproof glass for Windows™ NT networks

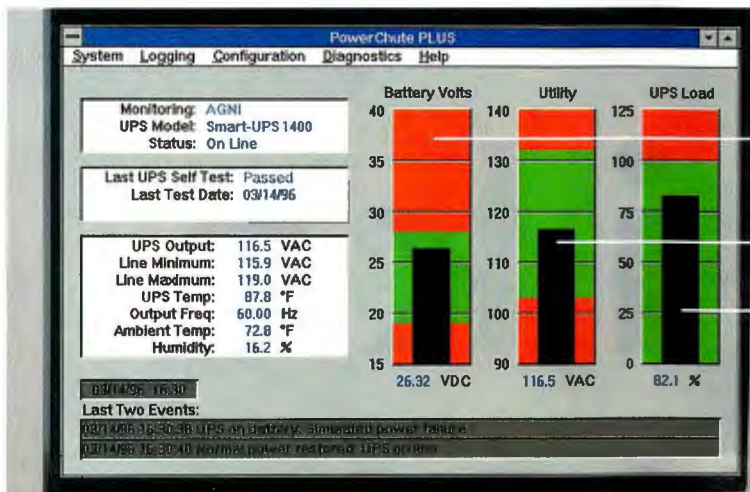

Battery runtime

Displays remaining battery runtime for system use and subsequent outages

Utility line voltage

Power quality display for fast problem diagnosis

%UPS load

Load capacity display prevents UPS overload

UPS self test

Unattended scheduled self tests provide peace of mind

Min./Max. power line voltage

Useful in diagnosing system problems

UPS temperature

Monitoring for proper UPS temperature to extend battery life



"an excellent piece of management software."

-Windows NT Magazine, Editor's Choice



According to Microsoft, "A UPS is an important part of any deployment of Windows NT systems..." Fortunately, APC provides the most comprehensive protection against the single largest cause of NT data loss—power problems. APC's PowerChute® plus for Windows NT and APC Smart-UPS combine to give you the power management features necessary to make SURE you're protected.

- Shut down system safely-graceful, unattended shutdown of Win NT & SMS Servers. Through scheduled shutdowns you can even cut energy costs by up to 76%.
- UPS testing/status-assures that system administrators are informed of power problems *before* they impact system integrity.

- Remote UPS management-eliminates the need to send trained personnel to remote sites to configure UPS parameters, reboot servers or diagnose power problems.

- Environmental/power monitoring-allows you to quickly diagnose power problems and thus decrease network downtime without the expense of an electrician.

PowerChute plus also provides:

- NEW FlexEvents-Want to be paged or have an E-Mail sent to you if there is a power problem? FlexEvents allows you to specify these and other customizable UPS reactions to power events.
- Systems Management Servers UPS MIF Support permits asset management of UPS systems.

"The Smart-UPS not only cuts the leading edge of power protection, its PowerChute plus software also delivers full management and control...[with] the best combination...of new and innovative features." -Network Computing



FREE DEMO DISK or 60 Page Catalog!

or download from our NEW PowerPage™
http://www.apcc.com
Click on "Free Stuff"

APC

AMERICAN POWER CONVERSION

800-800-4APC

Dept. A2

Germany-(+49)89 958 235
France-(+33)05.39.32.03
UK-(+44)753 511022
India-(+91) 44 434 1784

Japan-(+81)03 3798 3888
Russia-(+7)095 929 9095
China-(+86) (10) 7638917

SURGEARREST™ & PROTECTNET™
AC and data-line surge suppressors



STARTING AT \$19

BACK-UPS® & BACK-UPS® PRO
UPS for PC and advanced workstations



STARTING AT \$119

SMART-UPS® & SMART-UPS® V/S
Manageable UPS for servers and networks



STARTING AT \$299

MATRIX-UPS™ & ACCESSORIES
Modular UPS for client/server datacenters



STARTING AT \$3499

WE FINALLY MADE A WORKSTATION

just like everyone else's.

See what's possible

Introducing O2™. A workstation just as practical, reliable, and affordable as everyone else's. Except that it's better. Only O2 delivers industry-leading CPU and graphics performance as well as breakthrough video and imaging capabilities. All of this is possible because O2 is the only workstation in its class that is based on an innovative Unified Memory Architecture. In addition O2 is available with a MIPS® R5000™ CPU, or, for your most demanding needs, the more powerful MIPS® R10000™. If you think all this makes O2 stand out, wait until you see how well it fits in. O2 is designed to easily plug into your network as well as leverage the interactive capabilities of the web.



It comes standard with a full set of web-authoring tools and a personal web server, a combination which allows you to communicate your ideas to anyone, anywhere, on any computer. If you're looking for the performance of a workstation combined with the power of the web, as you can see, it isn't hard to find. For more information see www.sgi.com/O2 or call 800.636.8184 Dept. LS0055.

**O2 DESKTOP WORKSTATION
\$7,495**

MIPS R5000 180MHz processor
32-bit double-buffered graphics
Hardware texture mapping
Image processing engine
Video compression engine
Web-integrated user environment
64MB ECC SDRAM
2GB SCSI system disk
17" monitor, 1280x1040
100BaseTX/10BaseT Ethernet



SiliconGraphics
Computer Systems

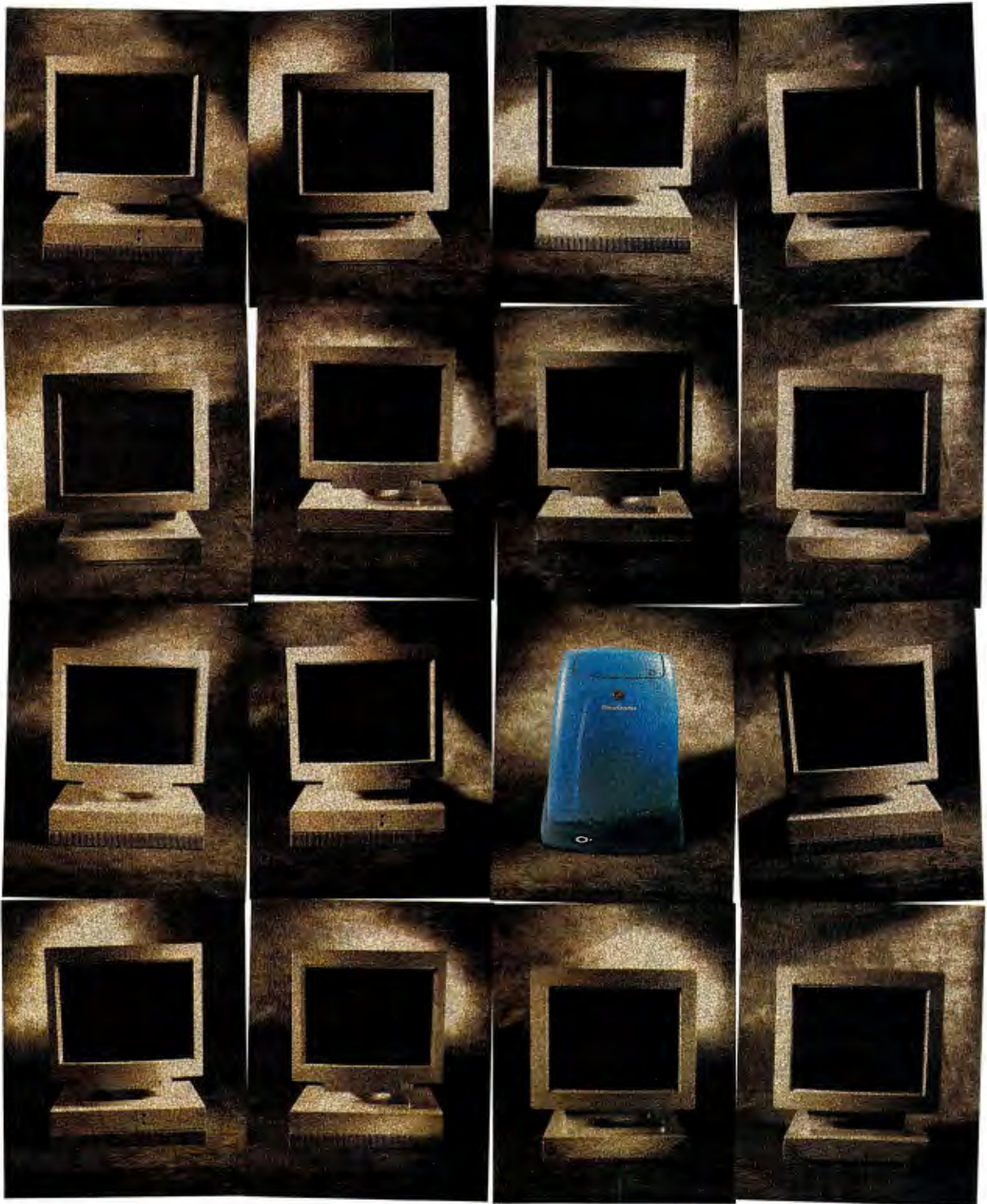

© 1996 Silicon Graphics, Inc. All rights reserved. Silicon Graphics and the Silicon Graphics logo are registered trademarks, D4, and See what's possible are trademarks, of Silicon Graphics, Inc. MIPS and the MIPS RISC Certified Power logo are registered trademarks, and R10000 and R5000 are trademarks, of MIPS Technologies, Inc.



Circle 163 on Inquiry Card.

FlashPix: Future Graphics Lingua Franca?

It isn't often that a file format generates much excitement or offers much to end users, but the new FlashPix architecture may be the exception. Kodak created FlashPix, in collaboration with Hewlett-Packard, Live Picture, and Microsoft, to provide a better way for people to work with digital images. One important design goal of the FlashPix file format, which should now be available, is to let you work with large photographic images without requiring high-end computing power or bandwidth.

FlashPix meets this challenge in an ingenious way, based on the premise that most people don't need to work with all parts of an image at once. Images saved in the FlashPix format are automatically stored in a tiled format of 64 pixels per square. In this way, you can save images of any size, and when a FlashPix-optimized software program asks for data, only the specific tile or tiles requested are loaded into memory. The benefits of this approach: Photo editing is much faster because only the affected area is loaded into memory, and the changes are available almost instantly for the same reason.

FlashPix stores single images at multiple resolutions and enables applications to automatically choose the best resolution for a particular activity. You can thus access a smaller low-resolution image for an on-line preview and then download a bigger high-resolution copy of the image. This should eliminate the long waits currently associated with viewing high-quality graphics on the Web.

Another big plus is FlashPix's ability to save edits as a linked file, which can reduce storage requirements, especially for graphic artists who often save multiple versions of the same image. You can link edits to an original file but store the edits separately, thus eliminating the need to store multiple versions of the entire file.

At press time, there was only one program, Microsoft's Picture It, an image-editing application, that supported FlashPix. Software Development Kits (SDKs) for writing Windows and Mac FlashPix applications should now be available.

Survey

Web-Commerce Polarization

This month's BYTE survey on Internet commerce and privacy reveals a sharp difference of opinion regarding how much privacy users are willing to give up in exchange for access to free information. The topic of cookies is an especially tricky one. Cookies, small pieces of code that are stored on an end user's computer, let a Web server automatically grant visitors access to areas to which they are specifically entitled. Paid subscribers can automatically access value-added information, for example, but Web masters can use cookies to track your activity on their sites in a detailed way.

This tracking capability makes users nervous. "Commercial sites have every right to monitor your actions within the spectrum of their site," says one respondent. "But they should not have the right to distribute that information to others." Another says, "Use of tracking data aggregated to eliminate individual identity is OK, but using individuals' data is too great an invasion."

Other respondents favored the use of advertiser-supported free information. Also, if faster links to the Internet become prevalent, letting ads come up more quickly in a Web browser, that may reduce complaints against on-line ads. What's the answer? Probably a mixture of strategies. As one respondent says, "I guess we live in interesting times when it comes to formulation of Net commerce."

Web Commerce: One Strategy Does Not Fit All

I Want to Participate in Internet Commerce

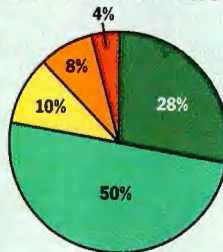

Cookies Invade My Privacy

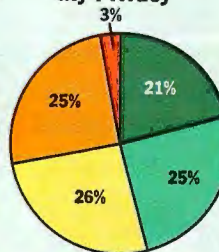

Advertising Should Support Web Info

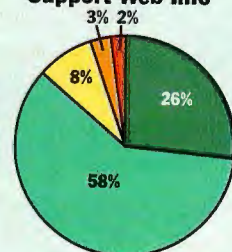

Users Are Willing to Pay for Web Info

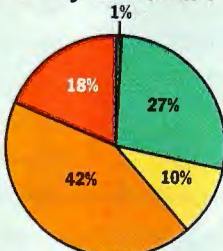

Web Ads Are Annoying

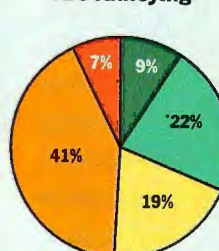

Web Ads Are Effective

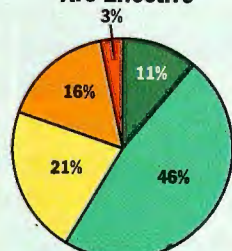

Legend: ■ Agree strongly ■ Agree ■ No opinion ■ Disagree ■ Disagree strongly

Source: BYTE Survey; www.byte.com/ (Due to rounding, not all percentages add up to 100.)

Several vendors may incorporate FlashPix into scanners, printers, and digital cameras. Microsoft says that it will incorporate FlashPix into its Internet Explorer Web browser.

However, not everyone has endorsed FlashPix. One notable company that had

not committed to the format as of press time was Adobe. Kodak officials say they will continue to discuss FlashPix with Adobe and others. If the standard is successful, FlashPix could make digital imaging easier, faster, and more fun.

—Jon Pepper



Now you can get point & click live data solutions on the Web

Introducing NEW IntraBuilder™ — the quickest, easiest way to transform your data into interactive information on your Intranet. Automated Experts guide you through every step of creating your data solutions with point & click ease. Plus, IntraBuilder's powerful, productivity-boosting visual tools make it easy for you to switch back and forth between working in the visual designers and the underlying JavaScript™ code. IntraBuilder Professional comes with Netscape Navigator™ Gold, Netscape FastTrack™ Server, and prebuilt business solutions, making it the only complete Intranet solution.

IntraBuilder supports all local and SQL database standards, so you can use your existing data. And with support for Windows 95 and Windows NT, Java™ applets, ActiveX controls, and industry-standard Web servers and browsers from Netscape and Microsoft, IntraBuilder bridges the industry standards gap.

Discover the fastest, easiest way to develop your live data solutions on the Web. To find out more, call 1-800-336-6464 or visit our Web site and download the free evaluation copy at www.borland.com/intrabuilder20/

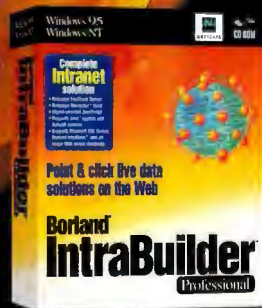

Call your
local reseller

CDW
1-800-334-4CDW

Software Spectrum
1-800-787-1166

Stream International
1-800-699-1736

Programmer's Paradise
1-800-445-7899

Borland
Making Development Easier

Circle 138 on Inquiry Card.

Java Forms: Better than HTML

Now that forms vendors have tackled the Common Gateway Interface (CGI) problem, they are addressing the next step in Internet forms software, the incorporation of Java. Vendors such as JetForm (<http://www.jetform.com>) and Caere (<http://www.caere.com>) have introduced products that let developers create—without having to learn CGI programming—forms solutions that can integrate with databases for electronic-commerce and work-flow applications.

However, the current solutions have trade-offs. You can let an end user fill out a Hypertext Markup Language (HTML) form using any Web browser, but HTML doesn't let you preserve the exact look of a paper-based form. Or, users can fill in a non-HTML form that has added intelligence (e.g., field validation and error checking at the client) and a more robust look, but that requires them to download a proprietary filler product such as JetForm Filler for the Web. This is where Java can save the day.

JetForm, which acquired Delrina's forms and work-flow technology from Symantec, is about to enter beta testing on an upgrade to its forms designer, which will soon emit a Java applet. According to Michael Cohen of Paperless Performance (<http://www.paperless.com>), a developer of electronic-forms solutions, Java support lets you have the best of both worlds. You can view forms in any Java-compliant Web browser, and, unlike HTML forms, the Java applet can have field-level intelligence and help, and also be an exact replica of a paper-based form. Field-level intelligence lets a form catch user-input errors before erroneous data is sent to a server. "And providing an exact replication of the paper form that may be used today makes people, especially computer novices, more comfortable when filling in the electronic form," says Cohen.

JetForm admits that the initial version of its Java solution will not have the full functionality of its JetForm Filler. For example, the initial Java implementation probably will not support database lookups. But JetForm officials say they will continue to improve their Java story. —D.A.

Book Reviews

What Was the Question?

The most obvious problem with this collection of nine essays on the frame problem in AI is that it does not tell you exactly what the frame problem is. Your best bet is to read the epilogue first. This pseudo-Mother Goose-style section is probably intended as an inside joke by the cognoscenti, but it's actually more helpful than the rest of the book.

As I understand it (and if I'm wrong, write to Ford and Pylyshyn, not me), the frame problem involves how much information you need to give a robot (or a computer) for it to perform a task as well as a human would. For example, when frying an egg, do robots need to know what to do when the egg carton is empty? What about when the frying pan used yesterday still sits in the sink, unwashed?

Other descriptions of the frame problem include "describing and updating a set of beliefs efficiently" and (my favorite) "Now what do I do?," which almost any reader of this book can say at anytime. Clearly, the folks who work on the frame problem have a hard time agreeing on exactly what it is. Furthermore, it overlaps many subject areas, including psychology, ethics, philosophy, and religion. Reading this book is tough work. The authors do not adequately define words

such as *metaphrands*, *metaphiers*, and *Quineian*, as well as references to concepts such as *Yale shooting*. The book lacks a glossary and provides a mere one-page index of topics. One particular essay, a poorly written science fiction story containing profanity and spelling and grammatical errors, illustrates the book's low level of editing.

I would recommend this book highly for anyone whose essay is published in it. For the rest of us, any robot story by Isaac Asimov or Stanislaw Lem will tell us more—

in a more lucid and entertaining manner—about the difficulties of designing thinking machines. Now what do I do?

—Edmund X. Dejesus

Deluxe Digital- Electronics Primer

Having picked up digital electronics on my own, I've always looked for a book that could fill in the holes in my piecemeal self-education. This is it. With clear explanations, many effective figures, and typical British humor, Clive Maxfield surveys not only the basics of computer electronics, but also state-of-the-art semiconductor fabrication and packaging techniques. I am happily amazed that Maxfield covers so much, so well. Four hundred plus pages on electronics have never gone so fast.

The humor that peppers the introduction, footnotes, and appendixes (especially the last one, a seafood gumbo recipe) makes for easy reading, but the content is serious, well researched, and up-to-date. It starts with just enough basics from chemistry, physics, and number systems to get you to the workings of semiconductors and simple logic circuits. From there, the book covers tools such as Boolean algebra, Karnaugh maps, and state diagrams that circuit designers use to build more complex logic from basic gates.

The book then switches gears to discuss semiconductor fabrication processes, the design of memory and programmable logic devices (PLDs), a bestiary of ASICs, packaging strategies (including multichip modules), and promising fabrication technologies such as 3-D interconnect. That the author obviously hand-edited the glossary and comprehensive index is a sign of the quality throughout. Books of this caliber are rare. —Dave Rowell

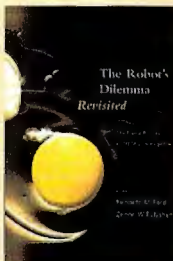
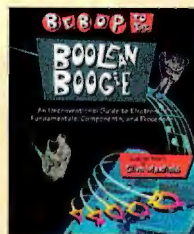

The Robot's Dilemma Revisited: The Frame Problem in Artificial Intelligence

Edited by Kenneth M. Ford and
Zenon W. Pylyshyn, Ablex Publishing
Corp., 141 pages,
ISBN 1-56750-143-5, \$22.95

Bebop to the Boolean Boogie (An Unconventional Guide to Electronic Fundamentals, Components, and Processes)

by Clive Maxfield, High Text
Publishers, 471 pages,
ISBN 1-878707-22-1, \$35



**NO MATTER WHAT HAPPENS BETWEEN NOW
AND THE YEAR 2003, OUR STORAGE
ENCLOSURES WILL STILL BE UNDER WARRANTY.**



Cell phone implants? Intergalactic zoning laws? There's no telling what the next seven years could bring. But one thing's for sure: Your Kingston® storage enclosures will still be under warranty. These rugged and reliable storage systems were designed for some of the most demanding environments—even the space shuttle. Plus, we offer the longest warranty in the industry. The Kingston Data Silo® DS500 tower or rack-mount enclosure can house 3.5-inch and 5.25-inch half-

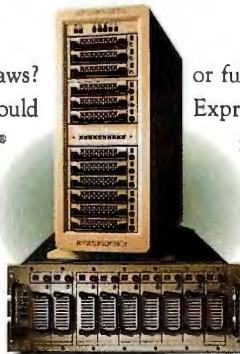

or full-height SCSI peripheral devices. Our Data Express® removable drive enclosures, integrated into our DS500 chassis, provide a variety of customized enclosures for up to 12 removable, hot-swappable SCSI devices. Of course, Kingston storage products are compatible with all major platforms. Want more information? Give us a call at (800) 435-0670, or you can send us e-mail at storage@kingston.com. 

Kingston
TECHNOLOGY

For more information, call us at (800) 435-0670  Visit our Web site: <http://www.kingston.com/b.htm>

**THERE IS A
REASON WHY FIVE
OF THE BIG SIX
ACCOUNTING
FIRMS BUY DELL.**

"Risk" is hardly an accountant's favorite word. So it's only natural that our Big Six customers have placed so much confidence in Dell PCs. They've learned that with Dell, high technology doesn't mean high risk.

Our OptiPlex GX^{pro} systems are a case in



point. Designed for Windows NT from the ground up, they're backed by eight months of testing and validation. They're fully loaded with Windows NT and all its native and non-native drivers, so they're network-ready. Their NT compatibility is assured by a cross-

company R&D effort involving every major system area. They even protect your data from both thermal and power failures.

For the Big Six – and for all companies regardless of size – Dell isn't just the right choice. It's the safe one.



DELL® OPTIPLEX® GXpro 200

200MHz PENTIUM® PRO PROCESSOR

- New Tool-less Convertible Desktop/Mini Tower Model
- 64MB EDO ECC DIMM RAM
- 256KB Integrated L2 Cache
- 2GB Fast SCSI Hard Drive
- 17LS Monitor (15.7" v.i.s., 28mm)
- S3 Trio 64v+ PCI with 2MB VRAM
- 8X SCSI CD-ROM Drive
- Integrated 3Com® PCI EtherLink® III
- Integrated Vibra 16 Audio
- Microsoft Windows NT® Workstation 4.0/1 Year Free NT Support
- 3 Year Limited Warranty¹

\$4299

Business Lease²: \$155/Mo.
Order Code: 300313

DELL OPTIPLEX GXpro 180

180MHz PENTIUM PRO PROCESSOR

- New Tool-less Convertible Desktop/Mini Tower Model
- 32MB EDO ECC DIMM RAM
- 256KB Integrated L2 Cache
- 2GB EIDE Hard Drive (10ms)
- 15TX Trinitron Monitor (13.7" v.i.s., 26mm)
- S3 Trio 64v+ PCI with 2MB VRAM
- 8X EIDE CD-ROM Drive
- Integrated 3Com PCI EtherLink III
- Integrated Vibra 16 Audio
- Microsoft Windows NT Workstation 4.0/1 Year Free NT Support
- 3 Year Limited Warranty

\$2799

Business Lease: \$104/Mo.
Order Code: 300311

DELL OPTIPLEX GXMT 5166

166MHz PENTIUM PRO PROCESSOR

- Mini Tower Model
- 32MB EDO RAM
- 256KB Pipeline Burst Cache
- 2GB EIDE Hard Drive (10ms)
- 15LS Monitor (13.7" v.i.s., 28mm)
- Integrated 64-bit PCI with 2MB DRAM
- 8X EIDE CD-ROM Drive
- Integrated 3Com PCI EtherLink III
- Integrated Vibra 16 Audio
- Microsoft® Windows® 95/30 Days Free Support/Windows 3.1 or Windows for Workgroups 3.11
- 3 Year Limited Warranty

\$2399

Business Lease: \$89/Mo.
Order Code: 300312

DELL OPTIPLEX GL 5133

133MHz PENTIUM PROCESSOR

- Low Profile Desktop Model
- 32MB EDO RAM
- 2GB EIDE Hard Drive (10ms)
- 15LS Monitor (13.7" v.i.s., 28mm)
- Integrated 64-bit PCI with 1MB DRAM
- Integrated 3Com PCI EtherLink III
- Microsoft Windows 95/30 Days Free Support/Windows 3.1 or Windows for Workgroups 3.11
- 3 Year Limited Warranty
- ★ 256KB Pipeline Burst Cache, add \$39.
- ★ 8X EIDE CD-ROM Drive, add \$149.

\$1899

Business Lease: \$70/Mo.
Order Code: 300310

DELL®

800-876-1190

<http://www.dell.com>

Mon-Fri 7am-9pm CT • Sat 10am-6pm CT
Sun 12pm-5pm In Canada* call 800-233-1589

Keycode #01162

¹For a complete copy of our Guarantees or Limited Warranties, please write Dell USA L.P., 2214 W. Braker Lane, Suite D, Austin, TX 78758. *Prices and specifications valid in the U.S. only and subject to change without notice. ²On-site service provided by Banctac Service Corp. On-site service may not be available in certain remote locations. MS, Microsoft, Windows and the Windows NT logo are registered trademarks of Microsoft Corp. The Intel Inside logo and Pentium are registered trademarks of Intel Corp. 3Com and EtherLink are registered trademarks of 3Com Corp. ©1996 Dell Computer Corporation. All rights reserved.

Datapro Report

Wanted: Client/Server Expertise

High costs and lack of expertise and systems management are the major obstacles on the way to realizing the benefits of client/server computing, according to Datapro's 1996 International Client/Server Issues Survey. Information systems executives understand the cost implications of client/server computing, realizing that, despite the conventional wisdom of the early 1990s, expenditures may be even higher

schemes. Additionally, about 75 percent of them incorporated legacy systems, and about one-third of those incorporated legacy systems through real-time connections, as opposed to gateways or batch data transfer.

As you can see in the chart, the perceived disadvantages of client/server computing among those who haven't implemented a system differ—in some cases by a large mar-

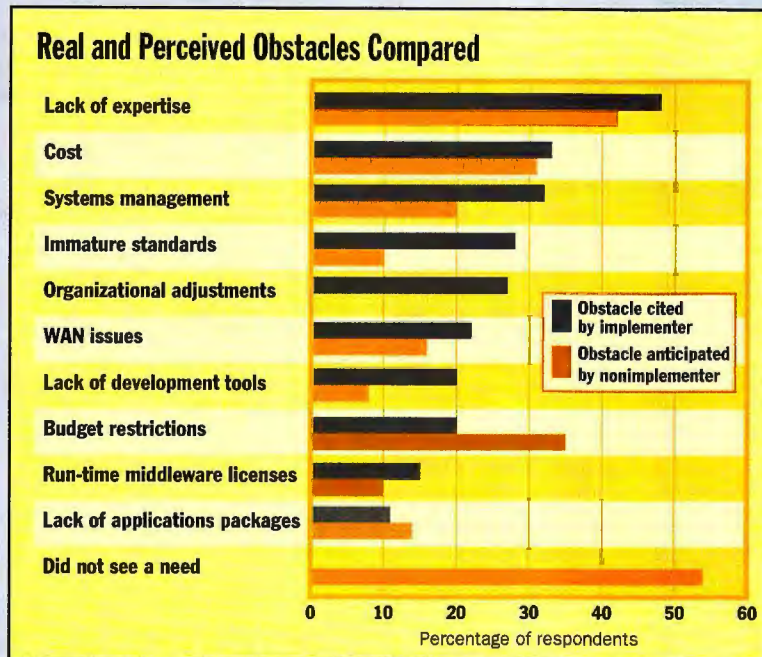

Those not implementing a client/server system underestimate the obstacles of management and immature standards.

than those of a monolithic system. However, they also believe that the benefits outweigh the cost and other disadvantages.

Implementers said the top benefits are improved end-user access to information, the ability to flexibly react to business needs, and scalability (i.e., the ability to add additional capacity).

As expected, the trend line for full implementation of a client/server system continues strongly upward. In 1994, 18 percent of the respondents to Datapro's survey had fully implemented a client/server system. By 1995, that number increased to 25 percent, and this year, it was up to 46 percent. Of the implementers, half use a two-tier scheme, but a third use multiple-tier

gin—from the disadvantages as stated by those who have completed their systems. Nonimplementers seem to have less awareness of the pitfalls of immature standards, system management, and the lack of development tools compared to those who have already implemented a client/server system. Of this year's respondents, 29 percent are still making client/server plans. Those who are still in the planning process might want to reevaluate how many resources they plan to devote to trouble areas such as systems management and immature standards. **Dennis Byron** is a senior analyst for Datapro Information Services. For more information on Datapro Information Services: (800) 328-2776, (609) 764-0100, or <http://www.datapro.com>.

Notebook Screen Future: Bigger and Wider

Major suppliers of LCD panels—including Sharp, NEC, and Mitsubishi—are developing displays that are larger and more advanced than today's 12.1-inch thin-film-transistor (TFT) standard. Sharp's new Super-V LCD, currently available only as a 13.8-inch prototype TFT model, has 1024- by 768-pixel resolution, a 140-degree viewing angle, an ultrahigh brightness-to-darkness contrast ratio (300-to-1), and a viewable image area roughly equivalent to that of a 16-inch CRT.

Although Sharp is not shipping this model yet, its PC-9090 notebook, due for delivery by the end of the year, will include some of its aspects. The PC-9090 uses a Super High Aperture 12.1-inch TFT with 1024- by 768-pixel resolution and brightness Sharp claims is 50 percent higher than previous models.

Sharp ((800) 237-4277 or <http://www.sharp-usa.com>) also just released the first wide-screen notebook, the 4.6-pound WideNote portable. Its 9.6- by 5.6-inch display (see the photo) can show two side-by-side Web pages or a standard-

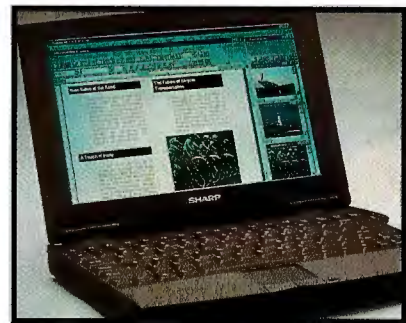

Sharp's WideNote display reduces the need to scroll through spreadsheets.

width letter with extra space left over on the side. The 16-to-9 aspect ratio is the same as a movie screen. The wide-screen LCD has a resolution of 1024 by 600 pixels and a diagonal measurement of 11.28 inches.

NEC and Mitsubishi (among others) are currently working on LCD screens bigger than 13 inches, and NEC has

What you do most, we do best.

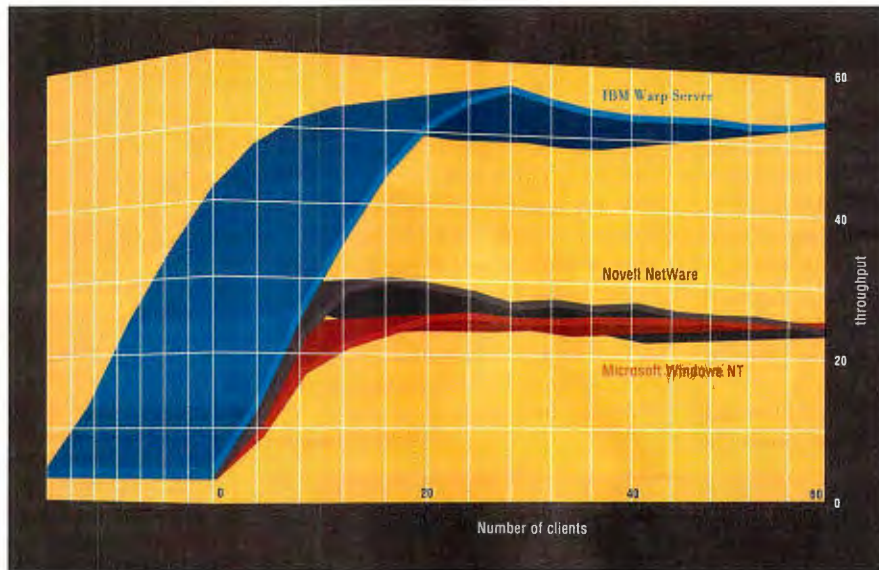

FILE AND PRINT SERVER PERFORMANCE

Network

We're very happy to report that OS/2®

Warp Server has now been shown to do some tasks up to 26% faster than Windows NT™ or Novell NetWare®.

We're even happier to report that these are the tasks your network does most often—file and print serving. So this is a speed boost everyone on the network is likely to notice.

(With our drag-and-drop GUI, the network administrator will see other tasks move faster, but that's a

whole other story.)

These are the results verified in independent tests by Ziff-Davis,

comparing the relative performance of the major network OS's.* And it's all there in black and white, for your reading pleasure.

Visit www.software.ibm.com for your copy of the lab test. And while you're at it, be sure to pick up our new Cost of Ownership White Paper.



Because now there's proof that OS/2 Warp Server saves more than time when compared to the other network OS's—it actually saves money.

Or use our automated fax-back service. Just call 1 800 IBM-4FAX and enter 5729 for the lab test and 5728 for the White Paper.



Solutions for a small planet™

demonstrated 20- and 26-inch panels in Japan. While those are not intended for use in a notebook (such screens are wider than today's standard laptop size), analysts expect the 13.8-inch size to appear in notebooks toward the end of 1997. Today's 12.1-inch display that seems large will soon look as outmoded as 10.4-inch displays do now. **-J.P.**

New PowerPCs Boost Macs

Results from BYTE's cross-platform BYTEmark benchmark indicate that the latest PowerPC-based Macs give users a significant performance boost. As we expected, Power Computing's PowerTower Pro 225 is the fastest Mac we have tested, in terms of its raw processing power. Indeed, its BYTEmark scores are the highest we've seen in a single-processor desktop system.

Due to differences in compiler technology, a careful reader will notice that

the results shown here for certain processors (e.g., the 200-MHz 603e) differ from the results we posted in our August issue. This is because we used different compilers to compile the BYTEmark suite for Windows NT and the Mac OS. Improvements in compiler technology can also improve performance on the same chip. For example, the 180-MHz 604 gets a big boost in integer performance when executing BYTEmarks that were compiled by release 3.0 of Motorola's PowerPC Software Development Kit (SDK)—see "New Power for the Mac" below—compared to release 2.0.

IBM and Motorola are preparing new PowerPC processors (code-named G3) for 1997. These will be based on the 603e and 604e, but with bigger caches and better system interfaces. Another generation will follow in 1998 (for more information on the PowerPC road map, see the article "PowerPC Regroups" on page 101). The much-delayed PowerPC 620 may finally ship within the next three or four months, as well.

-Tom Thompson

New Power for the Mac

New Mac OS systems based on the 225-MHz PowerPC 604e turn in the fastest BYTEmarks we've seen in a desktop computer.

Power Computing PowerTower 180 (180-MHz 604)*	5.2
Apple Performa 6400/200 (200-MHz 603e)*	4.8
Apple PowerBook 5300 (117-MHz 603e)*	2.5
Power Computing PowerTower Pro 225 (225-MHz 604e)	5.5
Apple Power Mac 9500/200 (200-MHz 604e)	4.8
Power Computing PowerTower 180 (180-MHz 604)	4.5
Apple Power Mac 8500/180 (180-MHz 604e)	4.5
PC clone (200-MHz Pentium Pro)	3.5
PC clone (200-MHz Pentium)	2.5
Apple Power Mac 7100/80 (80-MHz 601)	1.8

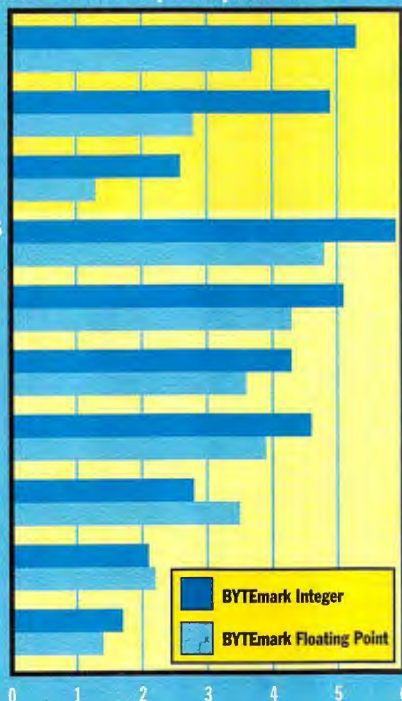

* BYTEmarks compiled using Motorola's PowerPC C/C++ SDK for the Mac OS, DR 3.0. All other Mac OS BYTEmarks compiled using Motorola's PowerPC C/C++ SDK for the Mac OS, DR 2.0. A 90-MHz Pentium equals 1. PC BYTEmarks compiled using Watcom release 10.

cd-rom review

Architecture Bible on CD-ROM

Moving a venerable reference book onto a CD-ROM can be either a waste of plastic or a huge step forward in terms of usefulness. You hope that such a transposi-

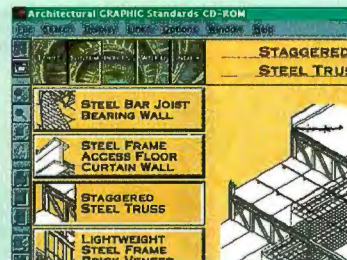

An architectural reference bible is now available on CD-ROM.

tion increases the convenience, searchability, and portability of the material.

John Wiley and Sons has put the entire contents of *Architectural Graphic Standards*, a reference bible for architects since 1932, on CD-ROM. The disc defines and explains structural, mechanical, and electrical systems with text and technical diagrams. You can search it by several methods, including standard text searching and an index.

A potentially great feature of a CD-ROM like this is the ability to use its included diagrams in your drawings. However, only 10 percent of the diagrams on this version are in accurate vector format.

The interface is intuitive, although navigation is difficult because it is hard to retrace your steps. You can export whole illustrations or parts of them into your word processing or graphics programs, but you cannot cut and paste from this program. Currently, tables and equations found in the CD-ROM are not interactive, but they will be in a future version (slated to ship in about a year and a half).

John Wiley and Sons has not created a perfect transition of *Architectural Graphic Standards* from one medium to another. However, it is an important beginning that hints at exciting possibilities.

-Jason Kraus

Architectural Graphics Standards

John Wiley and Sons, 605 Third Ave.,
New York, NY 10158,
(800) 225-5945,
<http://www.wiley.com>,
\$345

**Introducing the SPARC™
hyperSTATION.™ Design and
architecture so advanced...**

hS30



years from now, you'll still marvel at your applications' monumental performance.

THE SUNOS® AND SOLARIS® SOLUTION.

Just because the Sun is setting on your current operating system, it doesn't mean you're left in the dark. ROSS, the sole supplier of hyperSPARC™ CPUs to the SPARC market worldwide, creates hyperSTATION 20 and hyperSTATION 30—the dawn of a brand new day in SPARC workstation performance. Today, you can have the power you need to run SunOS 4.1.3 SunOS 4.1.4, and Solaris applications at speeds faster than you'd ever imagined possible. And you have the power to maintain that edge in the future.

THE LONG-TERM SOLUTION.

Our high performance SPARC microprocessor architecture is housed in a new chassis specifically designed for future generations of exactly what ROSS is famous for... multiprocessor upgrades. Shining examples of ROSS' forward-thinking approach, both hyperSTATIONS feature an advanced thermal management system, a stronger power supply, options for a 6X CD-ROM drive, 24-bit 2-D and



3-D graphics accelerator, and enough real estate for up to 6GB of hard disk space.

EXTENSIBLE, UPGRADEABLE, CONNECTABLE, RATIONAL AND AFFORDABLE.

You can always extend your performance level with our high speed single, dual- or quad-processor upgrades. And you can rest assured that our SPARC-based and UNIX-compliant open systems solutions will provide high connectability. When you think about it, ROSS hyperSTATIONS are the only way to go if you want to put your company's future on a predictable path for growth—without buying into the high costs and inevitable headaches of moving to alternative platforms.

INTRODUCING THE HYPERSTATION 20 AND 30.

HYPERSTATION 20. MORE SPARC FOR YOUR BUCK.

hyperSTATION 20 has more features than Sun's SPARCstation 20 for a lot less money. Dual 50 MHz MBus slots support up to four hyperSPARC processors and up to 512MB of RAM, so you can pick the level of speed you need. And with our 6X CD-ROM drive, ISDN and high performance graphic accelerator options, the hyperSTATION 20 gives you features the competition doesn't even offer.

HYPERSTATION 30. THE MASTER OF SPARCS.

hyperSTATION 30 is as fast as it gets. It features a new 66 MHz MBus for high-throughput multiprocessing and a 1GB physical system memory for advanced ECAD and database applications. Combine our current microprocessor speeds from 133 to 166 MHz and ROSS' evolutionary history of advanced hyperSPARC performance, and you'll start—and stay—on the fast track.

OTHER MARVELS OF ROSS TECHNOLOGY.

If you're in the market for memory, motherboard upgrades or microprocessor upgrades, from 90 to 166 MHz, we have them. Call us today for specifications and prices!

CALL 800-ROSS-YES.

ROSS

ROSS Technology, Inc.

CALL 800.ROSS.YES

5316 Highway 290 West Austin, Texas 78735 800.ROSS.YES International 512.349.3108 FAX 512.349.3101 <http://www.ross.com>

©1996 ROSS Technology, Inc. All rights reserved. ROSS Technology and the ROSS logo are registered trademarks, and hyperSTATION is a trademark of ROSS Technology, Inc. All SPARC trademarks are trademarks or registered trademarks of SPARC International, Inc. hyperSPARC is licensed exclusively to ROSS Technology, Inc. Products bearing SPARC trademarks are based upon an architecture developed by Sun Microsystems, Inc. All other product or service names mentioned herein are trademarks of their respective owners.

Circle 161 on Inquiry Card (RESELLERS: 162).

Blasts from the Past

5 Years ago in BYTE

The industry was in transition. Apple and IBM were working together, as were IBM and Microsoft, despite their recent public divorce. More details on a new OS called Windows NT began emerging. Sales of Windows 3.0 were encroaching the Mac, but Novell was still pushing DR DOS. Meanwhile, we put the ill-fated Momena computer on the cover. Pen-based computing hasn't yet broken into computing's mainstream, and Momena Corp.'s eventual collapse is a good analogy for the eventual fate of many of the pen-based start-ups. A stronger trend that we devoted coverage to in that issue: network interoperability.

10 Years ago in BYTE

BYTE took an early look at Compaq's Deskpro 386, which started at about \$6500. We also reviewed the Mac Plus, which upped the Mac's memory from 128 KB to 1 MB and increased the floppy drive from 400 to 800 KB, among other things. Also in that issue: scads of information on knowledge representation.

15 Years ago in BYTE

We focused on data management and the problems thereof. Other articles focused



on how to use the microcomputer as a laboratory instrument and a hardware product from Microsoft called the Softcard. This was a \$399 board

that allowed you to run programs and languages written for CP/M on your Apple computer.

Beyond R2D2: Robots Evolve

Takeo Kanade, director of the Robotics Institute at Carnegie Mellon University, reveals how robots will make our world better and more entertaining.



BYTE: *Robots are showing up in new places and in new forms. What interesting new uses are you exploring for robots?*

Kanade: The scope of where robots are used has been and will be expanded from the factory floor to more "natural" environments, including agricultural fields, mines, and construction sites. We are also looking at space and planetary exploration and other hazardous environments, including natural environments such as volcanoes and those of human origin, such as nuclear environments.

BYTE: *Your robots have explored volcanoes to gather data. What other tasks can robots do that humans currently must perform at great risk?*

Kanade: Another one that we are working on is a helicopter project, a flying robot. This has an advantage when rescuing people in bad weather or fire fighting. In bad weather, for example, a ship sinks and survivors are expected. The first thing is to try to find them. But the rescue mission may be put on hold in bad weather because the rescuers would also be in danger. Now if this is an unmanned mission, we can risk a helicopter crash. On all these dangerous missions, the key factor is, the more risk you take, the more effective is the mission. If you can do a task in such a way that even a crash is acceptable, the effectiveness grows rapidly.

BYTE: *A robot helicopter could help fight fires, too?*

Kanade: Yes, and again, the more effective the mission, the more dangerous. If you hit the hottest spot with a fire-fighting agent, it's very effective. But it's also dangerous. So human pilots don't fly that close. But a robot-powered airplane can accomplish dangerous missions without risking human life.

BYTE: *What about robots and entertainment?*

Kanade: That's a new breed of robotics, what is called *virtualized reality*. We have built a 51-camera dome that we call 3-D Dome. It's a 5-meter dome where the cameras are looking inside. In other words, the dome space is covered by a sea of cameras. And whatever happens inside is modeled into a CAD model. It's a natural event. So imagine that you are inside the dome, and you swing a baseball bat. How your shirt, body, and hand move are modeled into the computer. Because it is modeled, we call it virtualized reality. Once we do that, we can place you in that environment anyway you want. Thanks to the 3-D models, you can actually immerse yourself into that environment. One of the best applications that I envision is watching NBA basketball on the court.

BYTE: *So this would let you watch the game from the referee's point of view?*

Kanade: Or from anywhere inside the court. You could see what it's like blocking Michael Jordan. Or you can enjoy the view that the ball would see, if it could see.

BYTE: *What about using robots to manage data?*

Kanade: We have an infomedia project that lets you navigate in a large video database very quickly by using natural language as a query. The important viewpoint I would like to convey is that robotics is not limited to mechanical things.

For more information on the Robotics Institute, see <http://www.ri.cmu.edu>.

An OpenDoc word processor delivers on component software's promise of small, tightly coupled parts. By Tom Thompson

Componentized WAV of the Future

As Apple's cross-platform OpenDoc technology celebrates its first birthday, practical component software is starting to appear. One such component is Digital Harbor's WAV, which implements the bread-and-butter task of word processing. I saw a preliminary beta version. Currently, only a Power Mac version is available. As beta software, WAV has some rough edges and missing features, but it proves that OpenDoc's component-based architecture is sound.

At 1.5 MB, WAV offers a lean-and-mean set of features. That's fine: I don't want unnecessary wizards and other "features" that contribute to code bloat. For text, you get basic formatting, where you pick a typeface, style it (bold, italic, underline, and a color), and align it with a few points and clicks. WAV has a simple word-count command, a handy feature if you write to length. It does have advanced layout facilities, such as arranging the text into columns (a maximum of five) and the ability to tinker with the text spacing. To readily get at existing text, WAV has conversion filters for WordPerfect 3.x, Word 4.x, and Word 5.x files.

A FolderBay function consolidates operations or content into virtual "folders" with clickable tabs at the top of the document window. Default folders are text functions, CyberDog (Apple's Internet tool suite), and a parts folder for additional OpenDoc components (e.g., a draw editor part or a bit-map editor part). You can add your own "project" folder tab to consolidate work documents.

As an OpenDoc component, WAV takes a document-centric approach to creating and handling data. You don't launch WAV itself. Instead, you open a WAV stationary (or template) file to make a new document. A Document Info command lets you set each document's file type (e.g., WAV format or ASCII text) and

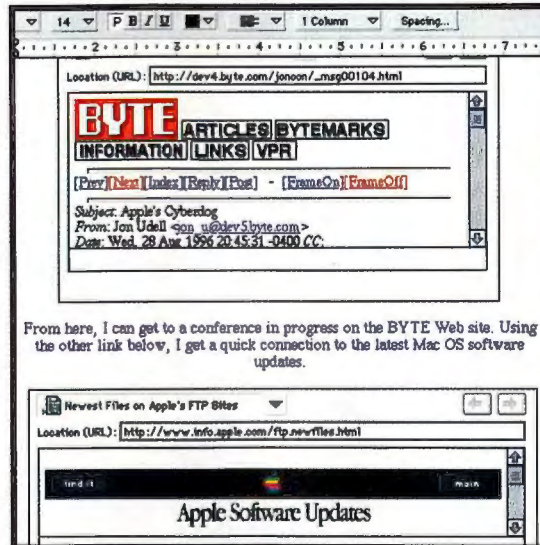

From here, I can get to a conference in progress on the BYTE Web site. Using the other link below, I get a quick connection to the latest Mac OS software updates.

WAV

\$49

(requires a Power Mac or compatible system running System 7.5.1 and OpenDoc 1.0.4)

Digital Harbor
London, UT

(801) 785-2115

fax: (801) 785-2414

<http://www.dharbor.com>

Circle 1069
on Inquiry Card.

WAV's tight Internet integration lets you build documents containing live updates.

memory size, so you can conserve memory by adjusting it to suit the document.

WAV integrates well with other OpenDoc parts. If you have CyberDog installed, its functions are immediately available from WAV's CyberDog tab. More important, you can drag and drop Internet uniform resource locators (URLs) and graphics from CyberDog into a WAV window, and save the information into a live document. When you next access the file, CyberDog automatically connects to the Internet and fetches the URL's current information.

For example, I have a WAV file that points to a conference on BYTE's Web site pertaining to CyberDog discussions. When I'm notified of new messages in this conference, I just open the WAV document, and I'm automatically positioned at the last-read message. Conventional Web browsers do this with bookmarks, but WAV does them one better: It lets you capture links, text, and graphics into doc-

uments, bypassing the usual download, file-conversion, and import stages.

Because OpenDoc components are small and tightly focused, development costs are lower. Thus, WAV costs only \$49. While you couldn't publish a book with

RATINGS

TECHNOLOGY	★ ★ ★ ★ ★
IMPLEMENTATION	★ ★ ★

it, you can crank out sophisticated publications with embedded images, diagrams, tables, and charts—thanks to the OpenDoc components that make WAV greater than the sum of its parts. Also, WAV represents the future of on-line publishing, where you build documents with dynamic links to information on the Web. WAV has no equal in this area. **B**

Tom Thompson is a BYTE senior technical editor at large. You can contact him at tom_thompson@bix.com.

Alps' MD-4000 prints high-quality, high-resolution color images, indelibly and inexpensively. By Robert L. Hummel

Waterproof Color That Lasts

Boasting inexpensive, high-quality color printing, Alps Electric hopes that its new \$499 MD-2010 color printer and \$699 MD-4000 printer/scanner will ride the current wave of interest in PC-based photo-realistic imaging. Using Alps' thermal-transfer "Micro Dry" inks, these units print waterproof, high-resolution color images (600 by 600 dpi in color, 1200 by 600 dpi in monochrome) affordably, though slowly, for systems running Windows 3.x and 95.

I tested the MD-4000 in a Windows environment. The MD-4000 resembles the MD-2010, but within it is a 24-bit, 600-dpi, TWAIN-compatible, sheet-feed color scanner, which makes it an affordable one-package solution for image acquisition and printing. Alps also offers a Mac version.

With four snap-in ribbon cartridges, the MD-4000 supports hands-off CMYK printing. The printer determines the position of each cartridge. If a needed color isn't loaded, the printer prompts you for it. A \$6.60 ribbon produces about 35 to 40 pages at 100 percent coverage. Alps also offers 20-page metallic ribbons (gold, cyan, magenta, and silver) for \$8.99 each.

Alps claims that the MD-4000 doesn't require special paper, and my testing bore this out. I printed full-color images on

TECH FOCUS

Micro What?

The Alps "Micro Dry" process applies dry resin-based inks to paper with a 240-element thermal-transfer head. Like wax-thermal-transfer printers, the MD-4000 melts small dots from an ink-coated ribbon, one pass per color. Unlike wax transfer, resin-thermal transfer doesn't require special paper, and the output doesn't look waxy.

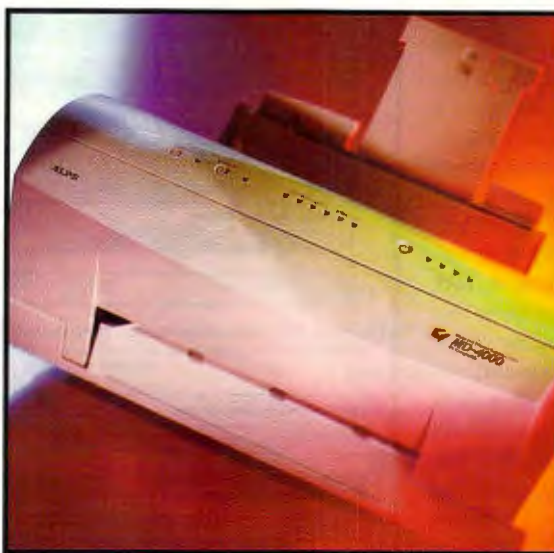

MD-4000
\$699
 (estimated street price)

Alps Electric, Inc.
 San Jose, CA

(800) 825-2577
 (408) 432-6000
 fax: (408) 432-6035

<http://www.alpsusa.com/>

Circle 1070
 on Inquiry Card.

The MD-4000 also has a 600-dpi color scanning head on its printing carriage. Printing and scanning share the same paper path.

copy paper, postcards, iron-on T-shirt transfers, transparencies, and photographs, as well as other coated papers, with good to excellent results. The MD-4000's multipass print engine shows minor banding only on large expanses of CMY-composite black. The printer's default color-matching produced acceptable-looking prints, and the Windows driver gives you ample opportunity to fine-tune the output.

The MD-4000's pluses are quality and affordability; speed is the minus. It took 8 minutes to print an A4-size color image at 600 dpi. Reducing image size or density accelerates the printing process proportionally. Text prints at a page per minute. Mechanically, the printer is less than rugged. A bevy of pull-out, flip-down, and sliding trays, drawers, and compartments invite accidents. I also found the feeder tray somewhat finicky.

To scan a document, you must place it in a plastic envelope—a 4- by 6-inch

unit for small documents and photos or an 8½- by 14-inch unit for larger media. The Alps Copy Studio software provides bare-bones service. For anything beyond color copying, you'll want to scan from your own TWAIN-compatible image edi-

RATINGS

TECHNOLOGY	★ ★ ★ ★
IMPLEMENTATION	★ ★ ★
PERFORMANCE	★ ★

tor. Alps includes Adobe's consumer-oriented PhotoDeluxe with the MD-4000.

The MD-4000 printer isn't likely to find a home in a high-production photo studio. But for the small office or home, the attraction is clear: durable, high-quality color printing and high-resolution scanning at an affordable price. **B**

Robert L. Hummel is an electrical engineer, programmer, and consultant. You can reach him at rhummel@monad.net.

Does Digital Video Get Any Better?



Yes, it does: miroVIDEO DC30.

Professional studio quality video for your PC,

CD quality audio with perfect lip synchronization,

Real-time video-overlay,

Optimal hard disk usage,

High-speed video editing,

because

miroVIDEO DC30 PCI bus mastering provides the fastest data rates (up to 6 MB/sec), the highest resolution (4:2:2 YUV TrueColor) with the best image quality (3.5:1 compression).

because

miroVIDEO DC30 integrates audio with video on a single board so you don't miss a beat.

because

miroVIDEO DC30 displays full-motion video directly on the PC monitor at all times. True WYSIWYG video during capture, edit and print-to-tape.

because

miroVIDEO DC30 has fully adjustable video resolution and compression settings to provide the best video quality in the space available.

because

miroVIDEO DC30 has specialized hardware and world-class drivers to accelerate video editing software – up to 10 times faster with Adobe Premiere software during “make movie” and “preview edit” mode.

Professional digital video and audio editing system

- ▶ PCI bus mastering technology, for the fastest data rates up to 6 MByte/sec.
- ▶ On-board CD audio
- ▶ Ready for Windows 95
- ▶ Input and output for S-VHS, Hi8, VHS, Video8
- ▶ All standards: NTSC, PAL, Secam at CCIR 601 pixel format and square pixels



COMDEX
Fall '96

M1937
Sands Convention Center, Las Vegas

Circle 192 on Inquiry Card (RESELLERS: 193).

miroVIDEO DC30

miro



“The
HEART
of an
Artist”

EO75
EO SERIES

Vivid colors. Ergonomic design. Performance and features to indulge the visionary in you.

Princeton Graphic Systems® monitors have always had a solid reputation for pushing performance barriers far beyond industry standards. This tradition was proven with the highly respected Ultra 15 which won *PC World's* Best Buy Award a remarkable three times in a row. The 135MHz/82KHz Ultra 17+ further redefined the industry with its award-winning, high refresh rate performance and ultra-low price. Now, our **ExtraOrdinary** new models surpass even our own stellar benchmarks.



Case in point, the EO75. With its super-high 95KHz horizontal frequency, 200MHz video bandwidth and an ultra-fine 0.26mm dot pitch, this 17" (15.8" viewable) monitor delivers a bold, flicker-free resolution of 1600 x 1200 @ 75Hz. That's rock-solid performance. Furthermore, our engineers added Enhanced Imaging Circuitry for a sharper focus without the moiré problems so common to other 0.26mm monitors. That's a difference you can see!

Princeton's next generation of EO monitors incorporates PreVu™ controls and Coloright™ technology perfect for intense, graphical applications. In addition, Princeton offers an **ExtraOrdinary**, full three year "Bucket to Bezel" limited warranty*.

The EO Series is already available at your nearby dealer. See it today. Their performance will win your heart. Their price will ease your soul.

“The **SOUL** of an
Accountant”

\$722 *ESP*



Princeton Graphic Systems • 2801 S. Yale St., Ste. 110 • Santa Ana, CA 92704 • Tel. 800/747-6249 or 714/751-8405 • Fax 714/751-5736 • Fax-On-Demand 714/751-0168 • Web Site: www.pgr.com

©1996 Princeton Graphic Systems. All rights reserved. All trademarks are the properties of their respective owners. As an Energy Star™ Partner, Princeton Graphic Systems has determined that these products meet Energy Star™ Guidelines for energy efficiency. Prices and specifications are subject to change without notice. *PreVu™ and Coloright™ are not available on the EO40. Full three-year limited warranty is offered on the following models: EO40, EO50, EO17, EO70 and EO75.

COMDEX
Fall '96 Las Vegas Convention Center
Booth No. LS205

PRINCETON®

GRAPHIC SYSTEMS

800-747-6249 ext. 165

With its latest GroupWise release, Novell goes head-to-head with groupware giants Lotus and Microsoft. By Steve Gillmor

GroupWise Sends a Message

Choosing the right groupware product is harder now with the release of Novell's GroupWise 5 (hereinafter GW5), which adds significant document management tools to an already feature-laden messaging product. The new version also has state-of-the-art NetWare Directory Service (NDS), TCP/IP client/server technology, OLE automation, shared folders, and an enhanced interface.

We installed the GW5 beta on a NetWare 4.1 server, using NetWare Administrator 4.1.1. An included two-user version of NetWare 4.x gives access to NDS tools. Initially, GW5 runs only on Windows NT Server. Setup went smoothly. The GroupWise Setup Adviser walks you through extending the NDS tree; defining domain, post office, and agent names, locations, and contexts; and adding current users or new ones.

The GW5 client adopts a three-pane interface, like cc:Mail, Lotus Notes, and Microsoft Exchange. The left window displays the folder list. You can organize multiple item types by subject or by project in folders within cabinets, and sharing folders is easy.

GW5 leads the pack in document management. Novell has integrated much of its Soft Solutions product, including doc-

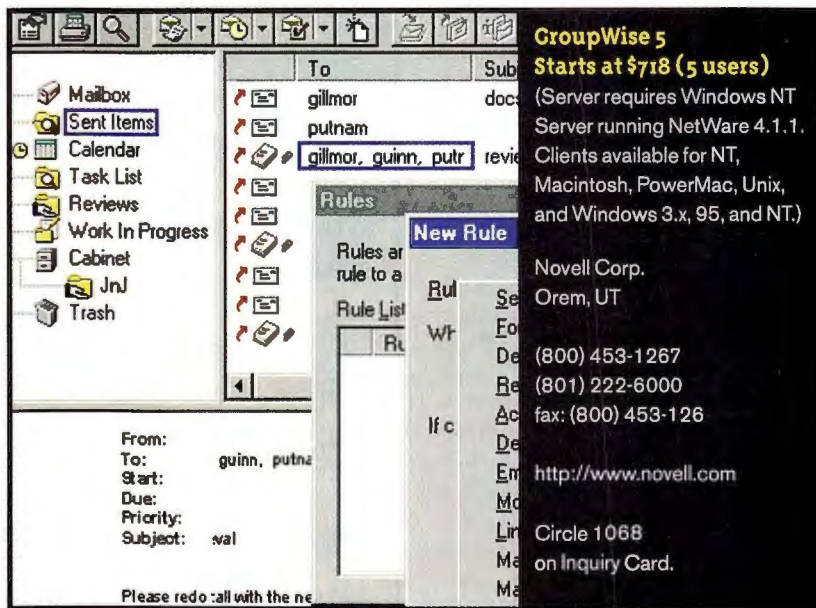

GroupWise 5
Starts at \$718 (5 users)
 (Server requires Windows NT Server running NetWare 4.1.1. Clients available for NT, Macintosh, PowerMac, Unix, and Windows 3.x, 95, and NT.)
 Novell Corp.
 Orem, UT
 (800) 453-1267
 (801) 222-6000
 Fax: (800) 453-126
<http://www.novell.com>
 Circle 1068
 on Inquiry Card.

Novell's GroupWise lets you use drop-down menus to select event types, condition filters, and actions.

ument check-in, check-out, versioning, sharing control, version-level security, and an activity log. Documents are stored in libraries, and mailboxes display only references to documents.

GW5 adds client/server connectivity while maintaining its drive-mapped access to the post office to ease migration and use existing hardware. GroupWise's proxy capability lets users access other mailboxes in different post offices.

With GW5 you can convert items from one type to another—for example, mail messages to calendar appointments. You can track message status by right-clicking a mailbox item and viewing its properties. You can also see incoming and outbound messages in a threaded view. You can create a rule to move items into folders, and you can define trigger events that let rules execute on a server—when you're away, for instance.

GroupWise offers a complete toolkit for messaging, calendaring, scheduling, and managing documents. It also gives you tools for single-point NDS-based

RATINGS	
TECHNOLOGY	★★★★★
IMPLEMENTATION	★★★★

administration. The package represents a tremendous value for existing NetWare shops. Its ease of use and configurability compete favorably with Exchange, but its Web integration lags behind Notes' Domino technology. And with Windows NT gaining fast on NetWare, the network administrator must think twice before making the leap to GroupWise. **B**

Steve Gillmor, of Southern Digital, has extensive experience with groupware applications. You can reach him at sgillmor@aol.com.

Still to Come

The initial release of GroupWise 5 does not include everything we'd hoped for. Here are a few important omissions:

- Novell's GroupWise WebAccess supports busy searches and virtually all of GroupWise's client functions via the Internet, but this isn't bundled into GW5.
- You can't create custom icons for specific URLs in the mailbox.
- Unix and OS/2 versions are in the works.
- Promised work-flow tools won't ship until a later, interim release.

MarketScape's WebCD packages Web content for off-line use and automates CD-ROM mastering. By Jon Udell

Hybrid Web/CD-ROM: Do It Yourself

Why bother with CD-ROMs in the Web era? There are lots of reasons. Try hosting an 8-minute video on your Web site. Try asking your sales force to demonstrate your site to non-Web-connected clients. Try using your site's content on an airplane. You can solve all these problems with MarketScape's WebCD.

CD-ROMs that venture on-line to augment static content with live updates have been around for a decade. MarketScape calls it the "big CD, small Web" model. WebCD heralds a new era—big Web, small CD. It acknowledges the primacy of the Web. It delivers a native Web-browsing experience and adds value to that experience by facilitating the effective use of high-bandwidth content, off-line access to all packaged content, seamless Web integration when on-line, and content aggregation across multiple sites.

To build a site image, you run WebCD Packager, a Windows 95 application that integrates a Web crawler, a browser, and a CD-ROM-mastering utility. Point it at your Web server—or even several of your servers, or any servers anywhere (be careful!)—and scoop up the content you need. As you construct a package, you can browse it live—no waiting until the build finishes before you can view it.

To distribute the image, you deliver it—on a CD Recordable (CD-R) disc, tape, or conceivably by way of FTP—to a mastering shop. The image contains all your Hypertext Markup Language (HTML), GIF, Audio Video Interleave (AVI), and other files, mapped to the eight-dot-three filename convention required by ISO-9660 and optimized for the peculiar access behavior of CD-ROM drives.

The image also contains a setup program that installs WebCD Viewer. It's a wrapper that will find and integrate with Netscape Navigator or Microsoft Inter-

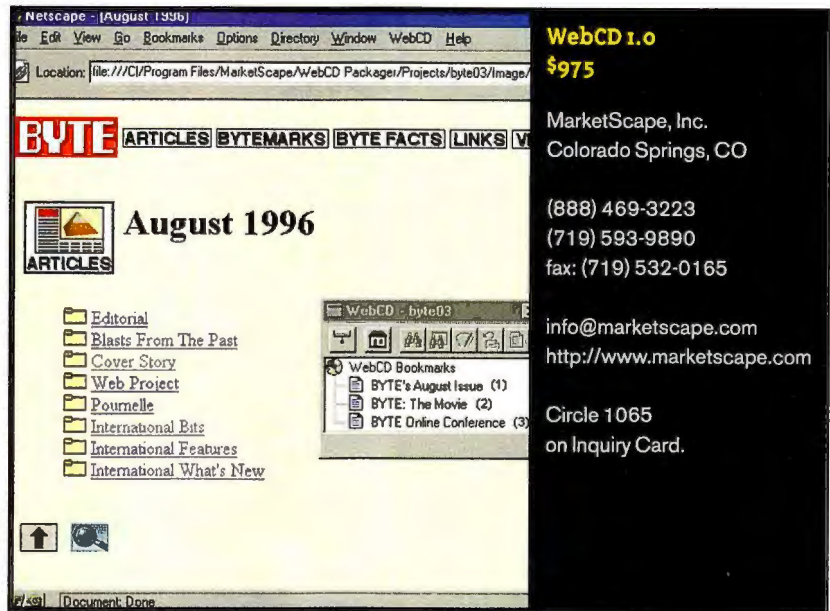

WebCD lets you seamlessly integrate live Web pages with static pages and high-bandwidth data types such as video.

net Explorer, adding to either browser a floating window that controls special WebCD search and bookmark functions. Mac and Unix users miss out on WebCD Viewer. However, they can point their browsers directly at the data.

I tested WebCD Packager on The BYTE Site. The image I built (see the photo) combines articles from our document server with messages from our conference server. When you aggregate content across multiple Web servers (or sites), where's the home page? You can choose an existing one or make a new one, but either way, you'll want WebCD Viewer's bookmarks to call out landmark pages.

I discovered a few glitches. Although it supports proxy servers, WebCD could not tunnel through our multiple-proxy setup. Because it interleaves uniform-resource-locator (URL) discovery and retrieval, I found it tricky to map out

our whole site before choosing what to package. Also, when I ran my first build, some links resolved on-line rather than locally. I'd have liked a verification tool

RATINGS	
TECHNOLOGY	★ ★ ★ ★ ★
IMPLEMENTATION	★ ★ ★ ★ ★

to ensure that all referenced pages were included in the package. You wouldn't want to find on-line dependencies after you mastered your CD-ROM.

Its minor immaturities aside, WebCD is an outstanding tool that I recommend highly. There's no easier or better way for marketers to transform a company's Web site into a distributable, stand-alone, high-impact presentation. **B**

Jon Udell (judell@bix.com) is BYTE's executive editor for new media.

Removable one-gig disks,
unlimited space,
fast as a hard drive.

That's a jammin' gig.

For the nearest dealer, call:
888-2-IOMEGA, ext. j22
Or see us at: www.iomega.com



The Jaz™ drive is you, man. It's fast, it holds tons of stuff, and it's personal. You won't find an easier or cooler way to upgrade your hard drive. Just connect it to your PC or Mac and you're jammin': files, pictures, graphics, video, CAD stuff, whatever. And with its dark green color, hey, the cat's got style.

jaz



The Unlimited Personal Hard Drive.

Endless storage space.
Load and edit projects instantly.
Goes anywhere you go.



1GB disks for as low as \$99.95.

Compact one-gigabyte cartridges.
Great for graphics, sound, and video.
Portable Files. Fast, easy backup.

BECAUSE IT'S YOUR STUFF.™



TAKE THE DAY OFF.



Your business decisions just got easier.

Now there's a PC that's flexible and sensibly priced for your office or department—the ClientPro™ system from Micron Electronics. Designed for long life and reliable, affordable performance, this new PC offers years of productive and adaptable computing without costly system upgrades. Now we are matching the power and reliability of the ClientPro PC with powerful system software by introducing the new 32-bit operating system everyone is talking about—Microsoft® Windows NT® Workstation. With the ClientPro PC, you get a system custom-configured to fit your office needs, network-ready with Windows NT Workstation and backed by our industry-leading Micron Power™ warranty.



Micron Power™ Warranty & Support

- 5-year limited warranty on microprocessor and main memory
- 3-year limited parts-only system warranty
- 1-, 2- or 3-year optional on-site service agreement for Micron desktop systems
- 30 days of free Micron-supplied software support for Micron desktop systems
- 30-day money-back policy
- 24-hour technical support

The foregoing is subject to and qualified by Micron's standard limited warranties and terms and conditions of sale. Terms and conditions of sale may vary for specific configurations. Copies of the limited warranties may be obtained on our Web site or by calling Micron.



ClientPro™ P120

- Intel 120MHz Pentium® processor
- 256KB pipeline burst cache, flash BIOS
- 3Com® 3C509 Combo network adapter
- 3.5" floppy drive
- PCI 64-bit graphics accelerator, 2MB EDO RAM
- Tool-free minitower or desktop
- Microsoft® Mouse, 104-key keyboard
- MS-DOS® 6.22/Windows® for Workgroups 3.11
- Microsoft Works preinstalled
- 5-year/3-year Micron PowerSM warranty

- 16MB EDO RAM • 1.2GB EIDE hard drive
- 14" Micron 14FGx, .28dp (12.9" display)

\$1,499

Bus. lease \$51/mo.

- 16MB EDO RAM • 2.1GB EIDE hard drive
- 15" Micron 15FGx, .28dp (13.7" display)

\$1,699

Bus. lease \$58/mo.

- With Intel 133MHz Pentium processor.....add \$50

ClientPro™ 2 P180

- Intel 180MHz Pentium® Pro processor
- 256KB internal burst cache, flash BIOS
- 3Com 3C509 Combo network adapter
- PCI 64-bit graphics accelerator, 2MB EDO RAM
- 3.5" floppy drive
- 16MB EDO RAM
- 1.2GB EIDE hard drive
- 14" Micron 14FGx, .28dp (12.9" display)
- Microsoft Works preinstalled
- Tool-free minitower or desktop
- Microsoft Mouse, 104-key keyboard
- Microsoft Windows NT® Workstation
- 5-year/3-year Micron Power warranty

\$1,999

Bus. lease \$68/mo.



pentium
PROCESSOR



PENTIUM-PRO
PROCESSOR

MICRON

ELECTRONICS, INC.

800-486-2059

<http://www.mei.micron.com>

 Tollfree from Canada
800-708-1758

 Tollfree from Mexico
95-800-708-1755

 Tollfree from Puerto Rico
800-708-1756

 International Sales
208-893-8970

 International Fax
208-893-7393

900 E. Karcher Road, Nampa, ID 83687 • Mon-Fri 6am-10pm Sat 7am-5pm (MT) International Sales Hours: Mon-Fri 6am-7pm (MT)
208-893-3434 • Fax 208-893-3424 • Purchase Order Fax 208-893-8992 • Technical Support Available 24 Hours / 7 Days

Technical Support E-mail: techsupport.mei@micron.com

©1996 Micron Electronics, Inc. All rights reserved. Micron Electronics is not responsible for omissions and/or errors in typography or photography. All purchases are subject to availability. Prices and specifications may be changed without notice; prices do not include shipping and handling. 30-day money-back policy does not include return freight and original shipping/handling charges, applies only to Micron brand products and begins from date of shipment. All sales are subject to Micron Electronics' current terms and conditions of sale. Lease prices based on 36-month lease. Intel, Intel Inside and Pentium are registered trademarks of the Intel Corporation. Microsoft, Windows, the Windows logo and Windows NT are registered trademarks of Microsoft Corporation. All other service marks, trademarks and registered trademarks are property of their respective companies. BYTE-CLPR-9611

Circle 174 on Inquiry Card.

A developer's dream come true...



#1 Protection Supplier

You'll have peace of mind with your software backed by world leader Rainbow

Leading Technology

Sentinel® is the *only* protection combining multiple algorithms and ASIC technology



ISO 9002



The Highest Quality

Only Sentinel keys meet ISO quality standards and offer the best reliability

Truly Compatible Security

The industry's largest engineering staff is dedicated to making your software safe on any platform

Increase Your Revenue

Sentinel stops piracy, ensuring you that every user of your software is a paying customer

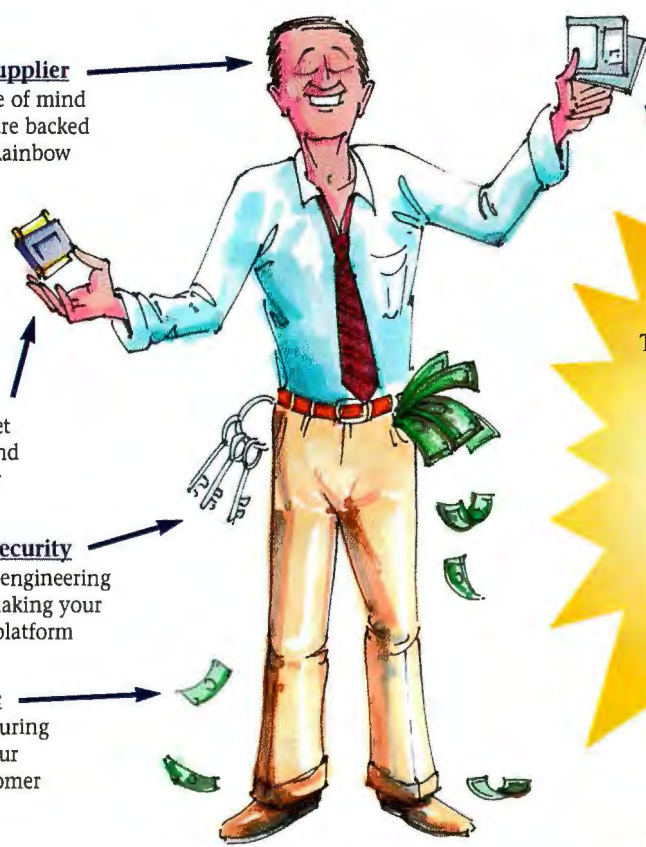

NEW

The SentinelWizard™ GUI is an innovative tool that makes protecting your software easier than ever

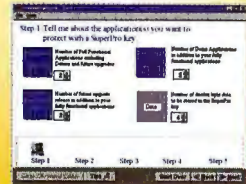

COMDEX/Fall '96
Visit Us At the Sands
Booth #S4381

The world's #1 software protection is now the easiest to implement!

You've always dreamed of superior software protection that was simple to integrate into your entire product line. The new SentinelWizard makes your dream a reality.

Just tell the SentinelWizard how you want to sell your products. It then automatically configures your Sentinel keys and generates the pseudo code necessary to complete the protection process.

Call now to order your Sentinel Developer's Kit, featuring the SentinelWizard.



1-800-852-8569

SENTINEL
Software Protection

Ask us about SentinelLM™ - the new software-based network license manager

Visit our web site
www.rnbo.com



HEADQUARTERS: 50 Technology Drive, Irvine, CA 92618 ■ Tel: (714) 450-7300 ■ Fax: (714) 450-7450
ASIA/LATIN AMERICA: (714) 450-7300 ■ FRANCE: (33) 1 41 43 29 00 ■ GERMANY: (49) 89 32 17 98 0 ■ U.K.: (44) 1932 579200
©1996 Rainbow Technologies, Inc. Sentinel, SentinelLM and SentinelWizard are trademarks of Rainbow Technologies. All other names are property of their respective owners.

ALGERIA: AFAK (213) 41 85 61
ARGENTINA: Agri-Aid, S.A. (54) 1 8030536
AUSTRALIA: LOADPLAN (61) 3 9690 0455
BELGIUM/LUXEMBURG: E2S (32) 92 21 11 17
BRAZIL: MIPS Sistemas Ltda. (55) 11 574 8686
BULGARIA: KSIMETRO (35) 9279 1478
CHINA (East): Shanghai Pudong Software Park Electronics Company (86) 21 6403 1966
CHINA (North): CS85 (86) 10 6217 7722 X2404
COLOMBIA: Construdata (57) 1 622 6011

CZECH REPUBLIC: ASKON Int'l (42) 2 3103 652
EGYPT: ZEDAN-ADS (202) 248 8994
GREECE: Byte Computer S.A. (301) 924 17 28
GUATEMALA: Soft Corporation (502) 2 304006
HONG KONG: AlfaLink Tech. Co. (852) 2333 0626
HUNGARY: Polyware Kft (36) 76 481 236
INDIA: ANC Engineering Co. (91) 11 4615680
INDONESIA PT. Promtrade InfoScan (62) 21 375 166
IRAN: GAM Electronics (98) 21 87 44 001
ITALY: BFI IBECSA SPA (39) 23 31 00535

ITALY: Siosistemi (39) 30 24 41 1
JAPAN: Giken Shoji Co., Ltd. (81) 52 972 6544
JORDAN: CDG Engineering (96) 26 863 861
KOREA: Genesis Technologies (82) 2 578 3528
LEBANON: National Group Cons. (961) 1 494317
MALAYSIA: Eastern Systems Design (M) Sdn Bhd (60) 3 241 118B
MEXICO: Impex Corp., S.A. de C.V. (52) 66 210 291
MOROCCO: Futur & Soft (212) 2 40 03 97

NETHERLANDS: IntroCom (31) 74 2430 105
NEW ZEALAND: Software Images (64) 09 378 9790
PERU: OpenSoft (51) 1 224 2125
PHILIPPINES: Mannasoft Technology Corporation (63) 2 813 4162
POLAND: HITEX Sp. z o.o. (48) 22 41 97 51
PORTUGAL: COMELTA (351) 1 941 65 07
RUSSIA: Multisoft Int'l (7 095) 186 35 84
SAUDI ARABIA: ZEDAN (966) 2 665 1904
SCANDINAVIA: Perico A/S (47) 2249 1500

SINGAPORE: Systems Design PTE LTD (65) 747 2266
SOUTH AFRICA: SOFTSECURE (27) 11 477 6053
SPAIN: MECCO (34) 3 422 7700
SWITZERLAND: BVV AG (41) 1 745 92 92
TAIWAN: Evershine Tech. (886) 2 8208925
THAILAND: BC5 Int'l (66) 2 319 4451
TUNISIA: Soft Informatique Tech (216) 17 19 486
TURKEY: BIMEKS, Ltd. (90) 216 348 3508
VENEZUELA: HRT-M Osers (58) 2 261 4282

Circle 160 on Inquiry Card.

Better reasons than tradition explain why Digital's VMS operating system continues to survive. By Ben Smith

VMS: Alive and Well

With a face betraying my shame, I mumble, "Hi. My name is Ben, and I am a VMS user." The crowd responds: "Hi, Ben. We're VMS users, too!" But using a 20-year-old OS called VMS—which unofficially stands for Virtual Memory operating System—doesn't mean you have a disease, or even a temporary condition.

Besides its longevity and proliferation, due in great part to its robustness and sophisticated management design, VMS is adept at handling mission-critical jobs, and its clustering capabilities make it well-suited for multiprocessing. The OS isn't without flaws, which become more apparent because of its age. But Unix, which is even older, is growing in popularity, whereas VMS is just holding its own. Is VMS at the end of its life cycle?

Who Uses VMS, Anyway?

The VAX computer and VMS have been inseparable since birth. In fact, the VAX is one of the earliest designs in which the software engineers played a major role in the hardware design: They determined what structures and services should be implemented in microcode. Now, with the VAX being supplanted by Alpha VMS servers, VMS survives beyond its original architecture despite the close hardware ties.

VAXes have been applied to every kind of computing, so VMS has been used by every kind of user, from scientists running supercomputing applications to office workers doing word processing. But the days of broad-spectrum computing are past. Personal computers and much simpler LANs have replaced VAXes and terminal servers for low-end office computing. What work can't be handled by desktop computers can be done inexpensively on Unix machines and, despite their immaturity, Windows NT servers. Still, VMS can be found handling the crit-

ical, the fault-tolerant, and the secure computing jobs such as bank and stock market transaction processing, record keeping, and billing systems. A hiccup in any of these applications could cost

lines of FORTRAN code that also fall into the category of legacy systems. These hoary applications work perfectly well in the VMS environment, and they continue to gain in performance whenever Digital ships a newer, faster, VMS server.

Another reason for the OS's continuing popularity is a feature that all VMS applications exploit: VMS programs can share the same data types, system resources, and process control. Developers can thus seamlessly build a monolithic application in which each individual part is crafted in the language best-suited for its function. For example, an application's general business logic might be coded in COBOL, its bit-manipulation aspects written in C, and its sophisticated numeric operations and utilities composed in FORTRAN.

VMS vs. Unix

VMS, along with its hardware counterpart, the VAX, was over a year in design, not counting the six months of discussions that took place before Gordon Bell (then head of R&D at Digital) wrote a memo, in April of '75, committing to its development. From the very beginning, VMS was built for demanding commercial applications. The VMS/VAX design team tried to anticipate all the levels and details that any commercial operation might need, and to implement them at as low a level as practical. High on the list of VMS features has been its consistency, its rich set of management features, and its security (C2/B1 rating from the U.S. government). Most important, VMS was the VAX's native operating system. Even today Unix, which is VMS's closest competitor, is considerably weaker in all these areas. Conversely, VMS's file system still lacks the ability to handle more than eight levels of subdirectories.

Unix is the quintessential example of ad hoc OS development. Unix grew out

millions of dollars in a flash, or even put lives in jeopardy.

Another important VMS feature is clusters. The basic concept is: If performance isn't adequate, add another server; they all appear as one.

The engineering and research communities have a huge investment in VMS applications. These are the millions of

A VMS Time Line

April 1975: DEC's Gordon Bell writes memo that starts formal work on VAX/VMS.

April 1978: First VAX shipped, with a preliminary version of VMS.

August 1978: VMS 1.0 ships.

April 1980: VMS 2.0, VAX/750 (first new processor) added to DEC product line.

April 1982: VMS 3.0, VAX/730 rolled out. Ethernet connectivity added.

September 1984: VMS 4.0 and VAXcluster introduced. Many new VAX models introduced.

September 1988: VMS 5.0, the VAX 6000, and symmetric multi-processor VAXes introduced.

November 1992: VMS 1.0 for the Alpha processor released.

July 1993: VMS 6.0 released. The major features are support for very large VAXes and a C2/B1 government security rating.

January 1996: VMS 7.0 released. Kernel-level support for DECthreads and 64-bit memory management supported on Alpha.

In Case of Emergency, Use Duplicate Clusters

Digital implements multiprocessor computing over the entire spectrum of configurations: from tightly coupled computers that share memory and whose processes must be tightly synchronized, to the very loose asynchronous model of networked heterogeneous computers that share tasks through remote procedure calls (RPCs). The VMScluster lies between these two extremes.

VMScluster implementations share resources between processors in such a way that the processors and the resources appear as a single system to the user. The connections between a cluster's elements can be through just about any method; the loosest is a simple Ethernet connection. These connections are made through redundant one-way cables with duplicate "send" and "receive" ports.

For disaster tolerance, portions of the cluster "mirror" the activity of the other portion, as shown in the figure at right. That is, the system takes all the processing and storage that lives on one part of the cluster and duplicates it in another part of the cluster. One side is designated as the primary segment of the cluster until it fails, at which time the other section becomes the primary.

By placing parts of a cluster several miles from the other and having the processing and storage mirrored between the sites, disasters such as a power failure or fire at one site don't affect the others. When the systems are connected by high-bandwidth

fiber-optic lines, processing continues uninterrupted. This kind of fault-tolerant computing is what stock exchanges, electronic

funds transfer centers, and military systems require. Additionally, VMS is laudably secure in contrast to the majority of Unix systems.

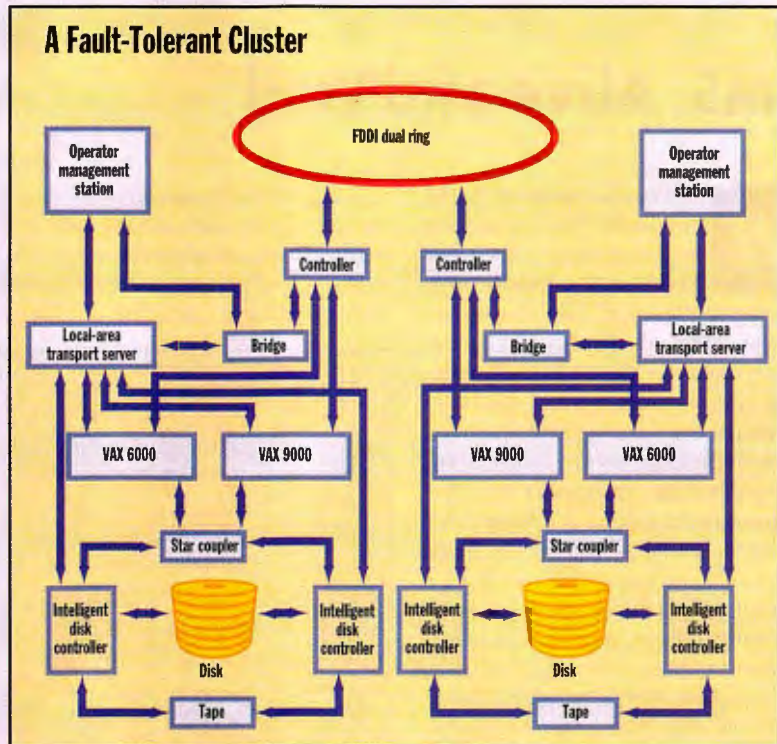

Smart disk controllers make devices they manage available to all processors on the net, thus resembling a unified system.

of a solution to running a compute-intensive simulation program on a computer that had been all but abandoned (ironically, a DEC PDP-7). Unix has grown as need be. Great leaps in design have been the result of some special application, research project, or academic program. Unix didn't actually become a commercial product (from Interactive Systems Corporation) until 1977, the same year that VAX/VMS was announced at a DEC stockholders' meeting.

While the VMS OS was integral to the VAX and hadn't (until the DEC Alpha) run on anything but VAX computers, Unix has been uniquely portable. Because of its humble roots and minimalist hardware requirements, Unix was quickly ported to all platforms, including the VAX. Despite the system's haphazard beginnings, many Unix features have become models for implementing simi-

lar services on other OSes, including Unix's simple file I/O, which was extended to devices and interprocess communications (through sockets); a configurable hierarchical file system; and more than one way for a user to interface with the OS (different command interpreters, or "shells").

Reports of My Death Are Greatly Exaggerated

An OS has reached its terminus when it's no longer breathing with new development. VMS is still alive. And it's drawing new energy from another OS: NT. The connection here is DEC's NT Affinity product and the concept of using VMS servers to do the high-end computing for NT servers and workstations. To support this capability, VMS has incorporated many of NT's data structures and design elements. There is a life-supporting trans-

fusion going on between VMS and NT.

The VMS development group is very much alive and well. Some of the original developers are still there, turning out new releases. The truth is, VMS does just fine for its long-term customers who are running COBOL and FORTRAN applications, as well as for customers writing applications in C/C++, using RDB or Oracle databases and doing distributed transaction processing. Both of these types of users are going to be around for a long, long time.

VMS still serves as a reliable tool for getting the job done, particularly in mission-critical situations. There is no shame in being a VMS user. **B**

Ben Smith is an independent contract programmer specializing in Unix and Perl. He used to be a BYTE technical editor. You can reach him at ben@ronin.com.

Visio Technical

There's a
new way

to create
technical
drawings.

Look who's using it.

Try it.

See what it can
do for you.



Just because your

work is complex

doesn't mean

it has to be difficult

Amoco is saving 5% per project or up to 20 million dollars by using Visio to plan and manage their oil exploration. Other companies use it to save time or increase productivity.



You'll find lots of companies have adopted Visio: Chrysler, National Semiconductor and Fluor Daniel, for example.

To get your work done, you've always needed CAD. But then along comes Visio® Technical, a Windows-based drawing program that's actually easy to learn and use. Our SmartShapes® technology lets you create 2-D technical drawings and schematics that are both intuitive and intelligent. You can finish drawings faster, make changes easily, work with AutoCAD files and even create custom solutions through OLE Automation. Make things easy on yourself for a change. Call 800-24-VISIO, ext. E27 or visit www.visio.com. For corporate evaluation call 800-VISIO-07.

Visualize your business™



Display Business Savvy.



Whether your business relies on basic spreadsheets or the most advanced multimedia applications, ViewSonic® has the perfect Graphics Series monitor for YOU! In fact, our Graphics Series offers NINE different monitors, ranging from 15" through 21" (various viewables) for both PC and Mac® systems. Each provides a unique combination of performance, features, value and screen size to meet your specific needs.

Graphics Series Monitors

Our Graphics Series offer features like OnView® controls for easy on-screen adjustments, ViewMatch® to match screen color to printer output, and overscan capabilities which provides use of the entire screen. And *Plug & Play*® for easy installation with Windows® 95.

For multimedia, personnel training and internet applications, the Graphics Series PerfectSound™ 15GA and 17GA multimedia monitors are the ideal choice.

Product	CRT Size/ Viewable	Dot Pitch Aperture Grille*	Max. NI Resolution	OnView® Controls	TCO Certified	MSRP
ViewSonic 15GS	15"/14.0"	0.28mm	1,280 x 1,024	Yes	Yes	\$449
ViewSonic 15GA	15"/14.0"	0.27mm	1,280 x 1,024	Yes	Yes	\$499
ViewSonic 17GS	17"/16.0"	0.27mm	1,280 x 1,024	Yes	Yes	\$699
ViewSonic 17GA	17"/16.0"	0.27mm	1,280 x 1,024	Yes	Yes	\$799
ViewSonic GT770	17"/15.9"	0.25mm*	1,280 x 1,024	Yes		\$795
ViewSonic 20G	20"/18.4"	0.28mm	1,600 x 1,280		Yes	\$1,299
ViewSonic GT800	20"/19.1"	0.30mm*	1,600 x 1,280	Yes		\$1,495
ViewSonic G810	21"/20.0"	0.25mm	1,600 x 1,280	Yes		\$1,745

All monitors are EPA Energy Star™ and MPR-II certified. *Aperture Grille. Free VMA-1 Mac cable adapter available.

With high fidelity speakers integrated into the bezel for directed stereo sound, a built-in microphone*, headphone jack, as well as mute and volume controls, these *award-winning* monitors offer a unique experience in sight and sound.

The ultimate in high performance monitors, the ViewSonic GT770 and GT800 blend aperture grille mask technology and the vertically flat SonicTron™ screen to produce the sharpest, most brilliant colors from center to corner. The high contrast images are the richest and brightest available today.

Our monitors are backed by a limited 3-year warranty on CRT, parts and labor... the best in the business. Plus your company can take advantage of our special 48-hour Express Exchange™ Service option.



ViewSonic®

At ViewSonic, we make more than just good business monitors. We make good business sense.

Phone: (800) 888-8583 or (909) 869-7976; Agent Code 1266
Internet: <http://www.viewsonic.com>

*Optional microphone adapter may be required with certain Macintosh™ systems. Prices and specifications subject to change without notice. Corporate names and trademarks stated herein are the property of their respective companies. © 1996 ViewSonic Corporation. All rights reserved.



Circle 170 on Inquiry Card (RESELLERS: 171).

Sun's revised NFS could overcome HTTP's limitations in handling large amounts of Web data. By Bob Friesenbalm

A File System for the Web

The popularity of the Web has skyrocketed in the past few years. Few technical challenges have impeded its expansion. However, it is beginning to show severe growing pains. Popular Web sites now use networks of multiple high-performance computers to sustain the heavy load when serving data via HTTP.

The intranet is now beginning to rival the Internet's growth. Corporate users expect to manipulate Web data in the same way that they deal with data in their other productivity applications. Unfortunately, poor data-manipulation capabilities are the Achilles' heel of existing Web technologies.

The Web is based on Hypertext Markup Language (HTML) and the simple HTTP. While it's simple to implement and understand, HTTP is an expensive protocol in terms of connection overhead and data transfer. Each object you transfer via HTTP requires a new TCP connection. (See "The Backbone of the Web," October BYTE, for details.) Furthermore, you must transfer the entire object at one time. Each HTML page can contain references to other objects (e.g., graphics images) that you must download to build the entire page. This requires additional TCP connections.

Web browsers such as Netscape's Navigator have adopted a threaded model that allows multiple HTTP accesses to be concurrent per HTML page. While threading helps avoid TCP-connection latencies (causing pages to load faster), it increases the load seen by the server.

What we need are more efficient Web data-access technologies that let users selectively access, manipulate, and update data as they have become accustomed to. Sun Microsystems believes it has a technology in its inventory that can provide the solution with a little brushing up. The basic technology is NFS, and

the Web-enhanced version is called WebNFS.

NFS in a Nutshell

NFS implements a virtual network file system that maps remote disks so that they appear local to a client computer on the network. NFS is a mature product that Sun introduced commercially in 1986. It

RFC 1014. Client and server versions of NFS are available for all major OSes. Development of NFS is relatively easy, because the source codes to XDR, RPC, and NFS are available in the public domain. Alternately, you can license NFS technology from Sun as part of its ONC+ platform, which most Unix system vendors license.

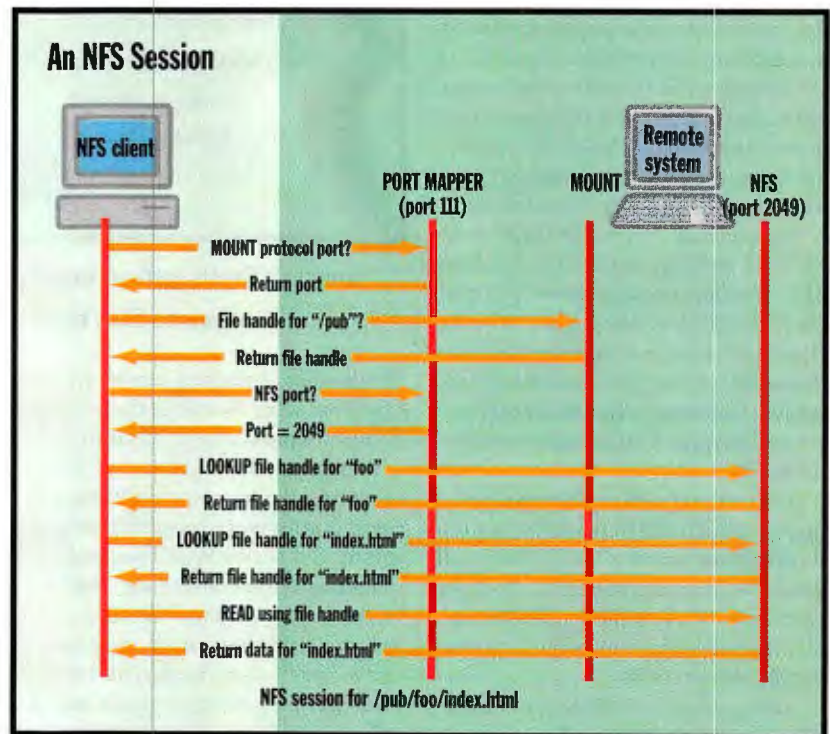

NFS requires many data transfers to establish access to a specific remote file.

rose to industry-standard status in 1989 with the publication of RFC 1094, covering NFS 2. In 1995, there was the publication of RFC 1813, which covers NFS 3.

NFS is based on Sun remote procedure call (RPC), RFC 1057, which is in turn based on data formats established by External Data Representation (XDR),

Sun considers any Web use of NFS—whether it's NFS 2, NFS 3, or NFS with WebNFS enhancements—to be a form of WebNFS. This can be extremely disconcerting to users, given that no specific form of the protocol can be labeled as WebNFS. In this article, I refer only to Web-enhanced versions (described

below) of NFS as WebNFS, rather than using Sun's broader scope.

The Evolution of NFS

If NFS is so great, how come we have not seen it used on the Internet? NFS is an efficient protocol that's optimized for LANs. As such, it originally relied on UDP, which provides no flow-control mechanisms or error recovery, other than for timeouts. Because of this, NFS has proven to be largely unusable over the Internet.

With the advent of NFS 3, TCP became the preferred transport protocol. TCP offers flow control, reliable transfer, and ordering characteristics that UDP lacks. With Sun's recent announcement of WebNFS, many of NFS's drawbacks over high-latency networks have now been eliminated.

Unaltered NFS is a terrible protocol for use over high-latency networks, as shown in the figure "An NFS Session." NFS's design was intended to be pure in that few assumptions were made regarding the OS's characteristics, such as path-name separators or even port addresses. Similar to other protocols based on Sun RPC, a port-mapper process maps the RPC protocol types to specific port addresses.

NFS depends on two RPC protocols: MOUNT and NFS. MOUNT gets a handle to the top, or start, of a directory tree. Once MOUNT accomplishes this, the client has "mounted" the server and uses this handle through the remainder of the session. Unfortunately, all this port mapping takes quite a bit of time over slow networks.

A more significant problem than port mapping is how NFS works with files. Rather than access files via their full paths, NFS iterates through the directory elements, retrieving file handles for each element. NFS then uses the final file handle to read the file.

To improve its performance over high-latency networks, NFS needs to eliminate port mapping, mounting, and path-name recursion overheads. To accomplish this, WebNFS makes three assumptions: The NFS default port is 2049, a directory can be exported as "public" with a known handle (zero or null length), and path-name delimiters are similar to an HTTP uniform resource locator (URL). That is, they use a forward slash to separate path elements, which lets full file paths be specified.

WebNFS thus introduces a new type of

URL, the *nfs* URL. *Nfs* URLs are specified via the format `nfs://server:port/path`, which is immediately familiar to Web users because the format is similar to that used by HTTP. As just mentioned, WebNFS uses the default NFS port of 2049, unless the URL specifies one.

The steps the modified protocol takes are illustrated in the figure "A WebNFS Session." These steps reduce the number of RPC packet transmissions to retrieve a relatively short path name from 12 to four. Furthermore, with traditional NFS, retrieving extra path elements increases

vide in the future) cannot be supported directly by WebNFS.

For example, WebNFS does not support the Multipurpose Internet Mail Extensions (MIME) Content-Type information, a feature that HTTP supports. Thus, data that's obtained via WebNFS must be identified locally by some means (usually a file extension) rather than being identified by the server (which could have more accurate information).

WebNFS has another significant limitation: It is impossible to support server applications without radical modifica-

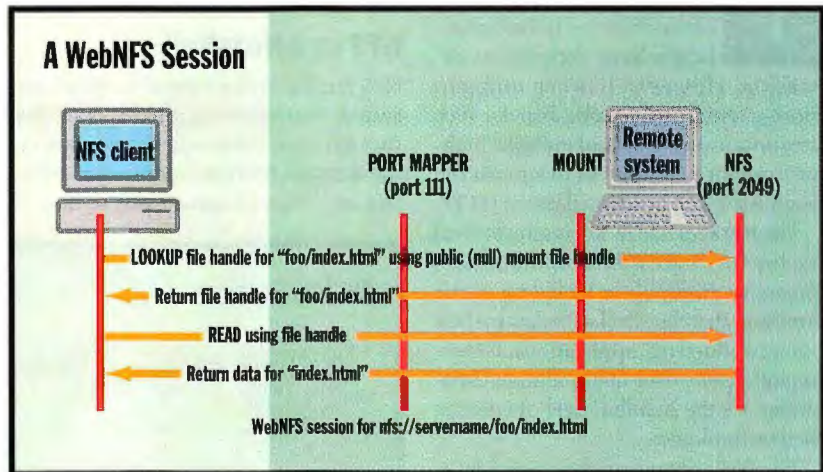

Smart defaults and an improved file mechanism reduce access to remote files to a fixed number of transfers.

the number of packets sent by two per element. With WebNFS, the required number of packets remains constant.

Presuming packet latencies of 250 milliseconds, the overhead to retrieve the first file on a server is reduced from a minimum of 3 seconds to 1 second (not including TCP-connect time). NFS RPC requests are inherently threaded in that you can send them in any meaningful order and back-to-back. This tremendously enhances throughput and decreases the effects of network latency, because responses stream back to the client as requests are serviced.

WebNFS Limits

While use of WebNFS provides significant performance and usability benefits, it has inherent limitations. They are related to the fact that NFS implements a file system. A network file system implements the semantics of a file system on a local disk drive. As a result, many features that HTTP provides today (or may pro-

vide) to the NFS server. You might overcome this limitation by simply using HTTP where NFS is not appropriate.

Will you ever see WebNFS in a Web browser near you? There are still many unanswered questions regarding how WebNFS would be made available in a browser, and even whether any major browsers will support it. WebNFS has the technical prowess to become a major Web technology. At the same time, we have seen how difficult it is to predict which technology will succeed. We can only wait and see how the story unfolds.

If you would like to learn more about WebNFS, Sun has made the technical details available (including an excellent white paper by Brent Callaghan of SunSoft) at <http://www.sun.com/sunsoft/solaris/networking/webnfs/>. **B**

Bob Friesenhahn is a consulting writer for BYTE who specializes in Unix and TCP/IP networking-related topics. You can reach him at bfriesen@simple.dallas.tx.us.

"They thought my new Multipath™ Back-UPS® Office™ was just a big surge suppressor – then the lights went out."

Back-UPS Office's Internet Ready Fax/Modem Protection prevents surges from damaging internal & external modems, motherboards, input/output cards, and other system components.

Six outlets guard your hardware with full-time surge protection. Three of the six outlets provide instantaneous battery back-up to keep your system from crashing in the event of a brownout or blackout.

Back-UPS Office has User-replaceable Batteries that can be easily swapped out, saving time and expense: no need to return to the factory for service. Batteries last 3-6 years under normal usage.

Full Time Surge Protection

Battery Power Supplied

Recused Master On/Off Switch prevents accidental shut-offs and conveniently controls power to the entire connected system.

Converts BlockSafe™ outlet spacing to accommodate all size plugs, including large transformer blocks.

LIFETIME EQUIPMENT PROTECTION \$25,000

Guaranteed protection against all power problems, on all power paths, for PCs and peripherals.

At last, a safe place to plug everything: Multipath Back-UPS Office for workstations, PC's and peripherals



Facing the darkness is hard, but inevitable: You have a better chance of winning the lottery than of escaping power problems: They're the single largest cause of computer data loss and hardware damage.

Back-UPS Office provides reliable power for your entire system. Instantaneous battery backup ensures uninterrupted operation of your CPU, monitor and an external storage device. Full-time surge suppression and site-wiring fault protection spreads a true Multipath™ safety net under any remaining integrated peripherals, like modems, printers, faxes and phone systems. Back-UPS Office also provides convenient BlockSafe™ outlet spacing to handle all size plugs – even large block transformers.

Unique Multipath protection keeps your PC and data safe

Plugging a phone line into your computer doubles your vulnerability to power

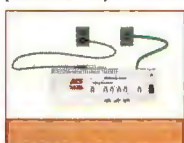

problems; add any peripheral, and it triples. Even if your AC power-line is shielded, when a surge hits an unprotected peripheral, it can haze down serial and data lines, and toast your expensive PC.

Back-UPS Office's compact design installs easily on desktop, floor or mounts to wall.

Multiple peripherals and data lines to and from your system are vital, but dangerous. Without them, you can't do your job. However, if a power sag makes your modem drop the line while you're downloading from the Internet, or locks your keyboard before you've saved work, you lose time, money and spend another late night at the office to meet your deadline.

Multipath™ Means Total Power Protection

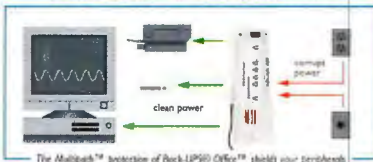

Back-UPS Office protects your entire system

Until now, protection for your entire system required several devices. But multi-device protection can leave you vulnerable to line noise and unwanted data glitches created by the voltage differential between outlets. Those glitches are prevented with the Back-UPS Office common voltage reference.

Back-UPS Office means true Multipath™ protection, clean, safe power to every

peripheral, and instant battery backup to keep your cutting edge system and O/S from crashing. It means protection for less by integrating the security of a surge suppressor with the power of a UPS, guaranteed up to \$25,000.

APC has won more awards for reliability than all other brands combined

THE MULTIPATH POWER PROTECTION ADVANTAGE	TRADITIONAL SURGE PROTECTION	TRADITIONAL UPS	BACK-UPS OFFICE
Protected Paths:			
AC	*	*	*
Data			*
Phone			*
Total Outlets:	7	2	4
Number of Block Outlets:			2
Protected Events:			
Surge	*	*	*
Spikes	*	*	*
Blackouts	*	*	*
Brownouts	*	*	*
Overvoltages	*	*	*
Typical Runtime in Minutes			
with Perseus 100 w/15" monitor		10	10
Battery Backup for:			
PC	*	*	*
Modem	*	*	*
Storage Devices/Zip Drives	*	*	*
Full-time surge protection for:			
Fax/Modem	*	*	*
Laser Printer	*	*	*
Speakers	*	*	*
Distalike protection for:			
Internet or Network	*	*	*

Traditionally, protecting all your equipment meant buying a surge suppressor and a UPS. Even then, only your AC line was protected. New Back-UPS Office protects all paths to your equipment: Builtproof Multipath protection

Protect yourself before you kick yourself. Get your new Back-UPS Office today (list price: \$179.99), or call APC for a FREE 60-page catalog!

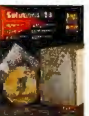

"Back-UPS Office [is] a show-in for the small-office/home-office computing market and for general desktop workstations"

-Computer Reseller News

APC

AMERICAN POWER CONVERSION

(800)800-4APC • <http://www.apcc.com>

(401)788-2797 Fax • (800)347-FAOX PowerFax
CompuServe: GO APCSUPPORT • Email: bloffice@apcc.com
132 Fairgrounds Road, West Kingston, RI 02892 USA

Dept. A2





WANT A 486 UPGRADE THAT OUTPERFORMS INTEL?
FOR \$139 YOU CAN PUT KINGSTON INSIDE.



Making your 486 run like a Pentium® doesn't take magic. It just takes a TurboChip™ and a little pocket change. Instantly, you will have 5 x 86 clock-quadrupled technology that will help your system run three times faster. And the TurboChip has all the power you need to run today's demanding software, whether you have a 486-based DX2, DX, SX2, or SX system. So how does the TurboChip compare to Intel's OverDrive®? Not only does the TurboChip beat the OverDrive in price,

compatibility, and warranty, but in a recent study* it also outperformed it. The TurboChip is designed with AMD's Am 5 x 86-P75 CPU and upgrades with most IBM-compatible desktop systems. And since the TurboChip is a chip-for-chip replacement upgrade, it's easy to install. Plus it preserves your system configuration. To find your nearest Kingston® distributor call us at (800) 251-9059, domestically or (714) 437-3334 for international sales.

Kingston
TECHNOLOGY CORPORATION

For more information call us domestically at (800) 251-9059, or for international sales call (714) 437-3334 or visit our Web site: <http://www.kingston.com/b.htm>



Circle 145 on Inquiry Card (RESELLERS: 146).



*Wintach test, Advanced Micro Devices, 1995. Kingston Technology Corporation, 17600 Newhope Street, Fountain Valley, CA 92708 USA, (714) 435-2600, Fax (714) 435-2699. © 1996 Kingston Technology Corporation. All rights reserved. Kingston is a registered trademark and Computing Without Limits and TurboChip are trademarks of Kingston Technology Corporation. All other registered trademarks are the property of their owners.

Motorola's embedded PowerPC processor offers a rich set of communications features. By Tom Thompson

The Consumer PowerPC Revisited

Motorola intends to expand its reach into the world of personal communications with a slimmed-down variant of the PowerPC called the MPC801. The chip began sampling recently and will be available in quantity late this year. The MPC801's feature set makes it attractive not only for use in communications products such as pagers and cellular phones but also for general-purpose embedded applications and consumer electronics.

The MPC801 is a three-metal-layer, 0.35-micron CMOS part with 800,000 transistors. The fully static 3.3-V chip consists of an embedded PowerPC core plus caches, timers, memory controller, and peripheral support logic. It has four low-power modes that make it suitable for hand-held products, for which long battery life is paramount. If these specifications sound familiar, it's because they're similar to IBM's embedded PowerPC processor, the 401GF (see "The PowerPC Goes Consumer," August BYTE). Upon closer examination, there are significant differences between the two chips.

IBM's 401GF serves primarily as an embedded controller. The MPC801 also acts as controller but, true to Motorola's heritage as a communications company, it sports a rich set of communications features. This includes two serial UARTs and a serial peripheral interface (SPI). (IBM can provide a custom 401GF part that includes a serial I/O interface.)

The heart of the MPC801 is its PowerPC core. It is a 32-bit implementation of the PowerPC architecture. It has thirty-two 32-bit general-purpose registers. Two function blocks, an integer unit and a load/store unit, execute all integer and load/store operations in the hardware.

To reduce the transistor count—which both reduces the processor's size and power consumption—the designers removed a number of features present in

the 60x architecture. The floating-point unit is gone, since embedded applications execute mostly integer instructions. Additionally, the core's architecture was simplified so that the core executes

The core has two on-chip caches, a 1-KB data cache and a 2-KB instruction cache. The caches are two-way set associative, which helps compensate for any performance hit due to their small size.

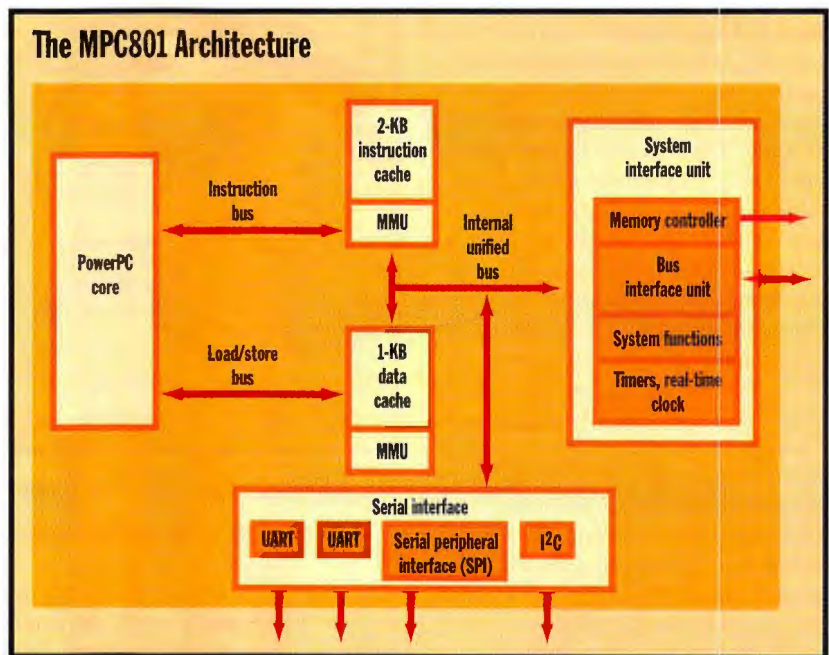

Motorola's MPC801 processor has a built-in memory controller and a number of serial functions.

only one instruction per cycle. This compromise eliminates the support logic required to implement multiple execution units. While this approach does exact a performance penalty, the design win is reduced power consumption. To boost performance, the core provides several instruction queues. It also has branch prediction logic that performs branch folding and branch prediction with conditional prefetch. However, in keeping with the goal of a simple, low-power design, the branch logic doesn't do any conditional execution on any prefetched instructions.

Portions of each cache can be locked to hold critical sections of code or frequently used data sets. Each cache has its own memory management unit (MMU). The MMUs support a variety of memory page sizes ranging from 4 KB to 8 MB. They can arrange a maximum of 16 virtual address spaces with 16 protection groups. You can program the MMUs to set the data caches to copyback or write-through modes and inhibit the caching of specific pages in memory (typically for memory-mapped I/O). The combination of the PowerPC core and the caches allows the MPC801 to deliver 33 MIPS at

25 MHz (using Dhrystone 2.1) and 52 MIPS at 40 MHz.

To reduce power consumption, the MPC801 supports four low-power modes: doze, sleep, deep sleep, and low-power stop. A phase-locked loop (PLL) obtains the processor clock signal, which enables a system designer to dynamically reduce the clock rate to conserve power when a hand-held device is idle.

Interfaces Galore

The MPC801 has a system interface unit (SIU) that enables it to work with a variety of peripherals. It handles dynamic bus sizing to 8-, 16-, and 32-bit wide memory and devices. The SIU's built-in memory controller can generate the signals and timings for SRAM, synchronous static RAM (SSRAM), EPROM, FLASH EPROM, DRAM, self-refreshed DRAM (SRDRAM), and extended data out (EDO) memory. It can manage up to eight separate memory banks. The processor supports a glueless interface to one bank of memory, but additional banks require external buffer logic to maintain the signal levels.

The MPC801 has two on-chip full-duplex serial UARTs. Each of these UARTs can be independently programmed for baud rates ranging from 300 bps to 115.2 Kbps. Eight maskable interrupts assist I/O transfers. Interestingly, these serial ports provide direct support of the IrDA physical layer protocol. IrDA is an infrared beam communications protocol, developed by the Infrared Device Association, that's used to transfer information in some hand-held machines. By implementing the IrDA protocol in the hardware, the MPC801 can reduce the parts count in a hand-held's design, thereby lowering its costs.

The processor also provides two other communications interfaces: SPI and I²C. The SPI is a four-wire, full-duplex, character-oriented interface. It supports 8- and 1-bit character operations, and it can operate in master or slave modes. Like the UARTs, the SPI can also interrupt the processor to expedite data transfers. I²C is a low-speed, full-duplex, two-wire

bus that enables the MPC801 to communicate with a variety of controller chips. It, too, supports interrupts.

ATMs and Web TVs

Because of its built-in communications functions, the MPC801 is thus ready-made for embedded applications that require such capabilities. It can be used

and hardware configuration settings, which can change over time. The I²C interface directs a microcontroller that scans the teller machine's keypad for key presses and reads the data from the magnetic strip on the customer's ATM card.

Here's the most intriguing application of the MPC801. Mitsubishi Consumer Electronics is using it to convert a 40-inch

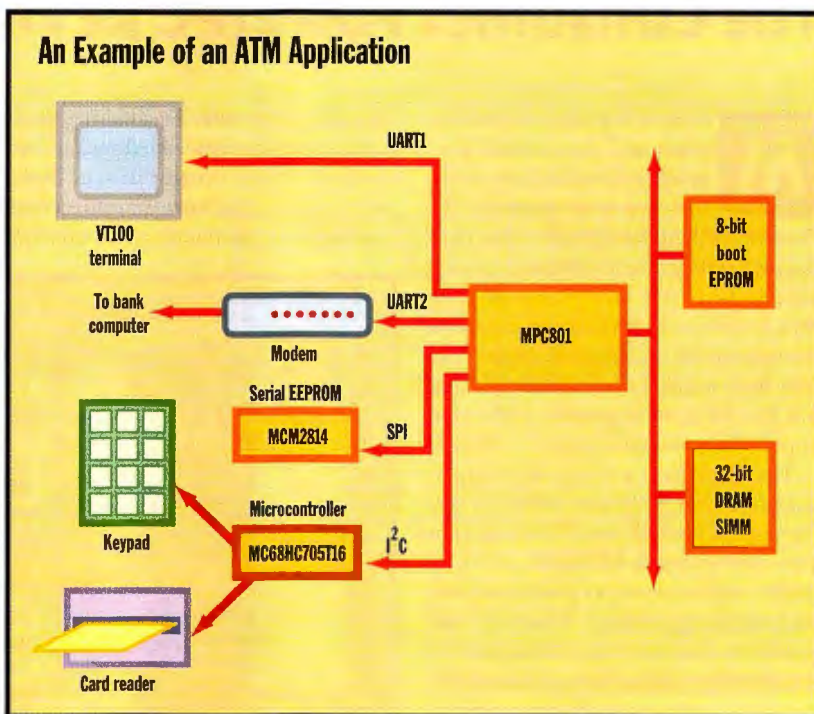

The MPC801 can operate the automated teller machine's hardware, display, and communications with the bank computer.

in set-top boxes, cellular base stations, automated teller machines (ATMs), hand-held computers, and Internet terminals or network computers. Two examples help emphasize how the MPC801 is an ideal fit for applications that demand extensive communications support. In the figure "An Example of an ATM Application," the MPC801 is shown acting as an embedded controller. The processor operates the hardware and handles the user's interactions with the machine. It can also manage the communications the ATM requires to verify transactions with a remote bank computer. One UART operates a smart terminal that serves as the teller machine's display screen; the other operates a modem that relays transaction data to and from the bank computer. The SPI updates nonvolatile data in a serial EPROM. This nonvolatile data might consist of encryption codes

TV into a Web browsing box called the DiamondWeb TV. Because of the MPC801's glueless interface to memory and to Motorola's Scorpion Graphics processor (which is used to mix text, graphics, and live video), the DiamondWeb TV's parts count—and therefore its cost—can be kept low.

The MPC801 implements a Web browser and a Java virtual machine on the device. Its serial connections help implement the TV's audio, modem, video, and TV monitor interface functions. The DiamondWeb represents the convergence of TV, the Web, and computing in one integrated device. The MPC801's capabilities make it all possible. And affordable. **B**

Tom Thompson is a BYTE senior technical editor at large. You can reach him at tom_thompson@bix.com.

WHERE TO FIND

Motorola Microprocessor and Memory Technologies Group
Austin, TX
(512) 891-3823
<http://www.mot.com/SPS/HPESD/prod/eppc/MPC801.html>

600 DPI COLOR
CAPABLE on any
office paper or
transparency.

5¢ A COLOR PAGE
A fraction of the
cost of color
photocopies.

\$3,495 From the work-
group color leader with 14
years in color printing.

6 PPM COLOR
Twice as fast as
any competitor's
desktop laser.

FREE BLACK INK
Now you can send
everything to your
color printer.

Brilliant performance. Breakthrough price.

The new Phaser® 350 costs less to own, less to use than any other laser-class, workgroup color printer. With award-winning performance that's become the hallmark of Tektronix: RISC processing. Ample RAM. Networking. So now our incredible speed and brilliant color are the most affordable and economical, too. No wonder, at over \$500 million in color printing revenue, Tektronix sells more workgroup color printers than anyone.

Call 800/835-6100, Ext. 1314. <http://www.tek.com/CPad?1314>

Tektronix



Phaser 140



Phaser 240



Phaser 350



Phaser 440



Phaser 550



Phaser 480X



Phaser 300X

**10 Mbps Or 100 Mbps
On Any Port.**



Now That's A Switch.

Now The Most Popular Fast Ethernet Switch Is Also The Most Affordable!



Network traffic only increases. That's why we offer the BayStack 28115 Fast Ethernet Switch. Not only is it the world's most popular Fast Ethernet Switch, but it also offers the best price/performance of any switch available. It lets you deploy 10 or 100 Mbps Fast Ethernet switching on all ports, so you can future-proof your network—adding bandwidth where and when you need it.

Equally important, you also get big-network reliability with redundant links and redundant power. That's because the 28115 Fast Ethernet Switch is part of our BayStack family that integrates hubs, routers and switches into a stackable, standards-based system. And with Optivity[®], you can manage your entire network as one cohesive unit—including remote sites.

So call **1-800-8-BAYNET ext.211** for a free copy of our Fast Ethernet Deployment Guide and CD. Because if you're considering switching, now's the perfect time.



A new programming model for parallel processing simplifies writing programs and promises code portability. By Dick Pountain

Parallel Processing in Bulk

Parallel processing—using more than one CPU to increase computation speed—is one of those cutting-edge technologies that always seems poised to break through into the mainstream. The problem has been that writing software for parallel computers is just too difficult. It requires complex code to synchronize the data and activity of tens or hundreds of processors. Furthermore, because parallel programs aren't portable between different supercomputer architectures, no volume software market has ever taken off to sustain the effort.

A new parallel-programming model, called Bulk Synchronous Parallelism (BSP), promises to remedy this situation. Developed by teams at Oxford in the U.K. and Harvard in the U.S., BSP offers a simple synchronization mechanism. It also has the potential to make parallel programs portable between different parallel-computer architectures.

Parallel's Pitfalls

Parallel programming's fundamental problem is that there has been no generally accepted model of what a parallel computer should look like. Some designers have favored distributed-memory machines, whose processing nodes communicate by passing messages. Others have preferred symmetric-multiprocessing (SMP) or shared-memory architectures, where all the processors read and write the same memory.

Yet others have used collections of workstations connected by a LAN to simulate a single parallel computer. The clustering of workstations into virtual parallel computers is immeasurably easier since the emergence of standard message-passing environments such as Message Passing Interface (MPI) and Parallel Virtual Machine (PVM). Still, moving a program from one type of parallel machine

to another normally involves a complete rewrite of the program.

What's needed is an abstract model of a parallel computer that describes all these schemes, hiding the physical details of particular architectures from programs to make them portable. Another desirable feature of such a model would

that efficiently supports a global memory space and a mechanism for the *barrier synchronization* of all the processors. Execution of a BSP program proceeds in phases, and all global communication takes place between phases.

Each phase is called a *superstep*. It consists of a number of parallel-running

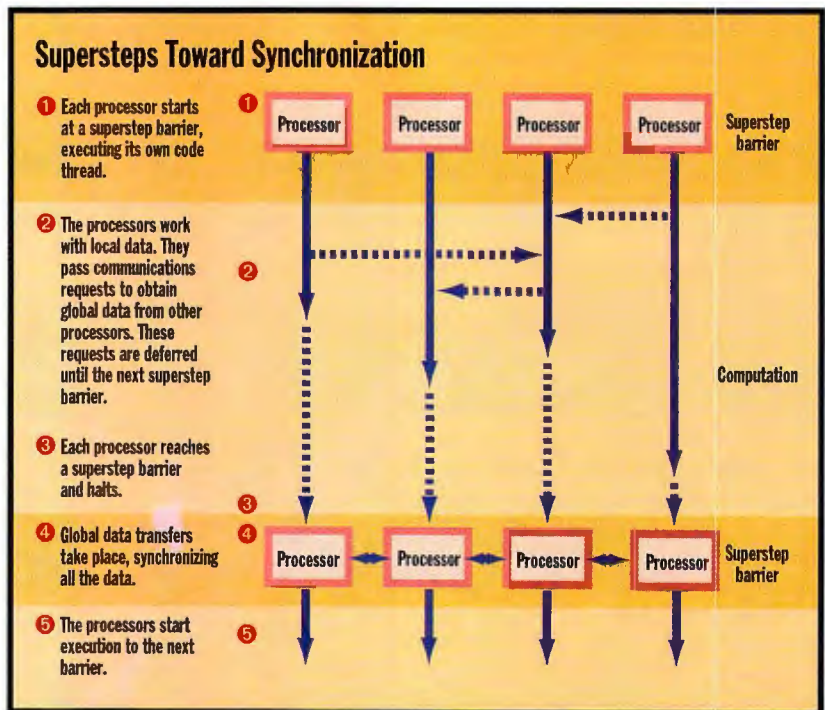

BSP's step-by-step scheme simplifies the synchronization of both processors and any shared (global) data.

be predictability (i.e., the ability to accurately analyze how such portable programs will perform on different real architectures). BSP provides just such a model.

BSP's Structure

The BSP model assumes a set of processor/memory pairs. These pairs are connected by a communications network

threads that contain any number of operations. The threads perform only local communication until they reach a synchronization point or barrier. At a barrier, all the threads must wait until the last one becomes ready, at which time all global communication (i.e., accesses to the physical memory of remote processors) takes place, as shown in the figure "Supersteps Toward Synchronization."

continued

This model completely decouples communication from synchronization, so that the synchronization of individual messages ceases to be of concern to the programmer.

BSP doesn't care whether a parallel computer implements barrier synchronization via hardware or software, because this affects only absolute performance. As an example, Cray's T3D, a massively parallel supercomputer based on Digital Equipment Alpha RISC processors, supports hardware barrier synchronization by providing each processor/memory node with a special barrier register.

BSP is equally unconcerned about the underlying mechanism used for communication. Thus, the same program could run on an Ethernet of PCs using the WinPVM library or on a T3D.

BSP Parameters

As important as BSP's support for program portability is the way it provides an analytic cost model for assessing the performance of parallel algorithms. This is something to which synchronized message-passing programs have never been amenable.

Any BSP computer is defined by three parameters: p , the number of processor/memory pairs; l , the latency, or number of time steps consumed by barrier synchronization; and g , a ratio obtained by dividing the total local operations performed by all processors per second by the total words delivered by the communications system per second. Note that g measures only a *bulk* property of the whole system, not the speed of individual CPUs or links. The l and g parameters are normalized with respect to a fourth parameter, s , the number of time steps per second or MFLOPS rate, so you can compare algorithms running on different hardware.

You can consider any scalable parallel system to be a BSP computer and determine what its p , l , and g parameters are by benchmarking. You can then use these

results to analyze the computational complexity of both architectures and algorithms. Designers of parallel architectures strive to reduce l and g to a minimum. Likewise, a programmer's choice of algorithm will try to offset the bad

ory primitives. There are also optimized native libraries for IBM's SP1/SP2, Cray's T3D, Silicon Graphics' Power Challenge, Meiko's CS/2, and other supercomputers.

Oxford Parallel is working on BSP support for SMP machines running Windows

Programming with BSP

BSP doesn't require the invention of any new programming languages. You can write BSP programs in conventional sequential languages such as C or FORTRAN 90. You then link the program to a library that implements a few primitive BSP operations.

The simplest primitives are `bsp_put` and `bsp_get`, which are requests for nonlocal data access, and `bsp_sync`, which marks a barrier for synchronization. `Put` and `get` are both one-sided operations, and you don't need to pair them: You either put a value into a remote process or get a value from it, but not both. They do, however, require variables to have the same names in different physical address spaces, so they are most suited for Single Program Multiple Data (SPMD) algorithms.

Other BSP primitives are better suited for different types of parallelism. `Put` and `get` are nonblocking, so the process that calls them can proceed immediately. Issuing a `put` or `get` guarantees only that the requested data operation will be completed by the end of the superstep or next barrier synchronization.

The C function, `bsp_allsums()`, hints at the flavor of BSP programming. It calculates the running sums of p integers stored on p processors. Put another way, if integer x_i is stored on processor i , the result on processor i is $x_0 + x_1 + \dots + x_i$.

You use the primitives `bsp_pushregister` and `bsp_popregister` to register the name of the destination variable `left` across all the processors. The cost of this algorithm is $\log(p) \times (g + l + 1) + 1$, as there are $\log(p) + 1$ supersteps (including one for the registration), and the addition operation costs 1 FLOP.

```
#include "bsp.h"
#include <stdio.h>
#include <stdlib.h>

int bsp_allsums(int x) {
    int i, left, right;
    bsp_pushregister(&left, sizeof(int));
    bsp_sync();

    right = x;
    for(i=1; i<bsp_nprocs(); i*=2) {
        if (bsp_pid()+i < bsp_nprocs())
            bsp_put(bsp_pid()+i, &right, &left, 0, sizeof(int));
        bsp_sync();
        if (bsp_pid()>=i) right = left + right;
    }
    bsp_popregister(&left);
    return right;
}
```

effects of large l and g inherent in a hardware design.

A Parallel Future

The Oxford University Computer Lab (OURL) has set up a unit called Oxford Parallel to commercialize and spread the word about BSP. The firm offers the Oxford BSP Library for a number of machines, including a free generic version for any homogeneous parallel Unix machine that has access to PARMACS, PVM, TCP/IP, or System V Shared Mem-

NT and for clusters of NT servers. Such a development would be timely indeed, given that the PC industry is entering an era of multimedia and 3-D graphics applications that cry out to be accelerated by parallel processing. Perhaps after all those false dawns, BSP is the technique that will bring parallel processing into the mainstream for the first time. **B**

Dick Pountain is a BYTE contributing editor based in London. You can contact him at dickp@bix.com.

WHERE TO FIND

Oxford Parallel
OURL
Oxford, U.K.
+44 1865 273897
fax: +44 1865 273819
oxpar@comlab.ox.ac.uk
<http://www.comlab.ox.ac.uk>

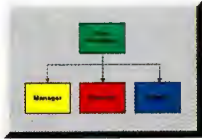

Human resource tools like organization charts and relationship diagrams

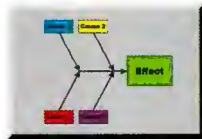

Management support diagrams like cause & effect, decision trees and timelines

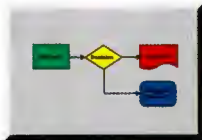

Business process re-engineering diagrams like flow charts and data flow diagrams

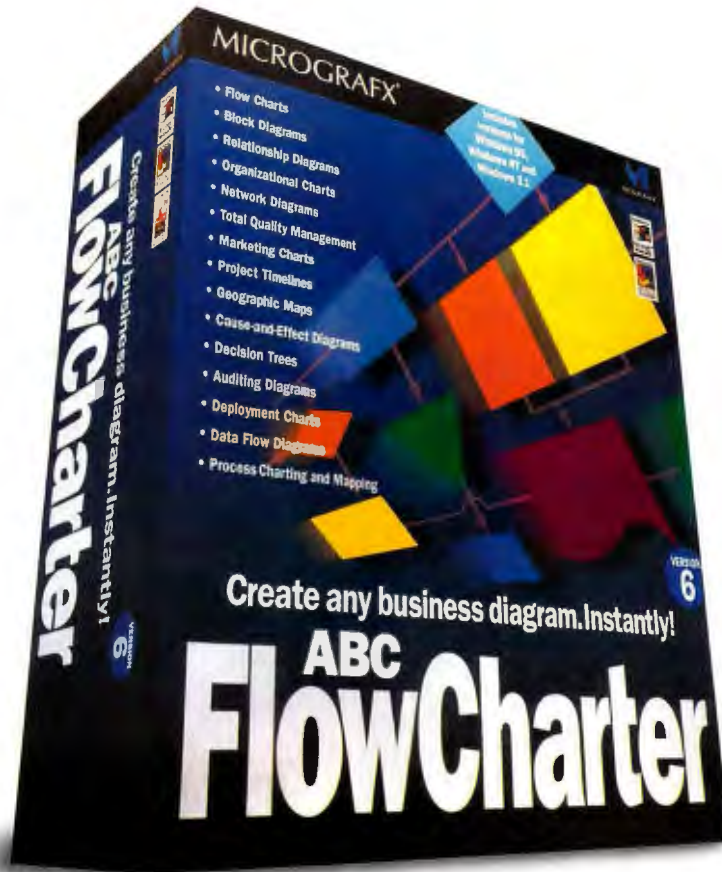

Marketing tools like venn diagrams, targets, pyramids and geographic diagrams



Total quality management diagrams like process charts and maps



IT and software design tools like network diagrams and object oriented design diagrams

ROCKET FUEL FOR THE BUSINESS PROCESS

Great businesses run fast. As fast as you can make obstacles disappear. That's why you need ABC FlowCharter®6. It shows you your business. Clearly. With diagrams that add a boost to your entire business process.

ABC FlowCharter is not just another drawing tool. It actually lets you relate charts to data, and automatically analyze the results. Unlike diagramming tools that hit the wall at the edge of the page, ABC FlowCharter is powerful. It can diagram any process. Across any number of pages. No matter how complex. With lines that re-route automatically and shapes that drop into place. In fact, it's so powerful,

it's used as the engine for Process Model®—the world's most advanced business simulation tool.

ABC FlowCharter does the work, while you work on making your business run better. See for yourself. Pick up your copy of ABC FlowCharter 6 today. If you want even more graphics power, you'll find ABC FlowCharter bundled in ABC Graphics Suite™. Visit your favorite reseller, or call 800-428-8716 now.



MICROGRAFX

www.micrografx.com



Softmart
The smart resource for business
1-800-328-1319

SOFTWARE SPECTRUM
1-800-624-0503

Stream
1-800-SOFTWARE

DESKTOP POWER WITH NEW-FOUND FREEDOM.

Take your work to new heights.

With its exclusive FlexOpr™ dual bay modular design, the Millennia TransPort™ notebook system from Micron Electronics lets you mix and match devices for a variety of customized choices. Drop in a modular CD-ROM drive to enhance multimedia capability. Add a second intelligent modular lithium-ion battery for up to eight hours' use without recharging*, or add a 2.1GB hard drive to more than double your storage capacity. And there's built-in flexibility, with features like the innovative Pick-a-Point™ system offering touchpad or pointing-stick operation and an infrared port for wireless printing from compatible printers. Top it off with our industry-leading Micron Power™ warranty, and you have the ideal portable computing solution.



Modular Bay #1

Modular Bay #2



8X CD-ROM



Second hard drive



3.5" floppy drive



Second lithium-ion battery

With up to eight hours' battery life* and full multimedia desktop performance, the Millennia TransPort™ puts compact, no-compromise computing where you need it.

Micron Power™  **Warranty & Support**

- 5-year limited warranty on microprocessor and main memory
- 3-year limited parts-only system warranty
- 1-, 2- or 3-year optional on-site service agreement for Micron desktop systems
- 30 days of free Micron-supplied software support for Micron desktop systems
- 30-day money-back policy
- 24-hour technical support

The foregoing is subject to and qualified by Micron's standard limited warranties and terms and conditions of sale. Terms and conditions of sale may vary for specific configurations. Copies of the limited warranties may be obtained on our Web site or by calling Micron.

*Actual battery performance will vary depending on applications and configurations. Based on two 4-hour batteries.



Millennia TransPort™

- 133MHz Mobile Intel Pentium® processor
- 16MB EDO memory (48MB max.)
- 12.1" active matrix color display, 800 x 600
- 1.2GB removable hard drive

\$4,399

Business lease \$150/month

- 133MHz Mobile Intel Pentium processor
- 32MB EDO memory (48MB max.)
- Motorola® Montana 28.8 fax/modem
- 12.1" active matrix color display, 800 x 600
- 1.2GB removable hard drive
- 2nd intelligent modular lithium-ion battery

\$5,199

Business lease \$163/month

- 150MHz Mobile Intel Pentium processor
- 32MB EDO memory (48MB max.)
- 12.1" active matrix color display, 800 x 600
- 2.1GB removable hard drive
- Motorola® Montana 28.8 fax/modem
- 2nd intelligent modular lithium-ion battery
- Samsonite leather carrying case

\$5,550

Business lease \$189/month



NEW



AUGUST, 1996
MILLENNIA
TRANSPORT P133



Tollfree from Canada
800-708-1758



Tollfree from Mexico
95-800-708-1755



Tollfree from Puerto Rico
800-708-1756

International Sales
208-893-8970



International Fax
208-893-7393

900 E. Karcher Road, Nampa, ID 83687 • Mon-Fri 6am-10pm Sat 7am-5pm (MT) International Sales Hours: Mon-Fri 6am-7pm (MT)
208-893-3434 • Fax 208-893-3424 • Purchase Order Fax 208-893-8992 • Technical Support Available 24 Hours / 7 Days
Technical Support E-mail: techsupport.meic@micron.com

©1996 Micron Electronics, Inc. All rights reserved. Micron Electronics is not responsible for omissions or errors in typography or photography. All purchases are subject to availability. Prices and specifications may be changed without notice; prices do not include shipping and handling. 30-day money-back policy does not include return freight and original shipping/handling charges, applies only to Micron brand products and begins from date of shipment. All sales are subject to Micron Electronics' current terms and conditions of sale. Lease prices based on 36-month lease. Intel, Intel Inside and Pentium are registered trademarks of the Intel Corporation. Microsoft, Windows the Windows logo and Windows NT are registered trademarks of Microsoft Corporation. All other service marks, trademarks and registered trademarks are the property of their respective companies. BYTE-TRANS-9611

Circle 175 on Inquiry Card.

Standard Features

- Mobile Intel Pentium processor
- Intel 430MX PCI chipset
- 256KB L2 pipeline burst cache
- 16MB EDO memory (48MB max.)
- 8X modular CD-ROM drive
- PCI graphics accelerator, 1MB EDO memory
- Pick-a-Point™ dual pointing devices integrate both pointing stick and touchpad
- Removable EIDE hard drive
- 3.5" modular floppy drive
- Intelligent modular lithium-ion battery
- 16-bit stereo sound
- Built-in stereo speakers and microphone
- 2 Type II or one Type III PCMCIA slots
- S-video and NTSC-video outputs
- Headphone, microphone and line-in jacks
- 2 infrared ports: one front, one back
- Parallel, serial, VGA and 2 PS/2 ports
- Dimensions: 11.7" x 9.4" x 2.0", Weight: 6.9 lbs.†
- Nylon carrying case
- Microsoft® Windows® 95 and MS® Plus! CD
- Microsoft Office Pro 95 and Bookshelf® 95 CDs
- Kensington™ security lock ready‡
- 5-year/3-year Micron PowerSM limited warranty*
† 6.9 lbs. includes 3.5" floppy and one battery
‡ Lock secures both Millennia TransPort and MicronDock™

Options:

- With 150MHz Mobile Intel Pentium processor add \$200
- With 2nd removable hard drive (1.2GB) add \$599
- With 2nd removable hard drive (2.1GB) add \$699
- With 16MB DIMM module upgrade add \$349
- With 32MB DIMM module upgrade add \$749
- With 3Com® 10BT IDBT PCMCIA add \$149
- With Motorola® Montana 28.8 PCMCIA fax/modem add \$259
- With MicronDock™ add \$299
- With MicronExec™ add \$799

MICRON™
ELECTRONICS, INC.

800-723-2998
<http://www.mei.micron.com>

Tomorrow's CPUs

The hard part will be choosing among major new chip platforms and families; easier to take will be the blazing speeds of tomorrow's processors.

Conventional wisdom says that Intel dominates the desktop CPU market. But look at the company's development plans for the next year, and you'll see a corporation that's acting a lot more like a hyperactive start-up than a sleepy giant.

Why? The CPU decisions we make will fuel a fundamentally new battle among processor architects. Some RISC-chip vendors are developing a new family of processors designed from the ground up to run Java applications at optimum speed. BYTE obtained exclusive technical details about Sun's picoJava architecture, which will provide the underpinnings for some Java chips that should ship next year. Early tests using Java-chip simulations point to significant speed advantages over general-purpose CPUs that use interpreters or just-in-time compilers to run Java code.

Intel hasn't announced Java-specific architectural changes for its processors, but it's not standing still, either. Over the next 12 months, the company will introduce three major new chips, including the first Pentium Pro to break the 300-MHz barrier. Stretch your sights into 1998, and you begin to see Intel's seventh-generation processor, the secretive Merced joint project with Hewlett-Packard.

Intel has good reason to continue to innovate. Even if Java chips never take off, we expect to see nine new x86 chips from AMD, Cyrix, and the lesser-known IMS. At the same time, the PowerPC Alliance is redoubling its efforts to develop pace-setting chips and a hardware standard that will spawn PowerPC systems for the Mac OS, Windows NT, and Unix.

Myriad CPU choices may be confusing at first, but if you choose wisely, your next computer might give you the fastest performance ever for the applications that are important to you. In relative terms, your next processor will deliver this performance at a bargain price. If you choose badly, however, you may be shackled with a processor that's blazingly fast for some applications but a slouch for others. If that happens, no price is a bargain.

The following stories can help you find your next CPU and begin to plan for the generation after that. In the end, you may long for the days when you needed only to compare clock speeds to find the right chip.

—Alan Joch

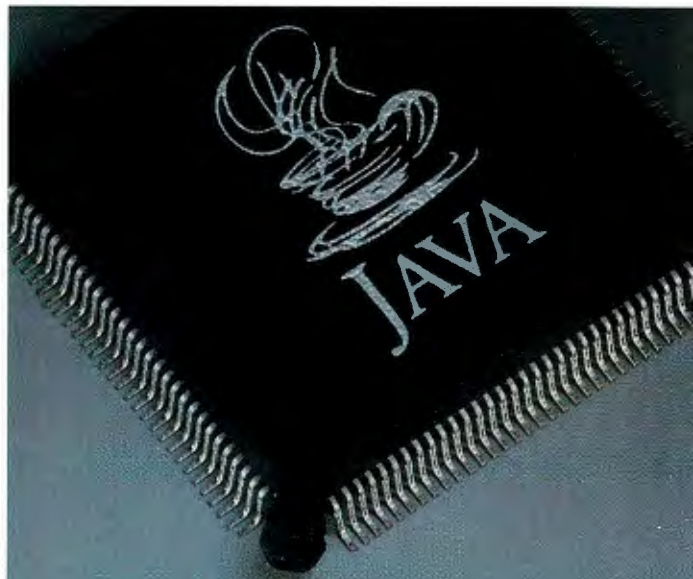

Inside picoJava

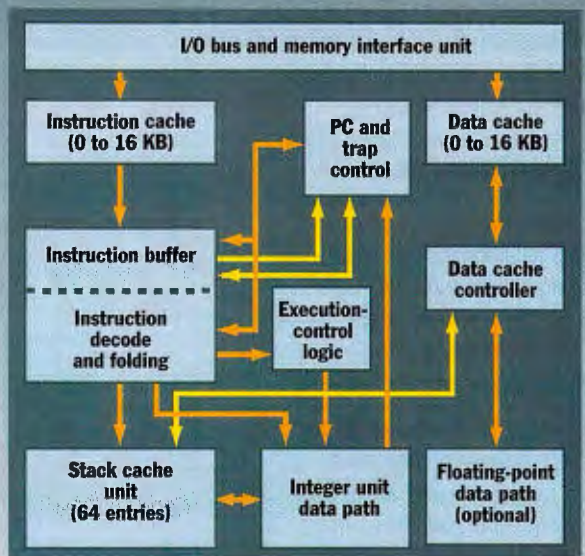

EXCLUSIVE

Sun Gambles on Java Chips...79

An innovative interpretation of RISC design could produce Java-specific processors that transform computing...

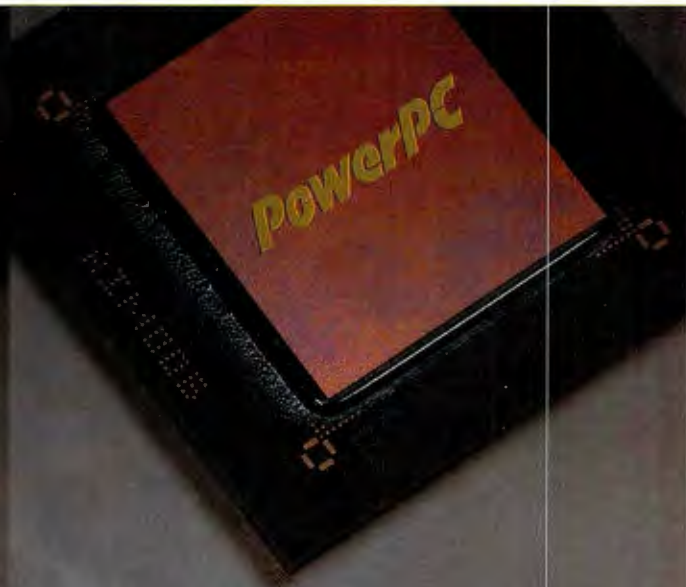

The x86's Growth Spurt

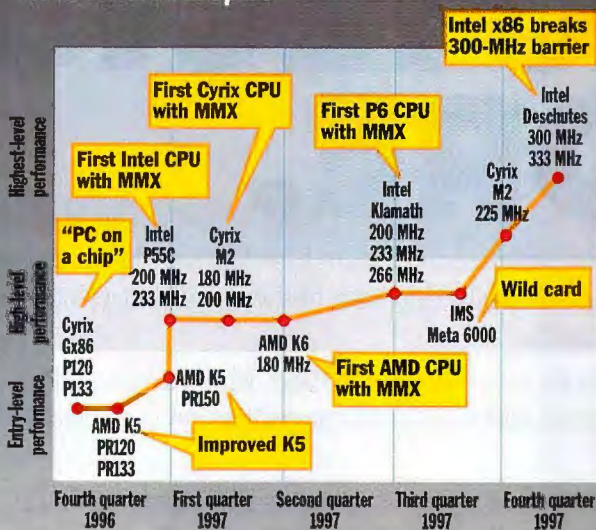

The x86 Gets Faster with Age... 89

...while Intel and a host of competitors plan a dizzying number of introductions in the next year intended to maintain the x86's dominance...

PowerPC Overpowers x86

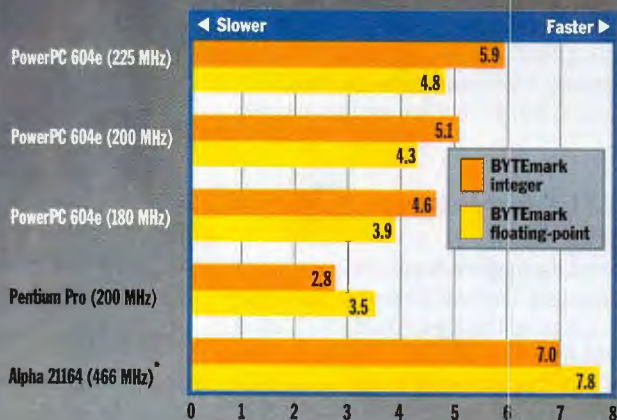

*For comparison. Alpha scores are fastest BYTEmark scores to date. From BYTEmark run on Windows NT.

PowerPC Regroups... 101

...and the PowerPC Alliance continues to push the performance envelope for general-purpose computers.

MORE DEVELOPERS PROTECT.



HASP Packs More Into Less.

Based on a full-custom ASIC utilizing 2500-gate, 1.5-micron E² technology, HASP packs the most advanced protection into the smallest key in the world.

HASP[®] PROTECTS MORE.

NSTL Study Rates HASP No. 1!



A recent test conducted by the National Software Testing Labs, the world's foremost independent lab, compared the flagship products of leading software protection vendors.* The result? HASP was rated the clear overall winner - and number one in all the major comparison categories.

NSTL TEST RESULTS, OCTOBER 1995 †

Scoring Category	Aladdin HASP	Rainbow Sentinel
Security	9.3	6.3
Ease of Learning	9.1	7.1
Ease of Use	8.3	7.2
Versatility/Features	10	8.7
Compatibility	6.7	6.5
Speed of API Calls	0.9	1.2
Final Score	8.5	6.5

*For a full copy of the NSTL report, contact your local HASP distributor.

These days, more and more developers are choosing to protect their software against piracy. They're protecting more products, on more platforms, with better protection – and selling more as a result.

And more of these developers are protecting with HASP. Why? Because HASP offers more security, more reliability and more features than any other product on the market.

HASP supports the most advanced platforms, including all Windows 32/16-bit environments, OS/2, DOS, Mac, Power Mac, NEC, UNIX and LANs.

To learn more about how you can protect better – and sell more – call now to order your HASP Developer's Kit.

Grow With Aladdin!

The fastest growing company in the industry, with over 4 million keys sold to 20 thousand developers worldwide, Aladdin is setting the standard for software security today.



North America Aladdin Knowledge Systems Inc. Tel: (800) 223 4277, 212-564 5678, Fax: 212-564 3377, E-mail: hasp.sales@us.aks.com
Int'l Office Aladdin Knowledge Systems Ltd. Tel: +972-3-636 2222, Fax: +972-3-537 5796, E-mail: hasp.sales@aks.com
Germany FAST Software Security AG Tel: +49 89 89 42 21-37, Fax: +49 89 89 42 21-40, E-mail: info@fast-ag.de
United Kingdom Aladdin Knowledge Systems UK Ltd. Tel: +44 1753-622266, Fax: +44 1753-622262, E-mail: sales@aldn.co.uk
Japan Aladdin Japan Co., Ltd. Tel: +81 426-60 7191, Fax: +81 426-60 7194, E-mail: sales@aladdin.co.jp
Benelux Aladdin Software Security Benelux B.V. Tel: +31 24-641 9777, Fax: +31 24-645 1981, E-mail: 100526.1356@compuserve.com

1-800-223-4277
www.aks.com

ALADDIN™

The Professional's Choice

■ Aladdin Russia 095 9230568 ■ Australia Corlab 03 9695685 ■ Chile Micrologica 02 7350041 ■ China Shanghai LRI 021 84377828 ■ Czech Atlas 02 766085 ■ Denmark Berendsen 039 577316 ■ Egypt Zeineldin 02 3604632 ■ Finland ID-Systems 0 8703520 ■ France 1 40859885 ■ Greece Unibrain 01 6756320 ■ Hong Kong Hastings 02 5464629 ■ India Solution 011 2148254 ■ Italy Partner Data 02 26147380 ■ Korea Dae-A 02 8484481 ■ Mexico SISOFT 5 2087472 ■ New Zealand Training 04 5868014 ■ Poland Sysheim 061 480273 ■ Portugal Futurmatca 01 4116289 ■ Romania Ro Interactive 064 1402693 ■ Singapore ITR 065 5666788 ■ South Africa D Le Roux 011 8664704 ■ Spain PC Hardware 03 4493193 ■ Switzerland Opeg 081 7169222 ■ Taiwan Tecc 02 5559676 ■ Turkey Mikrobeta 0312 4670635 ■ Yugoslavia Asys 021 623920

© Aladdin Knowledge Systems Ltd. 1985-1996. 09.96 HASP is a registered trademark of Aladdin Knowledge Systems Ltd. All other product names are trademarks of their respective owners. Mac & the Mac OS logo are trademarks of Apple Computer, Inc., used under license. NSTL makes no recommendation or endorsement of any product. † The NSTL report was commissioned by Aladdin.

Circle 125 on Inquiry Card (RESELLERS: 126).

Are Java chips better than general-purpose CPUs? Or will new compilers make them obsolete? By Peter Wayner

Sun Gambles on Java Chips

Download a small Java application from the Internet today and your trusty x86 or RISC processor won't blink. These CPUs are designed to optimally run C-based applications, but they also work well at emulating the Java virtual machine (VM) for the simple Web-based applets we're seeing now.

Life is good, as long as Java spawns nothing more complicated than cute dancing applets on Web pages. But Java has the potential to become much more. Its cross-platform compatibility is motivating some software companies, such as Corel, to develop large-scale business applications entirely in Java.

Suddenly, our decisions about which CPU platform to buy may become twice as difficult. Do we stick with a general-purpose processor and hope it will run tomorrow's Java applications efficiently? Or do we bank on a new generation of processors built from the ground up for fast Java performance?

Sun Microsystems, the company that launched Java, is betting on dedicated Java chips to deliver the performance needed for Java-based business and embedded applications. To this end, Sun is developing a core specification—known as picoJava—for Java chips. BYTE has exclusively obtained the spec prior to its public release. The architecture outlines a number of design innovations for optimally running Java code. At prices that fall below \$100 for even the most expensive versions of these chips, Sun hopes the price and performance characteristics of Java processors will both ride on and help power the Java wave. Chips based on Sun's picoJava core architecture should appear early in '97 and make their way into commercial products by the end of the year. Sun also wants to license the picoJava core design to other companies that want to produce their own Java chips.

Sun's strategy is compelling but not airtight. Platform-specific processors have

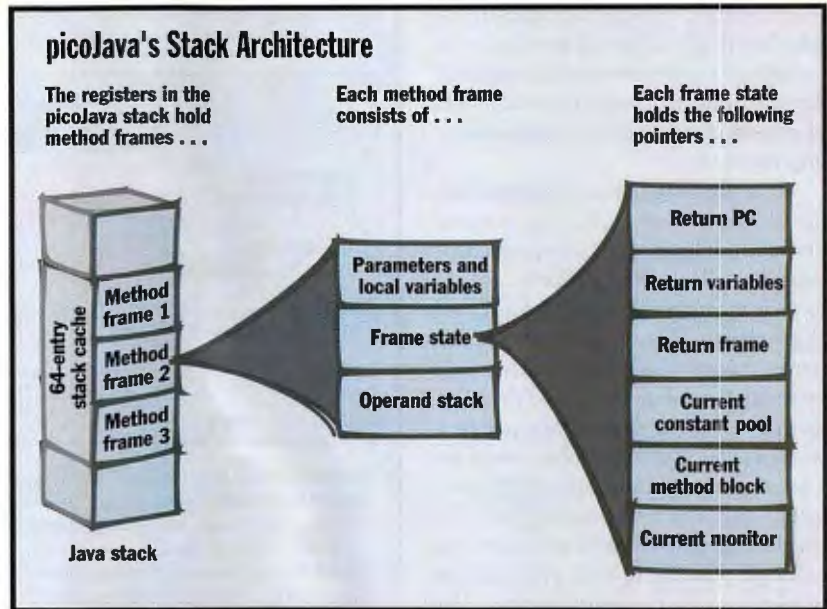

The picoJava stack uses 64 32-bit registers. picoJava allocates variables on the stack; method calls pass data through the stack.

been tried before with mixed results. And some competitors believe they can enhance their existing processors to boost Java performance without resorting to Java-specific chips.

Either way, we're watching the opening volley of a technical war that may take months or even years to resolve. While many questions will remain unanswered until we see actual silicon, we can begin to sort out the technical merits of Java chips today.

Two Flavors

Sun's picoJava architecture will be the foundation for the first-generation Java chips, known as microJava, a low-cost (approximately \$25-\$50) family for resource-stingy embedded applications. Typical applications might include industrial data-acquisition devices, PDAs, cellular phones, set-top boxes, and low-cost network computers.

Sun is also developing a more expensive (approximately \$100) chip called

ultraJava, which will be for desktop systems. Sun officials won't say whether or not ultraJava chips will use a picoJava core. However, these chips could include multimedia capabilities such as JPEG decompression and the graphics-processing optimizations now found in Sun's UltraSPARC RISC processors.

BYTE couldn't obtain actual silicon samples of Sun's Java chips at press time, so we don't know how well picoJava succeeds at boosting Java performance. According to Sun, these chips will run Java programs about 12 times faster than the same code executed by Sun's current Java interpreter. (See "Preliminary Speed Tests," page 80.) But Java bytecode interpreters are getting better, too. For instance, Intel has written its own Java interpreter for the x86 series and claims it runs Java code three times faster than Sun's interpreter.

Just-in-time (JIT) compilers can run Java code even faster than interpreters, but Sun says the picoJava chips could be

five times faster than a Pentium with a JIT compiler. However, Sun concedes that it still isn't certain how much picoJava's hardware improvements for thread synchronization and garbage collection will contribute to the overall speed of Java chips. Sun officials are optimistic about seeing performance improvements in these areas once they test actual silicon. Nevertheless, the actual performance improvement you get will depend on whether the Java program is heavy on computation and light on object juggling. Applications that require more system overhead may see a smaller performance improvement.

Sun is pinning much of its hopes on the developing market for Java-based embedded devices. MicroJava chips could fit well onto tiny platforms, thanks to their memory efficiency. Since a Java chip will natively execute Java bytecode without converting it to another CPU instruction set, it doesn't need the extra memory or cache space that's required when a general-purpose processor runs a Java bytecode interpreter or JIT compiler. Also, the bytecode is generally smaller than that for a RISC processor. For example, Java bytecode averages 1.8 bytes per instruction (without the tables for dynamically linking the code during method calls), while RISC code generally requires 4 bytes per instruction.

Pushing the Stack

What makes picoJava chips different from other processors? Foremost is how picoJava refines the stack. In the picoJava architecture, Java chips allocate variables locally on the stack, and method calls and bytecode operations also pass data through the stack.

Most C compilers convert C source code into a stack-based language, but the compilers then go through an addition-

Preliminary Speed Tests

When we went to press, chips based on Sun's picoJava core architecture didn't exist, so we were unable to evaluate performance of these dedicated processors. However, preliminary statistics from internal Sun tests indicate that Java chips could deliver significantly better performance than today's two main alternatives for running Java code: using a Java interpreter or a just-in-time (JIT) compiler with a general-purpose processor.

Note, however, that while Java chip advocates are finishing their core designs, developers of Java interpreters and JIT compilers are creating new and faster versions of these technologies. So view the following numbers as snapshots: The competition to deliver faster Java performance will continue to heat up over the coming months.

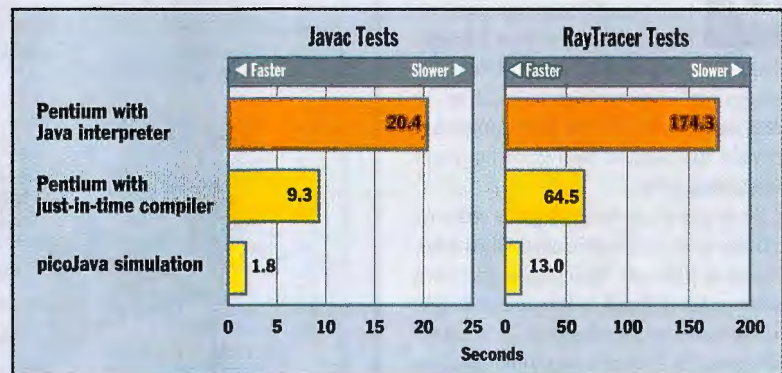

How Sun Tested: Javac is Sun's JDK 1.0.2 javac compiler for the RayTracer benchmark. It consists of 25,000 lines of Java code (with comments) in 170 different classes. The Java bytecode totals 422 KB. The RayTracer benchmark generates an image of a 1400-triangle dinosaur standing on a glossy table. RayTracer is a 3500-line Java program in 32 classes. The bytecode totals 36 KB. The picoJava simulator is 100 MHz, with 4 KB of direct-mapped instruction cache and 8 KB of two-way data cache and no off-chip cache. The FPU is present. DRAM is 120-ns latency.

The test Pentium machine was a Hewlett-Packard Vectra VL 5/166 Series 4, with 32 MB of RAM and 256 KB of off-chip cache. The inter-

preter is Sun's JDK 1.0.2 for Win 95/NT. The just-in-time (JIT) compiler is Symantec's Cafe 1.5 for Windows 95 and NT.

All the times were scaled to 100 MHz to match the picoJava simulator output. Thus, times for the Pentium system were multiplied by 1.66. The picoJava simulator does not accurately simulate I/O, so 0.8 seconds were added for the Javac benchmark for I/O, and 0.4 seconds for I/O were added to the RayTracer benchmark results. The effects of garbage collection were also minimized by sizing the amount of memory allocated by Java for the program. By allocating a large amount of memory for the benchmarks, garbage collection was never invoked.

al step of converting this intermediate language into native RISC code (see "RISC vs. CISC" on page 82). This allows the compiler to analyze the flow of data and keep the most essential elements in the CPU registers. A standard RISC processor

simulates a stack machine by loading or storing data from the stack into registers, then using one of the registers to represent the stack pointer. This operation is simple, but the number of registers limits the opportunities for optimization.

continued

Three Alternatives for Running Java Software

Java interpreters

Like a translator at the United Nations, Java interpreters translate Java bytecode into native instructions the CPU understands. Interpreters convert bytecode on-the-fly and must process the same code over and over again when you run the Java program. Java interpreters usually run slowly, sometimes at only 3-10 percent the speed of compiled C code.

Just-in-time (JIT) compilers

Just-in-time (JIT) compilers translate Java bytecode into native code like interpreters do, but they don't have to translate the same code over and over again because they cache the native code. This can result in significant performance improvements, but sometimes a JIT compiler takes an unacceptable amount of time and memory to do its job.

Java chips

Dedicated Java processors, like those that will be based on Sun's picoJava core architecture, natively understand Java bytecode without the overhead of an interpreter or JIT compiler. Proponents say native-code processing and Java-centric optimizations yield the best possible performance for more complex Java applications that might be on the horizon.

STATISTICA

Windows 3.1
and WINDOWS 95

STATISTICA (automatically configures itself for Windows 95 [long file names, etc.] or 3.1) ■ A complete data analysis system with thousands of on-screen customizable, presentation-quality graphs fully integrated with all procedures ■ Comprehensive Windows support, OLE (client and server), DDE, customizable *AutoTask* toolbars, pop-up menus ■ Multiple data-, results-, and graph-windows with *data-graph* links ■ The largest selection of statistics and graphs in a single system; comprehensive implementations of: Exploratory techniques with advanced brushing; multi-way tables with banners (presentation-quality reports); nonparametrics; distribution fitting; multiple regression; general nonlinear estimation; stepwise logit/probit; general ANCOVA/MANCOVA; stepwise discriminant analysis; log-linear analysis; confirmatory/exploratory factor analysis; cluster analysis; multidimensional scaling; canonical correlation; item analysis/reliability; correspondence analysis; survival analysis; a large selection of time series modeling/forecasting techniques; structural equation modeling with *Monte Carlo* simulations; and much more ■ On-line *Electronic Manual* with comprehensive introductions to each procedure and examples ■ Hypertext-based *Stats Advisor* expert system ■ Workbooks with multiple *AutoOpen* documents (e.g., graphs, reports) ■ Extensive data management facilities (fast spreadsheet of unlimited capacity with long formulas, *Drag-and-Drop*, *AutoFill*, *Auto-Recalculate*, split-screen/variable-speed scrolling, advanced Clipboard support, DDE links, hot links to graphs, relational merge, data verification/cleaning) ■ Powerful *STATISTICA BASIC* language (professional development environment) with matrix operations, full graphics support, and interface to external programs (*DLLs*) ■ Batch command language and editable macros, flexible "turn-key" and automation options, custom-designed procedures can be added to floating *Auto Task* toolbars ■ All output displayed in *Scrollsheets*™ (dynamic, customizable, presentation-quality tables with instant 2D, 3D, and multiple graphs) or word processor-style report editor (of unlimited capacity) that combines text and graphs ■ Extremely large analysis designs (e.g., correlation matrices up to 32,000x32,000, unlimited ANOVA designs) ■ Megafile Manager with up to 32,000 variables (8 Mb) per record ■ Unlimited size of files; extended ("quadruple") precision; unmatched speed ■ Exchanges data and graphs with other applications via DDE, OLE, or an extensive selection of file import/export facilities (incl. *ODBC* access to virtually all data bases and mainframe files) ■ Hundreds of types of graphs, incl. categorized multiple 2D and 3D graphs, ternary 2D/3D graphs, matrix plots, icons, and unique multivariate (e.g., 4D) graphs ■ Facilities to custom-design new graph types and add them permanently to menus or toolbars ■ On-screen graph customization with advanced drawing tools (e.g., scrolling and editing of complex objects in 32x real zoom mode), compound (nested) OLE documents, *Multiple-Graph AutoLayout Wizard*, templates, special effects, icons, page layout control for slides and printouts; unmatched speed of graph redraw ■ Interactive rotation, perspective and cross-sections of 3D displays ■ Large selection of tools for graphical exploration of data: extensive brushing tools with animation, fitting, smoothing, overlaying, spectral planes, projections, layered compressions, marked subsets ■ Price \$995.

Quick STATISTICA (for Windows) ■ A subset of *STATISTICA*; comprehensive selection of basic statistics and the full analytic and presentation-quality graphics capabilities of *STATISTICA* ■ Price \$495.

STATISTICA/QC - Industrial statistics add-on package (requires *STATISTICA* or Quick *STATISTICA* for Windows) ■ The largest selection of industrial statistics in a single package; quality control charts (compatible with real-time data acquisition systems), process capability analysis, R&R, sampling plans, and an extremely comprehensive selection of experimental design (DOE) methods ■ Flexible tools to customize and automate all analyses and reports (incl. "turn-key" system options, and tools to add custom procedures) ■ Price \$495.

STATISTICA/Mac (for Macintosh) ■ Price \$695 (Quick - \$395).

Domestic sh/h \$12 per product; 30-day money back guarantee.

STATISTICA has received the highest rating in EVERY comparative review of statistics software in which it was featured, since its first release.



2300 E. 14th St. • Tulsa, OK 74104 • (918) 749-1119
 Fax: (918) 749-2217 • WEB: <http://www.statsoft.com>
 e-mail: info@statsoft.com

Overseas Offices: StatSoft of Europe (Hamburg, FRG), ph: 040/ 4200347, fax: 040/4911310; StatSoft UK (London, UK), ph: 1767/ 600166, fax: 1767/ 600144; StatSoft France (Paris, France), ph: (1) 34 52 39 22, fax: (1) 34 52 28 48; StatSoft Polska (Krakow, Poland), ph: 12-391120, fax: 12-391121; StatSoft Italia (Padova, Italy), ph: 49-893-3227, fax: 49-893-2897; Available from other Authorized Representatives worldwide; Australia: Heame, ph: (03) 9602 5088, fax: (03) 9602 5050; Sweden: AkademiData Scientific, ph: 018-210035, fax: 018-210039; Finland: Statcon Oy, ph: 24-7336678, fax: 24-7336677; Belgium: Texma NewTech, ph: 010 616 828, fax 010 616 957; South Africa: Osirts, ph: 12-660-2884, fax 12-660-2886; Japan (Macintosh): Three's Company, Inc., ph: 03-3770-7800, fax: 03-3770-7724; Japan (Windows): Design Technologies, Inc., ph: 03-3667-1110, fax: 03-3668-3110; Taiwan: Intelligent Integration Corp., ph: 2-698-2060, fax: 2-698-2061; The Netherlands: Exstat, ph: (0) 50.5267310, fax: (0) 50.5277665; Russia: SoftLine Corp., ph: (095) 126-9065, fax: (095) 232-0023; Hungary: CheMicro, ph: 1 131-3847, fax: 1 132-9330. StatSoft, the StatSoft logo, STATISTICA, and Scrollsheet are trademarks of StatSoft, Inc.

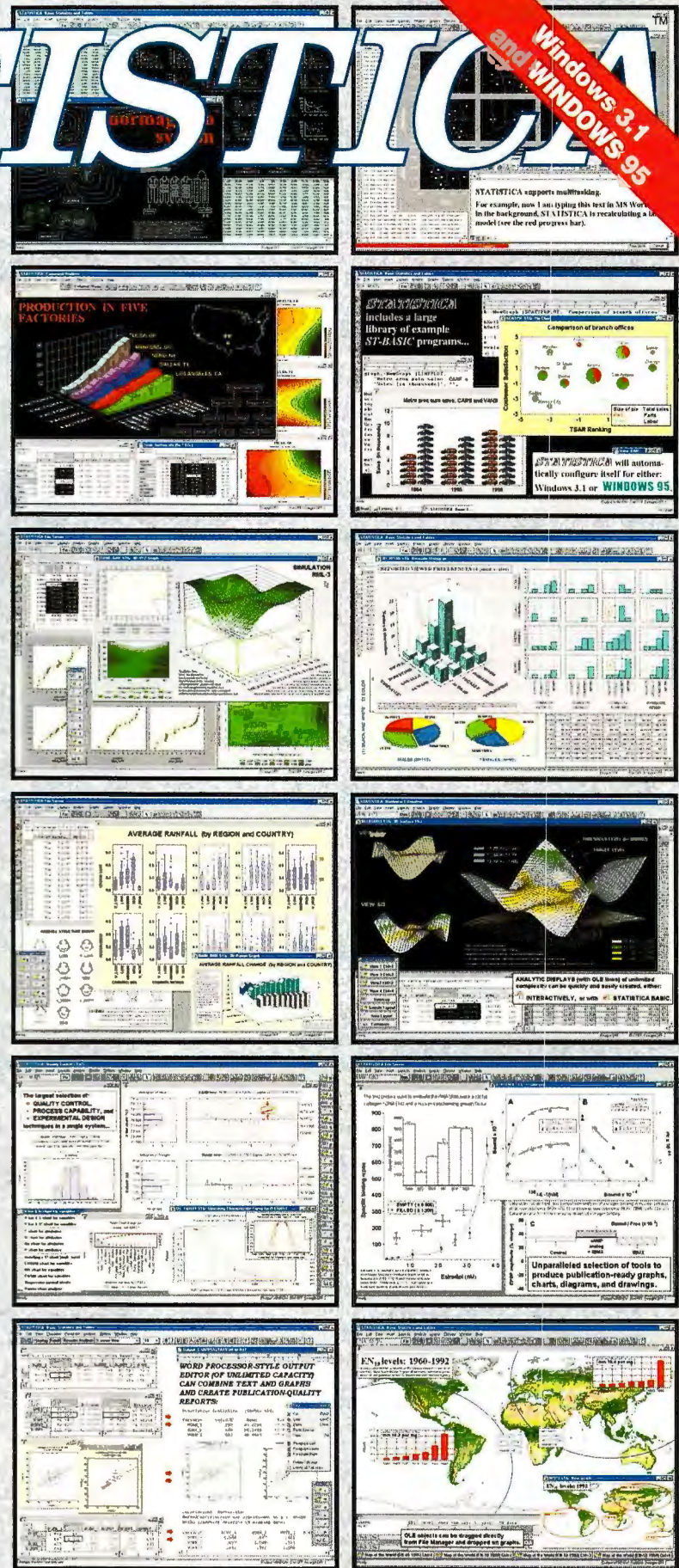

Circle 164 on Inquiry Card.

The picoJava architecture uses a stack of sixty-four 32-bit registers with a pointer to the top register on the stack (see "picoJava's Stack Architecture" on page 79). If you have 20 registers allocated for a particular stack frame (call it method A), then a call to another method (B) would begin using register 21. The pointer to the top of the stack would move down from 20 to the last register used by method B.

Smart Cache

Sun architects devised a clever method of caching data if all the registers are full (see the figure at right). For example, when you invoke method B, the picoJava register file allocates all remaining empty registers and carries over to register 1 if additional space beyond 64 is required. What happens to the method-A data in those registers if method B quits running and method A resumes? Something Sun calls the "dribbler" steps in from the background to restore the method-A data. The dribbler constantly reads and writes data from the 64 registers to a copy that's kept in memory. So when method B grabs the additional registers, the dribbler has already copied the data. (If for some reason the dribbler hadn't yet made a copy, the Java chip would pause any processing tasks until the dribbler fin-

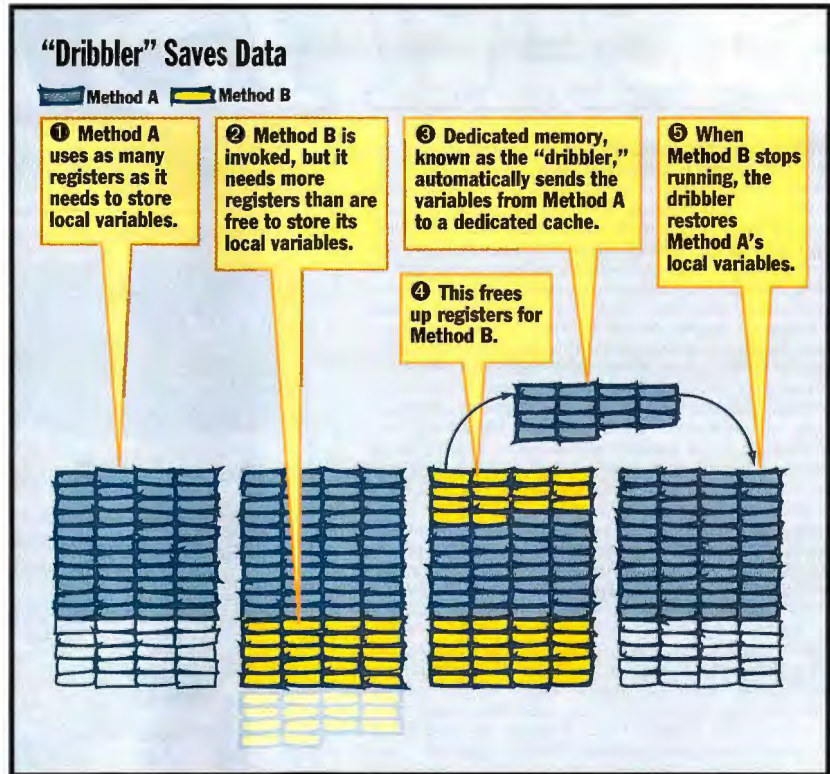

Sun's "dribbler" is a clever method of caching data and returning it to the stack when registers become full.

RISC vs. CISC

How does the x86 stack up against RISC chips when running Java? Interestingly, the ancient x86 has a few advantages. For example, the x86's PUSH and POP instructions could become more valuable. These combination instructions were some of the first to go with RISC. They were replaced by two instructions: a register increment or decrement followed by a load or a store. So the x86 might handle Java stack operations more efficiently than some RISC processors.

One big difference between RISC and CISC is the number of general-purpose registers for storing integer and floating-point values. RISC chips typically have 32 or 64 registers, while the x86 has only 16. Normally, this puts the x86 at a disadvantage. But Java is a stack language; all the information between subsequent instructions is kept on a stack. RISC registers offer no great advantage unless a just-in-time (JIT) compiler can schedule the use of the registers more efficiently.

ished this operation.) When method B stops running and gives up the registers, the dribbler restores the data to the stack, so method A is current.

The dribbler takes advantage of the fact that the data traffic between the registers and its image in memory is highly predictable. System designers are able to easily tune a cache to anticipate the requests of the dribbler and make sure the necessary data is available in the local data cache when it needs to be.

The flexible register approach of picoJava contrasts with the simple register files of RISC processors. Java's dribbler dynamically tries to keep all the local variables available in fast registers. RISC chips, on the other hand, rely upon the compiler to orchestrate the movement of information in and out of the chip. Static register allocation works well with scientific code, which may have complicated loops that use each piece of data in multiple calculations.

A robust compiler may find a way to unroll the loops and arrange the flow of data in and out of the registers. The compiler might also be able to leave data in a register in cases where the data needs to

be reused 50 cycles later.

The picoJava stack is not well suited for leaving data around or for pushing information deeply onto the stack so it can reemerge at the right time. (Smart compilers that do this magnificent optimization for scientific code should be able to do the same for Java code by creating faux local variables that act like registers.)

However, the picoJava stack can shine with code that calls many short procedures that are constantly starting and stopping. These function calls are constantly clearing and filling data in registers. The Java stack handles these chores in the background, with the dribbler keeping the register file accurate.

The stack at the center of the Java virtual machine is a simple conceit that makes it easy to pack code. This design challenges RISC machines and their ability to speed the flow of data by using registers in a smart way. A Java interpreter can't anticipate the flow of data through the stack, so it can't use the registers for much more than a temporary image of the very top of the stack. Just-in-time compilers may be able to do the analysis necessary to use the registers more effi-

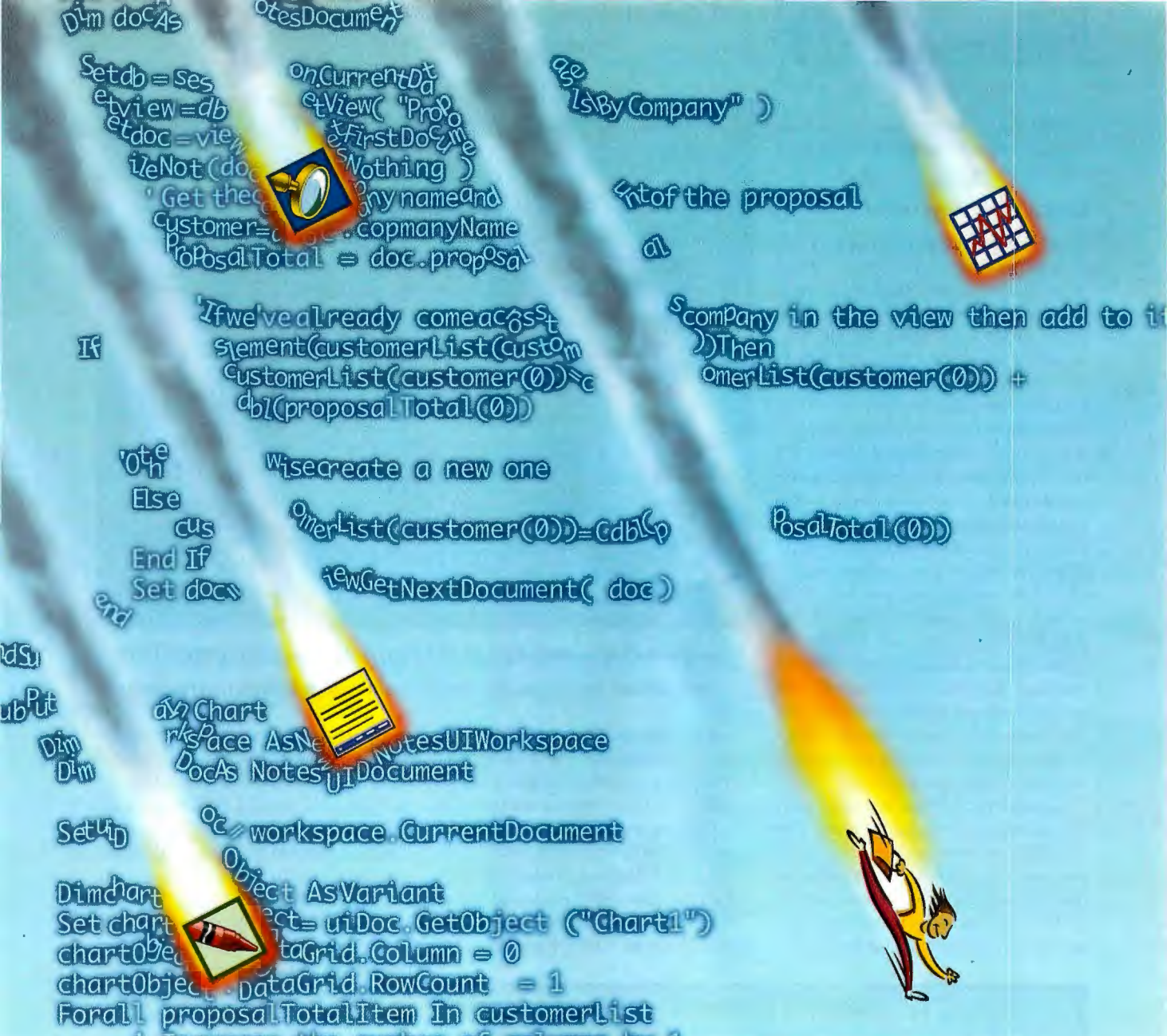

Something new has entered the Notes application development environment.

Introducing Lotus Components. Now you can develop customized Notes applications faster than ever before. Make no mistake about it. Lotus Components are going to revolutionize the way you build your Notes applications. Using pre-built, customizable "applets" you can now burn through

your development schedule. These task-focused, ActiveX controls include a spreadsheet, chart, comment, file viewer, draw/diagram and project scheduler. And each can be reused to build hundreds of customizable business objects for Notes applications never before possible.

For a free copy of The Lotus Components Discovery CD, including a trial version of Lotus Components, sample applications, and more... visit us at <http://components.lotus.com>. Or for more information call 1-800-TRADE-UP, ext. C200. Working Together Circle 606 on Inquiry Card (RESELLERS: 607).



ciently, but spending time on this kind of analysis would end up undermining their effectiveness.

Stack Efficiency

The picoJava architecture wrings out efficiency in another important way: It can dispatch simultaneous instructions when you need to move a local variable to the top of the stack and perform some computation on it (see the figure at right). If the instructions were not dispatched simultaneously, the data would be consumed immediately after it's written to the top of the stack. PicoJava issues the move and the arithmetic operation together so they execute at the same time without disturbing the stack, writing over a register, or forcing the dribbler to do anything. This reduces memory accesses and potentially cuts execution time.

Early reports from Sun indicate that the effect of simultaneous instructions can be dramatic. According to Sun's code analysis, stack operations account for 43 percent of all operations a picoJava-based chip performs. If you combine instructions, stack operations drop to 29 percent of the tasks done by a Java chip.

A persistent challenge in the design of all CPUs is how to manage the flow of data through the system. A modern RISC processor typically has two levels of cache that pull data in and out of main memory. The main memory, in turn, acts as a cache for a much larger amount of virtu-

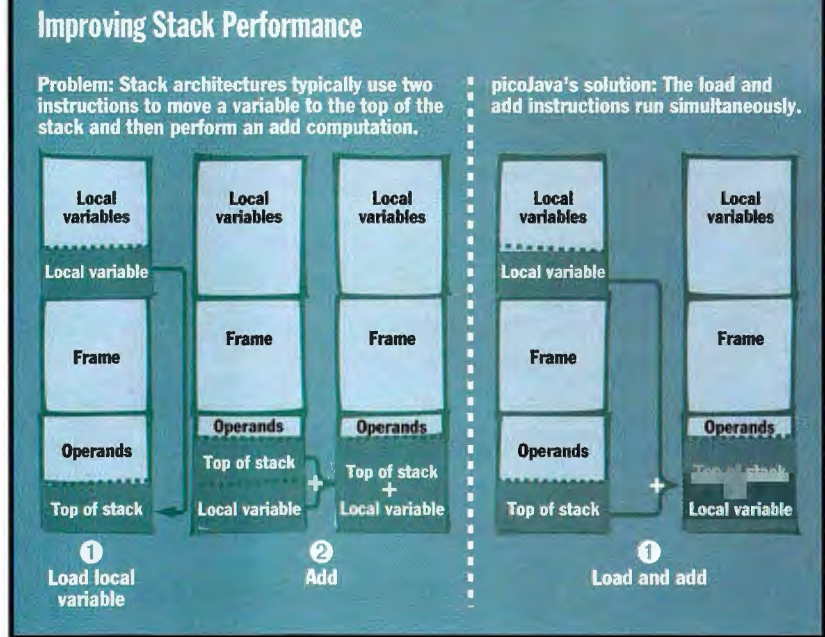

A picoJava chip moves data to the top of the unused registers in the stack and simultaneously dispatches a computation instruction.

al memory on the hard disk. Ordinarily this combination works to keep the most needed information as close as possible to the CPU, based on the assumption that the most recently accessed data is the most likely to be accessed again.

Garbage collection, in which the processor examines all objects and determines which ones are not in use, can ruin this scheme. This exhaustive search

can destroy all the work that the cache and the virtual memory controller have done to keep the most current and important data close to the CPU. Suddenly, *all* objects are the most recently accessed. This can be a real problem if the Java garbage collector runs as a concurrent thread, as it often does.

The simplest solution is to allow the software to turn parts of the cache on and off. This can help manage the stack because the top of the stack—more so than the bottom—is likely to be accessed next. Many RISC chips use this method of cache control.

A bigger problem results because even the simplest garbage-collection mechanism cannot be interrupted by normal system tasks. If garbage collection is interrupted, the list of referenced and unreferenced memory might be corrupted and good information thrown away. To guard against this, picoJava maintains a tag bit, known as a *write barrier*, on each object. This barrier allows garbage collection to operate in the background and practically eliminates the effect it can have on running code when the entire machine pauses to identify unreferenced memory.

Streamlined Pipeline

For optimum performance, any CPU design must balance the computational

Unanswered Questions

Architectural diagrams reveal a lot about picoJava, but a number of questions remain unanswered until we have live systems.

Q: How fast will systems based on Java chips run compared to PCs with general-purpose CPUs?

A: Sun says Java chips might run Java code 12 times faster than bytecode interpreters. But Java chips currently exist only as simulations, and new generations of general-purpose CPUs, Java interpreters, and just-in-time (JIT) compilers are closing the performance gap.

Q: Can Java chips satisfy multiple demands?

A: With an advanced TV set-top box—a prime potential application for Java chips—you could run Java applets from the World

Wide Web or play videogames. But the latest home videogame machines could do this, too. Some of these boxes are surprisingly powerful and are easily capable of running a fast JIT compiler on their general-purpose RISC processors.

Q: How important will Java become?

A: Java has the potential to become a standard for broad-based application development. The more specialized (but still significant) embedded-systems market may become even more important for Java.

Q: How will Java evolve?

A: If Java does become a foundation for a broad range of application software, the size and structure of Java bytecode could change, and hardware architects would need to adjust their designs.



Watcom C/C++. Performance on any Platform.



Watcom C/C++ accelerates development of lightning-fast, multi-platform 16 and 32 bit applications.

Reliable, high-performance code generation and consistent C and C++ language implementation are delivered across all supported platforms, making it easy to develop applications for several targets from a common source code base. In a single package, Watcom C/C++ provides a comprehensive development environment with the tools, SDKs and libraries you need to create powerful applications for popular PC platforms including Windows®, OS/2® Warp, Windows® 95, and Windows NT™.

*To find out more about
Watcom C/C++, call us at 1-800-265-4555
or visit <http://www.powersoft.com>*



Circle 172 on Inquiry Card.

Watcom C/C++ v10.6 Features

- Target Platforms:
Windows 95, Windows NT,
Windows 3.x, Win32s,
OS/2 Warp, OS/2 2.x,
Extended DOS, Novell NLN,
OS/2 1.x, DOS
- Comprehensive MFC support
with source, samples, and
documentation
- Visual Programmer by
Blue Sky Software for rapid
MFC application development
- 16 and 32 bit C and C++
compilers with industry-
leading optimization
technology
- Multi-platform toolset with
a consistent interface across
multiple platforms

power of each instruction so it can efficiently pipeline the code. Pipelining splits an instruction into several parts, with each part taking the same amount of time to process. This allows a superscalar (multipipelined) CPU to process several instructions simultaneously.

For pipelining to work, all the data needed for a computation must be in the right place at exactly the right time. RISC pipelines driven by optimizing compilers have done this quite well, and Sun uses a very RISC-like pipeline for picoJava. The pipeline has only four stages: fetch, decode, execute, and writeback (see "picoJava's Pipeline" at right).

The chip accesses the cache during the execute phase, which can also perform some addition operations. For example, some Java instructions demand that you access a field of an object by adding *n* bytes to the pointer at the start of the object. These Java instructions execute in the picoJava pipeline as one instruction.

Sun is hoping that an innovative stack architecture, a tweaked garbage-collection mechanism, and a stripped-down pipeline design will add up to fast performance for picoJava chips.

Do We Need Java Chips?

The great potential of Java has generated enthusiasm throughout the computer industry. However, not everyone believes dedicated Java chips are necessary. After all, university researchers have built

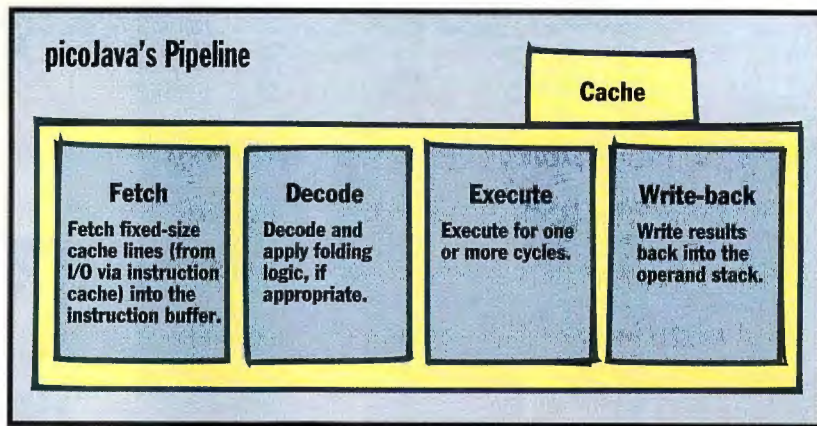

To get data in the right place at exactly the right time, picoJava uses a simple, RISC-like pipeline with only four stages.

specialized chips for languages such as LISP or Smalltalk only to discover that software implementations running on RISC chips offered superior performance.

Some chip vendors say their existing RISC and CISC architectures can handle Java quite well. Advanced Risc Machines (Cambridge, U.K.) tuned its StrongARM architecture (see "StrongARM Tactics," January BYTE) for embedded applications and stack-based languages, such as Java and PostScript. The StrongARM can move a stack frame in and out of the register set with a single instruction, according to Dave Jaggar, ARM's technical marketing director. By itself, this probably won't make Java programs run any faster,

Vital Statistics

Estimated picoJava die: .35 microns

picoJava core = 8.0 mm²

optional FPU = 5.5 mm²

Total 13.5 mm²*

*Total size without the instruction or data caches, which are both variable from 0 to 16 KB.

but it does conserve system resources and use the cache more efficiently.

Other processors will soon ship with subtle Java enhancements. The Mips division of Silicon Graphics is working on improvements to its Rx000 architecture that could speed up Java programs. These enhancements will save memory and bandwidth and help speed the interpretation of Java code. The Rx000 will probably use a single instruction to transfer a set of bytes from the stack to the registers while incrementing the stack pointer. Mips officials believe that users of Silicon Graphics workstations, set-top boxes, and videogame machines require computational performance first and Java prowess second. "We want to concentrate on evolving the Mips architecture," says Derek Meyer, director of international marketing and sales. "Java performance will follow."

Some embedded-systems developers are both encouraged and skeptical about Java. "There's a direct relation between Java and the Internet, and this has a lot of potential for embedded applications," says George Nicol, president of Silicon Composers (Palo Alto, CA). One idea his company has been investigating is to

Java vs. C

Designing a dedicated chip to run Java software is very different than designing a RISC chip to run C code. Here's why.

- Java is much more regimented than C. The Java virtual machine (VM) stores all its temporary data, including the results of each computation, on a stack. C uses a stack optionally.
- C compilers rarely know much about the pointers they manipulate. Java objects, by contrast, have a type from a strictly defined hierarchy, and this type information is available to the processor. The Java bytecode interpreter uses the structured information for security purposes and to optimize the code.
- Java centrally controls memory by allocating and reclaiming memory for all objects. Central control means engineers can tune the memory/processor interface to keep

the most important information available to the CPU. By contrast, RISC chips offer little support for memory control and simply rely upon the cache to deliver the data at the right time.

- Java dynamically links procedure calls and method invocations at run time. This may involve searching several tables and chasing several pointers. C programs have the branches and jumps hard-coded during linking so the CPU can't intervene to speed up the process.
- The Java specification explicitly identifies thread synchronization in the instruction stream. This means that picoJava chips can support synchronization primitives in hardware. In contrast, C programs that are running on a RISC chip carry out thread synchronization only through additional layers of software.

Come
See us at
DECUS in St. Louis!
Booth # 825.

The people have spoken.



“KEA!™ FOR VAX®/UNIX: CONNECTIVITY PRODUCT OF THE YEAR.”

AGAIN, FOR THE THIRD STRAIGHT YEAR, THE READERS OF DEC USER CAST THEIR VOTES FOR KEA! FROM ATTACHMATE® AS THE BEST PC-TO-VAX CONNECTIVITY PRODUCT.

THOSE CUSTOMERS ARE NOT ALONE. AFTER EXTENSIVE COMPETITIVE TESTING, DIGITAL® CAME TO THE SAME CONCLUSION WHEN THEY DECIDED TO BUNDLE KEA! 340 FOR WINDOWS NT™ WITH THEIR NEW MULTIA PRODUCT. AND MAKE IT THEIR OWN INTERNAL CONNECTIVITY STANDARD.

ACCLAIMED FOR ITS POWER, SIMPLICITY, VERSATILITY AND SECURITY, KEA! USERS THE WORLD' OVER CAN HAVE CUSTOM COLORS, KEYBOARD MAPPING, MENUS AND DIALOG BOXES FOR EACH HOST APPLICATION THEY USE, ALL IN A WINDOWS® ENVIRONMENT.

WHEN IT COMES TO EMPOWERING YOUR WORKSTATIONS, NOTHING IN THE VAX/UNIX ARENA CAN MATCH KEA!. TO DEVELOP CUSTOM CLIENT/SERVER APPLICATIONS, ONLY KEA! INCLUDES INTEGRATED SUPPORT FOR VISUAL BASIC®, POWERBUILDER™ AS WELL AS QUICKAPP®, THE POINT-AND-CLICK CODE WRITER.

YEAR AFTER YEAR THE PROFESSIONALS KEEP COMING BACK TO KEA! 340/420 FOR WINDOWS, WINDOWS 95 AND WINDOWS NT.

FOR YOUR FREE DEMO DISK OR TO QUALIFY FOR A FREE EVALUATION COPY, CALL 800-426-6283 OR 206-644-4010 AND MENTION RESPONSE CODE 322.01. OR VISIT OUR WEB SITE.
URL: [HTTP://WWW.ATTACHMATE.COM](http://www.attachmate.com)

Circle 601 on Inquiry Card.



Users GET TRAINED VERY, VERY QUICKLY.

Terrific tech support. a great bunch of people.

The best connectivity I've ever seen.

It's a snap to customize my sessions.

Our developers find the tool support unmatched.

Wow man... I love the colors!

Running C in a Java World

The picoJava design team knew it had to overcome one major hurdle: the Java language has no instructions for manipulating a computer's main memory. Most computers use memory locations to handle all input and output. For example, getting input from a mouse or a keyboard requires reading directly from memory. For security and safety reasons, Java won't allow this, which is why many system designers believe Java is unusable as a general system language.

But picoJava designers had a trick up their sleeves. They simply added new bytecode instructions for reading and writing memory. These instructions won't work on a Java-ready browser, but they will work for Java chips. Someone could even write an entire OS in Java. You also could compile C for Java-only chips and convert memory references. In fact, C is similar enough to Java that a Java chip running C might be faster than a C chip emulating Java.

connect real-time data-acquisition instrumentation to the Internet to distribute information quickly to widely dispersed groups of clients.

However, Nicol says the Java language specifications leave him cool in terms of performance for real-time process control and data acquisition. "The design doesn't seem as elegant as it could have been. There's a strong software orientation," he says. "But Java does have business momentum behind it."

Economics also enters the picture. ARM, Intel, and Mips sell their chips for a wide range of applications, so they can justify spending more engineering time on their core engines. This could lead to a tighter performance race between general-purpose CPUs with JIT compilers and picoJava chips. Another hurdle for Sun could be unforeseen problems integrating picoJava chips into systems.

In the end, the success of Java chips will depend largely on the success of Java. An advantage for Java chip proponents is how complex it is to design a chip for fast C and Java code performance. CPUs that run C well may do a good job of emulating the Java VM, but they may never approach the speed of a chip optimized for Java code. The reverse is also true. To compensate, designers need more than a thorough understanding of CPU

Are You a Prudent Person?

Then invest in DTK networking solutions with Pentium® Pro processors!



Here's what *Computer Reseller News*, the industry's bible, said about DTK's APRI-31 network workstation with the Intel Pentium® Pro processor: "H-P, DTK lead the Pentium® Pro pack"

"The APRI's all-SCSI peripherals, AMI BIOS, Intel 440FX chipset and proprietary motherboard combined to garner the highest overall score and to outpace the field in two of the five applications tests. It finished...a close second in the remaining three individual tests." "The DTK APRI-31M/P200 is a price/performance leader, and an excellent value..." —CRN, 9/2/96

Now, DTK's APRI-32 has **DUAL** Pentium® Pro processors!

The ultimate system for workstations and servers, it's DTK's new APRI-32, with dual Intel® Pentium® Pro 200MHz processors and an integrated Wide SCSI controller! The power of the new Windows® NT Workstation ver. 4.0 (shipped with the APRI-32) and DTK's new dual processor system make an ideal networking combination.

Your new APRI-32 can be custom-configured with up to 384MB of EDO DRAM and a 3D or 2D PCI graphics card.

And, with the Seagate Wide SCSI hard drive with 2, 4 or 9 gigabyte capacity (2GB is standard), the APRI-32 is an unbeatable workstation/server system.

All DTK systems are FCC-certified and UL-Listed. Technical support from our network-savvy specialists is free.

DTK has combined the most advanced technology with sensible pricing. It doesn't take a Wall Street analyst to recognize that the APRI-32 is a wise choice!

APRI-32

- **DUAL** Intel 200MHz Pentium® Pro processors w/256KB internal cache
- Up to 384MB EDO RAM on board
- 3COM Network Card
- AMI Flash BIOS
- 6X SCSI CD-ROM drive
- 2GB/4GB/9GB SCSI-2 or Wide SCSI Seagate Hard Drive
- PCI 64-bit Graphics Accelerator with 2MB or 4MB RAM
- 3.5-inch Floppy Disk Drive
- MS Mouse and MS Keyboard
- MS Windows NT Workstation v. 4.0
- 2-Yr. Ltd. Warranty (On Site Option)



PENTIUM PRO PROCESSOR

DTK Computer

Nationwide (800) 289-2385 ♦ See us at COMDEX - Booth S-3538

The Intel Inside Logo and Pentium are registered trademarks and the Pentium Processor Logo and the Pentium Processor Pro Logo are trademarks of Intel Corporation. All other trademarks are the properties of their respective owners. ©1996 DTK Computer Inc.

WHERE TO FIND

Sun Microsystems
Mountain View, CA
(415) 960-1300
<http://www.sun.com/sparc>

design; they need expertise in compilers and overall system architecture as well. But a one-size-fits-all approach to CPU design—with the right mix of software and hardware to wring out performance for two different platforms—probably won't satisfy end users if Java applications become ubiquitous.

If Java's platform independence and security features lead developers to embrace the language, users may be perfectly happy with Java-specific systems. But if native-code applications continue to dominate the market, specialized Java chips may be of interest only in the world of low-power embedded devices. **B**

BYTE consulting editor Peter Wayner lives in Baltimore. You can reach him at pcw@access.digex.net.

PC buyers face tough choices in 1997 as x86-chip vendors race to maintain their dominance. By Tom R. Halfhill

The x86 Gets Faster with Age

Call it the year of megahurts. Rarely have PC users shopping for a new system faced so many microprocessor-induced headaches. And it won't end in 1997; hotter competition, architectural transitions, and software factors will probably make users' decisions difficult for the next few years. Hibernation is not an option.

While novices continue to blindly compare megahertz and megabytes, knowledgeable users will be juggling many more variables. These are outlined below.

- Intel's fastest Pentium is cruising at 200 MHz this fall, but due to inherent limitations of its aging architecture, it's barely faster than a Pentium-166. Also, the current P54C-series Pentiums don't recognize Intel's new MMX multimedia instructions. Early next year, Intel will address these problems by introducing the new P55C-series Pentiums. But the P55C is still a fifth-generation x86 processor that will appear at a crucial juncture when Intel is attempting to push the mainstream market toward the sixth-generation Pentium Pro.

- Lower prices and new system chip sets are making Pentium Pro-based desktop PCs more affordable. Unfortunately, the Pentium Pro isn't the best choice if you're running 16-bit software, including Windows 95. Also, current Pentium Pros do not support MMX. Intel is readying a new P6-class processor, code-named Klamath, that improves 16-bit performance and supports MMX. But you'll have to wait for it until mid-1997 at the earliest, and the upgrade path for Pentium Pro users is muddy.

- Cyrix's rejuvenated 6x86 handily beats a comparable Pentium, has no trouble with 16-bit code, and boasts the fastest I/O bus in the business. However, Cyrix can't match Intel's fastest core speeds, and the 6x86 doesn't support MMX. In addition, BYTE recently discovered that some revisions of the 6x86 suffer from se-

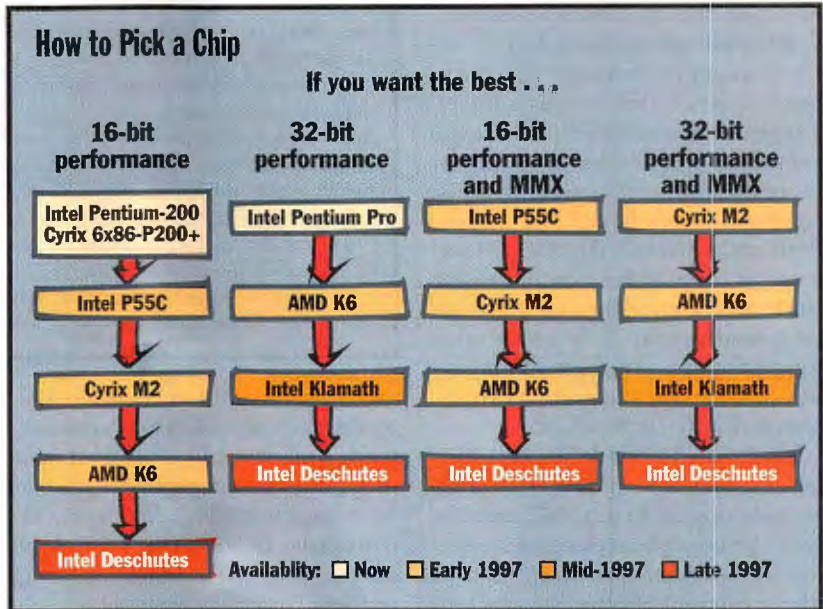

Are you confused by all the different x86 chips that are coming soon? Here's how to find your way through the maze.

rious performance problems when running on Windows NT Workstation 4.0.

- Cyrix plans to address all these issues early next year with an improved version of the 6x86, called the M2. But its MMX compatibility will be in question at first because Cyrix doesn't have a licensing agreement for the Intel technology.

- AMD, still struggling with its disappointing K5 series, will finally ship a version that lives up to the company's early promises. But the K5 is hopelessly far behind the leading edge. In 1997, AMD's hopes will ride on the K6, which is supposed to support MMX and match or exceed the performance of the Pentium Pro. After stumbling with the K5, AMD desperately needs to win back the confidence of system vendors and users.

- A new contender, International Meta Systems (IMS), claims that it will introduce a CPU that fits into Pentium sockets and approximates the performance of a Pentium Pro. IMS has made previous attempts to break into the x86 market, but

those products never shipped. This time, IMS is taking a different approach (see the text box "IMS Rides Again with the Meta-6000" on page 90).

- Looming on the horizon is Intel's seventh-generation x86, known as the P7 or Merced. It will introduce a 64-bit x86 architecture. However, systems built with this chip probably will not appear until 1998 at the earliest, so the Merced should not affect your near-term plans.

Intel's Introductions

To defend its high profit margins and to keep its huge wafer-fabrication plants busy, Intel must periodically abandon an older-generation CPU and steer the market toward the next-generation product. That's what will happen to the Pentium in 1997. Although the Pentium will remain a high-volume product next year, Intel wants users to start thinking of the Pentium Pro as a mainstream CPU. Until now, Intel has mainly positioned the Pentium Pro for servers and workstations.

continued

However, this predictable transition (which happens about every four years) is a little more confusing this time because Intel is simultaneously introducing MMX, an architectural enhancement that spans both generations (see "x86 Enters the Multimedia Era," July BYTE). Because MMX will debut with the Pentium, not the Pentium Pro, users who buy new systems during the transitional phase will have to wrestle with a few more decisions.

MMX will appear first in the P55C-series Pentiums, which are scheduled to begin shipping in the first quarter of 1997. They have improved pipelines and twice as much on-board cache: 16 KB each for the primary instruction and data caches, compared to the 8-KB caches in previous Pentiums. As a result, the P55C will outperform a regular Pentium at the same clock speed, even without MMX acceleration. Sources estimate the performance gain to be about 15 percent—an important point if you're comparing two systems with different Pentiums.

The P55C will likely debut at 200 MHz, but it may run as fast as 233 MHz. Unfortunately, upgrading to a P55C probably won't be as simple as plugging the chip into an existing Pentium socket. Although it's pin-compatible with existing sockets, Intel had to reduce the voltage so that the chip runs cool enough at higher clock speeds. Thus, you'll probably need a new motherboard for the P55C.

Waiting for Klamath

Astute users who want to postpone obsolescence are looking toward the next generation: the Pentium Pro. Unfortunately, this chip has several problems. It bogs down under 16-bit software and won't support MMX until after the P55C. It's also expensive, because it uses a multichip module to incorporate a 256- or 512-KB Level 2 (L2) cache in the same package with the CPU die. And it requires more costly system chip sets and six-layer motherboards.

Intel's solutions are the Klamath and new chip sets. Intel isn't talking about Klamath yet, but this P6-class chip will almost certainly eliminate the expensive multichip module. Intel will reportedly offer the Klamath on a small daughtercard that plugs into a special slot on the motherboard. The daughtercard would include the CPU and the L2 cache, and some daughtercards may have sockets for multiple CPUs.

IMS Rides Again With The Meta6000

Only two companies besides Intel make leading-edge x86 processors: AMD and Cyrix. International Meta Systems (IMS), a small company known for rogue CPU designs, thinks there's room for a third.

IMS claims it will introduce an x86 chip in late 1997 that fits into Pentium sockets and delivers P6-level performance. The CPU will adopt most of the techniques used by other fifth- and sixth-generation x86 processors, including deep pipelines, branch prediction, speculative execution, out-of-order execution, scoreboarding, and rename registers. It will also recognize Intel's MMX multimedia instructions. Unlike Intel's chips, however, it will support concurrent floating-point (FP) processing by internally shadowing the FP registers instead of reusing them.

It's difficult to judge the reliability of these claims. IMS has produced some language-

specific processors (for Smalltalk and FORTRAN) and is also working on a Java chip. But until now, the company has never competed against the big boys with an x86. In 1992, IMS announced the 3250, a unique RISC chip with rewritable microcode that could emulate an Intel 486 or a Motorola 68000. That chip never came out, although there were rumors that IMS licensed the technology to other companies.

Is the Meta6000 another vaporchip? Could be, but don't forget the NexGen story. NexGen labored for eight years before shipping the Nx586 in 1994. And although the Nx586 never became popular, it was a respectable design that beat AMD's and Cyrix's fifth-generation CPUs to market. Last year, AMD bought NexGen to obtain the sixth-generation Nx686, now called the K6. So don't diss IMS.

Getting rid of the multichip module would drastically reduce Intel's manufacturing costs. It would also make it easier to upgrade a system, because users could swap daughtercards to get a faster CPU, more cache, or both. That's why Apple started using CPU daughtercards in its high-end Power Macs last year.

But separating Klamath's CPU and L2 cache could have some less desirable side effects as well. First, there's the question of performance. The Pentium Pro's L2 cache is closely coupled to the CPU over a dedicated 64-bit bus that runs at the same clock speed as the core. It's an extraordinarily fast bus that contributes a lot to the Pentium Pro's superior 32-bit benchmark results. Moving the L2 cache out of the package may force Intel to adopt a slower bus. If so, Klamath would need a larger cache, higher clock speeds, and perhaps some additional enhancements to compensate for the loss. If Intel puts Klamath on a daughtercard, the bus that connects this card to the motherboard is another potential bottleneck.

Faster Clocks

In any case, Klamath will support MMX and probably include some modifications to enhance 16-bit performance. Higher clock speeds are a certainty, thanks to Intel's new 0.28- and 0.25-micron CMOS processes. In 1997, these smaller processes will supersede the 0.35-micron BiCMOS process on which today's Pentiums and Pentium Pros are built.

Klamath will debut sometime in 1997 at 0.28 micron, yielding a minimum clock speed of 200 or 233 MHz, going perhaps as high as 266 MHz. Later in the year, Intel will phase in the 0.25-micron CMOS process. This will lead to a P6-class chip (code-named Deschutes) that should hit 300 or 333 MHz.

That'll be great for new buyers, but where does it leave the early adopters of the Pentium Pro? If Intel, as expected, discards the multichip module, Klamath almost certainly won't be compatible with existing 387-pin Pentium Pro sockets. Moving the L2 cache outside the package onto an external 64-bit bus would require 72 more pins. The only alternative would be to interface the L2 cache to the front-side I/O bus, but that would seriously impair performance.

The bottom line: If Intel segregates the L2 cache, existing Pentium Pro systems probably won't be upgradable to Klamath. The new chip wouldn't fit the old sockets, and the old motherboards don't have a daughtercard slot. Intel has long-range plans for Pentium Pro OverDrive chips, but they probably won't appear before 1998. Pentium Pro users will end up swapping motherboards or buying a whole new system.

On the bright side, those new motherboards and systems will cost less. New system chip sets from Intel and Silicon Integrated Systems (SiS) are slashing the cost of building a Pentium Pro system. For example, Intel's new 440FX chip set has

Finish faster.

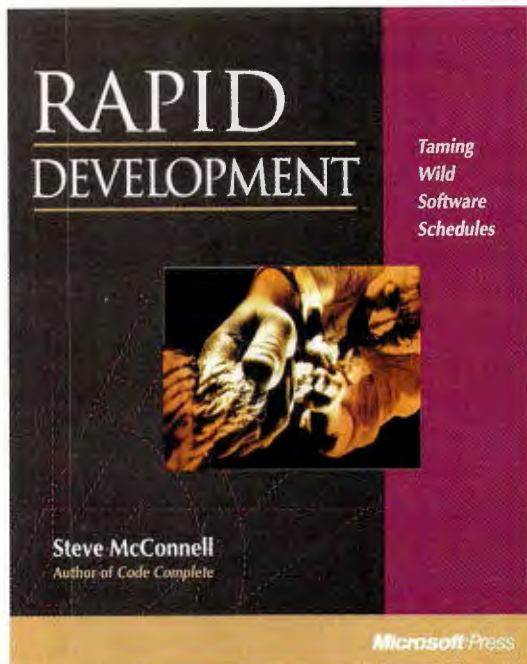

Rapid Development
ISBN 1-55615-900-5 \$35.00 (\$46.95 Canada)

“An indispensable road map for those who wish to write code as fast as humanly possible...”

—*G. Pascal Zachary, author of SHOWSTOPPER!: The Breakneck Race to Create Windows NT and the Next Generation at Microsoft*

In **RAPID DEVELOPMENT**, award-winning author Steve McConnell reveals the secrets to taming wild software schedules. He analyzes the development-speed implications of many traditional development practices, pointing out which are effective and which are harmful. The book alerts you to 36 classic mistakes—practices intended to shorten the development process that lengthen it instead. McConnell counters with 27 proven ways to shorten schedules and reduce the risk of schedule overruns. **RAPID DEVELOPMENT** has a hard-headed, practical focus—with the emphasis on suggestions you can use right away to finish your next development project faster.

Microsoft® Press

Available in quality bookstores and computer stores worldwide

To locate your nearest source for Microsoft Press® products, reach us at: www.microsoft.com/mspress/
1-800-MSPRESS in the U.S.



only three parts and costs less than half as much (\$94) as the eight-part 450KX chip set found on many of today's Pentium Pro motherboards. And SiS offers a one-chip solution, called Archer, that costs only about half as much (\$39) as the 440FX. Moreover, these solutions work with four-layer motherboards instead of the six-layer boards required by the 450KX. Although they sacrifice a few features—such as memory expandability and multiprocessor support—these compromises are reasonable for desktop systems priced in the \$2000-to-\$3000 range.

Merced Mania

Further out is Intel's seventh-generation x86, the mysterious P7/Merced. Merced will extend the 32-bit x86 architecture to 64 bits and introduce a new instruction set. This architecture, dubbed IA-64, will be backward compatible with the existing x86 architecture, just as the 32-bit architecture of the 386 was compatible with the 16-bit 286, 8086, and 8088.

Although Merced is the fruit of Intel's partnership with Hewlett-Packard, it's looking less likely that IA-64 will radically depart from today's x86 architecture by adopting very-long-instruction-word (VLIW) technology. Intel will probably take a more conservative approach by extending the microarchitecture of the Pentium Pro. Pure VLIW is the antithesis of Intel's current design track; the Pentium Pro optimizes the instruction stream during execution, while a true VLIW processor would shift that responsibility to the compiler at design time.

There's still plenty of performance to be gained by extending the Pentium Pro's "dynamic execution" core. Intel could expand the reorder buffer, tweak the reordering algorithms, improve the branch prediction, add more execution units, boost the Level 1 (L1) caches (which are relatively small), and make other general improvements that would legitimately represent a seventh-generation design.

If VLIW plays any role at all, perhaps Intel and HP have found a way to adapt some tenets of that philosophy to the x86, just as Intel has integrated some elements of RISC into the Pentium Pro. Or maybe a full-blown VLIW design will appear in a subsequent processor.

Intel's alliance with HP also calls for Merced to run PA-RISC software. Some observers think this trick will require emulation, in either software or hardware. It would be useful to run PC applications on an HP workstation, but it's doubtful that the ability to run PA-RISC software on PCs would win significant additional market share for Intel.

In any event, Intel is committed to a 64-bit CPU that runs 16- and 32-bit x86 software without emulation. Native IA-64 programs will run faster than 16- or 32-bit programs, but nobody—possibly not even Intel—knows exactly how much faster.

Another unknown is how quickly the industry will adopt IA-64. Remember, it's been 11 years since Intel went 32-bit with the 386 in 1985, and most PC users are only now migrating to 32 bits. Microsoft didn't ship a 32-bit OS until 1993, and the

vast majority of PC users still use 16-bit Windows 3.1 or 16-/32-bit Win 95. Although Microsoft recently dropped some vague hints about a 64-bit Windows NT, the first 64-bit OS for Merced will probably be Summit 3D, a new flavor of Unix currently under development by HP and The Santa Cruz Operation (SCO). If the 64-bit transition follows the same course as the 32-bit transition, then IA-64 won't be a significant market force until the year 2009.

Cyrix Crystal Ball

After a shaky start with the 6x86, Cyrix is finally gaining on Intel's price/performance lead. The first 0.6-micron version of the 6x86 suffered from a huge die. Cyrix switched to a process with five layers of metal instead of three, shrinking the die from 394 square millimeters to 210 mm². During the summer, Cyrix moved to a 0.5-micron process, achieving a die size of 170 mm².

Like an overweight athlete shedding excess fat, the 6x86 chip now runs a lot faster: 150 MHz instead of 100 MHz. And thanks to a more efficient microarchitecture, the 6x86 easily outruns a Pentium at the same clock speed. In fact, the 150-MHz 6x86 chip slightly outperforms a 200-MHz Pentium, which is why Cyrix designates this chip the 6x86-P200+ in accordance with the P-rating benchmark (see the text box "The Problem with P-Ratings" on page 94).

Recently, however, BYTE discovered that some 6x86-based systems have a serious problem with the final-release can-

Who's Who in x86

Here's what to expect from x86 vendors over the next year. (Note: Performance estimates and ship dates are BYTE's assumptions based on preliminary information from vendors.)

Company	CPU	x86 generation	MMX	Availability	Comments
AMD	K5	Fifth	No	Now	Latest versions have significantly increased performance.
AMD	K6	Sixth	Yes	March 1997	Redesigned NexGen Nx686.
Cyrix	Gx86	Fifth	No	Now	Highly integrated chip for low-cost PCs.
Cyrix	6x86	Sixth	No	Q1 1997	75-MHz I/O bus is the fastest on any x86 chip.
Cyrix	M2	Sixth	Yes	Q1 1997	Improved version of 6x86; MMX compatibility a challenge.
IMS	Meta6000	Sixth	Yes	Late 1997	Company has uncertain track record.
Intel	P54C Pentium	Fifth	No	Now	Dominates market; fastest speed is 200 MHz.
Intel	P55C Pentium	Fifth	Yes	Q1 1997	Slightly faster than P54C Pentium.
Intel	Pentium Pro	Sixth	No	Now	L2 cache in multichip module; poor 16-bit performance.
Intel	Klamath	Sixth	Yes	Mid-1997 (?)	Improved Pentium Pro; L2 cache probably separate.
Intel	Deschutes	Sixth	Yes	Late 1997	Improved Pentium Pro; should reach 300 MHz.
Intel	P7/Merced	Seventh	Yes	1998-1999 (?)	Highly secretive joint project with Hewlett-Packard.

SMART CACHE IV[®]

**New Ultra Wide Adapters
Now Available**

"Our competitors are solidly behind us."
20-50% behind us, to be exact.

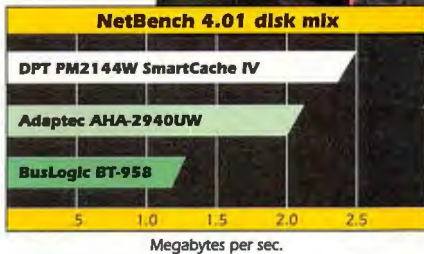

- PCI, EISA and ISA
- Upgradable to hardware RAID and caching
- Bus-mastering with on-board processor
- Support for all major operating systems
- **New:** Ultra SCSI models now available

This chart from the May, 1996 issue of **PC Magazine** (UK) shows the results described in their review of SCSI adapters entitled *"Survival of the Fastest"*. According to PC Magazine, *"SmartCache IV was demonstrably quicker than the other two [boards tested]."* (Adaptec 2940UW and BusLogic BT-958).

Here's your chance to get ahead of the competition. Call for more information about SmartCache IV SCSI adapters and modules. You'll see why we say: SmartCache, Smart Choice!

COMDEX
BOOTH NUMBER
L2762

1-800-860-4589

DPT
Distributed Processing Technology

B9611

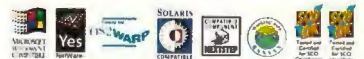

Circle 140 on Inquiry Card.

didate of Windows NT Workstation 4.0. We ran 32-bit Windows applications tests on a 6x86-P200+ system and then compared the results to those obtained on the same system with a beta version of NT 4.0. To our surprise, the tests ran about 25 percent slower on the release candidate of NT 4.0. The 6x86 also ran NT 4.0 about 16 percent slower than NT 3.51 and 24 percent slower than Win 95. In similar tests with Pentium-based PCs, performance improved on the release candidate of NT 4.0.

This problem might be related to some last-minute code that Microsoft added to NT to make it more stable on Cyrix-based PCs. Check The BYTE Site (<http://www.byte.com>) for the latest updates on this developing story.

Another upcoming challenge for the 6x86 is MMX. Cyrix was working on its own multimedia extensions when Intel unveiled MMX and announced a cross-licensing agreement with AMD. Cyrix doesn't have such a deal, but it promises that the next version of the 6x86—code-named M2—will be MMX compatible.

The M2 is scheduled to start sampling in the fourth quarter of this year and then begin volume production during the first quarter of 1997. That means the M2 will be committed to silicon before Cyrix's engineers can get a close look at the P55C. To support MMX, they will have to rely on publicly available technical data from Intel—and perhaps some Texas windage as well.

Cyrix says that it has indirect access to some Intel technology through its fab partners, IBM Microelectronics and SGS Thomson, which have licensing agreements with Intel. Cyrix also notes that it has a good track record of x86 compatibility. Even so, MMX will be a question mark until independent parties get a chance to thoroughly test the M2.

Klamath Competition

The M2 will also move to a 0.35-micron process and beef up its unified L1 cache to an impressive 64 KB. M2 clock speeds will be 180 MHz and 200 MHz at introduction, with 225 MHz coming later in 1997. In combination with other improvements, those clock rates should allow the M2 to beat a P55C and compete strongly against Klamath.

Cyrix's biggest contribution to the PC industry might be a kick in the pants toward 75-MHz I/O buses. The 6x86-P200+

The Problem with P-Ratings

AMD and Cyrix will soon face a dilemma: How can they compare the performance of their processors to that of Intel's when the baseline keeps changing?

Until recently, users could judge the relative performance of two different x86 chips of the same generation by comparing clock speeds. CPU cores from AMD, Cyrix, and Intel were similar enough that performance didn't vary much—a 33-MHz 486 from one vendor was as fast as a 33-MHz 486 from a competitor.

But as the x86 moves through its fifth and sixth generations, microarchitectures are

standardize on Performance Ratings, abbreviated as *P-ratings* by Cyrix and as *PR-ratings* by AMD.

MicroDesign Resources, which publishes the *Microprocessor Report*, acts as the independent testing lab. Cyrix's 150-MHz 6x86 is labeled the 6x86-P200+ because it matches or exceeds the performance of a Pentium-200; AMD's new 100-MHz K5 is called the K5-PR133 because it's comparable to a Pentium-133.

But P-ratings use today's Pentium as the baseline. When Intel introduces the P55C Pentiums in 1997, they're expected to per-

P-Ratings vs. Clock Speeds

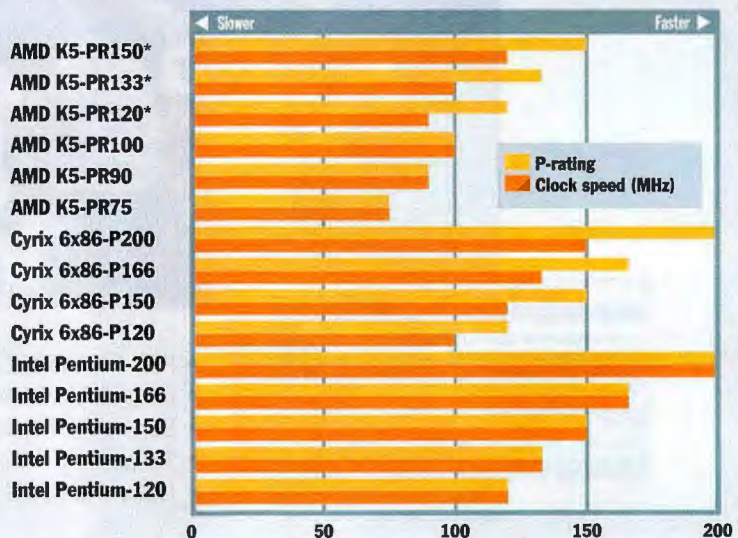

*Latest version of AMD K5 is faster than clock speed because of architectural improvements (see text).

An x86-compatible chip rated at P-120 delivers performance comparable to that of a 120-MHz Pentium.

diverging to the point where clock speeds are no longer valid, even for shorthand comparisons. For instance, Cyrix's 150-MHz 6x86 outruns a 200-MHz Pentium.

Industry-standard benchmarks, such as SPEC95, are one answer, as are magazine benchmarks, such as the BYTEmark and WinBench. But these tests typically yield measurements that don't directly compare different CPUs. (BYTEmarks are normalized to a Pentium-90 baseline, not relative clock speeds, although you could figure it out by doing a little math.)

AMD and Cyrix prefer numbers that users can compare directly to Intel clock speeds. That's why they joined forces last year to

form about 15 percent better than a regular Pentium at the same clock speed. Users might be confused: Which Pentium does the P-rating refer to?

Then there's the Pentium Pro. Comparisons to Intel's flagship CPU will require yet another variation of the P-rating.

Cyrix and AMD claim they're working on a solution. But knowledgeable buyers don't rely exclusively on vendors' performance claims, anyway. By collecting benchmark data from multiple sources—including the popular magazine benchmarks, which are freely available—expert users can reach their own conclusions, even if it takes a little more effort.



Novotec 19" RAID System

- 8 U-chassis
- modular expandable
- 2 redundant power supplies (600 W)
- maximum ventilation of all built-in components
- fast-SCSI and wide-SCSI cabling according to your requirements
- drive shuttles with hot-swapping

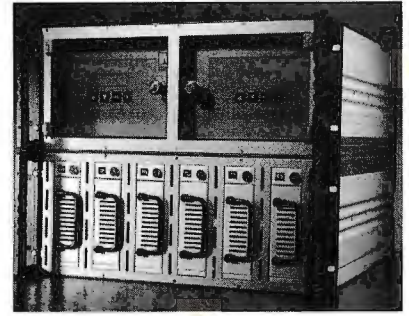
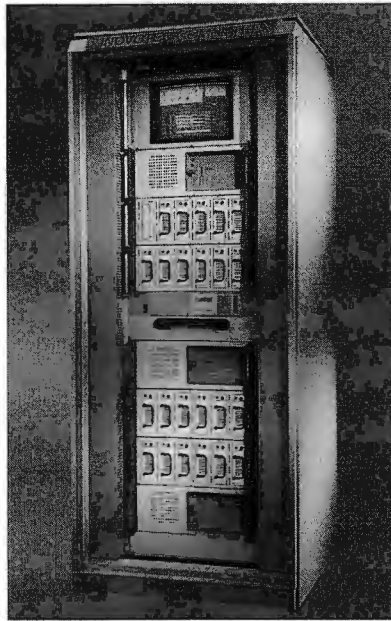

Novotec 19" Cluster

- 8 U-chassis
- modular expandable
- 2 redundant power supplies (600 W)
- maximum ventilation of all built-in components
- drive shuttles with hot-swapping
- flexibility by the use of 1-6 wide-SCSI-channels

19"-technology? Cases and server – solutions from NOVOTEC COMPUTERS

NOVOTEC COMPUTERS combines innovative technology, reliability and quality to an overall picture of high performance servers and fault tolerant disk-arrays. Highest quality and the use of modern technologies pay: the cases and systems from NOVOTEC COMPUTERS set standards. The flexible system concept allows full scope for expansions and therefore protects your previous investments.

NOVOTEC COMPUTERS uses only high-performance components from leading producers and thereby guarantees an open industry standard. The development, production and final checks are performed according to the regulations of the Standard ISO 9001.

Modular design, flexibility and special application solutions are the characteristics of the products of NOVOTEC COMPUTERS. Included are PC systems as well as complete network solutions, from concept to implementation.

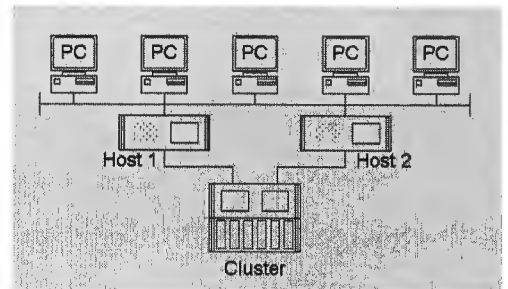

Decisive advantages of clustering:

- no down-time at breakdown of one controller or host
- increased performance by multiple-host-use

Innovative technologies, quality and reliability -
by NOVOTEC COMPUTERS



NOVOTEC Computers
Ingolstädter Straße 12
80807 Munich (Germany)
Phone: +49/89/35 62 97-0
Fax: +49/89/35 62 97-70
Mailbox: +49/89/35 65 15 33
<http://www.novotec.com>



Circle 266 on Inquiry Card (RESELLERS: 267).

COMDEX
Fall '96 Las Vegas
Nevada / USA
18. - 22. November 1996

runs its core at 150 MHz and the I/O bus at an unprecedented 75 MHz. Until now, the fastest x86 buses topped out at 66 MHz. That 14 percent improvement provides a significant boost for I/O-intensive servers.

Unfortunately, systems designers have trouble making 75-MHz motherboards, which is why nobody has done it until now. Only one system chip set (from VLSI Technology) currently supports the 75-MHz bus. Without that chip set, the 6x86-P200+ has to synchronize its bus at 50 MHz, which bleeds so much performance that the chip no longer merits the P200+ designation. Maybe that's why Cyrix entered the systems business last summer; if you want to get a 6x86-P200+ system with a 75-MHz bus, you can buy one directly from Cyrix.

Cyrix is also working on an 83-MHz bus. That's nearly 26 percent faster than 66 MHz and would certainly provoke server envy among rival vendors. Until chip-set makers and motherboard manufacturers catch up, however, these bus speeds are mainly a technical curiosity. It

will probably require the weight of Intel to shove the industry forward, and Intel hasn't publicly committed itself to speedier buses.

In another interesting move, Cyrix is introducing a highly integrated chip that would allow consumer PCs to retail for \$800. Tentatively called the Gx86, the new processor is based on a low-cost chip that Cyrix announced last year for notebook computers. If the \$800 consumer PCs succeed, Cyrix hopes to design a version for corporate intranets. Cyrix would position that chip as a CPU for low-cost, Windows-compatible network computers. (See the text box "Cyrix Gx86 for Dirt-Cheap PCs" at right.)

AMD Road Map

Sometimes a design that looks great on paper falls flat in the real world. AMD's ordeal with the K5 wasn't quite as embarrassing as the baggage-handling debacle at Denver's new airport, but it was bad enough. The K5 was supposed to bring AMD's chips within striking distance of Intel's top CPUs; instead, numerous prob-

lems have kept the K5 from seriously challenging even the Pentium, much less the Pentium Pro.

Despite the conventional wisdom that PC prices go nowhere but down, entry-level computers have been stuck in the \$1200-to-\$1500 range for a decade and have actually doubled in price since the early 1980s. Now that IBM, Oracle, Sun Microsystems, and others are promoting economical network computers, some PC vendors are exploring ways to make sub-\$1000 systems without sacrificing Windows compatibility.

Intel is taking a wait-and-see attitude. Cyrix, however, is jumping in with the Gx86, a highly integrated, low-cost PC-on-a-chip that allows a full-featured system to sell for about \$800. Buyers would get a PC with Pentium-120 or Pentium-133 performance, 16 MB of RAM, a hard disk, a six-speed CD-ROM drive, a modem, and input devices.

To make this possible, the Gx86 integrates several functions that normally require extra

PERSONALIZED BY YOU.

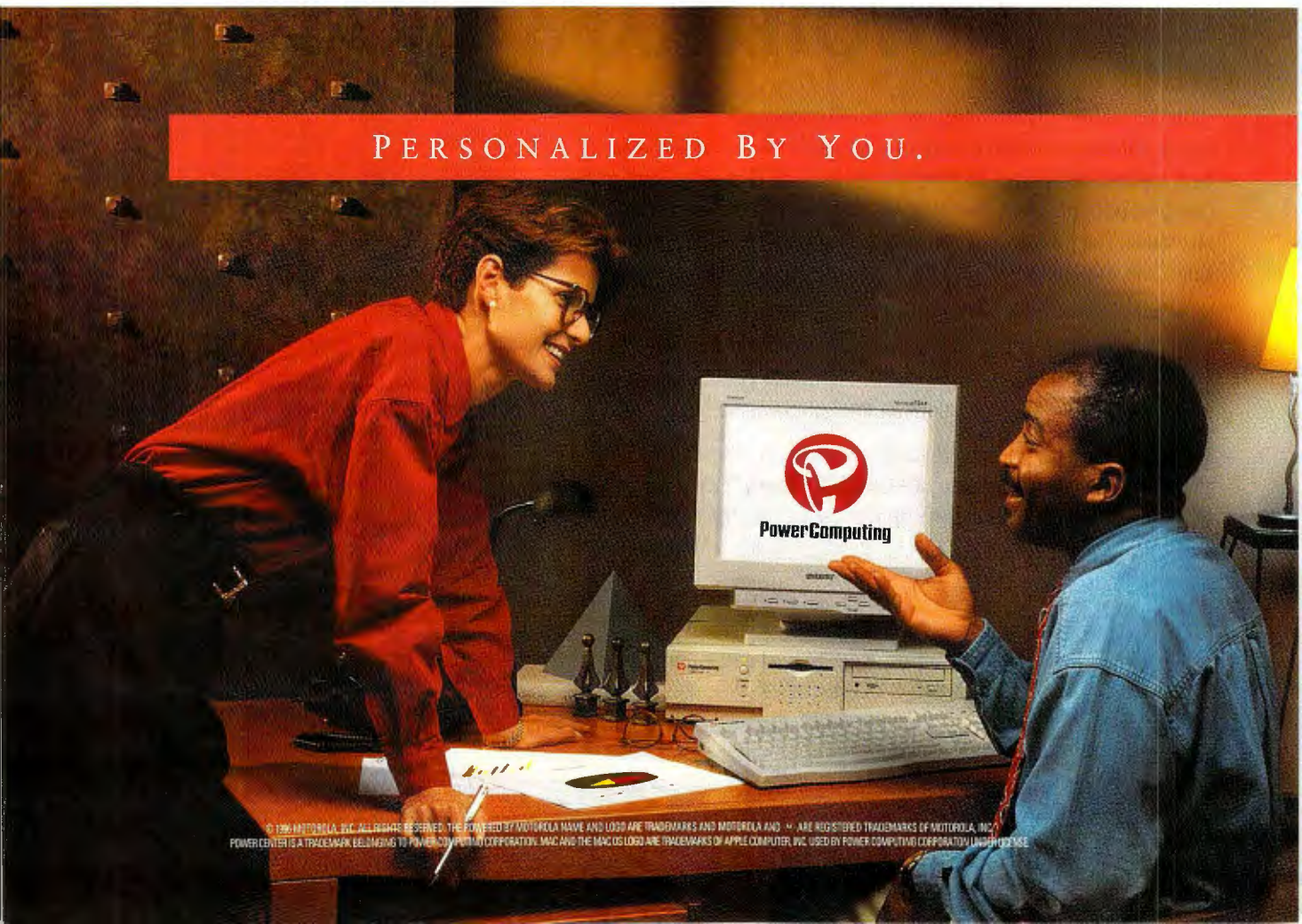

Now the K5 is back on track. It's too late for the chip to gain the leading edge, but it can still compete against the Pentium for

desktop PCs costing under \$2000. Currently, AMD is shipping the K5 at three speeds: 75, 90, and 100 MHz. They close-

ly match Pentium performance at equivalent clock rates, earning them P-ratings of PR75, PR90, and PR100, respectively.

Cyrix Gx86 for Dirt-Cheap PCs

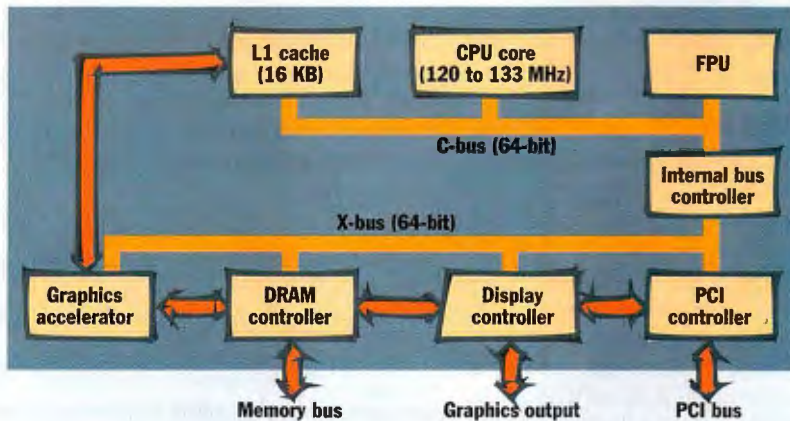

chips. It has built-in SVGA graphics, a PCI interface, and 16-bit Sound Blaster emulation. It also has a unified memory architecture (UMA), which buffers the screen data in main memory instead of in a separate frame buffer. UMA can degrade performance, but Cyrix says the Gx86 avoids this by integrating the video logic with the CPU.

The CPU core is a stripped-down version of the Cyrix 6x86. It sacrifices superscalar pipelines and speculative execution but still predicts branches and retains a 16-KB cache. Although the Gx86 probably would not do as well as a Pentium-120 or Pentium-133 when running a CPU-level benchmark, Cyrix claims the efficiencies of high integration allow the chip to deliver that level of overall system performance. (BYTE has not yet tested these claims.)

Cyrix expects to introduce the chip by the end of this year and says that several "top-tier" system vendors will ship Gx86-based PCs in early 1997.

The Gx86 integrates components that normally need separate chips and eliminates the frame buffer and Level 2 cache.

POWERED BY MOTOROLA™



People take their computers personally. Which is why every award-winning PowerCenter™ Mac OS™ system from Power Computing is designed to be customized by its end user. Priced under \$2K, these high-performance systems can be configured in an infinite number of ways.

Yet, every one of them attains its speed and power from an identical source. Motorola PowerPC 604™ RISC microprocessors are the *oomph!* that help PowerCenter computers live up to their name. From custom-configured computers to reloadable stored-value cards, Motorola powers innovative solutions that enable your success.

Visit us at <http://www.motorola-powered.com/> or call 1-800-521-6274 (Ref. #996).



MOTOROLA
Semiconductor Products Sector

What you never thought possible.™

The next versions of the K5—which are scheduled to ship in September or October—are supposed to live up to the K5's original specifications, which called for 20 percent to 30 percent greater performance than a Pentium running at the same clock speed. The new chips run at 90 and 100 MHz but carry P-ratings of PR120 and PR133, respectively.

To attain these higher P-ratings, AMD's engineers tweaked the K5 chips's core in several ways. First, they optimized the K5's execution of certain x86 instructions (e.g., repeat MOVs and far CALLs) that occur more often in real-world software than AMD's simulations had predicted. Next, they added a small prefetch cache in front of the L1 instruction cache. This fixed a problem that arose when the K5's prefetch logic aborted a cache fill in order to follow a branch to a new target address; if the program later branched back to the original instruction stream, the K5 had to fill the cache all over again. The new prefetch cache temporarily holds the cache lines to prevent a slow memory transaction. Finally, AMD elim-

inated some internal bus bottlenecks.

According to AMD, the K5 now runs about 30 percent faster than an equivalently clocked Pentium. (BYTE has not yet confirmed these claims.) In November or December, AMD plans to start shipping a 120-MHz version of this core, which would yield an equivalent Pentium performance of PR150. Even faster cores may appear in 1997.

Pinning Hopes on the K6

With Intel ramping up the P55C, Pentium Pro, and Klamath, 150-MHz performance will keep AMD firmly stuck in the number-two spot—or at number three, behind Cyrix. Clearly, AMD's future hopes ride on its next-generation product, the still-evolving K6 processor.

Here, too, the road to glory has been rocky. As originally designed by NexGen, the K6 was supposed to have a dedicated bus for the L2 cache, an integrated L2 cache controller, and a new execution unit for multimedia instructions. It was also going to be manufactured by IBM Microelectronics, NexGen's fab partner.

When AMD acquired NexGen in late 1995, those plans abruptly changed.

For the past year, AMD engineers have been modifying the K6 to make it compatible with MMX. This could require some major changes. The original K6 included a special multimedia execution unit, while Intel's MMX instructions are integer operations designed to execute in the regular integer units. It's possible that AMD will replace the multimedia unit with another integer unit, which would improve the K6's performance with non-MMX code, too.

WHERE TO FIND

AMD Sunnyvale, CA (408) 732-2400 http://www.amd.com	International Meta Systems El Segundo, CA (310) 524-9300 http://www.imes.com
Cyrix Richardson, TX (214) 968-8388 http://www.cyrix.com	Silicon Integrated Systems Sunnyvale, CA (408) 730-5600
Intel Santa Clara, CA (408) 765-8080 http://www.intel.com	

FUELED BY INNOVATION.

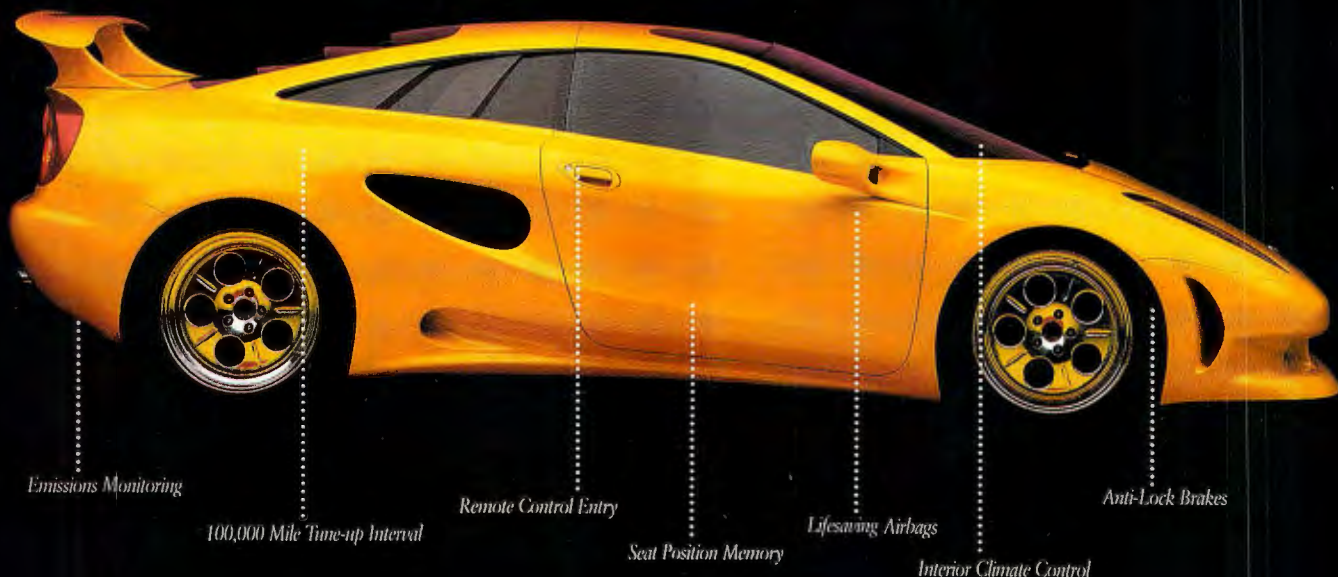

Another significant change is that the K6 will be pin-compatible with P54C-series Pentium sockets. The original Nx686 had a proprietary pin-out that required special system chip sets, a disadvantage that stunted the sales of NexGen's earlier Nx586 processor. Pin compatibility with Pentium sockets opens up a more lucrative market for the K6. Unfortunately, it also forces AMD to abandon the K6's high-speed L2 bus and integrated cache controller, because Pentium sockets don't support those features. To compensate, the K6's L1 caches now total 64 KB, compared to 32 KB for the Nx586.

Finally, engineers are reworking the K6 so that AMD can manufacture the chip at its new Fab 25 in Austin, Texas. The K6 will debut on AMD's 0.35-micron, five-layer-metal CMOS process, migrating later to 0.25 micron.

In an important move, AMD has licensed an advanced pad-bonding technology, called C4, from IBM Microelectronics. On most chips, the wires leading to the pins are soldered onto tiny pads crowded along the edges of the die. C4

technology allows circuit designers to distribute those pads anywhere on the die. This gives the designers more flexibility and also shortens the chip's critical paths, yielding higher performance. In addition, when the chip migrates to smaller processes, C4 prevents it from becoming "pad-limited"—AMD won't have to hold the die at a certain size just to leave room for the pads.

AMD says it will begin sampling the K6 late this year and start production in March. The K6 will debut at 180 MHz and support bus speeds as high as 75 MHz. AMD is sticking to NexGen's original performance estimates for the Nx686, claiming that it will be "competitive" with the Pentium Pro when running 32-bit software and considerably faster with 16-bit code. If AMD can deliver on those promises—admittedly, that's a big if—the K6 will help close the performance gap that widened when the K5 missed the target.

Look Before You Leap

In a transitional year like 1997, purchasing decisions will be more critical than

ever. It's not as simple as buying the fastest Pentium.

If multimedia matters, you should wait for MMX. If you want to get the best possible performance with 32-bit software, then wait for Klamath or even Deschutes. If you're running a great deal of 16-bit software (especially on Windows 3.1 or Win 95), wait to see how well Klamath and Deschutes address the Pentium Pro's 16-bit weaknesses—or consider getting a Cyrix or AMD chip. If you crave the fastest possible bus for an I/O-intensive server, the Cyrix 6x86-P200+ is the only game in town.

You can shop for bargains, too. There will be markdowns on regular Pentium systems after MMX appears and while Intel pushes the Pentium Pro as the next mainstream CPU. There's nothing wrong with buying a system that isn't top-of-the-line—as long as you know what you are getting. **B**

Tom R. Halfhill is a BYTE senior editor based in San Mateo, California. You can reach him at thalfhill@bix.com.

POWERED BY MOTOROLA™



A vehicle doesn't start with a key. It starts with a dream. Ideas are the fuel that drive the world's number one industry, and Motorola is the chip supplier that automotive engineers specify most to power those dreams to reality. In fact, numerous semiconductors are among the standard equipment that help make vehicles today more safe, comfortable

and environmentally friendly. From automotive electronics to wireless communications, Motorola powers innovative solutions that enable your success.

Visit us at <http://www.motorola-powered.com/> or call 1-800-521-6274 (Ref. #896).



MOTOROLA
Semiconductor Products Sector

What you never thought possible.™

Let Microway build your next Graphics Workstation,
Web Server or Personal Supercomputer using...

Screamer™ 500

*The fastest motherboard
on the planet
just got faster!*

500 MHz, 1 Gigaflop

Since 1982 Microway has provided the PC world with the fastest numeric devices and software available. No product in the last 14 years has excited us more than the 500 MHz Alpha Screamer. With its ability to execute 2 billion operations per second, the Screamer is the best choice for your next workstation or server! In addition to NT, the Screamer runs Digital UNIX, OpenVMS and Linux. This means you can run many of your VAX and MOTIF applications on the same hardware that runs Microsoft Excel or Word, Oracle, Adobe Photoshop; plus engineering and graphics applications like Pro/ENGINEER, Microstation, AutoCAD, Softimage and Lightwave. Plus, Digital's FX!32 makes it possible to run 32-bit WIN95 and NT applications on the Alpha. Over the last fourteen years we have designed systems for thousands of satisfied customers including many prestigious institutions. Our technicians are expert at configuring the four Alpha operating systems we support.

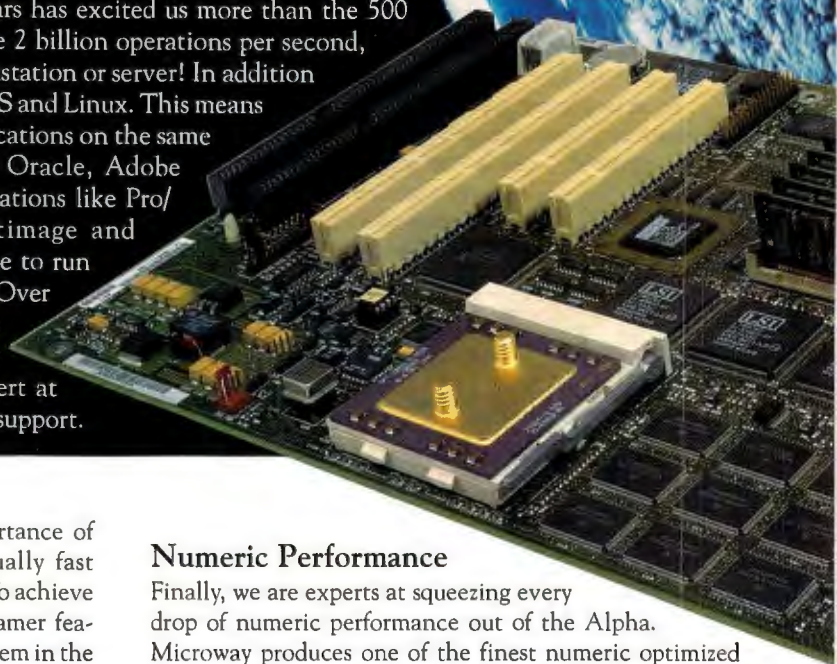

System Performance

Microway understands the importance of balancing a fast CPU with equally fast caches, memory and peripherals. To achieve balanced performance, the Screamer features the fastest cache/memory system in the industry, employing 1 to 2 MB of 9 nsec burst SRAMs fed by a 288-bit wide memory system. Its 64-bit PCI bus is driven by a state-of-the-art Digital chip set that feeds 32- and 64-bit PCI sockets. To take advantage of these resources, Microway installs the best graphics and hard disk controllers available, including controllers appropriate for 2 and 3D Graphics Workstations and RAID powered Servers.



Numeric Performance

Finally, we are experts at squeezing every drop of numeric performance out of the Alpha. Microway produces one of the finest numeric optimized compilers running on any platform - NDP Fortran. Since its introduction in 1986, hundreds of applications have been ported to the X86 with it, including well known industry standards like MATLAB and ASPEN. Our latest RISC scheduler has a number of features that make it easy to take advantage of the Alpha's quad-issue capability. Running on a 500 MHz 21164 that bursts at 1 gigaflop, a dot product kernel we use for compiler testing runs at a mind-boggling 844 megaflops!!! For a complete description of the optimization facilities provided by NDP Fortran or C++, our Screamer Systems and motherboards call 508-746-7341 or visit our WEB Site at: <http://www.microway.com>.

Digital, Alpha, OpenVMS and Digital UNIX™ Digital.
NT, Excel and Word™ Microsoft.
Screamer, NDP Fortran and Microway™ Microway.

Microway®

Technology You Can Count On

Corporate Headquarters: Research Park, Box 79, Kingston, MA 02364 USA • TEL 508-746-7341 • FAX 508-746-4678
www.microway.com, info@microway.com • France 33 146229988 • Germany 49 6997650001 • India 91 806637770
Italy 39 27490749 • Japan 81 64593113 • Korea 82 25981623 • Poland 48 22487172 • United Kingdom 44 1815415466

Stung by Intel's gains in processor performance, the PowerPC alliance will strike back with higher clock speeds and new chip designs. By Tom R. Halfhill

PowerPC Regroups

Don't count your megahertz before they're hatched. That's what the PowerPC alliance has learned after prematurely gloating over the imagined obsolescence of Intel's x86.

One famous advertisement from 1992 showed how CISC performance was falling flat while RISC technology soared toward the SPECint stratosphere. Another ad warned about the coming fate of x86-based PCs by picturing a highway running smack into a brick wall.

Somehow, things didn't work out that way. Intel's Pentium and Pentium Pro have not only managed to keep the 18-year-old x86 architecture competitive; they have at times surpassed the performance of leading RISC chips, including the PowerPC. Apple fulfilled its promise to sell millions of Power Macs, but system-level limitations have foiled Apple's attempts to exploit the full potential of the PowerPC chips. IBM fumbled the introduction of its own PowerPC desktop systems and embarrassingly failed to port OS/2 to PowerPC. And four years after the PowerPC's birth, the alliance is only now finalizing the PowerPC Reference Platform for clone makers.

If the PowerPC is to retain any credibility as an alternative to the x86, the alliance must deliver a steady stream of faster chips and a viable system standard that attracts big-volume vendors. In 1997, Motorola and IBM will roll out faster versions of current PowerPC chips, introduce a new generation of 32- and 64-bit processors, accelerate the development of future CPUs, and oversee the debut of PowerPC Platform systems that can run the Mac OS, Windows NT, and Unix. With Intel running full speed toward 300-MHz Pentium Pros and the 64-bit Merced, 1997 could be the PowerPC's last shot at glory.

The Indy 300

One measure of the PowerPC's competitiveness will be its ability to break the

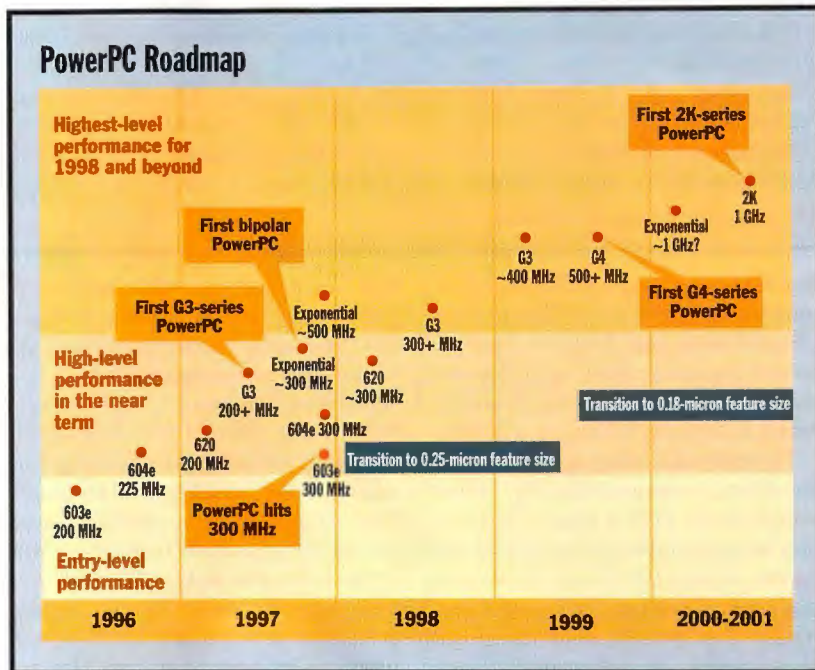

PowerPC designers need to achieve 300 MHz next year to stay in the performance race with the x86.

300-MHz barrier. Digital's exotic Alpha did it more than a year ago, but CPUs for mainstream desktop systems are only now creeping beyond 200 MHz. By the end of next year, we should see 300-MHz chips from Intel, IBM, Motorola, and probably Exponential Technology, a Silicon Valley startup that will ship the first PowerPC processor built with bipolar transistors (see "Exponential's Bid to Beat the Pack," page 104).

CPUs capable of attaining 300 MHz include Intel's Deschutes (a Pentium Pro variant), the PowerPC 603e, and the PowerPC 604e. At 300 MHz, the 603e and 604e will offer about five times the performance of the first PowerPC 601, which ran at 60 MHz.

Of course, raw clock speeds are no longer an adequate way to compare processor performance, especially between two architectures as disparate as the x86 and PowerPC. However, clock

speeds do indicate which companies have the most advanced wafer-fabrication processes and speed-tuned microarchitectures. Intel designed the super-pipelined Pentium Pro for high clock speeds to exploit its lead in building new fabrication plants (fabs). But IBM and Motorola are no slouches in this category, either. The PowerPC 604e hit 225 MHz last summer while Intel's chips were stuck at 200 MHz, and Mac clones running at 225 MHz and 240 MHz have been available for several months now from Power Computing. Even at 200 MHz, the 604e outguns Intel's fastest x86.

As part of their plan to carry the PowerPC architecture into the twenty-first century, IBM, Motorola, and Apple have forecast three generations of chips that will run at even higher clock speeds. They refer to these generations as G3, G4, and 2K. (The 601 is considered the first-generation PowerPC because it was a hybrid

Five Generations of PowerPC

Company	CPU	PPC Generation	Feature Size (micron)	Availability	Analysis
IBM/Motorola	601	1st	0.5	Phasing out	Maximum clock speed limited to 120 MHz
IBM/Motorola	603	2nd	0.5	Now	Smaller caches, slower clock than 603e
IBM/Motorola	603e	2nd	0.35	Now	Exceptionally low power consumption
IBM/Motorola	604	2nd	0.5	Now	Smaller caches, slower clock than 604e
IBM/Motorola	604e	2nd	0.35	Now	Outperforms Pentium Pro at same clock speed
IBM	615	Unknown	Unknown	Never	Dual PowerPC / x86; project probably canceled
IBM/Motorola	620	2nd	0.35	1997	Disappointing performance delayed introduction
Exponential	Bipolar	2nd	Unknown	1997	Unique hybrid of bipolar logic and CMOS cache
IBM/Motorola	G3*	3rd	0.35-0.25	1997	32- and 64-bit chips; up to 30 million transistors
IBM/Motorola	G4*	4th	0.25-0.18	1999	32- and 64-bit chips; up to 50 million transistors
IBM/Motorola	2K*	5th	0.18	2000-2001	Good bet to break 1-GHz barrier

*Code names for a series of chips in the same generation

chip based on IBM's POWER architecture and Motorola's 88110; the PowerPC 603, 603e, 604, 604e, and 620 are more mature designs that comprise the second generation.) All future generations will be compatible with today's PowerPC software.

The most significant departure from the alliance's original strategy, as first mapped out in 1991, is that the new projects are going forward concurrently, so the development work on each generation overlaps work on the previous generation. This is similar to the accelerated development schedule at Intel, where independent teams are working on new x86 generations simultaneously.

To make this possible, the PowerPC alliance has expanded its Somerset lab (a shared design center in Austin, Texas) by 50 percent. In addition, IBM and Motorola are working on PowerPC projects at their own labs in Texas, Vermont, and elsewhere. New designs can emanate from any of these labs, and IBM and Motorola share manufacturing rights to any PowerPC chips they jointly develop.

Future Generations

The G3 series is scheduled to arrive in mid-1997 with a CPU that will run at about 200 MHz on 0.35-micron CMOS. This chip has already taped out and is available in samples. Later G3-series chips will migrate to a 0.25-micron CMOS process, and clock speeds will scale upward to about 400 MHz, according to Will Swearingin, PowerPC product manager at Motorola. The fastest G3 chips will run about 10 times faster than the original PowerPC 601, he estimates.

Some chips in the G3 generation will

be 32-bit processors, while others will be 64-bit implementations based on the 620. Presumably they will improve on the 620, whose performance has been disappointing. A year ago, in fact, there were rumors that the 620 would be killed. Those rumors were greatly exaggerated, says IBM PowerPC product manager Dave Ryan; the 620 was merely delayed until a better process technology was ready. Instead of making its debut on a 0.5-micron process at 133 MHz, the 620 will appear next spring on a 0.35-micron process at 200 MHz. So far, only Motorola and Groupe Bull are committed to making 620-based systems.

Some G3-series chips will inherit the 128-bit backside bus that the 620 uses to address its secondary (level 2) cache. Others may have integrated L2 cache controllers, multichip module L2 packaging (like the Pentium Pro), or integrated L2 caches (like the Alpha). A strong clue that IBM and Motorola are thinking about integrated or closely coupled caches is that transistor counts in the G3 series will soar as high as 30 million, nearly an order of magnitude greater than the number of transistors in today's PowerPC chips. It's unlikely that the chip architects will design logic circuits requiring so many transistors in this generation; bigger caches are a virtual certainty.

In 1999, IBM and Motorola plan to introduce the G4 generation, which will first appear at about 500 MHz on 0.25-micron CMOS. Later, the G4-series chips will graduate to 0.18-micron CMOS, which should enable clock speeds approaching 1 GHz (1000 MHz). Transistor counts will range as high as 50 mil-

lion—again, mostly cache, not logic.

Some G4 chips will be 32-bit, but most will probably be 64-bit. Users probably won't realize the full benefit of 64-bit architectures until OS vendors and applications developers rewrite their software to take advantage of the wider architectures. Even then, I/O-intensive applications such as databases probably stand to gain more performance than mainstream desktop applications.

Even the 32-bit versions of the G4-series processors will match or exceed the performance of Intel's 64-bit Merced, Motorola's Swearingin claims. G4 chips will be available in mainstream desktop systems immediately after introduction, he says. (Intel's pattern is to introduce a new x86 generation in servers and high-end workstation PCs, then phase in the lower-priced desktops later.)

Both IBM and Motorola maintain that the PowerPC will weather the 32- to 64-bit transition better than the x86. Intel's Merced will introduce a new architecture, known as IA-64, that almost certainly will require developers to recompile their software to get maximum performance (see "The x86 Gets Faster with Age," page 89). Although PowerPC developers face a similar transition, it may be a little smoother simply because the PowerPC carries less architectural baggage. For example, x86 users will expect a 64-bit x86 to be backward compatible with 16- and 32-bit software dating as far back as 1981, while the PowerPC started life as a modern 32-bit architecture in the 1990s. Of course, there's no way to verify any of these claims until the end of the decade.

continued



6 days ago you had important data.
3 days ago you had a power spike.

Now you have a problem.

Bad power can corrupt *all* the files on a UNIX system.

And that's not all. Power problems can also cause network and hard drive crashes, read/write errors, corruption or loss of data, faulty data transmissions, system lock-ups, premature failure of components and much more.

Best Power products are your answer. They *clean up dirty power* before it reaches your

equipment, which can reduce your computer and network downtime up to *80%** And if you have a blackout, they provide backup power to shut down your system correctly.

And now, every Best Power Single-Phase UPS comes with *free software*, providing power monitoring and unattended shutdown for your entire computing environment.

So call Best Power for your power protection answers.

1-800-469-4842

Ask for operator 298

E-mail: info@bestpower.com
Internet: <http://www.bestpower.com>
24-hour FAX information line at 1-800-487-6813.

*A five-year power quality study conducted by Best Power's National Power Laboratory showed that the number of calls for computer service dropped 82% after installation of a UPS.



Fortress® Uninterruptible Power Systems (Includes Free Software)

Visit us at COMDEX/Fall, Booth #S3570

©1996 Best Power. All Rights Reserved.



Circle 132 on Inquiry Card (RESELLERS: 133).

The Answer in Power Protection

In 2000 or 2001, IBM and Motorola plan to introduce their fifth-generation PowerPC series, code-named 2K. The alliance is saying very little about this long-range project. If process technology stays on track, the 2K series will premiere at 0.18 micron and the best fabs will be moving toward feature sizes of 0.15 micron or smaller. That should yield CPUs with as many as 100 million transistors and clock speeds exceeding 1 GHz. When combined with further architectural improvements, the result should be microprocessors that run at least 10 times faster than today's CPUs.

No MMX or Java

Neither IBM nor Motorola acknowledge any plans for additional multimedia support in the PowerPC architecture. Intel, of course, is adding 57 new MMX instructions for multimedia to the x86 architecture next year. Multimedia enhancements are less imperative for the PowerPC architecture, which already includes some RISC instructions that duplicate MMX instructions. BYTE's tests show that PowerPC chips have overall better integer performance than x86 chips, and there's no context-switching penalty when the PowerPC mixes multimedia with floating-point operations, as there is with MMX. IBM and Motorola argue that the architecture of the whole system, not just the CPU, is the most important factor in multimedia performance.

Up to now, the vast majority of PowerPC-based systems have been Power Macs. Next year, however, PowerPC systems will undergo a major transition to the new PowerPC Platform. This is the system architecture for all future Power-

Exponential's Bid to Beat the Pack

Exponential Technology, a start-up company based in Silicon Valley, stands a good chance of breaking the 300-MHz barrier before the big names in the PowerPC alliance. Exponential is pinning its hopes on bipolar transistors, which can switch states much faster than conventional CMOS transistors; faster switching means higher clock speeds. Exponential's PowerPC 604-compatible chip (blessed with licenses from IBM and Motorola) uses bipolar transistors for almost all the logic, or about 40 percent of the chip's circuitry. The remaining 60 percent of the transistors are CMOS, mostly in the SRAM caches.

This radical new processor is on schedule to ship in the first half of 1997, the company says. Exponential estimates peg initial clock speeds at 300 to 400 MHz, with 500 MHz a possibility by the end of next year (see "Watch Out: 500-MHz PowerPCs Planned for 1997," May BYTE, page 40).

Even more intriguing is a little-known U.S. patent Exponential won last January. Exponential won't talk about the patent, but it covers a technique for sharing a CPU's

registers between two different instruction sets. This seems to indicate that Exponential is working on some kind of emulation technology. Could this be the spiritual descendant of IBM's PowerPC 615, which was supposed to run x86 software at native speeds? Sources say the 615 project is dead, but maybe Exponential is taking a different approach.

Another possibility is that Exponential is trying to integrate hardware support for 680x0 emulation in a PowerPC chip. Presumably the goal would be to run older Macintosh programs much faster than the software-based 680x0 emulator that Apple built into the Mac OS. (Apple is a major investor in Exponential.) This theory seems less likely because the most important Mac software has already been ported to the PowerPC, and a bipolar CPU that runs at 300 to 500 MHz wouldn't need hardware assistance to emulate 680x0 software faster than a 68040 could run it natively.

For an in-depth report on how Exponential plans to achieve this speed breakthrough, see our exclusive coverage next month.

PC systems, including Macs, Mac clones, and machines that run Windows NT and Unix. Although you might expect that a brand new system architecture would offer much better performance than the older x86-based PC architecture, it's not guaranteed. The PowerPC platform carries some baggage from both the existing PC architecture and the Mac because it's designed to work with industry standard PC components and Mac peripherals. It remains to be seen whether this baggage will compromise performance.

Likewise, it's too early to tell whether Java will become important enough to justify modifications to the PowerPC architecture. Sun is betting heavily on Java with a line of dedicated Java chips—but then, Sun invented Java. Another major chip vendor (which gave BYTE this information on a confidential basis) is planning to enhance its CPU architecture with new instructions that improve Java performance. Other chip makers are waiting to see if Java becomes a significant market force or fizzles out like a fad.

Turnaround: 1997?

Since the PowerPC alliance came together in 1991, it has largely kept its promise to offer microprocessors at roughly twice

the price/performance ratio of Intel's x86—in other words, twice the performance at a comparable price, or comparable performance at half the price. But the alliance has failed to even dent the x86's overwhelming market share.

Indeed, it's possible that the most significant impact of the PowerPC has been to prod Intel into accelerating its research and development. Ironically, Intel seemed to take the PowerPC more seriously than almost anyone else. As a result, the x86 is still highly competitive and far from obsolete. The PowerPC is the best-selling RISC architecture on the desktop, but almost all PowerPC systems are Power Macs, and Apple has less than 9 percent of the market.

The long-awaited PowerPC Platform is the best bet for a turnaround. After inexcusable delays, it's finally ready to open up the Mac clone market and provide a common hardware platform for multiple OSes. Although the PowerPC stands little chance of dethroning the x86, the alliance can at least do a better job of running in second place. **B**

Tom R. Halfhill is a BYTE senior editor based in San Mateo, California. You can reach him at thalfhill@bix.com.

WHERE TO FIND

Apple Computer
Cupertino, CA
(408) 996-1010
<http://www.apple.com>

IBM
Microelectronics
Fishkill, NY
(800) IBM-3333
askibm@www.ibm.com
<http://www.chips.ibm.com/products/ppc/index.html>

Exponential Technology
San Jose, CA
(408) 441-6050
fax: (408) 441-6051

info@exp.com
<http://www.exp.com>

Motorola Microprocessor Group
Austin, TX
(800) 845-MOTO
fax: (512) 244-9222
motorola@selectnet.com
<http://www.mot.com/SPS/General/chips.html>

PowerPC News
RimaTech
<http://www.rimatech.com/html/ppcnews.html>

The Pentium Pro
chip-based server
you can afford.

\$3799

DELL® POWEREDGE® 2100 SERVER

180MHz PENTIUM® PRO PROCESSOR

- ★ 32MB Error Correcting Code (ECC) EDO Memory (256MB Max)
- 256KB Integrated L2 Cache
- Integrated PCI Ultra/Wide SCSI-3 Controller
- ★ 2GB Fast/Wide SCSI-2 Hard Drive [7200RPM, 8ms] (12GB Max)
- 8X SCSI CD-ROM Drive
- ★ 3Com® 3C595 10/100 PCI Network Adapter
- ★ Intel® LANdesk Server Manager v2.5

- 6 Expansion Slots: 3 PCI, 3 EISA
- 6 Drive Bays: 3 External 5.25"/3 Internal 3.5"
- ★ Microsoft® Windows NT® Server included
- 3 Year Warranty¹ with 1 Year Next-Business-Day On-site² Service
- 24x7 Dedicated Server Hardware Tech Support
- ★ Upgrade to 64MB ECC EDO memory, add \$649.
- ★ Upgrade to a 4GB Fast/Wide SCSI-2 hard drive, add \$450.

Lease³: \$137/Mo.

Order Code #250020

**A NEW SERVER SO POWERFUL,
IT CAN ACTUALLY BRING
ITSELF IN UNDER BUDGET.**



Dell introduces a new Pentium Pro processor-based server built from the ground up for the network applications and high volume resource-sharing your business demands.

The 180MHz PowerEdge 2100 features Ultra/Wide SCSI-3 support for wickedly fast read/write to its 2GB hard drive (which you can expand to 12GB). It's loaded with 32MB

of high-speed ECC EDO memory which can be upgraded to a full 256MB. It also has Intel's LANdesk Server Manager v2.5. And it's Windows NT and Novell certified.

Best of all, it's backed by our award-winning on-site² service and 7 x 24 dedicated server tech support line. Call to order yours today. At a price like this you can't afford to wait.

DELL®

TO ORDER

800-726-3355

<http://www.dell.com>

Mon-Fri 7am-9pm CT • Sat 10am-6pm CT
Sun 12pm-5pm In Canada, call 800-233-1589

Keycode #01161

¹For a complete copy of our Guarantees or Limited Warranties, please write Dell USA L.P., 2214 W. Braker Lane, Suite D, Austin, TX 78758. ²Leasing arranged by Leasing Group, Inc. ³This on-site parts and labor service provided by Digital Equipment Corporation and is available in 29 metropolitan areas. *Prices and specifications valid in the U.S. only and subject to change without notice. Intel, the Intel Inside Pentium Pro logo and Pentium are registered trademarks and the Intel LANdesk logo is a trademark of Intel Corporation. Microsoft, Windows, Windows NT and the Windows NT logo are registered trademarks of Microsoft Corporation. ©1996 Dell Computer Corporation. All rights reserved.

GET REAL!

REAL-TIME COMPRESSION

REAL MPEG

REAL VALUE \$1,495*



MPEGator

Real-time MPEG 1
encoder board

**CALL
1-888-GET-MPEG**

Using Samsung's revolutionary **VIDEOFLOW™** chip set **MPEGator** captures and compresses your video and audio into MPEG 1 files in real-time. **MPEGator** utilizes all the advanced features of the MPEG compression standard to the fullest, and produces real MPEG streams with high quality IBP video frames and interleaved audio. **MPEGator** shatters the existing price structure of MPEG 1 compression boards. Yet, it offers more features such as preview during compression, accelerated

compression drivers for popular Windows® 95 nonlinear editors and animation programs, and even capture to an editable MPEG format. **MPEG** provides the best solution for a wealth of multimedia applications – video on the Internet, video presentations, Video CD creation, video conferencing, video e-mail, etc. **MPEGator** provides the best solution for making **MPEG**.



Darim
Darim Vision

Phone: (213) 637-1700 Fax: (213) 637-1705 <http://www.darvision.com/>

*USA list price for full version. Video only version available. Minimum system requirements: Pentium™ 90 with 16MB RAM, Windows® 95 operating system, one available PCI slot. All trademarks are properties of their respective owners. Specifications and prices subject to change without notice.

Circle 604 on Inquiry Card (RESELLERS: 605).

From LAN to WAN with ISDN

ISDN/LAN integration is sometimes complex, but the rewards are worth it.

By Jeffrey N. Fritz

Evangelists often tout the glamorous applications such as videoconferencing, real-time audio, and collaborative computing when they're preaching about the virtues of ISDN. But for many corporations, ISDN can be a cost-effective solution for linking LANs to remote sites and telecommuters, to enterprise networks, to business partners and clients, and to the Internet.

ISDN promises WAN connections that are up to 10 times faster than a 28.8-Kbps modem, call-setup times measured in milliseconds, costs that accrue only when using the digital pipe, flexible configurations, and near error-free transmissions. All this bodes well for integrating ISDN into LAN and WAN connections.

If you can get it at your location (and you probably can), ISDN can provide significantly enhanced remote LAN access. ISDN network equipment, once too pricey for the average user, has fallen into the affordable range. And while there has been some ambivalence from the telephone companies in setting ISDN rates, the general cost trend has been downward. ISDN/LAN integration benefits corporations, telecommuters, small office/home office workers, and Internet service providers. But all is not rosy when it comes to integrating ISDN into the LAN infrastructure.

Optimizing for ISDN

ISDN lines come in two flavors. The Basic Rate Interface (BRI) supports two 64-Kbps digital channels (called B channels) and one 16-bit D channel for carrying signaling and control information. The primary rate interface (PRI) uses a single D channel and 23 B channels (or 30 B channels in Europe). ISDN has

some notable advantages, especially when compared to analog phone lines, that make it ideal for the networked computing environment: It's digital, it supports both voice and data on a single line, and call-setup times are fast enough to make connections almost seamless.

Although ISDN can optimize WAN connections, its transmission speed of 64-Kbps is still meager when compared to the

native bandwidth of most corporate LANs. Therefore, it's vital to maximize the efficiency of the slower WAN connections. Most network devices come equipped with a variety of tools to overcome the lower bandwidth capacity of ISDN WAN links. Optimization strategies include combining ISDN B channels for additional bandwidth, filtering out unnecessary traffic from the WAN connection, and compressing data to achieve effective throughputs much greater than 128 Kbps. All these measures make the ISDN WAN perform more efficiently.

ISDN connections can be more economical than leased lines when WAN connectivity is intermittent, thanks to features such as networking on demand and bandwidth on demand (BOD). (For a comparison of current and future WAN technologies, see the chart

"Linking LANs: ISDN and Alternatives" on page 104NA 6.)

Unlike the case with a leased line, ISDN connection charges are based on usage, much like a standard phone call. When the ISDN line is not in use, you don't pay for it. To save money, many ISDN network devices are programmed to drop the WAN connection after a period of inactivity. Networking on demand keeps the call disconnected when there is no traffic for the network.

Much as networking on demand lets you pay for the con-

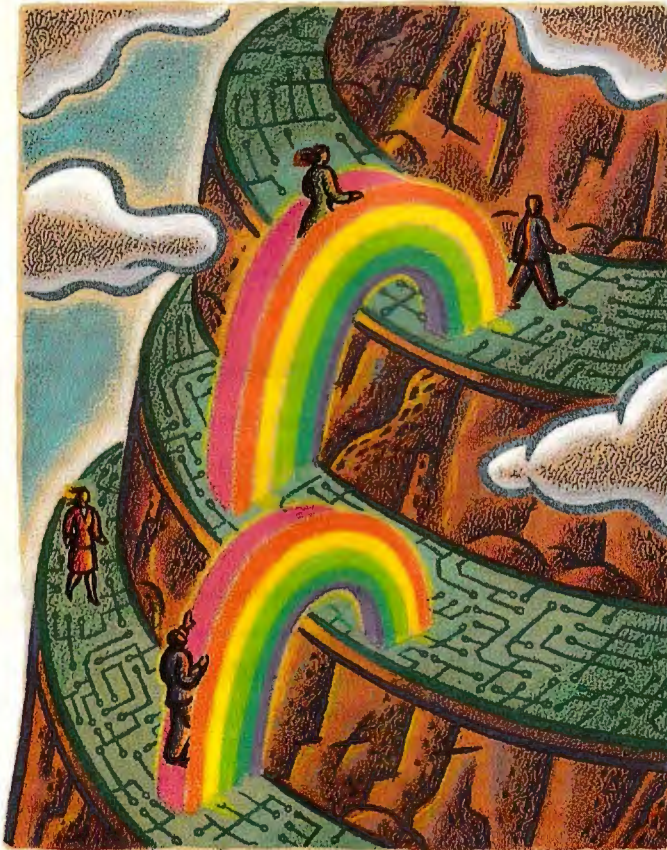

nection only when you need it, BOD lets you pay for bandwidth only as you need it. Not all network applications need the same bandwidth, and not all applications need the same bandwidth all the time. BOD can accommodate changes in WAN bandwidth requirements by aggregating multiple B channels into one faster virtual B channel. Depending on the device, bandwidth is usually scaled in 64-Kbps increments, called *N by 64*, all the way from 64 Kbps to T1 rates (1.544 Mbps). When traffic demands fall off, the additional channels can be dropped. If traffic picks up again, more channels can be allocated according to need. This channel flexibility makes WAN connections more cost-efficient than a dedicated line that incurs the cost for bandwidth whether it is used or not.

ISDN network devices that offer BOD generally do so by using the Multilink Point-to-Point Protocol (MP). MP can allocate and deallocate up to six B channels at once on-the-fly. MP negotiates channels rapidly, making it ideal for the bursty nature of network applications.

Compression Varies

Compression increases the apparent bandwidth of a WAN connection by reducing the size of the data files traversing the pipe. However, unless network devices support the same compression suites, the connection will come up without compression. That can slow down the WAN link considerably.

Compression figures are partially determined by file type. Ordinary text (ASCII) files compress well, binary files not so well, and precompressed files poorly. If a vendor measures compression strictly with text files, it will get a very high compression ratio. Another vendor, using the same compression algorithm with a mix of text, precompressed, and binary files, will report a much lower and probably more realistic number. Networks generally have a combination of all three file types traveling across the wires. So when you hear throughput numbers based on compression schemes, be wary. Try to find out the data mix used to devise the throughput numbers.

Most ISDN network devices, working in the real world with a decent mix of file types, can deliver 3:1 compression. Typically, the measured bandwidth for a connection with two B channels is 95 to 105 Kbps. Therefore, with 3:1 compression,

the real WAN throughput would generally be about 315 Kbps. While not 10 Mbps, this is respectable throughput—more than 10 times greater than that offered by a 28.8-Kbps modem.

Hardware and Software

If you have ever configured a bridge or router, you should have no difficulty handling most ISDN network devices. However, there are issues to keep in mind when

ISDN line. These devices are offered in both internal and external configurations, but keep in mind that the serial port's 115.2-Kbps data rate will become a bottleneck on an aggregated ISDN connection (128-Kbps or better). If you have remote PCs that need to hook into your LAN via ISDN, they will each need a terminal adapter installed. Major manufacturers such as Motorola, 3Com, and US Robotics now offer terminal adapters for

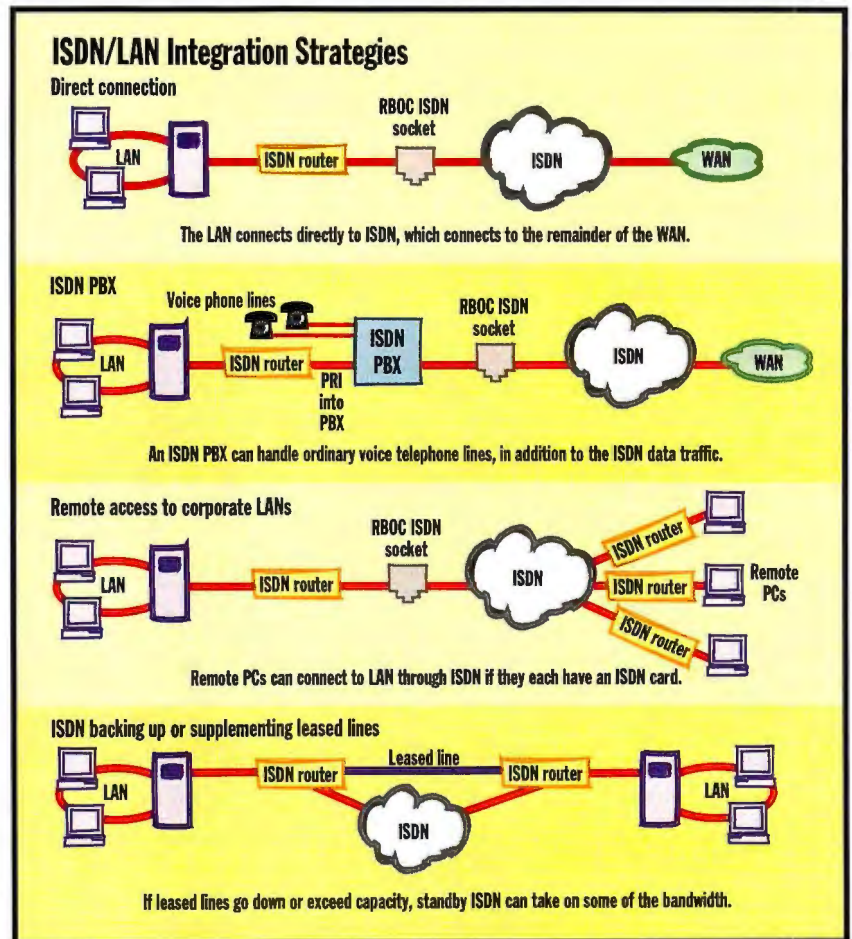

You can implement ISDN in a variety of ways to accommodate your communications equipment and applications.

integrating ISDN with LANs (see the figure "ISDN/LAN Integration Strategies" above). Configuring an ISDN bridge, for example, includes setting parameters for switch type, ISDN type, callback (on or off), compression, protocol filters, and security for remote access.

Hardware components in the ISDN/LAN equation include terminal adapters (TAs), ISDN bridges and routers, remote-access servers, and ISDN PC Cards. The TA connects your PC into the

an average cost of about \$500.

Most ISDN/LAN solutions use routers to direct traffic across the LAN/WAN link. Simple bridges do not always support the type of filtering required for network-on-demand configurations. ISDN routers usually support Ethernet connections to the LAN and a BRI or PRI port for the ISDN link. BRI routers cost \$1000 to \$1500.

If you're using ISDN to support telecommuters or other mobile workers, you'll need to consider remote-access

Highest Speed.



14.4 Kbps



28.8 Kbps



ISDN 128 Kbps

Lowest Price.



Get into the World Wide Web at breakneck speed without breaking the bank. Introducing Cardinal's new ISDN terminal adapter. With data transfer at rates up to 5 times faster than your 28.8 modem, it offers the performance you need at the low cost you want. With the Cardinal ISDN you can

move data at a maximum rate of 128Kbps, and getting an ISDN line installed is simplified with the enclosed  documentation. So get up to speed with the newest technology. Stop by your nearest Cardinal dealer or call 1-800-775-0899 ext. 667 for more information today.



Cardinal[®]
a member of THE PAUL ALLEN GROUP

™/® - these trademarks are the property of their registered owners.

<http://www.cardtech.com/>

Circle 603 on Inquiry Card.

solutions. Remote-access products from vendors such as Shiva, Microcom, and Gandalf now support ISDN. Remote-access servers with up to eight BRI ports range from \$7000 to \$10,000. Many models also support standard analog connections, so users well-served by your current analog solution won't have to upgrade right away. Of course, most telecommuters and mobile users carry portable computers, so they'll need an external TA or, better yet, an ISDN PC Card. Current PC Cards such as the IBM WaveRunner are somewhat bulky solutions because the required network terminator is not built in, but that should change soon as vendors ship cards with integrated network terminators.

Client Concerns

Whenever you add clients to a network, you've got to handle the assignment of network addresses, particularly for TCP/IP. With some protocols, such as IPX/SPX or AppleTalk, assigning addresses is semiautomatic. But for TCP/IP, you've got to do it manually with static addresses or dynamically through protocols such as Dynamic Host Configuration Protocol (DHCP) or Bootstrap Protocol (BootP). The point is that remote IP clients must be given an appropriate network address and subnet mask whenever they are connected to the enterprise IP network or the Internet.

Typical Configuration of an ISDN Bridge

Configuration parameters:

- Switch type 5ESS ← Set-up for an AT&T 5ESS custom switch
- ISDN type Custom
- Callback OFF ← Callback of remote user is turned off.
- Line speed 64K/line
- Protocol COMPRESSED ← Compression is turned on.
- Address age time 1000 ← Toss out addresses older than 1000 seconds.
- Connection type Auto On ← Automatically call the remote device.
- Packet timeout OFF
- Retry delay 30 ← If call is unsuccessful, try calling the remote every 30 seconds.
- Called number 2935555 ← Remote bridge phone number
- Ringback number

Security parameters:

- Access status ON ← Remote access of device for configuration is turned on.
- Client password Exists
- Callback security None
- Remote configuration PROTECTED ← Device configuration is password protected.

Protocol filtering:

- 0806 ACCEPT ← Pass these Ethernet protocol types to the WAN, filter all other protocols.
- 809b ACCEPT ←
- 80f3 ACCEPT ←
- Type forwarding mode is ONLY
- Type demand mode is ANY
- Number of Ethernet addresses: 20 ← Bridge has learned 20 Ethernet addresses.

Network administrators need to use parameters specific to ISDN services in order to configure bridges properly.

Additionally, whenever a client, remote or not, comes on the network, the network topology changes. This can be particularly tricky with network-on-demand connections that are dropped during inactivity. This capability can cause

problems for hosts and network protocols that may be looking for the disconnected remote client. On a client/server network, acknowledgment packets are often sent between nodes, even when the nodes are not sending live data. The

Linking LANs: ISDN and Alternatives

	Billing Structure	Strengths	Weaknesses
Current Technologies			
Leased Lines	Fixed rental by speed and distance	Cheap for constant, high-volume access	Too costly for occasional use
X.25	By speed, call duration, data volume	Good for interactive applications	Data volume charge costly for file transfer
Analog Dial-up Services	Same as telephone calls	Okay for short, nonrecurring communications	Low speed, iffy quality, long call setup; poor security
ISDN	By call duration, time of day, distance, per call	Cheap file transfer, cheaper than leased line for occasional use, easy to add more sites and bandwidth	Can be hard to order and set up, not available in some areas
Future Technologies			
Broadcast Satellite	Monthly charge for unlimited usage	Very low cost after initial investment (excellent for Web)	Inbound data only
Cable Modems	Purchase cable modem, setup and monthly rates	High bandwidth, low investment, cable probably already installed	Regulatory red tape, devices not yet widespread
Asymmetrical Digital Subscriber Line	Still in trial mode (no pricing yet)	High downstream bandwidth, works over regular phone lines	Modest to low upstream bandwidth, not ready for prime time



Simple
solutions...

...for global
communications.



NewCom brings you together.

You're in New York. Your design team is in Tokyo. With remarkable Digital Simultaneous Voice Data modems (DSVD) an ordinary analog phone line is all you need to collaborate. No expensive ISDN or T-1 lines needed, no quirky, hybrid modems; it's easily configured. Talk and send/receive data at the same time. Duplex technology makes voices from halfway around the world sound like they're next door. And NewCom quality modem design speeds your data at rates up to 28,800 Kbps.

The NewTalk 2000 family of DSVD modems for embedded applications responds instantly to the

demands of virtually all applications, from spreadsheets to word processing, from page design to multi-media. And at the end of the day, use NewTalk's remote gaming applications for remarkably lifelike game play with competitors on all parts of the globe.

NewCom also manufactures superior full duplex Speakerphone, Voicemail and Data/Fax modems for PC's in a configuration that's just right for your business or home.

Call 1-800-5NewCom.



NEWCOM™

Your.lift.2.the.info.superhwy.

NewCom, Inc., a subsidiary of Aura Systems, Inc. • 31166 Via Colinas, Westlake Village, CA 91362 Tel (818) 597-3200 • Fax (818) 597-3210
<http://www.newcominc.com>

Circle 610 on Inquiry Card (RESELLERS: 611).

packets can trigger a connection when one is not needed, which incurs additional costs. Different methods of spoofing fool the network by acknowledging the LAN packets locally, as if the WAN connection were still active. Spoofing can save significant costs by preventing unnecessary connections.

It's important to minimize superfluous traffic on the WAN. Typically this is done with address and protocol filtering. You can block unwanted protocols from the WAN link with intelligent filtering. You can also block WAN traffic to selected addresses. This is a key requirement, particularly when chatty protocols that may be on the enterprise network do not need to cross the ISDN WAN.

Hard to Order

An unfortunate problem that has plagued ISDN implementation since its inception is its burdensome ordering process. Although strides have been made in simplifying ordering and configuration of ISDN lines and equipment, the technology itself is complex, and some of the configuration details reflect this complexity.

One of the most confusing parts in integrating ISDN with LANs is in configuring the ISDN network device. Of all the parameters that must be entered, by far the most mystifying is the service profile identifier, or SPID. The SPID is used to identify the ISDN device to the ISDN network, much like an Ethernet address identifies a computer's network interface card. Without the SPID, which looks like a telephone number with a bunch of extra digits thrown in, the ISDN device simply will not work on most lines.

SPIDs are tricky because they vary from ISDN switch to ISDN switch. For example, some switches require a single SPID for both B channels in a BRI configuration. Other switches may want different SPID numbers assigned to each channel. The SPID itself can vary in format depending on what the switch expects. To make matters even more confusing, some switches do not require a SPID at all.

There is hope that SPIDs will soon be made a little easier. The North American ISDN Users' Forum, along with a number of switch vendors including Lucent Technologies, Nortel, Siemens, and Ericsson, has proposed the Generic SPID Specification. Basically, the Generic SPID replaces the horrendously wide variations in format with one common SPID format

The Generic SPID Format Looks Like:

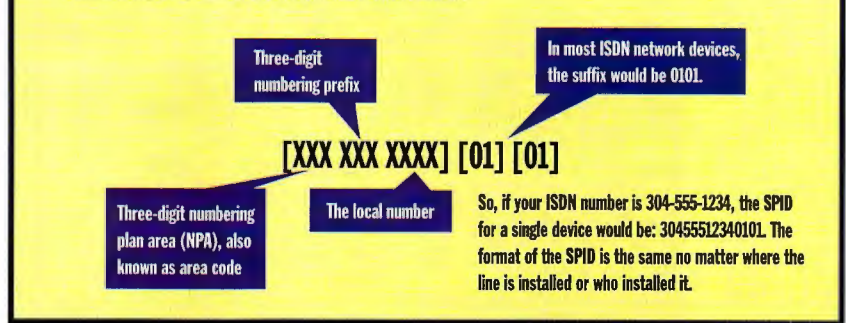

The service profile identifier, or SPID, looks like a phone number, but its job is to identify the ISDN device for the ISDN network.

for all new ISDN installations. This format is similar to an ordinary phone number, with a three-digit area code (the numbering plan area, or NPA) followed by a three-digit prefix and four-digit local number, but with a four-digit suffix (usually 0101) tacked on.

Getting Up to ISDN Speed

Inside your local telephone building sit the multimillion-dollar digital switches that are owned by the phone company. Until now, you probably could not care less about them. But with ISDN you are expected to know what switch is in your serving office, which software version it is running, and what form of ISDN (Custom or National) it is offering. You need this information to properly configure your ISDN network devices.

To configure a typical ISDN router, for example, you need to know how standard items like filtering, compression, callback, and security are handled. On top of that, the device configuration might also call for switch parameters such as line speed, switch type, and ISDN type. Without this information, which you must glean from your local phone company, the device probably won't work.

And don't assume that your network equipment is compatible with the local ISDN switch unless your vendor specifically says it is. While much of today's ISDN network equipment is designed to work with a variety of ISDN switches, there are still a few devices that are designed to operate only with a specific switch. These devices, when operated on an incompatible switch, either work poorly or not at all.

The good news for users is that

National ISDN, a highly interoperable form of ISDN, is now becoming widely available. Currently, there are three National ISDN versions: NI-1, NI-2, and NI-95. Most NI-1 devices will work with virtually any NI-equipped switch, usually without a lot of difficulty.

No matter what version you choose, ordering and configuring ISDN is still complex. Fortunately, once you get beyond the up-front hassles, you'll appreciate the payoff. ISDN brings powerful features to the LAN/WAN environment:

- High-quality digital lines reduce errors during data transmission.
- Bandwidth on demand and network on demand save significant costs over a leased line for intermittent LAN-to-LAN or LAN-to-WAN connectivity.
- ISDN is very flexible, especially when compared to a leased line, allowing you to establish alternate connections quickly and transparently with other ISDN-enabled sites.
- Dial-up and call connection are fast and transparent.

The bottom line is that ISDN/LAN integration extends your LAN out to the world in an efficient, cost-effective way. Plus, remote users will love their enhanced connections. **B**

Jeffrey Fritz is responsible for the operations of West Virginia University's data networks. He is chair emeritus of the North American ISDN Users' Forum Enterprise Network Data Interconnectivity Family. Fritz is author of Remote LAN Access: A Guide for Networkers and the Rest of Us and Sensible ISDN Data Applications. You can reach him at jfritz@wvu.edu.

Inside the NC

*Are network computers just stripped-down terminals? No way.
The official NC platform definition covers everything from a set-top box to a Cray.*

By Peter Wayner

Be suspicious when someone denounces network computers as being just dumb terminals: Either they don't know what they're talking about, or they're hoping you don't.

A network computer may indeed be a dumb terminal. It may even be a dumb terminal that runs Windows and applications faster than your PC does. Or it could be a conventional PC or Macintosh. It could be an under-\$500 TV set-top box or a million-dollar Cray supercomputer. It could be a desktop system tethered to a LAN or even a mobile notebook computer with a modem. A network computer can be any of these things because it's a unique platform that doesn't specify the type of hardware, CPU, or OS it sits on. Instead, it defines an open client model centered around familiar Internet standards and Java.

If this description of a network computer conflicts with what you've heard elsewhere, keep in mind that some people (and companies) who apparently feel threatened by this computing model appear to be spreading disinformation. Other sources are merely uninformed. Most of all, many companies today toss around the term "network computer" rather loosely, along with other terms such as Internet appliance, Web PC, browser box, and net-top box (see "Inside the Web PC," March BYTE cover story).

"Network computer" can be used as a generic term like "personal computer" or "PC." It can also refer to a specific platform standard, just as "PC" often refers to the standard originated by IBM with its Personal Computer in 1981. This article examines the specific network computer platform defined by a loose alliance of companies led by Oracle, Sun Microsystems, IBM, Apple, and Netscape. In fact, Oracle has trademarked the names "Network Computer" and "NC" and has spun off a new company called Network Computer Inc. This group's official NC

standard encompasses a wide variety of computing devices for business, education, and home markets.

Defining the Standard

Oracle's vision has two parts. First is the NC Reference Profile. Only computers that offer all the features in the profile can wear the designation "NC." A test suite of Java applets and documents will allow any manufacturer to verify compliance and earn the

designation. Numerous hardware and software companies are supporting this profile. (See "What It Takes to Make a Network Computer," page 108.)

In addition, Oracle's Network Computer subsidiary is developing and marketing a software package called the Oracle NC System Software Suite. It includes a microkernel OS known as NCOS, Sun's Java application environment, a Java-enabled Web browser, Macromedia's Director player, Oracle's Media Objects player, and additional software. A company that wants to sell an NC with a minimum of fuss could simply license this suite from Oracle and ship it along with the NC-compliant hardware (see "Oracle NC System Software Suite," page 108).

The NC Reference Profile is not a radical document. It's just a list of what

a system has to offer to make the cut. The Mac I'm using to write this article satisfies all the requirements because I've installed Eudora, Netscape Navigator, and Sun's Java Developer's Kit.

The NC basic hardware requirements are simple: a 640- by 480-pixel screen, a pointing device, some provision for text input, and audio output. A hard disk, floppy drive, or other form of persistent local storage is optional. There must be a network connection that can carry IP packets, but the channel is flexible: You can use an ordinary analog modem, a cable modem, a wireless modem, ISDN, or a LAN.

continued



The software requirements are equally conservative. NCs must communicate over a network using standard IP protocols: TCP, User Datagram Protocol (UDP), Dynamic Host Configuration Protocol (DHCP), Bootstrap Protocol (Bootp), and Simple Network Management Protocol (SNMP). If users store their data remotely, Sun's Network File System (NFS) will be the standard method for mounting remote drives. Optionally, NCs can support remote connections to other systems via FTP or Telnet, and they can establish secure connections via Secure Sockets Layer (SSL).

Some of these protocols are probably less familiar than others. UDP allows NFS to set up end-to-end application-specific communications. Bootp enables an NC to boot over a network. DHCP allows an NC to automatically acquire an IP address and send configuration data over the network when it boots. SNMP ensures that NCs will act like well-behaved clients on managed networks.

The key requirement in the profile is the ability to read and interpret Hypertext Markup Language (HTML) documents through the Hypertext Transfer Protocol (HTTP). In other words, the NC must run a Web browser. For now, the NC Reference Profile doesn't specify which version of HTML or which tags are required. To exchange e-mail, NCs will use a collection of well-understood mail protocols that dominate the Internet: Simple Mail Transfer Protocol (SMTP), Internet Message Access Protocol version 4 (IMAP4), and Post Office Protocol version 3 (POP3).

In addition, NCs must recognize the most common multimedia formats encountered on the Internet: JPEG and GIF graphics and WAV and AU audio files. Still to come are recommendations for sending output to printers.

Must Have Java

Perhaps the most fundamental requirement is that NCs must support the Java application environment, which includes the Java virtual machine (VM), the Java run-time interpreter, and the standard Java class libraries. There's nothing to prevent an NC from also running software written for Windows, MS-DOS, the Mac OS, Unix, OS/2, or any other OS. But at minimum, it must run Java.

In fact, there is no description of the OS layer at all in the NC Reference Pro-

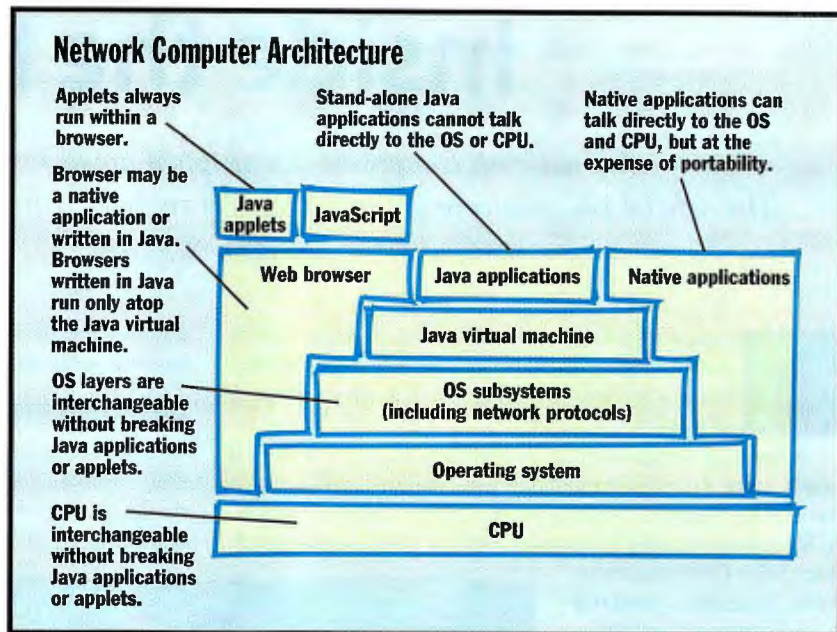

The Network Computer Reference Profile is based on an architecture not chained to specific hardware or operating system.

file. Theoretically, you could use CP/M or MVS if they supported the Java VM. In practice, however, there are some problems. For example, Java programs can be multithreaded, even though some OSes that support the Java VM are single-threaded. Currently, the behavior of multithreaded code varies from system to system because some OSes, like Windows 3.1, don't do a good job of supporting multiple threads. Others, like the Mac OS, do a reasonable job but don't offer preemptive switching with various priority levels. The best OS for an NC is one that offers full-fledged preemptive multithreading.

Above all, the OS must maintain a TCP/IP stack so the NC can communicate with the outside world. Other OS functions take a back seat—even file management and the user interface. In fact, there's no special GUI for an NC; in the absence of anything else, the Web browser can act as the GUI. If the user requests a file directory of a local or remote drive, the OS can format the directory listing into HTML and display it in the browser. (This isn't unique to NCs; some browsers on PCs already do this for FTP sessions, and Microsoft is adding optional browser views to Windows.)

Because the NC platform is neutral below the Java VM, an NC vendor can change the OS, the CPU, or just about anything else without affecting the user—if

the applications are written in Java. (See the figure "Network Computer Architecture" above.) Since Java is the only software guaranteed to run on all NCs, the success of the NC platform depends in large part on the success of Java.

Most Macs and PCs can hit the NC reference target with software you can get for free or little cost. Eudora Lite can handle the e-mail chores, and a free Web browser such as Microsoft's Internet Explorer can display HTML. Sun distributes free versions of its Java Development Kit that can execute Java applets. Some of these packages aren't full-featured, but you can purchase commercial versions at modest cost. In fact, the latest version of Netscape Navigator will handle both the HTML and e-mail requirements.

NC-Specific Hardware

NCs can be based on a wide variety of different processors and OSes, including some configurations optimized for low retail price and easy administration. For example, Oracle has an NC reference design whose parts cost less than \$300. (Oracle says it has no intention of manufacturing NCs; the reference design is for other vendors to use.) In corporate environments, the lower administration costs will be more important in the long run than the initial purchase price.

Most NCs will probably be desktop

Today,
millions
of people will experience
their worst nightmare.

They will lose presentations and reports to a computer crash.

They will blame their software or hardware when a power problem is really responsible.

Power problems can also cause network and hard drive crashes, read/write errors, corruption or loss of data, faulty data transmissions, system lockups, premature failure of components and much more.

Best Power products are your answer. They *clean up dirty power*, which can reduce your computer problems by up to **80%***. They also provide backup power to shutdown gracefully in a blackout.

And now, all Best Power Single-Phase UPSs come bundled with free software, providing power monitoring and automatic unattended shutdown for your system.

Don't take unnecessary risks. Call Best Power for your power protection answers.

1-800-469-4842

Ask for operator 299

E-mail: info@bestpower.com
Internet: <http://www.bestpower.com>
24-hour FAX information line at
1-800-487-6813.

* A five-year power quality study conducted by Best Power's National Power Laboratory showed that the number of calls for computer service dropped 82% after installation of a UPS.



Patriot® Plus Uninterruptible Power Systems
(Includes Free Software)

Visit us at COMDEX/Fall, Booth #S3570
©1996 Best Power. All Rights Reserved.



Circle 134 on Inquiry Card (RESELLERS: 135).

The Answer in Power Protection

What It Takes to Make a Network Computer

NC Reference Profile Requirements

- Java application environment (which includes the Java virtual machine, Java run-time interpreter, and standard Java class libraries)
- Text input capability
- Audio output
- Pointing device
- Minimum screen resolution: 640 by 480 pixels
- TCP/IP networking
- Simple Mail Transfer Protocol (SMTP), Internet Message Access Protocol v.4 (IMAP4), and Post Office Protocol v.3 (POP3) e-mail protocols
- SNMP for network manageability
- Ability to use the following file formats: HTML, JPEG, GIF, WAV, AU



NC specs are flexible enough to accommodate devices for office and home.

Oracle NC System Software Suite

All network computers built to Oracle's NC reference specifications will run NCOS and the NC System Software Suite without porting. The next version of the software

suite will include a portable OS capable of running on multiple hardware platforms, Oracle says.

NCOS is based largely on a multitasking OS from Acorn. Key features include antialiasing and dithering algorithms that make it possible to display high-quality text and graphics on lower-grade monitors and TVs. NCs can work with regular computer monitors, of course, but low-end devices for consumers may rely on a TV as the display device. The software must be compatible with GIF, GIF89a, JPEG, QuickTime, Indeo, AVI, WAV, AU, and Shockwave files.

The NC System Software Suite includes the following components:

- NCOS
- Web browser
- Macromedia Director player
- Oracle Media Objects player
- Oracle Interoffice suite, including e-mail, scheduling, and calendar functions, plus directory services
- Java virtual machine, with support for both streamlined Java applets and full-function, stand-alone Java applications
- NFS file services
- Network boot services (Bootp/DHCP)
- Support for Secure Sockets Layer (SSL)
- Smartcard authentication mechanism
- Support for streamed video

Optional Capabilities

- Secure Sockets Layer (SSL) for secure TCP/IP connections
- FTP if the NC has local storage
- Sun's Network File System (NFS) if the NC supports a distributed file system
- User Datagram Protocol (UDP) for application-specific, end-to-end connections under NFS
- Telnet (if the NC supports character-based console access to remote hosts)
- Bootstrap Protocol (Bootp) for booting the NC over a network
- Dynamic Host Configuration Protocol (DHCP) for network booting with automatic IP addressing and network configuration
- ISO 7816-standard smartcards
- Europay/MasterCard/Visa specifications

machines, but there's no reason why a mobile computer can't support the NC standard if it has occasional access to some sort of network. The NC standard does not require constant network connections. Mobile NCs will probably have some form of local storage to hold information between network sessions.

Some NCs will be set-top boxes that use a TV as the display device and connect to the Internet via a phone or cable modem. Just about all they need is a relatively fast CPU, a video controller, a network interface chip, and 4 to 8 MB of RAM. The latest home videogame machines from Nintendo, Sega, and Sony are more than powerful enough and cost less than \$300. The Nintendo 64 and Sony PlayStation have speedy CPUs based on the Mips R4000 and video capabilities that would put a \$2000 PC to shame.

Acorn, a major Oracle partner in the development of NCOS and the NC reference design, plans to introduce a low-cost NC this fall through a U.K. subsidiary, NChannel International. The NC will make its debut in the U.K. at an anticipated price of about £400 (approximately \$620). Acorn hopes to introduce a U.S. version a few months later that will sell for about \$400. Another company, NetChannel International, is planning to launch a consumer-oriented Internet service for NC users that would put a friendlier face on the Internet and the Web.

One of the most controversial features of the NC is the lack of local storage. This is completely optional, but there are good reasons to leave out the hard drive. The first is cost. Although prices have plunged, it's still difficult to buy drive mechanisms for less than \$75, and this can

add at least \$150 to the retail price. More important, local hard drives invite unskilled users to install untested software. This leads to the administration problems that plague PCs.

Some NCs will have local storage for caching purposes only. The OS and frequently used applications may reside on a local hard disk that's as transparent to users as a CPU cache. For longer-term storage of user files, these devices will rely on network servers.

For instance, Corel could sell its drawing software as Java applets that store their data on the same HTTP servers that offer the applets on the Web. If you create a drawing, you don't need to store it locally; you could store it on the Corel server. This frees users from the responsibility of creating backups. Of course, the downside is that moving large documents



FROM THE MAKERS OF CorelDRAW™

Precision 32-Bit 3D Solid Modeling

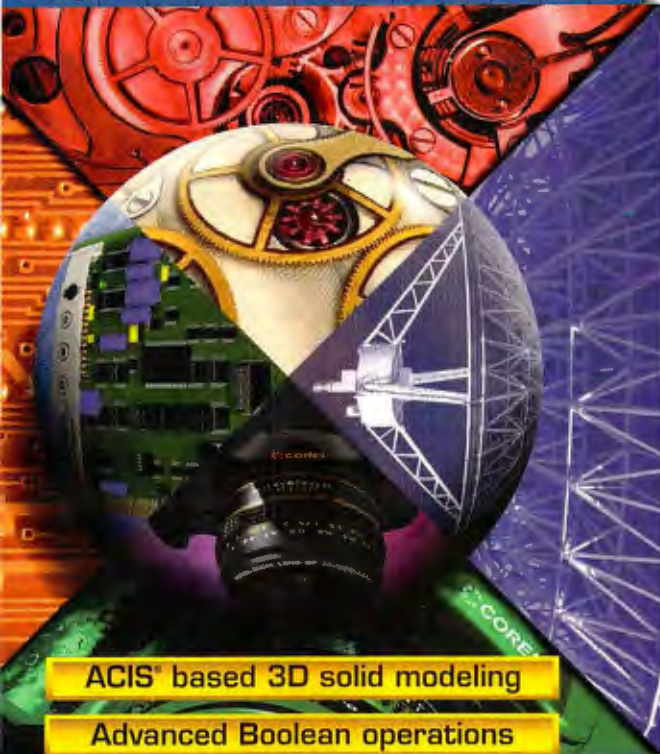

ACIS® based 3D solid modeling

Advanced Boolean operations

Realistic materials and rendering

Customizable user interface

Includes:

- CorelCAD™
- Corel Print Space™
- Corel DREAM 3D 6
- Corel MULTIMEDIA MANAGER™ 6
- Corel SCRIPT™

Plus:

- 7,000+ 2D drafting symbols
- 600+ 3D symbols
- 200+ house plans
- 750+ 3D models for Corel DREAM 3D 6
- 200+ Corel Professional Photos on CD-ROM backgrounds for Corel DREAM 3D 6
- 750 seamless bitmap files for Corel DREAM 3D 6
- 100 sample drawings
- 120 TrueType® fonts
- Corel House Select™
- CorelMEMO

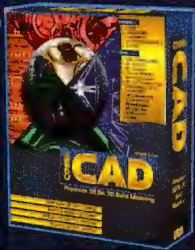

Corel and CorelCAD are either trademarks or registered trademarks of Corel Corporation in Canada, the United States and/or other countries. ACIS is a registered trademark of Spatial Technology, Inc. All other product and company names are trademarks or registered trademarks of their respective companies.



<http://www.corel.com>

COREL CAD™

For Windows® 95 and Windows NT™ CD-ROM Version

CorelCAD™ is a 32-bit design tool that allows easy, accurate modeling of real-world objects in 3D. A fully customizable interface and the industry-standard ACIS® solid modeling system will give you the flexibility to conceptualize, construct and revise product models and prototypes on the PC. Powerful Boolean operations, advanced blending, extrusions and 2D drafting features will help make your ideas a reality. Exceptional rendering capabilities let you view models with realistic shading and textures, while an extensive collection of symbols, models and utilities provide incredible value. Add a whole new dimension to all your design projects with CorelCAD!

Create logical groupings of your layers and display only the layers in that group.

View models in a Hidden Line view. Hidden lines can also be displayed as dotted lines.

Manage your drawing by using layers to control visibility, printability, color and locked status of each layer.

View list gives you quick access to predefined viewing angles, or create your own custom views.

Record commands and replay as a macro—ideal for automating repetitive tasks.

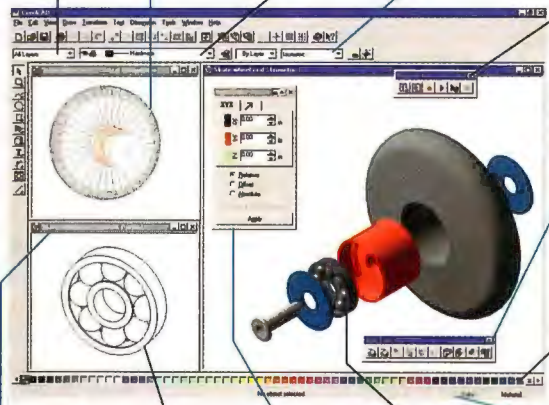

Customizable toolbars give you quick access to different tools.

Color palette gives you quick access to colors for your models.

Status line gives you information on the selected objects and step-by-step prompts to guide you through commands.

MDI support allows you to display different views of the same drawing or have several drawings open at the same time.

Render entire drawing, selected objects or portions of the screen.

Insert Point Roll-up allows you to place points precisely, using a Cartesian or Polar coordinate system.

Apply realistic material textures to your models, and render your models with up to 8 different light sources.

Corel Print Space™

Lay out your model drawings for printing by creating a viewport, placing your model, controlling the projection and rendering quality and scale of each viewport individually.

Create and format text for your printed drawing. Use tabs, bullets, automatic hyphenation, spell checker, Thesaurus and Type Assist.

Draw on your Corel Print Space™ layout using lines, curves, shapes and freehand drawing tools.

Add impact to your layout by adding color fills, shadows and outlines.

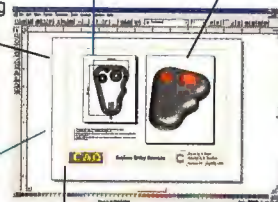

Insert objects from any OLE server.



From simple shapes, create intricate objects by using Boolean operations to add, subtract or intersect multiple objects. Project 2D shapes into 3D by using extrude or sweep.



MR-0219-US



\$584.98*
Full CD-ROM version

\$244.98*
Competitive upgrade CD-ROM version

1-800-258-2088

*US\$ plus applicable taxes and shipping.
Circle 139 on Inquiry Card.



Corel, Official World Title Sponsor of the COREL WTA TOUR

across the network consumes bandwidth. It's not the ideal client/server model if the files are large and the network connection is slow.

If the files are relatively small or if the connection is fast (for example, an Ethernet LAN or a broadband modem), a stripped-down NC coupled with a smart server could provide many of the functions of a traditional PC at a fraction of the cost. It's not really a new client/server model, but it does expand the definition of a client.

What's Missing?

The biggest problems in the NC concept are lack of compatibility with existing software and the slow speed at which the machines will run certain kinds of software. Backward compatibility isn't required by the reference specification, which leaves a Java-only NC at the mercy of Java. Simple solution: If the software you need hasn't been ported to Java, then don't buy a Java-only NC. Note that this doesn't prevent you from buying a so-called "thin client." You can still get relatively inexpensive and easily administered terminals that run Windows applications on a Windows NT server with Citrix multiuser software. Some of those terminals also meet the NC specification, so they're Java-ready.

Slowly executing software is another Java weakness. Java bytecode is interpreted, so it typically runs only 3 to 10 percent as fast as native code compiled in C. Just-in-time (JIT) compilers may soon



One of Oracle's four reference designs integrates a phone with an NC.

boost the performance of Java programs to about 50 percent the speed of native code. Still, there's a performance gap that may never be closed.

For some kinds of applications (word processing, Web browsing, database access, casual spreadsheet work), the difference may not be noticeable. For others (high-end image editing, graphics design, serious number-crunching, software development, games) the difference could be dramatic.

One solution is to take some well-designed APIs, such as Apple's QuickDraw 3D, and meld them into the Java class hierarchy. Java has a provision for classes compiled in native code, and this could provide significantly better performance. Of course, the native classes would have to be ported to different machines, but the cost might be worth the benefits.

Another solution is to optimize CPUs for Java. Sun is already working on Java-specific chips, and another chip vendor is planning to include Java optimizations in the next revision of its RISC instruction set. These chips are still in the testing stages, however (see "Sun Gambles on Java Chips," page 79).

In the meantime, the NC standard will evolve. The NC Reference Profile will undergo revisions as the partners become convinced that new technologies are popular enough and good enough to warrant making them part of the NC foundation, says Lu Kabir, vice president of worldwide sales for Network Computer Inc. In the future, video streaming and MPEG-2 decoding could allow an NC set-top box to replace a cable TV box. The NC standard will embrace Internet telephony in coming months, Kabir promises.

One of the most interesting (but cur-

rently optional) features of the NC specification is the ability to read ISO 7816-standard smartcards. These credit card-size devices contain a chip that can store personal information, such as bank balances or health records. They can also act as identification tokens because they can hold a public-key certificate. You could use an NC with a smartcard to download electronic cash or other types of secure information over the Internet.

Earning Respect

Moving forward from a collection of trademarks and buzzwords to a computing platform that earns respect in the marketplace is a hazardous endeavor that has defeated many seemingly good ideas. The NC spec makes a good start by building upon standards that already are commonplace. The ability to retrofit a PC as a makeshift NC provides an easy migration path for those who don't want to gamble on a very different kind of device.

But the NC concept also builds upon trends that are emerging with the development of the Internet. For some users, Web browsing and e-mail are major applications in their own right. Corporate intranets are beginning to challenge PC-centric networks and applications. Many databases are now accessible to Web browsers. Platform-independent productivity programs, such as word processors, are already under development.

The NC Reference Profile wisely avoids specifying an OS, CPU, and GUI. With technology in flux, setting a rigid standard is like trying to hit a moving target. The NC profile recognizes this and leaves them out of the picture.

Perhaps the biggest question is whether any force smaller than Microsoft can establish a new industry standard. Publicly, Microsoft still ridicules the concept of network computers. At the same time, Microsoft says it is committed to making all the software in the Windows realm capable of interacting with the Internet. Wintel PCs will soon meet the NC standard even though, for political reasons, they may never bear the trademarked name. ■

BYTE consulting editor Peter Wayner frequently writes about the Web and other Internet-related topics. You can reach him at pcw@access.digex.net or view his home page at <http://www.access.digex.net/~pcw/pcwpage.html>.

WHERE TO FIND

NC Reference Profile
http://192.86.154.91/nc_ref_profile.html

NC System Software Suite
<http://www.oracle.com/products/nc>

Acorn
Cambridge, England
<http://www.acorn.com.uk/anc>

Apple Computer
Cupertino, CA
<http://www.pippin.apple.com>

IBM
Armonk, NY
<http://www.internet.ibm.com>

NChannel International
Cambridge, England
<http://www.nchannel.com>

NetChannel
Palo Alto, CA
<http://www.netchannel1.com/index.html>

Netscape
Mountain View, CA
<http://home.netscape.com>

Oracle
Redwood Shores, CA
<http://www.oracle.com>

Sun Microsystems
Mountain View, CA
<http://www.sun.com>

While
you take

CheckUPS II

30 minutes

for a sandwich,

a blackout eats your
network for lunch.

Every Best Power
Single-Phase UPS
comes bundled with free
unattended-shutdown
and monitoring software.

What happens if you're away
from the office when an out-
age hits, even with a UPS?

Best Power unattended-
shutdown software is the
answer. In a power emer-
gency, it can page or

e-mail you, notify users of
impending shutdown, close
your system properly and
allow remote monitoring.

Plus, it's completely free.
Many UPS makers will tell
you their software's free
and just raise their prices.
But Best Power bundles **free**
software on CD-ROM with
every Single-Phase UPS, or
you can download it from
the Internet.

So when you leave your com-
puter or network, leave it in
good hands. Protect it with
Best Power's free software.

Call Best Power for your
power protection answers.

1-800-469-4842

Ask for operator 300

E-mail: info@bestpower.com
Internet: <http://www.bestpower.com>
24-hour FAX information line at
1-800-487-6813.



Fortress® Uninterruptible Power Systems
(Includes Free Software)

Visit us at COMDEX/Fall, Booth #S3570
©1996 Best Power. All Rights Reserved.

**Best
Power**

The Answer in Power Protection

Circle 136 on Inquiry Card (RESELLERS: 137).

Eight Twin-Engine Pentium Pro Workstations

For compute-intensive applications, a second Pentium Pro chip can make the job go faster.
 By Maggi Bender,
 Dorothy Hudson, Jim Kane,
 and John McDonough

For 32-bit number-crunching and running technical applications under a 32-bit OS like Windows NT, the Pentium Pro is the Intel processor of choice. For some people, two Pentium Pros is an even better choice, either to run a multiprocessing NT application or to multitask—downloading from an FTP site or handling e-mail with one processor while you tie up the other with your heavy-hitter 32-bit application.

In this month's Hardware Lab Report, we take a look at eight 200-MHz dual-processor Pentium Pro workstations that will keep you from sitting on your thumbs. Our test subjects come from Dell Computer, Digital Equipment, IBM, Hewlett-Packard, Polywell Computers, SAG Electronics, and Xi Computer (which supplied two systems). These vendors are betting that NT will emerge soon as a prominent general business platform. The recent release of Windows NT 4.0, in particular, has increased interest in high-end Pentium Pro systems.

Built for 32 Bits

With one of these symmetric multi-processor (SMP) speed demons on your desk, you can take full advantage of both 16- and 32-bit applications simultaneously. Admittedly, the Pentium Pro processor isn't optimized for 16-bit DOS and Windows 3.x software, or even for the mixture of 16- and 32-bit code found in Windows 95. Such software is full of segment writes, partial register operations, unaligned data accesses, and instruction-prefix bytes that have stymied the Pentium Pro in previous BYTE tests.

However, you won't care if a Pentium Pro doesn't run 16-bit code much faster than a less expensive Pentium system for two reasons. First, the clock speed is high enough that you won't notice a slowdown with an older legacy application, particularly if it's running on its own private processor. Your performance-critical software will be 32-bit. Second, business software is starting to go 32-bit; many office suites are already there. The proliferation of Windows NT-optimized

Six of the eight systems have SCSI hard drives of various flavors, while the Dell and Xi systems have slower-spinning, but less expensive, Enhanced IDE (EIDE) drives. Five systems use a Matrox Millennium graphics adapter, two have a Number 9 Imagine 128 Series 2 adapter, and one has a Diamond Stealth 64 card—all PCI. Most systems include six- or eight-speed CD-ROM drives; the Hewlett-Packard Vectra XU 6/200 has a four-speed drive. (See the features table on pages 120 and 121 for details.)

Most of the systems use Intel's latest 82440FX Pentium Pro chip set, which supports fast extended data out (EDO) memory, Universal Serial Bus (USB), and dual concurrent PCI buses. HP and Polywell stayed with the older 82450KX Orion chip set. Six systems actually implement USB by providing ports. The Dell and HP workstations have none. The Digital, Polywell, and Xi systems have two ports.

The USB defines a standardized connector and socket for many types of peripherals (see the Tech Focus on page 116). Because you can daisy chain many peripherals to a single port, USB has the potential to eventually eliminate the number and kinds of connectors on the back of a typical PC. With USB-enabled PCs, users will also be able to hot-plug USB peripherals without rebooting their systems or having to deal with IRQ settings, DMA channels, and I/O addresses. With USB, you could connect up to 127 devices to a single PC. USB's 12-Mbps serial data rate provides ample throughput for low- and mid-bandwidth peripheral devices. With strong support from Microsoft,

BYTE BEST
 P E N T I U M P R O

Dell's OptiPlex GXpro 200
Digital's Personal Workstation 200i
Polywell's Poly P6-200ND2

These three systems offer the best combination of performance, features, usability, and good price.

applications isn't an adequate reason in itself to buy a dual-Pentium Pro workstation, but it helps.

The desktop, mini-tower, and tower systems we review range in price from \$4700 to \$9200 as configured for testing: with 64 MB of system RAM, 2- to 9-GB hard drives, and 17-inch displays. The Dell, Digital, and SAG models came with integrated Ethernet, while HP provided an Ethernet card. In general, the vendors chose similar high-performance components in designing their dual-processor Pentium Pro systems. Only Dell went with the costly 512-KB-cache version of the Pentium Pro chip.

Typical Pentium Pro

POWER SUPPLY

Dual-processor Pentium Pro workhorses use lots of juice. A power supply in the 200-W to 300-W range is appropriate in most cases. A well-engineered system can get by with less.

DRIVE BAYS

The systems in a tower chassis—the SAG STF 3000, the Polywell Poly P6-200ND2, and the Xi Pro400 Ntower DP—provide more drive bays than the mini-tower and desktop systems.

EXPANSION SLOTS

A combination of PCI and ISA expansion slots matches the mix of 32- and 16-bit expansion cards you are likely to install in a system.

CD-ROM DRIVE

Most of the systems we tested have six-speed or eight-speed CD-ROM drives. Faster is better for installing development packages and reading on-line documentation.

DUAL CPU CHIPS

Most vendors place two Pentium Pro chips side-by-side in ZIF sockets on the motherboard, although the Dell OptiPlex GXpro 200 has one CPU on a riser card. To keep the CPUs from overheating, many vendors place a big heat sink and a cooling fan directly on top of the processors. HP takes the more sophisticated approach of directing airflow onto the CPUs from a larger, and perhaps more reliable, stand-alone fan blowing through plastic air conduits (not shown here).

HARD DISK

A SCSI hard drive provides the best performance for an NT workstation, even in single-drive configurations. Compared to EIDE, the disadvantage of SCSI command overhead is more than compensated for by the higher spin rates available with SCSI models.

MEMORY UPGRADE SLOTS

The Pentium Pro chip sets in these workstations support up to 1 GB of system memory, though only the Polywell and Xi systems can take that much. Half the test systems have SIMMs (shown here), and the others have newer DIMMs, which require half as many modules for a given capacity.

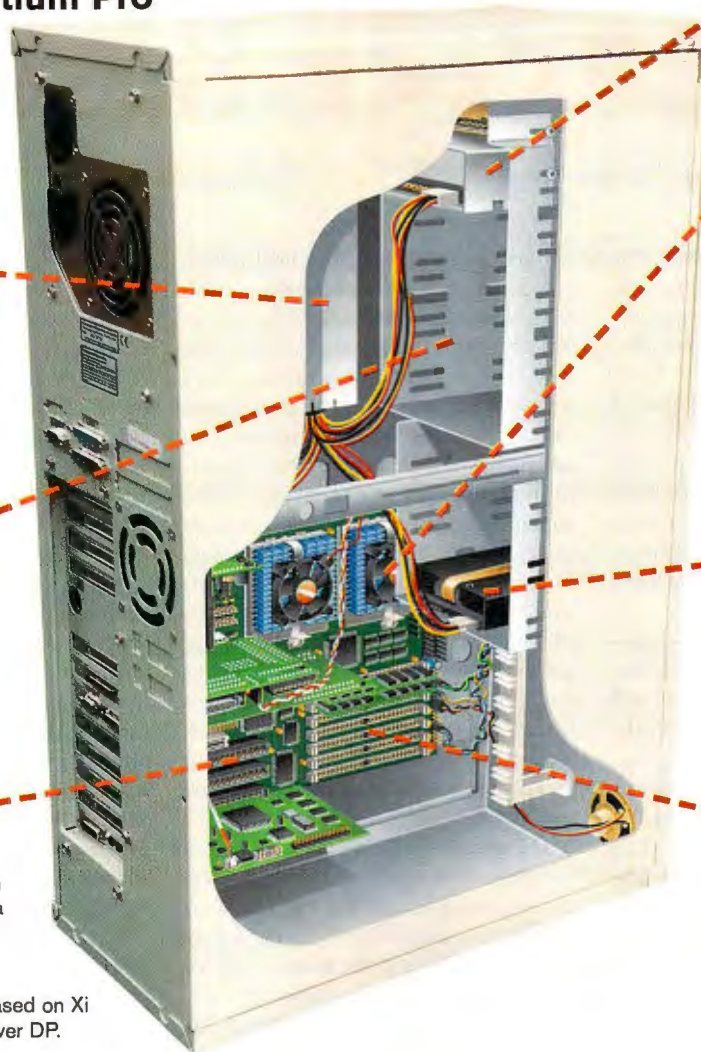

Illustration based on Xi Pro400 Ntower DP.

Intel, and big system vendors, USB is as inevitable as was PCI.

Tight Bunch

Although Windows NT 4.0 is the hot news, it was just out of beta when we were testing these systems, so we stuck with tried-and-true NT 3.51. Our suite of NT benchmarks shows that these systems provide unprecedented performance on the Intel x86 platform.

While the three fastest systems—Dell's OptiPlex GXpro 200, Digital's Personal Workstation 200i, and Polywell's Poly P6-200ND2—are benchmark burners, the remaining five models were right behind them. You won't notice speed differences among them when navigating through typical desktop applications. Though it wasn't the fastest overall, IBM's PC 365 performed best in the two benchmarks that test dual-processor efficiency (see Test Specs, page 119). The Dell took second.

Only one system lagged noticeably behind the others—Xi Computer's Pro400 Mtower DP—and that can be blamed on its EIDE hard drive. Xi's Pro400 Ntower DP, which had a high-rpm IBM Fast/Wide SCSI drive, ran right with the pack.

Who needs so much horsepower at their desk? Vendors' marketing plans give some idea. Hewlett-Packard aims its Vectra XU 6/200 at users who need enough computing force to create two-dimensional animation or to design electronic components with a package like AutoCAD. Polywell provides options for its Poly P6-200ND2 that let it serve as a CAD/CAM workstation, a SQL-based Internet server, or a video editing workstation. Dell sees its OptiPlex GXpro 200 as a number-crunching financial workstation. SAG Electronics offers the STF 3000 both as a workstation and, when configured with RAID 5 storage options using the Ultra-SCSI architecture, as a low-end network server; indeed, the SAG sys-

tem has many built-in server features such as temperature, fan speed, and voltage sensors, as well as the necessary software to report on problems these sensors find.

The systems we tested for this Lab Report were similar in their overall performance, mainly due to the commonality of architecture dictated by Intel's PCI chip sets. The small differences in speed are due mainly to the vendors' selections of hard drives and graphics cards. Given the narrow performance spread between these machines, we recommend that you pay more attention than usual to features, usability, and, of course, price.

Contributors

Jim Kane, Project Manager/NSTL
Dorothy Hudson, Project Manager/NSTL
John McDonough, Technical Writer/NSTL
Maggi Bender, Technical Analyst/NSTL
Dave Rowell, Senior Technical Editor/BYTE

Best Overall

P E N T I U M P R O W O R K S T A T I O N S

The eight dual-processor Pentium Pros we tested not only boast top-notch performance, they also provide a bridge to a future dominated by 32-bit applications. Loaded with 64 MB of RAM, they were all exceptionally fast in our benchmarks, with only small performance differences between them. Still, we had to pick winners in our two categories: Best Overall and High Performance. Tight scoring resulted in the same three-way tie in both categories.

Dell's OptiPlex GXpro 200 (\$6685)—a combined Best Overall and High Performance winner—differentiated itself by using Intel's most expensive CPU, the 200-MHz Pentium Pro with 512-KB cache. The big-cache chip helped it eke out a small lead in the performance testing, but at a cost of roughly \$1500 more than you'd pay for two Pentium Pros with 256-KB cache (also available). Like most of the other systems, the Dell uses Intel's 440FX Pentium Pro chip set.

Fast performance isn't the OptiPlex GXpro 200's only forte. It's tops in our

features category, too. The Dell system comes with integrated networking. It has 3Com's PCI Bus Mastering 3C59X Twisted Pair EtherLink III on the motherboard so you don't need a network interface card in one of your PCI slots. The test unit came with a 2-GB Seagate hard disk with an EIDE interface. EIDE drives are currently limited to 5400-rpm spin rates, which gives systems with 7200-rpm SCSI drives a slight performance advantage. The OptiPlex's other components include five drive bays, an eight-speed CD-ROM drive, a Number Nine Imagine 128 graphics card, and a Dell 17LS monitor. The small-footprint desktop chassis has a push-button removable cover, lever-locked expansion cards, and a hinged power supply, all of which helped the system's Usability score.

The second double winner is Polywell's Poly P6-200ND2. Its strengths are performance—particularly in the Excel/Word tests—and price. At \$5270, the Poly P6-200ND2 is one of the least expensive systems in this roundup. Polywell's machine could have scored even better if it

wasn't such a hassle to remove the chassis to get to the internal components.

Once inside the Poly P6-200ND2 you'll find plenty of room for expansion. The tower has six available expansion slots (two PCI and four ISA) and seven available drive bays for upgrades. The 4.3-GB Seagate ST15150W hard disk has a Fast/Wide SCSI-2 interface, but the S3-based Diamond Stealth 64-bit graphics card came with only 2 MB of DRAM.

Also tying for first place in both categories, Digital Equipment's Personal Workstation 200i (\$5834) had the best scores in our low-level InterMark performance tests, which stress the processor, hard disk, video, and CD-ROM components. The powerful mini-tower NT workstation arrived with a speedy 2-GB Seagate ST32550 Fast/Wide SCSI hard drive, a Matrox Millennium graphics adapter, and an eight-speed Toshiba CD-ROM drive.

The company markets the Personal Workstation 200i for graphics-intensive applications for mechanical CAD, digital content composition, and software engineering. Along these lines, Digital offers more capable 3-D graphics card options. The workstation sports innovative features such as two USB ports and integrated Ethernet (10Base-T/10Base-2) on the motherboard.

Best of the Rest

The IBM PC 365 (\$7081) provided unmatched speed in our CPU-intensive Fourier and Visual C++ benchmarks that challenge symmetrical dual-processing capabilities. We also found that it boots up Windows NT faster than any other system. IBM's desktop workstation features a Matrox Millennium graphics adapter with 4 MB of Window RAM (WRAM) that supports a 1600- by 1280-dpi screen resolution. The PC 365 has a 2.1-GB IBM hard disk with an Adaptec UltraSCSI PCI host adapter, and it has a six-speed CD-ROM drive.

IBM positions this system at the top of its desktop PC product line yet stresses the machine's network management

Dual-Processor Workstation Tests

The IBM PC 365 performed best overall with the two dual-processor tests. The Dell OptiPlex had the best C++ compilation time, while the Xi Pro400 Ntower did best with the Fourier analysis. Performance differences between the Xi Ntower and Mtower models are due to different hard drives (SCSI and EIDE, respectively). Both tests run two simultaneous instances of the test task.

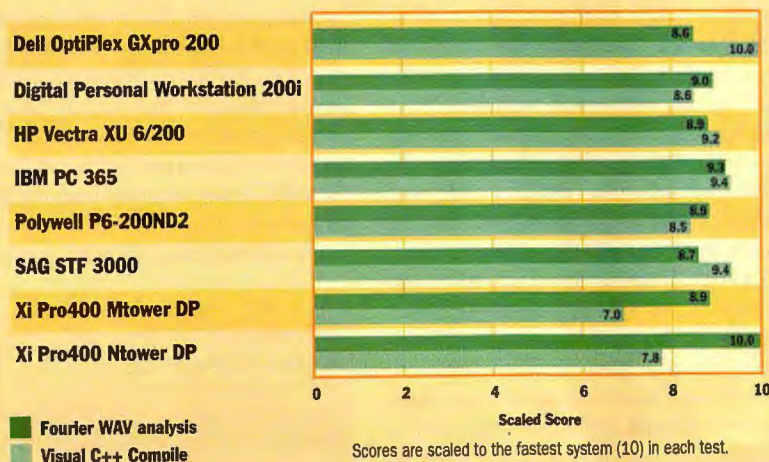

LAB RESULTS

W O R K S T A T I O N R A T I N G S

BEST OVERALL

Dell's OptiPlex GXpro 200, Digital's Personal Workstation 200i, and Polywell's Poly P6-200ND2

In a very tight race, the Dell, Digital, and Polywell workstations tied for first in Overall score. They are also the top three in our performance benchmarks. Dell's OptiPlex GXpro received the most impressive Features score thanks to important workstation ingredients like integrated networking and an eight-speed CD-ROM drive. A great performer, the roomy Poly P6-200ND2 also has one of the smallest price tags. Keep in mind that IBM and Xi (the Pro400 Ntower DP) were not far behind.

WEIGHTING

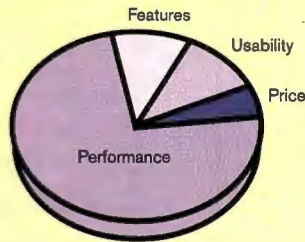

	PRICE	TECHNOLOGY	IMPLEMENTATION	PERFORMANCE	USABILITY	FEATURES	OVERALL RATING
Dell OptiPlex GXpro 200	\$6685	★★★★	★★★★	★★★★	★★★★	★★★★	★★★★
Polywell P6-200ND2	\$5270	★★★★	★★★★	★★★★	★★★	★★★★	★★★★
Digital Personal Workstation 200i	\$5834	★★★★	★★★★	★★★★	★★★	★★★★	★★★★
IBM PC 365	\$7081	★★★★	★★★★	★★★★	★★★★	★★★★	★★★★
Xi Pro400 Ntower DP	\$4788	★★★★	★★★★	★★★★	★★★★	★★★	★★★★
SAG STF 3000	\$5650	★★★★	★★★★	★★★★	★★★	★★★★	★★★★
HP Vectra XU 6/200	\$9206	★★★★	★★★★	★★★★	★★★★★	★★★	★★★★
Xi Pro400 Mtower DP	\$4688	★★★★	★★★	★★★	★★	★★★	★★★

HIGH PERFORMANCE

Dell's OptiPlex GXpro, Digital's Personal Workstation 200i, and Polywell's Poly P6-200ND2

As the top speedsters, these three systems performed within several hundredths of a point of each other. However, each excelled in a different test. The Dell OptiPlex took advantage of its large 512-KB L2 processor caches to get the high score in the dual-processor Visual C++ compiling benchmark. Digital's Personal Workstation 200i got the top score in the InterMark low-level test. Polywell's workstation finished far ahead in the Excel/Word application testing. Again, the other systems were not far behind. The IBM PC 365 had the highest combined score in the two dual-processor workstation tests, but it fared poorly in the less important Excel/Word tests.

WEIGHTING

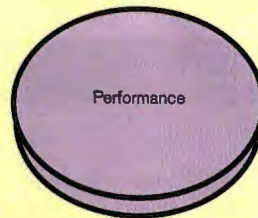

	PRICE	TECHNOLOGY	IMPLEMENTATION	PERFORMANCE	USABILITY	FEATURES	OVERALL RATING
Dell OptiPlex GXpro 200	\$6685	★★★★	★★★★	★★★★	★★★★	★★★★	★★★★
Polywell P6-200ND2	\$5270	★★★★	★★★★	★★★★	★★★	★★★★	★★★★
Digital Personal Workstation 200i	\$5834	★★★★	★★★★	★★★★	★★★	★★★★	★★★★
IBM PC 365	\$7081	★★★★	★★★★	★★★★	★★★★	★★★★	★★★★
SAG STF 3000	\$5650	★★★★	★★★★	★★★★	★★★	★★★★	★★★★
Xi Pro400 Ntower DP	\$4788	★★★★	★★★★	★★★★	★★★★	★★★	★★★★
HP Vectra XU 6/200	\$9206	★★★★	★★★★	★★★★	★★★★★	★★★	★★★★
Xi Pro400 Mtower DP	\$4688	★★★★	★★★	★★★	★★	★★★	★★★

★★★★★ Outstanding ★★★★ Very Good ★★★ Good ★★ Fair ★ Poor

capabilities. The box didn't come with a network card, but it does have Wake-on-LAN, IBM networking tools, and predictive-failure hard drive technology. Wake-on-LAN enables network managers to turn on unattended systems from anywhere on a local network. The system's USB port prepares users for the USB-based hardware

peripherals that will be arriving within the next year.

For those who can't afford to spend much more than \$4000 but still want power, the Xi Computer Xi Pro400 Ntower DP (\$4788), which scored very well in our tests, is a good bet. The tower system has plenty of room for expansion and fea-

tures top-notch components such as an eight-speed CD-ROM drive and a 2-GB Fast/Wide Seagate SCSI hard drive. At the other end of the price spectrum, Hewlett-Packard's well-engineered Vectra XU 6/200 was a cut above the rest in its Usability score, but it didn't stand out otherwise in this competitive field.

Designer's Choice

Kudos to the engineers at Dell and Hewlett-Packard for thoughtful system designs. Dell made its compact OptiPlex GXpro 200 (shown below) easy to service with a hinged power supply and expansion cards that lock in with a lever. Also easy to open, HP's Vectra XU 6/200 achieved our highest Usability score with features like accessible DIMM slots near the top of its mini-tower chassis.

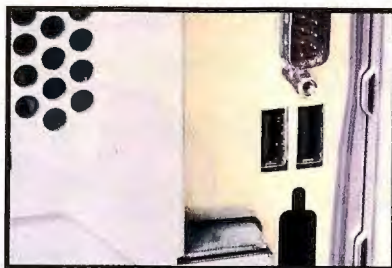

Betting Twice on USB

Digital believes Universal Serial Bus (USB) peripherals will become widely available in the next six to nine months and that you'll want both of the USB ports incorporated in the Personal Workstation 200i. You'll likely use one port to daisy chain the keyboard and mouse in front of the system, the other for peripherals like scanners and printers that cable out from the side or rear. Systems from Polywell and Xi also have dual USB ports.

Down to Three

Most of the systems we tested use Intel's new Pentium Pro chip set, the 440FX PCIset. For workstations, it provides performance efficiencies by reducing the chip count to three (from the seven chips of Intel's Orion sets), supporting EDO memory, and allowing its dual PCI buses to work concurrently.

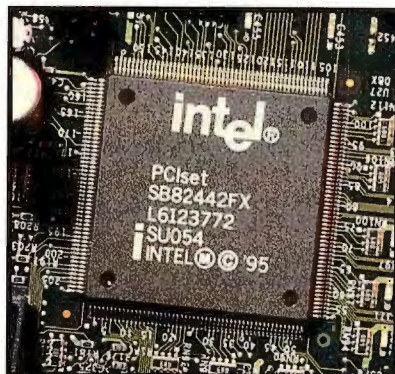

TECH FOCUS

PERIPHERAL INTERFACE

Let's Make It Universal

Though it has been on the boards for a while, the catchall Universal Serial Bus (USB) interface is working its way into mainstream desktop computers. The USB standard, sanctioned by Intel and Microsoft and strongly backed by major vendors like IBM, Digital, Compaq, and NEC, will arrive more quickly than did PCI. IBM introduced the first two business PCs with a USB port last summer; Compaq, Siemens Nixdorf, and Sony have, too. Six systems in this Lab Report, including the IBM, provide USB ports. The Digital, Polywell, and Xi have two. Microsoft is preparing Windows drivers, and Intel has developed USB device chips as well as USB support in its latest CPU chip sets.

Like the Apple Desktop Bus (ADB), USB lets you daisy chain peripherals like keyboards and pointing devices into a single port. With its 12-Mbps serial transfer rate, however, USB has enough bandwidth to support printers, scanners, ISDN terminal adapters, and telephony devices, including T1 or E1 lines. (The telephony angle explains Nortel's strong backing of USB.)

USB's convenient bus topology is actually more of a staggered star topology than a chain. Hubs that provide seven USB ports can be chained together with 5 meters between hubs to support as many as 127 USB devices from one host system. The four-line USB cable has two lines to carry differential serial signals, one for ground and a +5-V power line, which largely eliminates the need for power bricks for many peripheral devices. The spec defines three classes of device: low

power, bus-powered (100-mA maximum current draw); high power, bus-powered (500-mA maximum); and self-powered. USB devices like scanners and printers will obviously have their own power supplies but could use the USB power to exit power-saving states. The cabling is shielded twisted pair to support the 12-Mbps signaling rate. The spec allows a limited number of low-speed, 1.5-Mbps devices.

You will be able to hot-plug and unplug these devices, and they will automatically register with the host operating system in true Plug and Play manner. Not only is the USB topology LAN-like; its signaling protocols are, too. USB has abstraction layers similar to the first three levels of the Open Systems Interconnection (OSI) protocol stack. USB sets up point-to-point connections, termed pipes, between an application or USB driver program and a USB device on the bus. At the physical hardware level, the host controller (always the initiator) and the USB device send and receive serial signals on the bus. At the middle level, USB system software and a particular device send each other framed data. At the top level, an application talks to one of the device interfaces that a USB device can present.

The upshot is that you'll be able to easily attach external peripherals to a PC without rebooting, without confronting a confusing array of ports, and without having to deal with IRQ settings, DMA channels, and I/O addresses. Bring on those USB peripherals.

—Dave Rowell

RUGGED PORTABLES WITH LOTS OF SLOTS

Dolch Computer Systems builds portable computers for industrial and military applications that must withstand the rigors of rough treatment and harsh environments — demanding massive expansion capability and the performance of a high-end desktop.

GRIT, GRIME AND WATER PROOF

Dolch builds the world's toughest portables for sophisticated military and industrial users.

- Tested to Military and NEMA Standards — Shock to 50Gs
- Completely Sealed Systems — NotePAC™ Runs in the Rain
- Add-in Protection — Unique Card Retention System

MASSIVE EXPANSION

The PAC™, L-PAC™ (Light-PAC) and NotePAC families offer a wide variety of slot and drive specifications. Systems can be tailored to precisely match the application requirements.



- From 1 to 7 Expansion Slots — ISA, EISA, PCI and PCMCIA
- Up to 4 Drive Bays — Tape, CD-ROM, Removable, etc.
- Configurable System Power — 100 watts to 350 watts

UNRIVALED PERFORMANCE

Dolch PAC portables are available with a broad range of performance options — meeting or exceeding all the best of desktops.

- CPU Options — 486 up to Dual Pentium at 150MHz
- Displays — 16.7 Million Colors or Daylight Readable Mono
- Active Matrix TFT Screens — Up to 12.1-inches
- Resolution — 640 x 480, 800 x 600 and 1024 x 768
- Graphics Performance — In Excess of 115 WinMarks™
- Drives — EIDE or High-speed PCI SCSI — Up to 9 GB
- Memory — High Speed Cache and EDO DRAM

Dolch Computer Systems
3178 Laurelview Ct.
Fremont, CA 94538 USA

Tel. 510.661.2220 ; Fax 510.490.2360

Web Site — <http://www.dolch.com>

CALL TODAY: 1.800.995.7580.



Philips Brilliance Monitors.
They bring out
the Da Vinci in you.

See Us at

COMDEX
Fall '96
Booth L2625

Let's make things better.



BRILLIANCE[®]
HIGH RESOLUTION MONITORS

Whatever you're creating on screen, Philips Brilliance monitors will bring out the best in you. Because the really clever thing about them is their pixel perfect display, offering you incredibly high resolution, colour accuracy, contrast and consistency right across the range. They are available in 15", 17" and 21" sizes, which means that whether you're a design professional, office or small business user, or a game freak we have the right kind of monitor for you. So why waste your talents on anything less? Look into a Philips Brilliance monitor today.



PHILIPS

Philips Consumer Electronics Company
One Philips Drive
Post Office Box 14810
Knoxville, TN 37914-1810
(800) 835-3506

Circle 205 on Inquiry Card (RESELLERS: 206).

Test Specs

A workstation with Intel's fastest Pentium Pro processor provides great performance for running applications. A workstation with two 200-MHz Pentium Pros is even better—but not for everybody. To really get your money's worth, you'll have to be using a technical application that threads well over two processors, or running something computationally intensive as a background task while doing other work. You might, for example, want to write code or

SCSI or EIDE?

With higher data densities, quicker head movement, and faster spin rates, hard drives deliver data much faster than they used to, some with sustained rates higher than 8 MB/second. Both the IDE (as EIDE) and SCSI device interfaces have kept pace; either can shoot data to the host PC faster than a single drive can deliver it. So why are high-end Windows NT systems faster with SCSI drives? For single-drive systems that don't fully use SCSI multitasking, an EIDE drive may have a slight performance advantage over a SCSI drive because it has a simpler, more direct interface with little command overhead. The answer is that drive manufacturers put SCSI connectors on their fastest and most expensive drive mechanisms. Currently EIDE (or ATA) drives top off at 5400 rpm, while many high-end SCSI drives do 7200 rpm. Spin rate affects both sustained data rate and access time.

answer e-mail while compiling a large application.

The eight systems we tested can all handle this kind of work. For our evaluation, we requested 200-MHz dual-processor Pentium Pros with 64 MB of RAM, at least a 1-GB hard disk, and a 17-inch monitor. All came with at least 2-GB hard drives, mostly SCSI of various flavors; the SAG system came with a 9-GB Wide Ultra-SCSI drive from Seagate. Seven of the systems arrived with 256-KB-cache versions of the Pentium Pro; the Dell OptiPlex came with the newer CPU that has a 512-

KB cache (adding around \$1500 to its price). Most came with strong 2-D graphics cards from either Matrox or Number Nine. We evaluated the systems for usability, features, and performance with some consideration of price.

Performance

We tested performance under Windows NT 3.51 with our usual applications-based benchmarks and low-level InterMark tests, but we also hammered the dual-processor machines with two new tests that evaluate their multiprocessor efficiency under NT. Given the nature of the products, our Performance rating is weighted heavily (50 percent) by the dual-processor tests. After putting NT 3.51 on each system, we installed Microsoft Office and Visual C++ (4.2). We used each system's vendor-specified configurations and executed all the tests at 1024- by 768-dpi graphics resolution and 16-bit color depth (65,536 colors).

To evaluate multiprocessor performance, NSTL's R&D department devised two tests that measure system speed when both processors are being pushed to the limit. In the first test, we ran a floating-point-intensive Fourier transform program that analyzes the spectral content of a WAV file. A shell program loaded two simultaneous copies of the test and timed the results. The spectral analysis test has high data locality and little file I/O, so the test data generally resides in cache and the results are primarily dependent on raw floating-point power.

The second multiprocessor test measures how fast a system can build (compile and link) a large chunk of Visual C++ source code. We ran two simultaneous instances of the test. This benchmark produces results that depend on both CPU and hard disk performance; the test hits the hard disk often with both read and write operations.

Although dual-processor workstations are designed for high-end technical applications, many people will want the second processor to run general software. Our applications-based benchmark employs two 32-bit business programs, Microsoft's Word 7.0 and Excel 7.0. The macro-based tests exercise common func-

tions of each application. For example, the Excel test measures the time it takes to delete a variety of cell ranges and calculate various addition, financial, and statistical functions. The application tests account for 20 percent of the overall Performance score.

To get at the performance of important system components, we also ran NSTL's InterMark tests. In addition to CPU performance, these low-level tests measure the efficiency of such components as CD-ROM drive, hard disk, and video/graphics subsystems. InterMark accounts for 30 percent of the Performance rating.



Features and Usability

We also rated system features and checked how easy the PCs were to set up and upgrade. In coming up with our Features ratings, we rewarded system characteristics that differentiate these top-notch Pentium Pro workstations from each other. Length and completeness of the warranty, number of slots and drive bays free for expansion, built-in security, and amount of dedicated graphics memory to support high screen resolutions (1600 by 1200 pixels) all contributed to better ratings.

For usability, a screwless design that makes it easy to remove the case and install an adapter card is a plus, as are clearly labeled I/O ports. On the other hand, an obstructed expansion slot is a minus. We gave extra points to systems that came with clear, well-indexed documentation. We consider adequately detailed jumper and DIP switch settings to be particularly important.

Evaluations in this report represent the judgment of BYTE editors, based on tests conducted by NSTL, Inc., as documented in a recent issue of their monthly PC Digest. To purchase a copy of the full report, contact NSTL at 625 Ridge Pike, Conshohocken, PA 19428; (610) 941-9600; fax (610) 941-9950; on the Internet, editors@nstl.com. For a subscription, call (800) 257-9402. BYTE Magazine and NSTL are both operating units of the McGraw-Hill Companies.

PENTIUM PRO WORKSTATIONS FEATURES

	Dell Computer Corp. OptiPlex GXpro 200 	Digital Equipment Corp. Personal Workstation 2001 	Hewlett-Packard Co. Vectra XU 6/200
Price as tested (MSRP) with monitor	\$6885	\$5834	\$9206
Overall rating	8.2	8.2	7.7
Performance	8.3	8.3	7.8
Features	7.9	7.4	6.4
Usability	8.2	7.9	9.5
MICROPROCESSOR			
Manufacturer and model	Intel Pentium Pro 200	Intel Pentium Pro 200	Intel Pentium Pro 200
Secondary cache RAM per CPU (KB)	512	256	256
Number of processors/maximum number of processors	2/2	2/2	2/2
BIOS vendor and version	Phoenix A01	Phoenix 4.05	Hewlett-Packard
MEMORY			
Standard/as tested/maximum (MB)	32/64/128	32/64/512	32/64/256
Package type	DIMM	SIMM	DIMM
Speed (nanoseconds)	60	80	60
ECC	✓	✓	✓
Memory architecture	EDO	EDO	Fast-paged
MASS STORAGE			
Hard drive manufacturer and model number (capacity)	Seagate ST32140A (2-GB)	Seagate ST32550W (2-GB)	Seagate ST32550N (2-GB)
Hard drive interface	Integrated Intel PCI EIDE	Adaptec PCI Fast/Wide SCSI-2 card	Integrated AMD PCI Fast SCSI-2
Standard 3½-inch floppy drive	✓	✓	✓
Standard 5¼-inch floppy drive			
CD-ROM drive speed, manufacturer and model, interface	8x NEC A310-00, EIDE	8x Toshiba XM5602B-FW, EIDE	4x Sony CDU-76S, EIDE
DRIVE BAYS			
Total 3½-inch/5¼-inch	3/2	3/3	4/3
Total 3½-inch/5¼-inch with external access	3/0	1/3	2/3
Available 3½-inch/5¼-inch	2/0	2/2	2/2
GRAPHICS			
Graphics manufacturer and model	Number Nine Imagine 128 Seriea 2 PCI	Matrox MGA Millennium PCI	Matrox MGA Millennium PCI
Maximum noninterlaced display resolution (refresh rate)	1800 × 1200 (83 Hz)	1600 × 1200 (72 Hz)	1600 × 1200 (72 Hz)
Color depth at maximum noninterlaced display resolution (bits)	16	8	8
Standard graphics memory/as tested/maximum (MB)	0.5/4/4	2/2/8	2/2/8
MONITOR			
Manufacturer and model	17-inch Dell 17 LS	17-inch Digital SN-PCXAV-YZ	17-inch Hewlett-Packard Ultra VGA 1280
Dot pitch (mm)	0.28	0.26	0.28
Maximum noninterlaced display resolution (refresh rate)	1280 × 1024 (60 Hz)	1280 × 1024 (75 Hz)	1280 × 1024 (75 Hz)
EXPANSION SLOTS			
Number of PCI/ISA (shared)	5/2 (2 shared)	3/3 (1 shared)	3/2 (1 shared)
Number of slots used	2	2	2
I/O			
Serial/enhanced parallel	2/1	2/1	2/1
Rated throughput of serial port(s)	115.2 Kbps	115.2 Kbps	115.2 Kbps
UART compatibility	16550	16550	16550
Integrated EIDE	✓	✓	✓
Universal Serial Bus (USB) ports	0	2	0
Integrated Fast SCSI-2			✓
10Base-T Ethernet	Integrated	Integrated	Card
POWER SUPPLY			
Output rating (Watts)	230	300	160
AC voltage (V)	110/220	120/240	110/220
Autodetecting/autoswitching	✓		
Energy Star compliant	✓		
DIMENSIONS			
Height × width × depth (inches)	6.5 × 16.5 × 17.6	16 × 8.5 × 17.5	16.4 × 8.3 × 15.9
Weight (pounds)	30	21	33
FCC rating	B pending	B	B
CUSTOMER SUPPORT			
Warranty length (years)/coverage	3/P,L,F,R	3/P,F	3/P,L,R
Phone	Call local Dell dealer	Call local Digital Equipment dealer	Call local Hewlett-Packard dealer
Toll-free phone	(800) 289-3355	(800) 344-4825	(800) 752-0900
On-line address	http://www.dell.com	http://www.workstation.digital.com	http://www.hp.com
Inquiry no.	1011	1012	1013

 = BYTE Best ✓ = yes

Warranty: P = parts; L = labor;
F = freight to repair center; R = return to customer.

IBM Personal Computer Co. IBM PC 365	Polywell Computers, Inc. Poly P6-200ND2	 SAG Electronics STF 3000	Xi Computer Corp. Xi Pro400 Mtower DP	Xi Computer Corp. Xi Pro400 Ntower DP
\$7081	\$5270	\$5650	\$4688	\$4788
8.0	8.2	7.9	7.3	7.9
8.1	8.3	8.0	7.3	7.9
7.2	7.4	7.3	6.5	6.7
8.7	7.5	7.4	6.8	8.4
Intel Pentium Pro 200	Intel Pentium Pro 200	Intel Pentium Pro 200	Intel Pentium Pro 200	Intel Pentium Pro 200
256	256	256	256	256
2/2	2/2	2/2	2/2	2/2
IBM Flash Level 17A	AMI 3.0.8	AMI 1.01 Beta	Award 4.51 PG	Award 4.51 PG
32/64/512	64/64/1024	64/64/512	32/64/1024	32/64/1024
DIMM	SIMM	DIMM	SIMM	SIMM
60	60	60	60	60
✓	✓	✓	✓	✓
EDO	EDO	EDO	EDO	EDO
IBM Starfire SX-DFHS (2.1-GB)	Seagate ST15150W (4.3-GB)	Seagate ST19171W (9.1-GB)	Quantum Fireball 3200AT (3.2 GB)	IBM 32160 (2.25 GB)
Adaptec PCI Ultra SCSI card	Adaptec PCI Fast/Wide SCSI-2 card	Integrated Adaptec PCI Ultra Wide SCSI	Integrated Standard Micro Systems PCI EIDE	NCR PCI Fast/Wide SCSI-2 card
✓	✓	✓	✓	✓
6x Panasonic LF-1195, EIDE	6x Toshiba 3701B, EIDE	8x Plextor PX-83CS, SCSI	8x Goldstar GCD-R580B, EIDE	8x Goldstar GCD-R580B, EIDE
3/2	0/10	3/3	4/3	2/8
1/2	0/8	2/1	2/3	2/5
2/0	0/7	2/2	2/2	1/6
Matrox MGA Millennium PCI	Diamond Stealth 84 PCI	Number Nine Imagine 128 Series 2 PCI	Matrox MGA Millennium PCI	Matrox MGA Millennium PCI
1600 x 1280 (85 Hz)	1280 x 1024 (85 Hz)	1600 x 1200 (83 Hz)	1600 x 1280 (80 Hz)	1600 x 1280 (80 Hz)
16	8	16	16	16
4/4/8	2/2/4	4/4/8	2/4/8	2/4/8
17-inch IBM P70	17-inch Sampo 17MX	17-inch Princeton Graphics EO75	17-inch ViewSonic Optiquequest V775	17-inch ViewSonic Optiquequest V775
0.26	0.28	0.26	0.26	0.26
1280 x 1024 (60 Hz)	1280 x 1024 (60 Hz)	1600 x 1280 (75 Hz)	1600 x 1280 (60 Hz)	1600 x 1280 (80 Hz)
5/3 (3 shared)	4/4 (none shared)	3/1 (none shared)	5/3 (1 shared)	5/3 (1 shared)
2	2	1	3	3
1/1	2/1	2/1	2/1	2/1
115.2 Kbps	115.2 Kbps	115.2 Kbps	115.2 Kbps	115.2 Kbps
16550	16550	16550	16550	16550
✓	✓	✓	✓	✓
1	2	1	2	2
None	None	Integrated	None	None
200	300	230	235	300
115/230	110/240	115/240	110/220	110/220
	✓	✓	✓	
6.3 x 16.5 x 17.9	24 x 7.5 x 22.5	19.8 x 7.5 x 17	20 x 7.8 x 17	29 x 8.8 x 17.8
28	70	40	20	35
B	B	B	A	A
3/P,L,FR	3/P,R;5/L,R	2/P,L,FR	3/P,L,FR	3/P,L,FR
Call local IBM dealer	(415) 583-7222	(508) 683-0339	(714) 498-0858	(714) 498-0858
(800) 426-2968	(800) 300-7659	(800) 989-3475	(800) 432-0486	(800) 432-0486
http://www.pc.ibm	http://www.polywell.com	http://www.sagelec.com	http://www.xicomputer.com	http://www.xicomputer.com
1014	1015	1016	1017	1018

NSTL tests four remarkable packages for creating mixed-media hits.
By David Seachrist

How Multimedia Multitools Compare

Putting on a multimedia presentation used to be a real bear. But computer-based multimedia has changed all that. Everything is virtual.

We found the leading edge in four tools on the high end of the scale, all multimedia authoring packages that run under Windows 95 (though some are 16-bit and some are 32-bit): Macromedia's Authorware Interactive Studio 3.5 (hereinafter Authorware), Aimtech's IconAuthor 7.0, Innovus's Multimedia 2.1, and Asymetrix's ToolBook II Instructor 5.0.

As an all-around package for creating our test applications—a computer-based training (CBT) program and a kiosk program—ToolBook II Instructor offers the best balance of usability and flexibility. It comes with the most complete set of tools for developing and managing tests, offers a bevy of learning aids (including wizards and templates), provides the easiest integration of database information, and supports program distribution like no other product. Also, it's the best Web-enabled multimedia authoring tool for distributing CBT material via the Internet.

Macromedia is almost synonymous with multimedia, and its Authorware package is still the one to beat for producing games and other audiovisual-intensive material. However, for the test CBT and kiosk applications we created, the program's flowchart interface was less satisfactory than ToolBook II's screen-based approach. Authorware simply doesn't do as much to automate making tests and accessing databases.

The new kid on the block, Innovus

Multimedia, is impressive. Unlike many authoring tools, it isn't designed to create eye-popping audio and video extravaganzas. Innovus says the program is for "business multimedia." It's best used as a kind of programmable, interactive, super PowerPoint. The time-line view is helpful, and its scripting language—compatible with Visual Basic for Applications (VBA)—will be of interest to many people working in corporate environments.

BYTE BEST AUTHORING TOOLS

Asymetrix's ToolBook II Instructor 5.0 comes with the most complete testing tools and a bevy of learning aids. It integrates database information most easily and supports program distribution features like no other.

But the package's learning aids and test-writing tools aren't as complete as ToolBook II's. The next version's Rich Text Format (RTF) import facility and Internet support will be key enhancements.

Despite its power and many useful mini-applications, IconAuthor's interface, database connectivity, and tools for formulating tests are more difficult to learn and use than ToolBook II's or Innovus Multimedia's. But if you want to develop native OS/2 applications, IconAuthor is the only game in town.

How We Tested

We modeled our tests on typical multimedia projects likely to be encountered

in corporate and academic environments. Our target user is someone with basic knowledge of business software but no experience in writing program code. Because these tools can be used to build a vast range of applications, our ratings would likely change if the test application had been, for example, a computer game.

With each product, we created two applications. One was a CBT program designed to teach the user to play a song on the guitar; the program includes text, graphics, sound, digital video, and a test. The second program was an information-kiosk application tied to a real estate database.

We've evaluated these authoring tools primarily on the basis of their ease of learning and ease of use. Performance isn't a big issue with authoring software; speed of operation isn't as important as speed and ease of creation, and the time needed to add or import files into an application is minimal compared to the time needed to construct and check program logic.

Our testers needed approximately two days to learn the programs and create the two test applications with Authorware and IconAuthor. They needed one day with Innovus Multimedia and ToolBook II Instructor.

Structure or Content?

The heart of any authoring process is applying structure to content. You need both subject matter and a logical way to present it. For multimedia authoring, it's especially handy to be able to view both the structure and the content of a project.

Visual programming, shown here as implemented in **Authorware**, is the primary model for constructing multimedia projects with any of these packages.

However, the face of visual programming, as the user sees it, can vary considerably from one product to another, as illustrated by this **IconAuthor** program.

ToolBook II proved to be first rate for setting up tests. It has special tools that help the developer present questions and answers and plot actions based on the end-user's right or wrong responses.

Yet another approach, taken by **Innovus Multimedia**, is based on displaying the various project elements in a time line.

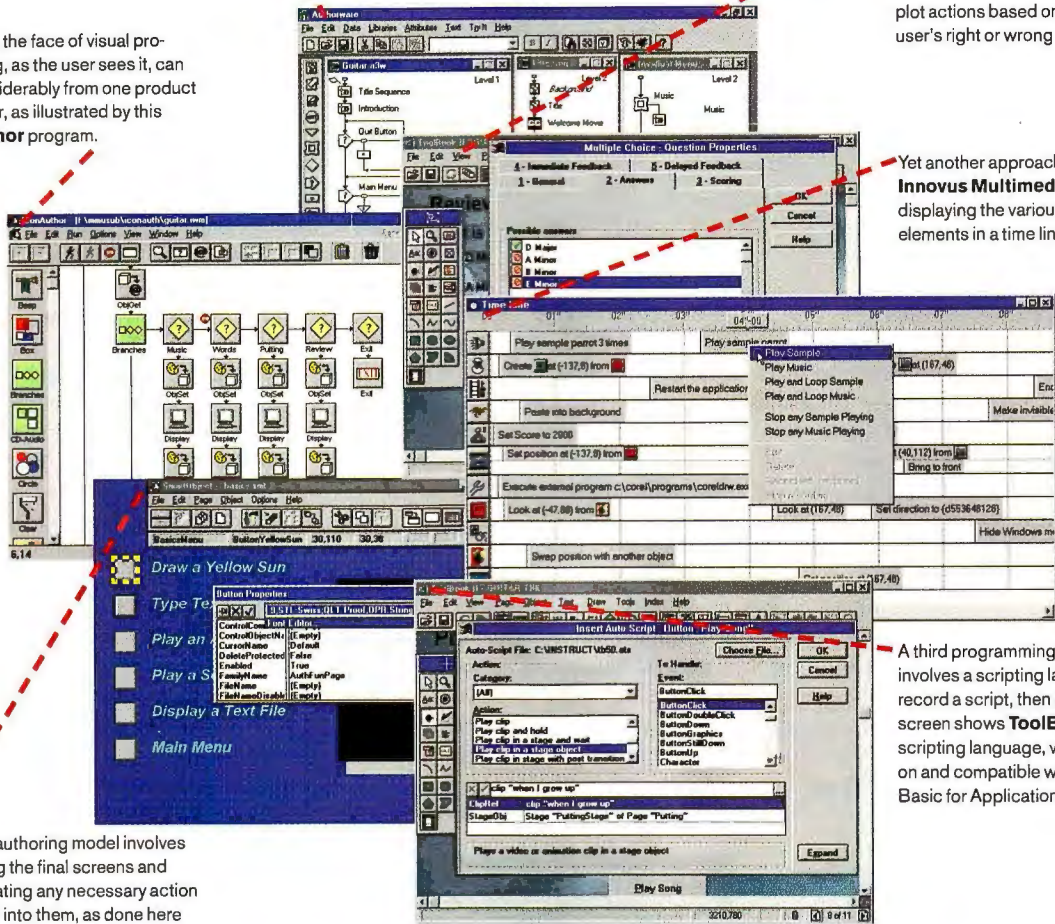

Another authoring model involves designing the final screens and incorporating any necessary action elements into them, as done here with **IconAuthor**.

A third programming model involves a scripting language. You record a script, then refine it. This screen shows **ToolBook II's** scripting language, which is based on and compatible with Visual Basic for Applications.

Name your multimedia programming style and it's probably supported by one of these versatile tools.

In fact, each of the four tested programs offers at least two authoring modes. One mode is organizational and provides a top-down view of the components in an application by showing their sequence and relationship to one another. A second mode lets you see how a screen will actually be displayed. Innovus Multimedia also offers a time-line view that shows graphically the timing of all the events and objects tied to a given screen. We found this especially helpful in creating a screen that plays a sound file and a video file.

Authorware, IconAuthor, and Innovus Multimedia all use a visual flowchart for structuring applications. ToolBook II uses an object browser to view component hier-

archies; its organizing principle is that of a book with chapters and pages. In constructing the CBT application, we found that Authorware and IconAuthor lend themselves to creating structure first and then adding content. Innovus Multimedia and ToolBook, on the other hand, are better suited to starting with the content and developing screens on-the-fly.

All the packages allow you to create applications using visual programming techniques, though the emphasis varies from program to program. Authorware and IconAuthor, for example, offer on-screen icons that work like elements of an electronic flowchart. To add a bit of programming logic to an application, you drag

an icon that represents the desired programming construct into the flowchart area of the screen. Authorware in particular rewards those who plan their text ahead. But as the project grows longer and more complicated, you have to consolidate the individual programming construct icons into compound icons, making it harder to maintain the bird's-eye view of the application.

ToolBook II's visual programming emphasis is on screen design. Making a button to play a video involves selecting a button tool, much as you would draw with a rectangle tool in an illustration program. After creating the button, you select menu options in order to assign properties that

MULTIMEDIA AUTHORING TOOLS

BEST OVERALL

Asymetrix ToolBook II Instructor 5.0

ToolBook II balances usability and flexibility with a wealth of construction and management tools, learning aids, and integrated Web features.

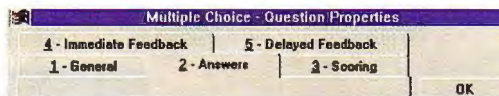

	PRICE (NEW/UPGRADE)	TECHNOLOGY	IMPLEMENTATION	USABILITY	OVERALL VALUE
ToolBook II Instructor 5.0	\$1995	★★★★	★★★★★	★★★★★	★★★★
Authorware Interactive Studio 3.5	\$4995/\$595	★★★★	★★★★	★★★★	★★★★
IconAuthor 7	\$1295/\$895	★★★	★★★	★★★	★★★
Innovus Multimedia 2.1	\$495/\$150	★★★	★★★	★★★	★★★

★★★★ Outstanding ★★★ Very Good ★★ Good ★★ Fair ★ Poor

define how the button will work.

All four programs offer strong features for application development and programming constructs, including the ability to create and evaluate variables, build looping and branching structures, accept and evaluate user input, and provide feedback. The powerful scripting languages in ToolBook II, Authorware, and Innovus Multimedia give these programs an advantage in a corporate environment with skilled programmers. Innovus's script language is compatible with VBA, and ToolBook II allows access to VBX controls to extend its power. All four programs support OLE, but only Authorware and Innovus currently support OLE 1.0 and 2.0.

Text in Context

Although "multimedia" conjures images of splashy graphics, sound, and video, text remains the fundamental means of communication. Any authoring tool worth its salt must provide flexible and easy-to-use text tools. The text editing environments in all four programs will seem below par compared to today's word processors. For example, Innovus Multimedia won't let you italicize just one word in a block, and you have to edit a block of text in a dialog rather than directly on-screen. IconAuthor's text editing is also less fluid than other aspects of the program.

Still, these packages are primarily for *combining* content, not creating it. Each one can import text, so you would normally edit and format screen text in with your word processor, then import it into the authoring program. With Innovus Multimedia, you can't currently import RTF files, just straight ASCII text, which doesn't maintain formatting attributes like bold type and character size. The next version, due out in November, will contain an RTF import capability.

Authorware offers the best text import, with the option to interpret page breaks as new screens. This really saves time when designing screens with lots of text. Innovus allows a similar option with straight text files, but the files require careful formatting with tabs, not page breaks.

Graphics and AV Tools

All four tools are good for creating, manipulating, and importing graphics. We did find that Authorware doesn't import JPEG graphics, and ToolBook II initially threw us for a loop until we learned that it loads JPEGs through its resource manager rather than through its graphic import option.

The relatively modest use of video and

audio in our CBT test application didn't challenge any of these tools. It was easy to attach sound files of guitar chords to the JPEG photos of the chords being played and to attach AVI (Video for Windows) files for video of the song being played. The only tricky element was synchronizing the video playback with the sound file. But all the programs control playback speed and can start and stop audio and video files easily.

Authorware has the most extensive audiovisual tool set, mainly because Macromedia bundles Director and SoundForge with it. But its tools are really geared toward building an audiovisual production, not the kind of application our tests focused on. You can make drawn objects

TECH FOCUS

DATABASE

Making the Data Connection

Many types of multimedia applications—encyclopedias, kiosks, even some games—depend on sophisticated databases. For these applications, a tool that supports database access is a necessity. All the products we tested offer some form of database support, but they vary drastically in how easy these functions are to use.

ToolBook II Instructor was by far the easiest for adding a database to our kiosk application. ToolBook has a database utility that parses database files and automatically creates a database front end with fields, labels, and browsing buttons. Unfortunately, what ToolBook gains in ease it loses in flexibility because dBase and Paradox are the only two file formats it supports. The other three programs are all compliant with Open Database Connectivity (ODBC) and support many database formats through the Microsoft ODBC driver.

Of these three, Innovus Multimedia was the easiest to use to add the database to the kiosk. It aids in formatting the screen by adding the field placeholders and record navigation buttons. In both Authorware and IconAuthor, the application designer has to add the proper field placeholders, labels, and record navigation buttons manually and individually. The process lacks the automation found in Innovus Multimedia.

Authorware's tutorial material for creating a kiosk application is less than satisfactory. The program comes with a sample application describing how to set up connections to various database formats and a booklet on connecting to databases using Microsoft's ODBC driver. But to succeed in using a database with an Authorware-constructed project, you will need a working knowledge of database structures and SQL statements. There are no automated tools to help here.

move in a designated path (path animation), and you can create simple cel (frame-by-frame) animations. Although ToolBook's animation and video tools aren't as complete as Authorware's, the program offers ancillary video capture and editing software at minimal additional cost.

Testing

ToolBook II is the environment of choice for creating courseware, although a third-party course management package is available at extra charge for Authorware. ToolBook II lets you develop interactive tests that use a wide variety of predefined question types (multiple choice, true/false, etc.). Its course management system allows an administrator to track students' progress and test scores. Design tasks—specifying correct and incorrect answers, answer feedback, and scoring—are all properties of question objects that the application designer can set from a single tabbed dialog box. This was by far the easiest approach to learn and use. Innovus Multimedia has question objects, but with fewer options. Authorware and IconAuthor have programming constructs to facilitate formulating test questions but lack the others' easy, object-oriented interface.

Program Distribution

Once an application is finished, it's time to distribute it. Authoring tools that can save programs as EXE files, easily manage resources (such as digital video, sound files, and drivers), and add an installation program can simplify this job.

All four packages let you freely distribute run-time players. IconAuthor, Innovus Multimedia, and ToolBook II have distribution programs that let you manage program resources and create floppy disk sets complete with an installation program. ToolBook II and Authorware allow you to save your programs as executables, so you don't need a run-time player. All in all, the packaging capabilities of ToolBook II and Innovus Multimedia are more complete than Authorware and easier to learn and use than IconAuthor.

Platform Support

Authorware is the only program we tested that runs as an authoring and playback application under both Windows and the Mac OS. IconAuthor offers OS/2 authoring and playback capabilities in addition to Windows support. Authorware and

FEATURES

	Authorware	IconAuthor	Innovus Multimedia	ToolBook II
GENERAL FEATURES				
Authoring metaphor	Flowchart	Flowchart	Flowchart	Book/Page
Built-in database				✓
ODBC support	✓	✓	✓	
Includes screen/page layout templates			✓	
Training/course management	(A)			✓
CROSS-PLATFORM COMPATIBILITY				
Windows 95: Authoring, playback	✓	16-bit	✓	16-bit
Windows 3.1: Authoring, playback	✓	✓	✓	✓
Macintosh: Authoring	✓			
Macintosh: Playback	✓	Future		Via Web
OS/2: Authoring, playback		✓		Web playback
Windows NT: Authoring, playback	✓	16-bit	✓	16-bit
Unix: Authoring, playback		Future		Web playback
APPLICATION DEVELOPMENT				
OLE 1.0 and 2.0 support	✓	OLE 1.0	✓	OLE 1.0
VBX support				✓
Scripting language	✓		✓	✓
Script recorder	✓		✓	✓
WYSIWYG structure/screen design	✓	✓	✓	screen only
Hypertext, hypermedia links, event handling	✓	✓	✓	✓
Assign procedures to screen controls	✓	✓	✓	✓
Program flow statements	(B)	(B)	✓	✓
Integrated debugging environment	✓	✓	✓	✓
TEXT TOOLS				
Import RTF and ASCII files	✓	✓	(C)	✓
Search and replace	✓	✓	(D)	✓
Text search and retrieval tools	✓			✓
DRAWING AND IMAGE TOOLS				
Number of graphics formats imported	7	34	14	20
Pen, line, rectangle, oval tools, snap-to grid	✓	✓	✓	✓
Image manipulation	✓	✓		✓
Graphics object manipulation commands	✓	✓	✓	✓
Clipart and tools included	✓	✓	✓	✓
ANIMATION AND VIDEO TOOLS				
Number of animation/movie formats imported	5	7	5	6
Path, frame-by-frame animation	✓	✓	✓	✓
Automatic, polymorphic in-betweening	✓			
Animate text	✓		✓	✓
Video capture and editing tools	✓	✓	✓	extra cost
Video control tools	✓	✓	✓	✓
Transition effects (fades, wipes, etc.)	✓	✓	✓	✓
AUDIO TOOLS				
Number of sound formats imported	3	3	3	3
Sound synchronization	✓	✓	✓	✓
Control sound speed, duration, sequence	✓	✓	✓	✓
INTERNET AND DEPLOYMENT TOOLS				
Package to Web server	✓	✓		✓
Save to HTML and Java				✓
FTP utility to transfer files to Web server	✓	✓		✓
Can be run from Web browser using player software or plug-in	✓	✓		✓
Network deployment	✓	✓	✓	✓
Free run-time player	✓	✓	✓	✓
Create distribution disks with install program		✓	✓	✓
Create stand-alone executables	✓			✓

✓ = Yes

A = Third-party application

B = Branching, conditional branching, and repeat until

C = Import ASCII (*.txt) files; RTF files supported via a separate RTF editor included with the authoring software.

D = Available in script editor environment

New Products, New Properties, New Prices

The range and number of multimedia authoring tools is expanding at an amazing rate. When NSTL started this evaluation a few months ago, none of the programs in this report were available for under \$1000, and two were priced at \$5000. But since then, several vendors have changed their pricing drastically. Authorware is the only program that remains at \$5000; rather than reduce price, Macromedia decided to add value by bundling Macromedia Director, Extreme 3D, SoundForge XP, and xRes with the product.

Several other programs were outside our focus or arrived too late for inclusion in this review. While we didn't put them through the rigors of our testing program, they are packages worth considering.

Corel Click & Create 2.0

This international production (a U.K. product sold by a Canadian company) is aimed at a variety of multimedia developers and users. The \$695 package (\$249 update) uses a storyboard paradigm, makes heavy use of drag-and-drop editing, and supports DirectX video, WinG, ODBC databases, QuickTime, and Rich Text Format. As with most Corel applications, it comes with hundreds of fonts, clipart, animation files, and video clips (on two CD-ROMs).

mTropolis 1.1

A heavy-duty performer from mFactory, this program lets you build applications out of reusable objects. It's intended primarily for designing commercial CD-ROMs and Internet presentations. It relies heavily on its

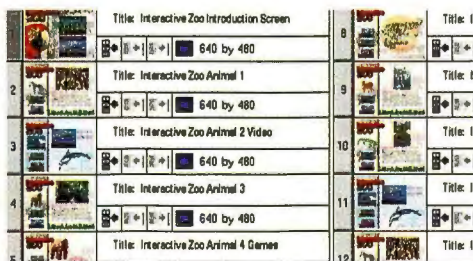

Corel's Click and Create, with its time line and storyboard, is especially versatile.

scripting language, which is extensible. With mTropolis, you create your multimedia program once and can then deploy it on the Macintosh (68K and PowerMac) and on Windows 3.1 and 95 platforms. Cost is \$1195.

Oracle Media Objects 1.1

Oracle's entry, as you might expect, readily connects to Oracle databases and is focused heavily on entertainment and interactive broadcast production as well as corporate communications and training. With this product, you can build your program on either a Windows machine or a Macintosh, then play it back on either platform or—tada!—Apple's forthcoming set-top box. With that addition, as well as Oracle's commitment to Web computers, this \$495 package may become an important player in the multimedia market.

PowerMedia 2.0

RadMedia's authoring package is a good bet if you don't need database support (though the company promises that for the future). What your \$495 buys now is a storyboarding environment that enables easy Web distribution with one-click hyperlinking and generating of Hypertext Markup Language files. You also get hundreds of screen layout templates; good support for a wide variety of graphics, video, and audio imports; an image editor; and illustration tools. This will be of interest to people developing educational courseware, Internet advertising, entertainment titles, and corporate communications.

Innovus Multimedia run as 32-bit applications under Windows 95.

But platform-specific support becomes less critical as the World Wide Web grows in popularity. Already, ToolBook II is powerfully Web-enabled; it can save applications in Hypertext Markup Language

(HTML) and Java formats, has a browser plug-in, and offers templates for building applications distributed via the Web. Authorware also offers a browser plug-in, and end-users can configure Authorware and IconAuthor run-times as helper applications. Innovus Multimedia plans Inter-

net capabilities for the next version, due out in November.

In the final analysis, ToolBook II is our top pick because it does the best job of balancing ease of use with a rich set of features. Innovus Multimedia, which takes a minimalist, PowerPoint-like approach, would be our second choice, especially for developing simple presentations. **B**

PRODUCT INFORMATION

Authorware 3.5
\$4995 (\$595 upgrade)
(486, 8 MB; 16 MB recommended)
Macromedia
San Francisco, CA
(800) 326-2128
(415) 252-2000
fax: (415) 626-0554
<http://www.macromedia.com>
Circle 1022 on Inquiry Card.

IconAuthor 7.0
\$1295 (\$895 upgrade)
(486, 8 MB; 16 MB recommended)
Aimtech
Nashua, NH
(800) 289-2884
(603) 883-0220
fax: (603) 883-5582
<http://www.aimtech.com>
Circle 1023 on Inquiry Card.

Innovus Multimedia 2.1
\$495 (\$150 upgrade)
(486SX, 8 MB; 16 MB recommended)

Innovus
Salt Lake City, UT
(800) 433-1806
(801) 463-8200
fax: (801) 484-9561
<http://www.innovusmm.com>
Circle 1024 on Inquiry Card.

ToolBook II Instructor 5.0
\$1995
(386DX, 8 MB; 12 MB recommended)
Asymetrix
Bellevue, WA
(206) 462-0501
fax: (206) 637-1650
<http://www.asymetrix.com>
Circle 1025 on Inquiry Card.

Corel Click and Create 2.0
\$695 (upgrade \$249)
Corel
Ottawa, Ontario, Canada
(613) 728-8200
<http://www.corel.com>
Circle 1026 on Inquiry Card.

mTropolis 1.0
\$1195
mFactory
Burlingame, CA
(415) 548-0600
<http://www.mfactory.com>
Circle 1027 on Inquiry Card.

Oracle Media Objects 1.1
\$495
Oracle
Redwood Shores, CA
(415) 506-7000
<http://www.oracle.com>
Circle 1028 on Inquiry Card.

PowerMedia 2.0
\$495
RadMedia
Palo Alto, CA
(415) 617-9430
fax: (415) 473-6826
<http://www.radmedia.com>
Circle 1029 on Inquiry Card.

David Seachrist has tested software for NSTL for 10 years, concentrating on desktop publishing and graphics. You can reach him at dseachrist@prodigy.com.

Evaluations in this report represent the judgment of BYTE technical editors, based in part on extensive tests conducted by National Software Testing Labs, as documented in a recent issue of NSTL's monthly Software Digest. To purchase a copy of that report, with NSTL's own evaluations and data, contact NSTL at 625 Ridge Pike, Conshohocken, PA 19428; (610) 941-9600; fax (610) 941-9950; editors@nstl.com. For a subscription, call (800) 257-9402. BYTE Magazine and NSTL are both operating units of The McGraw-Hill Companies.



If you think file transfer is all we do, you need some time away from the office.



To appreciate how much more LapLink® for Windows® 95 has to offer, all you have to do is hit the road.

Wherever you go—across the hall, across town or across the country—if you've got LapLink, you have everything you need to access anything you want on your desktop *or* your network.

With this single piece of software, you can read and send e-mail, run databases and custom applications, synchronize data and, yes, even transfer files.

Since there's no need to change apps to do all these things, there's no need to hang up and redial. And since LapLink works the same

way over modems, IPX and TCP/IP networks, serial cables, parallel cables, wireless, even the Internet, there's no need to laboriously reconfigure.

And there's no need to worry about compatibility. Our 16-bit version is built right into LapLink for Windows 95, so connecting to Windows 3.1 systems is no problem at all.

By now, you probably can't wait to get your hands on the latest LapLink. So you'll be glad to know that upgrading—from an earlier LapLink, or from another product altogether—is ridiculously inexpensive. Call 800-224-7704. Better yet, see your reseller. It'll give you an excuse to get away from the office.

TRAVELING
SOFTWARE





the world wide wait is over

Genuine,
truly personalized,
intelligent agent technology
for the 'Net is here.

Some have promised
but have they delivered?
Now, whether you're a consumer,
service provider, content publisher... whatever
your view of the 'Net - imagine
what Autonomy agentware could do for you.

This time it's personal.



real intelligent agents
are here @www.agentware.com

AUTONOMY
agentware

Web Project

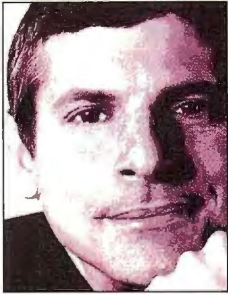

On-Line Componentware

I use AltaVista to build BYTE's Metasearch application and realize that every Web site is a software component.

Software components can turn up in the unlikeliest places. In our May 1994 cover story ("Componentware," <http://www.byte.com/art/9405/sec5/sec5.htm>), for instance, we pointed out that object-oriented programming (OOP) technology had failed to produce a rich harvest of plug-and-play software objects. However, we showed that Visual Basic custom control (VBX) technology—a hastily conceived mechanism for Visual Basic plugins—had, to everyone's surprise, jump-started a thriving component-software industry.

Fast-forward to 1996. I want to prototype a Web-search application that embraces BYTE and five fellow McGraw-Hill publications. I have only a few hours to spend on the task. What component can I pull off the shelf and use? Java or ActiveX components? They're coming, but they're not here yet. Distributable search engines? They exist, but deployment across six Web sites will take more than the allotted few hours.

As I drove home from work, I suddenly knew where to find the right component for the job. It was sitting in plain view at <http://www.altavista.digital.com/>. That's right—Digital Equipment's AltaVista, a public Web site, is also the software component that let me prototype the McGraw-Hill Metasearch application before I went to bed that night.

A powerful capability for ad hoc distributed computing arises naturally from the architecture of the Web. This month's column demonstrates that fact, in a compelling way, using AltaVista as an example. But the technique that I describe here applies equally to The BYTE Site or any public Web site. My intent is only to demonstrate the technique and consider how

Go to: dev4.byte.com/metasearch.pl

 **BYTE's McGraw-Hill Metasearch:
isdn+near+internet**

BYTE
[May 1996 / International Features](#)
[February 1996 / Cover Story / Toss Your TV](#)
[February 1996 / Cover Story / Toss Your TV](#)
[March 1994 / Cover Story / Building The Data Highway](#)
[January 1995 / Special Report / The Virtual Storefront](#)

Data Communications
[Network Software](#)
[Internet Watch](#)
[The 1996 Data Comm Market Forecast](#)
[Stop Singing Those Blues](#)
[International Network Services](#)
[Browse by Subject/Technology](#)

BusinessWeek
[SCIENCE & TECHNOLOGY -- 01/29/96](#)
[SCIENCE & TECHNOLOGY/1 -- 01/29/96](#)

UnixWorld Online
[UnixWorld Online: Hardware Review: No. 001](#)

Powered by [AltaVista](#)

 Document Done

In only a few hours, I created an application that intercepts AltaVista search results and groups them by site of origin.

it enables large-scale software componentry. For commercial-grade solutions that leverage AltaVista, check out the AltaVista Business Extensions at <http://altavista.software.digital.com/sitemap/nfbusexten.htm>.

Web Site as Software Component

Brad Allen, who created Quarterdeck's WebCompass, first showed me how a Web site can work as a software component. At Fall Comdex in 1995, he plugged The BYTE Site into WebCompass and

showed how Quarterdeck's product could add value to our site's native search function. How was this possible? If there is a telnet on your system, try doing this experiment:

```
telnet www.byte.com 80
get /
```

The above sequence transmits an HTTP GET request to the BYTE Web server and then asks for the server's root document. What telnet subsequently spews forth will be the Hypertext Markup Language

(HTML) source text of BYTE's home page.

Internet newcomers are often surprised to learn that the Web is built on such a simple mechanism. Old hands just take it for granted because they're familiar with other Internet applications that work the same way. For example, telnet to dev4.byte.com on port 119 and enter help to reveal the NNTP command set of BYTE's news server. And below is a way that you can query the BYTE archive and our Virtual Press Room for documents that contain references to NNTP:

```
telnet dev5.byte.com 80
get /cgi-bin/sw2.pl?keywords=
nntp&index=both
```

Like all Web sites that run scripts to generate pages, The BYTE Site has an implicit API. It's not documented, but it's easy to discover. Just run an interactive search

and then view the source of the results page. There you will see how the form variables keywords and index control the several search engines that are running on the site.

When you query interactively, those variables are transmitted by way of a temporary file using the HTTP POST method. However, an equivalent command line that uses the HTTP GET method, as shown above, works just as well.

A Naive Implementation of Metasearch

A little interactive experimentation with AltaVista revealed the API that I needed to call to implement Metasearch. I exploited AltaVista's fielded search capability to isolate a set of Web sites, like this:

```
q=host:www.byte.com+and+host:
lantimes.com+and+nntp
```

I couldn't expect users to telnet to AltaVista and type this junk. So my first naive implementation was a Web form that called a BYTE Site script that returned another form that called AltaVista.

Sound squirrely? It was. I needed the first form to capture the search keywords, the script to interpolate the keywords into a Common Gateway Interface (CGI) request template, and the second form to present the final request to the user as an action that could be invoked via an HTML Submit button.

When Javascript and VBScript stabilize, they'll eliminate the need for many of these CGI gymnastics. Simple active-client technology could have streamlined my naive implementation. But if Metasearch did nothing more than point the user's browser at AltaVista, I'd still call it naive.

The finished application does more. It adds value by intercepting the results that

Getting Along with AltaVista

Web-component interactions run back and forth along a two-way street. The BYTE Site now uses AltaVista as a component of Metasearch. But conversely, AltaVista uses The BYTE Site as a content-providing component. We're the source of about 5000 of the nearly 20 million pages in AltaVista's vast index. The API that AltaVista (or any robotic indexer) uses to access The BYTE Site (or any Web site) is the same as the one that humans use: uniform resource locators (URLs). Thus, you don't need to do anything special to make your site a pluggable AltaVista component.

Some Webmasters worry—with reason—that a robotic indexer will fetch too many pages too quickly and render a site unresponsive to normal users. That isn't a problem with AltaVista, which adapts dynamically to your site's ability to pump out pages. When I first heard about AltaVista last winter, I was amazed to learn it had already indexed our site.

Why the surprise? After a few other robots had applied heavy suction to our server, I added a "pig report" to my daily log processing. It highlights visitors who pull more than 1 percent of any day's pages. These high-volume customers are invariably Web crawlers. I like to keep track of who they are and how they use the data they vacuum out of my server.

But AltaVista never showed up on the pig report. Its inventor, Louis Monier, later explained why. Scooter, the AltaVista spider,

measures the time it takes to fetch a page from each of the hundred-odd sites it visits concurrently. It multiplies that interval by what Monier calls a "good-guy factor" and waits that long between fetches. Thus, Scooter can concurrently fetch once per second from a major site on a T3 link, and once every 5 minutes from a minor site on a 28.8-Kbps dial-up link.

The Robot-Exclusion Standard

There's an API that can govern site/Web-crawler interaction. It's called the robot-exclusion standard, and your site implements it by placing directives into a file called robots.txt at the Web-server root. Here is the robots.txt file that I use on several

BYTE Site development servers to lock out robots completely:

```
User-agent: *
Disallow: /
```

Why? A few months back, I did an AltaVista search and turned up URLs pointing not only to http://www.byte.com, but also to a backup archive on one of my development servers. I checked its log and found that about 5 percent of the official site's traffic had diverted to the backup server. Worse, the archive was several months out of date.

How did this happen? I'd let a page on the official site include a pointer to an unrestricted subtree on the backup server. Scooter found the hole and jumped through. Yikes!

To prevent Inktomi and WebCrawler and the rest from following suit, I plugged the hole using access controls and (for good measure) robots.txt. But AltaVista to this day remembers these unofficial URLs, and there's no way I can make it forget them.

An ambitious fix would be to regenerate the archive on the backup server, substituting redirection headers for documents. My less ambitious fix was to lock down the backup server and rig it to tell people to look instead on http://www.byte.com. If you're one of those people, I apologize for allowing the sorcerer's apprentice to run amok. Learn from my mistakes and use robots.txt (along with regular access controls) to protect what you don't want to publish.

AltaVista's Altruism

Problem: Robotic indexers can clog your Web site by trying to fetch too many pages too quickly.

Solution: AltaVista's indexer, called Scooter, multiplies the time it takes to fetch a page by a "good-guy factor." Thus, Scooter dynamically adapts itself to each site's ability to send out pages.

Result: Scooter may call upon a major site with a T3 link to pump pages at a rate of one per second, while the rate for a site with a 28.8-Kbps link may be one every 5 minutes.

BUSINESS MULTIMEDIA: No, it's not an oxymoron. And Bill Gravinsky, VB and C++ jock, knows it. Bill has redesigned the existing sales automation system to reduce errors and increase productivity of new in-house reps. His charter-develop a friendly GUI, make it easy to update product and customer information over the network—and have it done by Friday. So Bill's using INNOVUS Multimedia. Cool and useful—that's business multimedia. Question is what are you going to do with it?



What are you going to do with it?

\$250 BIG ONES: Business multimedia

is serious business. And it has a serious sound, too: "Cha-ching." That's right—because if you build a cool business app with INNOVUS Multimedia, you could win any or all of five \$50,000 cash awards. So if you're a yo-yo freak like Bill Gravinsky, you could amass the world's largest yo-yo collection. Wacky, yes, but he is building a killer app. Do the same, and the cash could be yours, instead of his. Question is, what are you going to do with it?

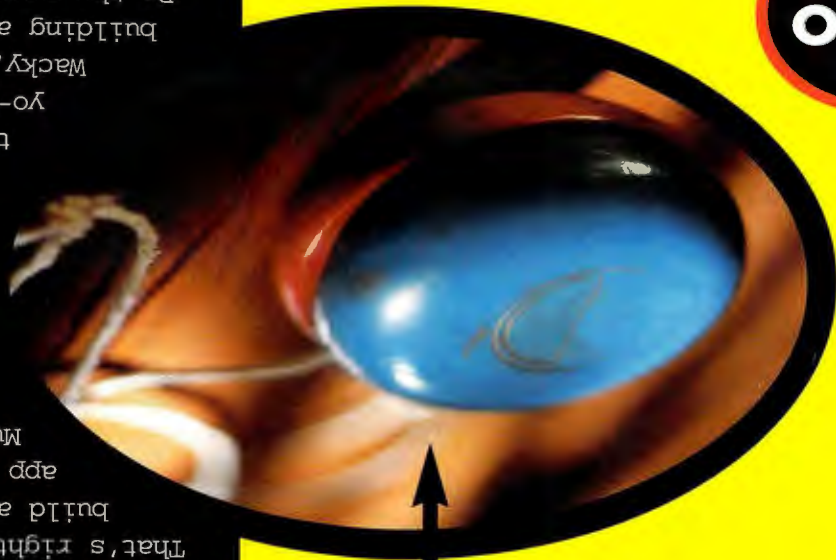

Win \$250 grand

Surf: www.innovusmm.com

© 1996 Innovus Corporation. INNOVUS Multimedia is a trademark of Innovus Corp. Circle 202 on Inquiry Card.

CALL 1.888.301.7728 toll free FOR A FREE CONTEST KIT & DEMO DISK



AltaVista returns and grouping them by site of origin (see the screen on page 129). You could achieve this effect using advanced active-client technology—a Java program or an appropriately scripted ActiveX control. Or, since these technologies are not yet widespread and stable, you could do it on the server side with conventional CGI techniques. Because I wanted to write the application in a few hours and know it would work on most installed browsers, I chose the latter approach.

Script Control

There are several Perl libraries that you can use to call uniform resource locators (URLs) from your own Perl scripts (see CPAN, the Comprehensive Perl Archive Network, at many URLs, including <ftp://ftp.digital.com/pub/plan/perl/CPAN/>). Two that I've tried are Roy Fielding's `libwww-perl` (<http://www.ics.uci.edu/pub/arcadia/libwww-perl/>) and Jim Richardson's `Wire.pm` (<http://www.maths.usyd.edu.au:8000/jmr/perl/PerlCode.html>).

For arbitrary reasons, I used `Wire.pm`, but `libwww-perl` (or another equivalent package) would also have worked. With any of these, you can pass a URL to a library function that "calls" it and "returns" the resulting HTML document (or perhaps just an HTTP header), which you assign to a Perl string variable. Then you can use Perl's unparalleled string-handling power to analyze and act on the result page. When that page is program output, it will typically exhibit a regular, repeating structure. Parsing these kinds of pages is like shooting fish in a barrel.

There was one complication. Rather than issuing a single request that combines all the Web sites that are checked on the form, Metasearch instead issues one request per site. Why? AltaVista chunks its results across a series of pages that must be fetched sequentially. A search that pro-

Plugging In the Linux Box

A few months back, analysis of the keywords used to search The BYTE Site revealed that *Linux* ranked fifth. Clearly, a lot of visitors knew something I didn't, and I resolved to find out what.

Today, a P150-based Dell running the Caldera distribution of Linux is an increasingly important pillar of The BYTE Site. All our conferences run there; INND supports newsreaders, and Apache provides an alternate Web-based view. I transfer files between Windows NT servers and Unix servers using Samba, a nifty SMB utility that makes the Linux server look like an NT peer file server.

And when I found that the key component of Metasearch (a Perl 5 module called `Wire.pm`) didn't like my NT Perl setup, I didn't waste time figuring out why. (A lot of Perl tools, though in principle are portable, in practice work better with Unix.) It was easier to build and run Metasearch over on the Linux box, so I did.

What's delightful about Web development is that the components you build can float effortlessly from one platform to another. NT and Unix offer complementary strengths. Exploit them both. And if you want to deploy a Unix system as part of the mix, Linux is a really useful one.

duces hits for all the selected sites often won't represent each of those sites on the first results page. That mandated a multi-request strategy.

One approach would be to thread a series of requests using the URL that's behind the Next link on every AltaVista result page. But how to decide when to stop? One query might yield a few result pages; another, dozens. So I opted for one page of results per selected site.

Doesn't that mean each site's results aren't fully enumerated? Yes. There are other problems, too. Metasearch is only as current as the most recent AltaVista visit to the sites I list. And it forces you to wait twice—once for AltaVista to return the results to The BYTE Site, and again for Metasearch to process them and return a final page to you.

Metasearch isn't a real solution. Some commercial-grade solutions are available from Digital, including one that will "custom crawl" a group of sites and maintain a separate index for that group. I describe Metasearch here only to show how the Web is transforming software development even more profoundly than it's transforming publishing.

A Web of Components

It should be clear to you now that you can use tools such as `libwww-perl` and `Wire.pm` to quite easily construct your own customized link checkers and Web spiders. Why bother? Well, I've tried a bunch of shareware and commercial link checkers, and none that I've found can integrate easily and well with my site-management procedures.

But spiders and link checkers merely

scratch the surface. Imagine a cousin to Metasearch called *Metaorder*, which would automatically spring into action when you ordered a subscription to BYTE using our site's order form. *Metaorder* might need to update four or five different databases in different locations around

BOOKNOTE

Where Wizards Stay Up Late: The Origins of the Internet

\$24

by Katie Hafner
and Matthew Lyon
Simon and Schuster

<http://www.simonsays.com/>



Tales from the sixties, when the Internet was just two tin cans and some string.

the world. Each of these databases might use a different engine and run on a different OS, but all could be available (behind layers of encryption and authentication) on the Web.

Metaorder could therefore orchestrate a heterogeneous two-phase commit. The "APIs" at each of the sites will have been built anyway to support browser-based interactive execution of these several tasks, per corporate intranet objectives. Once that's done, it shouldn't take 18 worker-months to prototype *Metaorder*. It should take a day. **B**

Jon Udell is *BYTE*'s executive editor for new media. You can contact him by sending e-mail to jon_u@dev5.byte.com.

TOOLWATCH



QuickDNS Pro

\$290

Men and Mice
Reykjavik, Iceland
<http://www.menandmice.com>

Who says you need a Unix box to provide DNS service for your site? QuickDNS Pro does it very nicely on a Macintosh.

OS Strategies

How to sort out the technical merits and shortcomings of tomorrow's versions of Unix, Windows NT, and Mac OS.



Your Next OS

Consider these six key issues before committing to a next-generation OS strategy.

Page 134

Unix Leads the 64-bit Charge

64-bit OSes can address massive amounts of memory. But where are the 64-bit applications?

Page 139

Unearthing Cairo

Cairo now may be a set of new features for Windows NT. Can it help Microsoft's enterprise push succeed?

Page 145

Copland, Revisited

Apple's upcoming OS offers new microkernel and hardware-abstraction services to compete with the other OSes. But when?

Page 151

YOUR NEXT OS

What to consider when evaluating next-generation operating systems.

By Dick Pountain

In this Special Report, we'll evaluate the next-generation implementations of three major OS platforms: Unix, with its continued enhancement of 64-bit architectures; Windows NT and the stops and starts of what has been known as Cairo; and Apple's Copland, which will arrive piecemeal over the coming months rather than as one integrated package.

Whether you're committed to one of these platforms or you're considering a switch to a different one, the decisions you make today will affect your OS strategy for years to come. How do you begin to evaluate tomorrow's operating systems? Start by analyzing six key areas.

ROBUSTNESS

An enterprise-level OS ought to run in protected mode and employ preemptive multitasking, so errant programs can be killed off without bringing down the OS itself. Windows NT and Unix both offer such protection now. However, some people are concerned about the robustness of the new kernel-mode graphics driver scheme in NT 4.0 (which will presumably persist in forthcoming versions) compared to the slower but safer scheme in earlier NT versions.

Copland still represents only a partial answer to Macintosh robustness. Copland's new microkernel runs applications, as far as possible, in protected memory, but it must allow kernel access from old applications to maintain System 7.x compatibility.

MULTIPROCESSING

What's driving the move to multiple CPUs? Partly the performance requirements of network servers; partly processing-intensive client-side applications, such as rendering 3-D graphics and calculating large spreadsheets. These applications don't require massively parallel supercomputers, just rather modest symmetrical multiprocessing (SMP) systems that use shared memory and an OS that automatically distributes multithreaded applications over different CPUs. NT already supports one to four processors, and machines like Intergraph's four-Pentium graphics PCs are exploiting NT's multiprocessing capabilities. At the same time, specialist vendors like Sequent run NT with up to 28

CPUs. The Cairo development effort worked at refining the existing thread-allocation algorithms to achieve better load balancing between the CPUs.

Apple desperately needs to provide SMP ability for Power Macs to keep its traditional high-end graphics users from defecting to NT to reduce rendering times. Copland will introduce SMP with the microkernel's Thread Manager, which can allocate threads to multiple CPUs. However, backward compatibility may constrain Copland's SMP abilities.

Unix has supported multiprocessing for years, and most massively parallel supercomputers run Unix-derived OSes. The main commercial Unix variants, such as SCO, Solaris, and UnixWare, all support SMP, and such systems often run with up to 64 CPUs.

CONFIGURATION MANAGEMENT

Perhaps the greatest single disadvantage of PCs today is the nightmarish difficulty of maintaining large numbers of them. Every new peripheral requires new drivers, which get updated frequently. Current PC OSes offer little assistance to a system manager who has to install new drivers on hundreds of machines.

Mature software version control has become a critical issue. OS upgrades commonly overwrite—without asking—system DLLs with new versions that break existing software installations. The Windows 95/NT registry scheme, for example, is inadequate and should be strengthened or replaced. Copland will track software revisions with a service called Patch Manager.

Unix management has traditionally been a matter of maintaining many text-based configuration files, the contents of which are a mystery to all but the gurus. Windows NT and the Mac OS have the advantage of GUIs and interactive configuration utilities. Even so, the sheer number of PC peripherals vendors has made management more and more arduous. Hence

Plug and Play becomes vital, and its absence has stalled wider acceptance of Windows NT.

The Macintosh has long been blessed with true plug and play and easy configuration (possibly due to less nonproprietary hardware). But with the growth of a clone Mac market, this could become an issue. Copland's hardware abstraction scheme, which organizes device drivers into related families, will maintain some discipline while still allowing third-party vendors to differentiate their products.

NETWORK CONFIGURATION

As networks grow, an administrator must get help from the OS to remotely configure systems and share configuration changes. Windows NT centralizes user management onto a single primary domain controller. But if network growth requires multiple domains, it becomes a beast. Microsoft's plan is to organize multiple domains into a tree structure like that of archival Novell's NetWare Directory Service (NDS). Future versions of NT will also support multiple master domain controllers, giving remote branch offices connected via WANs more independence while still maintaining system coherence. Microsoft also plans retooled directory services to simplify managing mixed networks by unifying log-in and administration procedures. The Open Directory Services Interface (ODSI) is intended to do for directory services what Open Database Connectivity (ODBC) does for database access: make it vendor-independent.

DISTRIBUTED OBJECTS

Unix vendors, under the Object Management Group (OMG), have spent several years on the Common Object Request Broker (CORBA) standard for different systems exchanging objects. OMG recently settled on Sun's Universal Networked Objects as the standard for remote interoperability and on OpenDoc as the compound document model for CORBA 2.0. This conflicts with Microsoft's own proprietary Distributed Common Object Model (DCOM) and ActiveX. To complicate matters, Sun's Java Component Architecture offers a way for Java components to talk across the Net. Sun's approach is backed by Netscape's 38 million copies of Navigator, which is ready to accept Java-based plug-ins. Netscape is cooperating with OMG to make Internet Interoperable ORB Protocol (IIOP) the unifying technology for Internet objects in all its future Web browsers.

This seems to have panicked Microsoft into a compromise: It will hand over its ActiveX object technology to a customer-driven open standards body (a first). So perhaps customer pressure might finally force a convergence of object standards.

64-BITNESS

Unix vendors worry how Microsoft and Apple plan to push Intel and the Mac further into traditional Unix domains. The Unix

solution is to move up to 64-bit OSes (see "Unix Leads the 64-bit Charge" on page 139). Microsoft has only just started offering PC users a fully 32-bit OS: NT, not the 16-/32-bit hybrid that is Windows 95.

The main attraction of these next-generation OSes is that you can access more memory through 64-bit addressing. A 32-bit address space allows up to 4 GB of memory. Until recently, most users have regarded gigabyte memories as quite enough (if not pure fantasy), but the rise of client/server computing has us contemplating servers that cache huge databases entirely in RAM to speed up access rates. Gigabytes of memory suddenly makes sense as a giant disk cache. And a 64-bit address bus and OS can access up to 18 billion gigabytes.

Windows NT already runs on DEC's 64-bit Alpha chips. To push NT as a server OS, Microsoft needs to let Alpha users fully exploit its 64-bitness, or Unix may tempt them away. However,

the lack of 64-bit applications, plus Intel holding 64-bit addressing for its next-generation Merced chip, means that this is not a top priority for Microsoft, or most of its users, just yet.

WHERE FROM HERE?

If you're a Unix user, you just have to choose when or if you'll move up to a 64-bit version. If you really need the huge address space of 64 bits, you probably already know it. Similarly, the question for a Macintosh user is not whether

you need Copland but rather how soon you can get it. If your graphics work involves high-resolution rendering, then you need the assistance of multiprocessing now. Because many Mac tools are being ported to NT, it's becoming a race: The longer Copland takes to deliver SMP, the more alluring are the cheaper hardware and existing SMP of NT.

Windows users face the most uncertainty. For intranets, you could use NT, NetWare, or Unix for the server OS, and any of a dozen choices for your Web servers. Microsoft's new Internet orientation might affect your plans in several ways. The next NT shell—with integrated Internet Explorer—is currently in beta; it presents an "HTML everywhere" desktop that can display live Web pages. Even the Windows Help file format abdicates to Hypertext Markup Language. Visual Basic's current incarnation is temporary, as its forms engine is not based on HTML. Planning to invest in a hypertext or document management system that doesn't involve HTML? Think hard.

Most important, though, you must decide whether Microsoft can make the more ambitious features of the Cairo project work and, if so, when. OS developments are exciting to watch, but excitement may not be what you want when it comes time to making decisions. If you can do it, waiting for the dust to settle may be the best strategy for the next few months. **B**

OS Features Checklist			
	NT	Copland	64-bit Unix
Symmetric multiprocessing support	✓	✓	✓
Protected-mode kernel	✓	✓	✓
Per-process memory protection	✓		✓
Preemptive task scheduling	✓	Not for legacy code	✓
Multithreaded execution	✓	✓	✓
Automatic hardware detection	✓	✓	
Component architecture	ActiveX	OpenDoc	Various
Extensible OS kernel		✓	Rebuild
64-bit address space			✓
Fault-tolerant file system	✓		Some
✓=yes			

Dick Pountain is a long-time BYTE contributing editor who lives in London. You can reach him at dickp@bix.com.

Microsoft Windows NT Workstation 4.0

has the ease of
It has the power
It has

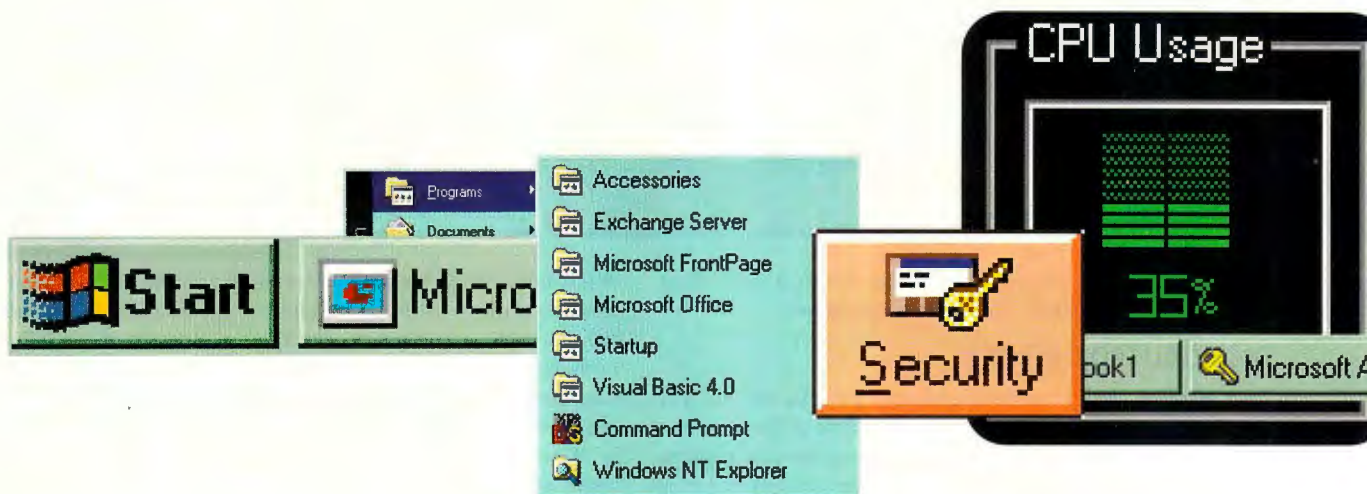

Windows 95. of Windows NT. computers everywhere drooling.

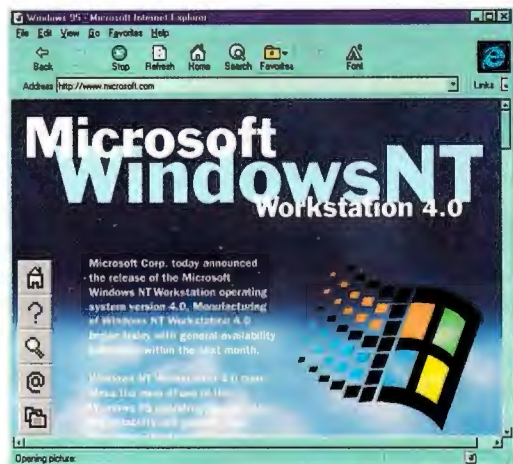
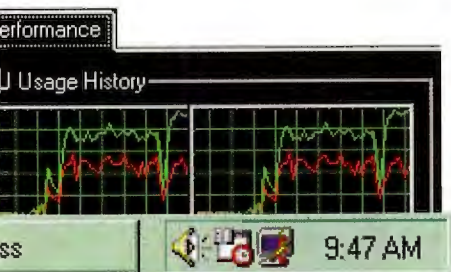

The new **Windows NT® Workstation 4.0** operating system has been designed to be the most powerful desktop operating system. And because all that power is controlled by the **Windows® 95 interface**, it's much easier to use. The total **32-bit power** of Windows NT Workstation means reliability, security, and easy access to the Internet and **intranet**. It's reliable because all applications run in their own memory space — so that new game beta won't crash last week's work. It's **secure** because integrated features let you **lock your system** all the way down to the file level, so you can count on applications and data being safe.

It's Internet-ready because it's loaded with built-in features like **TCP/IP**, the **Microsoft Internet Explorer** browser, and integrated **Peer Web Services**, which lets you create a small intranet for your workgroup. And because it's all controlled by the Windows 95 interface, you can customize your system to work and look however you like. So does all this mean Windows 95 is history? Absolutely not. Windows 95 may still be your best choice, depending on your existing hardware and applications. We suggest you dive headfirst into our Web site to compare and contrast operating systems to see which 32-bit desktop is best for you.

Microsoft®

Where do you want to go today?™ www.microsoft.com/ntworkstation/

WHAT DO LOCKHEED AND THE WEATHER CHANNEL HAVE IN COMMON?



THEY USE THE HIGHEST PERFORMING MULTI-PORT COMMUNICATIONS BOARD IN THE INDUSTRY!

When these companies were looking for speed, reliability, affordability, and ease of use for remote access and peripheral control, they chose a Control serial communications board.

Control's **RocketPort** is the industry's fastest controller. **Twice the speed of Digi's Accelport.** This breakthrough performance is achieved by putting eight ports and a RISC processor onto one chip.

Using this technology, internet access speed can be increased 16x from 28.8 Kbps to 460 Kbps full duplex across all ports.

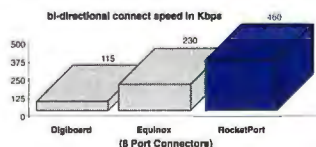

Control's software drivers and technical support make it **easy to switch**. We provide drivers for Novell Network Connect, Multiprotocol Routing, Windows NT RAS, UNIX,

OS/2, and Linux. If you are already using one of these drivers, all you need to do is install your **RocketPort** card. I/O mapping eliminates memory conflicts and allows plug and play compatibility. **RocketPort** also gives you **30 times faster** processing! This host CPU efficiency allows you to add more ports or free up valuable CPU time.

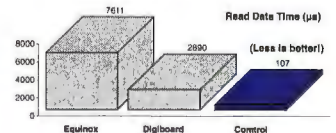

For your additional needs, our technical experts are just a phone call away to give you step-by-step instructions.

See for yourself! Call 1-800-926-6876, e-mail us at info@control.com, or look us up on our website: <http://www.control.com>. Control provides a 5 year limited warranty and a 30 day risk free trial for all products.

Get the best board at half the cost and personalized support from the company that created the multiport industry in 1982 — the only company with 14 years of experience...Control.

Circle 215 on Inquiry Card.



©Control Corporation, 1996



Unix Leads the 64-bit Charge

64-bit OSes are moving from the horizon to your desktop. And you get the benefits.

By Laurent Lachal

Computer technologies march relentlessly to the rhythm of bigger and faster. CPU clock speeds, which once seemed fast at 33 MHz, now push past the 200-MHz mark. Similarly, OSes that gave us a speed boost with 16-bit architectures now are evolving to 64-bit technology to meet the demands of processor-hungry applications, such as data warehousing and virtual reality (VR).

But if you're not setting up an on-line transaction-processing (OLTP) server, how much can you really benefit from today's 64-bit versions of Unix or tomorrow's 64-bit Windows NT or Mac OS? In reality, the added capabilities of 64 bits are narrow in scope. The most significant changes affect process and file management and memory capacities. The 64-bit transition leaves reasonably untouched such aspects of OSes as *concurrency* (where multiple applications share resources), scheduling, and security.

The answer to how you can benefit from a 64-bit OS ultimately depends on what applications you are running, whether your hardware is tuned for 64 bits, and whether your system has the massive amounts of memory needed to take advantage of the architecture. In the end, the possible advantages of 64-bit technology come in shades of gray, not the relatively black-and-white distinction that defines the performance differences between 16- and 32-bit systems.

Faster Number Crunching

Process management benefits from 64-bit OSes because the OS kernel executes larger instructions that can do more processing

per cycle. The kernel can also manipulate 64-bit integers to give applications faster, more complex number-crunching abilities.

This increased processing capability goes hand in hand with an exponential growth in the memory (virtual and real) that's addressable by each process. A 64-bit memory space can now address a maximum RAM of 2^{64} bits—or more than 18 billion

GB—compared to the mere 2^{32} bits (4 GB) possible for 32-bit OSes.

More and Larger Files

Virtual memory enables an application to use RAM as a disk cache. In turn, a larger disk cache is necessary with 64-bit OSes because not only can they handle a larger number of files, but they can accommodate much larger ones. Vendors are starting to speak in terms of terabytes—not just gigabytes—of data. Data handling among the CPU, memory, and hard disk improves with 64-bit registers because the registers not only enable the system to move data around more quickly but can also reference a larger number of data chunks.

You don't need a 64-bit OS just to handle 64-bit-long integers, manage large files, or get yourself more memory. After all, you can use several 32-bit instructions to

come up with a 64-bit operation, split large files into more manageable ones, use a parallel design for multiple storehouses of memory, or opt for a large block of memory residing on a hard disk. However, 64-bit OSes are certainly the most straightforward technology for achieving these capabilities.

Beyond these general benefits, 64-bit OSes have distinct implications for desktop systems and servers. Desktop applications



will be able to exploit 64 bits to provide Nintendo-like graphics—first for 3-D-based programs and then for VR-based ones. Advanced GUIs are already available: Computer Associates' flagship management tool, CA Unicenter TNG, sports a new VR interface.

On the server side, the very-large-memory (VLM) capability of 64-bit OSes will first attract developers in specialty areas, such as video on demand. The technology will then appeal to more mainstream OLTP and data-warehousing applications developers. Microsoft has pointed to credit-card transaction-authorization databases and worldwide reservation-system applications for its long-range move toward 64-bit NT.

DBMS vendors and, increasingly, business-applications vendors say they will use 64-bit architectures to develop leading-edge technology and support their large corporate customers. Similarly, Unix vendors have jumped on the 64-bit bandwagon, partly because it's a way to keep Microsoft's NT development team on its toes (prompting Microsoft's vague public comments about 64-bit technology being in NT's future). Unix vendors might also find themselves in a battle to keep up technologically with the "Joneses": namely, 64-bit pioneers Digital Equipment and Silicon Graphics.

The Impact on Applications

Overall, 64-bit technology should have little impact on the fundamental architecture of applications, since programs are discrete and rather small data structures. However, applications will benefit from the following.

64-bit high-speed I/O: Commercial applications that shift data rather than just massage it can take advantage of the capability to boss around larger chunks of data more quickly. Devices that require improved I/O, including Nintendo's latest game station, QMS's printers, and Cisco's routers, also have the ability to exploit 64-bit technology.

64-bit logical/arithmetic operations: These operations increase the performance of "rocket science" applications based on complex data calculations, including satellite-imaging, weather-forecasting, technical-modeling, genetic-research, and simulation applications. Graphics also inherently benefit from high-speed calculations and extended

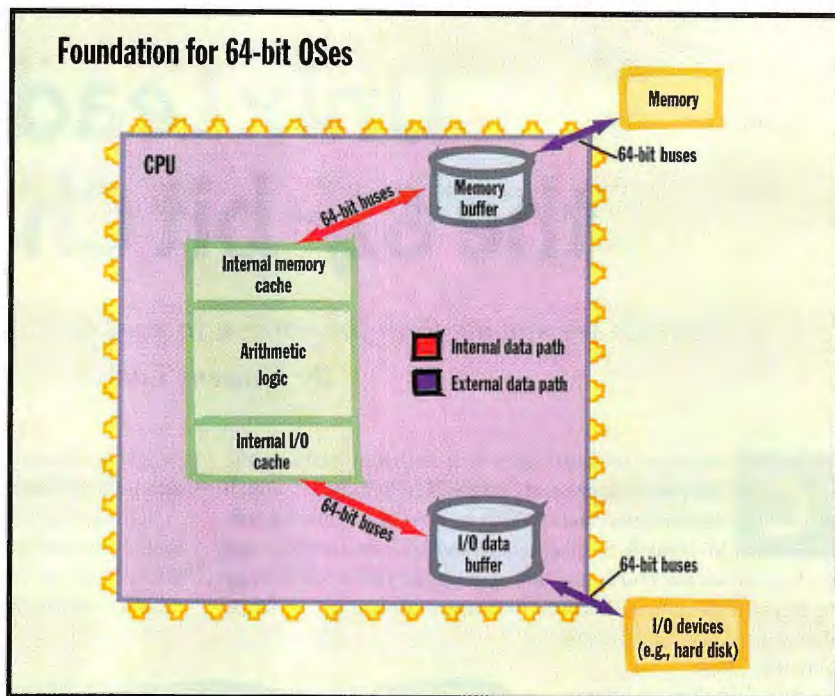

To deliver performance improvements over 32-bit systems, 64-bit OSes need CPUs with 64-bit data buses for memory and I/O.

memory capacity, as they are essentially continuous large data structures modeled discretely. In addition, 64-bit virtual addressing gives a boost to OLTP and data-warehousing applications, as well as more technical applications, such as computational fluid dynamics. All these types of applications require large amounts of memory.

Large files: This is a gain for all types of applications, as new features expand software and consume the ever-increasing hard disk space.

OS vendors are promising unified APIs and more advanced compiler technology for software developers who will need to write code for 64-bit OSes. Unix developers in particular will probably be the first to have a unified 64-bit Unix API that will enable 64-bit applications to run on any of the various versions of Unix that support 64-bit architectures.

You shouldn't expect an end to divergent APIs for 64-bit Unix, although we can certainly hope that the number of different APIs will be diminished. An interesting twist to the Unix tale is that the intricacies of 64-bit OSes are likely to lead to fewer versions of Unix as the smaller Unix vendors rally to the bigger ones, such as the Hewlett-Packard/Santa Cruz Operation team, which promises to deliver

a super 64-bit OS sometime during 1998.

How will OS vendors migrate from 32- to 64-bit applications support? Each designer team might take a different approach. For instance, Digital chose to skip 32-bit applications support, but it released a 32-bit translator for Ultrix and VMS to 64-bit Alphas. Sun pledges 100 percent binary compatibility between its 32-bit and 64-bit architectures.

Better Compilers

The same Solaris binary source will run on 32- and 64-bit systems, so it won't require the recompiling of 32-bit applications. However, this feature will come in handy only for a while, as recompilation is ultimately the only way to produce executables that use the full capabilities of 64-bit OSes. This process in turn requires sophisticated compilers that will be critical to the competitive edge of 64-bit OS vendors.

Even with a good 32-to-64-bit porting environment, there's still the question of which applications would benefit most from a conversion from 32 to 64 bits. The extra 64-bit coding is difficult to master and can actually decrease performance if the application doesn't have the ability to take advantage of the extra power delivered by the 64-bit OS.

WHAT 64 BITS BUYS YOU

Feature	Benefit vs. 32-bit OSes	Best Applications
Larger files	Can process terabytes of data (vs. megabyte-size files).	OLTP; data warehousing; high-end graphics; processing-intensive applications; general business applications.
Greater RAM	Memory can be a maximum of 18 billion GB (vs. 4 GB).	OLTP; data warehousing; high-end graphics.
Faster processing	Can handle more calculations faster.	High-end graphics; processing-intensive applications.
Faster I/O	Access times between main system and peripheral hardware are shortened dramatically.	High-end graphics; general business applications.

Unix Pushes the 64-bit Envelope

Digital Equipment's Unix, IBM's OS/400, and Silicon Graphics' Irix are the only full 64-bit OS environments available today. Siemens' Reliant Unix (the merger of Siemens' Sinix and Pyramid's DCOSX) should ship by the end of the year.

Other OS vendors have opted for a piecemeal approach. For example, Sun's Solaris already supports 64-bit extended-precision arithmetic and large files, which can both benefit from CPU-specific instructions to speed up networking. You can expect Solaris to handle file sizes up to 1 TB in 1997 and to become a full-featured 64-bit OS in 1998, with a 64-bit kernel and 64-bit virtual addressing.

When will Microsoft deliver a 64-bit OS? Last June, the company promised that Cairo would support 64-bit very large memory (VLM) for applications needing more than the 4 GB of memory addressable with 32-bit systems. But the rollout of Cairo continues to be a fuzzy target (see "Unearthing Cairo" on page 145).

VLM will most likely show up in Digital's Unix for 64-bit Alpha systems, which already can potentially provide 14 GB of addressable storage. This memory space will soon increase to 28 GB—significant, but still a long way from an 18-billion-GB addressable with a true 64-bit OS.

This is why software developers have not started to 64-bit-enable their applications en masse, as few of these packages actually exceed the capacity delivered by 32-bit systems. Indeed, 64-bit technology is likely to come hand in hand with market education; this way, companies will be able to avoid repeating the mistake that Intel made when people realized that the Pentium Pro boosts 32-bit-application performance but delivers poor 16-bit-application speed.

64-bit Technology vs. Parallelism

As important as 64-bit technology is, it's only a small part of some larger changes that are currently taking place in OS devel-

opment. One trend is the fragmentation and modularization of OSes, which will confine the hardware-specific portion of the OS code to a small microkernel. Another trend is the adaptation of de facto standard OSes to parallel environments—specifically, symmetric multiprocessing (SMP), a shared-disk architecture; massively parallel processing (MPP), a shared-nothing architecture; and clustering.

The advent of 64-bit architectures is interwoven closely with the various approaches to parallelism. Both technologies benefit from the R&D and marketing muscle of vendors of relational database management systems (RDBMSes). These companies are employing 64-bit technology and parallelism to support next-gen-

eration RDBMS products, such as content management systems (CMSes), which handle structured and unstructured data alike. (According to one study, reported in the May issue of *European Software Markets Service*, CMSes will represent 28 percent of the total European database market by the year 2000.)

Cost vs. Speed

The best mix of 64-bit technology and parallelism, however, is unclear. "There's no easy answer," says Oracle marketing director John Spiers. "You have to balance cost and need, since infinitely fast is also infinitely expensive."

Indeed, the RAM needed to hold gigabyte-size databases does not come inexpensively. For instance, 4 GB of memory costs hundreds of thousands of dollars, compared to just a few thousand dollars for installing an extra processor in a parallel system. On the other hand, according to Jean Jacques Pairault, senior consultant of R&D strategy at Groupe Bull, you get a decreasing performance boost with each added processor. The alternative—a complete 64-bit system with a lot of memory—yields increased performance over 32-bit systems.

Vendors are unsure about how these technologies will improve your life. "Parallelism boosts performance in all situations, while 64-bit OSes help mostly in read-only situations, such as data warehousing," says Arthur Hochberg, European marketing director for Informix. On the other hand, "the large-memory approach is more relevant to OLTP than to data warehousing, where databases have grown too large for current hardware platforms," explains Spiers.

Alternatively, 64-bit technology may not be the most important issue. "At the high end, where people concentrate more on scalability than on large memory size, [the emphasis is on] solutions that combine parallel systems with advanced disk-storage technology," explains Jon Barnes, RS/6000 hardware product manager at IBM U.K.

The debate goes on. For the moment, the combination of 64-bit and parallel technologies will prove more beneficial to SMP than to MPP and clusters. Why? First, a 64-bit address space dramatically improves the scalability of SMP systems. Second, both technologies address different bottlenecks: SMP addresses a processing-power bottleneck, while 64-bit

WHERE THE AEROSPACE

The Aviation Week Group: Print for every professional in global

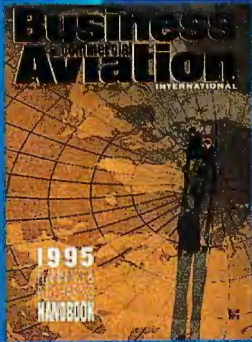
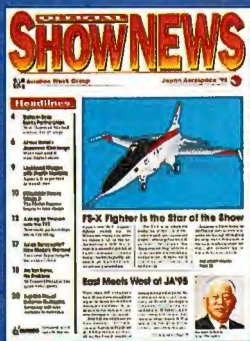

WORLD TURNS FIRST

and electronic products
aviation and aerospace

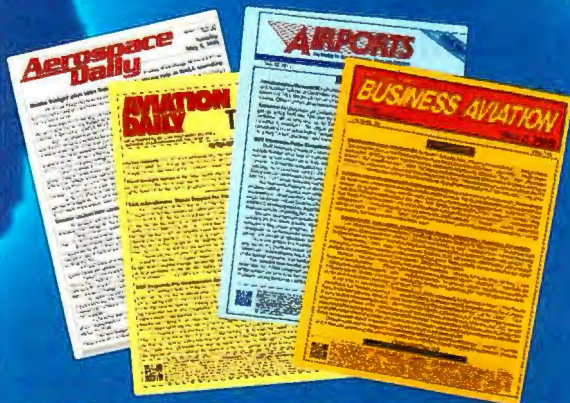

AW Group Electronic Products

AWG on CompuServe	Aviation/Aerospace On Line
Aviation Week Video	AW&ST Friday Radio Alert/WTOP-Wash., DC
WAD CD-ROM	LIFTOFF!

Aviation Week Group publications and electronic products comprise the most extensive family of leading information services in the global aviation and aerospace industry. Every publication is the leader in its market.

Whatever your professional affiliation with aerospace, you'll find magazines, newsletters, directories, conferences and electronic media ready-made to serve your specific information needs. Information when you want it, in the format of your choice.

If you are an advertiser, you'll find the Aviation Week Group has the media to match your markets. Civil, Military, Space — Technology, Business, Operations.

Aviation Week Group: 1 million+ readers
140+ countries

CONTACT US TODAY FOR MORE INFORMATION.

SUBSCRIPTIONS
TEL: 1-800-257-9402
FAX: 609-426-7087
(OUTSIDE U.S. CALL 609-426-5526)

ADVERTISING
TEL: 212-512-3084
FAX: 212-512-4225

AVIATION WEEK GROUP

memory reduces the processor-to-disk bottleneck.

Software developers are likely to postpone implementation of MPP, which requires a real architectural revolution, in favor of SMP, which is much closer to non-parallel systems. "For people who require very high throughput, the real battle will be between 64-bit technology and clusters," says Julian Lomberg, Solaris product manager for Europe. The cost/performance ratio currently favors clusters, due to the huge cost of memory.

In the long run, we will see tighter integration of 64-bit and parallel systems, for two reasons. First, parallel-systems vendors are moving, albeit slowly, toward an architecture that combines SMP and MPP. Second, the data-warehousing and OLTP markets are converging as demand emerges for read/write analytical databases, where decisions from analytical work automatically feed into changes to production data.

Technology Mix

Very few of the 64-bit-enabled hardware platforms that are currently shipping actually sport the huge memory capabilities that make a real performance difference. Digital acknowledges that only about 30 percent of its 2000 64-bit Turbo Laser systems sold during their first 15 months of release have shipped with enough memory to actually benefit from the VLM capability of Digital Unix.

But standard Alpha configurations may soon ship with substantially more memory, according to Pauline Nist, vice president for Alpha Server operations. "DRAM prices collapsed by over 60 percent in mid-1996," she says. "Digital responded with a midrange server, capable of 8 GB of RAM, that started shipping in June." Bill Reed, advanced technology consultant for IBM's AS/400 business, predicts that by the end the century, AS/400s

Hardware Platforms with 64-bit Muscle

What hardware is available to support 64-bit OSes? All the leading RISC architectures currently use 64-bit designs. Intel's Pentium processors use 64-bit arithmetic operations and internal data paths. We expect that its successor, dubbed Merced, will be a full-blown 64-bit architecture.

Processor designers are further along in embracing 64-bit architectures than are OS developers. Today, there are 64-bit implementations for CPUs and for the data buses that interconnect the main processors with memory and I/O modules. Many data buses are 64 bits (or wider) to keep up with the CPUs that first implemented 64-bit arithmetic operations (i.e., load and store, and then add and multiply). The buses first arrived with a 64-bit internal data path and then moved on with a 64-bit external data path and 64-bit addressing. The latter enhancement enables CPUs to talk directly to 64-bit-wide memory.

All this lane-widening helps the CPU shuffle and process more data per cycle than in 32-bit systems. However, 64-bit architectures aren't the only way to boost CPU performance. Other performance enhancements include larger caches, higher clock speeds, more compact silicon wafers, and technologies such as very long instruction word (VLIW) for fewer but more complex instructions per cycle.

Six for 64

The following companies now offer 64-bit RISC processors.

Company	Processor platform
Apple/IBM/Motorola	PowerPC
Digital Equipment	Alpha
Hewlett-Packard	PA-RISC
IBM	AS/400
Mips	Rx000
Sun	SPARC

will ship with at least 40 GB of memory and more than 50 TB of disk space.

Performance First

In the meantime, we need to closely watch how software suppliers take advantage of the underlying technology and see whether they implement 64-bit technology or parallelism, says Hochberg. But David Hughes-Solomon, director of technology at the client/server powerhouse SAP, believes end users don't care whether

their systems use a 32- or 64-bit OS. "End users are mostly concerned about how well an application performs, especially on a large scale. If it can deliver, then they look at the price and decide," he explains.

In the same way that most PCs consist of a mix of elements running at various speeds and bandwidth capacities (e.g., 128-bit memory buses, 64-bit graphics accelerators, and 32-bit processors), we will probably see a mix of 32- and 64-bit OSes, hardware, and applications. "Three to five years," reasons Hochberg, "seems a reasonable time frame for 64-bit technology to permeate the high end of the market, while 32-bit technology will keep on satisfying the bulk of the market for the foreseeable future." **B**

WHERE TO FIND

Digital Equipment Corp.
Maynard, MA
(508) 493-5111
fax: (508) 493-8780
<http://www.digital.com>

Groupe Bull
Louvenciennes, France
+331 3966 6060
fax: +331 3966 6062
<http://www.bull.com>

Hewlett-Packard
Palo Alto, CA
(415) 857-1501
fax: (415) 857-5518
<http://www.hp.com>

IBM
Old Orchard Road
Armonk, NY
(914) 765-1900
<http://www.ibm.com>

The Santa Cruz Operation
Santa Cruz, CA
(408) 425-7222
fax: (408) 458-4227
<http://www.sco.com>

Silicon Graphics, Inc.
Mountain View, CA
(415) 960-1980
fax: (415) 390-6220
<http://www.sgi.com>

Sun Microsystems, Inc.
Mountain View, CA
(415) 960-1300
fax: (415) 969-9131
<http://www.sun.com>

Laurent Lachal, a consultant specializing in IT, is editor of European Software Markets Service, a quarterly publication that analyzes OSes, applications development tools, business applications, and database management systems. You can contact him at editors@bix.com.

Unearthing Cairo

The next version of Windows NT will flex its enterprise muscle by incorporating features from "Cairo."

By Mark Minasi

At the first NT developers conference in 1992, Bill Gates announced that Cairo would arrive in three years and would incorporate object-oriented technologies, especially an object file system. Since then, we've seen Windows NT 3.1, NT 3.5, NT 3.51, and most recently NT 4.0. None is object oriented, none has an object file system, none is Cairo. It seems that Cairo is Microsoft's sly way of promising the world. "Will we see Plug and Play in NT?" "Oh yes, of course, in Cairo." "Will NT ever produce world peace and cheap antigravity?" "You bet—in Cairo."

What is becoming apparent is that we'll never see Cairo as the manifestation of Microsoft's next-generation operating system. But much of the development work that went into the Cairo project will see the light of day. Indeed, some Cairo features have already been bolted onto NT 4.0, and others may be slipstreamed into interim NT releases or will appear in the next major release of NT sometime in 1997 or early '98. Either way, don't expect to see a shrink-wrapped box of Cairo at your corner software store.

For its part, Microsoft is framing its course correction in the best possible light: Cairo isn't an OS, it's a set of technologies. What does this mean for current NT users or for those people who are contemplating a switch? Here's a rundown of the Cairo features you can expect to see in future versions of Windows NT.

Networking Enhancements

Windows NT will continue to be Microsoft's "enterprise" OS as the company tries to push into large corporations and pry data off mainframes and Unix machines and onto PCs. To that end, the company has partnered with companies such as Digital

Equipment to gain access to big-iron IS managers. But NT is developing a reputation more as an excellent OS for workgroup servers than for enterprise-level systems. Thus, one of Microsoft's missions is to instill NT with more enterprise character. To do that, Microsoft must refine how NT handles domains. NT's domain structure looked wonderful when compared to NetWare 3.x's server-based bindery, Novell's term for a server's list of recognized users. Unfortunately, domains pale as an enterprise structure beside NetWare 4.x's NetWare Directory Service (NDS).

That's because NT currently lets you centralize the lists of user accounts for a number of servers on one single server—kind of a security server—called a *primary domain controller*. Taken together, these servers constitute a domain, in Microsoft parlance. (NT allows you to establish "backup" domain controllers as well.) If you've got 50 servers in that domain, then you have to build your company's users only on one server rather than having to rebuild them 50 times, once on each server. But NT-based enterprise networks become clumsy when a second domain appears, which requires administrators to manage interdomain security treaties called *trust relationships*. The number of these relationships can easily

grow to become almost unmanageable. For example, six domains require 30 trust relationships, but in organizations with 50 domains, the number of relationships soars to 2450.

One of Microsoft's main development efforts will be to reply to NDS. Instead of having to create dozens of domains, and then having to establish hundreds of trust relationships among them, you'll probably be able to create "trees" of domains. While Microsoft hasn't released much information about this change,



we expect to see a domain tree notion that sounds suspiciously like Novell's directory trees in NDS. In fact, Microsoft has recently taken to calling its current domains-and-trusts model Microsoft Directory Services, or MDS.

Additionally, NT's current notion of one primary domain controller and a collection of subordinate domain controllers may give way to multiple master domain controllers, a great boon to maintaining geographically widespread domains. Currently, it's possible (and convenient) to put a backup domain controller in a branch office. That backup domain controller can authenticate network log-ins, so users in the branch office needn't wait for their log-ins to occur over the slower WAN links to the primary domain controller. In fact, the WAN link can be down altogether and users can still log on through the backup domain controller.

What users *can't* do now is change anything about their accounts: passwords, groups they're members of, etc. They can do that only if they're connected to the primary domain controller. The multiple master domain controller model would mean the domain controller in the branch office could handle changes locally, reconciling them with the other domain controllers when the WAN link comes back up.

The Cairo Internet

Two pillars of Microsoft's Internet strategy, the Dynamic Host Configuration Protocol (DHCP) and the Windows Internet Naming Service (WINS), will also see changes in future versions of NT. DHCP is a system that greatly simplifies installing IP addresses and TCP/IP configuration information on a new PC. DHCP allows you to create a server that hands out that configuration information. The problem is there's no simple way to provide fault tolerance for the server's function—it's not acceptable to have two DHCP servers on a network handing out IP addresses from the same pool of addresses. The Cairo development effort is working to change that: DHCP servers will be able to replicate among themselves so that if one goes down, the others know what that server was doing.

WINS, Microsoft's server-based "naming" system, supports NetBIOS-based programs (like Microsoft's own network redirector). And it provides translations between human-friendly names like

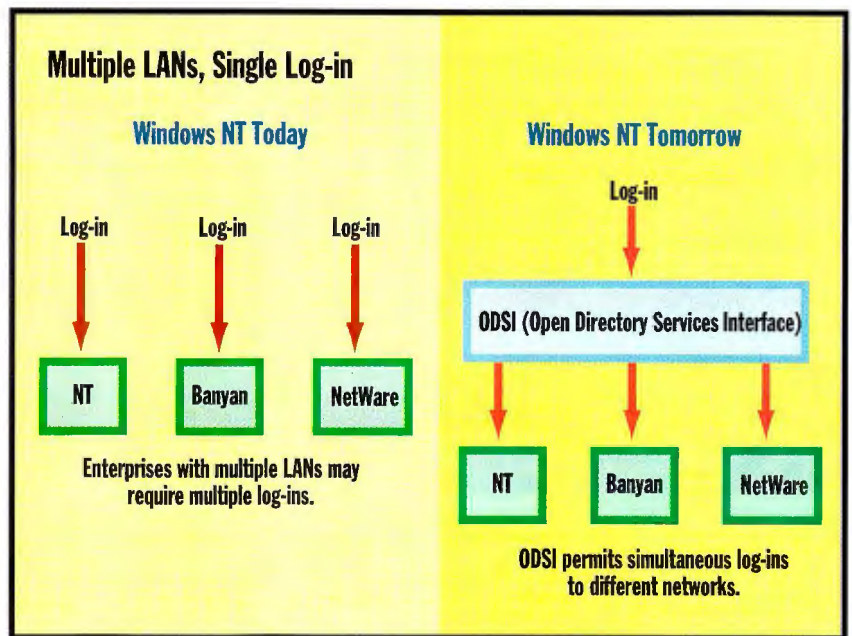

Open Directory Services Interface (ODSI) can support unified log-in and administration tools for a variety of network operating systems.

"Bigserver" and the necessary IP addresses like 210.32.11.87. The problem with WINS is there already is an Internet standard called the Domain Naming System (DNS) that handles this chore. NT-based Internet servers must run both WINS and DNS, and they must somehow persuade the WINS server to share its knowledge with the DNS server. The Cairo approach does away with WINS altogether by wedding DNS and WINS into something called Dynamic DNS, which reportedly is working its way through the request-for-comment process now.

What's more, Services for NetWare (the new name for the combined File and Print Services for NetWare and the Directory Services Manager for NetWare) will include NDS support, something even the NT 4.0 version of Services for NetWare lacks. The Microsoft networking client will include client-side support for the Lightweight Directory Access Protocol (LDAP) as well. Microsoft's big push for creating unified log-in and administration tools sits atop its support of Open Directory Services Interface (ODSI). A user control tool like the User Manager would sit atop an ODSI layer; there would be ODSI drivers for NT, Banyan, NetWare, or other networks. This ODSI-dependent User Manager would handle user accounts for each of those network operating systems. Similarly, an ODSI-based log-on could

perform simultaneous log-ins to different networks (see the figure "Multiple LANs, Single Log-in").

Desktop Enhancements

While the enterprise is important, Microsoft also has to battle for corporate desktops. First and foremost is Plug and Play support. This is essential if NT's going to be a simple-to-use OS, given today's PCs and the market's embracing of the PCI bus. PCI's great for its speed and flexibility, but it is nightmarish to try to set IRQs, DMAs, and memory addresses on PCI-based machines, which typically don't give you a way to control what resources your PCI add-in cards claim. Plug and Play gets rid of these problems.

So, why wasn't Plug and Play in Windows NT 4.0? According to NT product manager Andrew McGehee, Microsoft just didn't have time. While Plug and Play may be simpler on Intel platforms, putting it into Mips, PowerPC, or Alpha systems is tough and will require some development support from hardware vendors.

Microsoft is also working to make drivers for hardware easier to come by. The company will merge the driver models of Windows 95 and Windows NT. Because drivers for 95 and NT are now different, board vendors without large programming staffs often end up ignoring NT driver development or staying in "perpetual



Ministry of
Economics,
Technologie and
Transport
Nordrhein-Westfalen
Germany



GERMAN INNOVATION

Creative concepts begin in your head.
Our raw material is our know-how, our
capability to connect things. And that's how
precision solutions and products for the
challenges of tomorrow come about.

We in NRW, where innovation is tradition.

Comdex, Las Vegas, Sands Expo & Convention Center
18. - 22. November 1996 Upper Level, Stand S3666/S3966

Toll free fax back: 1-800-700-8247 ext. 400



made
in
Germany

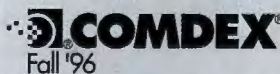

<http://www.byte.com/vpr.htm>
scan for: nrw.



Circle 222 on Inquiry Card.

Departmental or Internet Server...

Rack Mount or Tower SPARC 5/20 from Rave.

Now, An Exclusive SPARC™ System Not Available From Sun!

**ENGINE BY SUN,
BODY BY RAVE**

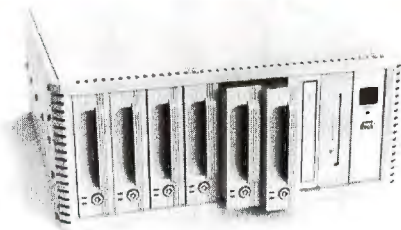

- 36GB internal hard disk capacity
- supports up to 8 internal devices
- SPARCstation 5 or SPARC-station 20 motherboard
- single, dual or quad processors
- Solaris® 1.x or 2.x operating system compatibility
- RAID-capable

Circle 220 on Inquiry Card.

The POWER Tower or Rack incorporates the flexibility of Sun's M-Bus or microSPARC™ II technology into a Rave POWER Rack or POWER Tower solution.

The POWER Tower or Rack provide easy front access for eight internal devices to simplify resource management for Firewall, Telco, Internet, Network Management and other servers. Sun original system boards in Rave exclusive chassis' optimize power and convenience for the real world enterprise.

Rave Computer Association, Inc.

36960 Metro Court • Sterling Heights, MI 48312

Fax: (810) 939-7431 • E-Mail: info@rave.com

1-800-966-7283

<http://www.rave.net>



All SPARC trademarks are registered trademarks of SPARC International, Inc. Products bearing SPARC trademarks are based upon an architecture developed by Sun Microsystems, Inc.

Cairo Inside

An object-oriented, next-generation operating system called Cairo may never ship. However, future versions of Windows NT will enjoy the fruits of the Cairo development effort.

Cairo Technologies

Microsoft Directory Services

Dynamic Host Configuration Protocol (DHCP) servers will replicate among each other.

Replace Windows Internet Naming Service (WINS)

Client-side support for the Lightweight Directory Access Protocol (LDAP)

Support for Open Directory Services Interface (ODSI)

Plug and Play support

Merge Windows 95/97 and Windows NT driver models

Bookmark API

Object File System

Power management

What They Do

Refine how NT handles domains; may use a tree structure à la Novell's NDS for creating one primary domain controller with a collection of subordinate domain controllers.

If one DHCP server goes down, another server will be able to take over.

Successor will wed WINS with Domain Naming System (DNS), the existing Internet standard for translating human-friendly server names and the necessary IP addresses.

Provides a low-overhead way for clients to access X.500 directory services.

Creates unified log-in and administration tools for enterprises with a variety of network operating systems.

Simplifies installation of peripherals that use the PCI bus.

A boon for NT users who often have to struggle to find appropriate drivers for their OS platform.

Restores the screen and PC state to where they were when you shut down the system.

Lets you create a pseudodirectory that unifies local, network, and Internet files.

Resource efficiency for laptop users.

beta" stage. Microsoft will also try to simultaneously ship Windows 97 and a new version of NT next year. The two OSes will still be quite different, but they'll use identical drivers for sound cards, video boards, network cards, and the like. Hardware vendors will all want to support Win 97, so there'll be tons of drivers for Cairo: a bonanza for NT users.

UI Updates

The NT user interface, which went to the Windows 95 style in version 4.0, will continue to evolve. Expect to see the "Nashville" version of the Explorer, which integrates a Web browser and a disk browser. This may appear before the next major edition of NT, perhaps as part of a service pack.

An interesting rumor, and potentially the most important UI improvement, is the Bookmark API, a set of programming extensions for the UI. Here's how it would work: You shut down NT

You Don't Have To Use Brute Force To Make Sure Users Pay For Their Software.



FLEXIm® *The Elegant Solution*

You don't have to use the brute force of a baseball bat – or dongles for that matter – to make sure only licensed, paying users have access to your software. There's a much more elegant and cost-effective solution: FLEXIm from GLOBEtrotter.

The De Facto Standard

FLEXIm is bundled in over \$15 billion of installed UNIX™ and Windows™ software products, making it the *de facto* standard in license management. And in 1995 alone, FLEXIm was used to ship over \$3 billion in software licenses over the Internet. That makes it the *de facto* standard in electronic commerce for software, too.

Even Works With Dongles

If you still want to use dongles, FLEXIm significantly reduces the number you need at a customer site by allowing low-cost dongles to be used as “network dongles,” and by sharing dongles across different products.

Your Customers Will Like It

In an independent survey, users preferred FLEXIm eighteen-to-one over other license managers. And all of us know customers really don't care for dongles. With FLEXIm, your customers benefit from:

- Floating licenses – allowing licenses to be shared over a network, while fairly compensating the vendor with a higher price per license.
- Fully functional evaluation software while the vendor knows the software will stop after a specific date.
- Built-in license compliance – customers don't need to buy expensive license metering utilities to verify they comply with vendor license terms.
- Installing software where it is most appropriate from a hardware or administration perspective, while protecting your software.

Windows, UNIX and Java

If your company develops products on multiple platforms, you should know FLEXIm runs on Windows, UNIX and Java.

For More Information

Call us at 408-370-2800, email us at info@globetrotter.com or visit our website at <http://www.globetrotter.com>. We'll be happy to arrange a demo and show you how to make sure all your users are licensed.

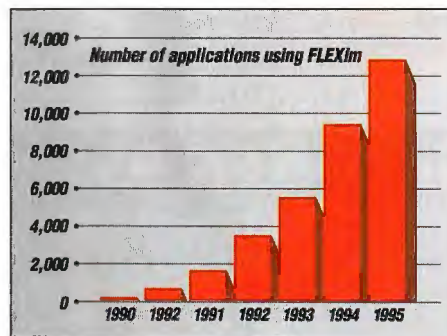

Key Features: *With FLEXIm you can:*

- Limit software use to licensed users
- License software in new ways

to gain new markets and customers

- Leverage the Internet and CD-ROMs to increase sales while reducing selling and manufacturing expenses
- Reduce the cost of product evaluation programs
- Significantly reduce the use of expensive dongles

Ask about our white paper on Electronic Commerce For Software

GLOBEtrotter

Electronic Commerce For Software™

<http://www.globetrotter.com>
Email: info@globetrotter.com
Telephone: 408-370-2800
Fax: 408-370-2884

FLEXIm is a registered trademark and “Electronic Commerce For Software” is a trademark of GLOBEtrotter Software. All other trademarks are the property of their respective owners.

while Word and Exchange are running. The system says to Word, "Tell me what you're doing." Word replies, "I'm on document X at page Y with the cursor on the 300th character." Exchange reports similar info. When you start up your system the next day, Word and Exchange launch, and document X loads. The screen and state of the PC go back to where you were when you shut down the day before.

Information may become easier to find thanks to the Object File System (OFS). For example, if you're interested in pictures of the Space Shuttle, you may already have some files on your C: drive and others on a D: drive. An FTP site may post new pictures, and Web sites may also store shuttle images. The OFS would allow you to create a pseudodirectory that would seem to contain the scattered data from all these locations.

Servers will benefit because network objects, such as shared directories, won't be associated with a particular machine. You'll just see a shared object called "mail database" and attach to it, without having to know what server it's on.

Other new features will include NT support for Direct3D and DirectInput, FireWire/P1394, and the Universal Serial Bus. And for laptop users, there's power management coming, Microsoft says.

Beyond Cairo

What must Microsoft address after Cairo pushes the evolution of NT? It will have to match the 64-bit muscle of chips like Digital's Alpha. Microsoft says there will be a 64-bit NT "in the next couple years." Fault tolerance *must* appear in all networking services, and NT's clustering "Wolfpack" technology will need to move beyond simple support of pairs of machines. Let's hope Microsoft's fascination with the Net extends to better support for TCP/IP infrastructure issues like better dynamic routing protocols, better support of static routing over

Beyond Cairo

Here's a wish list of improvements that need to be part of Microsoft's long-term development plans.

Support for 64-bit processors

Fault tolerance for all networking services

Clustering support for more than pairs of machines

Better dynamic routing protocols

Improved static routing over remote access servers

IPng support

remote access servers, and IPng.

But beware of basing your enterprise plans on Microsoft plans. Cheap anti-gravity may come before Plug and Play and other enhancements NT needs. **B**

Mark Minasi writes books and gives seminars on desktop and network OSES. You can reach him at mark@mmco.com.

WHERE TO FIND

Microsoft
Redmond, WA
(206) 882-8080
<http://www.microsoft.com>

Distinct NFS 95™

Easiest way to Share Files, Programs and Printers

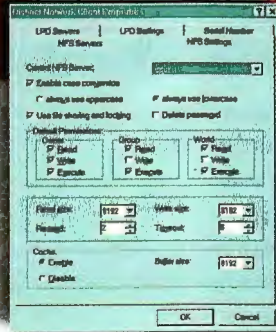
Highlights:

- Integrates seamlessly into Windows 95
- Mounts NFS drives from Explorer or Network Neighborhood
- Supports file and record locking
- Allows central authentication with a single server running PCNFS for all NFS connectivity
- Prints to NFS or LPD print servers
- Allows login to all systems with a single login name and password or different login names for each system
- Allows single-operation logout of all systems accessed through Network Neighborhood
- Fine tunes performance parameters for each server you access

Free Evaluation Copy Available at...



distinct
The world leader in internet development tools.

408.366.8933
<http://www.distinct.com>
Fax: 408.366.0153
E-mail: byte@distinct.com
Fastfacts: 408.366.2101

Distinct is a registered trademark and Windows 95 is a trademark of the Microsoft Corporation. Copyright 1996 Distinct Corporation. 1500 Network Avenue, Sunnyvale, CA 94089. Windows 95 is a registered trademark of the Microsoft Corporation. All other names, trademarks and logos are subject to change without notice.

Circle 268 on Inquiry Card (RESELLERS: 269).

Distinct IntelliTerm™

Integrated Terminal Emulator for DEC and IBM® Systems



Highlights:

- TN3270 Emulation—Models 2,3,4 and 5 (for IBM Mainframes)
- 3179G Vector Graphics & 3279S3G
- TN5250 (24x80, 27x132) (for AS/400)
- VT52, VT100, VT220, VT320 & VT420 emulation (for DEC and UNIX Systems)
- Customizable keyboard layouts, poppads and session profiles
- VBA™ Advanced Scripting Language
- DDE, HLLAPI, EHLLAPI, WinHLLAPI and Visual Basic™
- Available for Windows 3.11, Windows 95 and Windows NT

Free Evaluation Copy Available at...



distinct
The world leader in internet development tools.

408.366.8933
WWW: <http://www.distinct.com>
Fax: 408.366.0153
E-mail: bytemag@distinct.com
Fastfacts: 408.366.2101

Distinct is a registered trademark and IntelliTerm is a trademark of the Distinct Corporation. Copyright 1996 Distinct Corporation. 1500 Network Avenue, Sunnyvale, CA 94089. Windows 95 and Windows NT are registered trademarks of the Microsoft Corporation. All other names, trademarks and logos are subject to change without notice.

Circle 270 on Inquiry Card (RESELLERS: 271).

Copland, Revisited

A closer look at how the microkernel and hardware abstraction services will strengthen Apple's upcoming OS.

By Tom Thompson

For more than a year, Apple has provided tantalizing glimpses of Mac OS 8, its future OS, which is more commonly known by its code name of Copland. Unfortunately, much like Microsoft's Windows 95 launch, the release of Copland has been plagued with delays. The expected shipping date has slipped from this year until well into 1997. (For BYTE's previous coverage of Copland, see "Apple's New Operating System," June 1995, and "Copland: The Abstract Mac OS," July 1995.)

At the August MacWorld trade show in Boston, Apple CEO Gilbert Amelio announced a new blueprint for OS releases. Instead of a monolithic release of system software, as happened with System 7, Apple will release portions of Copland piecemeal over the next year.

Component of the Month

This piecemeal plan has several benefits. First, the development breaks into manageable chunks for the system-software engineers. Any bugs that appear after a release are probably due to the newly introduced OS components, which simplifies code maintenance.

Second, some of the promised Copland technologies will get into the hands of users without their having to wait for Apple to roll out other portions. For example, an OS release slated for the middle of 1997 will provide many Copland user-interface (UI) elements, Java support, and a much-needed multithreaded Finder update, as shown in the figure "Copland Architecture" on page 152. (The improved object-based UI, with sophisticated messaging and scripting functions, was the easiest part of the Mac OS to win early release.)

Finally, the staggered-release schedule means that Apple

can craft some of these components as 680x0 code. Thus, some of Copland's features—but not all—will be available to owners of 680x0-based Macs.

This incremental-release strategy has problems, too. Copland's elements can't all separate conveniently into discrete components. The most glaring examples: System 7.x's File Manager and parts of the I/O subsystem (still emulated 680x0 code). Releas-

ing these crucial parts as native code early would boost the performance of PowerPC-based Macs and Mac clones, but, says AppleSoft vice president Jim Gable, "Much of the file-system code is tightly coupled to the preemptive features of the Copland microkernel: There's no way to separate them."

This plan also affects new PowerPC Platform systems next year: Such systems will need a special System 7.x to manage the hardware abstraction for each hardware design. Finally, Apple must work closely with third-party developers to spot and fix problems that these small releases might cause to applications software.

In Apple's favor, it has experience in extending the OS in stages. Separate releases of QuickDraw GX, QuickTime, QuickDraw 3D, and Open Transport added new capabilities to System 7.5 without revamping the

OS code. Furthermore, Apple has been designing parts of the system software as OpenDoc components. This helps the plan because OpenDoc is a modular architecture, the very thing required to ship the OS as parts.

With all these sudden changes in direction, trying to figure out exactly what Copland is requires a scorecard. I'll review the Copland system architecture first, then focus on the latest information available on the microkernel and I/O abstraction.

continued

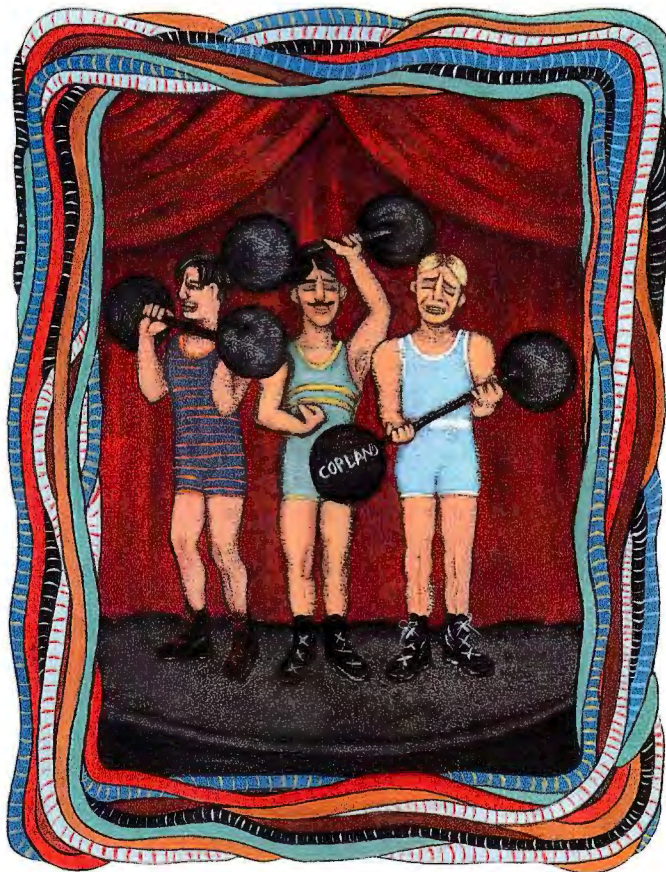

Copland Architecture

Its modular design allows system software to be released in stages.

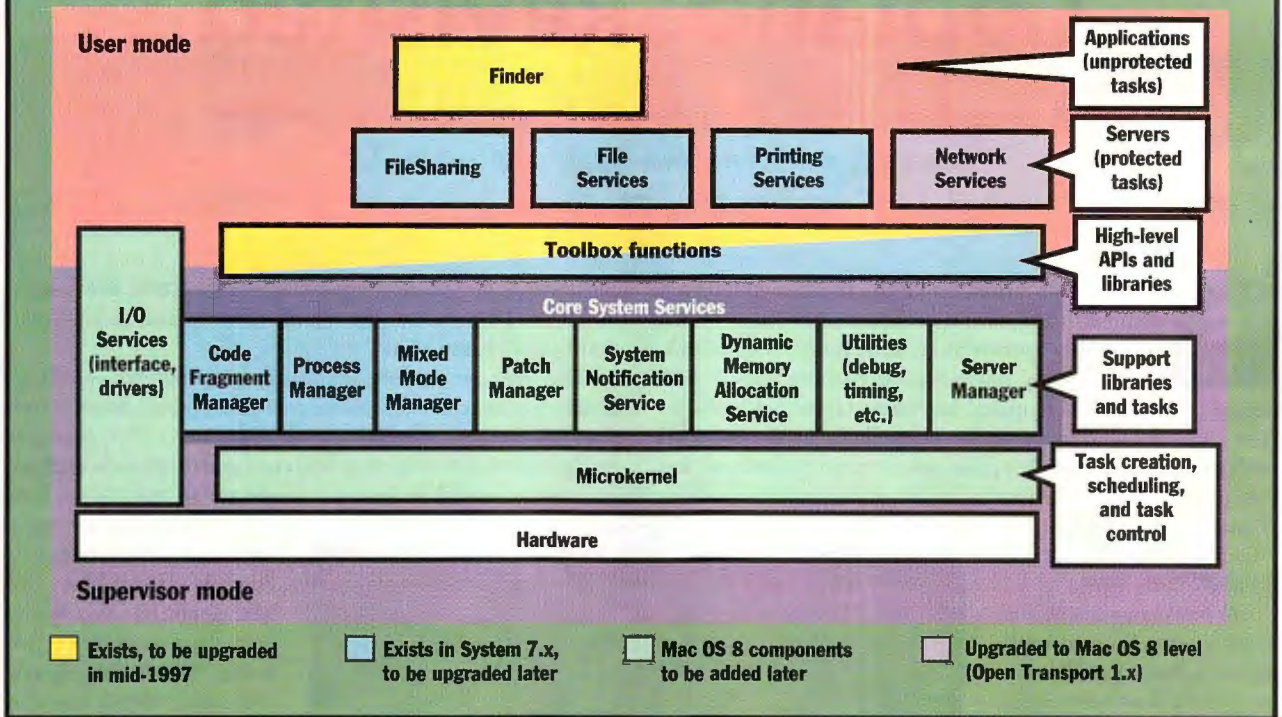

As of now, Copland consists of several parts: microkernel, core system services, and tasks. The microkernel performs all low-level services directly with the processor or hardware: task creation (programming the processor's memory management units [MMUs] to set up a separate memory space and access rights), scheduling (with the processor's interrupt mechanism and timers), and task control (which uses processor-specific atomic instructions for low-level messaging and semaphores).

Modular Microkernel

The microkernel has a modular structure that lets other software modules (e.g., ones that implement a virtual memory backing store or perform memory allocation) plug into it without modification. This differs from some Unix kernels, where adding a new service requires you to rebuild the kernel. The microkernel's design also supports symmetric multiprocessing (SMP) on systems that have multiple processors. A low-level multiprocessor API has been available for special-purpose applications under System 7.x, and it will work under Copland.

The core system services are clients of the microkernel. They implement a

number of services that higher-level portions of the Mac OS rely on. These services consist of either DLLs or OpenDoc components. Some of them are familiar services, such as Code Fragment Manager (which loads and unloads PowerPC code libraries), Process Manager (which manages task creation), and Mixed Mode Manager (which handles transitions between native PowerPC code and the 680x0 emulator).

However, there are also many new services, such as Patch Manager (tracks software patches), System Notification Service (coordinates tasks), and Dynamic Memory Allocation Service (no more fixed memory partitions). Some core software utilities have obvious functions, such as Debug Services, Interrupt Services, Timing Services, and Exception Handler. Another utility, Server Manager, creates and controls special-purpose processes, as described below.

The last part of the OS architecture consists of tasks. A task is a basic unit of program execution in Copland. Processes consist of one or more tasks and use a common set of memory and system resources. Notable examples of processes are the Finder (the shell application that manages the Desktop screen and han-

dles certain file operations), Printing Services, and FileSharing (which implements peer-to-peer network services).

A process's code might be located in RAM or on disk, and it has its own stack and register set. Even better, because of Dynamic Memory Allocation Service, such code need not occupy a contiguous section of memory. Instead, a process's code fragments can be located anywhere in memory, arranged as necessary to best fit a limited amount of RAM.

The familiar Mac application consists of a main task the Process Manager sets up, plus any threads this main task spawns via the Thread Manager. Mac applications can create one or more threads, which implement single paths of execution. For new Copland-aware applications, the microkernel can schedule the tasks to execute simultaneously, which improves load balancing on the system.

It's important to note that certain parts of Copland's services (e.g., the Quick-Draw graphics engine) contain nonreentrant code. Therefore, any task using these services must be scheduled to execute cooperatively (i.e., one at a time). Typically, these are applications because they make heavy use of the UI.

Because the Process Manager creates

ADOBE FRAMEMAKER 5 *on* WINDOWS 95 & NT. MAKES SHORT WORK OF LONG DOCUMENTS.



Adobe® FrameMaker® 5, the leading document publishing software, automates your time consuming authoring, formatting, and page layout tasks. And now its multi-platform* support includes Windows® 95

and NT. Adobe FrameMaker lets you easily create long documents like books with cross-references and indices. What's more, it's the perfect tool to distribute

Download a free HTML plug-in from
www.adobe.com/special/hotamale

critical documents on the Internet and intranet, making it easier than ever to publish online product documentation, business proposals, engineering specs, training manuals and more. If you've got a big job on any platform, now you've got the power to meet the challenge. For more on Adobe FrameMaker 5, call 1-800-388-9883 extension 23708.



If you can *dream* it, you can *do* it™ **Adobe**

*Also available on Windows 3.1, Macintosh®, Power Macintosh®, and UNIX: SunOS®, Sun™ Solaris®, HP/UX®, Digital UNIX®, Silicon Graphics® IRIX®, IBM® AIX®. Adobe, the Adobe logo, FrameMaker and the tagline, "If you can dream it, you can do it" are trademarks of Adobe Systems Incorporated. All other marks are the property of their respective companies. ©1996 Adobe Systems Incorporated. All rights reserved.

Circle 214 on Inquiry Card.

and launches each application's main task, it ensures that only one main task executes at a time. The microkernel, certain core system services, and any task that doesn't rely on graphics can operate under preemptive time scheduling. Processes that provide specific functions but don't need a UI—such as those that handle file-system and network services—are called servers.

Copland's architecture thus makes Apple's release plan possible. The scheduled mid-1997 release, for instance, consists of a new process (the Finder), which System 7.5 treats as an application. This release will also provide an assortment of DLLs that implement the Copland UI elements and the Java virtual machine, which, again, System 7.x's Code Fragment Manager can handle.

Memory Matters

Copland's microkernel provides memory protection and address-space isolation, except for existing System 7.5 applications. The microkernel, drivers, and certain servers execute in the PowerPC processor's privileged mode. Most servers and Mac applications operate in the processor's user mode, and they can obtain memory or perform I/O only by making requests to the OS. This improves the overall system reliability because it ensures that only the low-level OS code can directly operate the hardware, such as fielding interrupts, modifying the access attributes to sections of memory, and controlling the processor's caches.

The microkernel provides another level of protection by placing servers and OS code in separate address spaces. Accessing a separate space requires building its address using values from page-table entries (PTEs) in the processor's MMU. Because only the microkernel can use and modify the PTEs, this effectively "walls off" these tasks from any errant memory accesses that a malfunctioning program generates. Copland maps the microkernel code into every address space, so that tasks can quickly use system functions without involving cycle-stealing memory-access mechanisms. This scheme still provides ample protection, because the OS code is marked read-only.

For compatibility's sake, existing Mac applications and certain sections of the UI Toolbox code must cohabit a single memory space: The System 7.x application model expects a contiguous address space

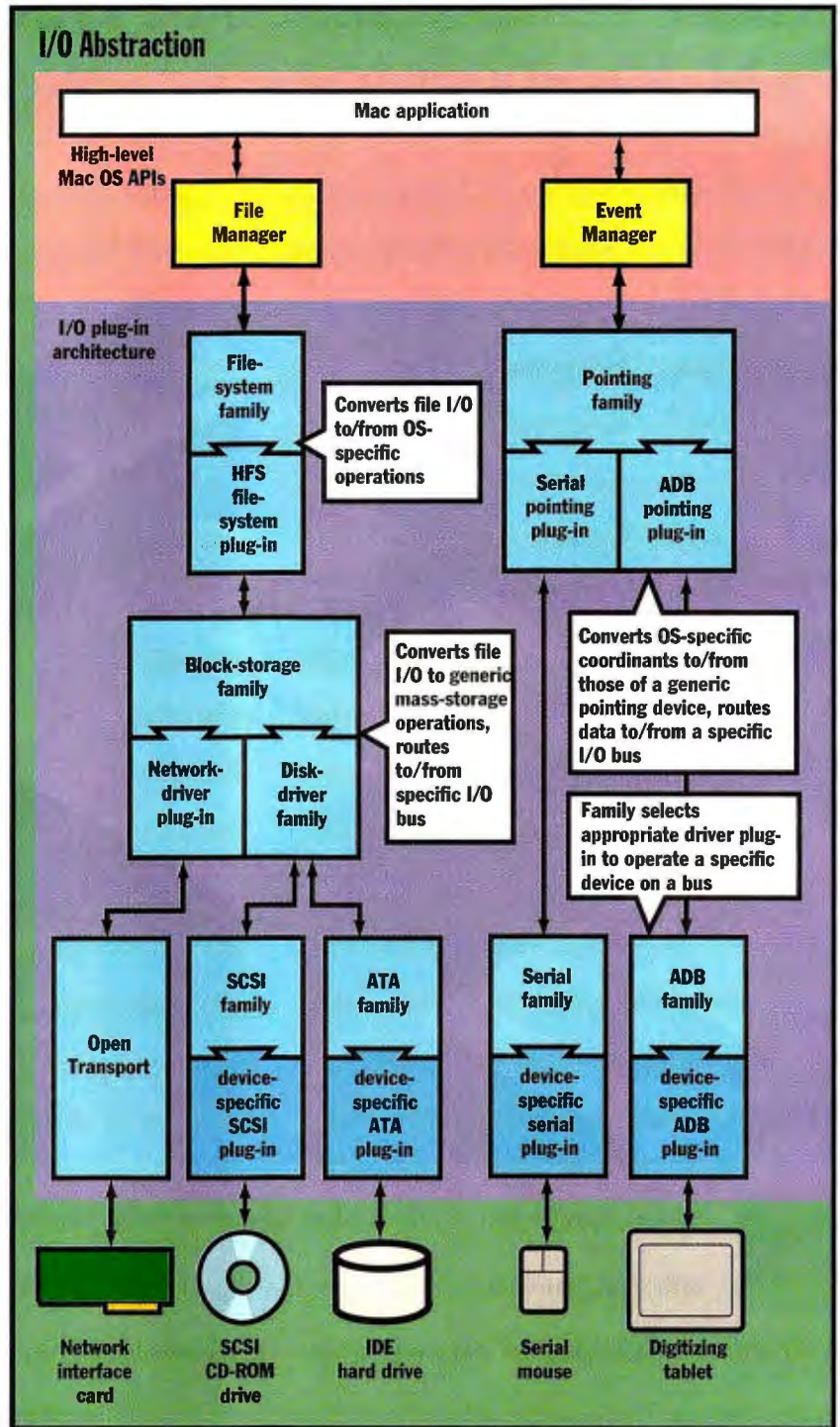

Copland achieves hardware independence through a layer of interface libraries and plug-in modules.

and unfettered access to some system globals. Still, Code Fragment Manager flags system code and native System 7.x applications as read-only, which offers some protection.

Process Manager also provides an extra level of safety. When it loads a System

7.x application, it places *guard pages* above and below the application's fixed memory partition. These guard pages are marked with excluded access permission. If an application attempts to overrun its boundaries, it generates an exception. It's possible that a misbehaving application

We put the **inexpensive** back in

3-Year
Controller Warranty

RAID

(Redundant Array of *Inexpensive* Disks according to original Berkeley acronym)



LynxStak™ - Maximum performance at a minimum price.

Inexpensive Cost Per Megabyte.

If you need the protection RAID has to offer, but the expense has been holding you back, then Artecon's new desktop **LynxStak** is your solution. For about the same price as many standard 3.5" drive subsystems, **LynxStak** gives you all the benefits of RAID. By purchasing the RAID system to fit your needs, you can expand incrementally without the limitations or cost of a pre-configured box. And **LynxStak** is the only desktop RAID solution that offers the high availability and redundancy once available at the more expensive enterprise level.

Removable, Redundant and Reliable.

LynxStak gives you the utmost in reliability with features like true hot plug removable disk drives. Independent front-removable power supplies and rear removable cooling fans provide both high availability and easy serviceability. Optional hot plug removable **LynxRAID** controllers can be configured for dual failover providing you with the extra redundancy needed for mission critical applications. **LynxStak** supports RAID levels 0, 1, 0+1, 3 or 5 for complete flexibility and optimal performance in your environment.

1-800-USA-ARTE

<http://www.artecon.com>

E-mail: stakad@artecon.com

Superior Price-Performance.

Don't let the low price of the **LynxStak** fool you. Exceptional performance and excellent transfer rates are packed into our compact 3.5" form factor. **LynxStak** outruns the other RAID systems on the market with a 486-DX2 processor resulting in extremely fast transfer rates at all RAID levels. Fast-wide end-to-end interfaces, multiple drive channels and custom ASICs contribute to maximum performance at a minimum price.

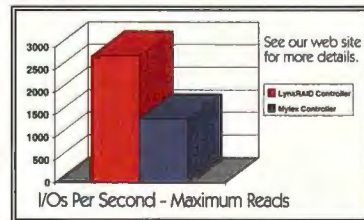

Investment Protection.

With **LynxStak**, you can incrementally upgrade into the RAID system of your choice as your needs grow. From a single desktop unit to a powerful server configuration, you never sacrifice your original **Lynx** investment. Desktop RAID systems start at 4GB and can be expanded easily and incrementally to over 100GB. And, **LynxStak** is compatible with virtually any platform including Sun, HP, SGI, Macintosh and PCs running Windows NT/Windows 95.

So call Artecon today and see how we stack up!

Visit us at **COMDEX Fall '96 Booth #S7011**

Enterprising solutions for your enterprise.™

Artecon



PO Box 9000, Carlsbad, CA 92018-9000
(619)931-5500 FAX (619) 931-5527
email: sales@artecon.com
A Member of the Nordic Group of Companies

Nihon Artecon 81-03-5458-8260 ▲ Artecon S.A. France 33-1-6918-1850 ▲ Artecon B.V. 31-53-4832208 ▲ Artecon U.K. 01344 636390

Artecon and the Artecon logo are registered trademarks of Artecon, Inc. All other trademarks are proprietary to their respective manufacturers.

Circle 219 on Inquiry Card.

might corrupt the data of another application, because everyone can modify any of the data inside this address space. However, given the address-space isolation and write-protection safeguards, Copland is significantly more reliable than its predecessor, which has no protection mechanisms.

The payback for this compromise is that users can carry their existing body of Mac software to Copland and expect it to work. AppleSoft's Gable admits: "If we could rewrite the OS without regard for the installed software base, the job would be done by now."

I/O Abstraction

One goal of Copland is greater independence from the hardware. Given the growing Mac-clone market, vendors need to differentiate their systems by distinctive hardware features. Also, the Mac OS needn't rely on erratic supplies of custom ASICs that have, on prior occasions, crimped sales.

All I/O operations—from hard drive to video to pointing devices—are grouped into families (see the figure "I/O Abstraction" on page 154). An I/O family is a set of software components to perform specific I/O services. If a task uses the SCSI family, that in turn uses interface modules (called plug-ins) to operate SCSI devices.

For example, one application might—via the OS—call the SCSI family to perform file I/O to a device on the SCSI bus. The SCSI-family module calls the plug-in that manages a SCSI hard drive. Next, a scanning application uses the SCSI family, but this time the SCSI-family module calls a plug-in to control a color scanner.

The I/O family provides an interface library that implements device functions and exports data structures for use by the applications or the OS. Although an I/O-family module provides one interface, it might have two sets of interface libraries: one for user-mode tasks and another for supervisor-mode tasks. The OS uses the supervisor-mode library, which can be performance-tuned because it doesn't require the user-mode I/O request mechanism, and no address-space conversions are involved.

The I/O-family architecture provides a remarkable degree of hardware abstraction, because an I/O family can call other families to route data to the appropriate device. Suppose an application calls File Manager to perform file I/O. File Man-

Copland Highlights

Apple will release the OS in stages. Open Transport for networking is already out. A mid-1997 release will provide:

- Native PowerPC multithreaded Finder.
- Java virtual machine.
- Advanced user-interface elements.
- OS parts for 680x0-based Macs.
- The Patch Manager's limited support for 680x0-trap patching.
- Complete memory protection for the kernel, drivers, and server tasks. The kernel provides preemptive scheduling with priority levels.
- Limited memory protection and cooperative task scheduling for existing applications that require user interface (necessary for compatibility).
- Support for multiple processors. QuickTime 2.5, QuickDraw 3D, etc., already multiprocessor-ready.

ager first calls a file-system family. This family calls a file-system plug-in, which implements a particular OS file format, such as the Mac's HFS or Windows NT's NT File System (NTFS).

The file-system plug-in next calls the block-storage family, which orchestrates operations on large-capacity, random-access storage devices, such as hard drives, CD-ROMs, or digital videodiscs (DVDs). This family in turn calls a disk-driver plug-in or a network plug-in if the target device is on a network. If the disk-driver plug-in is called, it might call the SCSI family or the ATA family, depending on whether the target device is a SCSI or an IDE drive.

Adding a new device usually requires writing a driver that conforms to the Open Firmware specification (IEEE-1275-1994) and a suitable plug-in. Practically, the Mac OS probably won't use an NTFS plug-in, because you normally access such storage indirectly through a networked NT server. However, that you *could* write such a plug-in shows that the microkernel is completely uncoupled from its file system. So, if Apple uses a better file-system format later, it can add a plug-in without revamping the system software.

Furthermore, access to new device interfaces and peripherals is vastly simplified. Normally, you'd have to wait for a new OS release to gain use of a new

device interface (e.g., IEEE-1394 Firewire). With Copland, you simply add a Firewire board and the corresponding plug-in modules that handle the Firewire interface. You then connect a peripheral.

The Once and Future OS

The major problem with Copland: When will it finally ship? While the incremental-release strategy is difficult, Apple has shown it can add new capabilities to System 7.x without overhauling the OS code. Open Transport's release is a prime example. This Copland networking technology was in users' hands last year, letting Apple fix bugs and tune performance before Copland itself ships. Still, releasing the microkernel as soon as is practical helps Apple, because it will significantly enhance the Mac platform.

First, Copland will boost the performance of PowerPC systems by eliminating almost all the emulated 680x0 code. The staged-release schedule also offers the possibility that some Copland services will appear on 680x0-based Macs. The new memory services will also make efficient use of available system RAM.

Another major benefit is that Copland will exploit the computing power of multiprocessor systems. The OS will distribute tasks, which server applications created by calling the microkernel services, among the processors for better load balancing. (For compatibility, applications that spawn threads via Thread Manager must be cooperatively scheduled.)

Technologies such as QuickDraw 3D and QuickTime 2.5 already use reentrant code and can automatically leverage the power of a multiprocessor system under Copland. The multiprocessor systems from Apple and DayStar Digital provide the hardware necessary for work in this area.

Finally, Copland's hardware abstraction will let clone vendors offer a variety of systems. One vendor might opt for low-cost parts, while another might provide advanced high-performance peripherals for vertical markets or custom jobs. This variety lets you pick the system that best fits your needs, and the competition will hold the line on system prices. ■

Tom Thompson is a BYTE senior technical editor at large with a B.S.E.E. degree from the University of Memphis. You can contact him on the Internet or BIX at tom_thompson@bix.com.

First Desktop RAID for SPARC™

RD10

RAID Storage Subsystem

Features

- High Availability
- True RAID data Integrity
- Fast throughput-17mb/sec
- Up to 25.2GB storage
- SPARC/SUN pizza box form factor
- Easy to use GUI

When you need your data safe, reliable, and ready, the Integrix RD10 delivers high performance with low cost per Mbyte.

Thanks to a dedicated 33MHz RISC processor and enhanced RAID technology, combined with dedicated I/O processors for each drive and host, the RD10 reaches throughput speeds in excess of 17Mbytes/sec. For high availability environments, dual fast/wide SCSI ports make your data available to two hosts simultaneously.

Five different hardware RAID levels, hot spare disks, and hot-swappable drives keep your data safe and secure. Data automatically and transparently rebuilds on the spare drive eliminating downtime and data loss. Data integrity is assured for all mission-critical applications.

The RD10 Graphical User Interface eliminates the need to type obscure commands found buried in the back of a service manual. Historical performance software analyzes and fine tunes your RAID. Configuration and firmware upgrades can be handled automatically. RD10 status and context-sensitive online help are made instantly available. All with the click of a mouse button.

RD10 RAID Storage Subsystem

Compatible with Solaris and Windows NT



RD10 RAID Throughput Performance

(5400rpm F/W SCSI-2 HDD)	Mbytes/sec	IOs/sec
Sequential Read (max)	16.8	1307
Sequential Write (max)	17.2	1247
Random Read (max)	9.9	620
Random Write (max)	13.0	357

RD10 RAID Subsystem Specifications

RAID Levels Supported	0, 1, 3, 5, 6, (0+1)
Processor	33MHz 32bit RISC
Cache Memory	8Mbytes to 128Mbytes
Channels	2 host channels 6 disk channels
Disks Supported	3.5", 1" high SCA-2 or 68-pin connector Fast/wide Single Ended SCSI-2 interface

Corporate Headquarters

2001 Corporate Center Drive
Newbury Park, California 91320
Tel: 800-300-8288 / 805-376-1000
Fax: 805-376-1001
Email: sales@integrix.com
http: //www.integrix.com

Asia

Beijing, P.R.China
Tel: 8610-253-5305
Fax: 8610-253-5306
Seoul, Korea
Tel: 822-515-5303
Fax: 822-515-5302



www.integrix.com

Diagnose any PC's problems fast with

the **UNIVERSAL DIAGNOSTICS TOOLKIT**™



Loop-back Plugs—
9-pin serial, 25-pin serial
and 25-pin parallel
plugs, used for external
I/O port testing.

- **Get the best, most accurate full-system diagnostics package for all your problem PCs.**
- **Low-Level Formats all hard drives including IDEs. Allows relocation of Track 0.**
- **Works with any PC regardless of O/S: DOS, Windows 95 & NT, O/S2, Unix, Novell, etc.**

2 Micro-Scope floppy disks—
containing the best
PC diagnostic tools
on the market.
Comes with both 3.5"
and 5.25" disks to
work with any PC.

Micro-Scope 6.1 UNIVERSAL DIAGNOSTIC SOFTWARE



**Fully O/S Independent
diagnostic software...**

*Call for upgrade pricing &
complete new features list!*

MICRO-SCOPE Universal Computer Diagnostics was developed to satisfy the expanding need for accurate system diagnosis in the rapidly growing desktop computer market. Patterned after super-mini and mainframe diagnostic routines, **MICRO-SCOPE** runs independently of any standard operating system, and is therefore at home on any machine in the Intel world. Speed, ease-of-use, and razor sharp **ACCURACY** are a few of the advantages that arise from this system independence. **Jerry Pournelle** awarded **MICRO-SCOPE** & **POST-PROBE** the User's Choice Award in the May 1994 issue of Byte Magazine, saying: **"You name it, this tests it. If you maintain PCs you'll love it."**

◆ **LOW-LEVEL FORMAT**—Performs low-level format on all hard drives including IDE drives. ◆ **TRUE HARDWARE DIAGNOSTICS**—Accurate testing of CPU, IRQ's, DMA's, memory, hard drives, floppy drives, video cards, etc. ◆ **RELOCATES TRACK 0** on hard drives that support relocation. ◆ **IRQ CHECK**—Talks directly to hardware and shows I/O address and IRQ of devices that respond. ◆ **O/S INDEPENDENT**—Does not rely on O/S for diagnostics. Talks to PC at hardware level. All tests are full function regardless of O/S (i.e. Windows, Novell, UNIX, O/S2). ◆ **IRQ DISPLAY**—Show bits enabled in IRQ chip for finding cards that are software driven (Network, Sound Card, etc.). ◆ **MEMORY DISPLAY**—Displays any physical bit of memory under 1 MB. Very useful for determining memory conflicts and available memory space. ◆ **AND MUCH MORE...** We don't have enough space here for everything this software can do!

Govt. Orders: NSN-7030-01-421-6459

**Call Now for Special Pricing
1-800-864-8008**



Complete Micro-Scope Manual— easy to follow testing procedures and detailed error code descriptions. See the features list at left to view some of the incredible wealth of testing capabilities this program contains.



100% accurate results...

Tri-State Logic Probe—works with Post-Probe and enables testing down to individual chip level.

Durable Zip-up Leatherette Carrying Case—all your tools in one organized easy to carry toolkit.

Post-Probe Diagnostic Card—when Post-Probe detects an error, a 2 digit BIOS code will display on the card telling you exactly what's wrong with your PC. 100% compatible with all ISA, EISA, Compaq and Micro-Channel PCs.

Micro-Channel Adapter Card—(behind Post-Probe card) allows Post-Probe to be used with Micro-Channel equipped computers.

NEW Optional Tutorial and PC Trouble Shooting Videos—Call for titles and current prices. A wealth of technical help at your fingertips.

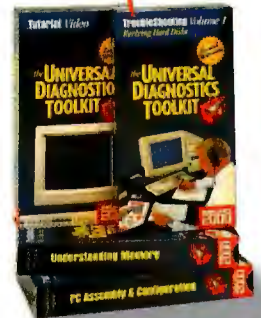

Post-Probe™

First Ever Universal P.O.S.T. Card for All PCs!



PC won't boot up? Find out why fast with our universal POST card...

"This is the only card that will function in every system on the market. The documentation is extensive, and not only covers the expected POST Codes for different BIOS versions, but also includes a detailed reference to the bus signals monitored by the card." —**Scott Mueller** from his globally recognized book, *'Upgrading & Repairing PCs, Second Edition'*

- ◆ Includes pads for voltmeter to attach for actual voltage testing under load.
- ◆ 4 LEDs monitor +5vdc -5vdc +12vdc -12vdc. ◆ Monitors Hi & Lo clock and OSC cycles to distinguish between clock chip or crystal failure. ◆ Monitors I/O Write and I/O Read to distinguish between write and read errors. ◆ Accurately monitors progress of POST for computers *without* POST codes. ◆ Reads POST codes from any IBM or compatible that emits POST codes. ISA/EISA/MCA.
- ◆ Compatible with Micro Channel computers. ◆ Dip switch allows easy selection of I/O ports to read. ◆ Includes **TRI-STATE LOGIC PROBE** to determine actual chip failures. ◆ Manual includes chip layouts and detailed POST procedures for all major BIOSs. ◆ **AND MUCH MORE...** call for more details.

Govt. Orders: NSN-7025-01-421-6467

Extensive Post-Probe Manual—exhaustively complete, containing BIOS error codes for most PCs on the market. Look up the 2-digit error code in this manual and instantly diagnose your PC's problem. Also contains common chip diagrams, descriptions and complete troubleshooting tips.

Micro 2000, Inc. *Makers of Professional PC Diagnostic Tools*

1100 East Broadway, Suite 301, Glendale, California, USA 91205
Toll Free: 800/864-8008 • Phone: 818/547-0125 • Fax: 818/547-0397

Web Site: <http://www.micro2000.com>

International Orders please call:

Micro 2000 Australia.....61-42-574-144
Micro 2000 UK.....44-1462-483-483
Micro 2000 Amsterdam.....31-206-384-433
Micro 2000 Germany.....49-69-420-8278



Copyright © 1996 Micro 2000, Inc. All Rights Reserved.
Circle 224 on Inquiry Card.



Copy Protection

Why use more and more developers **WIBU-KEY** to protect their software against piracy?

- ✓ **Longevity:** You could use a WIBU-BOX made in 1989 right now with Windows NT, which didn't exist 1989! Also you can run old software for DOS right now in a DOS box on Windows 95 or NT. Every WIBU-BOX comes with a full 3-year warranty.
- ✓ **The most flexible security system for you, the programmer:** Great Windows interface for programming WIBU-BOXes and protection of applications. Automatic detection of all WIBU-BOX variants at run time. Transparent and cascable WIBU™-BOXes for **LPT, COM** and **ADB**, as well as **PCCard** and **(E)ISA** card. No special, expensive "network" dongle – the same WIBU-BOX works for single stations and on a network with programmable usage limits. Protect over 200 different applications separately within one WIBU-BOX. One consistent API for **DOS, Windows 3.x, 95, NT OS/2, MacOS** and **Networks**, independent of the programming language.
- ✓ **The most user-friendly security system for your customer, the end user:** The WIBU-BOX is one of the smallest dongles available with a unique design and handling advantage for your customers. A powerful Control Panel applet provides easy installation and diagnostic tools for your customer. New sales or program updates can be handled by "Remote Programming" the WIBU-BOX on your customer's PC.
- ✓ **The most secure system:** WIBU-KEY doesn't just do a quick check to see if the dongle is connected – it works by encrypting through our custom ASIC. Each encryption through the WIBU-BOX is initialized by a FEAL algorithm (block chiffre, 64 bit key). Each encryption has over 4 BILLION variants, chosen by a 32 bit selection code. The odds of cracking one program's encryption are 1 in 1050, and that process would get you no further on cracking any other program's encryption.



WIBU-KEY on stage at these events:

SYSTEMS 96

Munich, Germany
October 21 - 25, 1996
Hall 12, Booth A12

COMDEX

Fall '96 S2031
Sands Expo, Las Vegas
November 18 - 22, 1996



Order your Test-Kit today!
Phone: (800) 986-6578
<http://www.griftech.com>
<http://www.wibu.de>

Providing the highest quality Software Protection since 1989

We are happy to serve you:

Circle 225 on Inquiry Card (RESELLERS: 226).



Germany and International:
WIBU-SYSTEMS AG
Rueppurrer Strasse 54 · D-76137 Karlsruhe
Tel. +49-721-93172-0 · FAX +49-721-93172-22
BBS +49-721-93172-23 · CIS 100142.1674
email: info@wibu.de · <http://www.wibu.de>



North and South America:
Griffin Technologies Inc.
1617 St. Andrew Dr, Lawrence, KS 66047
Tel. (800) 986-6578 + (913)832-2070
FAX (913) 832-8787 · CIS 71141.3624
email: sales@griftech.com · www.griftech.com

Belgium, Lux.: **COMPUSEC** · Tel. +32-2-6450944 · Fax +32-2-646-4766 · info@compusec.be
Croatia: **ARIES D.o.o.** · Tel. +385-1-222752 · Fax +385-1-2326535
Estand: **Lansoft Ltd.** · Tel. +372-2-444760 · Fax +372-2-682760 · lansoft@lansoft.ee
Japan: **Visual Networks Co. Ltd.** · Tel. +81-3-34057801 · Fax +81-3-34057818
email: trades-wns@cyboruz.net
Netherlands: **COMPUSEC** · Tel. +31-53-5740223 · Fax +31-53-5726822 · info@compusec.be

Pollution Solution.

This symbol identifies high performance energy-efficient computers and printers that save you money and reduce air pollution by "powering



down" when not in use.

Be part of the solution.

Start buying Energy

StarSM equipment

today. To receive

a list of available

products, call

the Energy StarSM

Hotline at

202 775-6650.



Buy It And Save.

INTERCON - PRODUCTS

PrintServers and PrinterPeripherals

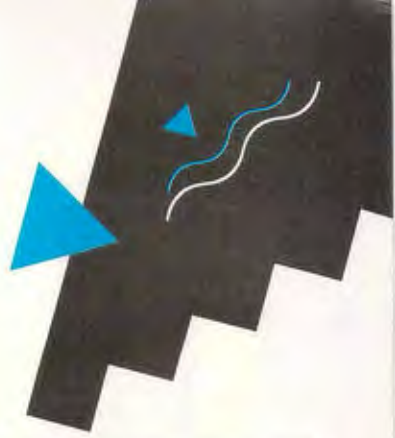

INTERCON-ETHER/TOKEN-HP-MIO Printserver

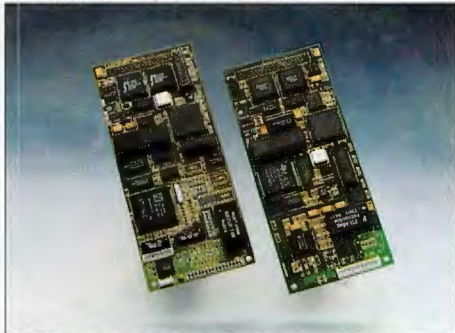

INTERCON-ETHER/TOKEN-KYO-FS Printserver



INTERCON-ETHER-EPSON Printserver

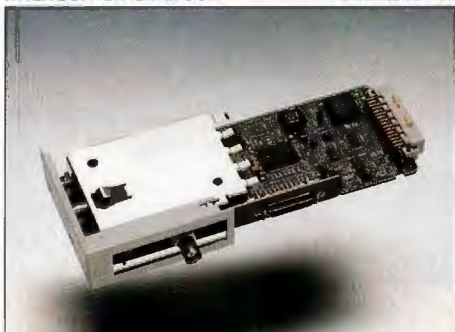

INTERCON-ETHER-MT Printserver

Multiprotocol support of

- SNMP (MIB II)
- NOVELL (IPX)
- UNIX (TCP/IP)
- Apple Ether/TokenTalk
- Windows NT (TCP/IP)
- Windows '95 (TCP/IP)
- Windows for Workgroups

Hardware Support

- Ethernet 10Base2 (BNC), 10Base5 (AUI), 10BaseT (RJ-45)
- Token Ring STP (IBM Typ1/2), UTP (IBM Typ3)

Printer / Plotter connections

- Interfaces for MIO V.5.x printers/plotters
- Interfaces for KYOCERA FS printers
- Interface for EPSON printers (Type B port)
- Interface for M-Tally MT350/360/380
- 2x Serial RS232 (Box-Versions)
- 2x Centronics (Box), 1x Centronics (Pocket)

Features

- HTML configurable with Internet browsers like Microsoft Internet Explorer or Netscape Navigator
- Multiprotocol support of all mentioned operating systems
- Automatic recognition of the used network connector
- Software update and upgrade via download in Flash-EPROM
- Printer status request from host computer
- Automatic protocol recognition
- Configuration parameters can be edited by software
- Automatic recognition and reaction to changes in the network environment
- Supports 64 queues on 16 servers (Novell)
- Easy installation via PCONSOLE (Novell)

More information about InterCon-Products

SEH Computertechnik GmbH, Germany
 Sunderweg 4 D-33649 Bielefeld
 Phone: +49/521/94226-0
 Fax: +49/521/444049
 Internet: [http:// www.seh.de](http://www.seh.de)
 E-Mail: info@seh.de
 CS-Id: 100742,1452



INTERCON-BOX / INTERCON-POCKET Printserver



INTERCON-INFRAPRINT IrDA Printer Adapter



INTERCON-MULTIPOINT Serial Parallel Adapter

SEH

Computertechnik GmbH

Circle 227 on Inquiry Card (RESELLERS: 228).

Discoo

& stay in



AirMedia and AirMedia Live are trademarks of Ex Machina, Inc. NewsCatcher is a registered trademark of Global Village Communication. All other products are trademarks or registered trademarks of their respective owners. © 1996 Ex Machina, Inc. All rights reserved.



It's a rapidly changing world out there and you don't want to lose touch with it. So don't. **INTRODUCING AIRMEDIA LIVE. IT'S WIRELESS.** We continually broadcast the best of the Internet directly to your PC, without needing to be on-line or tying up a phone line. AirMediaLive Internet Broadcast Network delivers breaking headline stories from sources like Reuters, the latest stock market updates from financial sites including Quote.com and up-to-the-minute sports scores from services like SportsLine. AirMedia Live never sleeps—you get E-Mail alerts, weather forecasts, entertainment reviews and more. Beamed right into your computer. **DON'T SEARCH, BE SOUGHT.** Once you've signed up, relax and use your computer as you always do. Before you know it you'll have audio and visual alerts flying in wirelessly *hot off the Internet™* and appearing above whatever application you are using. Click on one of these alert icons and now you've got your finger on the pulse of the web.

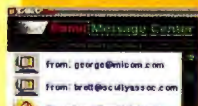
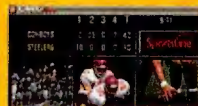

FOR THOSE WHO NEED TO KNOW FIRST. So how do you get your hands on this revolutionary service? Simple. Install a Global Village NewsCatcher along with our award winning multimedia software. Then sign-up and keep in touch with the world that counts the most...yours.

Visit us at www.airmedia.com or call 1-800-AIR-MEDIA.

AirMedia Live™

Knowing now makes the difference.

NewsCatcher from Global Village Communication. Featuring the AirMedia Live Internet Broadcast Network. Now available in a computer store near you.

Circle 232 on Inquiry Card (RESELLERS: 233).

THIS IS YOUR FASTEST LINK TO THE INTERNET!



To the Internet user phone lines are a frustrating, time consuming joke. Stop being limited by the technology behind the phone system and receive information from the internet quickly, easily and digitally.

Introducing the Hughes Network System Direct PC with Turbo Internet. Here's how it works: You send your requests for data out over your old 28.8 modem. (Remember, data requests are small binary commands that move just fine over standard phone lines.) Then, instead of sending all those graphical home pages and downloads back through your 28.8 modem, the information is shot down to your computer via your DirecPC satellite dish. The result: Now you can tour the Internet at 400kbps...14times faster than your 28.8 modem running at its fastest. That's it! You've got the information of the Internet without the World Wide Wait. It's easy to install, or we'll do it for you. Give us a call, they're going fast!



Your Entire Office Can Now Have The Internet!

Now everyone on your network can access the blinding speed of our Satellite interface. One 28.8 modem for the data requests, 1 DirecPC dish, 1 Isa card for the Server...That's it! From 5 to 50+ people can logon at the same time and surf simultaneously! What an Intranet tool! It gets even better...ask our sales reps how!

Pre-Configured systems are available. Starting at \$1995!

Only \$849

"At least 15 times faster than your standard 28.8..."
Desmond Crisis
C/Net 8/11/96

"A major speed bump on the so-called information superhighway has been cleared thanks to Renegade Systems of Gilbert" Tribune Newspapers, Phoenix, Arizona
8/18/96

- System includes:**
- 21" Fiberglass Dish
 - ISA Adapters
 - DirecPC Software

The Time it takes to Download a 4.8 megabyte file

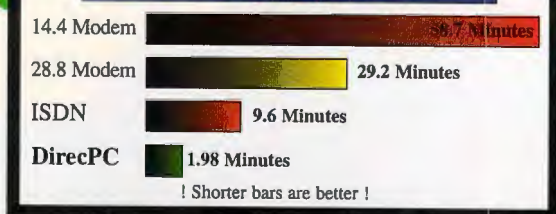

1.800.292.5742



SUREAIR
Exclusive National Installer



Let GeoSat put the world in your hands.

Shipping not included. All returns must have RMA# and be in original condition. 30 day money back guarantee, minus shipping. 10% restocking, 7% cancellation fee. Orders charged, processed and tested prior to shipping. All logos are trademarks of their respective companies. Not responsible for typographical errors. *100% Compatibility Guarantee involves certain restrictions, call for details. Hughes Network Systems Insight DirecPC, and Turbo Internet are trademarks of Hughes Network Systems, Inc.

Circle 230 on Inquiry Card (RESELLERS: 231).

Imagine if you could take all of your forms-based data and instantly send it to your database—**no manual data entry, no delays**. Stop imagining and do it today with **TELEform**, the most accurate and affordable forms processing software available.

TELEform has the power, speed and accuracy you need to automatically collect data from scanned or faxed-in forms. Using familiar communications—paper and pen, fax machines and modems—**TELEform** reads hand-printed, typed and filled-in data.

See us at COMDEX Booth M232

AUTOMATED DATA ENTRY.

ACCURACY FROM A TO Z.

READS MACHINE PRINT TEXT (OCR)

READS HAND PRINT TEXT (ICR)

READS OPTICAL MARK RECOGNITION ENTRIES (OMR)

READS BARCODES



Eliminating data entry means your staff will be free for more productive activities. Having data entered in seconds means increased productivity—you'll **work smarter, capture more data, faster and with less effort.**

Thousands of companies use **TELEform** to make their businesses more efficient. Join them by calling **800-659-8755** today.

For more information, visit Cardiff Software's Web site: <http://www.cardiffsw.com>.

REGISTRATION FORMS, SALES ORDERS, CLAIMS, TIME CARDS, SURVEYS AND MORE.



Cardiff Software
PHONE: 619-752-5200 FAX: 619-752-5222

TELEform includes technologies licensed from Advanced Telecommunications Technologies, iCR, Cognosoft, and others.

Go From Paper To Electronic Forms

mips Transform Suite™

The Total Solution for creating and using electronic forms.

Includes Transform™, TransFill™ and WordFill™

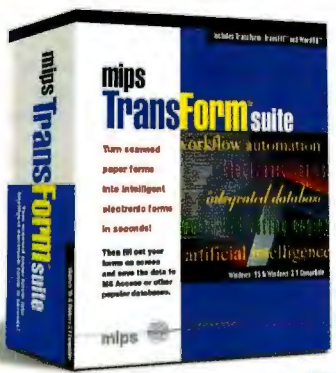

SRP \$299.00

Transform - Uses artificial intelligence and multiple OCR engines to redraw your scanned form into a fully editable vector graphic. Convert your paper forms to electronic forms in seconds by scanning or faxing them into Transform.

TransFill - An MS Access based form filler. Set up complex calculations with an easy point and click interface. Save the data you've entered to TransFill's database or your own database for future access.

WordFill - The ideal solution for easily processing forms directly into MS Word. Import forms created or scanned in Transform, including data-entry field information, straight into MS Word.

- ✓ Automatically creates intelligent WYSIWYG form templates for use with MS Word for Windows and MS Access, ensuring compatibility with the most popular e-mail, routing and internet packages.

- ✓ Supports calculations, range checking, data validation, look-ups, and multi-database look-ups with database attachments to Access, DBase, FoxPro, SQL Server, Paradox, Btrieve, ASCII delimited, ODBC and many more.

Call mips at (800) 898-8560

Also available through:

EGGHEAD
800-EGGHEAD

COMPUSA
800-COMPUSA

MicroWAREHOUSE
800-367-7080

TigerSoftware
800-888-4437



Datafile America, Inc.

Windows 3.1 & 95 Compatible

Tel: 619-679-4070 Fax: 619-679-4073
13240 Evening Creek Drive, Suite 311 - San Diego, CA 92128



Please visit us
at the FLC booth at N232
Main Las Vegas
Convention Center
November 18-22, 1996

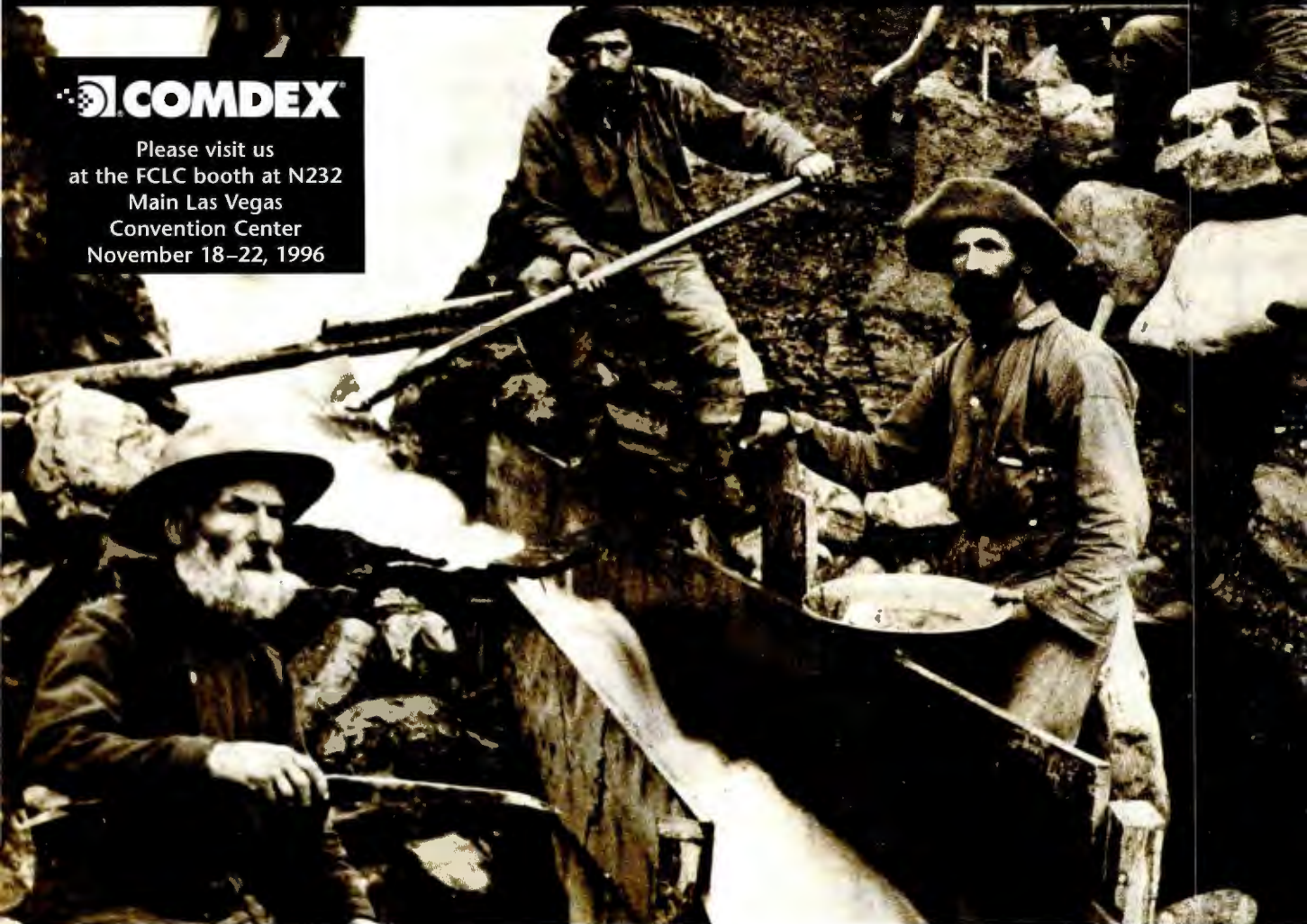

BOOST YOUR PRODUCTIVITY. INTRADISK™ FROM MRT.

If you communicate in open or closed networks, you will know all too well that the volume of information a network manages and the number of users connected have a significant effect on the access time to the data. Faster processors generally offer only a shortterm – and expensive – solution to this problem. But now things are changing! The new IntraDisk™ from MRT will meet both your current and future needs. IntraDisk™ pushes the specific information you require up to the surface. And unlike normal storage media, IntraDisk™ utilizes ultra-fast DRAMs, allowing you to access information 100 times faster. With an access time of under 100 μ s, you can process up to 3300 I/O requests per second depending on the application. And thanks to its modular design you can start at 128 MB and grow up to 1 GB per unit. See for yourself! IntraDisk™ is more than just a storage device. It's a complete storage solution. Interested in finding out more about IntraDisk™?

Simply give a call, send a fax, e-mail us or visit our homepage. *MRT micro Inc., USA, 8400 E. Prentice Ave. Suite 325, Englewood, CO 80111 – USA, Phone: +1 303 793 3660 or 888 MRT Sale, Fax: +1 303 793 3126, E-Mail Sales & Shipping: MRTUSA@aol.com, WEB site: <http://www.mrt.no>*



Ideas with a future!

Keep Networks Safe from Viruses

Your network can spread viruses, but it can also help get rid of them. Here's how.

By Barry Nance

The movie *Independence Day* showcased some clever humans defeating aliens by planting a virus in the alien mother ship's computer. The ship—the biggest file server ever—suffered physical damage and crashed. Obviously, the aliens hadn't heard of antivirus software.

Couched in a large dose of poetic license, this entertaining science fiction tale brings computer viruses to our attention yet one more time. Here on earth, computer viruses are a real threat to your data and your networks—but aliens aren't the culprits. Rather, a few individuals feel the need to distribute deliberately buggy software.

Viruses have been a problem for years, of course, but their threat is heightened today because of our growing interconnectedness. We now regularly share files on servers, download files from the Internet, and accept attachments to e-mail messages. Any one of these everyday activities can load buggy software into our computers. And no form of computer file seems to be immune. Java applets, ActiveX components, and word processing and spreadsheet files all can—and do—contain viruses.

Fortunately, there is help. A comprehensive backup plan and centralized antivirus scanning can reduce viruses to minor annoyances.

Network Vulnerabilities

Encountering a virus is riskiest on a network because of the indiscriminate way that people share executable files and data files alike through the file server. Combine inadequate data backups and a virus that's allowed to go unchecked for a period of time, and the cost to your organization in lost data and wasted time can be enormous.

Most organizations encourage the use of antivirus tools, but virus awareness is often left for individual departments or remote offices to administer. This is a mistake. Centralized, enterprise-wide virus detection and reporting are important, and for an important reason: An organization must know quickly whether it's dealing with an isolated virus incident so it can keep the cost

of antivirus measures commensurate with the level of threat. The most effective antivirus procedures are those that apply to an entire enterprise, use the organization's network to report any problems, distribute antivirus software updates over the network, and, via the use of log-in scripts, enforce the regular use of antivirus software.

But even before you can deal effectively with the problem by launching an enterprise-wide plan, you've first got to cut through all the vocabulary and euphemisms that have sprung up around viruses. Repeat after me: A computer virus is a buggy program that executes on the computers attached to your network. It's not a germ; viruses don't spread the way germs do. A virus simply copies itself through the file system on your computer or file server.

An antivirus utility does not "inoculate" your system or "disinfect" your PC. It scans for known virus programs, removing buggy programs and their effects using normal file- or disk-management operations. And what seems like an "outbreak" is not a contagious epidemic, but rather the result of a virus reading your computer's clock and taking some sort of action (erasing files, perhaps) on a certain date.

A computer virus is not self-aware. When an unsuspecting victim executes a program containing a virus, the virus program or program segment copies itself to another program file. The



NEW! Release 11 runs on Windows 3.1, Windows 95, and Windows NT - one product, one price!



MINITAB® Statistical Software. Master your data with ease.

For over 20 years in over 80 countries, users have experienced the power and simplicity of MINITAB Statistical Software. Used in businesses from start-ups to Fortune 500 companies, MINITAB is:

- **Powerful and comprehensive** – an “all in one” statistical software package from basic to complex statistical functions
- **Easy to use** – with dialog boxes and prompts every step of the way
- **Easy for data entry or importing** – enter data into MINITAB worksheets or import data from Excel®, Lotus® and other programs
- **Ready to use right out of the box** – with MINITAB Statistical Software, there is no lengthy learning process and a simple and quick tutorial gets you working right away
- **Available on multiple platforms** – MINITAB Statistical Software runs on Windows® 95, Windows® 3.1, Windows NT™, Macintosh and Power Macintosh
- **Fully supported** – on-line HELP is easy and quick plus skilled technical specialists are just a phone call away
- **Affordable** – priced under US \$1,000
- **Guaranteed** – when you purchase directly from MINITAB, you receive our unconditional 30-day, money-back guarantee

Moving data between MINITAB and other packages, including Excel and Lotus is a breeze

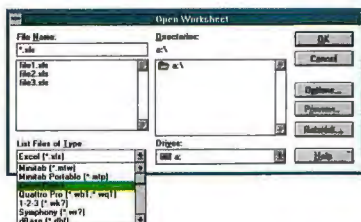

With MINITAB's wide range of analytical tools, you have complete flexibility in analyzing your data.

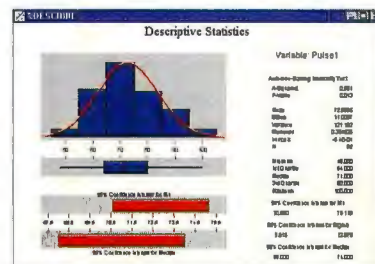

Project	Subject	Major	Score
1	1	1	100
2	1	2	100
3	1	3	100
4	1	4	100
5	1	5	100
6	1	6	100
7	1	7	100
8	1	8	100
9	1	9	100
10	1	10	100
11	1	11	100
12	1	12	100
13	1	13	100
14	1	14	100
15	1	15	100
16	1	16	100
17	1	17	100
18	1	18	100
19	1	19	100
20	1	20	100

MINITAB has pull-down menus for all of its statistical capabilities. Just click and work with your data!

Circle 153 on Inquiry Card.

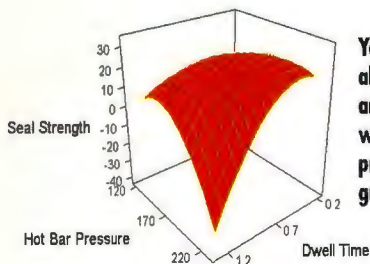

Your data comes alive quickly and attractively with MINITAB's presentation graphics.



MINITAB Statistical Software runs on Windows 95, Windows 3.1, Windows NT, Macintosh and Power Macintosh.

To learn more about MINITAB, visit us on our Web site:
<http://www.minitab.com>

MINITAB INC 
Making Data Analysis Easier

Minitab Inc., 3081 Enterprise Drive, State College, PA, USA;
In Europe, call +44-(0)1203-695-730; Outside Europe, fax 814-238-4383.

All product names are trademarks of their respective companies
© Minitab Inc., 1996 MINITAB is a trademark of Minitab Inc.

To order MINITAB Statistical Software, call:
800-448-3555 814-238-3280

target program is typically an executable file, but it can also be the master boot record of the hard disk. The new copy of the virus in the infected program also inherits the ability to copy itself when run.

Some viruses do nothing else but make copies of themselves. Or they might simply display a message on a certain date. But others are not so benign—they strike by changing or deleting your files.

It's a popular misconception that viruses affect only DOS-based computers and that protected-mode systems, such as OS/2, NT, and Unix, are immune. But viruses can attack these OSes. Viruses designed to infect native OS/2 executables are more complicated to write than their DOS counterparts. However, dual-boot OS/2 systems that occasionally run DOS are subject to the thousands of DOS-based viruses. These buggy programs can alter boot records and DOS program files on OS/2-based machines.

In addition, we know of two OS/2 viruses: OS2vir1 and Jiskefet. OS2vir1 replaces all EXE files in the current directory with copies of itself. As a result, this

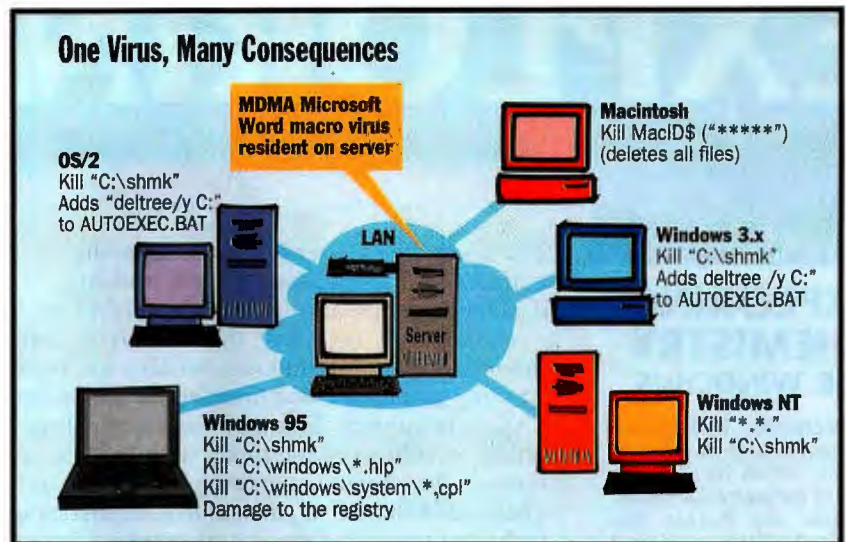

Once a macro virus, such as MDMA, infects a server, it can create cross-platform havoc throughout an organization.

virus is hard to overlook and thus does not spread very far. OS2vir1 displays messages identifying the files that it's replacing as it runs.

Jiskefet replaces EXE files with a new file that contains the original EXE file. When the new, infected file is executed, it re-creates the original EXE file under

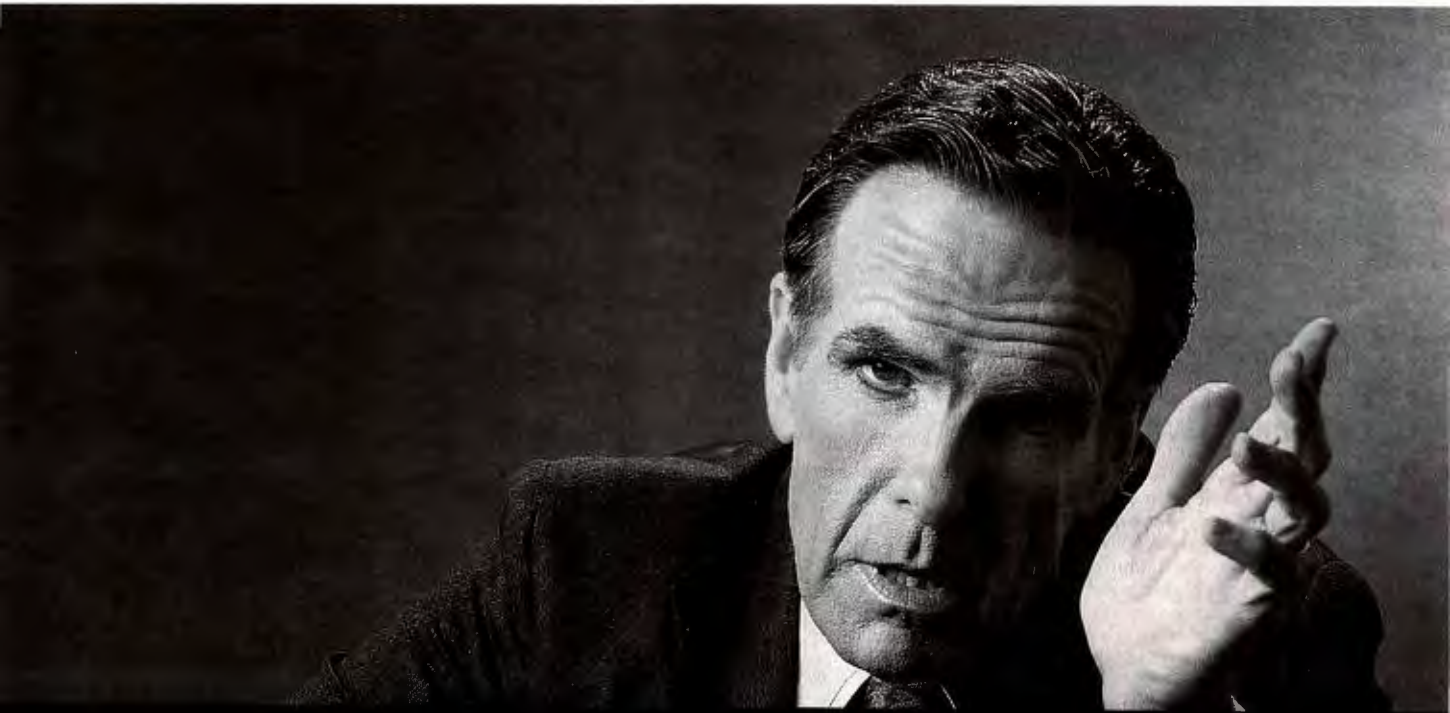

We sat through 5 big presentations in 3 days.
All the people and equipment... a logistical nightmare.

EXPLORING...

EXPLORING CHEMISTRY FOR WINDOWS

EXPLORING CHEMISTRY contains a large number of topics, which include: the laws of chemistry; Lavoisier, Dalton and Proust; the weighted balance of chemical reactions; matter; pure substances and mixtures; elements and compounds; atoms and molecules; atomic models; the orbital quantum model and chemical bonds. It is also possible to select the elements on the basis of their chemical and physical properties and to make a comparison of the data for several different elements by creating a graph.

The EXPLORING series is a multi-media collection for Secondary School students, designed specifically to help them learn in a simple and intuitive manner. It is not intended solely for students but also for anyone wanting to increase and broaden their knowledge of a specific subject. The user can learn all the information either by following the topics step by step or by navigating through the contents. Learning is pleasant and the results are guaranteed thanks to particularly sophisticated multi-media techniques, such as the use of graphics for a more effective understanding of the contents, hypertext links for moving from a given topic to other related ones and helpful functions for searching for the best-known terms.

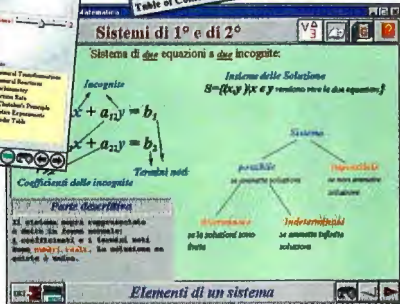
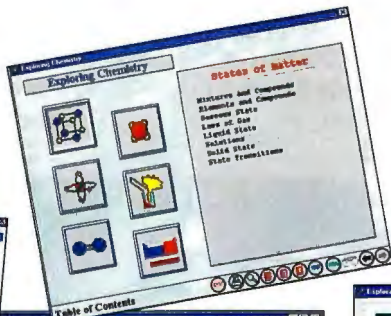
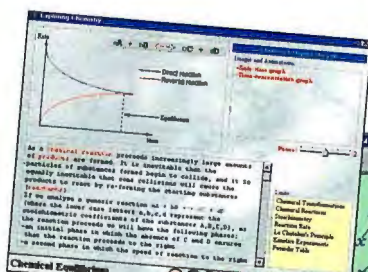

EXPLORING BIOLOGY FOR WINDOWS

Exploring Biology deals with a large number of topics that cover experimental analysis, scientific methodology, the instruments of scientific enquiry, the features underlying life, including the molecules that make up the structure of sugars, lipids, proteins and nucleic acids. The cell and its components, glycolysis, Krebs' cycle, cellular respiration, fermentation, chlorophyll related photosynthesis, genetics, nucleic acids, DNA and RNA, DNA duplication, proteic synthesis, cell reproduction, Mendel's laws, sexual reproduction, modern genetics, genetic diseases, Darwin's and Lamarck's theories of evolution, proof of evolution, evolutive mechanisms, the origin of life, the classification of life-forms, the binomial list, classification criteria. The kingdoms into which living beings are divided are also dealt with: the Viruses, the Monera, the Protista, the Fungi, the Plantae and the Animalia.



EXPLORING PHYSICS FOR WINDOWS

EXPLORING PHYSICS is split up into several learning units covering the main topics of physics: the measurement of physical magnitudes; units of measurement; the analysis of experimental data; from the analysis of data to physical laws; speed, acceleration and force; equilibrium in stiff bodies and fluids; energy, temperature and heat; and electricity and the related phenomena.

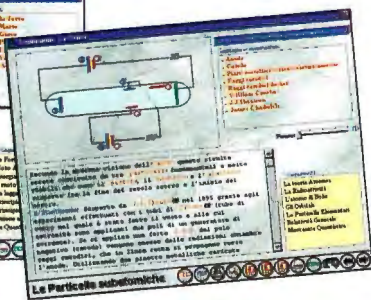

EXPLORING MATHEMATICS FOR WINDOWS

EXPLORING MATHEMATICS covers a range of many different topics: sets and their relationships, classes of equivalence, real and non-real numbers, operations and properties, algebraic expressions, monomials and polynomials, logical operations, equations and disequations, systems of equations and disequations and their performance, 1st and 2nd degree equations, radicals, parametric equations and biquadratic equations.

\$ 39.99
each title

Available in English, German, Spanish and Italian

MS-DOS and WINDOWS are registered trademarks of Microsoft Corporation.



FINSON srl
Via Montepulciano, 15
20124 Milano (Italy)
Tel. +39-2-6697036
Fax +39-2-6697027
E-MAIL: finson@finson.it

FINSON (UK) Ltd.
Parallel House - 32 London Road
Guildford - Surrey GU1 2AB
Tel. +44-1483-451856
Fax +44-1483-452144
E-MAIL: finson@finson.co.uk

For more information and demos:
<http://www.finson.com>

Minimum configuration: 100% MS-DOS compatible PC, CPU 80386 or higher, 4 Mb of RAM (8 Mb are recommended), hard disk with 6 Mb of available space, mouse, VGA graphic card or higher, Windows 3.1 or higher.
Recommended: Windows compatible audio card, Windows compatible printer.

Circle 184 on Inquiry Card.

another name and then executes the original file. Jiskefet is not particularly effective at finding new files to infect. Similar viruses in the DOS world have never spread exceptionally well, which suggests that Jiskefet will not pose any significant threat to OS/2 systems.

Both Windows 95 and NT are fertile ground for the spread of DOS viruses, as well as viruses specially targeted for Microsoft's two latest OSes. Every unique OS requires individually tailored antivirus-protection software.

Viruses that infect files typically install themselves as memory-resident TSRs. Win 95 and NT support TSRs running in DOS sessions. These memory-resident viruses can infect new programs or floppies as they are used. Some file-infecting viruses fail in the NT (and OS/2) environment because they attempt to use undocumented and unsupported DOS features. A memory-resident virus can't spread directly between separate DOS sessions, but any program executed in a DOS session that's running a virus will likely become infected. *continued*

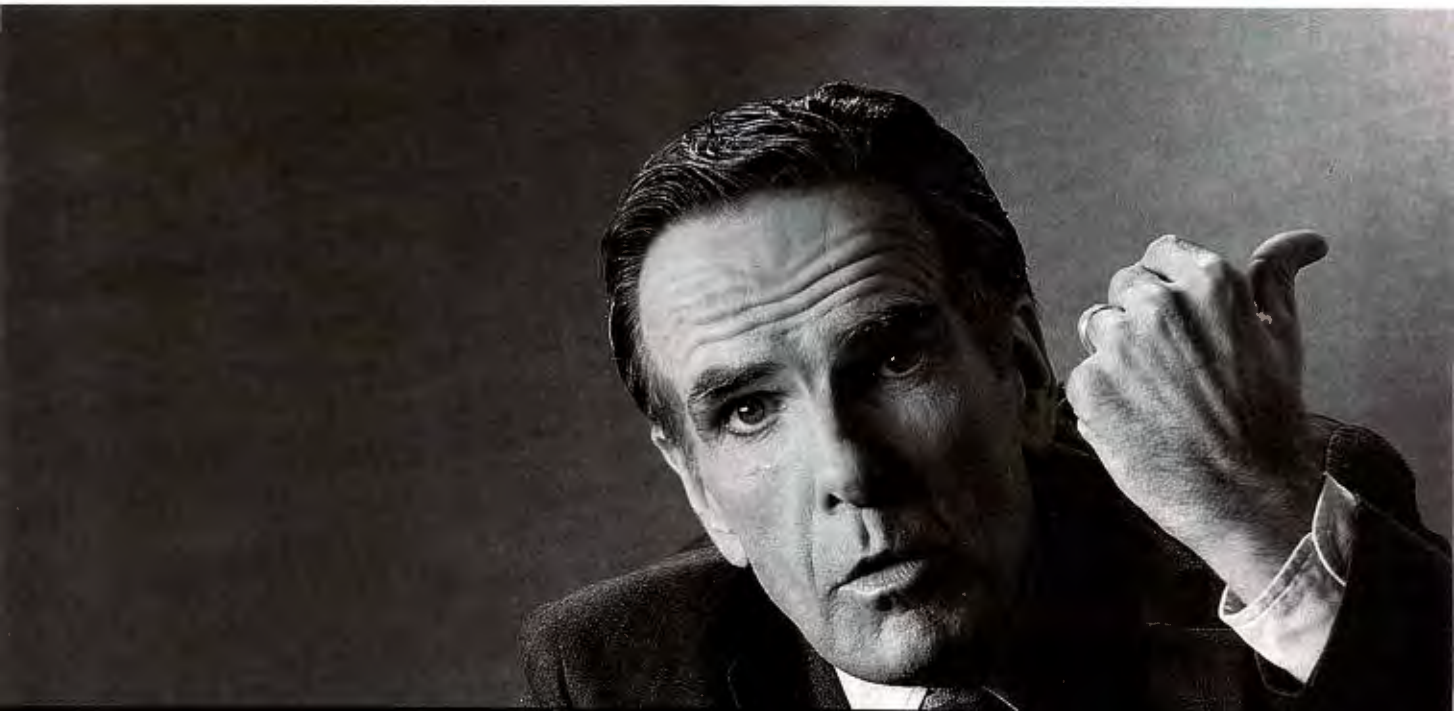
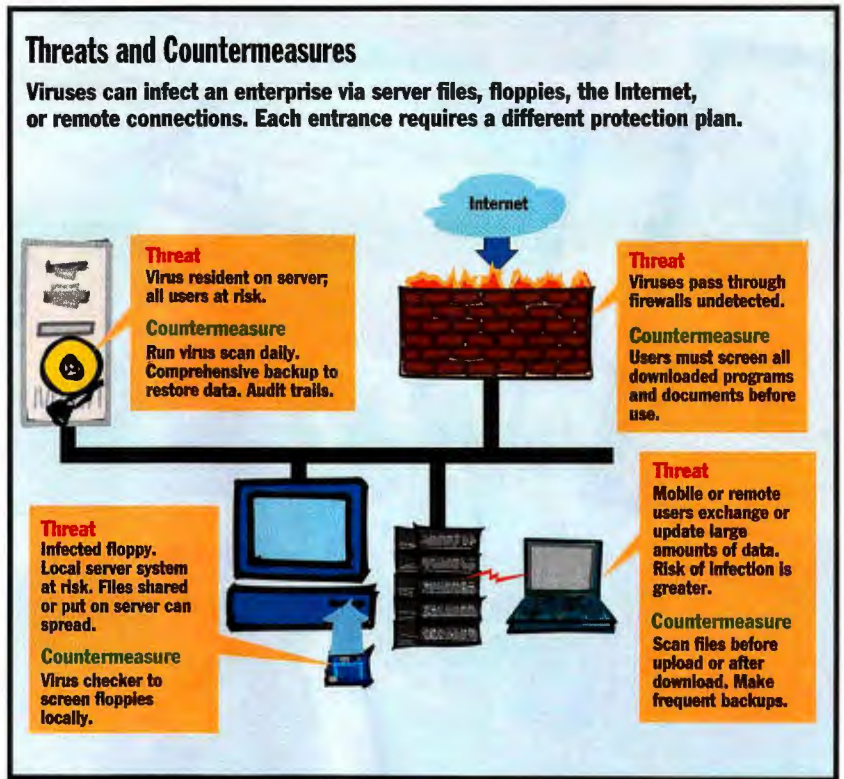

Then this guy walks in and only has two small bags, a laptop and what looks like *another* laptop.



**JUNE 3-7,
1997**

Taiwan's IT exports in 1996 shall reach US\$ 25 billion, making it the third largest IT producer in the world.

Whether it's monitors, notebooks, mainboards, scanners, keyboards, mouse devices, CD-ROM drives or multimedia kits, there's hardly a sector where Taiwan is not a potent force. The future of 3Cs is closely intertwined with that of Taiwan.

COMPUTEX TAIPEI is your link to the world's most comprehensive IT sourcing center. COMPUTEX TAIPEI is also the entire world of Information Technology in microcosm, coming from Asia's technical leader.

To be on-line with the future, plug in COMPUTEX TAIPEI!.



Organizers:
China External Trade Development Council (CETRA)
5 Hsinyi Rd., Sec. 5, Taipei, Taiwan, R.O.C.
Tel: 886-2-725-1111, Fax: 886-2-725-1314
<http://www.computextaipei.org>
<http://www.cetra.org.tw>



Taipei Computer Association (TCA)

Venues:

Taipei World Trade Center Exhibition Hall
Taipei Int'l Convention Center (TICC)



Sponsor:
Taipei World Trade Center

For more exhibition information, please contact CETRA.



COMPUTEX TAIPEI

THE 17TH TAIPEI INT'L COMPUTER SHOW

Circle 196 on Inquiry Card.

OS/2 programs use an executable file format that's different from that of ordinary DOS programs. A file-infecting virus that treats an OS/2 or NT executable file like a DOS file will likely render the target program inoperable. In some cases, starting an OS/2 program from within an infected DOS session will infect the program's *DOS stub* (the part of an OS/2 program that prints "This program cannot be run in DOS mode").

Word processor and spreadsheet macro viruses are nasty cross-platform problems. The destructive MDMA macro virus infects Microsoft Word documents and has the capability to delete files (see the figure "One Virus, Many Consequences" on page 169). Because this virus is application-based, it works across many platforms: OS/2, Windows, Win 95, NT, and the Macintosh. MDMA infects *NORMAL.DOT* as well as files that use the Auto-Close macro.

MDMA activates itself on the first day of the month. The result of an MDMA attack is different on different OSes. A typical effect: After the damage is done,

MDMA displays the following text in a message box: "You are infected with MDMA_DMV. Brought to you by MDMA (Many Delinquent Modern Anarchists)."

LAROUX is a another macro virus; it infects Microsoft Excel spreadsheets. LAROUX replicates itself but does not destroy data. It has been reported by only one company, at sites in Alaska and Africa.

The LAROUX virus infects the *PERSONAL.XLS* file, which is located by default in *\MSOFFICE\EXCEL\XLSTART.PPERSONAL.XLS* is a default filename similar to *NORMAL.DOT* for Microsoft Word for Windows. If this file does not exist, the virus creates it.

LAROUX uses two macros to replicate: *auto_open* and *check_files*. It infects Excel versions 5 and 7 on Windows 3.1, Win 95, NT, and OS/2. Because of the way it searches for *PERSONAL.XLS* (which is a DOS filename), the virus does not replicate on the Macintosh.

Viruses can spread on any system on which a program can create or modify another program. And they can spread between users anytime a program that

one user runs can create or modify a program that another user can run.

Viruses aren't typically network-aware, but there are two notable exceptions. In November 1988, an Internet worm infected thousands of Unix-based machines that were connected to the Internet. And the *CHRISTMA EXEC*, a Rexx program for IBM's VM OS, produced millions of copies of itself on computers attached to European university networks, as well as IBM's own computers. In both cases, the network structure enabled the programs to spread rapidly in a matter of hours. Within a day or so, network administrators waded in, disabling the programs and cleaning up the mess.

Recommended Dosage

So how do you stop viruses from attacking your enterprise? Stopping your work every 10 minutes to run an antivirus utility is unproductive. But running such a utility just once every few years is a wasted effort. For most organizations, balancing safety and productivity means running antivirus software as frequently



I say, "Where's your presentation?" He just smiles, plugs them together and BOOM... he blows us away!



QUANTUM PHYSICS. TERM OR LIFE.
THE INFIELD FLY RULE. CONVERGENCE.

Ah, we knew that last one would confuse you.

But then, which of life's complexities is tougher to decipher than the Convergence market? Where the need for expert Information Technology solutions turns every decision into a Pass/Fail test.

It can all seem overwhelming. Until you discover something nearly one million computing experts already know. It's called BYTE, and within its pages are the answers and insights IT decision-makers trust to make Convergence a reality instead of a nightmare.

Now, we're not saying BYTE can unravel all of life's mysteries. But if your company is in the Convergence market, or advertising to it, you'll find no one is more of an authority on the subject.

The Infield Fly Rule?

Hey, your guess is as good as ours.



Why do nearly one million computing experts worldwide read BYTE magazine every month? Because only BYTE delivers the global coverage and technical insights that illuminate Information Technology from problem through solution. That makes us something of an authority on the subject. And you something of a genius when you advertise in BYTE. For more information, call John Griffin, VP/Publisher at 603.924.2663. Or contact us at <http://www.byte.com>

THE GLOBAL AUTHORITY FOR COMPUTING TECHNOLOGY.

as once a day or as little as once a week. If your employees frequently use floppies or other uncontrolled media to transport data, running such a utility daily makes sense (see the figure "Threats and Countermeasures" on page 171).

Unfortunately, the majority of antivirus programs are outdated even before you install them; IBM estimates that up to five new viruses are written each day. Updates thus form an important part of any antivirus policy. A typical organization should plan to update its antivirus software at least every quarter.

To remind you of your potential exposure, many antivirus programs will announce their staleness when a certain date is reached. Distribute updates soon after the utility displays its out-of-date message, but let users know that it's OK to run a utility that claims it's a few months out of date. Be sure to distribute updates to all your sites on a timely basis.

You should require 100 percent compliance with your antivirus procedures. If you achieve 90 percent, then you will have a fairly effective antivirus program in place. If your network OS (NOS) is Net-

Ware, consider running the antivirus utility in NetWare's system log-in script. Each computer will then scan for viruses every time a user logs on to the network. DOS, Windows 3.1, Win 95, the latest version of NT, and OS/2 all support NetWare log-in scripts.

No Immunity

Inevitably, every organization will encounter a virus problem. Networked computers, especially those running DOS or Windows, are most at risk. Networks allow viruses, the majority of which are DOS-based, to spread quickly.

However, no computing environment has a natural immunity to viruses. A good backup of your data, along with an aggressive enterprise-wide antivirus strategy, is inexpensive insurance. **B**

Barry Nance, a BYTE consulting editor, has been a programmer for 25 years. He is the author of Using OS/2 Warp (Que, 1994), Introduction to Networking (Que, 1994), and Client/Server LAN Programming (Que, 1994). You can contact him at barryn@blx.com.

WHERE TO FIND

Cheyenne Software
Roslyn Heights, NY
(516) 484-5110
fax: (516) 484-3446
<http://www.chey.com>

IBM
Armonk, NY
(914) 765-1900
<http://www.ibm.com>

Intel Corp.
Santa Clara, CA
(408) 765-8080
<http://www.intel.com>

McAfee Associates
Santa Clara, CA
(408) 988-3832
fax: (408) 970-9727
<http://www.mcafee.com>

S&S Software International, Inc.
Burlington, MA
(617) 273-7400
fax: (617) 273-7474
<http://www.dr Solomon.com>

Symantec Corp.
Cupertino, CA
(408) 253-9600
<http://www.symantec.com>

TCT-ThunderByte Corp.
Cornwall, Ontario, Canada
(613) 930-4444
<http://www.thunderbyte.com>

Touchstone Software
Huntington Beach, CA
(800) 531-0450
<http://www.antivirus.com>



Introducing Proxima® Lightbook™

The first truly portable, lightweight, multimedia notebook projector built to withstand the rigors of the road. Call (800) 447-7692, ext. 443 to schedule your demonstration and request your free "The How-To's of Powerful Presentations" booklet.

Let us show you what portable really means.

PROXIMA®
MULTIMEDIA PROJECTORS

<http://www.prxm.com> • Main Office: 9440 Carroll Park Drive, San Diego, CA 92121-2298 • (619) 457-5500 FAX: (619) 457-9647
Proxima is a registered trademark of the Proxima Corporation. Lightbook is a trademark of the Proxima Corporation. Other trademarks are property of their respective owners.

Circle 176 on Inquiry Card (RESELLERS: 177).

Come On Out and Shake Your Peppers!



THE 1996 MICROGRAFX CHILI FOR CHILDREN COOK-OFF

TUESDAY, NOVEMBER 19, 1996 • 6 PM – 11 PM • THOMAS & MACK CENTER (UNLV)

Let yourself go at this year's Micrografx Chili for Children Cook-Off—COMDEX/Fall's premier charity event.

It's a zesty mix of fun, fun, fun—with chili judging and armadillo races, all topped off with a sizzling concert by **BTO** and the **VILLAGE PEOPLE**.

Your ticket to the Chili Cook-Off and concert is only \$50—or \$25 for the concert alone. And most important, it all goes to support the vital work of the National Center for Missing and Exploited Children (NCMEC).

For ticket information, call the Chili Hot Line today at 1-800-357-7255. Or visit our red-hot Chili Web Page

at <http://www.micrografx.com/chili.html> or drop into the Micrografx Chili for Children Booths at LVCC and Sands Expo Lobby at COMDEX/Fall. What's more, mention this ad and you'll get \$5 off the concert admission only.

So come on out and dance the night away. You'll have a great time, and you'll help us all go a long way towards helping missing children.



1996 CATTLE BARON SPONSORS



New versions of PowerBuilder and Centura offer improved performance and faster 32-bit applications. By Mark Hettler

Upgraded C/S Tools: How Much Better?

Earlier this year, we compared Borland International's Delphi Client/Server Suite, Microsoft's Visual Basic 4.0 Enterprise Edition, Powersoft's PowerBuilder Enterprise 4.0, and Gupta's SQLWindows 5.0 (see "New Leaders of

orders, and run simple and complex reports.

In our tests, PowerBuilder and Centura come out close together. PowerBuilder is a little easier to use and a little more powerful, but Centura builds better-performing applications more quickly. In the June review, Delphi showed itself to be several times faster than Visual Basic, which in turn was several times faster than its other competitors. Centura and PowerBuilder have narrowed the gap, but Visual Basic is still a solid second.

Using NSTL's overall ratings scheme, Centura's greatly improved performance and PowerBuilder's much better versatility move both products within striking distance of Visual Basic. In fact, on the 1-to-10 scale we use, a mere 0.2 delta separates the three runners-up. Though it's a good performer, Visual Basic is clearly on a tier below the other three products in terms of features. Delphi, though it has the steepest learning curve, is still the performance and features champ.

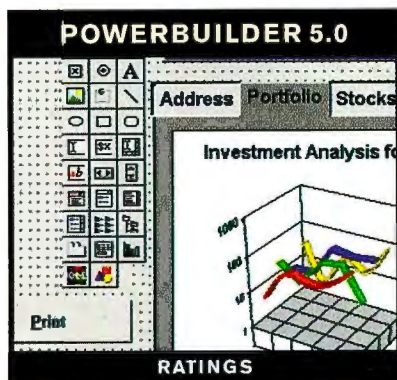
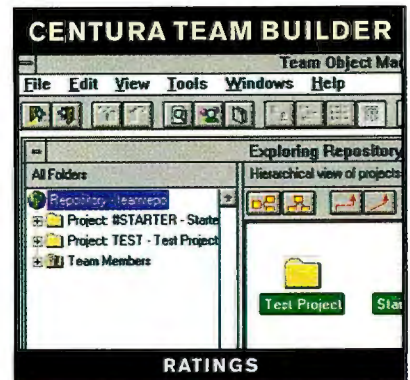

RATINGS	
TECHNOLOGY	★★★★
IMPLEMENTATION	★★★
PERFORMANCE	★★★

RATINGS	
TECHNOLOGY	★★★★
IMPLEMENTATION	★★★
PERFORMANCE	★★

the Client/Server Migration," June BYTE). Since then, Powersoft has released PowerBuilder 5.0, while Gupta has changed its name to Centura Software and issued Centura Team Developer 1.0. These products are so improved that we considered it important to look them over and update our previous ratings based on the new capabilities.

Both of these packages are development tools for creating custom, stand-alone client/server applications that let users enter, sort, filter, and report on your organization's data according to your business policies, procedures, and data operations. As in June, we tested these products for performance, usability, and versatility, using each one to develop an order-entry-system database of books, authors, and customer orders. With our test applications, users browse a database of 50,000 existing orders, enter new

PowerBuilder Enterprise 5.0

ADVANTAGES

- + Integrated version-control system that's remarkably easy to set up
- + Excellent support for three-tiered client/server applications that communicate with one another

DISADVANTAGES

- Repository platform requires Sybase's SQL Anywhere
- Improved performance still lags behind the competition

Most of the features and architecture that have made PowerBuilder popular are still in place in version 5.0. You still use interfaces called *painters* to create the various parts of applications, and DataWindows allow easy implementa-

tion of database access. InfoMaker, the report generator, looks and feels much the same as in PowerBuilder 4.0, but it's now available as a 32-bit application. Developers can create reusable components called *user objects*, which can be based on built-in components or other user objects and inherit their properties.

Beyond the familiar features, however, version 5.0 moves the product into the next generation of client/server development by introducing support for a three-tiered architecture. This capability is already available in Visual Basic and Delphi, but PowerBuilder is the best of the three products at providing step-by-step instructions for developing client and server applications that communicate with each other. Powersoft introduced nonvisual user objects in version 4.0. It extended the capability in version 5.0 to allow the nonvisual objects of one program to be executed by another.

Users familiar with PowerBuilder's Library Painter will go through virtually no additional learning curve with the new version-control system, ObjectCycle. Once you set up an ObjectCycle Server, you simply register the contents of a

library with ObjectCycle. From that point, you check components in and out as in earlier versions. Setting up the ObjectCycle Server is effortless. This is amazing given that the system must create a client/server database to store project data.

Centura Team Builder 1.0

ADVANTAGES

- + Much improved performance
- + Allows building of 32-bit applications
- + Data repository uses Oracle, Microsoft, Sybase, or Centura databases

DISADVANTAGES

- Features and versatility are little changed
- Application Server for three-tiered applications is not yet available
- Need to manually edit configuration files

The company that was formerly known as Gupta has adopted a completely new identity, renaming both its flagship software package and the company itself. Inside the new package, however, Centura Team Builder is essentially a version upgrade of SQLWindows. You still develop applications by writing code in the familiar Outliner interface, using the same SQLWindows Application Language (SAL) commands and functions that earlier versions used.

Developers can avoid the Outliner to a large degree by using QuickObjects, which generate forms and other objects automatically based on input supplied by the developer. This isn't a new feature, however, having been introduced in SQLWindows 5.0. The Team Object Manager is essentially Team Windows with a new user interface. Centura's much-touted Application Server, the tool for developing three-tiered applications, won't be available until later in the year.

The earlier version's annoying details are also still in place. To enable access to remote databases, you must still edit configuration files manually. Team Object Manager, like the earlier Team Windows, still leads the field in maximizing the power of the client/server environment for repository-based applications management, but it's still poorly integrated with the main development interface. Also, while QuickObjects produce applications and components more quickly than writing code in the Outliner, it is difficult and confusing to change properties after you generate them.

continued

PowerBuilder vs. Centura

You can access the full data, including Delphi and Visual Basic 4.0, complete with individual weightings and scores in each category and line item, on The BYTE Site (<http://www.byte.com/>).

	PowerBuilder	Centura
FORM DESIGN		
Visual query builder	✓	✓
Query by form	✓	
Quick form from database table	✓	✓
Move fields after generating	✓	✓
Quick master-detail form	✓	✓
Multiple record display	✓	✓
APPLICATION-CONTROL FEATURES		
Dynamic menu building		✓
Multitab dialog boxes	✓	✓
Form can call another form	✓	✓
EVENT HANDLING		
Procedures triggered by events	✓	✓
Detect keystroke/mouse-click/time event	✓	✓
Process based on old or new value	✓	✓
Cancel any event	✓	✓
ADVANCED FUNCTIONS		
Incorporate VBX and ActiveX controls	✓	✓
OLE 2.0 edit-in-place	✓	✓
Store OLE objects in database	✓	✓
SQL SUPPORT		
Generic SQL	✓	✓
Engine-specific native SQL	✓	✓
Transparent joins across engines		
REPORT GENERATOR		
Incorporate report into application	✓	✓
Quick report within application	✓	✓
Specify selection criteria, sort order at run time	✓	✓
Event procedures	✓	✓
Multiple records across page	✓	✓
APPLICATION REPOSITORY		
Store application components and reusable objects	✓	✓
Store multiple versions	✓	✓
Store form/report templates	✓	✓
WORKGROUP FEATURES		
Check out/check in	✓	✓
Built-in version control	✓	✓
Version control of external files	✓	✓
REMOTE AUTOMATION		
Produce remote programs	✓	
Call and exchange data with remote programs	✓	✓
Remote procedures can access database	✓	
Call in-process OLE server	✓	✓
Call out-of-process OLE server	✓	✓
Produce in-process OLE servers	✓	
OBJECT MANAGEMENT		
Copy objects between applications	✓	✓
Copy code snippets between applications	✓	✓
Reusable object classes	✓	✓
Subclasses with inheritance	✓	✓
Multiple inheritance		✓

* By retrieving status codes from database. ✓ = yes

OPERATING INSTRUCTIONS,
AS DESIGNED BY NETWORK
PROFESSIONALS.



PC-TO-UNIX
CONNECTIVITY, AS DESIGNED BY
NETWORK PROFESSIONALS.



New
WINDOWS NT
Version Available!

If it were up to you, even the most complicated things would be simplified: tricycle assembly, VCR programming, maybe even your UNIX network.

Not that you'd want to manage it with one button. But with Reflection X from WRQ, it's almost that easy. Reflection provides a powerful X11R6 PC X server and complete PC-to-UNIX connectivity that lets end-users handily access mission-critical applications right from the Windows desktop.

It has the highest level of application reliability, an award-winning TCP/IP stack, plus 32-bit architecture for faster performance. And best of all, it's everything you need—PC X server, transport, TCP applications, emulation, even an NFS client and Internet access tools—all from one vendor.

To try PC-to-UNIX connectivity designed from your point of view, get yourself in gear and call for a free evaluation copy. Then sit back and watch everything go like clockwork.



REFLECTION® X/REFLECTION SUITE FOR X

- ▲ **ARCHITECTURE:** 32-BIT WITH WINDOWS ACCELERATED VIDEO ENHANCEMENTS (WAVE); X11R6 COMPLIANCE (XTEST AND MULTI BUFFERING EXTENSION (MBX)), OPTIMIZED FOR WINDOWS 95
- ▲ **INTEGRATION TOOLS:** DIAL-UP X, CONFIGURABLE PANNING, VIRTUAL SCREEN, BACKING STORE AND SAVE UNDERS, 24-BIT COLOR SUPPORT, REMOTE AND LOCAL WINDOW MANAGEMENT, GUI KEYBOARD MAPPING, AND ENHANCED LOCAL PRINTING
- ▲ **TCP/IP AND APPLICATIONS:** VT420, VT320, SCO ANSI, BBS ANSI, LPR/LPD, NFS, FTP CLIENT/SERVER, SNMP MIB II, DHCP, FINGER, PING, NETWORK MANAGEMENT, INTERNET
- ▲ **MANAGEMENT TOOLS:** XTRACE UTILITY WITH CUSTOMIZED FILTERS, QUICK-START CONNECTION TEMPLATES, HOST RESPONSE WINDOW, AUTO-FONT SUBSTITUTION, AND CENTRALIZED SITE ADMINISTRATION
- ▲ **TECHNICAL SUPPORT:** FREE PHONE SUPPORT, BBS, TECH NOTES BY FAX AND WORLD WIDE WEB

WRQ REFLECTION OFFERS COMPLETE SOLUTIONS FOR UNIX, X, HP, DIGITAL, AS/400, 3270, AND TCP/IP CONNECTIVITY.



For a FREE evaluation copy, call
800.926.3896

WRQ Reflection
CONNECTIVITY FOR A CHANGING WORLD

CALL 800.926.3896 IN EUROPE, CALL +31.70.375.11.00
OUTSIDE EUROPE, CALL 206.217.7100
INTERNET: info@wrq.com WEB: http://www.wrq.com

WALKER RICHIE & QUINN, INC./ 1100 DEXTER AVENUE NORTH, SEATTLE, WASHINGTON 98109 USA / FAX: 206.217.0093 ▲ BUIHTR-0047
WALKER RICHIE & QUINN, INC./ 1100 DEXTER AVENUE NORTH, SEATTLE, WASHINGTON 98109 USA / FAX: 206.217.0093
GERMANY: WALKER RICHIE & QUINN, INC./ 1100 DEXTER AVENUE NORTH, SEATTLE, WASHINGTON 98109 USA / FAX: 206.217.0093
▲ WRQ AND REFLECTION ARE REGISTERED TRADEMARKS OF WALKER RICHIE & QUINN, INC. ALL OTHER TRADEMARKS ARE THE PROPERTY OF THEIR RESPECTIVE HOLDERS.

TECH FOCUS

VERSION CONTROL

New Versions, New Controls

In any development environment that involves more than one person, the issue of version control (sometimes called change control) becomes critically important. As a software project evolves and grows, you add and change routines and modules, requiring recompilation, relinking, and resynching of some or all of the executable files.

Both PowerBuilder Enterprise and Centura Team Developer include facilities for version control, and both use client/server database technology to create and manage a shared, central object repository. Centura's Team Object Manager lets developers choose from Oracle, Microsoft, Sybase, or Centura databases for a repository platform, while PowerBuilder's ObjectCycle requires Sybase's SQL Anywhere.

Object-based systems must store many types of objects together with their properties and histories, including windows stored in libraries, menus, ActiveXes, bit maps, icons, DLLs, and even Word documents. Centura Team Developer features a graphical class browser that visually describes inheritance relationships among objects and classes, management reports that detail where an object is used in an application, ownership information on objects, the assignment of separate roles to team members who function as class engineers or object assemblers, version control of objects, and much more. PowerBuilder has ObjectCycle Manager (see the screen at the right), a graphical interface to the ObjectCycle Server that provides administration of PowerBuilder objects and projects, and version control for non-PowerBuilder objects. Centura's Team Object Manager supports project branching (e.g., running development for versions 1.1 and 2.0 concurrently), coding standards management, deployment management,

impact analysis, audit trails, and management reporting.

Important tasks related to version control include the administration of multiple platform versions, configuration information, build management, quality control, and release management. Both companies claim that their version-control facilities are up to the complete task. For example, PowerBuilder has a build process that's quite different from that used in a C or C++ environment. Third-party tools have only a limited ability to handle such product-specific, cross-tool builds, and that can limit their usefulness and versatility. Centura has a build management feature with which you can specify how different files come together to constitute a deployable application.

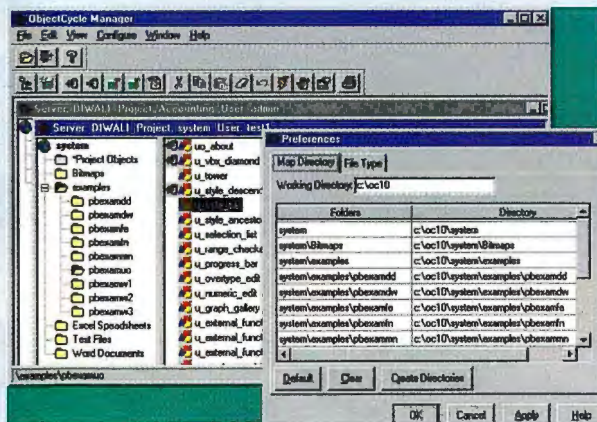

With all these holdovers, why did we bother with Centura? Its major new feature is that it now supports the development of 32-bit applications, a change that significantly improves performance (see the section below). In addition, the package incorporates Centura Ranger for database replication. Many leading database vendors (e.g., Oracle, Sybase, and Microsoft) support replication. Centura's strategy is to approach the issue from the client

side, providing heterogeneous replication between a variety of database formats. At present, however, it supports only SQL-Base and Oracle databases; replicating Oracle databases requires buying an additional product from Centura.

Performance

NSTL ran PowerBuilder 5.0 and Centura Team Builder through the same benchmark suite used in the June review, with the identical configuration: We executed applications on a Dell Dimension XPS P90 with 24 MB of RAM running Windows NT 3.51, accessing a Microsoft SQL Server database. This allowed us to compare the results directly to those of the June review, where PowerBuilder and SQLWindows trailed Delphi and Visual Basic by significant margins.

Both products are markedly faster, but Centura is by far the more significantly improved. This is due largely to its 32-bit capability; the previous 16-bit version was at a disadvantage to the other three products in the earlier review. However, data retrieval is dramatically improved as well. The time to retrieve a 50,000-record data

set is 80 percent shorter. Report generation takes a third less time for a complex report, more than half for a simple report. These improvements are enough to move Centura ahead of PowerBuilder, though it's still well behind Delphi and Visual Basic.

PowerBuilder has introduced a new machine code compiler. By Powersoft's own admission, however, the benefits for such operations as data retrieval and screen drawing—which are, after all, the central facets of an on-line database application—will be minimal at best.

Nonetheless, PowerBuilder 5.0 shows a consistent 20 percent to 30 percent increase over version 4.0 on most of the tests. Report execution times are reduced by more than a third, largely because the InfoMaker report generator is now a 32-bit application.

In the final analysis, PowerBuilder beats Centura (despite the latter's improvements), and neither beats Delphi for features and performance. **B**

Mark Hettler is a senior technical editor at NSTL. You can reach him at markh@nstl.com.

PRODUCT INFORMATION

Centura Team Developer 1.0

\$4995
(486 or better, 8 MB of RAM, 80 MB of disk space, Windows 95 or Windows NT)
Centura Software Corp.
Menlo Park, CA
(800) 444-8782
fax: (415) 321-5471
<http://www.centurasoft.com>
Circle 1004
on Inquiry Card.

PowerBuilder Enterprise 5.0

\$2995
(486 or better, 12 MB of RAM [16 MB is recommended], 32 MB of disk space, Windows 3.1x, Windows 95, or Windows NT)
Powersoft Corp.
Concord, MA
(800) 395-3525
(508) 287-1500
fax: (508) 369-8639
<http://www.powersoft.com>
Circle 1005
on Inquiry Card.

ObjectGeode, an OO CASE tool for real-time development, is a suite of tools based on accepted standards. By Rick Grehan

Real-Time RAD

Object-oriented (OO) CASE tools have been notoriously deficient when applied to real-time applications. Now, Verilog's ObjectGeode, with its triad of interwoven editors, will take on this real-world challenge.

Opponents of generic OO methodologies complain that they are not effective in modeling the asynchronicity, concurrency, and distribution of real-time systems, and that typical OO CASE tools provide no formal connection between abstract models and programs.

Consequently, ObjectGeode has some rapids to cross. It does so by lashing together a collection of tools based on well-accepted standards.

Editors, Editors

I tested ObjectGeode on a SparcClassic running Solaris 2.5. It is also available for SunSparc, Hewlett-Packard Series 9000/7xx-8xx, IBM RS/6000 and PowerPC, and DEC Alpha/OSF1.

At ObjectGeode's core are three editors: object modeling technique (OMT), specification and description language (SDL), and message sequence chart (MSC). The OMT editor is sometimes referred to as the class diagram editor. Each editor's notations are based on

RATINGS

TECHNOLOGY	★ ★ ★ ★
IMPLEMENTATION	★ ★ ★ ★
PERFORMANCE	★ ★ ★ ★

widely accepted standards: SDL and MSC are standard notations in the telecommunications industry. OMT is the well-known technique developed by James Rumbaugh and others.

The OMT Editor

This editor allows you to build class and instance diagrams using OMT notation.

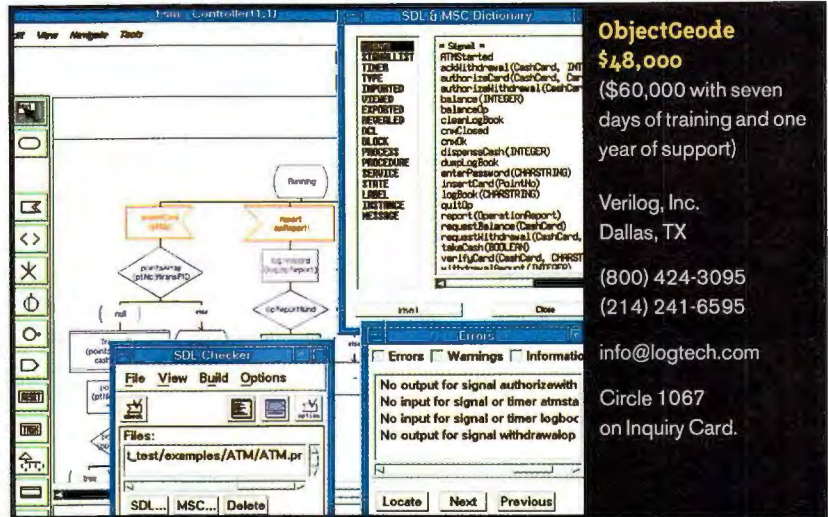

ObjectGeode

\$48,000

(\$60,000 with seven days of training and one year of support)

Verilog, Inc.
Dallas, TX

(800) 424-3095
(214) 241-6595

info@logtech.com

Circle 1067
on Inquiry Card.

ObjectGeode's SDL editor allows you to design finite state machines and will generate source code.

From within the OMT editor, you make sets of modules, each module being a particular view of the system. Typically, you create an overall view of the system to identify the principal actors (i.e., objects) and then construct other modules that describe those actors in increasing detail.

Diagrams you construct with the OMT editor are necessarily visual and fall into two categories: class diagrams and instance diagrams. Class diagrams show the internal structure (i.e., data items and methods) of—and relationships between—the system's objects. For example, if you are designing a system to control a bank's ATMs, you would use a class diagram to define what's inside the system's notion of a bank object and how that object relates to a customer object. Instance diagrams illustrate how a particular set of instances derived from the system's classes might be logically connected to one another.

ObjectGeode can generate C++ code from the modules you create in the OMT

editor. This code is really C++-style-header files containing class declarations filled with variable definitions and method prototypes. You can't use the OMT editor to specify the details of a given class's methods.

The MSC Editor

You turn to the MSC editor to diagram each use case, which is like the script of a play. You can read use-case diagrams to determine the actions that unfold as the system operates.

Other methodologies call use cases *usage scenarios* or *event traces*. But ObjectGeode scenarios refer to high-level event descriptions that are separate from the low-level details of the event. Thus, a scenario might be shown as a block labeled *SCSI read* in an MSC diagram, while the MSC would be the chart detailing the steps of the read operation.

It's important to note that the charts you build with the MSC editor show discrete activities, so you cannot use it to

model the entire behavior of the system. Additionally, MSCs show the *expected* behavior of the system—what the system is supposed to do, not how it does it.

Use cases are helpful in determining *derived requirements* of objects. In other words, working out the use case for a particular event may reveal an attribute that was omitted from an object participating in that event. It's a two-step process. First, you identify the functions the system must perform; next, you work through the details of the lowest-level activities.

The SDL Editor

ObjectGeode's SDL editor is a combination of three editors: a hierarchy editor, an interconnection editor, and a finite-state-machine (FSM) editor. The hierarchy editor is similar to one found in the MSC editor and is likewise a means of grouping similar activities.

With the interconnection editor, you can model communication between objects in the system like in a wiring diagram. It's easy to get confused here, because you're likely to conclude that objects in the SDL editor are the same as those you built in the OMT editor. This is not so, and the distinction is revealed once you understand ObjectGeode's design process. Simply put, you use the OMT editor in the problem domain and the SDL editor in the solution domain. Thus, SDL editor objects are often *artifacts*—objects that are constructed to solve the problem outlined in the OMT editor.

You program the machinations of the

processes themselves visually, using the FSM editor. From a distance, you could mistake the FSM diagrams for flowcharts, which in a sense they are. FSM diagrams reveal how SDL processes work.

The Process Process

Working through a project with ObjectGeode does not mean moving among editors sequentially. Rather, you visit the same editor multiple times. The overall process goes something like this:

Requirement-analysis phase. Using the OMT editor, you work out major classes based on real-world objects, identifying class attributes, methods, and relationships. In use-case modeling, you use the MSC editor to outline what the system should do, grouping cases into scenarios and defining messages between objects.

Architectural design. You introduce objects that will participate in the solution, avoiding specifics. Much of this happens in SDL. The focus shifts from objects to processes. The interconnection editor lets you map out how processes communicate with one another, thereby revealing the architecture of the system.

Detailed design. At this point, you use the FSM editor to begin working out the details of processes. Once you have the state machine of a process specified, you generate SDL code and run it in simulation on an SDL engine. This lets you catch such problems as deadlocks and unexpected signals. You can also backfill missing details in the OMT class diagrams that preceding phases have revealed.

Test design. You refine the MSCs produced in the requirement-analysis phase to construct detailed message sequences that exercise all possible scenarios. When running an SDL simulation, ObjectGeode will generate MSCs and match them with those specified. You can also create failure MSCs—message sequences that, if executed, indicate a failure of the system.

Targeting and testing. These phases convert the working SDL models to executable code. The conversion is straightforward, but it requires an SDL virtual machine on the target system. Virtual machines exist for a number of popular real-time OSes (RTOSes), including pSOS, VxWorks, and Vertex.

Good, Bad, and Ugly

ObjectGeode has competitors, most notably the real-time object-oriented modeling (ROOM) tool suite called ObjecTime (see "Systems Design in ObjecTime," December 1995 BYTE). Additionally, real-time projects have used the Shlaer-Mellor object-oriented-analysis (OOA) method, which is supported by development tools from Project Technology.

ObjectGeode's indisputable advantage is its use of standard notational languages and methodologies. This saves you from having to learn concepts that aren't applicable elsewhere.

Its use of SDL as the procedural notation provides a measure of portability. Not only can you target a variety of RTOSes, you can also deploy a single SDL model on different topologies (e.g., the same model can produce code for both single-processor and multiprocessor systems).

On the downside, ObjectGeode suffers from the difficulties in applying general-purpose OO-modeling methodologies to real-time systems, such as requiring translation "by hand" of items specified in the OMT and MSC notations into final code. ObjectGeode therefore can't provide a complete model-to-code solution. Contrast this with ObjecTime's ROOM, which uses an executable notation.

The pricing is steep as well. The software suite we tested costs \$48,000 (\$60,000 adds seven days of training and maintenance support for one year). The different components of ObjectGeode are available separately, and there are discounts for quantity purchases. **E**

Rick Grehan is a senior technical editor for BYTE reviews. You can reach him at rick_g@blx.com.

TECH FOCUS

SYSTEM TYPES

What's an Asynchronous System?

ObjectGeode addresses one class of real-time systems: asynchronous systems—those that service nonperiodic events. An example of an asynchronous system is a telecommunications switching system; there's no way for the system to predict when you'll pick up the phone. It's no surprise, then, to find that many of ObjectGeode's customers are in the telecommunications industry.

The other class of real-time systems—synchronous—deals with events or signals that arrive within a known period. (The dichotomy is not rigid. Plenty of real-time systems have both synchronous and asynchronous characteristics.) Synchronous systems also tend to be "hard real time" in nature. That is, not only do the events occur with known regularity, the system must service them in a specified amount of time. An example of a synchronous real-time system is a stepper-motor controller. Signal pulses must be transmitted to the motor at a certain frequency, or the motor simply won't step.

Designing a synchronous real-time system amounts to determining how many events will arrive at the system and at what frequency, and deploying tasks (or threads) to handle each event. The developer then explores worst-case scenarios to determine, for example, whether there would be enough horsepower to service events if they all arrived simultaneously.



Do more with less.

Most operating systems leave little room for important things. Like your application.

With the QNX realtime OS you'll pack more functionality into less memory. Achieve more performance with less-expensive CPUs. And deliver better solutions at a lower price.

Better yet, QNX supports more PC hardware than any other realtime OS. Whether it's PC/104 or PCMCIA, embedded X86 or the Pentium® Pro, QNX lets you use it right out of the box. Get to run time in less time!

More scalable than ever! From low-end to high-end, QNX offers you the ultimate in scalability. Even your deeply embedded systems can boast a scalable POSIX RTOS, thanks to our new, exceptionally small Neutrino™ microkernel.

And if you need to add the capabilities of a high-end GUI to your low-end system, you can. Our award-winning Photon microGUI™ gives you a phenomenal front end, with enough memory left over for important things . . . like your application!

www.qnx.com

Call **1 800 676-0566 (ext. 1028)**
or email **info@qnx.com**

QNX®

The Leading Realtime OS for PCs

QNX Software Systems Ltd., 175 Terence Matthews Crescent, Kanata, Ontario, Canada K2M 1W8 Voice: 613 591-0931 Fax: 613 591-3579
Europe: 49 Dove Park, Chorleywood, Hertfordshire. Voice: (44)(0)1923 284800 Fax: (44)(0)1923 285868 Email: QNXeurope@qnx.com
© QNX Software Systems Ltd. 1996. QNX is a registered trademark and Neutrino and Photon microGUI are trademarks of QNX Software Systems Ltd. All other trademarks belong to their respective owners.

Circle 158 on Inquiry Card.

Iomega's Ditto 2GB tape drive can back up all your data on a single cartridge—albeit slowly. By Robert L. Hummel

Ditto Your Data

Tape backup was once a murky, quirky domain where technicians tended expensive, proprietary black boxes. Today, ease of use and low prices make tape backup a sizzling consumer-oriented aftermarket. Iomega's latest entry into this pageant, the Ditto 2GB External, continues the trend toward higher-capacity media, lower-priced drives, and user-friendly software.

As the size of the average hard disk has swollen to epic proportions, so has the chance of data disaster. Given the cost of re-creating even a single complex file, personal tape-backup devices, such

replace it. Iomega decided to prevent the Ditto 2GB from formatting tapes, citing the long format time and higher cartridge price.

Single-Step Backup

The Ditto Tools backup software (developed for Iomega by Arcada Software) is as easy to use as could be. You can back up a single file or an entire set of drive volumes in one session. The simple 1-Step version, the ultimate in auto-pilot, manages backup operations automatically and restores files just as easily. More experienced users craving backup flexibility can choose from various options, including full, incremental, and differential backups. Supported environments include DOS, OS/2, and Windows 3.x and 95. Iomega promises an NT version soon.

You'll appreciate the software's support for unattended backups, given the Ditto's somewhat sluggish performance. For example, on an 8-MB 486DX/66 system running Win 95 with default settings, I measured an average disk-to-tape speed of about 4.5 MB per minute with a typical mixture of applications and data. (Iomega claims speeds up to 9.5 MBps with faster systems.) Adding in the time required to verify the backup reduced the effective backup speed to 1.7 MBpm. At that rate, filling up an entire tape could take 10 hours.

RATINGS	
TECHNOLOGY	★ ★ ★ ★
IMPLEMENTATION	★ ★ ★ ★
PERFORMANCE	★ ★ ★

The Ditto 2GB is not without problems—most of them common to all parallel-port tape drives. To function properly under DOS, for example, the drive needs exclusive use of a hardware interrupt. That means you have to resolve any potential conflicts with sound, net-



Ditto 2GB External
\$199
(estimated street price; for DOS, OS/2, Windows 3.1, and Win 95)

Iomega Corp., Roy, UT
(800) 697-8833; (801) 778-1000
fax: (801) 778-5763
<http://www.iomega.com/>

Circle 1066 on Inquiry Card.

work, or other expansion cards manually. Drive performance is also highly dependent on system speed. On slower systems running Windows 95, don't expect to perform other tasks while backing up in the background. It's possible, but not practical.

A Personal Ditto

The Ditto 2GB drive combines a 1-GB native capacity (or 2 GB, assuming typical file compression) with ultraportability and affordable pricing—both for the drive and the media. And although its parallel-port interface means that it's not the fastest tape drive around, the Ditto is a solid choice for personal system backups. **B**

Robert L. Hummel is an electrical engineer, programmer, and consultant. You can reach him on the Internet at rhummel@monad.net.

Ditto Data

Interface: Parallel port (with printer pass-through)

Read compatibility: QIC-80, QIC-80W, QIC-3010, and QIC-3020; Travan TR-1, TR-2, and TR-3

Writes: Preformatted Iomega 2GB only

Native capacity: 1 GB

Cartridge cost: Less than \$20

as the Ditto 2GB drive, are increasingly attractive.

Measuring 5.4 by 1.6 by 7.6 inches, the Ditto 2GB drive easily finds a home on a crowded desk. It connects to a parallel port (with printer pass-through), and it's eminently portable, weighing in at a svelte 1.4 pounds, although the largeish power brick weighs 1.7 pounds.

The drive reads many quarter-inch-cartridge (QIC)—standard tape formats, but it writes only to Iomega's proprietary 1-GB format (2 GB with compression). Fortunately, formatted Ditto 2GB cartridges have a street price below \$20—a lower cost per megabyte than comparable formats. If a tape becomes unusable for any reason, however, you'll have to

Chaos Manor

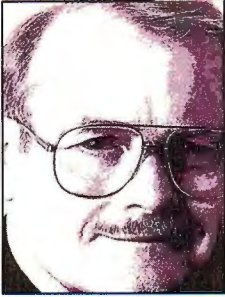

Don't Swap: Network!

Upgrading the Pournelle way means more than trading in one machine for another.

I've got a new method for writing fiction, and it's been working so far. Every morning, including Saturday, I get up at 8:00, have a leisurely breakfast, and read the papers. By 10:00, I'm upstairs in what used to be Alex's room. There's nothing in it but an elderly (in this business, three years is old) Gateway 2000 486DX2, a steno chair, a portable ice chest I fill with Dr. Pepper and root beer, and Alex's old high school books. There are no distractions. No phone. No modem. No computer games. No interesting books.

I stay there until 12:30. So far, I have averaged more than 1000 words a day plus rewriting the previous day's output. *Starswarm*, my new juvenile about a boy who grows up with a computer in his head, is taking shape wonderfully, with over 50,000 words done. At more than a thousand words a day, it will be finished in two weeks.

The Gateway 2000 486DX2 was Roberta's computer before we upgraded her to a Gateway Pentium 200. It's a perfectly good machine, and we've never had any trouble with it. It's certainly fast enough for what I'm doing. (Heck, for writing fiction, a 286 with Q&A Write is good enough.) The programs I run are Windows 95 (Win 95), Microsoft Office, Norton Commander (for DOS), and Info Select.

Info Select is a general notes program. It started life as Tornado Notes, which was a far better name than Info Select. When Micro Logic changed it from a DOS pop-up to a Windows utility, they changed names. I find the name ugly, but it's a terrific utility.

I use Info Select to accumulate and organize notes, such as character names,

locations, and all the other stuff that goes into my novels. It's easy to copy some text, such as the first scene where I name and describe a character, switch to Info Select, create a note or open an existing one, and stuff the new information into it. It's also great for diaries, keeping track of work in progress, and other stuff. You can learn to use it in about 5 minutes, and I don't see how anyone gets along without it. Micro Logic also makes DiskMapper, a program that graphically maps your hard drive and shows you exactly what's eating up all that disk space. I'll try to get to that soon, too.

Heck, for writing fiction, a 286 with Q&A Write is good enough.

I've also installed CyberMedia's First Aid 95 Deluxe on this Gateway machine. I chose it as much for its cleanup capability as anything else. Roberta had a whole bunch of stuff on the computer that I don't need, so after I copied it all to her new machine, I erased almost everything. That freed up a lot of disk space, but it left a whole bunch of Win 95 shortcuts and other junk. First Aid seems to have fixed all that.

I had what I thought were some problems with First Aid on another machine, but I know now that the problems were something else. I've been using First Aid on a number of machines without difficulties. It's good for cleaning up after big deletes, and while I haven't needed the recovery features so far, I might.

On the other hand, the installation program sucks rocks.

Actually, that's not true; the installation program works fine once you get it going. The problem is the serial number. First Aid comes on a CD-ROM. Appar-

ently, CyberMedia caught the serial-number disease from Microsoft, because you can't install First Aid without one. This means keeping paperwork handy, and I don't want to do that, so I use a marking pen to write the serial number on the face (the printed side, not the data side) of the CD-ROM. I do that on all those that need a serial number. Now I can't lose the serial number.

The First Aid CD-ROM is auto-play, so when you put it in the drive, it offers to install the program for you. So far, so good, but now it asks for the serial number. I opened the CD-ROM tray to read

the serial number. When I closed it, auto-play brought up another copy of the installation program. Eliminating that blew up the original installation program. There was nothing for it but to close down all attempts to install, copy the serial number on paper, and start over. Once that was done, things went smoothly enough, and First Aid's background programs came up on restart. I fail to understand the point of having serial numbers on CD-ROMs.

I formerly used Norton System Doctor to accomplish the same things that First Aid does, but System Doctor has an ugly feature: when it's running in the background, there's a steady blink-blink of the cursor on the desktop that I find extremely annoying. First Aid does not do that.

What I do on that upstairs machine is important. I back up to floppy disks every day, but I worry about power failures, so I have an American Power Conversion uninterruptible power supply (UPS) on

Instantly Document Corporate Policies, Procedures and Work Instructions

Have you ever drawn flowcharts for policies, procedures or process flows by hand...or with a PC drawing program?

If so, break your pencil in half...and delete those antiquated drawing programs from your hard drive.

Introducing a!lCLEAR.

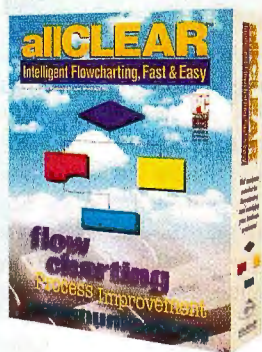

A better, faster, easier way to create all the flowcharts you need...integrate them into any written document...and rapidly revise them whenever your policies, procedures or processes change.

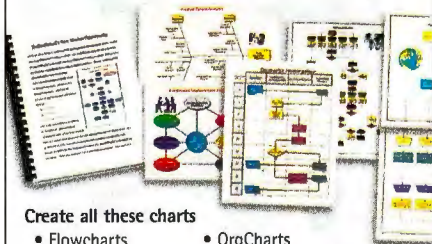

Create all these charts

- Flowcharts
- OrgCharts
- Network Diagrams
- TQM Diagrams
- Fishbone Diagrams
- Procedure Charts

It's fun, easy to use and it's guaranteed! So, stop wasting time and start churning out professional diagrams, like a pro, in minutes... even if you can't draw a straight line!



Free Offer

Call today to get your FREE report on how flowcharts can improve your processes.

1-800-338-1759



<http://www.clearsoft.com>



Circle 213 on Inquiry Card.

the machine. If First Aid 95 Deluxe has even a small chance of saving the work in progress, it's worth it, and having it there makes me feel better.

There are still plenty of Windows 3.11 systems out there, so we need one here as a test-bed. The machine that got stuck with the job is SuperCow, a Gateway 2000 486DX2 VL-Bus system. When we got that machine, it was the fastest thing in the house. Over the years, this column has featured upgrades to SuperCow: a Western Digital Caviar AC31000 1-GB hard drive, a new BIOS to support that drive, more memory, and new video cards. One of the first upgrades was a Creative Labs Sound Blaster 16 card and a CD-ROM drive. That was at least three years ago.

Since then, I've used SuperCow for nearly everything, including using it as the world's heaviest portable: I used to lug it down to the beach house when I'd go there to write. Whether it was from doing that

I've used SuperCow for nearly everything, including using it as the world's heaviest portable.

or something else, eventually the CD-ROM drive began to fail. It might have been the cable, or perhaps the laser needed cleaning—I'm not sure I ever cleaned it—but whatever happened, it stopped working. I decided this would be a good opportunity to update the double-speed CD-ROM drive, and as it happened, I had a new Creative Labs Sound Blaster Performance 8x Kit.

Physical installation was a bit tight. The CD-ROM cable Creative Labs supplied was shorter than the one that came with the original kit. However, because of the local-bus slots, I didn't have any choice where to put the sound card/CD-ROM controller. Eventually, I had to shuffle the drives so that the CD-ROM drive was on top, with the floppy drives beneath it; hardly a big sacrifice—indeed, it's an improvement—but just a bit annoying because I was working in close quarters.

When I got it installed, I tested it all under DOS. The sound card worked fine. So did the CD-ROM drive. I went into Windows. As Windows came up, Mr. Spock gave me some information about the confines of this solar system, so the sound was working; but when I accessed the CD-ROM drive, the system locked tighter than a drum. The only way out was the power switch.

That happened twice: the CD-ROM drive worked fine in DOS and locked up in Windows 3.1. Time to do some thinking. It took me longer than it should have to figure it out.

SuperCow is on my local Ethernet. When it comes up, it goes out on the network to connect to whatever machines it can find. Until that happens, though, the network card hasn't been accessed, and, more important, the interrupt request (IRQ) hasn't been used by the network card.

The Sound Blaster Performance 8x Kit comes set to use IRQ 5 for the sound card. This is standard: many DOS games expect it to be there, and a few can't be set to look elsewhere. As a general proposition, you are best off leaving your sound card set to IRQ 5. (If you have a second parallel port, you'll have to choose a different IRQ for the sound card.)

The sound card uses a different IRQ for the eight-speed CD-ROM drive, and that

is set by default to IRQ 10. Once again, this is no bad thing. Many systems use IRQ 10 for the CD-ROM drive. Unfortunately, that is where I long ago set the Intel EtherExpress card on the grounds that nothing uses IRQ 10 by default—which was true at the time. At least I'd found the cause of the problem.

I now had two choices: reset the EtherExpress card or the Sound Blaster. Resetting the EtherExpress card is simple, so in keeping with the notion that I go to a lot of trouble to try complex things so you don't have to, I decided to reset the Sound Blaster's CD-ROM drive IRQ.

In theory, that should be simple. Like the EtherExpress card, there are no jumpers on the Sound Blaster. Instead, there is software that automatically configures the card, an attempt at Plug and Play. There's also software that is supposed to let you change the card's configuration. It's not well documented, so I called Creative Labs' technical-support department. The first two people I talked to couldn't make it work. The next day, I got calls from increasingly savvy people. It didn't help. We'd manage to get the card to reset to a different IRQ—but as soon as I powered down and brought it back up, it seized IRQ 10 with a death grip.

To make the story short, I finally gave

up. IRQ 10 belongs to the Sound Blaster to control the CD-ROM card. I used SoftSet to change the IRQ for the EtherExpress card. That's a DOS program. One thing: if you change the IRQ for your network card in Windows 3.11, you must then invoke Windows with the command WIN /n, bringing it up without the network; go into the network settings; and manually change the IRQ to your new setting. If you don't, Windows will either lock up or try to change the card setting back to what it expects, and since Windows for Workgroups originally shipped with EtherExpress cards, Windows *knows how to do that*. The result is that you'll be back where you started. This is one case where attempts to Plug and Play actually get in the way.

Now that the IRQ conflict is over, SuperCow's CD-ROM, sound, and networking are fine. The CD-ROM drive is screamingly fast, the new speakers that came with the Creative Labs Sound Blaster Performance 8x Kit are wonderful, and all's right with the system. Of course, the processor is no faster than it was before, but like many of my readers, I get attached to my computers.

Note that if you install the Creative Labs Sound Blaster Performance 8x Kit on a system running Win 95, you shouldn't have any problems. The installation software was designed for Win 95 and understands it just fine. Do make sure you have the latest installation software from Creative Labs; they had some real teething problems with their early Win 95 installation, as did many others, and some of the old software is still in the dealer pipeline. The updates are on Creative Labs' BBS and Web site.

If you need sound—and most of us now do—and you want to add a CD-ROM drive to your system, the Creative Labs Sound Blaster Performance 8x Kit is a good way to go. The sound quality is more than good enough, you get a lot of neat software, and Sound Blaster is the standard that sound-using programs are written to. You won't have any trouble installing it in Win 95, and probably none in Windows 3.11 unless there's a conflict with your network card's IRQ. If there is, change the IRQ on the network card. Recommended.

You will have noted that we have several Gateway 2000 machines. There's RacingCow, a P5-133XL that Eric uses to cruise the Internet; SuperCow, and its non-VL-Bus counterpart I have upstairs; Joizy, my

Circle 144 on Inquiry Card.

Q: What does it take to deploy a superior client/server application? A: A SUPERIOR SERVER

START with the most advanced client-side SDK on the market: c-tree® Plus at \$895.

- Complete "C" Source code
- ROYALTY FREE (Client Side)
- Multiple supported protocols
- Fast, portable, reliable
- Powerful features like transaction processing
- Win95, NT, and Windows 3.1 ready

ADD a strong, multi-platform, industrial-strength Server that supports.

- File mirroring
- Heterogeneous networking
- Automatic disaster recovery
- Multi-threaded design
- Best price/performance available: from \$445- \$3745

RESULT? A solid, economical, easily deployable product that fits your needs.

- Portable
- Scalable
- Exceptional Performance
- Flexible
- Easy Server distribution
- Convenient OEM terms

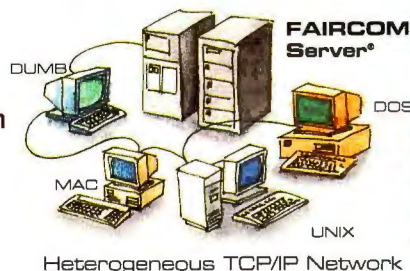

You can't find a better client SDK with these features!
Over sixteen years of proven reliability and performance.
No one else supports over 30 platforms in this price range!

c-tree Plus®

- Complete C Source
- Single/Multi User
- Client/Server (optional)
- Full ISAM functionality
- No Royalties
- Transaction Processing
- Fixed/Variable Length Records
- High Speed Data/Index Caching
- Batch Operations
- File Mirroring
- Multiple Contexts
- Unsurpassed Portability

FairCom Server®

- Client/Server Model
- Transaction Processing
- Requires <2MB RAM
- Online Backup
- Disaster Recovery
- Rollback - Forward
- Anti-Deadlock Resolution
- Client-side "C" Source
- Multi-threading
- Heterogeneous networking
- File Mirroring
- OEM/Source Available

FOR YOUR NEXT PROJECT CALL FAIRCOM: YOU CAN'T FIND A BETTER HETEROGENEOUS CLIENT/SERVER SOLUTION!

Also inquire about these FairCom products:

d-tree™ r-tree® ODBC Driver

FAIRCOM®

CORPORATION

WWWWeb Address: <http://www.faircom.com/>
800-234-8180

U.S.A. 4006 W. Broadway - Columbia, MO 65203-0100
phone (573) 445-6833 fax (573) 445-9698

EUROPE Via Patrioti, 6-24021 Albino (BG) - ITALY
phone (035) 773-464 fax (035) 773-806

JAPAN IKEDA Bldg. #3,4f-112-5, Komei-chou - Tsu-city, MIE 514 Japan
phone (0592) 29-7504 fax (0592) 24-9723



wife's new P5-200XL; the Liberty laptop; and Alex sometimes uses the old Hand-Book. We work these machines hard; indeed, SuperCow has undergone some real torture tests, what with frequently being taken apart to accommodate new equipment and every couple of months being carried off to the beach house in the trunk of the car.

Except for an initial problem finding a free IRQ so we could add a SCSI board to RacingCow—that system came fully equipped with an internal modem and sound card, and my first act was to add an Ethernet card, using the last free IRQ—we haven't had any problems with these machines. Roberta used the older Gateway machine for years and now has the P5-200XL, which she loves.

These are not special machines. I get them off the factory line, just as you do, and, indeed, the P5-200XL came with evidence of hard shipping since a few of the bezels in the front panel had been displaced. It didn't seem to matter; the machine worked just fine right out of the box.

I say all this because I get a lot of mail

asking if it's really safe to buy computers by mail order, and I can only reply that it depends on the mail-order outfit. I know of several good ones, and I can't possibly tell you which is best. I can only say that I

upgrade might keep that in mind. Example: we just acquired a Nimantics Orion 6x. It comes with a Pentium 150 processor, a built-in 6x CD-ROM drive, SoundBlaster, SVGA video in a 12.1-inch active-matrix

This is one case where attempts to Plug and Play actually get in the way.

can get just about any machine I want, and I've had quite satisfactory experiences with Gateway 2000 systems. I use them, and I rely on them.

Note also that I write only about what I'm familiar with. There was a time when I might try to keep up with the field and know what's best, but that was long ago. Now, all I can guarantee is that I don't write about what I won't use, and I sure won't use anything that's not more than good enough.

If my mail is any indication, a lot of you are concerned about upgrade paths. I've given this a bit of thought.

First, there are now full-featured laptops that are good enough to be your only computer, and people looking to

display, a 2.1-GB removable hard drive, and many other features. With 32 MB of RAM and the Pentium 150, Blue Streak—I've named it for the blue stripe on the packaging—is a real screamer.

The keyboard isn't bad, either: it's full-size, with plenty of keys—it's not one of those "space-saving" designs that assigns two or even three functions to every other key—and it includes so-called Windows 95 keys. Of course, keyboards are a personal thing, but I like this one, and I can write with it.

I could write books with this machine, and, in fact, if I didn't already have the Gateway machine installed upstairs in Alex's old room, I'd probably be taking Blue Streak up with me. Be warned: by



At Microsoft, small products are the beginning of gigantic opportunities.

Microsoft's new, lightweight Windows® CE operating system is ushering in the next generation of inexpensive computing devices. Along with big new opportunities for forward-thinking innovative individuals.

Based on the familiar Windows32™ OS, the Windows® CE kernel is now being introduced in affordable, easy-to-use hand-held computers designed to exchange information with desktop PCs, read and send e-mail, and access the Internet.

But that's only the beginning. Imagine a global positioning system for automobiles, or Windows® CE-based consumer products. Windows® CE opens the door for an amazing variety of applications that will entertain, communicate, instruct and inform. And they're all up to you.

E-mail your resume in ASCII text format (no attachments, please) to resume@microsoft.com (indicate Dept. A15h1-1196 in the subject header) or mail to: Microsoft Corporation, Attn. Recruiting A15h1-1196, One Microsoft Way, STE 303, Redmond, WA 98052-8303. No phone calls please. We are an equal opportunity employer and support workforce diversity.

Hardware Program Manager

You'll lead the integration of new hardware technologies into the new Windows® CE operating system. This includes evaluating new hardware technologies, working with leading industry hardware companies, recommending important new technologies, and following through with Microsoft software developers to implement support. Qualifications? Minimum 2 years hardware design. Driver or embedded software development experience required. Excellent communication and interpersonal skills preferred. Knowledge of CPU design, PCMCIA, small displays, touch panels, infrared, or RF wireless desired. Travel is required.

Microsoft
www.microsoft.com/jobs/

There Is Only One Choice For Data Compression.

PKZIP® for Windows



**New Version
Just Released**

New Features in PKZIP for Windows Version 2.50

- ▶ Ability to create .ZIP files that span multiple diskettes
- ▶ Create a Windows self-extractor
- ▶ Self-extractor can span multiple diskettes
- ▶ Long file name support for Windows 95 (16 and 32-bit) and Windows NT (32-bit)
- ▶ Integration with Windows 95 & NT Explorer
- ▶ Plus additional features

The growth of the Internet and the increased use of World Wide Web browsers are creating a greater need to compress and uncompress data files. Saving disk space and saving on-line phone charges are big benefits of compressing data files with *PKZIP® for Windows*. PKZIP for Windows compresses files an average of 50-70% with many large text and database files compressing well over 90%. PKZIP's simple point-and-click interface lets you easily compress one file or all files on an entire hard drive, and store them in the .ZIP file. PKWARE provides the best and fastest data compression technology on the market, try it and see!

PKZIP for Windows allows you to easily open files created with PKZIP for DOS Version 2.04g. PKZIP is also compatible with Windows 3.1 or higher, Windows 95 and Windows NT.

PKZIP for Windows \$49, PKZIP for DOS \$47 plus shipping and handling.

**To order call (414) 354-8699
or visit our Web Site <http://www.pkware.com>**

See us at COMDEX Booth #S2861



The Data Compression Experts®

9025 N. Deerwood Drive / Brown Deer, WI 53223 USA

FAX: 414-354-8559 BBS: 414-354-8670

Email: info@pkware.com



1992-1996 PC World World Class Award
1996 Government Computer News
Best New Product Award at FOSE Finalist
1995 Computer Currents Readers Choice Award
1993 Shareware Industry Award
1992 Premiere Computing Magazine Award
1992 Dvorsk/Zoom Award



Other PKWARE Products

Put Your Executables on a Diet



PKLITE™ increases your valuable disk space by compressing DOS and Windows 16-bit executable (.COM, .EXE and .DLL) files by an average of 45%. The operation of PKLITE is transparent, all you will notice is more available disk space! Price \$46

Software developers, save disk space and media costs with smaller executables. You can distribute your software in a compressed form with PKLITE Professional.™ PKLITE Professional gives you an extra option to compress files so that they cannot be expanded by PKLITE. This discourages reverse engineering of your programs. Price \$146

Put Compression Into YOUR Application

The PKWARE Data Compression Library® products allow you to incorporate data compression technology into your software applications. The application program controls all the input and output of data, allowing data to be compressed to or extracted from any device or area of memory.



The all-purpose Data Compression Algorithm compresses ASCII or binary data quickly. The routines can be used with most compatible language compilers. Separate DOS, DOS32, Windows, OS/2, Win32, UNIX and Macintosh versions are available! Call for pricing.

BY-1196

today's standards, it's a real heavyweight—about 8 pounds—if you're considering lugging it around airports, but on the other hand, it really is good enough to be your desktop machine. I don't have room here for as full a report as I'd like to give; but check the Pournelle bonus section on BYTE's Web site for much more on the Nimantics Orion 6x.

In my judgment, the best upgrade route is not to fiddle with your old system; get a new machine and network it to your old one. Ethernet boards are cheap and getting cheaper, and so are Ethernet PC Cards.

Win 95, and for that matter Windows 3.11, make networking simple and painless, and you'll soon find plenty to do with both systems. For one thing, you can do instant

If you've decided to upgrade by networking, get the fastest new system you can afford.

backups of important work by sending a copy to the other machine. That practice has saved me more than once.

Full-featured laptops—like the Nimantics Orion 6x—are one way to upgrade your capabilities. However, if you don't

need portability, you have other alternatives. The obvious one is to buy the fastest system you can find, a Pentium Pro, a Pentium 200, or one of the Cyrix wonders. Our

Cyrix 6x86-P166 system continues to work extremely well, and it's sure a fast machine.

Whatever you do, get a PCI-bus system and a PCI-bus Ethernet card for your new system; they're much easier to set up, and when Plug and Play works, it works very well.

On that subject, we've found there are two kinds of Ethernet cards to consider: 3Com and no-name generics. The no-names are cheap and often work, but if the drivers that come with them don't work well, you'll probably never get anything better. The 3Com cards come with good drivers, and when there are updates, you can download them. A PCI-bus 3Com Internet card will cost maybe \$30 more than a no-name card; in my judgment, the peace of mind and absence of installation problems are worth the money.

Understand, this is in the context of a low-cost upgrade by networking; those of you with more serious networking requirements should look into other alternatives, such as Applied Creative Technologies' Ultimate PCI-3000 network card. Of course, if you already have Ethernet cards that work, it's hardly worth buying new cards until you're ready for an upgrade to Fast Ethernet. We'll be doing that one of these days, but for the moment, I've found vanilla Ethernet plenty good enough.

Once you've decided to upgrade by networking, the obvious choice is to get the fastest new system you can afford. Less obvious—but possibly cheaper and better—is to get a reliable dual-Pentium system. If you go that route, you'll have to use Windows NT; Win 95 can't make use of your second processor, and given IBM's treatment of OS/2, I can't recommend that to anyone not already using it. That's a pity, but there it is. Fair warning: installation of NT isn't all that simple. If you don't know what you're doing, be prepared for headaches or get it preinstalled.

Once it's installed, you probably won't have any problems. We've been using NT 3.51 for a while, and it works well with a dual-processor system. Now there's NT 4.0, which is much like Win 95, so much so that most times you need to look to be sure

Gain Access to the World of Smartcards

In an increasingly wired world, thousands of profitable smartcard applications are just waiting to be developed, in a wide variety of fields - banking, security, telecom, education, healthcare and more.

To seize this opportunity and create successful smartcard applications, all you need is ASE™ — **The Aladdin Smartcard Environment.**

ASE is an integrated, PC-based development environment that gives developers an efficient, flexible and secure tool for making the most of this exciting new technology.

The quickest, easiest, and most effective introduction to the world of smartcards is the ASE Developer's Kit. Each Kit is a comprehensive package containing everything you need to get acquainted with ASE.



The ASE Developer's Kit includes ASEDrive, a versatile smartcard drive; ASESoft interfaces and utilities; and various types of ASECards.

To gain access to the world of smartcards - order your low-cost ASE Developer's Kit today!

North America 847-808 0300, Fax: 847-808 0313, E-mail: ase.sales@us.aks.com
Int'l Office +972-3-636 2222, Fax: +972-3-537 5796, E-mail: ase.sales@aks.com
Germany +49 89 89 42 21-37, Fax: +49 89 89 42 21-40, E-mail: info@fast-ag.de
United Kingdom +44 1753-622266, Fax: +44 1753-622262, E-mail: sales@aldn.co.uk
Japan +81 426-60 7191, Fax: +81 426-60 7194, E-mail: sales@aladdin.co.jp

Call us for details of your local distributor!

1-800-562-2543
 www.aks.com

ALADDIN
 KNOWLEDGE SYSTEMS LTD

© Aladdin Knowledge Systems Ltd 1985-1996 (9.96) ASE™ is a trademark of Aladdin Knowledge Systems Ltd. All other names are trademarks of their respective owners.

Save the whales, the rain forests and the red berry cheesecake.



On the Web, you'll find some of the most quickly disappearing things on earth. Now, you can save these files easily by transferring them to a CD-R disc. And the easiest way to do this, is through WebGrabber. It installs directly onto your copy of Netscape Navigator™ 3.0 and works entirely within the Netscape Navigator browser. Plus, it lets you open and browse these saved files from within the browser and link back to the internet directly from your CD-R disc. So with WebGrabber, transferring Web files to a CD-R disc is extremely easy. Or, in other words, a piece of cake.

Available now with Netscape Navigator 3.0
Get the full story at www.elektrosen.com

**Web
Grabber™**

by Elektrosen

Circle 185 on Inquiry Card (RESELLERS: 186).

you're not running Win 95. NT 4.0 is stable and, except for some DOS and Win 95 games, runs all your software.

If you are running multiple programs, especially if at least one is a DOS program, a dual 120 or 133 will likely be faster than one of the screamingly fast single-processor systems. You will almost certainly win with dual processors if you routinely run more than one DOS session simultaneously. DOS programs eat cycles, and handing control to a DOS program and then taking it back involves a deal of overhead. Dual processors let one run the application while the other does the overhead and housekeeping.

Actually, it's not quite that simple. The OS doesn't say "you do housekeeping and I'll do applications"; rather, the OS passes control back and forth as needed. Still, the effect is the same. The applications get the attention they need while the networking and other OS stuff goes on in the background.

A dual-processor system architecture will let you do all your networking and communications without losing speed.

We've been experimenting with Diamond Flower's dual-Pentium Doubleshot 133, and for many multiple tasks, it is by far the fastest machine in the house.

The original Pournelle's law was "one user, one CPU," but that was back when CPUs were really expensive. I've since amended it to "one user, at least one CPU." No one deep down inside likes to share CPU cycles with anyone—including oneself. I believe multiprocessor systems are the wave of the future. So, incidentally, does Intel. Of course, it's self-serving for Intel to recommend multiple processors, but that doesn't mean it's not a good way to go.

I'm still tracking down the hesitations I get in Win 95. A dozen readers have made helpful suggestions; and I think I now know what the problem is.

The symptom is that every few minutes there's a series of hesitations, typically manifesting itself when I am typing; I strike the key, and nothing happens for half a second or so. This goes on for a couple of seconds and then the system returns to normal.

The strange part is that Pentafluge, a Pentium 60 that was the fastest thing in the house when we built it, didn't have this problem under Windows 3.11; but as soon as we changed over to Win 95, the hesitations began, and we see them in Win 95, Windows 3.11, and DOS programs.

We don't see these hesitations on all the machines; the common element among those that do have the problem is that they all have Intel EtherExpress-16 ISA Ethernet cards. I am told by a reader that all I need to do is get the updated Win 95 EtherExpress drivers, and my glitches will go away.

I don't know if that's true. I downloaded what I thought were the proper Intel drivers. However, when I went to install them, Win 95 refused to believe there were any proper drivers in the directory I'd put them in. To make matters even worse, when I decided to reinstall the EtherExpress card with its original drivers, it took me five tries to get my network restored. The problem is that when Win 95 installs the EtherExpress hardware and default software, it does *not* automatically install NetBEUI.

continued

MOVING?

To change your subscription mailing address, please complete the form below and send it to:

BYTE

BYTE Magazine Subscriber Services, PO Box 555, Hightstown NJ 08520

Fax: 609-426-7087

Phone (9 a.m. to 8 p.m., Eastern Time, Monday through Friday): 800-232-2983 (U.S.), or 609-426-7676

Current/Old Address:

Account Number

Name

Company

Address

City/State/Zip

New Address:

Name

Company

Address

City/State/Zip

PLACE MAILING LABEL HERE

Please allow up to 8 weeks for this change to become effective.

A Division of The McGraw-Hill Companies





**IT'S AMAZING HOW MANY
COMPUTING EXPERTS PRACTICALLY LIVE
AT THIS ADDRESS.**

With so many web sites popping up today, it's hard to know which ones Net the best results. Especially if you're an advertiser looking to reach key Information Technology prospects.

Fortunately, the answer is close at hand. It's called The BYTE Site, and more computing influencers worldwide call it "home" than just about any address on the Web.

The BYTE Site is the online version of BYTE magazine, the worldwide technical authority for computing experts. That means it's chockfull of insights and information about the IT market from products to applications to trends. On The BYTE Site, visitors can instantly access every BYTE article published since 1993 through the BYTE Archive. Read all about the newest products and technologies in our Virtual Press Room. Share viewpoints with BYTE editors worldwide by on-site Email. Even download industry standard CPU test suites from our BYTEMarks benchmark service.

With features like these, it's no wonder The BYTE Site logged nearly 150,000 visits this past January alone, and posted an overall repeat visit rate of 41%. Not surprisingly, it's become equally popular among advertisers. That's because



The Byte Site offers such interactive marketing options as hot-linked AD-Action buttons to showcase product information, catalog listings and data sheets. Plus our Virtual Press Room where users can access the latest press releases from your company.

To learn more about The BYTE Site, call John Griffin, VP/Publisher at 603.924.2663. Or find him on The BYTE Site at <http://www.byte.com>. You'll discover reaching computing influencers worldwide is easy once you know where they live.

BYTE

A Division of The McGraw-Hill Companies 

THE GLOBAL AUTHORITY FOR COMPUTING TECHNOLOGY.

**If It Can Be Done
In a Conference Room,
You Can
Do It Online!**



**Introducing
Internet
CONFERENCE**

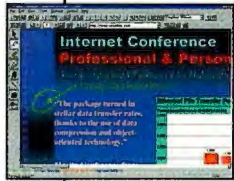

**View, discuss,
edit and
approve
documents
with anyone
in the world
over the
Internet.**

Everyone can see the document you're working on. Internet Conference Professional Version 2 brings seamless and efficient real-time multimedia communication to your desktop. Use it to give remote presentations and receive instant feedback. Link several offices and your clients together. Telecommute. Work online using the same programs you use now; use your own spreadsheet, word processor, contact manager, graphics or CAD/CAM program. Create documents or make changes. Even draw and highlight. Everyone meets in the same place... Your PC!

Make sales presentations remotely and interactively.

Turns your Microsoft® Office into an online application.

Work in Microsoft® Word, Excel or Powerpoint. Collaborate on projects.

Work on the Web together. Everyone views the same page at the same time.

Works on any network! Lan, Wan, Intranet, or Internet.



Download Free Trial

<http://www.vocaltec.com/560.HTM>

Call 800-899-3942

E-Mail: info@vocaltec.com



©1996 VocalTec Ltd. All rights reserved. VocalTec Inc., Internet Conference are all trademarks of VocalTec Ltd. Microsoft Office, Word, Excel, Powerpoint are registered trademarks of Microsoft Corporation.

NetBEUI is an elderly protocol whose major—almost only—use is Windows 3.11 and other Microsoft peer-to-peer networks, but you must have it for those.

Worse, the Network Troubleshooter wizard in the Win 95 Help system is almost useless. It does not ask if you have installed NetBEUI, so if you don't know you need that protocol, I don't know how you'd ever find out. I had forgotten I needed it, but since I had other systems networking properly, I could go study one that worked and see what I had left out.

In any event, I'm pretty sure the hesitations are caused by Intel EtherExpress cards running the Win 95 default drivers, and that they can be made to go away by either installing a different Ethernet card or getting the proper drivers for the EtherExpress card. I'll try to test that before we go to press next month.

The first book of the month is also the CD-ROM of the month: Erica Sadun's *Java Script CD-CookBook* (Charles River Media, ISBN 1-886801-35-5). This is a "book" you read with your Web browser. Clearly written, lots of examples, and probably the first of many "books" done this way.

A more traditional computer book of the month is Mark Warhol's *The Art of Programming with Visual Basic* (John Wiley and Sons, ISBN 0-471-12853-8). The subtitle is *Techniques for Writing Solid Code That's Easy to Maintain*, and it is all that and more. The chapter on naming conventions is worth the price of the book. If you do large Visual Basic programs, or you supervise people who do, this is nearly indispensable.

The book of the month is Thomas Cahill's *How the Irish Saved Civilization: The Untold Story of Ireland's Heroic Role*

from the *Fall of Rome to the Rise of Medieval Europe* (Doubleday, ISBN 0-385-41848-5). It's as much a delightful insight into Irish character as a history. Parts of it are serious enough, but even then you'll hear an echo of Irish laughter.

The game of the month is *The Pandora Directive* from Access Software. This is one of those role-playing movie games, and frankly I wouldn't have fired it up if I hadn't noticed that my old neighbor John Agar is in it.

It's actually a rather interesting plot hinging around what happened in Roswell, New Mexico, on July 6, 1947, involving UFOs. The acting is quite good. I find the pace of this game to be a bit slow, but that's really saying that I am not usually fond of the kind of game where you must poke around, looking in desk drawers and under rugs, and talking to everyone in sight. For those who do like that kind of game, *The Pandora Directive* is about as good a one as I have seen.

The piles grow higher at Chaos Manor, and even with the longer column—see BYTE's Web site for the parts of the column that didn't get into the printed edition—I can't keep up. We now have CD makers, a lot of great new software, so many CD-ROMs I have lost count, and a whole bunch of stuff I wish I had space to tell you about. The computer revolution isn't slowing down at all. **B**

Jerry Pournelle is a science fiction writer and BYTE's senior contributing editor. You can write to Jerry clo BYTE, One Phoenix Mill Lane, Peterborough, NH 03458. Please include a self-addressed, stamped envelope and put your address on the letter as well as on the envelope. Due to the high volume of letters, Jerry cannot guarantee a personal reply. You can also contact him on the Internet or BIX at jerry@bix.com.

PRODUCT INFORMATION

First Aid 95 Deluxe
about \$59.95
CyberMedia
Santa Monica, CA
(800) 721-7824
(310) 581-4700
fax: (310) 581-4736
<http://www.cybermedia.com>
Circle 1006 on Inquiry Card.

Info Select \$149.95
Micro Logic Corp.
Hackensack, NJ
(800) 342-5930
(201) 342-6518
fax: (201) 342-0370

<http://www.mielog.com>
Circle 1007 on Inquiry Card.

Orion 6x from \$2999
Nimantics, Inc.
Tustin, CA
(800) 646-5005
(714) 573-4030
fax: (714) 573-4025
<http://www.nimantics.com/>
Circle 1008 on Inquiry Card.

The Pandora Directive
\$79.95
Access Software, Inc.
Salt Lake City, UT
(800) 800-4880

(801) 359-2900
fax: (801) 359-2968
<http://www.accesssoftware.com>
Circle 1009 on Inquiry Card.

Sound Blaster Performance 8x Kit \$449
Creative Labs, Inc.
Milpitas, CA
(800) 998-5227
(408) 428-6600
fax: (408) 428-6611
<http://www.creativelabs.com>
Circle 1010 on Inquiry Card.

BYTE

BUYER'S GUIDE

Essential Products
and Services for
Technology Experts

Mail Order

Top mail-order vendors offer the latest hardware and software products at the best prices. **Page 196**

Hardware/Software Showcase

Your full-color guide to in-demand hardware and software products, categorized for quick access. **Page 219**

Buyer's Mart

The BYTE classified directory of computer products and services, by subject so you can easily locate the right product. **Page 228**



MICROTEK
Better Images Through Innovation.

ScanMaker E6

Capture lifelike color at a real-life price

- ◆ 600 x 1200 dpi optical, 4800 dpi interpolated resolution
- ◆ Single-pass scanning
- ◆ 30-bit color ◆ 8 x 13 scan area
- ◆ Includes: Image Pals 2 Go, OmniPage LTD and ScanWizard

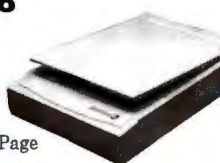

E6 Standard w/PhotoImpact **\$526.07** CDW 72263

E6 Pro w/full Photoshop **\$695.10** CDW 65671

ScanMaker E3

- ◆ 300 x 600 dpi optical resolution
- ◆ Single-pass scanning
- ◆ 24-bit color
- ◆ Includes PhotoImpact SE, Image Pals 2 Go, OmniPage LTD and ScanWizard

New lower price! **\$349.81** CDW 72264

WHY PAY RETAIL?

CDW Sells For Less!

Microsoft Windows NT Server V4.0

▲ One platform for e-mail, file server, databases and communications ▲ Integrates seamlessly with existing systems, including NetWare ▲ Built-in Internet, Intranet and communications services ▲ Includes web services: FrontPage and Internet Information Server ▲ Distributed on CD-ROM

- Server + 5-clients **\$738.93** CDW 73221
 - Server + 10-clients **\$1023.57** CDW 73222
 - Upg + 5 client licenses **\$377.15** CDW 73214
 - Upg + 10 client licenses **\$499.73** CDW 73218
- Call your CDW Account Executive for Microsoft Windows NT Server V3.51 and other V4.0 configurations!

COMPUTER DISCOUNT WAREHOUSE

HARDWARE, SOFTWARE & PERIPHERALS AT DISCOUNT PRICES

SOFTWARE	NETWORKING PRODUCTS	NETWORKING PRODUCTS	INPUT DEVICES
Adobe PageMaker V6.0 WIN 3.5/CD552.71	Novell	COMPAQ	Alps Desktop GlidePoint61.58
Adobe PageMaker V6.0 WIN upg 3.5/CD132.81	NetWare 4.1	EtherEZ 8TC 10BT hub103.31	Alps GlidePoint Windows 95 keyboard87.19
Adobe Photoshop V3.0.5 WIN 3.5/CD548.78	5-user CD719.00	Netelligent 100/100BTX PCI controller139.05	Calcomp Drawing Slate II 6x6 wireless pen178.94
Adobe Photoshop V3.0.5 WIN upg150.55	10-user CD1819.18	Netelligent 2000 8-port 10BT repeater477.16	Calcomp Drawing Slate II 12x12 wireless pen199.05
Arcade Backup for Windows 9586.90	25-user CD2381.71	Netelligent 5000 10/100BTX 6-port switch1029.19	Epson PhotoPC digital camera499.00
Caere OmniForm V2.0 WIN95171.13	50-user CD5231.25	Netelligent 5012 10/100BTX 12-port switch3114.08	Epson ES1000C optical scanner539.86
Caere OmniPage Pro V7.0 WIN95 vers upg113.65	100-user CD4509.48	EtherExpress PRO/10+ PCI combo139.71	Epson Vista 5-12 scanner1134.01
Corel WordPerfect Suite V7.0 WIN95 CD241.34	5-user 3.5"699.03	EtherExpress PRO/10+ PCI combo 5-pack591.23	Hewlett Packard ScanJet 4s184.27
Corel WordPerfect Suite V7.0 WIN95 upg 3.5/CD133.70	10-user 3.5"1074.17	EtherExpress PRO 100 PCI131.64	Hewlett Packard ScanJet 4c594.00
Corel WordPerfect Suite V7.0 WIN95 upg CD93.19	25-user 3.5"2328.29	EtherExpress PRO 100 PCI 5-pack592.28	Kodak DC40 Digital Science Camera599.00
Corel WordPerfect Suite WIN CD241.34	50-user 3.5"5231.25	Express 100 BTX 4-port stackable hub516.05	Kodak DC50 Digital Science Camera899.00
Corel WordPerfect Suite WIN upg 3.5/CD133.70	100-user 3.5"4509.48	Express 100 BTX switching hub3185.23	Logitech MouseMan 9649.17
Corel WordPerfect Suite WIN upg CD91.77	GroupWise V4.1	LANDesk Virus Protect V3.01 4-server pack606.15	Logitech TrackMan 9675.51
CorelDRAW V6.0 WIN95 CD434.37	Multilingual client/admin CD471.75	LANDesk Virus Protect V3.01 1-server pack1805.17	Logitech TrackMan Level cordless pointer109.40
Datostorm Procom Plus V3.0 WIN95/WIN122.77	Single-user license92.91	Combo Etherit LAN card26.29	Logitech PageScan optical scanner297.71
Datostorm Procom Plus V3.0 WIN95/WIN CD123.55	5-user CD497.20	Combo Etherit LAN card79.19	Microsoft PageWiz compact scanner114.69
Delrina WinFAX V7.0 WIN9577.38	25-user CD2337.53	Combo Etherit LAN card79.19	Microsoft ScanMaker E3 color flatbed149.81
Delrina WinFAX PRO V7.0 WIN95 CD78.24	10-user CD2745.82	Combo PC/Ethernet card 10BT109.11	Play Snappy video still capture165.92
Helix Hurricane V2.0 WIN95/WIN42.90	50-user CD1892.88	PC Card LAN/network 10BT339.85	Umax Vista S-12 scanner796.08
Intuit QuickBooks V4.0 WIN95.70	100-user CD4678.57	EtherFast 100/100TX LAN card104.92	Visioneer PaperPort Vx scanner257.45
Intuit QuickBooks Deluxe V5.0 WIN CD59.89	LAN WorkPlace V5.0	EtherFast 100BTX 12-port hub1093.74	Visioneer PaperPort X scanner297.24
Lotus 1-2-3 V5.0 WIN291.40	Single-user CD169.52	SMC	
Lotus 1-2-3 V5.0 WIN spec upg83.16	5-user CD3344.42	EtherEZ 5T 10BT hub86.00	
Lotus cc-Mail Mobile V6.0 WIN128.00	10-user CD1344.42	EtherEZ 16TC 10BT hub344.12	
Lotus SmartSuite 96 WIN95 upg CD138.72	25-user CD2337.53	EtherEZ 10BT ISA92.03	
McAfee VirusScan V2.0 WIN9544.23	Microsoft	EtherEZ 10BT ISA 5-pack372.03	
McAfee VirusScan V2.0 WIN95 upg44.17	BackOffice Server V2.0	EtherPower 10BT PCI117.39	
Microcom Carbon Copy V1.1 DOS86.61	Version upg CD896.74	Combo PC/Ethernet card 10BT109.11	
Microsoft Access V2.0 WIN206.94	Comp upg CD1381.08	EtherPower 100 BTX PCI139.36	
Microsoft Access7 WIN95 CD44.94	Full version CD1558.69	TigerStack 10BT 12-port hub499.02	
Microsoft Encarta '96 World Atlas WIN95 CD44.94	5-client license1169.68	TigerStack 10BT 26-port hub658.25	
Microsoft Encarta Encyclopedia 1996 WIN CD44.94	20-client license3087.64	DATA STORAGE	
Microsoft Excel V5.0 WIN comp upg114.89	Windows NT Server V3.51	COLORADO	
Microsoft FrontPage V1.1 WIN95137.34	Server CD622.50	Combo 350MB TBU internal89.70	
Microsoft MS-DOS V6.22 upg31.82	Network Value Pack Win95/NT V4.0	Jumbo 350 350MB TBU internal190.00	
Microsoft Office Professional V4.3 WIN935.47	Upg + 5-client license CD507.17	Jumbo 1400 1.3GB TBU internal190.00	
Microsoft Office Professional V4.3 WIN license458.68	Upg + 10-client license CD499.73	Trakker 350MB TBU parallel147.00	
Microsoft Office Professional V4.3 WIN upg354.25	Comp upg + 5-client license CD505.23	T1000E 800MB TBU parallel181.83	
MS Office Professional w/Access WIN95 upg314.50	Server + 5-client license CD1023.61	ionega	
MS Office Professional WIN95 CD w/Bkshel539.83	Single-client license upg16.82	Zip drive 100MB parallel199.00	
MS Office Professional WIN95 upg CD w/Bkshel V4.1514.29	Single-client license34.08	Zip drive 100MB SCSI199.00	
Microsoft Office Std WIN95 CD461.57	Version upg CD153.53	Dito Easy 800MB Travan internal119.00	
Microsoft Office Std WIN95 upg223.97	Single-client upg239.49	Dito Easy 800MB Travan external149.00	
Microsoft Office V4.2 WIN449.03	Full version CD283.20	Jaz drive 1GB internal SCSI-2399.00	
Microsoft Office V4.2 WIN upg268.37	Microsoft Windows NT Server V6.5	Jaz drive 1GB external SCSI-2499.00	
Microsoft Plus! Win95 CD44.84	Server + 5-client license CD1237.62	Jaz drive 1GB cartridge124.00	
Microsoft Plus! Win95 CD45.13	Server + 10-client license CD1781.65	SONY	
Microsoft Project V4.0 WIN418.73	Server + 25-client license CD3516.60	SDT-5200 DDS-2 DAT internal676.90	
Microsoft Publisher CD Deluxe WIN9569.20	5-client license2094.26	SDT-8200 DDS-2 DAT external788.68	
Microsoft Publisher V2.0 WIN69.20	20-client license716.04	SDT-5000 DDS-2 DAT internal841.63	
MS Visual Basic Pro V4.0 WIN95/WIN/NT CD443.49	Microsoft Systems Manager V1.1	SDT-7000 DDS-2 DAT internal927.77	
MS Visual Basic Pro V4.0 WIN95/WIN/NT vers upg CD86.33	SMS Server CD579.18	SyQuest	
Microsoft Visual C++ Subscription WIN95447.93	SMS Server upg593.18	EZ135 135MB IDE internal119.23	
Microsoft Windows 95183.47	SMS Server upg license40.14	EZ135 135MB SCSI external119.23	
Microsoft Windows 95 upg94.77	20-client license pack661.40	EZ135 135MB cartridge19.45	
Microsoft Windows V3.1192.06	Microsoft Exchange Server V4.0	EZFlyer 230MB SCSI external291.47	
Microsoft Windows V3.11 upg91.29	Server + 5-client license CD869.79	EZFlyer 230MB cartridge29.18	
Microsoft Word V6.0 WIN upg114.89	Server + 10-client license CD1218.21	MULTIMEDIA	
Microsoft Word V7.0 WIN95 upg55.35	Server + 25-client license CD1905.20	ADS TV Superscan 2 PC to TV converter292.20	
Microsoft Works V3.0 WIN42.13	3C900 EtherLink XL PCI 10BT112.16	Connectix QuickCam for Windows98.05	
Microsoft Works WIN9542.13	3C900 EtherLink XL PCI 10BT 5-pack504.30	Connectix QuickCam for Windows209.44	
NetManage ECCO Pro V3.0 WIN99.80	3C900 Ethernet XL PCI combo132.85	EXP 8X CD w/game port PCMCIA733.30	
QuarkXPress V5.32 WIN674.08	3C900 Ethernet XL PCI 5-pack196.87	EXP 8X CD w/sound module PCMCIA859.51	
Quarterdeck Clean Sweep V2.0 WIN9528.85	3C900 Fast EtherLink XL PCI 10/100BT136.95	Microsolutions 4X CD parallel219.87	
Quarterdeck OEMM V6.0 WIN95/WIN62.16	3C905 Fast EtherLink XL PCI 10/100BT 5-pack908.42	Microsolutions 6X CD w/sound parallel359.58	
Symantec ACTI V2.0 WIN171.24	SuperStack II Hub 12-port 10BT596.77	Microsolutions 8X CD parallel337.55	
Symantec Norton AntiVirus V2.0 WIN9568.00	SuperStack II Hub 24-port 10BT666.77	NEC 4x4 4X CD 4-disc changer internal99.00	
Symantec Norton AntiVirus V3.0 DOS/WIN40.20	SuperStack II Hub 48-port 100BT5974.26	NEC 4x4 4X CD 7-disc changer external342.15	
Symantec Norton AntiVirus WIN9572.14	SuperStack II Switch 1000 12-port Enet2492.74	NEC 6x1 6X CD internal243.82	
Symantec Norton AntiVirus WIN95 trade-up33.75	SuperStack II Switch 1000 24-port Enet3115.08	NEC 6x6 6X CD external339.65	
Symantec Norton NT Tools V1.0 WIN NT CD45.00	SuperStack II Hub TR 12-port1192.51	NEC 8V 8X CD internal SCSI-2153.71	
Symantec Norton Utilities V8.0 DOS/WIN116.53	SuperStack II Switch 2000 TR 12-port5349.47	NEC 8X 8X CD external SCSI-2341.78	
Symantec Norton Utilities WIN95 trade-up116.53	Artisoft	NEC 8X 8X CD external SCSI-2440.51	
Symantec Norton Utilities WIN95 trade-up87.24	LANTastic V7.0	Panasonic portable 4X CD SCSI399.00	
Symantec pcAnywhere V2.0 WIN119.21	Starter kit 3.5" + CD245.54	Sony portable 4X CD Discman®347.46	
Symantec pcAnywhere V6.0 DOS121.17	Add-on kit 3.5" + CD128.53	SunMoonStar 6X CD portable250.37	
Symantec pcAnywhere HERE V7.5 WIN95/NT upg91.79	1-user comp upg CD37.36	SunMoonStar 8X CD internal IDE/ATAPI181.12	
Symantec pcAnywhere PRO V7.5 WIN95/NT131.24	10-user comp upg CD232.51	SunMoonStar 8X CD portable271.86	
Symantec WinFAX Pro V4.0 WIN78.14	ModemShare V7.0		
Ventana Netscape Navigator V2.0 WIN43.94	1 shared port, unlimited users87.91		
Visio Technical V4.1 WIN95/WIN/NT289.78	4 shared ports, unlimited users291.24		
Visio V4.0 WIN 3.5/CD182.89	32 shared ports, unlimited users1560.24		

CDW

WINNER OF SEVEN COMPARETIVE AWARDS BEST BUY AWARDS

Best Buy

NASDAQ

BUY WITH CONFIDENCE

CDW® IS A NASDAQ TRADED COMPANY

TICKER SYMBOL CDWC

D & B rated 5A1

Dune 10-762-7952

DISCOVER NOW

VISA

MasterCard

Discover

CDW® TELEPHONE HOURS

Sales

Monday-Friday 7am-9pm CST

Saturday 9am-5pm CST

Tech Support for Customers

Monday-Friday 8am-9pm CST

Saturday 9am-5pm CST

If you find a better price, call CDW® before you buy

Fax: 847-465-6800

Sales: 800-959-4239 (4CDW)

PLAY
INSPIRATION

Snappy

The best way to get pictures into your PC

Grab sensational PC stills from any camcorder, VCR or TV. Just plug Play's Snappy into your PC's printer port, then connect to any video source with the included cable. With the press of a button, Snappy captures images in 16.8 million colors at resolutions up to 1500 x 1125. From desktop publishing to creating PC photo albums, Snappy makes your PC more powerful, more visual and more fun!

\$181.97 CDW 74744



FREE!
Includes Adobe
PhotoDeluxe,
MetaTools Kai's Power
GOO and Gryphon
Morph software

CDW®
SERVICES YOU
BETTER™

CDW® CARRIES OVER 20,000 PRODUCTS. IF YOU DON'T SEE IT, CALL!

COMPUTERS

TOSHIBA

Satellite & Satellite Pro Notebooks

110CS 5/100 6MB 810MB 11.3" dual	1939.75
110CT 5/100 6MB 810MB 11.3" active	2489.07
410CS 5/100 6MB 720MB 11.3" dual	2274.62
410CDT 5/100 6MB 720MB 11.3" active	2739.59
420CS 5/100 6MB 810MB 11.3" dual 6X CD	2508.75
420CDT 5/100 6MB 810MB 11.3" active 6X CD	2288.82

Portege Notebooks

610CT 5/100 6MB 720MB 9.5" active	2429.66
620CT 5/100 6MB 1.2GB 10.4" active	2431.18
550CT 5/133 1.6GB 11.3" active	4359.19

Tecra Notebooks

600CS 5/120 16MB 1.2GB 12.1" dual	3857.50
500CDT 5/120 16MB 1.2GB 12.1" active 6X CD	4619.50
720CDT 5/133 16MB 1.1GB 12.1" active 6X CD	3289.11
730CDT 5/150 16MB 2GB 12.1" active 6X CD	6002.57

AST

Ascentia Notebooks

J10 5/75 8MB 500MB 10.4" dual	1079.47
J20 5/100 8MB 540MB 11.3" dual	1736.97
J30 5/100 8MB 800MB 10.4" dual	2063.70
J30 5/100 8MB 800MB 10.4" active	2454.62
P30 5/133 8MB 800MB 10.4" active	2808.50
P30 5/100 8MB 800MB 11.3" dual 4X CD	2408.28
P30 5/100 8MB 1.2GB 11.3" dual 4X CD	2597.99
P40 5/120 16MB 1.2GB 11.3" active 6X CD	3237.93
P40 5/120 16MB 2.1GB 11.3" active 6X CD	3748.89
P50 5/133 8MB 800MB 11.3" active 4X CD	3528.11
P50 5/133 8MB 1.2GB 11.3" active 4X CD	3908.07
P50 5/133 24MB 1GB 12.1" active 6X CD	4217.73
P50 5/133 24MB 2.1GB 12.1" active 6X CD	4678.95

Advantage Lifestyle Mini-towers

9312 5/166 24MB 2.5GB 8X CD	2446.84
9310 5/166 24MB 2.5GB 8X CD	2351.94
9315 5/166 32MB 2.5GB 8X CD	2633.84
9316 5/200 32MB 3GB 8X CD	3821.44

Advantage! 9300 Series Mini-towers

9304 5/133 24MB 1.6GB 8X CD	1859.59
9306 5/166 24MB 2.5GB 8X CD	2073.30
9314 5/200 24MB 4GB 8X CD	2653.64

Bravo Desktops

LC 5100 5/100 6MB 630MB	1187.48
LC 5100 5/100 16MB 1.2GB	1287.19
LC 5133 5/133 8MB 630MB	1293.52
LC 5133 5/133 16MB 1.2GB	1378.74
LC 5133 5/166 16MB 1.2GB	1748.89
MS 5100 5/100 16MB 1.2GB	1377.41
MS 5100 5/100 16MB 2.1GB	1488.05
MS 5133 5/133 16MB 1.2GB	1499.11
MS 5133 5/133 16MB 2.1GB	1699.74
MS 5166 5/166 16MB 2.1GB CD	2052.28

Bravo Mini-towers

MS-T 5100 5/100 16MB 1.2GB	1398.54
MS-T 5100 5/100 16MB 2.1GB	1643.56
MS-T 5133 5/133 16MB 1.2GB	1854.43
MS-T 5133 5/133 16MB 2.1GB	1707.60

COMPAQ

Armada Notebooks

1120 5/100 8MB 810MB 10.4" dual	1888.23
1120T 5/100 8MB 810MB 10.4" active	2208.02
4110 5/100 8MB 810MB 11.3" dual	2496.17
4110 5/100 8MB 810MB 11.3" active	2879.37
4120 5/100 16MB 1.08GB 11.3" dual	3072.47
4120T 5/120 16MB 1.08GB 11.8" active	3474.82
4130T 5/133 16MB 1.08GB 11.8" active	4417.17

LTE 6000 Series Notebooks

5000 5/75 8MB 810MB 10.4" active	3548.77
5100 5/90 8MB 810MB 10.4" active	4032.87
5100 5/90 8MB 810MB 10.4" active 2X CD	4417.17
5150 5/100 8MB 810MB 11.3" dual	2879.37
5200 5/120 8MB 1.35GB 10.4" active	4801.37
5250 5/120 16MB 810MB 10.4" active	3648.77
5250 5/120 16MB 1.35GB 11.3" active	4417.17
5300 5/133 16MB 1.35GB 12.1" active	4601.37
5300 5/133 16MB 2.1GB 12.1" active	5761.87

Deskpro 2000 Series Desktops

5100/630 5/100 8MB 630MB	1119.70
5100/1200 5/100 8MB 1.2GB	1282.55
5100/1200 5/100 16MB 1.2GB	1384.25
5120/1200 5/120 8MB 1.2GB	1401.20
5120/1200 5/120 16MB 1.2GB	1802.90
5133/2500 5/133 16MB 1.2GB	1865.45
5133/2500 5/133 16MB 2.5GB	1858.85
5166/1200 5/166 16MB 1.2GB	1966.20
5166/2500 5/166 16MB 2.5GB	2169.60
5200/2500 5/200 32MB 2.5GB	2789.30
6180/1200CD 6/180 16MB 1.2GB 8X CD	2542.50
6200/2500CD 6/200 16MB 2.5GB 8X CD	3162.70

CDW® sells for less and services you better!™

Call for a free CDW® catalog

800-959-4239 (4CDW)

Visit our web site! www.cdw.com

©1996 CDW® Computer Centers, Inc. Byte 1833 11/96

Circle 235 on Inquiry Card.

COMPUTER DISCOUNT WAREHOUSE™

WHY SETTLE FOR LESS?

CDW® SERVICES YOU BETTER™

CDW® CARRIES OVER 20,000 PRODUCTS. IF YOU DON'T SEE IT, CALL!

COMPUTERS

COMPAQ

Deskpro 2000 Series Mini-towers

5133/2500CD 5/133 16MB 2.5GB 8X CD	2073.55
5166/2500CD 5/166 32MB 2.5GB 8X CD	2821.80
6200/2500CD 6/200 32MB 2.5GB 8X CD	3408.96

Deskpro 4000 Series Desktops

5120/1080 5/120 16MB 1.08GB	1627.20
5120/1620 5/120 16MB 1.62GB	1875.80
5133/1080 5/133 16MB 1.08GB	1808.00
5133/1620 5/133 16MB 1.62GB	1875.80
5166/1620 5/166 16MB 1.62GB	2186.55
5166/2500 5/166 16MB 2.5GB	2508.60
6180/1620/CDS 6/180 32MB 1.62GB 8X CD	3081.80
6200/2500/CDS 6/200 32MB 2.5GB 8X CD	3658.60

Deskpro 4000 Series Mini-towers

5133/1620 5/133 32MB 1.62GB	2308.85
5166/2500/CDS 5/166 32MB 2.5GB 8X CD	2881.50

Deskpro 6000 Series Desktops

5166/1080/CDS 5/166 16MB 1.08GB 8X CD	2847.80
5166/1080/CDS 5/166 32MB 1.08GB 8X CD	3107.50
5200/1080/CDS 5/200 32MB 1.08GB 8X CD	3519.95
6180/2150/CDS 6/180 32MB 2.15GB 8X CD	3813.75
6200/2150/CDS 6/200 32MB 2.15GB 8X CD	3983.25
6200/4200/PDS 6/200 32MB 4.2GB PD-CD	4847.70

Deskpro 6000 Series Mini-towers

5166/2150/CDS 5/166 32MB 2.15GB 8X CD	3519.95
6200/4200/PDS 6/200 32MB 4.2GB PD-CD	4881.60

Presario Desktops

4112 5/120 16MB 1.6GB 8X CD	1498.00
4122 5/150 16MB 2.5GB 8X CD	1899.00
4402 5/133 16MB 1.6GB 6X CD bulk/in 15" monitor	1999.00

Presario Mini-towers

4704 5/133 16MB 1.6GB 8X CD	1699.00
4712 5/166 24MB 2.5GB 8X CD	2199.00
6704 5/166 24MB 2.5GB 8X CD	2399.00
6702 5/166 24MB 2.5GB 8X CD	2499.00
4716 5/200 32MB 2.5GB 8X CD	2799.00
6706 5/200 32MB 2.5GB 8X CD	2999.00

IBM

ThinkPad Notebooks

385ED 5/100 8MB 540MB 10.4" dual 4X CD	1998.00
385ED 5/100 16MB 810MB 10.4" active 4X CD	2637.28
365X 5/100 8MB 810MB 10.4" dual	1999.00
365X 5/100 8MB 810MB 10.4" active	2359.00
365XD 5/100 8MB 810MB 10.4" dual 4X CD	2356.37
365XD 5/120 8MB 1GB 11.3" dual	2862.18
365XD 5/120 8MB 1GB 10.4" active 4X CD	2867.21
560 5/100 8MB 810MB 11.3" dual	2761.79
560 5/120 8MB 810MB 12.1" active	3743.78
560 5/133 8MB 1GB 12.1" active	4195.15
760E 5/120 8MB 810MB 12.1" active	4407.24
760E 5/120 8MB 1.2GB 12.1" active	4427.71
760E 5/133 16MB 1.08GB 12.1" active	5947.85
760E 5/133 16MB 1.2GB 12.1" active 4X CD	6894.88
760EL 5/100 8MB 810MB 11.3" dual	3206.62
760ELD 5/100 8MB 810MB 12.1" active 4X CD	4592.92
760EL 5/120 8MB 810MB 11.3" dual	3408.81
760EL 5/120 8MB 1.08GB 12.1" active	4392.50
760EL 5/133 16MB 1.08GB 12.1" active	5497.32

Aptiva Series Desktops

C33 5/133 16MB 1.6GB 8X CD	1999.00
C55 5/166 16MB 2GB 8X CD	2449.00
C73 5/200 16MB 2.5GB 8X CD	2809.00

PC300 Series Desktops

PC330 5/133 16MB 1.2GB 3 bays	1739.91
PC330 5/133 16MB 1.6GB 3 bays	1808.89
PC340 5/100 16MB 1.2GB 4 bays	1849.18
PC340 5/100 16MB 1.6GB 4 bays	1818.87
PC350 5/100 16MB 1.2GB 5 bays	1589.87
PC350 5/133 16MB 1.2GB 5 bays	1775.70
PC350 5/133 16MB 1.6GB 5 bays 6X CD	1998.82
PC350 5/166 16MB 1.6GB 5 bays	2146.32

PC700 Series Desktops

PC700 5/100 16MB 1.2GB 5 bays	1709.23
PC700 5/133 16MB 1.2GB 5 bays	1816.19
PC700 5/166 16MB 1.2GB 5 bays	2542.16

NEC

Versa Notebooks

2400 5/100 8MB 810MB 11.3" dual	2289.00
2400CD 5/100 16MB 1GB 11.3" dual 6X CD	2699.00
4200 5/100 8MB 810MB 10.4" active	2999.00
4250 5/133 8MB 1.08GB 10.4" active 6X CD	3899.00
4050H 5/90 8MB 810MB 10.4" active	2999.00
4080H 5/120 8MB 1GB 10.4" active	3699.00
6000H 5/100 16MB 1.08GB 11.3" active 6X CD	3999.00
6030H 5/133 16MB 1.35GB 12.1" active 6X CD	4999.00
6030X 5/133 16MB 1.4GB 12.1" active 6X CD	5399.00

AST Ascentia J Series

◆ Intel® Pentium® processor	
◆ 8MB RAM, upgradeable to 40MB	
◆ Hard drive upgradeable to 1.35GB	
◆ Integrated 14.4Kbps data/fax modem (J10, J30, J50)	
◆ 5.8lbs	

Model CPU Hard Drive Display Price CDW

J10	75MHz	500MB	10.4" dual-scan	\$1950.50	64481
J20	100MHz	540MB	11.3" dual-scan	\$1736.97	73027
J30	100MHz	800MB	10.4" active-matrix	\$2434.82	64483
J50	133MHz	800MB	10.4" active-matrix	\$2800.50	67377

The Intel Inside® Logo and Pentium® are Registered Trademarks of Intel Corporation

AST Ascentia J Series

- ◆ Intel® Pentium® processor
- ◆ 8MB RAM, upgradeable to 40MB
- ◆ Hard drive upgradeable to 1.35GB
- ◆ Integrated 14.4Kbps data/fax modem (J10, J30, J50)
- ◆ 5.8lbs

Model CPU Hard Drive Display Price CDW

J10	75MHz	500MB	10.4" dual-scan	\$1950.50	64481
J20	100MHz	540MB	11.3" dual-scan	\$1736.97	73027
J30	100MHz	800MB	10.4" active-matrix	\$2434.82	64483
J50	133MHz	800MB	10.4" active-matrix	\$2800.50	67377

The Intel Inside® Logo and Pentium® are Registered Trademarks of Intel Corporation

COMPUTERS

TEXAS INSTRUMENTS

Extrema Notebooks

510 5/100 8MB 810MB 10.4" dual	1739.77
555CD 5/75 8MB 524MB 10.4" dual	1354.80
570CD 5/100 8MB 810MB 11.3" dual 6X CD	2248.27
570CDT 5/100 8MB 1.2GB 10.4" active 6X CD	2634.07

TravelMate Notebooks

TM5200 5/120 8MB 1.2GB 11.3" active	2701.43
TM5300 5/133 8MB 1.2GB 11.3" active	2701.43
TM6020 5/120 8MB 1.08GB 11.3" active	4041.85
TM6030 5/133 16MB 1.2GB 12.1" active	4806.26

HEWLETT PACKARD

Vectra 500 Series Desktops

Vectra 500 Series Mini-towers

RAID

PERFORMANCE

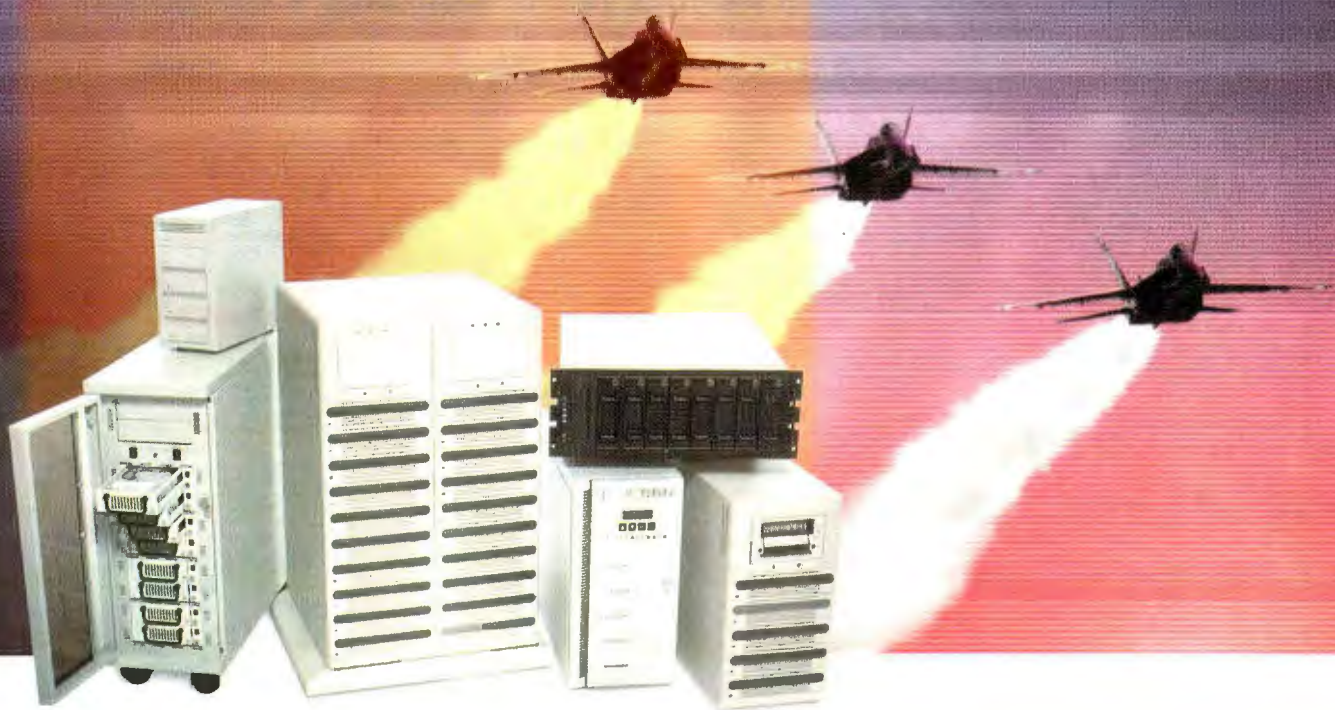

DATA INTEGRITY

Today's applications require higher performance and reliability from your storage configurations. Consan RAID systems are your storage solutions.

We have specialized in mass storage configurations for nine years and Consan designs the highest performing RAID configurations to meet your most demanding needs.

- **HARDWARE+SOFTWARE RAIDS** — All Raid levels for all platforms.
- **HOT SWAP** — Optional hot swap drives, power supplies, and fan.
- **DIGITAL VIDEO+CAD** — Digital Video + CAD Approved with most applications.
- **NETWORK SERVERS** — Combining performance and data integrity.

CONSAN builds Seagate based solutions as well as a full line of tape, optical and CDR storage products. For more information, call Consan toll-free at :

1-800-221-6732.



CONSAN

7676 EXECUTIVE DRIVE
EDEN PRAIRIE, MN 55344
TEL: 612-949-0053
FAX: 612-949-0453

1320 TOWER ROAD
SCHAUMBURG, IL 60173
TEL: 847-519-1080
FAX: 847-519-1248

101 EAST PARK BLVD.
PLANO, TX 75074
TEL: 214-422-3392
FAX: 214-422-3397



Switch to any Server by Name from an On-Screen Display!



Now, switching computers with your AutoBoot keyboard/video/mouse switch is even easier. Just call up the Director menu, choose a computer and you're done! No buttons to push or codes to remember. Since you name your computers whatever you like, picking one from the menu is a snap. Keep your current computer name on screen at all times, or for just a few seconds after switching.

Best of all, the Director works with any platform, operating system or software you use. All you need is a Commander product with keyboard control capability. And, because it's an add-on product to your existing Commander, there's no software to install.

With the Director, making the switch to Cybex is easier than ever!



COME SEE US AT
Networks Expo in Dallas, TX Oct. 29-31 Booth #1591
COMDEX/Fall '96 in Las Vegas NV, Nov. 18-22 at Booth #L4254



Cybex Computer Products Corporation
4912 Research Drive • Huntsville, AL 35805 USA
1-800-932-9239 • FAX (205) 430-4030
<http://www.cybex.com>

PC is a registered trademark of International Business Machines Corp. Macintosh is a registered trademark of Apple Computer, Inc. Sun is a trademark of Sun Microsystems. Cybex, Commander, AutoBoot and 4xP are trademarks of Cybex Computer Products Corporation.

Dealer Program Available

Made in USA

Circle 239 on Inquiry Card (RESELLERS: 240).

WE WILL TRY TO MATCH OR BEAT ANY ADVERTISED PRICE. CALL FOR LATEST PRICING!!

WE ACCEPT PO'S FROM QUALIFIED FIRMS

30 DAY MONEY BACK GUARANTEE

MEMORY

LIFETIME WARRANTY

SECURITY WILL CALL WINDOW NOW OPEN! NO SURCHARGE FOR MC, VISA AE & DISCOVER

HOT BOX SPECIALS

Compaq confura 400, 4Megg	\$49.00
4 x 8-80	29.00
4 x 8-70	19.00
Compaq 1Meg V-Ram Pl. No. 171017-001	39.00
Thinkpad 750, 720, 700, 360, 355 4Megg	49.00
1 x 1-80, 18 pin chip	2.00
1 x 9-80	12.00
256 x 1-10, 16 pin chip	50¢
Cyrix DRX2, 16-32	69.00
NEC Versa 4Megg	49.00
Panasonic 6500, 1Meg Module	14.00
HP 4P, 5P, 4V, 1Meg	14.00
HP 4, 1Meg	14.00

CACHE MEMORY

8Kx8	12NS	16NS	20NS	25NS
32Kx8	8.00	9.50	9.00	4.00
32Kx8 (3.3V)	11.00	9.00	8.00	6.00
64Kx4	11.00	9.00	8.00	6.00
64Kx4	11.00 (5V)	9.00 (3.3V)	8.00	6.00
128Kx4	8.00	7.00	6.00	5.00
128Kx4	23.00	20.00	18.00	16.00
32Kx16	12.00	11.00	9.00	8.00

CACHE MODULES

256K (160 pin) Pipelined Burst Cache Module	\$22.00
512K (160 pin) Pipelined Burst Cache Module	\$30.00
256K (160 pin) Async Cache Module compatible with IBM Aptiva	\$29.00

Individual D-RAM Chips

MEMORY FOR IBM & APPLE	SONS	SONS	SONS	SONS	SONS
1Mxg1	8.95	6.45	5.95	4.95	4.95
1Mxg2	10.00	7.50	7.00	6.00	5.00
1Mxg4 (2p Pk)	24.00	22.00	21.00	20.00	19.00
256K (Page Zip)	7.25	6.55	6.05	5.55	5.05
256K (Page Zip)	9.25	9.00	8.95	8.90	8.85
256K (Video Zip)	10.25	9.50	9.00	8.50	8.00
256K (SUD)	19.00	18.00	17.00	16.00	15.00
256K (160 pin)	3.25	2.55	2.15	2.15	2.15
64K	1.00	0.75	0.75	0.75	0.75
64K	1.00	0.75	0.75	0.75	0.75
256K 5U	39.00	38.00	37.00	36.00	35.00
256K 5U Edo	39.00	38.00	37.00	36.00	35.00
256K 5U Video Zp	49.00	39.00	38.00	37.00	36.00

INTEL Math Chips

80287-1X	49.00
80387-2D	39.00
80387-DX (Does All)	44.00
80487-DX (Does All)	59.00
Intel SX (Does All)	183.00
Intel M (Does All)	49.00
Intel 165K	29.00
Intel 165K	29.00
Intel 205K	29.00

CYRIX Fasmath

Cyrix 330X	\$39
Cyrix 400X	\$79

Make Your 486 Run like a Pentium®

3X Faster, for 486 Based Dx, Dx2, Sx, Sx2... ONLY \$135.00

SIMM MODULES (Add \$5.00 for SIPP)

256 x 9	40NS	SONS	SONS	SONS	SONS
1Mxg x 9 (3 chip)	16.00	13.00	13.00	13.00	13.00
1Mxg x 9 (9 chip)	22.00	19.00	19.00	19.00	19.00
4Mxg	41.00	39.00	39.00	39.00	39.00
16Mxg x 9 (8 chip)	179.00	169.00	169.00	169.00	169.00

72 PIN SIMMS (FPM, EDO)

256 x 38 1mg	60NS	70NS	80NS
1Mxg x 38 1mg	36.00	34.00	34.00
1Mxg x 38 2mg	36.00	34.00	34.00
2 x 38 8 mg	74.00	69.00	69.00
2 x 38 16 mg	148.00	138.00	138.00
2 x 38 32 mg	296.00	244.00	244.00
1 x 38 64 mg	592.00	488.00	488.00
1 x 38 128 mg	1184.00	976.00	976.00
1 x 38 256 mg	2368.00	1952.00	1952.00
1 x 38 512 mg	4736.00	3904.00	3904.00
1 x 38 1024 mg	9472.00	7808.00	7808.00
1 x 38 2048 mg	18944.00	15616.00	15616.00
1 x 38 4096 mg	37888.00	31232.00	31232.00
1 x 38 8192 mg	75776.00	62464.00	62464.00
1 x 38 16384 mg	151552.00	124928.00	124928.00
1 x 38 32768 mg	303104.00	249856.00	249856.00
1 x 38 65536 mg	606208.00	499712.00	499712.00
1 x 38 131072 mg	1212416.00	999424.00	999424.00
1 x 38 262144 mg	2424832.00	1998848.00	1998848.00
1 x 38 524288 mg	4849664.00	3997696.00	3997696.00
1 x 38 1048576 mg	9699328.00	7995392.00	7995392.00
1 x 38 2097152 mg	19398656.00	15990784.00	15990784.00
1 x 38 4194304 mg	38797312.00	31981568.00	31981568.00
1 x 38 8388608 mg	77594624.00	63963136.00	63963136.00
1 x 38 16777216 mg	155189248.00	127926272.00	127926272.00
1 x 38 33554432 mg	310378496.00	255852544.00	255852544.00
1 x 38 67108864 mg	620756992.00	511705088.00	511705088.00
1 x 38 134217728 mg	1241513984.00	1023410176.00	1023410176.00
1 x 38 268435456 mg	2483027968.00	2046820352.00	2046820352.00
1 x 38 536870912 mg	4966055936.00	4093640704.00	4093640704.00
1 x 38 1073741824 mg	9932111872.00	8187281408.00	8187281408.00
1 x 38 2147483648 mg	19864223744.00	16374562816.00	16374562816.00
1 x 38 4294967296 mg	39728447488.00	32749125632.00	32749125632.00
1 x 38 8589934592 mg	79456894976.00	65498251264.00	65498251264.00
1 x 38 17179869184 mg	158913789952.00	130996502528.00	130996502528.00
1 x 38 34359738368 mg	317827579904.00	261993005056.00	261993005056.00
1 x 38 68719476736 mg	635655159808.00	523986010112.00	523986010112.00
1 x 38 137438953472 mg	1271310319616.00	1047972020224.00	1047972020224.00
1 x 38 274877906944 mg	2542620639232.00	2095944040448.00	2095944040448.00
1 x 38 549755813888 mg	5085241278464.00	4191888080896.00	4191888080896.00
1 x 38 1099511627776 mg	10170482556928.00	8383776161792.00	8383776161792.00
1 x 38 2199023255552 mg	20340965113856.00	16767552323584.00	16767552323584.00
1 x 38 4398046511104 mg	40681930227712.00	33535104647168.00	33535104647168.00
1 x 38 8796093022208 mg	81363860455424.00	67070209294336.00	67070209294336.00
1 x 38 17592186044416 mg	162727720910848.00	134140418588672.00	134140418588672.00
1 x 38 35184372088832 mg	325455441821696.00	268280837177344.00	268280837177344.00
1 x 38 70368744177664 mg	650910883643392.00	536561674354688.00	536561674354688.00
1 x 38 140737488355328 mg	1301821767286784.00	1073123348709376.00	1073123348709376.00
1 x 38 281474976710656 mg	2603643534573568.00	2146246697418752.00	2146246697418752.00
1 x 38 562949953421312 mg	5207287069147136.00	4292493394837504.00	4292493394837504.00
1 x 38 1125899906842624 mg	10414574138294272.00	8584986789675008.00	8584986789675008.00
1 x 38 2251799813685248 mg	20829148276588544.00	17169973571350016.00	17169973571350016.00
1 x 38 4503599627370496 mg	41658296553177088.00	34339947142700032.00	34339947142700032.00
1 x 38 9007199254740992 mg	83316593106354176.00	68679894285400064.00	68679894285400064.00
1 x 38 18014398509481984 mg	166633186212708352.00	137359788570800128.00	137359788570800128.00
1 x 38 36028797018963968 mg	333266372425416704.00	274719577141600256.00	274719577141600256.00
1 x 38 72057594037927936 mg	666532744850833408.00	549439154283200512.00	549439154283200512.00
1 x 38 144115188075855872 mg	1333065489701666816.00	1098878288566401024.00	1098878288566401024.00
1 x 38 288230376151711744 mg	2666130978403333632.00	2197756577132802048.00	2197756577132802048.00
1 x 38 576460752303423488 mg	5332261956806667264.00	4395513154265604096.00	4395513154265604096.00
1 x 38 1152921504606846976 mg	10664523913733334528.00	8791026308531208192.00	8791026308531208192.00
1 x 38 2305843009213693952 mg	21329047827466668956.00	17582052617062416384.00	17582052617062416384.00
1 x 38 4611686018427387904 mg	42658095654933337912.00	35164105234124832768.00	35164105234124832768.00
1 x 38 9223372036854775808 mg	85316191309866675824.00	70328210468249665536.00	70328210468249665536.00
1 x 38 18446744073709556160 mg	170632382619733351648.00	140656420936499331072.00	140656420936499331072.00
1 x 38 36893488147419112320 mg	341264765239466703296.00	281312841872998662144.00	281312841872998662144.00
1 x 38 73786976294838224640 mg	682529530478933406592.00	562625683745997324288.00	562625683745997324288.00
1 x 38 147573952597676449280 mg	1365059060957866813184.00	1125251367491994648576.00	1125251367491994648576.00
1 x 38 295147905195352898560 mg	2730118121915733626368.00	2250502734923989297152.00	2250502734923989297152.00
1 x 38 590295810390705797120 mg	5460236243831467252736.00	4501005469847978594304.00	4501005469847978594304.00
1 x 38 1180591620781411594240 mg	10920472487662935005472.00	9002010939695957188608.00	9002010939695957188608.00
1 x 38 2361183241562823188480 mg	21840944975325870010944.00	18004021879391915377216.00	18004021879391915377216.00
1 x 38 4722366483125646376960 mg	43681889950651740021888.00	36008043758783830754432.00	36008043758783830754432.00
1 x 38 9444732966251292753920 mg	87363779901303480043776.00	72016087517567661508864.00	72016087517567661508864.00
1 x 38 18889465932502585507840 mg	174727559802606960087552.00	144032175135135323117728.00	144032175135135323117728.00
1 x 38 37778931865005171015680 mg	349455119605213920175104.00	288064350270270646235456.00	288064350270270646235456.00
1 x 38 75557863730010342031360 mg	698910239210427840350208.00	576128700540541292470912.00	576128700540541292470912.00
1 x 38 151115727460020684062720 mg	1397820478420855680700416.00	1152257401081082584941824.00	1152257401081082584941824.00
1 x 38 302231454920041368125440 mg	2795640956841711361400832.00	2304514802162165169883648.00	2304514802162165169883648.00
1 x 38 604462909840082736250880 mg	5591281913683422722801664.00	4609029604324330339767296.00	4609029604324330339767296.00
1 x 38 1208925819681654725201760 mg	11182563827366845445603328.00	9218059208648660679534592.00	9218059208648660679534592.00
1 x 38 2417851639363309450403520 mg	22365127654733690891206656.00	18436118417297321359069088.00	18436118417297321359069088.00
1 x 38 4835703278726618900807040 mg	44730255309467381782413312.00	36872236834594642718138176.00	36872236834594642718138176.00
1 x 38 9671406557453237801614080 mg	89460510618934763564826624.00	73744473669189285436274352.00</	

BECOME A CNE ...FAST!

THE FIRST CNE COMPUTER BASED TRAINING PROGRAM IS HERE...

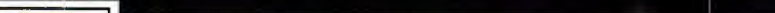

Novell NetWare
Protocol
Volume
File Servers
Work Stations

The AllMicro CNE Self-Study Course™ is the first 100% Computer Based Training (CBT) program to fully prepare you for Novell's CNE exams. Its innovative design provides fast, effective and convenient training to anyone wishing to become a Certified NetWare Engineer, even when hampered by a busy schedule. Our CNE CBT allows you to learn and practice *everything* you'll need for full NetWare certification.

- All on one CD
- Interactive NetWare simulation for hands-on exercises
- Study at your own pace
- Hundreds of practice questions
- Priced below competitive products
- Everything you need to prepare for Novell's test!

Effective!

Through the use of interactive exercises, you'll be able to gain practical hands-on knowledge under simulated situations without the need for a working network.

AllMicro's CNE CBT ensures that when you complete your training you'll be fully prepared to pass your CNE exams, and best of all, you'll be ready and confident to go into the workplace and perform vital CNE functions.

Convenient!

Our CNE CBT program offers you flexibility and portability unmatched by traditional training methods. You will study when and where it's convenient, at your own pace using a step-by-step format for either NetWare 3.1x or 4.1!

Affordable!

The AllMicro CNE Self-Study Course is priced far below other competitive training packages, so you can now get top quality training at a price you can easily afford.

Added Bonus!

The AllMicro CNE Self-Study Course even comes with the required Micro House Technical Library™. You'll have at your fingertips the latest specifications, diagrams, hardware settings, component locations, configurations, and other hardware technical information, all on CD-ROM. Familiarity with the Technical Library is required for full certification.

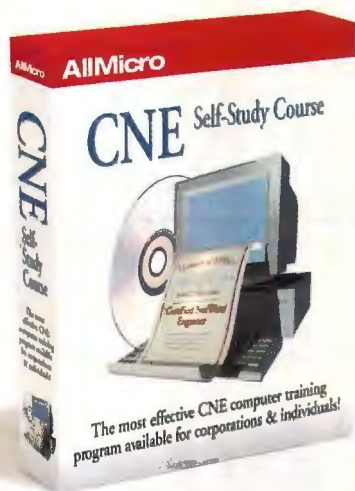

Don't put your career on hold any longer! Get the AllMicro CNE Self-Study Course and get certified...FAST!

COURSE MODULES INCLUDE:

- Administration v3.1x
- Advanced Administration v3.1x
- 3.1x Installation & Configuration (#802)
- Service & Support for NetWare (#801)
- TCP/IP Transport for NetWare
- Networking Technologies
- NetWare 3.1x to 4.1 Update
- *NetWare 4.1 course also available

NOTE: As of 6/30/96 current CNE's will lose their certification unless they pass Novell's new 3.1x-4.1 update test. We have the course!

CALL TODAY!!

For more information about our limited time discount pricing CALL: **1-800-653-4933**

INTERNATIONAL: (813) 539-7283 • FAX (813) 531-0200

FOREFRONT/AllMicro

18820 U.S. HWY. 19N., #215, CLEARWATER, FL 34624

Circle 255 on Inquiry Card.

BM

Delivering Great Computer Options!

SPORTSTER "33.6Kbps Data" Fax modem with Personal Voice Mail

Puts all the convenience of an answering machine, speakerphone, fax machine and reliable modem in one compact unit - and its easy to use, right from your home or office PC.

Sportster®



Robotics
The Intelligent Choice in Data Communications

- Supports true ITU-T V.34 data transmission at 33.6Kbps.
- Plug and Play design. 16550 UART for improved performance
- Speakerphone designed with Microphone Included.
- Multiple Voice Mail Boxes for convenient & confidential access.
- Fax on Demand Menu features ability for caller to choose requests.
- Quick, Remote Fax Retrieval! Ability to signal an alphanumeric pager!
- Full Duplex Speakerphone lets you talk and listen without interruptions.
- Caller ID and Distinctive Ring so you'll always know whose calling.
- 5 Year Limited Mfg Warranty: Factory Repair or Replacement

SPORT-VI 33.6Kbps Internal Faxmodem with Voice Mail
SPORT-VE 33.6Kbps External Faxmodem with Voice Mail

'179
209

Reliable & Affordable Ethernet Networking Products!

10BASE-T/BNC Adapter Card features Plug 'N Play I/O, interrupt and PROM address. NE2000/IEEE802.3 compliant with LED indicators for activity and link detection. Supports NOVELL, Microsoft, Artisoft, FTP and PC/NFS. Compatible with all Bus systems, 10Mbps transfer and is FCC certified.

Configuration options:

- Plug 'N Play Design
- I/O 300h,320h,340h & 360h
- Interrupt 2,3,4,5,10,12,15



AE-200-PNP-CE	10BaseT/BNC Adap.	33
AE-380PCI	32-Bit PCI 10Base T Adap.	59
AEF-350TX	PCI 10BaseT 10/100 Mbps Adap.	89
UTP16/L	16 Port 10BaseT Hub	190
UTP8SL	8 Port 10BaseT Hub	96

16-Port 10BASET Concentrator



- Reliable
- Compact
- Cost-effective!



Offers Sixteen 10BaseT ports with RJ45 connectors, One BNC and One AUI port for cascading hubs or connection to existing backbone, has 21 LED indicators for confirming status and operations. IEEE802.3 compliant.

BEN220	BOCAHUB-16 PLUS 10Base-T Concentrator	'247
BEN210	BOCAHUB-8 (Eight Port) 10Base-T Concentrator	99

Cat 5 & Coaxial Networking Bulk Cable

VDC5-4	Level 5, 4 Pair, Unshielded CL-2 PVC	1-99'	100-999'	1000'
VDC5-4P	Level 5, 4 Pair, Plenum	\$.15	\$.10	\$.09
RG58U	RG-58U Coaxial Systems PVC Cable	.45	.30	.26
		.15	.10	.09

Network CPU Switch

MASTER VIEW allows one console to access six servers (CPUs). Supports VGA to Multisync, has built-in buffer, is Daisy Chainable, AutoScan or Manual selection (3-40 sec. scan interval), Perfect for computer room access to file servers.

CS-106	MasterView (AT Only), 1 to 6	'279
CS-104	AT/PS2 MasterView, 1 to 4	269
CS-102	AT MasterView, 1 to 2	219
CS-122	PS/2 MasterView (1 to 2)	219

VIDEO SEPARATOR - Video Signal is enhanced for distance up to 210 ft. (Daisy Chainable)

VS-104	4 to 1	\$99
VS-108	8 to 1	159

Parallel Line Extender

PLE-100	DB25 Male to DB25 Male, 30'	\$43
PLE-110	DB25 Male to 36 P Male, 30'	43



Premium Cable Assemblies (Fully Shielded)

Part#	Description	Each	10+
PPC301-6	Printer Cable DB25-36 Pin Centronics, 6ft.	\$2.99	\$2.54
PPC1284-6	Bi-Directional EPP Printer Cables, 6 ft.	12.95	11.99
25M*-6	DB25, 25 Line Cable M-M or M-F, 6 ft.	3.99	3.51
HD15MM-6	15 Pin High Density, Male to Male, 6 ft.	4.99	4.24
5MM-6	5 Pin Din Male to Male, 6 ft.	2.99	2.54
KEC-6	AT Keyboard Extension Cable, 6 ft.	2.99	2.54
PS2KEC-6	PS2 Keyboard Extension Cable, 6 ft.	3.39	2.99
MEC-6	AT Monitor Extension Cable, (9M-9F) 6 ft.	2.99	2.54
PS2MEC-6	PS2 Monitor Extension Cable, 6 ft.	3.39	2.99
ATM-6	AT to Modem, 6 ft. (9S-25P)	2.99	2.60
ACPC-02	PC power cable, 6 ft.	2.49	2.24
ACPC-03	PC power adapter cable	2.29	2.06
ACPC-04	Monitor power ext. cable, 6 ft.	3.69	3.32
SCSI-II	50-Pin Centronics (M) - 50-Pin Half Pitch	29.95	28.50
SCSI-III-1	SCSI-III, 18" Internal Cable	29.95	28.50
NMA-*	RS-232 Null Modem Adapter (25S-25P or 9S-9P)	2.99	2.69

Gender Changers - Ultrathin

TGC-25*	25-pin M-M or F-F ultrathin	\$2.99	\$2.69
TGC-9*	9-pin M-M or F-F ultrathin	2.69	2.42

Category 5 10Base T Cables (Hi-Flex Gray, Red, Green, Blue, Black, Yellow)

Part#	Description Without Boot	1-9	10-49	50+
73-66_-3	3 ft.	\$3.82	\$3.47	\$3.18
73-66_-7	7 ft.	4.80	4.36	4.00
73-66_-15	15 ft.	6.92	6.29	5.77
73-66_-25	25 ft.	9.56	8.69	7.97
73-66_-50	50 ft.	15.20	13.82	12.67

Enjoy sharp color & clarity!

14" SVGA Monitor features 1024x768 resolution with 28mm aperture. Energy Star compliant with One-Year Mfg. Warranty.

MON-08	14"	'259
MON-13	15"	329
MON-11	17"	619



BCPER280	280VA, 175Watts, 2 Outlets	\$97
BCPRO675	675VA, 425Watts, DB9 Lan Port, 4 Outlets	231
BCINT280	280VA, 2 Outlets	99
BCINT675	675VA, 4 Outlets	230
OMNIPRO450	450VA, 280Watts, 4 Outlets	203



Altex

Computers & Electronics

1-800-531-5369

FAX: 210-637-3264 <http://www.altex.com>
Hours 7:30am-6:30pm M-F - 9-5pm Sat. CST



D10BT	RJ45 Ethernet, AS400/Sys3x Protector (Wires 1, 2, 3, 6)	24
DB25	Serial DB25, RS232 Protector (Pins 1-8, 20)	23
SUPER8	8 outlet, 18,000 amp spike protect., 6' cord, 2 yr.warr.	24
IB6ULTRA	6 outlet, 3 filter banks, LEDs, 6' cord, \$25K Ult. Ins.	52
ISOTELULT6	6 outlet, 3 filter banks, LEDs, \$25K Ult. Ins.	61
CC16-P	Command Console, 6 outlets, Fax/Modem protection., \$10K Ult. Ins.	69

CORPORATE, INSTITUTIONAL & GOVERNMENT PRICING WELCOME. NET 30 TERMS AVAILABLE UPON APPROVAL

TERMS: For C.O.D. orders add \$5 per package. Minimum \$25. Cash or Cashiers Check only. For orders under \$99 add \$3 handling charge. All shipping is FOB San Antonio, Texas and will be added to your invoice. Texas residents add 7.34% sales tax. All returns require RMA# and must be returned in original condition. A 15% restocking fee will be assessed on product returned in non-resaleable condition. Prices subject to change without notice. We are not responsible for typographical errors.

5 Texas Locations

- 11342 IH-35 North San Antonio, TX**
(210) 637-3200 • FAX: (210) 637-3264
- 10731 Gulfdale San Antonio, TX**
(210) 828-0503 • FAX: (210) 340-2409
- 10705 Metric Blvd. • Austin, TX**
(512) 832-9131 • FAX: (512) 835-1328
- 15207 Midway Road • Dallas, TX**
(972) 386-8882 • FAX: (972) 386-9182
- 2650 S.P.I.D. Corpus Christi, TX**
(512) 814-8882 • FAX: (512) 814-8812



Increase Your Storage Capacity While Maintaining World Class Speed.



Transfers data 3 times faster than other portables.

It's a clear-cut victory for the backpack 8000t, the fastest tape backup system in the field. It has a big 8GB capacity, and it's portable. This powerful drive transfers data at up to 30MB per minute. That's 3 times faster than you'll find elsewhere. Using a single Travan TR-4 tape, backup your large hard drives in record time. But that's not all. Installation is a breeze. Plug the backpack 8000t into your printer port and your printer into the backpack. There are no expensive card options to deal with.



Soaks up twice as much data as a TR-3 drive.

Then unplug and take it with you to backup data on other PCs. The backpack 8000t gives great performance at a price well under external DAT drives.

Now that's what you call a winner!



Plugs into any standard printer port. Share data between portables, desktops and laptops.



backpack
8000t

MicroSolutions
The port•ability leader.

Ph: 800-295-1214 (US and Canada)
or 815-756-3411, Fax: 815-756-2928
Internet: www.micro-solutions.com

Windows NT • Solaris • Linux • Windows 95 • OS/2 • PC-DOS • SCO UNIX

QNIX

NetWare

Switch without Risk!

System Commander makes it safe and easy to add as many OSes to your PC as you want!

Easy Automatic Installation

- Prepares your PC for new OSes in minutes
- Simply select the OS you want and *System Commander* does the rest
- To use another OS simply reboot and make another selection

Money-Saving Flexibility

- Minimize hardware expenses by putting up to 100 OSes on one PC
- Use any combination of hard drives

- Use any Intel compatible OS or combination of OSes, in English or any other language

System Commander is only \$99.95 and comes with an unconditional 60 day money back guarantee. Get **Free** overnight shipping when you mention this ad. *Order it now and have it on your desk tomorrow morning!

Free overnight shipping*
when you mention this ad.

800•648•8266
www.v-com.com

V Communications, Inc.
4320 Stevens Creek Blvd, #120-4BYT
San Jose, CA 95129
408.296.4224 fax 408.296.4441

“System Commander is a blooming miracle”
Jerry Pournelle- BYTE

* When ordered before noon PST. No Saturday delivery. Standard shipping outside US. CA res. add \$7.25 sales tax. Offer subject to change without notice. All logos and product names are trademarks of their respective companies. VISA/MC/Amex ©1996

Coherent Unix

UnixWare

XENIX

Windows v3.x • DOS/V • Windows 95J • Warp • MS-DOS • Linux • Merlin

Lose 500 pounds in 10 minutes

with a Rose keyboard monitor switch

Call today for free catalog

- ◆ Print servers
- ◆ Data switches
- ◆ Keyboard/video control

800-333-9343

Streamline your computer room by reducing excess equipment. Access up to 256 CPU's from a single keyboard, monitor, and mouse. ServeView is our best-selling switch, has every feature you can imagine, and installs in minutes. Compare price, features, performance, quality, and support and you'll find Rose can't be beat. Call us to discuss your application or to receive your free information kit.

Come See Us at
Fall COMDEX, Nov. 18-22
Las Vegas, NV Booth #S4424 and
Comdex Hispano America, Dec. 4-6
Miami, FL Booth #C323

P.O. Box 742571 ◆ HOUSTON, TEXAS 77274
TEL 713/933-7673 ◆ FAX 713/933-0044

Powered By Polywell

For CAD/CAM, Animation, Video Editing, Internet/Intranet, SQL Servers



Custom Configuration for high-end Alpha, Multi-processor Pentium Pro Server/Workstations.

PolyRaxx RackMounts
Clustering Disk Array
Portable Alpha, PCs



Optimized for:
Video/Animation Authoring,
Image Editing, Presentation,
CAD/CAM, 3D Rendering,
Internet/Intranet/SQL Server



433MHz (256-bit Alpha 21164A) Super System with 9GB HD
400MHz (256-bit Alpha 21164A) Advanced System with 4.3GB HD
300MHz (256-bit Alpha 21164) Standard System with 2.1GB HD
275MHz (128-bit Alpha 21064A) Basic System with 1.2GB HD

from \$9,995
from \$7,995
from \$4,995
from \$2,995



Quad Pentium Pro 4 x 200MHz SQL Server with 20GB Disk Array
Dual Pentium Pro 2 x 200MHz SMP NT System with 4.3GB HD
Single Pentium Pro 200MHz Standard NT Station with 2GB HD

from \$19,950
from \$4,500
from \$2,500



Pentium 200MHz High-Power PC with 2GB HD
Pentium 166MHz Standard PC with 1.6GB HD
Cyrix P166+ Budget PC with 1.2GB HD

from \$2,300
from \$1,995
from \$1,595

Polywell Computers, Inc (800) 789-8027
www.polywell.com

1461 San Mateo Ave., So. San Francisco, CA 94080, USA
Tel: (415)583-7222 Fax: (415) 583-1974 E-Mail: info@polywell.com



Warranty and Support
5-year in-house labor,
2-year standard parts,
10-year toll free support
30-day money back guarantee

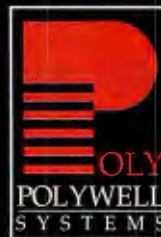

Circle 247 on Inquiry Card.

Access any PC attached to the AutoBoot Commander 4xP or 1xP via telephone lines!

- Works with any IBM PC/AT or 100% compatible computer
- Built-in support for both text and VGA graphics viewing modes
- Full remote keyboard control allows you to control any attached PC as if you were actually there
- Perfect for offsite troubleshooting! Change the CMOS setup, reboot, or even cold-boot any attached PC
- Won't interfere with running applications or network software
- Upload or download files to any attached PC; transfer files or upgrade the software on any computer



Key-View™



COME SEE US AT
COMDEX/Fall '96 in Las Vegas NV
Nov. 18-22 at Booth #L4254

An
**Inc.
500**
Company

Cybex Computer Products Corporation
4912 Research Drive Huntsville, AL 35805 USA
(205) 430-4000 (205) 430-4030 fax
<http://www.cybex.com/>



\$1,159*

(CD-ROM, Backup, and Removable Storage)



\$599*

(CD-ROM, Backup, and Removable Storage)



*Price comparison based on MSRP's as of 8/15/96.

Their Solutions. Micro Solutions.



Play CD-ROM programs, audio CDs, or use a PD cartridge for additional on-line storage.



Pack your files and tote them from PC to PC. Plugs into any IBM-compatible notebook or desktop.

Sure, you need to add function to your computer, but you don't need all those machines cluttering up your desk. The backpack pd/cd is a 3-in-1 mass storage solution that gives you a CD player and a removable cartridge storage drive. Backs up your hard drive, too.

Now, just in case you're not up on PDs (optical Phase Disks), they're a new kind of media you can read, write on, erase and remove an unlimited number of times. PDs look a lot like CDs, cost less than magnetic cartridges, and can store 650MB. Also, they can't be accidentally erased by magnetic fields.

Another good thing is the easy installation. Plug the backpack pd/cd into your printer port and your printer into the backpack. That's it. Save your precious few expansion slots for something else.

And best of all, the backpack pd/cd is half the price of those other solutions!



Standard 650MB optical disks can be erased. Use over and over.



backpack[®] pd/cd

MicroSolutions

The port•ability leader.

Ph: 800-295-1214 (US and Canada)
or 815-756-3411, Fax: 815-756-2928
Internet: www.micro-solutions.com

Available through computer dealers, computer superstores, and mail order catalogs.
Seagate Software is a trademark of Seagate Technology, Inc.

Circle 245 on Inquiry Card (RESELLERS: 246).

IBM

ThinkPad Notebooks

Thinkpad 560 Series

TPAD	560C	5/100	8/810MB	DSTN	W95	\$call
TPAD	560C	5/100	8/810MB	DSTN	W95	\$call
TPAD	560C	5/100	8/810MB	DSTN	W95	\$call

Thinkpad 365 Series

TPAD	365XD	5/100	8/810MB	4XCD	10.4	DSTN	\$2285.79
TPAD	365XD	5/120	8/1.08MB	4XCD	11.3	DSTN	\$2450.00
TPAD	365XD	5/120	8/1.08MB	4XCD	10.4	ACT	\$2918.75
TPAD	365E	5/100	8/540MB	10.4	DSTN	W95	\$1699.33
TPAD	365ED	5/100	8/540MB	4XCD	10.4	DSTN	\$2035.42

Thinkpad 760 Series

TPAD	760ED	5/133	16MB	EDO	12.1	ACT	1.2GB	HD	4XC	\$call
TPAD	760E	5/120	8MB	1.2GB	HD	12.1	TFT	OPT	CD	\$4493.75
TPAD	760E	5/133	16MB	EDO	1.08GB	HD	12.1	TFT	W95	\$6130.21
TPAD	760E	5/120	8MB	1.2GB	HD	12.1	TFT	OPT	CD	\$4341.67
TPAD	760EL	5/133	16MB	1.08GB	HD	12.1	TFT	W95	\$5469.79	
TPAD	760ELD	5/100	8MB	810	MB	HD	4XCD	12.1	TFT	\$4445.83
TPAD	760EL	5/120	8MB	810MB	HD	11.3	DSTN	W95	\$3333.33	
TPAD	760EL	5/100	8MB	810MB	HD	11.3	DSTN	W95	\$3148.96	

Call us before you buy IBM

NOVELL

Network 3.12/4.1 Promotion
5/10/25/50/100/250 USERS
RED or WHITE BOX

call for best price

☆ free network card with Purchase over \$2500.00 ☆

Visit Our Web Site
www.computerlane.com

HEWLETT PACKARD

Printers

HP DESKJET 340	\$295
HP DESKJET 600/660C	\$289/392
HP DESKJET 850C/1600C	\$495/call
HP LASERJET 5L/5P	\$485/call
HP LASERJET 4+/4M+	\$1340/1845
HP LASER 4V/4MV	\$1840/call
HP SCANJET 4S/4C	\$call/892
HP LASER 5SI/5SIMX	\$call
HP LASERJET 4+	\$1045
HP LASERJET 5/5M	\$1265/1699

COMPUTERS

VECTRA XU SYSTEMS

XU 6/150	16/1GBscsi+CD+Matrox	\$stock
XU 6/150	16/2GBscsi+CD+Matrox	\$stock
XU 6/200	16/1GBscsi+CD+Matrox	\$stock
XU 6/200	32/2GBscsi+CD+Matrox	\$stock

built in Network card, Windows NT preloaded

HP NETSERVER

Netserver LC	P/100/133/166	32/1gb+CD	\$call
Netserver LC	P/133/166	32/1gb+CD	\$call
Netserver LH	P/133/166	32mb, no disk, Array	\$call
Netserver LH	P/133/166	32mb, no disk	\$call
Netserver LH	P/133/166	64mb, 4.2gb, Array	\$call

** call for all other Netserver configuration **

HP VECTRA 500 COMPUTERS

515MCX 5/133	16/1.6 GB	+cd+sound+phone answering+headphones	\$stock
515MCX 5/166	16/1.6 GB	+cd+sound+phone answering+headphones	\$stock

Authorized Dealer & Service Center
COMPAQ, IBM, TOSHIBA, HEWLETT PACKARD

COMPAQ

Notebook Systems

Armada Notebook Systems

Armada 1120CSTN	P100	8/810MB	\$1850
Armada 1120CTFT	P100	8/810MB	\$2179
Armada 4110CSTN	P100	8/810MB	\$2450
Armada 4110CSTN	P100	8/810MB, cd,sound	\$2850
Armada 4110CSTN	P120	8/810MB	\$2999
Armada 4110CTFT	P120	8/810MB	\$3685
Armada 4130CTFT	P133	8/1GB	\$4350

LTE Notebook Systems

LTE 5150	P/75	8/810MB, Active	\$stock
LTE 5250	P/100	8/810MB, Active	\$stock
LTE 5250	P/120	16/1.3GB, Active	\$stock
LTE 5280	P/133	16/1.3GB, Active	\$stock

Deskpro 2000/4000/6000 Systems

Deskpro 2000	p/100, 8/1.2gb	\$1275
Deskpro 2000	p/133, 16/1.2gb	\$1675
Deskpro 2000	p/166, 16/2.5gb	\$2175
Deskpro 2000	6/200, 16/2.5gb	\$2690
Deskpro 2000	6/200cd, 32/2.5gb	\$3299
Deskpro 4000	6/200, 32/2.5gb, ed	\$2799
Deskpro 4000	5/120, 8/1gb	\$1599
Deskpro 6000	5/166, 8/1gb, cds	\$call
Deskpro 6000	6/200, 32/2.5gb, cd	\$1275

Compaq Server

Prosignia 300	Pentium 90, 120, 150Mhz	\$stock
Prosignia 500	Pentium 120, 150Mhz	\$stock
Prolnat 5000	6/166 Model1	\$stock
Prolnat 5000	6/166 Model1A	\$stock
Prolnat 5000	6/200 Model2	\$stock
Prolnat 5000	6/200 Model2A	\$stock
Prolnat 5000	6/166 (rackmount Models)	\$stock
Prolnat 5000	6/200 (rackmount Models)	\$stock

TOSHIBA

T2110CS	DX/475	4/390MB	\$stock
T2130CS	DX/475	8/540MB	\$stock
T2150CDS	DX/475	4/540MB+CD+Sound	\$stock
T2150CDT	DX/475	8/540MB+CD+Sound	\$stock
T2150CDT	DX/475	4/540MB+CD+Sound	\$stock
T1100CS	P/75	8/810MB	\$stock
T400CDT	P/75	8/810MB+CD	\$stock
T410CDT	P/90	8/810MB+CD	\$stock
T700CT	P/120	8/1.3GB	\$stock
T710CDT	P/133	16/1.3GB+CD	\$stock
T720CDT	P/133	16/1.3GB+CD	\$stock

NEW RELEASE

T110CS	P/100	8/810MB	\$stock
T110CT	P/100	8/810MB	\$stock
T420CDS	P/100	8/810MB	\$stock
T420CDT	P/100	8/810MB	\$stock
T500CS	P/100	16/1.3GB	\$stock
T500CDT	P/100	16/1.3GB	\$stock
T610CT	P/90	8/810MB	\$stock
T720CDT	P/133	16/1.3GB	\$stock
T730CDT	P/150	16/1.3GB	\$call

Also carry Toshiba
Refurbished Models
* Call for Price *

Specials of the Month

Matrox Millenium 2mb WRAM	.. \$189.00	Kodak DC 40 Digital Camera	.. \$523.00	Window NT Workstation 4.0	.. \$278.00
Matrox Millenium 4mb WRAM	.. \$250.00	Kodak DC 50 Digital Camera	.. \$859.00	Mag 15" SVGA Color Monitor	.. \$345.00
Matrox Millenium MPEG Capture card	.. \$call	Microtek Scanmaker E6 scanner	.. \$549.00	NEC XV+ 17" svga monitor	.. \$782.00
Creative Lab Recordable CD-R 4210	.. \$599.00	Seiko Smart Business Card Reader	.. \$call	Adaptec 2940 PCI SCSI	.. \$call
Creative Lab 8X IDE CD	.. \$119.00	Sportster 33.3 Fax/Modem Voice	.. \$169.00	PCMCIA 28.8 Megahertz	.. \$234.00
8X Parallel Port CD	.. \$325.00	Sportster 33.3 win modem	.. \$119.00	PCMCIA Xircom 2.8 fax modem	.. \$219.00
6X Parallel Port CD	.. \$259.00	Zip Drive 100 MB	.. \$195.00	Black computer case & Monitors	
Creative Lab SB 32 PnP	.. \$115.00	Jaz 1GB drive	.. \$365.00	14" 1024x768 .28ni	.. \$281.00
Panasonic 6X portable CD-ROM drive	.. \$379.00	Tapestor 8GB internal SCSI Drive	.. \$355.00	15" 1024x768 .28ni	.. \$399.00
Epson Style 500 color printer	.. \$369.00	Pentium Motherboard 512k pipeline cache	.. \$139.00	Mini Tower Case 250W 5 bays	.. \$99.00
ZEBRA S-500 Stripe barcode PR SER	.. \$1175.00	Ami Pentium Pro Merlin motherboard	.. \$640.00	Mid Tower Case 250W 6 bays	.. \$149.00
ZEBRA S-300 Stripe barcode PR SER	.. \$899.00	Intel Pentium Pro Venice motherboard	.. \$345.00	Mouse Serial	.. \$25.00
				Keyboard 101 Enhanced	.. \$49.00

Computerlane Inc.

Outside California: 1-800-526-3482

Inside California: 818-884-8644 • Fax: 818-884-8253

comlane@instanet.com

7500 Topanga Cyn Blvd., Canoga Park, CA 91303

Hours: Monday - Friday 9-6, Saturday 10-5

Compaq is a Registered Trademark of Compaq. IBM is a Registered Trademark of International Business Machines. All Quoted Prices Reflect A 5% Cash Discount. VISA, MasterCard, Wire Transfer Also Accepted. Prices Subject to Change Without Notice.

Academic Software

Microsoft Academic Partner

Microsoft Office Professional for windows 95 (with bookshelf)

\$165

MS WINDOWS NT WORKSTATION	.. \$125
MS windows NT Server	.. \$399.00
Ms Backoffice	.. \$1174.00
Ms SQL Server	.. \$799.00

call for other Microsoft Academic Prices

Products highlighted in yellow offer special pricing for BYTE readers only! Take advantage of these outstanding values by mentioning VIP NB6 when you call today to place your order.

Embedded 486 CPU Card for Panel PC Based System

For use with the passive back plane (P/N 133250) in industrial panel systems that use heavy duty chassis casing.

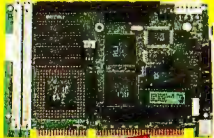

SPECIAL

- Award BIOS
- Compatible with following 168-pin PGA socket CPUs: 486SX/DX/DX2/DX4/5x86 (not included)
- 133241 Embedded CPU card.....\$299.95

Power Leap Upgrade Adapter For 486SX/DX/DX2 to 586-100/120

- Supports 5V 486 motherboards only
- 586-XXX chip not included
- Supports 64-bit X86 compatible processor with 16KB write-back cache
- 100 and 120MHz core speeds with 33, 40 and 50MHz bus options (BIOS written before 1995, will only work with AMD CPUs)
- Includes manual and 3.5" utility/test disk
- 131941 Upgrade adapter for 586 CPU.....\$49.95

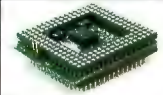

PCMCIA Type II Combo BNC/UTP Ethernet Card

- Minimum requirements: IBM compatible PC with 386SX, one type II PCMCIA socket, BNC/UTP Ethernet connectivity, PCMCIA release 2.1 compliant card services
- 10Mbps speed in 10BaseT and 10Base2 format
- 132581 PCMCIA network card.....\$99.95



SPECIAL

Jameco Printer Card 2 Bi-directional Parallel Ports

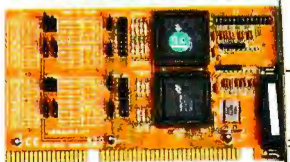

- 286/386/486 & Pentium® systems (16-bit bus)
- Supports ECP/EPP/SPP
- Select from IRQs: 3, 4, 5, 7, 9, 10, 11, 12, 15
- Address selectable to LPT1-LPT6
- Print mode jumper selectable
- 132214 2-port printer card.....\$39.95

Jameco High-Speed Serial Card 4 Serial Ports

- PC/XT/AT and compatibles
- Four serial ports; two each DB9M and DB25M
- High-speed 16C550 UARTs with 16 byte FIFO
- IRQs: 3, 4, 5, 7, 9, 10, 11, 12, 15
- Includes cables and instruction sheet
- 132572 4-port hi-speed serial card.....\$49.95

Dynamic RAM SIMMs

Part No.	Product No.	Description	Price
53701	94000S-70	4MB x 9 70ns.....	\$59.95
53719	94000S-80	4MB x 9 80ns.....	\$4.95
75117	P361000-xx-7	1MB x 36 (4MB).....	\$4.95
75096	P362000-xx-6	2MB x 36 (8MB).....	\$9.95
75168	P364000-xx-7	4MB x 36 (16MB).....	\$19.95
41515	41256A9B-70	256KB x 9 70ns.....	9.95
41769	42100A9B-80	1MB x 9 80ns.....	\$20.95

YNK 17" SVGA "Green" Color Monitor

- PC/XT/AT, 386, 486, Pentium®
- 0.28mm dot pitch
- 20 controlled presets for optimal operation
- Push-button degaussing eliminates spurious magnetism
- Green monitor power management
- 133786 17" SVGA monitor.....\$749.95



SPECIAL

Win '95 104-Key Keyboard w/ Trackball and Palm Rest

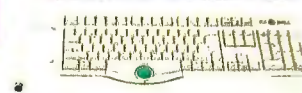

- Ergonomic design
- Removable palm rest
- Dual connectors: keyboard 5-pin DIN, and trackball 9-pin serial connection on one coiled cable
- 133760 Win '95 trackball keyboard.....\$49.95

IBM 89-Key Adjustable Keyboard

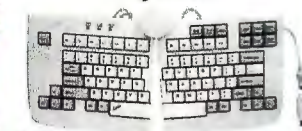

- PS/AT style
- Adjustable keyboard with standard QWERTY layout
- Left and right set of cursor-movement keys
- Erase-ease feature
- 132978 IBM 89-key adjustable keyboard.....\$44.95

QTRONIX Sheet Feeding Scanner

256 true gray scale - full width - Windows® '95 compatible!



- 800 dpi x 800 dpi in gray mode
- Minimum system requirements: IBM PC or compatible-386, DDS 3.3, Windows® 3.XX, 4MB RAM, 5MB hard drive space, one 16-bit ISA slot
- Includes software and manuals: Twin, Prestol, wordlinx and Image Prolmage Plus
- 133233 Paper feed gray scanner.....\$149.95

Microsoft® 2-Button Mouse

- Serial mouse
- PC/XT/AT/386/486/PS/2 and compatibles
- Includes Microsoft® setup diskette and manual
- 111860 2-button serial mouse.....\$39.95



Seagate Performance SCSI Hard Drive Solutions Hawk

- Average seek, read/write: 9/10.5msec
- 3.5" low profile
- One-year warranty
- 130542 Fast SCSI-II, 1.05GB.....\$409.95



- Barracuda 2LP**
- Average seek, read/write: 8/9msec
- 3.5" low profile
- One-year warranty
- 130577 Fast SCSI-II, 2.1GB.....\$849.95

- Barracuda**
- Average seek, read/write: 8/9msec
- 1024KB multisegmented cache buffer
- 3.5" low profile
- One-year warranty
- 130593 Fast & fast wide SCSI-II, 4.2GB...\$1199.95

Floppy Disk Drives

- PC/XT/AT compatible 118957
- 118957 Panasonic 1.2 MB 5.25".....\$39.95
- 118922 Panasonic 1.44 MB 3.5".....49.95
- 74392 Teac 3.5"/5.25" combo.....\$119.95

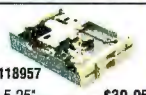

NEC 4X IDE CD-ROM Drive with 4-Disc Changer

- Use with enhanced IDE interface (P/N 127386)
- 600KB/sec. data transfer rate, 150KB audio
- Selection button for each drive with indicator
- Cables not included
- 133508 4X 4-disc DC-ROM drive.....\$149.95



6X Enhanced IDE CD-ROM Drive

- Requires enhanced IDE controller card
- SoundBlaster compatible
- 195ms access; 229ms seek time
- 256KB buffer memory
- 900KB/second transfer rate
- Power tray loading
- Windows® '95 compatible
- Also plays video, photo and audio CDs
- 133031 6X IDE CD-ROM drive.....\$79.95



SPECIAL

Apece Laser Pointer Pen

- 200 yard range
- 670nm red laser
- Heavy duty silver brass
- Power requirements: 2 AAA batteries (included)
- 127749 Laser pointer - pen.....\$59.95



Optical Laser Mouse

- Three modes of operation that are selected from a combination of clicking which facilitates mouse mode, sketch mode for 1 to 1 precision, and joystick mode.
- For 486 and Pentium® PCs
- Use with optical mouse pad (included)
- High resolution: 450 dpi
- Auto detection of direction without mechanical ball
- Automatic double click function-side button clicking
- Compatible with Microsoft® mouse and Windows® 95
- 133284 Laser Mouse w/ optical pad.....\$39.95



Jameco 64-Bit VESA Graphics Accelerator Card



- 1MB expandable to 2MB
- Non-interlaced resolution and Zero-Flicker™ refresh rates provide you with exceptional versatility and display clarity
- VESA-compliant 28-pin feature connector for multimedia applications
- Full VESA and VGA selectable modes
- 132935 VESA graphics card.....\$99.95

SPECOM Video-conferencing Card

- With VisionTime Pro Software
- This package offers friendly and affordable, easy to use desktop personal videoconferencing. With a PC and a modem, you can do document conferencing. If you use a DVSD modem, you can do voice conferencing, and adding a camera, actual two-way videoconferencing!
- 131844 Videoconf. card w/ software.....\$149.95



33.6 kbps Data/Fax Internal Modem

- 33,600 bps data modem, 14,400/9600 fax modem
- Fully compatible with ITU-T V.42, V.42bis, V.34, V.32bis, V32, V.22bis, V.21-23, MNP 2-5 and as a fax/modem communicates with all ITU-T group 3 fax machines
- 129672 Internal 33.6 fax/modem.....\$139.95

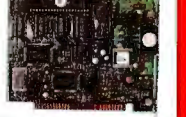

Modem Technical Guide

The Modem Technical Guide is a great tool for beginners and experienced modem users and includes a bonus CD-ROM! The book starts off with a modem primer, then gives you set-up information, hardware configuration settings and diagrams for many of the most popular modem models on the market.



133794 Modem Technical Guide.....\$49.95

Switchbox for 4 Monitors

- This unit allows you to duplicate a video signal from one source to 4 monitors up to 210 feet.
- Perfect for broadcast systems, conventions, schools and multiple display uses!
- Suitable for SVGA, VGA and multisync monitors
- Daisy chainable
- Power-save mode when computer is off, indicated by flashing power LED
- DB15 female connectors on box
- Slide switch for video signal gain control
- Includes power adapter 9VDC @ 130mA
- 133886 Switchbox for 4 monitors.....\$79.95



SL WABER Surge Protectors

- 330V clamping voltage
- EMI/RFI noise reduction
- Audible alarm
- 3-line protection
- SurgeSentry 6 Outlet**
- Ultimate 3-stage protection
- No limit connected equipment manufacturer guarantee
- 62,525 amp spike suppression; 880 joules
- 133090 6-outlet, suppress 62,525 amp.....\$29.95



DataGuard 7 Outlet

- Standard 1-stage protection
- \$1000 connected equipment manufacturer guarantee
- 13,000 amp spike suppression; 520 joules
- 133081 7-outlet, suppress 13,000 amp.....\$12.95



JAMECO
ELECTRONIC COMPONENTS
COMPUTER PRODUCTS

© 1996 Jameco 11/96

Ordering Hours: 5:30am - 5:30pm PST

1355 Shoreway Road
Belmont, CA 94002-4100
FAX: 1-800-237-6948 (Domestic)
FAX: 415-592-2503 (International)
E-mail: info@jameco.com
http://www.jameco.com



Call for your FREE catalog!



Mention V.I.P.#NB6

Call 1-800-831-4242 to order today!



Take the quickest route to healthcare Information Systems solutions

In today's dynamic healthcare climate, decisionmakers can't afford to get lost while searching for the right Information Systems solution.

MDB Information Services—an alliance with Datapro Information Services Group and MDB Information Network—delivers the break you've been looking for. We're the only worldwide, comprehensive provider of immediate, actionable data for purchasing Administrative Systems, Clinical Support Systems, Client Server Technology, and Network Integration.

MDB Information Network members annually save more than two to three times their membership cost to MDB Information Services by relying on MDB's up-to-the-minute acquisition and analysis of information on hundreds of Information Systems products and services.

Plus Added Value

MDB Information Services also delivers:

- Information technology briefings/strategic planning
- Custom RFP electronic templates to speed response
- Cost-benefit analysis of systems and technologies
- Success Matrix to measure process improvement
- Access to Consultation Center and on-line services

Administrative Systems

General Financials to Utilization Management, Ancillaries including Home Health and Long-term Care.

Clinical Support Systems

ER, Laboratory, Pharmacy, Radiology, Physician Management Systems, Clinical Pathways, and more.

Client Server Technology

From Workstations to Telemanagement, Scheduling to Network Management.

Network Integration

Network Operating Systems to Community Health Information and beyond.

Call 1-800-687-0001



MDB INFORMATION SERVICES

An alliance with Datapro Information Services Group, Andersen Consulting, and MDB Information Network

DATAPRO

We Carry

- ALPS** 
- BASF** **brother.**
- Canon**
- CENTRONICS**
- CITIZEN** 
- CREATIVE LABS INC.**
- CURTIS** Dataproducts
-  **Dysart**
- EPSON** **EXABYTE**
- FACIT** 
- GRAHAM MAGNETICS**
- GENICOM**
- HEWLETT PACKARD** **IBM**
- MEGA**  **KYOCERA**
- 3M** **M. TALLY**
- maxell** **MICROSOFT**
- Nashua** **NEC**
- OCLI** **OKIDATA**
- olivetti** **OLYMPIA**
- OTC** **PACIFIC DATA**
- Panasonic**
- Polaroid** **QMS**
- Qume** **RICOH**
- Seagate**
- SEIKOSHA** **SMITH CORONA**
- SONY** **star**
- SYQUEST** **TDK**
- TEAC** **Tektronix**
- TEXAS INSTRUMENTS** **TOSHIBA**
- TRIPPLITE**
- Verbatim** **WANG**

**and many more
OEM supplies!**

**ALL LOGOS ARE THE
PROPERTY OF THEIR
RESPECTIVE COMPANIES**

**HIGH-CLIP
PREFORMATTED
MF2HD 3.5" HD
1.44MB DISKS
10 PER BOX...\$3.00**

LOWEST PRICES

Prices in US \$ from America's Leading Exporter

DISKETTES (10 PER BOX)

DESCRIPTION	TDK	BASE	MAXELL	SONY
5 1/4" DS/DD	3.15	3.15	3.25	2.00
5 1/4" DS/HD	3.45	3.25	4.45	2.50
3 1/2" DS/DD	3.75	3.75	3.75	3.75
3 1/2" DS/HDF	3.65	3.35	3.65	3.65

BROTHER

DRUM UNIT 630/641/655/665	127.95
TONER CARTRIDGE 630/641/655	24.95
FAX CARTRIDGE 900 PC-91	20.95
FAX PRINT CARTRIDGE PC-101	28.95

DATA CARTRIDGES

DESCRIPTION	3M	MAXELL	SONY
DC-2120	8.90	8.20	8.50
DC-6150	9.50	9.30	9.30
DC-6250	12.50	12.30	12.30
DC-6525	16.50	16.30	16.30

OKIDATA

LASER	RIBBONS
400/800 TONER	320/321/100
400/800 DRUM	380/390/391
400E/810E TONER	520/521
400E/810E DRUM	590/591

4MM & 8MM CARTRIDGES

DESCRIPTION	TDK	SONY	EXABYTE
4MM 60 METER	4.50	5.15	7.50
4MM 90 METER	4.75	5.35	8.50
8MM 112 METER	4.75	5.25	7.50

OPTICAL DISKS

DESCRIPTION	MAXELL	3M	SONY
3.5" 512/128 MB	15.95	16.95	11.50
3.5" 512/230 MB	23.95	25.95	13.50
5.25" 600/650 MB	40.95	44.95	39.50
5.25" 1.2/1.3 GB	47.95	50.95	46.50

HEWLETT PACKARD

INK JETS	TRANSPARENCY/PAPER
HP51604A	HP51630Z
HP51625A	HP51630S
HP51626A	HP3835A
HP51629A	HP92281K
HP51649A	HP17703T

LASER TONERS	RIBBONS
HPC3900A	HP92151H
HPC3903A	HP92155A
HP92291A	HP92155L
HP92295A	HP92156S
HP92298A	HP92154B

We carry a complete line of HP Products. Please call for the lowest prices.

PANASONIC

KX-P115 RIBBON	6.99
KX-P155 RIBBON	6.99
KX-P4450 TONER KIT	28.69
KX-P4450 DRUM KIT	115.69

(CALL FOR OTHER PANASONIC ITEMS)

RICOH

TONER KIT 80/150	24.95
OPC KIT 80/81/150	125.95
FAX TONER SM3000	59.95
FAX TONER 2700L/4700L	88.95
FAX TONER SM1000	18.95
CD-R 74 MIN 650MB	6.75

KYOCERA

TONER	32.00
DEVELOPER	117.00
DRUM	156.00
FUSER	206.00

DIGITAL

LN03X-AC TONER KIT	36.75
LN03X-AD OPC KIT	136.00
TK-50 TAPE CARTRIDGE	14.95
TK-70 TAPE CARTRIDGE	23.95
TK-85 TAPE CARTRIDGE	34.95
TK-88 TAPE CARTRIDGE	93.95

Dec Ribbons & other supplies
Please call for the lowest prices.

IOMEGA (Bernoulli Cart)

5 1/4" GOLD 20 MB	63.95
5 1/4" GOLD 44 MB	107.95
5 1/4" GOLD 90 MB	77.95
5 1/4" GOLD 150 MB	79.95

SYQUEST (Removable Disk Cart)

44 MB	56.95
88 MB	56.95
105 MB	56.95
270 MB	55.95

CANON

BC-01 INK CARTRIDGE	17.50
BC-02 INK CARTRIDGE	18.50
FX-1 FAX TONER	75.50
FX-2 FAX TONER	64.50
EPB2 TONER HP C-3900A	119.50
EPS/SX TONER HP 92295A	54.50
EPL/IIP TONER HP 92275A	61.50

TEKTRONIX (Phaser III supplies)

016-1123-00 COLOR STIX BLACK	130.00
016-1124-00 COLOR STIX CYAN	75.00
016-1125-00 COLOR STIX MAGENTA	75.00
016-1128-00 COLOR STIX YELLOW	75.00
016-1144-00 CLEANING KIT	30.50
016-1103-00 TRANSPARENCY SHEETS	125.00
016-1219-00 TRANSPARENCY FILM	125.00

(CALL FOR OTHER TEKTRONIX ITEMS)

EPSON

RIBBONS	LASER
7753	3.45 SO50002
7754	3.85 SO51005
7762	5.85 SO51009
8750	3.05 SO51011
8755	3.45 SO51023
8762	5.85 INK JETS
8763	4.25 SO20002
8764	9.05 SO20025
8766	17.75 SO20034
8767	11.45 SO20036

COPIER TONERS

CANON	
F41-2302-100	75.00
F41-4102-710	100.00
F41-4214-700	89.00

CANON COLOR

F41-6811-000	83.00
F41-6821-000	83.00
F41-6801-000	83.00

KONICA

946-181	9.25
946-241	12.25
947-376	31.25

MINOLTA

8915-743	12.90
8915-348	27.90
8931-202	76.90

MITA

37037011	12.25
37041011	5.25
37042011	27.25

RICOH

887051	5.75
887132	6.75
887143	17.75

SHARP

SF-730MTI	16.50
SF-830MTI	14.50
SF-980MTI	33.50

TOSHIBA

T-220P	22.50
T-61P	10.50
T-68P	11.50

XEROX

6R-229	27.90
6R-244	51.90
6R-257	41.90

IBM

RIBBONS	LASER
1040150	8.20 1382100
1040282	45.30 1382150
1040440	11.40 1380850
1040930	7.50 1380950
1299095	1.80 1380200
1299790	9.90 1380520
1299845	3.90 1669113
1299933	13.80 1669115
1319308	11.30 1669151
1337765	2.70 70X7001
1361195	1.60 70X7002
1380999	3.40 70X7003
6295158	28.40 70X7280
6328829	5.30 70X7281
6845100	28.90 70X7243
7034437	27.50 70X7244
7034640	5.60 70X7285
7819690	12.80 70X7286

RECORDABLE CD'S

DESCRIPTION	
FUJI	CD-R 74 MIN
KODAK	CD-R 74 MIN
MAXELL	CD-R 74 MIN
MITSUI	CD-R 74 MIN
PHILIPS	CD-R 74 MIN
SONY	CD-R 74 MIN
TDK	CD-R 74 MIN
VERBATIM	CD-R 74 MIN

(PRICES SUBJECT TO AVAILABILITY)



STARTECH International
COMPUTER SUPPLIES

5575 Magnatron Blvd., Suite G
San Diego, CA 92111 USA

TEL: 619-278-2600
FAX: 619-278-2780

EXPORT SPECIALISTS

TERMS: WIRE TRANSFER (T/T)
L/C at sight
L/C at 90 days

Prices are subject to change without notice. We cannot be responsible for typographical errors.

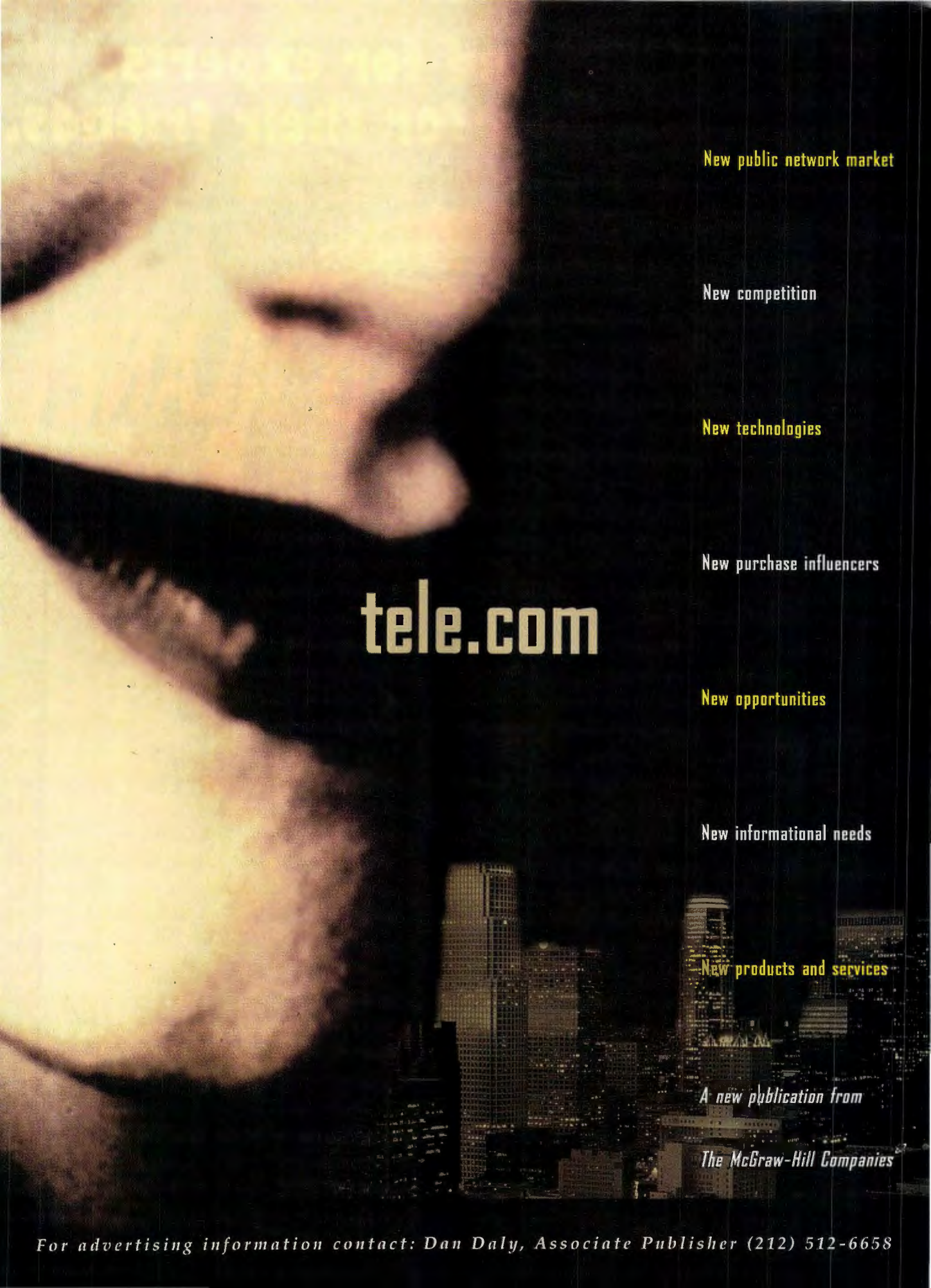

New public network market

New competition

New technologies

New purchase influencers

tele.com

New opportunities

New informational needs

New products and services

A new publication from

The McGraw-Hill Companies

For advertising information contact: Dan Daly, Associate Publisher (212) 512-6658

**A playground for experts.
Training wheels for their friends.**



Traveling the Information Highway

A new exhibit at

The Computer Museum

computer_info@tcm.org / 617.423.6758 / www.net.org

300 Congress Street, Boston, Massachusetts 02210

Principal Sponsor: Sprint

Major Sponsors: Apple Computer, Hewlett Packard, Novell,
NYNEX, Stratus, S.W.I.F.T.

BYTE

Official
Media Sponsor

ATTENTION INTERNET USERS

Call Global. Pay Local.

International Calls
from 10¢ a minute.*

(save up to 95% to any country in the world)

- FREE software from our website
- FREE trial to any toll-free number
- The first service which allows you to call any phone in the world from your PC
- No setup charges • Cellular Quality

RATES FROM THE U.S. TO	
CANADA	13¢
SWEDEN	17¢
U.K.	18¢
AUSTRALIA	20¢
GERMANY	26¢
SINGAPORE	26¢
JAPAN	29¢

Visit our website for complete details and download our free software:

<http://www.net2phone.com>

Call us toll-free using Net2Phone at 1-800-438-8879

Or call direct at 201-928-2990. E-mail us at: info@net2phone.com

NET2PHONE™

Putting global calling within everyone's reach.

Net2Phone requires caller only to have multimedia PC with any PPP Internet connection. Receiving party gets call on regular phone. *15¢ peak. 10¢ off peak. Rates to the U.S.

NET2PHONE IS A TRADEMARK OF IDT CORPORATION

**TOTAL
INTERNET**
\$15.95*
MONTHLY

FULLY
GRAPHIC!
FREE
Netscape™

For 56K or T1
please call
(800) 573-9438

**UNLIMITED!
UNCENSORED!**

The lowest flat monthly national Internet rate Macintosh™ and Windows™ 3.x/95 compatibility No per minute charges Unlimited tech support 24 hours a day Internet access available in most U.S. cities

http://www.idt.net/ 6126				
SAVE UP TO 99% MONTHLY WITH IDT				
Monthly Usage	CompuServe™	AOL™	AT&T™	IDT
1.5 Hours per day	\$73.70	\$93.70	\$19.95	\$15.95
3 Hours per day	\$161.45	\$226.45	\$19.95	\$15.95
All day	\$1,389.95	\$2,084.20	\$19.95	\$15.95

With IDT's EXCEL plan (\$19.95 without) With AT&T phone service (\$24.95 without), IDT phone rates are up to 50% below AT&T. Pricing as of July 1996 and subject to change. IDT is a trademark of IDT Corp. All other trademarks are the property of their respective owners.

1-800-689-9438

IDT Internet



To get a peek
at the first industrial
handheld with the power
of the Pentium® processor, come to
booth H9 in the Microsoft Partner Pavilion at COMDEX.

Visit us and see the new Tek-Field, the first industrial handheld computer that puts the power of the Pentium processor in the palm of your hand. It's a rugged, fully-contained unit, making it ideal for mobile applications of any kind. Features include a built-in Sound Blaster®, 6 PCMCIA expansion slots, dual mouse, 6.4" Active Matrix Color VGA monitor, touch screen, full I/O capability, and a Duracell® smart battery. Tek-Field is just one of the products available from Teknor Industrial Computers, Inc. for OEM applications and industrial systems integrators. For more information, call us at 1-800-387-4222, visit our web page at <http://www.teknor.com>, or see us at COMDEX.



TEKNOR
INDUSTRIAL COMPUTERS, INC.

Trademarks are the property of their respective companies. The Intel Inside logo and Pentium are registered trademarks of Intel Corporation.

It could be a best seller.

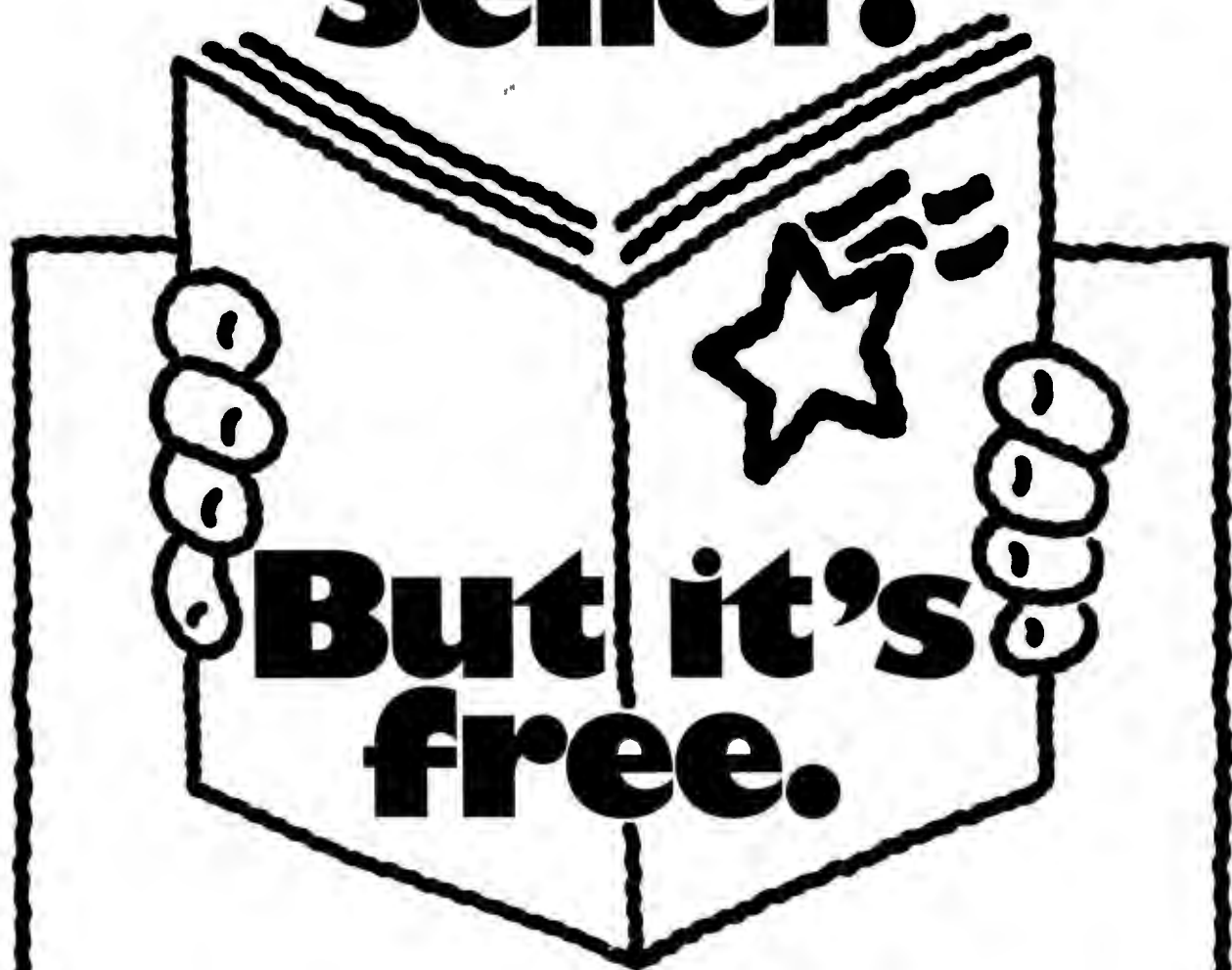

You can't buy the Consumer Information Catalog anywhere. But you can send for it, free! It's your guide to more than 200 free or low-cost government publications about getting federal benefits, finding jobs, staying healthy, buying a home, educating your children, saving and investing, and more.

Send today for your latest free Consumer Information Catalog. The Catalog is free. The information is priceless.

Send your name and address to:

**Consumer Information Center
Department BEST, Pueblo, Colorado 81009**

A public service of this publication and the Consumer Information Center of the U.S. General Services Administration

Making these two environments work together has been like mixing oil and water...





...until now
announcing

OPENNT™ for Microsoft WINDOWS NT™

Call 1-800-GET-UNIX today!

Softway Systems, Inc.

185 Berry Street, Suite 5514, San Francisco, CA, USA, 94107
Tel: 415-896-0708 • Toll Free: 800-438-8649 • Fax: 415-896-0709
Email: sales@softway.com • WWW: <http://www.softway.com/OpenNT>

OPENNT is a trademark of Softway Systems, Inc. This product includes software developed by the University of California, Berkeley and its contributors. All other registered trademarks and trademarks are the property of their respective owners.

OPENNT, from Softway Systems, is the first product to provide true POSIX.1 and POSIX.2 conformance for the Microsoft Windows NT operating system. By providing an enhanced POSIX.1 sub-system and a complete set of POSIX.2 utilities and shell, NT users are finally given a 100% POSIX conforming environment. The same POSIX environment that most UNIX systems use but without sacrificing your investment in Windows NT. The same POSIX environment required by the U.S. Government for all operating system purchases as specified by FIPS 151-2 & FIPS 189. Conformance means file links, case sensitive file names, user and group ownership, background processing and more. Add to this a real POSIX shell and all your favorite UNIX utilities (like *find*, *grep*, *awk*, *sed*, *ls*) and you end up with an environment so close to UNIX that you won't know it isn't UNIX!

OPENNT is available today. OPENNT Commands and Utilities is only **\$199** — and we include free updates for a year. Our 30-day money back guarantee and free technical support makes this a no risk opportunity to give your Windows NT system the POSIX punch it needs!

Call for Availability on Our Other OPENNT Products



Raidtec RAID

High-Performance SCSI RAID Systems

Discover the best RAID price/performance in the industry. Raidtec is the affordable, open, SCSI-to-SCSI hardware RAID solution for complete data protection. Ideal for mission critical applications, document imaging & multimedia.

It's time to re-visit the ultimate in high-availability storage. Contact Raidtec today at (770) 664-6066.



- Fast, Wide, Ultra SCSI
- Programmable RAID Level selection: 0, 1, 10, 3/5
- On-the-fly hardware parity generation eliminates read, modify, write-back performance overhead
- Single ended or differential
- Downloadable flash firmware
- Rackable, stackable
- Remote alarms, configuration & monitoring
- Environmental sensor ports
- Hot replaceable drive bays, fans & power supplies
- New EAM & Service Channel
- Single SCSI ID
- Solid state-of-the-art load sharing power subsystem
- LCD control panel status display

THE STANDARD IN ADVANCED MASS STORAGE SYSTEMS

Raidtec USA
105 Hembree Park Dr. • Suite C
Roswell, GA 30076, USA
Tel.: (770) 664-6066
FAX: (770) 664-6166
<http://www.raidtec.com>

Raidtec EUROPE
Glen Mervyn House • Glanmire
Cork, Ireland
Tel.: (353) 21-821454
FAX: (353) 21-821654



See the latest in Raidtec Fibre Channel technology at COMDEX #S3366

BYTE

To Subscribe to BYTE magazine, or for Customer Service, contact your local BYTE Subscription Representative:

Benelux

Gerry Westerhof
Phone: 31 72 509 1855
Fax: 31 72 509 1145

Bulgaria

Daniel Christov
Phone/Fax:
359 2 974 3557

France

Eric Le Quinio
Phone: 33 1 49 77 03 06
Fax: 33 1 43 78 74 29

Germany, Austria, Switzerland

Wolfgang Brazina
Phone: 49 89 525 847
Fax: 49 89 529 850

Greece

Maria Hadjiannou
Phone: 30 61 620384
Fax: 30 61 272072

Hungary

Imre Szabo
Phone: 36 76 488888
Fax: 36 76 488889

Ireland

Ian Bangham
Phone: 353 1 280 7133
Fax: 353 1 280 7157

Italy

Enrico Campia
Phone: 39 11 8127656
Fax: 39 11 8994422

Middle East

Zafar Inamdar
Phone: 971 4 866788
Fax: 971 4 821149

Poland

Wlodek Binczyk
Phone/Fax: 48 2 825 2275

Portugal

Manuel Neves
Phone: 351 1 3479301
Fax: 351 1 3475127

Scandinavia

Gunnar Sandbjerg
Phone: 45 3314 2226
Fax: 45 3314 2218
or Lauge Dehn
Phone: 45 86 223188
Fax: 45 86 228159

South Africa

Cape Town: J Trisos
Phone: 27 21 24 4094
Fax: 27 21 24 8661
Durban: T Tyson
Tel: 27 31 2027303
Fax: 27 31 2027307
Johannesburg: M Kendrick
Tel: 27 11 8804988
Fax: 27 11 4428327

Spain

Barcelona: Javier Casellas
Phone/Fax: 34 3 2380342
Madrid: Eduardo Montojo
Phone/Fax: 34 1 5716685
or Henri Mirrahi
Phone: 34 1 7337346
Fax: 34 1 7338970

Turkey

Cengiz Eren
Phone:
90 216 345 3473
Fax: 90 216 346 2464

United Kingdom

Peter Gregson
Phone: 44 1 61 430 3423
Fax: 44 1 61 494 6978
or John Luker
Phone: 44 1 258 821114
Fax: 44 1 258 821115

If there is no BYTE representative listed above for your country, please contact::

BYTE Subscriber Services

PO Box 72, Galway, Ireland
Fax: +1 353 91 752793.
Phone: +1 353 91 752792.



A Division of The McGraw-Hill Companies

8/96

A Message to Our Subscribers

From time to time we make the BYTE subscriber list available to other companies whose products or services would be of interest to our readers. We take great care to screen these companies, choosing only those who are reputable. Furthermore, subscriber names are made available for direct mail purposes only; telemarketing calls are strictly prohibited.

Many BYTE subscribers appreciate this carefully managed program, and look forward to receiving information of interest to them via the mail. While we believe this information is of benefit to our subscribers, we firmly respect the wishes of any subscriber who does not want to receive promotional literature. Should you wish to restrict the use of your name, please send your request (including your magazine mailing label, name, address, and subscription account number) to:



BYTE Magazine Subscriber Services
PO Box 555, Hightstown, NJ 08520



A Division of The McGraw-Hill Companies

SOMETHING MISSING?

Complete your BYTE collection by ordering Back Issues today!

	1991	1992	1993	1994	1995	1996
January	<input type="checkbox"/>	<input type="checkbox"/>	<input type="checkbox"/>	<input type="checkbox"/>	<input type="checkbox"/>	<input type="checkbox"/>
February	<input type="checkbox"/>	<input type="checkbox"/>	<input type="checkbox"/>	<input type="checkbox"/>	<input type="checkbox"/>	<input type="checkbox"/>
March	<input type="checkbox"/>	<input type="checkbox"/>	<input type="checkbox"/>	<input checked="" type="checkbox"/>	<input type="checkbox"/>	<input type="checkbox"/>
April	<input type="checkbox"/>	<input type="checkbox"/>	<input type="checkbox"/>	<input type="checkbox"/>	<input type="checkbox"/>	<input type="checkbox"/>
May	<input type="checkbox"/>	<input type="checkbox"/>	<input type="checkbox"/>	<input type="checkbox"/>	<input type="checkbox"/>	<input type="checkbox"/>
June	<input type="checkbox"/>	<input type="checkbox"/>	<input type="checkbox"/>	<input type="checkbox"/>	<input type="checkbox"/>	<input type="checkbox"/>
July	<input type="checkbox"/>	<input type="checkbox"/>	<input type="checkbox"/>	<input type="checkbox"/>	<input type="checkbox"/>	<input type="checkbox"/>
August	<input type="checkbox"/>	<input type="checkbox"/>	<input type="checkbox"/>	<input type="checkbox"/>	<input type="checkbox"/>	<input type="checkbox"/>
September	<input type="checkbox"/>	<input type="checkbox"/>	<input type="checkbox"/>	<input type="checkbox"/>	<input type="checkbox"/>	<input type="checkbox"/>
October	<input type="checkbox"/>	<input type="checkbox"/>	<input type="checkbox"/>	<input type="checkbox"/>	<input type="checkbox"/>	<input type="checkbox"/>
November	<input type="checkbox"/>	<input type="checkbox"/>	<input type="checkbox"/>	<input type="checkbox"/>	<input type="checkbox"/>	<input type="checkbox"/>
December	<input type="checkbox"/>	<input type="checkbox"/>	<input type="checkbox"/>	<input type="checkbox"/>	<input type="checkbox"/>	<input checked="" type="checkbox"/>
Special Issues	<input type="checkbox"/>	<input type="checkbox"/>	<input type="checkbox"/>	<input checked="" type="checkbox"/>	<input checked="" type="checkbox"/>	<input checked="" type="checkbox"/>

Outlook '92
Windows
Portability
Windows '93
B Guide Summer '93
B Guide Fall '93

Special Issues U.S. Delivery \$3.00, Foreign Delivery \$4.00. 1990 thru 1996 U.S. Delivery \$6.50, Foreign Delivery \$8.50, Canada & Mexico \$7.00. All issues prior to 1990 U.S. Delivery \$3.00, Foreign Delivery \$4.00. (Call for availability) These prices include postage (US), surface mail (foreign). All checks must be in U.S. funds and drawn on a U.S. bank. Please indicate which issues you would like by checking (✓) the boxes. Send requests with payment to:

BYTE Back Issues, One Phoenix Mill Lane, Peterborough, N.H. 03458, (603) 924-9281

Check enclosed Charge:

VISA MasterCard American Express

Card #

Exp. Date

Name

Signature

First Name

Last Name

Address

Address

City

State Zip



A Division of The McGraw-Hill Companies

Your Specialty PCMCIA Headquarters



If your needs are portable, Quatech has the solution. Our complete line of communication and data acquisition PCMCIA cards include:

- 1, 2, or 4 Port Serial RS-232/422/485 PCMCIA Cards
- Parallel Port/EPP PCMCIA Cards
- Multi-Protocol PCMCIA Adapter Cards
- Digital I/O PCMCIA Cards
- Analog Input and/or Output PCMCIA Cards
- IEEE 488.2 PCMCIA Interface Cards

For complete specifications on the above products, call one of Quatech's expert sales engineers today at 1-800-553-1170 or email sales@quatech.com. Ask for a free copy of Quatech's new 1997 Product Catalog.

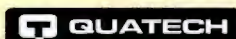

.....Application to Solution

Check us out on the web: <http://www.quatech.com>
See us at COMDEX, Booth #S3385

Circle 61 on Inquiry Card (RESELLERS: 62).

RS-232/RS-422/RS-485/Current Loop Serial Interface - Yes, Single Card Does It All!

\$110.00

- Uses standard RS-232 commands - no special drivers needed
- Automatic data flow control
- 16C550 UART with 16-byte FIFO buffer
- Transmission speeds up to 115K bps
- Complete RS-232 modem control signals
- Supports 2-wire or 4-wire operation for RS-422/485
- Both DB-9 and DB-25 connectors included
- PC-ComLIB software included, but not necessary
- Multi-port cards also available

Part # PCL-740

ADVANTECH

750 East Arques Ave., Sunnyvale, CA 94086
Tel. 408-245-6678 • Fax. 408-245-8268
Home page: <http://www.advantek.com> • e-mail: info@advantek.com

Circle 64 on Inquiry Card.

Supervisor Matrix

Ask for our Dealer Program!

Simultaneously manage up to 8 computers from up to 16 locations!



- Control with keyboard and control panel
- Scanning function • Lock access to a CPU
- File transfer function as option • Automatic booting of keyboard and mouse
- Supporting high-resolution monitors • Customization always available
- Rack mountable • 1 year warranty

Variable configurations available: any combination from 1 user to 2 computers up to 16 users to 8 computers

Minicom - CONNECTIVITY SOLUTIONS

Advanced Systems Ltd.
International Headquarters:
11 Beit Hadfus St.
95483 Jerusalem, Israel
Phone: +972 2 651 85 93
Fax: +972 2 651 89 71
Email: rguggenh@minicom.co.il

Visit our Home Page!
<http://www.minicom.netmedia.co.il>

Circle 66 on Inquiry Card.

Celebrating... LaserLite™ & DuraTrax™



The Next Generation
Get tough... Get metal!

Join the party as we celebrate two hot new products! LaserLite—the smallest portable laser bar code reader on the market! And DuraTrax—the first portable reader to fully integrate Touch Memory® and bar code technology.



Call for your free information kit!
See us at COMDEX, Booth #L143

1105 N.E. Circle Blvd., Corvallis, OR 97330
541-758-0521 • Fax 541-752-5285 • <http://www.videx.com>

GC0731

Circle 63 on Inquiry Card.

From \$259 MONEY BACK GUARANTEE

STARVIEW

PS/2 Model SV421

Control up to 216 Servers

with just 1 Monitor, Keyboard, and Mouse

- Supports SVGA, VGA, and Multisync Monitors
- Keyboard or pushbutton CPU selection
- Autoboots Keyboards and mice (SV421)
- Cascadable

Mouse
Keyboard
Starview
Servers

Models	Connector Type	Servers up to	Cable	Price
SV621	AT	6	216	\$349
SV421	PS/2	4	64	\$249
SV102	AT	2	64	\$259

Rack Mount Available

Listed Price Applies to CSA/JUL model

USA/Canada: 800-265-1844 (ext. 231)
France Office: 0-590-3661 / UK Office: 0-800-96-7710
Fax: (519) 455-9425 / Internet E-Mail: starstech.computer@onlinesys.com
<http://www.startechcomp.com>

StarTech
COMPUTER PRODUCTS

European/International Distribution use Fax or Internet or Call: (519) 455-9675 (ext. 231)

USA • Canada • UK • France
Netherlands • Hong Kong
Visa/Mastercard/American Express

Circle 70 on Inquiry Card.

TAKE CONTROL

of 2 to 64 SERVERS
FROM ONE KEYBOARD, MONITOR AND MOUSE

- Any mix of PCs; Mac, and Sun
- Keyboard/mouse emulation
- AUTOSCAN
- Front panel & Hot key operation
- Remote access to 150'
- Desktop or rack mount
- Over 50,000 in operation

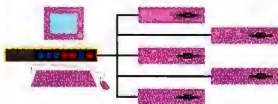

MasterConsole®

Rock solid, reliable control



CALL TODAY! 800-RCI-8090 X 71

Come see us at Comdex Fall, Las Vegas, Nov 18-22, Booth #L5000

DISTRIBUTORS LOCATED WORLDWIDE

RCI Europe (31)-10-458-6673
fax (31)-10-451-9610

RCI Taiwan (886) 2-218-1117
fax (886)-2-218-1221



Raritan Computer, Inc. 908.874.4072 fax 908.874.5274
10-1 Ilene Court, Belle Mead, NJ 08502 ■ sales@raritan.com ■ http://www.raritan.com

30 DAY MONEY-BACK GUARANTEE FULL 1-YEAR WARRANTY

Circle 67 on Inquiry Card (RESELLERS: 68).

Industrial PC Solutions



Rackmount PCs

Industrial PC Chassis

Industrial Workstations

Panel Display PCs

Pentium/486/386 CPU Cards

RS-232/422/485 Interface

Analog and digital I/Os

Data Acquisition

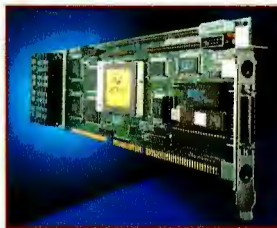

Call 800-800-6889 to receive a **FREE** 100-page Solution Guide for your OEM or system integration needs.

ADVANTECH.

750 E. Arques Ave.
Sunnyvale, CA 94086
408-245-6678, Fax 408-245-8268

Circle 71 on Inquiry Card.

DON'T GET MAD!
GET YOUR MESSAGES!
TTI's New 4-PLAY
Voice Processing Card &
Voice Window Application Software
PEACE OF MIND FOR UNDER A THOUSAND DOLLARS
1-800-945-4884

MC/VISA/AMEX
Developers/OEM Packages Available
Specialist in International Sales and Support

Talking Technology, Inc. 1125 Atlantic Ave. Alameda, CA 94501 USA
Phone: 510 522-3800 Fax: 510 522-5556 Email: sales@tti.net Web: http://www.tti.net

Circle 65 on Inquiry Card.

Industrial PC Chassis with Industrial AC / DC Power Supply

- ISA/PCI 3-20 Slots
- 85V~265VAC, -48VDC, +24VDC, +12VDC Inputs
- 200W~350W Power Supply
- 19" Rack-Mount / Wall-Mount



17 3 ~20-Slots Chassis Available !!

ACI Systems

Western Region: 1-800-983-1177
Eastern Region: 1-800-886-2243



Circle 80 on Inquiry Card (RESELLERS: 81).

Embedded PC Fits your applications and budget!

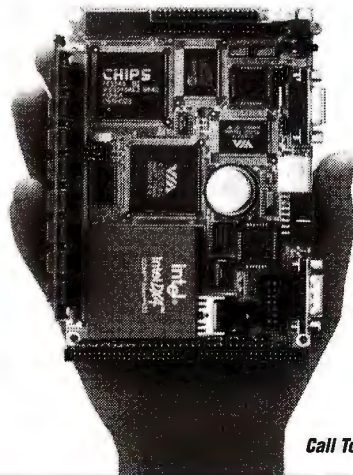

Biscuit PC
386/486 Single Board Computer with SVGA/LCD and more ...

- Ultra small size (145mm x 102mm)
- Supports all 486DX and 5x86 CPUs
- Local-bus SVGA/LCD interface
- Multi-port RS-232 and Ethernet communication
- Supports Solid State Disks
- PC/104 expansion

Call Today for a Free Catalogue !

U.S.A.
Tel: (408)522-4696 Fax: (408)245-8268
E-mail: info@advantech-USA.com
International
Tel: 886-2-2184567 Fax: 886-2-2183875
http://www.advantech.com.tw
E-mail: EBC@aci.advantech.com.tw

Industrial Automation with PCs
ADVANTECH.

Circle 72 on Inquiry Card.

Turn Key Solutions For Industrial Computers

200MHz Pentium® Processor PCI/ISA SBC ATX Mach 64 PCI SVGA, Pipeline Burst Cache, SCSI II Fast Wide



- Fault Tolerant System/RAID Solution
- Full Line of Rack Mount Products
- Partnership for the Future
 - Hyperspeed Reseller Program
 - OEM/Customized Design Projects
 - Government/Corporate Discounts

Catalog On Line!

http://www.appro.com
E-mail: appro@appro.com
800-927-5464

COMDEX Fall '96 Booth #91008
CTI Pavilion, Las Vegas Convention Center
Call For Free Brochure

APPRO International, Inc.
Industrial Technology of Tomorrow

2032 Bering Dr., San Jose, CA 95131 Tel (408) 452-9200 Fax (408) 452-9210

Circle 77 on Inquiry Card (RESELLERS: 78).

All-in-one Flat-Panel Rack-Mount Systems

For Your PC-based Control Application



\$1400



- TFT, EL or Mono flat-panel display
- 14-slot backplane
- 386/486/Pentium® with PCI Bus.
- 250 power supply
- Disk bay space: 5.25" x 1, 3.5" x 2

AXIOM
MEASUREMENT & CONTROL

Tel: 909-464-1881
Fax: 909-464-1882
E-mail: sales@axiomtek.com

Circle 82 on Inquiry Card (RESELLERS: 83).

Embedded Pentium™ CPU Card



Pentium™ Half-size Available !!



- Pentium™-166MHz
- PICMG Standard
- DiskOnChip™-2MB Flash Diak
- 256KB/512KB Pipelined Cache

- PCI VGA on-board
- 2 PCI IDE
- 2 16C550 RS232
- PS/2 Mouse

10 486 ~ Pentium™ CPU Cards Available !!

ICP ACQUIRE INC.
TEL: 415 967 7168
FAX: 415 967 5492

Circle 84 on Inquiry Card (RESELLERS: 85).

Rackmount

60 Models and Styles with New Sizes Added Every Month

AC, DC, Hot Swap, Power Supply

4-20 Slots ISA, PCI, B/P

INTERLOGIC INDUSTRIES

85 Marcus Dr., Melville, NY 11747 • 516.420.8111 • Fax: 516.420.8007 • www.infoview.com



Full Line CPU Cards

Custom Colors and Logos

Custom Systems Our Specialty

Call Us for Our Everyday Low Prices

Made in USA

Circle 89 on Inquiry Card (RESELLERS: 90).

NEW! 386 PC-IN-A-BOX



Portable PC System

- Battery operated 386
- DOS in ROM
- Graphics LCD
- 4M Ram, 1M Flash
- PCMCIA
- 3 serial, 2 parallel
- Keypad & Enclosure
- Peripherals & Support
- \$449+**

CPU CARDS

5-Serial Port 386

\$249+

KS-6B CPU: 33 MHz, RS-422/485, 2 parallel, 4M Dram, 1M Flash, 512K Sram, AT bus, PCMCIA, DOS in ROM.

Low Cost XT

\$139+

KS-1 CPU: V40, 3 serial, 2 parallel, 512K Dram, 1M Flash, 512K Sram, modem, 10 bit A/D, PCMCIA, XT bus, DOS in ROM.

KILA
DOS-IN-ROM

CALL 800-505-6749

303-444-7737

FAX 303-786-9983

email: sales@kila.com

Circle 73 on Inquiry Card.

RACKMASTER™ Fault Resilient System

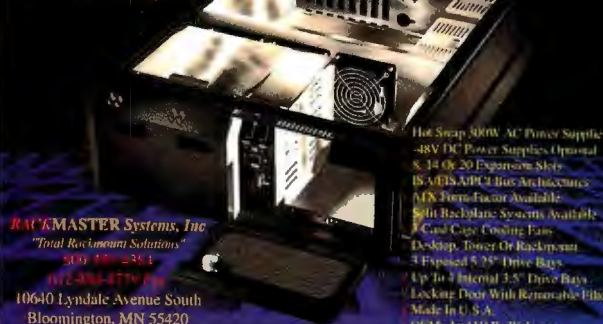

RACKMASTER Systems, Inc.
"Total Rackmount Solutions"
800-444-4779
10640 Lyndale Avenue South
Bloomington, MN 55420

- Hot Swap 300W AC Power Supplies
- 48V DC Power Supplies Optional
- 8, 14 Or 20 Expansion Slots
- ISA/EISA/PCI Bus Architectures
- 1/2 IN. Form-Factor Available
- 50/100 Backplane Systems Available
- 3 Card Cage Cooling Fans
- Desktop, Tower Or Rackmount
- 3 Exposed 5.25" Drive Bays
- Up To 4 Internal 3.5" Drive Bays
- Locking Door With Removable Filter
- Made In U.S.A.
- OEMs And VARs Welcome

Circle 88 on Inquiry Card.

Computer Systems

Single Board Computers



A large variety of SBCs in stock for fast delivery

- 486 AND PENTIUM CPUs
- UP TO 200MHZ SPEEDS
- PCI SCSI INTERFACE
- E-IDE INTERFACE
- SVGA VIDEO OUTPUT
- DUAL SERIAL PORTS
- ISA & PCI BACKPLANES

CALL TOLL FREE 1-888-RECORTEC

Tel: 1-408-734-1290
Fax: 1-408-734-2140
e-mail: info@recortec.com
http://www.recortec.com

RECORTEC
1290 Lawrence Station Road
Sunnyvale, CA 94089

Circle 75 on Inquiry Card.

Rack Mount Computers



Request our free Product Catalog

- COMPUTERS
- ENCLOSURES
- KEYBOARDS
- MONITORS
- PRINTERS
- CUSTOM DESIGNS

CALL TOLL FREE 1-888-RECORTEC

Tel: 1-408-734-1290
Fax: 1-408-734-2140
e-mail: info@recortec.com
http://www.recortec.com

RECORTEC
1290 Lawrence Station Road
Sunnyvale, CA 94089

Circle 76 on Inquiry Card.

Computer Systems • Data Acquisition

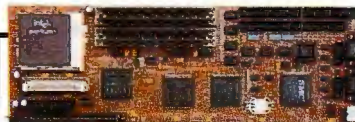

PENTIUM, 486 Single Board Computers & Mother Boards

RAVEN PENTIUM PCI/ISA
FALCON IV 486 Single Board
RACK MOUNT SYSTEMS
• On-Board IDE/FDD/IO
• REV Control • AMI BIOS
• OPTI CHIPSET

ORDER DESK 1-800-777-4875

US LOGIC

(619) 467-1100 • FAX (619) 467-1011
sales@uslogic.com

The Intel Inside Logo and Pentium are registered trademarks of Intel Corporation. 3 year warranty applies to Single Board Computers.



Circle 86 on Inquiry Card (RESELLERS: 87).

2 GS/s A/D and Scope Card



- ✓ 12 bit, 60 MSPS A/D
- ✓ 8 bit, 250 MSPS A/D
- 2 GS/s for repetitive signals
- ✓ Up to 16 Meg Memory
- ✓ Extensive Software Drivers



CSLITE 8 bit, 40 MSPS \$595
CS2125 8 bit, 250 MSPS \$4995
CS6012 12 bit, 60 MSPS \$6995
U.S. Prices. International prices may vary

Gage
1-800-567-GAGE

Ask for extension 3425

From outside the United States:
Contact Gage Applied Sciences Inc., 5610 Bois Franc, Montreal, QC, Canada H4S 1A9 Tel: (514) 337-8893 Fax: (514) 337-8411

Gage Applied Sciences (U.S.) Inc.
1233 Shelburne Road, Suite 400
South Burlington, VT 05403
Tel: (800) 567-4243 Fax: (800) 780-8411
e-mail: prodinfo@gage-applied.com
web site: http://www.gage-applied.com

Circle 104 on Inquiry Card.

SILICONRAX Leading you into the Future of Industrial Rackmount Systems...

- Completely Configured Systems
- Rackmount System Enclosures
- PCMCIA 4/2 Industrial Workstations
- Monitors • Modem Enclosures
- Keyboards • Keyboard Enclosures
- Single Board Computers
- Hot Swap PSUs Solutions (Data I/O units)

486 to Pentium Pro's
ISA/ VMEbus/ PCI

Hot Swap Redundant PS Avail. in 8, 14 or 20 slots

BEST VALUE

SRPC-210
19" Rackmount Chassis

For more information
800-700-8560
http://www.siliconrax.com
E-mail: info@siliconrax.com
Leasing option available
Tel. 408-726-1090 Fax 408-245-2570

Circle 79 on Inquiry Card.

IEEE 488 Controllers

- Boards for PC/AT, PCMCIA™, PCI, parallel, serial, Sun™ workstations & DEC™ workstations
- Drivers for DOS™, Windows™, Windows® 95, Windows® NT, LabVIEW®, UNIX™, & more

216-439-4091 • Fax: 216-439-4093
http://www.iotech.com

The Software and Hardware of Iotech, Inc., Digital Equipment Corp., PCMCIA, Windows & Windows 95, Microsoft Corp., LABVIEW, National Instruments, DEC, Digital Equipment Corp., and Iotech are trademarks of their respective owners. Iotech, Inc. is a member of the Iotech Group.

Circle 105 on Inquiry Card.

U.S.A. Made Rackmount Solutions from THE

Over 40 models, sized from 1U through 6U, 17" to 24" deep, plus rackmount switches, monitors up to 20", & keyboards with or without trackballs.

QTY. PRICING FROM \$138.

- 5 to 20 slot segmented or unsegmented passive backplanes w/ or w/o PCI slots.
- Complete line of 486 & Pentium slot boards & motherboards up to 200 MHz, including Intel's full line.

A.C. OR 48V
HOT SWAPS
UP TO 800W

Customized Colors Available

TRI VALLEY TECHNOLOGY, INC.
4569-A Las Positas Road, Livermore, CA 94550
VOC: 510 447-2030 • FAX: 510 447-4559 • www.rackco.com



VISA & M/C accepted

Circle 74 on Inquiry Card.

BYTE

Breaks the 4-Color Price Barrier with the Hardware/Software Showcase

See how affordable it is to advertise to BYTE's 500,000 computer professionals in this section!

For more information call your BYTE sales representative (see listing, page 233) or fax 603-924-2683

DAQValue™

Portable Data Acquisition
Performance and Portability –
We Give You Both.



DAQCard™ Series

- Six Type II PCMCIA cards
- Up to 100 ksamples/s
- 12-bit resolution
- Analog input and output
- Digital I/O and timing I/O



DAQPad™ Series

- Parallel port interface
- 100 ksamples/s
- 12 or 16-bit resolution
- Analog, digital, and timing I/O
- DC power, optional battery pack



SCXI Signal Conditioning

- Parallel port or PCMCIA interface
- Expandable to 384 channels
- DC power, optional battery pack



Software

- NI-DAQ® driver software for:
 - LabVIEW®
 - LabWindows®/CVI
 - ComponentWorks
 - Basic, C/C++, Visual Basic, Pascal, and many more



Call for **FREE DAQ Designer™ Software**
(800) 433-3488 (U.S. and Canada)



U.S. Corporate Headquarters • Tel: (512) 794-0100 • Fax: (512) 794-8411
E-mail: info@natinst.com • WWW: http://www.natinst.com

© Copyright 1996 National Instruments Corporation. All rights reserved.
Product and company names listed are trademarks or trade names of their respective companies.

Circle 106 on Inquiry Card.

Custom Fast 20 SCSI Tools

SCSIVue™ Active Terminator



- Optional Remote Display
- Benefits:**
- Improves SCSI Bus Performance
 - Less Errors; More Reliable Data Transfer
 - Diagnoses Problems • Analyzes Signal Quality
- Features:**
- Active Regulation • Supports 68 Pin, 50 Pin
 - Status Indicators • Gold Contacts

From: **\$39**

SCSIVue™ Gold Diagnostic Cables



- Benefits:**
- No Loss Of Important Data
 - Faster Performance • Test Cable Integrity
- Features:**
- Diagnostic Indicators • Large Ferrite Filters
 - Triple Shielding (Unique Cable Design)
 - Double Gold 20u" Plated Connectors
 - Extra Heavy 26 Gauge Wire, 50 & 68 Pin

Over 40 Cable Styles In Stock

SCSIVue™ Teflon Custom Internal Cables

- Benefits:**
- Less Errors, Ultimate Performance
 - Silver Wire Improves Signal Quality
- Features:**
- Perfect 90 Ohm Impedance Match
 - Triple Pronged Connector With Gold contacts



Custom Internal Cables in 1 DAY!

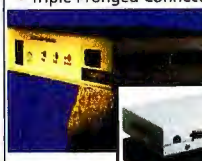

SCSIVue™ Active Digital Switch

- Benefits:**
- Share SCSI Devices Between 2 Computers
 - Attach up to 14 Devices to 1 Computer
- Features:**
- 2-1 Active Digital Switch/Repeater
 - Regenerates SCSI Signal for Long Runs

Granite Data Solutions
http://www.scsipro.com
3101 Whipple Rd. • Union City, CA. 94587 • Ph: 510-471-6442 • Fax 510-471-6267

Circle 91 on Inquiry Card (RESELLERS: 92).

Computer/LAN Tools and Diagnostics

Call for a free copy of the new Jensen Catalog for all of your PC/LAN diagnostic products and installation accessories.

JENSEN TOOLS

7815 S.46th St.,
Phoenix, AZ 85044
Ph: 800-426-1194
FAX: 800-366-9662
http://www.jensentools.com



Circle 108 on Inquiry Card (RESELLERS: 109).

SMART FAX MODEM?
Yes, a fax modem that works with your PC off!!

Introducing The Fax Modem That Stands Alone...

The FutureFax 144

ADVANCED MULTI-FUNCTION FAX SYSTEM
FOR DOS, WINDOWS & NETWORKS



- ✓ Send/Receive Faxes With Your PC Turned Off!
- ✓ Print Plain Paper Faxes Directly To Your Printer and save hundreds of \$ on thermal paper.

- ✓ STORES FAXES IN MEMORY
- ✓ VIEW FAXES BEFORE PRINTING
- ✓ FORWARD TO REMOTE LOCATION
- ✓ COMES WITH FREE SOFTWARE
- ✓ SUPPORTS CAS APPLICATIONS
- ✓ SEND FAXES WITH ANY SCANNER
- ✓ V.42, MNP DATA MODEM
- ✓ UP TO 32MB OF MEMORY
- ✓ AC OR BATTERY OPERATION
- ✓ AND MUCH, MUCH MORE!!

Call our 24 Hour Fax-On-Demand System for FREE Information. **1-888-GET-FAX4**



ADVANCED IMAGE COMMUNICATIONS
3343 VINCENT RD. #D PLEASANT HILL, CA 94523 FAX 1-510-947-1900

Circle 93 on Inquiry Card.

HeatSentry™

The only way to make sure your super-powered PC is properly cooled!

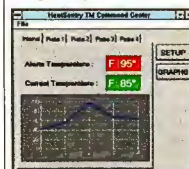

- Make sure your system and CPU are operating at proper temperature.
- Know the exact temperature of your system and CPU at all times.
- Prevent heat-related system crashes.
- Protect your data.
- Prolong your PC's life.
- Be notified automatically of overheat conditions.
- Windows 3.1 / 95 / NT, Novell versions available.



1-888-848-4321
http://www.camusa.com

816 Charcot Ave., San Jose, CA 95131 Tel: 1-408-321-9800 Fax: 1-408-321-9805

Circle 94 on Inquiry Card (RESELLERS: 95).

166Mhz PENTIUM POWER

BYTE MAGAZINE RECOMMENDED!

BYTE BEST LOW COST
 "Micro International's Mini 5200 gets the nod because of its great price/performance ratio."

- 11.3" 800x600 Dual-scan Color screen. 2MB DRAM. Optional 12.1" TFT Active Matrix.
- Built-in 6x CD-ROM drive, 16-bit stereo sound, 2 speakers, & mic.
- Two type II PCMCIA slots, serial, parallel, MIDI, PS/2, & infrared ports.
- Windows 95 or DOS / Windows.
- 1GB removable PCI EIDE HD (up to 2.1GB available).
- 16mb RAM (maximum 64mb) and 256K level 2 cache.
- 1 year parts and labor warranty. Extended warranties available.
- PS/2 Glide Point & Joystick.
- 3.5" removable floppy drive.

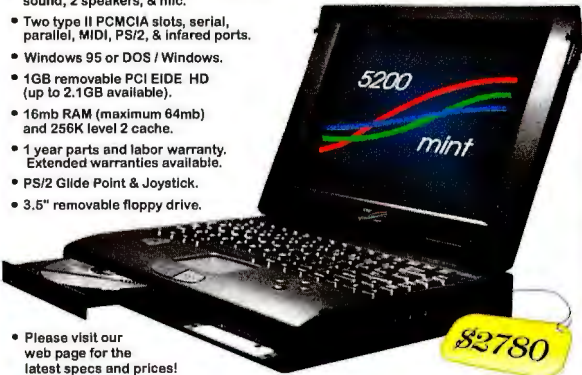

• Please visit our web page for the latest specs and prices!

Micro International, Inc. 10850 Seaboard Loop, Houston, Texas 77099. Top quality merchandise with excellent service and support since 1984! Houston: (713) 495-9096. Fax (713) 495-7791. Hours: 8-6 Monday-Friday.

*Pentium is a registered trademark of Intel Corporation.

1-800-967-5667
 Internet: <http://www.pemint.com>

DISASTER RECOVERY FOR WINDOWS 95

NEVER install Windows 95 Again!

CodeBLUE/2

- Simple as 1-2-3
- 1. Boot disaster recover diskette
- 2. RESTORE to any size drive
- 3. Re-Boot to Windows 95

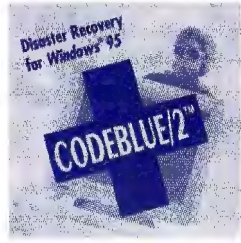

• COMPLETE PROTECTION

- Backup complete Windows 95 system: Registry, hidden files, LFN's
- Backup to any locally attached hard disk, Syquest EZ, Iomega Jaz & Zip drives, MO Drives.

\$49.00

plus S/H

Also works on Win NT with FAT 16 Hard Disk.

TAPEDISK Corp
800-827-3372

CodeBlue/2 REMOTE

- For network disaster recovery
 - Backup to server
 - DOS Boot client to network
 - Restore & reboot to Windows 95
- Call for network license price

tapedisk@tapedisk.com
<http://www.tapedisk.com>
 715-235-3388
 FAX: 715-235-3818
 TAPEDISK UK 1703-841 550
 TAPEDISK EURO +49 84.41.80.39.00
 Germany +49 761.59.21.00
 The Netherlands +31 23 563 39 60
 France +33 61.80.92.71

Circle 98 on Inquiry Card.

Sliger

is a vertically integrated design and manufacturing company specializing in computer enclosures, disk subsystem enclosures and fully integrated systems.

Engineering • Design • Fabrication

- Industrial PC Enclosures
- Tower PC Enclosures
- Tower Drive Enclosures
- Rack Systems
- Rackmount Accessories
- CPU Cards and Backplanes
- Rackmount Drive and PC Enclosures
- Industrial PS2 Power Supplies
- Redundant N+1 Load Sharing Power Supplies

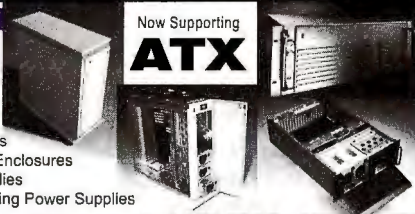

Now Supporting
ATX

Phone: 1-702-356-5595 Fax: 1-702-356-6361 Email: info@sliger.com
 Internet: <http://www.sliger.com> Postal: 1385 Greg St. Suite 101 Sparks, NV 89431

Circle 96 on Inquiry Card (RESELLERS: 97).

Flashlite™

- 8 Mhz V-25 + Processor
- 512 KB RAM
- 256 KB Flash
- 2 Serial Ports

EDN 100 Hot New Products of 1995

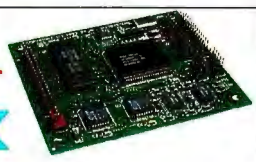

Single Board Computer with DOS and Utilities \$195

Embedded controller applications: Simple software development:
 2 fast DMA channels • 8 analog inputs with programmable comparator levels • priority interrupt controller with vector or register bank switching.

- Create on a PC compatible computer.
- Download in .exe or .com format to flash disk.
- Test and debug through the console serial port.
- Modify the startup batch file to load and execute the application on reset or powerup.

JK microsystems 510 236-1151 fax 510 236-2999
 1275 Yuba Ave., San Pablo, CA 94806 <http://www.dsp.com/jkmicro>

Circle 102 on Inquiry Card.

Design, Print and Apply CD Labels for \$79⁹⁵

That's NEATO!



NEATO™ CD LABELER KIT

- 1 Create your own artwork On Your Computer with easy-to-use NEATO Templates.
- 2 Print on Any Laser Printer using NEATO pressure sensitive die-cut labels.
- 3 Using the NEATO Label Device, apply labels... PERFECTLY EVERY TIME!

ORDER NOW!
FREE 100 LABELS

- KIT INCLUDES
- Label Design Templates (PC & Mac)
 - The Amazing Neato Labeler
 - Complete Instruction Guide

800-984-9800

MicroPatent® 250 Dodge Ave • East Haven, CT 06512
 203-466-5170 • Fax 203-466-5178
 In Europe: +44 (0)990 561571 • Fax +44 (0)181 932 0480
 See us at: <http://www.neato.com>

Circle 99 on Inquiry Card.

Low Cost 16-bit Controllers

Easy to program in Borland/Microsoft C/C++.
C-Engine™ Prices start at \$119 Qty 1, \$49 OEM

- 3.6x2.3", 24 I/O, 3 UARTs, 3 timers 2 counters
- Upto 512K SRAM, 512K EEPROM, Watchdog
- 11 12-bit ADC, 3 mA standby, Battery, RTC
- Networking, C library, Development kits



TERN INC.

216 F St. #104, Davis CA 95616 USA
 Tel: 916-758-0180 Fax: 916-758-0181
 Internet Email: tern@netcom.com
<http://ftp.netcom.com/pub/tern>

Circle 101 on Inquiry Card.

- LCD
- RELAYS
- ADC
- DAC
- RS232
- RS485
- SRAM
- EPROM
- FLASH
- EEPROM
- RTC
- TIMERS
- BATTERY
- WATCHDOG
- ENCLOSURES
- SOFTWARE
- PIO
- CORES
- DMA

Control Practically Anything. from \$79.



Little Star, \$195
30 I/O Lines

Our miniature controllers are ideal for machine control and data acquisition. Easy to program with our Dynamic C. Start saving time and money. Call for your free demo disk today!

1724 Picasso Ave.
Davis, CA 95616
916.757.3737
916.753.5141 FAX
<http://www.zworld.com>



For immediate information, use our 24-Hour AutoFAX. Call 916.753.0618 from your FAX. Request catalog #18.

Circle 100 on Inquiry Card.

We make software protection easier to handle.



Software Security's new UniKey® technology could change the way you think about software protection forever.

Even though our new hardware keys are small, they still offer the most powerful and reliable barrier against software piracy ever developed. And with competitive pricing, they won't squeeze your margins either.

- Secure protection for multiple applications/versions
- The industry's only patented protection technology
- Protects applications quickly, without programming
- Remote update capabilities
- DOS/Windows/95/NT/Unix/NetWare support
- Time/date-based execution control
- Made in U.S.A.

UniKey makes software protection easier on your customers, your developers, and your budget... but harder than ever on pirates. Call **1-800-841-1316** for more information, or to order our Developer's Kit, with everything you need to try UniKey protection on your application.



A new slant on software protection
6 Thorndal Circle, Darien, CT 06820-5421
(203) 656-3000 • Fax: (203) 656-3932
<http://www.softsec.com>



Circle 107 on Inquiry Card.

All steel construction Server & RAID chassis

- Front access with 14 #5 1/4" exposed drive bays
- Lockable front and both side doors
- 6 ball bearing cooling fans pre-installed
- 4 lockable casters pre-installed
- Redundant & heavy duty power supply options



ATX!

Non-Stop Server Chassis

- Front access 10 #5 1/4" exposed drive bays
- Lockable front door, open able side doors
- w/300W AT UL P/S.....\$178
- w/2x300W R.P.M.....\$399

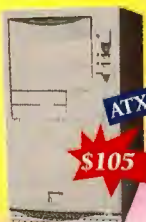

\$105

Slide-In M/B Drawer

- M/B: ATX, Baby AT, Full Size AT
- Drive Bays: 5.25"x3, 3.25"x2, 3.25"x2 (Internal)
- FCC class B, CE

Removable Hard Drive Modules

- Wide SCSI, SCSI or IDE Available, Patent protected
- Perfect for RAID & removable storage application



ATX! **Senstron**

Heavy Duty Power Supply

ETA-4000	600 watt AT\$221
ETA-4500	500 watt AT\$165
ETA-4000	400 watt AT\$146
APA-5400F-RV	400 watt AT\$195
SP2-4400	400 watt PS2\$121
SP2-4300	300 watt PS2\$ 61
AP2-5400F-3V	400 watt PS2\$155

Also available other power supply... 3.3V output optional.

Non-Stop Redundant Power Supply

- Balance Load-Sharing Design
- Power Fault Alarm/LED/Signal



AEH CORP.
254 S. 5th Ave., La Puente, CA 91746
Tel: (818) 369-2608 • Fax: (818) 961-0468
Central, TX, 800-454-9999 • M.T.C., NY, 800-366-4860

Circle 110 on Inquiry Card (RESELLERS: 111).

Seismic Proven 9-Track



4mm 8mm
Tape Libraries

Automated Backup Data Interchange Storage Management



3490E
800-468-0680 **QUALSTAR**
www.qualstar.com FAX: (818) 592-0116
TEL: (818) 592-0061

Circle 103 on Inquiry Card.

Let your "true colors shine through" when you advertise your computer products in the

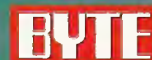

HARDWARE/SOFTWARE SHOWCASE

our popular, affordable, 4-color advertising section!

For more information call your BYTE sales representative (see listing, page 233) or fax 603-924-2683

NT MAIL™ NT LIST™ NT DOMAIN™

*the backbone
mail system
for Windows NT™ &
Windows95™*

- ◆ full featured SMTP, POP and FINGER server
- ◆ highly configurable, secure list server
- ◆ multiple independent mail domains on a single machine
- ◆ graphical installation and configuration

FROM ONLY \$49

A **FREE** FULLY FUNCTIONAL
TIME LIMITED EVALUATION COPY
IS AVAILABLE ON OUR WEB SITE



all trademarks are acknowledged and are the property of their respective owners

Internet Shopper Limited - PO Box 8064 - London - SW12 9XG - ENGLAND
<http://www.net-shopper.co.uk> ☎ 011 44 181 673 7422

Circle 112 on Inquiry Card (RESELLERS: 113).

FREE ENGINEERING SOFTWARE CATALOG



Engineering Software Direct is your #1 source for engineering software! The more than 1,000 products listed in this catalog were developed by companies and practicing engineers and represent a vast resource of tools that can help you get your job done better, more accurately, and more quickly.

1-800-898-9044

SciTech

SciTech International 2525 N. Elston Ave., Chicago, IL 60647 • Tel 773.486.9191
Fax 773.486.9234 • e-mail info@scitechint.com • URL <http://www.scitechint.com>

Circle 114 on Inquiry Card).

CAKE

Simple Software from Clou Consulting Co.

DOS OS/2 WIN Computer algebra by keyboard entry.

Something for everyone. Arithmetic, algebra and **MORE**. Practical and useful. No language to learn. Free upgrades.

Simply \$67.00 plus shipping.

Order: **1-800-226-0640** Fax: 612-553-0147
VISA MC AM-EX

1400-F Hwy 101 North, Suite 183, Plymouth, MN 55447

Circle 115 on Inquiry Card (RESELLERS: 116).

Put Your Company on the World Wide Web!

INTERNET

VIRTUAL
WEB
HOSTING

\$24.95
per month*

Place your order directly
into our automated
online system at:
<http://www.hway.net/home.html>

* minimum contract and 1st set-up fee required.
\$10 charge in first month only.

- Domain name registration provided (http://your_name)
- Unlimited updates via your own FTP account
- Complete domain mail processing (Multiple POP3, forwarding, autoresponders)
- 500 MB of data transfer per month (10:12 per MB over 500 MB)
- 20 MB of disk space for your html documents & graphics (11 per MB over 20 MB)
- T3 Connectivity to the Internet
- Unlimited e-mail address forwarding
- Microsoft Front Page® support
- CGI Scripting (Now includes shopping cart)
- Cybercash support
- Detailed web usage statistics & access to raw log files
- Controlled anonymous FTP
- TrueSpeech® server support included (real-time audio)

Also Available:
Real Audio™ 2.0
SSL Secure Processing
mSQL Database Tools

Hiway Technologies
THE WORLDWIDE LEADER IN WEB HOSTING

<http://www.hway.net> 1 800 339-HWAY, sales@hway.net (407) 989-8574

Circle 117 on Inquiry Card (RESELLERS: 118).

Lahey
Computer Systems, Inc.

Fortran is our forte

Specializing in Fortran
Language Systems Since 1967

The Lahey Advantage

FREE, unlimited,
expert technical support.

Guaranteed bug fixes or
workarounds within
60 days.

30-day
money-back
guarantee.

FREE
product patches
on the Web at
<http://www.lahey.com>.

800-548-4778
or
702-831-2500

Fax: 702-831-8123
sales@lahey.com
<http://www.lahey.com>

LF90 Delivers!

Speed. Dependability.
Great Tech Support.

Create Fortran programs or port
legacy code to the PC with the
most-productive, best-supported
Fortran 90 language system.

Lahey Fortran 90

- Fortran-smart Windows Development Environment.
- DOS, Windows 3.1x, Windows 95 and NT Support.
- DLL interfaces to VB, VC++, and Borland C++.
- State-of-the-Art Intel Pentium and Pentium Pro Optimizations.

US\$895
Educational, multiple-copy, and
site-license pricing available.

Lahey Computer Systems, Inc.

865 Tahoe Blvd., P.O. Box 6091
Incline Village, NV 89450 U.S.A.

Circle 119 on Inquiry Card (RESELLERS: 120).

**Learn Java™ Programming...
Simply, Quickly!**

Use the OML Learning Series™ to master Java programming quickly. It is the only CBT that offers you "traditional" and "by example" learning styles. The Java Series features:



Call us for information, and FREE Demo Software



Visa MC Amex



OBJECT MANAGEMENT LABORATORY
TEL: 805-373-8111
FAX: 805-373-8116

	Individual	Corporate
Java Series - I™ (Basics)	Each series: \$79	\$249
Java Series - II™ (Object Model)	Any 2 series: \$149	\$399
Java Series - III™ (Fundamentals)	Any 3 series: \$199	\$549
Java Series - IV™ (AWT)	All 4 series: \$249	\$649
	Other series: Call	

800-6789-OML

Circle 121 on Inquiry Card.

"Run Client/Server Applications Securely over the Internet"

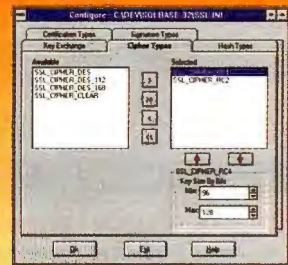

- Use the Internet as a secure virtual Wide Area Network
- Develop powerful Internet applications using 4GL tools
- Use SQLWindows, Visual Basic, Powerbuilder, Delphi, C++...
- Provides automatic data-stream encryption for all SQL data
- Uses RSA security and Netscape's secure socket references
- Includes a complete enhanced version of SQLBase v6.1
- Transparent to users, developers and administrators

Use the Internet to securely access your client/server applications

Use Client/Server tools for remote access solutions!



Pricing starts at \$1,595 for a 5-user version

Call 1-800-486-DUNN ext. 405

<http://www.dunnsys.com>



DUNN
systems, inc.

Circle 122 on Inquiry Card.

A Message to Our Subscribers

From time to time we make the BYTE subscriber list available to other companies whose products or services would be of interest to our readers. We take great care to screen these companies, choosing only those who are reputable. Furthermore, subscriber names are made available for direct mail purposes only; telemarketing calls are strictly prohibited.

Many BYTE subscribers appreciate this carefully managed program, and look forward to receiving information of interest to them via the mail. While we believe this information is of benefit to our subscribers, we firmly respect the wishes of any subscriber who does not want to receive promotional literature. Should you wish to restrict the use of your name, please send your request (including your magazine mailing label, name, address, and subscription account number) to:



BYTE Magazine Subscriber Services
PO Box 555, Hightstown
NJ 08520

A Division of The McGraw-Hill Companies

**The First Pan-European
Computer Postcard Deck
Targeting the
Exploding European Market!!!**



If you are a BYTE subscriber in Europe, watch for the EURODECK coming to you soon! The BYTE EURODECK contains a selection of state-of-the-art products important to you and your business.

Advertisers!

The BYTE EURODECK offers you a unique direct mail approach to increasing sales in this fast-paced computer market.

Circulation of the BYTE EURODECK is targeted to 50,000 computer buyers in over 20 countries in Western Europe. Take full advantage of the benefits BYTE provides you with this affordable direct channel to Europe. For information on the next BYTE EURODECK,

Call Mark Stone today at 603-924-2533!
Fax 603-924-2683 or E-mail: stonem@mcgraw-hill.com

Companies outside of North America, please contact your local representative



A Division of The McGraw-Hill Companies



THE BUYER'S MART

THE BUYER'S MART is a unique classified section organized by product category to help readers locate suppliers. Each ad has inquiry numbers to aid readers requesting information from advertisers.
AD FORMAT: Each ad will be designed and typeset by BYTE. Do NOT send logos or camera-ready artwork. Advertisers should furnish

typewritten copy. **2"x1 1/16"** ad can include headline (23 characters maximum), descriptive text (300 characters is the maximum recommended) plus company name, address, telephone and fax number. **2"x2 5/8"** ad has more space for descriptive text (850 characters is the maximum recommended).
DEADLINE: Ad copy is due

approximately 2 months prior to issue date. For example: November issue closes on September 8. Send your copy and payment to:
THE BUYER'S MART, BYTE Magazine, 1 Phoenix Mill Lane, Peterborough, NH 03458. For more information please call Vivian Bernier in BYTE sales at 603-924-2521 or **FAX: 603-924-2683.**

RATES (Jan. 1996)

	3-5 issues	6-11 issues	12 issues
1 ad	\$790	\$760	\$665
2"x1 1/16"			
2 ads/issue	-	-	635
3 ads/issue	-	-	600
1 ad	\$1,580	\$1,515	\$1,330
2"x2 5/8"			
2 ads/issue	-	-	1265
3 ads/issue	-	-	1200

*****COLOR - Add \$100*****

ACCESSORIES

SVGA Splitters

Monitor, Keyboard and Mouse splitters, multiplexers and high quality cables to 250 feet.
 > Connect 2 or more monitors to your PC
 > Support to 1600x1200 - **MADE IN USA**
 > Access 1 PC from several keyboards or vice versa
 > SVGA <-> TV Converters

HALL RESEARCH <http://www.hallresearch.com>
 Santa Ana, CA (714) 641-6607 **800-959-6439**

BAR CODE

Windows Bar Code Fonts

Add bar codes to any font based Windows program. Fonts designed for dot matrix, DeskJet and LaserJet. Print Codabar, 2 of 5, Code 128, UPC/EAN and Code 39 inside your Windows program. TrueType fonts, bitmaps and metafile support included. Only \$199.

Worthington Data Solutions
 (408) 458-9938 (800) 345-4220

BAR CODE

BAR CODE READERS

For PC, XT, AT, PS/2, & Serial Terminals

- > Emulates Keyboard: Works With Any Software
- > Data Appears as Keyboard Input
- > Uses Enhanced Decoding Algorithms
- > Accepts Wand, Slot/Badge, CCD, Laser, Magnetic Stripe Reader, & RS232 Serial Input
- > Reads All Popular Bar Codes (16 types)
- > Reads HIGH, MEDIUM, & LOW density codes
- > Auto-Discriminates Between Bar Code Types
- > Easily Programmed with a Bar Code Menu
- > Over 140 User Configurable Options
- > Daisy Chain Up to 96 Readers
- > Supports NOVELL Networks
- > Supports US & INTERNATIONAL Keyboards
- > Direct From Manufacturer
- > 30-day \$\$ Back Guarantee, 1 Year Warranty
- > Complete Unit with LASER Scanner - \$645
- > Complete Unit with CCD Scanner - \$299
- > Complete Unit with WAND Scanner - \$299

AMERICAN MICROSYSTEMS
 2190 Regal Parkway, Euless, TX 76040
 (800) 648-4452 (817) 571-9015 FAX (817) 685-6232
www.amitd.com

BAR CODE

Labeling Software

For DOS and Windows with dot-matrix, LaserJet or DeskJet. Easy WYSIWYG design. Any format/size. Mix big text, bar codes, and PCX graphics. Formats for AIAG, KMart, Sears, MIL-STD, Penneys, WalMart. File Input. LabelRIGHT for DOS-\$279. LabelRIGHT for Windows-\$295.

30 Day Money Back Guarantee
Worthington Data Solutions
 (408) 458-9938 800-345-4220

Bar Code Readers

for PC, XT, AT, PS/2, Macintosh and Serial Terminals

- * Attaches as 2nd Keyboard, no software changes
- * Reads 2of5, 128, UPC/EAN, Code 39, etc.
- * External or Internal attachment on PC
- * Wand, CCD, Slot Badge, Magstripe or Laser
- * Supports DOS, Novell, UNIX, Mac OS, etc.
- * 100+ Configurable Options
- * Supports USA and International Keyboards
- * 2 Year Warranty, 30 Day \$ Back Guarantee
- * Direct From Manufacturer
- * Top Rated by Independent Review
- * Complete with CCD Scanner - \$399
- * Complete with Laser Scanner - \$655
- * Complete Wand only Reader - \$299

<http://www.cruzio.com/~wds>
Worthington Data Solutions
 3004 Mission Street • Santa Cruz, CA 95060
 408-458-9938 • FAX 408-458-9964 **800-345-4220**

Bar Code Printing Software

LabelWorks for Windows

- > Prints all Popular Bar Code Types (19 Types)
- > Desktop Publishing Features: WYSIWYG, Scalable Fonts, Rulers, Guides, Lines, Shapes, Page Zooms (25%-400%), Templates
- > Rotates Text, Bar Codes, and Graphics
- > Supports Windows Compatible Fonts
- > Choose From Over One Hundred Popular Label Formats or Design Your Own
- > Rich Text Support: Mix Styles, Types, & Sizes
- > Automatically Prints Serial Numbers
- > Imports & Exports Graphic Files: TIFF, GIFF, BMP, PCX, WPG, WMF, TARGA
- > Supports Virtually all Windows Compatible Printers (PostScript, Laser, & Dot Matrix)
- > 30-day Money-Back Guarantee, \$295

CALL FOR FREE DEMO SOFTWARE
AMERICAN MICROSYSTEMS
 2190 Regal Parkway, Euless, TX 76040
 (800) 648-4452 (817) 571-9015 FAX (817) 685-6232
www.amitd.com

RF Terminal

Communicates 2 way to Serial Base Station from 400-1000 ft. Easily covers 1,000,000 square feet. 1-16 terminals per base station. Keyboard, wand, CCD or laser scanner input. 16 Selectable frequencies. Small size and low weight - 14 oz. with batteries. Base Station - \$845 Terminal - \$1095.

<http://www.cruzio.com/~wds>
Worthington Data Solutions
 3004 Mission Street • Santa Cruz, CA 95060
 408-458-9938 • FAX 408-458-9964 **800-345-4220**

Portable Bar Code Reader

- > Use as a PORTABLE, WEDGE, or SERIAL
- > 9V Battery Operation with Lithium Backup
- > 2x16 Supertwist LCD Display
- > 54 Key Keyboard with Separate Numeric Keys
- > Real-time Clock Supports Date & Time Stamps
- > Reads all Popular Bar Codes (16 types)
- > Wand, CCD, Laser, or Serial Input Devices
- > Built-In Program Generator
- > Create Your Own Custom Programs
- > 6 Built-in Inventory Programs
- > Up to 250 Programs Can Reside in Memory
- > Create up to 250 Data Files per Program
- > Up to 250 Look-Up Files in Memory
- > Built-In Calculator
- > Supports HAYES Compatible Modems
- > 64K Memory with Data Compression
- > 30-day \$\$ Back Guarantee - 1 Year Warranty
- > Complete Unit with WAND Scanner - \$795

AMERICAN MICROSYSTEMS
 2190 Regal Parkway, Euless, TX 76040
 (800) 648-4452 (817) 571-9015 FAX (817) 685-6232
www.amitd.com

Portable Reader

- * AA Battery Operated, 64K or 256K
- * Display messages and optional voice messages tell operator what to do. Messages are easily recorded (like answering machine) in any language. This unit is EASY!
- * Double duty as Non-portable Reader
- * 4x20 Supertwist LCD Display, 35 Rubber Keys
- * 2 Built-In Inventory Programs or create custom
- * Download tables and Pick Lists
- * Wand, CCD, or Laser Scanner Input
- * Reads 2of5, UPC/EAN, 128, Code 39, etc.
- * 2 year Warranty on Reader & Wand
- * 30 Day Money Back Guarantee
- * 64K Complete with Integrated Laser - \$1299
- * 64K Complete with Steel Wand - \$799
- * Small Size and very long battery life

<http://www.cruzio.com/~wds>
Worthington Data Solutions
 3004 Mission Street • Santa Cruz, CA 95060
 408-458-9938 • FAX 408-458-9964 **800-345-4220**

WINDOWS™ LABEL PRINTER

GEMINI is the ADC industry's first Windows-only label printer. Impeccable print quality, rugged all-metal construction, many bonus features standard; allows you to print labels and bar codes from the Windows applications you already use, without special labeling software or programming. Reseller inquiries welcome.

THARO SYSTEMS, INC.
 P.O. Box 798, Brunswick, OH 44212-0798
<http://www.tharo.com/tharo/> Internet e-mail: tharo@tharo.com
 330-273-4408 Fax: 330-225-0099

Inquiry 451.

BOOKS

12,000 COMPUTER TITLES

Easy browsing & ordering in our online stores. Computer books from 450 publishers. Web URL <http://www.compbooks.com>. Excellent customer service & technical assistance. Worldwide FedEx & USMail shipping. MC/Visa/AmEx/Novus/JCB cards. **CompuBooks® Online Bookstores** 512-321-9652 Fax 512-321-4525 800-880-6818

BUSINESS SOFTWARE

Accounting Software
<http://www.capitalsoft.fi>
□ 100% C++/MFC □ Source Available □
Oy Capital Soft Ltd
Tekniikantie 12, FIN-02150 Espoo, Finland
Phone: +358-9-4354 2450 Fax: +358-9-455 8508

Inquiry 452.

CAD

Circuit Design Software for Windows
Easy-to-use schematic entry, PCB design, and simulation software, starting at \$149 each. Complete PCB package with schematics, autorouter, and layout for 2-layer circuit boards, \$399. Enhanced version with autoplacement, more symbol libraries, and up to 16 layers, \$849. CAM file outputs.
Mental Automation, Inc.
5415 136th Place, SE-Bellevue WA 98006
(206) 641-2141 FAX (206) 649-0767 BBS (206) 641-2646
<http://www.mentala.com/>

Inquiry 453.

CAD/CAM

CONTOURING MOTION CONTROL FROM A PRINTER PORT!
Indexer LPT™ software **\$249** VISA/MC
VERSION 3
• Controls up to six step motors simultaneously.
• Linear and Circular Interpolation.
• New features to accommodate machine control.
• Easy-to-use device driver. Super Manual.
• CAD-CAM interface available.
Ability Systems
Corporation, 1422 Arnold Ave.
Roslyn, PA 19001 (215) 657-4338
FAX: (215) 657-7815
<http://www.abilitysystems.com>

Inquiry 454.

CAD Solutions Software
TG-CAD Professional v.6.0
A 16 & 32 bit C/C++ Windows 95, Win NT & Win 3.1 CAD Developers Kit. The best in CAD/CAM software kits. Free Demo and Technical Paper.
1-800-635-7760
Fax: 214-423-7288 BBS: 214-881-9322
Disk Software, Inc. P.O. Box 941152, Plano, TX USA 75094
E-Mail: disksoft@ix.netcom.com

Inquiry 455.

CD-ROM

Consolidated CDROM, Inc
Worldwide suppliers of CD-ROM software. We do import, export, publishing & distribution. We also buy & sell all types of memory chips. Dealers Wanted!
102 Greenwood Ave Wyncote PA 19095 USA
800-8CD-ROMS 215-572-9831/215-572-9832 fax
Email: cdrom@consldcdrom.com

Inquiry 456.

CD-ROM

CD-ROMS

JAVA - Dev Kit \$25.00
HotJAVA browser, demo applets, on-line docs
WINDOWS 95.COM...32-bit Shareware Collection \$30.00
WINSITE \$35.00
Utilities for Windows 3.1, NT, Windows 95, more!
HOBBES OS/2 \$35.00
Software, games, utilities, fixes, updates
BSDISC - NetBSD, FreeBSD, XFree86 & X11R6 \$35.00
INTERNET TOOLS \$30.00
Networking tools & utilities SLIP & PPP
LINUX Developer's Resource \$25.00
Stackware, Red Hat, more!
LINUX Installation & Getting Started Guide \$7.50
245 pg manual
LINUX TOOLBOX \$45.00
CD Set & Install Guide, For beginners!
MOO-TIFF for LINUX - 100% Motif compatible GUI \$99.00
MOO-TIFF for FreeBSD - 100% Motif compatible GUI \$89.00
MOTHER OF PERL \$35.00
Source & binaries for UNIX, DOS, NT, MAC
RUNNING LINUX \$19.95
576 pg manual for everything about Linux
SOURCE CODE - 4.4 BSD-Lite2, GNU InterViews, more \$30.00
STANDARDS - RFCs, IENS, ITU/CCITT BlueBook \$30.00
TCL/TK - software to develop X-Window apps \$35.00
TeX - typesetting tools for mathematical & scientific docs \$35.00
WORLD WIDE Catalog \$30.00
See the WWW without being on-line!
X-FILES - Complete sources for X11R6 & XFree86 \$35.00
Phone Orders: 1-800-800-6613
Fax Orders: +1-520-526-9573
Int'l Phone: +1-520-526-9565
Web Orders: www.infomagic.com E-mail: orders@infomagic.com
InfoMagic 11950 N. Hwy 89, Flagstaff, AZ 86004
We accept MC, VISA & AMEX

Inquiry 457.

CD ROM TOWERS & JUKEBOX SERVERS FOR ALL OPERATING SYSTEMS! RAID NOW AVAILABLE

No Device Drivers/ MSCDEX needed. Complete Kit Networks CD Roms, unlimited user license, DISCPORT.
"JES, NONE BETTER AT ANY PRICE"
Call NOW: 1 (800) 482-1866 305-597-3980
<http://www.jescdrom.com>

Inquiry 458.

WALNUT CREEK CDROM

FreeBSD 2.1.5 Rock solid Berkeley Unix for PC w/src.
2 disc set, easy install, 6 mo updates \$39.95
Linux Slackware 96 4 disc set, Slackware 96 *OFFICIAL* release by Patrick Volkerding, Internet's favorite \$39.95
Cica MS Windows 2 disc set, 1900+ Windows programs, games, drivers, fonts, shells, src. Indexes in German/Italian/French/English/Japanese. Quar. updates \$29.95
Hobbes OS/2 1000 MB Free/Shareware drivers, app's, etc. OS/2 Mag's product of the year! 6 mo updates \$29.95
Sintel MSDOS 2 discs, premier Internet technical, programming Free/Shareware \$29.95
Blackhawk - New Win. 95 shareware collection \$29.95
Internet Info 13,400 doc's, FAQs, FRCS, & IENS \$39.95
Music Workshop Music prog., midi, demos, etc \$39.95
Project Gutenberg 560+ must-read works of literature.
Each document is in ASCII format text \$39.95
Scientific Library Technical shareware, DOS/Win \$39.95
PDV-Ray Ray-tracing images, src, documentation \$39.95
70+ titles about Windows 95 & NT, games, Tcl, perl, QRZ!
Ham Radio, Music, Fonts, Royalty-free images
Call for your FREE catalog today!
All our products have a one year unconditional guarantee!
1-800-786-9907
4041 Pike Lane, Ste D-215, Concord, CA 94520
+1-510-674-0783 Visa/MC/AMEx, Fax: +1-510-674-0821
orders@cdrom.com <http://www.cdrom.com/>

Inquiry 459.

COMMUNICATION-VOICE/FAX

InfoOnCall
Your Communications Solution
Customizable phone operator, voice mail box, and fax machine all in one! Create:
Automated tech-support • Co. news by voice or fax
Product lists • Pager • and much more!
For OS/2, Win 95, Win 3.1, & DOS!
TTC Computer Products (972) 594-8103
Download the demo at www.InfoOnCall.com

Inquiry 460.

COMMUNICATIONS

Frame Relay, X.25, BSC, HDLC, SDLC, PPP
Rock solid, compliant, inexpensive and robust PC APIs and router implementations. On board protocol support reduces PC overhead.
• For MS-DOS, Windows, Win NT, Unix, OS/2, Netware and others.
• Routers interconnect any PC systems or LANs.
• Cards for 56kbps to T1/E1.
• Superior test and diagnostics including SNMP.
Sangoma Technologies Inc.
(800)-388-2475 • (905)-474-1990 • Fax: (905)-474-9223
E-Mail: dm@sangoma.com • Web: www.sangoma.com

DATA ENTRY SOFTWARE

DATA ENTRY SOFTWARE
Full featured, heads-down data entry with two-pass verification, edit language, output record reformat, operator statistics, key from images (NEW!), free tech support.
For PC, PC LAN, S/36, AS/400.
FREE 30 day trial.
Computer Keyes Tel: 206-776-6443
21929 Makah Rd., Fax: 206-776-7210
Woodway, WA 98020 USA: 800-356-0203

DATA RECOVERY

We Can Save It!
All Platforms - All Storage Devices
Proprietary techniques so advanced we rescue data others simply abandon.
DRIVESAVERS
Restoring data since 1985
1-800-440-1904
415-883-4232

Inquiry 461.

The Leader in Data Recovery

• Expertise in virtually every operating system & media storage device.
• 24-Hour support & emergency services available.
• Call for a FREE consultation!
ONTRACK DATA RECOVERY
MN: 1-800-872-2599 • CA: 1-800-752-7557
DC: 1-800-650-2410 • Europe: +44 1372 741999

Inquiry 462.

DATA RECOVERY when I.T. Matters
• Tape, Optical or C.D. Media
• Accidental Overwrites
• Hardware or Software Failure
VOGON
Europe Tel +44 (0) 118-989-0042
Fax +44 (0) 118-989-0040
USA Tel 405-321-2585 Fax 8242
Germany Tel +49 (0) 180-522-15-42
Fax +49 (0) 89-69-37-00-55

Inquiry 463.

DATA/DISK CONVERSION

CONVERSION/DUPLICATION
Tape: 4MM, QIC, 8MM, DLT, 9-trk, 3480/90/90E
Disk: 3", 3 1/2", 5 1/4", 8" CD-ROM
1-800-357-6250
Shaffstall Corporation 317-642-2077
7901 East 88th Street Fax 317-642-8294
Indianapolis IN 46256 sales@shaffstall.com
Since 1973 <http://www.shaffstall.com>

Inquiry 464.

EDUCATION

B.S. & M.S. In COMPUTER SCIENCE
 The American Institute For Computer Sciences offers an in-depth home study program to earn your Bachelor of Science at home. B.S. subjects covered are: MS/DOS, BASIC, PASCAL, C, C++, Data File Processing, Data Structures & Operating Systems. M.S. program includes subjects in Software Engineering and Artificial Intelligence. Ada and Using Windows courses also available. Accredited Member: World Association of Universities and Colleges.

AMERICAN INST. FOR COMPUTER SCIENCES
 2101-BY Magnolia Ave., Suite 200, Birmingham, AL 35205
 1-800-767-2427 • 1-205-323-6191

ENGINEERING SOFTWARE

ENTERPRISE WIDE VIEWING AND MARKUP

Use AutoVue Professional to view and mark up documents. Gain access to over 160 file formats from engineering, vector, raster, hybrid, wordprocessor, spreadsheet, database, fax, and more. Supported formats include AutoCAD DWG, MicroStation DGN, TIFF, Word, WordPerfect, Excel, and more. Available for Windows, DOS, and UNIX.

Cimmetry Systems Inc.
 (800) 361-1904 Tel: 514-735-3219 Fax: 514-735-6440

Inquiry 465.

FOREIGN LANGUAGES

WORLD'S LANGUAGE CENTER
 Automatic Translation with a push of the button Chinese, Japanese, Russian, 150 languages Dictionaries - Fonts - Learning - OCR etc.
 Best Prices • Best Service
 FREE CATALOG

TransLanguage Inc.
 800-308-8883 Fax 714-279-9368
 PO Box 18024, Anaheim Hills, CA 92807

Inquiry 466.

HARDWARE

Pre-Owned Electronics, Inc.TM
 THE Independent Provider, serving the Dealer, Professional, Corporate, Government, and Educational Buyer since 1985.

APPLE II® & MACINTOSH® SYSTEMS • PARTS • EXCHANGE REPAIRS

Call for a Catalog... **800-274-5343**
 Office: 617-778-4600 • FAX: 617-778-4848
 125 MIDDLESEX TURNPIKE • BEDFORD, MA 01730

Inquiry 467.

HEWLETT-PACKARD

Buy - Sell - Trade

LaserJet	ColorPro
DeskJet	DraftPro
RuggedWriter	DraftMaster
Electrostatic Plotters	DesignJet

HP 9000 Workstations and Vectras also available.

Ted Dasher & Associates
 Your Hewlett Packard Remarketing Specialist
 Office: (205) 591-4747 Fax: (205) 591-1108
 (800) 638-4833 E-mail: sales@dasher.com

Inquiry 468.

INTERNET

GAMELON® INTERNET FILES
<http://www.menal.com>

Build powerful, sophisticated programs with a fast OO persistent data software library that fits the architecture of the Internet. Gather lumpy Internet data or use the Internet for program-to-program data exchange. Object nesting, hyperlinking, indexing, transaction management, and more.

- Solaris, Windows 3.1, Windows 95/NT, OS/2 (ask for Mac, Linux)
- APIs for C++, C, Visual Basic & Delphi (ask for JAVA)

Menal Corporation
 1010 El Camino Real, Suite 370, Menlo Park, California 94025
 (800) 426-3566 (U.S.) or (415) 853-6450
 FAX (415) 853-6453 E-mail: info@menal.com

Inquiry 469.

LANs

Little Big LAN
 The most flexible network

- Peer to Peer LAN to 250 nodes
- \$75 total software cost, not per node!
- Link via serial, parallel, or Modems
- Also via Ethernet or Arcnet, or mix!
- Typically only 40k of RAM

Information Modes
 817-387-3339 / P.O. Drawer F, Denton TX 76202
 Fax 817-382-7407 Orders 800-628-7992

Inquiry 470.

LASERJET PCL VIEWER

Visual PCL- End-user & Developer Versions

View your multi-page PCL5e print files in Windows complete with all fonts and macros. Print to non-PCL printers. Fax using standard Windows software. Uses true PCL5e Intellifont typefaces and rendering software. Runs under Windows 95, NT and 3.x. Full evaluation available on Web site. 16/32 bit Libraries available for OEM integration.

Visual Software <http://www.visual.co.uk>
 Fax: +44 1306 742 425 geddes@visual.co.uk

Inquiry 471.

PROGRAMMERS TOOLS

High-Speed xBASE Engine for Java...
 C, C++, Visual Basic and Delphi programmers. Get multi-user compatibility with FoxPro, Clipper and dBASE files. CodeBase is portable between DOS, Windows and UNIX! Includes client/server option as well as data-aware custom controls and a visual report writer

FREE 30 day test drive!
 Call **Sequiter Software Inc.** for details.
 Phone 403 437-2410 FAX 403 436-2999

Inquiry 472.

SECURITY

AZ-TECH SOFTWARE, INC.
 Leaders in Software Security

EVERLOCK Safe-D EVERKEY

Phone: (816) 776-2700 x310
 Fax: (816) 776-8398 * Dept: SMG-310
 Internet: www.az-tech.com
 E-MAIL: sales@az-tech.com

Inquiry 473.

THE ULTIMATE SOFTWARE SECURITY

- STOPCOPY family - UNCOPIABLE copy protection
- STOPVIEW software encryption
- NETLIMIT network license metering
- DOS, Windows (3.X, 95, NT), Mac, OS/2, support
- Machine Tie, Internet Protection, CD-ROM Protection, Serialization, Date & Execution Limitation, Registration, Remote Authentication, Concurrent User Limitation
- Our products destroy ALL of our competition

BBI Computer Systems, Inc.
 14105 Heritage Lane, Silver Spring, MD 20906
 800/TRY-ABBI • 800/879-2224 • 301/871-1094 • FAX: 301/488-7545
 E-mail: bbi@bbics.com • Web: <http://www.bbics.com>

Inquiry 474.

Cop's CopyLock II
 Professional software protection.
 DOS, OS2, Win 3.1, Win 95, NT, Networks, CD-ROM and Internet Security.
 Known and used world-wide since 1984.

www.linkdata.com
LINK Data Security
 Int'l: + 45 3123-2350 Fax: + 45 3123-8448

SECURITY

CRYPKEY SOFTWARE LICENSING SYSTEM
 "Software Protection with NO hardware lock and NO disk key"
 CrypKey is software copy protection that is:

- completely secure from any disk copy program
- perfect for CD-ROM or INTERNET distribution!
- cost effective, user friendly, and 100% guaranteed to satisfy!

CrypKey can increase your software sales:

- upsell options and levels of your software
- lease or demo your software by runs or time
- enable or upgrade your customers instantly by phone, fax or email!

New! unique Ready-To-Try feature upon install allows 1 trial period only per customer. New! unique Add-On feature - add more options, levels, runs or time to existing licenses. New! CrypKey Instant! - protects in just 5 minutes with no source code changes.

CrypKey is completely compatible with MS-DOS, MS-Windows 3.x, Win32s, Win95, Win NT, and manages network licenses on all Novell and Microsoft operating system based networks. CrypKey is produced by Kenonic Controls Ltd. - software and engineering since 1972.

Kenonic Controls Limited
 7175-12th Street South East
 Calgary, Alberta, Canada T2H 2S6
 (403) 258-6200 • fax: (403) 258-6201
 INTERNET: crypkey@kenonic.com
 WEB: <http://www.kenonic.com/crypkey.htm>

Inquiry 475.

CRYPTO-BOX™ locks in your profits!
 The Marx CRYPTO-BOX is the result of 10 years experience in effective software protection.

- microprocessor controls ID codes, memory, dynamic algorithm and high speed data encryption
- remote access to passwords and counters
- license metering in networks: single key per LAN

MARX International, Inc.
 See us at COMDEX in Las Vegas Microsoft Partner Pavilion #806
 404-321-3020 1-800-MARX-INT fax: 404-321-0760
 Visit our Home Page: <http://www.marx.com>

Inquiry 476.

KEY-LOK II™ SECURITY
 Software Piracy Prevention — Survival 14 years proves effectiveness. Active algorithm, programmable memory, counters, date control, remote update. No ID on device.
 Low pricing (e.g. \$16.50 each for 5).
 No startup costs.

Also, ACCESS CONTROL systems and disk drive/system LOCKS

MICROCOMPUTER APPLICATIONS, INC.
 3167 E. Otero Circle, Littleton, CO 80122
<http://www.csn.net/keylok>
 1-800-453-9565 (303) 770-1917 FAX: (303) 770-1863

Inquiry 477.

SOFTWARE/DEVELOPMENT

ADVANCED DEVELOPMENT TOOLKITS

EDAT

Cimmetry System's Engineering Data Access Technology (EDAT) provides programmers with complete access to CAD drawing information. Use EDAT to read, query, write and modify AutoCAD DWG, DXF, and MicroStation DGN formats. EDAT is available on Windows, Win 32s, UNIX and DOS.

VCET

View enable your application with VCET (Viewing and Conversion Enabling Technology), the most extensive viewing libraries. Add viewing capabilities for over 160 file formats within your Windows application in a matter of hours. The same technology used in AutoVue and other leading viewing and document management software.

Cimmetry Systems Inc.
 (800) 361-1904 Tel: 514-735-3219 Fax: 514-735-6440

Inquiry 478.

SOFTWARE PACKAGING

FREE SOFTWARE PACKAGING CATALOG

Everything you will need to Package, Distribute, and Ship Your Software! From manuals and binders to mailers and shippers

LABELS • LABELS • LABELS

For your diskettes, plain or custom printed dot matrix or laser printer... free samples

...FREE CATALOG...

Hice & Associates

8586 Monticello Dr., West Chester, OH 45069
Phone/Fax: 513-779-7977

Inquiry 479.

SOFTWARE/ENGINEERING

Analog/Digital Simulation!!

- Windows, NT, DOS
- Power Mac, Macintosh
- IS-SPICE4 Real Time SPICE
- Mixed Mode Simulation
- Schematic Entry
- New AHDL Modeling Kit!!
- Model Libraries, RF, Power
- More Than 5000 parts
- Waveform Analysis
- Full SPICE programs
- starting at \$95. Complete systems, \$595-\$2595

P.O. Box 710 San Pedro, CA 90733-0710

(310)833-0710, FAX (310)833-9658

Call for your Free Demo and information kit.

intusoft

Inquiry 480.

SpiceAge*4W

Windows Analog Circuit Simulator

The "value for the dollar" package you've heard about!

- ◆ High speed Interactive Real-time analysis: AC, DC, Transient, Fourier, Temperature ◆ Fast primitives
- ◆ Added functions ◆ Gain, phase, Impedance, group delay, noise, reflection coeff, and MORE are included ◆

Starting at \$895

Tatum Labs, Inc.

1287 N. Silo Ridge Drive, Ann Arbor, MI 48108

313-663-8810

FAX 313-663-3640

Inquiry 481.

SOFTWARE/GRAPHICS

The Next Generation of Imaging Toolkits™

ImageGear™ 6.0

AccuSoft announces the new standard in imaging toolkits, ImageGear™ 6.0, the successor to the top-selling AccuSoft Image Format Library™.

New Features include:

- ◆ Over 45 Raster Image Formats!
- ◆ Fastest JPEG, Group 3/Group 4
- ◆ Over 100 new API functions
- ◆ Available for all platforms
- ◆ New GUI functions
- ◆ Faster image display & transparency
- ◆ Display with sub-pixel accuracy
- ◆ Advanced image processing
- ◆ Faster image compression
- ◆ New display features, effects, and more!

AccuSoft Corporation

Call (800) 525-3577

www.accusoft.com

TEL(508) 898-2770 / FAX (508) 898-9662 Dept. BM4
2 Westborough Business Park Westborough, MA 01581 USA

Inquiry 482.

WINDOWS

FREE INTERNET

Free PPP, Get On-Line Immediately, Telnet to other BBS's, Surf the World Wide Web, 28.8k modems

1-914-346-1777

All You Pay For Is The Call

Inquiry 483.

**U.S. POSTAL SERVICE
STATEMENT OF OWNERSHIP, MANAGEMENT
AND CIRCULATION**

(Act of August 12, 1970, Section 3685, Title 39,
United States Code)

1. Title of publication: BYTE
2. Publication No.: 535-150
3. Date of filing: 9-12-96
4. Frequency of issue: Monthly
5. Number of issues published annually: 12
6. Annual subscription price: \$29.95
7. Mailing address of known office of publication: One Phoenix Mill Lane, Peterborough, NH 03458
8. Mailing address of headquarters or general business office of publisher: One Phoenix Mill Lane, Peterborough, NH 03458
9. Full names and addresses of publisher, editor, and managing editor: Publisher: John M. Griffin — One Phoenix Mill Lane, Peterborough, NH 03458; Editor: Mark Schlack — One Phoenix Mill Lane, Peterborough, NH 03458; Managing Editor: Jenny Donelan — One Phoenix Mill Lane, Peterborough, NH 03458

10. Owner: The McGraw-Hill Companies, Inc., 1221 Avenue of the Americas, New York, NY 10020. Stockholders holding 1 percent or more of outstanding common stock are: Donald C. McGraw, Jr.; Harold W. McGraw, Jr.; John L. McGraw; William H. McGraw; June M. McBroom; all c/o The McGraw-Hill Companies, Inc., 1221 Avenue of the Americas, New York, NY 10020; Bankers Trust c/o Proxy Unit, MS 7230, 648 Grassmere Park Drive, 2nd Floor, Nashville, TN 37211; BZW Barclays Global Investors, 980 Ninth Street, 6th Floor, Sacramento, CA 95814.

11. Known bondholders, mortgagees, and other security holders owning or holding 1 percent or more of total amount of bonds, mortgages, or other securities: None
12. Has not changed during preceding months.
13. Publication name: BYTE
14. Issue date for circulation data below: October 1996.
15. Extent and nature of circulation:

	Average No. Copies Each Issue During Preceding 12 Months	Actual No. Copies of Single Issue Published Nearest to Filing Date
A. Total No. Copies Printed (Net Press Run)	727,063	739,502
B. Paid and/or Requested Circulation		
1. Sales through dealers and carriers, street vendors, and counter sales	130,051	314,440
2. Paid or Requested Mail Subscriptions	413,658	409,923
C. Total Paid and/or Requested Circulation	543,709	724,363
D. Free Distribution by Mail Samples, Complimentary, and Other Free	5,959	2,146
E. Free Distribution Outside the Mail Carriers or Other Means	8,585	9,545
F. Total Free Distribution	14,544	11,691
G. Total Distribution	558,253	736,054
H. Copies Not Distributed		
1. Office use, left over, spoiled	8,127	3,448
2. Return from News Agents	160,683	none to date
I. Total	727,063	739,502
Percent Paid and/or Requested Circulation	97.39%	98.41%

16. This Statement of Ownership will be printed in the November 1996 issue of this publication.

17. Signature and Title of Editor, Publisher, Business Manager, or Owner

John M. Griffin, Publisher

I certify that all information furnished on this form is true and complete. I understand that anyone who furnishes false or misleading information on this form or who omits material or information requested on the form may be subject to criminal sanctions (including fines and imprisonment) and/or civil sanctions (including multiple damages and civil penalties).

ADVERTISER CONTACT INFORMATION

To order products or request free information, call advertisers directly or send in the Direct Link Card by mail or fax! **Let them know you saw it in BYTE!**

INQUIRY NO.	PAGE NO.	PHONE NO.	INQUIRY NO.	PAGE NO.	PHONE NO.	INQUIRY NO.	PAGE NO.	PHONE NO.
A			D			M		
80-81	ACI	220 888-618-6188	604-605	DARIM	104NA 2 888-GET-MPEG	224	MICRO 2000	158-159 800-864-8008
214	ADOBE SYSTEMS INC	153 800-521-1976 G0159	*	DATAPRO	211	243-244	MICRO SOLUTIONS COMP PROD	203 800-295-1214
93	ADVANCED IMAGE COMMUNICATIONS	223 510-947-1000	*	DELL COMPUTER CORP	40-41 800-876-1190	245-246	MICRO SOLUTIONS COMP PROD	207 800-295-12140
110-111	AE HOME CORPORATION	225 818-981-2409	*	DELL COMPUTER CORP	104NA 1 800-728-3355	*	MICROGRAFX	73 800-877-3040
232-233	AIR MEDIA	162-163 714-644-8223	*	DELL COMPUTER CORP	CV-CVI 800-348-8153	*	MICROGRAFX	176 800-877-3040
125-126	ALADDIN SOFTWARE SECURITY INC	78 800-223-4277	*	DELL COMPUTER CORP (FOR 1000)	CV-CVI 800-247-4709	*	MICRO-INTERNATIONAL INC	224 800-987-5867
127-128	ALADDIN SOFTWARE SECURITY INC	190 800-223-4277	*	DELL COMPUTER CORP (FOR 1000)	CVII 800-433-6681	173	MICRON ELECTRONICS	CII-1 800-382-7308
234	ALTEX COMPUTERS & ELECTRONICS	202 800-531-5369	*	DELL COMPUTER CORP (FOR 1000)	CVII 800-822-6092	174	MICRON ELECTRONICS	56-57 800-486-2059
*	AMERICA ONLINE	OUTSERT	*	DELL COMPUTER CORP (FOR 1000)	CVIII 800-759-9783	175	MICRON ELECTRONICS	74-75 800-723-2998
64	AMERICAN ADVANTECH	219 800-800-8889	*	DELL COMPUTER CORP (FOR 1000)	CVIII 800-588-2902	99	MICROPATENT	224 800-984-9800
71	AMERICAN ADVANTECH	220 800-800-8889	190-191	DEXON SYSTEMS LTD	22 +36-1-393-2618**	*	MICROSOFT CORPORATION	188
72	AMERICAN ADVANTECH	220 800-800-8889	268-271	DISTINCT CORPORATION	150 408-368-8933	*	MICROSOFT CORPORATION	2-3
*	AMERICAN POWER CONVERSION	32A-B	140	DISTRIBUTED PROCESSING TECH	93 407-830-5522	*	MICROSOFT CORPORATION	136-137
129	AMERICAN POWER CONVERSION	33 401-788-2797**	141	DOLCH COMPUTER SYSTEMS	117 800-995-7580	*	MICROSOFT PRESS INC	91 800-MSPRESS
*	AMERICAN POWER CONVERSION	64A-B	142-143	DTK COMPUTER INC	88 800-289-2385	*	MICROWAY	110 508-746-7341
130	AMERICAN POWER CONVERSION	85 800-800-4APC DPT,A2	122	DUNN SYSTEMS	227 800-486-DUNN ext 405	68	MINICOM/CLASSNET VIDEO	219 800-922-8020
77-78	APPRO INTERNATIONAL INC	221 800-927-5464	E			153	MINITAB INC	168 814-238-3280
219	ARTECON	155 800-872-2783	185-186	ELEKTROSON BV	191 +31-40-2515-065	229	MIPS DATALINE AMERICA INC	165 619-679-4070
601	ATTACHMATE CORP	87 800-426-6283	F			192-193	MIRO COMPUTER PRODUCTS AG	51 +49-531-2113-100
207-208	AUTONOMY SYSTEMS	128 +44 01223 421583**	144	FAIRCOM CORPORATION	187 314-445-6833	*	MOTOROLA-SEMICONDUCTOR	96-97
*	AVIATION WEEK	142-143 809-426-5526	184	FINSON	170 +39-2-8698-7036	*	MOTOROLA-SEMICONDUCTOR	98-99
82-83	AXIOM TECHNOLOGY	221 909-464-1881	241-242	FIRST SOURCE INTL	210 714-448-7750	187-188	MRT	166 +47 63 89 63 00
B			255	FOREFRONT/ALLMICRO INC	201 800-653-4933	N		
602	BAY NETWORKS	70 800-8-BAYNET ext 27	G			108	NATIONAL INSTRUMENTS	223 800-433-3488
132-133	BEST POWER	103 800-469-4842 ext 298	104	GAGE APPLIED SCIENCES INC	222 800-587-GAGE ext 3425	*	NET2PHONE	215 201-928-2990
134-135	BEST POWER	107 800-469-4842 ext 299	230-231	GEOSAT	164 800-772-3687	610-611	NEWCOM	104NA 7 818-597-3200
136-137	BEST POWER	111 800-469-4842 ext 300	221	GLOBETROTTER SOFTWARE INC	149 408-370-2800	266-267	NOVOTEC	95 +49-89-35629770
450	BIX	246 800-695-4775	91-92	GRANITE DIGITAL	223 510-471-6442	222	NRW	147 +49-211-837-2761**
136	BORLAND INTERNATIONAL	37 800-336-8464	225-226	GRIFFIN TECHNOLOGIES	160 800-988-6578	154	NSTL	243 610-941-9600
*	BYTE	174 603-924-2663	H			209-210	NSTOR CORPORATION	23 800-724-3511
*	BYTE	193 603-924-2663	117-118	HIWAY TECHNOLOGIES	226 800-339-HWAY	O		
*	BYTE BACK ISSUES	216 603-924-9281	*	IBM OS/2	15 800-328-2504	121	OBJECT MANAGEMENT LABORATORY	227 800-6789-OML
*	BYTE CUSTOMER SERVICE	218 800-232-2963	*	IBM OS/2	43 800-IBM-4FAX # 5228	*	OSBORNE MCGRAW-HILL	238-239 800-822-8158
*	BYTE MOVING?	192	84-85	ICP ACQUIRE	221 888-618-6188	205-206	PHILIPS BUSINESS ELECTRONICS	118 +888 3 45 49566**
*	BYTE ON CD ROM	245 800-924-6621	*	IDT INTERNET	215 800-889-9438	155-156	PINNACLE MICRO	7 714-789-3000
*	BYTE PUBL STATEMENT	231	202	INNOVUS MULTIMEDIA	131 888-301-7728	157	PKWARE INC	189 414-354-8899
*	BYTE SUB MESSAGE	218	216	INTEGRIX INC	157 800-300-8288	247	POLYWELL SYSTEMS	205 800-300-7859
*	BYTE WEB SITE	237 http://www.byte.com/	*	INTEL CORPORATION	24-25 800-538-3373	172	POWERSOFT C++	85 800-265-4555
94-95	CAMELEON TECHNOLOGY INC	223 800-440-7488	89-90	INTERLOGIC INDUSTRIES	221 516-420-8111	178	POWERSOFT OPTIMA	31 800-395-3525
223	CARDIFF SOFTWARE	165 800-659-8755	112-113	INTERNET SHOPPER	226 +44-(0)181 673 2149*	194-195	PRINCETON GRAPHIC SYSTEMS	52 800-747-8249 ext 165
603	CARDINAL TECHNOLOGIES	104NA 5 800-775-0899 ext 687	105	IO TECH	222 216-439-4091	*	PROXIMA CORPORATION	169
196	CETRA	172	*	IOMEGA	55 888-2-OMEGA ext j22	*	PROXIMA CORPORATION	171
213	CLEAR SOFTWARE	186 817-985-6755	179-180	IQ SOFTWARE	12-13 800-458-0386	*	PROXIMA CORPORATION	173
115-116	CLOU CONSULTING	226 800-226-0840	J			176-177	PROXIMA CORPORATION	175 800-447-7692 ext 443
*	COMPAQ	8-9 800-392-6883	*	JAMECO ELECTRONICS	209 800-831-4242	159	QNX EXPLR2	18 800-862-1863
235	COMPUTER DISCOUNT WAREHOUSE	196-197 800-959-4CDW	108-109	JENSEN TOOLS	223 800-428-1194	158	QNX SOFTWARE SYSTEMS LTD	183 800-656-0566 ext 102
236	COMPUTERLANE UNLIMITED	208 800-526-3482	102	JK MICROSYSTEMS	224 510-238-1151	103	QUALSTAR CORP	225 800-468-0880
215	CONTROL CORP	138 800-925-6876	K			61-62	QUATECH INC.	219 800-553-1170
252-253	CONSAN INC	198 800-221-6732	73	KILA	221 800-505-6749	88	RACKMASTER	221 800-480-4384
252-253	CONSAN INC	196 800-221-6732	145-146	KINGSTON CPU UPGRADE	66 800-435-0056	258-259	RAIDTEC CORPORATION	217 770-664-6068
*	CONSUMER INFORMATION CENTER	216	147-148	KINGSTON STORAGE	39 800-251-9059	180	RAINBOW TECHNOLOGIES	58 800-852-8569
139	COREL	109 813-728-0826 ext 3080	L			220	RAVE COMPUTER ASSOCIATES	148 800-966-RAVE
239-240	CYBEX COMPUTER PRODUCTS CORP	169 205-430-4000	256-257	LA TRADE	200 800-433-3728	67-68	RCI	220 800-RCI-8090 ext 71
237-238	CYBEX COMPUTER PRODUCTS CORP	206 205-430-4000	119-120	LAHEY COMPUTER SYSTEMS	226 800-548-4778	75-76	RECORTEC INC	222 888-RECORTEC
			806-607	LOTUS COMPONENTS	83 800-TRADE-UP ext C200	248-249	ROSE ELECTRONICS	204 800-333-9343
			806-808	LOTUS NOTES	16-17 800-828-7086 ext C371	161-162	ROSS TECHNOLOGY INC	46-47 800-ROSS-YES
						183	SAG ELECTRONICS	21 508-682-0055

ADVERTISER CONTACT INFORMATION

INQUIRY NO.	PAGE NO.	PHONE NO.	INQUIRY NO.	PAGE NO.	PHONE NO.	INQUIRY NO.	PAGE NO.	PHONE NO.			
114	SCITECH INTERNATIONAL	226	800-898-9044	264-265	TEKNOR INDUSTRIAL COMPUTERS	215	800-387-4222	63	VIDEX INC	219	541-758-0521
227-228	SEH COMPUTERTECHNIK GMBH	161	+49-521-94228-0	165	TEKTRONIX	69	800-835-6100	170-171	VIEWSONIC	62	800-888-8583
163	SILICON GRAPHICS	34-35	800-636-8184 D440	*	TELE.COM	213		*	VISIO CORPORATION	61	800-24-VISIO E27
79	SILICONRAX	222	800-700-8560	101	TERN INC	224	918-758-0110	211-212	VOCALTEC	194	800-899-3942
96-97	SLIGER DESIGNS	224	702-358-5595	*	THE COMPUTER MUSEUM	214	916-758-0110	W			
107	SOFTWARE SECURITY	225	203-856-3932*	166	TOSHIBA AMERICA INC	28-29	800-457-7777	*	WALKER, RICHER & QUINN	178	206-217-7100
260-261	SOFTWAY SYSTEMS	217	415-896-0708	167-168	TRAVELING SOFTWARE	127	800-224-7704	225-226	WIBU SYSTEMS AG	160	800-986-6578
70	STARTECH COMPUTER PRODUCTS	219	800-265-1844 ext 231	74	TRI VALLEY TECHNOLOGY INC	222	510-447-2030	612	WINBOOK COMPUTER CORPORATION	11	800-293-1639
250-251	STARTECH INTERNATIONAL	212	819-278-2800	U				613	WINBOOK COMPUTER CORPORATION	45	800-268-1538
184	STATSOFT	81	918-749-1119	V				Z			
65	TALKING TECHNOLOGY INC	220	800-945-4884	86-87	U.S.LOGIC	222	800-777-4875	100	Z-WORLD ENGINEERING	225	916-757-3737
98	TAPEDISK CORPORATION	224	715-235-3388	282-283	VCOMMUNICATIONS	204	800-648-8265				

BYTE ADVERTISING SALES STAFF

John M. Griffin, Vice President, Publisher, One Phoenix Mill Lane, Peterborough, NH 03458,
Tel: (603) 924-2615, Fax: (603) 924-7620, jgriffin@mcgraw-hill.com

NEW ENGLAND

CT, MA, ME, NH, NY, RI, VT,
Ontario, Canada, Eastern Canada
John Ferraro (617) 860-6221,
(212) 512-2555
jferraro@mcgraw-hill.com
Jeanne Beeson (617) 860-6349
jbeeson@mcgraw-hill.com
The McGraw-Hill Companies
24 Hartwell Avenue
Lexington, MA 02173
FAX: (617) 860-6307

NEW YORK

NY Metro, NJ
Michael Feinberg (212) 512-4811
feinberg@mcgraw-hill.com
Jill Pollak (212) 512-3585
jpollak@mcgraw-hill.com
The McGraw-Hill Companies
1221 Avenue of Americas—28th Floor
New York, NY 10020
FAX: (212) 512-2075

SOUTHWEST, ROCKY MOUNTAIN

AL, AR, LA, MS, OK, TN, TX
Bert Panganiban (214) 688-5165
bertpang@mcgraw-hill.com
Brian Higgins (603) 924-2596
bhiggins@mcgraw-hill.com
The McGraw-Hill Companies
Mockingbird Towers
Ste. 1104E
1341 W. Mockingbird Lane
Dallas, TX 75247-4943
FAX: (214) 688-5167

MID ATLANTIC—SOUTHEAST

NEW MEDIA/ONLINE PRODUCTS
DC, DE, FL, GA, KY, MD, NC, PA, SC, VA, WV
Neil Helms (770) 242-6298
nhelms@mcgraw-hill.com
Paul Franchak (614) 899-4912
franchak@mcgraw-hill.com
The McGraw-Hill Companies
6050 Peachtree Pkwy.
Suite 340-191
Norcross, GA 30092
FAX: (770) 409-9622

CENTRAL U.S.

IA, IL, IN, KS, MI, MN, MO, ND, NE, OH,
SD, WI
Lori Silverstein (614) 899-4908
lorisf@mcgraw-hill.com
Paul Franchak (614) 899-4912
franchak@mcgraw-hill.com
The McGraw-Hill Companies
921 Eastwind Drive, Suite 118
Westerville, OH 43081
FAX: (614) 899-4999

NORTH PACIFIC

AK, Northern CA, HI, ID, MT, OR, Silicon
Valley, UT, WA, WY,
Western Canada
Roy J. Kops (415) 513-6861
rkops@mcgraw-hill.com
Lisa Farrell (415) 513-6862
ifarrell@mcgraw-hill.com
The McGraw-Hill Companies
1900 O'Farrell Street, Suite 200
San Mateo, CA 94403
FAX: (415) 513-6867

SOUTH PACIFIC

AZ, Southern CA, CO, NM, NV
Beth Dudas (714) 753-8140
bdudas@mcgraw-hill.com
Geanette Perez (714) 753-8140
gperez@mcgraw-hill.com
The McGraw-Hill Companies
15635 Alton Pkwy., Suite 290
Irvine, CA 92718
FAX: (714) 753-8147

PETERBOROUGH, NH OFFICE:

Sales FAX: 603-924-2683
Advertising FAX: 603-924-7507

BUYERS MART

Mark Stone (603) 924-2533
stonem@mcgraw-hill.com
BYTE
One Phoenix Mill Lane
Peterborough, NH 03458

BYTE Deck

Brian Higgins (603) 924-2596
bhiggins@mcgraw-hill.com
BYTE
One Phoenix Mill Lane
Peterborough, NH 03458

EURO-DECK

Mark Stone (603) 924-2533
stonem@mcgraw-hill.com
BYTE
One Phoenix Mill Lane
Peterborough, NH 03458

INTERNATIONAL ADVERTISING SALES STAFF

L. Bradley Browne, International Sales Director, One Phoenix Mill Lane, Peterborough, NH 03458,
Tel: (603) 924-2501, Fax: (603) 924-2602, lbrowne@mcgraw-hill.com

UNITED KINGDOM, BENELUX

Jonathan McGowan
jonmccgow@mcgraw-hill.com
The McGraw-Hill Companies
34 Dover St.
London W1X 4BR
England
Tel: +44 171 495 6781
FAX: +44 171 4956734

ISRAEL

Dan Aronovic
rhodanny@actcom.co.il
DARA International
41 Ravutski
Ra'anana 43220
Israel
Tel: +972-9-7419544
FAX: +972-9-7481934

KOREA

Young-Seoh Chinn
JES Media International
6th Fl., Donghye Bldg.
47-16, Myungil-Dong
Kangdong-Gu
Seoul 134-070, Korea
Tel: +82-2-4813411
FAX: +82-4813414

ITALY, FRANCE, SPAIN, PORTUGAL, SCANDINAVIA

Zena Coupé, Amanda Blaskett
101645.1710@compuserve.com
A-Z International Sales Ltd.
70 Chalk Farm Road
London NW1 8AN
England
Tel: +44 171 2843171
FAX: +44 171 2843174

GERMANY, SWITZERLAND, AUSTRIA

Jürgen Heise
jheise@mcgraw-hill.com
The McGraw-Hill Companies
Emil von Behring Strasse 2
D-60439 Frankfurt
Germany
Tel: +49 69 5801 140
FAX: +49 69 5801 145

JAPAN

Hirokazu Morita
Japanese Advertising
Communications, Inc.
Three Star Building
3-10-3 Kanda Jimbocho
Chiyoda-ku, Tokyo 101 Japan
Tel: +81 3 3261 4591
FAX: +81 3 3261 6126

BYTE ASIA-PACIFIC

AUSTRALIA, HONG KONG, INDIA,
INDONESIA, KOREA, MALAYSIA,
PAKISTAN, PHILIPPINES, OTHER
ASIA AND PACIFIC COUNTRIES,
SINGAPORE, TAIWAN
Weiye In
weilin@mcgraw-hill.com
Jennifer Chen
jennchen@mcgraw-hill.com
#305 Nanking East Road, Section 3,
10th floor
Taipei, Taiwan, R.O.C.
Tel: +886-2-715-2205
FAX: +886-2-715-2342

Subscription Customer Service

U.S. 1-800-232-2983

Outside U.S. +1-609-426-7676

For a New Subscription

U.S. 1-800-257-9402

Outside U.S. +1-609-426-5526

INDEX TO ADVERTISED PRODUCTS

For free product information from individual advertisers, circle the corresponding inquiry numbers on the response card!

To receive information for an entire product category, circle the category number on the response card!

CATEGORY NO. INQUIRY NO.	PAGE NO.	CATEGORY NO. INQUIRY NO.	PAGE NO.	CATEGORY NO. INQUIRY NO.	PAGE NO.
HARDWARE					
1 ACCESSORIES/SUPPLIES		174 MICRON ELECTRONICS	56-57	* MICRO-INTERNATIONAL INC	224
108-109 JENSEN TOOLS	223	175 MICRON ELECTRONICS	74-75	740-741 MITAC	CV
2 ADD-IN BOARDS		* MICROWAY	100	742-743 MITAC	48IS 24
82-83 AXIOM TECHNOLOGY	221	740-741 MITAC	CV	166 TOSHIBA AMERICA INC	28-29
94-95 CAMELEON TECHNOLOGY INC	223	742-743 MITAC	48IS 24	167-168 TRAVELING SOFTWARE	127
215 COMTROL CORP	138	266-267 NOVOTEC	95	612 WINBOOK COMPUTER CORPORATION	11
604-605 DARIM	104NA 2	154 NSTL	243	813 WINBOOK COMPUTER CORPORATION	45
190-191 DEXON SYSTEMS LTD	22	247 POLYWELL SYSTEMS	205	14 MAIL ORDER	
746-747 FIRST INTERNATIONAL COMPUTER	48IS 2	88 RACKMASTER	221	234 ALTEX COMPUTERS & ELECTRONICS	202
* MICROWAY	100	220 RAVE COMPUTER ASSOCIATES	148	235 COMPUTER DISCOUNT WAREHOUSE	196-197
81-82 QUATECH INC	219	75-76 RECORTEC INC	222	* JAMECO ELECTRONICS	209
86-87 U.S.LOGIC	222	230-231 RENEGADE SYSTEMS	164	250-251 STARTECH INTERNATIONAL	212
3 BAR CODING		183 SAG ELECTRONICS	21	15 MEMORY/CHIPS/UPGRADES	
63 VIDEX INC	219	183 SILICON GRAPHICS	34-35	94-95 CAMELEON TECHNOLOGY INC	223
4 COMMUNICATIONS/ NETWORKING		79 SILICONRAX	222	241-242 FIRST SOURCE INT'L	210
767-768 ACCTON TECHNOLOGY	48IS 23	264-265 TEKNOR INDUSTRIAL COMPUTERS	215	145-148 KINGSTON TECHNOLOGY	66
234 ALTEX COMPUTERS & ELECTRONICS	202	74 TRI VALLEY TECHNOLOGY INC	222	256-257 LA TRADE	200
64 AMERICAN ADVANTECH	219	86-87 U.S.LOGIC	222	780 PHILIPS SEMI-CONDUCTORS	8-9
744-745 ATRIE	48IS 18	6 DATA ACQUISITION		161-162 ROSS TECHNOLOGY INC	46-47
721-722 AXIS COMMUNICATIONS	11	82-83 AXIOM TECHNOLOGY	221	16 MISCELLANEOUS HARDWARE	
602 BAY NETWORKS	70	104 GAGE APPLIED SCIENCES INC	222	110-111 AE HOME CORPORATION	225
701-702 COMPEX INC	43	105 IO TECH	222	* MOTOROLA-SEMICONDUCTOR	96-97
236 COMPUTERLANE UNLIMITED	208	714 NATIONAL INSTRUMENTS	48IS 36	* MOTOROLA-SEMICONDUCTOR	98-99
215 COMTROL CORP	138	106 NATIONAL INSTRUMENTS	223	96-97 SLIGER DESIGNS	224
736-737 DBTEL	48IS 39	81-82 QUATECH INC	219	17 MODEMS & MULTIPLEXORS	
738-739 E-TECH	48IS 31	86-87 U.S.LOGIC	222	767-768 ACCTON TECHNOLOGY	48IS 23
216 INTEGRIX INC	157	53 DIAGNOSTIC EQUIPMENT		744-745 ATRIE	48IS 18
108-109 JENSEN TOOLS	223	255 FOREFRONT/ALLMICRO INC	201	603 CARDINAL TECHNOLOGIES	104NA 5
68 MINICOM/CLASSNET VIDEO	219	108-109 JENSEN TOOLS	223	736-737 DBTEL	48IS 39
761-762 NOKIA MOBILE PHONES	48IS 5	224 MICRO 2000	158-159	738-739 E-TECH	48IS 31
716 RAD DATA COMMUNICATION LTD	83	7 DISK & OPTICAL DRIVES		610-611 NEWCOM	104NA 7
87-68 RCI	220	219 ARTECON	155	752-753 TAINET COMMUNICATION SYSTEM	48IS 22
248-249 ROSE ELECTRONICS	204	252-253 CONSAN INC	198	18 MONITORS & TERMINALS	
70 STARTECH COMPUTER PRODUCTS	219	91-92 GRANITE DIGITAL	223	754-755 GVC	48IS 37
752-753 TAINET COMMUNICATION SYSTEM	48IS 22	* IOMEGA	55	748-749 KUO FENG CORPORATION	48IS 19
85 TALKING TECHNOLOGY INC	220	147-148 KINGSTON TECHNOLOGY	39	740-741 MITAC	CV
5 COMPUTER SYSTEMS		243-244 MICRO SOLUTIONS COMP PROD	203	742-743 MITAC	48IS 24
80-81 ACI	220	245-246 MICRO SOLUTIONS COMP PROD	207	205-206 PHILIPS BUSINESS ELECTRONICS	118
* ACORN COMPUTER GROUP	KEY	155-156 PINNACLE MICRO	7	194-195 PRINCETON GRAPHIC SYSTEMS	52
72 AMERICAN ADVANTECH	220	250-251 STARTECH INTERNATIONAL	212	170-171 VIEWSONIC	62
71 AMERICAN ADVANTECH	220	9 FAX BOARDS/MACHINES		19 MULTIMEDIA/CD-ROM	
77-78 APPRO INTERNATIONAL INC	221	93 ADVANCED IMAGE COMMUNICATIONS	223	252-253 CONSAN INC	198
82-83 AXIOM TECHNOLOGY	221	610-611 NEWCOM	104NA 7	604-605 DARIM	104NA 2
758-759 CHICONY ELECTRONICS CO	46IS 15	12 LAN HARDWARE		736-737 DBTEL	48IS 39
* COMPAQ	8-9	767-768 ACCTON TECHNOLOGY	48IS 23	185-186 ELEKTROSON BV	191
* DELL COMPUTER CORP	CV-CVI	110-111 AE HOME CORPORATION	225	733 INFOCUS	48IS 13
* DELL COMPUTER CORP	CVII-CVIII	215 COMTROL CORP	138	* MCGRAW HILL ON LINE	48IS 29
* DELL COMPUTER CORP	40-41	704-705 CYBEX COMPUTER PRODUCTS CORP	CVI	99 MICROPATENT	224
* DELL COMPUTER CORP	104NA 1	239-240 CYBEX COMPUTER PRODUCTS CORP	199	182-193 MIRO COMPUTER PRODUCTS AG	51
142-143 DTK COMPUTER INC	88	237-238 CYBEX COMPUTER PRODUCTS CORP	206	* PROXIMA CORPORATION	169
746-747 FIRST INTERNATIONAL COMPUTER	48IS 2	241-242 FIRST SOURCE INT'L	210	* PROXIMA CORPORATION	171
84-85 ICP ACQUIRE	221	720 LANSOURCE TECHNOLOGY	48IS 16	* PROXIMA CORPORATION	173
216 INTEGRIX INC	157	183 SAG ELECTRONICS	21	176-177 PROXIMA CORPORATION	175
* INTEL CORPORATION	24-25	227-228 SEH COMPUTERTECHNIK GMBH	161	163 SILICON GRAPHICS	34-35
89-90 INTERLOGIC INDUSTRIES	221	13 LAPTOPS & NOTEBOOKS		96 TAPEDISK CORPORATION	224
73 KILA	221	758-759 CHICONY ELECTRONICS CO	48IS 15	57 PCMCIA	
173 MICRON ELECTRONICS	CII-1	236 COMPUTERLANE UNLIMITED	208	167-188 MRT	166
		141 DOLCH COMPUTER SYSTEMS	117	20 PRINTERS/PLOTTERS	
		746-747 FIRST INTERNATIONAL COMPUTER	48IS 2	750-751 AVISION	48IS 27
		733 INFOCUS	48IS 13	236 COMPUTERLANE UNLIMITED	208

INDEX TO ADVERTISED PRODUCTS

CATEGORY NO. INQUIRY NO.	PAGE NO.	CATEGORY NO. INQUIRY NO.	PAGE NO.	CATEGORY NO. INQUIRY NO.	PAGE NO.
734-735	45	167-168	127	121	227
227-228	161	211-212	194	719	481S 28
165	69	*	179	172	85
21 PROGRAMMABLE HARDWARE		29 DATABASE		178	31
127-128	190	144	187	717-718	481S 14
708-709	237	725-726	481S 40	*	179
102	224	179-180	12-13	225-226	160
101	224	712-713	481S 11	41 SECURITY	
100	225	30 EDUCATIONAL		125-126	78
56 RAID DRIVE ARRAYS		115-116	226	127-128	190
110-111	225	31 ENGINEERING/SCIENTIFIC		122	227
219	155	115-116	226	706-707	481S 8
769-770	481S 6	719	481S 28	708-709	237
140	93	114	226	763-764	481S 20
218	157	33 GRAPHICS		160	58
266-267	95	213	186	225-226	160
209-210	23	139	109	45 UNIX	
258-259	217	190-191	22	*	22
183	21	*	73	144	187
22 SCANNERS/OCR/DIGITIZERS		229	165	260-261	217
750-751	481S 27	*	169	*	179
59 SCSI		*	171	46 UTILITIES	
769-770	481S 6	*	173	255	201
52 SECURITY		176-177	175	224	158-159
125-126	78	35 MAIL ORDER		157	189
127-128	190	235	196-197	98	224
708-709	237	703	481S 26	167-168	127
160	58	710	481S 32	47 WINDOWS	
107	225	36 MATHEMATICAL/STATISTICAL		*	22
225-226	180	115-116	226	98	224
23 TAPE DRIVES		153	168	*	61
785-786	481S 29	184	81	612	11
243-244	203	37 MISCELLANEOUS SOFTWARE		613	45
245-246	207	184	170	48 WORD PROCESSING/DTP	
103	225	38 ON-LINE SERVICES		214	153
24 UPS/POWER MANAGEMENT		232-233	162-163	GENERAL	
129	33	*	OUTSERT	49 BOOKS/PUBLICATIONS	
130	65	207-208	128	*	142-143
132-133	103	450	246	*	245
134-135	107	117-118	226	*	40-41
136-137	111	*	215	*	91
729-730	481S 21	*	2-3	*	238-239
756-757	481S 30	39 OPERATING SYSTEMS		*	16-17
55 VOICE TECHNOLOGY		*	136-137	50 RECRUITMENT	
610-611	104NA 7	159	18	*	188
SOFTWARE		158	183	51 MISCELLANEOUS	
25 BUSINESS		262-263	204	*	174
223	165	54 OS/2		*	193
184	170	*	15	*	87
608-609	18-17	*	43	*	218
606-607	83	40 PROGRAMMING LANGUAGES/TOOLS		*	218
*	169	731-732	481S 10	*	61
*	171	138	37	*	481S 38
*	173	*	22	*	192
176-177	175	122	227	*	231
27 COMMUNICATIONS/ NETWORKING		144	187	*	70
601	87	221	149	*	218
268-271	150	710	481S 32	*	481S 35
241-242	210	723-724	481S 40	*	237
112-113	226	202	131	196	172
121	227	179-180	12-13	*	176
715	481S 9	119-120	226	222	147
		712-713	481S 11		

EDITORIAL INDEX

For more information on any of the companies covered in articles, columns, or news stories in this issue, circle the appropriate inquiry number on the response card. Each page number refers to the first page of the article or section in which the company name appears.

INQUIRY NO.	PAGE NO.	INQUIRY NO.	PAGE NO.	INQUIRY NO.	PAGE NO.	INQUIRY NO.	PAGE NO.
A		1012 , Digital Equipment 59, 112, 129, 134, 139, 240		Madge Networks Europe 48IS 7		R	
1009 Access Software	185	1063		1065 MarketScape	26, 54	1029 RadMedia	122
Acer	48IS 25	1069 Digital Harbor	49	981 Mathcomp	48IS 33	977 Rhetorex Europe	48IS 33
Acorn	105	E		1031 Maximizer Technologies	240	S	
998 Advantech	48IS 33	985 Ematek Infomatik	48IS 33	McAfee	167	S&S International	167
1023 Aimtech	122	Envox	48IS 7	989 MCE Computer Peripherie	48IS 33	1016 SAG Electronics	112
1070 Alps Electric	50	F		1049 MCSI	240	The Santa Cruz Operation	139
AMD	89	997 First International Computer	48IS 25, 48IS 33	979 MegaSoft	48IS 33	1039 Sequel Technology	240
1034 American Data Acquisition	240	Folio	26	Men and Mice	129	1041 Server Technology	240
996 APE Ptacek Engineering	48IS 33	1030 Fractal Design	240	1027 mFactory	122	1032 ServiceSoft	240
Apple Computer	14, 26, 101, 105, 134, 151	Fujitsu	48IS 25	1043 Micro Design International	240	Sharp Electronics	26
Asustek Computer	48IS 25	G		1007 Micro Logic	185	Silicon Graphics	139
1025 Asymetrix	122	1052 Gage Applied Sciences	240	1048 Micronics Computers/Orchid Technology	240	Silicon Integrated Systems	89
995 ATDI	48IS 33	1047 Gateway 2000	240	Microsoft	14, 26, 134, 145	software.com	26
ATML	48IS 17	Groupe Bull	139	988 miro Computer Products	48IS 33	1033 Solid Oak Software	240
1038 AutoGraph International	240	GVC	48IS 25	Mitel Telecom	48IS 7	1044 Strata	240
1054 , Axis Communications	240	H		Motorola	14, 26, 67	Sun Microsystems	14, 63, 79, 105, 139
1062		991 Hantz & Partner	48IS 33	N		Symantec	167
B		1013 , Hewlett-Packard	112, 139, 240	NChannel International	105	T	
BackWeb	26	1057		NetChannel	105	TCT-ThunderByte	167
1042 Bluecurve	240	1055 Hitachi Computer Products	240	Netscape	105	984 TechLog	48IS 33
986 Bradford University Software Services	48IS 33	I		1008 Nimantics	185	1058 Tecmar Technologies	240
C		IBM	14, 105, 139, 167, 248	1068 Novell	53	983 ToolShop	48IS 33
Caere	26	1014 IBM Personal Computer	112	O		980 Toplevel Computing	48IS 33
1040 Cambridge Quality Management	240	992 ICP Vortex Computersysteme	48IS 33	1060 Okidata	240	Toshiba	48IS 3
Canal +	48IS 3	1024 Innovus	122	Olicom	48IS 17	Touchstone Software	167
1004 Centura Software	177	Intel	14, 89, 167	1059 Olympus Image Systems	240	U	
1037 Century Software	240	International Meta Systems	89	990 Opti International	48IS 33	1051 U.S. Robotics	240
Cheyenne Software	167	1066 Iomega	184	1028 Oracle	105, 122	V	
1064 Compaq Computer	240	976 Isoft	48IS 33	Oxford Parallel	71	1067 Verilog	181
1000 Computertechnik	48IS 33	J		P		1050 Vivitar	240
1026 , Corel	122, 240	1046 JASC	240	1053 Pacific Data Products	240	VoiceBit	48IS 7
1035		JetForm	26	PhoNet	48IS 7	VSN Systemen	48IS 7
1045 Core Technology	240	K		1056 PixelVision	240	W	
1010 Creative Labs	185	993 KTT	48IS 33	Pointcast	26	1036 Wessex	240
1006 CyberMedia	185	L		1015 Polywell Computers	112	982 Windmill Software	48IS 33
Cyrix	26, 89	994 Loughborough Sound Images	48IS 33	1005 Powersoft	177	X	
D		M		1061 Procom Technology	240	1017 , Xi Computer	112
1011 Dell Computer	112	1022 Macromedia	122	Q		1018	
				978 QBS Software	48IS 33		

IS pages appear only in the International edition.

The BYTE Site brings you today's hottest technologies with extended product and technology coverage that's the perfect complement to BYTE magazine.



THE **BYTE** SITE

<http://www.byte.com>

The World's Technology Authority
Online!

■ **The BYTE Archive**

Two years of BYTE, more than 3,000 full-text articles, illustrations, and photos... all indexed for quick retrieval!

■ **The BYTE Network Project**

The BYTE Site... a living laboratory showcasing the best tools for building Web applications. Read about it in BYTE... try it out online!

■ **The Virtual Press Room**

Instant access to vendor press releases and white papers! Links to vendor web sites!

■ **BYTEMarks**

FREE Benchmark! Download the BYTEMark – the benchmark with teeth!

■ **Direct Access to Advertisers**

Contact Byte advertisers DIRECTLY through the online advertiser index!

BYTE

The BYTE Site. The World's Online Technology Authority.

A Division of The McGraw-Hill Companies



PEAK PERFORMANCE IS THE NAME OF THE GAME

The name of the book to get you there is the

BYTE Guide to Optimizing Windows 95

Don't let Windows 95 run your life. With the **BYTE Guide to Optimizing Windows 95**, you're in control. Filled with fresh solutions and optimizing shortcuts, you'll find slick tips and expert advice on

- *Installing Windows 95*
- *The Internet*
- *Multimedia*
- *Handling old Windows and DOS applications*
- *Networking with Windows*
- *Troubleshooting... and much more*

You'll also get the real scoop on hardware issues and third-party products. An ideal guide and handy reference, you'll turn to the **BYTE Guide to Optimizing Windows 95** again and again as you power up Windows 95 to your standards.



BYTE Guide to Optimizing Windows 95
by Lenny Bailes
with Bermant, Menefee, and Heilborn
\$29.95 USA
ISBN: 0-07-882120-7



BYTE Guide to CD-ROM, Second Edition
by Michael Nadeau
Includes One CD-ROM Disc
\$39.95 USA
ISBN: 0-07-882104-5

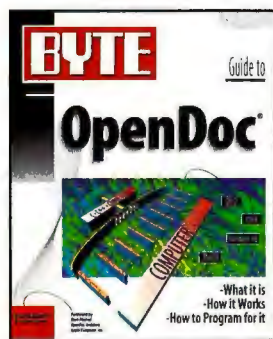

BYTE Guide to OpenDoc
by Joshua Susser &
Andrew MacBride
\$29.95 USA
ISBN: 0-07-882118-5

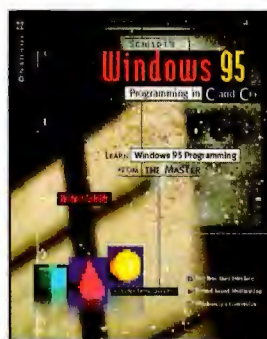

Schildt's Windows 95 Programming in C and C++
by Herbert Schildt
\$29.95 USA
ISBN: 0-07-882081-2

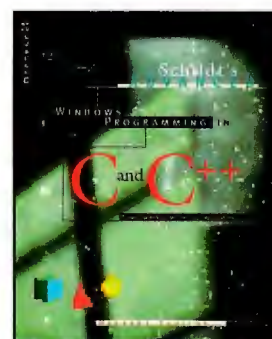

Schildt's Advanced Windows 95 Programming in C and C++
by Herbert Schildt
\$29.95 USA
ISBN: 0-07-882174-6

OSBORNE 
<http://www.osborne.com>

Available now at your local book and computer stores
or call 1-800-822-8158 and use your American Express,
VISA, Discover, or MasterCard.

CODE=SF36BYL

A Division of The McGraw-Hill Companies 

AT NATIONWIDE STORES

BARNES & NOBLE

BEST BUY

BOOKSTAR

BORDBERS

COMP USA

ELEK-TEK

MEDIA PLAY

MICRO CENTER

SOFTWARE, ETC.

SUPER CROWN

TAYLORS

WALDENBOOKS

BYTE/OSBORNE BOOKS ARE AVAILABLE AT THE FOLLOWING LOCATIONS

ALABAMA
Madison
Madison Books &
Computers
PH: 205-772-9250
FAX: 205-461-8076

ARIZONA
Phoenix
Computer Library
PH: 602-547-0331

CALIFORNIA
Berkeley
Cody's Books Inc.
PH: 800-479-7744 in CA
PH: 800-995-1180
Nationally

Citrus Heights
Tower Books
PH: 916-961-7202

Cupertino
Computer Literacy
Bookshops
PH: 408-973-9955

Davis
UCD Bookstore
University of California
Davis
PH: 916-752-2944

Los Angeles
ASUCLA Students Store
PH: 310-206-0763

Mountain View
Printer's Inc.
PH: 415-961-8500

Palo Alto
Printer's Inc.
PH: 415-327-6500

Stanford Bookstore
PH: 800-673-2348

Sacramento
Tower Books
1600 Broadway
PH: 916-444-6688

San Francisco
Stacey's Professional
Bookstore
PH: 800-926-6511
EMAIL: staceysbk@aol.com

San Luis Obispo
Earthing Bookshop
PH: 805-543-7951
FAX: 805-543-8488

Santa Barbara
Chaucer's Bookstore
PH: 805-563-0010

UCSB Bookstore
The University of California
Santa Barbara
PH: 805-893-2082

Sunnyvale
Computer Literacy
Bookshops
PH: 408-730-9955

COLORADO
Boulder
University Book Center
CU Boulder
PH: 303-492-6411
FAX: 303-492-0421

Colorado Springs
The Chinoook Bookshop
PH: 719-635-1195
FAX: 719-635-0792

Denver
Biblio Tek
PH: 303-534-3460

Longmont
Unifed Techbook Co.
PH: 303-651-3184
FAX: 303-651-3405

CONNECTICUT
New Haven
Yale Co-Op
PH: 800-ELI-YALE
FAX: 203-772-3665

FLORIDA
Gainesville
Construction Bookstore
PH: 904-378-9784
FAX: 904-378-2791

GEORGIA
Atlanta
Oxford Bookstore
PH: 404-262-3333
FAX: 404-364-2729

HAWAII
Honolulu
University of Hawaii
Bookstores
PH: 808-956-4338
FAX: 808-956-4323

ILLINOIS
Naperville
Books and Bytes
PH: 708-416-0102
FAX: 708-416-0375

MARYLAND
College Park
Maryland Book Exchange
PH: 301-927-2510
FAX: 301-209-7118

Boston
Charlesbank Bookshops
PH: 617-236-7442
FAX: 617-236-7418

Burlington
SoftPro Books
PH: 617-273-2919
FAX: 617-273-2499
EMAIL: books@softproeast.com

Cambridge
Quantum Books
PH: 617-494-5042
FAX: 617-577-7282
EMAIL: quanbook@world.std.com

Newton Highlands
New England Mobile
Bookfair
PH: 617-527-5817
FAX: 617-527-0113

MICHIGAN
Kalamazoo
Western Michigan
University Bookstore
PH: 616-387-3930
FAX: 616-387-3941

MINNESOTA
Minneapolis
University of MN East Bank
Bookstore
PH: 612-625-3005
FAX: 612-625-1861

NEW HAMPSHIRE
Hanover
Dartmouth Bookstore
PH: 800-624-8800 (outside
NH)
PH: 800-675-3616 (in NH)
FAX: 603-643-5170

NEW JERSEY
New Brunswick
Rutgers University
Bookstore
PH: 908-246-8448

NEW MEXICO
Albuquerque
Page One, Inc.
PH: 505-294-2026

NEW YORK
Buffalo
Village Green Bookstore
PH: 716-884-1200
FAX: 716-884-3007

Huntington
Books Revue
PH: 516-271-1442
FAX: 516-271-5890

New York City
Benjamin Books
PH: 212-432-1103
FAX: 212-432-1104

Coliseum Bookstore
PH: 212-757-8103
FAX: 212-489-0925

J & R Computer World
PH: 212-732-8600

McGraw-Hill Bookstore
PH: 212-512-4100
FAX: 212-512-4105

New York University
Computer Store
PH: 212-998-4591

Rochester
Campus Connections (RIT)
PH: 716-475-2504

Village Green Bookstore
1954 West Ridge Road
PH: 716-723-1600
FAX: 716-723-1669

Village Green Bookstore
716 Monroe Avenue
PH: 716-461-5380
FAX: 716-461-9333

Syracuse
Syracuse University
Bookstore
PH: 315-443-1654

OHIO
Cleveland
Business Outreach
PH: 216-348-1744
FAX: 216-348-0375

Dayton
Wilkie's Downtown
PH: 513-223-2541
FAX: 513-223-2869

Fairborn
Wilkie's Fairborn
PH: 513-429-1677

Lima
Readmore
217 Flanders
PH: 419-225-5826
FAX: 419-225-5537

Readmore's Hallmark
3330 W. Elm Street
PH: 419-225-5826

Youngstown
Youngstown State
University Bookstore
PH: 216-742-3589
FAX: 216-742-3145

OREGON
Beaverton
Powell's Bookstore at
Cascade Plaza
PH: 503-643-3131
FAX: 503-641-1554

Eugene
Book Mark
PH: 503-484-0512
FAX: 503-484-3130

Portland
Powell's Technical Books
PH: 503-228-3906
FAX: 503-228-0505

PENNSYLVANIA
Doylstown
Village Green Bookstore
PH: 215-230-7610
FAX: 215-230-7615

Erie
The Erie Book Store
PH: 800-252-3354
FAX: 814-456-2702

Philadelphia
Bookstore of the University
of Pennsylvania
PH: 215-898-4900
FAX: 215-898-6997

Pittsburgh
Book Center
University of Pittsburgh
PH: 412-648-2321
FAX: 412-648-1902

Scranton
Paperback Booksmith
PH: 717-346-9162

RHODE ISLAND
Providence
Brown Bookstore
PH: 401-863-3168
FAX: 401-863-2233

TEXAS
Arlington
Taylor's Technical Books
PH: 817-548-TECH

Austin
University Co-Op
PH: 512-476-7211

Dallas
Taylor's Technical Books
PH: 214-239-TECH

Houston
Brown Book Shop
PH: 713-652-3937
FAX: 713-652-1914

VIRGINIA
Blacksburg
University Bookstore,
Virginia Tech
PH: 703-231-5991
FAX: 703-231-3410

Vienna
Computer Literacy
Bookshops
PH: 703-734-7771
EMAIL: sales@tc.clbooks.com

WASHINGTON
Bellevue
University Bookstore
PH: 206-646-3300
FAX: 206-646-3340

Pullman
Students Book Corporation
PH: 509-332-2537
FAX: 509-332-8239

Seattle
Tower Books
PH: 206-283-6333
FAX: 206-285-2188

Tacoma
Tower Books
PH: 206-473-3362
FAX: 206-473-9141

WISCONSIN
Madison
University Bookstore
PH: 608-257-3784
FAX: 608-257-9479

Milwaukee
University of Wisconsin
Milwaukee
PH: 414-229-4201
FAX: 414-229-6194

What's New

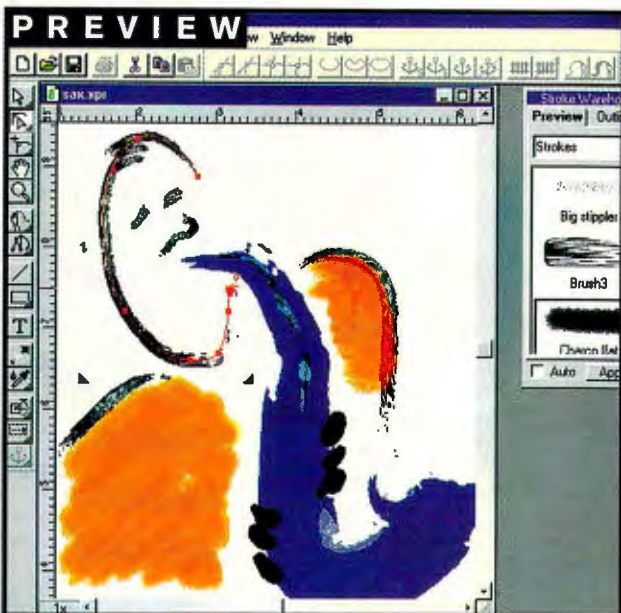

Expression
\$449

Circle 1030
on Inquiry Card.

Fractal Design Corp.
Aptos, CA
(800) 846-0111
(408) 688-5300
<http://www.fractal.com>

Mr. Natural Does Vector Graphics

Imagine van Gogh doing technical illustrations: chip schematics done with thick dabs of yellow paint; network diagrams that look like fields of wheat. Not that you'd want impressionistic schematics, but this should give you an idea of the kind of output you can create with Expression, Fractal Design's new drawing program.

If you've worked with other vector packages, you know that to draw, you put down a path. Expression's innovation, called "skeletal strokes," lets you easily change the attributes of a path (which Fractal Design calls a "stroke"), but it also lets you apply any vector picture to a path. The best part is working with vectors in a way that's close to working with traditional art tools.

Expression's toolbox includes line- and shape-drawing tools, node tools, a freehand brush, and color gradients and fills. The Windows 95 beta version that I used delivered snappy performance without making me wait several seconds for the lines I drew to appear on-screen. I used Expression with a Wacom pressure-sensitive tablet (the ArtZ II), and the combination worked like a charm.

Expression can handle most vector formats and can save files in these formats, as well as export in bit-map formats. If I had to buy my first illustration program now, I'd buy Expression. It goes beyond the standard packages, and it has that natural feel. —Dennis Barker

Business

Download Sales Leads from the Internet

YOU CAN ACCESS, SEARCH, AND DOWNLOAD contact information on 10 million North American businesses directly into Maximizer Enterprise 3.0is (US\$660 per seat) via the Internet and MultiActive Data's MultiActive Eagle on-line database. The product combines a contact manager, an application that automatically synchronizes field and home-office databases, and a translator that enables you to read and write Maximizer data from ODBC-compliant applications.



Contact: *Maximizer Technologies, Inc., Vancouver, British Columbia, Canada, (800) 804-6299 or (604) 601-8000; <http://www.maximizer.com>.*
Circle 1031 on Inquiry Card.

Self-Service Customer Support

NOW ORGANIZATIONS CAN PROVIDE GUIDED, self-service customer support using the Web or corporate intranets. The Knowledge Builder development environment (\$5000 per development-system license) integrates several problem-resolution methodologies, such as natural-language retrieval, case-based rea-

soning, decision trees, and cause/effect models, into an object-oriented development environment used by the Web Advisor application. Web Advisor (\$1500 per concurrent user session) guides users through dialog boxes to solve their problems; it also records customer interaction.

Contact: *ServiceSoft Corp., Needham, MA, (800) 737-8738 or (617) 449-0049; <http://www.servicsoft.com>.*
Circle 1032 on Inquiry Card.

Communications

Advanced E-Mail Processing

DESIGNED FOR WINDOWS 95 AND NT, Re:Ply (\$59.95) checks for and downloads e-mail from multiple accounts; generates responses to e-mail according to your criteria; maintains a library of responses or letters that it can automatically plug in; and maintains mailing lists. You can send and receive encrypted e-mail to and from other Re:Ply users; instruct the program to automatically return unwanted e-mail; forward and redirect messages; and send MIME and UUE attachments. Contact: *Solid Oak Software, Inc., Santa Barbara, CA, (800) 388-2761 or (805) 892-2550; <http://www.solidoak.com>.*
Circle 1033 on Inquiry Card.

Data Acquisition

Windows Data-Acquisition Software

WITH WINVIEW (\$99), YOU CAN ACQUIRE, display, and store data from data-

For our Previews, we take a look at Fractal Design's drawing package, Expression, and Gateway's big-screen notebook, the Solo 2100 S5-120.

acquisition boards. The program can display collected data in engineering units, including volts, degrees, and microstrain; display inputs in one graph or in separate graphs per channel; provide selectable x-axis settings for samples, seconds, minutes, hours, or days; and stream to disk at up to 333 kHz.

Contact: American Data Acquisition Corp., Woburn, MA, (800) 648-6589 or (617) 935-3200; <http://www.adac.com>.

Circle 1034 on Inquiry Card.

Macintosh

Graphics and Word Processing Solution

THE CORELDRAW 6 SUITE FOR POWER Macintosh (US\$595) includes CorelDraw 6, WordPerfect 3.5, CorelDream 3D 6, Corel Texture 6, Corel Artisan 6, Corel Multimedia Manager 6, CorelTrace 6, MasterJuggler 2.0 Pro, and CorelChart 6. It offers more than 25,000 clip-art images, 1000 high-resolution photos, 1000 Type 1 fonts, and 700 TrueType fonts.

Contact: Corel Corp., Ottawa, Ontario, Canada, (800) 772-6735 or (613) 728-3733; <http://www.corel.com>.

Circle 1035 on Inquiry Card.

Mapping

Mapping in Excel 95

A MAPPING ADD-IN FOR MICROSOFT Excel 95 and Microsoft Office 95, the FirstMap CD-ROM (\$69) includes boundary maps and data for counties, ZIP codes, and census tracts in

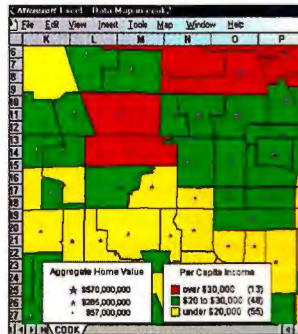

the U.S. The package also includes U.S. census information, such as age, gender, race, household, income, employment, and industry. In Excel, you can use FirstMap to create maps of your sales, potential earnings, and competition, from a national level to a neighborhood surrounding a specific store or outlet, and print them out.

Contact: Wessex, Inc., Winnetka, IL, (800) 892-6906 or (708) 501-3662; <http://www.wessex.com>.

Circle 1036 on Inquiry Card.

Networking

A Client/Server Intranet Suite

TO GIVE DESKTOP PC USERS SHARED ACCESS to applications, information, and peripherals located on a server or on another workstation, Plus[NFS] (single user, \$199; multiple-license packages, from \$179 per user) of-

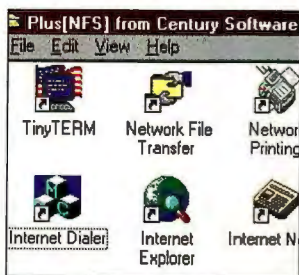

fers the TinyTerm terminal-emulation utility, which allows desktop connections to popular Unix applications; FTP file transfers; an e-mail and newsreader client; a Web browser; TCP/IP file and printer sharing; and client/server and peer-to-peer networking capabilities using TCP/IP.

Contact: Century Software, Inc., Salt Lake City, UT, (800) 877-3088 or (801) 268-3088; <http://www.censoft.com>.

Circle 1037 on Inquiry Card.

Advanced CD-ROM Networking

WITH SCSI EXPRESS 2.0 FOR WINDOWS NT (\$1995 to \$3995, depending on device support), you can use NT's performance monitoring to choose optimal configurations for networked CD-ROM drives. The program can map multiple CD-ROMs as a single network share to bypass the 23-drive-letter limitation; it also enables users to share a CD-ROM across multiple groups. The Autoshare feature provides automatic sharing of CDs.

Contact: Micro Design International, Inc., Winter Park, FL, (800) 228-0891 or (407) 677-8333; <http://www.mdi.com>.

Circle 1043 on Inquiry Card.

Unix

Scanning Software for Unix

NOW UNIX USERS HAVE A SET OF TOOLS for scanning and working with scanned images. EasyCopy/Scan (single-user license, \$695) lets you prescan a page in low resolution, display the prescan, and modify it

before the final scan. You can set the resolution to match a given file's size or an image's dimensions, or you can impose a maximum file size on the available resolution.

Contact: AutoGraph International, Inc., San Jose, CA, (408) 436-7227; <http://www.augrin.com>.

Circle 1038 on Inquiry Card.

The Web

Web-Server Log-File Analysis

WITH WEB TRACKER 1.0 (\$495), YOU CAN analyze access patterns for your Web site. The program, for Windows

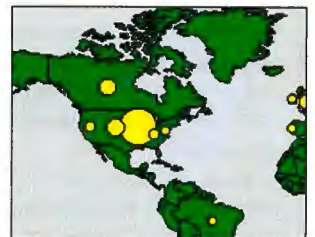

3.x, 95, and NT, supports exploratory analysis through fast drill-down and a variety of trending and geographical charting functions. Contact: Cambridge Quality Management, Inc., San Francisco, CA, (415) 750-1327; <http://www.CQMInc.com>.

Circle 1040 on Inquiry Card.

Monitor Internet Usage

COMPANIES CAN MANAGE AND REPORT their Internet, intranet, and on-line usage with Sequel Net Access Manager 1.0 (one to 49 users, US\$89 per user). You can have the program report at the group level; activate or deactivate logging or monitor-

ing functions; and grant or deny site access. The program enables you to monitor Internet activity based on protocols such as HTTP, NNTP, FTP, and SMTP; internal Web servers; and centrally accessed on-line services.

Contact: *Sequel Technology Corp.*, Willowdale, Ontario, Canada, (800) 881-2465 or (416) 756-3551; <http://www.sequeltech.com>.
Circle 1039 on Inquiry Card.

Windows NT

Analyze Windows NT Client/Server Systems

DYNAMEASURE (FOUNDATION LICENSE, \$29,995) puts controlled stress on Windows NT client/server systems and then measures the effect of the stress. Test specifications include OLTP reads, writes, and mixed read/

write tests, including versions that use BLOBs.

Contact: *Bluecurve, Inc.*, Oakland, CA, (510) 267-1500; <http://www.bluecurve.com>.
Circle 1042 on Inquiry Card.

Orderly Shutdown for Windows NT Servers

DESIGNED FOR UNATTENDED REMOTE Windows NT servers, Sentry ShutDown Remote Power Manager provides a multilevel-password interface for power management of mission-critical NT servers and workstations. The product comes in two versions, supporting out-of-band modem and RS-232 communications (\$669.95 and \$719.95, respectively); an optional model supports an in-band telnet TCP/IP session.
 Contact: *Server Technology, Inc.*, Sunnyvale, CA, (800) 835-1515 or (408) 745-0300; <http://www.servertech.com>.
Circle 1041 on Inquiry Card.

Software Updates

StudioPro 2.0 for Power Macintosh, a modeling, rendering, and animation package, adds in-context modelers; on-the-fly animation; a deformation tool; spline and polygonal-based modeling; a project window; an Environment Palette; a scan-line renderer; and camera controls. \$1495.

Contact: *Strata, Inc.*, St. George, UT, (800) 678-7282 or (801) 628-5218; <http://www.strata3d.com>.

Circle 1044 on Inquiry Card.

A computerized in/out board and messaging package for LANs and WANs, **Who's Where 2.0 for Windows** offers automated status log-in upon start-up, automated status log-out upon shutdown, group messaging, TCP/IP support, reporting capabilities, and integration with e-mail. Stand-alone version, from \$50; 10-user license, \$395; 25-user license, \$835; 50-user license, \$1295.

Contact: *Core Technology Corp.*, Lansing, MI, (800) 338-2117 or (517) 627-1521; <http://www.ctc-core.com>.

Circle 1045 on Inquiry Card.

An image editor for Windows 95 and NT, **Paint Shop Pro 4.0** provides an enhanced paintbrush tool; special effects; support for 33 formats; an enhanced retouch tool; a selections feature, which allows you to adjust overall opacity, designate a transparent color, or feather a selected area; an Image Arithmetic feature; and an integrated image browser. \$69.

Contact: *JASC, Inc.*, Eden Prairie, MN, (800) 622-2793 or (612) 930-9800; <http://www.jasc.com>.

Circle 1046 on Inquiry Card.

HARDWARE

Add-Ins

2-D and 3-D Graphics and Video Acceleration

BASED ON THE S3 VIRGE 64-BIT GRAPHICS and video accelerator chip, the Fahrenheit Video 3D package (with 2 MB of memory, \$239) comes in a 2-MB EDO DRAM configuration for the PCI bus and supports screen resolutions up to 1600 by 1200 pixels, true color depths, and refresh rates up to 160 Hz. Digital video acceleration and SuperZoom video scaling provide full-screen, full-motion playback at resolutions up to 1024 by 768 pixels.

Contact: *Micronics Computers, Inc./Orchid Technology*, Fremont, CA, (800) 577-0977 or (510) 651-2300; <http://www.orchid.com>.
Circle 1048 on Inquiry Card.

12-bit A/D System

THE COMPUSCOPE 8012 (\$7995) IS AN IBM AT-compatible ISA-bus card capable of performing 12-bit A/D conversion at real-time sampling rates up to 100 MSPS in single-channel mode and 50 MSPS in dual-channel mode, with a bandwidth of 40 MHz. The card can store up to 4 million samples in its on-board memory, and you can stack data from successive triggers.

Contact: *Gage Applied Sciences, Inc.*, South Burlington, VT, (800) 567-4243 or (514) 337-6893; <http://www.gage-applied.com>.
Circle 1052 on Inquiry Card.

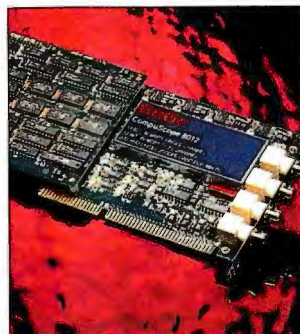

166-MHz 586 ISA/PCI CPU Board

DESIGNED FOR INDUSTRIAL APPLICATIONS, the IPV-586 ISA/PCI Pentium board (\$925) comes with two serial ports, a bidirectional parallel port, a dual floppy drive port, a dual EIDE hard drive port, a VGA accelerator interface with feature connector, a PS/2 keyboard port, a PS/2 mouse port, an on-board speaker, a watchdog timer, and up to 128 MB of DRAM.
 Contact: *MCSI, Vista, CA*, (619) 598-2177; mcsi@mcsi1.com.

Circle 1049 on Inquiry Card.

Communications

ISDN/Analog Multiport System

THE MP/8-I MODEM AND MP/16-I Modem integrate U.S. Robotics' V.34/ Everything modem technology with ISDN terminal adapters. Be-



cause each port has the ability to automatically detect the remote device type, you can send or receive analog and ISDN calls. The MP/8-I (\$6495) includes four ISDN terminal-adaptor interfaces, supporting eight B-channels/ports. The MP/16-I (\$10,995) includes eight ISDN terminal adapters, supporting 16 B-channels/ports.

Contact: *U.S. Robotics, Skokie, IL*, (800) 877-2677 or (847) 982-5010; <http://www.usr.com>.

Circle 1051 on Inquiry Card.

Motion-Picture Phone

THE VIVITAR MPP-2 (\$249.95), A COL- or video phone system, transmits sight and sound over standard telephone lines using a 486-based mul-



NSTL is the official product testing lab
for Data Communications

Convince
your
customers
that your
product
won't
CLOG
their
network
traffic



TEST *with* NSTL

You need to know how to keep the information flowing safely, cost-effectively, and quickly. NSTL can help you break the networking bottlenecks.

NSTL gives you the answers you need to assure potential customers of your product's performance. We'll work with you to design a cost-effective testing program to give you the answers to your customers' network performance questions.

Contact us early in your product development lifecycle to learn how NSTL can help you avoid costly and embarrassing mistakes.

Call 1-610-941-9600 to request a brochure or a proposal detailing the scope, pricing, and scheduling of confidential network services.

<http://www.nstl.com>

NSTL

A Division of The McGraw-Hill Companies 

Tel: 1 610 941 9600 | in US: 1 800 220 NSTL | Fax: 1 610 941 9952 | email: info@nstl.com

Circle 154 on Inquiry Card.

PREVIEW

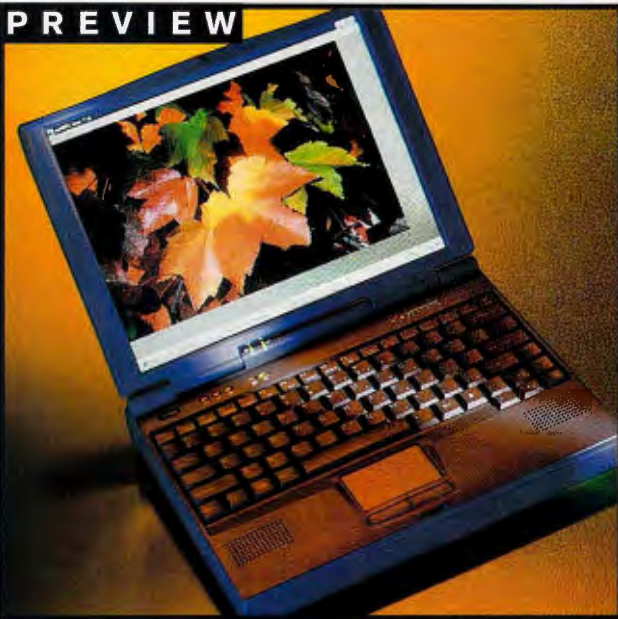

Gateway 2100 S5-120
\$3799 as reviewed

Circle 1047
on Inquiry Card.

Gateway 2000
North Sioux City, SD
(800) 846-2000
(605) 232-2000
<http://www.gw2k.com>

Gateway's Big-Screen Notebook Debut

The Solo 2100 series of multimedia notebooks blends raw power and good looks into a 7-pound package that's a perfect fit for on-the-go computing. Sporting a rich set of standard features and available options, the Solo 2100 affords Gateway the hope of garnering a bigger share of the portables market.

Gateway lets you configure your Solo with a wide array of options: a 100-, 120-, or 133-MHz Pentium; a 256-KB cache; up to 40 MB of EDO RAM; and a 540-MB to 1.3-GB hard drive. Multimedia support includes a six-speed CD-ROM, which you can pop out to insert a floppy drive module as needed; 16-bit sound; and speakers. I found the sound quality from the Solo 2100 S5-120's tiny speakers adequate for Windows' sounds and business audio.

The Solo's 12.1-inch active-matrix color display (see the photo), which is powered by a 32-bit accelerator with 1 MB of EDO video memory, rivals a 14-inch desktop monitor. When configured for a resolution of 800 by 600 pixels and 64,000 colors, images and text were sharp and clear.

Fitting a keyboard and a pointing device onto a notebook can create problems, and the Solo 2100 S5-120 is not exempt. The keys in the top row—including the Ins, Del, Home, End, and function keys—are smaller than normal, making them difficult to find without peeking. And the addition of four new keys to the bottom row shrinks the space bar to a diminutive 3-inch target. The Synaptics touchpad is a joy to operate, but I soon found that its position, directly below the tiny space bar, left me no room to rest my thumbs, which led to a spate of accidental pointing and clicking.

Although it suffers from the same drawback as its peers—cramming a lot of computer into a small package—good looks and versatility make the Solo 2100 S5-120 an attractive choice for mobile computing.

—Robert L. Hummel



timedia PC and a 14.4-Kbps modem. The plug-and-play system comes with a golf-ball-size, pre-focused camera that mounts on top of your monitor and provides refresh rates up to 10 fps. The package includes PictureWorks' PhotoEnhancer software and Smith Micro's VideoLink videoconferencing software.

Contact: *Vivitar Corp.*,
Newbury Park, CA,
(805) 498-7008.

Circle 1050 on Inquiry Card.

Networking

External and Pocket Print Servers

THE DIRECTNET EX II EXTERNAL PRINT server and the DirectNet PEPS2 Plus pocket print server facilitate access to printer locations on NetWare, TCP/IP, and AppleTalk networks. The EX II (\$399) includes two high-speed bidirectional parallel data ports; the PEPS2 Plus has one. Both units support Novell's 4.x Network



Directory Service and have 10Base-2 and 10Base-T connectors.

Contact: *Pacific Data Products*,
San Diego, CA, (800) 737-7117 or (619) 552-0880;
<http://www.pacdata.com>.

Circle 1053 on Inquiry Card.

Network-Ready Color Camera

DESIGNED FOR INTERNET AND INTRANET applications, the Axis NetEye 200 (\$1299) is a self-contained, palm-

size camera that attaches directly to a 10-MB Ethernet network. You can use the camera as a replacement for closed-circuit video or a PC with a frame-grabber.

Contact: *Axis Communications, Inc.*, Woburn, MA, (800) 444-2947 or (617) 938-1188; <http://www.axisinc.com>.

Circle 1054 on Inquiry Card.

Workgroup Switching

FOUR FAST ETHERNET DEVICES, THE Hi-Speed 150 series (from \$7595) provides up to 32 Ethernet connect-



tions, as many as 16 Fast Ethernet connections, and the ability to let users interchange FDDI, ATM, and WAN uplinks within the same unit. All Fast Ethernet ports support automatic switchable operation at 10 or 100 Mbps.

Contact: *Hitachi Computer Products, Inc.*, Santa Clara, CA, (800) 448-2244 or (408) 986-9770.

Circle 1055 on Inquiry Card.

Peripherals

16-inch Flat-Panel Monitor

THE PV116SX (UNDER \$10,000) IS AN active-matrix color LCD flat-panel monitor that measures about 3 inches deep and has a resolution of 1280 by 1024 pixels and a diagonal viewing area of 16.1 inches. The monitor provides a 2-million-color palette, on-screen menu controls, and options for finger-touch

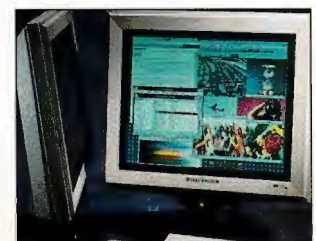

The Definitive Reference Source!



5 Years of **BYTE**
1991-1995

Call **1-800-924-6621**

PLUS: Quarterly Updates with Every Issue in 1996

SEARCH ▼

EXPORT ▼

FIND ▶

SELECT ▼

Instant Access To More Than 60 Issues of BYTE

- Product Reviews & Commentary
- BYTE Lab/NSTL Reports
- Benchmarks
- Cover Stories & Features

Text to Articles & Full Text Database



It's all at your fingertips—emerging trends, comprehensive world-wide industry analysis, multiplatform coverage of all the technologies, in-depth testing and product evaluations, advice, tips expert opinions, and much more! It's ideal for anyone who's evaluating the significance of new technologies . . . doing research . . . making complex multiplatform purchasing decisions . . . developing the next generation hardware or software products . . . preparing strategic corporate plans.

LOCATE ▲

SCAN ▲

It's Comprehensive . . . Time Saving . . . and Easy to Use!
It's all in BYTE on CD-ROM

Order Today!
1-800-924-6621

Order Now!

Toll-free national numbers:

Belgium	080071635
Germany	0130826112
U.K.	0800973017
Italy	167876155
France	05916088
Netherlands	05916088
Switzerland	1557257
Denmark	80017728
Sweden	020791136
Spain	900933539

Other

International	091-752792
United States	1-800-924-6621
Fax:	609-426-5434

Yes! I want the power & convenience of **BYTE on CD-ROM**

- Send me **Byte on CD-ROM PLUS!** Full text from 1991-1995 issues of BYTE plus quarterly CD-ROM updates with full text and colorful graphics for all the 1996 issues of BYTE for just **\$54.95**.
- Send me **BYTE on CD-ROM**. Full text from 1991-1995 issues of BYTE—more than 60 issues for only **\$39.95**.

Charge my: MasterCard VISA Amex Check enclosed (make checks payable to BYTE magazine, US funds only)

Card# _____ Exp. Date _____ Signature _____

Name _____

Address _____

City _____ State/Country _____ Zip/Postal Code _____

Mail to: **BYTE on CD-ROM, P.O. Box 526, Hightstown, NJ 08520** **P.O. Box 85, Galway, Ireland**



Canadian and U.S. orders, please add \$2.95 for shipping and handling, and state sales tax where applicable. (Canadian orders add appropriate GST.) Outside North America, add \$5.00 for air mail delivery. Allow 6-8 weeks for delivery.

A Division of the McGraw-Hill Companies

CDBY096

B. Y. O. I. S. P.

(Bring Your Own Internet Service Provider)

Log into BIX and you'll find people like yourself. People who are glad to lend a helping hand when someone asks a question. People who listen to what you have to say. People who know about things that will surprise you.

Now BIX is available at a price never before seen online.

If you already have Internet access, telnet to BIX

Flat Rate: \$6.95/mo \$14.97/3mo \$24.97/6mo \$34.97/year

This plan allows unlimited use of both our text-based services and Web services available only to BIX members.

If you need Internet access, BIX offers a Flat Rate plan at prices ranging from \$23.95/month (down to as low as \$16.95/month if you pay by the year) including nationwide access at speeds up to 28.8kbps or X.25 access at speeds up to 14.4kbps, and a pay-as-you-go plan for \$12.95/month for six hours of access plus \$2/hour thereafter.

Complete details are available from our e-mail auto-responder at info@bix.com or by visiting the BIX Web Site (see below).

To sign up for BIX, dial (800) 695-4882 or dial (617) 492-8300, enter *bix* when prompted and enter *bix.rd* at the Name? prompt. A step by step procedure will get you logged into BIX. The same procedure works if you telnet to bix.com or x25.bix.com, and you can also sign up on our Web Site.

BIX *ahead of its time
always was, always will be.*

Visit us on the Web at <http://www.bix.com/>

and pen-input versions.
Contact: PixelVision, Acton, MA, (508) 264-9443;
<http://www.pixelvision.com>.
Circle 1056 on Inquiry Card.

Low-Cost Color Ink-Jet Printer

THE DESKJET 400 (ABOUT \$199) OFFERS 600- by 300-dpi black printing, Hewlett-Packard's Resolution Enhancement technology for crisp text and smooth edges, and 300- by 300-dpi color printing at a rate of 3 ppm. Plug-and-play-ready for Windows 95, the printer includes a 50-sheet paper tray and a manual-feed path for printing labels, postcards, standard-size envelopes, and nonstandard paper sizes.
Contact: Hewlett-Packard Co., Santa Clara, CA, (800) 752-0900 or call local Hewlett-Packard dealer; <http://www.hp.com>.
Circle 1057 on Inquiry Card.

Universal QIC Drive

FEATURING 2.5-GB LINEAR TECHNOLOGY, the Wangtek 52000 Universal QIC drive (about \$475) offers a standard SCSI-2 connection with a sustained data transfer rate of 17 MB per minute. Linear recording and read-after-write verification ensure that information can be easily and accurately restored in the event of data-loss incidents.
Contact: Tecmar Technologies, Inc., Longmont, CO, (800) 422-2587 or (303) 682-3700; <http://www.tecmar.com>.
Circle 1058 on Inquiry Card.

Optical Storage on 230-MB Cartridges

A PALMTOP-SIZE OPTICAL-STORAGE DEVICE for Mac, Windows, and DOS computers, the SYS.230 Personal Stor-



age System (about \$359) can store images downloaded from the Internet or from digital cameras; back up and archive files and databases; store music; and transport your work between office and home. The SYS.230 transfers data at up to 2.4 MBps and offers a seek time of less than 17 ms.

Contact: Olympus Image Systems, Inc., Melville, NY, (800) 347-4027 or (516) 844-5000; <http://www.olympusamerica.com>.
Circle 1059 on Inquiry Card.

Dot-Matrix Printers for Multipart Forms

NOW YOU CAN PRINT ON MULTIPART FORMS and on stock measuring up to twice the thickness that standard dot-



matrix printers are able to handle. The Microline 320/321 Turbo (from \$499) includes Courier and Gothic fonts, plus NLQ, utility, high-speed draft, and super-speed draft, as well as eight scalable bar codes. The Windows 95-compatible printer has 64 KB of RAM and a 28-KB receive buffer.
Contact: Okidata, Mount Laurel, NJ, (800) 654-3282 or (609) 235-2600; <http://www.okidata.com>.
Circle 1060 on Inquiry Card.

Servers

CD-ROM Servers with Eight-Speed Drives

PROCOM'S CD TOWER-RAX (CADDY, \$56,928; tray, \$56,008) rack-enclosed CD-ROM servers can contain up to 56 caddy- or tray-based CD-ROM drives to provide up to 36.4 GB of data over a network. The servers deliver a sustained data



transfer rate of 1200 Kbps and an average seek time of 115 ms. The CD Tower-Rax servers offer one to eight racks of seven drives; a smart board that maps each seven-drive rack to one SCSI ID; 100- or 166-MHz Pentium CPUs; 4 to 128 MB of SIMMs; eight CD-ROM management software packages; two SCSI host adapters; a VGA monitor; a keyboard; a mouse; and a hard drive.

Contact: Procom Technology, Inc., Irvine, CA, (800) 800-8600 ext. 414 or (714) 852-1000; <http://www.procom.com>.
Circle 1061 on Inquiry Card.

Network CD-ROM Servers

THE AXIS STORPOINT CD-ROM SERVERS, for Ethernet and Token Ring LANs, allow users in NetWare, Windows



NT/95, Windows for Workgroups, OS/2, Unix, and Web/intranet environments to access and share CD-ROMs and CD-ROM-based information over a network. The servers (from \$799) have the ability to simultaneously connect seven drives directly and up to 49 drives through LUN expansion.

Contact: Axis Communications, Inc., Woburn, MA, (800) 444-2947 or (617) 938-1188; <http://www.axisinc.com>.
Circle 1062 on Inquiry Card.

Systems

Alpha 21164 Desktop Workstation

THE ALPHASTATION 500/500 (\$54,660) supports Digital Unix, Windows NT, and OpenVMS. The workstation comes with 128 to 512 MB of memory; 2 MB of cache; 4 MB of texture memory; a 256-bit-wide memory bus; a PowerStorm 4D60T graphics adapter; a 2-GB hard drive; a 21-inch color monitor; a floppy drive; a quad-speed CD-ROM drive; five storage slots; four PCI bays; one 64-bit PCI expansion slot; twisted-pair and thin-wire Ethernet; and stereo-quality audio.

Contact: Digital Equipment Corp., Maynard, MA, (800) 344-4825 or call local Digital dealer; <http://www.workstations.digital.com>.
Circle 1063 on Inquiry Card.

Multimedia PC

DESIGNED FOR MULTIMEDIA AND GAMING enthusiasts, the Presario 8000 Series (from \$2499, without a monitor) delivers PowerVR Arcade 3-D Graphics technology, featuring 6 MB of graphics memory and supporting up to 1 million large polygons per second; the InterWave sound system; and JBL Pro speakers, with a separate tweeter and full elliptical driver. A 33.6-Kbps Talk and Send DSVD modem provides Internet access over standard telephone lines. Other features include up-to-200-MHz Pentium processors; 24 to 32 MB of RAM; 512 KB of pipeline burst cache; and up-to-3.8-GB hard drives.



Contact: Compaq Computer Corp., Houston, TX, (800) 345-1518 or (713) 514-0484; <http://www.compaq.com>.
Circle 1064 on Inquiry Card.

Visual Age for BASIC...Sort Of

IBM's Visual Age for BASIC looks like VB but adds OOP underneath.

By Rick Grehan

Regular readers of this column may recall that in October 1995, I examined IBM's Visual Age for C++ on OS/2. Since then, IBM has extended the Visual Age product line to new OSes and languages. Visual Age for Smalltalk existed before the C++ variant. Visual Age for C++ is now available on Windows NT. IBM has also released Visual Age for COBOL. The most recent addition to the product line, Visual Age for BASIC (the product had a code name of Bart), however, more closely resembles Microsoft's Visual Basic than it does any of the other Visual Age products.

The Visual Age paradigm encourages construction by *parts* (in IBM lingo, a part is a visual or nonvisual component). The developer specifies the interactions of parts and, therefore, the execution behavior of the application by wiring together parts and defining activities associated with those connections.

For example, suppose you're building a data-input screen that consists of a listbox and a "clear" button. You want the clear button to erase whatever is in the listbox. Using the Visual Age construction methodology, you connect the button to the box—the Visual Age integrated development environment (IDE) will draw a line from button to box—and associate an event with that connection. In this case, you tell the system that a click event on the button triggers the `erase()` method of the listbox. This construction technique applies to nonvisual objects as well as the visual ones I used in the example.

Thus, when Visual Age for BASIC appeared (I examined a late beta version running under NT, but IBM says it will also release versions for OS/2 and AIX), I was eager to explore the Visual Age interface elements of the package and investigate

how IBM had whipped BASIC into object-oriented shape. Unfortunately, although I was looking forward more to the former aspect—the program's Visual Ageness—it was the latter aspect—the object-oriented features—that proved to be more interesting.

Bluntly put, it appears that the sole reason the package carries the Visual Age prefix is that IBM chose to call it Visual Age for BASIC. Were Visual Age for BASIC and Visual Age for C++ presented to me as siblings, I'd suggest that the presenter go back and check the parentage. Visual Age for BASIC's interface is obviously descended from Visual Basic.

Missing from all the documentation (available in the beta version only in on-line format) is any mention of the word *part*. Instead, the documentation speaks of *components*. Though some might suggest that I'm nit-picking, I can't shake the feeling that there's some sort of capitulation going on here.

Applications construction under Visual Age for BASIC proceeds along lines similar to those of Visual Basic and draws from a similar cast of characters. Forms

WHERE TO FIND

IBM
<http://www.software.ibm.com/ad/vabasic/>

are the fundamental window units, and you populate them with controls by selecting from a toolbar. Once a control is situated, you can summon an associated properties window and a code-editing window. However, if you are familiar with Visual Basic, you've seen all this before.

On a more positive note, Visual Age for BASIC does a good job of clothing BASIC in object-oriented garb. It supports class hierarchies and multiple inheritance



as well as inheritance-based polymorphism. Also, Visual Age for BASIC can digest System Object Model (SOM) objects as well as OLE objects.

Finally, if your design work tends toward client/server database development using DB2 on NT, Visual Age for BASIC recognizes a separate stored procedure project, which allows you to build and test stored procedures much as you would build BASIC applications. (Admittedly, I did not experiment with that portion of the package.)

Visual Age for BASIC's first release amounts to a somewhat improved Visual Basic. (If you've been wondering, from what I've seen so far, the syntax differences between Visual Age for BASIC and Visual Basic are so minor that porting programs written for the latter to the former should be—and I stress the words *should be*—painless.) IBM representatives have suggested that future versions might incorporate more of the original Visual Age environment. I'd like to see that. **B**

Rick Grehan is a senior technical editor for BYTE reviews and the coauthor of The Client/Server Toolkit. You can reach him by sending e-mail to rick_g@bix.com.

DELL LATITUDE
Dependable Notebooks
With Superior Battery Life

DELL® LATITUDE® LM P133ST
133MHz PENTIUM® PROCESSOR

- NEW Multimedia Notebook
- ★ **12.1" SVGA Active Matrix Color Display**
- 16MB RAM/810MB Hard Drive
- 256KB L2 Cache
- Options Bay accepts 6X CD-ROM, 3.5" Floppy Drive (both included) or Optional 2nd Li-Ion Battery
- ★ **PCI Bus with 128-bit Graphics Accelerator**

- Integrated 16-bit Stereo Sound
- Smart Lithium Ion Battery
- Touchpad
- IrDA 1.0 Standard Compliant
- Under 7 Pounds*
- Extendable 1 Year Warranty†
- ★ **Upgrade to 40MB RAM, add \$299.**
- ★ **28.8 XJACK®/Cabled Modem, add \$199.**

Business Lease‡: \$111/Mo.
Order Code #800051

NEW Multimedia
Dell Latitude LM
Notebook

\$2999



**ANOTHER DELL FIRST: THE USE OF "MULTIMEDIA"
AND "AFFORDABLE" IN THE SAME SENTENCE.**

Multimedia notebook meet affordable. Affordable meet multimedia notebook. We refer to the Dell® Latitude® LM notebook.

For a temptingly low price you receive Neo-Magic's stunning 128-bit graphics accelerator, "an industry first." MPEG software for up to 30-frames-per-second video.

The vibrancy of a 12.1 inch SVGA (800 x 600) active matrix display. A 6X CD-ROM. Along with integrated 16-bit stereo sound and built-in speakers.

What's more, this system is built around Dell's famous Lithium-Ion battery technology. Which means your graphics presentations can dazzle crowds for hours and hours.

We're the first on our block to offer such a notebook. Why not be the first on your block to own one? Give us a call today.



DELL®

TO ORDER

800-433-6681

<http://www.dell.com>

Mon-Fri 7am-9pm CT • Sat 10am-6pm CT
Sun 12pm-5pm In Canada, call 800-233-1589

Keycode #01158

THE SYSTEMS ARE GREAT THE PRICES ARE EVEN BETTER

DELL DIMENSION™ XPS PENTIUM® PRO CHIP-BASED WORKSTATIONS

Base features: • Mini Tower Model • 256KB Internal L2 Cache • NEW 12X EIDE CD-ROM
• MS® Office Professional with Bookshelf for Windows® 95 • MS Internet Explorer • 30 Days Free Support*
• MS Mouse • 3 Year Limited Warranty† with 1 Year On-site‡ Service

DELL DIMENSION XPS Pro200n 200MHz PENTIUM® PRO PROCESSOR

- 64MB EDO Parity Memory
- 3.2GB Hard Drive [9.5ms]
- 20TD Trinitron Monitor (19.1" v.i.s., .26dp, 1600 x 1200 max. res.)
- Imagine 128 Series 2 Graphics Accelerator with 4MB VRAM
- Microsoft® Windows NT® Workstation 4.0
- ★ Upgrade to 2GB SCSI Hard Drive (7200 RPM, 8ms), add \$460.

\$4299

Business Lease^o: \$155/Mo.
Order Code #500354

DELL DIMENSION XPS Pro200n 200MHz PENTIUM PRO PROCESSOR

- 64MB EDO Parity Memory
- 3.2GB Hard Drive [9.5ms]
- 17HS Trinitron Monitor (15.9" v.i.s., .26dp, 1600 x 1200 max. res.)
- 2MB EDO VIRGE 3D Video Card
- Microsoft Windows NT Workstation 4.0
- ★ Upgrade to a 20TD Trinitron Monitor (19.1" v.i.s., .26dp, 1600 x 1200 max. res.), add \$799.

\$3399

Business Lease: \$126/Mo.
Order Code #500355

DELL DIMENSION XPS Pro180n 180MHz PENTIUM PRO PROCESSOR

- 32MB EDO Memory
- NEW 2.1GB Hard Drive [10.5ms]
- 17LS Monitor (15.7" v.i.s.)
- 2MB EDO VIRGE 3D Video Card
- FREE Norton/Visio Express Software Suite
- Microsoft Windows 95/MS Plus! CD
- ★ Upgrade to 64MB EDO Parity Memory, add \$399.
- ★ Upgrade to a 3.2GB Hard Drive (9.5ms), add \$99.

\$2499

Business Lease: \$92/Mo.
Order Code #500356

DELL DIMENSION XPS PENTIUM

Base features: • Mini Tower Model • MS Office Professional with Bookshelf for Windows 95 • MS Plus! CD • MS Internet

DELL DIMENSION XPS P200s 200MHz PENTIUM PROCESSOR

- 64MB SDRAM Memory
- 3.2GB Hard Drive [9.5ms]
- 17HS Trinitron Monitor (15.9" v.i.s., .26dp, 1600 x 1200 max. res.)
- Matrox Millennium 4MB WRAM Video Card
- NEW 12X EIDE CD-ROM Drive
- 33.6 US Robotics Telephony Modem
- ★ Upgrade to a 20TD Trinitron Monitor (19.1" v.i.s., .26dp, 1600 x 1200 max. res.), add \$799.

\$3499

Business Lease: \$129/Mo.
Order Code #500352

DELL DIMENSION PENTIUM CHIP-BASED DESKTOPS

Base features: • Mini Tower Model • 256KB Pipeline Burst Cache
• 8X EIDE CD-ROM Drive • 64-bit PCI 2MB DRAM Video
• Microsoft Windows 95 • MS Plus! CD • MS Internet Explorer • 30 Days Free Support • Dell Mouse • 3 Year Limited Warranty with 1 Year On-site Service

DELL DIMENSION P200v 200MHz PENTIUM PROCESSOR

- 16MB SDRAM Memory
- NEW 2.1GB Hard Drive [10.5ms]
- 15TX Trinitron Monitor (13.7" v.i.s.)
- ★ Upgrade to 32MB SDRAM, add \$199.
- ★ Upgrade to a 3.2GB Hard Drive (11ms), add \$85.
- ★ Upgrade to a 17LS Monitor (15.7" v.i.s.), add \$179.

\$1999

Business Lease: \$74/Mo.
Order Code #500348

DELL DIMENSION P133v 133MHz PENTIUM PROCESSOR

- 16MB SDRAM Memory
- NEW 2.1GB Hard Drive [10.5ms]
- 15LS Monitor (13.7" v.i.s.)
- 3Com EtherLink Interface Combo PCI Card
- ★ Upgrade to 32MB SDRAM, add \$199.
- ★ Upgrade to a 3.2GB Hard Drive (11ms), add \$85.
- ★ Upgrade to a 15TX Trinitron Monitor (13.7" v.i.s.), add \$40.

\$1799

Business Lease: \$67/Mo.
Order Code #500347

DELL® POWEREDGE® PENTIUM PRO CHIP-BASED SERVERS

Base features: MS Windows NT Server • 256KB Integrated L2 Cache • Integrated PCI Ultra/Wide SCSI-3 Controller • 8X SCSI CD-ROM • 3Com 3C595 10/100 PCI Network Adapter • Intel LANDesk Server Manager v2.5 • 3 Year Warranty with 1 Year On-site Service • 24 x 7 Dedicated Server Hardware Tech Support†

DELL POWEREDGE 2100 SERVER 180MHz PENTIUM PRO PROCESSOR

- 32MB Error Correcting Code (ECC) EDO Memory (256MB Max)
- 2GB Fast/Wide SCSI-2 Hard Drive [7200RPM, 8ms] (12GB Max)
- 6 Expansion Slots: 3 PCI, 3 EISA
- 6 Drive Bays: 3 External 5.25"/3 Internal 3.5"
- ★ 2nd 2GB Fast/Wide SCSI-2 Hard Drive, add \$749.
- ★ Upgrade to a 15LS Monitor (13.7" v.i.s.), add \$349.
- ★ Upgrade to 3 Years On-Site Service, add \$99.

\$3799

Business Lease: \$137/Mo.
Order Code #250020

DELL POWEREDGE 2100 SERVER 180MHz PENTIUM PRO PROCESSOR

- 64MB Error Correcting Code (ECC) EDO Memory (256MB Max)
- 4GB Fast/Wide SCSI-2 Hard Drive [7200RPM, 8ms] (12GB Max)
- 6 Expansion Slots: 3 PCI, 3 EISA
- 6 Drive Bays: 3 External 5.25"/3 Internal 3.5"
- ★ Upgrade to 96MB ECC EDO Memory, add \$649.
- ★ 4/8GB DAT SCSI Internal TBU, add \$999.
- ★ Upgrade to 3 Years On-site Service, add \$99.

\$4399

Business Lease: \$159/Mo.
Order Code #250012



‡Pricing is not discountable. †For a complete copy of our Guarantees or Limited Warranties, please write Dell USA L.P., 2214 W. Braker Lane, Suite D, Austin, TX 78758. ‡Business leasing arranged by Leasing Group, Inc. **Norton/Visio Express Software Suite is available only on Dell Dimension systems purchased with the combination of MS Office and Microsoft Windows 95. Visio Express 4.0 is an OEM version and a subset of Visio 4.0. Software may not include all documentation and may differ from retail version. *System weight with floppy drive in options bay. †On-site service provided by BancTec Service Corporation. On-site service may not be available in certain remote locations. ‡On-site service for the Poweredge 2100 Server is provided by Digital Equipment Corporation and is available in 29 metropolitan areas. *Prices and specifications valid in the U.S. only and subject to change without notice. The Intel Inside logo and Pentium are registered trademarks and the Intel LANDesk logo is a trademark of Intel Corporation. MS, Microsoft, Windows and Windows NT are registered trademarks and the Genuine Microsoft Products logo is a trademark of Microsoft Corporation. XJACK is a registered trademark of US Robotics Mobile Communications Corporation. 3Com and EtherLink are registered trademarks of 3Com Corporation. ©1996 Dell Computer Corporation. All rights reserved.



EAT. BETTER.



CHIP-BASED DESKTOPS

2KB Pipeline Burst Cache • AWE32 Wave Table Upgrade Card • Altec Lansing ACS-31 Speakers with Subwoofer • MS Office 95 • **FREE Norton/Visio Express Software Suite** (Norton AntiVirus, Navigator, Utilities and Visio Express 4.0) • Microsoft Internet Explorer • 30 Days Free Support • MS Mouse • 3 Year Limited Warranty with 1 Year On-site Service

DELL DIMENSION XPS P200s

200MHz PENTIUM PROCESSOR

- 32MB SDRAM Memory
- NEW 2.1GB Hard Drive [10.5ms]
- 15TX Trinitron Monitor (13.7" v.i.s.)
- Matrox Millennium 4MB WRAM Video Card
- NEW 12X EIDE CD-ROM Drive
- ★ Upgrade to a 3.2GB Hard Drive (9.5ms), add \$99.
- ★ Upgrade to a 17LS Monitor (15.7" v.i.s.), add \$179.

\$2599

Business Lease: \$96/Mo.
Order Code #500351

DELL DIMENSION XPS P166s

166MHz PENTIUM PROCESSOR

- 32MB SDRAM Memory
- 3.2GB Hard Drive [9.5ms]
- 17HS Trinitron Monitor (15.9" v.i.s., .26dp, 1600 x 1200 max. res.)
- Matrox Millennium 4MB WRAM Video Card
- 8X EIDE CD-ROM Drive
- ★ Upgrade to 64MB SDRAM, add \$299.
- ★ Upgrade to a 20TD Trinitron Monitor (19.1" v.i.s., .26dp, 1600 x 1200 max. res.), add \$799.

\$2899

Business Lease: \$107/Mo.
Order Code #500350

DELL DIMENSION XPS P166s

166MHz PENTIUM PROCESSOR

- 32MB SDRAM Memory
- 3.2GB Hard Drive [9.5ms]
- 15TX Trinitron Monitor (13.7" v.i.s.)
- 2MB EDO VIRGE 3D Video Card
- 8X EIDE CD-ROM Drive
- ★ Upgrade to 64MB SDRAM, add \$299.
- ★ Upgrade to a 17LS Monitor (15.7" v.i.s.), add \$179.

\$2399

Business Lease: \$89/Mo.
Order Code #500349

DIMENSION UPGRADES ADD

- 33.6 US Robotics Telephony Modem \$149
- 104-Key Performance Keyboard \$ 29
- 1.6GB/3.2GB Travan Tape Backup with Accelerator \$225
- 3Com® EtherLink® Interface Combo PCI Card \$139
- Upgrade to 3 Years On-site Service \$ 99

FREE Norton/Visio Express Software Suite includes Norton AntiVirus, Navigator, Utilities and Visio Express 4.0.

DELL LATITUDE® PENTIUM CHIP-BASED NOTEBOOKS

Base features: ♦ 256KB L2 Cache ♦ PCI Bus with 128-bit Graphics Accelerator ♦ Integrated 16-bit Stereo Sound ♦ Smart Lithium Ion Battery ♦ Touchpad ♦ IrDA 1.0 Standard Compliant ♦ Optional Dell Latitude LM Port Replicator Available ♦ Extendable 1 Year Warranty!

DELL LATITUDE LM P133ST

133MHz PENTIUM PROCESSOR

- 12.1" SVGA Active Matrix Color Display
- 40MB/1.3GB Hard Drive
- Options Bay accepts 6X CD-ROM, 3.5" Floppy Drive (both included) or Optional 2nd Li-Ion Battery
- MS Office Professional for Windows 95
- 28.8 XJACK®/Cabled Modem
- Leather Carrying Case
- ★ 3Com 10 BaseT Network Card, add \$159.

\$3999

Business Lease: \$144/Mo.
Order Code #800060

DELL LATITUDE LM P133ST

133MHz PENTIUM PROCESSOR

- 12.1" SVGA Active Matrix Color Display
- 16MB/810MB Hard Drive
- Options Bay accepts 6X CD-ROM, 3.5" Floppy Drive (both included) or Optional 2nd Li-Ion Battery
- ★ Dell Latitude Port Replicator, add \$159.
- ★ 15TX Trinitron Monitor (13.7" v.i.s.), MS Mouse and 104-key Win95 Keyboard, add \$479.

\$2999

Business Lease: \$111/Mo.
Order Code #800051

DELL LATITUDE LM P100SD

100MHz PENTIUM PROCESSOR

- 11.3" SVGA Dual Scan Color Display
- 24MB/810MB Hard Drive
- Options Bay accepts 6X CD-ROM, 3.5" Floppy Drive (both included) or Optional 2nd Li-Ion Battery
- MS Office Professional for Windows 95
- Nylon Carrying Case
- ★ 28.8 XJACK/Cabled Modem, add \$199.
- ★ 2nd Li-Ion Battery, add \$249.

\$2799

Business Lease: \$104/Mo.
Order Code #800059

DELL LATITUDE LM P100SD

100MHz PENTIUM PROCESSOR

- 11.3" SVGA Dual Scan Color Display
- 16MB/810MB Hard Drive
- Options Bay accepts 6X CD-ROM, 3.5" Floppy Drive (both included) or Optional 2nd Li-Ion Battery
- ★ Upgrade to 24MB RAM, add \$99.
- ★ Upgrade to a 1.3GB Hard Drive, add \$200.
- ★ 2nd Lithium Ion Battery, add \$249.
- ★ Leather Carrying Case, add \$129.
- ★ 3Com 10 BaseT Network Card, add \$159.

\$2399

Business Lease: \$89/Mo.
Order Code #800049

DELL OPENS STORE ON THE WEB

Now you can buy Dell systems online. In fact, you can custom configure, price and track delivery of your PCs right on the Web. It's simple, secure and open twenty-four hours a day. So make shopping easier on yourself. Visit the new Dell web site Store today. Just point your browser to www.dell.com and click on "Buy A Dell!"

Mon-Fri 7am-9pm CT • Sat 10am-6pm CT
Sun 12pm-5pm In Canada, call 800-233-1589

Keycode #01160

TO ORDER

800-348-6153

<http://www.dell.com>

DELL®

\$2599
With Free Software

DELL DIMENSION™ XPS P200s
200MHz PENTIUM® PROCESSOR

- ★ 32MB SDRAM Memory
- 512KB Pipeline Burst Cache
- ★ **NEW 2.1GB Hard Drive [10.5ms]**
- 15TX Trinitron Monitor (13.7" v.i.s.)
- ★ **Matrox Millennium 4MB WRAM Video Card**
- ★ **NEW 12X EIDE CD-ROM Drive**
- AWE32 Wave Table Upgrade Card
- Altec Lansing ACS-31 Speakers

- MS® Office Professional with Bookshelf
- ★ **FREE Norton/Visio Express Software Suite¹**
- Microsoft® Windows 95/MS Plus! CD/30 Days Free Support/MS Mouse
- 3 Year Limited Warranty¹ with 1 Year On-site Service¹
- ★ **Upgrade to a 3.2GB hard drive (9.5ms), add \$99.**
- ★ **Upgrade to a 17LS monitor (15.7" v.i.s.), add \$179.**

Business Lease²: \$96/Mo.
Order Code #500351

FREE!

**NORTON
AntiVirus¹**

**SYMANTEC
NORTON
Navigator**

**SYMANTEC
NORTON
UTILITIES**

**Visio
EXPRESS 4.0**

**HOW TO SUCCEED
IN BUSINESS WITHOUT
BUYING SOFTWARE.**

Besides its formidable 200MHz Pentium processor, this Dell Dimension comes with a powerful package of business software** pre-loaded. Not games. Not fluff. Serious stuff like Microsoft Office for Windows 95.



The 32-bit virus protection of Norton AntiVirus. The powerful

file management features of Norton Navigator. The data protection and recovery tools of Norton Utilities. And the many diagramming tools of Visio Express 4.0. Of course, it also comes with built-in Dell reliability, built-in Dell value, and our guaranteed next-business-day on-site¹ service. So pick up the phone and order today. It may be the fastest way to get ahead in business yet.

DELL®

TO ORDER

800-759-9783

<http://www.dell.com>

Mon-Fri 7am-9pm CT • Sat 10am-6pm CT
Sun 12pm-5pm In Canada, call 800-233-1589

Keycode #01157