

SETTING THE STANDARDS

15
YEARS

BYTE

OCTOBER 1989

A MCGRAW-HILL PUBLICATION

Special Reports:

COMPUTING
WITH
LIGHT

OPTICAL
TECHNOLOGIES
PAGE 228

OPTICAL
STORAGE
PAGE 160

Apple's new portable

MAC *to go*

Quattro 2

Bill Gates on BASIC

Parallel Processing with Macs

Understanding Disk Caching

Inside AppleTalk and NetBIOS

6 Short Takes

REVIEWS

New IBM and Mitac
SX Systems

ColorQuick Mac Printer

Two Portable Printers

Logitech's MultiScope
Debugger

A new X Window System



02662



\$3.50 U.S.A./\$4.50 IN CANADA
0360-5280

0 440235 0

10

OCTOBER 1989

BYTE

MAC PORTABLE • OPTICAL TECHNOLOGIES • OPTICAL STORAGE

Volume 14, Number 10

**SO HOW COME
YOU NEVER CALL?**



*"The new
top-of-the-line
Dell System 325 is
a flagship worth
putting out in front
of the fleet."*

February 14, 1989





THE DELL SYSTEM® 310
20 MHz 386.

The best combination of performance and value available in its class.

STANDARD FEATURES:

- Intel 80386 microprocessor running at 20 MHz.
- Choice of 1 MB, 2 MB, or 4 MB of RAM* expandable to 16 MB (using a dedicated high-speed 32-bit memory slot).
- Advanced Intel 82385 Cache Memory Controller with 32 KB of high speed static RAM cache.
- Page mode interleaved memory architecture.
- VGA systems include a high performance 16-bit video adapter.
- Socket for 20 MHz Intel 80387 or 20 MHz WEITEK 3167 math coprocessor.
- 5.25" 1.2 MB or 3.5" 1.44 MB diskette drive.
- Dual diskette and hard drive controller.
- Enhanced 101-key keyboard.
- 1 parallel and 2 serial ports.
- 200-watt power supply.
- 8 industry standard expansion slots (6 available).

**Lease for as low as \$131/month.
△ Extended Service Plan pricing starts at \$251.

40 MB TTL Monochrome System	\$3,599
40 MB VGA Color Plus System	\$4,099
100 MB VGA Color Plus System	\$4,699
100 MB Super VGA Color System (800x600)	\$4,799

Prices listed reflect 1 MB of RAM. 150 and 322 MB hard drive configurations also available.

*Performance Enhancements (Systems 325, 310, 316 and 220): within the first megabyte of memory, 384 KB of memory is reserved for use by the system to enhance performance.
4 MB configurations available on all systems.
Call for pricing.



THE DELL SYSTEM® 316
16 MHz 386SX.™

Expandable, affordable access to 386 architecture.

STANDARD FEATURES:

- Intel 80386SX microprocessor running at 16 MHz.
- Choice of 1 MB, 2 MB, or 4 MB of RAM* expandable to 16 MB (8 MB on the system board).
- Page mode interleaved memory architecture.
- VGA systems include a high performance 16-bit video adapter.
- LIM 4.0 support for memory over 1 MB.
- Socket for 16 MHz Intel 80387SX math coprocessor.
- 5.25" 1.2 MB or 3.5" 1.44 MB diskette drive.
- Integrated high performance hard disk drive interface and diskette controller on system board. (ESDI based systems include a hard disk controller.)
- Enhanced 101-key keyboard.
- 1 parallel and 2 serial ports.
- 200-watt power supply.
- 8 industry standard expansion slots (7 available).

**Lease for as low as \$98/month.
△ Extended Service Plan pricing starts at \$234.

40 MB TTL Monochrome System	\$2,699
40 MB VGA Color Plus System	\$3,199
100 MB VGA Color Plus System	\$3,799
100 MB Super VGA Color System (800x600)	\$3,899

Prices listed reflect 1 MB of RAM. 150 and 322 MB hard drive configurations also available.



THE DELL SYSTEM® 220
20 MHz 286.

It's faster than many 386 computers, and has a smaller footprint.

STANDARD FEATURES:

- 80286 microprocessor running at 20 MHz.
- Choice of 1 MB, 2 MB, or 4 MB of RAM* expandable to 16 MB (8 MB on system board).
- Page mode interleaved memory architecture.
- LIM 4.0 support for memory over 1 MB.
- Integrated diskette and VGA video controller on system board.
- Socket for Intel 80287 math coprocessor.
- One 3.5" 1.44 MB diskette drive.
- Integrated high performance hard disk interface on system board.
- Enhanced 101-key keyboard.
- 1 parallel and 2 serial ports (integrated on system board).
- 3 full-sized 16-bit AT expansion slots available.

**Lease for as low as \$109/month.
△ Extended Service Plan pricing starts at \$264.

40 MB VGA Monochrome System	\$2,999
40 MB VGA Color Plus System	\$3,299
100 MB VGA Monochrome System	\$3,599
100 MB VGA Color Plus System	\$3,899

Prices listed reflect 1 MB of RAM. External 5.25" 1.2 MB diskette drive available.



THE NEW DELL SYSTEM® 210
12.5 MHz 286.

The price says this is an entry-level system. The performance says it's a lot more.

STANDARD FEATURES:

- Intel 80286 microprocessor running at 12.5 MHz.
- Choice of 512 KB, 640 KB††, 1 MB, or 2 MB of RAM expandable to 16 MB (6 MB on system board).
- Page mode interleaved memory architecture.
- LIM 4.0 support for memory over 1 MB.
- Integrated diskette and high performance 16-bit VGA video controller on system board.
- Socket for Intel 80287 math coprocessor.
- 5.25" 1.2 MB or 3.5" 1.44 MB diskette drive.
- Integrated high performance hard disk interface on system board.
- Enhanced 101-key keyboard.
- 1 parallel and 2 serial ports.
- 3 full-sized 16-bit AT expansion slots available.

**Lease for as low as \$64/month.
△ Extended Service Plan pricing starts at \$190.

20 MB VGA Monochrome System	\$1,699
20 MB VGA Color Plus System	\$1,999
40 MB VGA Monochrome System	\$1,899
40 MB VGA Color Plus System	\$2,199

Prices listed reflect 512 KB of RAM. ††640 KB versions of the above systems are available for an additional \$80. 100 MB hard drive configurations also available.

All prices and specifications are subject to change without notice. Dell cannot be responsible for errors in typography or photography. **Payments based on a 36-month open-end lease. †Leasing arranged by Leasing Group, Inc. In Canada, configurations and prices will vary. DELL SYSTEM is a registered trademark of Dell Computer Corporation. Microsoft, MS, MS-DOS and XENIX are registered trademarks owned by Microsoft Corp. Intel is a registered trademark of Intel Corporation. UNIX is a registered trademark of AT&T. Dell UNIX System V is based on INTERACTIVE Systems Corporation's 386ix.™ ††Signifies trademarks of entities other than Dell Computer Corporation. †Service provided by Xerox Corporation. Service in remote locations will incur additional travel charges. ©1989 Dell Computer Corporation. All rights reserved.

THE DELL SYSTEM® 325 25 MHz 386.

When you need a truly high-performance 386 computer, this is it.

STANDARD FEATURES:

- Intel 80386 microprocessor running at 25 MHz.
- Choice of 1 MB, 2 MB, or 4 MB of RAM* expandable to 16 MB (using a dedicated high-speed 32-bit memory slot).
- Advanced Intel 82385 Cache Memory Controller with 32 KB of high speed static RAM cache.
- Page mode interleaved memory architecture.
- VGA systems include a high performance 16-bit video adapter.
- Socket for 25 MHz Intel 80387 or 25 MHz WEITEK 3167 math coprocessor.
- 5.25" 1.2 MB or 3.5" 1.44 MB diskette drive.
- Dual diskette and hard drive controller.

- Enhanced 101-key keyboard.
- 1 parallel and 2 serial ports.
- 200-watt power supply.
- 8 industry standard expansion slots (6 available).

**Lease for as low as \$196/month.
△ Extended Service Plan pricing starts at \$370.

40 MB VGA Monochrome System	\$5,399
100 MB VGA Color Plus System	\$6,299
100 MB Super VGA Color System (800x600)	\$6,399
150 MB Super VGA Color System (800x600)	\$6,899

Prices listed reflect 1 MB of RAM. 322 MB hard drive configurations also available.

All systems are photographed with optional extras.

Technically speaking, the Dell System[®] 325 is one of the most advanced 386™ computers available. And, according to PC Magazine, it's one of the most advanced 386 computers they've ever tested.

In benchmark after benchmark, the 25 MHz Dell System 325 ran circles around

THE FIRST PERSONAL COMPUTER THAT'S REALLY PERSONAL.

Of the more than 150,000 personal computers we've sold to date, each one has been individually configured to fit the needs of its owner.

The System 325 takes that idea

to its logical extreme.

For example, it runs either MS-DOS[®], MS[®]OS/2, or our own Dell UNIX[®] System V. Which is compatible with AT&T's System V Interface Definition. And the world of XENIX[®] applications.

If speed is of the essence, we can include an optional Intel[®]

THE DELL 386 SYSTEM 325 HAS A 25 MHz CLOCK RATE, CACHE MEMORY CONTROLLER, IDE OR ESDI HARD DISK DRIVE, PAGE MODE INTERLEAVED MEMORY, AND 100% COMPATIBILITY WITH MS-DOS, OS/2 AND UNIX SYSTEM V.

a field of 386-based systems. A field that included the Compaq[^] 386/25.

A show of prowess that earned the System 325 PC Magazine's Editor's Choice award.

It was a goal we set for ourselves from the very beginning. And an objective anyone with a penchant for power and performance can appreciate.



80387 or WEITEK 3167 math coprocessor. And since nothing about this system is lightweight, the standard mass storage is a 100 MB hard disk drive. Or we can configure it with a 40, 150 or 322 MB hard drive.

As you might expect, the output is just as intense. You can choose between VGA Mono-chrome with



paper-white screen, VGA Color Plus, or Super VGA for high resolution colors displayed on a larger screen.

Even though the 325 gives you all this performance, it still leaves you six open slots for whatever else you might want to add.

And once you've told us what you want, we'll make sure what you want works—by burning-in the entire system unit.

COMPUTER RETAILERS ARE NO KNOWS.

There are some good reasons computer retailers won't know much about the System 325.

First, with all the new and increasingly sophisticated systems they have to keep up with on a daily basis, you can hardly expect them to know everything.

Second, because Dell sells direct.

Which means you now have the unique opportunity to talk directly with the people who make them. And ask things like, "What is page mode interleaved memory?" or, "How much SIMM RAM should I add?"

In other words, the kinds of details that are important to people who make computers and people who use them.

So dealing direct not only can save you up to the 35% mark-up, but 100% of the frustration.

WE COME WHEN WE'RE CALLED.

One of the things that very clearly sets Dell systems apart from other computers is not

just how they're sold but how they're supported.

Overkill was one description used in a recent PC Week article.

Perhaps.

But then, we think you'll agree, when something goes wrong, you want as much help as possible, right?

MAYBE YOU SHOULDN'T BUY ONE AFTER ALL.

No matter how many reasons we give you to buy a Dell system, sometimes it makes more sense to lease one instead.

Whether you need a single computer, or an entire office

**BEST OF ALL,
YOU WON'T HAVE TO
EXPLAIN TO A
COMPUTER RETAILER
WHAT ALL
THAT MEANS.**

Which is why every Dell system comes with a toll-free technical support line and self-diagnostic software. We're able to solve 90% of all problems right over the phone. The other 10% receive next-day, desk-side service. Thanks to our new alliance with Xerox Corporation.

And you get all this help for a full year—whenever you need it—at no extra charge.^Δ

As you've probably guessed, one of the things that drives us most is customer satisfaction.

So we'd like to give you the ultimate guarantee:

Try a System 325 in your office for a month. Run your toughest applications. Put it through its paces, at your pace. If you're not completely satisfied, send it back anytime within 30 days. And we'll refund your money.

No questions asked.

full, there is a leasing plan for your business that is just like 100% financing.

And just as we can custom configure your computers, we can see to it you get a custom designed lease plan to fit your exact business needs.[†] A fact that has not gone unnoticed. Especially by the Fortune 500. Over half of whom now own or lease Dell systems.

And just as we welcome their business, we welcome your business, too.

Just call us, toll-free. And don't be afraid to ask us the tough questions.

That's the part we like best.

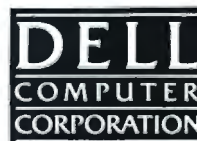

TO ORDER, CALL
800-426-5150
IN CANADA, CALL 800-387-5752
IN GERMANY, CALL 06103/701100
IN THE U.K., CALL 0800 414535



power⁴...The most advanced Cache What else would you expect



PC MAGAZINE, January 1989,
*"In a field of powerhouse machines
there can only be one winner, and
ALR's FlexCache is it."*

INFO WORLD, July 1989,
*"ALR Systems Unleash 486 Power. The
PowerCache 4 shines in the CPU-
specific portion of the InfoWorld Auto-
mated Benchmark Test, gaining a score
of 16.3."*

PC WEEK, July 1989,
*"Based on a series of benchmarks run
last week on Advanced Logic Research,
Inc.'s prototype 486 desktop system,
ALR will enter the 486 market with a
bang."*

At ALR, we will never rest on our laurels. We strive to be the best, as proven by our past achievements. Now with the introduction of the new ALR PowerCache 4™, we've designed a system that is far beyond comparison. Again, we have taken PC-microprocessing power a step further by designing a unique proprietary PowerCache 4 cache controller using ALR's custom ASIC chips which deliver the fastest processing speed ever.

More important, PowerCache 4 is the first PC to fully utilize 128-bit burst mode and a "read and write-back" 128KB cache design, providing a better than zero wait state performance as compared to the i386. Furthermore, the ALR PowerCache 4 is 100% IBM® PS/2™ Micro Channel™-compatible supporting bus mastering devices and giving

	ALR M130 Desktop	ALR M150, M350 M650 Floor-Standing	IBM M70-A21 Power Platform™
CPU	25 MHz i486	25 MHz i486	25 MHz i486
Bus	MCA	MCA	MCA
External Cache	128 KB cache Read and Write-Back	128 KB cache Read and Write-Back	None
Video Opt. on board	640x480 1024x768	640x480 1024x768	640x480 None
I/O Slots	6 expansion slots	6 expansion slots	3 expansion slots
Storage Expansion	4-3 1/2"	1-full height 2-1/2"-height 2-3 1/2" drives	3-3 1/2" drives
Disk Capacity	130 MB-260 MB	150 MB-650 MB	110 MB
Price	\$9,990	Starting at \$11,490	\$12,990

Take any 1 of 3 sets for only \$4.⁹⁵

when you join the
Small Computer Book Club

Please accept my application for trial membership and send me the set that I have indicated below, billing me only \$4.95, plus shipping and handling, and send my free disk, Alfred Glossbrenner's Selected Shareware. I agree to purchase at least three additional Selections or Alternates over the next 12 months. Savings range up to 30% and occasionally even more. My membership is cancelable any time after I buy these three additional books. A shipping and handling charge is added to all shipments.

Check which one you want:

- C Programmer's Library (00010)
 Turbo Pascal Programmer's Library (00011)
 dBase Programmer's Library (00012)

No-Risk Guarantee: If I am not satisfied—for any reason—I may return my introductory set and Alfred Glossbrenner's Selected Shareware within 10 days. My membership will be canceled, and I will owe nothing.

Name _____

Address _____ Apt. _____

City _____

State _____ Zip _____

(Books purchased for professional purposes may be a tax-deductible expense. Offer good in Continental U.S. and Canada only. Prices slightly higher in Canada.)

Byte 10/89

Y-CF3

Take any 1 of 3 sets for only \$4.⁹⁵

when you join the
Small Computer Book Club

Please accept my application for trial membership and send me the set that I have indicated below, billing me only \$4.95, plus shipping and handling, and send my free disk, Alfred Glossbrenner's Selected Shareware. I agree to purchase at least three additional Selections or Alternates over the next 12 months. Savings range up to 30% and occasionally even more. My membership is cancelable any time after I buy these three additional books. A shipping and handling charge is added to all shipments.

Check which one you want:

- C Programmer's Library (00010)
 Turbo Pascal Programmer's Library (00011)
 dBase Programmer's Library (00012)

No-Risk Guarantee: If I am not satisfied—for any reason—I may return my introductory set and Alfred Glossbrenner's Selected Shareware within 10 days. My membership will be canceled, and I will owe nothing.

Name _____

Address _____ Apt. _____

City _____

State _____ Zip _____

(Books purchased for professional purposes may be a tax-deductible expense. Offer good in Continental U.S. and Canada only. Prices slightly higher in Canada.)

Byte 10/89

Y-CF3

Take any 1 of 3 sets
for only \$4.95!



BUSINESS REPLY MAIL
FIRST CLASS PERMIT NO.230 DELRAN, N.J.

POSTAGE WILL BE PAID BY ADDRESSEE

NO POSTAGE
NECESSARY
IF MAILED
IN THE
UNITED STATES



**THE SMALL COMPUTER
BOOK CLUB**

900 Chester Avenue
Delran, New Jersey 08075-9889



Take any 1 of 3 sets
for only \$4.95!

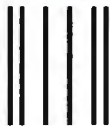

BUSINESS REPLY MAIL
FIRST CLASS PERMIT NO.230 DELRAN, N.J.

POSTAGE WILL BE PAID BY ADDRESSEE

NO POSTAGE
NECESSARY
IF MAILED
IN THE
UNITED STATES



**THE SMALL COMPUTER
BOOK CLUB**

900 Chester Avenue
Delran, New Jersey 08075-9889





**California Anza-Borrego
Desert State Park**

*(Cannonball-shaped sandstone.
These concretions are
formed of onion-skin layers of
minerals resistant to erosion.)*

i486TM system in the world. from the leader in 386TM technology.

you a more efficient system for a variety of multi-user and fileserver applications. Like most ALR computers, the PowerCache 4 is a truly balanced system. The fastest power is achieved by enhancing our PowerCache 4 design with the industry's fastest disk drives and interface. The PowerCache 4 systems come standard with a high-speed 15MHz ESDI and 32 KB hard disk cache on the disk controller. What more could you possibly need.

It's no wonder ALR remains ahead of the pack with our innovative design expertise. As far back as 1986, we've been recognized in the industry as a leader in performance. Recently, the highly acclaimed 386/220 won us "Best of 1987" from *PC Magazine*. 1988 brought us the honor of receiving the *PC Magazine* Award for Technical Excellence for designing the industry's most advanced cache architecture. As for 1989 we've already begun to excite the industry with the PowerCache 4.

Now, what else would you expect from a company who is so committed to innovation and high-performance technology that we take you a step beyond. At ALR, we are concerned with your processing needs. Our technical support staff is available to assist you by one simple phone call. All our systems are backed by a one year warranty. Call today for more information on the new PowerCache 4 and the name of an authorized reseller nearest you.

1-800-444-4ALR



PowerCache 4 is the first PC to fully utilize 128-bit burst mode and a "read and write-back" 128KB cache design, providing better than zero wait state performance as compared to the i386.



Advanced Logic Research, Inc.
9401 Jeronimo Irvine, CA 92718
(714) 581-6770 FAX: (714) 581-9240
For our Canadian office:
1-800-443-4CAN
For our UK office:
0 635-521 844 FAX: 0 635-521 844
For our Singapore:
(65) 258-1286 FAX: (65) 258-1285

ALR and Advanced Logic Research, Inc. are registered trademarks. PowerCache 4 is a registered trademark of Advanced Logic Research, Inc. IBM and PC, PS/2, Micro Channel are registered trademarks of International Business Machines Corporation. Intel, 386 and i486 are registered trademarks of Intel Corporation.

PRODUCTS IN PERSPECTIVE

49 What's New

81 Short Takes

PageMaker for OS/2 Presentation Manager, Aldus puts desktop publishing in the fast lane
Think C 4.0, a major upgrade from Symantec
DeskWriter, Hewlett-Packard's ink-jet printer for the Mac
HyperAccess/5, Hilgraeve adds many new features
DOS Mounter, a utility from Dayna to use with Apple's FDHD
hyperStore-816 and **SmartCache PM3011**, caching disk controllers from Perceptive Solutions and Distributed Processing Technology

FIRST IMPRESSIONS

- 111 **VROOOM Goes the Spreadsheet**
by Rich Malloy
Borland's new Quattro combines the advantages of Excel with Lotus 1-2-3 compatibility.



COVER STORY

The Portable and the Powerful

by Tom Thompson
and Frank Hayes
page 98

Apple's Portable Mac finally arrives, accompanied by the impressive Mac IICI.

REVIEWS

- 160 **Product Focus: The Optical Option**
by Steve Apiki and Howard Eglowstein
WORM and erasable optical disk systems offer practical, large-scale storage.
- 181 **MCA Meets SX**
by Mark L. Van Name and Bill Catchings
IBM's PS/2 Model 55 SX and American Mitac's MPS2386 combine MCA with the 80386SX.
- 187 **Color Printer Quells Price-Tag Blues**
by Tom Thompson
ColorQuick offers Mac users a slow but effective alternative to pricey thermal printers.
- 191 **Speed Separates Two Portable Printers**
by Wayne Rash Jr.
Kodak and Toshiba take different routes to design printers for the road.

EXPERT ADVICE

- 115 **Computing at Chaos Manor: Disasters and Diversions**
by Jerry Pournelle
Jerry tries to revive a damaged floppy disk and glories in using new CD-ROM products.
- 131 **The Unix /bin: The Root to Happiness**
by David Fiedler
Working with Unix has its privileges—literally.
- 143 **OS/2 Notebook: A Compendium of OS/2 Applications**
by Mark J. Minasi
A new OS/2 application guide lists hundreds of programs.



- 144E **Macinations: Crimes of the Heart?**
by Don Crabb
Don delineates his Macintosh wish list.
- 151 **Down to Business: IBM's Vision for Your Office**
by Wayne Rash Jr.
OfficeVision brings IBM's grand plan into view.
- 155 **NetWorks: Breaking Down the Barriers**
by Mark L. Van Name and Bill Catchings
A look at the issues you'll face if you try to integrate PCs and Macs on a LAN.

REGIONAL SECTION
begins after page 80

- 195 **Four Debuggers in One**
by Martin Heller
The MultiScope OS/2 debugger from Logitech challenges Microsoft's CodeView.
- 201 **X Window System on the March**
by Tom Yager
A look at 386/ix X11, a new 80386 X Window system from Interactive Systems.
- 211 **Visually Map Your Data**
by Stan Miastkowski
Mapping Information Systems' MapInfo puts your dBASE III data on the map—literally.
- 217 **How Super Is SuperCard?**
by Richard D. Lasky
Silicon Beach's improvement on HyperCard's features may have been costly in performance.

IN DEPTH

- 228 **Introduction: Optical Technologies**
- 231 **Computing With Light**
by H. John Caulfield
Optical computers combine the best of the electronic and optical worlds.
- 239 **The Nitty Gritty Optical Band**
Optical developments occur in the "nitty gritty" aspects of packaging, interconnections, ICs, and signaling:
- 240 **Levels of Light**
by Joseph W. Goodman
Optical interconnections are one route to high-speed computing.
- 244 **Joining Forces**
by Donald J. Channin
Optoelectronics combines optics and electronics on a single chip.
- 249 **Reflected Light**
by Gary T. Forrest
Laser technology has an impact on everything from laser printers to optical disks.

- 259 **Gigabytes On-Line**
by James J. Burke and Bob Ryan
Erasable optical disk drives will change your notions of mass storage.
- 266 **Read/Write Optical Subsystems**
A guide to optical drive systems that let you store your own data.

FEATURES



- 268 **The 25th Birthday of BASIC**
by Bill Gates
Microsoft's chairman and coauthor of Microsoft BASIC tells where BASIC has been and where it's going.
- 279 **Occam II**
by Dick Pountain
The Occam II language is designed for parallel processing.
- 287 **Hands-On Parallel Processing**
by Geoffrey C. Fox, Alex W. Ho, Paul Messina, and Terry Cole
How to assemble a functional hypercube using Macs and AppleTalk.

HANDS ON

- 297 **Under the Hood: Disk Caching**
by L. Brett Glass
How to evaluate different disk-caching schemes.
- 303 **Some Assembly Required: Two Tin Cans and Some String, Part 1**
by Rick Grehan
The first of a two-part series comparing AppleTalk and NetBIOS.

DEPARTMENTS

- 8 Editorial:
Hip-Deep and Rising
- 17 Microbytes
- 32 Letters and Ask BYTE
- 48C Chaos Manor Mail
- 351 Coming Up in BYTE
- 360 Print Queue
- 364 Stop Bit
- READER SERVICE**
- 350 Editorial Index by Company
- 352 Alphabetical Index to Advertisers
- 354 Index to Advertisers by Product Category
- Inquiry Reply Cards: after 356

PROGRAM LISTINGS

From BIX: See 358

From BYTEnet:
call (617) 861-9764

On disk:
See card after 248

COVER LASER ANIMATION
AND PHOTOGRAPHY:
IMAGE ENGINEERING © 1989

BYTE (ISSN 0360-5280) is published monthly with an additional issue in October by McGraw-Hill, Inc. Postmaster: Send address changes, USPS Form 3579, and fulfillment questions to BYTE Subscriptions, P.O. Box 551, Hightstown, NJ 08520. Second-class postage paid at Peterborough, NH 03458, and additional mailing offices. Postage paid at Winnipeg, Manitoba, Registration number 9321. Printed in the United States of America.

Not responsible for lost manuscripts or photos. Opinions expressed by the authors are not necessarily those of BYTE.

Copyright © 1989 by McGraw-Hill, Inc. All rights reserved. Trademark registered in the United States Patent and Trademark Office.



Subscription questions or problems should be addressed to: BYTE Subscriber Service, P.O. Box 551, Hightstown, NJ 08520.

Microsoft Excel - FFBLNS01.XLS

File Edit Formula Format Data Options Macro Window Help

B34

Future Fortune Company Consolidated Balance Sheet

Assets	1988	1987	1986
Current Assets	\$132,546	\$104,668	\$91,787
Accounts Receivable	\$55,034	\$55,061	\$41,017
Inventories			
Other			
Total Current Assets			
Other Assets			
TOTAL ASSETS			
Liabilities and Stock			
Current Liability			
Accounts Payable			
Customer Deposits/D			
Royalties and Comm			
Accrued Compensat			
Notes Payable			
Income Taxes Payab			

Designer - HKTSHR02.DRW

File Edit Draw View Change Arrange Line Pattern Text

Sales Volume to Trend

By no small coincidence, Microsoft Windows works the way you do: On more than one thing at a time.

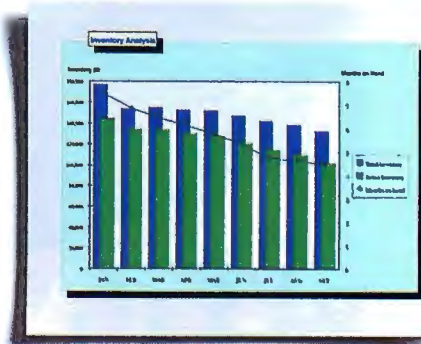

WYSIWYG. What you see on screen...

...is exactly what you get on paper.

An entire environment that lets

Future Fortune Company

Dough placement and size distinguishes Future Fortune's cookies from all others. Note: Diameter should be the standard 6 cm, while the thickness of the cookie should be reduced to .05 cm. FFC accountants report a reduction in thickness could mean millions of dollars in dough savings.

Old sayings may cost Future Fortune

It has been roughly 68 years since FFC last created new fortunes. But in light of the new logo and the whole new look brought to the company in the past year, the board of directors has unanimously voted to replace the old fortunes. President Jim Dearing explained, "As we exit the 1980's, people no longer believe in the same old lines, it's time to change".



More good news: Hundreds of great Windows applications are available right now, as you read.

Fortune Teller
1989

Cookie Standards, rolling in the dough

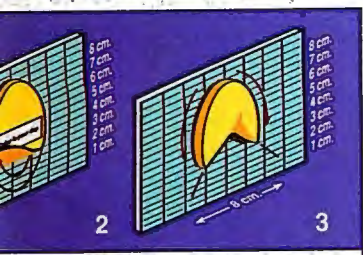

results, the fortune is lower third of the and slightly to the bottom is folded, the fortune should be placement is all-in-owns the consumer to cookie without tear.

The last, and the most intricate, step in Future Fortune Cookie making is when our trade dimple is placed on the cookie. As the arrows indicate, it is important to pull down on both sides of the cookie so the dimple is pushed in from the bottom.

Fortunes for the month of August

- and a reliable au pair.
- important call on your car phone.
- urgery lifts spirits as well as wrinkles.
- will never return from maternity leave.
- it is a thing of the past. Invest in a car soon.
- est in real estate will only lead to frustration.
- osper as will your accountant.
- ishes second nobody remembers.

do amazing things—like this—simply.



We'd like everyone who's using Windows applications on a part-time basis to please stop.

The trouble with using Windows™ applications every once in a while, is that you're only amazingly productive every once in a while.

This has got to stop. Which is why there's the Microsoft® Windows environment—the first and only graphical environment to let you work with multiple Windows or DOS applications without ever closing a single file, or quitting a single program.



You may never see your C prompt again. Just give Microsoft Windows a 40-hour work week and you'll be pointing, clicking, cutting, pasting and flying through your work with the greatest of ease. Cut from a spreadsheet and paste onto a word processing document—without scissors and a copy machine. Exchange information, link files and programs, then watch your data get updated automatically, or if you prefer, at your command.

Call us at (800) 541-1261, Dept. J89 for more facts about how Windows can open up doors, and for our free Windows Shopping Catalog.

And see how the only way to get the most out of your Windows, is to look into ours.

Microsoft
Making it all make sense™

Customers inside the 50 United States, call (800) 541-1261, Dept. J89. In Canada, call (416) 673-9811. Outside the U.S. and Canada, call (206) 882-8661. © 1989 Microsoft Corporation. All rights reserved. Microsoft and the Microsoft logo are registered trademarks and Making it all make sense and Windows are trademarks of Microsoft Corporation.

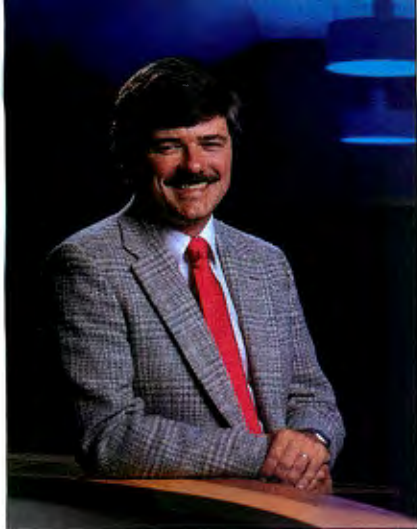

HIP-DEEP AND RISING

Smoke, mirrors, and misinformation can make your computing decisions needlessly complex

Some decisions are easy. Some are inherently difficult. And far too many are made unnecessarily difficult by smoke, bluster, and misinformation.

It's a problem that knows no boundaries of brand, operating system, or architecture, but for simplicity's sake, consider just the decisions involved when upgrading 80286- and 80386-based machines. I'll look at the 80386-based machines first.

If you bought a 16-MHz 80386-based machine a few years ago, you're probably now wondering about upgrading to 20, 25, or 33 MHz. If your current machine is working fine, it's merely a matter of checking out the specifications, benchmark results, and prices of the newer machines to see how many bucks *the extra bang* is going to cost you. Either the increase in speed (and, one assumes, productivity) is worth the expense, or it isn't. It's a relatively simple equation, with all factors known or knowable. Piece of cake.

Yes, certain complications can muddy the waters. For example, some early 80386 boxes accommodate only a relatively small amount of RAM on the motherboard and lack 32-bit memory-card slots. If you want to run memory-hungry software on such a machine, you'll have to use a regular AT-class memory card and suffer the delays imposed by the 16-bit bottleneck. This factor alone may justify an upgrade, even if there's nothing else "wrong" with your current setup.

A few unlucky souls face some really oddball complications. For example, some early 80386 chips were buggy. Once Intel knew there was a problem, it (laudably) instituted a liberal exchange policy to get the bad chips out of circulation. But despite Intel's efforts, there's little doubt that some manufacturers—especially the low-end cloners—shipped some systems with bad chips.

The total number of bad chips now in daily use is probably small, but for those who have those early chips, it could be bad news. One of the bugs, for instance, causes incorrect 32-bit multiplies, which may be no big deal under vanilla DOS but can be a real headache with 32-bit software.

Factoring this kind of problem into an upgrade decision involves a little spelunking: You'd need to physically examine or test a suspect chip. (Intel stamped two Greek sigmas on chips that were known to be good.) Also, there's public domain software that performs a quick-and-dirty 32-bit multiply and then checks the answer for accuracy. Such software is available on BIX in the IBM Exchange: Search for "bug" or "multiply" to find it.

So far, so good. Even with some oddball complications thrown in, you can find good answers to most upgrade questions. But artificial, unnecessary complications, like the spread of bad information, can make upgrade decisions very hard indeed.

Take the 80286 versus 80386SX question, for example. It shouldn't be at all difficult to sort out. BYTE readers got the full story last March, when our 80286 versus 80386SX cover story "Battle of the Chips" detailed the similarities and differences between the chips. Readers could fairly easily determine when it made sense to stay with fast 80286-based machines, when it made sense to opt for an 80386SX, and when it made the most sense to go with a "real" 80386 (without the SX's 32-bit-to-16-bit bottleneck).

But there's still a ton of confusion among users at large. Some people still think you need an 80386 to run OS/2. (You don't. An 80386-specific version of OS/2 won't be available until next year.) Some think that an 80386SX is inherently faster than an 80286. (It's not. At any given clock speed, an 80286 will generally keep up with an 80386SX; and in a number of important areas, like task switching, the 80286 is substantially faster than the SX.) Some think an 80386SX will save them money. (Not really. Most SX machines cost hundreds of dollars more than just-as-fast 80286 boxes. And some low-end 80386 clones, with full 32-bit memory buses, actually cost less than some name-brand SX machines, with their 16-bit buses.)

The problem here isn't the SX—there are cases where the SX is indeed the best choice. And as prices for the SX continue to drop, it will become more attractive and more competitive.

The problem is that this is just one of a growing number of instances where misinformation makes a computer decision needlessly complex. The sources of misinformation abound—some innocent, and some deliberate. Compare BYTE's SX story to a recent cover story in another major computer magazine, whose purpose seems not to be helping readers match the right tool for the job, but pushing them toward buying powerful and expensive gear, regardless of whether it's overkill. Misleading ads are bad enough, but when supposedly objective publications start acting as shells, it's downright scary.

As consumers, we need to be exceptionally alert to the hidden agendas of our information sources. Caveat emptor was never sounder advice. Upgrade decisions are hard enough without getting distracted by bad recommendations, bad information, or plain old hype.

—Fred Langa
Editor in Chief
(BIX name "flanga")

At last, an assistant that follows your directions



Wouldn't it be great to delegate your routing?

You can! We know your time is valuable. That's why Wintek pioneered comprehensive and affordable CAD packages for IBM personal computers. HiWIRE-Plus continued that tradition, integrating schematic-capture features and printed-circuit-artwork capabilities into one versatile package.

New autorouter.

The Autorouter for HiWIRE-Plus is powerful enough to handle the most demanding design problems, yet simple enough for a casual user. Just turn it loose on your design. It's hassle free because it works long hours, without supervision or errors.

100% autorouting.

The autorouter for HiWIRE-Plus rips-up, reroutes, and with appropriate design rules, racks up 100% completion.

- Forget gridded routers. This autorouter places vias and traces anywhere your design rules allow. With 1-mil resolution.
- Vary trace width and spacing for individual networks. Route 1, 2, 3, or more tracks between IC and connector pins.
- Set up boards from 1 to 250 layers, up to 60" x 60".
- Specify shape, size, and type of vias, layer-by-layer: through-hole, blind, buried, micro. Specify via types for individual networks.
- Use fewer vias and layers than comparably priced autorouters.
- For use on your IBM PC, XT, AT, PS/2, or compatible with 640K RAM.

Why pay more for a 100% autorouter?

Compare the features and performance to packages costing five times more. HiWIRE-Plus and the Autorouter for HiWIRE-Plus sell for \$895 each. Both have a no-nonsense, 30-day money-back guarantee. With unlimited, toll-free, no-charge technical support.

Let HiWIRE convince you that it makes a great assistant. Call us toll-free at (800) 742-6809 today and put HiWIRE-Plus and the Autorouter for HiWIRE-Plus to work for you tomorrow.



Wintek Corporation
1801 South Street
Lafayette, IN 47904-2993
Fax: (317) 448-4823
Phone: (317) 742-8428 or

(800) 742-6809

OUTSTANDING IN THEIR FIELD.

We've been recognized for being outstanding in our field because we're committed to our customers. We founded Gateway 2000 to provide *quality computers at aggressive prices with uncompromising service after the sale.* We've done what we set out to do.

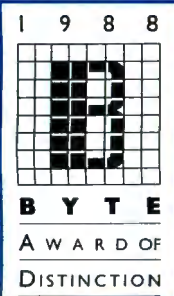

Gateway computer systems are assembled by

hand in our factory located just outside Sioux City, Iowa. The midwest work ethic is evident in every computer we produce. You'll also find the latest technology in all of our systems.

One look at our prices and you'll see we're aggressive. Most importantly, look at our *commitment to service.* We give you a full one-year warranty which includes *free on-site*

service in most locations nationwide. Of course you also receive a 30-day money back guarantee and *lifetime* toll-free phone support.

If you're shopping for real value in a computer system, call Gateway 2000. *You have our personal pledge that you will be completely satisfied!*

Ted Waitt
President

Norm W. Waitt
Vice President

12 MHZ 286 LAPTOP

- Gas Plasma Display Screen
- 2.6 Megs RAM
- 1.44 Meg 3.5" Floppy Drive
- External Port for 5¼" Drive
- 40 Meg 28ms Hard Drive
- 1 Parallel & 1 Serial Port
- Expansion Slot (16 Bit)
- External EGA Monitor Port
- 84 Key Keyboard
- MS DOS 3.3 Installed

\$2995.00



**12 MHZ
286 VGA**

**16 MHZ
286 VGA**

**20 MHZ
286 VGA**

**20 MHZ
386 VGA**

- 80286-12 Processor
- 2 Megs RAM
- 1.2 Meg 5¼" Drive
- 1.44 Meg 3.5" Drive
- 40 Meg 28ms Drive
- 16 Bit VGA Board
- 14" Multisynch Monitor
- 1 Parallel & 2 Serial Ports
- 101 Key Keyboard
- MS DOS 3.3 or 4.01

\$2195.00

- 80286-16 Processor
- 2 Megs RAM
- 1.2 Meg 5¼" Drive
- 1.44 Meg 3.5" Drive
- 40 Meg 28ms Drive
- 16 Bit VGA Board
- 14" Multisynch Monitor
- 1 Parallel & 2 Serial Ports
- 101 Key Keyboard
- MS DOS 3.3 or 4.01

\$2295.00

- 80286-20 Processor
- 2 Megs RAM
- 1.2 Meg 5¼" Drive
- 1.44 Meg 3.5" Drive
- 40 Meg 28ms Drive
- 16 Bit VGA Board
- 14" Multisynch Monitor
- 1 Parallel & 2 Serial Ports
- 101 Key Keyboard
- MS DOS 3.3 or 4.01

\$2395.00

- 1 Meg RAM
- 1.2 Meg 5¼" Drive
- 1.44 Meg 3.5" Drive
- 80 Meg 28ms Drive
- 16 Bit VGA Board
- 14" Multisynch Monitor
- 1 Parallel & 2 Serial Ports
- 101 Key Keyboard
- MS DOS 3.3 or 4.01

\$2995.00

*Upgrade to 4 Megs \$500
64K Cache Add \$250*

Monochrome Systems Deduct \$500

**25 MHZ
386 VGA**

**33 MHZ
386 VGA**

- 4 Megs RAM
- 1.2 Meg 5¼" Drive
- 1.44 Meg 3.5" Drive
- 150 Meg 16.5ms ESDI Drive
- 16 Bit VGA Board
- 14" Multisynch Monitor
- 1 Parallel & 2 Serial Ports
- 101 Key Keyboard
- MS DOS 3.3 or 4.01

\$4245.00

64K Cache Add \$500

- 64K Cache RAM
- 4 Megs RAM
- 1.2 Meg 5¼" Drive
- 1.44 Meg 3.5" Drive
- 150 Meg 16.5ms ESDI Drive
- 16 Bit VGA Board
- 14" Multisynch Monitor
- 1 Parallel & 2 Serial Ports
- 101 Key Keyboard
- MS DOS 3.3 or 4.01

\$5495.00



**GATEWAY 2000 • P.O. BOX 2000
SERGEANT BLUFF, IOWA 51054
IN IOWA 712-943-2000
TOLL FREE 800-523-2000**

Due to the volatility in the DRAM market, all prices are subject to change.

BYTE

EDITOR IN CHIEF
Frederic S. Langa

PUBLISHER/GROUP VICE PRESIDENT
J. Burt Totaro

OPERATIONS
Glenn Hartwig *Associate Managing Editor*

REVIEWS (Hardware, Software, Product Focus)
Michael Nadeau *Associate Managing Editor*, Dennis Allen *Senior Technical Editor, Software*, Richard Grehan *Director, BYTE Lab*, Stephen Apiki *Testing Editor, BYTE Lab*, Stanford Diehl *Testing Editor, BYTE Lab*, Howard Eglowstein *Testing Editor, BYTE Lab*, Stanley Wszola *Testing Editor, BYTE Lab*

NEWS AND TECHNOLOGY (Microbytes, What's New, Short Takes)
Rich Malloy *Associate Managing Editor*, D. Barker *Senior Editor, News and Technology*, Anne Fischer *Lent Senior Editor, New Products*, Andrew Reinhardt *Associate News Editor*
Peterborough: Roger Adams *Associate News Editor*, David Andrews *Associate News Editor*, Martha Hicks *Associate News Editor*
West Coast: Gene Smarte *Bureau Chief*, Costa Mesa, Nicholas Baran *Senior Technical Editor*, Frank Hayes *News Editor*, Jeffrey Bertolucci *Associate News Editor*, San Francisco

SENIOR TECHNICAL EDITORS
Ken Sheldon *Features*, Jane Morrill Tazelaar *In Depth*, Tom Thompson *At Large*, Jon Udell *At Large*

TECHNICAL EDITORS
Janet J. Barron, Alan Joch, Robert Mitchell, Robert M. Ryan, Ben Smith

SENIOR CONTRIBUTING EDITOR
Jerry Pournelle

CONTRIBUTING EDITORS
Don Crabb, David Fiedler, L. Brett Glass, Hugh Kenner, Mark Minasi, Wayne Rash Jr.

CONSULTING EDITORS
Jonathan Amsterdam, Laurence H. Loeb, Trevor Marshall, Stan Miastkowski, Dick Pountain, Phillip Robinson, George A. Stewart, Mark L. Van Name, Peter Wayne

COPY EDITORS
Lauren Stickler *Chief*, Cathy Kingery *Copy Administrator*, Susan Colwell, Jeff Edmonds, Judy Grehan, Nancy Hayes, Margaret A. Richard, Warren Williamson

EDITORIAL ASSISTANTS
Peggy Dunham *Office Manager*, Linda C. Ryan, June N. Sheldon, Lynn Susan Valley

ART
Nancy Rice *Director*, Joseph A. Gallagher *Assistant Director*, Lisa Nardecchia *Assistant*, Jan Muller *Assistant*, Alan Easton *Technical Artist*

PRODUCTION
David R. Anderson *Director*, Virginia Reardon *Senior Editorial Production Coordinator*, Barbara Busenbark *Editorial Production Coordinator*, Denise Chartrand *Editorial Production Coordinator*, Michael J. Lonsky *Editorial Production Coordinator*

TYPOGRAPHY
Sherry Fiske *Systems Manager*, Donna Sweeney *Applications Manager*, Christa Patterson

ADVERTISING/PRODUCTION (603) 924-6448
Lisa Wozmak *Director of Advertising Services*, Linda Fluhr *Customer Service Supervisor*, Lyda Clark *Senior Account Coordinator*, Dale Christensen, Karen Cilley, Roxanne Hollenbeck, Rod Holden, Wai Chiu Li *Quality Control Manager*

EDITORIAL AND BUSINESS OFFICE:
One Phoenix Mill Lane, Peterborough, NH 03458, (603) 924-9281.
West Coast Branch Offices: 425 Battery St., San Francisco, CA 94111, (415) 954-9718; 3001 Red Hill Ave., Building #1, Suite 222, Costa Mesa, CA 92626, (714) 557-6292.
New York Branch Editorial Office: 1221 Avenue of the Americas, New York, NY 10020, (212) 512-3175.
BYTEnet: (617) 881-9764 (set modem at 8-1-N or 7-1-E; 300 or 1200 baud).
Editorial Fax: (603) 924-2550. Advertising Fax: (603) 924-7507.
SUBSCRIPTION CUSTOMER SERVICE: Outside U.S. (609) 426-7070; inside U.S. (800) 232-BYTE.
For a new subscription—(800) 257-9402 U.S. only, or write to BYTE Subscription Dept., P.O. Box 555, Hightstown, NJ 08520.

Officers of McGraw-Hill Information Services Company: President: Walter D. Serwatka. Executive Vice Presidents: Kenneth E. Gazzola, Aerospace and Defense; Ira Herenstein, Computers and Communications; Russell C. White, Construction; Robert P. McGraw, Healthcare; Brian H. Hall, Legal. Senior Vice Presidents—Publishers: Laurence Altman, Data Communications; David J. McGrath, Engineering News-Record. Senior Vice Presidents: John W. Fink, Finance; Michael J. Koeller, Human Resources. Group Vice Presidents: J. Burt Totaro, BYTE; Norbert Schumacher, Energy/Process Industries. Vice Presidents: George Elsingner, Circulation; Julia Lenard, Systems Planning and Technology; Elisabeth K. Allison, Planning and Development.

Officers of McGraw-Hill, Inc.: Joseph L. Dionne, Chairman, President, and Chief Executive Officer; Robert N. Landes, Executive Vice President, General Counsel, and Secretary; Robert J. Bahash, Executive Vice President and Chief Financial Officer; Frank D. Panglase, Senior Vice President, Treasury Operations.

ADMINISTRATION
Donna Nordlund *Publisher's Assistant*

MARKETING AND PLANNING
L. Bradley Browne *Director*
Pamela Petrakos-Wilson *Marketing Communications Manager*, Dawn Matthews *Public Relations Manager*, Lisa Jo Steiner *Assistant Promotion Manager*, Stephanie Warnesky *Marketing Art Director*, Sharon Price *Associate Art Director*, Julie Perron *Senior Market Research Analyst*, Faith Kluntz *Copyrights Coordinator*, Cynthia Damato *Sands Reader Service Coordinator*, Carol Pitman *Marketing Assistant*

FINANCIAL SERVICES
Philip L. Penny *Director of Finance and Services*, Kenneth A. King *Business Manager*, Marilyn Parker, Diane Henry, JoAnn Walter, Jaime Huber, Agnes Perry

CIRCULATION
Dan McLaughlin *Director*
Vicki Weston *Assistant Manager*, Karen Desroches *Distribution Coordinator*, Louise Menegus *Back Issues*

PERSONNEL
Patricia Burke *Human Resources Administrator*, Beverly Goss *Receptionist*

BUILDING SERVICES
Tony Bennett *Manager*, Cliff Monkton, Mark Monkton, Gary Graham

BIX BYTE INFORMATION EXCHANGE

DIRECTOR
Stephen M. Laliberte

EXECUTIVE EDITOR
George Bond

MANAGING EDITOR
Tony Lockwood

MICROBYTES DAILY
D. Barker *Coordinator*, Peterborough, Rich Malloy *New York*, Gene Smarte *Costa Mesa*, Nicholas Baran *San Francisco*, Rick Cook *Phoenix*, Frank Hayes *San Francisco*, Martin Heller *Boston*, Jason Levitt *Austin, TX*, Laurence H. Loeb *Wallington, CT*, Brock N. Meeks *San Francisco*, Stan Miastkowski *Peterborough*, Wayne Rash Jr. *Washington, DC*, Andrew Reinhardt *New York*, Sue Rosenberg *Washington, DC*, David Reed *Lexington, KY*

GROUP MODERATORS
David Allen *Applications*, Leroy Casterline *Other*, Marc Greenfield *Programming Languages*, Jim Howard *Graphics*, Gary Kendall *Operating Systems*, Steve Krenek *Computers*, Brock N. Meeks *Telecommunications*, Barry Nance *New Technology*, Donald Osgood *Computers*, Sue Rosenberg *Other*, Jon Swanson *Chips*

EXCHANGE EDITOR
Laurence H. Loeb *Macintosh Exchange Editor*

BUSINESS AND MARKETING
Patricia Bausum *Secretary*, Denise A. Greene *Customer Service*, Brian Warnock *Customer Service*, Tammy Burgess *Customer Credit and Billing*

TECHNOLOGY
Clayton Lisle *Director*, *Business Systems Technology, ISCo.*, John Spadatoro *Programmer/Analyst*, Wayne Power *Senior Business Systems Analyst*

ADVERTISING SALES
Steven M. Vito *Associate Publisher*, *Vice President of Marketing*

Sara Lyon *Administrative Assistant*

Arthur H. Kossack *Eastern Regional Sales Manager*, (312) 751-3700
Jennifer L. Bartel *Western Regional Sales Manager*, (214) 644-1111
Susan Vernon *Sales Assistant*

NEW ENGLAND
ME, NH, VT, MA, RI, ONTARIO, CANADA & EASTERN CANADA
John C. Moon (617) 282-1180

ATLANTIC
NY, NYC, CT, NJ (NORTH)
Kim Norris (212) 512-2845

EAST
PA, KY, NJ (SOUTH), MD, W. VA, DE, DC
Thomas J. Brun (215) 498-3833

SOUTHEAST
NC, SC, GA, FL, AL, TN, VA, MS
Thomas H. Tolbert (404) 252-0628

MIDWEST
IL, MO, KS, IA, ND, SD, MN, WI, NE, IN, MI, OH
Kurt Kelley (312) 751-3740

SOUTHWEST, ROCKY MOUNTAIN
CO, WY, OK, TX, AR, LA
Karl Heinrich (713) 482-0757

SOUTH PACIFIC
SOUTHERN CA, AZ, NM, LAS VEGAS, UT
Ron Cordek (714) 557-6292
Tom Harvey (213) 480-5243

NORTH PACIFIC
HI, WA, OR, ID, MT, NORTHERN CA, NV (except LAS VEGAS), WESTERN CANADA
Bill McAfee (408) 879-0371
Christine Kopec (415) 362-4600

TELEMARKETING
Liz Coymark *Director*
Susan Boyd *Administrative Assistant*

NATIONAL SALES
Dan Harper (603) 924-2598
Elisa Lister (603) 924-2598

BYTE BITS (2x3)
Mark Stone (603) 924-6830

THE BUYER'S MART (1x2)
Brian Higgins (603) 924-3754

REGIONAL ADVERTISING SECTIONS
Scott Gagnon (603) 924-4380
Larry Levine (603) 924-4379
Barry Echavarría (603) 924-2574

BYTE POSTCARD DECK MAILINGS

BYTE DECK
Ed Ware (603) 924-6166

COMPUTING FOR DESIGN & CONSTRUCTION
COMPUTING FOR ENGINEERS
Mary Ann Goulding (603) 924-9281

INTERNATIONAL ADVERTISING SALES STAFF
See listing on page 353.

Founder: James H. McGraw (1860-1948). Executive, editorial, circulation, and advertising offices: One Phoenix Mill Lane, Peterborough, NH 03458, phone (603) 924-9281. Office hours: Monday through Thursday 8:30 AM-4:30 PM, Friday 8:30 AM-1:00 PM, Eastern Time. Address subscriptions to BYTE Subscriptions, P.O. Box 551, Hightstown, NJ 08520. Subscriptions are \$26.95 for one year, \$54.95 for two years, and \$74.95 for three years in the U.S. and its possessions. In Canada and Mexico, \$31.95 for one year, \$59.95 for two years, \$79.95 for three years. \$50 for one-year air delivery to Europe, \$28,800 for one-year air delivery to Japan, \$14,400 for one-year surface delivery to Japan, \$30 surface delivery elsewhere. Air delivery to selected areas at additional rates upon request. Single copy price is \$3.50 in the U.S. and its possessions, \$3.95 in Canada, \$4.50 in Europe, and \$5 elsewhere. Foreign subscriptions and sales should be remitted in U.S. funds drawn on a U.S. bank. Please allow six to eight weeks for delivery of first issue. Address editorial correspondence to: Editor, BYTE, One Phoenix Mill Lane, Peterborough, NH 03458. Unacceptable manuscripts will be returned if accompanied by sufficient postage. Where necessary, permission is granted by the copyright owner for libraries and others registered with the Copyright Clearance Center (CCC) to photocopy any article herein for the flat fee of 1.50 per copy of the article or any part thereof. Correspondence and payment should be sent directly to the CCC, 29 Congress St., Salem, MA 01970. Specify ISSN 0360-5280/83, \$1.50. Copying done for other than personal or internal reference use without the permission of McGraw-Hill, Inc., is prohibited. Requests for special permission or bulk orders should be addressed to the publisher. BYTE is available in microform from University Microfilms International, 300 North Zeeb Rd., Dept. PR, Ann Arbor, MI 48106 or 18 Bedford Row, Dept. PR, London WC1R 4EJ, England.

BYTE and **BYTE** are registered trademarks of McGraw-Hill, Inc.



PC WEEK POLL: C COMPILERS

	Overall Weighted Score	Overall Reliability	Complete of Command Descript.	Overall Perform.	Complete & Organiz. Document.	Document Clarity	Compiling Process Efficiency	Product Support Quality	Value Relative To Cost	Product Support Access.
Turbo C 2.0 (Borland International)	81	87	79	84	77	78	86	72	70	93
C Optimizing Compiler 5.1 (Microsoft Corp.)	76	83	80	81	78	74	76	68	67	70
C++ 1.07 (Zortech Inc.)	66	68	64	71	63	63	69	60	58	76

"Microsoft was No. 1, but they have been unseated by Borland." PC Week, May 8, 1989

PC WEEK POLL: SOFTWARE DEBUGGERS

	Overall Weighted Score	Overall Reliability	Effective. Programmer Interface	Document. Clarity	Complete. Command Descript.	Complete. & Organiz. Document	Overall Perform.	Integration Within Programming Environment	C Compiler Compatibility	Product Support Quality	Product Support Access	Value Relative To Cost
Turbo Debugger 1.0 (Borland International)	84	89	90	81	81	81	89	88	81	73	72	93
Codeview 2.2 (Microsoft Corp.)	73	80	71	72	74	74	74	74	78	67	64	72

"Borland's Debugger outshines Microsoft's Codeview." PC Week, May 15, 1989

It's two winners in one.

Turbo C,* the core of Turbo C Professional, was the outright winner in PC Week's Poll of Corporate Satisfaction on C compilers. Overall, Borland won with 81. Microsoft* placed second.

Turbo Debugger,* also included in Turbo C Professional, was the outright winner in EVERY category in PC Week's Poll Of Corporate Satisfaction on Debuggers. And, once again, we topped the score with 84, overall. Microsoft came in second-best, 11 points behind.

Get Borland's Turbo C Professional and get the best of both worlds: our top-rated C compiler and our top-rated Debugger.

Call (800) 345-2888* and we'll send you both PC Week polls and technical specifications on Turbo C and Turbo Debugger.

Turbo C Professional includes both Turbo C 2.0 and Turbo Assembler® & Debugger.

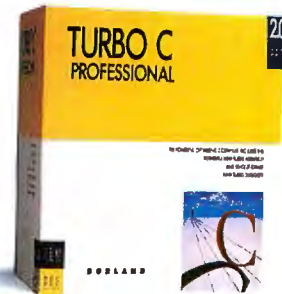

B O R L A N D

Code:MC35

*From Canada, Call (408) 848-4391. Reprinted from PC Week, May 8, 1989; PC Week, May 15, 1989. Copyright © 1989 Ziff Communications Company. Turbo C, Turbo Debugger, and Turbo Assembler are registered trademarks of Borland International. Copyright © 1989 Borland International, Inc. All rights reserved. BI 1328

Circle 42 on Reader Service Card (DEALERS: 43)

At last! A new HP LaserJet just for you.

At only \$1495*, it's got your name on it.

The HP LaserJet printer family has expanded—in a small way.

The new HP LaserJet IIP (as in Personal) fits right on your desk. And, with a price almost half of the multi-user LaserJet Series II*, into most budgets.

Its simple front panel gives you easy, push-button control over the menu, the 14 internal fonts, form feed and other functions. It handles four different paper sizes: letter, legal, executive and A4, as well as envelopes. In portrait

*Suggested U.S. list prices:
LaserJet IIP \$1495;
LaserJet Series II \$2695.
Dealer prices vary.

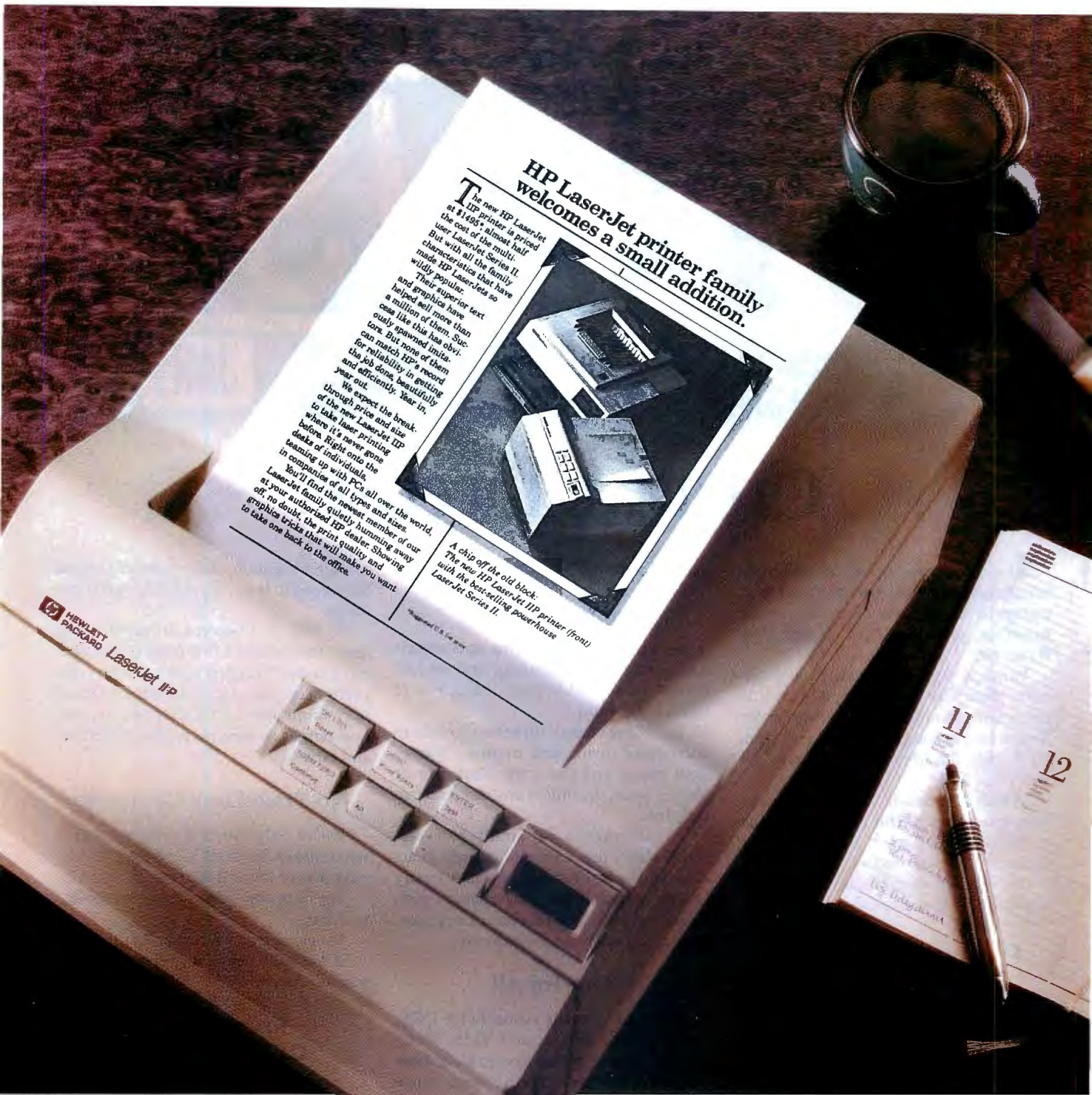

**HP LaserJet printer family
welcomes a small addition.**

The new HP LaserJet IIP printer is priced at \$1495* almost half the cost of the multi-user LaserJet Series II. But with all the family characteristics that have made HP LaserJets so widely popular. Their superior text and graphics have helped sell more than a million of them than case like this has obviously spawned imitations. But none of them can match HP's record for reliability in getting the job done beautifully and efficiently. Year in, year out.

We expect the breakthrough price and size of the new LaserJet IIP to take laser printing where it's never gone before. Right onto the desks of individuals, teams of individuals, in companies of all sizes.

You'll find the newest member of our LaserJet family quietly humming away at your authorized HP dealer. Showing off, no doubt, the print quality and graphics tricks that will make you want to take one back to the office.



*A chip off the old block:
The new HP LaserJet IIP printer (front)
with the best-selling powerhouse
LaserJet Series II.*

**HEWLETT
PACKARD** LaserJet IIP



The new HP LaserJet IIP printer.

or landscape configurations. At four pages a minute. From one or two paper bins (the second is optional).

The 512K standard memory is upgradable to 4.5 Mbytes for more complex graphics and publishing programs.

And, of course, our new printer is compatible with the HP LaserJet Series II and virtually all popular PC software.

So call **1-800-752-0900, Ext. 277J** for your nearest authorized HP dealer. Then

introduce people at your company to their very own HP LaserJets.

There is a better way.



Circle 116 on Reader Service Card



Creative License.

If you've ever tried to combine windows, menus, forms, and text entry to create an effective user interface, you know how challenging it can be.

Perhaps you've turned to a third-party library for help. Only to run into restrictions, limitations, and dead ends. So you had to compromise your design. Or modify the library source code. Or start over.

Which is precisely why we designed Vermont Views™, the new generation of Windows for Data®, the best-selling C library for user interfaces.

Vermont Views offers unbridled, unrestricted creative license.

The Human Interface Of Your Dreams

Vermont Views offers an unparalleled set of interface building blocks that you can combine in unlimited ways:

- Menus can be created in any style you choose, made scrollable vertically and horizontally, and nested to any level. Features include n-th character selection, checkmarks, and unavailable items.

- Data entry forms can be bigger than their display windows, have scrollable regions for the entry of variable lines of items, lists of choices for data entry, context sensitive help, and special decimal, date, time, and toggle fields.

- A mini word processor can be attached to a field window in a form or

used as a pop-up note taker.

You're In Charge

Because you can write and attach functions to the beginning and end of menus, forms, fields, and to keys, you're always in control.

Use these control functions to call up subsidiary forms and menus, change field values and the active field, exit or abort a form, do almost any task you can imagine.

All interactive capabilities of Vermont Views use a unique system of accessible keytables, so you can easily change or disable key assignments – even add to the functions provided for menus, forms, text entry, and windows.

One For All

Vermont Views is available for DOS, OS/2, UNIX, XENIX, and VMS. Maintain the same user interface on all of these operating systems with the same source code.

Vermont Views provides international portability as well, with full support for IBM international characters, flexible date and time formats, and changeable decimal and thousands separators.

Novice Or Expert

Despite its depth and flexibility, Vermont Views is easy to learn and use. Each major facility is covered in a single, self-

contained section of the manual, so you only need to learn capabilities as you use them.

To help you become an expert in no time, we include a free copy of the Norton Guides™ Engine and our own comprehensive Pop-Up Reference™. You'll have immediate, on-line access to function names, reference pages, structures and tables.

No-Time-Limit Guarantee

We've only touched on a fraction of what makes Vermont Views special. The only way to know it is to use it.

Try Vermont Views on your hardest problems.

For as long as you want. At no risk.

If not fully satisfied, return for a full refund. Anytime.

To Order Today Call 1-800-848-1248

Call to order Vermont Views today. And we'll send your "creative license" right away.

Prices: DOS \$395; with Source \$790. UNIX, XENIX, VMS, OS/2 please call.



Vermont
Creative
Software

Pinnacle Meadows, Richford, VT 05476

MICROBYTES

Staff-written highlights of developments in technology and the microcomputer industry, compiled from Microbytes Daily and BYTEweek reports

Is Classroom Computing Making the Grade?

Are computers in schools helping children learn? As school districts across the nation become more pressed for money, educators are having to ask themselves if computers are worth the expense. Many of the 2000 computer coordinators, administrators, and teachers at the National Educational Computing Conference in Boston recently said that they came looking for justification for using high-cost technology. But judging by papers delivered and comments made at the NECC, final grades aren't in yet on the benefits of computers and computer courses in the classroom.

After *The National Assessment of Educational Progress* was published by the Educational Commission of States, painting a grim picture of U.S. schools, some educators proposed programming courses as a means to improve weak thinking skills. But while the number of schools teaching programming courses continues to increase, so does the number of studies failing to document significant improvements in students' thinking skills as a result of these courses.

Mark L. Walker and Sharon Carver of the University of Rochester say that schools justify every subject in the curriculum on the grounds of two educational goals: "transmission of substantive subject-matter knowledge and the enhancement of general problem-solving skills."

Walker and Carver studied and tested the effectiveness of a curricu-

lum to foster planning skills. The students started their 18 months of Logo programming in the fifth grade, doing tasks that involved list processing and essay writing. The team studied the think-aloud protocols used by the students. Their study concluded that programming effectively enhanced general problem-solving skills when students already had "the relevant prerequisite knowledge in each of the domains" in which they expected students to apply the general skills. The students who lacked the prerequisite knowledge did not benefit from learning to program a computer, the study said.

Another study, by Yuen-Kuang Liao and George W. Bright of the University of Houston, presented in a paper entitled "Computer Programming and Problem-Solving Abilities," suggested that "the outcomes of learning a computer language go beyond the content of that specific computer language." Students are able to obtain some cognitive skills, such as reasoning, planning, and general problem solving "through computer programming activities," they wrote. However, Liao and Bright said they need to clarify the "exact nature of the problem-solving abilities most likely to be developed through programming." They question whether computer programming is as efficient at developing these problem-solving abilities as other possible instructional approaches.

Pocket Memory Cards: Companies Seek Standards for Tiny Storage Devices

Memory cards are an essential component in the new wave of notebook-size computers. Without such tiny storage devices—they're about the same dimensions as a credit card—manufacturers such as NEC, Agilis, and Poqet wouldn't have been able to fit their full-fledged computers into packages more portable than a six-pack of beer. These cards, made by NEC, Fujitsu, Toshiba, Hitachi/

Maxell, Epson, Mitsubishi, and others, range in storage capacity from as little as 16K bytes to as much as 16 megabytes. Because of their size and simplicity, they will become prevalent in featherweight computers.

But first the industry has to solve one critical issue: No standard physical, electrical, or logical formats exist for these cards. The dimensions

continued

NANOBYTES

The best **power source for portable computers** would be rechargeable lithium batteries, which would offer twice the voltage at half the weight of current batteries, says computer designer **George Morrow**. However, Morrow says, lithium is an extremely reactive metal, and the U.S. Environmental Protection Agency has refused to allow lithium batteries larger than AA size. The EPA is concerned with the possibility of larger lithium batteries, which explode more violently than conventional batteries, breaking open and releasing the metal into the environment.

Computer Professionals for Social Responsibility has issued a call for papers for its next symposium on Directions and Implications of Advanced Computing. The DIAC-90 conference will address "**ethical, social, and moral issues** in which computing plays a part." Papers should cover topics in general categories, such as direction and sources of research funding, defense applications, computers in a democratic society, and computers used for the public welfare. "Papers on ethics and values are especially desirable," a spokesperson said. Papers are due by March 1, 1990. The symposium is scheduled for July 1990 in Boston. Contact program chair Doug Schuler at (206) 865-3226.

IBM has brought its **4-megabit memory chips** to market on a board for upper-end PS/2 computers, making it the first PC product that uses the new, denser memory chips. The PS/2 Enhanced 80386 Memory Option, which works in Model 70s and 80s, comes in 2- and 4-megabyte versions, priced at \$1795 and \$3495, respectively. IBM says the 4-megabit chips, made at plants in Vermont, West Germany, and Japan, can access a bit of data in 80 ns.

NANOBYTES

Oki Electric (Tokyo) has joined the group of vendors working to develop a **multiprocessor version of Unix for Intel's 80386, 80486, and 80860** processors. Other members of the project are Intel, AT&T's Unix Software Operation, Olivetti, Unisys, and Prime. The software will conform to AT&T's System V Interface Definition. Intel said that the multiprocessor version will be ready for beta test sometime during the last quarter of this year and will be ready for commercial release next year.

Unix, Italian style: The Italian market for Unix-based systems will hit 1100 billion lira, or \$750 million, this year, says the Italian research firm Mate. Last year, 30,000 Unix-based computers, worth 800 billion lira (\$548 million), were shipped in Italy, a Mate report says. In 1987, 80286- and 80386-based systems running **Xenix** accounted for 71 percent of the units at Unix installations in Italy, but those machines have been gradually losing ground to engineering workstations, Mate's study shows.

OS/2 is such a good environment for developing code that **Jensen & Partners International** is now using it to develop all its products, said company president Neils Jensen during a demo of JPI's new C compiler. JPI is also using OS/2 to create MS-DOS versions of its compilers, said Jensen, who developed software at Borland International before starting his own company. OS/2 "could be very successful if IBM would push it as a developer's platform," Jensen said. JPI's latest developer's product is TopSpeed C.

Paul Mace, known for his eponymous company's line of software utilities, such as Mace Gold and Vaccine, will now be developing programs exclusively for **Fifth Generation Systems** (Baton Rouge, LA), which has taken over the ownership and marketing of Mace's commercial products. Fifth Generation is known for Fastback, Suitcase II, Pyro!, and other utility programs.

aren't standard, the electrical specifications (e.g., the voltage thresholds) aren't standard, and the logical format for storing and executing data and applications aren't standard.

In an effort to establish these standards, most of the memory-card manufacturers, some of the hand-held system vendors (e.g., Toshiba, NEC, and Poqet), and some major software companies (e.g., Lotus, Microsoft, WordPerfect, and WordStar USA) have set up a technical committee that will attempt to iron out a consensus. The committee is establishing technical and marketing groups to begin work on the standards as well as to promote memory cards as a competitive storage medium.

Competing technologies already in place will make it difficult to arrive at a single standard. NEC's UltraLite uses a 60-pin memory card that appears as an additional floppy disk drive on the computer; applications are loaded into system RAM and executed just as they would be from a floppy or hard disk drive.

The Poqet Computer memory card uses a 68-pin connector and executes the application directly from the ROM on the memory card. This configuration is supported by the Japanese Electronics Industry and Development Association (JEIDA), whose members include Fujitsu, Toshiba, Hitachi/Maxell, and Epson.

Agilis's hand-held workstation uses a proprietary format developed by Mitsubishi; it also formats the card like a floppy disk drive, but it is not compatible with the NEC approach. The memory cards in these various systems are not interchangeable.

These various formats and code-execution schemes mean that software developers have to write different versions of their software for each system. The easiest format, from a software developer's standpoint, is NEC's, which requires very minor

modification of programs designed to run off floppy disk drives. The Poqet approach requires the software application to use a different memory scheme, which means that a developer has to make some code modifications to existing applications. However, the execution scheme supports LIM/EMS and will not require "a major rewrite if the code is written well," said Neal Chandra, vice president of business development at Poqet.

Software companies are eager to see a single standard. It would reduce R&D expenses and allow vendors to supply a single version of their software for all the different memory cards, said Jim Prelack, Lotus's manager of technical marketing for spreadsheets. And, of course, it would be nice if users could swap memory cards between different computers.

Despite the obstacles, there's optimism that a standard will emerge. Agilis marketing director Bert Keely said he thinks that the standard will be determined by which type of memory card has the most software installed on it. NEC marketing representative Jim Bartlett said he thinks there might be two standards: a standard for microcomputers based on NEC's design, and a "low-end" standard for calculators and other electronic devices, based on the JEIDA ROM-executable approach. Bartlett said that the JEIDA approach "is not applicable to this [the U.S.] market" because there is no installed base of machines supporting that standard in this country.

The standards can't come soon enough for product designers. As Fujitsu's John Reimer pointed out, "A whole generation of laptops and notebook computers are in the planning stages, and decisions are being made right now." Without standardization, memory cards will remain expensive, and software developers will be reluctant to tailor their software to them.

BIT Speeds Up SPARC with New Process

Bipolar Integrated Technology (Beaverton, OR) says it has produced the first emitter-coupled logic (ECL) RISC microprocessor and claims that it's the fastest chip yet based on Sun Microsystems' Scalable Processor Architecture. The new 32-bit SPARC microprocessor runs at 80 MHz and executes 50 to 65 million

instructions per second, the company says. The accompanying floating-point chip set can execute up to 40 million floating-point operations per second and offers a sustained processing rate of 14 MFLOPS, BIT says. That would make it comparable to Intel's new 80860 chip. Sun has said

continued

Now QuickPascal makes this software go even faster.

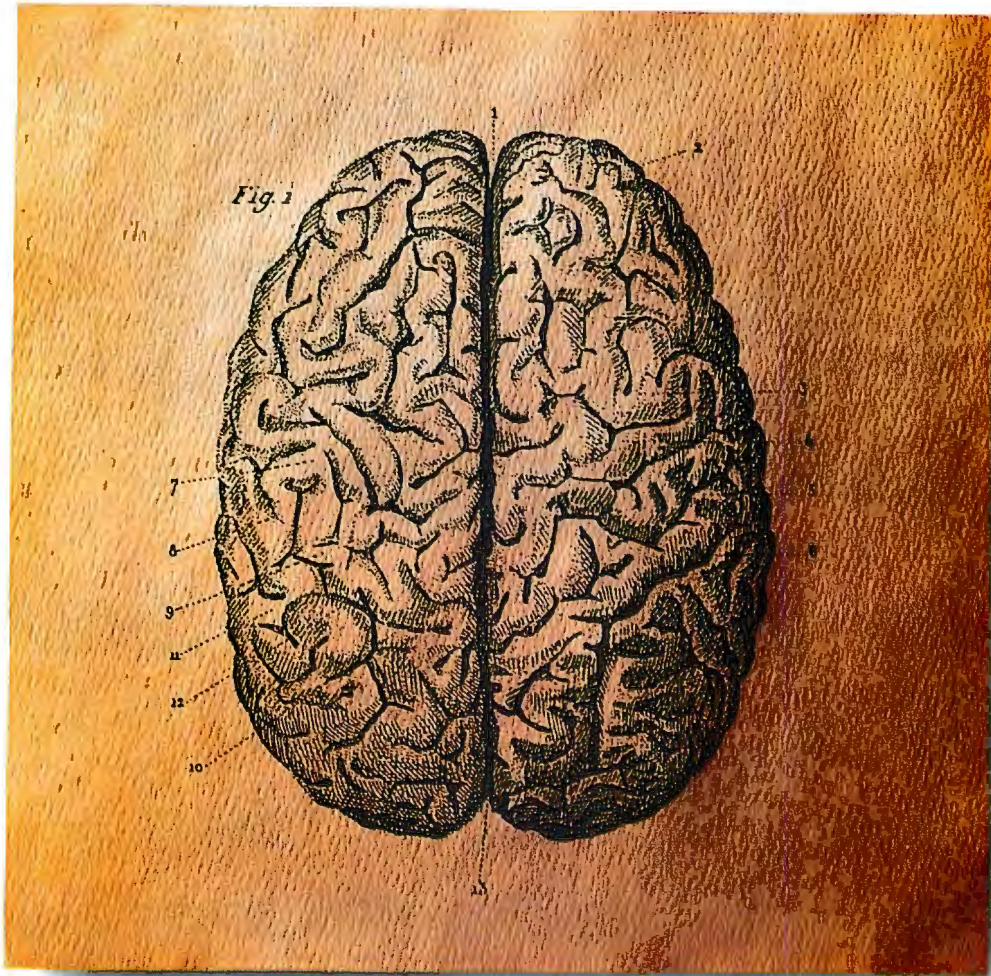

Even the quickest minds tend to brake suddenly when confronting new languages.

Enter new Microsoft® QuickPascal Compiler.

The first Pascal that is not only powerful but easy, intuitive and 100% headache-free.

For example, our new hypertext QuickPascal Advisor offers on-the-job training: by

cutting and pasting sample code you can learn to program in Pascal from scratch. And if you do hit a snag, the Quick Advisor can straighten everything out right on the spot.

To accelerate your thought processes even more, all of our processes are seamlessly integrated; no other Pascal offers you easier

access to your editor, debugger and compiler.

What's more, QuickPascal is the first PC Pascal to offer Object Oriented Programming, or OOP. With objects, you can easily assemble whole programs from modular building blocks of code and data. And once you know Pascal, OOP is a snap. Which means, you get maximum productivity with minimum effort.

Naturally, our Pascal is also fully source compatible with Turbo Pascal®.

So stop by your Microsoft dealer soon.

You'll find our software is on the same wavelength as yours.

Microsoft
Making it all make sense.



UNTIL NOW,
LASER PRINTING HAS BEEN OUT OF REACH FOR
MANY PEOPLE IN BUSINESS.



*With the new, affordable
EPL-6000 from Epson, more businesses
will be looking better on paper.*

Opting for the quality of a laser printer has just become decidedly easier. Introducing the EPL-6000 laser printer from Epson.*

Coming from the company with the longest running success in the printer business, reliability is a given. What's more, the new EPL-6000 is compatible with application software written for HP LaserJet II.*

As for value, this new Epson combines solid, businesslike performance with a price that is as attractive as the printing. In fact, for quality, reliability and value in a laser printer, you could say Epson has the solution well in hand.

EPSON

**WHEN YOU'VE GOT AN EPSON,
YOU'VE GOT A LOT OF COMPANY.™**

NANOBYTES

If you've ever had the **battery in your PC AT die**, you know how painful *that* can be. The lithium batteries in most ATs are good for a year or two, but once they croak, new ones are hard to find. **Rupp Corp.** (New York, NY) now has a nice means of insurance: a rechargeable backup battery for AT-type computers. Rupp's bATPac (\$39.95) continually charges itself while your computer is on and will last for at least 10 years, the company says.

Data General's Aviion computers, based on Motorola's 88000 RISC processor, will be able to run **DOS applications**, thanks to a deal DG (Westborough, MA) signed with **Phoenix Technologies** (Norwood, MA). Phoenix will develop a version of its OpenPC software that will enable the DG systems to run DOS programs simultaneously with Unix programs.

NCR Corp. (Dayton, OH) and **IMC Networks Corp.** (Tustin, CA) are teaming up to develop a **32-bit Ethernet card** that will take advantage of the Micro Channel architecture's bus-mastering capabilities. The communications card will be built around NCR's 32-bit Ethernet controller chip, the 92C28. The forthcoming PCnic MCA bus card will comply with IEEE 802.3 Ethernet standards and will work with both thick and thin coaxial cable. The companies say the card will be out this quarter and will sell for \$995.

Data Translation (Marlborough, MA) has **dropped prices** of its image processing and data acquisition products by as much as 25 percent. The DT2853-SQ PC AT Frame Grabber, for example, has gone down from \$1895 to \$1595, and the DT2817 PC Digital I/O Board has gone from \$239 to \$215.

AST Research (Irvine, CA) **lowered prices** on its computer systems with hard disk drives. The Premium 386/25 Model 95, for example, dwindled in price to \$7195, a drop of \$1100. AST also lowered the price of its hard disk drive upgrades.

that it has the BIT chips running now in its labs and plans to use them in future systems.

ECL designs have long offered higher speed than traditional TTL or CMOS chips, but they have suffered from higher power dissipation and lower gate densities. BIT claims to have solved these problems through a proprietary process called BITIII, which permits the company to make chips with the density of MOS chips and the speed of ECL chips.

The BITIII process uses three metal layers and 1.2-micron lithography but employs conventional

semiconductor manufacturing equipment, the company says. By reducing power consumption and reducing the size of transistors, BIT says it can squeeze as many as 250,000 transistors on a single chip.

The heart of the BIT chip set is the B5000, a 32-bit monolithic integer unit consisting of 125,000 transistors; it has been tested in the lab at up to 100 MHz, company officials say. The B5000 averages 1.2 cycles per instruction versus up to 1.6 cycles of instruction for previous SPARC implementations, according to information provided by BIT.

Portable with Color LCD First of More to Come

NEC has just started selling in Japan a portable computer with a supertwist color LCD. The 80286-based color computer has a list price of 748,000 yen, or about \$5250. The 19-pound PC-9801LX5C, measuring 4.5 by 13.3 by 14.9 inches, comes with two 3.5-inch floppy disk drives and a 40-megabyte hard disk drive. The display, which measures 9 inches diagonally, supports resolution of up to 640 by 400 pixels and up to eight colors. Although the company does not have plans at this time to offer the new system in the U.S., the computer will soon show up on these shores in one form or another, and it won't be the only color-LCD portable on the market.

Other companies are readying color laptops for the U.S. market, including Sharp, which showed its PC-8000 earlier this year at CeBIT and Spring Comdex. The 80386-based Sharp machine has a 14-inch color screen capable of showing 16 colors from a palette of 512 at a resolution of up to 640 by 480 pixels. This portable is expected to be available early next year and to cost closer to

\$10,000, though the price has not been set yet. The backlit Sharp screen uses a series of tiny glass filters that "reflect" the basic red, green, and blue color components.

Hitachi has shown a prototype 6-inch active-matrix color screen installed in a computer but has not disclosed any product plans. The company is selling the display to other manufacturers, though, for about \$2200 each. Hitachi's prototype screen manifested one of the problems that's still bugging active-matrix technology: It's hard to produce a perfect model. A careful observer could see that a few pixels were not working properly; active-matrix displays look great, but even one faulty transistor among several hundred thousand can result in a bad pixel.

Toshiba has made no product announcements but has shown prototypes of active-matrix color displays, one 11 inches wide and the other 14 inches. At last viewing, the display was crisp but fragile; company representatives at Spring Comdex would show the display for only 2 hours each day.

George Morrow Ready for New Computer

Four years ago, George Morrow was busy designing a portable computer called the Morrow Pivot, probably the first of the so-called lunchbox computers. Now the industry pioneer is working on another laptop, one that he promises will be ready for next month's Fall Comdex.

Morrow's new machine will be a

conventional laptop, rather than a "pocketable" computer like those announced by Poqet and Atari, or a hand-held system like the NEC UltraLite, the Zenith MinisPort, and similar machines coming soon from the likes of Toshiba. The CPU will be an Intel 80386SX, a chip that Morrow

continued

Windows menu system means you'll learn fast. If you can use Windows you can quickly use Windows CAD.

Multiple viewports allow you to work on up to four views of your drawing at the same time.

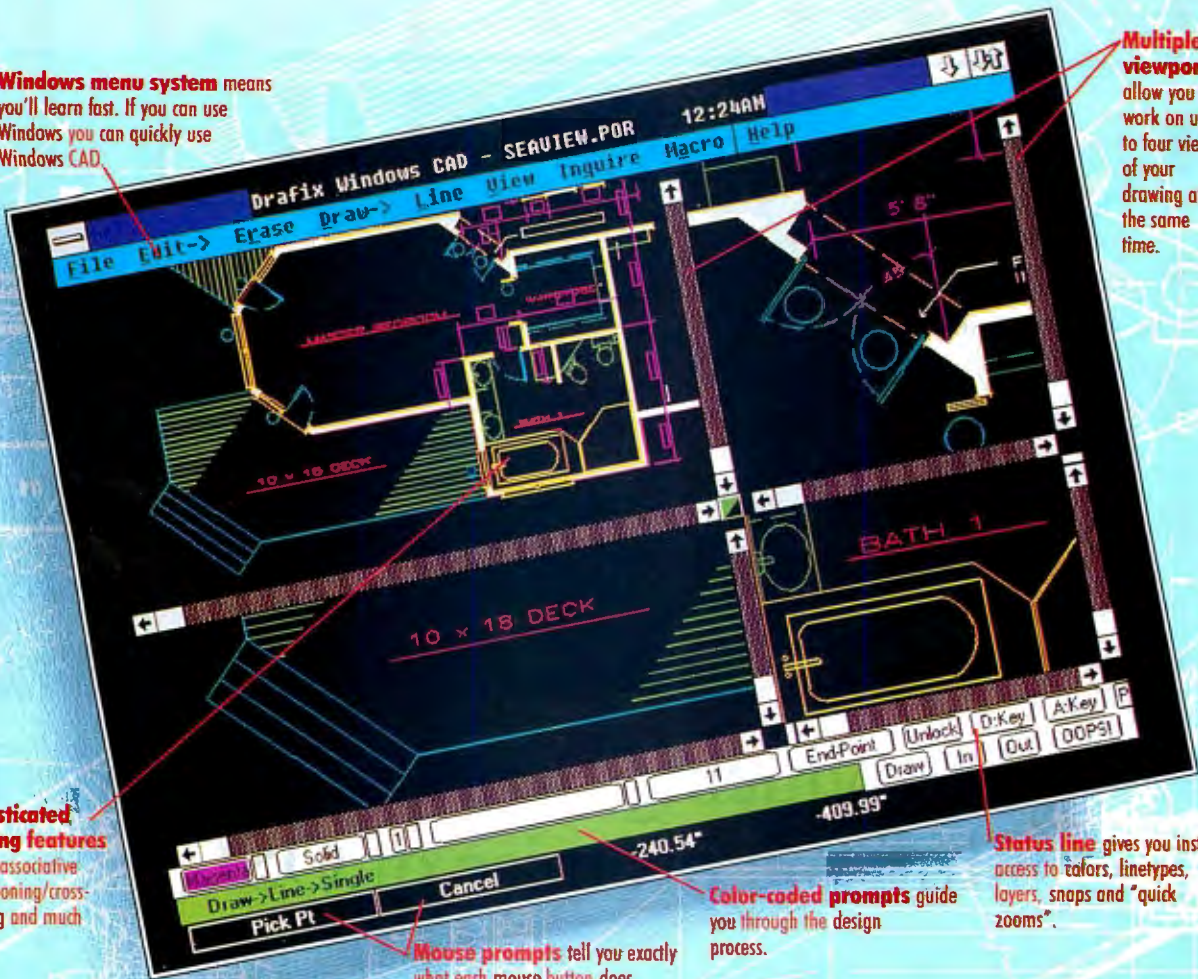

Sophisticated drawing features include associative dimensioning/cross-hatching and much more.

Mouse prompts tell you exactly what each mouse button does.

Color-coded prompts guide you through the design process.

Status line gives you instant access to colors, linetypes, layers, snaps and "quick zooms".

FINALLY, CAD FOR WINDOWS. DRAFIX™ WINDOWS CAD.™

At last the power of true, high performance CAD is available for Windows. Drafix Windows CAD. With features that take you far beyond any Windows drawing package you currently use.

Powerful CAD. Windows CAD is the first and only Windows software to provide all of the designing and editing functions demanded by engineers, drafters, architects and other serious CAD users. It offers multiple interactive viewports, allowing you to work in four views simultaneously. Associative dimensioning, associative crosshatching and a powerful macro programming language are just a few of its features—and that's just the beginning.

Quick to learn, easy to use. Windows CAD lets you take full advantage of your Windows experience. If you already use Excel, Pagemaker, Micrografx Designer, or any Windows package, Windows CAD will have you doing precise, accurate CAD design in no time. And of course you can use all of the plotters, printers and video devices that work with Windows.

From a proven line of CAD products. Windows CAD is the latest in a full line of highly rated CAD software that includes Drafix CAD Ultra, Drafix CAD QwkStart and Drafix 3-D Modeler.

Order your copy of Drafix Windows CAD today! Now if you have Windows, you can have the full power of true CAD. Drafix Windows CAD. Only \$695. For more information call us today at 1-800-231-8574.

Drafix Windows CAD has features you usually find in packages costing 5 times as much!

Item Attributes 256 layers 8 colors 9 linetypes Up to 60 database attributes to any entity Multiple line widths

Drawing Features Lines: single, double, tangent, parallel, perpendicular, multiple width Arcs/Circles Curves/Splines Polygons and Polylines Ellipses Pointmarkers Freehand sketching

Input Methods Windows menu system Keyboard equivalents Ortho lock 10 item and grid snaps, including endpt, midpt, tangent and more Keyboard entry of coordinates OOPS (Undo) feature Dynamic Drag Quick zoom/pan Multiple viewports, all active

Powerful Editing Features Trim entities to each other Stretch Fillet (round) Chamfer (bevel) Erase Copy Move Mirror Rotate Arrays Select items by region, entity, attribute or combinations

Associative Dimensioning Linear, Radius, Diameter Single, Continuous, Baseline Ordinate, Elevation or Bearing format 23 terminator types Any alignment Tolerancing English and metric Fraction or Decimal

Associative Crosshatching and Solid Fill 15 crosshatch patterns, ANSI specs 64 solid fills

Text Editing Word processing window Multiple font styles

On-Line "Help" system

Macro Programming Language

System Requirements '286 or '386 processor Microsoft Windows 2.1 or later 1 Mb internal memory or greater Windows-supported mouse

File Compatibility Autocad DXF Drafix CAD HPGL CDF, SDF for database information



**Foresight Resources Corp.
1-800-231-8574**

Excel, Pagemaker and Micrografx Designer are trademarks of their respective companies.

Circle 100 on Reader Service Card (DEALERS: 101)



Smalltalk/V[®] PM.
 Think of it as a bold,
 "seat-of-the-pants" solution
 that cuts to the heart of the
 OS/2 Presentation Manager
 complexity challenge. Thus
 unlocking the potential of this
 powerful operating system.

With the introduction
 of Smalltalk/V PM, object-
 oriented programming



Introducing Smalltalk/V PM. The to fulfill the promise of OS/2.

moves out of the realm of mystery
 and into a new era of breakthrough
 applications that promises to be of
 legendary proportions.

OS/2 PM is designed to push

"user friendly" to a whole new level
 of sophistication. If you compare it
 to an orchestra, OS/2 has capabili-
 ties no ordinary assemblage of in-
 struments has ever dreamed of

possessing. Yet to tap

its potential, OS/2
 PM demands a con-
 ductor capable of true
 genius. That conduc-
 tor is Smalltalk/V
 PM.

You'll find Small-
 talk/V PM a perfect
 language for repre-
 senting and manipu-
 lating high-level
 information. Because

you go from designing to prototyp-
 ing to delivering a completed appli-
 cation in one seamless step, you
 cleanly avoid the old costly "crash
 and burn" delays so common with
 languages born in the age of main-
 frames.

UNLEASHING THE AWESOME POWER OF OS/2 PM

Smalltalk/V PM. It helps stop
 the natural drift toward vaporware
 so common in software develop-
 ment today. It lets you dive right in
 and get to the creative parts with-
 out the usual grunt work. For ex-
 ample, if you want to ignore the
 complexities of understanding
 OS/2 PM details you can immedi-

Is The Most Important Part Of Your Developer's Kit Missing?

OS/2 PM offers you a powerful, rich environment
 loaded with advantages like a Graphics Program-
 ming Interface (GPI), a LAN manager, multitask-
 ing, SQL, just for starters. And all of these
 components are accessible in a standard way using
 Smalltalk/V PM through Dynamic Link Libraries
 (DLLs). Combined with DDE (Dynamic Data
 Exchange), you can call and exchange data with
 other PM services or applications. Seamlessly.
 Now developers can write truly reusable compo-
 nents, which greatly increases their value. And
 you'll find Smalltalk/V PM the perfect "glue"
 between applications written in other languages.





The Great cut through the convoluted challenge with one bold, swift stroke of his sword. This "seat-of-the-pants" solution set in motion the prophecy that whoever unraveled the knot would one day rule Asia.

"THIS IS THE RIGHT WAY TO DEVELOP APPLICATIONS FOR OS/2 PM. OS/2 PM is a tremendously rich environment, which makes it inherently complex. Smalltalk/V PM removes that complexity, and lets you concentrate on writing great programs. Smalltalk/V PM is the kind of powerful tool that will make OS/2 the successor to MS/DOS."

*Bill Gates, Chairman
Microsoft Corp.*

grammer struggling with the complexities of Presentation Manager should take a close look at this product."

*Charles Petzold, Contributing Editor,
PC Magazine*

"Digitalk's Smalltalk/V PM is dazzling! This product makes Presentation Manager pay off."

*Jeff Duntemann, Contributing Editor,
Dr. Dobbs Journal*

"Smalltalk/V PM is an excellent tool for rapid delivery of prototypes which have all the functionality and user interface of a complete PM application."

*Richard A. Landsman,
System Architect, Lotus Development*

"Smalltalk/V PM from Digitalk is the greatest! This is an incredible product."

*J.D. Hildebrand
Editor-in-Chief, Computer Language*

THE BEST PM INVESTMENT YOU'LL EVER MAKE

Smalltalk/V PM \$499.95

Prices and information on these and other Digitalk products are available on request:

Smalltalk/V, Smalltalk/V 286, Smalltalk/V Mac

Smalltalk/V. A product of Digitalk Inc., 9841 Airport Blvd., Los Angeles, CA 90045. For information or to find a dealer near you call:

1-800-922-8255
1-213-645-1082
CompuServe 71361,1636
FAX 1-213-645-1306

Smalltalk/V is a registered trademark of Digitalk Inc. Prices subject to change without notice. Other product names are trademarks or registered trademarks of their respective holders.



fast, seat-of-the-pants way



THE FIRST FULLY-COMPILED SMALLTALK.
Because Smalltalk/V PM is fully compiled it provides you with a more responsive environment than ever before. Now you'll be able to generate stand-alone applications (.EXE).

debugger simplifies application development and gives you instant response when you implement an idea. Our extensive user manuals and tutorials have earned us high praise.

SMALLTALK/V PM. THE TALKING HAS

ALREADY STARTED.

"Digitalk's Smalltalk/V PM is a masterful implementation of a classical object-oriented programming language and a state of the art graphical user interface. Any pro-

ately start creating without any limitations on your efficiency.

However, if you're the curious type, we have tools called browsers to help you fathom the masterpiece called OS/2 PM. You'll also find our incremental program development capability and push-button

Smalltalk/V

NANOBYTES

Texas Instruments (Houston) has officially released its **TI Graphics Architecture interface specification**, which is designed to optimize communications between TI's TMS340x0 graphics processor and the host processor that it's working with. TI is now offering several kits for software developers who want to make their applications compatible with TIGA. Meanwhile, TIGA continues to collect fans, with the latest major backer being **Hewlett-Packard**; HP said that TIGA will result in more applications supporting high-resolution graphics on personal computers.

After investing \$100 million in Steve Jobs's **NeXT Computer** (thus buying one-sixth of the company), **Canon** has introduced the black cube to Japan. At the machine's official debut in Tokyo in July, about 3000 people showed up to see Jobs and his company's new system, a BIX user in Japan said. The event took place in a hall next to the site of Tokyo Disneyland, which somehow seems appropriate. In Japan, Canon will sell the basic NeXT computer for 1,980,000 yen, or about \$14,000; with a 660-megabyte hard disk drive, for 3,980,000 yen, or about \$28,000. A Japanese-language version is slated for next year. "Many people believe **Asia** will be the growth market for computers in the 1990s, and we believe that too," Jobs said.

Symbolics (Los Angeles) has moved its professional-grade **Animation and Paint System** from the high-end Symbolics 3600 workstations to the Mac II-based **MacIvory** system. The software is geared toward industrial design, scientific visualization, and engineering applications. The basic setup includes a Mac II with a MacIvory board, 5 megabytes of main memory, 16 megabytes of NuBus memory, a 320-megabyte SCSI hard disk drive, a 32-bit NuVista frame grabber/buffer, and a 16-inch monochrome monitor. Prices start at \$49,500 and ascend to \$75,900 for a system capable of three-dimensional painting, but these prices are about half of what the 3600-based models sell for.

said will become the standard in laptops in the next year.

VGA resolution (640 by 480 pixels) with at least eight shades of gray is the standard for laptop displays now, Morrow says; his machine will have at least 16 gray shades and perhaps as many as 32, using a new graphics controller from Cirrus Logic.

Although several color LCD screen prototypes have been seen at trade shows and NEC is now selling a portable with a color LCD, Morrow says he doesn't think they're practical yet for laptops. Aside from their high cost, the current color screens use tremendous amounts of battery power and tend to heat up. However, Morrow said that fiber-optic technology could make color screens practical sometime next year.

Like current laptops from Zenith and Compaq, the new Morrow machine will use power-management

controller chips to push power requirements down; Morrow said he hopes that his system will offer 8 hours of use on a single battery charge. The key, he says, is replacing the typical nickel-cadmium batteries with nickel-hydride batteries, which weigh half as much for the juice they produce.

Will the new machine have a floppy disk drive? Maybe not. One possibility that Morrow is considering is to offer one of the new tiny 20- or 40-megabyte hard disk drives that weigh far less and use less power than a floppy disk drive. That, of course, would require some unconventional ways of getting programs and data into the laptop; Morrow says he's looking seriously at some exotic technologies, including infrared and radio-frequency modems.

Morrow says prices for the new system will start at \$3995.

Government Agencies at Odds over Computer Sales to Soviets and Warsaw Pact Countries

The U.S. Commerce Department has lifted restrictions on the sale of most 80286-based desktop computers to Soviet-bloc countries, a move that pleased people in the computer industry but drew flak from other segments of the federal government.

U.S. companies can now sell to Soviet-bloc nations standard desktop personal computers with a Processing Data Rate of up to 68. The PDR is the Commerce Department's formula for computer power. A PDR of 68 would represent the equivalent of a system with an Intel 80286, up to 4 megabytes of RAM, and hard disk drive storage of up to 140 megabytes. The change represents a tenfold PDR increase; the previous level was 6.5.

The Commerce Department also lifted export restrictions for systems such as the Apple Macintosh Plus and SE and the IBM PS/2 Model 30. Restrictions are still in place for systems based on the 80386, the 68020, and the 68030, and for certain laptop computers.

"We are creating new opportunities for U.S. manufacturers to sell more widely abroad," said Commerce Secretary Robert Mosbacher. The Commerce Department says that some 6 million AT-compatible desktop computers were sold worldwide by U.S. companies in 1988; 2.7 million of

them, worth more than a billion dollars, were sold outside of the U.S. Computer makers, including IBM, Apple, and Compaq, welcomed the change but expressed reservations about the size and profitability of the Soviet market.

The decision is not without detractors. Secretary of Defense Richard Cheney told reporters that he opposed the move, saying it will give the Soviet Union "significant capabilities" that it does not currently possess and will give the Soviets computers with "military applications." But Mosbacher said the Commerce Department had found that AT-type systems were already readily available in Eastern European and Soviet-bloc countries.

The U.S. Department of State agrees with the Department of Defense. The U.S. will continue to withhold high-technology exports from the Soviet Union and other Warsaw Pact countries, a State Department official said shortly after the Commerce Department announced its revised restriction list. The State Department will continue to "deny Moscow any such technology that could enhance its military capacity," the official told *Microbytes Daily*.

Exporting sophisticated computer

continued

**NOW! Larger Data Sets,
Upgrades Available**

MODEL FITTING RESULTS FOR: YIELD

INDEPENDENT VARIABLE	COEFFICIENT	STD. ERROR	T-VALUE	SIG. LEVEL
CONSTANT	-3977.847583	747.932209	-5.3185	0.0018
time	17.862499	3.288094	5.4325	0.0016
time^2	-0.021469	0.006136	-2.6386	0.0386
temp	44.997502	9.614533	4.6802	
temp^2	-0.124651	0.032546	-3.8300	
time*temp	-0.0975	0.020297	-4.8037	

R-SQ. (ADJ.) = 0.7865
 Previously: 0.0000
 12 observations fitted, forecast(s) computed for 0 missing val. of dep

SE = 2.029674
 0.000000
 MAE = 1.173868
 0.000000

FURTHER ANOVA FOR VARIABLES IN THE ORDER

SOURCE	SUM OF SQUARES	DF	MEAN SQ.
time	15.3890909	1	15.389091
time^2	15.6011921	1	15.601192
temp	1.0765857	1	1.076586
temp^2	60.4298606	1	60.429861
time*temp	95.0625000	1	95.062500
Model	187.559209	5	

CHEMICAL YIELD AS A FUNCTION OF TIME AND TEMPERATURE
 (POINTS REPRESENT ACTUAL OBSERVATIONS)

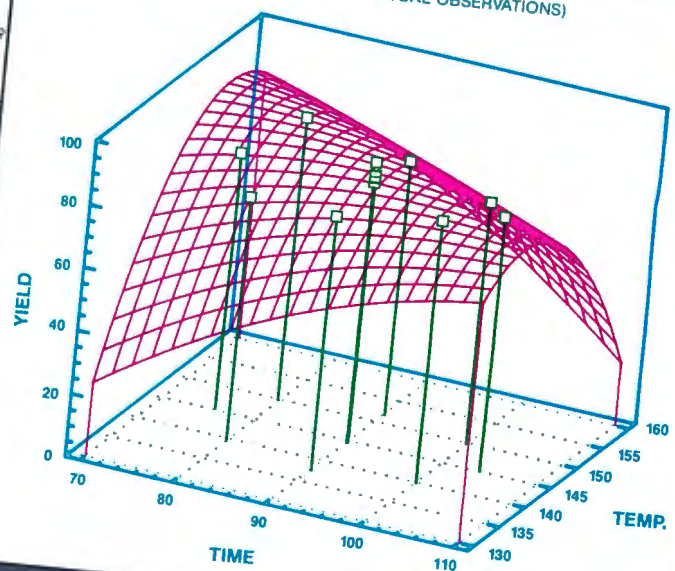

BRAINS & BEAUTY

STATGRAPHICS®. Sophisticated Data Analysis and Gorgeous Graphics — In An Easy-to-Use PC Statistics Package.

Get the best of both worlds with STATGRAPHICS — sophisticated data analysis *and* a dazzling array of graphics in an easy-to-use PC statistics package.

Powerful Statistics. Realize the full potential of your analytical skills. STATGRAPHICS gives you over 250 statistical procedures including ANOVA, regression analysis, quality control procedures, experimental design, multivariate techniques, nonparametric methods, exploratory data analysis, forecasting, time series analysis, and more.

Incredible Graphics. Turn the "Ho-Hum" into the "Ah-Ha!" STATGRAPHICS includes over 50 types of graphs that allow you to analyze your data visually and communicate your results brilliantly!

Easy To Learn and Use. Enter your data using our full-screen editor, or import data directly from your ASCII, dBASE®, Lotus®, or DIF files. STATGRAPHICS is completely menu-driven and includes online HELP, a self-paced tutorial,

handy reference cards, and a user's guide complete with examples and sample data sets. No wonder *InfoWorld* said STATGRAPHICS "makes interactive data analysis and knock-your-socks-off graphics easy."

Why compromise? Get the power of sophisticated data analysis *and* gorgeous graphics with STATGRAPHICS — all for only \$895.* For more details or to order today, call:

(800) 592-0050 ext. 400

In Maryland, (301) 984-5123;
 Outside the U.S., (301) 984-5412 for the name of the dealer nearest you.

Ask about our money-back guarantee!



March 14, 1989

STSC STSC, Inc.
 2115 East Jefferson Street
 Rockville, MD 20852

Circle 263 on Reader Service Card

*Suggested retail price in U.S. and Canada. International prices vary. STATGRAPHICS, dBASE, and Lotus are registered trademarks of Statistical Graphics Corp., Ashton-Tate, and Lotus Development Corp., respectively.

Spreadsheet Rivalry Heats Up

to meet the...
officials...
'Things are getting down and dirty,' a computer analyst observes.
Dealers who have seen what will be...

The Spreadsheet Market

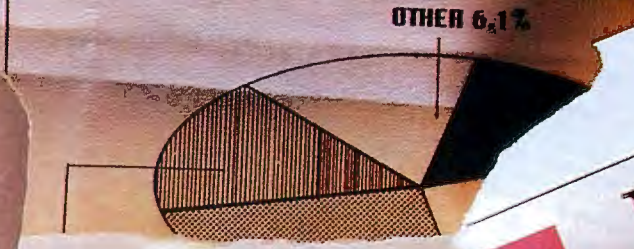

RACE OF VS. POS

We Interrupt T War For This Im

To all those unlucky enough to be stuck smack in the middle of the current spreadsheet confusion, take heart.

Offering hundreds of presentation treatments from word charts to three-dimensional bar, pie, scatter, and polar graphs.

There is, at last, a viable alternative to war: revolution.

One that delivers even more performance than you have (ahem) been waiting for, but without demanding expensive new hardware or extensive retraining. And without abruptly cutting you off from any user in your company, even those on mainframes.

The name of the spreadsheet is SuperCalc®5.

And what it can do for you is, frankly, quite revolutionary.

Let's begin at the end. Stand-alone quality graphic capabilities have been built in.

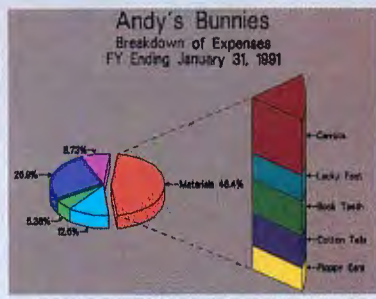

Present a state-of-the-art picture of your work.

Andy's Bunnies 198-Year Commitment						
	North	South	East	West	Total	
Live	\$484,109	\$200,445	\$989,551	\$945,317	\$2,880,422	
Dead	\$141,452	\$159,208	\$197,453	\$184,777	\$682,890	
Andy's Bunnies Quarter 2 Results						
	North	South	East	West	Total	
Live	\$289,444	\$279,883	\$444,896	\$381,438	\$1,415,761	
Dead	\$64,597	\$75,624	\$97,631	\$89,125	\$327,277	
Andy's Bunnies Quarter 1 Results						
	North	South	East	West	Total	
Live	\$251,665	\$389,442	\$445,661	\$413,889	\$1,480,657	
Dead	\$76,889	\$89,144	\$109,842	\$95,222	\$351,097	

Link just about everything in sight.

And with SuperCalc5, you select fonts, lines, boxes, grids and shading. All of which can be used to produce the highest quality customized reports.

Plus, SuperCalc5 actually makes productivity easier. An integrated Undo feature simply reverses unwanted commands. And a truly comprehensive system of debugging highlights costly errors and analyzes macro logic.

Perhaps even more impressive



Catch bugs before they come back to bite you.

is the way SuperCalc5 can link spreadsheets. Up to 255

**POWER
TION**

...the field had been ranked and the odds
...personal computer spreadsheet software...

**New program
...to fend off
...spreadsheet war**

**Spreadsheet
Ready to Pounce**

January 28, 1989

**Gain
on River**

The Spreadsheet Important Update.

to be precise. Linking either in memory or on disk, either pages of the same spreadsheet or independent, either SuperCalc5's files or Lotus® 1-2-3®'s.

and compatible computers but also takes full advantage of 286 and 386 machines when you decide to make that transition.

Andy's Bunnies
Income Statement
FY Ending January 31, 1991
Unaudited

Revenues			
Sales	\$5,726,403	\$5,088,857	
Licensing	\$1,444,275	\$4,921,155	
Sales Discounts	(845,990)	(449,753)	
Net Sales	\$6,324,688	\$9,560,259	
Cost of Sales			
Opening Inventory	\$9,662,331	\$5,074,719	
Purchases	(1,019,814)	(9,023,341)	
Freight In	(56,727)	(32,252)	
Ending Inventory	\$2,314,113	(9,182,201)	
Cost of materials	\$2,042,782	(8,982,585)	
Direct Labor	\$1,447,981	\$2,025,264	
Employee benefits	\$285,360	(276,481)	
Manufacturing	\$672,444	(820,245)	
Total Cost of Sales	\$4,448,567	\$11,084,575	
Gross Profit	\$1,876,121	(1,524,316)	
Less selling, general and admin expenses	(449,287)	(3,051,723)	
Marketing Good from operations	\$1,426,834	(4,576,039)	
Other income and expense			
Interest Income	\$11,309	(8,544)	
Other Income	\$17,289	(3,041)	
Gain (Loss) on sale of fixed assets	(827)	(8)	
Provision for income taxes	\$28,820	(20,491)	
Current income taxes	\$1,043,287	(3,000,295)	
Deferred income taxes	\$1,043,287	(3,000,295)	
Net earnings (Loss) for period	\$116,337	(10,601,971)	

Which brings us to the "L" word. SuperCalc5 not only reads and writes Lotus® 1-2-3® files, it totally coexists with Lotus.

And if all that isn't enough to make you run out today and join the revolution, there's even more incentive.

Like our free demo disk offer through July 31, 1989. And our \$100 upgrade offer for just about any spreadsheet you're using. Call 1-800-531-5236. In Canada call 1-800-663-6904.

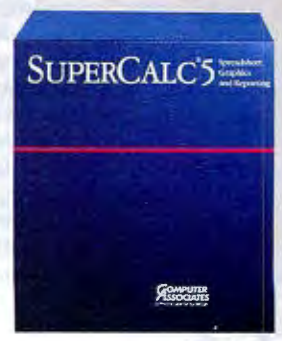

Which finally brings us to our admittedly biased outlook for the much touted spreadsheet war. With SuperCalc5, peace is at hand.

Letting you easily move 1-2-3 macros into SuperCalc5 and back again. Even toggling between menus is a snap for SuperCalc5.

But not for Excel®. Which now brings us to the "E" word. Unlike Excel, SuperCalc5 runs on all IBM®

Microsoft, IBM is a registered trademark of International Business Machines.



NANOBYTES

NCUBE (Beaverton, OR) has started shipping what it claims is the **fastest supercomputer in the world**. The massively parallel NCUBE 2 can be outfitted with as many as **8192 processors**; with that many of the 64-bit processors working together, the system can execute 60 billion instructions per second and 27 billion scalar-point operations per second, the designers say. NCUBE plans to have a version of Unix running on the supercomputer. Oracle has already said that it will port its database management software to the parallel system. The NCUBE 2 starts at \$495,000.

Remember **CEBus** and the **Smart Home**? CEBus is a set of specifications for encoding and transmitting information over AC power lines. Home-electronics makers hope to design 'smart' appliances that talk to each other. But there's been 'embarrassingly little change' since CEBus made its debut in January, said Bob Garry of Diablo Research, one company working on the CEBus technology. Problems involving the networking of appliances over AC lines have yet to be ironed out, he said.

Vapor chasers: An Ashton-Tate attorney recently sent a letter to **WordTech** demanding that WordTech cease and desist marketing a product called **dBASE/SQL**. "Please be advised that your use of the 'dBASE' mark constitutes a violation of Ashton-Tate's federally registered trademark," wrote the ever-vigilant A-T attorney on the case. The letter demanded that WordTech, which makes products that integrate its dBASE-compatible **DBXL** with **SQL**, change the name of **dBASE/SQL** and destroy any materials that refer to **dBASE/SQL**. Fulfilling the A-T mandate will be tough: WordTech says it doesn't make a product called **dBASE/SQL**. Company president David Miller referred to "**dBASE/SQL**" as "**the ultimate vaporware**, since it's unannounced, undesignated, undeveloped, unknown, has no marketing plan, sales plan, packaging plan, nor any release date or pricing."

technology could "provide the Soviets with sufficient advancements in military design, which in turn would make it even more expensive for the U.S. to maintain a military advantage," said one member of the State Department.

The State Department's clarification of its stance coincided with meetings being held by the Coordinating Committee for Multilateral Export Controls in Paris. COCOM is the organization of NATO countries that

oversees technology trade with the Eastern Bloc. Most COCOM representatives have favored loosening export restrictions to the USSR, if for no other reason than because they don't think the restrictions are working. Prohibiting export of AT-style machines had "become almost impossible to enforce because they are available through so many sources," said Frank Deliberti of the Department of Commerce's Office of Export Enforcement.

Intel Delivers EISA Chips to System Makers But Says Bus Won't Drive Users' Choices

Ten months after nine computer makers said they didn't need IBM's Micro Channel architecture (MCA) and announced their own 32-bit bus standard, Intel officially introduced the chips that will make the Extended Industry Standard Architecture a hardware reality. Computer makers adopting the EISA bus said that they'd have EISA-compatible systems ready by Comdex next month.

The new Intel EISA 82350 package consists of four chips. The 82357 incorporates enhanced direct-memory-access control, a timer/counter, interrupt control, bus arbitration, and DRAM refresh functions on a single chip. Intel says the chip offers a maximum DMA transfer rate of 33 megabytes per second, which is more than eight times faster than the transfer rate of the AT bus. By comparison, the MCA bus has a maximum data transfer rate of 20 megabytes per second, according to Intel. The 82357 also handles bus arbitration.

The 82358 EISA bus controller interfaces with the 8-/16-bit AT bus, the 32-bit EISA bus, and the host CPU bus. It will allow existing AT boards and the future EISA boards to coexist in an EISA system.

The 82352 EISA bus buffer is used to integrate the data swap logic, the address buffers, and the data parity buffer. It's designed to integrate

approximately 17 components, thus lowering the system board chip count and cost. According to Intel, the 82352 chip is intended for those system manufacturers seeking higher integration on the system board.

The 82355 bus-master interface controller acts as an interface between the local functions of the bus-master card and the EISA bus-master protocol. The 82355 "arbitrates" for bus ownership and can take control of the bus from the host CPU for bus-intensive tasks, such as database management and high-performance file serving.

The new chip set won't add much to the cost of an EISA system, Intel said. At current prices, the EISA chips would increase the cost of a machine by \$50 to \$100 over an AT system, according to Intel. Company officials predict that by next year, EISA and MCA chip sets will cost the same as 16-bit AT chip sets, hence increasing the allure of 32-bit systems.

But Intel officials say the decision to buy an MCA or EISA system will ultimately be based on factors other than bus technology. These factors include loyalty to a particular manufacturer; prices of competing systems; proprietary features that manufacturers say increase performance of their systems; and 'geopolitical considerations,' purchasing decisions based on nontechnical or emotional issues.

NEWS STAFF SEEKS NEWS. DIAL (603) 924-9281.

The BYTE news staff is always interested in hearing about new developments that might affect microcomputers, the way they work, or the way people work with them. If you know of a project that could shape the state of the art, please give us a call at (603) 924-9281 or write to us at One Phoenix Mill Lane, Peterborough, NH 03458. An electronic version of Microbytes, offering a wider variety of computer-related news on a daily basis, is available on BIX.

Without Teamwork[®] on your PS/2,

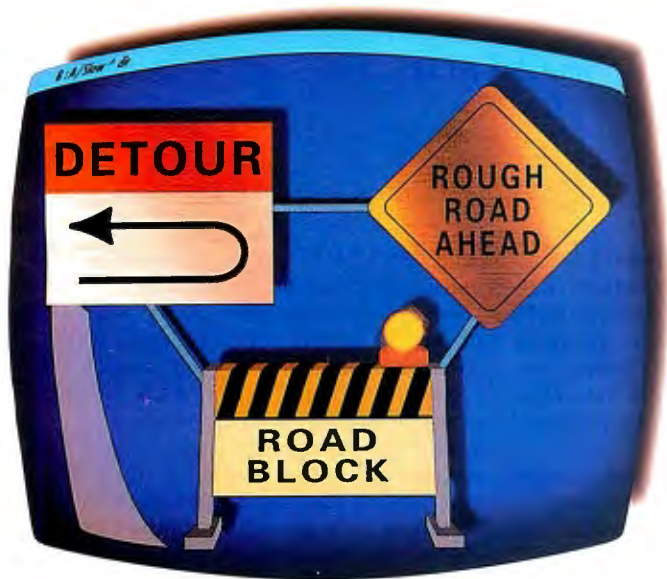

your development teams will never shift into high gear.

Now you can speed up the performance of your entire work group with a true multi-processing development environment for OS/2. Teamwork is the first CASE toolset to support OS/2 software developers. So if you've been driving DOS-based CASE tools and you're ready for workstation power, get ready to fasten your seatbelt.

The intuitive graphic user interface and the advanced multi-window, multi-tasking capabilities of Teamwork immediately improve individual and team productivity. Each developer creates, edits, and inspects multiple design views simultaneously with simple point and click operations. Teamwork fully integrates graphics and data for structured analysis, data modeling, real-time analysis, and structured design models. Rigorous support of standard methods, complete syntactical checking and balancing assure system quality.

Teamwork's own configuration management and project status help manage and control even your largest projects. Projects can be partitioned to allow parallel development by multiple analysts and designers. The project manager controls the process by the baseline, merge, and reconcile features of Teamwork.

If you're just getting started with CASE tools, Teamwork/PCSA is a DOS-based structured analysis tool that can also run on your PS/2. As your projects grow, Teamwork/PCSA gives you an easy migration path since it is fully compatible with Teamwork for OS/2.

Thousands of developers with applications ranging from financial to avionics already rely on the power of Teamwork. In fact, Teamwork is the world's leading workstation-based CASE toolset.

Cadre's hotline support, maintenance services, excellent documentation, and effective educational offerings make sure you get started right on the right track. That's all a part of Teamwork.

Call (401) 351-CASE

If you're ready to shift into high gear, then you're ready for Teamwork. Anything less, just won't meet your standards.

CADRE

Cadre Technologies Inc.
222 Richmond St.
Providence, RI 02903

Teamwork is a registered trademark of Cadre Technologies Inc. PS/2 and OS/2 are trademarks of International Business Machines.

Circle 28 on Reader Service Card

See Your Data



MapInfo software can find, display and analyze your data geographically. See your prospects, customers, facilities—anything in your database. Find addresses by street, ZIP code, city, etc. (We can even supply the maps.)



Any point or region on the map can have a complete record of data behind it. See your *actual* dBASE data in a window to view, edit, and print. Draw your own boundaries. Add titles and legends for high quality presentations.

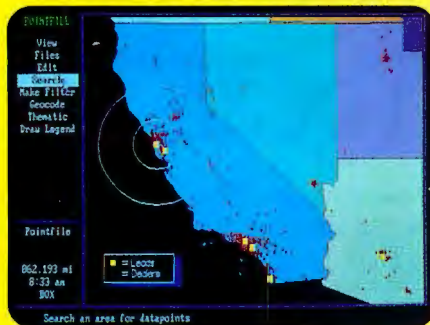

Perform analyses on your data to sum, average, or count your database records by location. Color sales territories by volume of orders, ZIP codes by numbers of leads, countries by your demographic data.

From street-level to worldwide, MapInfo can merge your databases with maps. Play visual "what if" with your data. See patterns, trends, and opportunities you never knew existed. If you need to map your data, MapInfo can do it for as little as \$750.

MapInfo now includes a map of the world and the U.S. with all ZIP code locations. Runs on IBM PCs or compatibles with 640K memory, a hard disk drive, and graphics, and comes network-ready.

MapInfo™ Corp.

Changing The Way The World Looks At Information™

200 Broadway, Troy NY 12180
To order, call 1-518-274-8673
or 1-800-FASTMAP Toll free.

MapInfo is a trademark of MapInfo Corp. dBASE is a trademark of Ashton-Tate.

LETTERS

and Ask BYTE

Who Invented the Computer?

How can John William Mauchly Jr. (Letters, July) write an 800-word letter on the Atanasoff/Mauchly controversy (Book Reviews, September 1988) without acknowledging the court decision in *Honeywell, Inc. v. Sperry Rand Corp., et al.*, of October 1973?

Here is the record, developed in a trial lasting more than two years. Section 3 of Judge Larson's opinion states, among other things, that "Eckert and Mauchly did not themselves first invent the automatic electronic digital computer, but instead derived that subject matter from one Dr. John Vincent Atanasoff."

Mauchly the younger claims "ample evidence to the contrary." He mentions a letter, an experimental counter, and several unnamed students. Sperry Rand, in a case involving million-dollar patent rights, would not or could not produce any such evidence for the record. Instead, the court record shows a letter from Mauchly requesting permission to incorporate Atanasoff's ideas. If Mauchly's evidence is so clear-cut, why didn't Sperry use it to preserve its patent? Why didn't Sperry appeal the decision?

Anyone wishing to form an independent judgment should read Clark R. Mollenhoff's 1988 book, *Atanasoff: Forgotten Father of the Computer*.

George Wright
("georgew" on BIX)
Lutherville, MD

Warning Optional

We would like to commend Martin Heller for "Breaking the Memory Barrier

with 386|VMM" (July). MicroEMACS consists of more than 570K bytes of C source code, and Heller only had to change 34 lines of code to compile it in MetaWare High C for both protected mode and virtual memory mode, either of which will access 4 gigabytes!

Our only complaint is that he didn't mention the compiler switch to turn off warning announcements. We think that warnings are a good thing, but if a user doesn't like them, they switch right off.

Heller will be happy to know that most of the minor changes he required are already in beta test here at MetaWare. We don't agree that old 8086 methods are best, particularly in this new 80386 arena, but programs are daily being migrated to the 80386 via High C. We will supply the functions to make conversion easy, and then lobby for better methods.

Steve Blackwell
Product Group Manager
MetaWare, Inc.
Santa Cruz, CA

Mac OS Wish List

My wish list for the Mac OS would include two items Don Crabb didn't mention ("The Mac Interface: Showing Its Age," Macintosh Special Edition, June): a simple but powerful text editor, and a print spooler for dot-matrix printing.

The TeachText editor that comes with the Mac operating system is too rudimentary to be much more than a toy. Its most serious problem is that it cannot reformat paragraphs that contain carriage returns at the end of each line. Simple text-file transfer among arbitrary computer systems requires the use of such files (i.e., those that end in hard returns). A capable text editor, preferably one that can edit multiple files at the same time, is an essential aspect of any operating system. Of course, the DOS EDLIN hardly qualifies; the Unix editor, vi, is only a slight improvement over EDLIN; and the Windows notepad has even more limitations than TeachText, so my opinion on this seems to be out of favor with operating system vendors.

continued

WE WANT TO HEAR FROM YOU. Please double-space your letter on one side of the page and include your name and address. We can print listings and tables along with a letter if they are short and legible. Address correspondence to Letters Editor, *BYTE*, One Phoenix Mill Lane, Peterborough, NH 03458.

Because of space limitations, we reserve the right to edit letters. Generally, it takes four months from the time we receive a letter until we publish it.

Take 1 of 3 sets for only \$495

and get a FREE 5 1/4" disk as your introduction to the **SMALL COMPUTER BOOK CLUB**

VALUES TO \$106.85

You simply agree to buy three more books—at handsome discounts—within the next 12 months.

C Programmer's Library

- Create full-color graphics and develop programs that interact with users via character displays and keyboards.
- Develop pop-up and pull-down menus, windows, on-line help screens, dialog boxes, and more.
- Write C codes that run under varying C implementations as well as different operating systems and hardware.

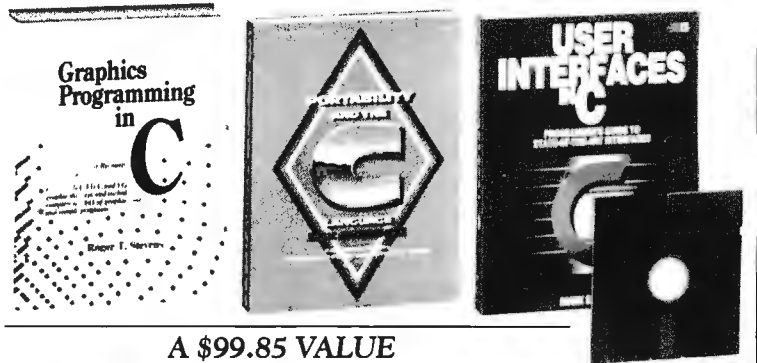

A \$99.85 VALUE

Turbo Pascal Programmer's Library

- Make your Turbo Pascal programs faster, more powerful, and easier to use.
- Master routines for elaborate printer control, formatting and error recovery.
- Maximize use of windows, scroll bars, text graphics, and data compression.

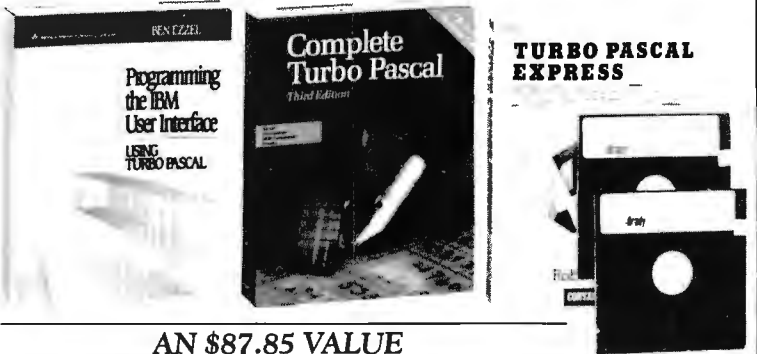

AN \$87.85 VALUE

dBASE Programmer's Library

- Convert and upgrade program files without a hitch while making the most out of user-defined functions.
- Develop databases for many different environments, using a range of dBASE products.
- Master the various features of SQL, dBASE IV, dBASE III Plus, Clipper, FoxBASE, and more.

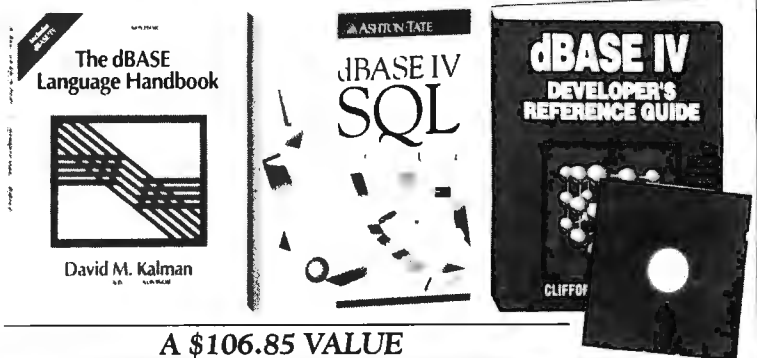

A \$106.85 VALUE

plus FREE with any set
Alfred Glossbrenner's
Selected Shareware Library

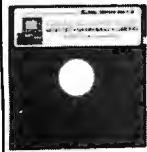

Over 500K of archived programs, including CLEAN-UP, LIST, CHOP, and QDR programs.

MEMBERSHIP BENEFITS • In addition to getting 1 of 3 sets for only \$4.95 and Alfred Glossbrenner's Selected Shareware Library for free when you join, you keep saving substantially on the books you buy. • Also, you will immediately become eligible to participate in our Bonus Book Plan, with savings of 65% off the publishers' prices. • At 3-4 week intervals (16 times per year), you will receive the Small Computer Book Club News, describing the coming Main Selection and Alternate Selections, together with a dated reply card. • If you want the Main Selection, do nothing, and it will be sent to you automatically. • If you prefer another selection, or no book at all, simply indicate your choice on the card and return it by the date specified. • You will have at least 10 days to decide. If, because of late mail delivery of the News, you should receive a book you do not want, we guarantee return postage.

SMALL COMPUTER BOOK CLUB is a division of the Library of Computer and Information Sciences, the oldest, largest and most respected computer book club in the world. Unlike other microcomputer clubs, Small Computer Book Club offers books from a wide variety of leading publishers.

If reply card is missing, please write to Small Computer Book Club, Dept. Y-CF3, 900 Chester Avenue, Delran, NJ 08075, for membership information and an application.

BYTE 10/89

Much of my work is done on DEC VAX systems, where I'm spoiled by edit and tpu, both highly capable editors intrinsic to the VMS operating system.

Dot-matrix printing is generally more time-consuming at the printer end than laser printing is. Therefore, it seems even more essential to provide a print spooler for dot-matrix printing than for laser printing. Yet Apple provides a spooler only for laser printers. It can't be any more difficult to spool Imagewriter

files than to spool the wide variety of printer files that Windows can handle.

I think Apple should indeed be on notice that its operating system is showing signs of age. It's the best available, but right now its chief advantage over other competitors, such as DOS/Windows and Unix/X Window, lies in the wealth of excellent Mac software that has been written and in the transparent access to large amounts of RAM that it and the Macintosh provide. In view of the disarray

apparent in the world of Windows/OS/2/Presentation Manager, this may be enough of an advantage for the time being. But I hope that Apple will be objective enough to incorporate the best of the ideas that are being implemented by its competitors as elaborations of the graphical user interface, while demonstrating that the use of a graphical interface needn't involve the loss of any of the best features of text-based command-line interfaces.

Thomas E. Moore
Huntsville, AL

Finally, A Trackball for your PC

Two High Performance Mouse Alternatives



PC-TRAC™
Serial version \$119
Bus version \$139

The standard in PC Trackballs for direct mouse replacement



FastTRAP™
Serial version \$149
Bus version \$169

Trackball with Trackwheel™ for third axis pointing capability in advanced applications

Attention PC users. Introducing two products that have been quietly appearing on desks of thousands of PC users for over a year: MicroSpeed's PC-TRAC™ and FastTRAP™ trackballs.

- Uses 1/3 the desk space of a mouse

Free up your desk space to do what it was designed to do — hold your coffee cup and stacks of incoming work.

- Plug and play compatibility

MicroSpeed's advanced pointing device driver is fully compatible with application software supporting Microsoft™, Logitech™, and other popular mice. Also included is a Windows™ driver and a utility for use with non-mouse driven software.

- PC-TRAC and FastTRAP work where you put them

No more "row, row, row the mouse" when you run out of desk space before you run out of screen. Scroll across spreadsheets with finger tip

control. Page up and down documents without so much as moving your wrist. Control CAD programs to a single pixel. All in a space less than 4 1/4" wide.

- Pinpoint accuracy automatically

MicroSpeed's pointing device driver has "self adjusting" resolution from 50 to 1,000 dpi. Speeding across the screen or working with precision graphics, the MicroSpeed driver automatically adjusts to the resolution you need.

- PC-TRAC and FastTRAP require no cleaning

Our quiet, durable opto-mechanical design requires no cleaning or maintenance.

Looking for a proven mouse alternative for your PC? Give us a call. We're rolling!

1-800-232-7888

In California call (415) 490-1403
FAX (415) 490-1665

MicroSpeed, PC-TRAC, FastTRAP and Trackwheel are registered trademarks of MicroSpeed, Inc. Microsoft and Windows are registered trademarks of Microsoft Corporation. Logitech is a registered trademark of Logitech, Inc.



Clarifying Chaos

I have a minor point of clarification to Hugh Kenner's fine review of Ian Stewart's *Does God Play Dice?: The Mathematics of Chaos* (Print Queue, July). Referring to the iterative system given by the logistic equation $y = kx(1-x)$, Kenner says, "And for values of k above 3, what we see is chaos." This wording may be misconstrued. While chaos certainly occurs at infinitely many values of k above 3, there is a dense set of values above 3 at which the system is periodic (i.e., nonchaotic).

Stan Franklin
Professor of Mathematical Sciences
Memphis State University
Memphis, TN

Windows and Multitasking

"A Guide to GUIs" (July) states that "You can also minimize a window under Microsoft Windows, but since Windows is not a multitasking operating system, the program in the window suspends operation until you 'maximize' it again."

This is not true and never has been. Has the author ever run the clock program? Or the rotating hypercube? Notice that the hands on the clock icon continue to move even when minimized. That's because the clock program is still running and because the icon is not a static bit map but is actually a small window, and the clock program is continually painting it.

Microsoft Windows is multitasking and always has been. (It's just not preemptive, which means that if one application wants to hog the system, Windows will not interfere with that application.) Nonpreemptive multitasking is genuine multitasking. It differs from preemptive multitasking (as in OS/2 with Presentation Manager) only in these few ways:

1. It is easier to write the system code.
2. It is faster at task switching than preemptive multitasking is (because it

continued

WHEN YOU NEED YOUR DESK FOR MORE THAN JUST A COMPUTER...



Introducing Emerald's LANstation I.

The LANstation I, a 286 diskless workstation, delivers lightning fast performance, an ultra-small footprint, dazzling EGA video display, and compatibility with any network card or operating system at an affordable price.

Emerald has incorporated the latest technologies in every feature to eliminate the typical space, noise, heat and security problems that plague standard PCs on a network.

Design experts agree . . .

. . . that the LANstation I is the finest example in functional ergonomic design. International Design Magazine said "products like yours express the leading edge of contemporary design."

Emerald provides the best warranty program in the industry. 48-hour repair or replace, guaranteed—at no charge!

For more information on the latest in diskless workstation technology contact your Emerald Computers marketing representative at (800) 321-5711.



\$2,195.
Suggested List for 12 MHz 286



EMERALD COMPUTERS, INC. COMMERCIAL PRODUCTS GROUP
7324 SW Durham Road Portland, Oregon 97224
(800) 321-5711 (503) 620-6094 FAX: (503) 639-7932



Circle 97 on Reader Service Card

happens only at known safe times).

- It puts the power (to choose when you will execute) in the hands of the application rather than the system (i.e., the Windows system is the slave; the Presentation Manager system is the master).

I am tired of seeing Windows dinged in the press as "not real multitasking" because it suffers from these advantages.

Marlin Eller
Seattle, WA

Graphical User Interfaces

Thanks for "A Guide to GUIs" by Frank Hayes and Nick Baran. The figure comparing features of the 12 top GUIs was especially lucid.

Your readers might want to know about two recent enhancements of the Commodore Amiga that Hayes and Baran did not mention. First, AmigaDOS 1.3 supports a second user through its AUX: device driver and a character-cell terminal connected to the serial port. Second, GfxBase (Milpitas, CA) now offers the X Window System for the Amiga.

I agree with Hayes and Baran's statement that "Intuition is arguably the father of MultiFinder." MultiFinder is more like an illegitimate son, given that it puts one task on hold when the user activates another task. In contrast, Intuition provides true multitasking, letting each task contend for CPU and direct-memory-access coprocessor time according to priority and demand.

Kirk Mahoney
Los Angeles, CA

Let's Hear It for Fixed-Point

"Floating-Point Revisited" by Rick Grehan (April) really points up why more applications should be using fixed-point operations. For most applications, especially in business, fixed-point will run circles around Grehan's decimal floating-point procedures, with no loss in capability.

We still suffer from certain hangovers from the days when 64K bytes was a lot of memory. There's not much excuse for using binary-coded decimal floating-point computing anymore. BCD is convenient for I/O formatting, but you don't need speed in I/O operations. Where you

need speed is in invisible internal calculations. Division by 10 (used repeatedly in formatting binary numbers for output) is time-consuming to the extent that a few milliseconds might be needed for a very large number; given how slowly screens and printers operate, this is entirely negligible.

Correct use of fixed-point programming requires choosing units properly. For business purposes, you use cents, not dollars. The input \$3.21 has to be parsed as 321¢. Actually, this may lead to some situations in which the last penny isn't right. You can adjust for this by using internally smaller units and still fit the national debt into 64 bits. Having units appropriate to the decimal system avoids the inconvenience of trying to work in base 10 on a binary computer.

Binary floating-point and fixed-point arithmetical operations do not differ at the core. For addition and subtraction, fixed-point is faster, while floating-point is faster for division and multiplication. The big distinction is that fixed-point can be kept precise, while floating-point has inherent round-off errors. This

continued

Compact Desk.



This pocket-sized box instantly turns a portable computer into a laptop office. Introducing the WorldPort 2496™ portable fax and data modem.

If your business is like most, fax is a way of life. The WorldPort 2496 is the fax of life on the road.

Weighing less than 8 ounces, with battery, it also runs on AC power and connects to RJ11s or optional acoustic couplers for public phone

use anywhere. Via Bell or CCITT standards. It even sends and receives fax and data messages unattended or while you run other applications.

Suddenly, a laptop in the field is a full communications center. With up-to-the-minute incoming from your host. Overnight outgoing to the branches. And on-the-run faxes to any client. Over pay phones, hotel phones and PBXs worldwide.

Get the WorldPort 2496. It adds the power of your office to the portability of your laptop. And the advantages of a fax to the convenience of your desktop.

Call us today at 800-541-0345 (in New York, 516-261-0423) for more on the WorldPort line and the dealer nearest you.



Touchbase Systems, Inc.
160 Laurel Avenue
Northport, NY 11768
(516) 261-0423
Fax (516) 754-3491

WorldPort 2496 is a trademark of Touchbase Systems, Inc. © 1989 Touchbase Systems, Inc.

Faster computers sooner... from FORTRON.



NetSet™ 286
12, 16, 20 MHz

NetSet™ 325, 333 DeskTop or Power

Desktop 286 or 386
12, 16, 20 MHz

As fast as products are designed, that's about how fast you can get them from Fortron. In early 1987 we were one of the first to ship an Intel 386™ based personal computer.

Now we're ready to dazzle you with speed again: the **NetSet™ 325** and **NetSet™ 333** personal computers, based on Intel 386™ 25 MHz and 33 MHz microprocessors. Designed for optimum performance of **CAD/CAM, UNIX, XENIX, and network server** applications.

Like all our other personal computers, these come with **one full year of service, free, at your site (USA)**. We're that sure of the reliability. And because we manufacture the computers ourselves, right here in California, you know exactly who to call with any technical questions; and if they do need service, we can fix them fast. **Speed, service, and savings. That's Fortron.**

BASIC SYSTEM PRICES START AT:

NetSet 286-12	386-16	386-20 Plus	NetSet 386-325	NetSet 386-333
\$995	\$1950	\$2400	\$3290	\$5450
512K	2MB	1MB	1MB	4MB

To Order Call Toll Free
1-800-821-9771

In CA 415-373-1008

Leasing Program Available
International Distributors Wanted

*386™ is a trademark of Intel Corp.
NetSet is a trademark of Fortron/Source Corp.

FORTRON

Fortron/Source Corp.
6818-G Patterson Pass Road
Livermore, CA 94550
Tel: 415-373-1008
FAX: 415-373-1168 TELEX: 559291

Please have a sales representative call me.

Please send me more information.

1. I am most interested in
A. 286-based systems
B. 386-based systems

2. I am a
A. End User
B. VAR
C. Corporate Purchaser
D. DP/MIS.

Name _____

Title _____

Company _____

Address _____

City _____

State _____

Zip _____

Phone No. _____

10/89

Better is

The new 16" MultiSync® 4D and 20" 5D both offer compatibility with a wide range of graphics boards and computer systems.

NEC's award-winning multiple frequency technology, now available in larger, digitally controlled, high-resolution color monitors.

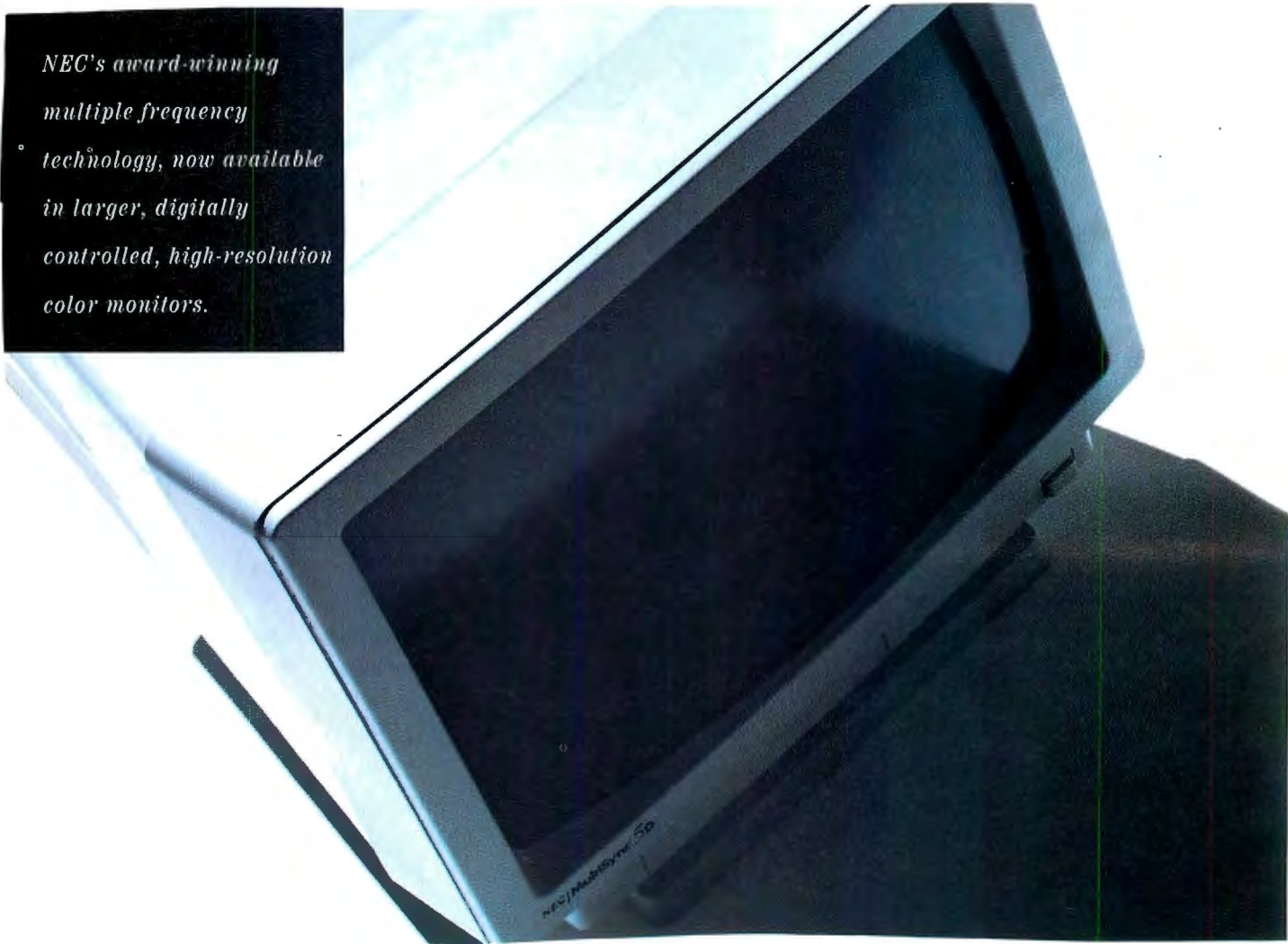

Both are optimized for the IBM PS/2, PC/AT/XT (and 100% compatibles) and the Macintosh II. Both offer a microprocessor-based digital control system for preset and custom graphics modes, automatic screen

MultiSync is a registered trademark of NEC Home Electronics (USA) Inc



bigger.

configuration and optimal image. And both give you great resolution—
the 4D, from VGA up to 1024 x 768; the 5D, from VGA to 1280 x 1024.

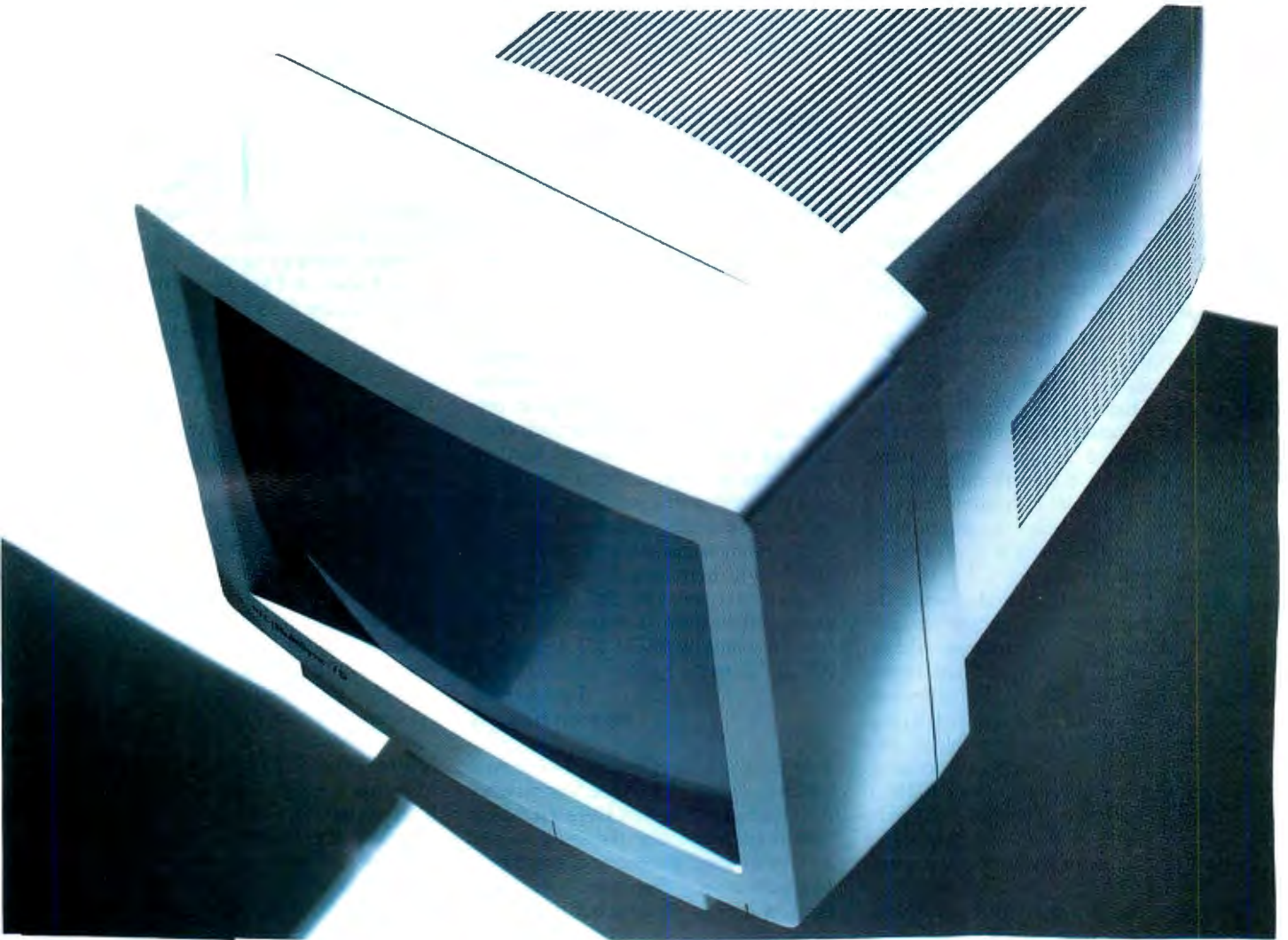

The main difference: one is for large ideas. The other, for extra-

IBM PC/AT XT and PS/2 are registered trademarks of the International Business Machines Corporation

large. For literature, call 1-800-826-2255. For details, call NEC Home

Macintosh II is a registered trademark of Apple Computer, Inc.

Electronics (USA) Inc. 1-800-FONE-NEC.

©1989 NEC Home Electronics (USA) Inc.

NEC

Circle 189 on Reader Service Card

is not significant unless you are dealing with numbers larger than any that would occur in business applications. To be sure, floating-point is superior for transcendental functions. However, if you don't need high accuracy (e.g., in graphical display), fixed-point with lookup tables (e.g., for sines and cosines) will outperform floating-point. True algebraic operations, such as square root, are performed about the same in both.

The main distinction between fixed-point and floating-point programming arises in the storage of variables. Programming general-purpose modules requires you to anticipate exceptional cases. A floating-point variable occupies a fixed amount of memory. When there is insufficient space to carry out operations correctly, floating-point simply gives a wrong number. Try $x \times x - (x + 1) \times 8(x - 1)$ where x fits accurately but x^2 does not. In fixed-point, however, intermediate operations may overflow any prescribed size. Thus, fixed-point requires dynamic memory allocation; the amount of memory set aside for the storage of a variable varies with the size of the variable and changes as the variable changes. The DOS file allocation table is a standard example of dynamic memory allocation. A little extra programming is required, but there is little loss of speed in most applications.

Numerical coprocessors change the picture. For intensive number-crunching, a floating-point coprocessor like the 80287 is much faster at fixed-point operations than is the 80286. There are several reasons for this. First, the 64-bit registers of the 80287 are effectively twice as fast for all arithmetical operations than the 16-bit registers of the 80286 if you're dealing with integers with more than 16 bits. Second, the hard-wired code on the coprocessor operates much more quickly than code fetched from memory. Third, with optimized coding, you can store variables in the 80287 stack rather than having to move them around in memory. The last two differences would matter less if you had a high-speed cache memory. Fourth, you can, with good coding, do coprocessing; the 80286 can compute the address of the next variable needed from memory while the 80287 is doing arithmetic. Finally, the overhead required for handling the variable size of fixed-point numbers adds up over thousands of iterations.

My original motivation for getting an 8087 was for use in a program where I had to deal with fairly large integers and didn't want to take the time to construct code for fixed-point operations. Alas,

the numbers got too big—beyond the 64-bit limit—and I needed exact answers.

Carl Herz
Department of Mathematics
and Statistics
McGill University
Montreal, Quebec, Canada

There now, see? With a little effort, you can extend my floating-point package to as many significant digits as you need. Yes, it would be slow—but it would work.

—Rick Grehan

Uncrackable Code?

The writers of the articles on security (In Depth section, June) consider it unsatisfactory to use a password that initiates a word-substitution program. The procedure, of course, is quite pedestrian. I have worked on these matters as a hobby and have come to use an algorithm that encrypts a text in such a way that I defy anybody to crack the code.

The secret is to take an obscure text of 200 words or so and "add" this text letter for letter to the text to be encrypted, producing a new ASCII code for each character of text. The "password text" is never stored on the hard disk but resides on a floppy disk that you insert when you want to do encoding and decoding.

No common analyses of letter frequencies would help you decode this encrypted text, because the translations change all the time: In one case, "a" may be represented by ASCII 202; in another, ASCII 72; and so forth.

Paul A. Elias
Fountain Hills, AZ

Your method is in effect a one-time pad, which is, indeed, a foolproof system when used properly. However, there's a flaw in your application. For the one-time pad method to work, the encryption text must be used just once. Therefore, it must be at least as long as the original text, and it cannot be reused for multiple encryption processes. If it is, sophisticated methods of pattern recognition and frequency analysis will leave the encrypted text open to deciphering.—G. A. S.



ASK BYTE

I Love This Machine, But . . .

I purchased my IBM PS/2 Model 50 Z in August 1988, and up until about two months ago I had no problems with it. But since then, whenever I start up the computer, it gives me a 1782 error mes-

sage and directs me to the DOS manual for further information. The book told me to do a system test, so I did. The test reported a parallel port error. So I took the system to an authorized IBM center. A technician spent a week checking the CPU and the ports and found nothing. She then said that since a 1782 error is a hard disk error, she would like to format the hard disk to locate the problem. I reluctantly agreed. The check found nothing wrong. I took the system home and got it running again. Guess what? About a week later, the error came up again.

This was very frustrating, especially since the IBM center did not find anything wrong with the system. I should also mention that if I turn the computer off and back on again (sometimes several times), the error does not occur and the machine operates correctly. Rebooting doesn't work, so I am worried about constantly turning the system on and off.

Son C. Nguyen
Boston, MA

The 1782 error message actually refers to the hard disk drive controller card. The IBM PS/2 series of computers is unique partly because the IBM engineers tried to minimize the use of connecting cables. The hard disk drive in your Model 50 Z plugs directly into the hard disk drive controller card. You mention that the problem goes away after turning the computer on and off several times; the problem may be due to an intermittent connection in the connector between the hard disk drive and the controller card, between the controller card and the system bus, or within one of the chips on the controller card. The problem goes away after you turn the computer on and off because the internal components in the computer are "warmed" to their usual operating temperature and the thermal expansion of the components finally makes the electronic connection.

I suggest that you remove your hard disk drive and controller card from the computer and clean the card edge connectors. Use a commercial electronic contact cleaner or denatured alcohol. Also, if there are any DIP chips on the card, make sure that they are firmly seated in their sockets. Then plug the card and drive back into your computer.

If the problem persists, have your IBM dealer test your hard disk drive controller card in another Model 50 Z.—S. W.

Database Security

I am a graduate student in computer science, and I'm currently working on

continued

The fastest way to see what you think.



Introducing the MultiSync® Graphics Engine™ Board. Now when an idea pops into your head it won't take long to pop up on screen. Because NEC's MultiSync Graphics Engine is the first graphics

board specifically designed to increase productivity in Windows, CAD/CAM and desktop publishing applications. For instance, it can run Windows 386 as much as four times faster. When used in conjunction with our accelerator software (purchased separately), Presentation Manager applications run up to five times faster. What's more, the MultiSync Graphics Engine Board is compatible with VGA, Super VGA (800 x 600) and 1024 x 768 interlaced and non-interlaced resolutions. So, whether you're a power user, professional designer or publisher, you can see your ideas on screen in world-class time. For technical details and information, call NEC Home Electronics (USA) Inc. at 1-800-FONE-NEC. For product literature call 1-800-826-2255. The MultiSync Graphics Engine Board. When you've got tons of thoughts racing through your mind, it's the fastest route from head to screen.



MultiSync is a registered trademark of NEC Home Electronics (USA) Inc. Graphics Engine is a trademark of NEC Home Electronics (USA) Inc. NEC is a registered trademark of NEC Corporation. Windows and Windows 386 are registered trademarks of Microsoft Corp. Presentation Manager is a trademark of the International Business Machines Corporation. © 1989 NEC Home Electronics (USA) Inc.

C&C Computers and Communications

Circle 190 on Reader Service Card

NEC

A MESSAGE TO OUR SUBSCRIBERS

FROM TIME TO TIME WE MAKE THE BYTE SUBSCRIBER list available to other companies who wish to send our subscribers material about their products. We take great care to screen these companies, choosing only those who are reputable, and whose products, services, or information we feel would be of interest to you. Direct mail is an efficient medium for presenting the latest personal computer goods and services to our subscribers.

Many BYTE subscribers appreciate this controlled use of our mailing list, and look forward to finding information of interest to them in the mail. Used are our subscribers' names and addresses only (no other information we may have is ever given).

While we believe the distribution of this information is of benefit to our subscribers, we firmly respect the wishes of any subscriber who does not want to receive such promotional literature. Should you wish to restrict the use of your name, simply send your request to the following address.

BYTE MAGAZINE

ATTN: SUBSCRIBER SERVICE
P.O. Box 555
HIGHTSTOWN, NJ 08520



research paper on database security. I'd appreciate it if you could provide me with any information on the subject.

Earnest D. Harris
Memphis; TN

Your first stop should be BYTE's June issue, in which the In Depth section is devoted to security. Next, see if you can locate a copy of DataBase Management Systems, edited by R. A. Frost (McGraw-Hill, 1984), which contains at least one case study focusing on database security. Finally, be on the lookout for Computer and Communications Security by James Arlin Cooper (McGraw-Hill, 1989), which includes discussions of network-systems security.—R. G.

The Leap from Apple

I have a number of disks in Apple CP/M, formatted on an Apple II with 16 sector drives and a Microsoft Z80 SoftCard. The SoftCard Apple CP/M is a 60K-byte version 2.23. I would like to transfer the disks to an IBM PC XT running PC DOS 3.3. They contain programs in dBASE II, as well as files that I created with WordStar. I have tried using Xenocopy, but the Apple II is not among the systems that it supports.

M. S. C. Ong
Seremban, Malaysia

Whenever I receive a letter about file transfer between dissimilar machines, my first suggestion is always: Locate a public domain communications program for each machine, put a serial port together, and shoot the files across that way. That's usually the cheapest way to go; it involves some investment in time and a minimal investment in hardware. (I am, of course, presuming that both machines already have RS-232C interfaces installed.)

Depending on how much you're willing to spend, you might also want to look into PC Transporter from Applied Engineering (P.O. Box 5100, Carrollton, TX 75011, (214) 241-6060). Not only will you be able to copy files between Apple and PC format disks, you'll be able to run the programs on your Apple II.

—R. G.

PC Music

I want to build a music synthesizer on an IBM PC expansion board, using a number of dedicated chips such as the 6581 sound interface device (SID) found in Commodore machines. Are there other similar devices more appropriate for use on the PC bus? Alternatively, what sort

continued

Call us for a free AnthroCart catalog: 800-325-3841



**Anthro®
Technology Furniture®**
3221 N.W. Yeon St.
Portland, Oregon 97210
(503) 241-7113

Anthro, AnthroCart and Technology Furniture are registered trademarks of Anthro.

GET THE PC NETWORK ADVANTAGE

Join Today -- Receive A FREE Surprise Package of Gifts, and More...

9 Reasons Why You Should Join The Club...

Over 100,000 Satisfied Club Memberships. PC Network Members come to us for everything from basic software/hardware to complex computer system needs. We answer tough questions, offer great merchandise selection, and provide excellent service. When you join you receive...

1. Red Carpet Service

Club members receive exclusive privileges, plus special merchandise offers, streamlined 24-hour order processing, shipping, and service.

2. Warehouse Pricing

Club members get low warehouse-to-you prices every day. (Just take a "peek" at our specials.)

3. Exclusive PC Network Credit Card.

Now you can apply for a credit card devoted to your computing needs. Great when you need fast warehouse-to-you shipments.

4. Used Computer Hardware Exchange

Sell your used computer hardware to other Club members. Upgrade your system. Available to Club members at a nominal cost.

5. Members ONLINE Bulletin Board

Download "Freeware" and "Shareware" from our massive collection of Public Domain software. Place orders. Get information. Not just a bulletin board, but a complete member information network.



6. Club Leasing — Business Option

With other computer companies, if you wanted to lease computer hardware, you had to be a big business. Now small businesses and professional Club members have this option available.

7. Dow Jones Information Retrieval

Have access to this information service at members only discount rates plus receive special discount certificates, worth over \$50.00 in FREE services.

8. No Minimum Purchase-EVER!

That's right. Club members have no pre-set purchase requirements. No complicated forms. No unwanted or un-ordered merchandise-ever. You pick and choose what you want-when you want it.

9. Exceptional Service-Unequalled Privileges.

You have toll-free direct lines to PC Network whenever you need to talk to a Technical Consultant or Computer Consultant. Plus, your very own Club Representative to answer your computer questions.

Members Take Advantage Of Specials Like These



Accept Our Invitation

Join today and receive our latest Buyer's Guide and your New Member's kit, with personalized I.D., PLUS—if you're one of the first 1,000 new members, you will automatically receive a special FREE surprise package of gifts. Open a world of exceptional service and unequalled privileges—all for only \$19.95 a year. Join now, find out for yourself why "Personal Computing" magazine ranked PC Network, "Best for Overall Pricing-Overall Value!"

Join Now, 1-800-621-7283

PC NETWORK

MMG
MICROCOMPUTER
MARKETING GROUP



A SIMPLE AUDIO AMPLIFIER

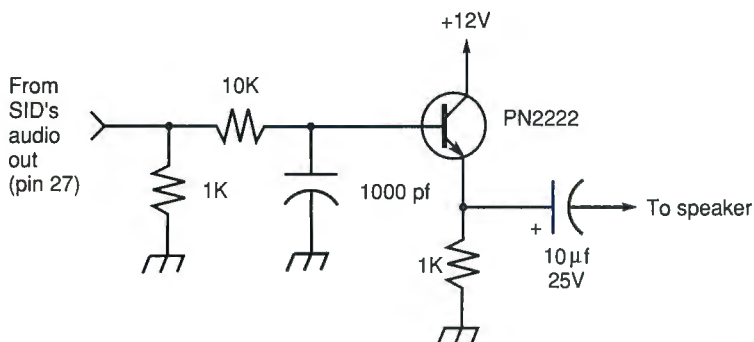

An audio amplifier circuit for the 6581 sound interface device (SID).

of adaptations must I provide to interface the 1-MHz 6581 with the PC bus?

Ivo Busko
Baltimore, MD

I might be telling you something you already know, but before you go putting together your own music synthesis card for the PC, you should look into the possibil-

ity of purchasing (or building) a MIDI interface for your PC. You'd probably get a lot more mileage out of MIDI than a do-it-yourself synthesizer card. Manufacturers of MIDI interfaces for the PC include Music Quest, Inc. (2504 Ave. K, Suite 500-492, Plano, TX 75074, (214) 881-7408), Roland Corp. (7200 Dominion Circle, Los Angeles, CA 90040, (213)

685-5141), and so many more that I wouldn't have space for them all. Locate a recent issue of Electronic Musician magazine and do some browsing. You'll find plenty of possibilities.

If you want to build your own MIDI adapter, "A MIDI Project" in BYTE's June 1986 issue should fill the bill. I've even heard of people modifying ordinary IBM PC serial interfaces to work with MIDI. Key Electronic Enterprises (9112 Hwy. 80 W, Suite 221-E, Fort Worth, TX 76116, (817) 560-1912) makes a device that operates off PC serial ports.

Finally, if you're simply desperate to put the 6581 SID into your PC, you could probably do it by building a parallel I/O board with an 8255 on it and controlling the inputs to the SID through the 8255's ports. As you've already noted, you'll have to include a 1.0-MHz source for the SID chip (easily done with a crystal from Jameco or JDR Microdevices).

For details on how to put together the 8255 interface, locate a copy of Handbook of Software and Hardware Interfacing for IBM PCs by Jeffrey P. Royer (Prentice-Hall, Englewood Cliffs, NJ, continued

IN SOME WAYS WE DON'T STACK UP

FROM 6 REMOTE PCs

MODEMS

"FUSS" BASED

NETWORK CONTROLLER IN EACH PC HUB

IN SOME WAYS WE DO!

QL 1002 - 2 PCs per board

FROM 6 REMOTE PCs

MODEMS

BUS-BASED

Remote Communications Made Easy

The QL 1000 PC-on-a-board Series is the elegant, low-cost alternative to standalone dial-in, dial-out communication servers for Novell NetWare and CBIS Network-OS networks.

Instead of dedicating noisy, bulky standalone PCs to specific network tasks, QL 1000 Series computers-on-a-card install neatly inside the fileserver chassis — not visible, but ready to process tasks upon demand.

Each user's processor, memory and I/O are on an AT bus based add-in board. Data travels at bus speed. Compatible with Ethernet, ARCnet, or Token Ring.

By using QL 1000 boards, you don't need a stack of money AND a stack of PCs to install remote communications and high speed networking.

Call 1-800-648-2130 for details

Novell NetWare is a trademark of Novell, Inc.
CBIS Network-OS is a trademark of CBIS, Inc.

Cubix Corporate Offices • 2800 Lockheed Way, Carson City, Nevada 89706
Tel (702) 883-7611 • Fax (702) 882-2407



	MODEL	DESCRIPTION	ANALOG INPUTS		PRICE	
			Channels	Resolution (bits)		
LOW COST	DT2811-PGH	Low Cost A/D, D/A, Interrupt	16SF/8DI	12	\$5	
	DT2811-PGL	Low Cost, Low-Level A/D, D/A; Interrupt	16SF/8DI	12	\$15	
	DT2814	Low Cost A/D, Int	16SF	12	\$95	
	DT2815	Low Cost D/A	---	---	\$75	
	DT2817	Low Cost DIO	---	---	\$239	
GENERAL PURPOSE	DT2819	Am2935A Counter/Timer, DIO	---	---	\$595	
	DT2808	Low Cost, DMA	16SF	10	\$995	
	DT2801	General Purpose, DMA	16SF/8DI	12	\$1,095	
	DT2801-A	Higher Throughput, DMA	16SF/8DI	12	\$1,970	
	DT2801/5716A	High Resolution, DMA	8DI	16	\$1,095	
	DT2805	Low Level, DMA	8DI	12	\$2,070	
	DT2805/5716A	Low Level, DMA	8DI	16	\$2,495	
	DT2809	16-bit SS&H, DMA	8SF SS&H	16	\$1,895	
	DT2816	SS&H, DMA	4SF SS&H	12	\$1,095	
	DT2824-PGH	High Throughput, Low Cost A/D, DMA, Ints.	16SF/8DI	12	\$1,345	
DT2824-PGL				\$1,995		
ARRAY PROCESSING: IBM PC/XT/AT						
	MODEL	DESCRIPTION	COMPUTER	IEEE 23-BIT FLOATING-POINT ARITHMETIC	PEAK PERFORMANCE	CY/CLK
ARRAY PROCESSING	DT7020	Floating-Point Array Processor	PC/AT	✓	8 MFLOPS	\$2,895
	DT7010	Floating-Point Array Processor	PC/XT/AT	✓	6.5 MFLOPS	\$1,545
DT-Connect	DT2828	High Throughput, SS&H, DMA, Interrupts		✓	4SF, 55&H	\$2,585
	DT2829	16-bit SS&H, DMA, Int.		✓	8SF, 55&H	\$2,195
	DT2841	40kHz, DT-Connect		✓	16SF/8DI	\$2,995
	DT2841-F-16SE, DT2841-F-8DI	150kHz, DT-Connect		✓	16SF or 8DI	\$1,450
	DT2841-G-16SE, DT2841-G-8DI	250kHz, DT-Connect		✓	16SF or 8DI	\$2,095
	DT2841-L	750kHz, DT-Connect		✓	4DI	\$2,695
	DT2847	16-bit, DT-Connect		✓	4DI	\$2,995
FLEXIBLE I/O	DT2848	55&H, DT-Connect		✓	4SE	\$2,495
	DT2806	18BX A/D		✓	Up to 80SF/40DI	\$2,095

-Fred Molinari, President

Pages 14-17, New Products Handbook

If you hunger for faster data acquisition and processing, here's the recipe...in real time.

The DT2841 and DT7020, 750kHz throughput. 32-bit floating point processing. Data acquisition has never been faster.

If PC AT® throughput bottlenecks are frustrating you, Data Translation has the answer. Our external interface, DT-Connect™, surmounts the historically slow AT bus to deliver much faster data acquisition and array processing.

This is the answer for high-speed DSP

operations such as filters and FFTs. It features A/D, D/A, DIO, and a Timer/Counter . . . plus, MACH™ Subroutine Libraries that support most programming languages.

At last. High-speed data acquisition and high-speed computation power.

Together. In one tasty package.

Call (508) 481-3700
In Canada, call (800) 268-0427

FREE 1989 Data Acquisition Handbook.



DATA TRANSLATION®

World Headquarters: Data Translation Inc., 100 Locke Drive, Marlboro MA 01752-1192 USA, (508) 481-3700 Tlx 951646

United Kingdom Headquarters: Data Translation Ltd., The Mulberry Business Park, Wokingham, Berkshire RG11 2QJ, U.K. (0734) 793838 Tlx 94011914

West Germany Headquarters: Data Translation GmbH, Stuttgarter Strasse 66, 7120 Bietigheim-Bissingen, West Germany 01742-54025

International Sales Offices: Australia (2) 562-4255; Belgium (2) 466-8199; Canada (416) 625-1907; China (1) 868-721 x4017, (408) 727-8222; Denmark (2) 274511; Finland (0) 372144; France (1) 69077802; Greece (1) 951-4944, (31) 527.039 (1) 361-4300; Hong Kong (5) 448963; India (22) 23-1040; Israel (3) 5401524; Italy (2) 82470.1; Japan (3) 502-5550, (3) 348-8301, (3) 355-1111; Korea (2) 756-9954; Netherlands (70) 99 6360; New Zealand (64) 9-545313; Norway (2) 53 12 50; Portugal (1) 545313; Singapore (65) 7797621; South Africa (12) 8037680/93; Spain (1) 455-8112; Sweden (8) 761-7820; Switzerland (1) 723-1410; Taiwan (2) 7020405

DT-Connect and MACH are trademarks and Data Translation is a registered trademark of Data Translation, Inc. All other trademarks are the property of their respective holders.

Circle 78 on Reader Service Card

1987). A simple audio amplifier circuit for the SID (as suggested by Commodore) appears in the figure. To keep digital noise out of the audio stage, be sure your ground connections for the SID and the amplifier stage are separate from the grounds used by the 8255 and its attendant support circuitry.—R. G.

More Megabytes

In January, I purchased—through mail order—Digital Electronics Company's DE386 20-/25-MHz Desktop VII computer with 1 megabyte of RAM. Since April, I have been unable to contact Digital Electronics (the company was located in Rockville, MD). Certified mail that I have sent to the company remains unclaimed and is returned to me.

Basically, my system performs without problems, although the turbo mode—which is supposed to speed up the system to 25 MHz—causes all my programs to freeze.

I am in desperate need of more RAM. The manual that came with the machine reads, "The system memory board will support up to 16-Mb of 32-bit expansion memory through the use of special Digi-

tal Electronics expansion memory boards which attach to the main memory board in piggy-back fashion." The memory board, now fully loaded with 2 megabytes' worth of 256K-byte chips, is manufactured in Taiwan and is imprinted with the following information: ET-3 Pulsar MDS USA87, serial number P8706306.

Do you have any information regarding Digital Electronics Company? If not, what is the best way for me to upgrade my existing 32-bit memory board to its full potential? Obviously, I'd be happiest if I could find a compatible piggyback board.

Daniel Kalmann
New York, NY

You're about to embark on one of the more interesting aspects of owning a personal computer—the care and feeding of orphans. The memory expansion on most of these AT clones is proprietary to the manufacturer. I've called around and have been unable to reach Digital Electronics or locate anyone with information on your motherboard. What to do?

First off, I'm guessing that you added 1

megabyte to your machine, bringing it up to 2 megabytes. Is the memory you added fast enough? Is it from the same manufacturer as the original RAM? Yes, it matters. Japanese RAM has different timing than American RAM. When you push a processor at 25 MHz, the subtle timing differences can become significant. You might try substituting different RAM chips for the ones that you added. Another sad fact is that many of these boards simply won't work at their "turbo" speed no matter what you do.

If it were my machine, I'd forget about expanding the system board and buy a memory card for the bus. The Intel Above-Board, the Everex RAM 3000, or any good memory card may work. The memory will run a bit slower (being out on the bus), but you have the added advantage of being able to move the memory from this machine to another if this one ever dies. Depending on the BIOS, you may not even be able to add RAM on the bus.

The safest way would be to take the machine into a good computer store and try the memory card right in the store. If you buy a card mail order and it doesn't work, well . . . —H. E. ■



Finally. OS/2 debugging help has arrived.

Introducing MultiScope™, an OS/2, multi-language, CodeView™-compatible debugger, like nothing you've seen before.

For a start, it provides 13 views of your program: Source—Data—Graphic Data—Assembly—Thread—Breakpoint—Watch—Register—Module—Call—Memory—Log—and Output.

Other unique features include: run-time and post-mortem debugging options; OS/2 text mode and Presentation Manager user interfaces; and even a graphical representation of your data structures! All for \$299.

*Call toll free 800-231-7717.
In CA 800-552-8885. Fax 415-792-8901.*



From LOGITECH Software

Circle 310 on Reader Service Card (DEALERS: 311)

THE NEW STANDARD FOR HIGH PERFORMANCE STATISTICAL SOFTWARE

CSS

**COMPLETE STATISTICAL SYSTEM
WITH DATA BASE MANAGEMENT
AND GRAPHICS**

A powerful, comprehensive, elegant, and super-fast statistical package for IBM (PC, AT, PS/2) and compatible computers. ■ The CSS optimized user interface with fast hierarchical menus incorporates elements of artificial intelligence; even complex analyses require only a few keystrokes (batch processing is also supported). ■ CSS features comprehensive, state of the art implementations of: *Basic statistics, Multi-way frequency tables, Nonparametric statistics, Exploratory data analysis with analytic graphs, Multiple regression methods, Time series analysis with modeling and forecasting (incl. full ARIMA), General ANOVA/ANCOVA/MANOVA, Contrast analysis, Discriminant function analysis, Factor analysis, Principal components, Multidimensional scaling, Item analysis/Reliability, Log-linear analysis, Cluster analysis, Non-linear estimation, Logit/Probit analysis, Canonical analysis, Survival and Failure Time analysis (Censored data), Quality Control analysis, and much more.* ■ All statistical procedures are integrated with fast data base management and instant, presentation quality graphics (over 100 types); full support for all mono and color graphics boards (incl. VGA) and over 100 plotters and printers (incl. the HP and Postscript standards). ■ All CSS screen output is displayed via customized Scrollsheets™ (i.e., dynamic, user controlled, multi-layered tables with cells expandable into pop-up windows); all numbers in a Scrollsheet™ can be instantly converted into a variety of presentation quality graphs; contents of different Scrollsheets™ can be instantly aggregated, combined, compared, plotted, printed, or saved. ■ The flexibility of the CSS input/output is practically unlimited: CSS offers an intelligent interface (read/write) to all common file formats (Lotus, Symphony, dBI, dBIII+, DIF, SYLK, . . .) and special utilities to easily access data from incompatible programs; graphics can be saved in files compatible with desktop publishing programs (Aldus, Ventura). ■ CSS data files can be as large as your operating system (DOS) allows; OS/2 version coming soon. ■ CSS precision exceeds the standards of all common precision benchmarks. ■ *Technical note: The CSS user interface and all I/O were written in Assembler and bypass DOS; graphics and data management were written in Assembler and C; the computational algorithms were written in Assembler and optimized Fortran.* ■ \$495 (plus \$5 sh/h); 14-day money back guarantee.

Circle 259 on Reader Service Card



StatSoft

2325 East 13th Street ■ Tulsa, OK 74104 ■ (918) 583-4149
Fax: (918) 583-4376

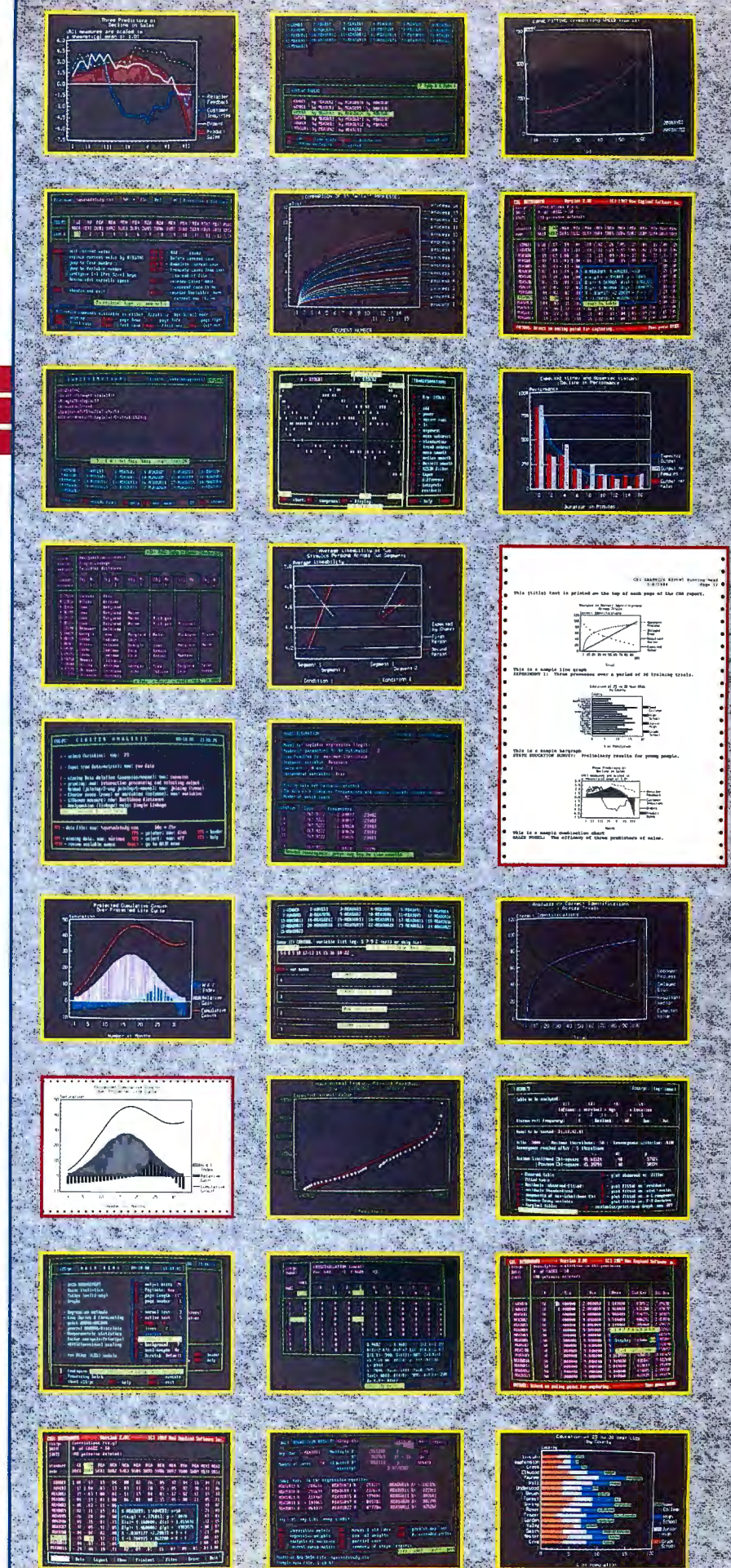

Overseas Offices: StatSoft of Europe (Hamburg, FRG), ph: 040/4200347, fax: 040/4208724, StatSoft UK (London, UK), ph: 0438/310056 or 316561, fax: 0438/310001, StatSoft Pacific (Melbourne, Australia), ph: 613-663-6580, fax: 613-663-6117, StatSoft Canada-CCO (Ontario), ph: 416-849-0737, fax: 416-849-0918 Available From: CORPORATE SOFTWARE and other Authorized Representatives Worldwide: Holland: Lemax BV 02968-94210; France: Conceptel (1) 45669700; Sweden: AkademiData 018-696201; Korea: Geul Bang (02) 272-1973

“When Fosberry said a PS/2 with Micro Channel would let him juggle ten things at once and still have time to break for lunch, he meant it.”

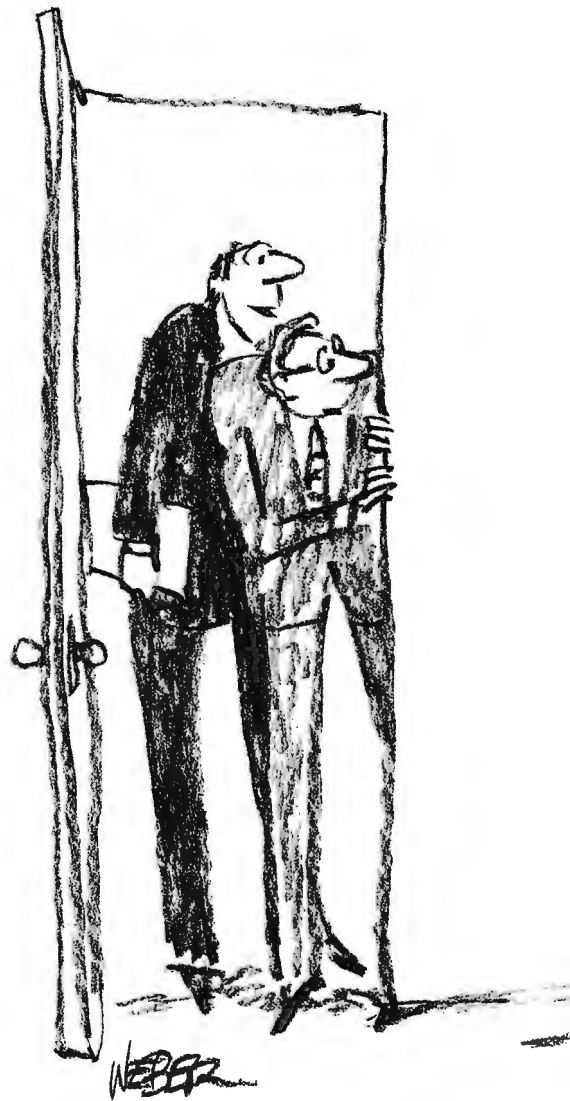

How're you going to do it?

These days, no matter what size your company, you've got to be able to keep a lot of balls in the air to stay competitive.

The Genius Of Micro Channel. Which is why IBM developed the Personal System/2[®] with Micro Channel.[™] Micro Channel can support multiple operating microprocessors. So you can, for example, separately manage peripherals, while freeing up the main processor to crunch numbers. A bus master can even be sending a fax while another manages traffic on a network, all with greater reliability.

Naturally, every PS/2[®] with Micro Channel runs DOS and OS/2.[™] So with OS/2 Presentation Manager,[™] you can do multiple tasks concur-



PS/2 it!

rently, all with an easy-to-use graphical interface. What's more, with Micro Channel, there are no DIP switches to set, for simpler, more reliable installation. You can find and reset cards anywhere in the network—right from your desk!

The Solution Is IBM. So, to manage lots of information, jobs, hardware and software, invest in the PS/2 with Micro Channel. Contact your IBM Authorized Dealer or IBM marketing representative. For a dealer near you, call 1 800 IBM-2468, ext. 142. You'll learn there's almost nothing you can't do if you PS/2 it!



IBM[®]

"Number crunching's for when I'm in the office. Out here, just give me a great little PC. And I mean little."



ZENITH INNOVATES AGAIN™



A BRIEF CASE FOR MINISPORT

- Under 6 pounds
- Removable MiniDisks
- DayBright™ LCD screen
- 3+ hours battery life

The leader in laptop PCs* now brings you a notebook portable that fits your business and your briefcase.

Finally, desktop performance on a moment's notice. That's the sleek MinisPort™ from Zenith Data Systems.

Under 6 pounds, MinisPort rides in a briefcase like a notebook. But unlike other notebook PCs, it uses removable MiniDisks to store all the data you need...just like your desktop. You also get a DayBright™ backlit screen for crisp text in any light. And over 3 hours of battery life.

So bring your portable computing down to a more manageable size with Zenith's sleek MinisPort.

For your nearest Zenith Data Systems authorized dealer, call: 1-800-842-9000, ext. 1.

ZENITH | data systems

THE QUALITY GOES IN BEFORE THE NAME GOES ON*

*Source: Dataquest—True portable PC sales.

Graphics simulate Microsoft® Windows, a product and trademark of Microsoft Corporation.

© 1989, Zenith Data Systems

CHAOS MANOR MAIL

*Jerry Pournelle answers questions about his column
and related computer topics*

ST Lacks Fax

Dear Jerry,

As an Atari ST owner, I'm aware that there doesn't seem to be any possibility of inserting a fax card into my machine, since there are no slots. However, there is a modem port. Could you please explain if there is some way of composing a document in memory and some describable protocol to send it to a fax receiver via a modem?

Also, are there any 9600-bps or higher fax machine protocols? Would the same protocols work for digitized documents, and are there different resolution standards? What else would be required to receive and store fax messages in memory, so they could be displayed on a monitor instead of having to be printed? We're all bracing for the coming fax revolution, and we're planning to get a digitizer for desktop publishing. It seems that with the proper elements we should be able to do both faxing and DTP, but it would help to know exactly how to make them work together properly.

Frederick Bernard
Vancouver, BC, Canada

Sorry, but I don't know of any way to do that. Perhaps one of BYTE's readers will know. They seem to know everything.

—Jerry

Face-Up vs. Face-Down Output

Dear Jerry,

Recently you complained about the face-up output of your LaserJet Plus printer. We have a similar machine at work, and it has a feature that enables you to switch the output between face-up and face-down. There is a two-position lever to the right of the output slot with some indecipherable symbols indicating this function. In one position the printer outputs each page face-up; in the other, it outputs face-down. I hope this reduces future problems.

Dave Swanson
Elgin, IL

Hmm. My LaserJet Plus is an original LaserJet (I got it way back in CP/M

days!) that was upgraded to a Plus, and it certainly has no such switch. The LaserJet II has that option, of course. So does our big Kyocera printer and Mrs. Pournelle's Mannesman-Talley printer.

I have long thought that I ought to put the LaserJet Plus downstairs for the staff and bring the Kyocera up here; it's much the superior printer, so why should they have it? The only reason I can give for not having done it is sloth (and I don't do that much printing up here; most of it is done downstairs on the Tandon computer and the Kyocera printer).—Jerry

Windows in Monochrome

Dear Jerry,

The March issue of BYTE was full of good news for those of us who use and like Microsoft Windows. Mark Minasi reported on Micrografx's Mirrors, Ray Valdés reviewed XVT, and you had the wisdom to name Windows the Software Trendsetter of 1988.

Windows has its problems (how is it possible to design a graphical interface that doesn't manage the most graphical data structure, the directory tree?), but it does many things DOS can't, and at a far lower cost than OS/2. It even runs well on systems that can't run OS/2.

I would like to make some observations on your comment that you can get Excel and MacInTax for your AT, "provided you have a good EGA video system." Neither Windows nor Windows applications require high-resolution color. In fact, using an EGA or VGA color video system will slow down Windows considerably.

I have an AT&T PC 6310 AT compatible. It runs at 8 MHz with one wait state and has a 16-bit video card that provides a 640- by 400-pixel monochrome

continued

Jerry Pournelle holds a doctorate in psychology and is a science fiction writer who also earns a comfortable living writing about computers present and future. He can be reached c/o BYTE, One Phoenix Mill Lane, Peterborough, NH 03458, or on BIX as "jerryip."

situation:

**Puzzled over
which Pascal
compiler is best
for you?**

solution:

BLAISE COMPUTING INC.

Our tools support both
QuickPascal and Turbo Pascal.

POWER TOOLS PLUS/5.0 \$149

Full featured function library

- ◆ Features context sensitive help screens
- ◆ window oriented pick lists ◆ multiple-line edit fields with fully configurable edit keys
- ◆ moving bar pull-down menus and windows
- ◆ in-memory sort routines ◆ EMS support
- ◆ TSRs and ISRs ◆ and much more!

ASYNCH PLUS \$129

Asynchronous communication manager

- ◆ Features speeds to 19.2K baud
- ◆ XON/XOFF protocol ◆ support for up to 4 comm ports ◆ hardware handshaking
- ◆ XModem file transfer ◆ I/O buffers up to 64K
- ◆ and much more!

POWER SCREEN \$129

Screen I/O manager

- ◆ Features screen painter ◆ virtual screens
- ◆ data validation ◆ context sensitive help
- ◆ unlimited screens ◆ definable keys
- ◆ and much more!

Fast, flexible and affordable!

Blaise Computing offers programming tools that are fast, flexible and affordable. Call now to order or to ask for a free brochure on our full line of products for C and Pascal.

FREE with these products!

Source code, complete sample programs, a comprehensive reference manual with extensive examples, the Norton Guides Instant Access Program, and a comprehensive online database.

Supports QuickPascal and Turbo Pascal!

All of these products support Turbo Pascal 4.0, 5.0, and 5.5 and Quickpascal 1.0.

Put Blaise tools to the test!

If at any time during the first 30 days you are not completely satisfied with their speed and flexibility, we'll refund your money.

Call (800) 333-8087 today!

FAX: (415) 540-1938

BLAISE COMPUTING INC.

2540 Ninth Street, Suite 318, Berkeley, CA 94710 (415) 540-5447

Turbo Pascal is a registered trademark of Borland International. QuickPascal is a registered trademark of Microsoft Corporation.

display. This is hardly state-of-the-art technology, but it runs Windows very well. I've been trying out Windows software on systems that run far faster, have far more memory, and are equipped with fast 16-bit VGA cards. Windows' performance on these machines is miserable.

When you think about it, it's apparent why a high-resolution color video system slows Windows down. The CPU must deal with a much larger video RAM space and an equally large screen buffer in main memory. A monochrome display represents a far smaller load on the CPU. Unless your work absolutely requires color output, you should run Windows in a monochrome mode (I believe Microsoft supplies graphics drivers for the EGA 640- by 350-pixel and VGA 640- by 480-pixel monochrome modes).

A solution to this problem will probably come in the form of video coprocessors (I have this fantasy of an Amiga 500 motherboard as an AT video card). Until then, we should remind ourselves that black-and-white is different, not worse.

Noah Jacobs
San Francisco, CA

Well, but I sure do like color.—Jerry

Low-Cost Compiling

Dear Jerry,

I enjoy your Computing at Chaos Manor column. It was the column that originally sold me on BYTE, and it remains BYTE's major attraction. I appreciate your hands-on reviews and your willingness to express your opinions.

I'd like your advice and/or a reference to an appropriate review regarding the various C compilers on the market. I have experience with FORTRAN (college, circa 1970) and interpreted BASIC. I've been working with a Unix-based system in my office, and I've started

learning some C with the AT&T System V compiler. I'd like to buy a C compiler for my AT clone at home. However, the advertised prices in BYTE range from \$50 to \$400, with only advertising copy for comparison. Can I get a potent compiler without breaking the bank?

Nic Steussy
Springfield, TN

Thanks for the kind words. BIX is getting less expensive because of new marketing techniques, and it's the ideal place to ask questions like this.

I am no C authority. I understand that Borland's Turbo C is very good and reasonably priced. After that, you'd better get more expert advice. BYTE did a Product Focus on C compilers in the February issue. There are a lot of C compilers, and they are not all equal.—Jerry

Amiga Notes

Dear Jerry,

I'm one of the great unwashed who scrimped and saved and finally splurged on an Amiga 1000 after your first very positive BYTE review. I've been reading your comments since then with some concern, and I have to agree that they've been fair and factual. Nonetheless, I was glad to see your report on more positive developments such as Unix, because despite everything I've grown rather fond of my idiot child.

It's fun to read your column and dream of being surrounded by great snarling 80386 beasts, as at Chaos Manor. I hope someday you'll install a 68030 board in your Amiga 2000, because, chip for chip, it is said to have four times the computing power of the 80386.

I often think your asides about the concrete problems of setting up an "ergonomic" work environment are your most useful and lasting contributions. I con-

stantly use the copy holder I kludged onto a drafting light fixture after seeing you using something similar in a photograph taken eons ago. In addition to the wide, flat desk for global input of paperwork, I recommend cheap cork tiling on all walls not occupied by bookshelves. It holds reams of stuff you don't want to rummage for and provides a resilient surface for your skull during debugging.

Charles Heckel
Van Nuys, CA

Thanks.—Jerry

All Thumbs

Dear Jerry,

You responded to James T. Oitzinger's suggestion (April) that dividing a keyboard's space bar into two parts might result in a better keyboard by saying, "That sounds like an interesting idea. I've been watching, and I hardly ever use my left thumb for anything. Fascinating. Thanks for the suggestion."

I, too, thought it was an interesting idea, so I read Oitzinger's letter to my wife. Her response was that the left thumbs of keyboard users must be kind of lazy, because her (old) bassoon has eight different keys controlled by her left thumb, and sometimes she must depress four or five of them *at the same time*. (She also said that newer bassoons have nine keys for the left thumb.)

That really makes me appreciate my one-bar-for-both-thumbs keyboard!

Dr. Myron A. Calhoun
Manhattan, KS

Right! I'm using a Northgate keyboard, with the Backspace key where it belongs (up there where the [] keys are on other keyboards). Alas, they only made about five of them, and I think I have them all.

—Jerry ■

High Performance Multi-Channel Serial I/O

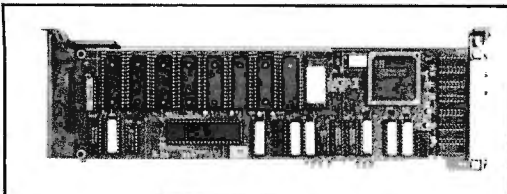

MCSS-9IM

GTEK .INC

Development Hardware & Software
P. O. Box 2310
Bay St. Louis, MS 39521-2310

Order Toll Free 1-800-255-GTEK (4835)

Fax: 1-601-467-0935 MS & Technical Support 1-601-467-8048

MCSS-9IM

For IBM Micro-Channel compatible bus

- ▶ Serial Communication Co-processor with 9 channels per card.
- ▶ Dynamemory™ automatically finds and allocates up to 1 Megabyte of buffer memory. To add more memory just plug it in!
- ▶ Baud rates up to 57,600 baud. Upward compatible with the PCSS-8I.

PCSS-8IM

For IBM PC/XT/AT compatible bus

- ▶ Serial Communication Co-processor with 8 channels per card.
- ▶ Dynamemory™ automatically finds and allocates up to 2 Megabytes of buffer memory. To add more memory just plug it in!
- ▶ Baud rates up to 57,600 baud. Upward compatible with the PCSS-8I.

MCSS-6T

For IBM Micro-Channel compatible bus

- ▶ Serial I/O card adds 6 channels to a Micro-Channel machine.
- ▶ Compatible with the PCSS-8T, PCSS-8TX, and the PCSS-8TH.

PC/XT/AT and Micro-Channel are registered trademarks of IBM Corp.

Subscribe to BYTE now and

SAVE up to 52%

PLUS, get the annual IBM PC Special Issue as an

EXTRA BONUS!

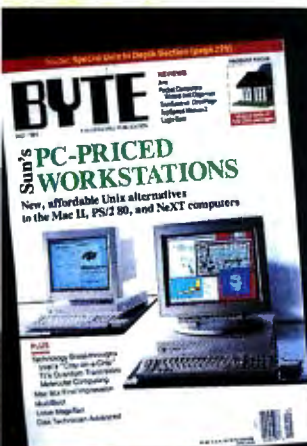

- Stay in the know on all major microcomputer products and innovations
- Save time and money—invest in the best equipment for your needs
- Harness the maximum power of your micro.

Subscribe today and save!

In a hurry? Call Toll-Free 1-800-257-9402 weekdays 9-5 EST. In NJ, call 1-609-426-5535.

Enjoy MORE SPEED!

SAVE up to \$66.05 PLUS

get the extra IBM PC Special Issue

Send me BYTE for:

- 1 year (12 issues) for \$24.95 (Save 40% off the newsstand cost)
- 2 years (24 issues) for \$44.95 (Save 46% off the newsstand cost)
- 3 years (36 issues) – \$59.95 SAVE 52% off the newsstand cost (20% off the basic subscription price)

Name _____

Company _____

Address _____

City/State/Zip _____

Payment enclosed Bill me

No-Risk Guarantee: If dissatisfied, cancel anytime for a full 100% refund. Your subscription will start in 6-8 weeks. Watch for it! Single copy \$3.50. The basic annual subscription rate is \$29.95.

IBK5228

Profit from MORE POWER!

SAVE up to 52% PLUS

get the extra IBM PC Special Issue

Send me BYTE for:

- 1 year (12 issues) for \$24.95 (Save 40% off the newsstand cost)
- 2 years (24 issues) for \$44.95 (Save 46% off the newsstand cost)
- 3 years (36 issues) – \$59.95 SAVE 52% off the newsstand cost (20% off the basic subscription price)

Name _____

Company _____

Address _____

City/State/Zip _____

Payment enclosed Bill me

No-Risk Guarantee: If dissatisfied, cancel anytime for a full 100% refund. Your subscription will start in 6-8 weeks. Watch for it! Single copy \$3.50. The basic annual subscription rate is \$29.95.

IBK5228

Gain MORE APPLICATIONS!

SAVE up to 52% PLUS

get the extra IBM PC Special Issue

Send me BYTE for:

- 1 year (12 issues) for \$24.95 (Save 40% off the newsstand cost)
- 2 years (24 issues) for \$44.95 (Save 46% off the newsstand cost)
- 3 years (36 issues) – \$59.95 SAVE 52% off the newsstand cost (20% off the basic subscription price)

Name _____

Company _____

Address _____

City/State/Zip _____

Payment enclosed Bill me

No-Risk Guarantee: If dissatisfied, cancel anytime for a full 100% refund. Your subscription will start in 6-8 weeks. Watch for it! Single copy \$3.50. The basic annual subscription rate is \$29.95.

IBK5228



BUSINESS REPLY MAIL
FIRST CLASS MAIL PERMIT NO. 42 HIGHTSTOWN, NJ

POSTAGE WILL BE PAID BY ADDRESSEE:

BYTE

Subscription Department
P.O. Box 558
Hightstown, N.J. 08520-9409

NO POSTAGE
NECESSARY
IF MAILED
IN THE
UNITED STATES



BUSINESS REPLY MAIL
FIRST CLASS MAIL PERMIT NO. 42 HIGHTSTOWN, NJ

POSTAGE WILL BE PAID BY ADDRESSEE:

BYTE

Subscription Department
P.O. Box 558
Hightstown, N.J. 08520-9409

NO POSTAGE
NECESSARY
IF MAILED
IN THE
UNITED STATES



BUSINESS REPLY MAIL
FIRST CLASS MAIL PERMIT NO. 42 HIGHTSTOWN, NJ

POSTAGE WILL BE PAID BY ADDRESSEE:

BYTE

Subscription Department
P.O. Box 558
Hightstown, N.J. 08520-9409

NO POSTAGE
NECESSARY
IF MAILED
IN THE
UNITED STATES



Detach and mail card
now to

**SAVE up to
52%**
on BYTE . . .

PLUS,
get the annual IBM
PC Special Issue as
an

**EXTRA
BONUS!**



*Order even faster by
phone:*

**Call
Toll-Free**

1-800-257-9402
weekdays 9-5 EST.
In NJ, call
1-609-426-5535.

WHAT'S NEW

HARDWARE • SYSTEMS

MCA Clones from France

The NS70-25 is a small Micro Channel architecture-compatible 25-MHz 80386 desktop system from France. Other NS systems include a 16-MHz 80286, a 16-MHz 80386SX, and a 20-MHz 80386.

All these machines use a proprietary Normerel BIOS; the company calls it "multilingual," because it is user selectable at setup to English, French, Spanish, or German. The NS70-25 includes 1 megabyte of RAM (upgradable to 4 megabytes), a 64K-byte disk cache, and one 1.44-megabyte floppy disk drive (with support for another 3½-inch internal drive and a 5¼-inch external drive). The standard hard disk drive is Quantum's 84-megabyte SCSI-based drive with a 19-ms average access time.

Included in the NS70-25 package is a 102-key PS/2-style keyboard and DOS 3.3. A 140-megabyte hard disk drive is optional.

The 16-MHz NS machines include your choice of 40- or 80-megabyte SCSI drives, but they don't include disk caching.

Price: NS70-25, \$7229.

Contact: Normerel USA, Inc., 7665 Currency Dr., Orlando, FL 32809, (800) 940-8500 or (407) 240-8828. **Inquiry 1135.**

DEC Gets Low on RISC

The DECstation 2100 is a low-priced small-footprint RISC system. It's based on the 12.5-MHz R2000 processor from MIPS Computer



Normerel's 25-MHz NS70-25 has an MCA bus.

Systems, and it includes 8 megabytes of RAM (expandable to 24 megabytes), a 15-inch monitor with 1024- by 864-pixel resolution, a thick and thin Ethernet interface, a mouse, a keyboard, and Ultrix Workstation Software, which includes an Ultrix (DEC's Unix) license for up to two users. Software includes TCP/IP, NFS, a C compiler, and DECwindows/X Window System programming tools and applications.

The systems can hold two internal 104-megabyte SCSI hard disk drives. DEC provides SoftPC DOS-emulation software for running DOS applications.

Price: With monochrome monitor, \$7950; with color monitor, \$11,450.

Contact: Digital Equipment Corp., 146 Main St., Maynard, MA 01754, (508) 493-5111.

Inquiry 1134.

SEND US YOUR NEW PRODUCT RELEASE

We'd like to consider your product for publication. Send us full information, including price, ship date, and an address and telephone number where readers can get further information. Send to New Products Editor, BYTE, One Phoenix Mill Lane, Peterborough, NH 03458. Information contained in these items is based on manufacturers' written statements and/or telephone interviews with BYTE reporters. BYTE has not formally reviewed each product mentioned. These items, along with additional new product announcements, are posted regularly on BIX in the *microbytes.sw* and *microbytes.hw* conferences.

Switchable CPUs and a Small Footprint, Too

The small-footprint desktop CompuStar II comes with your choice of interchangeable CPU modules in the Wells American tradition of the original tower-based CompuStar.

You can transform your CompuStar II from a 20-MHz 80286 Model 220 to a 33-MHz 80386 Model 333 simply by changing the CPU module. You can also make it a 16-MHz 80386SX, a 20-MHz 80386, or a 25-MHz 80386.

The basic chassis measures 16 by 16 by 4 inches and comes with ports for a keyboard, a modem, a serial connection, and a parallel connection. The basic system also includes a 101-key firm- or soft-touch keyboard. Inside, you'll find a 200-W power supply, a motherboard (minus the CPU), six 16-bit slots (one for the CPU module), snap-mount connectors for up to 8 megabytes of RAM, a disk controller with cabling, and a hard disk drive interface.

There's room for a 3½-inch hard disk drive, mounted vertically to the right of where you'll find three 5¼-inch slots. CompuStar II options include a 40-, 100-, or 200-megabyte hard disk drive.

Price: Chassis, \$750; Model 220/40 with 42-megabyte hard disk drive and monochrome monitor, \$2765; Model 333/100 with 104-megabyte hard disk drive and VGA color monitor, \$6655.

Contact: Wells American, 3243 Sunset Blvd., West Columbia, SC 29169, (803) 796-7800.

Inquiry 1132.

continued

Back to the Basics with the HeadStart Explorer

The Explorer is for people who want to learn about computers but are reluctant to take the first step.

It's based on a 4.77-/9.54-MHz 8088 microprocessor and comes with 512K bytes of RAM (expandable to 768K bytes), one 720K-byte 3½-inch floppy disk drive, and a 40-megabyte hard disk drive. There's an attached 84-key keyboard. Built-in software includes DOS 3.4, a word processor, a calculator, a datebook, and an address book.

The monitor is optional.

Price: \$599.

Contact: HeadStart Technologies Co., 40 Cutter Mill Rd., Suite 438, Great Neck, NY 11021, (516) 482-4255.

Inquiry 1133.

NEC Grasps More Graphics

The new graphics monitors from NEC include two analog color monitors, the MultiSync 4D and 5D, and a monitor for text-based applications such as desktop publishing.

The 4D has a 15-inch (diagonal) screen and supports VGA, SuperVGA, 8514/A (1024 by 768 pixels interlaced), 1024 by 768 pixels noninterlaced, and Apple Macintosh II graphics standards. The dot pitch is 0.28 mm. Variable horizontal scan rates range from 30 to 57 kHz, and vertical rates range from 50 to 90 Hz. The number of possible colors is determined by the graphics board you use.

The MultiSync 5D is a 19-inch display that adds support for 1280- by 1024-pixel (non-interlaced) graphics to those listed above for the 4D. The dot pitch is 0.31 mm. The monitor offers horizontal scan rates of up to 66 kHz. Like the 4D, it incorporates a microprocessor-based digital control system that NEC says "automatically scans the incoming video signal and adjusts the screen parameters to show the optimum image."

The third monitor is a 13-inch gray-scale unit called the MultiSync GS2A. The analog GS2A has a paper-white phosphor screen, offers virtually unlimited shades of gray (the maximum is determined by the graphics board), and supports VGA, SuperVGA, and Apple Mac II graphics standards (up to 800- by 600-pixel resolution).

Price: 4D, \$1799; 5D, \$3699; GS2A, \$349.

Contact: NEC Home Electronics (U.S.A.), Inc., 1255 Michael Dr., Wood Dale, IL 60191, (312) 860-9500.
Inquiry 1137.



NEC's MultiSync 5D supports a variety of graphics modes, including VGA, SuperVGA, 8514/A, and Apple Mac II standards.

Seiko Enters Mac Market with New Color Printer

Seiko Instruments has announced a version of its CH-5500 color thermal printer for the Macintosh.

The QD5500 series includes a QuickDraw device driver that supports a set of 35 scalable outline fonts, similar in concept (but not identical) to the fonts that Apple will supply with System 7.0.

The printer offers 300-dpi resolution and comes in two sizes—8½ by 11 inches and 11 by 17 inches. It features a roll feed with an automatic cutter, which allows for a larger print area, Seiko says.

The 8½- by 11-inch printer includes 1 or 3 megabytes of RAM. The 3-megabyte version improves performance because you can access the entire color image in one pass through memory.

Price: 8½- by 11-inch printer with 1 megabyte of RAM, \$7000.

Contact: Seiko Instruments

USA, 1130 Ringwood Court, San Jose, CA 95131, (408) 943-9100.

Inquiry 1138.

A Half Gigabyte in a Half-Height Drive

Imprimis Technology's Wren VI is a SCSI-, ESDI-, or ST-506-based 502-megabyte hard disk drive that fits in a half-height 5¼-inch slot.

Data transfer is rated at 15 to 21 MHz, and the average seek time is 16 ms. The company claims that it can pack so much information in so little space because of its patented Zone Bit Recording method (also known as Constant Density Recording), which varies the frequency ranges of disk writing from the inside of the disk to the outside for optimum performance.

Imprimis also uses a "look-ahead buffer" with 32K bytes of RAM.

Price: \$3200.

Contact: Imprimis Technology, Inc., 12501 Whitewater Dr., Minnetonka, MN 55343, (800) 828-8001, ext. 82.

Inquiry 1136.

A Large-Screen Monitor with a Budget Price

The MegaScreen Rival is a two-page, 19-inch monochrome display system for your Macintosh.

Features include 75-dpi, 1024- by 826-pixel resolution, a 75-Hz refresh rate, a paper-white phosphor display with darkened glass for glare reduction, and a built-in tilt-and-swivel stand. Each Rival system includes the monitor, add-in card, stand, and cables.

The MegaScreen monitor is 18 by 15 by 19 inches and weighs 46 pounds.

Price: For Mac SE, II, IIx, and IIcx, \$1698; for Mac Plus, \$1748.

Contact: MegaGraphics, Inc., 439 Calle San Pablo, Camarillo, CA 93010, (805) 484-3799.

Inquiry 1140.

Mac Drive Includes Five Types of Data Backup

The Silhouette Mac RD-44 is a removable SCSI-based Macintosh hard disk drive with a 25-ms access time and 44-megabyte disk cartridges.

The included software has five backup modes: shadow, periodic incremental, file-by-file, time-of-day, and mirror image. The drive comes with one cartridge.

Price: \$1595; extra cartridges, \$149.

Contact: Cumulus Corp., 23500 Mercantile Rd., Cleveland, OH 44122, (216) 464-2211.

Inquiry 1139.

continued

After centuries of practice, mankind perfects engineering calculations: MathCAD.

Announcing MathCAD 2.5: The Dawn of a New Age.

What the historians will call it, one time will tell.

Perhaps the Century of Speed, or the Era of Ease. But whatever the name, this is the age of MathCAD 2.5, the only math package that looks and works the way you think.

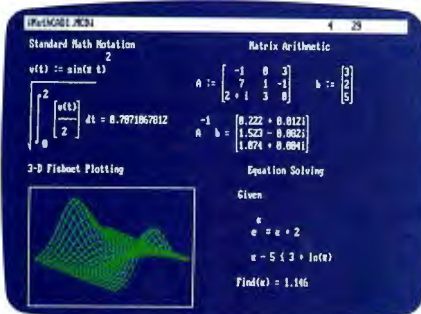

MathCAD 2.5 includes 3-D plotting, HPGL sketch import, and PostScript output.

MathCAD is far and away the best-selling math package in the world. Because it lets you perform engineering and scientific calculations in a way that's faster, more natural and less error-prone than the way you're doing them now—whether you're using a scratchpad, calculator, spreadsheet or program that you wrote yourself.

And now we've made the best even better. MathCAD 2.5 is a dramatically improved version that includes three-dimensional plotting, enhanced numerical analysis, and the ability to import HPGL files from most popular CAD programs, including AutoCAD.® And now you can print on PostScript® compatible printers.

And like before. MathCAD's live document interface™ lets you enter

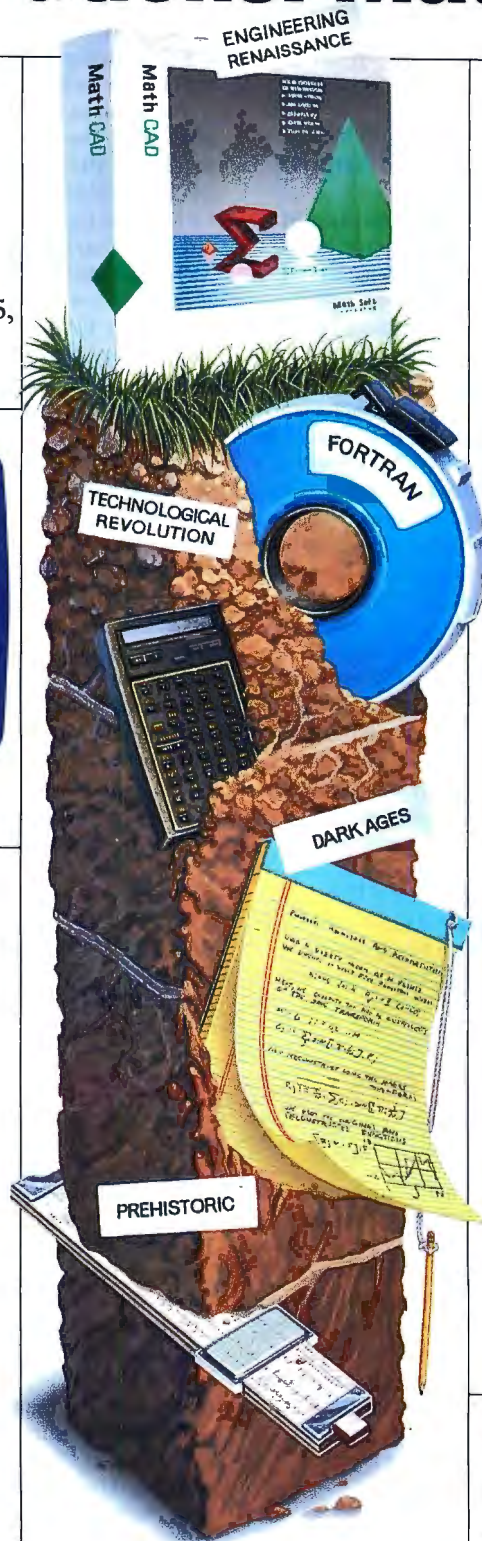

equations anywhere on the screen, add text to support your work, and graph the results. Then print your analysis in presentation-quality documents.

It has over 120 commonly used functions built right in, for handling equations and formulas, as well as exponentials, differentials, cubic splines, FFTs and matrices.

No matter what kind of math you do, MathCAD 2.5 has a solution for you. In fact, it's used by over 60,000 engineers and scientists, including electrical, industrial, and mechanical engineers, physicists, biologists, and economists.

But don't take our word for it; just ask the experts. PC Magazine recently described MathCAD as "everything you have ever dreamed of in a mathematical toolbox."



March 14, 1989 issue.
Best of '88
Best of '87

And for Macintosh® users, we present MathCAD 2.0, rewritten to take full advantage of the Macintosh interface. Entering operators and Greek letters into equations is pure simplicity!

Look for MathCAD 2.5 at your local software dealer, or give us a call. For more information, a free demo disk, or upgrade information, dial 1-800-MATHCAD (in MA, 617-577-1017).

Available for IBM® compatibles and Macintosh computers.

TM and ® signify manufacturer's trademark or manufacturer's registered trademark respectively.

MathCAD®

MathSoft, Inc. One Kendall Square, Cambridge, MA 02139

Inexpensive Real-Time TV for Your Macintosh

The MicroTV II is a low-priced NuBus card that displays real-time TV (or any other video source) in 128 levels of gray on a Mac II equipped with an 8-bit color card and color monitor.

The video appears in your window, complete with a refresh rate of one-thirtieth of a second. It makes your window look like a black-and-white TV, complete with "knobs" for channel, volume, contrast selection, and an on/off switch. Software also lets you copy and paste.

The board is cable-ready, so you can plug the coaxial cabling from your local cable TV franchise directly into the back of the card. Then the 108-channel tuner takes over, manipulating composite and direct audio/video inputs.

To extend the software that makes use of the card, a developer's toolkit contains HyperCard and SuperCard external commands, interfaces for popular development systems, technical information, sample applications with source code, and MacApp object libraries.

Price: \$395.

Contact: Aapps Corp., 110 Pioneer Way, Mountain View, CA 94041, (415) 961-4033.
Inquiry 1141.

Triple the Speed of the Mac II and IIX

DayStar Digital plans to speed up your Mac's CPU, bus, RAM access, video performance, and SCSI-peripheral-based performance with a line of add-in boards.

To do this, the company is starting with a line of accelerator cards (for CPU speeds up to five times faster) and is introducing a proprietary bus alternative that speeds up bus transfers by a factor of three. To run on the proprietary bus or to default to the slower NuBus, DayStar Digital's new RAM card doubles accessible RAM. The company is also developing video and SCSI cards with NuBus and proprietary bus interfaces. Now in beta testing, they are scheduled to be delivered before the year's end.

The Accelerator II and the Accelerator IIX (for the Mac II and IIX) are based on Motorola's 68030 microprocessor. They feature speeds of 25,

33, 40, and 50 MHz and attain zero-wait-state performance by incorporating a 32K-byte cache with 15-ns static RAM. A Motorola 40-MHz 68882 math coprocessor is an option with each accelerator.

To eliminate the NuBus bottleneck, DayStar Digital's Extended CPU Interface (XCI) backplane card features 33-MHz performance and three proprietary slots. (An XCI is included with every accelerator board you purchase.) The RAM card, with a proprietary port and a default port for NuBus, features 100-ns RAM, expandable to 16 megabytes.

Inside your Mac, the CPU accelerator board fits horizontally above the motherboard and doesn't use any of your six NuBus slots. The XCI backplane is a half-width card that fits across the front of your system and plugs into both the accelerator card and the front ends of the proprietary RAM card (and the video and SCSI cards, when they're available).
Price: 25/030 Accelerator II/IIX, \$2995; 33/030, \$4995; 40/030, \$5995; 50/030, \$6995.

Contact: DayStar Digital, 5556 Atlanta Hwy., Flowery Branch, GA 30542, (404) 967-2077.

Inquiry 1144.

Put a Padlock on Unpaid Computers

One of the continuing problems for computer dealers who rent or lease systems is what to do if clients don't make their payments. Collecting money or repossessing systems can be risky business.

Genesys has come up with a singular solution to the problem. Its uniquely named and uniquely featured Click/Clock is an add-in card for IBM PCs and compatibles.

It automatically locks up a system if a payment hasn't been received by a specific date that is programmed into the card.

Click/Clock operates independently of both DOS and the existing hardware, and it even has a tamper-resistant lock so that it can't be removed from the system. Since the computer is completely unusable once Click/Clock locks it up, you can use the customer's own data as collateral.

Price: \$249.

Contact: Genesys, 2301 Lucien Way, Suite 105, Maitland, FL 32751, (407) 875-0101.
Inquiry 1143.

A Long and Happy Life for Your AT Battery

If you've ever had your IBM AT's battery suddenly die, you know that once the CMOS that stores your system parameters loses data, your computer is virtually useless. A dead battery causes loss of time/date, loss of drive setup data, and mysterious soft-

ware and hardware errors. The lithium batteries that most ATs use are normally good for a year or two, but they are often difficult to purchase and a challenge to replace.

With its bATPac, Rupp Corp. offers the first rechargeable backup battery for ATs and compatibles.

The bATPac is a sealed

rechargeable battery with an expected lifetime of at least 10 years, which will make it last long after your computer has become completely obsolete. It continually charges while the system is on and can keep the CMOS happy for at least a year of power-down.

The unit measures 2 $\frac{3}{8}$ by 2 $\frac{3}{8}$ by 1 inch. You install it by plugging it into your AT's internal battery connector. The battery is charged using power from a disk drive power

connector. It includes a Y-connector, along with a Velcro attachment for securing the bATPac to the side of your system's power supply.

Price: \$39.95.

Contact: Rupp Corp., 835 Madison Ave., New York, NY 10021, (212) 517-7775.

Inquiry 1145.

continued

If You Want To Talk Fast DBMS Call 1-800-db_RAIMA And Start Screaming

You'll be screaming, all right. db_VISTA III from Raima Corporation combines the flexibility of a relational DBMS and the lightning speed of the network database model.

C db_VISTA III is written for C Programmers.

Source code available. The interactive database utilities and outstanding documentation make db_VISTA III easy to learn. All applications are portable to VMS, UNIX, OS/2, MS-DOS, even Macintosh. No royalties.

db_VISTA III is *Fast*. Using benchmarks originated at PC Tech Journal Laboratories, db_VISTA III measured 3 to 12 times faster than the average relational database! Call us and we'll send you the results.

Relational and Network Model Technology for Programming Flexibility.
Retrieve a record fast using the relational keyed access method

db_VISTA III Database Development System		
Features	Yes	No
db_VISTA 3.1 High Performance DBMS:		
Single and Multi-User available	✓	
Relational B-tree Indexing	✓	
Network Database Model	✓	
Multiple database access	✓	
Referential integrity	✓	
Automatic recovery	✓	
Record & File locking	✓	
RAM resident		✓
db_QUERY 2.1 SQL-based Query:		
Relational Query & Report Writer	✓	
db_REVISE 1.0 Database Restructure Program:		
Total database redesign/restructuring	✓	
Operating Systems*: VMS, ULTRIX, UNIX	✓	
BSD 4.2, SunOS, XENIX, MS-DOS	✓	
Macintosh and MS Windows, OS/2 compatible	✓	
C Compilers*: Most compilers supported	✓	
C++ compatible	✓	
LANs*: 3COM, Novell, Banyan, AppleShare	✓	
WKS Library:		
Read & Write WKS, WK1 & DBF files	✓	
SOURCE CODE AVAILABLE:	✓	
ROYALTIES: (Absolutely not!)		✓✓

*Other environments are supported; call for complete list.

and all related records can be immediately available using the network model. You decide how to combine these for best application performance.

 **SQL Support** with SQL-based db_QUERY, db_VISTA III's relational query and report writer.

db_VISTA Puts You in Some Fast Company.

Thousands of C programmers in over 50 countries worldwide use db_VISTA III, including APPLE, ARCO, AT&T, EDS, Federal Express, Hewlett-Packard, IBM, NASA...

Don't wait. Call Raima for more information about how you can build applications that are *screaming-fast!*

Call 1-800-db_RAIMA
(That's 1-800-327-2462)

db_VISTA III™
Database Development System

 **RAIMA**™
CORPORATION **BY109**

RAIMA Corporation 3245 146th Place S.E., Bellevue, WA 98007 USA: (206) 747-1991 Telex: 6503018237 MCI UW FAX: (206) 747-1991 Texas: (214) 231-3131 International Distributors:
Denmark: (45) 300919 Germany: 07127/5244 Switzerland: 015723 0416 France: (1) 46092828 Benelux: 31(02159) 46 814 Sweden: (013) 124780 Italy: 045/584711 Norway: 47 244 88 55
Denmark: (2) 887249 Singapore: 468 3888 Australia: (02) 959 5122 Japan: (03) 473 7432 Taiwan: (02) 511 3277 Mexico: (83) 57 35 94 Central America: (506) 28 07 64
Caribbean: (809) 834 4069 Colombia: 57 1 218 9245 Argentina: 54 1 313 5371 Chile: 56 2 696-4308 Uruguay: 92 19 37 Brazil: (0192) 52 9770 © 1989

WIENER HUT



\$1.75
1.50

Polish Dog
Stanley Steam
Weiner Special
Soft Drinks
Chips
Pretzels



Get a long little doggie.

FREE KITTENS



Yellow a
CALL

Cat scan.

See you later.



Uplifting.

Show boat.

SONATA

SONATA QUASI UNA FANTASIA
Op. 27, No. 2 Chopin

LUDWIG VAN BEETHOVEN



Roll over Beethoven.

BANANA CAKE

1/2 cup minus two table-
spoons butter
2 cups sifted flour
1 teaspoon soda
1 and 1-3 cup sugar
1/2 cup buttermilk
1 cup mashed ripe bananas
2 eggs
1/2 cup coarsely chopped
nuts
1 teaspoon vanilla
Stir shortening to
sift in dry ingredie
and remaining ingr

Take the cake.

FOR SALE BY OWNER



Over 1000 sq. ft. of living space and 100 sq. ft. of deck space. Call for more information. Call 1-800-555-1234.

ADMAX
The Largest For Sale By Owner Market in the World

Raise the roof.

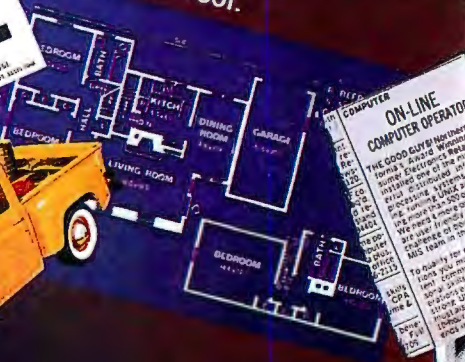

ON-LINE COMPUTER OPERATOR

THE GOOD CLUB is looking for computer operators to work from home. This is a great opportunity for anyone with a computer and internet access. For more information, call 1-800-555-1234.

Shoot the moon.



Pick up trucks.



Lift off.



Let her roll.



Make amends.

Give them a piece of your mind.



See lion.



CONFIDENTIAL LEASE

This Lease is entered into as of the 1st day of January, 1998, between the undersigned and the undersigned.

ARTICLE I
The lessor hereby leases to the lessee the premises described in the schedule hereof for the term of 12 months, commencing on the date hereof and ending on the date hereof.

ARTICLE II
The lessee shall pay to the lessor the sum of \$1,000 per month as rent for the premises hereunder, in advance, on the first day of each month.

ARTICLE III
The lessee shall be responsible for all taxes and charges which may be levied or assessed against the premises hereunder.

ARTICLE IV
This lease shall be subject to the terms and conditions set forth in the schedule hereof.

ARTICLE V
This lease shall be subject to the terms and conditions set forth in the schedule hereof.

ARTICLE VI
This lease shall be subject to the terms and conditions set forth in the schedule hereof.

ARTICLE VII
This lease shall be subject to the terms and conditions set forth in the schedule hereof.

ARTICLE VIII
This lease shall be subject to the terms and conditions set forth in the schedule hereof.

ARTICLE IX
This lease shall be subject to the terms and conditions set forth in the schedule hereof.

ARTICLE X
This lease shall be subject to the terms and conditions set forth in the schedule hereof.

ARTICLE XI
This lease shall be subject to the terms and conditions set forth in the schedule hereof.

ARTICLE XII
This lease shall be subject to the terms and conditions set forth in the schedule hereof.

ARTICLE XIII
This lease shall be subject to the terms and conditions set forth in the schedule hereof.

ARTICLE XIV
This lease shall be subject to the terms and conditions set forth in the schedule hereof.

ARTICLE XV
This lease shall be subject to the terms and conditions set forth in the schedule hereof.

ARTICLE XVI
This lease shall be subject to the terms and conditions set forth in the schedule hereof.

ARTICLE XVII
This lease shall be subject to the terms and conditions set forth in the schedule hereof.

ARTICLE XVIII
This lease shall be subject to the terms and conditions set forth in the schedule hereof.

ARTICLE XIX
This lease shall be subject to the terms and conditions set forth in the schedule hereof.

ARTICLE XX
This lease shall be subject to the terms and conditions set forth in the schedule hereof.

ARTICLE XXI
This lease shall be subject to the terms and conditions set forth in the schedule hereof.

ARTICLE XXII
This lease shall be subject to the terms and conditions set forth in the schedule hereof.

ARTICLE XXIII
This lease shall be subject to the terms and conditions set forth in the schedule hereof.

ARTICLE XXIV
This lease shall be subject to the terms and conditions set forth in the schedule hereof.

ARTICLE XXV
This lease shall be subject to the terms and conditions set forth in the schedule hereof.

ARTICLE XXVI
This lease shall be subject to the terms and conditions set forth in the schedule hereof.

ARTICLE XXVII
This lease shall be subject to the terms and conditions set forth in the schedule hereof.

ARTICLE XXVIII
This lease shall be subject to the terms and conditions set forth in the schedule hereof.

ARTICLE XXIX
This lease shall be subject to the terms and conditions set forth in the schedule hereof.

ARTICLE XXX
This lease shall be subject to the terms and conditions set forth in the schedule hereof.



What can a ScanMan™ scan, man?

Virtually anything. Logos or photos. Digits or dingbats. Art or articles. A soda can. How can you get them into your PC? You could play cut and paste with the copier down the hall. Or use your own, do-it-in-a-flash, hand-held scanner. ScanMan.

Images. Select 1, 2, 3, or 400 d.p.i., then pop any image up to 4" x 14" into a file for your publishing program. Or into your Windows™ clipboard. Or use PaintShow Plus™—included with your ScanMan—for editing and coloring.

Text. Our Catchword™ software converts virtually any typeface into ASCII files for your word processor, desktop publisher, or spreadsheet. It reads horizontally or vertically, scans words or numbers from 6 to 20 point, and matches adjacently scanned columns perfectly.

Should you buy it? Once you've got it you'll wonder what you did without it. And it's only \$339*. Backed by our Customer Satisfaction Guarantee, and 7 Days-a-Week Support.

For information, call: 800-231-7717

In California:
800-552-8885
In Europe: ++41
-21-869-96-56



LOGITECH

*For IBM PC and compatibles, includes Paintshow Plus. List price for the IBM Micro-Channel version is \$399. Catchword is an optional extra for \$199.

Circle 161 on Reader Service Card (DEALERS: 162)



Save that tiger.

Save face.

Scan the globe.

Take this job and shove it.

Catch a wave.

Save the day.

Can scan.

There goes the neighborhood.

Scan the horizon.

Get reel.

TODAY'S TIMES ONLY

FIELD OF DREAMS (PG) Thr. Sound
12:30, 1:45, 4:30, 7:30, 10:05

SCANDAL (R)
11:35, 1:15, 4:50, 7:15, 9:40 Dolby

BARON MUNCHHAUSEN (PG)
11:30, 2:10, 4:35, 7:40, 10:30 Dolby

RENEGADES (R) Dolby
11:35, 2:20, 5:00, 7:50, 10:14

NO HOLDS BARRED (PG-13)
12:10, 2:40, 5:15, 8:00, 10:10

A FEW DAYS WITH ME (PG-13)
11:20, 2:00, 4:40, 7:20, 9:55

BEACHES (PG-13) Dolby
11:40, 2:15, 5:00, 7:50, 10:35

WARM NIGHTS ON A SLOW
11:40, 2:15, 5:00, 7:50, 10:35

MOVING TRAIN — Summer Maximal
SPECIAL ADMISSION — SHORT CIRCUIT II 10
MOVING TRAIN — SHORT CIRCUIT II 10
SPECIAL ADMISSION — SHORT CIRCUIT II 10
SPECIAL ADMISSION — SHORT CIRCUIT II 10

SHIR PUPPIES 11:30, 1:45, 4:00, 6:15, 8:30, 10:45

WING* AFTER 5

Voice I Translates from English to Spanish

The Voice I system is a small microprocessor-based system that translates spoken English into Spanish, Advanced Products claims. It's built on a proprietary platform with one 8-bit and two 16-bit microprocessors, and it uses a proprietary operating system.

Although it will operate as a stand-alone unit, it also includes an RS-232C port for personal computer connection.

The Voice I is primarily designed to translate from English to other languages with specially designed cassette-size modules. The English to Spanish module can translate more than 35,000 phrases, the company claims.

A second module, scheduled to ship this month, will translate spoken English into French. There's also the Voice Assistant module, a personal information manager (with calendar, daily scheduler, phone list, and search capabilities) based on voice recognition and natural-language processing.

With a translation module, the 3-pound, 8- by 7- by 3-inch hand-held unit translates phrases almost instantly. But you have to speak slowly, word by word. Your words are also displayed on the 160- by 128-pixel LCD. The Voice I will work if the input rate is below 60 words per minute.

The basic system includes 4 megabytes of addressable memory. There's also an internal microphone and a speaker, a microphone jack



When you say, "I don't speak Spanish," the Voice I says, "No hablo Español."

for an external microphone and headset, an external speaker connector, a rechargeable battery, and an AC power adapter.

Price: \$2000; Voice Assistant module, \$300; English to Spanish module, \$300.

Contact: Advanced Products & Technologies, Inc., 15444 Northeast 95th St., Redmond, WA 98052, (206) 883-8297.

Inquiry 1147.

And the Word Became Code

Franklin Computer's Electronic Holy Bible includes a microprocessor, 1 megabyte of ROM, a tactile-feedback QWERTY keyboard, a supertwist LCD, and word processing-style software. It is available in both

King James and Revised Standard versions.

The NEC V20 microprocessor allows the Bible-size, notebook-computer-styled device to almost instantaneously find specific text. If you don't know the exact spelling of the word on which you're doing a search, you can approximate the word phonetically.

The screen always displays the names of books of the Bible, which you can select with the cursor and access by pressing Return. Above the icons is room for four lines of type, with nearly 40 characters in each line. Each character cell has a resolution of 5 by 8 pixels.

Price: \$299.

Contact: Franklin Computer, 122 Burrs Rd., Mt. Holly, NJ 08060, (609) 261-4800.

Inquiry 1148.

HP's Spectrum Analyzers Designed Around PCs

Hewlett-Packard's two new spectrum analyzers are PC-based instruments designed to help engineers solve mechanical-test, production-test, and signal characterization problems. Specifically, they measure frequency response functions, auto/cross correlation, transient-time capture, one-third octave with A-weighting, stimulus-response testing, and order tracking.

The two models, the HP 3567A and the 3566A, feature two and six channels, respectively.

You need at least a DOS-based 80286 machine running Microsoft Windows with EGA graphics. Each analyzer comes with a software driver, and you connect the fast Fourier transform module on the spectrum analyzer through cabling to your computer's serial port.

The software lets you manipulate up to 16 channels of incoming data, eight on-screen at a time. For measurement automation, you can access every automation feature by programs written in a variety of Microsoft-supported programming languages.

Price: HP 3567A, \$18,000; HP 3566A, \$22,000.

Contact: Hewlett-Packard Co. Inquiries, 19310 Pruneridge Ave., Cupertino, CA 95014, (800) 752-0900.

Inquiry 1146.

continued



Okay.

You're using dBASE. You're trying to develop a payroll application for the entire company, and you've just hit the wall. So the first thing you do is try a few workarounds, then some more. And ignore the fact that you don't have any decent back-up and recovery, data integrity, database security or multi-user concurrency.

No big deal. It's only the fate of the company, your closest friends, and their children.

dBASE® was the computing environment of the 80's. Back before businesses became dependent on LANs and multi-user applications.

ORACLE is the computing environment for the 90's. From the very beginning, Professional ORACLE® was designed for multi-user workgroup applications. Its SQL architecture is built in (not tacked on like dBASE) and includes all the fourth-generation development tools you need to develop applications that run on over 80 different platforms. And every major operating system, even OS/2.™

It's so reliable, in fact, that over 47 of the Fortune 50 rely on Professional ORACLE.

You can have Professional ORACLE for \$1,299. Or the Trial Version for \$199.

And if, after 30 days, you're not happy with it, return it for a full refund.

Call 1-800-ORACLE 1, Ext. 4956 to order. And enter the computing environment of the 90's.

ORACLE®
Compatibility • Portability • Connectivity

If it's that important, develop with ORACLE on the PC. Call 1-800-ORACLE 1, Ext. 4956.

Offer valid in U.S. only. Professional ORACLE Requirements: MS-DOS-80286/80386 PC with MS-DOS V3.1+, hard disk, 640KB of memory and 896K extended memory required. 2.5MB of extended memory recommended (required for SQL*ReportWriter™). OS/2-80286/80386 PC w/ OS/2 V1.0+, hard disk, 3MB memory. SQL*ReportWriter™ not available for OS/2 and is replaced by SQL*Report®. Copyright ©1989 by Oracle Corporation. dBASE, dBASE IV and Ashton-Tate are registered trademarks of Ashton-Tate Corp. ORACLE and SQL*Report are registered trademarks of Oracle Corporation. SQL*ReportWriter is a trademark of Oracle Corporation. MS-DOS is a trademark of Microsoft Corp. OS/2 is a trademark of International Business Machines Corp.

Replace Cabling Headaches with Radio or Light

While there are few new choices in LAN cabling, there are now two cable-less networking solutions. Telesystems SLW has a cellular radio solution for NetWare-based LANs, and Photonics has an infrared-based LocalTalk-compatible transceiver.

The ARLAN 450 card plugs into any IBM PC or compatible and runs under Novell NetWare. The wireless two-thirds-length card uses cellular radio frequencies for 230-kbps data transmission rates. It's an 8-bit bus-based version of Telesystems' serial product.

Telesystems recommends that you use an ARLAN 450 (which has a built-in transceiver) at each of the nodes, and an ARLAN 440 and its separate transceiver, Model 010, at your file server. The 450 is the equivalent of the 440 with the 010, but by separating the transceiver, you don't have to locate your file server in the physical middle of the nodes. Both boards include NetWare drivers.

You use unshielded or shielded twisted-pair cable between the 440 in the file server and the brick-size 010 transceiver. Distance is limited to less than 2000 feet.

In an office environment with physical barriers, Telesystems recommends that you link no more than 10 450-based PCs in a radius of no more than 250 feet from the file server. In an open factory, the radius recommendation is 1500 feet. Or you can use the transceivers as bridges, as long as there's a clear line of sight, for transmission distances of up to 6 miles.

Using "spread spectrum" radio technology with radio output power of 1 W, there's



Each Photolink transceiver replaces a strand of LocalTalk cabling.

no need for an FCC license to use the ARLAN card, Telesystems reports. **Price:** ARLAN 450, \$1500; ARLAN 440, \$500; ARLAN 010, \$2000.

Contact: Telesystems SLW, Inc., 85 Scarsdale Rd., Suite 201, Don Mills, Ontario, Canada M3B 2R2, (416) 441-9966. **Inquiry 1149.**

Meanwhile, Photolink uses beams of invisible infrared light, reflected off the ceiling, to communicate between Macintosh computers. Photonics says that replacing cables with infrared light increases flexibility, lowers costs, and even improves security. The company is also working on a version that provides serial communications between terminals and hosts.

A Photolink installation consists of individual transceiver units mounted on top of office partitions and pointing toward a common spot on the ceiling. Each wedge-shaped unit, about the size of a telephone, can support up to four Macs, which plug in via phone cables connected to the LocalTalk network port.

Photolink is effective in an unobstructed area of roughly 70 feet in diameter, the company says. The ceiling does not have to be specially prepared; Photonics says the system will work on everything from acoustical tile to dark oak beams.

AppleTalk networks run at about 230 kbps, as does Photolink, although Photonics claims that the current units are capable of running at 1 Mbps. The company plans a 4-Mbps Token Ring model for 1990 and a 10-Mbps Ethernet

version for 1991.

Price: Transceiver, \$995. **Contact:** Photonics Corp., 200 East Hacienda Ave., Campbell, CA 95008, (408) 370-3033.

Inquiry 1150.

Ready, Set, Network

ReadyNet might be for you if you want a simple, low-cost LAN for your home or small business. It's an unshielded twisted-pair-based (telephone wiring), bus-based network with XT- and AT-compatible adapter boards and CSMA collision avoidance. The data rate is 1 Mbps.

The start-up kit includes two boards, 50 feet of cabling with RJ-11 connectors on each end, and software drivers that configure the two-node basic network. You purchase each add-on node in a kit that includes a separate card, cabling, and a software driver. The primary server requires 184K bytes of RAM; each node requires 60K bytes.

ReadyNet has an automatic preconfigured connection feature and provides basic functions, such as messaging, file transfer, and printer spooling. There's also a remote-control "virtual console" function that lets one person at one ReadyNet PC control another person's application.

ReadyNet supports up to 24 PCs at distances of up to 1000 feet from the primary server. The network operating system was designed for this network and is therefore proprietary.

Price: Start-up kit, \$499; each add-on, \$249. **Contact:** Corvus Systems, Inc., 160 Great Oaks Blvd., San Jose, CA 95119, (408) 281-4100.

Inquiry 1152.

continued

Here's How We Protect Your Software And Profits Better.



We'll Never Tell.

Because our key-interrogation routines are *encrypted*, and our hardware is custom-wired to distinguish each of our clients' keys, our clients have the highest degree of security available.

Unlike other manufacturers, our routines assume responsibility for all hardware, software and timing issues. And what this means is that your engineering time and money won't be wasted reinventing protection schemes.

We offer two high security products for copy control: the KEY and the MEMORY KEY.™

Our protection devices can also be used for serialization techniques, software leasing,

modular software management, creative revenue collection, demo control and a path for future upgrades.

The information stored in the MEMORY KEY can be conveniently reprogrammed by your application software or at the end user's site via software disk or modem.

All our products attach conveniently to the printer port, are transparent and allow for unlimited back up copies.

For serious software protection, call now. And start protecting your profits.

Hands down, we're better.

Encrypted routines provide the highest degree of security

Custom hardware and software for each developer

No batteries to fail or replace



No programming adapters necessary

Can be dynamically reprogrammed at the user site via diskette or modem.

Over 55 languages supported in DOS, XENIX and OS/2



PROTECH
MARKETING, INC.
1-800-843-0413

Se Habla Español

In Europe: Microphar, 42, Ave. Sainte Foy 92200, Neuilly Sur-Seine France
Tel: 33-1-47-38-21-21 Fax: 33-1-46-24-76-91, Call to obtain distributor addresses in:
Belgium, Ireland, Italy, Netherlands, Portugal, Spain, Switzerland, U.K. & W. Germany.

For Europe circle 211 on Reader Service Card

In the Americas and the Pacific: ProTech, 9600-J Southern Pines Blvd. Charlotte, NC 28217
Tel: 704-523-9500 Fax: 704-523-7651 Hours: Mon-Thurs: 8:30-7:00 ET, Fri: 8:30-5:30 ET
FOR A DEMONSTRATION PACKAGE OR ADDITIONAL INFORMATION, PLEASE WRITE OR CALL.

For Americas & Pacific circle 212 on Reader Service Card

Programmer's Paradise - when you



WE'LL MATCH NATIONALLY ADVERTISED PRICES.

386 PRODUCTS

	LIST OURS	OURS
386 ASMLINK	495	435
386/VMM	295	239
386MAX	75	66
386MAX PROFESSIONAL	129	115
C Network Compiler/386	995	799
DESQview 386	190	169
Lahey F77L-EM/32	895	795
NDP FORTRAN-386	595	549
Paradox/386	895	625
VM/386	245	209
VM/386 Multi-User	895	759
VM/386 NetPak	150	129
VMOS/3	99	89

ADA LANGUAGE

	LIST OURS	OURS
IntegrAda	795	749
Janus/Ada Compiler	300	269
Janus/Ada Options Kit	500	449
Meridian:		
AdaGraduate	495	445
AdaStudent	50	45
AdaTutor	150	135
AdaVantage Developer's Kit	1095	985
AdaVantage PC Prof. Dev. Kit	1780	1599

ASSEMBLY LANGUAGE

	LIST OURS	OURS
Advantage Disassembler	295	279
MS Macro Assembler	150	105
OPTASM	125	109
Sourceur w/ BIOS source	140	125
Turbo Assembler/Debugger	150	105
Visible Computer: 80286	100	89

BASIC LANGUAGE

	LIST OURS	OURS
db/LIB	139	121
GraphPak Professional	149	129
MS BASIC/6.0	295	209
P.D.Q.	99	89
ProBas	135	125
ProScreen	99	94
QuickBASIC	99	69
QuickComm	139	125
QuickPak Professional	149	129
QuickWindows Advanced	139	125
True BASIC	100	69
Turbo Basic	100	69

C COMPILERS

	LIST OURS	OURS
C Network Compiler	695	559
Lattice C 6.0	250	199
Microsoft C	450	299
MS QuickC	99	69
MS QuickC w/ Mouse	199	99
MS QuickC w/ QuickAssembler	199	135
Turbo C	150	105
Turbo C Professional	250	175
WATCOM C 7.0	395	319
Zortech C	90	79

C++

	LIST OURS	OURS
Guidelines C++	295	269
M++	495	CALL
Zortech C++	150	129
w/ source	250	209
Zortech C++ Tools	100	89
Zortech C++ Video	CALL	CALL

C-COMMUNICATIONS

	LIST OURS	OURS
Breakout II	125	99
C Asynch Manager 3.0	189	139
Essential Communications	249	199
Greenleaf Comm. Library	299	209
Greenleaf ViewComm	559	475
Lattice Communication Library	250	209

C-FILE MANAGEMENT

	LIST OURS	OURS
Btrieve	245	185
Btrieve for DOS 3.1 Networks	595	459
CBTREE	159	135
C Index + (Microsoft C)	195	179
C Index + (Turbo C)	99	89
C-ISAM	225	209
Codebase IV	295	219
c-tree	395	318
d-tree	495	395
r-tree	295	241
CQL	225	199
w/ PASS	395	349
dBC III	250	219
dBC III Plus	500	439
db_FILE Bundle	295	249
Essential B-Tree	99	89
pBase	149	135
XQL	795	599
Xtrieve PLUS	595	459

C-GENERAL LIBRARIES

	LIST OURS	OURS
C TOOLS PLUS/6.0	149	109
C Utility Library	199	159
Greenleaf Functions	229	165
Greenleaf SuperFunctions	299	209
Turbo C TOOLS/2.0	149	115

C SCREENS

	LIST OURS	OURS
C-Worthy w/ forms and source	495	CALL
Facelt	99	89
Greenleaf DataWindows	395	279
JAM	595	529
Panel Plus	495	395
Vermont Views	395	CALL
w/ source code	790	CALL
Vitamin C	225	165
VC Screen	149	125
Vlib	149	129

C-SOURCE ANALYSIS

	LIST OURS	OURS
AutoFlow-C	299	269
C/Analyst	150	135
Clear +	200	169
C:Lines/C:Tree	80	75
Codan	395	359

C-UTILITIES/OTHER

	LIST OURS	OURS
Code Master v. 2	289	259
Csource	395	359
C-Terp	300	219
Heap Expander	80	70
JAKE	495	429
Norton Guides for C	100	65
PC-lint	139	105
PRO-C	675	569
TimeSlicer	295	279
w/source	1000	899
Vmem/C	189	169

LIST OURS

COBOL LANGUAGE

	LIST OURS	OURS
Micro Focus:		
COBOL/2 w/ Toolset	1800	1499
COBOL/2 Toolset	900	749
Personal COBOL	149	129
MS COBOL	900	629
Realia COBOL	995	849
w/ RealMENU	1145	979
SCREENIO	400	375

DATABASE DEVELOPMENT

	LIST OURS	OURS
Clarion 2.0	695	499
Clipper 5.0	695	439
dBASE IV	795	489
dGE	195	179
FoxBASE+	395	249
Magic PC	299	249
Paradox 3.0	725	509
R&R Report Writer	150	129
w/ Clipper/ FoxBASE module	200	159
R&R Code Generator	150	129
SilverComm Library 2.0	189	165
Tom Rettig's Library	100	80

DEBUGGERS

	LIST OURS	OURS
386 DEBUG	195	159
Multiscope	299	CALL
Periscope II-X	145	105
Periscope IV/16 MHz	1995	1849
Periscope IV/20 MHz	2295	1995
Periscope IV/25 MHz	2595	2295
Sherlock	195	179
Soft Probe II/TX	395	345
VM Debug	99	89

EDITORS

	LIST OURS	OURS
BRIEF	195	CALL
Epsilon	195	159
KEDIT 4.0	150	125
MKS Vi	149	129
Norton Editor	75	59
SLICK Editor	195	175
SPF/PC	245	199
VEDIT	69	59
VEDIT PLUS	185	115

FORTRAN LANGUAGE

	LIST OURS	OURS
Grafmatic	135	119
Lahey F77L	595	529
Lahey Personal FORTRAN 77	95	89
MS FORTRAN	450	299
Plotmatic	135	119
Printmatic	135	119
RM/FORTRAN	595	499

GRAPHICS LIBRARIES

	LIST OURS	OURS
Baby Driver	250	225
Essential Graphics	299	239
Font-Tools	150	135
Graf-Text	89	79
GraphicC 5.0	395	322
Graphics-MENU	195	175
GSS Graphics Devel. Toolkit	595	509
HALO	395	279
HALO Window Toolkit	595	419
Icon-Tools/Plus	150	135
MetaWindow	195	159
FontWindow	95	85
Menuet	250	225
PCX Effects	99	89
PCX Programmer's Toolkit	195	175
PCX Text	99	89
XVT	595	509

LANGUAGE DEVELOPERS

	LIST OURS	OURS
LALR	99	90
MKS LEX & YACC	249	209
PCYACC Professional	395	359

LINKERS/LIBRARIANS

	LIST OURS	OURS
Plink86plus	495	419
PolyLibrarian II	149	135
.RTLlink	195	185

MODULA-2

	LIST OURS	OURS
LOGITECH Modula-2:		
Compiler Pack	99	75
Development System	249	199
Repertoire	149	135
Solid B+ Toolkit	100	90
TopSpeed Modula-2:		
B-Tree Toolkit	80	72
Communications Toolkit	80	72
Compiler Kit	100	89
DOS 3-Pack	200	179
TechKit	60	55
VID	60	55

OS/2 TOOLS

	LIST OURS	OURS
Brief	195	CALL
Btrieve	595	459
Greenleaf DataWindows	395	309
HALO	695	489
MKS RCS	395	335
MKS Toolkit V3.1	495	419
MS OS/2 Present. Mgr. Toolkit	500	349
MS OS/2 Present. Mgr. Softset	150	105
Paradox OS/2	725	543
TopSpeed Modula-2	195	179
Vitamin C	345	279

PASCAL LANGUAGE

	LIST OURS	OURS
Asynch PLUS	149	115
B-free Filer	125	99
MS QuickPASCAL	99	69
Object Professional	150	119
Power Screen 1.1	149	115
Power Tools PLUS/5.0	149	115
Turbo Analyst	99	79
TurboMAGIC	199	179
Turbo Pascal 5.5	150	99
Turbo Pascal 5.5 Professional	250	169
Turbo-Plus 5.5	150	129
Turbo Professional 5.0	125	99

PROTOTYPING

	LIST OURS	OURS
Dan Bricklin's Demo II	195	179
Instant Replay III	150	135
Show Partner F/X	350	319

SMALLTALK LANGUAGE

	LIST OURS	OURS
Smalltalk-80 (386)	595	535
Smalltalk/V	100	85
Goodies Libraries	50	45
Smalltalk/V 286	200	169
Smalltalk/V PM	CALL	CALL

UTILITIES

	LIST OURS	OURS
1 DIR Plus	95	75
Copy II PC	40	35
Copy II PC Option Board	159	139
Disk Technician Advanced	190	159
Disk Technician Plus	130	109
Dr. Switch	60	55
Fast!	99	89
FASTBACK Plus	189	159
hTest:hFormat	90	80
Lotus Magellan	195	CALL
MACE GOLD	149	129
MKS Toolkit	249	209
Norton Utilities	100	65
Norton Utilities Advanced	150	105
PC Fullback	70	59
PC/Tools Deluxe	129	89
Spiritie	59	49
Vfeature Deluxe	120	109
V OPT	60	55
XENOCOPY-PC	80	70
XTreePro	129	109

VERSION CONTROL SYS.

	LIST OURS	OURS
MKS Make	149	129
MKS RCS	189	159
Personal PVCS	149	125
PolyMake	149	125
Professional PVCS	395	335
Seidl Version Manager	300	269
TLIB	100	90
5 Station LAN	300	259

WINDOWS (MS) TOOLS

	LIST OURS	OURS
Actor	495	429
Case:W	795	759
C-Talk/Views	450	375
dBast/Windows	249	229
MS Windows Development Kit	500	349
Whitewater Resource Toolkit	195	169
WinTrieve	395	339

NEW RELEASES

WinTrieve™
Microsoft® Windows-based file management system for application programmers using C or Actor. WinTrieve efficiently manages large amounts of information by storing data records on disk in indexed sequential access method (ISAM) files.

List: \$395 Ours: \$339

MKS TOOLKIT V3.1

Excellent for learning UNIX! New 260 page user guide includes an overview to introduce novices to general commands. Contains full MKS AWK, KornShell and Vi tutorials. New install and config programs make it easy to set up the configuration that best suits your needs. 15 new utilities added.

List: \$249 Ours: \$209

SMALLTALK/V PM

Combines the power of the industry's leading object-oriented environment with the richness of Presentation Manager. Fully compiled, giving a PM application developer an extremely responsive environment with which to work. Source code compatibility with Digital's other Smalltalk products.

List: CALL Ours: CALL

needed it yesterday! (800) 445-7899

Special of the Month: NOVELL

The **Novell C Network Compiler** gives you a direct link into NetWare, the leading network operating system with the world's largest installed base of network application users.

Order the **C Network Compiler from Programmer's Paradise before October 29** and save \$95 on the purchase of any other software that we carry!

CALL FOR DETAILS!!

ADDITIONAL PRODUCTS

	LIST OURS	
Baler Spreadsheet Compiler	495	459
EasyFlow, Interactive	150	125
Inside!	125	109
Logic Gem	198	179
Matrix Layout	150	129
muLISP-87 Interpreter	300	219
Opt-Tech Sort	149	129
Paginate	100	89
PC/Forth +	250	225
PC Metric	199	185
PC Scheme	95	79
Personal Rexx	150	129
Source Print	99	89
Tree Diagrammer	99	89

UNIX SOFTWARE

Aspen Korn Shell	145	109
Basmark QuickBASIC	695	629
Epsilon	195	159
Interactive 386/IX	1095	989
PRO-C	1835	1559
SCO XENIX 386 Complete Sys. for PS/2	1595	1355
SCO XENIX 386 Oper. Sys.	1695	1439
Terminal Control	695	589
VPIIX 386 Unlimited	995	845

BLAISE

Asynch Plus	149	115
C Asynch Manager 3.0	189	139
C Tools Plus/6.0	149	109
Exec	95	75
KeyPilot	50	39
Power Screen 1.1	149	115
Power Search	149	115
Power Tools Plus/5.0	149	115
Turbo C Tools/2.0	149	115

BORLAND

Paradox 3.0	725	509
SideKick Plus	200	139
Sprint	200	139
Turbo Assembler/Debugger	150	105
Turbo Basic	100	69
Turbo C 2.0	150	105
Turbo C 2.0 Professional	250	175
Turbo Pascal 5.0	150	99
Turbo Pascal 5.0 Professional	250	169
Turbo Prolog	150	105
Turbo Prolog Toolbox	100	69

GREENLEAF

Greenleaf Bus. MathLib	395	279
Greenleaf Comm. Library	299	209
Greenleaf DataWindows	395	279
Greenleaf Functions	229	165
Greenleaf MakeForm	125	95
Greenleaf SuperFunctions	299	209
Greenleaf ViewComm	559	475

MEDIA CYBERNETICS

Dr. HALO III	140	101
HALO	395	279
HALO for MS Developers	595	419
HALO for OS/2	695	489
HALO for two languages	545	389
HALO Programmer's Workbook	80	59
HALO Window Toolkit	595	419

MICROSOFT

MS BASIC/6.0	295	209
MS C	450	299
MS COBOL	900	629
MS Excel	495	299
MS FORTRAN	450	299
MS Macro Assembler	150	105
MS Mouse Bus or Serial w/ EasyCAD	175	125
w/ Paintbrush & Mouse Menus	150	105
w/ Paintbrush & Windows	200	139
MS OS/2 Present. Mgr. Toolkit	500	349
MS OS/2 Softset	150	105
MS Pascal	300	209
MS QuickBASIC 4.5	99	69
MS QuickC 2.0	99	69

LIST OURS

MS QuickPASCAL	99	69
MS Sort	195	139
MS Windows	99	69
MS Windows/386	195	136
MS Windows Development Kit	500	349
MS Word 5.0	450	285

MORTICE KERN SYSTEMS

MKS Awk	99	85
MKS Lex and Yacc	249	209
MKS Make	149	129
MKS Make for OS/2	249	209
MKS Programming Platform	665	565
MKS RCS	189	159
MKS RCS for OS/2	395	335
MKS SoftQuad Publishing Sys.	495	469
MKS Software Mgmt. Team	299	255
MKS Toolkit V3.1	249	209
MKS Toolkit V3.1 for OS/2	495	419
MKS Vi	149	129
MKS Vi for OS/2	199	169

NOVELL

Btrieve Single-User	245	185
Btrieve for DOS 3.1 Networks	595	459
Btrieve for OS/2	595	459
Btrieve for XENIX	595	459
C Network Compiler	695	559
C Network 386 Compiler	995	799
NetWare C Interface for DOS	295	239
NetWare MHS	100	79
NetWare MHS Interface Guide	145	129
NetWare RPC	950	759
NetWare RPC for OS/2	1750	1399
NetWare SQL	595	459
NetWare System Calls for DOS	195	159
XQL	795	599
Xtrieve PLUS	595	459
Xtrieve PLUS for OS/2	595	459

POLYTRON

Personal PVCIS	149	125
Plink86plus	495	419
PolyAWK	99	85
PolyDoc	199	169
PolyLibrarian	99	85
PolyMake	149	125
PolyXRef	99	85
Professional PVCIS	395	335

RAIMA

db_FILE Bundle (Single User)	595	509
db_FILE Bundle (Multi-User)	295	249
WKS Library	195	165

SOUTH MOUNTAIN

Breakout-II	125	99
C Utility Library	199	159
Essential B-Tree (w/ source)	99	79
Essential Communications 3.0	249	199
Essential Graphics	299	239
Hold Everything (w/ source)	129	109
Resident_C (w/ source)	198	159
ScreenStar (w/ source)	198	159

WHITewater GROUP

Actor	495	429
Language Extensions I	99	85
Whitewater Resource Toolkit	195	169
WinTrieve	395	339

PROGRAMMER'S POLICIES

Phone Orders

Hours 9 AM-7 PM EST. We accept MasterCard, Visa, American Express. Include \$4.00 per item for shipping and handling. All shipments by UPS ground. Rush service available.

Mail Orders

POs by mail or fax are welcome. Please include phone number.

International Service

Phone number required with order. Call or fax for additional information.

Dealers and Corporate Accounts

Call for information.

Unbeatable Prices

We'll match nationally advertised prices. (Subject to same terms and conditions.)

Return Policy

30-day no-hassle return policy. Some manufacturer's products cannot be returned once disk seals are broken.

Turbo Pascal 5.5

Borland's Turbo Pascal, the world-standard Pascal compiler with more than one million copies in use, has added object-oriented programming to its newest release, version 5.5. Borland combined the simplicity of Apple's Object Pascal language with the power and efficiency of C++ to create Turbo Pascal 5.5. With Turbo Pascal objects, your code will be compact, flexible and reusable. And it will be easier to extend and maintain.



Turbo Pascal 5.5: \$99

BORLAND Turbo Pascal Professional 5.5 (with Turbo Debugger): \$169

Whitewater Resource Toolkit™

The **Whitewater Resource Toolkit** is a new on-screen editor for creating and managing Windows resources such as menus and dialog boxes. Application developers and system integrators use the **Whitewater Resource Toolkit** for designing or customizing an application's look and feel.

Microsoft® Windows Resource Editor—NEW!
Special Price: \$169



The Whitewater Group

The toolkit is an integrated set of seven interactive editors to create dialog boxes, menus, color bitmaps, cursors, icons, strings and accelerators.

With it, you can manage resources for any new or existing Windows program written in C or Actor. The Windows SDK and resource compiler are not required.

C TOOLS PLUS/6.0

New from Blaise Computing

Filled with many advanced routines for developing high-powered Microsoft C applications, including: virtual, stackable menus and windows with full mouse support; multiple virtual pop-up help screens; functions for writing interrupt service routines, creating pop-up memory resident applications, and much more.



C TOOLS PLUS includes all source code, complete sample programs, and an online database compatible with the QuickC Advisor.
Special Price: \$109

BLAISE COMPUTING INC.

db_FILE™ Bundle

db_FILE combines relational B-tree indexing and network model database technology assuring flexibility and optimum performance. Both access methods may be used independently or in combination for real power. db_FILE is written in C. Your db_FILE applications will be portable to most C language environments.

Special offer: Buy db_FILE now at our low special price and you will also receive complete C source code and db_RETRIEVE, the SQL-based Query and Report Writer.

Single User: \$249 (Valued at \$1,780)
Multi-User: \$509 (Valued at \$2,890)



RAIMA CORPORATION

International: 201-389-8950

Customer Service: 201-389-8950

Fax: 201-389-9227

Call or Write for Latest Free Catalog!

1-800-445-7899

Programmer's Paradise

A Division of Voyager Software Corp
1163 Shrewsbury Ave., Shrewsbury, NJ 07702



Outfit Your PC for ISDN

If you're an IBM PC user who wants ISDN capabilities, the PC² is an economical board/software package that provides full 144-kbps connectivity through all three ISDN channels.

Like most other ISDN products for personal computers, it's compatible only with AT&T's 5ESS central office computer switch. For simultaneous voice and data, it uses a coprocessor, an 80C188, and TSR software on top of DOS. Memory requirements are 242K bytes with standard RAM.

PC² features seven applications, including an optional Screen Share package that lets two people simultaneously work on the same PC application from two different locations.

The Vadis system software provides ISDN connectivity through the built-in transparent DOS- or NetBIOS-based remote file access/file sharing system or through the on-board serial port emulation, with or without an AT modem command-set interpreter.

The Voice Call Manager initially helps you place a voice-based call to anyone on your phone list database. It also gives you a help screen for all 64 ISDN telephone voice features.

The Data Call Manager helps you place a data-only call to another ISDN device, with up to 16 "terminal profiles" selectable by name, and it lets you perform a file transfer in the background. It also lets you talk to others through an interactive conferencing system.

An E-mail function lets you send and receive messages between PC² devices and through established public or host-based E-mail systems. The Desktop Calendar is simi-



PC² links up to seven ISDN applications to your phone and your DOS computer, including screen sharing.

lar to most calendars in personal information management software, including an audible signal for reminders.

The Script Processing function gives you information on the people calling you before you pick up the phone, but only if they're on another PC² device.

Price: \$1180; Screen Share, \$125.

Contact: Vadis, Inc., 2201 Waterview Pkwy., Suite 1200, Richardson, TX 75080, (214) 690-2481.

Inquiry 1153.

LAN RAM Saver for NetWare

LANSpace, from Lan Systems, is a RAM saver for NetWare 286. It takes the NetWare drivers (Net3 or Net4) out of conventional memory and puts them into extended memory, saving 35K bytes of RAM.

LANSpace also allows you to load and unload NetBIOS without rebooting, for an additional savings of 21K bytes of RAM, the company claims.

Price: \$495 per server.

Contact: LAN Systems, Inc., 599 Broadway, 11th Floor, New York, NY 10012, (800) 827-5267.

Inquiry 1151.

Crosstalk Now Appearing in Windows

Crosstalk, one of the most popular communications packages for the IBM PC, has moved over to Microsoft's Windows environment.

One of the main features of the program is its support of the Dynamic Data Exchange facility of Windows. This allows Crosstalk to import and export data easily to and from other Windows applications, such as Microsoft's Excel spreadsheet program. Digital Communications Associates reports that an Excel macro can automatically call a remote database, download a small list of stock prices, and graph the results.

Like other Windows packages, Crosstalk makes full use of pull-down menus and other user-friendly features. If you select a certain item from a menu with a mouse, Crosstalk will echo that item back to the host system.

The new Crosstalk is compatible with the script language of Crosstalk Mark IV.

Price: \$195.

Contact: Digital Communications Associates, 1000 Holcomb Woods Pkwy., Suite 440, Roswell, GA 30076, (404) 998-3998.

Inquiry 1154.

Proteon Offers Unshielded Support for Token Rings

The company that introduced the first token-passing ring LAN in 1981 is now the first to ship unshielded twisted-pair wiring support for 4-, 10-, and 16-Mbps token-ring networks.

Support for 16-Mbps token ring over unshielded and shielded twisted-pair cabling lets Proteon take advantage of inexpensive, readily available wiring. Unshielded twisted-pair wiring is used by AT&T for Private Branch Exchange installations.

The key to Proteon's support for unshielded twisted-pair wiring is a new multi-access unit called the Series 70 Intelligent Wire Center. The p7202 modular hub supports the 4- and 16-Mbps data transmission rates afforded by IBM's 802.5-compliant Token Ring solution, as well as the 10-Mbps data rates supported by Proteon's eight-year-old proprietary networking hardware.

Electromagnetic interference problems, Proteon says, have been solved with passive filtering at both ends of the cable. Each multi-access unit supports a cabling distance of 279 feet.

If you prefer IBM's wiring scheme and shielded twisted-pair media, Proteon offers the Series 70 p7201 modular hub. For the same price as the p7202, it supports 4- and 16-Mbps token rings, but not Proteon's proprietary 10-Mbps token ring.

Price: \$1295, not including token ring PC boards.
Contact: Proteon, Inc., Two Technology Dr., Westborough, MA 01581, (508) 898-2800.

Inquiry 1155.

continued

"SCO Sets UNIX Standard"
—COMPUTER DEALER NEWS (U.K.)

First, they built the
world's standard.

Then they added standards
no one else had.

And that was just
the beginning.

THE SANTA CRUZ OPERATION, INC. PRESENTS

UNIX NOW!

THE SCO LEGEND CONTINUES

AN SCO™ PRODUCTION IN EXCLUSIVE ASSOCIATION WITH MICROSOFT CORPORATION AND AT&T • SCO'S BLOCKBUSTER 3.2 RELEASE OF UNIX™ SYSTEM V/386 FOR ISA, EISA, AND MCA SYSTEMS "UNIX NOW!"

STARRING FIPS POSIX™ • X/OPEN™ • C2 TRUSTED SECURITY • MICROSOFT™ C, MASM, AND COOEVIEW™

CO STARRING AT&T FILE SYSTEM SWITCH, STREAMS, SHARED LIBRARIES, PCC, AND SDB • BERKELEY SELECT • DOS, OS/2™, AND XENIX™ CROSS-DEVELOPMENT • COMPUTER GRAPHICS INTERFACE

ONLINE MANUALS • EXTENSIBLE CONSOLE, MOUSE, AND SCSI DRIVERS • ALL SCO XENIX FEATURES INCLUDING MULTISCREEN™, SERIAL CONSOLE, AND AUTOMATIC POWER FAIL RECOVERY

AND INTRODUCING AUTOMATIC INSTALLATION • ACER™ FAST FILE SYSTEM • TRANSPARENT DOS FILE SYSTEM • DEVICE DRIVER WRITER'S GUIDE (WITH ANNOTATED SAMPLE SOURCE CODE)

SYSADM SHELL AS THE EASY-TO-USE SYSTEM MANAGER • MULTIPLE GROUPS, JOB CONTROL, AND RELIABLE SIGNALS AS THE FIPS POSIX EXTENSIONS • MMOF II AS THE MAIL DELIVERY AGENT

SUPPORTING CASE SCO EROFF™ • SCO MULTIVIEW™ • SCO XSIGHT™ X WINDOW SYSTEM™ • SCO NFS™ • SCO TCP/IP • SCO VP/ix™ • SCO uniPATH™ SNA-3270

PLUS HUNDREDS OF SUPPORTED PERIPHERALS INCLUDING TERMINALS, PRINTERS, SERIAL CARDS, TAPE DRIVES, AND ST506, RLL, ESDI, AND SCSI CONTROLLERS

PLUS THOUSANDS OF PROVEN APPLICATIONS SUPPORTED EXCLUSIVELY ON SCO SYSTEM V INCLUDING THE SCO PORTFOLIO™ FAMILY, SCO FoxBASE+™, MICROSOFT WORD, AND AutoCAD®

PRODUCED, DEVELOPED, AND DIRECTED BY THE SANTA CRUZ OPERATION, INC. "UNIX" TRADEMARK CONFORMANCE SPECIFICATION BY AT&T

NOMINATED FOR MOST OPEN-SYSTEM STANDARDS! ★ EASIEST-TO-USE UNIX SYSTEM! ★ FASTEST 386/486 UNIX SYSTEM! ★ BEST XENIX COMPATIBILITY!
MOST APPLICATIONS SUPPORTED! ★ MOST PERIPHERALS SUPPORTED! ★ MOST COMPLETE DEVELOPMENT SYSTEM! ★ BEST INTERNATIONALIZATION!
BEST UNIX SYSTEM DOCUMENTATION! ★ BEST SUPPORT! ★ BEST TRAINING! ★ BEST WORLDWIDE DISTRIBUTION! ★ MOST WORLDWIDE OEM SUPPORT!

OS OPEN SYSTEM
RECOMMENDED FOR AUDIENCES
WITH STANDARDS

SCO
THE SANTA CRUZ OPERATION

**OPEN
DESKTOP™**
IS BASED ON SCO UNIX SYSTEM V/386

SCO, the SCO logo, MultiScreen, SCO MultiView, SCO Portfolio, Open Desktop, and the Open Desktop logo are trademarks of The Santa Cruz Operation, Inc. • UNIX is a registered trademark of AT&T in the USA and other countries. • POSIX is a trademark of The Institute of Electrical and Electronics Engineers (IEEE). • X/Open is a registered trademark of X/Open Company Ltd. • Microsoft, CodeView, and XENIX are registered trademarks of Microsoft Corporation. • OS/2 is a registered trademark of International Business Machines Corporation. • Acer is a registered trademark of Acer International. • EROFF is a trademark of Elan Computer Group, Inc. • Xsight is a registered trademark of Locus Computing Corporation. • X Window System is a trademark of Massachusetts Institute of Technology. • NFS is a trademark of Sun Microsystems, Inc. • VP/ix is a trademark of Phoenix Technologies Ltd. and Interactive Systems Corporation. • uniPATH is a trademark of Pathway Design, Inc. • FoxBASE+ is a trademark of Fox Software, Inc. • AutoCAD is a registered trademark of Autodesk, Inc.

©MCMXXXIX The Santa Cruz Operation, Inc. All Rights Reserved. The Santa Cruz Operation, Inc., 400 Encinal Street, P.O. Box 1900, Santa Cruz, California 95061 USA. The Santa Cruz Operation, Ltd., Croxley Centre, Hatters Lane, Watford WD1 8YN, Great Britain, +44(0)923 816344, FAX +44(0)923 817781, TELEX: 917372 SCOLON G

NOW SHOWING AT AUTHORIZED SCO RESELLERS!

**OPEN
DESKTOP™**

**WORLDWIDE TECHNICAL SEMINARS FOR DEVELOPERS
CALL SCO'S OPEN DESKTOP™ SEMINAR HOTLINE TODAY!**

(800) SCO-UNIX (726-8649)

(408)425-7222

FAX: (408)458-4227

E-MAIL: ...!uunet!sco!info info@sco.COM

Circle 248 on Reader Service Card

Find the Bugs in OS/2 Code

Logitech's MultiScope Debugger is designed specifically for those of you attempting to cope with the slings and arrows of OS/2 development. It offers run-time and postmortem debugging options. The run-time debugger controls execution with a set of control features and stepping commands. The post-mortem debugger captures the program execution state of an application running outside the debugger at the time of the crash. You can then examine the resulting dump file to find the program crash condition.

The debugger uses multiple overlapping windows to display up to 13 different program views simultaneously. You can create custom configurations of source, assembly, data, register, memory, module, breakpoint, watchpoint, graphical data, threads, call chain, log, and output views. MultiScope also includes complete support for debugging threads, dynamic link libraries, and child processes.

One of the program's unique features is a specialized data display that shows complex data structures in a graphical form. MultiScope is compatible with any language that generates standard CodeView OS/2 debugging information, including Logitech Modula OS/2, Microsoft C, and IBM C/2. It works in OS/2 text mode and under Presentation Manager.

Price: \$299.

Contact: Logitech, Inc., 6505 Kaiser Dr., Fremont, CA 94555, (415) 795-8500.

Inquiry 1102.

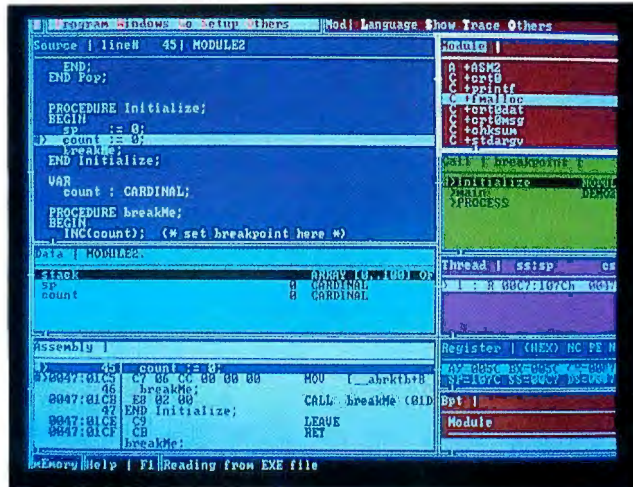

Developed with OS/2 for OS/2, MultiScope works under Presentation Manager and in text mode.

Express C Compiler for OS/2, DOS

The TopSpeed C Professional Edition compilers automatically create dynamic link libraries and support Microsoft Windows and the OS/2 Presentation Manager. The Jensen & Partners International (JPI) compiler is based on an optimized code generator that lets you integrate routines from multiple languages into a single application.

The code generator automatically detects the type of source code in each window, calls the appropriate compiler, and links the routines. It provides a common run-time library and consistent memory allocation routines for all the JPI language implementations (currently, Modula II, C, and Assembler).

The Professional Editions include start-up assembler code, full source code to libraries, and a watch utility for viewing any selection of DOS calls.

The TopSpeed C compiler includes a Make facility that automatically updates and maintains file dependencies. It is fully ANSI-compatible. The company hopes to ship a C++ compiler early next year, and an Ada compiler is under development.

Price: Standard Edition (includes debugger and compiler), \$199; DOS Professional Edition, \$395; OS/2 Professional Edition, \$495.

Contact: Jensen & Partners International, 1101 San Antonio Rd., Suite 301, Mountain View, CA 94043, (800) 543-5202 or (415) 967-3200.

Inquiry 1103.

Search Engine Zeros in on String Patterns

Blaise Computing says that Power Search, a library of C functions, uses a new technology to execute fast searches for strings or expressions in DOS- and OS/2-based applications. It generates and executes custom machine code that's optimized for a specific pattern.

Power Search matches both ordinary strings and regular characters. Strings can include metacharacters that represent common character classes, such as digits or lowercase letters.

The package includes pre-compiled libraries for Micro-

soft C, QuickC, and Borland Turbo C. For Microsoft C, it includes libraries for generating bound applications that run under both DOS and OS/2.

Price: \$149.

Contact: Blaise Computing, 2560 Ninth St., Suite 316, Berkeley, CA 94710, (415) 540-5441.

Inquiry 1104.

Zap Your Apps into PROMS

If you need to turn an IBM PC into a diskless standalone workstation or protect your custom code from prying eyes and piracy, Annabook's PromKit can help by putting any DOS program (or even DOS itself) into EPROM or static RAM (SRAM).

With a one-line command, you can turn an application or DOS into a binary image that you can load into a PROM and place into a PC motherboard or add-in card. PromKit lets you choose which drives you want to emulate. And if you use SRAM, the PC can even write to the drive.

The company says that even though the PC's EPROM address space is limited, you can use paged EPROMs to emulate a full 360K-byte drive by using three 27011 chips for data and a single 27128 for the driver module.

PromKit comes with complete source code (written in Microsoft C 5.1), including listings for utilities that convert files from binary to Intel hex format, and split files into even and odd bytes. To use PromKit, you'll need an IBM PC or compatible, 640K bytes of RAM, a hard disk drive, and an EPROM programmer.

Price: \$179.

Contact: Annabooks, 12145 Alta Carmel Court, Suite 250-262, San Diego, CA 92128, (619) 271-9526.

Inquiry 1105.

continued

IF YOU LIKED OUR AD, YOU'LL LOVE THE BOOK.

For your free Dell product catalog, write us. Or
call 800-426-5150. In Canada, call 800-387-5752.

Name: _____

Title: _____

Company: _____

Address: _____

City: _____ State: _____ Zip: _____

Phone (Daytime): _____

Type of Business: _____

Please have a Dell representative call me.

386 and 386SX are trademarks of Intel Corporation. ©1989 DELL COMPUTER CORPORATION.

1. Which products are you most interested in?
A 286-based systems
B 386SX™-based systems
C 386™-based systems
 Other _____
4. Are you a (select one):
A End user
B Consultant
C Reseller
D Corporate Purchaser
E DP/MIS Purchaser
F Government Purchaser
 Other _____

2. How many PCs do you (your company) plan to purchase in the next year?

3. Is your requirement:

- A Immediate
- B 1-3 Months
- C 3-6 Months
- D 6-12 Months
- E Over 12 Months
- F Info only

5. How many PCs do you have installed now?



AD CODE 51EK9



NO POSTAGE
NECESSARY
IF MAILED
IN THE
UNITED STATES

BUSINESS REPLY MAIL

FIRST CLASS MAIL

PERMIT NO. 6745

AUSTIN, TEXAS

POSTAGE WILL BE PAID BY ADDRESSEE

DELL COMPUTER CORPORATION
Dept. ME
9505 Arboretum Boulevard
Austin, Texas 78759-9969



SEND AWAY FOR YOUR VERY OWN COMPUTER STORE.

When you buy a computer, about 35% of your money goes to the store.

But we'd much rather see your money go to somebody who deserves it a lot more.

You.

So we give you a completely different kind of computer store.

The Dell Computer Store.

Instead of a crowded, high-overhead showroom, you get our brand new 44-page catalog. Which gives you a full line of 386™ and 286 systems, printers, peripherals, software, and accessories.

And since you buy direct from the manufacturer, you save about 35%.



But there's a lot more to it than saving money. We offer you the most complete service and support in the industry. Including a 30-day money-back guarantee. A toll-free technical support hotline. Self-diagnostic software. And next-day deside service from

Xerox Corporation. If you read our ad in the front of this magazine, it will tell you a lot more about the systems we offer. And the service we put behind them. So if you'd like a much more intelligent way to buy a personal computer, have a look at our ad. Or call us at 800-426-5150. Or send us the card on this page.

And we'll send the best computer store you've ever seen.

One you don't have to set foot in.

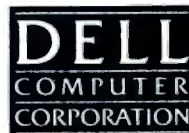

TO ORDER, CALL US.
800-426-5150.
FOR DELL IN CANADA, CALL 800-387-5752.



What better way to run Novell's 386 NetWare .

Novell's new 386 NetWare® will do for networking what gunpowder did for negotiating leverage. Provided you've got a 386 machine that's designed to be 100 percent compatible with it.

Not to worry.

Samsung's LAN hardware was co-designed by Novell® Which should put any compatibility concerns to rest. That's why the Samsung/Novell co-label is on our 386AE Fileserver and our PCterminal/286 LAN workstation.

NETWORKING vs. NOTWORKING.

Both the Samsung 386AE and PCterminal/286 have been tested exhaustively by Novell for compatibility with popular networking hardware and NetWare products. In fact, no other LAN hardware

has ever undergone such extensive testing.

But then Samsung and Novell didn't set out to design just another make-do desktop computer.

Samsung's 386AE Fileserver, for example, was designed from the bus up to be a high-performance fileserver, starting with its Novell-developed BIOS. It also sports eight expansion slots for the inevitable inventory of interface and controller cards. Plus an oversize power supply capable of driving the requisite 100 megabyte-plus hard disk, tape backup system, etc. And it includes 4 megabytes of high-speed RAM for disk caching.

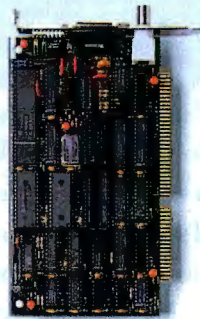

A TOTAL LAN SOLUTION.

To maintain NetWare compatibility throughout

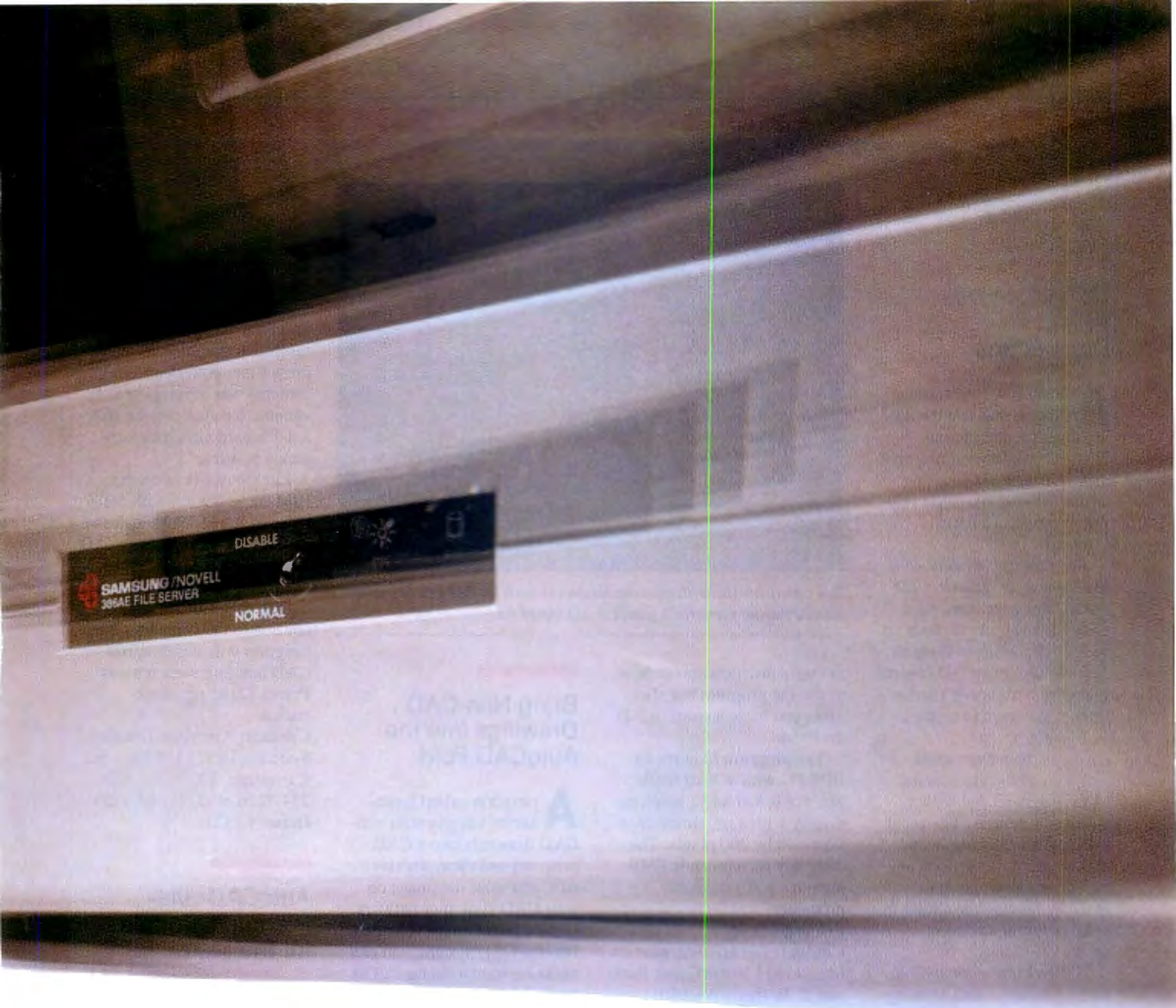

your network, choose Samsung's PCterminal/286, a Novell-tested LAN workstation. Inside you'll find a built-in Ethernet interface adapter, and functional features like Novell's NetWare Autoboot EPROM.

THE NO BOTTLENECK ETHERNET CARD.

Our new SE2100 Ethernet interface eliminates the network bottleneck. Designed by Samsung, this high-performance 16-bit card provides twice the throughput of other Ethernet interfaces. And you can retrofit your existing workstations and file servers with the SE2100 for dramatic improvements in your network's productivity.

LOOK FOR THE CO-LABEL.

The partnership between Samsung and Novell has

created a hardware/software compatibility standard unparalleled in the industry. That means your network can experience all the speed of Novell's new 386 NetWare without being subjected to a lot of hardware hiccups.

Just look for the Samsung/Novell co-label. You'll find it at your nearest reseller. For the location, call **1-800-366-7472**.



Circle 301 on Reader Service Card (DEALERS: 302)

Generic Moves in Three Dimensions

A fairly intuitive drawing process and two navigational aids to help three-dimensional drawing are what make Generic 3D Drafting an easy-to-use 3-D CAD program, reports Generic Software.

The program's interface is the same as in Generic's 2D CADD program, making it easy for 2-D users to move up to 3-D, according to Generic. You can also draw 2-D objects and then extrude and further manipulate them to create a 3-D object.

One of the navigational aids is a color-coded cursor, which you can label with *x*, *y*, and *z* directions. The other aid is called *tracking*, which allows you to move along any axis to any given point in space by moving the cursor instead of typing in coordinates.

3D Drafting is compatible with Generic CADD drawing files. It also gives you 256 layers, 256 colors, and 256 line types. An in-depth tutorial

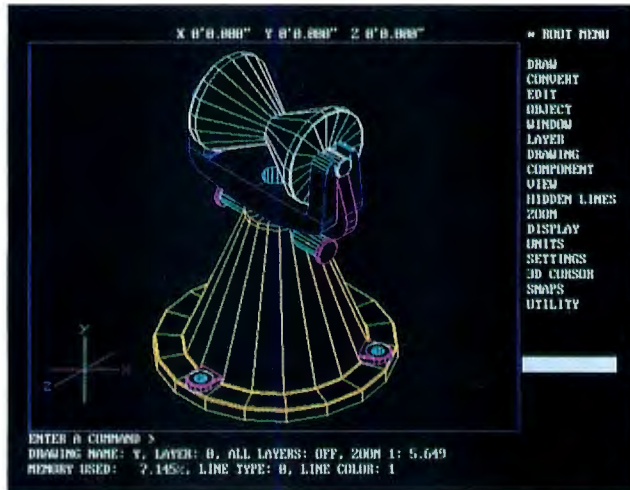

You can draw three-dimensional objects such as this gravity saw support using Generic's familiar 2D interface.

not only instructs you on how to use the program but also gives you basic lessons in 3-D drafting.

The program requires an IBM PC with at least 640K bytes of RAM and a graphics display with a resolution of at least 640 by 200 pixels. The company recommends EMS memory and a math coprocessor.

Price: \$249.95.

Contact: Generic Software, Inc., 11911 North Creek Parkway S, Bothell, WA 98011, (800) 228-3601 or (206) 487-2233.

Inquiry 1123.

Bring Non-CAD Drawings into the AutoCAD Fold

A program called LunaSeries lets you scan non-CAD drawings into a CAD program and view, archive, edit, and store the image on your CAD system or network. Once a raster image is loaded into the CAD system, you can make on-screen changes. The program displays the original image and your changes. After editing the image, you can merge the original draw-

ing with your changes and save them in CAD format.

Version 2.31 of the program now supports all high-resolution graphics cards. At press time, American Imaging Systems was developing a version that supports all Hewlett-Packard Graphics Language plotters.

LunaSeries runs on the IBM AT or higher with 640K bytes of RAM, 512K bytes of expanded memory, AutoCAD 2.6 or higher, VersaCAD 5.3 or higher, or CADKEY 3.5 or higher. Later this year, according to the company, the program will support IBM CAD and Sun workstations.

Price: \$2185 per workstation.

Contact: American Imaging Systems, Inc., 2315 Luna Rd., Carrollton, TX 75006, (800) 234-7226 or (214) 484-3339.

Inquiry 1121.

AutoCAD Site-Planning Modules for the Mac

A set of applications from LandCADD lets you capture AutoCAD designs and customize them for land planning. The Site Planning and Landscape Design module includes a symbols library and routines for parking, coordinate geometry, topography, and cut and fill.

LandCADD runs on the Mac II or Ix with AutoCAD, 4 megabytes of memory, and 8 megabytes of free space on your hard disk drive.

Price: Site Planning and Landscape Design, \$695; Irrigation Design, Quadrangle DTM, and EZ-Estimate Plus, \$595 each; CADD Construction Details, \$895; Plant Specifier, \$295.

Contact: LandCADD, Inc., 7519 East Highway 86, Franktown, CO 80116, (303) 688-8160.

Inquiry 1120.

AutoCAD Add-on Helps Draw Industrial Facilities

FactoryCAD is an industrial facilities design and drafting program you can use within AutoCAD. The program's functions and routines automatically generate walls, doors, grids, docks, conveyor belts, and other functions that help you design facilities.

The program has more than 70 predefined layers; you can extract a layer from one drawing and insert it into another. FactoryCAD's utilities can draw power lines, water, compressed air, gas, and steam, each on its own layer with its own color.

The program works on the IBM AT or higher with 640K bytes of RAM, a math coprocessor, 1.5 megabytes of extended memory, and AutoCAD release 9 or 10.

Price: \$695.

Contact: Cimtechnologies Corp., 525 East Second, Suite 500, Ames, IA 50010, (515) 232-9914.

Inquiry 1118.

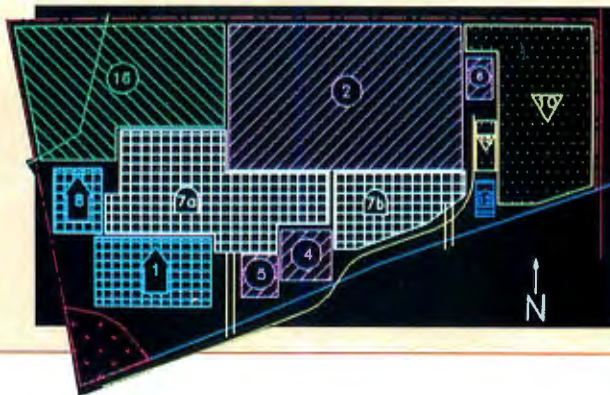



QNX[®]

The OS for over-achievers[™]

QNX programmers have a decided advantage.

You see, people who use QNX enjoy the freedom that comes only with a flexible, modular OS. They appreciate the elegance of a **message-passing architecture**. And they marvel at the fact that QNX runs so lean—under 150K—yet out-performs any other PC operating system.

QNX users never worry about whether their applications will make it at runtime, because they know QNX has proven itself again and again in the real world.

It's no wonder that QNX users have achieved so much since the product was first released for the PC in 1982: over 80,000 systems installed in 47 countries world-wide, in all kinds of applications—from making cars to selling books to handling online credit card transactions.

One reviewer dubbed QNX "The multi-everything OS." Now, you might expect

multiuser and multitasking, but realtime? *And* integrated networking? *And* true distributed processing? Best of all, these terms take on a new meaning with QNX.

Multiuser, for instance, means up to 32 terminals per micro. **Multitasking** cashes out as 150 tasks per machine.

Realtime means not only priority-driven, preemptive task scheduling, but also speed: at 6,896 task switches/sec on a 16MHz 286, QNX is at least a full order of magnitude faster than a typical UNIX system. **Integrated networking** means you won't need yet another layer of software to set up a LAN, and you can use *any mix* of Intel-based micros—from vintage '81 PCs to PS/2s.

Distributed processing with QNX sounds too good to be true. But it is: *Any task can access any resource*—programs, files, devices, even CPUs—without going through the bottleneck of a central file server.

Besides the satisfaction that QNX developers get from using a fast, powerful, and flexible OS, did we mention that they also enjoy *free technical support*?

If you're wondering why you don't already know all about this great OS, you could try asking the over-achievers who are smugly guarding the secret of their success.

Better yet, give us a call. We'll tell you everything you need to know to become an over-achiever yourself.



Circle 229 on Reader Service Card

For more information or a free demo disk, please phone (613) 591-0931.

Quantum Software Systems Ltd., 175 Terrence Matthews Crescent, Kanata, Ontario, Canada K2M 1W8

QNX is a registered trademark of Quantum Software Systems Ltd., UNIX is a registered trademark of AT&T, PS/2 is a registered trademark of International Business Machines Corporation.

© 1989 Quantum Software Systems Ltd.

Microstat-II Now With Graphics
Interface and New Multivariate Module

2.0
Release

Now you can use YOUR favorite graphics package with Microstat-II.

Just some of the packages covered include *3-D Perspective Jr.*, *Harvard Graphics*, *Microsoft's Chart*, *Grapher*, and others.

Microstat-II also includes new procedures for:

- Canonical Correlation
- Factor Analysis
- MANOVA
- Discriminant Analysis
- Principal Components Analysis
- Cluster Analysis
- Covariance Analysis

While Release 1.0 was good:

"... one of the fastest IBM PC statistical packages we have tested... using Microstat-II is a breeze."

Infoworld

"Installation of Microstat-II is simple... The user interface is clean... a pleasant package to use..."

PC Magazine

Microstat-II Release 2.0 is even better!

For a limited time, you can purchase Microstat-II Release 2.0 for \$395.00. Microstat-II requires an IBM PC, XT, AT, PS2 or compatible with 512K memory or more with either a hard disk or two floppy drives. For more information, contact your local computer dealer or call:

Ecosoft, Inc.

6413 N. College Ave.
Indianapolis, IN 46220
Orders: 1-800-952-0472
Info: 1-317-255-6476
FAX: 1-317-251-4604



3-D Perspective Jr.

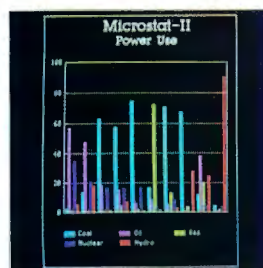

Harvard Graphics

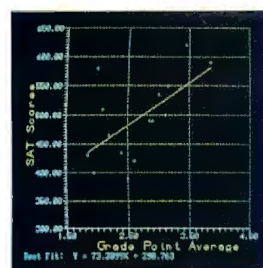

Grapher

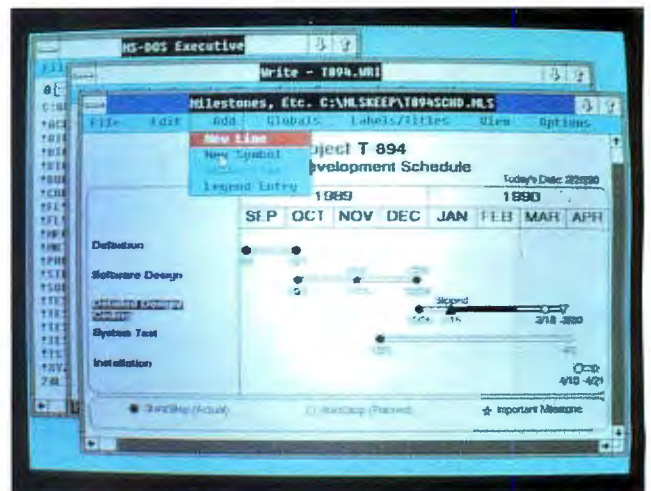

Milestones, Etc. lets you place lines, symbols, and legend entries anywhere on your chart.

Create Gantt, Milestone Charts Under Windows

SoftPro developed *Milestones, Etc.* for businesses that need to create presentation-quality Gantt and Milestone charts. The program runs under Windows and features 28 symbol types, 15 connections, and the ability to lock a symbol onto a specified date.

With the program's current date-sensitive option, the program automatically blackens symbols prior to the current date and makes them hollow after the date. With this option, you can produce an updated chart that reflects the project's progress. Charts can be several pages long, and multiple-page charts can be numbered.

You can merge charts created with *Milestones, Etc.* with *PageMaker*, *Ventura Publisher*, *WordPerfect*, and any other program that accepts Windows metafiles or the Hewlett-Packard Graphics Language format.

Milestones, Etc. works on the IBM AT or higher with Windows 2.0 or higher and a Microsoft-compatible mouse.

Price: \$89.

Contact: SoftPro, P.O. Box 1167, Manchaca, TX 78652, (800) 666-3886 or (512) 282-1544.

Inquiry 1125.

Five Forecasting Programs

Sales and marketing managers can use TSM Associates' *Forecaster* program to generate sales forecasts for products, companies, and individual sales personnel. The program comes in two versions: the distributor's version for the multiline distributor and manufacturer's representative, and the manufacturer's version.

Each version generates a variety of reports and has databases for forecast records, products, and individual personnel; the distributor's version also has a principal's database and breaks down sales by sales representative, products, customer, and time to purchase.

The *Forecaster* runs on the IBM PC with 512K bytes of RAM and a hard disk drive.

Price: \$495.

Contact: TSM Associates, 4 La Cerra Dr., Rancho Mirage, CA 92270, (619) 321-5730.

Inquiry 1128.

3-D Perspective Jr., Harvard Graphics, Grapher, Microsoft's Chart and IBM are all registered or unregistered trademarks of the following companies respectively: 3-D Graphics, Inc., Software Publishing Corp., Golden Software Inc., Microsoft Inc., IBM Inc.

ECOSOFT

Intelligent Database Tools are Here!

Is your Database an Asset or just a File?

As your database grows, its potential value increases. Your challenge is to keep it error-free, understand it, and use it to make effective decisions. These are the tools you need:

SUPERVISOR

Maintain data quality and data integrity. Keep your database error-free. Database/Supervisor analyzes your databases and identifies *suspicious data items*, and patterns which are out of the ordinary. It automatically detects errors which violate statistical or logical integrity constraints. *If your database is being corrupted, Database/Supervisor will show you where.*

IXL The Machine Learning SYSTEM

Discover *hidden patterns and unexpected relationships* in your large database. IXL analyzes your database and generates easy-to-read rules using artificial intelligence and statistical techniques. While Database/Supervisor detects errors, IXL produces rules and decision-making insight. *The solutions you are looking for may already be in your database, waiting to be discovered.*

NEURAL/QUERY

Don't deny yourself inexact, but potentially valuable, answers to your database queries. Close matches are more valuable than *no response*. IXL and Neural/Query are perfect partners. IXL generates rules which can be exported. However, Neural/Query analyzes your large database, builds a network of partial matches, and provides the closest matching answer to your database queries. *Use the full informational content of your database.*

Intelligence COMPILER

The highest-level, easiest-to-use intelligent database environment today. Build dialogs automatically, link them with rules, frames and hypertext *in minutes*. Develop your intelligent application quickly and efficiently, then run it on multiple operating systems. The built-in relational database combines expert system logic with SQL-based object oriented queries. *Accomplish in hours what would otherwise take weeks.*

Discover *hidden patterns and unexpected relationships* in your large database. IXL analyzes your database and generates easy-to-read rules using artificial intelligence and statistical techniques. While Database/Supervisor detects errors, IXL produces rules and decision-making insight. *The solutions you are looking for may already be in your database, waiting to be discovered.*

Experts love our software:

The Intelligence/Compiler is a powerful state of the art system for real-world applications. Its intelligent editing and debugging facilities are a bonus. *AI/Expert Magazine*, February 1988.

Considering the variety of features that the Intelligence/Compiler provides, it is hard to believe that you can get better value for your money. *PC/AI Magazine*, June 1989.

Having used IXL on a large database of geological test data, we were surprised by the many relationships it found. This has greatly helped us to interpret our Oil Company database. *Mr. James Brown*, Oil Industry Consultant, July 1989.

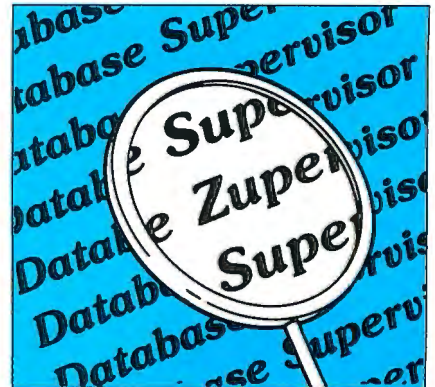

Will your database errors live forever?



Alone in a universe of data? Let IXL be your guide.

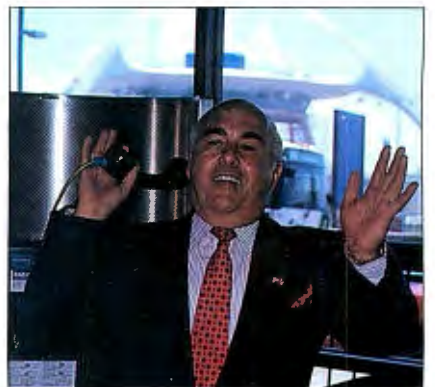

Are you sure you have no listing for the Vite House.

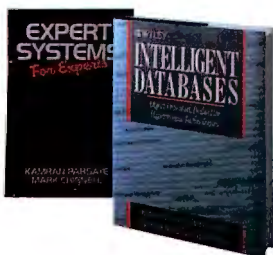

Our leadership in this field of technology is unsurpassed. Ask for our books *Intelligent Databases* and *Expert Systems for Experts* by K. Parsaye, et al., published by John Wiley.



IntelligenceWare
The Next Level in Computing
Circle 132 on Reader Service Card

Yes, I want to win with your easy-to-use intelligent database tools.

Send me your complete collection of intelligent database tools for \$1,490.

Send me the three components: _____, _____, _____, for \$990.

Send me the single component: _____ for \$490.

Computer system: IBM/PC PS/2 Macintosh Also available on VMS, Unix and OS/2

Name _____ Check enclosed, Charge to: Visa MC AMX

Company: _____ Card No: _____ Expiration _____

Address: _____

Telephone: _____

For telephone orders call (800) 888-2996
Shipping and handling: US \$9, Canada and Hawaii \$20,
Overseas Air \$50. California residents please add 6.5% sales tax.

IntelligenceWare
9800 S. Sepulveda Blvd.
Los Angeles, CA 90045-5228
Telephone: (213) 417-8896
Telefax: (213) 417-8897



1991-1992

Inside: Bonus Graphics Soup

BYTE

33 MHz
SIA's new
386 / 32

brad@brad.com

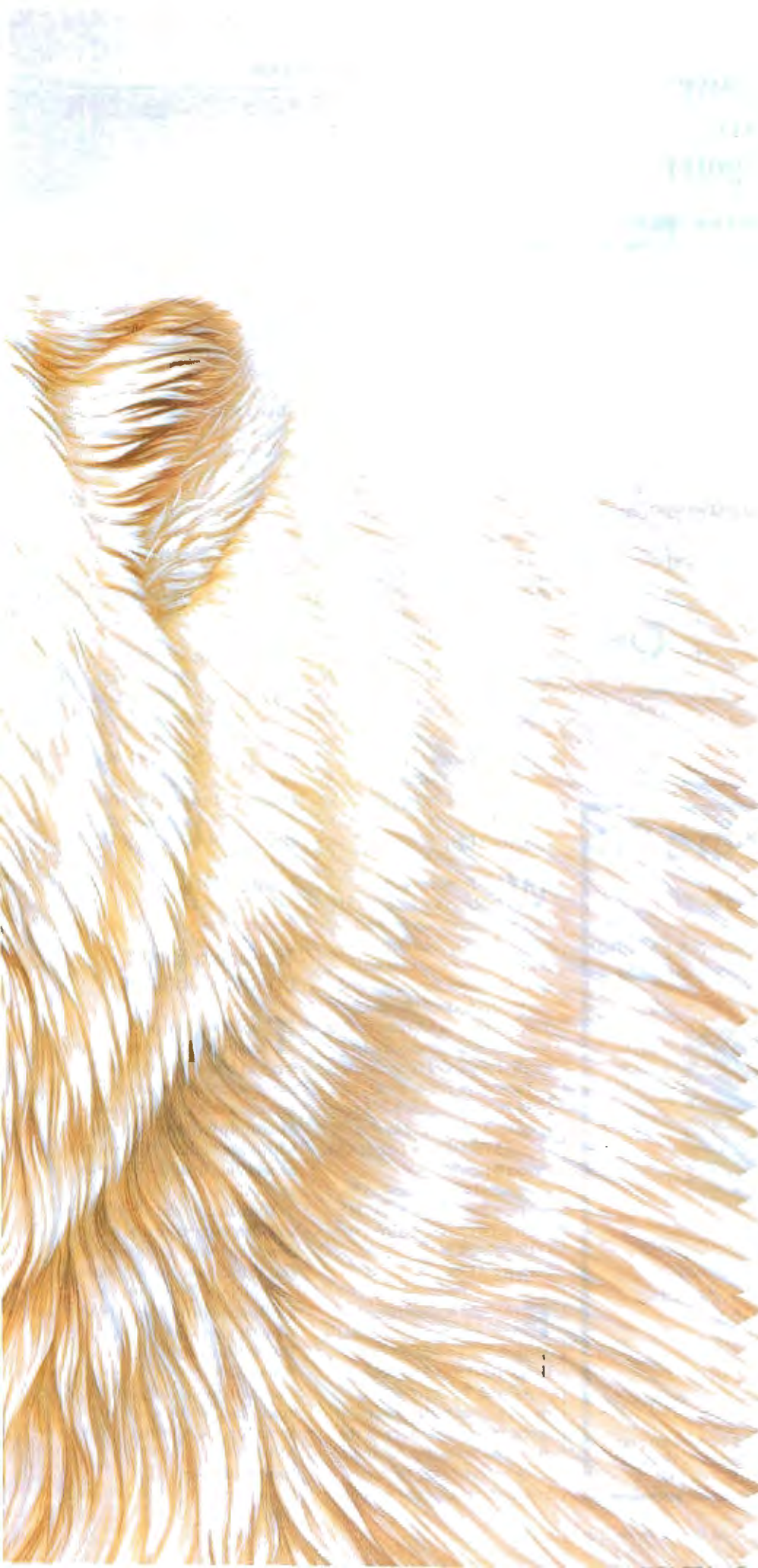

Thalarctos maritimus

#3 in a series on consumer habits

The polar bear is the great white hunter of the Arctic Circle. Migrating long distances over the vast frozen desert, it tracks large prey such as seals and sea lions. In a sprint, it can reach speeds of up to 25 mph. When it raids the ice box, it doesn't waste energy on small fish. The readers of BYTE magazine are just as selective. For they, too, are relentless hunters with big appetites. They are advanced personal computing experts whose hunger for new product information is insatiable. They seek technical analyses. Extensive reviews. A complete rundown of product comparisons. Which is what they get in every BYTE. Some publications may promise you more paid readers than BYTE's 450,000. But none so voracious.



Easy and Effective Data Security For Your Computer

Data Guard is a transparent data encryption program. With Data Guard, you don't have to encrypt or decrypt your files each time you use them. Data Guard does it for you automatically.

Because Data Guard's operation is transparent, it's far superior than other encryption programs. (see Martin Kochanski's article [BYTE: 6/89 p260] about transparent encryption)

Data Guard takes the burden away from the user to insure maximum safety for your system.

If you are serious about protecting sensitive information on your IBM PC or compatible system. Data Guard is the ideal choice.

For more information, Please call (617) 695-0549

To order: send \$195 + \$4 S/H
MA resident add 5% tax
(Check or MO) To:

LogicVision
P.O. Box 32
Boston, MA 02112

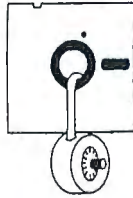

Read Mac Disks in a PC MatchMaker

— the best way to share data between a PC and a Mac. The **MatchMaker** card lets you plug a Macintosh floppy drive into a PC.

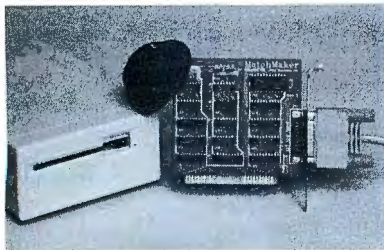

- Easy-to-install half-size card.
- Use any external Macintosh drive.
- DOS-like command software included.
- 1 year warranty, Made in USA.
- Also available; **MatchPoint-PC** to read/write Apple II disks.

"...by far the most cost effective solution..." PC WEEK

MicroSolutions
Computer Products

132 W. Lincoln Hwy.
DeKalb, IL 60115
(815) 756-3411

The NAI Forecasting System handles personnel forecasting for companies, including those that are in growth or downsizing cycles, acquiring other companies, or shifting personnel among divisions.

The program identifies human resource shortages and personnel for each of five-future time periods, which you designate. The program's front end, a human resource data-gathering system, can import planning data from a Human Resource Information System database.

The NAI Forecasting System runs on the IBM AT or higher with a hard disk drive, DOS 3.0 or higher, 640K bytes of RAM, and a math coprocessor.

Price: \$15,000.

Contact: Nardoni Associates, Inc., 157 Route 31, Lebanon, NJ 08833, (201) 730-9444.

Inquiry 1129.

With Tomorrow, you highlight a range of historical information on your Lotus 1-2-3 spreadsheet, including subtotals, summaries, and other formulas, and the program does the rest. Tomorrow doesn't require that you understand the complicated statistics of forecasting.

Tomorrow runs on the IBM PC with Lotus 1-2-3 release 2, 2.01, or 2.2 and requires 55K bytes of free RAM.

Price: \$129.95.

Contact: Isogon Corp., 330 Seventh Ave., New York, NY 10001, (800) 662-6036 or (212) 967-2424.

Inquiry 1130.

ForeCalc is a statistical forecasting program that's designed as an add-on for Lotus 1-2-3 and Symphony.

As with Tomorrow, you specify from within your spreadsheet the history of the data, and ForeCalc automatically generates the forecasts.

ForeCalc is designed for peo-

ple with no prior knowledge of statistics.

ForeCalc incorporates several exponential smoothing models to create the forecasts and to choose the best technique automatically.

Unlike ForeCalc, Forecast Master Plus is for people familiar with statistics. Business Forecast Systems developed it for the professional business forecaster familiar with complicated forecasting models. You can choose from eight forecasting models, ranging from exponential smoothing and Box-Jenkins to variable parameter regression.

Forecast Master Plus works on the IBM PC with 640K bytes of RAM, a hard disk drive, and a math coprocessor.

Price: ForeCalc, \$149; Forecast Master Plus, \$695.

Contact: Business Forecast Systems, 68 Leonard St., Belmont, MA 02178, (617) 484-5050.

Inquiry 1131.

TopDown Steps up into Windows

TopDown, the project management program that lets you break down projects into a series of hierarchically arranged tasks, now supports Microsoft Windows, taking advantage of the Clipboard to export data to other Windows applications.

You can edit your PERT and Gantt charts in any window, and the program will flag critical and late activities.

TopDown Project Planner for Windows runs on an IBM AT or higher with Windows 286 or Windows/386.

Price: \$249.

Contact: Ajida Technologies, Inc., 613 Fourth St., Santa Rosa, CA 95404, (707) 545-7777.

Inquiry 1124.

continued

If Looks Could Kill...



The ViVa24 Modem knocks 'em dead with style and convenience.



Finally! An affordable, state-of-the-art modem designed to maximize any workstation or desktop and take up minimal space. The new 2400 baud modem from Computer Peripherals, Inc. is a 100% Hayes compatible external modem which boasts more high-tech features than its competition at an unbelievable price tag. 🖨️

The compact, distinctively sleek tower design simplifies placement, and it's easily accessible, front panel power switch eliminates fumbling around the back of the unit. The handsome weighted base holds the ViVa24 firmly in place, and sharp LED indicator lights are aligned for comfortable viewing, utilizing international graphic icons that make the ViVa24 simple to understand. 🖨️

The small tower design creates a natural flow of air over the surface of the board, allowing the ViVa24 to run cooler and affording you 24-hour, worry-free operation. The Viva24 modem provides the user compatibility with IBM PC, XT, AT, IBM PS/2, Apple Macintosh computers and any computer that supports RS-232C. 🖨️

The ViVa24 modem represents innovation from its footprint up with features such as: use of the Hayes "AT" command set, asynchronous data format, auto-dialing, auto answer, adaptive equalization, non-volatile memory, automatic tone and pulse dialing, remote access while your computer is unattended, self-test and built-in diagnostics. Best, of all, the ViVa24 is fully backed with a five-year limited warranty. 🖨️

Before investing in an ordinary modem, be sure to investigate the ViVa24. For more details, call your Ingrar. MicroD representative now at:

1-800-456-8000 (East)

1-800-642-7631 (West)

HIGH FIDELITY™

By Computer Peripherals, Inc.

667 Rancho Conejo Blvd.

Newbury Park, CA 91320

TEL: (805) 499-5751

Trademarks: IBM, International Business Machines, Corp.; Hayes Microcomputer Products; Apple Macintosh; High Fidelity, Computer Peripherals, Inc.

Circle 322 on Reader Service Card

Automation For The 90's From The Heartland

CORPORATE COMPUTERS OF IOWA provides the nation's most aggressive prices on our entire line of state of the art 286 and 386 desktop computers as well as all TOSHIBA*, EPSON*, NEC* and PANASONIC* printers, FAX machines and laptops.

Call one of our account executives today and experience the performance and quality you'd expect for the "Heartland."

CCI AT 286/12 MHZ



80286 Processor Running at 6 to 12 MHZ

Phoenix Bios/Digital Speed Display

80287 Math Co-Processor Socket

8 Expansion Slots 6-16 Bit, 2-8 Bit

2 Meg of 0-Wait State Memory (Expandable to 4)

1.2 Meg Floppy

1.44 Meg Floppy

40 Meg Seagate ST 251-1 (28 MSEC.)
WD Controller (1-1 Interleave)

Norton SI 15.3

FCC Class B Approved

14" Multisynch Monitor 800 x 600 Tilt Swivel

Orchid Prodesign and 512K VGA Card

1-Parallel, 2-Serial, Game Port

101 Key at Keyboard with Dust Cover

DOS 4.01 with GW Basic or DOS 3.3 with
GW Basic

Surge Suppressor

1 Year Parts and Labor Warranty (FREE)

1 Year On-Site Service

30 Day Money Back Guarantee
(No Restocking Fee)

2nd Year Warranty (\$49.95)

Complete System Price \$2195.00

FREE

Free with the purchase of any CCI System . . . one year, on-site warranty through Data Access Systems Inc. Provides response time of 8 business hours and covers all parts, labor, travel and technical support. Extended warranty available.

CCI AT 286/20 MHZ



80286 Processor Running at 20, Switchable to 10

Phoenix Bios/Digital Speed Display

80287 Math Co-Processor Socket

8 Expansion Slots, 6-16 Bit, 2-8 Bit

2 Meg RAM 0-Wait State (Expandable to 8)

80 Meg Seagate ST 4096 (28 MSEC.)
WD Controller (1-1 Interleave)

Norton SI 22.5

FCC Class B Approved

14" Multisynch Monitor 800 x 600 Tilt Swivel

Orchid Prodesign and 512K VGA Card

1-Parallel, 2-Serial, Game Port

101 Key at Keyboard with Dust Cover

DOS 4.01 with GW Basic or DOS 3.3 with GW Basic

Surge Suppressor

1 Year Parts and Labor Warranty (FREE)

1 Year On-Site Service

30 Day Money Back Guarantee
(No Restocking Fee)

2nd Year Warranty (\$49.95)

Complete System Price \$2799.00

1-800-533-0948

FAX 712-277-8626

1-800-533-0948

CCI 386/25 MHZ CACHE



80386-25 MHZ Intel Processor 0-Wait State (32K Cache Memory)
 AMI 386 Bios with an in ROM Set-up Routine
 Socket Support for 80287, 80387 and Weitek Co-Processors
 One 32 Bit Slot, Five 16 Bit Slots, and Two 8 Bit Slots
 4 Meg Memory on Board, Expandable to 8MB, 1MB/2MB when using 256K D-RAM, 4MB/8MB when using 1M Bit D-RAM, Expandable to 16MB
 1.2 Meg Floppy
 1.44 Meg Floppy
 80 Meg Seagate-4096 (28 MSEC.)
 WD Controller (1-1 Interleave)
 Norton SI 30.5

FCC Class B Approved
 Mitsubishi Diamond Scan 14" 800 x 600 Tilt Swivel
 Orchid Prodesign and 512K VGA Card
 1-Parallel, 2-Serial, Game Port
 101 Key at Keyboard with Dust Cover
 DOS4.01 with GW Basic or 3.3 DOS with GW Basic
 Surge Suppressor
 1 Year Parts and Labor Warranty (FREE)
 1 Year On-Site Service
 30 Day Money Back Guarantee (No Restocking Fee)
 2nd Year Warranty (\$49.95)

Complete System Price \$3999.00

"FREE" HI-REZ MOUSE

EPSON PRINTERS

	RETAIL	CCI PRICE
LX-810	\$ 299.00	\$174.00
LQ-510	\$ 529.00	\$315.00
LQ-850	\$ 859.00	\$505.00
LQ-950	\$ 949.00	\$560.00
LQ-1050	\$1,199.00	\$695.00
LQ-2550	\$1,499.00	\$899.00

"FREE" Printer Cable

PANASONIC PRINTERS & FAX MACHINES

	RETAIL	CCI PRICE
KXP-1180	\$ 299.95	\$ 179.00
KXP-1191	\$ 399.95	\$ 230.00
KXP-1592	\$ 649.95	\$ 389.00
KXP-1595	\$ 729.95	\$ 429.00
KXP-1124	\$ 529.95	\$ 315.00
KXP-1524	\$ 899.95	\$ 539.00
UF-150 FAX	\$1,795.00	\$ 955.00
UF-260 FAX	\$2,795.00	\$1,479.00

"FREE" Printer Cable

NEC LAPTOPS

		RETAIL	CCI PRICE
PRO-SPEED	286-20 MB	\$5,099.00	\$3,025.00
PRO-SPEED	286-40 MB	\$5,599.00	\$3,189.00
PRO-SPEED	386-40 MB	\$7,699.00	\$4,299.00
PRO-SPEED	386-100 MB	\$8,999.00	\$5,275.00

TOSHIBA LAPTOPS

	RETAIL	CCI PRICE
T-1000	\$ 1,249.00	\$ 759.00
T-1200 F	\$ 2,099.00	\$1,279.00
T-1200 FB	\$ 2,199.00	\$1,350.00
T-1200 H	\$ 2,799.00	\$1,699.00
T-1200 HB	\$ 2,999.00	\$1,800.00
T-1600	\$ 4,999.00	\$3,025.00
T-3100 E	\$ 4,299.00	\$2,599.00
T-5100	\$ 7,199.00	\$4,295.00
T-5200 (40)	\$ 9,499.00	\$5,700.00
T-5200 (100)	\$10,999.00	\$6,699.00

Corporate Computers of Iowa Policies

- Toll Free Number 1-800-533-0948 For Ordering And Post Sale Support
- Master Card, VISA, No Surcharge. American Express - Add 3%
- C.O.D. Cashier Checks
- 30 Day, Money Back Guarantee
- Prices Subject To Change In Manufacturers Pricing
- Allow 10 Days For Personal Checks To Clear
- Call For Corporate Purchase Orders



P.O. Box 714
 Sioux City, Iowa 51102
 712/277-2100
 Toll Free: 1-800-533-0948
 Corporate Showroom
 609 5th Street
 Sioux City, Iowa 51101

Circle 71 on Reader Service Card (DEALERS: 72)

NEW FROM

NOVAS

The Leader in High Performance Since 1982

NOVAS NEAT 286-20MHz 40MB VGA SYSTEM

- 1 MB SIMM Module RAM
- 1.2 MB or 1.44MB Diskette Drive
- High Speed 1:1 Dual Controller
- Enhanced 101 Tactile Keyboard
- 200W Power Supply
- Mini-Tower Case
- 40MB 28ms Hard Drive
- 16 Bit High Speed VGA Controller
- High Resolution VGA Monitor
- DOS 3.3 w/GW Basic
- 80286 Harris CMOS
- 16MHz CPU Running at 20MHz
- Chips & Technologies 286 Neat Chipset
- Interleave/Page Mode 0 Wait
- Shadow RAM, Clock, Battery, AMI BIOS
- 8 I/O Expansion slots, EMS 4.0 support
- Expandable to 8MB on Motherboard
- 287 Socket, 2 Serial, & 1 Parallel Port

POWER METER MIPS = 3.38

\$2195

*Option: 80MB VGA System \$2375

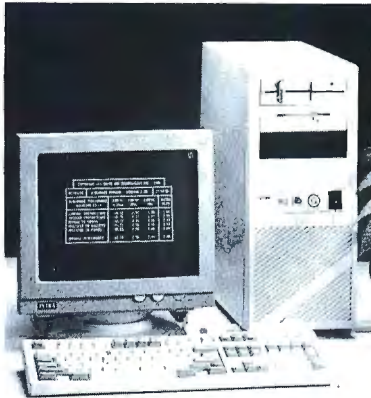

NOVAS 386-25MHz W/CACHE 80MB VGA SYSTEM



- 1 MB SIMM Module RAM
- 1.2 MB or 1.44MB Diskette Drive
- Chips & Technology 82C307 Cache
- High Speed 1:1 Dual Controller
- Enhanced 101 Tactile Keyboard
- 200W Power Supply
- Tower Case
- 80MB 28ms Hard Drive
- 16 Bit High Speed VGA Controller
- High Resolution VGA Monitor
- DOS 3.3 w/GW Basic
- 80386 Intel 25MHz CPU
- Chips & Technologies 386 Chipset
- Interleave/Page Mode 0 Wait
- Shadow RAM, Clock, Battery, AMI BIOS
- 8 I/O Expansion slots, EMS 4.0 support
- Expandable to 16MB on Motherboard
- Socket for 287/387/Weitek
- 2 Serial, & 1 Parallel Port

POWER METER MIPS = 5.87

\$3495

*Option: 150MB ESDI VGA System \$4295

1. Baby Neat 286-14MHz (12MHz CPU) Motherboard W/OK \$315
2. Baby Neat 286-20MHz (16MHz CPU) Motherboard W/OK \$425
3. Baby 386-20MHz (20MHz CPU) W/OK \$645
4. AT 386-25MHz (25MHz CPU) W/OK W/Chips 82C307 Cache Controller \$1395
5. NOVAS 4000 Super 16 Bit VGA 1MB INSTALLED 1024 x 768, 16 COLORS 800 x 600, 256 COLORS \$295

"... FULLY LICENSED TO UTILIZE **IBM** PATENTS..."

NOVAS

Quality Products From
COMPUTRADE CO.
780 MONTAGUE EXPRESSWAY,
SUITE 501, SAN JOSE, CA 95131

SPECIAL PRICING FOR OEM, VAR, & DEALERS
Corporate & University Discounts

*VGA, XT, AT & IBM are trademarks of International Business Machines
*Prices & specs subject to change

U.S. SALES: (408) 435-2662
U.S. FAX: (408) 435-5458

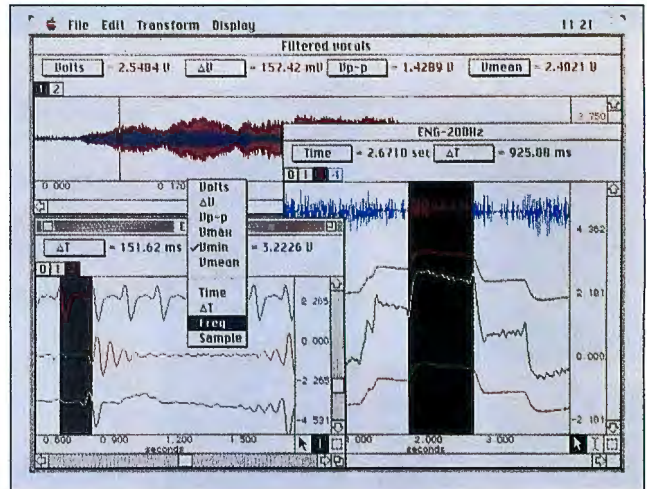

Transform your Mac into a digital signal processing workstation with AcqKnowledge.

Generate Waveforms Two Ways

Snap-Generator is a menu-driven program that generates waveforms using a D/A converter. You can generate standard functions, such as sine, cosine, square, triangular, and ramp, or you can define your own. For sources of output, you can use previously acquired data or HEM's Snap-Calc.

To run Snap-Generator, you specify the shape of the waveform and select AC or DC amplitudes within the range of the D/A. The waveform can be bipolar or unipolar. Swept-frequency waves let you quickly assess frequency response characteristics of the device under test, according to HEM. Sweep rates can be linear or logarithmic. The maximum D/A rate is 30,000 kHz. Up to 32,768 points are generated for a channel before the waveform is repeated. Snap-Generator can output eight channels, with each independently defined. It will also drive an x,y recorder.

Hardware requirements include an IBM PC running HEM's Snapshot Storage Scope and Snap-Calc, and an analog I/O board from Burr-

Brown, Intelligent Instrumentation, or Heath/Zenith.

Price: Snap-Generator, \$395; \$1185 for all three software programs.

Contact: HEM Data Corp., 17336 Twelve Mile Rd., Suite 200, Southfield, MI 48076, (313) 559-5607.

Inquiry 1115.

AcqKnowledge lets you and your Mac work with waveform data. Included in the package are measurement, transformation, filtering, and spectral analysis functions, and both printing and file handling capabilities. For presentations, you can cut and paste AcqKnowledge graphics into any word processing or desktop publishing package.

Among AcqKnowledge's waveform processing capabilities are digital filtering (low-pass, bandpass, high-pass, and notch); spectral analysis using fast Fourier transfers; waveform integration, differentiation, and smoothing; scalar and delta amplitude and time measurements; and waveform arithmetic.

Biopac says that AcqKnowledge is directly compatible with all of the company's data acquisition hardware, but it also works with any data acquisition system that can store data in a text format. If you want to customize the

continued

More Powerful Than Ever ... Up To 5 KVA



MINUTE MAN
UNINTERRUPTIBLE POWER SUPPLIES

STANDBY UPS MODELS

- 250 To 1600 Watt Output
- Synchronized Sinewave with 1 msec Switching Time
- Full One Year Warranty

ON-LINE UPS MODELS

- 1000 To 5000 VA Sinewave Output
- True On-Line — Total Isolation
- Static Bypass Switch Standard

SHUTDOWN SOFTWARE

- Auto Shutdown of Local Area Networks for Unattended Operation
- Compatible with SCO XENIX 2.2.3 and above
- Novell ELS 2.12 and above
Advanced Netware 2.11 & above
SFT Netware 2.11 and above



STANDBY UPS MODELS

Power Output	120 Volt Models	208-240 Volt Models
250 WATT	\$ 379.00	\$ 429.00
300 WATT	\$ 549.00	N/A
500 WATT	\$ 699.00	\$ 799.00
600 WATT	\$ 899.00	\$1049.00
900 WATT	\$1249.00	N/A
1200 WATT	\$1499.00	\$1749.00
1600 WATT	\$1999.00	\$2299.00

TRUE ON-LINE UPS MODELS

Power Output	120 Volt Models	208-240 Volt Models
1000 WATT	\$2249.00	Available
3000 WATT	\$5495.00	Available
5000 WATT	\$8950.00	Available



FOR L.A.N.
NOVELL LABS
TESTED AND
APPROVED
NetWare Compatible

PARA SYSTEMS, INC.

1455 LeMay Drive
Carrollton, TX 75007

Telephone:
(214) 446-7363

1-800-238-7272

FAX: (214) 446-9011

TELEX: 140275 OMEGA

Want to save Time, Money,
& Headaches?



GET SUPERSOFT'S SERVICE DIAGNOSTICS

All the software, alignment diskettes, parallel/serial wrap-around plugs, ROM POSTs and extensive, professional documentation to provide the most comprehensive testing available for IBM PCs, XTs, ATs and *all compatibles* under DOS or Stand Alone. No other diagnostics offers such in-depth testing on as many different types of equipment by isolating problems to the board and chip level.

NEW: SuperSoft's **ROM POST** performs the most advanced **Power-on-Self-Test** available for system boards that are compatible with the IBM ROM BIOS. It works even in circumstances when the Service Diagnostics diskette cannot be loaded.

NEW: 386 diagnostics for hybrids and **PS/2s!**

For over nine years, major manufacturers have been relying on SuperSoft's diagnostics software to help them and their customers repair microcomputers. End users have been relying on SuperSoft's Diagnostics II for the most thorough hardware error isolation available. Now versions of Service Diagnostics are available to save everyone (including every serious repair technician) time, money, and headaches in fixing their computers, even non-IBM equipment.

All CPUs & Numeric Co-processors	All Color Graphics & Monochrome Monitors
System Expansion & Extended Memory	Parallel & Serial Ports
Floppy, Fixed & Non-standard Disk Drives	Mono, CGA, Hercules & EGA
Standard & Non-standard Printers	Adapters
System Board: DMA, Timers, Interrupt,	All Keyboards & the 8042 Controller
Real-time Clock & CMOS config. RAM	

Join the ranks of XEROX, NCR, CDC, SONY, PRIME, ... who have bundled SuperSoft's diagnostics with their microcomputers with no risk because of our 30 day money back guarantee.

Service Diagnostics for PC, PC/XT, and compatibles only	\$169
Alignment Diskette for PC, PC/XT and compatibles (48 tpi drives)	\$ 50
Wrap-around Plug for PC, PC/XT and compatibles (parallel and serial)	\$ 30
Service Diagnostics for AT and compatibles only	\$169
Alignment Diskette for AT and compatibles (96 tpi drives)	\$ 50
Wrap-around Plug for AT (serial)	\$ 15
ROM POST for PC, PC/XT and compatibles only	\$245
ROM POST for AT and compatibles only	\$245
Service Diagnostics: The KIT (includes all of the above—save \$502)	\$495
Service Diagnostics for 386 or V2, V30, or Harris, etc. (please specify)	\$195
Diagnostics II is the solution to the service problems of users of all	
CP/M-80, CP/M-86 and MS-DOS computers	\$125
ROM POST for PS/2 and compatibles only	\$245
Alignment Diskette for PS/2 and compatibles (3.5 inch)	\$ 50

To order, call 800-678-3600 or 408-745-0234
FAX 408-745-0231, or write SuperSoft.

your microcomputer repair solution

SuperSoft

FIRST IN SOFTWARE TECHNOLOGY P.O. Box 611328, San Jose, CA 95161-1328 (408) 745-0234 Telex 270385

SUPERSOFT is a registered trademark of SuperSoft, Inc.; CDC of Control Data Corp.; IBM PC, AT & XT of International Business Machines Corp.; MS-DOS of MicroSoft Corp.; NEC of NEC Information Systems, Inc.; PRIME of PRIME INC.; Sony of Sony Corp.

package, it comes with both textual and mathematical descriptions of the signal-processing algorithms that it uses. AcqKnowledge works with all models of the Macintosh from the 512KE up.

Price: \$495.

Contact: Biopac Systems, 5960 Mandarin Dr., Suite D5, Goleta, CA 93117, (805) 967-6615.

Inquiry 1116.

Interactive Neural Network Simulation

Desire/Neunet is an integrated environment that simulates neural networks. It includes a screen editor, compiler, and debugger and lets you combine up to 16,380 neurons and 16,380 interconnections.

The run-time compiler generates processor-specific 80287 or 80387 machine code for matrix computations and differential equations. You can simulate network paradigms, such as back propagation, counterpropagation, bidirectional associative memories, competitive learning, and adaptive resonance. The program also offers six integration rules and handles multirun experiments, complex frequency-response plots, fast Fourier transforms, and matrices.

Desire/Neunet runs on the IBM AT with 500K bytes of RAM, an 80287 or 80387 math coprocessor, and an EGA or VGA card.

Price: \$695.

Contact: Korn Industrial Consultants, 6801 Opatas St., Tucson, AZ 85715, (602) 298-7054.

Inquiry 1112.

Math and a Whole Lot More

Formula/One, a math program that features presentation graphics, now supports dBASE II, III, and III Plus databases, and Lotus 1-2-3 and Excel spreadsheets. It is also compatible with CGA, EGA, VGA, MCGA, and Hercules graphics cards.

According to Ocean Isle Software, Formula/One 2.0 solves up to 250 simultaneous equations and processes arrays of up to 8000 entries. It fits linear and nonlinear curves to your data and performs advanced multivariable linear-regression analysis for up to 10 independent variables.

You can input your equations with values for all known variables, and the program will solve for all unknown variables no matter where they appear in the equation. It also has 73 built-in functions, including common trigonometry, logarithms, and general math functions, and a set of business math functions.

You can also create an application display in which you can create a fill-in-the-blanks-type screen for an inexperienced user to fill in with any known values. The program will then fill in the rest.

The program also supports a mouse and features pull-down menus.

Formula/One 2.0 runs on the IBM PC, XT, AT, and PS/2s with DOS 2.1 or higher and 385K bytes of RAM. It also supports math coprocessors.

Price: \$295.

Contact: Ocean Isle Software, Ocean Isle Square, Building 3, Ocean Isle Beach, NC 28459, (800) 882-8664.

Inquiry 1113.



HARMONY COMPUTERS

1801 FLATBUSH AVE.. (BET. AVES. J & K) BKLYN. NY 11210
ORDER DEPT. ONLY 800-441-1144 OR 718-692-3232 — INFORMATION 718-692-2828

10th Anniversary Specials

TOSHIBA T-1000 LAPTOP
\$599.00

H.P. LASERJET II
\$1579.00

PANASONIC 1180
\$164.00

IBM PS/2 #30 (286) 20 Meg
\$1749.00

WORD PERFECT 5.0
\$209.00

NEC MULTISYNC 3D
\$599.00

"PRINTER SPECIALS"

Apple Image Writer II 449
Diconix Ink Jet 150 plus 299
Epson LX810 189
Epson FX 850 334

Epson FX 1050 439

Epson LQ 510 329
Epson LQ 850 519
Epson LQ 950 589
Epson LQ 1050 729
Epson LQ2550 929
H.P. Laser Jet 2 1579
H.P. Desk Jet Plus 679
IBM Proprinter 3 459
IBM Proprinter X24E 599
IBM Proprinter 3XL 589
IBM Proprinter XL24E 799

IBM AND COMPATIBLES

IBM PS/2 #30 (286) 512k, 1.44 Meg Dr. 1399
As above w/ IBM 20 Meg 1749
IBM PS/2 Model 50Z (30 Meg) 2249
IBM PS/2 Model 50Z (60 Meg) 2549
512K Upgrade for IBM PS/2 249
IBM PS/2 #55 SX 30 Meg. (386) 2799
IBM PS/2 #55 SX 60 Meg. (386) 3099
IBM P/S 2 Mono Monitor (8503) 199
IBM P/S 2 Color (8512) Monitor 449
IBM P/S 2 Color (8513) Monitor 518



TURBO 386 (20 MHZ) 1.2 Drive 1 Meg
Serial Parallel 1849

TURBO AT 286 12 MHZ, 1.2 Meg Drive
Serial Parallel, 512K w/Monitor 849

EVEREX XT 12 MHZ w/ Monitor 549

HARD DRIVES

Seagate 20 Meg. w/controller 249
Seagate 20 Meg. 229
Seagate 30 Meg. w/controller 274
Seagate 30 Meg. 254
Seagate 40 Meg. #251 329
Seagate 40 Meg. #251-1 349
Seagate 80 Meg. #4096 579



Western Digital XT Controller (20, 40, 80 Meg.) 79
Western Digital (AT) Controller 149
Miniscribe 20 Meg. Hard Card 299
Miniscribe 30 Meg. Hard Card 319
Mountain 30 Meg. Hardcard 309
Tandon 20 Meg. Hard Card 279
Seagate 20 Meg. External (for Macintosh) 479
Seagate 20 Meg 3 1/2 inch #125N SCSI Adapter 299
Seagate 20 Meg 3 1/2 inch #125 259
Seagate 30 Meg 3 1/2 inch #138N SCSI Adapter 339
Seagate 30 Meg 3 1/2 inch #138MFM 399
Seagate 50 Meg 3 1/2 inch #157NS SCSI Adapter 369
Seagate 50 Meg 3 1/2 inch #157 349
Seagate 80 Meg 3 1/2 inch #269N SCSI Adapter 519
Hosi Adapter for IBM PS/2 49

PC BOARDS, DRIVES, MEMORY CHIPS

IBM Original 5 1/4 Disk Dr (360K) 89
Toahiba 5 1/4 Disk Dr (360 K) 89
Toshiba 3 1/2 Disk Dr (720 K) 89
Toshiba 3 1/2 Disk Dr (1.44 Meg) 109
Toshiba 1.2 Meg Disk Dr 99
PS/2 5 1/4 360K External Drive 249
AST Six Pack Plus 64K 129
Quadram Multifunction 384K 179

AST Rampage Plus (286) 512K 379

Intel above board 286 plus w/512K 379
Intel above board 286 Plus I/O Parallel/Serial 429
Intel above PS/2 (50,60) 289
AST Rampage PS/2 (60,60) 399
64K DRAM chips Call
256K DRAM chips Call
256K Simm Module and Sipp Module Call
One Meg. DRAM chips Call
One Meg. Simm Module and Sipp Module Call

INTEL MATH COPROCESSORS

Intel 8087-3 (PC, PC XT up to 6 MHZ) 89
Intel 8087-2 (PC, PC XT up to 8 MHZ) 119
Intel 8087-1 (PC, PC XT 10 MHZ and faster) 159
Intel 80287-3 (PC, AT up to 8 MHZ) 129
Intel 80287-8 (PC, AT up to 10MHZ) 189
Intel 80287-10 (10 MHZ and faster) 224
Intel 80387-16 (PCAT up to 16 MHZ) 339
Intel 80387-20 (PC AT up to 20 MHZ) 379
Intel 80387-25 (PC AT 25 MHZ and faster) 479
Intel 80387 SX (All 80387 SX Computers) 299
Intel 80C287 274

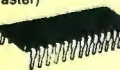

NEC P2200XE 329

NEC P5200 489
NEC P5300 669
Okidata 172 199
Okidata 182 Turbo 224
Okidata 183 (Wide Carriage) 249
Okidata 320 329
Okidata 321 469
Okidata 390 469
Okidata 391 639
Okidata 393 999
Panasonic 1180 159
Panasonic 1191 209

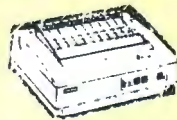

Panasonic 1124 299

Panasonic 1592 369
Panasonic 1595 409
Panasonic 1524 489
Panasonic 3131 299

VIDEO CARDS

Hercules Monographic Plus w/Ramfort 154

Hercules VGA Card 179

Genoa Super Hi Res Plus 169
Genoa 5400 VGA w/512K 299
Video 7 VGA 229
Video 7 VGA Fastwrite 256K 279
Video 7 VGA Fastwrite 512K 349
Video 7 VGA VRAM 399
Orchard Pro Designer (VGA) 256K 249
Orchard Pro Designer (VGA) Plus 512K 319
ATI VGA Wonder 512K 289

ATI VGA Wonder 256K 219

ATI VGA Wonder 256K w/Mouse 249
ATI VGA Wonder 512K w/Mouse 319
Paradise Auto Switch (480) 159
Paradise VGA Plus 219
Paradise VGA Plus (16 Bit) 239
Paradise VGA Professional 512K 319
Everex Auto Sync (480) Deluxe 149
Everex EVGA 219
Everex Viewpoint VGA 256K 249
Everex Viewpoint VGA 512K 319
Harmony VGA (800 x 600) 149

MONITORS

Amdek 410A 149
Amdek 732 (VGA) 399
Princeton Max 15 249
Princeton Ultra Sync (12 inch) 479
Princeton Ultra Sync (14 inch) 499
Princeton Ultra 16 849
NEC Multisync G.S. (Paperwhite) 229
Packard Bell (Paperwhite) VGA 149



NEC Multisync 2A (VGA) 489

NEC Multisync 3D 599
NEC Multisync Plus 879
Sony 1304 Multiscan (1024x768) 649
Sony 1320 VGA 489

Seiko #1430 (Res. 1024 x 768) 499

Zenith 1480 Flat Screen (640X480) 579
Mitsubishi Diamondscan #1381A 479
Golostar Supercan 448
Packard Bell (EGA) #1439 349
Packard Bell TTL Amber 12 Inch #1272A 89
Packard Bell TTL Amber 14 Inch #1472A 129
Packard Bell (RGB) #1452 249
Magnavox (RGB, Composite) 8CM515 269
Magnavox VGA 349

MODEMS

Hayes 1200 Personal 129
Hayes 2400 Personal 159
Hayes 1200 269
Hayes 1200B w/Smartcom 2 269
Hayes 2400 409
Hayes 2400B w/Smartcom 2 409
Hayes Smartcom II Software 89
Everex Internal 1200B 79
Everex 2400 Plus Internal 149
Everex 2400 E Plus External 189



Everex Macintosh 2400 External 229
Packard Bell 1200 External 89
Prometheus 2400 External 179
Prometheus 2400 Internal 139
Prometheus 2400 Plus Internal 199
Megahertz Laptop Modem 1200 Internal 159
Megahertz Laptop Modem 2400 Internal 199
Cardinal 2400 Internal w/Software 119
Cardinal 2400 External 139

Star XR-1000 329
Star XR-1500 429

Star NX 1000R (color) 209

Star NX-2400 284
Star NX 1000 159
Star NX15 299
Toshiba 301 (24 Pin Portable Printer) 299
Toshiba Expresswriter 311 379
Toshiba 321 SL 399
Toshiba 341 SL 589
Toshiba 351 SX 949

LAPTOPS

NEC Ultralite One Meg. 1989
NEC Ultralite 2 Meg. 2349

NEC Prospeed 286 20 Meg. 3199

NEC Prospeed 286 40 Meg. 3599
Toshiba T 1000 599
Toshiba 1200 2 Drive (Backlit) 1399
Toshiba 1200 20 Meg. (Backlit) 1899
Mitsubishi 286L (20 Meg.) 2249
Mitsubishi 288L (40 Meg.) 2899
Dataview Spark EL (20 Meg) 1769
Dataview Spark EL (2 Drives) 1069
Bondwell 286 20 Meg. (w/Case and Modem) 2149
Zenith 184-1 Supersport (2 Drive) 1349
Zenith 184-2 Supersport 20 Meg 2049
Zenith Supersport 286 (20 Meg.) 3099
Zenith Supersport 286 (40 Meg.) 3399
Toshiba 301 (24 Pin Portable Printer) 299
Diconix 150 Plus Portable Ink Jet Printer 299
Fastwire II (Data Transfer Software 3 1/2 to 5 1/4) 49



Megahertz Laptop Modem 1200 Baud 159
Megahertz Laptop Modem 2400 Baud 199

IBM SOFTWARE

Aldus Pagemaker 3.0 449
Lotus 123 Release 3 329
Funk Always (For Lotus 1-2-3 Ver. 2.0) 49
Lotus Symphony 2.0 429
Lotus 123 Version 2.2 329
D Base 4 429
Multimate Advantage II 289
Microsoft Excel 269
Microsoft Word 5.0 209

Microsoft Windows 286 44

Microsoft Windows 386 209

Word Perfect 5.0 214

Word Perfect Library 2.0 69
Q & A 3.0 199
PFS Professional Write (2.1) 129
PC Tools Deluxe 5.5 79
Norton Utilities 4.5 54
Fastback Plus 99
Norton Utilities Advanced 4.5 84
Copy 2 PC Deluxe Board 2149
Microsoft Mouse 99
Microsoft Mouse w/easy Card 119
Microsoft Mouse with Windows 139
Logitech Scanman 18
Logitech New Hi Res mouse (320 DPI) 89
Logitech with Publisher 129
Logitech with Cad 139
Wordstar Professional Rel. 5.5 (After \$55 Rebate) 149
Ventura Desk Top Publishing ver 2.0 489
Managing Your Money - Release 5 119
Fast Wire II (Data Transfer Software and cables) 49
MS DOS 3.3 w/Basic 79
MS DOS 4.01 w/Basic 79



FAX MACHINES

Ricoh RF-850 699
Ricoh RF-900 829
Sharp UX-180 649
Sharp FO 220 649
Sharp FO 330 849
Sharp UX 350 1079
Sharp FO 420 1079
Sharp FX 550 1449
Panafax #120 w/Answering Machine 889
Panafax #140 799
Panafax #250 1269
Panafax #280 1449
Cannon Fax #15 649
Cannon Fax #20 899
Toshiba #3300 799
Toshiba #3600 999



Epson Priority Fax #1000 799

Epson Priority Fax #2000 899
We Carry A Full Line of Fax Paper

Master Card and Visa welcome at no additional charge. For your protection we check for stolen credit cards. Shipping & handling extra. Defective merchandise will be replaced or repaired at our discretion within the terms of our warranty. Price and availability subject to change without notice. We do not allow non-defective returns.

WHAT'S NEW

METRO NEW YORK • NEW ENGLAND

Optical Storage Field Study on the Eastern Seaboard

Rothchild Consultants is sponsoring a study mission that will give participants an opportunity to visit organizations that use optical disk systems and applications. The tour, which will include demonstrations and interactive discussions, begins in New York on October 20 and ends in Washington, D.C., on October 27.

The field study will follow a tutorial workshop and conference on optical storage for large systems, which is being held in New York City's Grand Hyatt Hotel on October 17-19.

Price: Study mission only,

\$5495; conference only, \$995; conference, tutorial, and mission, \$6125.

Contact: Rothchild Consultants, 256 Laguna Honda Blvd., San Francisco, CA 94116, (415) 681-3700.

Technology Conference and Seminar Nanobytes

The Baltimore Computer Conference and Exposition, organized by the Maryland Association of Certified Public Accountants and National Trade Productions, is expected to become an annual event. It will be held at the Baltimore Convention Center on December 13-14. One of the five session tracks will focus on digital image/optical

disk technologies and applications.

Price: Conference: one day, \$35; both days, \$50; exposition is free.

Contact: National Trade Productions, Inc., 313 South Patrick St., Alexandria, VA 22314, (800) 638-8510 or (703) 683-8500; Maryland Association of CPAs, 1300 York Rd., Suite 10, P.O. Box 484, Lutherville, MD 21093, (301) 296-6250.

The Northeast Computer Conference and Expo, formerly the Northeast Computer Faire, will take place at the Bayside Exposition Center in Boston on October 12-14.

Price: Three days, \$15; one day, \$9.

Contact: The Interface Group, Inc., 300 First Ave.,

Needham, MA 02194, (617) 449-6600.

Clearpoint Research will hold a two-day symposium called Policy and Parity: U.S.-Japan High Technology Trade Policy. The symposium will take place on October 12-14 at the World Trade Center in Boston. Clearpoint says the symposium will be an open forum for both countries to discuss trade policy issues.

Price: \$400; students, \$150.

Contact: Clearpoint Research Corp., 99 South St., Hopkinton, MA 01748, (508) 435-2000.

Messaging '89, the conference for integrated messaging applications, systems, and services, will be

continued

Exclusive Software

High Quality Software! Great Prices!
Zephyr Originals, NOT Public Domain
Pick the Ones You Want:

Financer Plus~ 16 most needed financial calculations. Menu selectable for: amortization schedule, present values, future values, simple & compound interest, installment loan, & much more. Output to screen or printer. "FINANCER is best!" G.W. Montana IBM & compat. \$24.95

AstroInfo~ High accuracy data for the Sun, Moon and all planets. Most results accurate to seconds of arc. Select any date from 999BC to 4000AD and any latitude and longitude. Provides position in sky, brightness, rise/set times, & much more. Do searches for conjunctions of objects, distances, and locations in the sky. Generates location tables to screen, printer or ASCII files on disk for later use. IBM & compat. \$49.95

Form Machine~ Easily create, print and save forms for later use. Ideal for message forms, expense reports, invoices, personal data records, etc. Just design what you need on screen and then you are ready to print and use. Include text with regular or condensed print, add boxes, lines, drawings. Create the forms you need as you want them! IBM & compat. \$29.95

MortgageMaster~ Analyze mortgage terms for a variety of situations. Specify and printout mortgage tables. Use irregular payments or additional payments. Make yearly, monthly, quarterly, weekly, biweekly, etc. payments. Generate tables of rate or term variations. Do 4 factor analysis of interest, length, amount and rate for missing value. IBM & Compat. \$39.95

Spanish Helper~ Learn the Spanish language with your computer. Developed by language experts to contain the 2000 most essential words and phrases to know basic Spanish. Includes introduction to grammar and syntax. With graphics you get to play a game as reward for your progress (graphics not required to run program). FrenchHelper also available. Each \$29.95

AlgeTutor~ Teaches you algebra and how to apply it. Starts from the easiest level to more advanced topics. Includes example problems with solutions. Learn as you review concepts and then apply them. Ideal for student or as refresher course. Use at your own pace to master this valuable part of math. IBM \$29.95

TimeChecker~ Now you can always have high accuracy time on your PC or for other needs. TimeChecker automatically calls, logs on and sets your PC system time using the US government standard time service. Also displays correct time and date for all 25 world time zones. You can also access other data related to time and astronomy. IBM, 1200b modem \$39.95

TideMaster~ Calculates and prints tide tables and graphs for any U.S. coastal state for any day in 1989 or 1990. Includes all US government tide locations. "If you sail, fish, go to beach, TideMaster is a must! Excellent." PC Magazine. Specify for which state. IBM & compat. \$39.95 per US state

ArtPack~ Generate 10 types of computer art to provide hours of entertainment for you or your kids. Supports CGA, EGA or VGA color monitors for complex & brightly colored creations. Fractals, Moire patterns, Roses from polar equations, Serendipitous circles, Spirographs, 1 and 2 dimensional "life" patterns, Wallpaper art, Sierpinski curves. Picture generation from names or text. Give your computer a real graphics workout! IBM. \$29.95

StatCalc~ Key statistical functions for student or experienced user. Includes Correlation & Regression, Normal, T, Poisson, Binomial, Chi-square, distributions, data handling for sorts, mean, standard deviation, range, median. Save data to disk. Manual on statistics and program use with examples. IBM, Apple II \$39.95

SuperCat~ Professional level cataloging for up to 5,000 books per directory with hard disk or 1000 per floppy (300 for Apple). Multiple subjects & authors, call #, title, publisher, etc. for 13 held titles. Print 3x5 index cards & reports in various formats. Sort & retrieve data by any field. Fast and easy to use. IBM & Compat., Apple II \$49.95

HoroScopics II~ For your birthdate, time & location sky conditions calculated. Get Natal horoscope chart printed or on screen, with zodiac, sun, moon & all planets. Gives astrological reading, sun & moon sign, ascendant, conjunctions & oppositions, other aspects, table of houses & planets (Placidus & Equal house). "Accurate, a software bargain!" PC Mag. IBM \$29.95

MyDraftsman~ Create detailed drawings on screen and print in variable scale on dot-matrix or laser printers. Use circles, lines, boxes, arcs in a variety of widths and styles. Add text in different fonts and sizes. Use multiple layers for complex drawings. Create objects to save/use later. Works with or without a mouse. Ideal for design work, illustrations, architecture or creative fun! Supports printers and plotters. IBM CGA/EGA \$39.95

GraphMaster~ Create bar, line, pie, scatter and text charts or graphs, box, circle & line drawing; correlation & regression analysis & curve fitting; scatter plots. Translate data into meaningful graphic pictures, on screen or printed out, in minutes. Use at pixel level and produce drawings and illustrations or just enter a set of data and have GraphMaster create the chart you need. Plot any math function. Save graphs & revise later. IBM \$39.95

LabelWorks~ Create and maintain mailing lists. Print labels 1, 2, 3, or 4 across. Get reference listings printed in 9 different formats. Easy to use fill-in form on screen to add, revise, or delete names. Also print general labels as tags, labels, etc. IBM & Compat., Apple II \$29.95

SunTimes~ Generates monthly or yearly sunrise and sunset tables for any year and for any location on Earth. Get output to screen or printer. Also calculates the times of twilight (civil, nautical and astronomical) the maximum altitude of the sun and the hours of sunshine for each day. Accurate, easy to use. IBM. \$29.95

Do you have a professional quality original program? We may want to publish it. Write for our programmer's guidelines. Please do NOT send any software.

Write n' Tell~ Analyzes handwriting to reveal personality traits. For business testing or fun with family, friends. Developed by certified graphologists. Easy to answer questions yield multi-page report on personality, drives, intellect, emotions. Analyze signatures or text. Detailed manual & handwriting samples provide guidance for accurate use. IBM/Apple II \$49.95

DietHelper~ Great for weight control, menu planning, special diets, recipe analysis. Tracks intake of calories, sodium, cholesterol fiber & 20 others for over 1000 foods, & calories for 100 exercises. Add your own foods or recipes. Tutorial disk included teaches you the program. "Extremely easy to use. Highly recommended." Creative Computing. IBM \$39.95

LodeStar~ The Ultimate Sky Machine! Get an accurate, variable size view of the sky for any date (9999BC to 9999AD) & location on Earth. Investigate the past, present and future with LodeStar! Includes over 9,000 stars, Messier objects & the Sun, Moon & all planets. Any size view from 180 deg. to 0.18 deg. See solar eclipses, planetary conjunctions, occultations, transits, etc. Zoom in or out. Get printouts for field or desk. IBM or compat., 384K, CGA/EGA/VGA. Works with/without co-processor. \$89.95

LifeLines~ Input the facts on your ancestors, near and far, from distant generations to the present, then generate various reports and listings to make clear your family heritage. Pedigree charts, descendants charts, marriage lists, family groups, alphabetical listings & more. You needn't be a genealogical expert, just select from menus for reports. IBM \$39.95

PhysiCalc~ Introduction to Physics for high school/college level. Includes mechanics, gravity, electricity, light, quantum mechanics & relativity. 30 key equations explained with easy on screen calculations. Example problems and answers, physics terms and history. IBM or Apple II \$29.95

DiskAtlas-USA~ Over 29,000 US cities. Plots cities on state or US maps. Zoom in or out to scale needed. Locates all cities a given distance from another city or along a line specified by user. Includes national parks, monuments, etc. Calculates distances between 2 cities. Practical, educational, fun! IBM CGA/EGA \$39.95

Plus 55 More Excellent Programs!



Order Today!



1-800-533-6666

9-9 MON - SAT Orders Only

For Info or in PA Call 412-422-6600

By phone or mail. Check, M.O., credit card (#& expir.). Add \$3 shipping (\$5 overseas). PA add 6%. Give computer type. Add \$1/prog. for 3.5" IBM. Join tens of thousands of satisfied customers in 50 states & 86 countries. Fast shipment!

ZEPHYR SERVICES

1900 Murray Ave. Dept. E Our
Pittsburgh, PA 15217 8th
FREE Catalog-Call or Write Year



There are two ways to build PCs

Theirs OR Ours

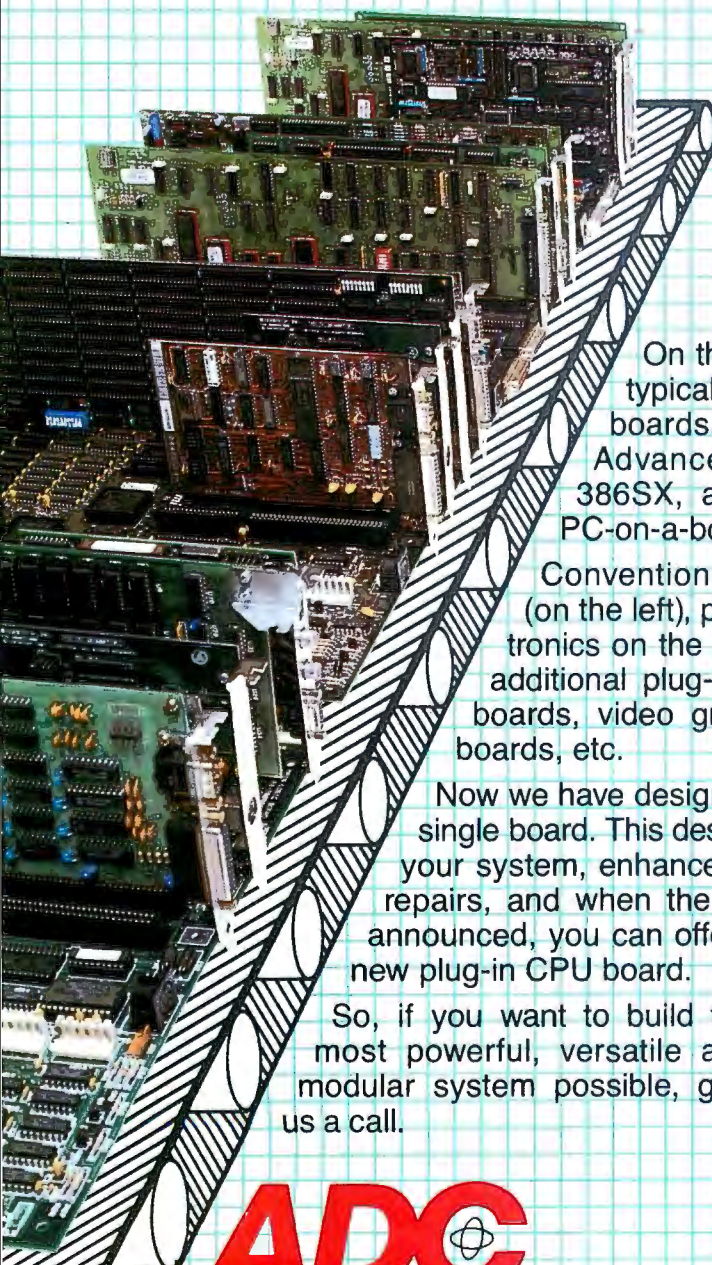

On the left are your typical PC/AT motherboards. On the right is Advanced Digital's SBC-386SX, a versatile, modular PC-on-a-board.

Conventional computer systems, (on the left), placed some of their electronics on the motherboard and required additional plug-in cards such as; memory boards, video graphic boards, serial/parallel boards, etc.

Now we have designed all of those functions onto a single board. This design provides the ability to upgrade your system, enhances serviceability by reducing costly repairs, and when the next generation of CPU chips are announced, you can offer your customers an upgrade with a new plug-in CPU board.

So, if you want to build the most powerful, versatile and modular system possible, give us a call.

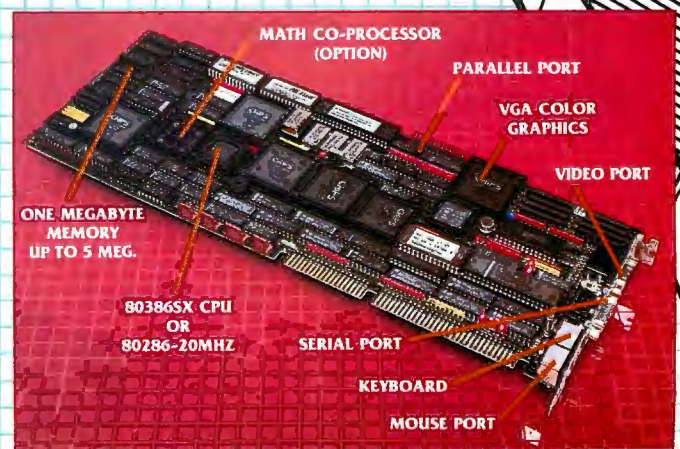
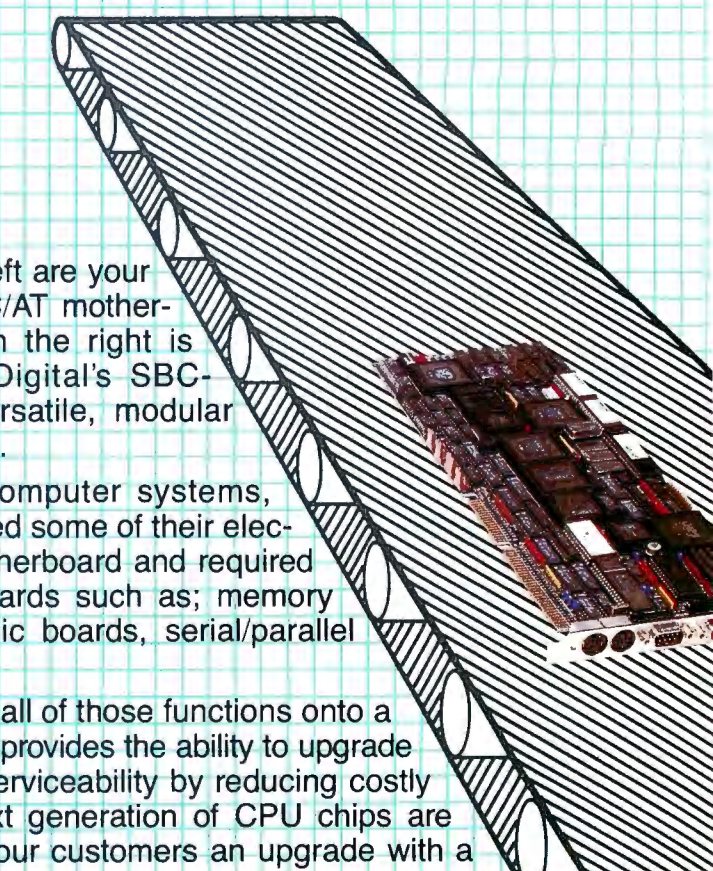

ADC

ADVANCED DIGITAL CORPORATION

In the U.S.: Advanced Digital Corporation
5432 Production Drive, Huntington Beach, CA 92649
(714) 891-4004

In Europe: Advanced Digital (U.K.) Ltd.
21 Newman Street
London W1P3HB United Kingdom • (01) 323-1120

IBM and PC/AT are registered trademarks of International Business Machines.

The Choice is Yours.

Circle 521 on Reader Service Card (DEALERS: 522)

held on November 6-8 at the New York Hilton and Towers in New York City.

Price: Full conference, \$795; exhibits only, no charge.
Contact: Messaging '89, Information Publishing Corp., P.O. Box 42375, Houston, TX 77242, (800) 777-4442 or (713) 974-6637.

Info '89, the conference for MIS and DP professionals, will be held at the Jacob K. Javits Convention Center in New York City on October 10-13.

Price: \$20.

Contact: Cahners Exposition Group, 999 Summer St., Stamford, CT 06902, (203) 964-0000.

Binghamton, New York, will be the site of the 1989 IEEE Frontiers in Edu-

cation conference, to be held on October 14-17. This year's theme is "New Directions in Engineering Education."

Price: \$140.

Contact: Dr. Richard S. Culver, General Chairman, Watson School, State University of New York, Binghamton, NY 13901, (607) 777-2872.

The 1989 Workshop on Applications of Signal Processing to Audio and Acoustics will be held in New Paltz, New York. According to its organizers, topics will include signal processing relating to music, VLSI, wide-band audio, and speech signal processing. The conference, which will be held on October 15-18, was timed to coincide with the fall foliage.
Price: \$75.

Contact: Stephen G. Raymond, Bell Northern Research, Box 3511, Station C, Ottawa, Ontario, Canada K1Y 4H7, (613) 763-4537.

The magazine that covers the Tandy Color Computer, *Rainbow*, is sponsoring Rainbowfest at the Hilton in Somerset, New Jersey, on October 20-22. Tutorials and exhibitions are for the Color Computer only.

Price: Three days, \$9; one day, \$7.

Contact: *Rainbow*, The Falsoft Building, 9509 U.S. Hwy. 42, P.O. Box 385, Prospect, KY 40059, (502) 228-4492.

The Philadelphia Civic Center will be the site for the fifth annual Scientific Computing and Automation Conference and Exposition

on October 11-13. The show is dedicated to computing and automated technology.

Price: Three days, \$95.

Contact: SCACE '89, Don Weise, 301 Gibraltar Dr., P.O. Box 650, Morris Plains, NJ 07950, (201) 292-5100.

A conference on computer security for the government and the private sector will be held at the Baltimore Convention Center on October 10-13. The Twelfth Computer Security Conference will focus on systems application guidance, security education and training, and more.

Price: \$175.

Contact: Irene Gilbert, A254 Technology Building, National Institute of Standards and Technology, Gaithersburg, MD 20899, (301) 975-3360.

DON'T BYTE AT THE WRONG PRICE

If you're in the market for a solution, give us a call today and we'll show you why, byte for byte, our prices can't be beat.



286-16

- Full AT case
- 2 MB (exp. to 16 MB)

\$1899.95



386-25

- 64 KB cache on board
- 2 MB (exp. to 16 MB)
- VGA
- VGA card
- Std bus mouse
- Ideal for CAD/CAM

\$4699.95



386-20

- "LAN Server"
- 4 MB (exp. to 16 MB)

\$2799.95

Above systems include: 2S/1P, 1.2 MB floppy disk drive, 40 MB/28 MS HDD, W D 1006 combined controller, 14" mono, mono card, DOS 3.3

- Quick Delivery
- Quality Products
- Service and Support
- On-site Service Available
- 30-Day Satisfaction Guarantee

AUTURA
SYSTEMS

3 Dundee Park, Andover, MA 01810

Order line: 800-448-1461
In Mass.: 508-470-0086

CompFax Puts Efficiency at Your Fingertips

A

re you planning to add a FAX machine to your office?

Then you already know the advantages... increased efficiency, better productivity, lightning-fast communications with cross-town or cross-country customers and suppliers.

Now, consider the benefits of buying your unit from CompFax:

- the most competitive prices
- a full line of FAX machines to fit individual needs
- expert technical service and support
- fast delivery
- flexible credit terms
- service contracts
- price protection warranty

CompFax puts it all at your fingertips!

Sharp FO-220

Incorporates many networking features of higher-priced models, such as confidential transmission and relay broadcast request.

\$799.99/List: \$1595.00
Blow out price!

Sharp FO-300

Incorporates high end features like rapid transmission, confidential reception. Increased half-tone transmission abilities.

\$1049.00/
List \$1995.00

Sharp FO-330

Features an automatic cutter, 10-page automatic feeder, timer transmission and polling, halftone and auto-contrast controls.

\$1149.00/
List \$1795.00



CompFax

Customer Support Line and Orders
Dealer inquiries welcome

1-800-243-7775

Call Today!

Illinois

312-394-3334 FAX 312-394-5235

Circle 528 on Reader Service Card (DEALERS: 529)

KX-P4450 LASER PRINTER



Faster output,
11 pages per minute,
large choice of fonts, two paper
cassettes, five printer emulations,
up front controls, parallel &
serial, collated copies.

\$1495

OPTIONAL:
Delivery & set up, maintenance
contract, site service agreement,
loaner program.

**DESKTOP PUBLISHING
SOFTWARE BY PAGEMAKER**

**NOVELL NETWORK SYSTEMS
AUTHORIZED INSTALLS
AND SUPPORT**

Other models available at comparable prices.

Panasonic
Office Automation **OA**

**Back to
school special
Complete
system**



FX-1650

- Includes 8086-2 cpu
- Enhanced keyboard
- Built-in 3 1/2" 720K floppy
- 5 expansion slots
- PC XT compatability
- 640K on board
- Serial/parallel port
- Monitor/tilt & swivel

Complete Package **\$649**

NEW

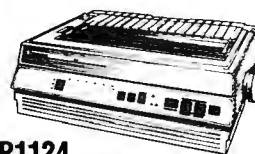

KX-P1124
24 Pin Dot Matrix Printer

24 pin push/pull swivel mount tractor
with rear, bottom or front feed paper
paths for versatile forms handling.

KX-P1180 \$179
KX-P1191 \$249 **\$339**

LITTLE BIG FAX UF 250

Auto dialer (100) stations,
CCITT G3, 2, delayed & multi
station transmission, transmits
page in 15 seconds, relay
transmission request, confirmation
transmission & polling, error correction mode,
white line skip, 6 gray scale, local copy.

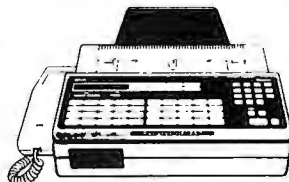

\$1495

CALL FOR A DEMONSTRATION

In Stock: Ribbons, Toner, Drums, Developer, Fax paper, etc.

HARVARD INFO SYSTEMS
200 NEWTON ST.
WALTHAM, MA 02154

**CALL FOR
LOW PRICE**

**SALES SERVICE SUPPORT
AUTHORIZED**
1-800-346-5324
617-899-7155

SUPER VGA, NO COMPROMISE ... ALL GUTS!

Supercharged 16 bit speed, uncompromised compatibility and performance!

This is the Super VGA card you've been hearing about. Fully compatible with all VGA, MCGA, EGA, CGA and MDA modes at the register level! Turbo 16 bit design means you can write to the screen up to 500% faster. Super sharp 16 x 16 SUPERFONT. Supports 132 columns with up to 60 lines! Up to 256 colors from a palette of 256,000! 256k of RAM (512k opt.). Supports 800 x 600 with 16 colors, and 1024 x 768. Works on 8 or 16 bit bus. Both analog and digital output. Novell, Unix, OS/2, protected mode, 8088 through 80386.

More colors, feature, resolutions and speed than any other card in its price class or YOUR MONEY BACK! It's as simple as that. Our special introductory price includes OVERNIGHT delivery anywhere in the 48 contiguous States at NO EXTRA CHARGE! Order by 6 p.m. EASTERN time and you'll have your new card TOMORROW!

- VGA, MCGA, EGA, CGA and MDA compatible at the register level!
- All 17 standard VGA Modes and 17 extended VGA modes!
- Super VGA resolution up to 1024 x 768!
- Up to 5 times faster than Paradise!
- Drivers for Autocad, Windows, Wordperfect, Gem, Ventura, Autocad, 1-2-3, etc.
- Trident Graphics chip!

Nationwide Toll Free Order Line:
800-747-9069

Info: 612-823-4111
Toll Free 24 hr. Order Fax
800-728-8412
Fax: 612-823-7057

Now that you've chosen the right card, choose the right monitor: the 3 Lynx Intellisync 14" monitor. Brilliant colors and crisp clarity, it handles SUPER VGA resolutions with ease. Enjoy true, lush colors for only \$479.00 plus shipping! Call us!



\$269
Includes overnight delivery!

Blue Circle Group, Inc.
5253 Chicago Ave. S.
Minneapolis, MN 55417

Terms: Mastercard, Visa, COD. 15 day moneyback guarantee. 1 Year Warranty. 512k upgrade: add \$99. Trademarks appearing in this ad are trademarks of their respective companies.

HERTZ
Computer Corporation

PC
MAGAZINE

September 13, 1988
"Ahead of the Pack: The Hottest 386s"

"Built solidly, performs well... don't pass it over when you shop for your next power PC..."

May 30, 1989
"PC Labs tested 104 computers from 58 companies"

"Hertz Computer... reliability and quality are its sales tools... the machines exemplify the company's commitment to engineering dependable systems... they are the ones to look at if your priorities are dependability and reliability..."

INFO
WORLD MAGAZINE
November 14, 1988
"InfoWorld looks at the eight fastest 386 machines"

"The Hertz 386/25 is a rugged desktop computer... extra thought went into the design... it passed our software and hardware test suites with flying colors... good value... excellent performance... well-trained support staff."

May 1, 1989
"The InfoWorld test center benchmarks 18 of the fastest DOS systems in the market."
"One of the best overall values."

Go Ahead, Compare!

Word for word, number for number, feature for feature... and you'll find out that a HERTZ 386/25 computer is the best buy. If you are not convinced yet, read what others say about us and notice who certifies our performance and compatibility.

You will find NO MATCH!

Hertz Computer has been consistently delivering the best overall values in Micro-Computers for the past eight years!

Build a foundation for your company's future with a Hertz Computer.

It's a proven investment!

- THE HERTZ 386/25 SYSTEM:
STANDARD FEATURES:**
- Intel 80386-25 C.P.U.
 - Intel 80386 8 Layer System Board
 - Intel Fast 64 KB Cache Memory
 - 1 MB of 32-bit RAM
Upgradable to 24 MB
 - Page Mode Interleaved Memory
 - 8 Industry Standard Expansion Slots
 - Intel 80387 & WEITEK 3167 Sockets
 - 1 Floppy Drive - User choice
 - 2 Serial and 1 Parallel Port
 - 220 - watt Power Supply 110/220 V.
 - 2 Cooling Fans
 - 101 or 84-key Keyboard

HERTZ 386/25 HARD DISK	MONOGRAPHIC BOARD & MONO MONITOR			VGA 16-bit BOARD & 14" VGA MONITOR		
	1MB RAM	2MB RAM	4MB RAM	1MB RAM	2MB RAM	4MB RAM
40MB MFM 28ms	\$ 4699	\$ 4969	\$ 5399	\$ 5299	\$ 5569	\$ 5999
72MB MFM 28ms	\$ 4879	\$ 5149	\$ 5579	\$ 5479	\$ 5749	\$ 6179
160MB ESDI 16ms	\$ 5599	\$ 5869	\$ 6299	\$ 6199	\$ 6469	\$ 6899
330MB ESDI 17ms	\$ 6169	\$ 6439	\$ 6869	\$ 6769	\$ 7039	\$ 7469
660MB ESDI 16ms	\$ 7399	\$ 7669	\$ 8099	\$ 7999	\$ 8269	\$ 8699

In NY, NJ & CT Call: **212-684-4141**

Other areas Call: **1-800-BE-A-USER**

Certified
File Server

NOVELL

Certified
Multiuser Unix Server

SCO

Serviceable Worldwide

By
intel

HERTZ
Computer Corporation

THE SOLUTION TO YOUR BUSINESS!

Halskar Offers High Performance Personal Computers and Industrial Control Systems

386 COMPUTERS

80386/386SX/286/88 Desk-Top Systems

High-performance 0-wait system board;
Floppy disk drive & hard disk drive;
Dual FDD/dual HDD controller card;
101-key Keyboard, 200W power supply;
Serial, Parallel & Game ports;
Monitor & controller card are optional.
Cache memory size = 64K [386 cache system only.]



CONFIGURATION	16MHz	20MHz	25MHz	33MHz
80386 Cache System (M:1MB, F:1.2M, H:40M)	N/A	\$2645	\$3145	\$3490
80386 Basic System (M:1MB, F:1.2M, H:40M)	\$2095	\$2295	\$2670	\$2950
80386SX Basic System (M:1MB, F:1.2M, H:20M)	\$1565	N/A	N/A	N/A

CONFIGURATION	8MHz	10MHz	12MHz	16MHz	20MHz
80286 NEAT System (M:1MB, F:1.2M, H:20M)	N/A	N/A	\$1345	\$1545	\$1695
80286 Basic System (M:1MB, F:1.2M, H:20M)	\$945	\$1095	\$1195	\$1395	N/A
80286 Basic System (M:640KB, F:1.2M, H:20M)	\$895	\$1045	\$1145	N/A	N/A

CONFIGURATION	4.77MHz	8MHz	10MHz
8088 Basic System (M:640KB, F:360K, H:20M)	\$695	\$725	\$765
8088 Starter System (M:256KB, F:360K, H:None)	\$345	\$365	\$385

Monitor Options

CONFIGURATION	12" Monitor	14" + Monitor
Mono Monitor w/MGP Card (Amber/White/Green)	\$129	\$150
Color Monitor w/CGP Card (RGB,640x240)	N/A	\$275
EGA Color Monitor (640x350) w/EGA Card	N/A	\$450
Multisync EGA Monitor (640x480/800x600) w/EGA Card	N/A	\$635
VGA Monitor (640x800/800x600) w/VGA Card	N/A	\$615

8088 Based Multi-User Terminal (with Mono Monitor, 84 Kybrd & Srl/Prl ports)

CONFIGURATION	4.77MHz	8MHz	10MHz
8088 Basic Terminal (M:256KB, F:360K, H:None)	\$399	\$429	\$459
8088 Minimum Terminal (M:64KB, F:None, H:None)	\$249	\$269	\$289

We Supply a Complete Line of Components and Accessories for Personal Computers and Industrial Control Systems. We also Design, Repair & Service Personal Computers & Related Products.

Plasma And LCD Laptop Computers with FREE Modem

High-performance 0-wait system board;
3.5" floppy disk drive;
Hard disk drive (28ms);
Built-in keyboard & Numeric keypad;
110/220VAC power supply;
Serial, Parallel, monitor & FDD ports;
External or Internal Modem module;
Expansion slots;

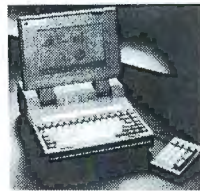

CONFIGURATION	MEM	MM SPC	FDD	HDD	BATTRY	DSP Cmpl	PRICE
80286 12MHz VGA Plasma Laptop	1M	5M	1.44M	40M	None	MG/CG/VG	\$3795
80286 12MHz CCFT EGA LCD Laptop	1M	4M	1.44M	40M	1.5 hr	MG/CG/EG	\$3195
80286 12MHz Plasma Laptop	640K	4.6M	1.44M	20M	None	MG/CG	\$2495
8088 10MHz LCD Laptop	1M	1M	2x720K	None	8 hr	MG/CG	\$1045

HK-4080/5080 Portable Computer

High-performance 0-wait system board;
Floppy disk drive & 20MB hard disk drive;
Built-in display and keyboard;
110/220VAC power supply;
Serial and parallel ports;
Expansion slots;



CONFIGURATION	9" EGA	9" AMBR	PLASMA	HR-LCD	EG-LCD	VG-PLSM
80386 16MHz Prtbl (F:1.2M, M:1MB)	\$3275	\$2350	\$3125	\$2685	\$3025	\$3785
386SX 16MHz Prtbl (F:1.2M, M:1MB)	\$2975	\$2050	\$2825	\$2385	\$2725	\$3485
80286 12MHz Prtbl (F:1.2M, M:1MB)	\$2595	\$1675	\$2495	\$1920	\$2395	\$3090
8088 10MHz Prtbl (F:360K, M:640KB)	\$2165	\$1275	\$2165	\$1495	\$2065	\$2795
Note: Gross Weight (lb)	42	38	26	23	23	26
Expansion slot	3	3	2	2	2	2

System Board Speed: 8, 10, 12, 16, 20, 25, 33MHz available, please call.

HK-7000 Industrial Control Terminal

(with System Board, Serial Port, Opt. I/O, 12-bit AD/DA brds)

CONFIGURATION	DIG-IN	DIG-OUT	A-TO-D	D-TO-A	OPTION	PRICE
8088 Remote Control Termml	32	8	8	3	None	\$1295
80286 Remote Control Termml	32	8	8	3	None	\$1695

Reseller, Corporate, Government & School POs welcomed!!

Quantity Discount available, please call for quotation.
All prices and terms subject to change without notice.

1 YEAR WARRANTY
ORDER HOTLINE: 1-800-728-4348
HALSKAR SYSTEMS

Personal Computers & Industrial Control Systems

Multi-User Controller Cards

HK-774P Eight-port intelligent SrL Adap for PCMCOS	\$545
HK-774U Eight-port intelligent SrL Adap (UNIX/XENIX)	\$695
HK-775 Enhanced Ethernet Controller Card (8-bit)	\$229
HK-776 Enhanced Ethernet Controller Card (16-bit)	\$324
HK-778 3278/3279 Emulation Card	\$279

Monitors

HK-338 Magicsync Hi-Res VGA Monitor (820x600)	\$445
HK-321 Relisys VGA Monitor (720x480)	\$395
HK-337 Magicsync Multisync EGA Monitor (820x600)	\$485
HK-322 Relisys Multisync EGA Monitor (800x560)	\$485
HK-324 NEC MultisyncIIA EGA Monitor, 800x560 (Analog)	\$590
HK-328 Voltron EGA Monitor, 640x350 (TTL)	\$349
HK-312 Casper RGB Monitor, 640x350 (TTL)	\$239
HK-336 Magicsync Portrait Mono Monitor (768x1024)	\$345
HK-314 BTC/Voltron 14" Mono Monitor (720x350)	\$98
HK-311 Caspar/Voltron 12" Amber Monitor (720x350)	\$76
HK-320 Center 12" Green Monitor (720x350)	\$62

Display Controller Adaptors

HK-120A VGA Controller Card (800x600, 16-bit)	\$219
HK-120 VGA Controller Card (800x600, 8-bit)	\$185
HK-119 Super EGA Controller Card (800x600)	\$138
HK-118 Autoswitch EGA Controller Card (640x480)	\$109
HK-116 Color Graph & Mono Graph Card w/PP	\$59
HK-115 Color Graph Controller Card (640x200)	\$42
HK-114 Color Graph Controller Card w/PP (640x200)	\$46
HK-113 Full Page HR Mono Graphic Card (768x1024)	\$325
HK-112 Monochrome Graphic Card w/PP (720x348)	\$48

Printers

Panasonic 1191 Dot Mtrx Printr (9-pin, 110cps, 80clm)	\$234
Panasonic 1124 Dot Mtrx Printr (24-pin, 120cps, 80clm)	\$355
Panasonic 1524 Dot Mtrx Printr (24-pin, 120cps, 132clm)	\$515
Panasonic 1592 Dot Mtrx Printr (9-pin, 180cps, 132clm)	\$415
Panasonic KX-P4450 Laser Printer	\$1405
HP Laserjet Series-II Laser Printer	\$1695

Floppy Disk Drives

BRAND	1.44MB	1.2MB	720KB	360KB
Fujitsu	\$93	\$83	\$85	\$69
Teac	\$97	\$87	\$87	\$77
Toshiba	\$92	\$85	\$83	\$73
Chinon	\$89	\$79	\$80	\$68

Hard Disk Drives & Tape Backup

BRAND-MODEL	SIZE	CAPACITY	ACS-TIME	PRICE
Seagate-125	3.5"HH	20MB (MFM)	40/28	\$239/\$275
Seagate-138	3.5"HH	30MB (MFM)	40/28	\$285/\$319
Seagate-138R	3.5"HH	30MB (RLL)	40/28	\$255/\$289
Seagate-225	5.3"HH	20MB (MFM)	65	\$219
Seagate-238R	5.3"HH	30MB (RLL)	65	\$244
Seagate-251-1	5.3"HH	40MB (MFM)	28	\$369
Seagate-277R	5.3"HH	65MB (RLL)	40/28	\$429/\$519
Seagate-4096	5.3"FH	80MB (MFM)	28	\$579
Seagate-4144R	5.3"FH	121MB (RLL)	28	\$889
Toshiba-MK134 FA	3.5"HH	42/64/81 (M/R/C)	25	\$439
Toshiba-MK72PC	5.3"HH	73MB (MFM)	28	\$599
Toshiba-MK156 FA	5.3"FH	147MB(ESDI)	17	\$1279
Mnscr-3180E	5.3"FH	157MB(ESDI)	23	\$1345
Mnscr-9380E	5.3"FH	338MB(ESDI)	17	\$1950
CMS-DJ10 Jumbo	5.3"HH	40/60MB Int	Tape Bkup	\$295

FLP DSK & HRD DSK DRV Control Cards

MODEL	FUNCTION	BIT	PRICE
HK-121	360KB FDDC	8	\$34
HK-122A	360K/720K/1.2M/1.44MB FDDC	8	\$54
HK-127	MFM HDDC (WD-GEN/DTC-5150X)	8	\$69
HK-128	RLL HDDC (WD-27X/DTC-5160X)	8	\$79
HK-129	Comprsd HDDC (Perstor XT)	8	\$210
HK-227	MFM 3:1 H/FDDC (WA5/MM2)	16	\$86
HK-227A	MFM 3:1 H/FDDC (WA3-16MHz)	16	\$99
HK-227F	MFM 1:1 H/FDDC (DTC-7280/MM5)	16	\$142
HK-228	RLL 3:1 H/FDDC (DTC-5287)	16	\$139
HK-228F	RLL 1:1 H/FDDC (DTC-7287)	16	\$159
HK-229	Cmprs 1:1 H/FDDC (Perstor)	16	\$319
HK-229E	ESDI 1:1 H/FDDC (WDC)	16	\$209
HK-229S	ESCI 1:1 H/FDDC (Seagate)	16	\$69

Accessories

MODEL	FUNCTION	PRICE
HK-484	External Drive Case w/Cable (1HH)	\$75
HK-485	Extrnl Drv Case w/60W Pwr Supl (2HH)	\$95
HK-631	300W Uninterruptable Power system	\$245
HK-620	6 Outlets Power Pad (6 switches)	\$23
HK-850	Parallel Printer Cable (6ft/10ft)	\$8/\$10
HK-680	Keyboard Storage Drawer (metal)	\$32
HK-781/E	1200 BAUD Internal/External Modem	\$64/\$74
HK-782/E	2400 BAUD Internal/External Modem	\$98/\$108



See us at
COMDEX/Fall '89
November 13-17, 1989
Bally's Las Vegas
Las Vegas, Nevada

多功能 高品質 全相容

COSTS LESS.*

Introducing Minta Computers. Maximum Systems. Minimum Cost.

Listen to the language of Minta - a complete line of powerful, reliable PCs for less. Minta means the maximum PC for the money.

Minta's unique, slim all-in-one design, its high speed performance, its excellent, professional service - Minta is the **only PC with a 2-year warranty** - all have made Minta a best seller in Europe and the Far East for years.

And then there's the price. If all PCs were equal, Minta would still cost less.

Ask your PC supplier about the computer people are talking about all over the world.

Because in any language, Minta means more - and costs less.

**To find the Minta Distributor nearest you
Call: 1-800-82-MINTA**



MINTA MEANS MORE.

Edison, New Jersey • Taipei, Taiwan • Hamburg, West Germany

Circle 551 on Reader Service Card



***Powerful. Compatible.
Reliable.**

競爭性强

DOS Tree Program for \$50

Treeview is a hard disk file manager that displays your files in a tree-like structure. The program features of the program include the ability to display up to six directories or drives simultaneously, EGA 43-line/VGA 50-line mode support, and support for up to 30 definable function keys. The program works on the IBM PC with DOS 2.0 or higher and 256K bytes of RAM.

Price: \$50.

Contact: Magee Enterprises, Inc., P.O. Box 1587, Norcross, GA 30091, (404) 446-6611.

Inquiry 1009.

Fast 3-D Gets Silicon

Video control and drawing (VCAD) chips, Vermont Microsystems claims, permit Unix-based PCs with X/Series graphics boards to produce three-dimensional wire-frame and solids renderings at workstation speeds.

With the Texas Instruments TMS34010 graphics engine, the X/Series graphics boards can produce 3-D images at 1280- by 1024-pixel resolutions.

The base configuration board produces 400,000 2-D 10-pixel vectors per second, 70,000 characters per second, and 11 million pixels per second scrolling. It contains up to 1 megabyte of RAM and is available in 16 or 256 colors. It's also field-upgradable with modules, or you can buy boards with the modules in-



A Treeview display, showing the contents of two directories and drive A in 43-line mode.

cluded in either 2-D or 3-D configurations.

The Math module, which includes an AT&T DSP32C math coprocessor for 32-bit floating-point calculations, gives the Cobra Station a performance of up to 25 MFLOPS. It can produce 195,000 3-D vectors per second.

The Z-buffer module replaces the painter's algorithm with hardware for hidden surface removal. With the Cobra Station, it is capable of producing 10,000 hidden, Gouraud-shaded triangles per second.

Boards that bundle the base configuration board with these modules are called the X/Series Math, X/Series Z, and X/Series Math Z. The top-of-the-line X/Series Math Z is capable of producing 384,000 vectors per second and 22,000 hidden, Gouraud-shaded triangles.

Price: 16-color Cobra Station 2-D, \$2995; 256-color Cobra Station 2-D, \$3995; X/Series Math, \$5795; X/Series Z, \$7295; X/Series Math Z, \$8295.

Contact: Vermont Microsystems, Inc., 11 Tigan St., P.O. Box 236, Winooski, VT 05404, (802) 655-2860.

Inquiry 1014.

Design Detention Ponds with the Mac

Hydro Mac is a hydrographics program for civil and municipal engineers who need to design detention ponds using the rational method. With the program, you can design ponds of up to a square mile to accommodate water runoff.

Because the rational method is not suitable for the design of ponds larger than 640 acres, Hydro Mac is also available in a version that accommodates the Soil Conservation Service method, for larger projects.

Both programs work on the Mac Plus or higher with 1 megabyte of RAM, and they are compatible with MacWrite, MultiFinder, and the Image-writer printer.

Price: \$395; SCS version, \$800.

Contact: Applications Design Group, 60 East Hanover Ave., No. 6, P.O. Box 512, Morris Plains, NJ 07950, (201) 285-5160.

Inquiry 1025.

Mac Program Helps Pediatricians with Telephone Triage

Triage, the process that doctors use to make decisions regarding the seriousness of an illness, is often performed by a pediatrician or staff member over the telephone. A program for the Macintosh called Pediatric Telephone Protocols (PTP) runs under HyperCard and lets a pediatric office do telephone triage efficiently while providing a way to document each incoming call and flag phone calls for follow-up.

When a parent calls in with a child's medical problem, the first screen lets you enter the patient's name, phone number, and other information. Then, if the parent suspects chicken pox or knows only the symptoms, you click on the Find card. An appropriate complaint card appears with a horizontal triage line. If the patient has any symptom above the line, it recommends immediate medical attention. If the symptoms are below the line, a list of recommended home treatments appears with symptoms that, should they occur, would require a callback.

You can flag each phone encounter for later follow-up, print it for inclusion in a chart record, or store it to disk. You can also use the program to calculate a recommended dosage strength by the child's weight.

PTP works on the Mac Plus or higher with HyperCard. The program was written by a pediatrician and is based on *Pediatric Telephone Advice* by Barton D. Schmitt. **Price:** \$199.

Contact: HealthTek Medical Software, Inc., 9950 West 80th Ave., Suite 24, Arvada, CO 80005, (303) 420-7438. **Inquiry 1020.**

X-BANDIT

Break the 640K DOS barrier and utilize the Advanced Features of the LIM 4.0 standard while using only one motherboard slot!

"should be very useful for DOS users who are straining the limits of the 640K barrier"
—BYTEweek June 12, 1989

DESIGN PHILOSOPHY

- The Teletek X-Bandit was specifically designed to utilize the advanced features of the Lotus/Intel/Microsoft EMS 4.0 Specification. Further, the X-Bandit's Segmented Memory Mapping capability allows the user to extend DOS size beyond the 640K barrier. It is available in both 8 and 16 bit versions for use in the IBM XT, AT, and compatibles.

MEMORY

- Segmented Memory Mapping allows the user to fill out unused memory segments between 640K and 1024K. By "claiming" unused portions of memory in 16K increments, the user effectively increases TPA size. LAN or custom software modules, for example, can be loaded into these high memory areas thus relieving the lower 640K of TPA for other application programs.
- Split Memory Addressing allows the user to fill out conventional memory to 640K.
- Extended Memory Addressing is available for the PC/AT version.
- 2 MB capacity in a single slot. Up to 8 MB per system.
- Parity checking.

SOFTWARE

- Easy menu-driven auto configuration software.
- Device driver includes print spooler and RAM drive.
- Supports multitasking with the appropriate shell-resident software package.

SPEED

- 6/8/10 MHz speed with 0 wait states. 12 MHz speed with 1 wait state.

WARRANTY

- One year parts and labor.
- Now includes SYSTEM SLEUTH™ from DTG, Inc. A \$149.00 value.

TELETEK

4600 Pell Drive
Sacramento, CA 95838
(916) 920-4600
Fax (916) 927-7684

Circle 565 on Reader Service Card (DEALERS: 566)

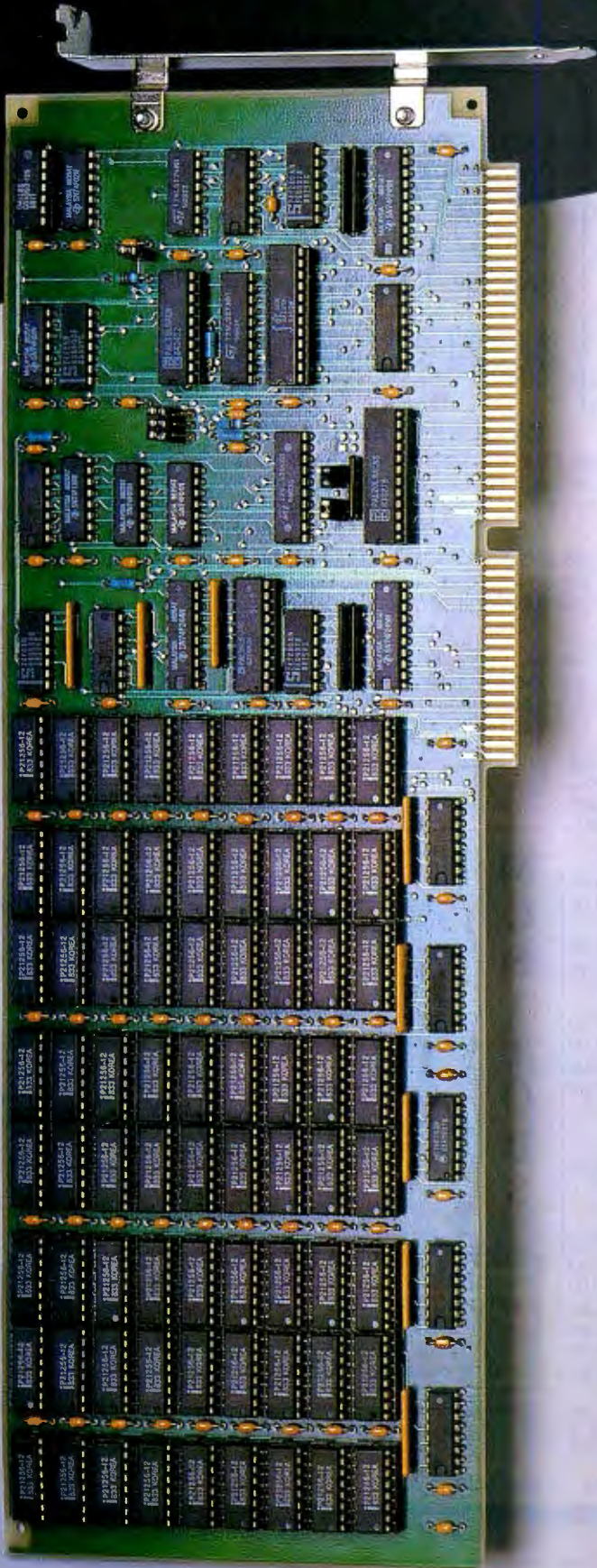

HY-TEC

Computer Hardware, Inc.
Software Systems, Inc.

7087 West Blvd., #14 Boardman, OH 44512

Printers

PANASONIC	
KXP-4450 11PPM 300 DPI 11 FONTS.....	\$1398.00
QUME	
CRYSTAL PRINT II 6PPM 512RAM 6 FONTS.....	\$1690.00
CRYSTAL PRINT PUB 6PPM 3MB RAM 35 FONTS.....	\$3580.00
SCRIPTEN 10PPM 3MB RAM 35 FONTS.....	\$3655.00
NEC	
LC-860 8PPM 1.3MB 4 FONTS.....	\$2605.00
LC-890 8PPM 3MB 35 FONTS.....	\$3830.00
FUJITSU	
POSTSCRIPT LASER 2MB.....	\$3525.00
POSTSCRIPT LASER 4MB.....	\$3795.00

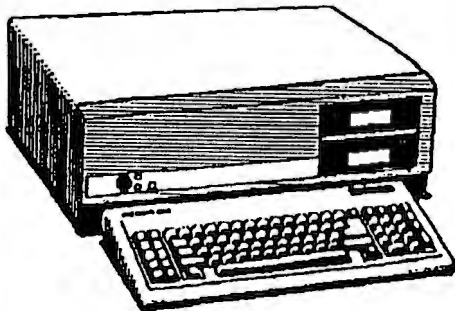

IDEAL SCANNER	
CAD/DESKTOP.....	\$10375.00
CADIMAGE FOR SCANNER....	\$ 980.00
EXTRA SOFTWARE	CALL
PANASONIC	
FXRSS05 SCANNER.....	\$1080.00
FXRSS06 SCANNER.....	\$1355.00
HP	
SCANJET 9190A.....	\$1275.00
SCANJET INTERFACE KIT.....	\$434.00

COMPUTERS

PACKARD BELL	
PB900 286 12/8 Mhz 1MB RAM 1.2 FDD.....	\$1175.00
PB1000 286 12/8 Mhz 2MB RAM 1.2 FDD.....	\$1640.00
PB386-20 1MB RAM 20/8 Mhz 1.2 FDDER.....	\$2950.00
ACER	
915MB 286 12/8 Mhz 1.2 FDD 512KB RAM.....	\$1615.00
1100-16 386 16 Mhz 2MB RAM 1.2 FDD.....	\$3150.00
1100-20 386 20Mhz 2MB RAM 1.2 FDD.....	\$4432.00
AST	
MODEL 90 286 10Mhz 1MB RAM 1.2 FDD.....	\$2364.00
MODEL 300 386 20Mhz 1MB RAM 1.2 FDD.....	\$3100.00
MODEL 300C 386 20Mhz 1MB RAM 1.2 FDD.....	\$3250.00
MITSUBISHI	
BASIC 286.....	\$1499.00
EGA 286.....	\$1999.00
BASIC 386.....	\$2597.00
EGA 386.....	\$3399.00

MONITERM	
VIKING 2 19" WHITE 1280x960 W/CONTROLLER.....	\$1680.00
VIKING GS 19" GRAY SCALE MACH W/CONTROLLER.....	\$2650.00
VIKING 2 21" COLOR 1024x768 W/CONTROLLER.....	\$3575.00
VIKING 2400 24" MONOCHROME W/CONTROLLER.....	\$2225.00
NEC	
DM2000P 20" DATASART MONITOR.....	\$2241.00
DM2600P 26" DATASART MONITOR.....	\$3090.00
DM3000P 30" DATASART MONITOR.....	\$4098.00
DM5200A 52" MULTI SYNC REAR DATA PROJECTION.....	\$9200.00
PANASONIC	
PANASYNC C1391 14" MULTI FREQ COLOR MONITOR.....	\$568.00
RELISYS	
RE5154 EGA/CGA.....	\$407.47
RE9513 VGA PS/2.....	\$407.47
RE5155 MULTI SCAN ANALOG.....	\$529.00
RE1475 MAC COLOR 640x480.....	\$447.35
RM9503 PS/2 WHITE ANALOG.....	\$182.85
RE1520 SUPER MULTISCAN.....	\$833.75
RM1541 GRAYSCALE.....	\$407.47

MONITORS



CALL FOR SHIPPING INFO PRICES SUBJECT TO CHANGE WITHOUT NOTICE 15% RESTOCKING FEE FOR RETURNED ITEMS MAKE CHECKS PAYABLE TO HY-TEC COMPUTER HARDWARE, INC 7087 WEST BLVD BOARDMAN OH 44512

To Order Call 1 (800) UR-HY-TEC

1(800) 874-9832 Local (216) 726-5967

**Save
Time &
Money**

Network Your PCs Using Standard Telephone Connectors and Cables!

That's right the NET-127 PC Network board, telephone cable and standard RJ11 jacks are all you need to be up and running. NET-127 gives you all the power you'd expect from a high-quality low-end network, without the hassle and expense of traditional network cabling.

- Allows Sharing of Hard Disks, Printers, Plotters, Tape Back-ups, etc.
- Supports Spreadsheets, Word Processing, CAD/CAM & More
- Connect Up to 127 Stations Without Additional Accessories
- Easy-to-use Multitasking O/S on Each Machine
- Throughput Speed of 10,000 Bytes/Second
- Low Memory Requirement — 4 to 32K
- 30 Day Money-Back Guarantee
- No File Server Required

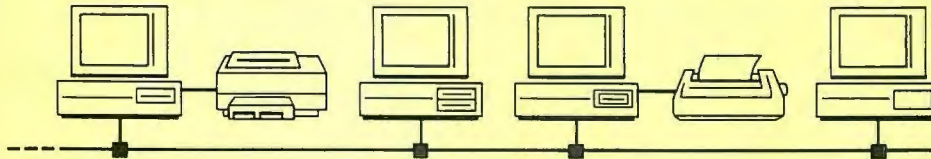

We take pride in our customer service.

TRANS-M CORP.
28 Blacksmith Drive
Medfield, MA 02052
508-359-5144

Improve Data Acquisition, Communication and Control by 1000 Times or More!

HPB RS-485 SDLC communication interface,
for PC/XT/AT/80386

- Save time and money using twisted pair wiring scheme
- Cut development costs and time by at least 50%
- Cut programming development effort by 50%
- Easily connects up to 255 controllers/stations/file servers
- No complex data switches
- Real time multiuser access
- 99% CPU time available for processing controls *

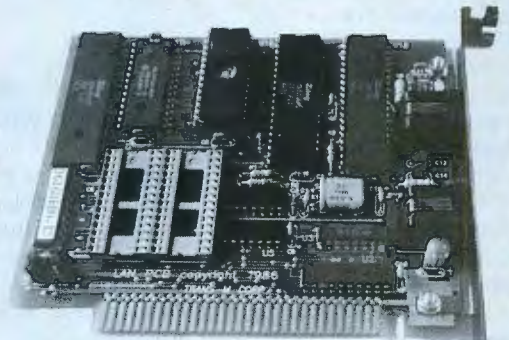

- Buffered messages (512 byte / message) • 250K bps data transfer rate • RS-485 interface with SDLC protocol
- Handles up to 255 station IDs • 255 drivers, 255 receivers on the network • 8K memory buffer
- Ethernet-like network OS with CSMA/CD/CA • Programming interface supports Assembly, C, Pascal, Basic
- 4000 ft. bus length with 2 wire twisted pair • Communication software source code available

* Host CPU interrupts 1000 times less on a three station network; more efficient on larger network.

For Free Information CALL NOW **508-359-5144**



**We take pride
in our
customer service.**

TRANS-M CORP.

28 Blacksmith Drive
Medfield, MA 02052

A Scaled-Down Office System for Your Travels

MicroDirect's data management system features the Bondwell B300, an 80286-based 10-MHz laptop with 1 megabyte of RAM, a 10½-inch backlit LCD, a 20-megabyte hard disk drive, a 1.44-megabyte 3½-inch floppy disk drive, and a Hayes-compatible 300- or 1200-bps modem. Plug in the RJ-11 connector, and you're ready to travel. A carrying case encloses the 4- by 14- by 12-inch, 15-pound unit (including battery).

The Bondwell BFA100 quadruples as a fax, a scanner, a copier, and a printer. It's a standard Group 3 (9600-bps) fax machine coupled with a 203-lpi by 98-lpi, 16-step half-tone gray-scale scanner. Like most fax machines, it will also copy the 8½-inch-wide page on thermal paper, and its parallel port links it to the laptop for printing on the same thermal paper. The BFA100 weighs 11 pounds. Dr. Halo III graphics software is included.

Price: \$4500.

Contact: MicroDirect, Inc., 2010 Revere Beach Pkwy., P.O. Box 835, Everett, MA 02149, (800) 872-4286 or (617) 387-2200.

Inquiry 1011.

Animate to the Beat with PageSync

Mindware International's PageSync for the Amiga allows external MIDI events and computer animation to control each other. With the program, you can use a MIDI instrument to advance, stop, or reverse a computer animation. If you own a MIDI drum machine, you can use it to advance the animation by



MicroDirect's laptop system includes a fax, a scanner, a copier, and a printer.

one frame per drumbeat, keeping the animation in time with the music.

PageSync can also do the opposite function, letting an animation running on an Amiga play the MIDI instrument.

PageSync runs on the Amiga 500, 1000, and 2500 with at least 1 megabyte of RAM.

Price: \$100.

Contact: Mindware International, 110 Dunlop St. W, P.O. Box 22158, Barrie, Ontario, Canada L4M 5R3, (705) 737-5998.

Inquiry 1016.

Run a Bulk Mailing Operation with a Mac

MacEnvelope Plus is a program that lets you manage your mailing lists and print postal bar codes on an envelope or label, entitling you to postage rate reductions in a bulk mailing.

The program can handle up to 100,000 names in a list. You can sort the names alphabetically, by last name first, and by ZIP code. You can also eliminate duplicate names and create merge files. You can flag names and add comments to them. The program has a routine for importing lists from programs like FileMaker, Word, 4th Di-

mension, Overview, Works, and Excel.

MacEnvelope Plus works on the Mac Plus or higher.

Price: \$295.

Contact: Synex, 692 10th St., Brooklyn, NY 11215, (800) 447-9639 or (718) 499-6293.

Inquiry 1024.

80386 System Includes Its Own UPS

When you're introducing an 80386 system into an already-crowded market, one way to distance yourself from the pack is to include an uninterruptible power supply (UPS) and other devices normally considered optional: a 90-megabyte SCSI hard disk drive with a SCSI adapter, an 80-megabyte streaming tape drive, a 16-bit VGA controller, a 1024- by 768-pixel monochrome monitor, a mouse, and a surge protector with four outlets for external peripherals. The Echo386 base system includes MS-DOS 3.3, DESQview, and PC Tools.

By incorporating a battery into the system's power supply, Pan Overseas says that it was able to provide uninterruptibility at low cost. The system also comes with a small (4K-byte) TSR software package that will automatically back up the system onto a hard disk. If the power fails or if you turn the system off, the

software saves an "image" of the system—including all running applications and TSR software—onto the hard disk. The next time you turn the system on, you have a choice of resetting the system or returning it to the same state it was in when the power was turned off.

Price: \$4395.

Contact: Pan Overseas Computer, 44 Route 46, Pine Brook, NJ 07058, (201) 808-1900.

Inquiry 1012.

SkiSoft Word Processor Features Large Text

Eye Relief is a full-function word processor that lets you enlarge your text by as much as 300 percent.

The display text can range from the normal 80 columns by 25 rows up to 33 columns by 7 rows. Magnification is user-selectable in four modes. You can change the space between lines and the space between letters without creating jagged-edge letters. And you can make the cursor blink at any desired rate—or not at all, a feature important for epileptics because blinking lights often cause seizures.

The editor features flexible formatting for indentation and layouts, and it stores files in ASCII. You can define up to 46 macros, each tied to the Alt key. Eye Relief requires 512K bytes of RAM and MS-DOS, and it is compatible with Hercules, CGA, EGA, and VGA graphics.

Price: \$295.

Contact: SkiSoft Publishing Corp., 1644 Massachusetts Ave., Suite 79, Lexington, MA 02173, (800) 456-8465 or (617) 863-1876.

Inquiry 1017.

How does FOUNTAIN 386SX compare with a true 386?

	128K NOP Loop	DO- Nothing Loop	Integer Add Loop	Integer Multiply Loop	String Sort and Move	Prime Number Sieve	80286 Instruction Set
FOUNTAIN-386SX	2.09	1.97	0.88	0.61	1.20	1.76	4.07
COMPAQ-386/16	2.09	1.86	0.99	0.60	1.37	1.87	4.23

PC Magazine Benchmark Tests (Time in Seconds)

FOUNTAIN 386SX The Smart Choice.

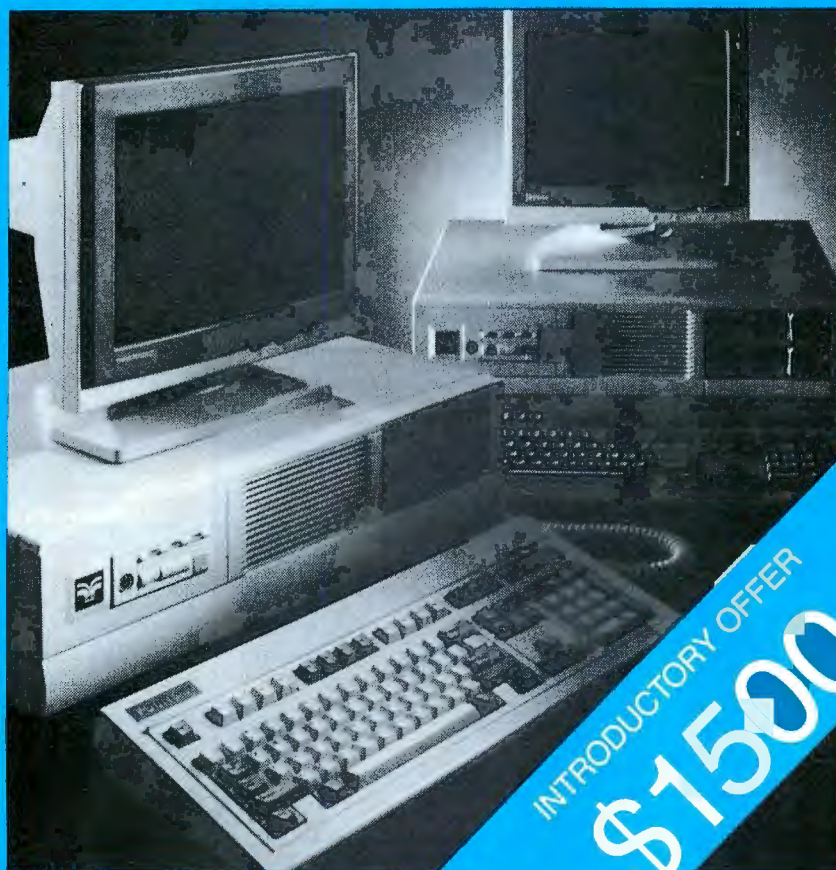

FOUNTAIN TECHNOLOGIES INC.
12K World's Fair Drive Somerset NJ 08873 (201) 563-4800

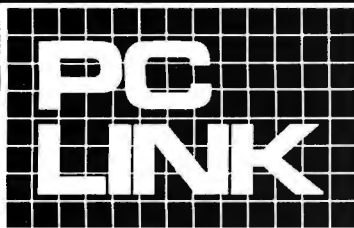

INDEPENDENT STORE IN NYC DEDICATED TO IBM® PC SOFTWARE AND PERIPHERALS ONLY

STORE HOURS: 9:00 A.M.-5:30 P.M. E.S.T. MON.-FRI.

SATURDAYS: 10:00 A.M.-4:00 P.M.

Terms, Conditions and Prices May Differ In Our Store.

CORPORATE ACCOUNTS WELCOMED.

PC LINK CORP. 29 WEST 38TH STREET, 2ND FL., NEW YORK, NY 10018

CALL TOLL FREE 1-800-221-0343 FOR ORDERS ONLY

All prices listed in this ad are effective Oct. 1-31, 1989. All Brands are Registered Trademarks. IBM is a Registered Trademark of IBM Corp.

IN NEW YORK CALL 1-212-730-8036 FOR ORDERS & INQUIRIES

MICROSOFT. Bus or Serial MOUSE **99.00** **WORDPERFECT CORP.** Wordperfect 5.0 **239.00** **LOTUS DEV.** Free Lance Plus **329.00** **WALLSOFT.** UI Programmer 2 **359.00**

This Month's Specials---October 1st through 31st

BUSINESS SOFTWARE

ASHTON-TATE
DBASE IV (In Store Only) ... CALL
MULTIMATE ADVANTAGE II ... CALL
BLOCK PUBLISHING
FORMTOOL ... 69.00
FORMFILLER ... 109.00
PERSONAL LAWYER ... 49.00

BORLAND INT.

PARADOX V 2.0 ... 459.00
REFLEX V 2.0 ... 199.00
SIDEKICK PLUS ... 149.00
TURBO C 2.0 ... 119.00
TURBO PASCAL 5.0 ... 119.00
QUATTRO PLUS ... CALL
CLARION SOFT. CLARION Personal ... 129.00
CLARION SOFT. CLARION Professional ... 595.00
CLEAR SOFT. CLEAR+ ... 159.00

CONCENTRIC DATA

R & R REPORT WRITER FOR DBASE III+ ... 139.00
CROSSTALK COMMUNICATIONS
CROSSTALK MK.4 ... 109.00
CROSSTALK XVI 3.6 ... 85.00
FORMWORX FORMWORX With Fill & File ... 119.00

FOX SOFTWARE

FOX BASE PLUS V 2.1 ... 219.00
FOX BASE+ MULTIUSER ... 379.00
GREAT PLAINS. Accounting Packages ... CALL
JAVELIN SOFT. JAVELIN ... 69.00
KORTEK. FREEWAY ADVANCED ... 99.00

LOTUS DEV. CORP.

LOTUS 1-2-3 (SOLD IN OUR STORE) ... 379.00
AGENDA (SOLD IN OUR STORE) ... 295.00
MERIDIAN. CARBON COPY PLUS ... 139.00

MICRO PRO

WORDSTAR PROFESSIONAL REL.5.5 ... 209.00
MICROSOFT
C COMPILER ... 309.00
FORTRAN COMPILER ... 309.00
MACRO ASSEMBLER ... 119.00
EXCEL ... 329.00

QUICK BASIC

QUICK C ... 79.00
WINDOWS ... 79.00
WINDOWS 386 ... 145.00
WORD VERSION 5.0 ... 229.00
WORKS ... 109.00
NANTUCKET. CLIPPER ... 479.00
OWL INT. GUIDE 2.0 ... 159.00
QUARTERDECK. DESQ VIEW 386 ... 139.00
SBT. ACCOUNTING SOFTWARE (Sold In Store) ... CALL

STSC

APL+PLUS V 7.0 ... 649.00
STATGRAPHICS ... 649.00
SOFTWARE GROUP+ ENABE OA ... 459.00

SOFTWARE PUBLISHING

Harvard Total Project Manager 111 ... 349.00
PROFESSIONAL FILE/PLAN ea. ... 159.00
PROFESSIONAL WRITE ... 139.00
SYMANTEC. Q&A 3.0 ... 259.00

WALLSOFT

THE UI PROGRAMMER V.2 ... 399.00
WORDPERFECT CORP.
WORDPERFECT V 5.0 ... 259.00
WORDTECH SYSTEMS
D B X L ... 119.00
QUICK SILVER DIAMOND ... 369.00
XYQUEST. XY WRITE III + ... 259.00

DESK TOP PUBLISHING & FONTS

ALDUS. PAGE MAKER (Sold In Store only). ... CALL
BITSTREAM FONTWARE ... 149.00
BRIGHTBILL-ROBERTS
SHOW PARTNER ... 69.00
SHOW PARTNER F/X ... 249.00
DIGITAL. GEM DRAW PLUS ... 175.00
HEWLETT-PACKARD SOFT FONTS ... 159.00
LOTUS DEV. FREE LANCE+(Sold In Store) ... 359.00
MICROGRAFX. DRAW PLUS ... 299.00
SOFTCRAFT
FONT SOLUTION PACK ... 425.00

SPIN FONTS ... 79.00
SOFTWARE PUBLISHING
Harvard Presentation Graphics ... 339.00
XEROX. VENTURA VERSION 2.0 ... CALL
XEROX. VENTURA Professional Extension ... CALL

UTILITIES

CORE INT. CORE FAST ... 119.00
EXECUSYSTEMS. XTREE PRO ... 79.00
FIFTH GENERATION. FAST BACK+ ... 129.00
FUNK SOFT. SIDWAYS 3.2 ... 59.00
MICROLYTICS. GOFER ... 49.00
NORTON. UTILITIES V 4.5 ... 59.00
NORTON. UTILITIES ADVANCED 4.5 ... 99.00
TRAVELING SOFT. LAP-LINK III ... 139.00

MICE

LOGITECH. HIREZ MOUSE (Bus Version) ... 75.00
LOGITECH. C7 PUBLISHERS MOUSE ... 89.00
MICROSOFT. SERIAL OR BUS MOUSE ... 105.00

PRINTERS

HEWLETT-PACKARD. LASERJET 11D ... CALL
HEWLETT-PACKARD. LASERJET Series 11 ... CALL
HEWLETT-PACKARD. DESKJET+ ... CALL
OUTPUT TECH. OT-850XL 850 CPS ... CALL
TOSHIBA. P351SX ... 995.00
TOSHIBA. P321SL ... 499.00

HP LASER ACCESSORIES

HEWLETT-PACKARD
FONT CARTRIDGES
(A,C,D,E,G,H.) ea. ... 109.00
(B,F,J,K,L,M,N,P,Q,T,U,V,W,X,Y) ea. ... 199.00
(R,Z) ea. ... 275.00

MEMORY FOR LASERJET II ONLY

1MB/2MB/4MB MEMORY BOARDS ... CALL
Priceton Publishing Labs. PS-388 Accelerator, A PostScript compatible controller board, for HP Laserjet series 11, 3Mb Ram, 35 Outline Bitstream Fonts, with its RISC architecture, prints 30 times faster than conventional Postscript printer. ... 2295.00

MONITORS

AMDEK. 1280 MONITOR ... 739.00
AMDEK. 410A MONITOR ... 189.00
Elite Business. Design VIEW/19 (1280X1024) 1495.00
PGS. MAX-12 (MONO MONITOR) ... 189.00
N E C. MULTISYNCH 2A VGA ... 569.00
N E C. MULTISYNCH 3D VGA/EGA ... 769.00
SONY. CPD-1304 ... CALL
WYSE. 700 1280X800 HI RES. Monitor ... 789.00

MODEMS

EVEREX. EVERCOM 1200 (Internal) ... 109.00
EVEREX. EVERCOM 2400 (Internal) ... 199.00
HAYES. SMARTMODEM 2400 ... 499.00
HAYES. SMARTMODEM 1200 ... 299.00
HAYES. 1200B+SMARTCOM II ... 299.00
HAYES. 2400B+SMARTCOM II ... 499.00
MIGENT. 1200 POCKET MODEM ... 139.00

MIDI PRODUCTS

MUSIC QUEST
MIDI Co-Processor Card ... 99.00
Starter System+ ... 169.00
Starter System ... 145.00

TWELVE TONE SYSTEMS

CakeWalk 2.0 Sequencer ... 89.00

DISKDRIVES

MICROPOLIS. 1558-15 338Mb 18Ms ESDI drive ... CALL
MICROPOLIS. 1335 71Mb 26Ms drive ... 695.00
MINISCRIBE. 3053 40Mb hard disk for AT ... 479.00
PLUS DEV. Passport 20 or 40MB ... CALL
SEAGATE. ST-225 20MB With controller ... 289.00
SEAGATE. ST-251-1 40MB FOR AT ... 399.00
SYSGEN. BRIDGE FILE ... 349.00
SYSGEN. BRIDGE TAPE ... 549.00
TOSHIBA. 3 1/2" & 5 1/4" Drives ... CALL

EXPANSION BOARDS

64K 150NS RAM CHIPS ... CALL
256K 150NS RAM CHIPS ... CALL
HERCULES. MONO GRAPHICS PLUS ... 199.00
INTEL. ABOVE BOARD PS/286 512K ... 459.00
ORCHID. Prodesiner VGA Plus 512K ... 379.00

VIDEO 7. VEGA DELUXE ... 219.00
VIDEO 7. VRAM-VGA 256K ... 399.00

NETWORKING

INVISIBLE NETWORK 200 ... 209.00
SERVER TECHNOLOGY
EASLAN STARTER KIT FOR 2 PC'S ... 179.00
EASLAN EXPANSION KIT FOR 1 PC'S ... 79.00

COMPUTERS

PC LINK

386 Model 1. 16MHz, 1Mb 32 Bit RAM, One 1.2MB Drive, One serial/parallel port 101 keyboard ... 1895.00

386 Model 11. 16MHz, 1Mb 32 Bit RAM, One 1.2MB Drive, 40MB 28Ms Hard Disk, One serial/parallel port 101 Keyboard ... 2395.00

**386 Model 111. 16MHz, 1MB 32 Bit RAM, One 1.2MB Drive, 40MB 28Ms Hard Disk, One serial/parallel ports Vega VGA adapter, NEC Multisynch 2A monitor, 101 Keyboard. ... 3295.00

386-20 Model 1. 20MHz, 1Mb 32 Bit RAM, One 1.2MB Drive, One serial/parallel port 101 keyboard ... 2295.00

386-20 Model 11. 20MHz, 1Mb 32 Bit RAM, One 1.2MB Drive, 40MB 28Ms Hard Disk, One serial/parallel port 101 Keyboard ... 2895.00

*386-20 Model 111. 20MHz, 1MB 32 Bit RAM, One 1.2MB Drive, 40MB 28Ms Hard Disk, One serial/parallel ports Vega VGA adapter, NEC Multisynch 2A monitor, 101 Keyboard. ... 3895.00
FCC CLASS B APPROVED.

* "...you've got the equivalent of a sixties streetcorner dragster..."

- Winn Rosch, PC Magazine November 29, 1988

** "...The components are good enough to make you forget about the 1-year parts-and-labor warranty."

- Edward Mendelson, PC Magazine May 30th, 1989

Reprinted from PC Magazine copyright ©1988, ©1989 Ziff Davis Communications Company

Powerfull PC LINK 386 33MHz at affordable Price. 386-33 Model 115. 33MHz computer, 4Mb Ram, One 1.2Mb Drive, 159Mb 16Ms ESDI Hard Disk 64Kb Ram Cache, One serial/parallel ports 16 bit VGA adapter, 101 Keyboard, DOS.* 5995.00
FCC CLASS A APPROVED

All PC LINK computers carry **ONE YEAR Parts & Labor WARRANTY**, MICROSOFT MS-DOS 3.3* ... 79.00
MICROSOFT MS-DOS 4.01* ... 89.00
***When purchased with any PC LINK Computer.**

STORE SPECIAL

**At the time you purchase any PC LINK 386 Model 111, you can buy Hewlett-Packard Laserjet Series II with toner for only ... 1649.00

** Order must be placed at the same time when purchasing PC LINK 386 Model 111 computers, no exceptions.

TOSHIBA

T1000 512KB ONE 3 1/2" DRIVE 4.77MHZ ... CALL
T1200HB 1MB 20MB HD. ONE 3 1/2" DRIVE ... CALL
T1600 12MHz 1mb Ram One 3.5", 20mb HD ... CALL
T5100 2MB RAM ONE 3 1/2", 40MB HD ... CALL

HAUPPAUGE COMPUTER WORKS.

Upgrade your IBM/PC or IBM/XT with HCW Replacement Motherboard, 16MHz, 1Mb RAM, Zero Wait State ... 1395.00

TERMS AND CONDITIONS

We reserve the right to repair, replace or return to manufacturer for repair, all goods acknowledged faulty or damaged on receipt by customer. Customer Must Call For Return Authorization Number Before Returning Any Goods. Prompt attention will be given to all damaged and faulty returned goods. Any goods returned for credit are subject to 20% restocking charge, plus shipping charge. No Returns For Credit On Any Software. Customer must deal directly with the manufacturer if the customer finds any false claims made by the manufacturer. All goods are shipped VIA U.P.S. ONLY. Shipping charges are 2% of the total purchase price or \$3.00, whichever is greater. Please call for shipping charges on Printers & Accessories. C.O.D. goods are shipped for Cash or Cashier's Check Only. Max \$1500.00. Please allow 7 to 10 working days for personal or corporate checks to clear. To expedite shipping send money order or cashier's check, or charge to your VISA OR MASTERCARD. WE DO NOT Add a Service Charge For Credit Card Usage. PRICES SUBJECT TO CHANGE WITHOUT NOTICE. NOT RESPONSIBLE FOR TYPOGRAPHICAL ERRORS.



Integrated CD-ROM Packages

Available from
Online Products
Corporation

A subsidiary of
Online Computer Systems, Inc.

Online Products Corporation offers several unique hardware and software packages with some of the most popular CD-ROMs.

Grolier's New Electronic Encyclopedia®, Microsoft's® Bookshelf, Programmer's Library, StatPac, and Small Business Consultant are all available in one fully integrated hardware and software package for the IBM® PC, PC/AT®, PC/XT™, PC compatible, or IBM PS/2®. Macintosh versions of some products will be available soon.

In addition, Online has developed OPTI-NET®, a software product which allows CD-ROM applications to run on NETBIOS™ compatible LANS including: IBM Token Ring®, IBM PC Net, 3Com®, Novell®, and Ungermann-Bass®.

Educational Price Listing

	STAND ALONE	PACKAGES*
Grolier's New Electronic Encyclopedia	\$ 395	\$1195
Microsoft's Bookshelf	\$ 295	\$ 995
Microsoft's Programmer's Library	\$ 395	\$1095
Microsoft's StatPac	\$ 125	\$ 895
Microsoft's Small Business Consultant	\$ 149	\$ 895
OPTI-NET Networking 1-8 users	\$ 795	**
OPTI-NET Networking 9-100 users	\$1495	**

*IBM PS/2 Micro Channel™ Controller Card Add \$100.

**Call for networked package pricing options.

Other Databases are available. Please call for further information.

**ON
LINE**

- Networked systems are available.
- Educational prices available to authorized educational institution affiliates. Verification of affiliation may be required.
- All package prices include shipping and handling.
- Overnight delivery is extra.
- Prices subject to change without notice.

Ordering Information

To order, call our toll-free number from 9:00 to 5:00 Eastern Time Monday through Friday.

- Visa, MasterCard, and American Express accepted.
- Maryland state residents please add 5% sales tax.

**For Immediate Delivery Call
Online Products Corporation**

1-800-922-9204

In Maryland call (301) 428-3700

FAX (301) 428-2903

TELEX 374-6439



Online Products Corporation

20251 Century Boulevard
Germantown, MD 20874

OPTI-NET is a registered trademark of Online Computer Systems, Inc. Microsoft is a registered trademark of Microsoft Corporation. IBM Personal System/PS/2 and Token Ring are registered trademarks of the International Business Machines Corporation. 3Com is a registered trademark of 3Com Corporation. Novell is a registered trademark of Novell, Inc. Electronic Encyclopedia is a registered trademark of Grolier Electronic Publishing. Macintosh is a registered trademark of Apple Computer, Inc.

Online Products Corporation is a wholly-owned subsidiary of Online Computer Systems, Inc.

© Copyright 1989. Online Computer Systems, Inc. All rights reserved.

Image Processing to Go

Ricoh's Portable Digital Information System gives you image-capture, processing, printing, and faxing capabilities in a briefcase-size package.

The MC50 copier/digitizer is the heart of the system. Within this 12- by 6- by 2-inch self-contained unit is a nickel-cadmium battery, the printing mechanism, and the paper supply. When you digitize an image with the flatbed-type scanner, you make a copy that's 3 $\frac{3}{8}$ by 6 $\frac{1}{2}$ inches.

You're not limited to thermal paper with the MC50, as with many portable peripherals. In fact, you can also use transparent sheets and plain paper. The MC50's scanning head incorporates a 798-pixel image sensor and produces images with a 200-dpi density and 200-lpi horizontal and vertical resolution.

For scanning into your system, you can buy the 5- by 5- by 1-inch IM-A image controller/scanner module with an RS-232C interface. (It's compatible with XTs, ATs, and Macs.) Its buffer memory is large enough to store a 3 $\frac{3}{8}$ - by 6 $\frac{1}{2}$ -inch page, and you can enlarge and reduce the size.

A second peripheral is the IM-F50 fax interface, with Group 3 compatibility and a V.27-compatible (4800-bps, half-duplex) modem. Horizontal and vertical resolution is 200 dpi. It measures 6 by 6 by 2 inches.

Price: MC50, \$540; IM-A, \$510; IM-F50, \$540.

Contact: Ricoh Consumer Products Group, 155 Passaic Ave., Fairfield, NJ 07006, (800) 255-5550, ext. 176.

Inquiry 1010.



The MC50 copier/digitizer can scan images at 26 inches per minute.

Music Notation on the Mac Gets Slimmed Down

Coda Music Software developed MusicProse for musicians who need a music notation program but don't need all the functions of Finale, the company's high-end program for professional musicians. Like Finale, MusicProse is based on ENIGMA, Coda's proprietary operating system. MusicProse lets you transcribe music into notation via MIDI in real-time mode.

Two other input modes include simple entry, a step-time mode that uses a keyboard and a mouse, and speedy entry, which uses the computer keyboard and a MIDI instrument.

You can use the program to write MIDI files for use in a sequencing program, analyze block chords for accurate chord symbol labeling, automatically align lyrics to note heads, and quickly change key, meter, and clef.

MusicProse works on a Mac Plus with 1 megabyte of RAM and a hard disk drive. The program supports all Imagewriter printers, Coda reports.

Price: \$249.

Contact: Coda Music Software, 1401 East 79th St., Bloomington, MN 55425, (612) 854-1288.

Inquiry 1015.

XyWrite III Plus for the NEC UltraLite

XyWrite III Plus is now available on a ROM card that works on the UltraLite, NEC's diminutive laptop computer. The XyWrite ROM card will include all the essential program files, spelling dictionaries, printer files, A La Carte menus, and a keyboard configuration file for the UltraLite.

Other printer files and supplemental files for customizing XyWrite come on two 3 $\frac{1}{2}$ -inch disks. You can load those files into RAM from floppy disks or the UltraLite's hard disk drive. The ROM card, which is about the size of a credit card, also has a file that helps you prepare documents for transmission through the UltraLite's 2400-bps modem.

Price: \$445.

Contact: XyQuest, Inc., 44 Manning Rd., Billerica, MA 01821, (508) 671-0888; NEC Home Electronics (U.S.A.), Inc., 1255 Michael Dr., Wood Dale, IL 60191, (312) 860-9500.

Inquiry 1019.

Client-Tracking Software Works with WordPerfect

Contact Plus 2.1, a client-tracking program, has an interface to WordPerfect 4.2 and 5.0 that lets you generate form letters with one keystroke. You can enter as many contacts as your system's memory will allow, and if you don't have WordPerfect, you can use the program's own word processor.

Contact Plus 2.1 can dial a client's phone number automatically. Once you're connected, you can record the elapsed time spent on the call, whether you reached the person you were calling, what you discussed, and when to call back. If you need to pop out of the program and access another application, Contact Plus will continue to monitor the call's length.

The program can store the last 30 phone calls and 15 letters for a client; if you need to store more, an audit log records every phone call and letter. You can enter 15 reminders for each contact to remind you of important dates.

Contact Plus 2.1 runs on the IBM PC with 512K bytes of RAM and DOS 2.1 or higher. The company reports that it is working on a Novell-compatible version and an expense module.

Price: \$195.

Contact: E. Trujillo Software, P.O. Box 3992, Albuquerque, NM 87190, (800) 628-2828, ext. 581, or (505) 881-3223.

Inquiry 1022.

IF YOU ARE LOOKING FOR QUALITY, RELIABILITY, AND SERVICE



LOOK NO FURTHER!!! WE ARE PC-PLUS TECHNOLOGIES, INC.

All Brands of Software available . . . call for PRICES!

PC-PLUS XT Base System	PC-PLUS AT 286-12	PC-PLUS 386-20	PC-PLUS 386-25
<ul style="list-style-type: none"> *4.7712 MHZ Motherboard *Phoenix Bios *8 Expansion Slots *150 Watt Power Supply *640K of Memory *360K Floppy Drive *12" Monochrome Monitor *Monographics Card *Parallel-Serial-Game Ports *Clock Calendar *84 Key Keyboard *MS DOS 4.01 & GWBasic *2 Year Warranty 	<ul style="list-style-type: none"> *6/12 MHZ Motherboard *Phoenix Bios *8 Expansion Slots *Landmark 15.9 MHZ *220W Power Supply *640K of Memory *1.2MB 5.25" or A 1.44MB 3.5" Floppy Drive *12" Monochrome Monitor *Monographics Card *Parallel-2 Serial-Game Ports *101 Key Keyboard *MS DOS 4.01 & GWBasic *2 Year Warranty 	<ul style="list-style-type: none"> *6/20 MHZ Motherboard *Phoenix Bios *8 Expansion Slots *Landmark 26.7 MHZ *220W Power Supply *1024 of Memory (Exp. to 8MB) *1.2MB 5.25" or A 1.44MB 3.5" Floppy Drive *12" Monochrome Monitor *Monographics Card *Parallel-2 Serial-Game Ports *101 Key Keyboard *MS DOS 4.01 & GWBasic *2 Year Warranty 	<ul style="list-style-type: none"> *6/20 MHZ Motherboard *Phoenix Bios *8 Expansion Slots *Landmark 43.5 MHZ *220W Power Supply *1024K of Memory (Exp. to 8MB) *1.2MB 5.25" or A 1.44MB 3.5" Floppy Drive *Monographics Card *12" Monochrome Monitor *Parallel-2 Serial-Game Ports *101 Key Keyboard *MS DOS 4.01 & GWBasic *2 Year Warranty
<p>\$699</p> <p><i>XT Mono</i></p> <ul style="list-style-type: none"> *20MB Hard Drive \$989 *30MB Hard Drive \$1019 *40MB Hard Drive \$1129 *60MB Hard Drive \$1219 	<p>\$999</p> <p><i>286/12 Mono</i></p> <ul style="list-style-type: none"> *20MB Hard Drive \$1319 *30MB Hard Drive \$1339 *40MB Hard Drive \$1499 *60MB Hard Drive \$1539 *80MB Hard Drive \$1759 	<p>\$1769</p> <p><i>386/20 Mono</i></p> <ul style="list-style-type: none"> *20MB Hard Drive \$2079 *30MB Hard Drive \$2099 *40MB Hard Drive \$2259 *60MB Hard Drive \$2299 *80MB Hard Drive \$2519 	<p>\$2639</p> <p><i>386/25 Mono</i></p> <ul style="list-style-type: none"> *20MB Hard Drive \$2869 *30MB Hard Drive \$3009 *40MB Hard Drive \$3169 *60MB Hard Drive \$3219 *80MB Hard Drive \$3429
<p><i>XT CGA Color System</i></p> <p>\$859 with:</p> <ul style="list-style-type: none"> *20MB Hard Drive \$1159 *30MB Hard Drive \$1129 *40MB Hard Drive \$1309 *60MB Hard Drive \$1389 	<p><i>286-12 EGA Color System</i></p> <p>\$1419 with:</p> <ul style="list-style-type: none"> *20MB Hard Drive \$1729 *30MB Hard Drive \$1749 *40MB Hard Drive \$1899 *60MB Hard Drive \$1949 *80MB Hard Drive \$2169 	<p><i>386-20 EGA Color System</i></p> <p>\$2109 with:</p> <ul style="list-style-type: none"> *20MB Hard Drive \$2419 *30MB Hard Drive \$2439 *40MB Hard Drive \$2599 *60MB Hard Drive \$2649 *80MB Hard Drive \$2649 	<p><i>386-25 EGA Color System</i></p> <p>\$3139 with:</p> <ul style="list-style-type: none"> *20MB Hard Drive \$3489 *30MB Hard Drive \$3519 *40MB Hard Drive \$3669 *60MB Hard Drive \$3719 *80MB Hard Drive \$3929
<p><i>XT EGA Color System</i></p> <p>\$1099 with:</p> <ul style="list-style-type: none"> *20MB Hard Drive \$1399 *30MB Hard Drive \$1419 *40MB Hard Drive \$1549 *60MB Hard Drive \$1629 	<p><i>286-12 VGA Color System</i></p> <p>\$1599 with:</p> <ul style="list-style-type: none"> *20MB Hard Drive \$1919 *30MB Hard Drive \$1939 *40MB Hard Drive \$2069 *60MB Hard Drive \$2139 *80MB Hard Drive \$2340 	<p><i>386-20 VGA Color System</i></p> <p>\$2299 with:</p> <ul style="list-style-type: none"> *20MB Hard Drive \$2609 *30MB Hard Drive \$2629 *40MB Hard Drive \$2789 *60MB Hard Drive \$2829 *80MB Hard Drive \$3049 	<p><i>386-25 VGA Color System</i></p> <p>\$3399 with:</p> <ul style="list-style-type: none"> *20MB Hard Drive \$3749 *30MB Hard Drive \$3769 *40MB Hard Drive \$3929 *60MB Hard Drive \$3979 *80MB Hard Drive \$4189

**TOLL-FREE
TECHNICAL SUPPORT**

**MONEY-BACK
SATISFACTION
GUARANTEE**

**2 YEAR
LIMITED WARRANTY**

**QUALITY AND
RELIABILITY**

TWO-YEAR WARRANTY

**PC-PLUS TECHNOLOGIES
CALL TOLL FREE 1-800-422-4947**

**Loft Plaza ■ 65 Southbridge Street ■ Auburn, MA 01501
PHONE: (508) 831-9826 ■ FAX: (508) 799-9941**

PAYMENT TERMS:

We accept MasterCard, VISA, Am Ex., Discover, Certified Checks, Money Orders, Personal Checks (allow 7-10 days for processing). We also accept Corporate, Equivalent, Governmental P.O.'s.

*Massachusetts residents add 5% sales tax.

*Prices subject to change without notice.



EXPAND YOUR NET WORTH ... AFFORDABLY BEST PRICES — GREAT VALUES!

NETWORKS



NOVELL®
ELS I \$495
ELS II \$895
Advanced 2.15 \$1695
SFT2.15 Call

LATTISNET®

UTP Transceiver 505 \$499
UTP Thin Net Adapter 2500-01 \$2099
UTP Concentrator 2500-01 \$1539
Dept Concentrator 1010-01 Call
Other Lattisnet products Call

ARCNET SMC®

Arcnet 1/2 card PC-120 \$155
16 bit Arcnet w/nc pc 500w/S \$489
8 port active Hub AH-01 \$429
Other Arcnet products Call

3COM®

Etherlink II 3C503 \$299
Etherlink MCA 3C523 \$499
3S400 Server
3C1200G \$8,999
Other 3COM products Call

TOKEN RING, PROTEON®

Pronet 10 Adapter P1300 \$399
Pronet 4 Adapter P1340 \$559
Active Hub #2000 141812 \$210/\$560/\$834
Other Token Ring products Call

BANYAN®

Vines 386 software \$4189
DTS 253 Server 3MB/144MB \$9450
CNS 54B Server 8MB/320MB \$26,995
CALL FOR COMPLETE NETWORK SOLUTIONS

HARD DRIVES

CDC/IMPRIMIS®

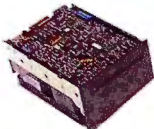

106MB 5 1/4" 18ms 40,000 MTBF \$995
182MB 5 1/4" 16.5ms 40,000 MTBF \$1245
228MB 5 1/4" 18ms 40,000 MTBF \$1595
383MB 5 1/4" 14.5ms 40,000 MTBF \$1985
385MB 5 1/4" 10.7ms 40,000 MTBF \$2295
627MB 5 1/4" 16ms 40,000 MTBF \$2989
766MB 5 1/4" 14ms 40,000 MTBF \$3195
1.2GB 8" drives Call

PRIAM®

ID330 330MB 20ms \$2399
ID130 132MB Internal AT \$1599
ID60 60MB Internal AT \$649
ID43 43MB Internal AT \$549

MINISCRIBE®

MS 3650/3053 40MB 55ms/25ms \$269/\$369
MS 6085/3085 \$525/\$575
MS3180 150MB \$1125
MS 9380E 330MB \$1995

TOSHIBA®

MK 134 FA 3 1/2" 40MB 20ms Call

SEAGATE SCSI®

ST 157N 3 1/2" 43MB SCSI \$421
ST 277N 5 1/4" SCSI HH \$429
ST 296N 5 1/4" SCSI HH \$559

PS/2® HARD DRIVES

EDI 106/182 MCA \$1395/\$1695
EDI 383/637 MCA \$3595/\$3795



EDI 386/33/25*

Time is money. Don't let your computer slow you down. These systems are designed to work as stand alone or as Novell/3 Com LAN servers. Parts and labor warranty is included! Assembled in the USA

Landmark: 54Mhz

- 64K cache memory
- 80386 33Mhz CPU
- Socket for 80387-20
- 1MB exp to 10MB
- Tower case w/ turbo light switch
- HD/FD 1:1 cont
- Mono monitor
- MGA card
- 85MB Hi performance HD
- 1.2MB floppy
- 101 kybd (BTC or Maxiswitch)
- OS/2, Unix, Xenix, Novell comp

Same configuration available with desk top case.

\$3249*

EDI 386/20/16

The fastest! Intel 80286 based computer available. It rivals an 80386 in speed in certain applications. Ready for Novell®, 3 Com® and all other LANs or stand alone use. Assembled in USA.

Landmark: 31 Mhz

- 20 Mhz 80386 - 0 wait state
- 1MB RAM exp to 16MB
- 64K cache
- 80387 support
- 40MB 25ms HD
- Enhanced keyboard
- Turbo tower case w light & reset
- HiRes Mono monitor/card
- 1:1 interleave HD/FD controller
- Serial/parallel ports
- 1.2MB FD (supports 1.44MB, 720K, 360K)
- OS/2, Unix, Xenix & Novell compatible

\$2699*

EDI 286/20/16/12

Designed to replace your old PC systems. Works well as a work station or as a server in small LAN's.

Landmark: 20.8Mhz

- 20 Mhz 80286 - 0 wait DRAM
- 1MB RAM exp to 16MB
- 80287 support
- 40MB 40ms HD
- Enhanced keyboard
- Turbo tower case w light & reset
- HiRes Mono monitor/card
- 1:1 interleave HD/FD controller
- Serial/parallel ports
- 1.2MB FD (supports 1.44MB, 720K, 360K)
- OS/2, Unix, Xenix & Novell compatible

\$1989*

EGA, VGA, color, High Capacity Hard Drives and other configurations available. Pre-installed Networks are our specialty. All systems have a parts & labor warranty.

Call us today.

TAPE DRIVES

ARCHIVE®

ARC 5240 40MB Internal \$389
40MB Int/ext for PS/2 \$249/\$389
135MB Int for Compaq \$1199

EMERALD®

VAST 2.2GB Backup AT or MCA \$5995
150MB Int/ext cart \$2059/\$2399

MAYNARD®

60MB Int/ext XT/AT cass \$789/\$999
150MB Int/ext XT/AT cart \$1299/\$1499
60MB Int/ext PS/2 cass \$959/\$1099
2.2GByte \$5499

CAD/GRAPHICS

DIGITIZERS/TABLETS



Genius tablet GT1212A \$315
Genius tablet w/stylus \$379
Calcomp 23120 12x12 \$589
Kurta IS-1 12x17 \$621
IS-3 24x24 \$2389
IS-3 30x36 \$3289
IS-3 36x48 \$3689
IS-3 12x60 \$4489

PLOTTERS

HEWLETT PACKARD®

HP 7440A \$969
HP 7457A \$1495
HP 7550A \$3099
HP 7570A \$3175
HP 7575DXL \$4029
HP 7576EXL \$5239
HP 7576A Draftmaster \$8349
HP 7596A Draftmaster \$9915

ROLAND DG®

DXY-865 desktop plotter, 8 pen AB size \$691
DXY-1100 \$909
DXY-1300 \$1749
GRX-300 A-O Drafting plotter \$3539
GPX-400 A-E Drafting plotter \$4991
DPX-2000 A-C Flatbed plotter, 8 pens \$2191
DPX-3300 A-D Flatbed, 8 pen, 7777 \$3441

HOUSTON INSTRUMENTS®

DMP 29/40 \$1691/\$891
DMP 52/52MP \$2471/\$2791
Others Call

CALCOMP®

1023 Artisan pen plotter \$3781
1025 Artisan pen plotter \$5347
1042GT w/plot mgr \$7491
1044GT w/plot mgr \$10,241

MICE

Genius Dyna Mouse \$59
GM 6000 \$59
Lagitech Hi res serial \$99
Others Call

SCANNERS

Genius hand scanner \$209
Others Call

APPLE MAC®/SCSI HIGH PERFORMANCE DRIVES

EDI 62MB \$799
EDI 1280MB Int/ext 1280 mb/rti \$6899/\$6999
EDI 680MB Int/ext 680 mb/rti \$4789/\$4789
EDI 627MB Int/ext 627 mb/rti \$3489/\$3989
EDI 383MB Int/ext 383 mb/rti \$2349/\$2899
EDI 182MB Int/ext 182 mb/rti \$1699/\$1949
EDI 106MB Int/ext 106 mb/rti \$999/\$1199

DRIVES FOR LAPTOP COMPUTERS

EDI 40MB for laptops \$629
EDI 100MB for laptops Call
EDI 200MB for laptops Call
Call us for difficult drive solutions

286 AT

MOTHER BOARDS

286/12 Mhz \$189
286/8Mhz \$139

EDI

An International Data Systems Company
IDS Inc.

12800 Garden Grove Blvd., Bldg. E., Garden Grove, CA 92643

SALES (714) 530-8677
TECH SUPPORT (714) 530-8697

SHIPPING INFORMATION (714) 530-8697
FAX (714) 530-0815



A-TRONIC COMPUTER

WE BEAT ANY PRICE • 1 YEAR PARTS AND LABOR WARRANTY

ATC 386-25 \$2050

- Intel 80386 Microprocessor
- 25 MHZ M/Board 20 MHZ CPU
- 4Mb Installed
- 80387 socket on board
- 1.2 High Density Drive
- W.D. Hard/Floppy Controller
- 230 Watt Power Supply
- Vertical case w/reset button and LED light
- Digital CPU Speed Reading
- Hi-Res TTL Monitor
- Monochrome (Herc.) Graphic Card
- 101 Enhanced Keyboard

W/64K CACHE
25MHZ CPU
\$2,560.00

ATC 286-12 \$799

- IBM AT-286 Compatible
- 6/12 MHZ CPU 0 Wait State
- Phoenix Bios
- 512k memory on Board
- 1.2 High Density Drive
- W.D. Hard/Floppy Controller
- 200 Watt Power Supply
- AT 3 Opening Case w/reset buttons
- Clock and calendar on board
- 101 Enhance Keyboard
- Mono Card
- Parallel Printer Port
- Hi Res TTL Monitor
- FCC Class B Approved

ATC TURBO-10 \$459

- IBM XT Compatible
- 4.77 / 10 MHZ CPU
- Intel 8088
- Phoenix Bios
- 640K on board (1024K expandable)
- 360k Floppy Drive
- 165 Watt Power Supply
- AT Style Case w/Led Power & Turbo Light, Reset & Turbo button
- Monochrome Card
- Parallel Printer Port
- Hi Res TTL Monitor
- AT Style 84k Key Board
- FCC Class B Approved

HYUNDAI SUPER-16E \$699

- Turbo-10Mhz (8088-1)
- 640K on board
- 360K Floppy Drive
- Serial/Parallel
- Clock Calendar w/batt. b/up.
- Multi video (MDA/MGA/CGA)
- Hi-Res TTL Monitor
- 101 Enhance keyboard
- MSDOS 3.3 w/GW Basic
- Key Works and Electric Desk Software
- 18 Months nation-wide warranty



Comdex Fall '89
See us in Hotel Riviera
Booth #8019

This Month Specials:

PLATINUM VGA-16

\$189

- 1024 x 768
- 256K on board
- 512K expandable
- 100% Software/Hardware compatible

We Distribute



&



Products

• UPGRADE •

- Color Monitor w/Graphic Card **\$160**
- EGA Monitor w/EGA Card **\$350**
- VGA Monitor w/VGA Card **\$410**
- Multisync Monitor w/Hi-res. Card **\$530**

HARD DISK

- Seagate St-225 w/Cont. **\$259**
- Seagate St-238 w/Cont. **279**
- Seagate St-251 **339**
- Seagate St-251-1 **389**
- Seagate St-277R **389**
- Seagate St-4096 **579**
- Seagate St-125 **235**
- Seagate St-138 **279**
- Seagate St-4144R **650**

- Miniscribe 3085 **\$559**
- Miniscribe 3650 **305**
- Micropolis w/Controller (150 MB) **1350**

A-TRONIC COMPUTER

Industrial Office: 15703 East Valley Blvd.
City Of Industry, Ca. 91744

Order Hot Line: **(818) 333-0193**

Fax No. (818) 961-4337

L.A. Branch: 7150 Beverly Blvd.
Los Angeles, Ca 90036

Tele: **(213) 930-2823**

Fax: (213) 930-2826

Circle 525 on Reader Service Card

Mon-Fri 8:00 - 6:00 (West Coast)
Mon-Fri 11:00 - 9:00 (East Coast)

ORDER BY MAIL: Check and Money Order, California add 6.5% Sales Tax
ORDER BY PHONE: COD & Cashier Check's

TERMS: All prices are subject to changes and quantities may be limited and we reserve the Right to Substitute Equivalent Items. Unauthorized Returns are subject to 15% Restocking Fee. Call for RMA Numbers for Returns and Repairs. Returning items must be sent shipping prepaid by customer. 1 year parts and labor.

OCTOBER 1989 • B Y T E 80NE-21

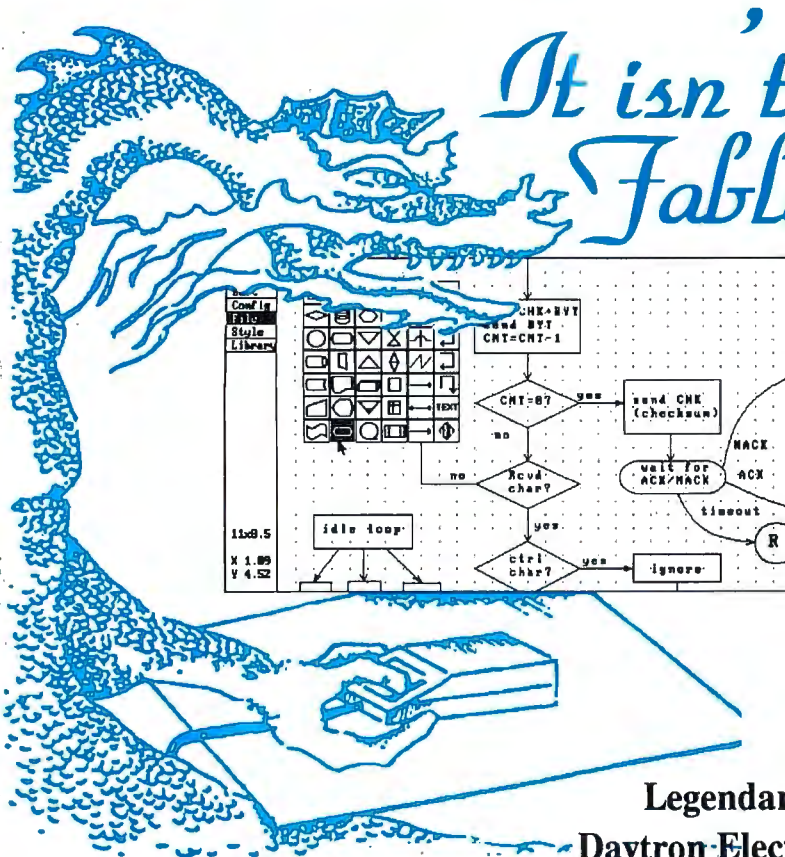

It isn't just another Fable

TurboFlow is serious flowcharting software at a price that won't cost you your kingdom. It's easy to use and more powerful than Merlin's magic.

TurboFlow runs on an IBM PC, features a complete set of ANSI symbols, is menu driven, interfaces with desktop publishing software, and supports a variety of printers and plotters.

So stop living in the dark ages. Call 1-800-882-5822 and order your copy, or ask for our free brochure.

TurboFlow & Logitech Mouse **\$89**

TurboFlow **\$69**



TurboFlow

Legendary Software from:

Daytron Electronics, Inc.

610 S. Sherman suite 104, Richardson, Tx 75081 (214)669-2137

NOCONA

ELECTRONICS

Tandy®
Computers & Printers

Radio Shack™
Products



WHOLESALE PRICES TO EVERYONE

256K MOD 1000 HX	509.00	MOD 102 TERMINAL	419.00	DMP 107 PRINTER	209.00
384K MOD 1000 SL	559.00	1400 FD PORTABLE	1175.00	DMP 133 PRINTER	275.00
640K MOD 1000 TX	759.00	VM-5 MONO MONITOR	109.00	DMP 300 PRINTER	439.00
640K MOD 1000 TL-2	929.00	CM-5 COLOR MONITOR	209.00	DMP 2102 PRINTER	719.00
512K MOD 3000 NL	1139.00	CM-11 COLOR MONITOR	299.00	LP 1000 PRINTER	1759.00
1MG MOD 4000 SX	1799.00	VGM 100	149.00	DWP 230 PRINTER	259.00
2MG MOD 4000 LX	2888.00	VGM 300	429.00	DWP 520 PRINTER	429.00
DT-110 TERMINAL	449.00	EGM-1 COLOR MONITOR	489.00	20MG 1400 HD	1875.00

* PRICES SUBJECT TO CHANGE WITHOUT NOTICE

20% TO 60% OFF CATALOG PRICES. STANDARD WARRANTY 100% RADIO SHACK COMPONENTS
UPS DELIVERY VISA..MASTERCARD..AMERICAN EXPRESS..FRIENDLY SERVICE
IMMEDIATE SHIPMENTS REQUIRE CASHIER'S CHECK OR MONEY ORDER

(817) 825-4027

NOCONA ELECTRONICS • BOX 593 NOCONA, • TX 76255

Local Area Network Cookbook

- * 30 Day Money Back Guarantee on hardware, no questions asked (sorry, but no refunds on software)
- * All systems support PC-DOS/MS-DOS, OS/2, UNIX, XENIX, AutoCAD, Novell, Windows 286/386 (as appropriate), LIM/EMS 4.0, and other IBM PC/AT/Compaq 386 applications. Fully IBM PC/AT compatible.
- * MC/Visa accepted (no surcharge), as are personal checks (take approx. 2 weeks), COD cashier's check
- * Assistance from experienced technicians who use the hardware and software (e.g., this ad was composed in-house)
- * 72 hour burn-in on all systems * 1 year parts and service warranty
- * 45 page user manual included * Ergonomic cases with front panel power, reset, turbo switches
- * Authorized Novell Dealer * High performance Ethernet hardware, Novell/Lantastic software



286 Model 112

- Beginner's computer system or entry level small business workstation.
- * 286 CPU, 6/12.5 MHz, 80287 coprocessor socket
 - * Award BIOS
 - * 640KB memory (expandable to 4 MB on the motherboard)
 - * small footprint case 14" W x 7" H x 16" D with power, reset, and turbo switches up front, 3 half-height and 1 3-1/2" externally accessible devices
 - * 5-1/4" 1.2MB floppy drive
 - * Western Digital chip controller card supports up to 2 floppy and 2 hard drives
 - * 20 MB, 65 ms or fast 38 ms access time, MFM ST506/412 hard drive
 - * 12" amber monochrome, 14" EGA (16/64 color) monitor, or 14" VGA (256/256,000 color) monitor
 - * IBM monochrome display/Hercules monochrome graphics (720x348 pixels), EGA color (640x350 pixels) card, or VGA color (640x480 pixels) card
 - * 2 serial, 1 game, 1 parallel ports
 - * Six 16-Bit, Two 8-Bit slots, bus speed 8 MHz
 - * Real time clock with 10-year life battery
 - * 200 watt power supply
 - * 101 key keyboard
 - * Ratings: Landmark, 12.5, Norton SI, 12.3



386 Model 420

- Corporate engineering workstation, or medium business/corporate departmental file server
- * 386 CPU, 20 MHz, 80387 or Weitek 1167 or 3167 socket
 - * Phoenix BIOS
 - * 4 MB memory, 32-Bit wide memory bus up to 16 Mbytes
 - * tower case 8" W x 25" H x 18" D with power, reset, and turbo switches up front, 3 half-height externally accessible, 1 full-height and 1 3-1/2" internal devices
 - * 5-1/4" 1.2 MB floppy drive
 - * Western Digital chip controller card supports up to 2 floppy and 2 hard drives
 - * 66 MB 22 ms RLL 1:1 interleave ST506/412, or 142 MB 22 ms MFM ESDI, hard drive
 - * 12" amber monochrome, 14" EGA (16/64 color), or 14" VGA (256/256,000 color) monitor
 - * IBM monochrome display/Hercules monochrome graphics (720x348 pixels), EGA color (640x350 pixels), or VGA color (640x480 pixels) card
 - * 2 serial, 1 parallel, 1 game ports
 - * Five 16-Bit, Two 8-Bit slots
 - * Real time clock
 - * 200 watt power supply
 - * 101 key keyboard
 - * MS-DOS 4.01
 - * Logitech HiRez Bus Mouse
 - * Ratings: Landmark, 25.5, Norton SI, 23.0

	20MB 65 ms	38 ms
Mono	\$1,099	\$1,149
EGA	\$1,549	\$1,599
VGA	\$1,599	\$1,649

	66MB 22ms	142MB 22 ms
Mono	\$2,649	\$3,449
EGA	\$3,099	\$3,899
VGA	\$3,199	\$3,999

LANsystem 8142

8 simultaneous logged in user maximum. Novell ELS II based network system. Base system includes 1 central file server (can be used as a workstation in an emergency), 1 manager workstation, and 1 user workstation

FILE SERVER

- * 386 Model 420 Mono with 142 MB 22 ms hard drive but without mouse or MS-DOS 4.01
- * 16 bit Ethernet network interface card
- * Terminator/T connector
- * Preinstalled Novell ELS II network operating system with user access rights, online system manager tutorial, login menus
- * Network Boot floppy
- * MS-DOS 3.3

MANAGER WORKSTATION

- * 286 Model 112 EGA with 20MB 38 ms hard drive
 - * 8 bit Ethernet Network interface card
 - * 40 ft. cable
 - * Terminator/T connector
 - * 40MB tape backup unit
 - * Network Boot floppy
- ### USER WORKSTATION
- * 286 Model 112 Mono except without hard drive and hard drive controller
 - * 8 bit network interface card
 - * T connector
 - * 40 ft. cable
 - * Network Boot floppy

LAN8142 as above

\$8,514

- Addl User Workstation **\$1,130**
- Addl Mgr Workstation (without tape unit) **\$1,835**

We welcome add-ons but no substitutions please on the items in this ad.

(603) 888-8288 10am-7pm ET MonSat

FAX (603) 888-8289 24 hr

LANsystem 220

120 simultaneous logged in user maximum Lantastic based network system. Base system includes 2 workstations distributed file servers. Upgradable to LANsystem 8142.

MANAGER WORKSTATION

- * 286 Model 112 EGA with 20MB, 38 ms hard drive
- * 8 bit Ethernet network interface card
- * Terminator/T connector
- * Network Boot floppy
- * MS DOS 3.3
- * Preinstalled Lantastic network operating system with user access rights, login menus

USER WORKSTATION

- * 286 Model 112 Mono with 20 MB 38 ms hard drive
- * 8 bit Ethernet network interface card
- * Terminator/T connector
- * 40 ft. cable
- * Network Boot floppy

LAN220 as above

\$4,357

- Addl User Workstation **\$1,464**
- Addl Mgr Workstation (with 40 ft. cable) **\$1,983**

All brand and product names are trademarks or registered trademarks of their respective companies. Specifications subject to change without notice.

L&W

MicroComputing Corp.
278 D W Hwy South
Nashua, NH 03060

FREE 1-YEAR SUBSCRIPTION TO DATA COMMUNICATIONS

If You Qualify

If you are responsible for the use, planning, design or implementation of data and information systems...we want to offer you a **one-year subscription to Data Communications FREE-OF-CHARGE!**

The leading networking magazine since 1972, DATA COMMUNICATIONS is the *only monthly publication devoted solely to networking*. It will keep you fully informed on the latest technology, equipment, services, opportunities and challenges that affect your network. No other publication delivers the timely, technical analysis that is crucial to you.

You'll see how you can *cash in on profitable new strategies and applications* for factory and office automation, distributed processing, and electronic mail. Plus, DATA COMMUNICATIONS *warns you of the dramatic changes ahead in tariffs, regulations and standards* - and what they'll mean to you and your company.

Here is a preview of what you'll be seeing:

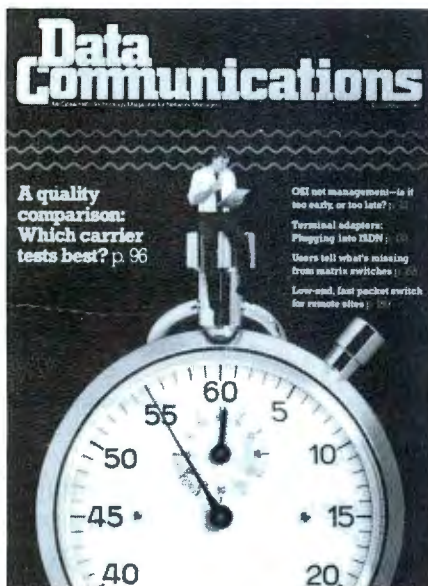

October issue - Our editors will lay out the technical and market trends for TI in this issue.

November issue - OSI products, prospects, and services. Which vendors are offering real solutions and which are only offering lip service - Find out.

November LAN Strategies Special Issue - Includes LAN operating systems and applications, gateways, bridges, routers and cabling schemes.

December issue - A report from the field outlines how integrated network management works and doesn't work.

1990 Buyers' Guide issue - The powerful, year-round reference that provides vital product and vendor information networking decision-makers need when they are ready to buy.

Don't get left behind! Stay on top of the rapid changes in technology and discover how you can take full advantage of the latest advances with DATA COMMUNICATIONS.

Fill in and mail your FREE subscription application **today!**



NO POSTAGE
NECESSARY
IF MAILED
IN THE
UNITED STATES

BUSINESS REPLY MAIL
FIRST CLASS PERMIT NO. 42 HIGHTSTOWN, NJ

POSTAGE WILL BE PAID BY ADDRESSEE



**Data
Communications**

**P.O. Box 477
Hightstown, NJ 08520-9362**

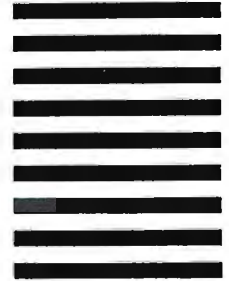

FREE SUBSCRIPTION

YES, Please enter my FREE one-year subscription to DATA COMMUNICATIONS

No, I'm not interested in this FREE offer.

IBD0292

Signature _____ Date _____

Name _____ Title _____

Company _____ Div. or Dept. _____

Address _____ City _____

State _____ Zip _____ **Please Note: Company affiliation and address must be given.**

Check here if you want publication sent to home address:

Street _____ City _____

State _____ Zip _____

ALL QUESTIONS MUST BE ANSWERED TO QUALIFY FOR FREE SUBSCRIPTION.

1. Which of the following best describes your company? (Check one only)

- 1. Manufacturer (other than communications/computer equipment)
- 2. Transportation
- 3. Healthcare/Medical
- 4. Education
- 5. Retail/Wholesale Trade
- 6. Other End Users of Communications Systems, Equipment and Services
- 7. Manufacturer of Communications Products and Services
- 8. Government — Federal/State/Local
- 9. Regulatory Agency
- 10. Finance: Banking, Insurance, Investment Firm, Brokerage
- 11. Bell Operating Company
- 12. Telephone Company (non-Bell)
- 13. Inter-Exchange Company
- 14. Other Carrier (Including Public Data Network Provider)
- 15. Broadcast
- 16. PTT
- 17. Interconnect Company
- 18. Reseller of Communications/Computer Equipment
- 19. Systems Integrator
- 20. Value Added Reseller
- 21. Systems House
- 22. Software Vendor
- 23. Distributor
- 24. Consulting
- 25. Other _____

(Please specify)

2. What is your job function? (Check one only)

- 1. Network Management (VP, Director, Department Head, etc.)
- 2. Data Communications Management (VP, Director, Department Head, etc.)
- 3. Telecommunications Management (VP, Director, Department Head, etc.)
- 4. MIS Management (VP, Director, Department Head, etc.)
- 5. Corporate Management (Chairman, President, Owner, General Manager, CEO, CIO, VP)
- 6. Financial Manager/Analyst
- 7. Engineering Management
- 8. Consultant
- 9. Other _____

(Please specify)

3. What is your primary responsibility? (Check one only)

- 1. Data networking
- 2. Voice networking
- 3. Both
- 4. Other _____

(Please specify)

PLEASE SIGN, DATE AND MAIL THIS POSTAGE-PAID FORM BACK TO US. THANK YOU.

THE PUBLISHER RESERVES THE RIGHT TO ACCEPT OR REJECT ANY SUBSCRIPTION.

LOWEST PRICES
QUICK DELIVERY

Electrified



WE WILL TRY TO BEAT ANY PRICE ON ANYTHING FROM ANYWHERE !!!
A TRULY PROFESSIONAL STAFF WITH A COMMITMENT TO SERVICE !!!

★ **MULTIMATE** ★
Professional Word
Processing Software
Version 3.31
BRAND NEW For IBM & Compatibles
LIST \$495 - COST
\$99
MULTIMATE ADVANTAGE
SOLD BELOW DEALER COST
\$149

★ COMPUTER COUNTRY ★

COMPARE!!! ★ **THE AWESOME AT** ★ BRAND NEW!!!
QUADRANT — AT — 80286 FULLY IBM — AT COMPATIBLE

SYSTEM OPTIONS:
Controller — Dual HD/FD \$ 79
1.2MB — 5 1/4 Drive 79
350K — 5 1/4 Drive 79
720K — 3 1/2 Drive 99
1.44MB — 3 1/2 Drive-Requires DOS 3.3 119
20MB — Hard Drive 199
32MB — Hard Drive — 30MS Fast 249
40MB — Hard Drive 299
Larger Hard Drives Available Call
IRWIN-20MB Tape Back-Up System-Model 125 249
15" Mono Monitor and Card 99
Color Monitor—Hi Res with Color Card 229
DOS 3.1/3.2/3.3/4.01 39/49/69/79
Parallel Card 19
Serial Card 19
AT-Par Serial Card 29

512K INSTALLED • Full Size AT Case • 6Mghz • 200 Watt Power Supply
• 80287 Socket • Phoenix BIOS • 84 Key-AT Style-True IBM Style Click Keyboard
• Clock/Calendar with Battery Backup • 6-AT and 2-KT Slots
• Diagnostic Disk • 6 Month Warranty

SPECIAL 512K MEMORY BOARD UPGRADE - 1 MEG OF SYSTEM MEMORY ONLY \$99

\$499 COST UNBELIEVABLE!!!

★ PRINTER POWER ★

SAVE **IBM 5182**
★ COLOR PRINTER ★
LIST \$1995
\$499
★ BRAND NEW • HEAVY DUTY ★
• WIDE CARRIAGE (132 Column)
• 200 CPS Draft, 110 CPS Correspondence, 35CPS N.L.Q.
• Prints Black, 4 Colors, and 8 Colors • Bidirectional Dot Matrix
• 9 Wire-Parallel Interface • Tractor Included
FRONT — BOTTOM — REAR PAPER FEED
30 DAY WARRANTY

PAPER RACK AVAILABLE - Stacks Printed Paper — ONLY 12.95
Easy change Cartridge Ribbons - AVAILABLE
★ ★ QUANTITY PRICING — CALL!!! ★ ★

★ THE SUPER SYSTEM ★

XT-TURBO COMPUTER SYSTEM SUPER INEXPENSIVE!!!
1-DRIVE IBM COMPATIBLE SYSTEM WITH 256K MEMORY!!!! SUPER VALUE!!!
SYSTEM INCLUDES: **256K INSTALLED** 8088-2 Processor
• 1-Half Height, 360K, 5 1/4 Drive INSTALLED • Dual Speed — 4.77Mghz and 8Mghz
— **TURBO** • 8 slots • 8087 Socket • 150 Watt Power Supply • Deluxe Keyboard
• Full Size Case for 4-1/2Ht. Drives • 1 Year Parts and Labor Warranty on Base Unit (Hard Drives 90 Days)

SYSTEM OPTIONS:
ADD a 2nd 360K 5 1/4 Drive \$ 79
ALL HARD DRIVES INCLUDE CONTROLLERS
ADD a 10MB Drive 149
ADD a 20MB Drive 199 (Super Special)
ADD a 30MB Drive 299
ADD a 40MB Drive 359 (FAST 30MS Speed)
ADD a 45MB Drive 399
15" Mono Monitor and Card 99
Color Monitor—
Hi Res with Color Card 229

Serial Card 19
Parallel Card 19
Clock Calendar Card 29
Par/Ser/Clk/Game Card 49
DOS 3.1 39
DOS 3.2 with Basic 49
Memory Upgrade to 512K 69
(For 4.77Mghz Systems Only)
Memory Upgrade to 640K 99

\$299
Quantity Pricing Available!

IMPOSSIBLE PRICE:

CITIZEN MSP-50

BRAND NEW! - COLOR OPTIONAL!!

300 CPS, 50 NLQ - Narrow Carriage, 9 - Wire
Epson/IBM Compatibility - Push or Pull Tractor
Zero Tear Off - Top or Bottom Feed,
Automatic Paper Loading - 8K Buffer
18 Month Manufacturers Warranty - Parallel Interface
List = \$499

MSP-50 Options
Color Kit (7 colors) \$59
Serial Interface \$49
Font Card (640x480) \$59
Black or Color Ribbons Available - Call!!!

Amazing Only \$269

Quantity Prices
3 in \$249
6 in \$245
12 in \$239
24 in \$229

★ HARD DRIVE DEAL ★

SEAGATE ST-238
30MB • 1/2Ht • 5 1/4" Drive • RLL **\$169**

TANDON-TM 262-20MB - 3 1/4" 5 1/4" Hardware-65MS \$139
Seagate ST-225 - 20MB - 1/2Ht. - 65MS 169
Seagate ST-251-0 - 40MB - 1/2Ht. - 40MS 279
Western Digital Gen Controller - NEW 49
REFURBISHED — 90 DAY WARRANTY

FULLY TESTED — 3 MONTH WARRANTY
REFURBISHED — BRAND NEW CONDITION

CENTRONICS GLP

BRAND NEW!!
100 CPS — 25NLQ
with Tractor
Parallel/Serial Interface
NARROW CARRIAGE
FULL WARRANTY!!
Only **\$139**

Quantity Pricing
6 = \$129
12 = \$125
Over 12 - CALL!!

LIST \$343

WESTERN DIGITAL NEW—1-Year Warranty
RLL Controller for XT and Seagate ST-238 **\$49** ONLY
Complete with Cables

★ **IBM — 256K — MEMORY CARD** ★
Fully Populated with 256K
Only Works at 4.77MHz Speed
COST \$69 Quantity 1
COST \$65 Quantity 12

★ MONITOR MANIA ★

PRINCETON GRAPHICS
ULTRASYNIC
LIST 1849 12" Multisync - Ultra Hi-Res
28 Dot Pitch - 800 x 600
Demo Product - MINT CONDITION
FULL WARRANTY 1-YEAR!!!
BRAND-NEW CONDITION!!!
ONLY **\$399**

Monitor Cards on Special Also!!!

THE BEST MONITOR DEALS IN THE USA!!
MAJOR Manufacturer
14" CGA COLOR MONITOR
SUPER Hi-Res - 640 x 400
BRAND NEW!
COLOR CARD INCLUDED
BETTER THAN EGA RESOLUTION!!
.31 Dot Pitch - Anti Glare Screen - Includes Graphic Memory Upgrade Kit - 90 Day Warranty
THE BEST CGA RESOLUTION YOU CAN BUY!!!
ONLY LIST \$963
\$249
Unbelievable!
Quantity Pricing
3 - \$239 6 - \$235
12 - \$229 24 - \$225
Over 24 - CALL!

★★ **Electrified Discounters** ★★
1066 SHERMAN AVENUE
HAMDEN, CT 06514
FAX 203-248-8680
\$2 refund on all telephone orders over \$100
(203) 287-1976
DEALER INQUIRIES INVITED
CATALOG SENT WITH ALL ORDERS
MasterCard VISA AMERICAN EXPRESS
All prices listed are Cash Discounts. Add 5% for MasterCard, Visa or AMEX. Not responsible for typographic errors. Prices are subject to change without notice. Some items are available by special order. Quantities are limited. Prices do not include freight. Allow 2 weeks for product completion. (This includes 30% restocking and handling fee on all orders. Company is not responsible for shipping delays or non-delivery of products. It is a registered trademark of International Electronic Machines, Inc.)

PageLaser 6 Features LaserJet Slots

Toshiba's PageLaser 6 weighs 35 pounds, prints 6 pages per minute at 300 dpi, and is priced just under \$2000.

The printer features two LaserJet-compatible font slots. The printer's four resident fonts are available in portrait and landscape orientations. It comes standard with 512K bytes of RAM, but you can upgrade to 1, 2, or 4 megabytes.

The toner cartridge and drum are user-accessible, and each cartridge is rated for at least 3000 prints. When you change the toner, you also change a counter in its socket that tells you through a color-coded light whether it's fresh toner, whether you need to order new toner, or whether you're approaching the 3000-sheet limit. Each toner kit includes two 1500-print toner cartridges and one drum-counter key.

Standard emulations include Hewlett-Packard LaserJet Series II and IBM Printer XL24. The company says it's working on a PostScript-compatible version. **Price:** Less than \$2000; toner kit, \$49. **Contact:** Toshiba America Information Systems, Inc., Computer Systems Division, 9740 Irvine Blvd., Irvine, CA 92718, (800) 457-7777 or (714) 583-3000. **Inquiry 1013.**

C Libraries for Multiple Platforms

Vermont Views is a set of C libraries for DOS, Unix, Xenix, VMS, and, soon, OS/2 that were developed to allow portability

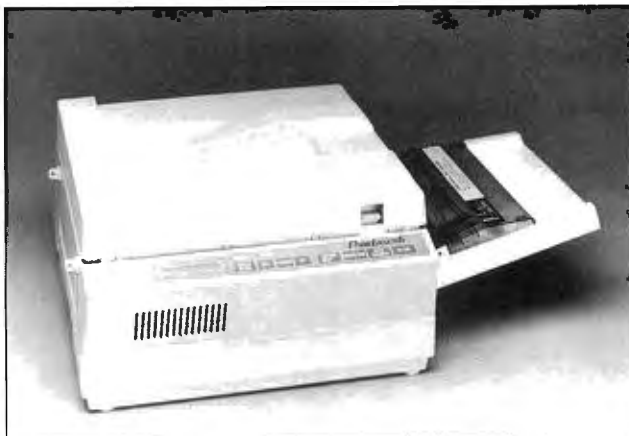

The PageLaser 6's input and output trays have a capacity of 150 letter-size sheets.

among operating systems. According to Vermont Creative Software (VCS), you can recompile and relink source code with different versions of Vermont Views with little or no source code modification.

Vermont Views lets you create and manage windows, menus, data-entry forms, text entry, and context-sensitive help. Other features include forms and menus that are bigger than their display windows, automatic scroll bars, horizontally scrollable text fields, scrollable regions for entering variable lines of items, and a mini word processor that you can attach to a field.

VCS reports that it developed the libraries for international portability as well. The programs support any Roman-based language, and the DOS version supports all non-English characters of the IBM Extended Character Set, including utilities to handle uppercase-to-lowercase and lowercase-to-uppercase conversions. You can enter, validate, and manipulate dates and times to accommodate international or military formats, and you can change characters used as decimal and thousands separators.

Price: DOS version, \$395 (\$795 with full source code); Unix and VMS, \$2395 and up; Xenix, \$1595; OS/2, \$495. **Contact:** Vermont Creative Software, Pinnacle Meadows, Richford, VT 05476, (800) 848-1248 or (802) 848-7731. **Inquiry 1021.**

Interactive Fiction Videodisk for the Mac

Frame Up places you in the shoes of Eddy, who falls asleep in a department store and wakes to discover he's suspected of burglary. It's your job to get Eddy out of the store before the police arrive or to somehow prove his innocence.

The story's plot isn't unusual for an interactive simulation. What makes Frame Up different is that you prove his innocence by creating a video montage, by editing 10 videotapes that are part of the store's security system. You can view any of the 10 cameras once you get into the control room, or you can play back tapes from 10 VCRs. The tapes are actual film sequences that Imedia International shot to add realism to the program. If you're caught, you're given about 4 minutes to edit the tapes and prove that Eddy is innocent.

The game runs on a Macintosh that's hooked up to a Sony, Pioneer, or Philips industrial videodisk player. The video portion of the program appears in a window, and you make decisions and edit in another window.

Frame Up works on the Mac Plus or higher with HyperCard. Other versions are available for the Amiga and the IBM PC.

Price: \$100. **Contact:** Imedia International, Inc., 6061 Paseo Canyon Dr., Malibu, CA 90265, (213) 457-8045. **Inquiry 1023.**

Statistical Analysis and Probability

Monte Carlo Simulations 2.1 consists of three modules to help actuaries, engineers, and educators compare raw statistical data and produce probabilistic models. The program's simulation module now supports 100 variables per model. New built-in functions include INT, LOG, EXP, and others.

A statistical analysis module lets you compare raw data to 13 probability distributions and use the Chi-Square and Kolmogorov-Smirnov Goodness of Fit tests. Another module lets you create long-term random models, with inflation and other adjustment factors.

The program requires an IBM PC with 384K bytes of RAM, or a Mac Plus or higher with 1 megabyte of RAM. **Price:** \$395. **Contact:** Actuarial Micro Software, The ACS Group, 8025 North Point Blvd., Suite 215E, Winston-Salem, NC 27106, (919) 773-1313 or (919) 759-2013. **Inquiry 1026.**

PERFORMANCE PRICE SERVICE

FIND THEM ALL AT ON LINE COMPUTER

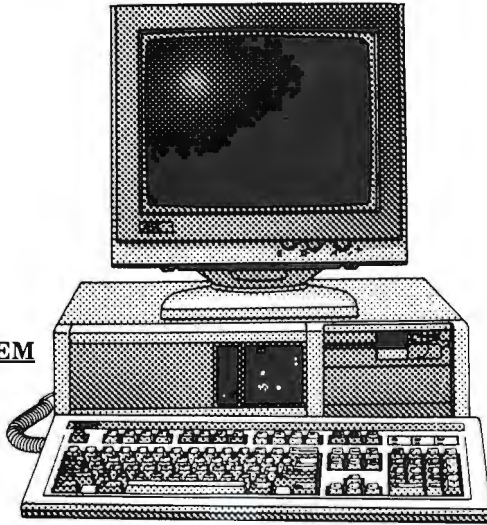

ON LINE 286 MULTISYNC COLOR SYSTEM

- 12 MHz Motherboard
- 80286 - 12 CPU
- Seagate 20MB Hard Drive
- 1:1 Interleave Hard Drive Controller
- 1.2 MB Floppy
- 1MB RAM (Expandable to 4MB)
- 2 Serial Ports • 1 Parallel Port • 1 Game Port
- 8 Expansion Slots • 200w Power Supply
- 101 Key Keyboard • Reset Button
- 14" VGA Multisync Monitor • Keyboard Lock
- VGA Multisync Graphic Adapter Card
- Clock/Calendar with battery backup
- Socket for 80287 Math Coprocessor

COMPLETE SYSTEM ONLY
\$1895

ON LINE 386 MULTISYNC COLOR SYSTEM

- 20 MHz Motherboard
- 80386 - 20 CPU
- Seagate 40MB Hard Drive (28ms)
- 1:1 Interleave Hard Drive Controller
- 1.2 MB Floppy
- 1MB RAM (Expandable to 16MB)
- 2 Serial Ports • 1 Parallel Port • 1 Game Port
- 8 Expansion Slots • 200w Power Supply
- 101 Key Keyboard • Reset Button
- 14" VGA Multisync Monitor • Keyboard Lock
- VGA Multisync Graphic Adapter Card
- Clock/Calendar with battery backup
- Socket for 80387 Math Coprocessor

COMPLETE SYSTEM ONLY
\$2795

BOTH SYSTEMS COME WITH A LIMITED 2 YEAR WARRANTY

On Line Computer is a full service store serving the public for more than 6 years. We carry a large assortment of software for: IBM (and compatibles), Atari, Macs, & Commodore 64. We also carry a full line of supplies & accessories at low prices.

QUANTITY DISCOUNTS FOR SCHOOLS AND CORPORATE ACCOUNTS

AUTHORIZED DEALER FOR:



AT&T STARLAN AND NOVELL NETWORKING

ON LINE COMPUTER

STORE WIDE SAVINGS ALWAYS AVAILABLE AT TWO CONVENIENT LOCATIONS:

280 Main Street (RT 28)
Colonnade Building
North Reading, MA
Across from Atlantic Plaza

(508) 664-1110

450 South Broadway
Newman Plaza
Salem, NH
Next to Newman Ford

(603) 894-6314

DIAL
(617)

L • A • P • T • O • P • S

5 2 7 8 6 7 7

Authorized Service for: Zenith • Toshiba • NEC

— OFFERING —

NEC • ZENITH • TOSHIBA

Sharp • Olgivar

MacLite/288 • Sanyo ... more

20 models on display

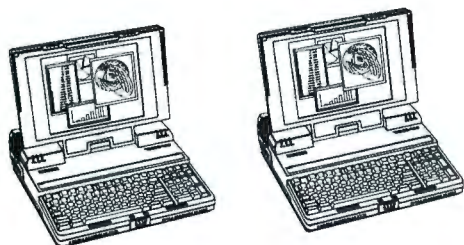

Windows 386

\$50 with 386 purchase

**Attn: MIS Departments
and 386 Users!!!**

- NEC ProSpeed Models 286 and 386
 - Toshiba 5200 and 5100 40 or 100 MB Hard Disk
 - Zenith TurboSport 386 w/modems
 - T1000, T1200, T3100, T1600, T3200
 - Zenith 286 and 8088
 - All Toshiba models
 - All Sharp models
- Most other laptops supported

***Our Laptops come
with more than just
the Box!!***

- Factory trained technicians
- Professional Solution Consultants
- Rent/Lease/Financing
- System formatted and tested

SAVE \$351



- Richly featured, yet weighs just 6.4 pounds.
- Includes 512KB memory, expandable to 1.2MB.
- 720KB 3.5" floppy drive, reflective supertwist display and MS-DOS®2.11 in ROM standard.
- Runs on NiCad rechargeable battery pack or AC power for continuous operation.

T1000 Reg. \$1,000

cpu

only \$649

B10/89

with this coupon

Best Prices in New England

**New Zenith Minisport
Available**

Corporate PO^s Welcome • Massachusetts SOMBA Certified

Boston/Cambridge, MA • Washington, D.C. • Baltimore, MD • Falls Church, VA

LAPTOPS, etc. 164 HAMPSHIRE STREET, CAMBRIDGE, MA 02139 (617) 527-8677

THE SLASHER

has slashed prices
on all of our printer
and typewriter
ribbons up to 50%.



DEALER INQUIRIES ARE INVITED

Buy direct from the manufacturer and save!!

NYLON RIBBONS

NO.	DESCRIPTION	PRICE EACH	NO.	DESCRIPTION	PRICE EACH	NO.	DESCRIPTION	PRICE EACH
100	ANADEX 9500	4.25	580	IDS ¼" BLACK	4.58	1040	IBM 6240	1.95
110	APPLE IMAGEWRITER 4 COLOR	9.25	590	IDS ¼" PROCESS	10.50	1050	MANNESMAN TALLY SP. 80	4.50
120	APPLE IMAGEWRITER LQ	17.00	600	MANNESMAN TALLY MT 85	5.00	1060	NAKAJIMA	3.40
130	BROTHER 1409	5.00	610	MANNESMAN TALLY MT 86	5.84	1070	NEC SPINWRITER 5500	3.16
140	BROTHER 1509	5.70	620	MANNESMAN TALLY 160	5.00	1080	NEC 3500 FLIP	6.00
150	BROTHER HR 15	4.50	630	MANNESMAN TALLY 180	5.42	1090	OLIVETTI ET121	4.00
160	CANON A 1200	3.70	640	NEC 2140	4.55	1100	QUME I 3/5	1.95
170	CENTRONICS 101	4.15	650	NCR 499	6.00	1110	QUME II	2.65
180	CENTRONICS 350	9.30	660	NEC 3500	4.60	1120	QUME IV	3.15
190	CENTRONICS 6000	9.10	670	NEC P 2200	5.90	1130	RICOH 1300/1600	3.10
200	CENTRONICS 704	4.95	680	NEC P 5	4.20	1140	WANG 5	2.60
210	CENTRONICS M 150	2.91	690	NEC PINWRITER P2	4.30	1150	XEROX 610	3.17
220	CITIZEN 120 D	4.95	700	NEC PINWRITER P3	5.00	CORRECTABLE RIBBONS AND LIFT OFF TAPES		
230	COMMODORE MPS 801	3.50	710	NEC SPINWRITER 5500	3.75	1300	ADLER 1010/5010	3.45
240	COMMODORE MPS 803	3.82	720	OKIDATA 182	4.20	1310	BROTHER EM 200	2.50
250	C. ITOH 8500	3.10	730	OKIDATA 292	6.00	1320	BROTHER AX 10-12	2.72
260	COMREX 420	7.55	740	OKIDATA 293	5.45	1330	BROTHER 701	3.85
270	DATA GENERAL LP 2	5.50	750	OKIDATA 393	19.00	1340	CANON AP 100	3.00
280	DATA PRODUCTS 8010	4.50	760	OKIDATA MICROLINE 80/82	1.35	1350	DAISY WHEEL LOT SUPER DRY	.60
290	DATA PRODUCTS 8020	5.50	770	OKIDATA MICROLINE 84/94	3.34	1360	IBM WHEELWRITER	3.30
300	DATA PRODUCTS B 300	5.50	780	PANASONIC 1090	4.50	1370	IBM WHEELWRITER LOT	2.90
310	DATA PRODUCTS B 1000	7.15	790	PANASONIC 1524	6.00	1380	IBM SELECTRIC II	1.50
320	DATA PRODUCTS M 200	4.20	800	PRINTRONIX P 300	6.00	1390	IBM SELECTRIC II LOT DRY	.60
330	DIABLO HT II	3.25	810	QUME I 3/5	3.00	1400	IBM SELECTRIC II LOT TACKY	.60
340	DIGITAL LA 30	3.00	820	QUME IV	4.40	1410	IBM SELECTRIC II TECH III	2.10
350	DIGITAL LA 34	3.20	830	RADIO SHACK 3/5	4.10	1420	IBM SELECTRIC II CUT	.80
360	DIGITAL LA 120	3.85	840	RADIO SHACK 6/8	3.25	1430	IBM ACTIONWRITER	2.50
370	EPSON ERC 03	3.00	850	SEIKOSHA SP 1000	4.30	1440	NAKAJIMA	2.68
380	EPSON LQ 800	3.80	860	STAR NX 10000	5.00	1450	OLIVETTI LEXICON LOT	1.00
390	EPSON LQ 1000	4.90	870	STAR MICRONICS NB 15	6.50	1460	OLIVETTI ET 121	2.55
400	EPSON LQ 1500	3.60	880	STAR MICRONICS NX 10	3.95	1470	OLIVETTI 111/115	4.00
410	EPSON LQ 2500	4.95	890	STAR MICRONIX NX 15	5.75	1480	OLIVETTI PRAXIS	2.50
420	EPSON LQ 2550	5.25	900	STAR MICRONICS SD 10	6.00	1490	OLIVETTI PRAXIS LOT	.90
430	EPSON LX 80	2.75	910	STAR MICRONICS SD 15	7.00	1500	OLYMPIA ESW 3000	3.15
440	EPSON MX 80	3.80	920	TALLY MANNESMAN 1000	3.50	1510	PANASONIC RKT 40	3.00
450	EPSON MX 100	4.90	930	TELETYPE 43	5.85	1520	ROYAL ALPHA 600	2.61
460	FUJITSU DMPG 9	4.30	940	TEXAS INSTRUMENTS 850	3.95	1530	SHARP ZX 400/500	3.55
470	HEWLETT PACKARD 2631	12.00	950	TEXAS INSTRUMENTS 860	5.00	1540	SILVER REED EX 42/44	2.25
480	IBM ½" HARMONICA	4.25	965	TOSHIBA 1350	3.20	1550	SILVER REED EX 42/44 LOT	.90
490	IBM ¾" HARMONICA	4.58	960	TOSHIBA P 321 SL	5.00	1560	XEROX 610	2.35
500	IBM 3262	6.25	970	TRITEL/DATA ROYAL	3.67	1570	XEROX 610 LOT	.90
510	IBM 5211	4.80	980	WANG BEARCLAW	7.00	1580	XEROX 610 LOT DOUBLE PASS	1.25
520	IBM 5242 LG. HANDBAG	3.50	MULTI STRIKE RIBBONS			1590	XEROX 6010	4.80
530	IBM 5256 SM. HANDBAG	2.75	1000	BROTHER HR 15	3.55	1600	SHARP PA 3100	3.25
540	IBM BASEBALL BAT	14.50	1010	COMMODORE 1526	4.50	*\$.00 shipping and handling charge on all orders under \$50.00. For orders over \$50.00 actual freight is charged.		
550	IBM PROPRINTER	4.15	1020	DIABLO HT II	2.25			
560	IBM PROPRINTER XL	4.95	1030	IBM DISPLAYWRITER	7.00			
570	IBM SILVER \$ CUP	1.95						

516-767-0178

800-645-6113

FAX 516-767-0585

103 HARBOR ROAD

PORT WASHINGTON, NY 11050

MSTC
MOLTY STRYK CORPORATION

Buy with

Confidence

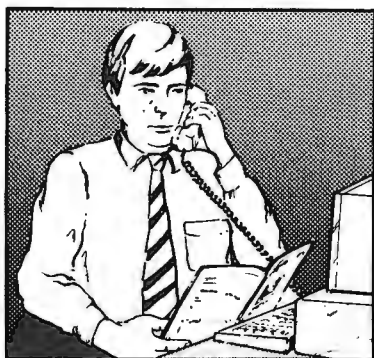

In an effort to make your telephone purchasing a more successful and pleasurable activity, The Microcomputer Marketing Council of the Direct Marketing Association, Inc. offers this advice, "A knowledgeable buyer will be a successful buyer." These are specific facts you should know about the prospective seller before placing an order:

Ask These Important Questions

- How long has the company been in business?
- Does the company offer technical assistance?
- Is there a service facility?
- Are manufacturer's warranties handled through the company?
- Does the seller have formal return and refund policies?
- Is there an additional charge for use of credit cards?
- Are credit card charges held until time of shipment?
- What are shipping costs for items ordered?

Reputable computer dealers will answer all these questions to your satisfaction. Don't settle for less when buying your computer hardware, software, peripherals and supplies.

Purchasing Guidelines

- State as completely and accurately as you can what merchandise you want including brand name, model number, catalog number.
- Establish that the item is in stock and confirm shipping date.
- Confirm that the price is as advertised.
- Obtain an order number and identification of the sales representative.
- Make a record of your order, noting exact price including shipping, date of order, promised shipping date and order number.

If you ever have a problem, remember to deal first with the seller. If you cannot resolve the problem, write to MAIL ORDER ACTION LINE, c/o DMA, 6 E. 43rd St., New York, NY 10017.

This message is brought to you by:

the MICROCOMPUTER
MARKETING COUNCIL
of the Direct Marketing
Association, Inc.
6 E. 43rd St.,
New York, NY 10017

MMCG
MICROCOMPUTER
MARKETING COUNCIL
of the Direct Marketing Association, Inc.

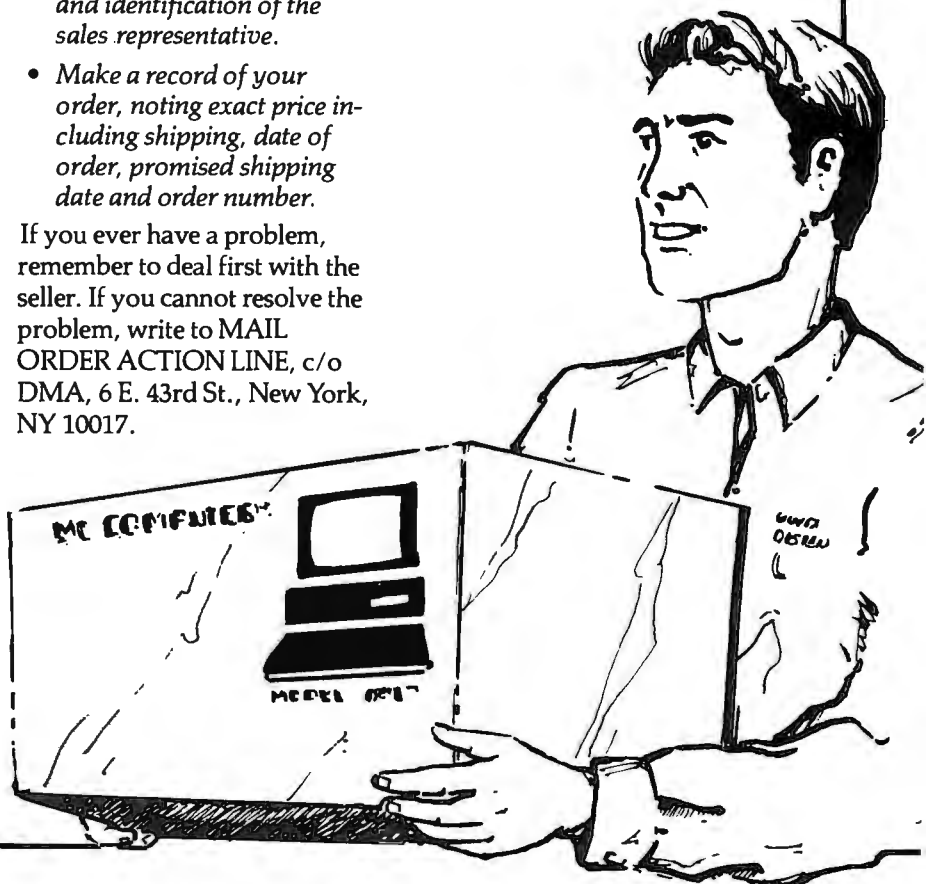

Adtech's 33 MHz* 286... 386 Performance at a 286 Price!



16 MHz* 286

\$799

- 8 / 16 MHz selectable
- 1 MB Exp. to 4 MB on board
- 80287 socket
- Space saving AT style minicase
- 200 watt P/S
- 1.2 MB Teac floppy

27 MHz* 286

\$999

- 80286-20 C.P.U.
- 1 MB Exp. to 4 MB on board
- 80287 Socket
- Shadow RAM Enable
- Space saving AT style minicase
- 200 watt P/S
- 1.2 MB Teac floppy

33 MHz* 386

\$1399

- 80386 ΣΣ C.P.U. running at 25 MHz
- 1 - 32 bit, 5 - 16 bit, 2 - 8 bit slots
- 80287 and 80387 sockets
- 1 MB Exp. to 8 MB on board
- Shadow RAM Enable
- Space saving AT style minicase
- 200 watt P/S
- 1.2 MB Teac floppy

33 MHz* 286

\$1049

- 80286 CPU running at 25 MHz
- 1 MB Exp. to 8 MB on board
- 80287 socket
- Shadow RAM Enable
- Space saving AT style minicase
- 200 watt P/S
- 1.2 MB Teac floppy

Standard System Features

- 1:1 Dual floppy / HD cont.
- Parallel, 2 serial, game, clock
- Keytronics 101 keyboard
- 24 hour burn-in

System Options

Includes Monitor & Adapter Card	
Monographics (Hi-Res)	129
Color Graphics (RGB)	249
EGA (640 x 350)	488
VGA (16 bit)	599
Multisync (16 bit)	699

Mother Boards

16 MHz* 286	219
33 MHz* 286	449
33 MHz* 386	799

System Upgrades

1:1 RLL	25
Full Size Case	25
Full Size Vertical Case	100
Mini Vertical Case	50

Hard Drives

20 Meg - Seagate ST-125 (30ms)	259
30 Meg - Seagate ST-138 (30 ms)	309
40 Meg - Seagate ST251 (38ms)	349
40 Meg - Seagate ST251-1 (28ms)	359
66 Meg - Toshiba (23ms)	439
66 Meg - Seagate ST-151 (23ms)	399

Miscellaneous

5.25" 360k (Fujitsu)	59
5.25" 1.2 MB	85
3.5" 1.44 MB	89
Logitech Hi-res Mouse (New)	89
2400 Baud Modem	99
16 bit VGA (1024 x 768)	199



Adtech

(408) 954-8038 1 (800) 326-6548

(408) 954-1647 FAX

2003 O'Toole Ave., San Jose, CA 95131

Circle 523 on Reader Service Card (DEALERS: 524)

Terms and conditions. Returns subject to 20% restocking fee. Prices and availability subject to change without notice. RMA # required for all returns. CA residents add 7% sales tax. No surcharge MasterCard and Visa. * Landmark speed test.

ONE YEAR PARTS AND LABOR WARRANTY ON ALL SYSTEMS!

SYSTEMS

AA44 CEI Baby 286/12MHz (0 wait) . . . \$899
 • Baby size footprint, 1MB memory
 • Hard and floppy drive controller
 • 2 serial and 1 parallel ports
 • 1.2MB floppy drive, 101 key enhanced keyboard
 • FCC class B, UL listed, base system made by DTK
 • Also available in mini (ltrim) size w/ 4 exp. slots (\$899)

AA46 CEI 386/20MHz (0 wait) . . . \$1899
 • 1MB SCRAM, takes 4MB on motherboard
 • Hard and floppy drive controller
 • 1.2MB floppy drive, 101 key enhanced keyboard
 • FCC class B, base system made in USA by CSS

AA16 CEI 386/33C (0 wait) . . . \$4299
 • 4MB static column memory
 • ESDI hard and floppy drive controller
 • 32K cache, expandable to 64K
 • 1.2MB floppy drive, 101 key enhanced keyboard
 • Also available at 25MHz (AA15 \$3999)
 • FCC Class A, base system made in USA by CSS

AA86 Chicony Laptop 286-16MHz . . . \$3199
 • Gas Plasma, NEAT Chipset
 • 800x400 VGA Mode, 1MB
 • Par. Ser Ports, 1.44MB FDD
 • 4MB Hard Drive, HFDD
 • FCC Class B

All systems have 6 months limited warranty on parts and labor.
 After 20 days from shipping date, all monitors & printers warranties are carried out by the manufacturer.

MOTHER BOARDS

A07 88 8MHz Phoenix BIOS, 1MB (OK) (MP) . . . \$84
 A04 88 10MHz Phoenix BIOS 1MB (OK) (MP) . . . \$89
 A10 286-10MHz XT Size, Award BIOS (DTX) . . . \$229
 A13 286-10MHz AT Size, Award BIOS (DTX) . . . \$239
 A11 286-12MHz XT Size, w/ P, S Port, (DTX) . . . \$269
 A17 286-12MHz AT Size, Phoenix BIOS (MP) . . . \$239
 A15 286-10MHz XT Size, Phx. Bios, 4MB(OK) (MP) . . . \$229
 A18 286-12MHz XT Size, Phx. Bios, 4MB(OK) (MP) . . . \$269
 A19 286-12MHz AT* Size, Phoenix BIOS (MP) . . . \$279
 A25 286-12MHz XT* Size, 2MB(S12K), NEAT* chipset
 fits original IBM XT* Chassis (CSS) . . . \$489
 A26 286-16MHz XT* Size, 2MB(S12K), NEAT* chipset
 fits original IBM XT* Chassis (CSS) . . . \$559
 A20 286-16MHz XT* Size, NEAT* chipset, BIOS (DTX) \$359
 A47 386 20MHz XT* Size, Award BIOS (DTX) . . . \$799
 A48 386/3 16MHz Baby Size, BIOS (DTX) . . . \$Call
 A32 386 20MHz AT* Size, 4MB(1MB) using SCRAM
 Award BIOS (CSS) . . . \$1299
 A60 386 25MHz AT* Size, Award BIOS, 32K cache,
 4MB SCRAM on 8MB 32-bit ramcard (CSS) . . . \$3299
 A35 386 33MHz AT* Size, Award BIOS, 32K cache,
 4MB SCRAM on 8MB 32-bit ramcard (CSS) . . . \$3599

ADD-ON CARDS FOR XT*

B05/24/85 Clock/Game/Printer Card . . . \$19/15/15
 B15 EMS Card 2MB (OK) (Everex) . . . \$69
 B30 I/O Card w/S.G.C. (DTX) . . . \$45
 B40 MultiFunction 384K (OK) (DPI) . . . \$79
 B70 Multi I/O w/S.G.C. FDD (DTX) . . . \$58
 B70 RAM Card 640K(OK) (DTP) . . . \$25
 B75 2nd RS232 1% DTK/4% DFI . . . \$20/79
 B85 2nd Serial Port Kit for 850 and 850 DTK . . . \$19
 B81 Turbo Speed Board 286-12MHz (Everex) . . . \$269

ADD-ON CARDS FOR AT*

C02 EMS/DRAM-3MB (OK) (Everex) . . . \$105
 C03 EMS/DRAM-6MB (OK) LIM 4.0 (Everex) . . . \$319
 C05 C/D0 P.O.P. S.P. S.G Ports (DTX) . . . \$35/\$43
 C07 I/O + MGA P.S.G. Mono w/ CGA Emulation (DFI) \$49
 C08 I/O + P.S.G Port, COM1.1, A configurable (DFI) . . . \$49
 C10 I/O + 2 Serial/1 Parallel/1 Game Ports . . . \$55
 C15 Multifunction 3MB (OK) (DPI) . . . \$119
 C24/25 RS232 2's/4's(DFI) . . . \$75/\$99
 C31 2nd Serial Port Kit for C08 & C24 (DFI) . . . \$20

HARD/FLOPPY CONTROLLERS

E01 FDC 2's . . . \$19
 E04 FDC 2's Run 1.44M, 1.2M, 720K, 360K . . . \$49
 E06 FDC 4's Run 1.44M, 1.2M, 720K, 360K
 4 ft or 8 ft & 2.5" w/d. Cable for 2 drives . . . \$79
 E07 FDC 2's 1.44M, 1.2M, 720K, 360K
 Can Co-exist with FDDC or FHDC . . . \$69
 E11/09 XT* HD controller (WD) WX1XT-GM \$69/\$59
 E10 XT* RLL HD controller ST225, 251, DTC150 . . . \$65
 E22 XT* RLL HD controller WD1002A-27X . . . \$69
 E12 AT* H/FDC 2.1 MFPM, WD1003V-MM2 (WD) . . . \$119
 E11 AT* H/FDC Western Digital chipset (Everex) . . . \$89
 E35 AT* H/FDC MFPM, WD1003V-MM1 (WD) . . . \$99
 E16 AT* H/FDC XT* Height DTC280 . . . \$129
 E19 AT* H/FDC MFPM, 1.1; Interface, WD1003V-MM1 \$119
 E18 AT* H/FDC MFPM, 1.1; WD1003V-MM2 . . . \$139
 E30 AT* H/FDC ESDI, 1.1; Interface, WD1007-WA2 \$179
 E31 AT* H/FDC ESDI, 1.1; Interface, WD1007-WA2 \$129
 E23 AT* RLL H/FDC WD1003V-SR2 . . . \$149
 E40 AT* HD SCSI Host Adapter 8 bit for D61 . . . \$79
 E42 AT* HD SCSI Host Adapter 16 bit (WD) . . . \$439

MONITORS

L02 Samsung Moni T/S 12" . . . \$89
 L10/20/21 Samsung 14" RGBEGA/VGA \$239/349/399
 L35/34 QUILAX Mono 14" Amber/Flatscreen \$129/149
 L44/46 Multiscan 14" EGA/MM2 \$369/499
 L39/38 QUILAX VGA 14" Color/Paperwhite \$399/199
 L30/33 NEC Multisync 2A/SW . . . \$599/769
 L55/56 Multiscan 14" Color Seiko/Mitsubishi \$649/599
 L57 Cable connects L56 to Seiko . . . \$45

* **COMPANY POLICIES:**
 • IBM, PC, XT, AT, & PS/2 are trademarks of International Business Machines Corporation
 • MS-DOS & Microsoft are trademarks of Microsoft Corporation
 • All others are trademarks of their respective companies

Not responsible for typographical errors. Prices are subject to change without prior notice. These prices apply to mail orders only. Minimum order \$50.00. \$3.00 handling fee on each package. Shipping fee is extra & paid by customer. COD orders please add \$3.00 extra for each package. All returns must carry an RMA #. All RMA #'s can only be used one time within 14 days of issue date and can not be used for any other items besides authorized return items. Shipping back fee must be prepaid by customer. All return items must come back with manuals & packing intact in resalable condition. Unauthorized returns & refused shipments are subject to 10% or \$10 restocking fee whichever comes larger. No refund on any repair or replacement on defective or incompatible items after 20 days from the date of shipment. All returns based on the cost of item(s) only (less shipping, handling, insurance, and surcharge). It will also be subject to a minimum of \$10 or 10% restocking charge whichever comes larger. 90 days warranty on all items except if specified otherwise. 3% surcharge on Mastercard and Visa.

STAR ARCNET

K72/74 Plus & Plus Arcnet 8 bit/16 bit . . . \$109/219
 K35/37 Cnet Arcnet 8 bit/16 bit . . . \$109/219
 K92 Plus & Plus Intelligent Arcnet . . . \$Call
 K11 25' Arcnet Cable/CS 9mm RGBE, Coaxial . . . \$25
 K08/03 Hub Active 8's/Passive 4's . . . \$249/30

BUS ARCNET

K71/76 Plus & Plus Arcnet 8 bit/16 bit . . . \$129/239
 K36/39 Cnet Arcnet 8 bit/16 bit . . . \$129/239
 K09 Bus Terminator 93 ohms . . . \$8

TWISTED PAIR ARCNET

K34/38 Cnet Arcnet Adapter 8 bit/16 bit . . . \$129/239

ETHERNET

K70 3COM EtherLink II #3C503 . . . \$359
 K77/73 Plus & Plus Ethernet 8 bit/16 bit w/ 16 bit \$189/299
 K32/33 Cnet Ethernet 8 bit/16 bit . . . \$179/289
 K91 Plus & Plus Ethernet for PS/2-MCA . . . \$Call
 K98 Plus & Plus Ethernet Repewter . . . \$Call
 K56 Ethernet Concentrator Twisted Pair . . . \$Call
 K10/05 Ethernet (25' Cable)/(Terminator) . . . \$30/6

COAX ACCESSORIES

K04/14 BNC T Adapter/Crimping Tool . . . \$6/25
 K13/15 BNC Crimp Connector for Arcnet/Ethernet/6/6

MULTIUSER

K06/16 K RSN32 for Xenix(DPI/FAST) . . . \$169/429
 K07 Terminal Wyse-60 w/ KBD . . . \$469
 K18/17 Compuserne Serial Ports 4's/8's . . . \$499/599

TOPS

K40 Tops Network Software for Macintosh
 to connect to PC, Unix, & Minintosh . . . \$189
 K41 Tops Network Software for DOS Systems
 to connect to PC, Unix, & Minintosh . . . \$149
 K42 Tops Flashcard PC or Appletalk Network . . . \$199
 K43 Tops Netprint PC shares Appletalk printers . . . \$159

OTHER NETWORK

K20/21 Balun/50 ohms BNC/Twinax . . . \$8/16
 K80/50 Token Card Compatible by WD/Other/Call \$39
 K51/53 Token Ring (IBM) Adapter/Adapter II \$699/799

FLOPPY DISK DRIVES

D01/02 Fujitsu 360K For XT*/AT* (Rais-55) . . . \$67/70
 D03/05 Fujitsu (1.2MB Gray Plate) (1.44MB I0I) \$80/90
 D10/11 Teac 360K (XT* black)(AT* gray) . . . \$75/80
 D12 Teac 1.2MB Gray Plate . . . \$89
 D13/15 Teac w/ Mounting Kit 720K/1.44MB . . . \$85/95
 D17/18 Toshiba 360K (Black)(GRAY) . . . \$75/78
 D19 Toshiba 1.2MB (Gray) . . . \$89
 D20/22 Toshiba 720K with Mounting Kit/No Kit \$80/85
 D21/23 Toshiba 1.4M with Mounting Kit/No Kit \$95/90
 D30/32 Ext 1.44M/720K (w/ conn)/(no conn) \$249/199
 D35 External 1.2M/360K for Toshiba laptop . . . \$249

HARD DISK DRIVES

D42 Micropolts 1375 150MB, SCSI, 23MS, w/C \$1499
 D43 Micropolts 1578 300MB, SCSI, 18ms, w/C \$2199
 D44 Micropolts 1558 300MB ESDI w/C . . . \$75/80
 D45 Maxtor 2190 150MB, 28ms, w/C . . . \$1699
 D46 Maxtor 4380 ESDI 320MB, 29MS w/C \$2399
 D47/48 Maxtor (ESDI 155MB)(ESDI) . . . \$1699/1699
 D00/01 CUC ESDI, 16ms, w/C 90MB/150MB/\$1099/1799
 D82 CDC-383H 320MB ESDI, 14.5ms, w/ C \$2599
 D50/51 Seagate ST225 20MB Kilo Drive Only \$259/219
 D52 Seagate ST238 w/ Contr. 30MB, 65ms, for AT* \$289
 D57 Seagate ST138 w/ Mounting Kit, 30MB, 40ms, \$329
 D58 Seagate ST125 20MB, 40ms, FH Drive Only \$249
 D56 Seagate ST251-1 40MB, 28ms, for AT* . . . \$379
 D60 Seagate ST277N SCSI, 60MB, 28ms, HH . . . \$599
 D61 Seagate ST296N SCSI, 80MB, 28ms, HH . . . \$659
 D55 Seagate ST4096 80MB, 25ms, for AT* . . . \$639
 D70 30MB Int 35ms, for Compaq Portable III-286 . . . \$559
 D71 40MB Int 28ms, for Compaq Portable III-286 . . . \$729
 D74 40MB Int 25ms, for Compaq 386/5 & 20E . . . \$729
 D75 100MB Int 28ms, for Compaq 360/5 & 20E \$1499
 D72 80MB Int 30ms, for Compaq Deskpro 286/386 \$959
 D90 Bernoulli Box II 40MB Int, w/ Cont. . . \$1259
 D95 Plus Hard Card 40MB . . . \$749
 D96 Plus Passport 40MB, 28ms, Removable HD \$659
 D97 Passport PC Adapter & Base Kit . . . \$519
 D10/11/11 CD-ROM 540MB (NEC) Ex/Int \$1099/1029
 D112 WORM SCSI 200MB w/ Adapter (Panasonic) \$2599
 D113 Disk Cartridge 400MB for D112 . . . \$119

VIDEO DISPLAY ADAPTERS

V01/05 Color Graphic CGA/CGA/c printer ports \$47/49
 V20/21 Monor Graphic w/P (DTX)(DPI) . . . \$52/55
 V30 EGA Autoswitch, 640x480, 120col, (Everex) . . . \$139
 V32 EGA Autoswitch, 640x480, Paradise Chip (MP) \$129
 V35 EGA Autoswitch, 800x600, Gemini Chip (P&P) \$149
 V44 VGA 16 Bit, Paradise Chipset (Plus & Plus) . . . \$199
 V46 VGA 16 bit (Everex) . . . \$299
 V50 Super VGA 1024 x 768, Teong Chipset . . . \$269

August 18, 1989

Byte Magazine

FOR PS/2

P04 EMS 4MB OK (Everex) . . . \$319
 P19/20 Ext 360K for (PS2)/(PS2/M30-286) . . . \$179/219
 P16/17 Ext 1.2MB for (PS2)/(PS2/M30-286) . . . \$199/259
 P54/46 Ext 1.44MB for (PS2)/(PS2/M30-286) \$269/299
 P50/51 Irwin 40MB Tape Drv w/ Vdpt Int/Ext \$599/759
 P56/57 Archive 60MB Tape Drv Vdpt Int/Ext \$999/1199
 P21/27 HD Int, for Model 30 (CMS) 20MB/30MB \$399/479
 P22/26 HD Int, for Model 50 (CMS) 40/60MB \$599/999
 P35 60MB Int 27ms HD for Model 50, 70 (CMS) . . . \$999
 P24/28 HD ESDI, for Mod 60,60/70/155MB . . . \$899/1359
 P30 60MB HD 23ms for Model 60 (Pliam) . . . \$799
 P31/32 HD ESDI, 20ms, for Model 60, 80 (Pliam) 130MB/300MB . . . \$1799/2699
 P40 CD ROM 540MB (NEC) . . . \$1199

COPROCESSOR & CHIP

M11/12 80287-8-10 . . . \$219/239
 M08/09/07 8087-3-2-1 . . . \$99/139/189
 M14/15/16/17 80387-16-20/25-33 \$339/399/499/639
 M20/21 Y20-8/10 . . . \$17/25
 M60/61 276-200/271-28-50 . . . \$47/52
 M30/31/33 DRAM 64-15/12/10 . . . \$2,252/753/640
 N32/34 4466/4210 . . . \$5,996/6,499
 N43/44 4041/42 256-15-15/12-10/18 \$3,999/4,505/6,500
 M45/46 256x4 DRAM 8-10 . . . \$16/15
 M78/79 1MBx1 DRAM 100-8 for ATis & ATis . . . \$15/17
 M82 IMB of 256K SDDP (4 banks) . . . \$229
 M83/84 1MB SCRAM Set for CSS 832/834 \$299/299
 M85/86 SCRAM 256x4 514255-10/256/1 51255-10/5409
 M90/91 SIMM 256x4 for PS/2 Mod 30-12/10 . . . \$69/79
 M98 SIMM 256x90ms . . . \$89
 M92 SIMM 1MBx9-10 for PS/2 Mod 30-286 . . . \$199
 M93/70 for PS/2 50 & 60 1MBx5/2MB kit . . . \$299/499
 M94/95 SIMM 1MBx9 for Mod 70 E61/A21 \$259/259
 M96 SIMM 1MBx9 for PS/2 Mod 70 . . . \$279
 N97/71 SIMM 2MBx9 for PS/2 70 E61/A21 \$499/499
 N98/72 SIMM 2MB for PS/2 80-111/311 . . . \$499/499

MODEMS

G01 Smartone 1200 Int w/ Bitcom . . . \$59
 G20/21 Smartone 2400 Int/Ext . . . \$99/115
 G25/26 Smartone for PS/2 1200 Int/2400 Int \$159/219
 G27/28 Smartone Toshiba Laptop/2000/4000 \$179/259
 G10 Everex 1200 w/ Bitcom Int . . . \$69
 G11/12 Everex 2400 Int/Ext . . . \$149/189
 G16 Everex 2400 Int for PS/2 . . . \$219

MOUSE & DIGITIZERS

Y01 Genius Mouse (GMST Serial w/Driver) . . . \$47
 Y20 Genius Mouse (GM46) Dr. Halo III, 14 Res, 350DPI, 200MB Dynamic DPI . . . \$69
 Y25 Genius Mouse GM-10 for PS/2 . . . \$59
 Y03/05 Logitech Mouse Serial/Bus . . . \$69/75
 Y06 Logitech Hi-Res Mouse Bus . . . \$99
 Y22 Genius Digitizing Tablet G2-1212A Summagraphic Compatible, 12"x12" Dr. Halo III, 1000 lines/inch, works with Autocad \$299
 Y26 Summasketch 12"x12" (Summagraphic) . . . \$379

SCANNERS

Y13 DFI 4" Handy Image Scanner (HS3000+) Portable Size w/ PC Paintbrush, 600DPI . . . \$199
 Y12 DFI 4" Handy Image Scanner for PS/2 . . . \$279
 Y30 OCR for DFI Handy Scanner for Y13 . . . \$89
 Y31 OCR Deluxe/Can Read Most Magazine Text for Y11 DFI Handy Scanner . . . \$299
 Y27 Genius 8" Handy Image Scanner . . . \$699
 Y15 Video Catcher GrabB Picture from TV, VCR, or Camera into Computer Mono Mode (DPI) . . . \$229

BAR CODE READERS

Y45 BTC Wand & Decoder Emulates Keyboard \$339
 Y44 BTC Serial Reader & Decoder Emulates Keyboard \$389
 Y46 Software for BTC Bar Code . . . \$289
 Y50 Techway HW410 Barcode Keyboard Emulator \$279
 Y51 Techway HW420 RS232C/422 Bar Code Reader \$299
 Y52 Techway HW430 Portable Bar Code Reader 48K Memory of Data Storage . . . \$549
 Y56 Techway HW435 4 Line LCD Programmable \$659
 Y53 Techway HW440 Bar Code Online Reader . . . \$449
 Y54 Techway HW460 EZ Barcode II Software Package for printing barcodes . . . \$109

TAPE BACKUP

F10/11 Colorado Mem Sys 40MB Int/Ext . . . \$299/399
 F08/09 Irwin Int (120MB 2100)(150MB 6151)\$799/1199
 F23/23/29B Irwin Ext (745 40MB)(1765 60MB) \$699/799
 F34/35 Irwin Kit Ext (8200 20MB)(1465A 40MB) \$439/579
 F24/25 Archive 60MB (FTG 60)(UT600 Int) \$699/699
 F26 Archive 5T600S 125MB Int, 56MB Int . . . \$899
 F60/61 Archive 60MB (NP80 Int)/(VP60 Ext) \$899/1099
 F62/63 Archive (5540E 40MB)/(5580 80MB) \$549/579

ACCESSORIES

R01 Juystick . . . \$17
 R03/R04 MS DOS 3.3/4.0 . . . \$79/89
 R50 10 Piece PC Tool Kits With Zipper Case . . . \$18
 R54/51 Adj. Mon. Arm/Vertical CPU Stand \$89/14

SWITCH BOX

TU0/2 2 Way (CN36F/1DB25F)/(CN36F/2DB25F) \$16/18
 T03/04/11 2 Way (3 CN36F)/(3 DB25F)/(3 DB98) \$20/20/20
 T05/06 2 Way Cross (4 DB25F/14 CN36F) . . . \$35/\$35
 T10 2 Way 2-9 Pin F & 2-5 Pin F (Monitor, KBD) . . . \$35
 T07/08 2 Way (3 RJ11F)/(3 RJ45F) . . . \$30/30
 P70/71 2 Way (4 Way (Monitor & Kbd) for PS/2 . . . \$35/50
 T12/13/16 4 Way (CN36F)/(5DB25F)/(5DB9F) \$35/\$35/\$35
 T14 ABCD Multiserial (1DB25M, 1DB25F) . . . \$45
 T15 4 Way (CN36F/1DB25F) . . . \$45
 T20/21 4 Way (RF11F)/(5RJ45F) . . . \$50/50
 T18/19 W Type 2 in-3 out (DB25F)/(CN36F) . . . \$55/\$55
 T31/33 Printer Buffer 256K Parallel/Serial . . . \$199/269
 T40/41 4 Way Auto-Scan Switch, Parallel/Serial \$129/149
 T30/32 8 Way Auto-Scan Switch, Parallel/Serial \$179/199
 T50/51 Converter (Par to Ser)/(Ser to Par) . . . \$69/69

PRINTER CABLES/ADAPTERS

N01/12/73/74 Printer 6710/15/25' . . . \$71/22/30/30
 N53/54 6' to HP Laser Printer from AT*/XT* . . . \$15/15
 N04 6' Centronic 36P M/M Parallel Switchbox . . . \$10
 N39/37 DB25F-CN36M/DB25M-CN36M . . . \$8/8
 N36/38 DB25F-CN36F/DB25M-CN36F . . . \$8/8

SERIAL CABLES/ADAPTERS

N05/06 6' Modem Cable DB25 F-M XT/AT* . . . \$7/7
 N44/45 Serial Adapter DB25M-DB9/DB25F-DB9M \$5/5
 N90/91 Adapter DB25M-DB9M/DB25F-DB9F . . . \$5/5
 N80/81 Adapter RT1-DB25/RJ11-DB9 . . . \$7/7
 N82/83 Adapter RT45-DB25/RT45-DB9 . . . \$9/9
 N02/77 DB25 M/M Serial Switchbox 6710's . . . \$7/23
 N78/79 DB9 M/M Serial & monitor switchbox 6710's \$5/23
 N03/70 DB25 M/M Serial Extension 6710's . . . \$7/23
 N71/72 DB25 M/M Serial Extension 251's . . . \$30/45
 N17/14 DB9 M/M AT* Serial Extension 6710' . . . \$7/10
 N16/19 2nd SP Connector (for DTK) XT*/AT*/\$7/7

DRIVE CABLES/ADAPTERS

N09/13 XT HD Cable/AT H&FD Cables . . . \$7/10
 N20/21 FDC Cable XT*/AT* . . . \$5/5
 N65/64 Y Twin Drive Power Adapter 5.25"/5" \$7/7
 N66 5.25" to 3.5" Drive Power Adapter . . . \$7/7
 N55 SCSI Flat Cable (DC50/DC50) . . . \$12
 N61 External Floppy Drive Adapter for 2 drives \$25
 N68 40 to 34 Pin Floppy Adapter for PS/2 . . . \$50

MONITOR & KBD CABLES

N17/14 DB9 M/M Monitor Extension 6710' . . . \$7/10
 P14 6' PS/2 Monitor Ext Cable High density DB9 \$14
 P05/06/07/13 6' VGA Adapter Cable for Mitsubishi/SONY/Samsung/NEC . . . \$20/20/20/20
 N11/50 Monitor (Power/Control)(Adapter) . . . \$7/7
 N52 6' Monitor Power Extension Cable . . . \$7
 N18/10 Keyboard Ext Cable/10' . . . \$7/10
 N69/611 PS/2 Kbd Cable Adapter/Extension . . . \$12/15

GENDER CHARGES

N40/41 DB9 M/M-F-F . . . \$5/5
 N42/43 DB25 M-M-F-F . . . \$5/5
 N48/49 Centronics 36P M-M-F-F . . . \$8/8

NULL MODEMS

N46/47/47' DB25 NM Adapter M-M-F-F-M-F \$10/10/10
 N95/96/97 DB9 NM Adapter M-M-F-F-M-F \$8/8/8
 N60/61 6' Null Modem Cable DB25 M-M-F-F . . . \$12/12

OTHER WIRINGS

N15 Power Supply Cord . . . \$7
 N26 Jumper Box DB25 M/F . . . \$10
 N30 RS232 Mini Tester with LED's DB25 M/F . . . \$10
 N29/25 RS232 (Breakout Box)/(Seagate Protector) \$40/7

POWER SUPPLIES & UPS

J01/10 UL Recognized 150W XT/200W AT* . . . \$49/69
 J11 200W Baby AT*/UL Recognized . . . \$69

DragonSlayer!!

Turn your LAN into a COMPLETE BUSINESS and TIME MANAGEMENT system!

Most Accounting software does basic bookkeeping,
BUT WHAT ABOUT:

- ★ SALES LEAD GENERATION?
- ★ QUOTE PREPARATION?
- ★ SALES MANAGEMENT?
- ★ QUOTE TRACKING?
- ★ HANDLING TELEPHONE INQUIRIES?
- ★ STAFF SCHEDULING?
- ★ MAILING LIST CREATION?
- ★ COLLECTION ACTIVITIES?
- ★ WARRANTY TRACKING?
- ★ SPECIAL CUSTOMER PRICING?
- ★ COMMISSION CALCULATIONS?
- ★ TRAINING NEW EMPLOYEES?
- ★ CASH FLOW MANAGEMENT?

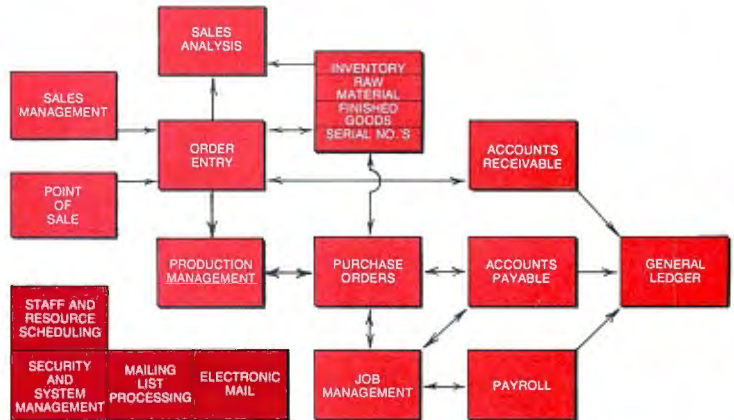

EASY-TO-USE

USER CUSTOMIZABLE on-line HELP reduces installation, training. Easy-to-use, INTUITIVE menus and data entry screens. USER specific ON-LINE TICKLER file provides electronic desk. Inter-user MESSAGING eases scheduling pains. CONCISE manuals provide installation and reference sections. RECALL vendors, customers, items, employees, prospects, or other data by FULL or PARTIAL NAME. FAST DATA ENTRY for high transaction environments.

DISTRIBUTION

Process sales orders for SERIAL, one-of-a-kind, or CATALOGUE items with full integration. AUTOMATICALLY prepares QUOTES, CONVERTS quotes to orders. EASILY process COMPLEX PRICING and COMMISSION CALCULATIONS. ON-LINE PURCHASE and QUOTE HISTORY by customer by item. UNLIMITED SUBSTITUTE and ALTERNATE item codes. Analyze SALES or PROFIT by salesperson, customer, or line.

MANUFACTURING

SPLIT sales orders among up to three sales reps. AUTOMATICALLY create COMMON CARRIER freight invoices. EXPLODE or CREATE Bill-of-Materials at Order Entry. STORED PHRASE RECALL and DIRECTABLE COMMENTS allow complex crate marking or shipping instructions. Comprehensive JOB COST and STANDARD COSTING. WARRANTY TRACKING by customer and item. Comprehensive CASH MANAGEMENT facility calculates AVERAGE DAYS TO PAY based on customer payment history and forecast cash flow.

RETAIL

POINT-OF-SALE allows for serialized and catalogue items. POP-UP window provides secure TIME CLOCK function. POS transaction SUSPEND and RECALL function speeds customer checkout. Recall customer account data by NAME or PHONE NO. Supports MULTIPLE ELECTRONIC CASH DRAWERS, BAR CODES. POP-UP window for shelf location, pricing, quantity, for any item by full or partial name search.

AND MORE!

For more detailed information, or diskette based demonstrations, call

800-447-2522

(in PA 412-279-8882)

DragonSlayer is actively seeking authorized resellers.

DragonSlayer Systems

Circle 533 on Reader Service Card

"Comprehensive — Not Complex"

2275 Swallowhill Road, Building 900 • Pittsburgh, PA 15220

(412)279-8882

MORE POWER TO YOUR PC'S



SUMMA WARE

**The PC-Based LAN
total accounting
solution.**

Ideally suited for manufacturing
and distribution operations.

AND YOUR XT's, AT's, 386's, PS/2's[®] AND HP's.

SUMMAWARE contains the most powerful networking and operating system on the market today.

It is designed to bring more power to your computer network, no matter what type of IBM or IBM compatible you use. So you're not limited to the hardware you can use with SUMMAWARE. SUMMAWARE runs on any mix of machines, either standalone or in a network. With SUMMAWARE you get the power, expandability and flexibility not found in other operating systems.

MULTI-TASKING

SUMMAWARE's speed in switchover, changing from one program to another, is unsurpassed. And it does not require a dedicated file server.

MULTI-USER

With SUMMAWARE you have the power to spare and the power to share. All programs, data and resources such as printers, terminals, modems and CPUs can be shared across the entire network. And it can support up to 255 nodes.

MULTI-WINDOWING

SUMMAWARE uses standard windows so it is easy to learn, easy to use. On-screen help is always just one keystroke away. View up to four processes operating concurrently.

TRULY DISTRIBUTED PROCESSING

SUMMANET features 100% distributed processing, 100% back-up and resource sharing across the entire network. Any computer on your network can make its disks, printers, serial ports and CPUs available for all tasks.

Start with SUMMANET, the most powerful operating system available.

Based on the QNX[®] operating system, SUMMANET is the heart and brains of the SUMMAWARE package. And it's lean and quick, taking up a mere 148K. SUMMANET is capable of supporting 512 disk drives with virtually unlimited storage.

Built-in features for increased office efficiency.

- SUMMADATE allows you to keep track of all your appointments and the appointments of your associates.
- SUMMAMAIL is the solution to your electronic mail problems. It allows you to send normal, confidential, encrypted or registered messages to any and all on your network. High security and fast-efficient communications, across the hall or around the world.

Add SUMMACOUNT, a powerful distribution and manufacturing accounting system.

Suited to diverse businesses with varying levels of accounting complexity, SUMMACOUNT is based on MCBA[®] Accounting Software, the recognized leader in accounting software.

Optional additional packages include: word processing, spread sheet programs and a 4 GL/Data Base Management System. Call SUMMA for in-depth information on the SUMMAWARE family.

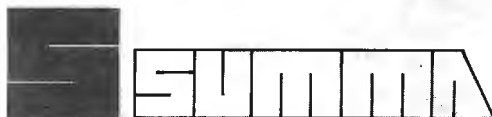

215 East Water Street, Syracuse, NY 13202
Call Toll-free: 1-800-255-1133 Ext. 320

IBM XT, AT & PS/2 are registered trademarks of International Business Machines. QNX is a registered trademark of Quantum Software Systems Ltd. The UNIX Operating System is a registered trademark of AT&T. HP is a registered trademark of Hewlett-Packard Co. MCBA is a registered trademark of MCBA[®], Inc. SummaDate and SummaMail are licensed software products from Quantum Software Systems Ltd.

Circle 564 on Reader Service Card

80NE-34 B Y T E • OCTOBER 1989

REPLACE YOUR MOTHER.

PC WORLD
"Upgrade Product of the Year."



PC
MAGAZINE
EDITOR'S
CHOICE

Installed in minutes, the Renegade 386 motherboard transforms any IBM or compatible PC, XT or AT into an astoundingly powerful new computer with both old software AND new OS/2 releases. Available with 16/20/25/33 MHz Intel 80386 chips.

Is this you? Would you like to have extraordinary computing speed and power? You want number crunching ability. You need complex CAD capabilities. Or networking. Or multi-tasking.

And you haven't got it. And you don't want to spend a fortune to replace good equipment with the latest industry standard.

You can turn your present system into the latest, high-performance system that will equal or exceed the best of the new computers.

Renegade 386. A new heart and brain for your computer.

Renegade offers designers, engineers, architects and computer dependent businesses a simple and reliable alternative to obsolescence. Or the unreasonable expense of a new system.



Multi-task with Lotus 1-2-3 and other applications running Microsoft Windows/386.

Simply replace the "motherboard" of your present system with a Renegade 386 motherboard.

It takes a screwdriver and less than 20 minutes.

Renegade gives you more than just the latest industry standard. You can run your old software on it. Virtually anything you use now.

Thanks to the compatibility of the Renegade 386, you can run the new generation of DOS, OS/2, Windows/386, UNIX V, DESQview 386, and XENIX/386 Plus. The Renegade 386 can be configured with either a

16/20/25 or 33 MHz Intel 80386 chip.

The Renegade 386 is available with an Intel 82385 Cache controller and supports both the Intel 387 and Weitek coprocessors to maximize overall system performance.

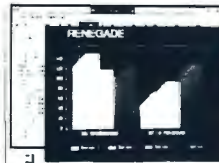

Faster, easier presentation graphics with newest breakthrough software releases.

Renegade 386 gives you a full-featured new computer.

The Renegade 386 includes a 32 bit RAM expansion slot allowing you to populate your system with up to 16 megabytes of RAM.

In practical terms, that simply means programs like Lotus 1-2-3, AutoCAD, Aldus PageMaker and Microsoft Windows will run faster than anything you have ever seen.

So plug in your new Renegade 386 Motherboard and run your programs at the speed God intended.

from
\$1495

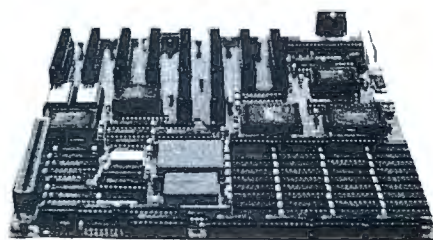

30 DAY TRIAL OFFER AND OUR NO-RISK GUARANTEE

We understand perfectly that you have no reason to believe anything you read. Including this ad. We read too.

So we invite you to evaluate the Renegade 386 yourself. Call and order one today. We'll send it with clear detailed instructions. Use it in your own system, on your own work for 30 days. Try it for brilliant presentation graphics, make massive and instant spreadsheet recalculations, run huge memory-hungry CAD programs. Wring it out on anything your software is up to.

After 30 days, if it isn't for you, for any reason, we'll take it back and refund your full purchase price.

Call toll-free today. You have nothing to lose but yesterday's computer system.

1-800-922-4130

Renegade

We do it all.

IBM PC, XT, AT, Microsoft Windows, AutoCAD, Lotus 1-2-3, Aldus PageMaker, Intel and other brands and products are trademarks or registered trademarks of their respective holders.



MEMORY PRODUCTS & MORE

ONE STOP SOURCE FOR ALL PC MEMORY UPGRADES
 2808 Lafayette • Newport Beach, CA 92663
 (714) 723-4510 • (800) 222-8861 • FAX: (714) 723-0732

Compaq Memory Upgrades

MODEL	MEMORY ADDED	PRICE
DESKPRO 386/33	2MB MODULE	\$ 695
DESKPRO 386/25	1MB MODULE	265
	4MB MODULE	795
DESKPRO 386/20	1MB MODULE	265
	4MB MODULE	795
DESKPRO 386 \$	1MB BOARD	350
	4MB BOARD	995
	1MB MODULE	265
	4MB MODULE	795
DESKPRO 386/20E	1MB BOARD	350
	4MB BOARD	995
	1MB MODULE	265
	4MB MODULE	795
DESKPRO 386/16	1MB KIT	210
	1-2MB BOARD	CALL
	4-8MB BOARD	1250
PORTABLE 386	1MB KIT	395
	4MB BOARD	1195
PORTABLE III	512K KIT	114
	2MB KIT	295
COMPAQ SLT/286	1MB MODULE	395
DESKPRO 286/E	1MB BOARD	460

IBM Memory Upgrades

MODEL	MEMORY ADDED	PRICE
PS/2 30-286	512 KIT	\$ 99
	2MB KIT	360
PS/2 50 AND 60	512 KIT	99
	2MB KIT	360
PS/2 50Z	2MB MODULE	495
	512 KIT	99
	2MB KIT	360
PS/2 55-SX	2MB MODULE	495
PS/2 70-F61	1MB MODULE	275
	2MB MODULE	495
PS/2 70-121	1MB MODULE	275
	2MB MODULE	495
PS/2 70-A21	2MB MODULE	495
(THE ABOVE MODULE GOES ON THE MOTHER BOARD)		
	1MB MODULE	275
	2MB MODULE	495
(THESE MODULE GO ON THE ADD-ON CARD)		
PS/2 80-041	1MB MODULE	275
PS/2 80-111	2MB MODULE	595
PS/2 80-311	2MB MODULE	595

Apple Memory Upgrades

MODEL	MEMORY ADDED	PRICE
Mac 11	256K X 8 SIM	\$ 54
	1MEG KIT (4 SIMS)	180
	1MEG X 8 SIM	126
	4MEG KIT (4 SIMS)	504
MAC PLUS	256K X 8 SIM	45
	1MEG KIT (4 SIMS)	180
	1MEG X 8 SIMS	126
	2MEG KIT (2 SIMS)	252
	4MEG KIT (4 SIMS)	504
MAC SE	256K X 8 SIM	45
	1MEG KIT (4 SIMS)	180
	1MEG X 8 SIMS	126
	2MEG KIT (2 SIMS)	252
	4MEG KIT (4 SIMS)	504
MAC 11CX	256K X 8 SIM	45
	1MEG KIT (4 SIMS)	180
	1MEG X 8 SIMS	126
	4MEG KIT (4 SIMS)	504
MAC SE/30	256K X 8 SIM	45
	1MEG KIT (4 SIMS)	180
	1MEG X 8 SIM	126
	2MEG KIT (2 SIMS)	252
	4MEG KIT (4 SIMS)	504

Sun Micro Systems Memory Upgrades

MODEL	MEMORY ADDED	PRICE
SUN 360/60	4MB KIT	\$ 590
SUN 360/1	4MB KIT	590
SUN 410	4MB KIT	620
SUN 4/10	4MB KIT	620
SPARC STATION	4MB KIT	590

AT & T Memory Upgrades

MODEL	MEMORY ADDED	PRICE
6386 WGS	1MB KIT	\$ 196
	4MB KIT	590
6386 EWGS	1MB KIT	196
	4MB KIT	590
6286	2MB KIT	295

Everex Memory Upgrades

MODEL	MEMORY ADDED	PRICE
386 STEP 16	1MB KIT	\$ 196
	4MB KIT	590
386 STEP 20	1MB KIT	196
	4MB KIT	590
386 STEP 25	1MB KIT	196
	2MB KIT	590

Zenith Memory Upgrades

MODEL	MEMORY ADDED	PRICE
386/25	1MB KIT	\$ 295
	2MB KIT	595
386/33	1MB KIT	325
	2MB KIT	625

Epson Memory Upgrades

MODEL	MEMORY ADDED	PRICE
EQUITY 386	1MB KIT	\$ 210
	2MB KIT	350

HP Laser Jet Series II & IID Memory Upgrades

MEMORY	PRICE
1MB	\$ 299
2MB	399
4MB	699

Hewlett Packard Memory Upgrades

MODEL	MEMORY ADDED	PRICE
VECTRA RS/25C	1MB KIT	\$ 228
	4MB KIT	620
VECTRA RS/25	1MB KIT	228
	4MB KIT	620
VECTRA RS/20	1MB KIT	228
	4MB KIT	620
VECTRA RS/20C	1MB KIT	196
	4MB KIT	590
VECTRA QS/20	1MB KIT	196
	4MB KIT	590
VECTRA QS/16	1MB KIT	196
	4MB KIT	590
HP LASER JET 11	1MB KIT	299
	2MB KIT	399
	4MB KIT	699
HP LASER JET 11D	1MB KIT	299
	2MB KIT	399
	4MB KIT	699

AST Memory Upgrades

MODEL	MEMORY ADDED	PRICE
BRAVO/286	128 KIT	\$ 52
	512K KIT	94
	2MB KIT	295
	4MB KIT	590
AST PREMIUM 386	1MB KIT	228
	4MB KIT	620
AST PREMIUM 386C	1MB KIT	196
	4MB KIT	590
AST PREMIUM 386/16	1MB KIT	196
	4MB KIT	590
AST WORKSTATION 286	512K KIT	94
	2MB KIT	295
AST WORKSTATION 386	512K KIT	94
	1MB KIT	196
	2MB KIT	295
	4MB KIT	590
AST PREMIUM 386/25	1MB KIT	225
AST PREMIUM 386/33	1MB KIT	245

COMPAQ • IBM • APPLE • HEWLETT PACKARD • AST • AT & T and More...
 • 5 Year Guarantee • Same-Day Shipping • Full Technical Support

SHORT TAKES

BYTE editors' hands-on views of new and developing products

PageMaker for OS/2
Presentation Manager

Think C 4.0

DeskWriter

HyperAccess/5

DOS Mounter

hyperStore-816 and
SmartCache PM3011

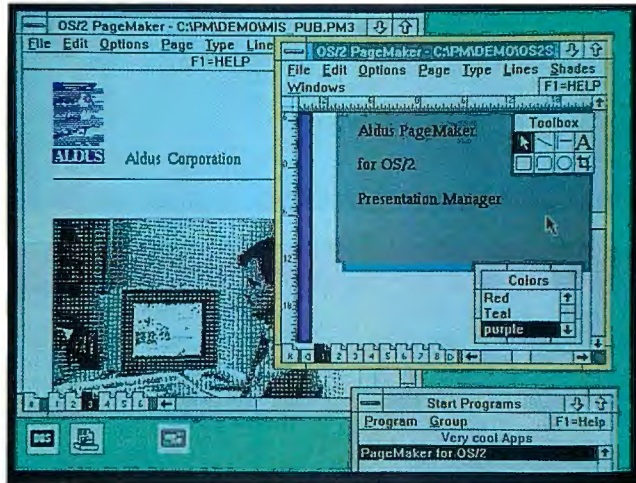

OS/2 Puts Desktop Publishing in the Fast Lane

Imagine a desktop publishing (DTP) package with the power of PageMaker 3.0 and the added ability to handle multiple documents simultaneously. If that sounds like a dream come true, how about a product that runs faster than PageMaker 3.0 yet can share files with it? **PageMaker for OS/2 Presentation Manager** can do all that and more.

It may be that for DTP software users OS/2 has found a *raison d'être*. PageMaker has always been an excellent package, holding a position as one of the two most popular DTP packages for the IBM PC. But I've always thought that it would benefit from a bit more speed, a little less disk swapping, and better font control.

OS/2 provides facilities for managing much more memory than the maximum of 640K bytes handled by DOS. Thus, this version of PageMaker has more memory to use, so it runs much faster than its DOS cousin. Multiple document windows let PageMaker for OS/2 easily transfer graphics elements from document to document. The DOS version has been unable to do

this since the conversion from PageMaker 1.0 to 3.0.

OS/2 also fixes something about Windows 2.10 that has always bugged me—the screen fonts. Under Windows, the imprecise font display made it difficult to tell how the printed document would look. You had to trust that PageMaker knew more than it could show you on-screen. I was pleasantly surprised to see how terrific the Presentation Manager fonts looked by comparison. Perhaps I've just never installed Windows fonts correctly, but if that's true, I'm not alone.

Multitasking isn't wasted on PageMaker, either. If you've used PageMaker 3.0, you know what a godsend autoflow was. The ability to automatically run text from one column to another and from one page to another got rid of one of PageMaker 1.0's biggest limitations. But it wasn't the fastest function, and it tied up the computer for a fair amount of time on long text.

Multitasking OS/2 lets the new PageMaker autoflow one document while you work on another. I tested it with a

lengthy piece of text and found that I could work smoothly on a second document while the first was still processing.

To make full use of PageMaker for OS/2 right now, you'll have to run under both DOS and OS/2, at least until paint, scanning, and text-editing packages are available for OS/2. This may sound like *déjà vu* to those of you who remember how frustrating PageMaker was in the early days of version 1.0, when few programs were compatible with Windows.

THE FACTS

**PageMaker for OS/2
Presentation Manager**
\$795

Requirements:

IBM PS/2 Model 70, Model 80, or other 80386 system with a 40-megabyte hard disk drive; 4 to 6 megabytes of extended memory; an EGA, VGA, or high-resolution color monitor and adapter card; an OS/2-compatible pointing device; and a PostScript- or OS/2-compatible printer.

Aldus Corp.
411 First Ave. S,
Suite 200
Seattle, WA 98104
(206) 622-5500
Inquiry 1002.

So, again we must wait. But when the programs are available, PageMaker for OS/2 may be a good enough reason to consider buying OS/2. If you're already running OS/2 and don't have a DTP program, you'll want to give this package a serious look. □

—Howard Eglowstein

Think C Goes OOP

Like fine wine, some Macintosh software gets better with age. So it is with Symantec's C compiler, **Think C**, now upgraded to version 4.0. It uses an integrated development environment that contains an editor, a compiler, and a linker combined in a single application for fast code development. Under MultiFinder, a source debugger lets you step through source code, set breakpoints, and examine

the contents of variables, arrays, and structures. So what's new this time around?

First, the compiler and C libraries now conform to the ANSI standard. Second, the compiler can generate multi-segmented code resources (a capability that had been previously limited to applications, drivers, and desk accessories). Third, the compiler's in-line assembler has been

continued

rewritten: The assembly language syntax has been relaxed to support 68020/68030 addressing modes and instructions. The compiler supports the 68881/68882 FPU, but the 68851 paged-memory-management-unit and 68030 MMU instructions are not supported. Last but not least, Think C now supports object-oriented programming (OOP) in language extensions called Object C.

Object C's syntax is loosely based on C++. As with C++, you implement objects by first declaring a *class*. In Object C, these declarations are extensions of *struct* declarations. You allocate or remove objects from memory by using the *new()* and *delete()* functions, respectively. Object C's message dispatcher supports polymorphism; that is, during execution, the dispatcher determines the class of the method that the message is going to (also called run-time binding). This allows you the flexibility to write methods within your program that will override existing methods within a class.

Run-time binding exacts a performance penalty, but the Think C linker looks for ways to overcome this. It evaluates your code, and if a particular method is monomorphic (i.e., it doesn't override another class and is itself not overrid-

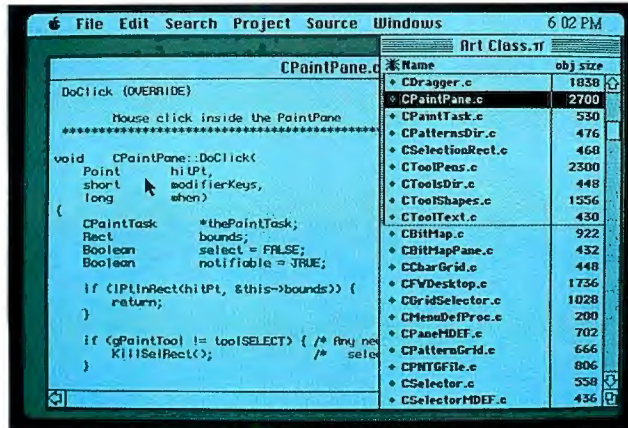

THE FACTS

Think C 4.0
\$249; upgrade, \$69

Requirements:

Mac with 1 megabyte of RAM (2 megabytes and MultiFinder are required to run the source debugger) and System 6.0.2 or higher; a hard disk drive is recommended.

Symantec Corp.
135 South Rd.
Bedford, MA 01730
(617) 275-4800
Inquiry 1003.

den), it generates a direct call to the method, rather than routing it through the dispatcher. A set of class libraries that let you easily use Mac windows, handle the menu bar, and process events is also provided.

The big advantage of Object C is that you can trace through it using the Think C source debugger. You can actually

watch the thread of execution pass through objects and see instance variables modified. Two new sample programs (besides the usual application and desk accessory files) are provided: a paint application written in Object C and an object-oriented cdev. Normally, you can use only the source debugger to debug applications, but Symantec also supplies a

special application shell that lets you debug a cdev. The preliminary documentation covers only the Unix libraries and Object C extensions. A list of Mac Toolbox calls with the appropriate Think C arguments would be helpful.

I used a prerelease version of the compiler to complete two works in progress. The first was an application that makes extensive use of AppleTalk. The second was an FKEY that output two characters to the Mac's printer port to disengage a smart serial switch I was using to share an Apple ImageWriter with a Mac and a PC.

I had no trouble making the switch to the new compiler and experienced no problems completing the programs. Compiling and linking were snappy, as in version 3.0. I also traced program flow with the source debugger, with both the sample cdev and the object-oriented paint application.

If you already own Think C, it's time to upgrade. If you want a low-cost, fast C development package for the Mac with object-oriented extensions, look no further. Think C continues its reputation as a high-quality product, and its class libraries and source debugger can shed light on how objects *really* work. □

—Tom Thompson

An Ink-Jet Printer for the Mac

Macintosh users now have an ink-jet printer to call their own. The **DeskWriter** from Hewlett-Packard is the new Mac printer that's based on DeskJet technology.

Using a relatively simple paper path, ink is deposited at a rate of 300 dots per inch from a disposable ink cartridge. The cartridges are priced at a reasonable \$18.95. However, if they last only as long as those in the DeskJet Plus, you'd better buy a handful.

You can increase the print speed up to 50 percent with the

draft-quality mode, which prints at 150 dpi.

This 15-pound printer is powered by an external power supply from an AC outlet. To hook it up, you'll need an M0197 Apple male-mini-8-to-male-mini-8 cord, which you connect to the serial port of your Mac.

The printer uses QuickDraw to do its imaging and has a driver from Palomar Software. You can scale the fonts from 4 to 250 points without having to install fonts for each point size. While this is simi-

THE FACTS

DeskWriter
\$1195

Requirements:
Mac Plus, SE, or II with a hard disk drive for font storage and a standard peripheral/8 cable.

Hewlett-Packard Co.
19310 Pruneridge Ave.
Cupertino, CA 95014
(800) 752-0900
Inquiry 1004.

lar to the printing mechanism envisioned in Apple's forthcoming System 7.0, it remains to be seen what effect the release of System 7.0 will have

on the printer driver. It will probably be minimal, since the overall design appears to conform to Apple guidelines.

continued



Embedded systems designers have already used CrossCode C in over 413 different applications.

CrossCode C has twelve important features to help you program your 68000-based ROMable applications

It's the one 68000 C compiler that's tailor-made for embedded systems development

CrossCode C is designed specifically to help you write ROMable code for all members of the Motorola 68000 family. It comes with these twelve special features to help you get your code into ROM:

1. A 100% ROMable Compiler: CrossCode C splits its output into five memory sections for easy placement into ROM or RAM at link time.

2. Integrated C and Assembler: You can write your code in any combination of C and assembly language.

3. Readable Assembly Language Output: The compiler generates assembly language code *with your C language source code embedded as comments*, so you can see each statement's compiled output.

4. Optimized Code: CrossCode C uses minimum required precision when evaluating expressions. It also "folds" constants at compilation time, converts multiplications to shifts when possible, and eliminates superfluous branches.

5. Custom Optimization: You can optimize compiler output for your application because *you* control the sizes of C types, including pointers, *floats*, and all integral types.

6. Register Optimization: Ten registers are reserved for your register variables, and there's an option to automatically declare all stack variables as *register*, so you can instantly optimize programs that were written without registers in mind.

7. C Library Source: An extensive C library containing over 47 C functions is provided in source form.

8. No Limitations: No matter how large your program is, CrossCode C will compile it. There are no limits on the number of symbols in your program, the size of your input file, or the size of a C function.

9. 68030 Support: If you're using the 68030, CrossCode C will use its extra instructions and addressing modes.

10. Floating Point Support: If you're using the 68881, the compiler performs floating point operations through the coprocessor, and floating point register variables are stored in 68881 registers.

11. Position Independence: Both position independent code and data can be generated if needed.

12. ANSI Standards: CrossCode C tracks the ANSI C standard, so *your* code

will always be standard, too.

There's More

CrossCode C comes with an assembler, a linker, and a tool to help you prepare your object code for transmission to PROM programmers and emulators. And there's another special tool that gives you symbolic debugging support by helping you to prepare symbol tables for virtually all types of emulators.

CrossCode C is available under MS-DOS for just \$1595, and it runs on all IBM PCs and compatibles (640K memory and hard disk are required). Also available under UNIX, XENIX, and VMS.

CALL TODAY for more information:

1-800-448-7733
(ask for extension 2003)

Outside the United States, please dial

PHONE: 1-312-971-8170
FAX: 1-312-971-8513

SOFTWARE DEVELOPMENT SYSTEMS, INC.
DEPARTMENT 23
4248 BELLE AIRE LANE
DOWNERS GROVE, ILLINOIS 60515 USA

CrossCode™ is a trademark of SOFTWARE DEVELOPMENT SYSTEMS, INC. MS-DOS® is a registered trademark of Microsoft. UNIX® is a registered trademark of AT&T. XENIX® is a registered trademark of Microsoft.

We had no trouble using the DeskWriter with most Mac programs. Programs that provide PostScript output, however, aren't compatible. These exceptions are well documented in the manual.

The DeskWriter comes with four fonts: Courier, Times, Helvetica, and Symbol. We thought the quality of the printing was remarkable and found that we could create documents that look identical

to LaserWriter output. We uploaded some bit-map fonts, which also produced an extremely crisp page.

For \$200 less than a dot-matrix ImageWriter LQ, you get ink-jet quality. While the

DeskWriter is not networkable, it appears to be ideal for low-quantity (fewer than 50 documents a day), high-quality personal printing. □

—Anne Fischer Lent and
Laurence H. Loeb

Communications Get Hyper

Hilgraeve's **HyperAccess/5**, the newest version of its venerable communications program for the IBM PC, is overflowing with every communications feature you can imagine.

Although adding feature after feature to a package isn't unusual these days, I'm a purist. I like my communications software to do a few simple things well, like logging onto a system and doing file transfers. So I found HyperAccess/5 to be a bit overdone, with a confusing user interface that stubbornly told me it was connected to BIX before it even dialed the number. I finally found out what I was doing wrong, but the beta software I was using continued to blow up at unexpected times.

However, some of its features did grow on me. HyperAccess/5 let me set up a simple command-line method to access the systems I use most often, but I first had to wade through a myriad of screens and help files and also read the manual to figure it out. And although they're common in communications software these days, the package's "smart" method of automatically learning log-ons and its ability to scroll back through a session are handy indeed.

But HyperAccess/5's most noteworthy features are its ability to be highly customized to a wide variety of terminal emulations and modems. And somehow, the package's designers have managed to make it perhaps the most well-

THE FACTS	
HyperAccess/5 \$199	Hilgraeve Genesis Center 111 Conant Ave., Suite A Monroe, MI 48161 (800) 826-2760 Inquiry 1005.
Requirements: IBM PC, AT, PS/2, or compatible running OS/2 1.0 or higher (or DOS 2.0 or higher) with 384K bytes of RAM.	

behaved software around. It runs fine under Microsoft Windows. Also, HyperAccess/5 adds OS/2 support, becoming the first communications program to run under Presentation Manager.

Then there are the built-in editor, extensive BBS capabilities (even call-back), and time-triggered calling. About

the only thing that I found to be missing was background operation (except under OS/2). If you want simple and inexpensive communications, make another choice. But if you are willing to ascend its steep learning curve, HyperAccess/5 can open new horizons. □

—Stan Miastkowski

Swapping DOS to Mac the Convenient Way



One of the greatest things Apple has ever done is to come up with the FDHD (for floppy disk high-density) unit. This terrific device with the terrible moniker hooks to a Macintosh and lets it read and write 3½-inch floppy disks from a DOS machine. For those of us who use both a Mac and a DOS computer and who work at a place where disks might come our way, this product is an essential piece of hardware.

Now Dayna Communications has come up with an essential piece of software for anyone who has an FDHD unit. **DOS Mounter** is a utility program that lets the FDHD unit access DOS disks without having to use the Apple File

Exchange (i.e., a file converter that lets the Mac work with alien formats). **DOS Mounter** causes a foreign disk to appear on the Desktop as a Mac disk; you can work with the files on the disk as if they came from a Mac.

After I installed **DOS Mounter** in the System folder of a Mac IIcx, I tried opening some PageMaker files created on a Compaq computer. No problem. Not only did the files open intact, but all the formats and styles translated properly. I also checked out some files from PC versions of Excel and Microsoft Word. No problem. Dayna, though, warns that not all files will be so thoroughly maintained. I'd recommend knowing your applications'

continued

We think programmers need more drive.

Get the tools you need to enter
the CD-ROM age.
**Microsoft Programmer's Library
Software plus a Denon
CD-ROM Drive—for under \$1,000.**

Call Microsoft direct at (800) 227-4679
now for complete details on the bundled bargain
of the year: Microsoft *Programmer's Library*

*"If you do much
programming and
your time is worth
anything at all, get
a CD-ROM reader
and Microsoft's
Programmer's
Library. You won't
regret it. Highly
recommended."*

—Jerry Pournelle,
Byte Magazine, Sept. 1989

with 72 reference
manuals and guides
—over 278 MB of
data on a single
compact disc. Plus
3-user OPTI-NET™
software, including
2 additional user li-
censes (a \$130 sav-
ings). And Denon's
SCSI CD-ROM
drive system, com-
plete with interface
card and cables...
all for just \$949.

With accelerating hardware and soft-
ware development by leading companies like
IBM, Intel, Lotus and Microsoft, CD-ROM is
fast becoming a standard peripheral of the 90's.
Utilizing CD-ROM technology, Microsoft Pro-
grammer's Library helps you work faster...and
smarter. Over 100,000 hypertext links stream-
line your search time, giving you instant access
to all documentation on networks, hardware,

OS/2, Windows™ and MS-DOS® environments,
C, Macro Assembler, Pascal, FORTRAN and
BASIC. And the latest versions of 72 essential
reference texts, with regular updates avail-
able from Microsoft. You'll also have 26 MB of
indexed code you can actually cut-and-paste
right into your text editor.

The Denon CD-ROM drive—with its
advanced servo-circuitry, high reliability, multi-
mode flexibility and access time of 400 ms.—
dramatically cuts manual search time and
downtime. And when you really want to switch
modes, the built-in speaker and jacks let you
play your favorite audio CDs. So you can *listen*
to a keyboard for a change. But if you just can't
stop programming, Microsoft audio software
turns your CD drive into a programmable audio
CD player. Order now and this special music
program (a \$99 value) is *yours free...* while
supplies last.

*15-Day Money-Back Guarantee. Order
direct from Microsoft today and get Microsoft
Programmer's Library complete with the
Denon CD-ROM Drive (IBM® AT® version)
and Microsoft's audio program for just \$949.*

**Call now and save \$799!
(800) 227-4679**

Microsoft
Making it all make sense

C for the 8051 Compare:

Benchmark Results —Sample program: Eratosthenese sieve
Program from BYTE (1/83) expanded with I/O and interrupt handling.

	Archimedes		
	ICC51 v2.20A	MCC51 v1.2	FRANKLIN C51 v2.1
Compilation time	12 sec ✓	18 sec	17 sec
Linkage time	29 sec	9 sec	6 sec ✓
Execution time	11.45 sec	9.00 sec	0.88 sec ✓
Total code size	5318 bytes	3798	1726 ✓
Sieve module size	736	1021	541 ✓

Call now for your free DEMO disk.

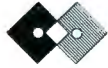

FRANKLIN

SOFTWARE, INC.

888 Saratoga Ave. #2 • San Jose, CA 95129
(408) 296-8051 • FAX (408) 296-8061

Europe A: (0222) 25 36 26 B: (010) 22 34 55 CH: (032) 41 01 11 D: KEIL
(089) 46 50 57 DK: (02) 65 82 00 F: (1) 64 07 85 64 GB: (0962) 73 31
40 NL: (01858) 16133 S: (040) 92 24 25 Far East: Aust: (61) 04 65 41
873 R.O.C.: (02) 76 40 2156 N.Z. (64) 04 694 129 (fax).

NEW FOR TURBO C PROGRAMMERS

Three Serious Tools to maximize your time.

Your time is valuable! Now you can reduce your programming time like you never imagined, using The Working Toolbox Software program by Be Aware Inc. Our program comes with an extensive 310 page, easy-to-use manual that is loaded with examples. Also included is a 30-day money back guarantee. Here are some of the features of these three great timesaving tools.

THE WORKING TOOLBOX

THE WORKING ISAM

- Stores data in B+ Trees.
- Maximum of 256 indexes.
- RAM buffers for high speed.
- 6 types of indexes available.
- Multi-field indexing.
- All indexes stored in one file.
- Automatic Recovery.
- FREE SOURCE CODE

THE WORKING SCREEN PAINTER

- Friendly interactive environment.
- Data entry and display.
- Box & line drawing supported.
- Multi color screens at a glance!
- SUPER FAST SCREENS
- Writes C source code ready to be compiled under any memory model.

THE HANDY LIBRARY

- Great functions for easier programming and professional results.
- Intelligent data entry and display.
- Overlapping windows
- Pop Up, Pull down and bar menus with one function call!
- All memory models supported.
- Date conversion functions.

Don't waste any more time, order now! Special introductory price of \$179.99 plus S & H. Call (our toll-free number) or fax your order.

Be Aware Inc.

5197 N.W. 15th St., Suite 120, Margate, FL 33063

No Royalties! ORDER NOW ONLY \$179.99
1 800-423-1611 or 305-970-0372
or FAX 305-735-3459

Turbo C is a registered trademark of Borland International.

capabilities for saving files to certain formats before investing in an FDHD unit or DOS Mounter.

The package comes with an "extension mapping" feature that lets you open a DOS file by just double-clicking on the file's icon instead of having to first call up the application. This feature basically links DOS file extensions with Mac applications, like DBF with dBASE Mac.

The program's extension table is set up for common programs like dBASE, Excel, and PageMaker. You can customize this table in a window that's similar to the Font/DA Mover. Extension mapping doesn't eliminate the need for file translation when working with incompatible files or programs. Mapping a DOS file to an incompatible Mac program will result in either the program not starting up or the file containing weird characters.

DOS Mounter cannot initialize or erase DOS disks. For

that you need the Apple File Exchange 1.1.1, which comes with DOS Mounter. You're supposed to be able to initialize disks in either 720K-byte or 1.44-megabyte formats, but the version that I worked with didn't have a button for the higher density.

I took some disks formatted in the FDHD unit and tried using them with several different DOS computers. I thought that my skepticism was justified when a certain PC clone wouldn't have anything to do with one of the Macintosh-born disks, but it turned out that the clone had some bad parts and wouldn't even accept true-blue disks.

If you're a Mac user who's frequently working with data files from a DOS computer and you like convenience, you need an Apple FDHD unit. And if you need an FDHD unit for your Mac, you probably also need the DOS Mounter software. □

—D. Barker

THE FACTS

DOS Mounter
\$89.95

Requirements:
Mac with an FDHD unit
and System 6.0.2 or higher.

Dayna Communications
50 South Main, Suite 530
Salt Lake City, UT 84144
(801) 531-0600
Inquiry 1006.

Cold Cache for Your Hard Disk

Caching disk controllers, which use dedicated RAM to store most-often-used data for virtually immediate access, have been available for several years. But the last few months have seen the arrival of a new generation of "smart" caching controllers that put a big dent in the hard disk drive data transfer bottleneck.

Two such controllers are **hyperStore-816** from Perceptive Solutions and **Smart-Cache PM3011** from Distributed Processing Technology (DPT). Starting with a 10-

MHz IBM PC AT clone, I used both controllers with a Seagate ST577R 64-megabyte run-length-limited (RLL) hard disk drive. The results were impressive.

Of the two, the hyperStore-816 has the more radical design. It's a full-length single-slot caching controller that includes a custom hard disk drive BIOS and its own operating system controlling a dedicated Zilog Z80280 microprocessor. Cache RAM is neatly packaged in single in-line memory modules. Although

continued

THE \$49 DISK SPACE SOLUTION — PACK MAGIC!



GUARANTEED.

Whether you're a hard disk user who is quickly running out of space, or a software developer whose program no longer fits on a single disk, PACK MAGIC is for you. PACK MAGIC works hard to solve these common disk space problems:

PROBLEM: You never dreamed it would happen, but your hard disk is now fast running out of room.

SOLUTION: Use PACK MAGIC to quickly compress directories when you're not using them. (They'll usually shrink by more than 50%!) When you're ready to use them, PACK MAGIC's rocket-fast algorithm expands any directory in record time.

The following savings are possible with PACK MAGIC:

Disk Size	Space Before PACK MAGIC	Space After PACK MAGIC
20 Megabytes	4 Megabytes	12 Megabytes
40 Megabytes	5 Megabytes	23 Megabytes

It's like getting a bigger hard disk!

PROBLEM: Backing up your hard disk takes forever, so you do it far less often than you should.

SOLUTION: Use PACK MAGIC to compress your directories before backing up. You'll cut the time and number of disks needed to back up by half or more.

PROBLEM: You'd like to reduce the amount of space occupied by the programs you use frequently, or you're a software developer and your program is too large to operate on a 360K floppy disk.

SOLUTION: Also use PACK MAGIC to compress your active program files (.com and .exe files). The average reduction for program files is 22%! Your programs will continue to function normally, but will occupy less disk space.

PACK MAGIC is easy-to-use, comes with a menu-driven interface, on-line help, free technical support and a printed manual.

Try PACK MAGIC for 30 days—if you're not completely satisfied, return it for a full refund (excluding shipping).

For Same Day Shipping

VISA, MASTERCARD & C.O.D. ORDERS CALL

1-800-223-6925

In Canada call: 319-395-7300

Mon.-Fri. 8:30 a.m. to 5:00 p.m. CST

FAX: 319-395-0217

Or send check or money order payable to Parsons Technology.



PACK MAGIC

\$49 + \$5 shipping

NOT COPY PROTECTED
INCLUDES PRINTED MANUAL



Dept.
375 Collins Road NE
Cedar Rapids, Iowa 52402

NAME _____

ADDRESS _____

CITY _____

STATE/ZIP _____ PHONE _____

CHECK MONEY ORDER VISA MASTERCARD

CARD # _____ EXP. DATE _____

PACK MAGIC requires an IBM*/Tandy*/Compaq* or compatible computer, 384K or more RAM and DOS 2.0 or higher. Add \$5 shipping/handling—\$10 outside North America. Iowa residents, please add 4% sales tax.

*IBM, Tandy and Compaq are registered trademarks of International Business Machines Corp., Tandy Corp., and Compaq Computer Corp. respectively.

NEW! REAL-TIME MONITORING & CONTROL

MENU-DRIVEN, EASY-TO-USE STAND-ALONE COMPUTER

The stand-alone SOLUS™ computer connects to an IBM PC's RS-232 port, and provides 36 digital/analog I/O channels.

Menu-driven operation and a large graphics library make it easy to create monitoring and control applications. Use modems to remote locations. And daisychain up to 256 SOLUS computers.

For details or to order, call toll-free.

(800) 247-5712
In Oregon
(503) 635-3966



Only
\$895

VISA/MC/
AMEX
accepted.
Software
additional.

SOLUS™

PERSONAL CONTROL COMPUTER™



TMI, inc.
4000 Kruse Way Place, 2-120
Lake Oswego, OR 97035
FAX (503) 635-3004

Introducing Smallest 80386 based PC Compatible Single Board Computer

Now Available
DR DOS®



Only
4" x 6"

Quark/PC® II

- EGA® Video/Color LCD Controller
- SCSI Hard Disk Control • Floppy Disk Control
- Up to 4 Mbytes Memory and much more. . .

To order or enquire call us today.
Megatel Computer Corporation
(416) 245-2953 FAX (416) 245-6505

125 Wendell Ave., Weston, Ontario M9N 3K9

REPS: Italy 39 331 256 524 Austria 43 222 587 6475
W. Germany 49 6074 98031 Finland 358 0757 1711
U.K. 44 959 71011 Sweden 46 40 78 078
Netherlands 31 838 529 505 Norway 47 986 9970
Australia 61 03 568 0988 Denmark 45 244 0488

Trademarks: Quark - F. + K. Mfg. Co. DRDOS - Digital Research Ltd. EGA - IBM Corp.

megatel

SHORT TAKES

512K bytes is standard, the unit I tested was packed with the maximum of four 1-mega-byte SIMMs.

Perceptive Solutions puts its standard floppy disk drive controller and the hard disk drive interface modules on small daughterboards that are mounted to the main hyperStore-816 board. This perceptive design lets you easily change the hard disk drive interface (RLL, modified frequency modulation, ESDI, or SCSI) should you upgrade your hard disk drive.

DPT's SmartCache has a Motorola 68000 microprocessor and uses a more conventional design, with the (optional) floppy disk drive controller and hard disk drive interface integrated onto a single board. This can be a real pain if you change to a drive with a different interface, requiring you to buy an entire new controller. If you want to use a larger cache than the standard 512K bytes, you also need to add a second full-size board. DPT uses standard 1-megabit chips; the board can hold up to 12 megabytes.

After making a full backup of my drive, I found both boards easy to install.

After DOS partitioning and formatting the drives, I immediately booted and used the

system in the normal manner. The increase in performance was dramatic. Objective benchmarking of these boards is almost impossible, because the jealously guarded proprietary algorithms "watched" how I worked and became progressively faster as I used them. Both companies claim an effective disk-access time of about 0.5 ms, and I have to agree. What this means in real-world terms is that most applications run eight to 12 times faster.

Although both boards gave me similar results, each had idiosyncrasies. I liked the compact design and easy expandability of the hyperStore-816, but the unit I tested worked only with vanilla DOS. (The company says that drivers for Unix, OS/2, and Novell NetWare are on the way.) SmartCache works with all operating systems, but the necessity of using a second slot for additional cache memory is inconvenient. In addition, my SmartCache ran very hot, although the company assured me that it was normal. Although fully configured caching controllers are not inexpensive, I found that the real speed they added to my system is a better investment than a faster microprocessor. ■

—Stan Miastkowski

THE FACTS

hyperStore-816
\$1195 (with 512K bytes)

Requirements:
IBM AT or compatible.

Perceptive Solutions, Inc.
1509 Falcon St.,
Suite 104
DeSoto, TX 75115
(800) 343-0903
Inquiry 1007.

SmartCache PM3011
\$1150 (with 512K bytes)

Requirements:
IBM AT or compatible.

Options:
Floppy disk support, \$80;
mirroring option, \$800;
BIOS expander chip set,
\$50.

Distributed Processing
Technology
132 Candace Dr.
P.O. Box 1864
Maitland, FL 32751
(407) 830-5522
Inquiry 1008.

Teach your HP LaserJet Series II[®] the powerful PostScript[®] language. In one easy lesson.

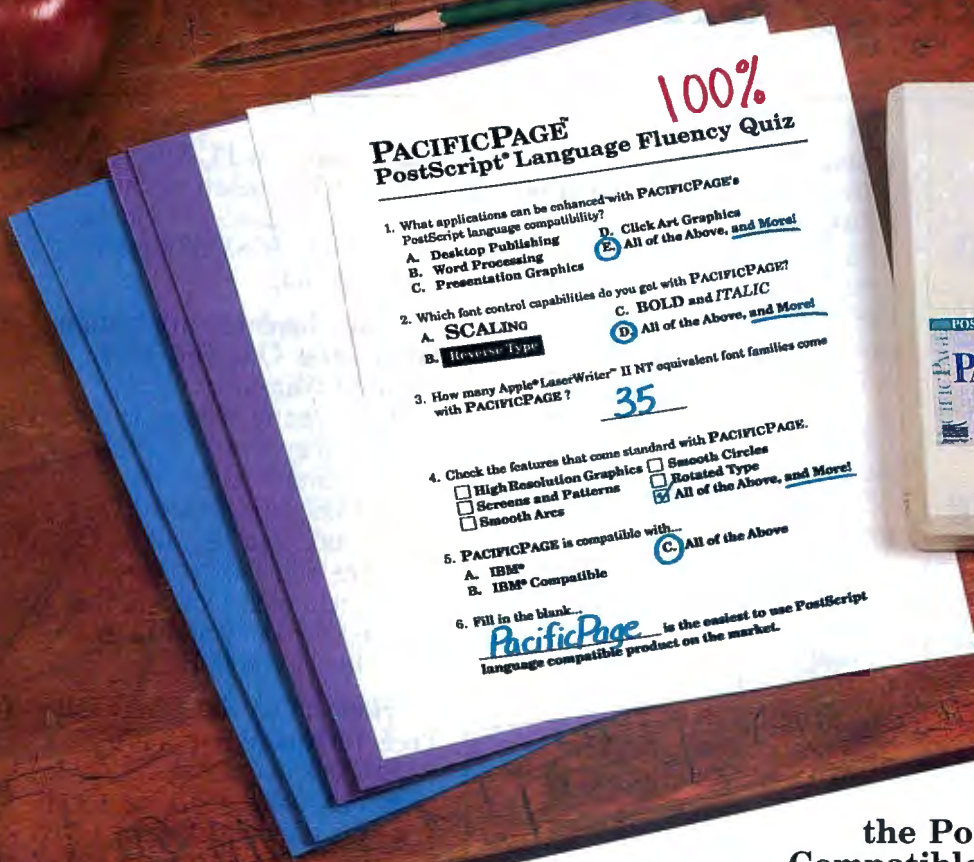

100% PACIFICPAGE[™] PostScript[®] Language Fluency Quiz

- What applications can be enhanced with PACIFICPAGE's PostScript language compatibility?
 - A. Desktop Publishing
 - B. Word Processing
 - C. Presentation Graphics
 - D. Click Art Graphics
 - E. All of the Above, and More!
- Which font control capabilities do you get with PACIFICPAGE?
 - A. SCALING
 - B. Reverse Type
 - C. BOLD and ITALIC
 - D. All of the Above, and More!
- How many Apple[®] LaserWriter[™] II NT equivalent font families come with PACIFICPAGE? 35
- Check the features that come standard with PACIFICPAGE.

<input type="checkbox"/> High Resolution Graphics	<input type="checkbox"/> Smooth Circles
<input type="checkbox"/> Screens and Patterns	<input type="checkbox"/> Rotated Type
<input type="checkbox"/> Smooth Arcs	<input checked="" type="checkbox"/> All of the Above, and More!
- PACIFICPAGE is compatible with...
 - A. IBM[®]
 - B. IBM[®] Compatible
 - C. All of the Above
- Fill in the blank...
PacificPage is the easiest to use PostScript language compatible product on the market.



PACIFICPAGE[™] the PostScript[®] Language Compatible Plug-in Cartridge

It's never been this easy.
Now, you can turn your HP LaserJet Series II into a PostScript language compatible printer simply by plugging in Pacific Data Products' *PacificPage* cartridge. That's all. No other add-ins, software or cables are required.

Immediately start printing PostScript language output from Ventura Publisher[®], Aldus PageMaker[®], WordPerfect 5.0[®], Microsoft Word[®] as well as many other graphics and business application software packages. And *PacificPage* is compatible

with IBM[®] and IBM-compatibles.

PacificPage is the result of the proven cartridge-based technology—*Plotter in a Cartridge[™], 25 Cartridges in One![™]*—from Pacific Data Products and the innovative PostScript emulation skills of Phoenix Technologies, Ltd.

Authorized Dealer:

DATA LINK

NORTHWEST

All font cartridges carry lifetime warranty

14430 18th Ave. SW
Seattle, WA 98166

(206) 244-2355

1-800-544-1720

PACIFIC
DATA PRODUCTS

6404 Nancy Ridge Dr., San Diego, CA 92121 • (619) 552-0880 FAX (619) 552-0889 • PacificPage, 25 Cartridges in One!, and Plotter in a Cartridge are trademarks of Pacific Data Products, Inc. PostScript is a registered trademark of Adobe Systems Inc. PhoenixPage is a registered trademark of Phoenix Technologies, Ltd. Copyright 1987, 1988 Phoenix Technologies Ltd. All other company and product names are trademarks of the company or manufacturer respectively. Copyright 1989 Pacific Data Products, Inc.



ZEOS[®] 386SX

ZEOS Smashes the '386

Your best reason yet to move up to a '386. Now you can own a complete ZEOS '386SX 16MHz hard drive system for less than comparable '286 systems.

The ZEOS '386SX. ZEOS performance, quality and support. ZEOS value. The Choice is Clear.

If you plan to buy a 16- or 20MHz 286 machine, think again.

A fundamental change in computing is about to take place. Systems based on the 80286 processor will be replaced by systems based on the 80386SX.

As America's premier manufacturer of 80386 based systems, we've designed the new ZEOS 386SX to provide everyone with a window to the future. A future of '386 speed and performance at a fraction of what you would expect to pay.

And ZEOS knows '386 systems better than anyone. After all, PC Magazine chose ZEOS above 57 other companies for "*For Overall Excellence*" in their recent '386 Blockbuster issue.

The new ZEOS 386SX simply runs circles around '286 based machines. PC magazine noted that the ZEOS 16MHz 386SX compares "favorably with the 20MHz '286 machines reviewed in 'The 80286: Unsafe at Higher Speeds?'" (PC Magazine, December 27, 1988).

So forget those 16- and 20MHz '286 machines forever. The ZEOS '386SX-16 "blows 'em right out

of the water." As PC Magazine says, "386SX-based machines are the right choice..." and the new ZEOS 386SX is the right choice for you.

30 Day Absolute Satisfaction Guarantee. One Full Year Limited Warranty.

If a company believes in their product, they should stand Rock Solid behind it. That's why your new ZEOS 386SX hard drive system includes our famous 30 Day Absolute Satisfaction *Money Back* Guarantee, One Full Year Limited Warranty and Express Parts Replacement Policy.

24 Hour a Day Sales and Toll Free Technical Support!

And talk about service! ZEOS is the only computer company in America standing by ready to help you *Toll Free, 24 hours a day, 365 days a year*. Nobody supports their customers like ZEOS!

Order your new ZEOS 386SX now with confidence. Your choice of ZEOS quality and performance is *Guaranteed*. Order now by calling 800-423-5891.

Only \$1695. Price Barrier!



The New ZEOS 386SX Hard Drive System. Below '286 Prices! Only \$1,695

The future is now!

Why be left behind with yesterday's '286 technology? This fast new ZEOS 386SX system is your high performance ticket to '386 computing power. It's actually faster and yet less expensive than comparable '286 systems.

- 80386SX-16 CPU, 8/16MHz Dual Speed Keyboard Selectable. Reset/Turbo Buttons.
- 512K DRAM, expandable to a System Total of 16MB.
- Shadow RAM and EMS capability.
- Fast 32MB Seagate 138R Hard Drive with autopark, 1.2MB Teac floppy drive.
- Ultra high speed Hard/Floppy controller. 1:1 interleave, High Speed transfer.
- Genuine Hercules® brand graphics controller. High-Res Amber Display with Tilt/Swivel.
- ZEOS/RS Enhanced Tactile/Click keyboard.
- 2 High Speed Serial Ports plus one Parallel and one Game Port.
- 6-16, 2-8 bit expansion slots. 80387SX support.
- Rugged ZEOS space saver case. Security lock and LED indicators.
- Includes ZEOS 24 Hour a Day Toll Free Technical Support and Customer Satisfaction package.



Order Now Toll Free
800-423-5891

FAX Orders Dial: 612-633-1325
In Minnesota Call: 612-633-4591
MasterCard, VISA, ZCARD, COD
Open 24 Hours a day, 365 Days
a year.

ZEOS'386 Systems

"For Overall Excellence..."

PC Magazine, May 30, 1989

Complete ZEOS 20MHz '386 System. 80MB SCSI Drive!

Only \$2995

16MHz systems from \$2295!

The standard by which others are measured! Featuring 64K CACHE (twice that of most competitors) providing Zero-Wait State performance vastly superior to page/interleave memory schemes. Incredible Value.

- *High speed Zero-Wait 64K read and write-back SRAM CACHE. The fastest method known.*
- *Genuine 32-bit Intel 80386-20MHz CPU.*
- *1MB of Zero-Wait DRAM Expandable to 16MB.*
- *Fast 80MB, 28ms SCSI Seagate Hard Drive, Teac® 1.2MB Floppy Drive.*
- *High speed HDD/FDD SCSI Host Adaptor with Software.*
- *Genuine Hercules® brand graphics controller. High-Res Amber Display with Tilt/Swivel.*



Performance Comparisons using PC Labs Benchmark Series Release 4:

	80386 Instruction Mix	Floating Point Calculation	Conventional Memory
ZEOS 386/16 Desktop	3.58	13.62	0.58
ZEOS 386/20 Desktop	2.87	10.82	0.38
IBM PS/2 Model 70-E61	4.08	16.04	0.75
Compaq Deskpro 386/16	4.12	15.47	0.75

- *101 Key ZEOS Tactile/Click keyboard.*
- *2 High Speed Serial Ports plus one Parallel and one Game port.*
- *1-32, 6-16 and 1-8 bit slots.*
- *80387 math coprocessor support.*
- *Rugged ZEOS 5-bay case. Including Security Lock and LED indicators.*
- *Includes ZEOS 24 Hour a Day Toll Free Technical Support and Customer Satisfaction package.*

Options Galore: Including 14" VGA, add only \$595. And an incredible selection of hard drives: SCSI, RLL, ESDI or MFM and virtually any other add-on you could want!

Order Now Toll Free
800-423-5891

FAX Orders Dial: 612-633-1325
In Minnesota Call: 612-633-4591
MasterCard, VISA, ZCARD, COD
Open 24 Hours a day, 365 Days a year.

"Out of 104 machines from 58 companies... For overall excellence we selected ZEOS International's 386-16 and 386-20" *PC Magazine, May 30, 1989*

The Editors of *PC Magazine* came to this conclusion after investing "25,000 hours of work by 60 people testing and reviewing 104 '386 PCs." The review was thorough and their conclusion specific. Simply, that out of all the manufacturers in the world, ZEOS offers you the very best '386 Value.

In *all* areas, ZEOS machines are top performers. With uncompromising attention to quality and detail throughout. Not only do ZEOS systems themselves afford you the very best *Values* in computing today, they're backed up by the strongest after sales support in the industry.

At ZEOS we feel that if a company believes in its products it should stand Rock Solid behind them.

That's why ZEOS offers *Toll*

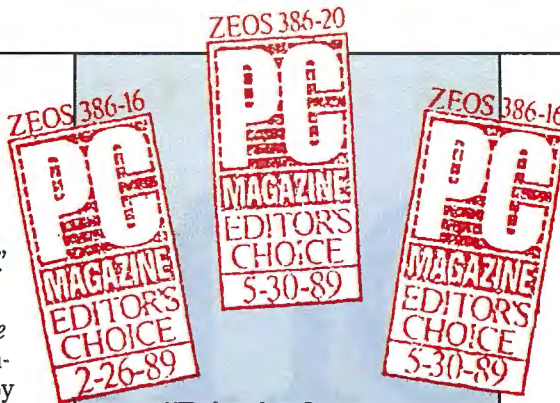

"Price is always a consideration. So are benchmark test results. But both factors can be deceiving, which is why we consider them in the context of other aspects that will make the difference months and years down the road. Things like quality of construction, reliability, expandability, and ease of service?"

PC Magazine, On "What Makes an Editor's Choice"

Free Technical Support 24 Hours a day, seven days a week, 365 days a year! At ZEOS, we believe in standing by our customers whenever they need us.

Then add our 30 Day Absolute Satisfaction *Money Back* Guarantee, One Full Year Limited Warranty and Express Parts Replacement Policy. You've got the best.

And when you order your ZEOS '386 you can have your pick from the industry's broadest selection of options. As *PC Magazine* said, ZEOS offers "more options than even the most configuration hungry hound could possibly need"

Quality, Performance, Reliability and Support. *Overall Excellence.* That's why ZEOS is *PC Magazine's #1 choice.* And that's why ZEOS is *your best choice as well.* So pick out that dream machine today and order it now with confidence. Your choice of ZEOS excellence is Guaranteed. Order now by calling 800-423-5891.

Complete 25MHz '386 Vertical System. 80MB SCSI Drive!

Only \$3995

Complete 33MHz systems only \$4995!

ZEOS 25MHz and 33MHz 80386 systems are the fastest, most advanced available anywhere. Government Computer News calls the ZEOS '386-33 "arguably the fastest MS-DOS and OS/2 micro in the world." Review after review, these ZEOS systems are selected as the best price/performance buys. A power user's dream!

- *Ultra High speed Zero-Wait 64K SRAM CACHE.*
- *Genuine 32-bit Intel '386-25 or 33MHz CPU.*
- *1MB of Zero-Wait DRAM Expandable to 16MB.*
- *Fast 80MB, 28ms SCSI Seagate Hard Drive, Teac® 1.2MB Floppy Drive.*
- *High speed HDD/FDD SCSI Host Adaptor with Software.*



Performance Comparisons using PC Labs Benchmark Series Release 4:

	80386 Instruction Mix	Floating Point Calculation	Conventional Memory
ZEOS 386/25 Desktop	2.29	8.37	0.33
ZEOS 386/33 Desktop	1.67	6.43	0.27
IBM PS/2 Model A	2.27	8.33	0.60
Compaq Deskpro 386/25	2.36	8.59	0.37

- *Genuine Hercules® brand graphics controller. High-Res Amber Display with Tilt/Swivel.*
- *BIOS and Video Shadow RAM plus EMS support.*
- *ZEOS Tactile/Click keyboard.*
- *2 High Speed Serial Ports plus one Parallel and one Game port.*
- *1-32, 6-16 and 1-8 bit slots.*
- *80387 math coprocessor support.*
- *Rugged ZEOS 5-bay case. Security Lock, LED indicators.*
- *Includes ZEOS 24 Hour a Day Toll Free Technical Support.*

Many options available: Including 14" VGA, add only \$595. Plus a large selection of SCSI, RLL, ESDI or MFM hard drives and more.

**Order Now Toll Free
800-423-5891**



Comput

Right Now. Guaranteed!*

Yes, we can ship your new ZEOS® '286 or '386 today! We've built up an extra supply of the hottest selling computers in America. The celebrated ZEOS 286-12 and PC Magazine's Editor's Choice—the ultra fast ZEOS 386-16.

Take your pick now for immediate delivery. These are both *complete*, genuine ZEOS Zero-Wait state systems. Both include an ultra-fast Seagate hard drive and all the other goodies. And they're ready to ship. *Right Now.*

Here's how it works. We have these extra systems pre-built and ready to ship. They include both High Resolution Monochrome and VGA systems. While supplies last, we will ship either of these systems to you *the day you order* subject to these conditions:

1. Your order must be received by 1PM Central Time.
2. Credit Cards are subject to credit card authorization.
3. Orders must be for our standard 286-12MHz system or 386-16MHz system, either monochrome or VGA. Any other systems or upgrades are custom built and will take slightly longer.

*Our Guarantee to You:

If we fail to ship your system under the conditions outlined, we will ship it *at our expense* as soon as it is ready. All systems are fully burned in and tested. Each system includes our 30 day Money Back Guarantee and One Full Year Limited Warranty. *Toll Free* technical support and Express Parts Replacement are included too!

This offer is good only as long as these pre-built

Complete ZEOS 12MHz '286 with 32MB Hard Drive!

Only \$1,395

For VGA color add \$595

FREE Shareware Disks Too!
25 Software Programs Included
 Every system will include 5 ready to run Shareware programs on free disks. Included are programs for Word Processing, Spread Sheets, Educational, Financial, Business, Games and more. With Shareware you can try the programs first before you register them with the author. What a great idea!

Standard Features Include:

- 80286-12 CPU, 6/12MHz Dual Speed keyboard/hardware selectable. Reset and Turbo buttons right up front.
- Zero-Wait State DRAM, 512K expandable to 4MB on the mother board (16MB System Total). EMS Capability on board.



Performance Comparisons using PC Labs Benchmark Series Release 4:

	80286 Instruction Mix	Floating Point Calculation	Conventional Memory
ZEOS 286/12 Desktop	4.78	18.84	0.72
IBM PC AT (8MHz)	8.96	35.60	1.32
IBM PS/2 Model 50	7.20	28.34	1.05

- Fast 32MB Seagate 138R Hard Drive with auto-park, 1.2MB Floppy Drive.
- Ultra high speed Hard/Floppy controller. 1:1 interleave, 800 KB/sec transfer rate.
- Genuine Hercules® (Yes, Hercules!) Brand graphics card. High-Res Amber Display with Tilt/Swivel Base.
- ZEOS Enhanced 101 Key Keyboard with our Pleasant Tactile/Click Feel.
- Serial and Parallel Printer Ports.
- Clock/Calendar with Battery Backup.
- 6-16 and 2-8 bit expansion slots.
- 80287 support, up to 12 MHz.
- Heavy Duty Case Complete with Security Lock and LED indicators.

**Order Now Toll Free
 800-423-5891**

ers Now! SM

systems remain in stock; please give us a call to verify availability. This offer does not apply to other ZEOS systems or custom configurations.

Immediate shipment is only part of the story.

ZEOS builds Rock Solid computers. That's why we offer you our 30 Day Money Back Guarantee, Toll Free technical support and Full One Year Limited Warranty. Compare that to the others. Then compare performance.

Performance is what ZEOS is all about. If you're buying a computer you may as well buy the fastest. The ZEOS 286-12 is *the fastest* in its class. It features true Zero-Wait state operation with speeds close to many 386 systems!

Or select the ZEOS 386-16. The Editors of *PC Magazine* did. In fact they selected the ZEOS '386

as *Editor's Choice*. And is it ever a screamer. As *PC Magazine* said, "This ZEOS 386-16 blows away every other computer..." Another *PC Magazine* editor said "Don't pass up the ZEOS... solid construction, flexible design and escape-velocity performance make it a top flight choice."

PC Resource Magazine put it this way "ZEOS... provides quality comparable with the IBM or Compaq and does so for about 70% of the cost" *Personal Computing* simply says "The best value we've come across so far."

We couldn't have said it better ourselves.

And these are the machines that we have ready to ship to you *right now*. Rock solid block buster ZEOS machines with quality and performance that is, in a word, *Guaranteed*. Order now by calling 800-423-5891.

Complete ZEOS 16MHz '386 with 80MB 28ms SCSI Drive!

Only \$2,495

For VGA color add \$595



Standard Features Include:

- Genuine 52-bit Intel 80386-16MHz CPU.
- High speed Zero-Wait 64K SRAM CACHE.
- 1MB of Zero-Wait DRAM Expandable to 16MB system total.
- Fast 80MB, 28ms SCSI Seagate Hard Drive, 1.2MB Floppy Drive.
- Ultra high speed Hard/Floppy SCSI controller.
- Genuine Hercules® Brand graphics card. High-Res Amber Display with Tilt/Swivel Base.



Performance Comparisons using PC Labs Benchmark Series Release 4:

	80386 Instruction Mix	Floating Point Calculation	Conventional Memory
ZEOS 386/16 Desktop	3.58	13.62	0.58
IBM PS/2 Model 70-E61	4.11	16.14	0.77
Compaq Deskpro 386/16	4.12	15.47	0.75

- 101 Key ZEOS Tactile/Click keyboard.
- High speed Serial and Parallel Ports.
- 1-32, 5-16 and 2-8 bit slots.
- 80387 math co-processor support.
- ZEOS 5-bay case with security lock and LED indicators.

**Order Now Toll Free
800-423-5891**

FAX Orders Dial: 612-633-1325
In Minnesota Call: 612-633-4591
MasterCard, VISA and COD
Open days, evenings and weekends
Se habla Español.
ZEOS International, Ltd.
530 5th Avenue, N.W.
St. Paul, MN 55112 USA



10 Good Reasons To Buy From ZEOS[®]

NEWSFLASH!
ZEOS International
Announces 24 Hour
a Day Toll Free
Technical Support!

Effective July 15, 1989, ZEOS makes industry history by launching 24 Hour a day, Toll Free Technical and Sales Support.

That's right, ZEOS is now open to serve our customers 24 Hours a day, 365 days a year! There is no other computer company in the world so dedicated to its customers. Now, no matter what time you need help, ZEOS will be there. Day or night. Toll Free.

During the day there are perhaps thousands of computer companies ready to sell you a computer. Many offer technical support if you are willing to pay for the call. And when they get tired, they turn off the lights and go home. Unfortunately, that may be just when you need their help.

At ZEOS, we never sleep. Because somewhere out there, there might just be a customer who needs us. Even at 3:30 A.M.

It's comforting to know. As night encompasses your home or your office, your research lab or your classroom, away in St. Paul sits a small group of very qualified and dedicated people. They're camped there, around the telephone. Just waiting for that small chance. The chance that you might be the one tonight who needs their help.

Across the vast expanse of North America, whether you're in Newfoundland or Hawaii, Florida or Alaska, or anywhere in between—ZEOS is there for you. Any time of the day or night. Any hour or day of the year. We're waiting to help. And you don't even have to pay for the call.

Reason #1

"Overall Excellence."

As *PC Magazine* said "Price is always a consideration. So are bench mark test results. But both factors can be deceiving, which is why we consider them in the context of other aspects that will make the difference months and years down the road."

These are the attributes which *PC Magazine* used in awarding ZEOS the coveted Editor's Choice, not once but three times thus far in 1989. And "Overall Excellence" are the very words *PC Magazine* used in comparing ZEOS systems to all others.

Reason #2

Dazzling Performance.

In their February 28th '386 review, *PC Magazine* awarded ZEOS Editor's Choice. "The ZEOS '386 blows away every other computer... a smart choice" is what they said. And in a recent review, *Government Computer News* said the ZEOS 33MHz '386 is "arguably the fastest MS-DOS and 'OS/2 micro in the world."

Dazzling Performance is built into every ZEOS system. It's a key component of ZEOS Overall Excellence.

Reason #3

Exceptional Quality.

PC Resource Magazine put it this way, "ZEOS... provides quality comparable with IBM or Compaq and does so for about 70% of the price." ZEOS uses only the very best components. And every system is fully tested and burned-in right in our own labs.

Reason #4

Value.

InfoWorld says, "We find the ZEOS '386 an excellent value. Speed: Excellent. Compatibility: Excellent. Value: Excellent." *Personal Computing* said, "ZEOS... is the best value we've come across... its performance is right up there with the slickest, most expensive PCs you can buy."

Reason #5

Warranties and Guarantees.

ZEOS believes in its products. That's why we offer each and every customer our 30 Day Absolute Satisfaction Money Back Guarantee, no questions asked. Plus, our One Full Year Limited Warranty and Express Parts Replacement Policy. Optional On Site Service is available too. Call for details.

Reason #6

24 Hour Toll Free Technical and Sales Support.

At ZEOS, the customer is #1. That's why we're open around the clock. For *your* convenience. If you buy a product from us we feel we should be there to help, 24 Hours a day. Our Help Lines are Toll Free too. Because you shouldn't have to pay for the call.

Reason #7

Experience.

Almost unique in the mail order computer industry, ZEOS maintains its own chip level Research and Development staff. In addition to Systems Manufacturing facility.

ZEOS has been involved in Research and Development since our incorporation back in 1981. Our strong and experienced Research, Manufacturing and Technical Staff translates into superior factory direct computer systems for you.

Reason #8

A Sterling Reputation.

In magazine after magazine and review after review ZEOS systems are sighted for *Overall Excellence*, for *Excellent Value*, as the *Right Choice* and so on. All of this is flattering but the most important thing is this: What do our customers think? Frankly, they love us. The system and the support. That means more to us than anything.

Reason #9

Easy to Buy.

ZEOS systems are easy to buy. You can pick up the phone any time of the day or night and order your new ZEOS computer. And we accept MasterCard, Visa, and Corporate Purchase Orders from Fortune 1000 Companies, Colleges, Universities and Governments. Complete Leasing Programs are available as well.

And now the ZCARD! It's your very own ZEOS Credit Card and you can apply today. With the ZCARD you can charge your ZEOS purchases and pay in easy monthly installments. It's just like a Bank Card. *Fill out and mail your ZCARD application now!*

Reason #10

You're Going to be Very Satisfied.

When it comes right down to it, you're going to be very satisfied with your new ZEOS system. Our goal is your complete satisfaction. And that's our commitment to you. To quality. To performance. To reliability and support. To *Value*. We don't just say it, we *Guarantee it!*



Order Now Toll Free
800-423-5891

FAX Orders Dial: 612-633-1325
In Minnesota Call: 612-633-4591
MasterCard, VISA, ZCARD and COD
Open 24 Hours a day, 365 Days a year.

The Portable and

Apple introduces a portable Macintosh line and its newest high-performance modular Macintosh

Apple has finally entered the portable computer sweepstakes with its introduction of the Macintosh Portable, a hefty wedge of computing power that's all Macintosh. At the same time, Apple announced the most powerful Macintosh ever: a high-speed muscle machine called the Mac IIci that rewrites the rules on limits to the Macintosh computer.

The long-awaited Macintosh Portable isn't a laptop—measuring nearly a foot and a half on each side and weighing in at roughly 16 pounds, it won't fit comfortably on your lap. But the Portable still lives up to its name: It can operate for up to a full working day away from a power

outlet, its razor-sharp reflective LCD screen sports more pixels than the Mac SE's screen, and it includes a built-in trackball that replaces the mouse. It's a fully functional Macintosh, using a 16-MHz 68000 processor and enhanced Mac SE ROMs.

The high-powered Mac IIci looks like the twin of its six-month-old cousin, the Mac IIcx. But a closer look reveals a video connector on the back, hinting at the changes inside. Internally, the Mac IIci has been completely redesigned, using a 25-MHz 68030 processor, a much improved memory subsystem with faster memory, and a slot for a memory cache board.



the Powerful

Mac Portable: An Outside Tour

With its tilt-up display stowed, the Portable resembles a wedge 15 1/4 inches wide by 14 1/16 inches deep that's taller at the back (about 4 inches high) than at the front (about 2 inches high). Its outer shell is made of high-impact platinum-gray plastic.

The Portable comes out of the box packed in its carrying case. If the unit has a hard disk drive, the system software is preinstalled. A built-in handle running the width of the wedge's shorter end pops out to make carrying the computer easier. To open the unit, you push the handle back into the wedge's body until the top of the case unlatches. The hinged case-

top contains the display, and it uncovers a full-size keyboard with 63 keys. The hinge has a friction clutch so that you can adjust the display to any angle.

To the right of the keyboard is a miniature (1 1/2-inch-diameter) trackball that replaces the mouse as the pointing device. Beneath it is a large button that serves as a mouse button. For the purists, a single Apple Desktop Bus (ADB) port at the rear allows use of a low-power mouse.

All other Macs have two ADB ports (except the Mac Plus, which doesn't use the ADB for its mouse/keyboard connections), but since the Portable's keyboard and trackball use internal ADB connec-

tions, the missing second ADB port isn't a problem. You can use a conventional ADB mouse, but it consumes more power and will shorten the Portable's operating time. If you're using an external mouse, you can replace the trackball with a numeric keypad.

Apple has a knack for handling fine details, and one place where this shows is in the trackball/keyboard design. Both the keyboard and the trackball can be popped out of the chassis and swapped so that the trackball is to the left of the keyboard, making it more convenient for left-handed users. (See photo 1.)

A 1.4-megabyte 3 1/2-inch FDHD "SuperDrive" reads Mac, Apple II, or DOS-compatible 3 1/2-inch floppy disks. The FDHD is located toward the back of the Portable, on the right side. At the rear are the usual I/O ports and several new connectors: a video port, an RJ-11 connector for an optional internal modem, and a battery charger connector. The external battery charger can operate in the 70- to 270-volt range and can handle frequencies of 40 to 70 Hz. This makes the battery charger usable anywhere in the world, provided you have a connector for the wall outlet conductors.

The Portable's display is a 9 1/2-inch-diagonal flat-panel screen that uses a reflective, active-matrix, LCD technology to provide a 640- by 400-pixel black-and-white display in which every pixel is controlled by a separate transistor. By comparison, compact Macs have a 9-inch-diagonal screen with a 512- by 342-pixel display, and modular Macs using a Macintosh II video board have a 12- or 13-inch-diagonal screen (depending on the monitor type) with a 640- by 480-pixel display.

The Portable is the first computer to use the active-matrix LCD. This technology provides the high contrast and high response speed required to display the mouse pointer in real time. Two other significant advantages of this

continued



display are its low power consumption and wide viewing angle. The video port supplies only LCD signals; an optional adapter converts these signals into analog signals for a Mac monochrome monitor or into National Television System Committee, PAL, or Séquentiel à Mémoire (SECAM) video signals.

You switch on the Portable by hitting any key on the keyboard. It has no cooling fan since it consumes so little power (1 watt without a hard disk drive and 3 W on average when the hard disk drive is running).

Mac Portable: The Inside Tour

The Macintosh Portable's ancestry can be traced to the Mac SE. However, the two computers differ as markedly on the inside as they do on the outside. Interestingly, the Portable's designers have packed more functions and slots into the smaller system.

Photo 2 shows the Portable motherboard. Its heart is a low-power CMOS 68000 processor beating at 15.67 MHz—twice the speed of the Mac SE. The 256K bytes of ROM contain enhanced Mac SE firmware that incorporates bug fixes to existing Mac SE ROMs, the LCD driver, and new functions that manage the Portable's power use. Sound generation is much improved because the Portable uses the same Apple Sound Chip (ASC) found in the Mac II to generate stereo sound.

The system comes equipped with 1 megabyte of 100-nanosecond static RAM (SRAM). A 50-pin RAM expansion slot lets you expand system RAM via a 1-megabyte RAM board, for a total of 2 megabytes. When higher-density RAM becomes available, future RAM boards will expand the Portable's maximum memory to 9 megabytes. A 50-pin ROM expansion slot either provides for a possible ROM upgrade (by moving the appropriate jumper—the Portable addresses the ROM slot rather than on-board firmware at boot-up) or allows a vendor to install up to 4 megabytes of embedded software. This latter capability would be useful, for example, to salespeople who need custom software to access on-line databases or to process forms.

Like the Mac SE, the Portable also contains a Processor Direct Slot that provides unbuffered CPU signals for use by hardware expansion boards. Although this slot uses the same 96-pin Euro-DIN connector as the Mac SE, it's incompatible electrically because of differences in the processor speed, power consumption, and additional control signals. The Portable, unlike the Mac SE, has no external access port for the PDS.

As if enough hardware wasn't packed in there already, the Portable also has a slot for an optional 2400-bps modem board and room for an optional one-third-height 40-megabyte 3½-inch SCSI hard disk drive. (See photo 3.)

Conserving Energy

To get the most out of the system, you need a reliable power source. A 2-pound, 6-V, lead-acid gel battery supplies the Portable's 5-V power. Apple chose lead-acid batteries over other battery technologies for several reasons. First, the technology is a proven one. Second, the battery voltage varies slightly as it is discharged. This gives a rough indication of the battery's remaining power—unlike a nickel-cadmium battery, whose voltage drops only when its power is nearly exhausted. Third, a lead-acid battery can be completely recharged from any level of discharge, while a nickel-cadmium battery must be discharged completely before it can be fully recharged.

Wherever possible, Apple used low-power CMOS components in the Portable. Since a CMOS version of the 68030 processor was not available, that processor was not used; it would have consumed far too much power. The main memory's SRAM eliminates the need for memory refresh circuitry. The reflective LCD uses little power, and none is spent backlighting the screen. The Portable's SCSI hard disk drive was selected for low power consumption and its ability to be switched on and off frequently.

However, even these measures aren't enough. The Portable uses a dedicated processor termed a "power manager" (not to be confused with the software Managers present in the Mac ROMs) that actively regulates power in the computer. The power manager is a Mitsubishi 50753 processor, and it primarily provides "hooks" that the System software can use to switch various subsystems on or off as needed. The power manager accomplishes this by either disabling the clock signals to various components (e.g., the Standard Wozniak Integrated Machine [SWIM] chip and the serial communications controller [SCC] chip) or switching off the power to the hard disk drive.

If a certain subsystem is inactive for a predetermined amount of time, the power manager shuts it off. Likewise, if application software is going to write to an inactive device (say, the hard disk drive or the serial port), the device driver turns the subsystem on. The power manager also takes over the duties of parameter RAM, manages the real-time clock, and serves as an ADB transceiver. It also monitors the battery voltage.

The Portable operates in several modes, each using a different amount of power. In the *active mode*, the Portable operates at 16 MHz and uses the most



Photo 1: The keyboard and the trackball can be removed and swapped to accommodate left-handed users. Mouse users can replace the trackball with a keypad.

power. If the system sits idle (i.e., no user activity and no I/O in progress) for more than 15 seconds, the Portable enters a power-saving *rest mode*. In this mode, additional wait states (64 per bus cycle) are added to each RAM or ROM access. This slows the Portable's effective speed to 1 MHz and reduces the power consumption of the processor and memory subsystem by 20 percent.

If the Portable continues to remain idle for over several minutes (the exact interval is user-selectable from a Control Panel cdev), it enters a low-power *sleep mode*. To enter this mode, the power manager first saves the state of the 68000 processor and certain system variables. Then the CPU, display, and many of the peripheral subsystems are turned off. Finally, the power manager switches itself off by disabling its own 3.9-MHz clock. The SRAM and video memory remain powered, preserving their contents. Also, portions of the modem board and several chips (i.e., the Versatile Interface Adapter, the SCC, and the keyboard processor) remain powered.

A clock signal reactivates the power manager every sixtieth of a second, and it evaluates the situation to see if the Portable should "awake" into active mode. Several conditions can terminate the sleep mode. One is hitting a key; this closes a gate that a keyboard processor detects, and it in turn notifies the power manager. Since the ADB circuits are inactive in the sleep mode, moving the trackball or clicking the mouse button will not awaken the system.

By saving the system's state and preserving main memory, these actions "freeze" the state of a running application when the Portable enters sleep mode. When the power manager restores the Portable to active mode, the application resumes from the point at which it stopped.

In another example of Apple's attention to detail, you can also set a predetermined wake-up time for the power manager. This way you can set the Portable to wake up at night and have a suspended telecommunications application start executing a script to log onto an on-line information service. Better still, the modem board's ring-detect circuitry remains powered, so that an incoming call to the Portable's modem can wake up the system, and it can resume running, say, an application to receive E-mail or a report.

The Portable presents you with several alert boxes as the battery's power diminishes. The first alert box appears when
continued

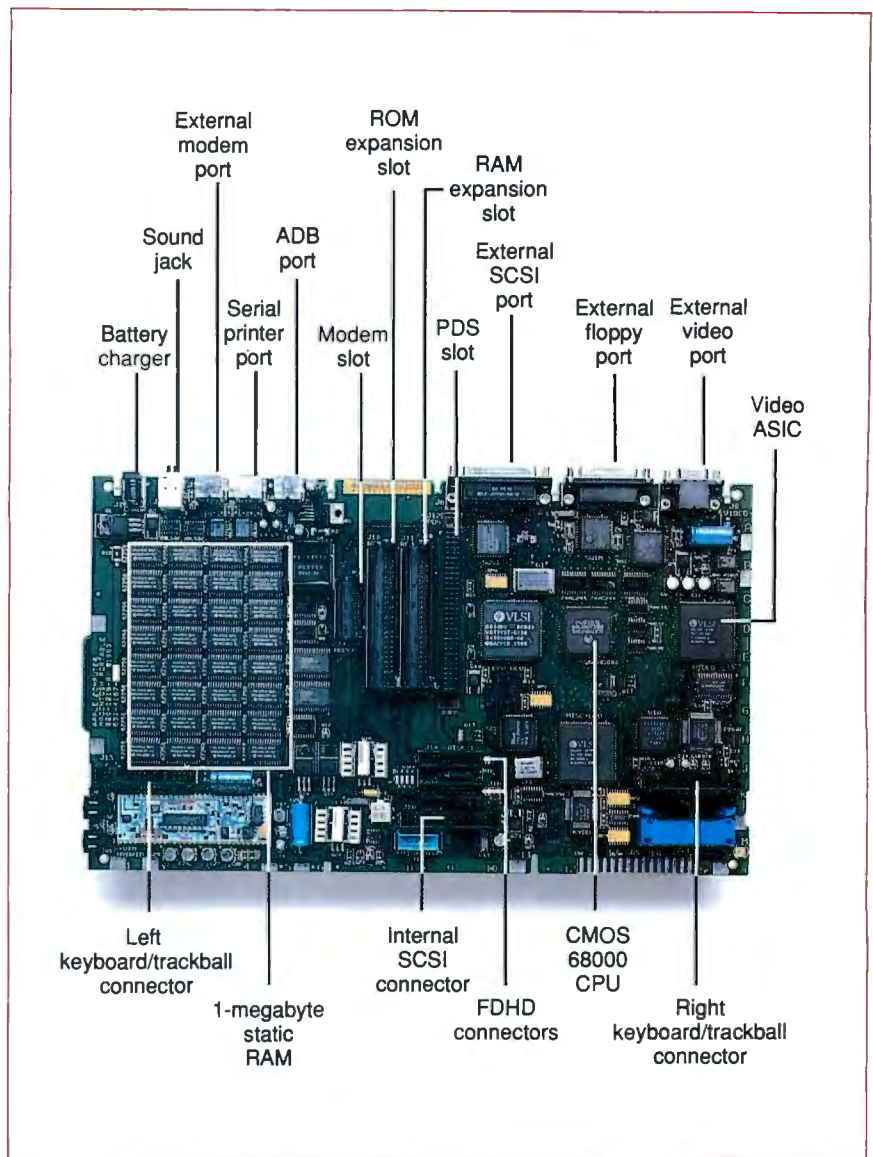

Photo 2: The Mac Portable motherboard. It uses CMOS components to reduce power consumption. The 68000 CPU runs at 15.67 MHz, twice the rate of a Mac SE.

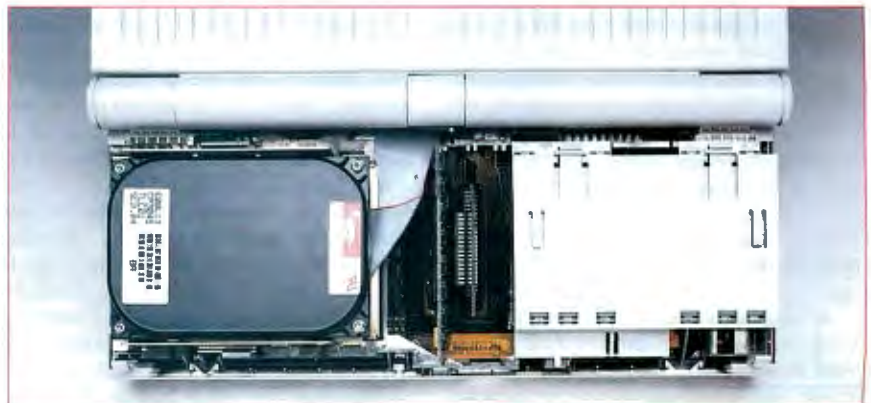

Photo 3: Inside the Portable. At left is an optional 40-megabyte SCSI hard disk drive; in the center are RAM/ROM expansion slots; to the right is the battery housing.

there is roughly an hour of battery life left (the exact interval depends on the Portable's configuration and usage). It tells you that you are running on reserve power and warns you to recharge the battery. The second and third alert boxes appear when the battery is at 50 percent and 25 percent of this reserve capacity. When the power level becomes critical, the Portable automatically puts itself into sleep mode. The battery preserves the state of the machine and memory for about four days thereafter. You can run the Portable while recharging the battery, or, if you need to swap batteries, a conventional 9-V battery energizes the system long enough for you to make the exchange.

Software Considerations

The Portable runs System 6.0.4, which is required to deal with the new hardware in the computer. A Portable cdev lets you adjust the LCD's contrast, time-out intervals for entering the sleep mode and switching off the hard disk drive, wake-up time, and whether to use the internal modem or an external modem via the serial port. You can also set the size of a RAM disk so you can operate out of RAM rather than use a power-hungry hard disk drive. As a safeguard, the rest mode can also be disabled.

The Finder's Special menu has a new item: Sleep. On the Portable, only minor differences exist between Shut Down and Sleep. Both power down the computer, but Shut Down closes all active applications while Sleep only suspends them.

Naturally, there are the usual concerns about software compatibility with this new Macintosh. Anything that addresses the serial ports directly (some MIDI applications) or the ADB hardware will break, since that particular I/O subsystem might be switched off. Applications should use either the appropriate traps or the serial drivers, so that the Mac OS can switch the subsystem's power back on before performing the operation. Sound generation is a problem because in many cases the old sound drivers were accessed directly. The Mac OS monitors the ASC for accesses and powers on the chip as required. Newer applications should use the Sound Manager whenever possible.

Applications that perform lengthy calculations must take precautions to prevent the Portable from entering the rest mode and lengthening the process—a distinct possibility if the operation takes more than 15 seconds. This problem has an easy fix: The Portable won't enter rest

mode if the mouse pointer is a stopwatch icon, normally indicating a time-consuming process. Most applications already use either the watch or the MPW "beach ball" to indicate that the application is busy, so this shouldn't be a problem.

Finally, software designers should beef up their error checking, since the user can put the Portable into sleep mode at any time and the rest mode can produce significant delays. Both actions can produce new and unanticipated errors.

The Mac IICI

The Mac IICI is Apple's newest high-performance member of the modular Macintosh line. The Mac IICI's outside looks almost identical to that of the Mac IICx, down to the same compact case, but it has

The Mac IICI goes a long way toward using all the features of the 68030 processor.

a faster CPU and a completely redesigned motherboard.

Like the Mac IICx, the Mac IICI uses a Motorola 68030 processor and a 68882 FPU, three NuBus slots, and a 3½-inch FDHD drive. It also has the IICx's collection of I/O ports: two ADB connectors, a DB-25 SCSI connector, an external floppy disk drive connector, two mini-DIN-8 serial ports, and a stereo sound connector.

But here the resemblance ends. The Mac IICI's CPU and FPU are clocked at 25 MHz rather than 16 MHz—a 56 percent jump in clock speed. The Mac IICI's memory subsystem is beefed up in several ways. First, the memory itself is faster, using 80-ns fast-paged DRAM instead of the IICx's 120-ns DRAM. A special slot for memory-cache boards provides direct memory caching. For the first time, memory parity-checking is also an option. Using 4-megabit-density RAM mounted in single in-line memory modules (SIMMs), you can expand the Mac IICI's memory to 32 megabytes.

The Mac IICI also has an on-board video subsystem that generates monochrome or color signals through a standard DB-15 video port on the computer's

back, and user-selectable screen depths of 1 (black-and-white), 2, 4, or 8 bits (gray scales or 256 colors). The maximum screen depth is 4 or 8 bits, as determined by the monitor type.

Last, but certainly not least, the Mac IICI now has new 512K-byte ROMs for system firmware, as opposed to the Mac IICx's 256K-byte ROMs.

Engineered for High Performance

The real star of the show is the Mac IICI's new, faster processing core (see photo 4). The 25-MHz 68030 and 68882 and the 80-ns memory mean that software runs faster. But the supporting cast is critical, too: You can't just drop a faster processor and memory into any computer, least of all a Macintosh. Unless you're planning to redesign every peripheral in the system, the other timing functions—such as those for the serial ports, the FDHD controller chip, and the ADB controller—must remain the same.

The Mac IICI's design team elegantly solved the problem by decoupling the processor and memory clock speeds from the clock speed of the I/O subsystems. Earlier members of the Mac II family used a single oscillator to generate a clock signal that was then divided into signals for the CPU and other subsystems. (A separate oscillator generates the 10-MHz NuBus clock.) Attempting to boost the clock speed of this type of design triggers a cascade of modifications. Therefore, the Mac IICI uses a separate oscillator for the CPU and memory, another for the various I/O subsystems, and still another set of oscillators for running the on-board video. As a result, future Macs will be able to run still faster processors without major revisions to the overall design.

The Mac IIX and IICx failed to use all the features of the 68030 processor. The IICI goes a long way toward filling that gap. First, it uses the 68030's burst access mode, which allows the CPU to read 16 bytes of data at a time in about half the clock cycles. The result is another 10 percent improvement in performance.

Along with faster DRAM, the Mac IICI also includes a 120-pin connector for a user-installed direct memory cache board. In a direct memory cache, cache memory is a simple mirror image of a section of memory (unlike the more complex *set-associative* caching systems commonly used on PC-compatible machines). As a result, the Mac IICI's cache may have a somewhat lower "hit rate" (i.e., how often the required data is actually in the cache; on a "cache miss," the

continued

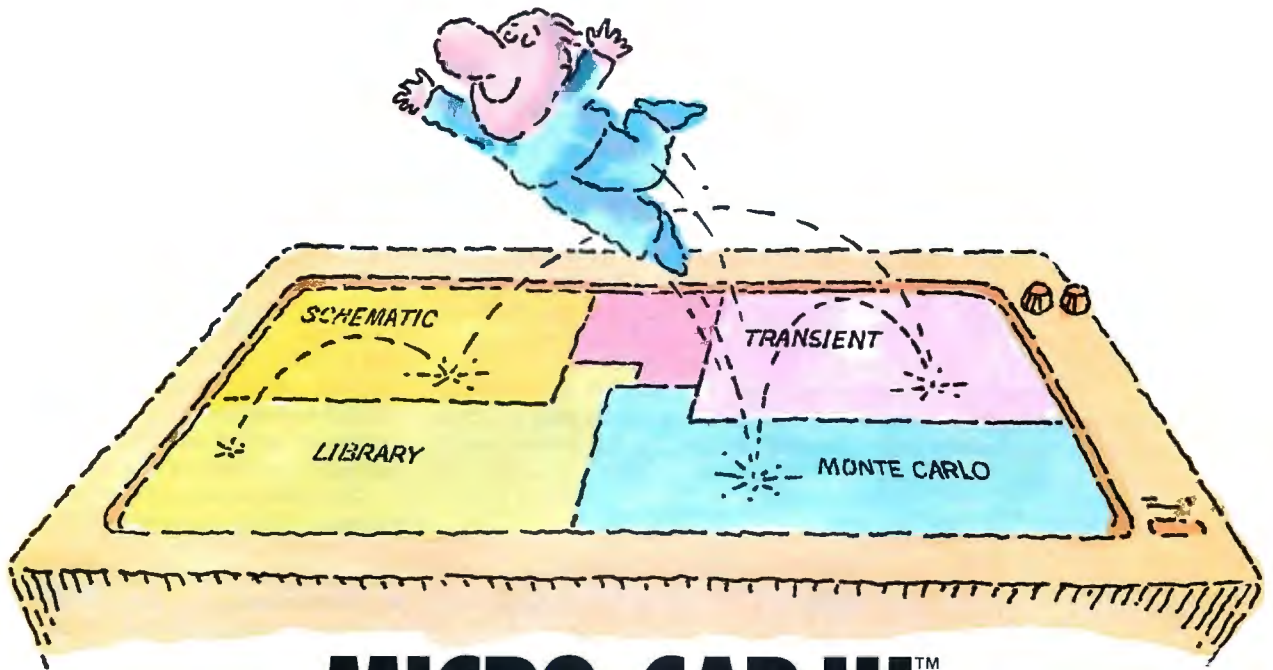

MICRO-CAP III.™

THIRD-GENERATION INTERACTIVE CIRCUIT ANALYSIS. MORE POWER. MORE SPEED. LESS WORK.

MICRO-CAP III,™ the third generation of the top selling IBM® PC-based interactive CAE tool, adds even more accuracy, speed, and simplicity to circuit design and simulation.

The program's window-based operation and schematic editor make circuit creation a breeze. And super-fast SPICE-like routines mean quick AC, DC, Fourier and transient analysis — right from schematics. You can combine simulations of digital and analog circuits via integrated switch models and macros. And, using stepped component values, rapidly generate multiple plots to fine-tune your circuits.

We've added routines for noise, impedance and conductance — even Monte Carlo routines for statistical analysis of production yield. Plus algebraic formula parsers for plotting almost any desired function.

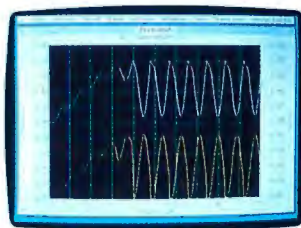

Transient analysis

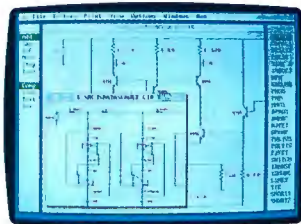

Schematic editor

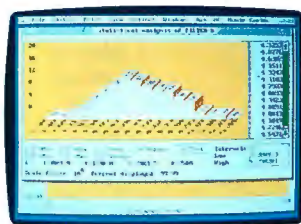

Monte Carlo analysis

Modeling power leaps upward as well, to Gummel-Poon BJT and Level 3 MOS — supported, of course, by a built-in Parameter Estimation Program and extended standard parts library.

There's support for Hercules,® CGA, MCGA, EGA and VGA displays. Output for laser plotters and printers. And a lot more.

The cost? Just \$1495. Evaluation versions are only \$150.

Naturally, you'll want to call or write for a free brochure and demo disk.

Spectrum

1021 S. Wolfe Road,
Sunnyvale, CA 94086
(408) 738-4387

MICRO-CAP III is a registered trademark of Spectrum Software.
Hercules is a registered trademark of Hercules Computer Technology.
IBM is a registered trademark of International Business Machines, Inc.

CPU must wait a little longer while the data is fetched from main memory).

Apple is working on its own direct-memory cache board, but it won't be available until next year. Apple claims that the Mac IIci normally operates 45 percent faster than a Mac IIcx, and with a cache board, up to 55 percent faster.

Built-in Video

Perhaps the most unique feature of the Mac IIci is the video subsystem built onto

the motherboard. It supports a 640- by 480-pixel display that can be 1, 2, 4, or 8 bits deep and is functionally equivalent to a Macintosh II video board. It also supports Apple's Portrait Display monitor with a 640- by 870-pixel display at screen depths of 1, 2, or 4 bits, which ordinarily would require yet another NuBus video board to use.

No special installation is required to use the video: You simply plug an Apple monitor into the Mac IIci's video socket

and start the computer. The Mac IIci automatically configures the system to drive the monitor. The Start Manager (software used to run hardware diagnostics, initialize the system, boot from a start-up drive, and then launch the Finder) examines three lines on the video connector. If a monitor is attached, certain combinations of these lines will be grounded, and the Start Manager knows to use the on-board video subsystem. The grounding pattern identifies the type of monitor connected to the system.

This built-in video accomplishes two purposes. First, it means a price reduction, since—unlike the rest of the Mac II family—it's no longer necessary to buy a video board to use the Mac IIci. Second, this frees up one of the three NuBus slots that the video board normally occupied. The Mac IIci still supports NuBus video boards if your application requires it (e.g., for 24-bit color) or if you add a second monitor.

The Mac IIci's built-in video provides a significant jump in video performance. This is because a section of ordinary system RAM, rather than video RAM on a NuBus board, is used for the video frame buffer. The 68030 can put video information directly into memory at full speed, rather than sending it through the somewhat slower NuBus. Two new custom application-specific ICs make this all possible: a Memory Decode Unit and a RAM-Based Video chip. The RBV maintains the display by supplying raster data from a first-in/first-out queue to the digital-to-analog converter that drives the monitor. When the FIFO is half empty, it requests more data from the MDU. The MDU uses a bus buffer to lock access to bank A of main memory and then performs a direct-memory-access (DMA) burst read of 32 bytes from the frame buffer into the RBV's FIFO.

There is a catch, though. While the MDU chip is grabbing video data, the CPU is locked out of memory bank A for 800 ns at a time. How often this occurs depends on the screen depth; since a deeper screen means that there is more data to read, bank A will be locked longer. This memory contention can reduce performance by 8 percent. With a cache card installed, of course, the performance penalty would be much less.

Fortunately, the Mac IIci's design holds a partial solution. In previous Mac II designs, memory had to be contiguous. This meant that higher-density SIMMs had to be installed in bank A first, and then in bank B. In the Mac IIci, the same MDU that assists the on-board

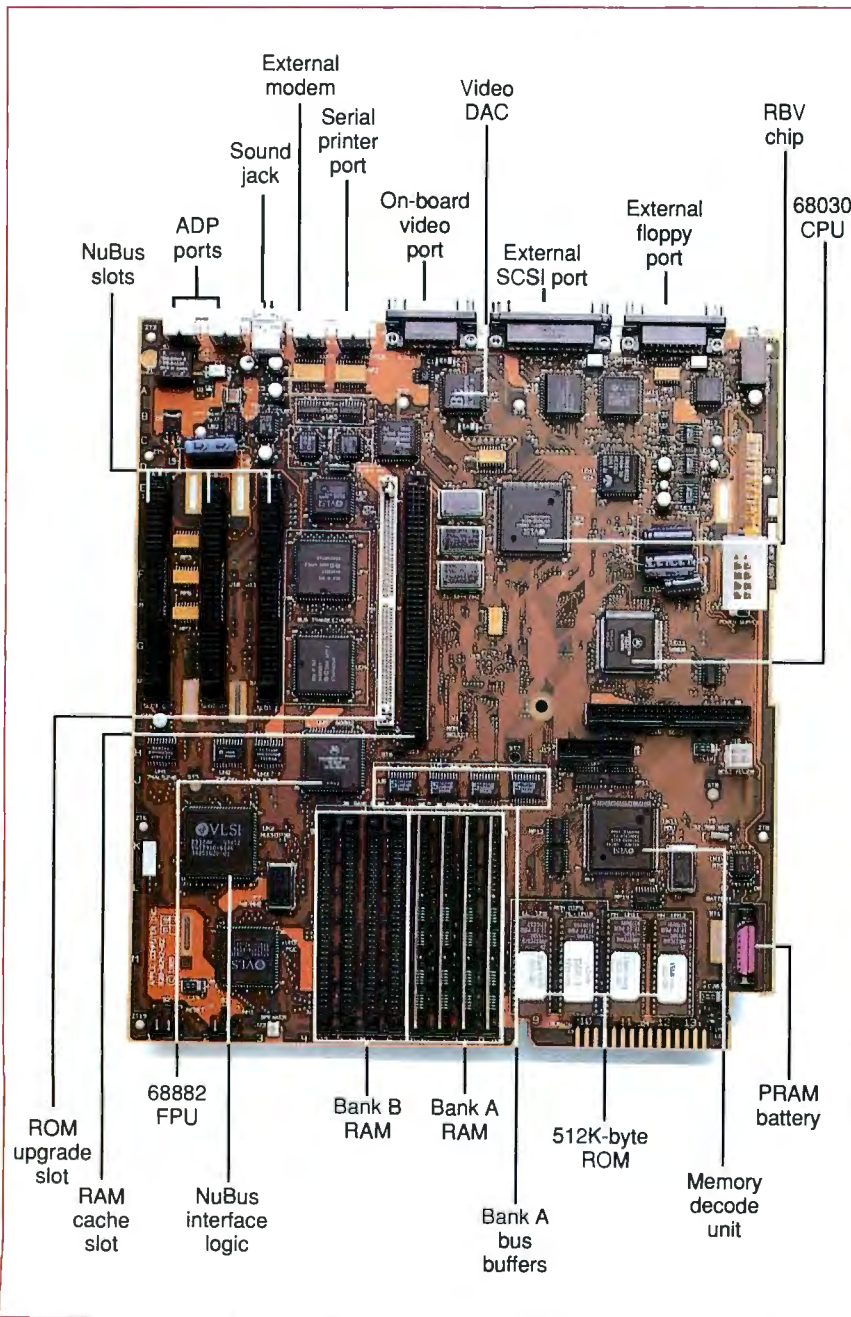

Photo 4: The Mac IIci motherboard. The various application-specific ICs reduce the board's component count and thus improve its reliability.

continued

“Xerox this memo.” “FedEx this proposal.” “LapLink these files.”

When something becomes a standard, using it becomes second nature. That's true about LapLink. It's so effective that it has become the most popular laptop-to-desktop and desktop-to-desktop file transfer program ever.

And now Release III improves on the original with added power—while preserving the simple design that has made LapLink the choice of more major corporations.

LapLink III offers both serial and parallel file transfer, and you can take advantage of parallel transfer speeds of 500,000 baud or higher. It comes with a “six headed” universal cable that provides you with everything you need to use both serial and parallel modes.

And LapLink III will even install itself automatically on a remote computer.

That's in addition to ease-of-use and productivity features like our popular split screen design, flexible transfer options, and disk and printer sharing.

For the same fast, error-free file transfers between PCs and Macintoshes, get LapLink Mac. And for more information about any Traveling Software product, call us at (800)662-2652.

LapLink III. The standard in file transfer software.

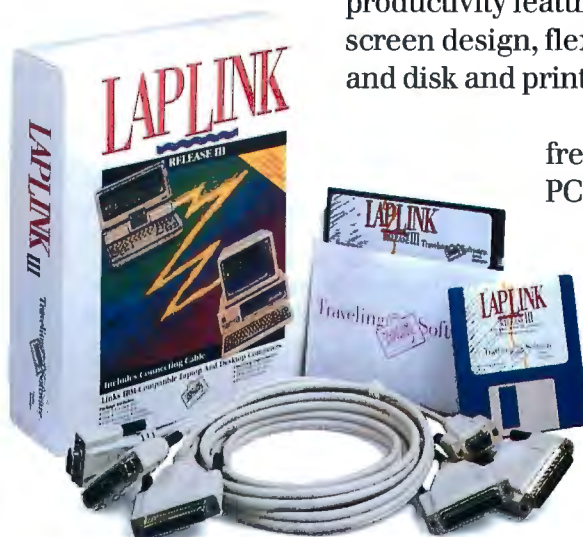

Suggested Retail Price \$139.95

LAPLINK III



Traveling Software, Inc.
18702 North Creek Parkway, Bothell, WA 98011
(206) 483-8088

Traveling Software Europe
Lords Court, St Leonards Road, Windsor
Berks, SL4 3DB, England
(44) 0753 831855

video also performs the physical address mapping for all the RAM, ROM, and I/O peripherals. The 68030's memory management unit then maps the physical addresses supplied by the MDU into a contiguous set of logical addresses. Simply put, the MDU/MMU address translations effectively "knit" noncontiguous physical memory into what appears to be contiguous memory to the Mac OS. Since the Mac IIci's memory is no longer required to be contiguous, it's possible to place the higher-density SIMMs in memory bank B without filling up bank A first. As a result, you can install a large complement of memory (up to 16 megabytes) that will never be hit by video subsystem lockouts.

How you use the Mac IIci can also sidestep the problem. When you use the Finder, important system globals used by applications are loaded into bank A, so there's a decrease in performance. If you use MultiFinder, it loads an application and these globals into bank B first.

When all the factors are considered, Apple claims that the on-board video still outruns NuBus video at screen depths of 1, 2, and 4 bits; with a cache board installed, it can even outrun NuBus at the 8-bit screen depth.

Another problem with on-board video is that the frame buffer's memory consumes system RAM. A 640- by 480-pixel display that's 1 bit deep requires a reasonable 64K bytes of RAM (actually only 38K bytes, but for performance reasons, RAM is allocated in 32K-byte blocks). When the same display is 8 bits deep, however, it requires 320K bytes of RAM. For a basic Mac IIci system with 1 megabyte of RAM, that's a huge percentage of available memory.

Exactly how much system memory the on-board video system uses depends on the amount of RAM available. With a 1-megabyte system, the Mac IIci defaults to the 1-bit-deep black-and-white display. You can override this by using the `Monitors cdev`, which is enhanced in System 6.0.4 so that you can adjust the size of the Mac IIci's frame buffer. With 2 megabytes or more, the Mac IIci defaults to the 8-bit-deep display. With a NuBus video card installed, of course, you eliminate the problems of memory lockout and frame buffer size entirely, but at the expense of using a NuBus slot.

New and Improved ROMs

The Mac IIci ROMs include significant changes from the Mac IIcx ROMs. To begin with, 32-Bit QuickDraw and patches to existing Mac II routines are now incorporated into the firmware (32-

Bit QuickDraw lives as a RAM patch on the other Mac II-family computers). New additions to the ROM code include the driver for the on-board video, an enhanced Script Manager, a revised Slot Manager that better deals with NuBus master boards, and virtual memory support.

These ROMs were optimized for the 68030's architecture by arranging the code so that all the Mac Toolbox routines start at 16-byte boundaries. This arrangement matches the organization of the 68030's instruction cache and thus takes full advantage of the code cache's operation by ensuring that its 16-byte buffers remain filled. Since much of what a Macintosh does is accomplished by Toolbox routines, this provides an overall improvement in performance.

Using
*the Mac IIci is like
being strapped into a
rocket sled.*

But perhaps the most important change to these ROMs is that the code is "32-bit clean" (i.e., it can fully use the 68030's 32-bit address space). Until now, the Mac OS has been hampered by the 24-bit addressing limitations built into QuickDraw and the Memory Manager—a legacy of the 68000's 24-bit address space. 32-Bit QuickDraw fixes the addressing problems with QuickDraw, and a new 32-bit Memory Manager, using a new master pointer structure, is embedded in the Mac IIci ROMs. However, until System 7.0 arrives, the older 24-bit Memory Manager, which is also embedded in ROM, will be used to provide compatibility with the existing software base.

What applications software might break on the Mac IIci? Those applications that rely on physical addresses (e.g., expecting Toolbox routines at specific addresses) will break. Also, any application that happened to work because of "memory wrapping" will now break. For example, an application might accidentally dereference a NIL window pointer. On other Macintoshes, this out-of-range memory reference truncates to a 24-bit address within physical memory,

and unless an existing data structure gets corrupted, the window happens to work. However, the Mac IIci's MDU won't truncate the address but instead maps it to a physical 32-bit address. The 68030's MMU then attempts to access this non-sense address and signals a bus error.

Complex color applications should use the logical graphics device, `gDevice`, so that the Mac IIci can route the display to its on-board video subsystem. As usual, applications that follow the Apple software guidelines should work fine.

Observations

We had a chance to examine preliminary versions of both machines in late July and obtain some benchmark timings. Since we only had a few hours to examine a Mac Portable running a beta version of System 6.0.4, we can't comment on its expected battery life. But we determined that the Mac Portable is, without a doubt, a fully functional Mac. It ran popular software easily under MultiFinder, and the trackball was easy to use.

The bad news is that the Mac Portable's dimensions and weight place it in the "luggable" category, and you're certainly not going to rest it on your lap. Although you can carry it onto a plane, you won't be able to use it comfortably in-flight. Furthermore, it won't fit under some plane seats. On a Boeing 727, for example, the Portable in its carrying case would fit easily under the first-class and middle coach seats, tightly under coach window seats, and not at all under coach aisle seats. Clearly, though the Mac Portable is portable, its size and weight are its biggest disappointments.

The good news is that even without backlighting, the Mac Portable's active-matrix LCD is crisp and sharp, with excellent contrast. Although the tilt of the display is adjustable, we didn't bother with it because of the display's huge viewing angle.

The display is also exceptionally fast. The mouse pointer is always clearly visible on the screen: There's no blurring, no disappearing act. It's far and away the finest LCD screen we've ever seen, with or without backlighting, and it's better than most portable displays, period. Even if you don't plan to buy the computer, stop in to check out the display.

If you're used to a 68000-based Mac and have had the opportunity to try a 68030-based Mac, you may have compared the feeling to driving a sports car for the first time. Using the Mac IIci is like being strapped into a rocket sled: It's *fast*. For the first time, it is practical to

continued

Works with
HP® LaserJet™ Series II

The BigBin 1000. Because 200 sheets is not enough.



BigBin™
1000-sheet
capacity for
Apple® LaserWriter®
IISC, LaserWriter
IINT, and Laser-
Writer IINTX

The BigBin is a motorized paper tray that replaces your LaserWriter II's old 200-sheet paper tray to give you 1,000 sheets of paper. That means you can print bigger jobs unattended. Satisfy the paper-hungry needs of a Macintosh® network. And spend less time refilling paper.

Sizable advantages BigBin lets you load 1,000 sheets of letter-size paper. All at once. You can even add a kit that handles legal-size.

Simple addition BigBin is a simple addition to your computer system. Just replace your printer's paper tray with BigBin and plug it into the wall. It's fully approved by Apple Computer for use with Apple LaserWriter IISC, LaserWriter IINT, and LaserWriter IINTX. And BigBin is covered by a limited 90-day warranty.

Despite the big name, BigBin needs only about a foot of space in front of your printer, and it weighs in at only 14 pounds.

To make the connection BigBin is available exclusively through authorized Laser Connection™ dealers. For more information on how BigBin can maximize your paper handling, call Laser Connection at **1-800-523-2696** for the dealer nearest you.

And be sure to ask for a free copy of *The Sourcebook*™—our exclusive catalog filled with the latest laser printer products and enhancements.

LASER CONNECTION™
A QMS® Company



The following are trademarks of their respective companies: BigBin, The Sourcebook, Laser Connection of QMS, Inc.; Apple, LaserWriter, Macintosh of Apple Computer, Inc.

©1989 QMS, Inc.

Circle 222 on Reader Service Card (DEALERS: 223)

Table 1: On the BYTE Small-C benchmarks, the Mac Portable was roughly twice as fast as a Mac SE, and the Mac IICI was roughly 60 percent faster than a Mac IIcx. Disk I/O and floating-point performance were not measured. See text for details.

PRELIMINARY BYTE BENCHMARK RESULTS

Text	Mac SE	Mac Portable	Mac IIcx	Mac IICI
Matrix	67.1	34.2	16.2	10.5
String move				
Byte-wide	374.5	174.9	82.7	51.8
Word-wide	186.7	87.4	42.1	26.6
Doubleword-wide	92.4	59.9	22.9	14.5
Sieve	170.2	84.1	31.4	19.8
Sort	154.2	76.3	29.7	19.4
Graphics				
Slow test	84.4	57.2	52.5	19.0
QuickDraw	1.1	0.7	0.3	0.2
Text				
TextEdit	15.1	9.9	4.6	2.8
DrawString	3.8	3.2	1.6	0.8

Notes

1. All times are in seconds.
2. Both systems ran the Finder.
3. The rest mode was disabled on the Mac Portable while running the benchmark tests.
4. The Mac IICI was set to 1-bit mode and had no cache board installed.

scroll through a document in 1-bit mode rather than having to page through it.

Performance and Pricing

We ran our BYTE Small-C benchmarks on the two computers to measure their performance. These results are preliminary, of course, but they do give a rough indication of the machines' capabilities. The benchmarks ran fine on both Macs, and the results are given in table 1.

As you might expect, the Portable easily outpaces the Mac SE, largely due to its higher processor clock rate. What you might not expect is that, under certain conditions, it's more than twice as fast as the Mac SE, as some of the memory tests (i.e., string and sort) and processing tests (i.e., Sieve and matrix) show. This is because the Portable, like the Mac SE/30, uses separate video RAM for the display's frame buffer. This eliminates the bus contention for memory between the processor and video circuits that occurs in the Mac Plus and Mac SE's design and so degrades their performance.

The Mac IICI is faster than the Mac IIcx. It's not an incremental step in performance, but a broad jump. As the tests on a stock Mac IICI (no cache board installed) show, the memory subsystem runs quite a bit faster: roughly 60 percent, the same as the increase in clock speed. We'll have to run application benchmarks to get the hard disk drive and heavy video usage into the act to see

how well the Mac IICI performs overall, but the low-level results indicate that Apple's performance figures are probably accurate. The Mac IICI is a real processing powerhouse, and we haven't even considered the effects of the cache board.

Performance of the on-board video in 1-bit mode is very good: The Graphics Slow and Text DrawString tests ran at least twice as fast as on the IIcx. Even when the on-board video was set to the 8-bit mode, the times for the Slow test (21.9 seconds) and the QuickDraw test (0.23 seconds) were still better than those of a IIcx in 1-bit mode.

As we went to press, no firm prices had been set. However, you can expect the Macintosh Portable to cost in the range of \$6500 to \$7000—steep, but similar in price to 80386 portables such as the GRiDCase 1530, Toshiba T5100, and NEC PowerMate Portable SX, and only the GRiDCase 1530 uses a battery. If you're thinking about a Mac IICI, be prepared to pay a premium price: Estimates are \$1500 to \$2000 more than a similarly equipped Mac IIcx. Thus, a Mac IICI with 1 megabyte of RAM, a 40-megabyte hard disk drive, an Apple monochrome monitor, and a standard keyboard could cost about \$7397. Mac IIcx owners will be able to upgrade to a Mac IICI with a logic board swap and a memory swap (remember that the IICI uses faster RAM). The prices and timetable for the upgrades had not been set.

Future Directions

The Mac Portable is an impressive first try by Apple to enter the portable computer market. Now working professionals don't have to give up the Mac's unique processing capabilities while on the road. The Portable won't make more problems than it solves because its battery life promises to be good and its LCD is as easy to read as a piece of paper. If the designers compromised on anything, it was size and weight. But considering what's crammed into the Portable's case and the quality of its display, we commend their judgment.

A few months ago, an official for a major laptop maker commented that his company would never design another model with a nonbacklit screen and neither would his competitors. "Even they aren't that stupid," he told a press conference. A few months ago, that sounded like a reasonable prediction. But Apple has done nothing less than change the rules of the game. Five years ago, the graphical user interface of the Macintosh screen was the face of the future. Today, the Macintosh Portable's active-matrix LCD is the face of the future all over again.

The Mac IICI represents the first major jump in performance for a Macintosh computer since the Mac II was introduced over two years ago. Its computing power, on-board video, and small desktop footprint make it equal or superior to a PS/2 Model 70 system. The Mac IICI is clearly ready to tackle the large computing jobs coming in the 1990s because, on top of its processing power, it is prepared to work in a 32-bit address space, all the way down to its firmware.

The Mac IICI's design also tells us much about Apple's future plans. The design optimizations indicate that the Motorola 68030 processor will be the heart of the Macintosh for some time to come. However, with the computer's I/O decoupled from the rest of the system, it's going to be easier than ever before to design Macs using faster 68030s. But what's really a welcome trend is that cache slot; it indicates that Apple is finally going to try to reduce the CPU's burden by off-loading certain functions onto dedicated hardware. We hope that they're considering DMA channels and a graphics coprocessor in future Macs. ■

Tom Thompson is a BYTE senior technical editor at large. He can be reached on BIX as "tom_thompson." Frank Hayes is a BYTE news editor based in San Francisco. He can be reached on BIX as "frankhayes."

THE EASY WAY OUT.



DISK TRACER AUTOMATES DISKETTE COPYING.

Put time-consuming formatting and copying tasks behind you with the new Disk Tracer. Now you can format and copy diskettes easily and automatically. Just as the paper copier eliminated messy carbon paper, now Disk Tracer eliminates the slow, tedious task of copying diskettes manually.

Simply place your original diskette and blank diskettes in the top tray, select the quantity desired, press COPY and walk away. Don't walk too far, Disk Tracer produces a perfect copy every 24 seconds... without your effort or attention! Disk Tracer does it all automatically, *fast*, freeing you and your computer. And by reducing your labor cost, it quickly pays for itself.

Disk Tracer is one of many state-of-the-art diskette copiers brought to you by Trace, with a product family that answers every need from high volume industrial diskette copying to our inexpensive desktop copiers. Trace is the number one choice of professionals worldwide. Call us today for more information or the name of a distributor near you.

Information Hotline: 1-800-366-5560



WORLD LEADER IN DISKETTE AND TAPE DUPLICATION SYSTEMS
TRACE PRODUCTS 2190 Bering Drive, San Jose, CA 95131

Circle 278 on Reader Service Card

Quit bitching about batch.

Now you can eliminate 90% of your batch file problems for \$99.95.

The Builder™ is the first compiler that transforms sluggish batch files into blazingly fast .COM and .EXE files. Not only does it give you turbo language speed, it extends the DOS batch language with over 50 new commands and keywords.

For example, menu commands like *DropDown*, *PopUp*, and *LookAndFeel*

are built into the language, so you can quickly produce an unlimited number of programs, and distribute as many copies as you wish.

The Builder also includes a powerful editor to provide an integrated development environment.

And it's the perfect tool for creating installation scripts. The Builder has DOS dexterity that BASIC and C can't match.

And its small compiled code size won't hog memory or disk space.

What's more, by compiling a program with The Builder before you distribute it, you'll have bulletproof security.

Don't keep bitching about batch. Order The Builder today.

Call **1-800-873-9993** for complete details. Visa and Mastercard are welcome. Shipping and handling are free.

THE BUILDER

What batch files should have been in the first place.

VROOMM Goes the Spreadsheet

Borland's VROOMM technology gives the new Quattro spreadsheet plenty of capabilities in a relatively small amount of memory

VROOMM, which stands for Virtual Real-Time Object-Oriented Memory Manager, is Borland's alternative to OS/2 and Extended DOS. The new memory-expanding technique is similar to the overlays used in many large programs, but it is much more flexible. With it, Borland has been able to endow the just-announced Quattro version 2 with a large grab bag of features, making it a very strong competitor for Lotus 1-2-3.

We were impressed with the way VROOMM allowed the new program to fit into tight memory spaces. We also liked a number of Quattro's new features. But on some low-end systems, the overhead processing that VROOMM memory management requires carries a price in general performance.

What VROOMM Does

The whole point of VROOMM is to avoid the "out of memory" error messages that are increasingly common in these days of large TSR programs and memory-gobbling network drivers.

VROOMM is a virtual memory system based on small, variable-size program segments. Borland calls these segments "objects" since, like the objects in object-oriented programming systems, they can call each other. However, the

VROOMM objects are modules of binary code rather than source code and do not appear to share some of the benefits of traditional objects, such as accessibility by outside programmers and inheritance.

Whatever name they're called, the VROOMM objects have a fine granularity—most are only 2K bytes to 4K bytes in size. This lets the program load into memory only those parts of the program that will most likely be used. It also means that, unlike with traditional overlays, objects will load from disk quickly.

All this is fine for Borland's programmers, since it gives them a lot of room to work with. Other programmers may benefit as well, since the company has stated that it will someday make VROOMM technology available as a programming tool. But the question now is, what can the new Quattro do?

Linking with 3-D

Probably the hottest issue in spreadsheets this year has been three-dimensionality, and Quattro does not ignore this trend. While it does not have true 3-D capability, in the style of the new Lotus 1-2-3 release 3.0 or the older BoeingCalc, it does have enhanced linking capabilities that allow you to simulate 3-D spreadsheets. Both approaches allow you to break up large, complex worksheets into several small, interrelated ones.

In 1-2-3 release 3.0, each cell in a spreadsheet has three variables: column (A to IV), row (1 to 8192), and page (A to IV). Quattro takes a different approach, choosing instead to stay with the 2-D spreadsheet, but enhancing the ways these spreadsheets interact with each other. In Quattro, you can display four spreadsheets (e.g., DEPT-A, DEPT-B, DEPT-C, and DIV-1), consolidating the results from three departmental spreadsheets. The consolidation spreadsheet, DIV-1, can easily access data from any of the departmental spreadsheets. You can also perform summations over sev-

eral similarly named spreadsheets. For example, the @SUM([DEPT-*]C7) formula uses the DOS filename wild card * and calculates the sum of the contents of the C7 cells in every spreadsheet file whose name fits the DEPT-* specification (i.e., DEPT-A, DEPT-B, and so on).

Quattro can also access information from non-Quattro spreadsheet files on a network, or from database files that are being updated by other network users.

Annotating Graphs

Unfortunately, Quattro does not yet support true 3-D graphics; however, the graphics capabilities it does offer are truly striking. The program includes the usual assortment of pie charts, bar graphs, line graphs, and so on, plus new text-only charts. These graphs are greatly enhanced by high-quality text fonts.

In addition to a set of fairly standard fonts (e.g., roman, sans serif, and Old English), Quattro includes a small set of Bitstream fonts. These fonts produce very high-quality text on a laser printer, as you might expect, but they can also do a surprisingly good job on a low-end dot-matrix printer.

Whenever Quattro needs a Bitstream font in a particular size or style (such as bold or italic), it generates the appropriate font file. This can happen whenever you view, annotate, or print a graph, or when you view or print a spreadsheet. Generating each file can take a lot of time, especially on slower machines, but once that particular font file is generated, you do not need to generate it again. You can save some time by generating most font files at once when you install the program. However, all these font files take up a lot of disk space and dominate your Quattro directory.

Another interesting part of Quattro is its annotation facility, which allows you to modify graphs in a WYSIWYG fashion. With this feature, it is easy to select text and move it around the screen, or to

continued

File Manager For C

C Programmers choose db_FILE because it's fast and flexible.

The combination of relational B-tree indexing and network model database technology delivers better performance than file managers using relational technology alone. Build simple B-tree/ISAM applications or complex database applications. You decide how to optimize runtime performance.

SQL Support included.

db_RETRIEVE – the SQL-based relational Query and Report Writer is now included in this special offer.

Applications completely portable.

Free lifetime phone support.

C source code is now included!

No royalties.

SPECIAL LIMITED OFFER

db_FILE, db_RETRIEVE and source code for each – at one low price!

Single-User Package \$295.00

A \$1780 value.

Multi-User Package \$595.00

A \$2890 value.

db_FILE™

File Manager 2.2

File Structure: Relational B-tree indexing and network database model. Use independently or in combination for real power.

Transaction processing supported

Not RAM resident

Operating Systems: MS-DOS, UNIX, XENIX

C Compilers: UNIX, XENIX, Microsoft, Lattice, TurboC

Major LANs Supported

For your nearest distributor call:
1-800-db_RAIMA (1-800-327-2462).

RAIMA™
CORPORATION

BY109FM

*Raima reserves the right to discontinue this promotion at any time without notice, so please check pricing when you call.
Raima Corporation 3245 146th Place S.E., Bellevue, WA 98007 USA (206)747-5570 Telex: 6503018237 MCI UW FAX: (206)747-1991
Texas: (214) 231-3131 International Distributors: U.K.: (0992) 500919
Germany: 07127/5244 Switzerland: (01)725 0410 France: (1)46092828
Benelux: 31(02159)46 814 Sweden: (013)124780 Italy: 045/584711
Norway: 47 244 88 55 Denmark: (2)887249 Singapore: 468 3888
Australia: (02) 959 5122 Japan: (03)473 7432 Taiwan: (02)511 3277
Mexico: (83) 57 35 94 Brazil: (0192) 52 9770 Colombia: 57 1 218 9245
Argentina: 54 1 313 5371 Chile: 56 2 696-4308 Uruguay: 92 19 37
Caribbean: (809) 834 4069 Central America: (506) 28 07 64
© Copyright Raima Corporation 1989

COMPANY INFORMATION

Borland International, Inc.
1800 Green Hills Rd.
P.O. Box 660001
Scotts Valley, CA 95066
(408) 438-5300
Inquiry 860.

add a small text box and an arrow pointing to a particular feature of a graph.

Quattro's graphics capabilities also include two other features not often found in spreadsheet programs: the ability to include graphs inside spreadsheets, and the ability to arrange graphs into a slide show-style presentation.

"Publishing" Spreadsheets

One of the strong points of the Windows- and Macintosh-oriented spreadsheets, such as Excel, is their ability to use multiple fonts, both on the screen and in printed documents. The problem with this approach is that drawing the various fonts on the screen can take a lot of time.

Borland has implemented a compromise approach for Quattro. You can have up to eight different fonts in the printed version of your spreadsheet, but, to save time, the on-screen version of your spreadsheet will show only one standard font. As you can imagine, it can get a little confusing trying to remember which cells in a spreadsheet are in which font. You can preview the spreadsheet to see what it will look like when printed, but this takes some time.

Quattro also includes other desktop publishing-like features, such as boxes, grids, and shading. And, unlike the case with the text fonts, Quattro does give you some indication on the screen as to what the lines will look like. Unfortunately, the lines on the screen take up a whole row or column, thus reducing the amount of the spreadsheet that you can display on your screen.

Recalculations Faster than 1-2-3

In tests of brute-strength recalculation, our early version of the program invariably beat out all the current versions of 1-2-3 (releases 2.01, 2.2, and 3.0). This speed advantage may be due in part to what Borland calls Intelligent Minimal Recalculation, where the program somehow decides whether it is faster to do a minimal recalculation or a full recalculation (when almost all the cells are involved, as in most benchmark tests). Quattro also features background recalculation, which can make the program seem even faster.

The early version of Quattro was also fast at scrolling and inserting rows. One area, however, where Quattro seems to be slower than 1-2-3 is with operations regarding disk access, such as loading the program or loading spreadsheets.

I should also add that benchmarking, while never easy, is particularly hard with Quattro. The problem has to do with VROOMM and the way Quattro—or the part of it that resides in memory—keeps changing from operation to operation. For example, we found that in some cases a recalculation got faster on successive iterations or slowed down, depending on which part of the spreadsheet was displayed.

Another weakness of VROOMM is apparent even to a casual user. Sometimes, every keystroke that you enter results in a disk swap. This is related to the small size of the VROOMM objects: Although they will load quickly, they must also be loaded more often. This is especially noticeable on low-end systems or when you are using very large spreadsheets. After loading a 335K-byte spreadsheet, the program told us we still had 40K bytes of memory left, but it became extremely slow. Whenever we hit a cursor key, a considerable amount of disk swapping took place. Borland claims, however, that this will be speeded up by the time the product ships.

A 1-2-3/Windows Hybrid

In general, the new Quattro, like the original version, is pretty much a cross between 1-2-3 and Excel. It provides both good 1-2-3 compatibility and superior printing and graph-making capabilities. And it provides a rash of other features, such as Undo, a transcript of user actions (useful for macros or returning a spreadsheet to a previous condition), the ability to edit menus, good mouse support, and the ability to read and write a large number of file formats without translation. The product's list price is \$495, twice that of the previous version.

Our only serious complaint with Quattro is that there should be some way for users to signify different fonts on the screen. Also, VROOMM's object-swapping mechanism is a little slow, but that will probably be fixed by the time the product ships. Otherwise, Quattro looks like a very useful product, especially for users who want the advantages of Excel (and then some) but do not want to sacrifice compatibility with 1-2-3. ■

Rich Malloy is an associate managing editor for BYTE. He can be reached on BIX as "rmlloy."

3 books for only \$2.95



and get FREE!
dBASE IV™ Essentials

YES! Please accept my membership in the *Computer Professionals' Book Society* and send me the volumes I have listed below, *plus* my free copy of dBASE IV Essentials (3116P), billing me only \$2.95 plus shipping and handling charges. I understand that the books are sent on a 10-Day Free Examination

basis. If dissatisfied in any way, I may return the books within 10 days and incur no further obligation. Otherwise, I agree to pay the provided invoice promptly and to receive regular Society bulletins as described in "How the Society Works." To complete my membership obligation I need only purchase 3 additional books at regular members' prices during the next 2 years, and may resign at any time thereafter.

Name _____

Name of Firm _____

(If you want Society Bulletins sent to your office)

Address _____

City _____ State _____ Zip _____

Signature _____

Valid for new members only. Foreign applicants will receive special ordering instructions. Canada must remit in U.S. currency. This order subject to acceptance by the *Computer Professionals' Book Society*. BYP1089

Call 1-800-233-1128 Now!

3 books for only \$2.95



and get FREE!
dBASE IV™ Essentials

YES! Please accept my membership in the *Computer Professionals' Book Society* and send me the volumes I have listed below, *plus* my free copy of dBASE IV Essentials (3116P), billing me only \$2.95 plus shipping and handling charges. I understand that the books are sent on a 10-Day Free Examination

basis. If dissatisfied in any way, I may return the books within 10 days and incur no further obligation. Otherwise, I agree to pay the provided invoice promptly and to receive regular Society bulletins as described in "How the Society Works." To complete my membership obligation I need only purchase 3 additional books at regular members' prices during the next 2 years, and may resign at any time thereafter.

Name _____

Name of Firm _____

(If you want Society Bulletins sent to your office)

Address _____

City _____ State _____ Zip _____

Signature _____

Valid for new members only. Foreign applicants will receive special ordering instructions. Canada must remit in U.S. currency. This order subject to acceptance by the *Computer Professionals' Book Society*. BYP1089

Call 1-800-233-1128 Now!



NO POSTAGE
NECESSARY
IF MAILED
IN THE
UNITED STATES

BUSINESS REPLY MAIL

FIRST CLASS PERMIT NO. 9 BLUE RIDGE SUMMIT, PA 17214

POSTAGE WILL BE PAID BY ADDRESSEE

Computer Professionals'
Book Society
Blue Ridge Summit, PA 17214-9988



NO POSTAGE
NECESSARY
IF MAILED
IN THE
UNITED STATES

BUSINESS REPLY MAIL

FIRST CLASS PERMIT NO. 9 BLUE RIDGE SUMMIT, PA 17214

POSTAGE WILL BE PAID BY ADDRESSEE

Computer Professionals'
Book Society
Blue Ridge Summit, PA 17214-9988

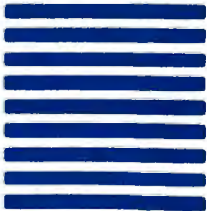

THE COMPUTER PROFESSIONALS' BOOK SOCIETY

The easy, reliable way to satisfy your professional book needs . . .

3 books for only \$2⁹⁵ (Values to \$145.80)

and get **dBASE IV™ Essentials** FREE!



3131 \$24.95

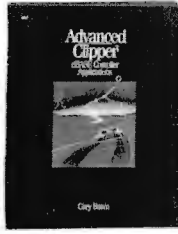

3007P \$17.95



9824 \$49.95

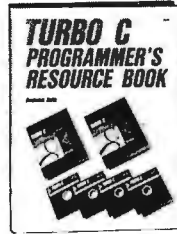

3030P \$17.95



3221 \$29.95



3028P \$19.95

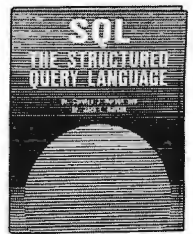

3016P \$17.95



2838 \$19.95

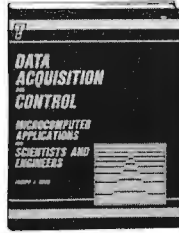

2956 \$32.95
Counts as 2



3066P \$26.95

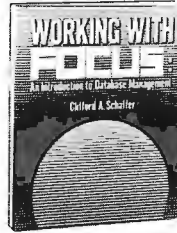

2810P \$22.95

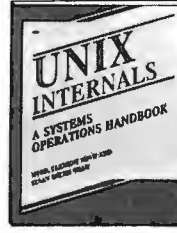

2951P \$18.95

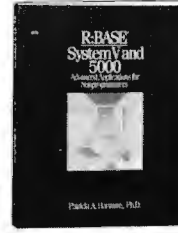

2978P \$17.95

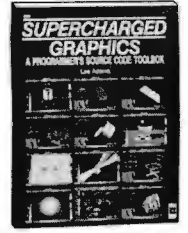

2959P \$19.95

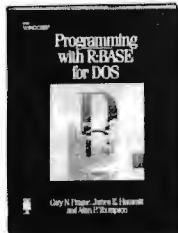

3196P \$24.95



2897 \$28.95

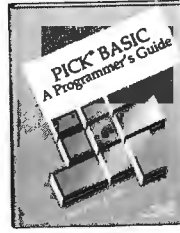

2845 \$34.95
Counts as 2



9810P \$24.95

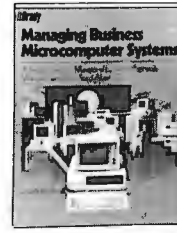

9764P \$19.95



9832 \$36.95



9152 \$39.95
Counts as 2



9786 \$32.95



9813 \$39.95



2916P \$19.95

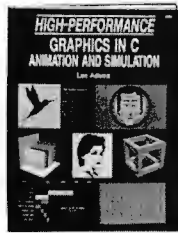

3049 \$36.95
Counts as 2

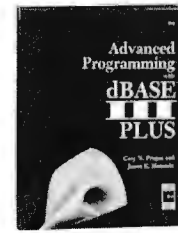

2876P \$19.95



9808 \$34.95

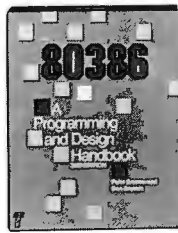

3237P \$24.95

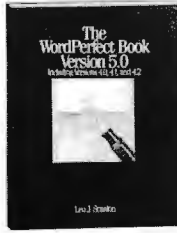

3127P \$16.95



2888 \$32.95

All books are hardcover unless numbers are followed by a "P" for paperback.
©1989 Computer Professionals' Book Society, Blue Ridge Summit, PA 17294-0870

FREE when you join the



dBASE IV™ Essentials

A unique and timely discussion of all the new programming features offered by dBASE IV™ —including both SQL and QBE.



How the Club Works

YOUR BENEFITS: You get 3 books for \$29.95 plus shipping and handling when you join. You keep on saving with discounts up to 50% off as a member.

YOUR PROFESSIONAL BOOKSTORE BY MAIL: Every 3-4 weeks, you will receive the Computer Professionals' Book Society News describing the Main Selection and Alternates, as well as bonus offers and special sales, with scores of titles to choose from.

AUTOMATIC ORDER: If you want the Main Selection, do nothing and it will be sent to you automatically. If you prefer another selection, or no selection at all, simply indicate your choice on the reply form provided. As a member, you agree to purchase at least 3 books within the next 2 years and may resign at any time thereafter.

BONUS BOOKS: Starting immediately, you will be eligible for our *Bonus Book Plan*, with savings of up to 80% off publishers' prices.

IRONCLAD NO-RISK GUARANTEE: If not satisfied with your books, return them within 10 days without obligation!

EXCEPTIONAL QUALITY: All books are quality publishers' editions especially selected by our Editorial Board.

Aw...What the Heck!

EXTREMELY POWERFUL

DesignCAD 3-D version 2.0 is as powerful as most CAD systems costing \$5000 - \$10,000! Features like: Complex Extrusions-linear, scaler, and circular, Blending of Surfaces, Shading, Cross Sectioning, Complex Sweeps and Translations, and Boolean operations make DesignCAD 3-D one of the most powerful 3-D CAD systems available... at any price! Engineers, Architects and Consultants constantly tell us that they use CAD systems costing thousands of dollars which are not as powerful as DesignCAD 3-D.

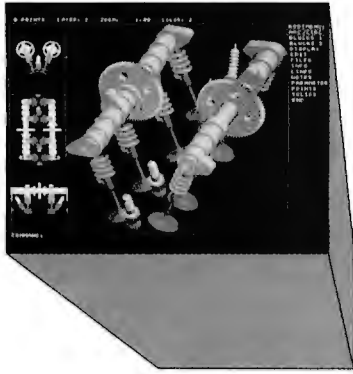

VERY EASY TO USE

Just because DesignCAD 3-D is powerful doesn't mean it is difficult to use. Single keystroke commands and side-bar menus which give short directions on how to proceed make DesignCAD 3-D a snap to use! While not required, DesignCAD 3-D supports all popular digitizers and mice.

Many of the older, more cumbersome CAD systems require weeks of training before a user can be productive. DesignCAD 3-D users find they can be producing useful drawings in a matter of minutes! In a recent CAD contest only one contestant was able to match our drawing time. The package sold for \$3000.00. The other CAD packages took up to twice as long to perform the same drawing and cost up to \$5000.00!

Still don't believe us? The goblet pictured below required only 16 keystrokes and 3 commands to create! The top, front, side, and isometric views were created simultaneously... in less than one minute!

VERY LOW PRICED

The first question asked by many people is, "Why is DesignCAD 3-D priced so low?" The answer? After developing DesignCAD 3-D version 2.0, we were unable to decide how the product should be priced. We consulted experts. We used the finest spreadsheets on the market. We took employee polls. Finally, in the great American Tradition, we said, "Aw... What the Heck! Let's see the other guys beat this price!" DesignCAD 3-D version 2.0 sells for \$399.

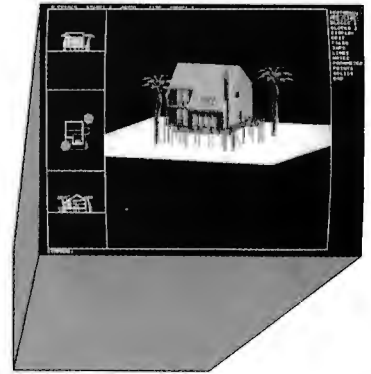

DesignCAD 3-D only \$399!

WHY BUY THIS ONE?

There is a very important reason to buy DesignCAD 3-D. PERFORMANCE. No other CAD system can match our price/performance ratio. Many people make the serious mistake of thinking that it is necessary to spend thousands of dollars to obtain "a good 3-D CAD system." This is not true! We talk to people everyday that are sadly disappointed with their "expensive" CAD systems. Don't be one of them! Call us and we will send you a complete set of literature and a free slide show demo disk. Once you compare DesignCAD 3-D version 2.0 with other CAD systems we know you will choose DesignCAD 3-D.

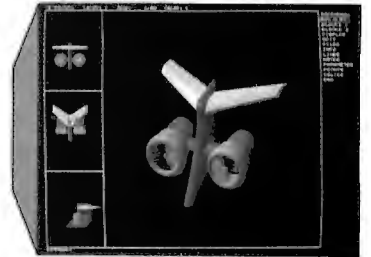

DON'T TAKE OUR WORD FOR IT

Here is what other people have to say about DesignCAD 3-D:

"After you've worked with DesignCAD, the single keystroke commands are simple to remember and it becomes easy to "flick one key" to execute a command. An extremely ergonomically designed program."

HENRY LEVET, Levet & Daigle Architects - New Orleans, LA
Designed a 65,000 sq. ft. nursing home using DesignCAD

"Recently I worked with a firm that builds decks. They purchased your product on my recommendation. I sat down with them and in two hours they were very proficient in DesignCAD. Now they are more effective; and we can communicate... it's wonderful to be able to do a block repeat 42 times and there are 42 2x4's to make the deck!"

J. TURNER, Architect, TAO Ltd. - The Woodlands, Texas

"Allows scientists and engineers to expend minimum time learning and using CAD software so that their time can be expended on the project at hand. It also allows scientists and engineers to quickly present to management all views of a subject. (3-D)."

DR. STEVENS, NASA Space Scientist/Engineer

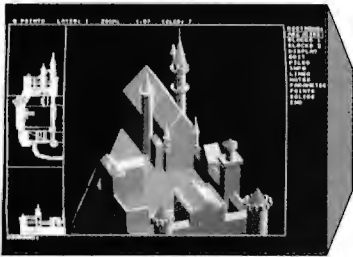

HOW DO I GET ONE?

DesignCAD 3-D version 2.0 is available from most retail computer stores, or you may order directly from us. DesignCAD 3-D is available in a number of foreign languages from distributors throughout the world. All you need to run DesignCAD 3-D is an IBM PC Compatible and 640K RAM. DesignCAD 3-D supports most graphics cards, printers, plotters and digitizers. Free information and a demo diskette are available by contacting us at:

American
Small Business Computers, Inc.

327 South Mill Street
Pryor, OK 74361
918/825-4844
FAX: 01-918-825-6359
TELEX: 9102400302



DISASTERS AND DIVERSIONS

The agony of a drenched disk and the thrill of new CD-ROMs

I have just spent half an hour using Krazy Glue and epoxy to mend an Austrian ceramic *ButterKasse* we bought during our trip to Graz three years ago; it arrived broken in shipment. Given just how far behind I am—*Wrath of God* is going to be good, but writing it has been blooming slow work—you'd think something that has waited three years for repairs might be allowed to wait a little longer, but read on. A story goes with it.

It all started when I got an Amiga game called *Populous*, written by Bullfrog Games and published by Electronic Arts (EA). *Populous* is one of a recent flock of new programs for the Amiga. Most are games, but I'm told by people I trust that there's a flood of new general-purpose and business products for the Amiga just around the corner. By contrast, Atari seems to have fallen into the doldrums and is pinning its hopes on becoming another PC clone maker.

I've always had a soft spot for Commodore, a company that's trying to do new and innovative things rather than follow the crowd, and the Amiga remains one of the most interesting machines around.

Anyway, shortly after I got to looking at the box blurbs for *Populous*, it became clear that this is no ordinary game: it appears to be an electronic implementation of the Manichaean heresy. The blurbs include: "Cruel ice, lush grassland, parched desert. With 500 worlds, a deity's work is never done" and "The all-powerful can perform miracles in their sleep. But omnipotence isn't what it used to be. These days, it takes an awesome natural disaster to dominate a world."

This is clearly not your run-of-the-mill computer game.

However, it takes determination to play this game if you have an Amiga 2500. My first attempt was a failure. That is: I treated the thing much as I would a game for the Macintosh. I booted up the system, inserted the *Populous* disk, clicked on its icon to open it, clicked on the *Populous* icon—and found myself stuck in the demonstration mode. It wouldn't actually play the game.

This is because EA has an arcane copy-protection scheme. It requires you to boot up your machine, catch it before it loads the rest of the operating system, and insert the EA game disk. AmigaDOS comes in two parts: the DOS itself, and a disk of programs called the Workbench that you must have to do anything other than play games.

Many EA games require you to substitute the game for the Workbench, which is easy enough if you boot up with floppy disks but requires tricky timing if you have a hard disk. Doing it the EA way deprives you of the Amiga's main advantage, true multitasking; the Workbench runs at least as well as Macintosh's MultiFinder.

Booting up with the *Populous* disk already inserted in the floppy disk drive didn't work either. It got me to the introductory part of the game, including instructions and the tutorial, but when I attempted to actually play, the machine went galley-west. Now what?

A quick call for help on BIX got me the following advice: the Amiga 2500 has both 68000 and 68020 chips on-board. Left to itself, the machine uses the 68020, but if you hold down both mouse buttons when you power up, you're given a choice of booting with either chip (or with Unix, although that's not implemented yet). To play *Populous*, you must tell the machine to boot with the 68000. It seems there exist in the 68000 instruction set a couple of commands that have inconsistent undocumented features.

When Motorola brought out the 68020, there were fixes. Alas, some Amiga programmers like the 68000's incompatible instructions.

Anyway, booting with the 68000 chip did the trick: *Populous* worked fine.

Fascinations

It turns out that the silly game is fascinating; at least it was for me. It's fairly easy to learn. It's strategy-oriented but works in real time. You can pause the game, but if you don't, you sure can't just sit there and watch, lest Satan kill off all your followers. Not every second counts, but certainly every minute does.

The graphics are neat. The user interface is odd but learnable. Despite appearances, this isn't a game review, so I won't go into details; suffice it to say that I started playing this strange game at midnight and found myself still sitting there at 7:00 a.m. listening to the birds. Worse: that happened *twice*. Which still doesn't explain why I was mending a ceramic *ButterKasse*, but read on.

Meanwhile, it's summer-vacation time here at Chaos Manor, and our youngest son, Richard, is taking the summer off from college. One way he's been amusing himself is with *Accolade's* Fast Break 3-on-3 basketball game on the Amiga. He plays in the mornings before I get up—on this particular morning, after I came to my senses and turned off the Amiga.

An hour ago I came upstairs to finish this column. I'd had it about half done before I started *Populous* last night—I'm not a *complete* idiot—so it looked to be a short job. First, though, a quick look at *Populous*, "to get a couple of details to write about," said I to myself. When I booted up, the Amiga pronounced my disk—the uncopiable, irreplaceable *Populous* disk—unreadable.

Close examination showed just why. While I was asleep, Richard had managed to upset a glass of orange soda on

continued

the Populous disk, and it was now all wet and sticky.

Futility

Years ago I read about a library whose 8-inch CP/M floppy disks were all soaked in dousing a fire. Since there was nothing else to try, the librarians dried out the disks—and lo, they worked. Maybe, thought I, the same could be done with the 3½-inch Populous disks. What the heck, it was worth a try.

There were four disks soaked in orange soda. I washed them all out and set them in front of a fan to dry. Then, being impatient, I experimented with one of them: wash it out, shake it to get as much water out as possible, and try to dry it with a hair dryer.

That didn't work.

Neither did letting the disks dry naturally at low temperature in front of a fan. I put one disk on top of the vent from the Zenith FTM monitor, where the temperature is about 109°F. That didn't work either.

In fact, nothing I tried worked. Unlike 8-inch and 5¼-inch floppy disks, if a 3½-inch disk gets wet, it's probably just plain dead.

Certainly my Populous disks were dead. Nothing for it but to get another set. To do that, I'd have to telephone the company.

No phone number on the Populous box. Maybe on the game manual? But my desk was all set up for doing the column, meaning that it was covered to a depth of 9 inches in paper and boxes and manuals, so it took 10 minutes of increasingly frustrating activity until I found the Populous manual. Of course, it had no phone number in it, and while I was looking for that manual, I managed to kick over the large glass of water Richard had left on the floor by the Amiga. . . .

While I cleaned that up, Mrs. Pournelle got the phone number from Pacific Bell information. I called. Two rings, and it was answered by a computer that began an interminable spiel, offering me the opportunity to get various people I didn't want to talk to if only I'd punch in various numbers; eventually I punched "0" and got a human. By now I was speaking in a preternaturally calm voice: "Please let me speak to the product manager for the game called Populous."

There were several mysterious clicks and clanks and sounds from the telephone. Several rings. More clicks. Finally a recording told me that someone, I forget just who, wasn't available, and would I care to leave a message? Very

slowly and calmly I hung up and dialed the number again. I got the machine, but punching "0" got a human—so far as I knew, the only human EA employed. "The product manager for Populous isn't answering," I said carefully. "May I have the director of public relations or press relations?"

This time I got a very pleasant young lady who much sympathized with my problem and promised to mail me a new disk. Now it's time to have a few words with my son. I figured that before I did that I really ought to calm myself: I should do something requiring a maximum of care and patience and a minimum of brain—and that, preferably, has nothing to do with either computers or people; at which point I spotted the broken *ButterKasse*. . . .

I'm sure there's a moral to this story, but I'm not certain what it is.

First, who's the villain? The proximate cause is Richard for spilling the drink, but my leaving it on that table is at least contributory negligence. In any case, the incident wouldn't have been worth mentioning if it hadn't involved an irreplaceable disk.

Next, there's EA with their arcane copy-protection scheme, which not only makes the disk irreplaceable, but also makes the game frustratingly hard to boot up and play. Behind them are the petty thieves—they like to call themselves "pirates," but they don't deserve such a glamorous term—who copy and distribute copyrighted software and make EA believe that copy protection is necessary.

For reasons I have never quite understood, in the Amiga and Atari worlds it's very common for stolen copies of new games to be available on BBSes and at swap meets as soon as they appear on the market—indeed, sometimes before they're officially released.

The rest of the computer world is abandoning copy protection. In the IBM PC world, I think there are no copy-protected games at all; instead, the companies rely on "security checks," in which you're required to type in a word from the manual. This doesn't prevent illegal copying of the games—manuals can be photocopied—but it does slow things down, and it's pretty hard to distribute a printed manual on a BBS.

There's still some copy protection in the Mac world. Less every year, though, and what's left is the "key disk" variety that lets you play a game off a hard disk and checks only to see that you've got the original distribution floppy disk.

In the Amiga and Atari worlds, copy

protection is the rule rather than the exception.

I don't know why this is. I do note that there are fewer Macs than PCs, and fewer Ataris and Amigas than Macs. The elaborate manuals customary for PC games may be too expensive an investment for the smaller markets. Finally, copy protection is much harder in the PC and Mac systems than in Atari and Amiga systems. Really wicked schemes like the unlamented ProLock are harder to implement. Besides, anyone can buy disk copying programs like Copy II PC and Copy II for the Macintosh if they get unhappy enough. If there's something similar available for the Amiga, I don't know about it.

Whatever the reason, I sure wish companies like EA would rethink their position. The house rule at Chaos Manor is that I won't review copy-protected business software. I will look at copy-protected games. That doesn't mean I like having to do it.

Words!

The latest item at Chaos Manor is the *Oxford English Dictionary (OED)* on CD-ROM. I've had it for about a week now, and it's just wonderful. Every word in the English language—well, every word used up to 1928, anyway—with every meaning, its history, who used it first in print, and who's typically been using it since. Just this year, they brought out a new and revised edition of the *OED* that brings it up to the 1980s.

I first got the *OED* in the two-volume set (complete with magnifying glass in a small drawer of the slipcase) as a bonus for joining the Book of the Month Club. (Karen Anderson dubbed that the "transistorized version," which tells how long ago *that* was.) I use it at least weekly, although it isn't very convenient: the books are enormous and hard to set down, and the magnifying glass is a must. Thus, I was quite excited at the prospect of getting the *OED* on a CD-ROM.

The *OED* CD-ROM is the original edition—alas, without a four-volume *Supplement*. A new CD-ROM of the second edition is in preparation.

The manual states that "The *OED* on CD cannot be a substitute for the book itself, since reading its very long entries on screen (some are as long as 60,000 words) would be tiring and impractical. . . ." I've got news for them: compared to reading those lengthy entries in the tiny print of the transistorized version I've got, reading them on the screen is flipping bliss.

continued

OURS

THEIRS?

or

Quality	Features	Service
---------	----------	---------

Reliability...
Value...
Ergonomic...

✓ Performance ▶

- ✓ Lower Price
- ✓ Higher Resolution
1600(H) x 1280(V)
Pixels
- ✓ 3 yr Warranty
- ✓ 60 Day Money Back
Guarantee
- ✓ Faster
- ✓ Custom Screen Fonts
- ✓ The Elite/1600™
Display System ▶
- ✓ Highest Data Rate
- ✓ Unlimited Technical
Support

Expensive	Features
-----------	----------

- ✓ Higher Price
- ✓ Lower Resolution
1280(H) x 960(V)
Pixels
- ✓ 1 yr Warranty
- ✓ NO Money Back
Guarantee
- ✓ Slower
- ✓ ???

✓ Delivers a picture that
Publish magazine called
*"a real knockout with the
finest text display you'll
find on any monitor-
Mac or PC."*

GET THE PICTURE?

Meet our new Elite/1600™ a complete ultra high resolution 19-inch monochrome display system with a 1600 x 1280 pixel resolution. It offers the highest quality two-page display system available for the IBM PS/2 Series, and IBM PC and compatible.

It has the same resolution as the Sun-4 workstation monitor. The extraordinary display, combined with a clean, stable, flicker-free picture means your images are razor sharp, alignment perfect, drawings pin-point precise.

Each display system comes complete with a high resolution monitor, video interface card, and software drivers.

The Elite/1600™ is part of our extensive family of display products for the IBM compatible and Macintosh computers.

We carry a complete line of high resolution color, monochrome and gray-scale display systems.

The monitor you've got in mind is probably in our warehouse right now!

Call our toll free number today, for our free information package.

1-800-343-5532

Discover for yourself how beautiful a big monitor can be.

Got the picture?



4201 Remo Crescent, Bensalem, PA 19020 USA
Phone: (215) 639-1636 FAX: (215) 639-3420

The OED CD-ROM is extremely well indexed and has good retrieval software. The user interface is really odd. To look up a word, you set a variable called "the lemma" to equal the word. Naturally, on learning that, the first thing I did was "set lemma=lemma." For my pains, I got four screens of definitions and origins. The first definition is the expected one from mathematics. The second definition is: "The argument or subject of a literary composition, prefixed as a head-

ing or a title," which, when you think of it, sort of fits, since once you've set the lemma, the OED CD-ROM lets you look things up in a variety of ways.

You can see every instance of its use; you can see which writers used it in ways the OED editors thought worth recording. You can look up its etymology. Doing that with the word *lemma* took me to the word *dilemma*, which is a term originating in rhetoric and formal debate; also to *argument*, which originally

didn't mean "dispute" but referred to the points you made in a debate; and so forth, for 10 minutes before I got back to work. The OED CD-ROM is a wonderful time trap.

Some of the other features aren't easily learned, either. I just looked up the word *phoenix* and was told it couldn't be found, but to try the spelling index. Eventually I figured that one out: tell it the lemma is ph*, and it wants at least three letters. Tell it it's pho*, and it finds nothing. Tell it phe*, and by gollies it finds *phenix*, which is listed as "obsolete spelling of ph<oe>nix," and finally ph<oe>nix itself. It won't search on ph<oe>*. This isn't an optimum way of handling diphthongs. I can live with it, but I sure wish they'd fix that in the next edition.

You can get the OED CD-ROM direct from Oxford University Press. Mine was arranged courtesy of the (private dealer despite the name) Bureau of Electronic Publishing (P.O. Box 779, Upper Montclair, NJ 07043, (201) 857-4300), which puts out a catalog of interesting CD-ROM products, including both disks and drives.

I had no trouble at all getting the OED CD-ROM to run inside its own DESQview window (but see last month's column; I run DESQview with an 80386 and QEMM-386 to get *big* windows). Alas, unlike Microsoft Bookshelf, the OED software isn't memory-resident; you can't run anything else like a word processor with it, and for that matter, it eats up so much memory that I wasn't even able to get SideKick up—I'd hoped to use SideKick to cut and paste. However, the DESQview Notebook utility does work properly, letting you cut stuff out of the OED CD-ROM screen and paste it into other windows.

I can think of tons of improvements they could make to the user interface, but so what? What's here now is wonderful. I could rave on for the rest of the column. For anyone in love with words, the OED on CD-ROM isn't just recommended, it's a necessity, and more than enough reason to go buy a CD-ROM drive. (Indeed, enough CD-ROMs are out there now that I wish I could have several drives on-line at once: OED, Microsoft Bookshelf, World Factbook...)

Romanji

I was never any use at foreign languages. Somehow I got through high school Latin, which greatly improved my English. The University of Washington Ph.D. program required knowledge of

continued

ARE YOU STILL DRAWING FLOWCHARTS BY HAND?

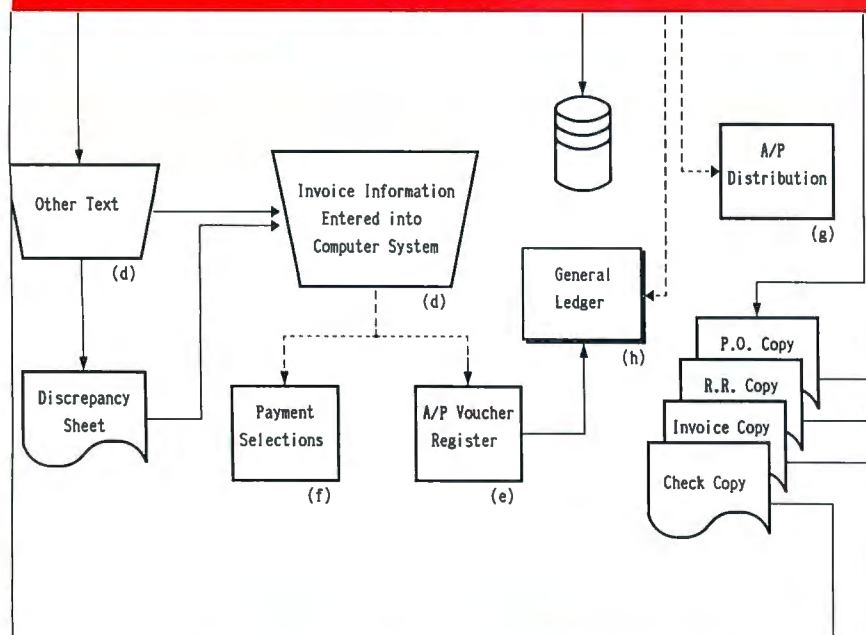

FLOW CHARTING II+

Flow Charting II+ will *amaze* you with its speed, power and simplicity.

- Update and print charts as fast as the situation changes
- See your revisions right away—no long wait for charts to be hand drawn
- Select 26 standard shapes; 10 text fonts
- Tutorial manual makes learning easy
- Runs on IBM or compatibles
- Produces excellent organizational charts!
- Only \$229!

PATTON & PATTON

Software Corporation

Excellence in charting the flow of ideas

For more information, see your local retailer or call
1-800-525-0082, ext. 47 (outside Calif.) 408-629-5376 (Calif./Int'l.)
81 Great Oaks Blvd., San Jose, CA 95119

Our MAJOR ADVANTAGE-Supplying you with the Broadest Range of Software Ammunition.

LIST OURS

APPLICATION SOFTWARE

COMMUNICATIONS

Carbon Copy plus	195	115
Close-Up		
Customer	195	135
Support	245	165
Co/Session	249	182
Crosstalk XVI	195	99
Mirror III	100	67
PC Anywhere III	145	79
Procomm Plus	75	49

DATABASE

Clarion	695	409
Clipper	695	439
dBASE IV	795	489
dBXL	249	145
FoxBASE+	395	199
FoxBASE+/MAC	395	199
Paradox 3.0	725	479
PFS:Professional File	299	189
Q&A	349	229
R&R	149	109
R:Base for DOS	725	489

DESKTOP PUBLISHING

Adobe Illustrator '88	695	409
Adobe Illustrator '88 (MAC)	495	300
Corel Draw!	495	299
Draw Applause	495	315
First Publisher	99	79
First Publisher Art Gallery	129	82
GEM Artline	495	285
GEM Desktop Publisher	299	183
PageMaker	795	489
PageMaker (MAC)	595	299
Ready, Set, Go (MAC)	495	320
Springboard Publisher	139	80
Ventura Publisher	895	539

GRAPHICS

Chart-Master	375	239
Freelance Plus	495	CALL
GEM Graph Present. Team	495	305
Graph Plus	495	329
GraphWriter II	495	CALL
Graph-in-the-Box	140	75
Harvard Graphics	495	289
Micrografix Designer	695	459
Microsoft Chart	395	270
Perspective Junior	149	109
PinStripe Presenter	200	CALL
PIXIE	295	177
Powerpoint (MAC)	395	265
Xerox Presents	495	319

INFORMATION ORGANIZERS

Agenda	395	CALL
askSam	295	179
GOfer	80	45
GrandView	295	189
Memory Mate	70	43
SideKick Plus	200	135
Tomado	100	55
Who-What-When	190	119
ZyIndex Professional	295	159

PROJECT MANAGEMENT

Harvard Project Manager	695	439
InstaPlan 2.0	99	95
Microsoft Project	495	329
SuperProject Plus	395	255
Time Line v. 3.0	595	359
Time Line Graphics	195	135

SPREADSHEETS

Legend Twin Level III	249	195
Lotus 1-2-3	CALL	CALL
Lucid 3-D	149	CALL
Microsoft Excel	495	239
Microsoft Excel (MAC)	395	270
Microsoft Multiplan 4.0	195	125
Microsoft Multiplan (MAC)	195	125
PFS:Professional Plan	99	CALL
PlanPerfect	395	199
Quattro	248	165
SuperCalc5	495	319
Symphony	695	CALL
Wingz (MAC)	495	299



ADVANTAGE SOFTWARE

LIST OURS

SPREADSHEET UTILITIES

3-D Graphics	145	129
4Views	150	119
4Word	100	61
@ BASE	195	119
@ Liberty	295	199
Allways	150	85
Baler	495	449
Graph-in-the-Box	140	75
Hai	150	CALL
Impress	140	CALL
Inword	100	59
Look & Link	100	60
Note-It Plus	80	55
Noteworthy	80	49
PanaView	145	129
See More	80	49
Sideways	70	43
SmartNotes	80	48
Spellin!	80	49
SOZ Plus	100	63

WORD PROCESSING

Ami	199	129
DisplayWrite 4	495	342
Grammatik III	99	52
Manuscript	495	CALL
MaxThink 89	89	71
Microsoft Word	450	249
Microsoft Word (MAC)	395	249
MultiMate Advantage II	695	299
Office Writer 6.0	495	302
PFS:Professional Write	199	129
Q & A Write	199	135
RightWriter	95	52
Samna Word IV	595	316
Sprint	200	139
WordPerfect 5.0	495	239
WordPerfect (MAC)	395	231
WordPerfect Executive	249	129
WordPerfect Library	129	69
WordStar 2000+ Personal	495	302
WordStar Professional Rel 5	495	239
XyWrite III Plus	445	256

LANGUAGES

Lahey F7L	595	535
Micro Focus COBOL	CALL	CALL
Microsoft C	450	299
MS FORTRAN	450	299
MS Macro Assembler	150	99
MS QuickPASCAL	99	69
Smalltalk/IV 286	200	149
Turbo C 2.0	150	99
Turbo C 2.0 Professional	250	169
Turbo Pascal 5.0	150	99
Turbo Pascal 5.0 Professional	250	169

LIST OURS

OPERATING SYSTEMS/CONTROL PROGRAMS

Concurrent DOS 386 2.0	395	235
DESQview 386 (w/QEMM)	190	115
Interactive 386/IX	1095	989
GEMM 386	60	39
MS Windows/386	195	125
PC-MOS 386 (single user)	195	179
PC-MOS 386 (five users)	595	539
SCO 386 UNIX Sys V (comp)	1495	1195
SCO UNIX Sys V (comp)	1295	999
VM/386	245	199
VM/386 Multi-User	895	759
VM/386 NetPak	150	129

LIST OURS

SCIENCE/ENGINEERING

CAD

AutoCAD Release 10	3000	CALL
AutoShade	500	389
AutoSketch	150	95
DesignCAD	CALL	CALL
DesignCAD 3-D	399	209
Drafix CAD Ultra	395	259
Generic CADD Level 3	300	179
Generic 3-D Solids Modeling	349	195

PCB ARTWORK/SCHEMATICS

HIWIRE Plus	895	805
Micro-CAP III	1495	1269
Schema II	495	450
smARTWORK	895	805
Tango-CAD Pack	995	949
Tango-PCB Series II	595	559

DATA ACQUISITION/ANALYSIS

Asystant Plus	995	849
DADISP	795	719
LABTECH Notebook	995	799

MATHEMATICAL TOOLBOXES

Derive	200	166
Eureka: The Solver	167	115
Eureka: The Solver (MAC)	195	134
Gauss Math & Stat System	395	350
Mathematica 386	695	CALL
AT 386/7	995	CALL
Mathematica (MAC)	795	CALL
PC MathCAD 2.5	495	315
Appl. Packs (for MathCAD)	99	89
PC-Matlab	695	559
Control System Toolbox	495	399
System ID Box	495	399
TK! Solver Plus	395	319

PLOTTING AND GRAPHING

Grapher	199	149
Grapher/Surfer Bundle	600	499
Surfer	499	379
TECH*GRAPH*PAD	395	319
Temple Graph	299	259

WordPerfect

WordPerfect 5.0 integrates text and graphics to let you create professional looking newsletters, reports, and documents—without neglecting the features that made it number one in the first place!

Graphic images can be placed anywhere on the page, scaled, moved, and can include a caption and border. 5.0 also has enhanced print capabilities, and a WYSIWYG preview mode. Master Document combines files to generate tables of contents, indexes, etc.

WordPerfect 5.0 succeeds 4.2 as the world's best word processor. Once you've tried it, you'll never go back!

List: \$495

Ours: \$249



WordPerfect CORPORATION

UTILITIES

Brooklyn Bridge	140	85
Copy II PC	40	25
Disk Technician Advanced	190	119
FASTBACK Plus	189	109
Laplank 3	140	85
MACE GOLD	150	88
Magellan	195	CALL
MKS Toolkit	199	155
Norton Commander	89	52
Norton Utilities	100	59
Norton Utilities Advanced	150	89
PC Tools Deluxe	129	80
Software Carousel	80	49
Spirrite	59	49
V feature Deluxe	120	95
XTree	70	39
XTreePro	129	70

SCIENTIFIC TEXT PROCESSING

ChWriter	150	129
EXP	150	129
PC TEX	249	226
T*	595	479

STATISTICS

CSS	495	469
Microstat II	395	336
NWA StatPak	495	366
P-Stat	695	639
SPSS/PC+	795	727
StatGraphics	895	599
StatPac Gold	595	549
Statview II (MAC)	495	345
SYSTAT	595	449
SYSTAT (MAC)	595	449
SYSTAT (w/ SYGRAPH)	795	595

Terms & Policies

All prices subject to change without notice. We accept Visa, MC, AMEX (2% surcharge on AMEX). Shipping \$4 per item sent UPS Ground. Allow 14 days for personal/company check clearance. Returns subject to 15% restocking fee. RA # required. PO's welcome from Fortune 1000 and other qualified organizations.



ADVANTAGE SOFTWARE

A Division of Voyager Software Corp

In the U.S. call:

1-800-333-3141

International: 201-389-8950

Fax: 201-389-9227

1163 Shrewsbury Ave., Shrewsbury, NJ 07702

Circle 16 on Reader Service Card



Now Available
386

Experts Agree on WATCOM C:

"We searched the industry for the best 286 and 386 C-compiler technology to incorporate with our developer toolkits. Our choice was WATCOM."

Nancy Woodward, VP & GM Development Products
Novell, Inc.

"WATCOM's latest release of its rising star is a clear winner....It is a clearly superior value when compared to all compilers..."

Richard Relph
INFOWORLD, May 22, 1989



"WATCOM is definitely the leader in object-level optimizations...For flat-out executable speed, WATCOM's compiler was the clear winner."

Steve Apiki and Jon Udell
BYTE, February 1989

"WATCOM C broke with tradition to make a fast, efficient C programming environment that has other C compiler designers rethinking their strategy."

Bill Machrone
PC Magazine, January 17, 1989



"Microsoft library- and source-compatibility makes WATCOM C7.0/386 ideal for porting DOS applications to 32-bit native mode. This compiler enables full 386 performance without 640K limitations."

Richard M. Smith, President
Phar Lap Software, Inc.

WATCOM C7.0

100% ANSI C optimizing compiler and run-time library, graphics library, windowed source-level debugger, development tools, and Express C integrated environment for DOS and embedded systems. Price: \$395.00

Now WATCOM C7.0/386

100% ANSI C optimizing compiler and run-time library plus development tools supporting 386 32-bit protect mode for embedded systems and DOS extenders including 80386 software tools from Phar Lap Software and OS/386 from A. I. Architects. Price: \$895.00

For specifications, licensing options and orders, contact:

WATCOM

1-800-265-4555

WATCOM
415 Phillip Street Telephone: (519) 886-3700
Waterloo, Ontario Telex: 06-955458
Canada N2L 3X2 FAX: (519) 747-4971

WATCOM & Express C are trademarks of WATCOM Systems Inc.
© Copyright 1989 WATCOM Products Inc.

two foreign languages, but fortunately you could demonstrate competence by taking an examination. I've always been good at boning up for exams, and that plus psyching the test got me through.

One of my languages was Spanish, and between formal study and living in Southern California, I learned enough to get by in Cal-Mex (which we consider more elegant than Tex-Mex). On the whole, though, I am absolutely the wrong person to evaluate a computerized language instruction program. You've been warned.

Traveler's Guild: Japanese consists of a couple of thin manuals, two 3½-inch floppy disks, and a tape. The program starts you off with a map of Japan, goes through some generalities, and then gets down to drilling you on vocabulary through a phrase-book approach. Phrase categories are standard: greetings, personal condition, going places, weather/seasons, food/eating, and so on. Words and phrases are given on-screen, questions are asked, and you type in the answers. In addition, there's a booklet that accompanies the pronunciation tape.

It all seems to work as advertised; that is, the program works, and the tape gives you pronunciations. Whether or not it will teach you Japanese is something I'm not competent to say. It can't hurt.

One thing it won't teach you is to read Japanese.

There are four different types of characters in use in modern Japan. First, there's kanji, an ideographic system borrowed from Chinese, in which each character—some quite elaborate—stands for a different word. Second, there's hiragana, which looks a bit like ancient Mycenaean Greek: each character stands for a syllable (e.g., ma, pa, ta, and ga). Third is katakana, which is similar to hiragana but has more elaborate characters and is used for syllabic representation of words of foreign origin; and finally there's romanji, which is a roman alphabetic representation of katakana and hiragana characters.

Traveler's Guild: Japanese uses romanji characters because, according to its book, they are "easiest for English speakers to learn and remember," which is probably true. But it's also true that romanji is a lot easier to get onto your screen; anything else would have to be in graphics mode.

Since no program whatever is likely to teach me Japanese—I have enough trouble remembering the names of my favorite sushi items—all I can do is make you aware of this program. I surely can't evaluate it.

More Words

The gadget of the month is WordFinder WF-224 marketed by SelecTronics. This is a box about half again the size of a package of cigarettes. You could carry it in a pocket, but you probably wouldn't; for that you'd want the WF-225, which is smaller than a box of coffin nails. Both hinge open, with a small screen on one half and a QWERTY keyboard on the other. The WF-225's keyboard is harder to use, and the screen is smaller; but you can use it. Otherwise, the two units are identical.

The software and dictionary are the ones you find in the WordFinder thesaurus program: some 100,000 words, including major countries and cities, and some proper names, like Pournelle and Dvorak. There are also some 220,000 synonyms (which, unlike the primary dictionary words, don't have in-box definitions). You type in a word, spelled correctly or not; it attempts to correct the spelling if it's wrong. Once you have a valid word, you can get a definition (some of them are fairly complex) or a synonym.

So far it's an interesting gadget, but nothing I'd be likely to write about. Indeed, I'd probably have ignored the WF-224 if it hadn't come from Mike Wiener of Microlytics, the developer of the WordFinder software and the chap who saw to it that my personal electronic dictionary was incorporated into the original WordFinder thesaurus. When Mike sent the WF-224, he enclosed a note calling my attention to a unique feature: the Flashcard. When the WF-224 asks you for a word, enter the * (wild card) character and press the Def key; instantly there appears a random word. Mike's note said, "I bet you'll see a word you don't know within 10 tries."

Foo, thought I. I grant you a tiny box like that will have some words I don't know, but it's not going to have so many that it will find one in 10 tries. After all, I make my living with words. But what the heck, it's worth a try.

The fifth word up was *rollick*. OK, I thought I knew what it meant, but let's be honest: I wasn't sure. I pressed the Def key again. "To behave in a carefree, jovial way" came up on the WF-224 screen. Interesting. A quick trip to the OED—I have it ready in a DESQview window—told me *rollick* is also a noun meaning "exuberant gaiety," but the verb is "To frolic, sport, or romp in a joyous, careless fashion; to go off, move along, enter, etc., in this manner." Certainly the WF-224 was close enough.

continued

FINALLY. A debugging tool tough enough to handle the DOS Nasties.

New Version 2.0



Nasty over-write? No sweat!

Soft-ICE memory range break points help you track down memory over-write problems whether you are doing the over-writing or another program is over-writing you.

Hung program? No problem!

When the system hangs, you now have hope. With Soft-ICE you can break out of hung programs no matter how bad the system has been trashed. And with Soft-ICE's back trace ranges you can re-play the instructions that led up to the crash.

Program too large? Not with Soft-ICE!

Soft-ICE runs entirely in extended memory. This means you can debug even the largest DOS programs. And since your program runs at the same address whether Soft-ICE is loaded or not you can find those subtle bugs that change when the starting address of your code changes.

System debugging? Soft-ICE is a natural!

Soft-ICE is ideal for full source level debugging of TSRs, interrupt service routines, self booting programs, DOS loadable device drivers, real-time kernels, non-DOS O/Ss and ROMs. Soft-ICE can even debug within DOS & BIOS.

How Soft-ICE Works

Soft-ICE uses the power of the 80386 to surround your program in a virtual machine.

This gives you complete control of the DOS environment, while Soft-ICE runs safely in protected mode. Soft-ICE uses the 80386 to provide real-time break points on memory locations, memory ranges, execution, I/O ports, hardware & software interrupts. With Soft-ICE you get all the speed and power of a hardware-assisted debugger at a software price.

Don't want to switch debuggers?

You don't have to!

Soft-ICE can run stand-alone or it can add its powerful break points to the debugger you already use. Use your favorite debugger until you require Soft-ICE. Simply pop up the Soft-ICE window to set powerful real-time break points. When a break point is reached, your debugger will be activated automatically.

MagicCV with Soft-ICE

Using Soft-ICE with CodeView gives you the features necessary for professional level systems debugging. MagicCV and Soft-ICE can work in concert with CodeView to provide the most powerful debugging platform you will find anywhere.

"These may be the only two products I've seen in the last two or three years that exceeded my wildest expectations for power, compatibility and ease-of-use."

— Paul Mace
Paul Mace Software

Soft-ICE	\$386
MagicCV	\$199
MagicCV for Windows	\$199
Buy Soft-ICE & MagicCV(W)	—Save \$86.
Buy MagicCV and MagicCVW	—Save \$100.
Buy All 3	—Save \$186.

30 day money-back guarantee
Visa, MasterCard and
AmEx accepted



New Soft-ICE 2.0 features

- Back Trace Ranges
- Symbolic & Source level debugging
- EMS 4.0 support with special EMS debugging commands
- Windowed user interface



Nu-Mega
TECHNOLOGIES

CALL TODAY (603) 888-2386
or FAX (603) 888-2465

RUN CODEVIEW IN 8K **MagicCV**



CodeView is a great integrated debugger, but it uses over 200K of conventional memory. MagicCV uses advanced features of the 80386 to load CodeView and symbols in extended memory. This allows MagicCV to run CodeView in less than 8K of conventional memory on your 80386 PC.

NEW—Version 2.0 includes EMS 4.0 driver.
Attention Windows Developers!
Version available for CVW.

P.O. BOX 7607 ■ NASHUA, NH ■ 03060-7607

ITEMS DISCUSSED

Ami\$199 Samna Corp. 5600 Glenridge Dr. Atlanta, GA 30342 (404) 851-0007 Inquiry 987.	Mrs. Pournelle's Reading Program \$100 Roberta J. Pournelle 3960 Laurel Canyon Blvd., Suite 372 North Hollywood, CA 91604 Inquiry 992.	QuickPak Professional\$149 Crescent Software 11 Grandview Ave. Stamford, CT 06905 (203) 846-2500 Inquiry 997.
Expert 87\$495 Magic 7 Software 101 First St., Suite 237 Los Altos, CA 94022 (415) 941-2616 Inquiry 988.	Oxford English Dictionary CD-ROM\$950 Oxford University Press, Inc. 200 Madison Ave. New York, NY 10016 (212) 679-7300 Inquiry 993.	The MicroHelp Toolbox \$79 MicroHelp, Inc. 4636 Huntridge Dr. Roswell, GA 30075 (404) 552-0565 Inquiry 998.
Fast Break 3-on-3 IBM PC..... \$39.95 Mac.....\$44.95 Accolade, Inc. 550 South Winchester Blvd., Suite 200 San Jose, CA 95128 (800) 245-7744 Inquiry 989.	Populous \$49.95 Electronic Arts 1820 Gateway Dr. San Mateo, CA 94404 (415) 571-7171 Inquiry 994.	Traveler's Guild: Japanese\$139 Traveler's Guild 315 West Washington Marquette, MI 49855 (906) 228-5030 Inquiry 999.
Grolier's Academic American Encyclopedia on CD-ROM\$395 Grolier Electronic Publishing Sherman Tpk. Danbury, CT 06816 (800) 356-5590 Inquiry 990.	ProBas ToolKit \$99 Hammerly Computer Services, Inc. 9309 Jasmine Court Laurel, MD 20707 (800) 343-7484 Inquiry 995.	WordFinder WF-224 \$99.95 SelecTronics 701 Decatur Ave. N, Building 204 Minneapolis, MN 55427 (612) 545-6823 Inquiry 1000.
Logitech Mouse\$139. Logitech, Inc. 6505 Kaiser Dr. Fremont, CA 94555 (415) 795-8500 Inquiry 991.	ProIcon\$175 The ProIcon Group P.O. Box 1123 Salida, CO 81201 (719) 539-3884 Inquiry 996.	WordStar 5.5\$495 WordStar International, Inc. 33 San Pablo Ave. San Rafael, CA 94903 (415) 499-1200 Inquiry 1001.

Incidentally, I used the DESQview mark-and-transfer routine to move the definitions from the OED window to this one. Works like a charm.

Try the WF-224 again. The sixth word this time was *abscission*. Well, all right, I know what that means, but I can't say I was *sure*. Try again. It took 18 tries to come up with *perfecto*, which turns out to be a thick tapered cigar, and no, I didn't know that. I thought they'd included a word of foreign origin.

The WF-224 also checks spelling. If you punch in *Pournelle*, it says that's spelled right. But if you give it *Pournell*, it corrects it to *perennial*; however, if you hit the right-arrow button, it finds something else and will keep trying until, by gollies, it gets *Pournelle* on about the fourth try! It accepts *perenial* and gives the right answer, but if you give it *mispeled*, it finds *misapplied* as the first

choice; keep hitting the right arrow, though, and it gets it right.

It's a fun gadget. I'll lend it to one of my college sons and see what happens.

Of Mice and Bugs

Logitech has new mouse software. They no longer bundle the Point editor with their mice, although I gather you can get it if you buy their desktop publishing package. Now they include a thing called Pop-Up DOS, which is a DOS shell. Pop-Up DOS enthusiasts swear it's easier to use and just plain better than Norton Commander. Maybe. I'm quite certain that had I learned Pop-Up DOS before I learned the Commander, I'd never have been tempted to switch; now the burden's the other way, and so far I'm still using the Commander, but we'll see as time goes on. One thing: Pop-Up DOS comes with a good tutorial and reference

book, although I do wish the index and table of contents were a little more thorough.

Obviously, Pop-Up DOS works well with a Logitech mouse. You get the help file by pressing the center mouse button, for example. They've kept the pattern from Niklaus Wirth's Lilith operating system, in which the center button produces a menu, the left button executes commands, and the right button makes the menu go away and generally acts as the Escape key; but since that can drop you right out of the program, Pop-Up DOS requires that you double-click on the right button or physically press the Escape key.

Pop-Up DOS does a number of things similar to the Norton Commander. It shows a full tree of your hard disk directory structure. There's a neat little card

continued

When we started selling MKS products in 1986, the Tax Collectors were among the first to notice. They assessed our promise to bring the power and flexibility of a UNIX environment to the DOS desktop.

And then they came to call.

We're happy to report that the Tax People* quickly decided that MKS products were the perfect way to train users on UNIX operating systems using the PCs everyone was already familiar with. And the perfect way to speed development of new programs and procedures.

Get the new - but don't give up the old

The MKS Programming Platform gives programmers the best of both worlds - virtually unrestricted access to the power and flexibility of UNIX operating systems, and full DOS or OS/2 capabilities. With MKS your PC becomes a powerful and productive UNIX workstation, whenever you need it.

The Platform includes four proven members of the MKS family of software: *MKS Toolkit*, *LEX & YACC*, *RCS*, and *Make*.

The heart of the Platform is the *MKS Toolkit*. It provides a complete set of utility programs and over 150 commands compatible with UNIX System V.3. It also includes the MKS Korn Shell, a command interpreter, MKS Vi editor, and the MKS AWK programming language.

Next is *MKS LEX & YACC*, which work together as a

highly efficient program generator, simplifying the creation of languages and compilers for DOS and OS/2. The set is completed with *MKS RCS* (Revision Control System), which gives total control of text file revisions, and *MKS Make*, which provides an efficient way to automate the production and maintenance of any size project.

All together they are the most efficient, most productive, and friendliest way to cross the bridge between DOS or OS/2, and UNIX.



Beyond multiple platform support

The Programming Platform performs on standard PC networks like Novell NetWare and PC NFS with the illusion of a complete UNIX timesharing system. This means you can hook your PC to PC NFS, allowing it to be used as a UNIX workstation.

MKS is an active participant on the POSIX standards committee, and we track the shell and utilities standard to the fullest extent. We take care to build the underlying POSIX kernel functionality on DOS and OS/2 into MKS software before moving utilities. That's why the Platform gives you 100% UNIX and POSIX compatibility, with no surprises.

Ideal training tools

Fast, painless training is another benefit of the Programming Platform. Developers can use their familiar PC keyboards while moving effortlessly to UNIX on the desktop, and exposure to new commands and functionality becomes part of the novice's working day.

The Taxman adds it up

When you stack up all the advantages of the Programming Platform - access to powerful development tools, time-saving management functions, full portability, easy training, and our unwavering dedication to the POSIX standard - it's no wonder that the people with the toughest jobs to do, like the Taxman, turn to MKS. To learn more about The Programming Platform and other MKS productivity and development tools, call us today. Maybe we can make your job a little less taxing.

After Long Investigation, The Taxman Came To Talk To Us

30 day money-back guarantee
MKS Programming Platform prices are:

DOS \$665
OS/2 \$1225

In Continental USA call: 1-800-265-2797
Outside Continental USA call: 1-519-884-2251
Fax: 1-519-884-8861

Authorized MKS Dealers:

Belgium 2-736-6064
England 364-53499 or
1-833-1022 or
0763-73455
Netherlands 20-14-24-63
West Germany 551-792488 or
061-214908 or
721-886-664

Head Office:

35 King Street North
Waterloo, Ontario
Canada, N2J 2W9



More Power to You

*We're not allowed to use their official name. But you know who we mean.
MKS is a trademark of Mortice Kern Systems Inc. Other trademarks have been cited and MKS acknowledges them.

file built in; alas, there's no provision for sorting those silly cards. I'm seriously thinking of writing a small Turbo Pascal program that will do it. You can launch programs from within Pop-Up DOS, but in addition you can link programs. You can define all .GV files as GrandView applications, so if you double-click on a .GV file, it launches GrandView with that file in it.

Other Pop-Up DOS features include a calendar, a hexadecimal/decimal calcu-

lator, and a small editor that is more than good enough to edit stuff like AUTO-EXEC.BAT, CONFIG.SYS, and generally whatever else you want. Unlike the SideKick editor, it doesn't do word wrap. On the other hand, it works nicely with mice (as you'd expect). On the gripping hand, Pop-Up DOS has no view or examine function that lets you read files; to get the equivalent of the DOS TYPE command, you have to either exit Pop-Up DOS or click on the file bringing it into

the Pop-Up DOS editor—either of which is inconvenient compared to Norton Commander's F3-view command.

In other words, Pop-Up DOS is a reasonable competitor to Norton Commander and other DOS shells, and since you get it free with the Logitech Mouse, it's certainly worth trying, especially if you haven't got used to something else.

That's the one hand. On the other hand, the new Logitech Mouse has an odd shape: instead of the modified wedge that Logitech has made famous, the new version looks like a slice of a cylinder. Some people like it. I don't; I have trouble distinguishing the buttons.

On the gripping hand, by the time you read this, Logitech will have brought out a new trackball. I've had almost no time to play with it, but from what little experience I've had, I think it may well replace the mouse as the proper pointing device. I know there have been trackballs before, but most have been clumsily designed. The Logitech trackball is small; it's set so that you manipulate the ball with your thumb, leaving the fingers to rest on the buttons in a natural manner. This is definitely the right way to go. More next month.

Finally, while I'm discussing Logitech, I want to again praise MultiScope, their new OS/2 Presentation Manager debugger. While MultiScope naturally works with Logitech Modula-OS/2, it's also the best debugger I know of for IBM C/2, Pascal Compiler/2, and Macro Assembler/2; and for Microsoft C, Pascal, and Macro Assembler. It works in both run-time and postmortem modes and with both OS/2 Text and PM.

If you're programming for OS/2 in any language, you need MultiScope. Highly recommended.

Failure

I keep hearing wonders about Windows, and Windows/386 in particular. More, I have Ami, a Windows text editor and desktop composition program that looks awfully good in demonstrations. This looked like a good program to try on the new Northgate 386 with the Video Seven VGA card and Princeton monitor.

There's only one problem. It takes 40 minutes to install Windows/386. When I finished this tedious process, the program reported that everything was all right, and I only needed to reboot and type WIN386. I did that, the screen flickered, and I was back at DOS again. No error message. Nothing. Just click, clack, and no effect.

Clearly, there are some odd bugs in
continued

All the advantages of Ampro's Little Board/286. Now in a single slot.

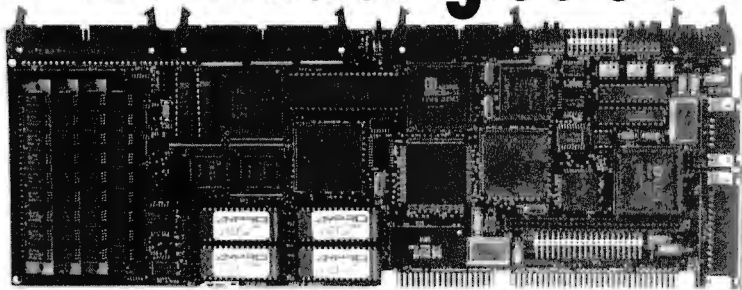

Slot Board/286.

One philosophy. Two systems. Ampro's new Slot Board/286, like the Little Board/286, is a complete AT-compatible single board system. Each is equivalent to an AT motherboard and four expansion cards. Now, you can choose between stackable systems with the Little Board/286 or passive backplane systems with the Slot Board/286.

PC/AT Software compatible. Supports all standard PC/AT operating systems. DR-DOS is included with each board.

Everything you need. StackPlane™ or backplane. 512K to 4 MB on-board DRAM. Boot-

able Solid State Disk. Disk controllers. Display controllers. A selection of I/O ports. Card cages and passive backplanes for easier system implementation.

Better answers for embedded systems. Bolt-in or plug-in. Little Board/PC and Little Board/286 with their compact, easy to build-in StackPlane architecture. Slot Board/286 with its passive backplane for I/O and peripheral intensive applications.

Available worldwide. Call Ampro or any of the distributors listed below for complete details on Ampro Little Boards or Slot Board/286.

Reps: USA - contact AMPRO for the name of your nearest rep. Australia - 61 3 720-3298; Austria - 43-1/45 4510-0; Canada - (604) 438-0028; Denmark - 45 3 66 20 30; Finland - 358 0 585-322; France - 331 4502-1800; Germany, West - 49 89 611-6151; Hong Kong/P.R.C. - 5 8613118; Israel - 972 3 49-16-95; Italy - 39 6 811 9406; Japan - 81 3 257-2630; Netherlands - 31-10-411 8521; Sweden - 46 8 55-00-65; Switzerland - 41 1 740-41-05; United Kingdom - 0296-435511

Slot Board/286 Features

- IBM PC/AT compatible
- 12 or 16 MHz 80C286 CMOS CPU
- Up to 4MB DRAM
- On-board Bootable Solid State Disk
- 2 serial ports (RS232C/RS422/RS485)
- Parallel printer port
- AT Bus hard disk interface
- Floppy disk controller
- SCSI controller
- Enhanced Award ROM BIOS
- Math co-processor support
- Real time clock
- Low power (approx. 8 Watts)
- Wide operating temp. range: 0 to 60° C
- Low parts count. High reliability
- Optional Mini Modules: Video controllers LCD Display Driver Serial/Parallel expansion Modem ... and more

All trademarks are the property of their respective owners

(408) 734-2800

AMPRO
SINGLE BOARD SYSTEMS

Ampro Computers, Inc., 1130 Mountain View/Alviso Road, Sunnyvale, CA 94089. Telex: 4940302 FAX: (408) 734-2939

How an upside down idea made the mouse obsolete.



Frankly, we thought any input device that operated by dragging it across an already cluttered desk was great technology misapplied. We took a different approach.

Now RollerMouse makes the conventional mouse obsolete.

Control Without Bending Your Elbow

All the pointing accuracy and speed you only hoped for from your old mouse is right at your fingertips. Moving from point to point with our oversized trackball is fluid, effortless and fast at 200 CPI resolution.

Using our exclusive four-button control, you have maximum click and click lock versatility. With programmable pop-up menus, RollerMouse works with software written with or without a mouse in mind. And RollerMouse technology means you never need to disassemble it for cleaning.

More Application Productivity

If you work with the latest graphics-based applications, such as desktop publishing, CAD/CAM/CAE or any object-oriented PS/2, PC or Mac operating system, don't be held back by old mouse technology.

Buy from the leader in precision pointing devices. CH Products perfected computer control technology more than 25 years ago. And the latest technology is at a dealer near you.

For more information, call:
(619) 744-8546

8:00 a.m. - 4:30 p.m. PST

For credit card orders, call:

USA (800) 624-5804

CA (800) 262-2004

8:00 a.m. - 4:30 p.m. PST

RollerMouse™

The other kind of mouse.



A Division of Joystick Technologies, Inc.
1225 Stone Drive, San Marcos, CA 92069

All product names are registered trademarks of their respective owners. All rights reserved.

Circle 50 on Reader Service Card
(DEALERS: 51)

Windows/386; perhaps I'll learn, but for the moment I think I'll stick to DOS and DESQview. It's sure less frustrating. I have installed Windows/286, but just now I'm sufficiently disgusted with Windows that it wouldn't be fair to Ami to try it. I'll report on it another time. Meanwhile, I sure wish Microsoft would get its installation act together. It could at least give an error message.

Grolier

I keep my radio on the local university's good music station, and tonight they're doing a docudrama about the French Revolution, with Captain James Tiberius Kirk (aka William Shatner) as Robespierre yet. One event portrayed was the assassination of Marat by Charlotte Corday. I got to wondering what happened to her after she stabbed Marat (who certainly had it coming).

I've got plenty of books, including Carlyle's *The French Revolution*, and Corday's story is in one of them, but this seemed like a good opportunity to try the new version of Grolier's Academic American Encyclopedia on CD-ROM. You may recall that this was just about the first CD-ROM of any size to be published, and Gary Kildall's Knowledge Corp. developed the early indexing and data-retrieval software. The user interface was, to be kind, not optimum. Since then, there have been several revisions.

Installation of the new version 2 is straightforward: the program comes with a floppy disk as well as the CD-ROM. Put the floppy disk in drive A, log on, and type Install. It takes care of the situation from there.

I'm pleased to say that the new Grolier software is considerably improved over the first version. It's now quite intuitive. There are also multiple (up to 10) windows and hypertext links from one article to another, which is neat.

Looking up Corday yielded six references in four articles. The primary one told me that she'd been guillotined, which I suppose is no surprise, since almost everyone you ever heard of who lived in France around 1789 seems to have been shortened. I then got myself trapped playing around with linkages and ended up reading a lot more about European history than I'd intended; the hypertext-link feature really does work, making it simple to trace down ideas.

Grolier's Academic American Encyclopedia isn't the world's best encyclopedia, but it's certainly not the worst. It does get rather cursory in places, and details of history aren't its strongest point; but then encyclopedias are supposed to

be a starting point for learning, not the entire accumulated knowledge of the human race. You can learn a lot browsing through it with hypertext links.

I do wish they'd use the new Grolier retrieval software on an even more complete encyclopedia, but until they do I'm glad to have this one. Recommended.

Languages Yet Again

I've been considering just what you can do with Turbo Pascal. Modern programmers would have you believe that Pascal and Modula-2 are dead, and that C is the only viable language. For my money, that just isn't so.

Indeed, I'd go the other way: every time I hear of a big software project in trouble, I find it was written in C. More to the point, it was written by one programmer but needs to be maintained by another. Under those circumstances, C becomes something close to a write-only language, particularly if combined with Unix. The code is perfectly comprehensible to the person who wrote it—provided said person is a full-time programmer—but it becomes unfathomable for someone coming in from outside.

Pascal, on the other hand, and in particular Turbo Pascal, may not completely live up to Niklaus Wirth's goal of a self-documenting language, but it's sure closer than C. True, Pascal doesn't always produce code that's as compact as C code; but it's generally good enough, and me, I'd rather have fat, understandable code than a program that's compact, efficient, and incomprehensible.

For that matter, BASIC most certainly isn't dead. If you take Microsoft QuickBASIC and add toolkits like those published by Crescent Software, Hammerly Computer Services, and MicroHelp, you can do anything you like, including TSR programs. True, compiled BASIC makes for fat code, but most of the tools I mentioned are in assembly language and will thus be smaller and run faster than the same stuff in C. If you make a program that's largely links between assembly language routines, the result can be quite impressive—and still be readable. I'm in the process of going through Mrs. Pournelle's Reading Program and replacing my own code with routines from these toolkits, and the result is gratifying.

I've been saying this for years, and I still believe it: the real computer revolution comes about when people stop having to worry about *how* to make the computer do something and concentrate on *what* they want it to do. Moves—such as Windows and OS/2—that take us toward the use of C and other arcane languages

are steps in the wrong direction.

OS/2 got more accessible when Logitech put out Modula-OS/2; it will get even more so when we have QuickBASIC and Turbo Pascal for OS/2.

Winding Down

There's still an enormous pile on my desk. There's Expert 87 from Magic 7 Software, which looks fair to be the PC-DOS "expert system generator" for the rest of us. I liked the original version, and it has been revised to be even better. A bit complex, but that kind of program always is. Recommended.

There's WordStar 5.5, which is so much improved I may change over; if they'd had this four years ago, WordStar International would own the world.

Finally, there's ProIcon, a Mac implementation of the Icon programming language (the book *The Icon Programming Language* by Ralph and Madge Griswold is available from Prentice-Hall). This is a high-level, SNOBOL-like, string and list processing language (see "SNOBOL and Icon" by Ezra Shapiro in the July 1985 BYTE) available on Unix systems, including the VAX, the Amiga, and the Atari ST. Programs in Icon look a bit like a cross between Pascal and C. It is not as strongly typed as Pascal, but more so than C. More another time.

The pseudobook of the month is *The Man-Kzin Wars II* series created by Larry Niven; the story of interest is "The Children's Hour," a novella by Pournelle and S. M. Stirling (Baen Books, 1989). The real book of the month is *The Bloody Crossroads: Where Literature and Politics Meet* by Norman Podhoretz (Simon and Schuster, 1986, \$16.95). I particularly liked his essays on George Orwell and Albert Camus.

The game of the month is Accolade's Fast Break 3-on-3. Richard says it's very hard to learn, but once you've got the hang of it, it's both fun and instructive. It must be fascinating; he's still coming up here to play it on the Amiga. We're both a lot more careful about orange soda. ■

Jerry Pournelle holds a doctorate in psychology and is a science fiction writer who also earns a comfortable living writing about computers present and future. Jerry welcomes readers' comments and opinions. Send a self-addressed, stamped envelope to Jerry Pournelle, c/o BYTE, One Phoenix Mill Lane, Peterborough, NH 03458. Please put your address on the letter as well as on the envelope. Due to the high volume of letters, Jerry cannot guarantee a personal reply. You can also contact him on BIX as "jerryyp."

TOPSPEED C

The next generation



TopSpeed C. Compiler and library conform 100% with proposed ANSI standard. Source compatible with MS C and Turbo C (where ANSI compatible). Library is a superset of both MS and Turbo C's libraries. Extensions include: Time-sliced scheduler for concurrent functions. Powerful text window management. Borland text windows supported. MS's graphics, plus: Bar chart & polygon plotting, standard formatted text IO to graphics windows. Interface to Borland's Graphics Interface (BGI). Mouse support. All BIOS and DOS calls supported. Common UNIX calls. 6 memory models plus user-definable memory models. Smart linker includes only functions and data used in the final program. Optional run-time checks include overflow, stack, array bounds, and pointer checks. Run-time and compilation errors automatically pinpointed in source code.

Common optimizing code generator. All compilers produce highly optimized code using the same code generator. 8086/286/386 specific code. Automatic optimal register allocation. Common Sub-expression Elimination. Expand any function as inline code. Pass parameters in registers (optional). Inline 80x87 code or emulation.

Automatic make. Fully automatic make with version control recompiles and rebuilds EXE, LIB and DLL files as necessary without the need of a make script. Make dependencies are described by project files, which simply list the objects to be included, as

well as the names of other dependent projects. One single make can result in multiple compilations using different compilers and/or assemblers, linking and building of libraries, DLLs and an EXE file.

Seamlessly integrated environment. Up to 10 active editor windows, each with a capacity of 1/2 MB source code. Compiler errors and warnings pinpointed in source code; automatic file-switch when stepping between errors or warnings. All menus and hot-keys redefinable. By default, editor commands compatible with Turbo and SideKick. Keyboard macros a la SuperKey. Cut and paste between editors, help system, and directly from screen memory. Multi-file search commands, programmer's calculator, built-in ASCII, key scancode, and color tables. HyperText help system with library reference.

DOS and OS/2 Professional Editions. Professional Editions include: Support for Microsoft Windows. DOS Dynamic Link Libraries. Full source code to libraries. Start-up assembler code. High-speed Assembler is fully integrated in the environment. Disassembler. Program execution profiler. Code locator for embedded systems programming. Watch utility for viewing any selection of DOS calls as they are executed. Programmer's interface to debugger. Post Mortem Debugger. And more. OS/2 Professional Edition has full support for Presentation Manager.

TopSpeed and TechKit are trademarks of Jensen & Partners International. Other brand and product names are trademarks or registered trademarks of their respective holders.

TOPSPEED C:

Standard Edition \$199
(DOS Compiler & VID)

DOS Prof Edition \$395

OS/2 Prof Edition \$495

Call on TopSpeed Modula-2 (with objects) compiler & toolkit prices.

TO ORDER:

In the U.S., call:

1-800-543-5202

In Canada, call:

1-800-543-8452

Call on shipping & handling charges & volume discounts. VISA/MC accepted.

30-day unconditional money-back guarantee.



Jensen &
Partners
International

1101 San Antonio Road, Suite 301
Mountain View, CA 94043
Phone: (415)967-3200
FAX: (415)967-3288

In England & Europe contact:

Jensen & Partners UK Ltd., 63 Clerkenwell Road, London EC1M 5NP.
Phone: (01)253-4333. FAX: (01)251-1442. C Standard Edition £149; C DOS Prof Edition £295; C OS/2 Prof Edition £370. Call on handling & VAT charges, and TopSpeed Modula-2 product prices.

Quarterdeck

DESQview 2.2 and DESQview 386. The multitasking, windowing environments that work with your favorite software.

DESQview™ is the operating environment that brings OS/2™ power to DOS. And it lets you, with your trusty 8088, 8086, 80286, or 80386 PC, leap into the next generation in PC productivity. For not much money. And without throwing away your favorite software.

Introducing DESQview 2.2

And now, DESQview 2.2 adds capabilities, performance, and compatibility enhancements you've been asking for:

Like being able to fine tune DESQview performance "on the fly." Run Lotus Express and Metro. And the Intel Connection Co Processor. Even use the DOS 4.0 shell with DESQview. Have DESQview automatically install Quattro, Sprint, Aldus PageMaker, Microsoft Excel, Word Perfect, Dataease and as many as 80 other programs. And using the DESQview API, be able to dynamically link them.

More bang; less bytes

While other programs get bigger, we've worked to make DESQview smaller. And we've succeeded in a big way on PCs and PS/2™s with extended, EMS 3.2 (AboveBoard), EEMS and EMS 4.0 memory—as well as on 386 PCs and



DESQview lets you run your favorite programs in windows side-by-side.

PS/2s. For example, DESQview overhead on EMS 4.0 and 386 PCs can be as low as 10K on EGA/VGA PCs. And DESQview actually *increases* memory 30K on CGA PCs; 20K on monochrome and Hercules PCs. That's good news for users of big desktop publishing, CAD and database programs.

Introducing DESQview 386

For users of 80386 PCs and PS/2s (or PCs with 80386 add-in boards, such as the Intel Inboard 386), there's DESQview 386 (a combination of DESQview 2.2 and the new QEMM-386

Quarterdeck Expanded Memory Manager, version 4.2).

DESQview 386 gives you extraordinary power. Run text, CGA, EGA, VGA, and Hercules programs in windows and in the

background. Run 32-bit 386 programs, like Paradox 386, and IBM Interleaf simultaneously with your favorite DOS programs. All with the speed and performance you expect out of your 386. And with protection against 'misbehaved' programs.

Promise and performance

And, of course, both DESQviews have all the features that made prior versions the popular choice in operating environments. The ability to multitask in 640K and beyond. View programs in windows or full screen. Transfer data. Access DOS via menus. Dial your phone. And create keystroke macros within and between programs.

Our story gets better and better

If there's any doubt about our commitment to your PC and PS/2 productivity, just look at our accomplishments over the years. We think you will understand why GE, Ford, Aetna, Monsanto, and so many other major corporations use DESQview.

And why PC Magazine twice gave DESQview its Editor's Choice Award for "The Best Alternative to OS/2," why readers of InfoWorld voted DESQview "Product of the Year" three times.

Why, by popular vote at Comdex Fall for two years in a row, DESQview was chosen "Best PC Environment" in PC Tech Journal's Systems Builder Contest, and just won their "Professional Solutions" Award.

DESQview lets you have it all now.



Quarterdeck Delivers.

QEMM. Break the 640K barrier for \$59.95

Your 80386 PC, IBM Personal System/2 Model 80, PC or AT with 80386 add-in board, as well as your IBM Personal System/2 Models 50 or 60 can all break through the DOS 640K barrier. Now you can have maximum use of your memory—whether you have one megabyte or 32—with the Quarterdeck Expanded Memory Manager. All without having to purchase special expanded memory boards.

QEMM uses hidden features within your existing memory to make it compatible with the Lotus-Intel-Microsoft Expanded Memory Specification (EMS) version 4.0.



Now you can run colossal spreadsheets, databases, and CAD models designed for expanded memory, using Lotus 1-2-3, Symphony Framework, Paradox, AutoCAD, Excel and more.

And if you'd like to use these programs all together—multitasking beyond 640K—QEMM works with our popular DESQview multitasking environment.

If you are one of the 12 million or so 8088, 8086 or 80286 PC users who feel left out, don't despair. We have options that let you keep your computer and favorite programs and give you today what the newest PCs and operating systems are promising for the future.

Visit your dealer for more information on barrier-breaking Quarterdeck products.

DESQview API Toolkit. New C and Pascal Libraries, Debugger. Panel Designer. And more.

API Reference Manual

The key to the power of the DESQview API, our Reference Manual contains all you need to know to write Assembly Language programs that take full advantage of DESQview's capabilities. And there's an 'include' file with symbols and macros to aid you in development.

API C Library

Here are C language interfaces for the entire set of API functions. It supports the Lattice™ C, Metaware™ C, Microsoft® C, and Turbo C compilers for all memory models. Included with the C Library package is the API Reference Manual and source code for the library.

API Pascal Library **NEW!**

The Pascal library provides interfaces for the entire set of API functions. It supports Turbo Pascal V4.0 and V5.0 compilers. Included are the API Reference Manual, source code for the library, and example programs.

API Debugger

The DESQview API Debugger is an interactive tool enabling the API programmer to trace and single step through API calls from several concurrently running DESQview-specific programs. Trace information is reported sym-

bolically along with the program counter, registers, and stack at the time of the call. Trace conditions can be specified so that only calls of interest are reported.

API Panel Designer

This interactive tool helps you design windows, menus, help screens, error messages, and forms. It includes an editor that lets you construct an image of your panel using simple commands to enter, edit, copy, and move text, as well as draw lines and boxes. You can then define the characteristics of the window that will contain the panel, such as its position, size, and title. Finally, you can specify the locations and types of fields in the panel.

The Panel Designer automatically generates all the DESQview API data streams necessary to display and take input from your panel. These data streams may be grouped into panel libraries and stored on disk or as part of your program.

More Tools are Coming

Quarterdeck is committed to adding tools as needed by our users. To that end we have been working with Ashton Tate and Buzzwords International on dBASE III and dBASE IV translators. And in the works, we have BASIC and DOS Extender libraries.

Quarterdeck

Quarterdeck Office Systems, 150 Pico Blvd., Santa Monica, CA 90405 (213) 392-9851
FAX: (213) 399-3802

For additional information, please use the following Reader Service numbers: DESQview: #230 QEMM: #231 API Tools: #232 API Conference: #233

MONTGOMERY GRANT

BYTE
10 89

**OUTSIDE USACALL
(718)692-0790**

Retail Outlet: Penn Station, Main Concourse
(Beneath Madison Square Garden) New York City, NY, 10001

Store Hours: Mon-Thurs, 8:30am-8pm/ Fri, 8:30am-4:30pm/ Sat, Closed / Sun, 9:30am-7pm
FOR ORDERS & INFORMATION CALL TOLL FREE

OR WRITE TO:
Montgomery-Grant Mail Order
Department, P.O. Box 58,
Brooklyn, N.Y., 11230

**For Customer Service
Call Mon-Fri: 9:30am-4:30pm
(718) 692-1148**

1-800-759-6565

**FAX NO. 7186923372
TELEX 422-132 MGRANT**

**ORDER HOURS: Mon-Thur 9am-7pm/Fri 9am-5:00pm/Saturday CLOSED/ Sunday, 9:30am-6:00pm
NO SURCHARGE FOR CREDIT CARD ORDERS / WE INVITE CORPORATE AND EDUCATIONAL CUSTOMERS
CORPORATE LEASING & PERSONAL FINANCING AVAILABLE / DISCOUNTS FOR QUANTITY ORDERS/TOLL FREE TECHNICAL SUPPORT**

**EPSON EQUITY 1+
IBM XT COMPATIBLE**

- 640K RAM w/Clock Calendar • 4.77-10 MHz • 360K Drive • Serial & Parallel Ports • MS DOS 3.3 • GW Basic

\$669

SAME w/SEAGATE 20MB HARD DRIVE.....\$919
SAME w/SEAGATE 30MB HARD DRIVE.....\$949
SAME w/SEAGATE 40MB HARD DRIVE.....\$1019
SAME w/TWO 360K FLOPPIES.....\$719
EPSON EQUITY 1c.....\$729

**EPSON EQUITY II+
IBM AT COMPATIBLE**

- 640K RAM • 80286 Microprocessor • 1.2MB Floppy Drive • Serial & Parallel Ports • MS DOS 3.3 • GW Basic

\$1059

SAME w/SEAGATE 20MB HARD DRIVE.....\$1299
SAME w/SEAGATE 30MB HARD DRIVE.....\$1339
SAME w/SEAGATE 40MB HARD DRIVE.....\$1399

EPSON EQUITY 386/20

- 80386 Microprocessor • 20MHz • 1MB RAM Expandable • 1016MB • 1.2MB Floppy Drive • MS DOS 3.3 • GW Basic

\$2599

WE CAN RECONFIGURE ANY OF OUR COMPUTER PACKAGES TO FIT YOUR SPECIFICATIONS. CALL FOR INFORMATION. ALL COMPUTER SYSTEMS SUPPORT MDA, CGA, EGA, VGA & MULTISCAN. WE CARRY MODEMS, DRIVES, CARDS, MONITORS, MEMORY UPGRADES & ALL OTHER ACCESSORIES FOR YOUR COMPUTER.

**LEADING EDGE MODEL D
IBM XT COMPATIBLE PKG.**

- 512K RAM Expandable to 768MB • 8088-2 Microprocessor • 360K Floppy Drive • 4.77-7.16 MHz • MS DOS 3.3 & GW Basic • 12" Monitor

\$599

SAME w/SEAGATE 20MB HARD DRIVE.....\$829
SAME w/SEAGATE 30MB HARD DRIVE.....\$869
SAME w/SEAGATE 40MB HARD DRIVE.....\$929

LEADING EDGE MODEL D2+ w/30MB.....\$1599

AST 286 IBM AT COMPATIBLE

- 80286 Processor • 512K Expandable to 4MB • 1.2MB Floppy Drive • Serial & Parallel Ports • Video Card

\$799

SAME w/SEAGATE 20MB HARD DRIVE.....\$1049
SAME w/SEAGATE 30MB HARD DRIVE.....\$1079
SAME w/SEAGATE 40MB HARD DRIVE.....\$1149
AST PREMIUM 386/16 MHz.....\$2199

AST 386/25 MHz.....\$3475
AST 386/33 MHz.....\$4199

LAPTOP COMPUTERS

AMSTRAD PPC-512 512K, 1 FLOPPY.....\$499	NEC ULTRALITE 2MB.....\$2399
AMSTRAD PPC-640, 640K, 2 DRIVES, MODEM.....\$699	NEC MULTISPEED HD.....\$1949
TOSHIBA 1000.....\$639	NEC PROSPEED 286 w/20MB.....\$3099
TOSHIBA 1000.....\$7179	NEC PROSPEED 386 w/40MB.....\$4499
TOSHIBA 3100e.....\$2399	ZENITH 184 w/2 FLOPPIES.....\$1499
TOSHIBA 1200H.....\$1849	ZENITH 184-2 w/20MB.....\$2199
TOSHIBA 1200HB.....\$1999	ZENITH 286 w/20MB.....\$2999
TOSHIBA 3200.....\$3299	SPARK EL.....\$899
TOSHIBA 5100.....\$4199	COMPAQ SLT 286-20.....\$3799
TOSHIBA 5100 w/100MB.....\$4799	COMPAQ SLT 286-40.....\$4199
TOSHIBA 5200.....\$4999	
TOSHIBA 5200 w/100MB.....\$5299	

**MODEMS, EXTERNAL DRIVES, & ACCESSORIES
AVAILABLE FOR ALL LAPTOPS.**

AMIGA 500 • 2000 • 2500 • COMPUTERS

Amiga 500 w/Built-in 5.25" Drive **\$549**

Amiga 500 w/1084 Monitor **\$819**

Amiga 2000 H.D. **\$1999**

Amiga 2000 w/Built-In 3.5" Drive **\$1449**

Amiga 2500 **\$3269**

Amiga 1084 RGB Monitor **\$289**

Amiga 1010 Disk Drive **\$179**

PRINTERS

STAR

NX-1000.....\$164.95
NX-1000 RAINBOW.....\$214.95
NX-2400.....\$284.95

CITIZEN

180 D.....\$149.95

DICONIX

150+.....\$329.95

OKIDATA

OKIMATE 20.....\$139.95
OKIDATA 180+.....\$219.95
OKIDATA 185.....\$249.95
OKIDATA 320.....\$329.95
OKIDATA 321.....\$459.95
OKIDATA 390.....\$454.95
OKIDATA 391.....\$629.95

EPSON

FX-1050.....\$429.95
FX-850.....\$334.95
LQ-510.....\$329.95
LQ-850.....\$519.95
LQ-950.....\$569.95
LQ-1050.....\$719.95
LQ-2550.....\$899.95
LX-810.....\$179.95

NEC

P-2200.....\$319.95
P-5200.....\$489.95
P-5300.....\$649.95

PANASONIC

KXP-1092L.....\$289.95
KXP-1524.....\$519.95
KXP-1595.....\$409.95
KXP-1124.....\$309.95
KXP-1180.....\$177.95
KXP-1191.....\$229.95
KXP-3131.....\$294.95

TOSHIBA

301.....\$329.95
311.....\$369.95

SANYO PR-3000A

DAISY WHEEL.....\$59.95
HP DESKJET.....\$599
HP DESKJET PLUS.....\$689
HP PAINTJET.....\$1029

LASER PRINTERS

HP LASERJET SERIES II

\$1629

1MB EXPANDER.....\$299
2MB EXPANDER FOR LASERJET IJ.....\$499
HP LASERJET IJ.....\$2799
PANASONIC KXP-4450.....\$1349
BROTHER HL-8E.....\$1859

MONITORS

MAGNAVOX EGA.....\$319
w/EGA Card.....\$449
MAGNAVOX VGA.....\$349
w/VGA Card.....\$519
ZENITH 1490.....\$329
NEC MULTISYNC IIA.....\$509
NEC MULTISYNC IIB.....\$619
PARADISE VIDEO CARDS.....IN STOCK!

**NEC POWERMATE 1
IBM AT COMPATIBLE**

- 80286 Microprocessor • 10 MHz • 640K RAM Expandable to 10.6MB • 1.2MB Floppy Drive • Serial & Parallel Ports • MS DOS 3.3 & GW Basic

\$999

SAME w/SEAGATE 20MB HARD DRIVE.....\$1249
SAME w/SEAGATE 30MB HARD DRIVE.....\$1279
SAME w/SEAGATE 40MB HARD DRIVE.....\$1349

**NEC POWERMATE 1+
IBM AT COMPATIBLE**

- 640K RAM Expandable to 16MB • Zero Wait State • 8-12 MHz • 1.2MB Floppy Drive • Serial & Parallel Ports • MS DOS 3.3 • GW Basic • 80286 Processor

\$1149

SAME w/SEAGATE 20MB HARD DRIVE.....\$1399
SAME w/SEAGATE 30MB HARD DRIVE.....\$1439
SAME w/SEAGATE 40MB HARD DRIVE.....\$1499

NEC POWERMATE 386 SX

- 80386 SX Microprocessor • 2MB RAM • 16 MHz • 1.2MB Floppy Drive • Windows 386 • Serial & Parallel Ports • MS DOS 3.3

\$1769

NEC POWERMATE 386SX w/NEC 42MB.....\$2299
NEC POWERMATE 386/20 w/42 MB.....\$3599

VENDEX HEADSTART III

- 8-12 MHz • 1MB RAM • 5.25" 1.2MB Floppy Drive • 3.5" 1.44MB Floppy • 30MB Hard Drive • VGA/EGA/CGA/MDA Included • Serial & Parallel Ports • Mouse • MS DOS 3.3

\$2299

\$1000 SOFTWARE INCLUDED

IBM XT

- 256K RAM Expandable to 640K • 360K Disk Drive

\$699

IBM XT w/TWO FLOPPIES.....\$799
IBM XT w/1 FLOPPY & SEAGATE 20MB H.D.....\$949

IBM PERSONAL SYSTEM 2

ALL MODELS IN STOCK.....CALL

5.25" 360K EXTERNAL DRIVE FOR IBM PS/II-30.....\$129
PACIFIC RIM 5.25" 1.2MB EXTERNAL DRIVE FOR IBM PS/II 50/60/70/80.....\$259

HYUNDAI MODEL 286E

- 640K RAM Expandable to 1MB • 80286 Microprocessor • 12 MHz • 1.2MB Floppy Drive • Serial & Parallel Ports • MS DOS 3.3 • GW Basic

\$899

SAME w/SEAGATE 20MB HARD DRIVE.....\$1149
SAME w/SEAGATE 30MB HARD DRIVE.....\$1179
SAME w/SEAGATE 40MB HARD DRIVE.....\$1249

EVEREX STEP 386 IS

- 386 SX Microprocessor • 16MHz • 1MB RAM • 1.2MB Floppy Drive

\$1799

EVEREX 386/20MHz w/1MB.....\$2999
EVEREX 386/20MHz w/4MB.....\$3899
EVEREX 386/25 MHz.....\$3499

APPLE IIGS COMPUTER PKG.

- Apple IIGS Computer • 512K Upgrade • RGB Color Monitor • 3.5" Disk Drive

\$1299

IMAGEWRITER II PRINTER.....\$439
ALL OTHER APPLE MODELS.....CALL

COMPAQ DESKPRO 286

- 640K Expandable to 2.1MB • 8-12MHz • 80286 Microprocessor • 1.2MB Floppy Drive • Serial/Parallel Ports

\$1629

SAME PKG. w/SEAGATE 20MB.....\$1879
SAME PKG. w/SEAGATE 30MB.....\$1919
SAME PKG. w/SEAGATE 40MB.....\$1979

COMPAQ 286e **\$1849**

DESKPRO 386S

- 80386 SX Microprocessor • 1MB RAM Expandable to 13MB • Serial/Parallel Ports • 16 MHz • 1.2 MB Floppy Drive

\$2399

COMPAQ 386/33 w/84MB **\$7499**

DESKPRO 386-20e

- 80386 SX Microprocessor • 1MB RAM Expandable to 16MB • Serial/Parallel Ports • 20 MHz • 1.2 MB Floppy Drive

\$3699

CUSTOM CONFIGURATIONS AVAILABLE FOR ALL COMPUTERS

RUSH SERVICE AVAILABLE. CALL FOR DETAILS.

Certified Check, Bank Check, Money Orders, Approved P.O.s, Visa, Mastercard, Am-Ex, Diner's Club, Carte Blanche, & C.O.D.s accepted. Please call before submitting P.O.s. No additional surcharge for Credit Card orders. Non-certified checks must wait 4-6 weeks for clearance. N.Y. residents add applicable sales tax. Prices and availability subject to change without notice. Not responsible for typographical errors. Return of defective merchandise must have prior return authorization number or returns will not be accepted. IBM XT AT are registered trademarks of International Business Machines Corp. Please add 5% shipping & handling. Volume orders over \$2000 are discounted to 3% shipping and handling. APO/FPO orders please add 10% shipping and handling. All APO/FPO orders are shipped first class priority air. All orders can be shipped Air Express. Call for details. DCA 8800233



THE ROOT TO HAPPINESS

Having installed Unix, you can assign privileges and get down to working with the printer

In the last issue, I discussed some of the pros and cons of running Unix on a personal computer. I also outlined a brief scenario of installing Unix co-resident with DOS, using SCO Xenix as a practical example. In this and the next few columns, I'll go over some specific commands and procedures that you might find useful when setting up your system. Since I assume you have access to Unix manuals, I won't go into specific details of all standard Unix commands.

Getting Started

Once you have installed the Unix or Xenix system, you will find that you are running your system as the system administrator, with full *superuser* (also known as *root*) privileges. At this level, you can do essentially anything you want on the system, from running backups to reading other people's mail.

The system administrator has great power. As with any power, a certain amount of responsibility is needed, if for no other reason than because careless use of root privileges can wipe out an entire system in seconds. So you should get into the habit of logging in as root only when necessary to perform superuser functions, and then logging off. (Most of the procedures in these early columns will require you to use root privileges.)

Needless to say, you should carefully protect the root password, because anybody who discovers it can have free access to your system. But you should not protect it so well that you yourself forget

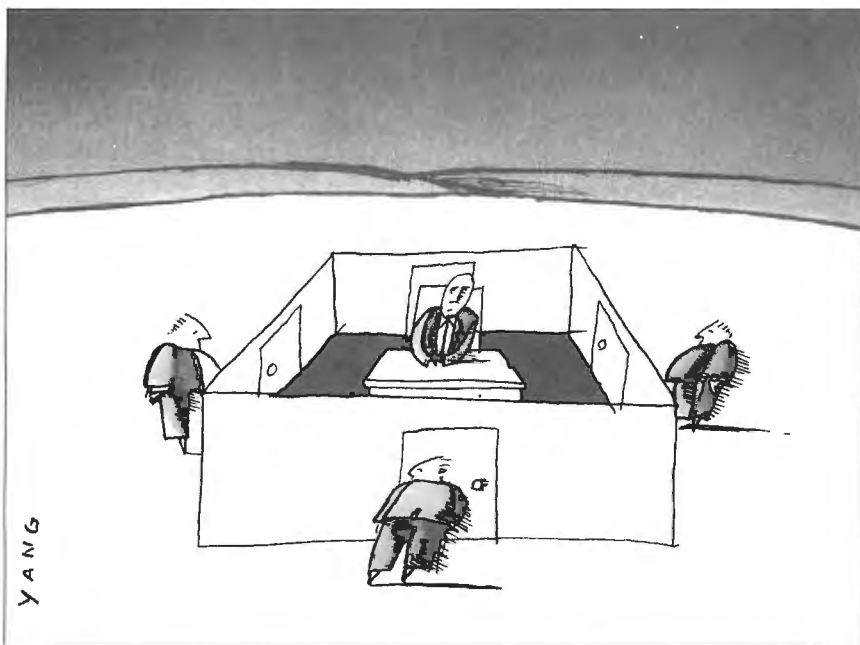

it. Write it down in a safe place.

Much of the worry about needing root privileges can be negated by using one of the system-administration utility packages provided on many systems. On SCO Xenix, for instance, there is a good package called *sysadmsh*, which is a full-screen menu-based utility. (The *sysadm* log-in uses this shell exclusively.) In the long run, it pays to learn the details of the administration commands without the menu. Such knowledge allows you not only to get the most out of your system, but also to be able to use it on other versions of Unix, should you need to. While most versions of Unix are administered in the same general way, the menu systems are guaranteed to be entirely different. The selections in administration menus on different systems may have very different results than those you expect.

Adding Users

If the entire system is used only by you, there's no law that says you can't log in as

root all the time, since that's essentially what you're always doing on a single-user system like DOS or the Mac. This method does make administration easier. Otherwise, the first thing you will probably want to do is give yourself log-in permission. But adding new users is a superuser function; you must be root.

The process of manually adding a user to the system is not really hard, but even experienced Unix system administrators prefer to use an automated process since there are many options and, therefore, many things to forget. Done by hand, you would have to add an entry to the */etc/passwd* file containing the new user's log-in name, user ID number, group ID number, home directory, and log-in shell. If the user ID or log-in name matches anyone else's on the system, there will be problems, so these must be checked. The */etc/group* file should be updated with the new user's real name. An initial password must be selected, and a home

continued

TPU for UNIX and DOS.

Introducing nu/TPU from a/Soft.

nu/TPU gives you one hundred powerful TPU subroutines for faster and easier UNIX and DOS applications development. EVE, EDT, and VI interfaces are all included plus multiple windows, its own programming language, and unlimited extensions. You can import your customized VAX TPU programs to your UNIX or DOS system without change. nu/TPU comes with one year of free hotline support, 30 day money-back guarantee, free TPU library exchange, our technical bulletin board for news, interface code samples, and our TPU open forum. Call us for more technical details.

(508) 683-4369



a/Soft Development, Inc.
1353 Salem Street
North Andover, MA 01845

nu/TPU is a trademark of a/Soft Development. VAX is a trademark of Digital Equipment Corporation. UNIX is a trademark of AT&T. MS-DOS is a trademark of Microsoft.

directory and mail file created and set to appropriate access permissions. Finally, a copy of your system's standard user .profile or .cshrc file should be placed in the new user's home directory and suitably modified, if necessary, for that user's terminal type. It's better to use the program to be sure all this is done. Many systems have a program called mkuser, newuser, or adduser, or a selection in the administration menu for this task.

The Joys of Printing

A Unix system with a dedicated printer is a joy to work with. You simply plug in the cable and copy a file to /dev/lp, and you're on your way. (On some systems the printer port may be called /dev/lp0, on others, /dev/lp1.) Want to do background printing? Just make your copy in background with a command like this:

```
cp filename /dev/lp &
```

(The & specifies that this is a background task.) Nothing could be easier. And although Unix has a wonderful line-printer spooling system, it can be annoying to set up and run, so I recommend that you leave well enough alone for starters (on small, single-user systems, at least). Once you start adding other users and processes that have to access your single printer, you can learn to run the spooler. Meanwhile, at least you'll have hard-copy output. Systems like SCO Xenix, with its mkdev lp script, greatly simplify spooler setup.

Serial printers are trickier, since the serial ports on a Unix system are usually set up for terminal log-ins, not printers. The trick here is knowing the default baud rate of a serial line, which in many cases is 9600 bps. Therefore, the first steps to take are: Set the printer to 9600 bps and disable the log-in on its port.

With SCO Xenix, to disable the log-in, you can simply type `disable tty2a`. Regular Unix is a bit more complicated; you have to edit the `/etc/inittab` file. A typical entry might contain the line

```
2a:2:respawn:/etc/getty
tty2a 9600
```

and you want to change the word `respawn` (which means that a log-in process will be continually generated for that line) to `off`. The final step is to run the command `init q`, which forces the `inittab` to be reread, activating your new entry (and deactivating the port for log-ins).

Try directing a copy of a text file to the serial port (using `cat /etc/passwd > /dev/tty2a`), and see what happens. A

printout of the password file means you got it on the first try. Garbled nonsense output, even a single character, is a good sign because it means that some data is getting to the printer but the baud rate on the printer doesn't match the port.

No output could mean that you are ad-

A Unix
system with a dedicated
printer is a joy
to work with.

ressing the wrong port or that the transmit and receive pins (pins 2 and 3 on a regular 25-pin RS-232C connector) are switched. The best method of diagnosing this is with a through connector with LEDs that show data flow. If your computer is an AT compatible, you might try the port under DOS to make sure that the hardware, at least, is physically working.

Baud Rate Blues

If your printer won't work when set to 9600 bps, you may have to force the printer port to 9600 bps or whatever your printer will accept. You have to create a small shell driver program that accepts a filename or standard input. While the program is active, it changes the port's baud setting; that is just what you want:

```
stty 4800 ixon -ixany ixoff \
-parity -echo clocal \
opost -tabs </dev/tty2a \
2>/dev/null
cat -
```

Everything after the baud rate is part of the set of options to the `stty` command. The three `ix` options ensure that the standard XON/XOFF protocol will be followed (your printer should be set up to match), `-parity` turns off parity encoding, and the other options tend to work well on printers. You must redirect the `stty` command from the device; this forces the settings to be in effect for that device, rather than for your current terminal port. Use this driver program by piping standard input to it, and then redirecting the output to your printer port:

```
cat /etc/group | drive_prog > \
/dev/tty2a
```

THE UNIX /bin

Creeping Featurism

You can make the whole thing a bit neater by wrapping all this in a one-line shell program. If your printer is an Epson, call the program `epson`:

```
cat $* | drive_prog > /dev/tty2a
```

Now simply typing `epson filename` will print that file on your Epson printer. You can make things fancier by adding the `pr` command to the `epson` program to format the output into pages, create another command with the `pr` command built in, or use `getopt` to add capabilities to `epson`. This is how you begin customizing your system. (It's also the beginning of creeping featurism.)

Final Note

For regular users—not just root—to execute the programs `drive_prog` and `epson`, both must be marked as readable and executable, and placed in the default search path of the standard shell. As a regular user, if you type the one-line command `echo $PATH`, you will see a list of directories that the shell searches for executable files (minimally, the list generally contains `/bin` and `/usr/bin`). If you find the programs useful, type the following lines as superuser and then log out and back in as yourself to make them part of your system's repertoire:

```
chmod u=rwx,g=rx,o=rx \
drive_prog epson
cp drive_prog epson /usr/bin
```

The first line lets regular users use (but not modify) the two files. The `chmod` command must operate on three sets of permission bits, so its syntax can get complex. You could also write the same command as `chmod 755 filenames`; this does the same thing but operates directly in octal notation. The second line simply copies your programs to the system `/usr/bin` directory. To be safe, do an `ls /usr/bin` before typing the `cp` command, to make sure there are no programs of the same name already there.

In the next issue, I'll discuss modifying the search path so it will be in effect automatically for all system users. ■

David Fiedler is editor and publisher of the Unix newsletters Unique and Root and coauthor of the book Unix System Administration. He can be reached on BIX as "fiedler."

Your questions and comments are welcome. Write to: Editor, BYTE, One Phoenix Mill Lane, Peterborough, NH 03458.

DISC DRIVE REPAIR SPECIAL

Formatted Cap.	Fiat Rate	SPECIAL	SHIPPING YOUR DRIVE FOR REPAIR
10-19 mb	\$99	89.10	Pack your drive carefully and fully protected in a sturdy shipping box. Include your name, address and daytime telephone number. Allow \$9 for shipping per drive.
20-29 mb	\$125	112.50	
30-39 mb	\$150	135.00	
40-49 mb	\$175	157.50	
50-85 mb	\$210	189.00	
86-120 mb	\$275	247.50	
121-150 mb	\$325	292.50	
151-275 mb	\$425	382.50	
276-380 mb	\$495	445.50	
TEST & EVALUATION \$25			WE DO DATA RECOVERY CALL FOR QUOTE FLOPPY 5 1/4" REPAIR \$45 VALID THROUGH 11/30/89

DISC DRIVES LIQUIDATION**XT/AT FLOPPY DRIVES**

3 1/2"....720k.....NEW...\$105	5 MB.....REF.....\$75
3 1/2"....1.44mb...NEW...115	10 MB.....UNU.....105
5 1/4"....360k.....REF.....49	20 MB.....REF.....159
5 1/4"....720k.....REF.....59	30 MB.....REF.....239
5 1/4"....1.2mb....REF.....89	42 MB.....UNU.....295
	72 MB.....REF.....595
	120 MB....NEW.....1295

KITS FOR IBM AT & COMPATIBLES

84 MB.....ST506.....\$695	
147 MB.....ESDI.....1395	
230 MB.....ESDI.....1695	20 MB \$225 85 MB \$995
320 MB.....ESDI.....1995	42 MB 295 147 MB 1495

SCSI HARD DRIVES**THOUSANDS OF DISC DRIVES IN STOCK**

We Feature Technical Support for Everything We Sell
We Specialize in Disc Drives — Ask for Our Brochure

jb TECHNOLOGIES, INC.

21011 Itasca St., #F Chatsworth, CA 91311

TEL 818 • 709 • 6400

FAX 818 • 314 • 2935

TELEX 678953

UTAH

COBOL™

VERSION 5.0

\$69.95

Plus \$4.00 Shipping



For IBM® PC's, XT's, AT's and other DOS machines. Needs only 1 disk drive and 128K memory. This is the one you've heard so much about - with fast compile times, small object code modules, not copy protected, no royalties, and clear error messages. Version 5.0 is based upon ANSI-74 standards with new dynamite features including:

- Nested IF's and nested conditions.
- Indexed files (ISAM) with up to 24 keys (includes START verb). This advanced feature requires the software package Btrieve® which is optionally available.
- ACCEPT (line, column) numerics with decimal point alignment, numeric

checking, AUTO-SKIP, SECURITY, LENGTH-CHECK, EMPTY-CHECK, ATTRIBUTE (color), FROM ESCAPE KEY, DAY, DATE, TIME, DAY-OF-WEEK.

- Fast memory mapped DISPLAY's (line, column) ERASE, BEEP, ATTRIBUTE (color). Can display entire screen with one DISPLAY statement.
- Windowing, pop-ups, color and overlays. This advanced feature requires the software package Saywhat?™ which is optionally available.
- An easy to use, COBOL source code EDITOR with auto line numbering, A-margin, B-margin tabing with full screen cursor control.

Also available: Utah SuperSort®, a fast sort program callable from Utah COBOL; Utah FORTRAN; Utah BASIC; Utah PASCAL; Utah PILOT. Used by 50,000 professionals, students and teachers in 40 countries. 30-day money back guarantee. Discover the ease and simplicity of COBOL, today!

Phone order rushed
by UPS 2nd Day Air:
(702) 827-3030



Since 1977

Ellis Computing, Inc.
5655 Riggins Court, Suite 10
Reno, Nevada 89502

IBM is a registered trademark of International Business Machines, Inc. Btrieve is a registered trademark of Novell, Inc. Saywhat? is a trademark of The Research Group. SuperSort is a registered trademark of Micropro International Corporation. Utah COBOL is a trademark of Ellis Computing, Inc. © 1987 Ellis Computing, Inc.



You could buy a new

DELL^{SYSTEM} **210** with

512K of RAM

20 Mbyte Hard Drive

12.5 MHz Processor Speed

\$1699⁰⁰

OR Northgate'sTM New 212





MicrostationTM with...

How can Northgate afford to offer a 286/12 with 32MB hard drive and one full megabyte of RAM when Dell's newest Series 210 system, for the same money doesn't match up?

Maybe it's the high cost of color advertising. We use two colors and pass the savings on to our customers. Would you rather get more computer for the money...or be entertained with color pictures?

Here's a fresh idea... Make Northgate and Dell's money-back guarantee program meaningful: Order from both companies.

30 days later send back the loser. Or keep life simple and place your order with Northgate. Odds are it's the one you'll keep anyway.



"We hear you!" Northgate Computer Systems, Inc.
13705 First Avenue North
Plymouth, Minnesota 55441

Phone Northgate for full details and pricing

800-548-1993

Canada Toll Free Order Hotline: 800-338-8383



FINANCING: Use the Northgate "Big N" revolving credit card instead of tying up Visa or MC credit. Millions in financing available, easy to qualify. OR...Lease Northgate with up to five-year terms. Ideal when cash flow is important. Phone for details.

Northgate, 212 Microstation, and OMNIKEY/102 are registered trademarks of Northgate Computer Systems, Inc. © 1989.

© 1989. Northgate, OMNIKEY/102, OmniKey PLUS, and the Northgate 'N' logo are trademarks of Northgate Computer Systems, Inc. All other product and brand names are trademarks and registered trademarks of their respective companies.

Prices and specifications are subject to change without notice. Northgate reserves the right to substitute components of equal or greater quality or performance. All items subject to availability.

Northgate offers flexible purchase plans including a lease program to fit your individual financing needs.

P.S. Ask about OmniKey PLUS, the new Northgate Keyboard designed the way you want!

1 Full Megabyte RAM
100% GREATER!

32 Mbyte Hard Drive
50% LARGER!

12 MHz Processor Speed

\$1699⁰⁰

BUYER'S SCORE SHEET.

Read the Specs. Check the Leader.

Total the winning checks and make your decision.

Standard Features	DELL	✓	NORTHGATE	✓
Processor	12.5 MHz 80286		12 MHz 80286	
Memory	512K		One Megabyte	
Video Interface	16 Bit Built-In (Factory Fixable) Only		16 Bit Add-on (On-Site Fixable)	
Display	12" VGA Mono .31 DP		12" VGA Mono .31 DP	
Floppy Drive	One - 1.2 or 1.44		None - 1.2 or 1.44	
Std. Hard Drive Capacity	20 Mbyte		32 Mbyte RLL	
Hard Drive Type	IDE Built-In		Can use - RLL, MFM, IDE, ESDI	
I/O Capabilities	2 Ser., 1 PP		2 Ser., 1 PP	
Keyboard	"Mushy Touch" 101		Famous OmniKey/102	
Software	Diagnostic		On-Line Help, MS-DOS	
Space Saver Case	15"W, 15"L, 4"H		14.5"W, 16.5"L, 5.5"H	
Moneyback Period	30 Days		30 Days	
Warranty	1 Yr. Parts & Labor		1 Yr. Parts & Labor	
Phone Tech Support	Unlimited, Toll Free		Unlimited, Toll Free	
Hours Open - Sales	Standard Daytime, Eve		24 Hrs. All Day Every Day - Effective 9/1/89	
Hours Open - Tech	Standard Daytime, Eve		24 Hrs. All Day Every Day - Effective 9/1/89	
Total	\$1,699		\$1,699	
SCORE	DELL		NORTHGATE	

And the winner is...

Call NOW!



Hot
386/20 MHz
System

Scorching
386/20 MHz
Price

\$2599⁰⁰

COMPLETE SYSTEM: 20MHz Processor; 65MB Hard Drive; 800,000 KBS Data Transfer; 1MB RAM (Expandable to 16MB); 1.2 and 1.44 high density floppy drives; 14" Monitor; Herc. Compat. Card; MS-DOS 4.01; Full Size Desktop Case with 5 drive bays; OmniKey Keyboard; 1-Year parts/labor warranty; Replacement parts express overnight at our expense or At-Your-Office next day onsite service, one year at no extra cost. **THE BEST PHONE TECH SUPPORT IN THE COMPUTER BUSINESS.** Toll free, unlimited.

NOTE: Pipeline Page Mode system architecture is preferred in many applications to cache design. It is faster than all but the largest cache systems in certain applications requiring substantial memory calls.

**Buyers Beware! Northgate charges credit card sales only when system is in the shipping process. Others use your money by charging cards at time of sale. We recommend you be aware of this when considering your vendor.

**When you want to know
all about a computer
system ... Ask
Dr. Jerry Pournelle.***

Put a machine in Pournelle's workshop. He'll soon tell you everything you want to know about it with no punches pulled.

Recently, Dr. Pournelle looked at Northgate's 80386 Pipeline Page Mode system and reported in **BYTE** July, 1989 (excerpted):

*Jerry Pournelle holds a doctorate in psychology and is a writer who also earns a comfortable living writing about computers present and future.



“... the case is sturdy, and the motherboard construction is clean and neat. The boards are thick; I’ve seen some clones with boards so thin they wave in the breeze.”

“... I like this machine a lot.”

“... The workmanship is superior.”

“... there sure wasn’t any installation required for this system. I just turned it on, and it came up in MS-DOS 4.01.”

[a software program] ... “which is all graphics is almost twice as fast on the Northgate 80386 as on my other machines. So is Windows ...”

“... I rate the Northgate 80386 as better than good enough on CPU and disk speed and wow! on video speed.”

“... I have reports from other people who have Northgate computers, and they’re happy.”

“... All in all, the Northgate 80386 looks like one of the best deals in town.”

Sudden Service: We Ship All Orders for 386/20 Systems within 4 days!**



“We hear you!”

800-548-1993

NORTHGATE COMPUTER SYSTEMS, INC.

13705 First Avenue North, Plymouth, Minnesota 55441

Canada Toll Free Order Hotline: 800-338-8383



HOURS: Monday - Friday 7 a.m. - 8 p.m. Central
NEW EXTENDED SAT. HOURS: 8 a.m. - 4 p.m. Central

FINANCING: Use the Northgate “Big N” revolving credit card instead of tying up Visa or MC credit. Millions in financing available, easy to qualify. OR...Lease Northgate with up to five-year terms. Ideal when cash flow is important. Phone for details.

©1989, Northgate, OMNIKEY/102, OmniKey PLUS, and the Northgate 'N' logo are trademarks of Northgate Computer Systems, Inc. All other product and brand names are trademarks and registered trademarks of their respective companies.

Announcing...

NEW...

Northgate OmniKey/PLUS™

The keyboard you asked us to design!

Thousands of you asked us to make a keyboard designed the way you want, not what IBM and all their keyboard clones force on you.

Now . . . discover OmniKey/PLUS!

As are all our keyboards, Northgate's engineers designed this gem from the ground up. It's not a PacRim economy job anyone can buy. IT'S EXCLUSIVELY NORTHGATE.

One look, one touch tells you this is the best in keyboard design, in quality, in all its many features so you can type faster, confident all the keys are where you want them.

Now! Two separate keypads. Cursor arrows in logical, comfortable array—gone is the ill-conceived "inverted T." And the backslash key is placed "just right." See detail panels.

Will you prefer OmniKey/PLUS enough to discard your current keyboard? Take ten days to make up your mind. If not, return for full product cost refund.

Quantities may be limited so call or send your order today.



F KEYS ON THE LEFT...

12 easy to reach, programmable F Keys where they belong and where your fingers expect to find them instinctively.

CONVENIENCE CLUSTER ...

Large Backspace Key, hard to miss; L shaped Enter Key; Backslash next to Shift; Unshifted Asterisk Key—a wonderful addition.

LOOK! Just a few new

■ Alps Click/Tactile Key Switches

■ Dip Switch compatible with nearly any IBM PC type system—PS/2, Zenith, Compaq, Dell, Tandy, AT&T

■ OmniKey/PLUS weighs 5.5 lbs., made to stay put on your desk

■ Cable plugs into back of keyboard

■ Low Profile Elegant Styling!

Introductory Limited Time Price

\$119⁰⁰
PATENTS PENDING

For Dealer and Distributor Program Pricing, Phone Keyboard Dept. at 612-553-0734.



CURSOR/SCREEN KEYPAD ...
 With arrows in familiar diamond pattern. No need to hit Num Lock or hold down Shift Key, and we "nuked" the inverted T.

NUMERIC KEYPAD ...
 With all the math operands in place around the numbers. Large INS, DEL and ENTER Keys. Has lighted indicators above pad.

Features of OmniKey/PLUS.

Compatible with virtually every IBM type computer in the world!

Ten-day trial return for unquestioned full refund

Three-year unconditional warranty, any cause, we will repair or replace.

New OmniKey/102 Model Also Available . . . \$99.00

For those who prefer Northgate's OmniKey/102, an up-dated version now joins our line. Same trial offer, same 3-year warranty.



Phone Toll Free

800-526-2446

HOURS: Mon.-Fri 7am-8pm, Sat. 8am-4pm Central
 Canada Toll Free Order Hotline: 800-338-8383



"We hear you!"

Northgate Computer Systems, Inc.
 13705 First Avenue North
 Plymouth, Minnesota 55441

©1989. Northgate, OMNIKEY/102, OmniKey PLUS, and the Northgate 'N' logo are trademarks of Northgate Computer Systems, Inc. All other product and brand names are trademarks and registered trademarks of their respective companies.



Yes. Ship my OmniKey order(s). I understand I may use it for 10 days and if I wish, may return it for full product cost refund. I agree to pay for freight both ways.

Northgate will accept COD and purchase orders from credit-worthy buyers for quantities totalling \$500.00 or greater. Dealer and distributors: for quantity prices phone our corporate headquarters 612-553-0734.

FAX orders to 612-553-1695.

SHIPPING: Allow 5 days for order processing before shipment. Thereafter, shipments can be:

- UPS Ground add \$7.00 ea.; allow 2-3 weeks for delivery.
- Overnight Air add \$25.00 ea.
- Second Day Air add \$12.00 ea.

Northgate Computer Systems, Inc.
 13705 First Avenue North, Plymouth, Minnesota 55441

Name _____
 Company _____
 Ship to (address) _____
 City _____ State _____ Zip _____
 Phone _____
 Computer Brand & Type _____

Qty.	Item	Shipping	Total
	OmniKey/PLUS*	\$119.00	
	OmniKey 102	\$ 99.00	
	C/T 101	\$ 99.00	
TOTAL OR ORDER*		\$	

*You must specify which cable you require—for additional cables add \$25.00 ea

Compatibility Notes: Please read before placing your order. OmniKey/PLUS is made compatible through a combination of dip switch settings and the proper connecting cable. We must know the computer make and model you will be using with OmniKey/PLUS. Otherwise we cannot guarantee compatibility.

Brand _____ Model (AT/XT) _____

Prepaid amount enclosed \$ _____

Please charge to my: Visa MasterCard

Card No. _____ Expires _____

Signature of Cardholder _____

(My signature authorizes a charge to my account for the above merchandise prior to shipping to initiate processing of my order.)

Here's How Buyers Who Demand the World's Highest Performance and Quality... Order from Northgate™

DIAL 800-548-1993

Canada 800-338-8383

You'll be connected to a Northgate Account Manager. In an instant, you'll know you're dealing with a professional. A highly trained individual who understands computers and more importantly, understands people like you.

You'll immediately feel confident. Your questions will receive intelligent, careful consideration. And you'll get the truth, not the baloney.

If you're strictly shopping for the lowest price without considering quality and performance, don't call. But if you want the most computer for your investment...a system that runs rings around the others...with the most meaningful warranty in the computer industry...*

CALL NORTHGATE TODAY!

Join the ranks of
Fortune 500 corporations...
colleges and universities...
individuals...government
agencies around the world.



HOURS: Monday through Friday 7 a.m. - 8 p.m. Central
NEW EXTENDED SATURDAY HOURS: 8 a.m. - 4 p.m. Central



**NORTHGATE™
COMPUTER
SYSTEMS**

NORTHGATE COMPUTER SYSTEMS, INC.
13705 First Avenue North, Plymouth, Minnesota 55441

"We hear you!"

*If anything in your Northgate system goes down and disables your computer, Northgate guarantees to ship the proper replacement part OVERNIGHT AT OUR FREIGHT EXPENSE. You get a brand new part—be it the largest and most expensive hard drive to the smallest part—and it's shipped to you BEFORE YOU RETURN THE OFFENDING PART. Check our competition. In most cases, they must get the part back before you get a replacement. Often that's weeks. And you sit there, out of business until they get the old part repaired or replaced.

Northgate's phone tech crew is here to back you up. Unlimited phone help is available for as long as you own your Northgate. And for one year, you're protected with Northgate's Overnight Parts Replacement Warranty. If a system needs to come back for service, all parts and labor are FREE unless damage is caused by the end user.

Call Northgate™ Today!

Now Northgate Gives You Credit and No Payments Until 1990*

(Payments begin 90 days from the date your Northgate Computer System is delivered to you.)

Payments as low as \$40/month**



WHY TIE UP YOUR OTHER CREDIT CARDS?

Use the Northgate, "Big N" credit card, and avoid the "payment crunch."

Simply fill out the "Big N" application, and send it in. Prompt approval assured!

Once you're approved, simply call our TOLL FREE number and one of our expert system consultants can help you design the Northgate System which will best suit your needs, and it will be shipped to you right away.

Best of all, there will be no payments due on your Northgate System for a full 90 days starting from the day you take delivery!

Northgate also offers flexible long term leasing plans too. You can choose the plan that will best fit your needs, with terms up to 5 years.

Phone Northgate Now!...

800-548-1993

HOURS: Monday - Friday 7 a.m. - 8 p.m. Central
NEW EXTENDED SAT. HOURS: 8 a.m. - 4 p.m. Central
Canada Toll Free Order Hotline: 800-338-8383



NORTHGATE COMPUTER SYSTEMS, INC.
13705 First Avenue North, Plymouth, Minnesota 55441

BIG 'N' REQUEST FOR CREDIT

NOTICE TO WISCONSIN APPLICANTS

You must disclose your marital status
 married
 unmarried
 legally separated

A married person may apply for individual credit. I am applying for (please check appropriate box):
 JOINT CREDIT with another person. Complete entire application.
 INDIVIDUAL CREDIT but rely on income or assets of another person as a basis for repaying the credit requested. Complete entire application.
 INDIVIDUAL CREDIT. Complete sections "a" and "b" only.

Please complete all appropriate sections, providing at least two year's residence and employment history. This will enable your application to be processed as quickly as possible. If you are self-employed, please be sure to complete section "d" on back.

Applicants must be 18 years of age or older.

a. Your Personal Information							Requested Line of Credit \$ _____	
Your Name: First Initial Last			Date of Birth: Mo. Day Yr.		Social Security Number: _____			
Present Address: Street Apt. #		City State Zip		Home Phone: () _____				
Date of Residence: Month Year		Monthly Payment: \$ _____		Buy <input type="checkbox"/> Rent <input type="checkbox"/> Other <input type="checkbox"/>				
Previous Address: _____		Dates of Residence: From _____ To _____						
Your Employer: (If self-employed, see rear panel.)		Date of Employment: Mo. Yr.		Position: _____		Monthly Income: Gross \$ _____ Net \$ _____		
Employer's Address: Street Apt. #		City State Zip		Business Phone: () _____				
Previous Employer: _____		Address: _____		Dates of Employment: From _____ To _____				
Income from alimony, child support or separate maintenance payments need not be disclosed if you do not wish to have it considered as a basis for repaying this obligation		Other Income: _____		I have received since: (Date) _____		Monthly Income: Gross \$ _____ Net \$ _____		
Name and Address of Nearest Relative Not Living With You: _____							Relationship _____	

b. Credit Information		Include joint applicant's information, if joint account requested.	
Bank Account: _____		Bank Name _____ Address _____	
Bank Account: _____			
Bank Loan Reference: _____		Payment _____ Balance _____	
Bank Card Reference: <input type="checkbox"/> VISA <input type="checkbox"/> Mastercard			
Other Credit Card Reference: _____			
Other Credit References: _____		Account No. _____ Expires: _____	
Driver's License No. _____		State: _____ Expires: _____	

c. Joint Applicant's Personal Information							*If you are a married Wisconsin applicant, you must provide your spouse's information below, even though your spouse may not be signing this contract.	
Joint Applicant's Name: First Initial Last			Date of Birth: Mo. Day Yr.		Social Security Number: _____			
Address: Street Apt. #		City State Zip		Date of Residence: Mo. Yr.		Home Phone: () _____		
Employer: _____		Date of Employment: Mo. Yr.		Position: _____		Monthly Income: Gross \$ _____ Net \$ _____		
Employer's Address: Street Apt. #		City State Zip		Business Phone: () _____				

d. Self-Employed Information				Complete this section only if you are self employed			
Business Name: _____		Proprietorship <input type="checkbox"/> Corporation <input type="checkbox"/> Partnership <input type="checkbox"/>		Business Address: _____		Business Telephone: () _____	
Description of Business: _____		Your Position: _____		In Business Since: _____			
Your annual income from business: _____		Business' annual income: (gross) _____ (net) _____					
You must provide at least one of the following:							
1. Business Name: _____		Telephone: () _____		Personal Banker's Name: _____			
2. Accountant's Name: _____		Telephone: () _____					
3. Financial statement on business attached.							

BY1089

Complete this application and mail to Northgate today!

*Interest will accrue during deferred period. 1.5% per month. 18% APR.
 **Based on purchase price of \$1,299.00 on the "Big N" revolving charge. Process subject to change without notice. Offer not valid for APO or FPO customers.

© 1989, Northgate, OMNIKEY/102, OmniKey PLUS, and the Northgate 'N' logo are trademarks of Northgate Computer Systems, Inc. All other product and brand names are trademarks and registered trademarks of their respective companies.

Compuclassics

IF YOU DON'T SEE
YOUR PRODUCT
LISTED PLEASE CALL
US!

ABOVE SOFTWARE	
Above Disk	52.00
ACCOLADE	
Test Drive II	26.00
ADOBE	
Illustrator/Windows	409.00
ALDUS	
Pagemaker	479.00
ALPHA	
Alpha/4	319.00
AMERICAN SMALL BUSINESS	
Design Cad	159.00
Design Cad 3D	209.00
APPLAUSE	
Perfect Addition	39.00
APPLICATION TECHNIQUES	
Pizazz Plus	69.00
ASHTON-TATE	
DBase IV	485.00
Framework III	455.00
DBase III Plus	455.00
DBase IV LAN	649.00
Multimate Advantage II	295.00
ASK SAM	
Ask Sam 4.2	179.00
AUTODESK	
Autosketch 2.0	95.00
BANNER BLUE	
Org Plus	52.00
BITSTREAM	
Bitstream Fonts	Call
BLOC PUBLISHING	
FormFiler 2.0	85.00
BLAISE	
Turbo C Tools	92.00
Turbo Power Tools Plus	92.00
BORLAND	
Turbo C	99.00
Turbo Pascal	99.00
Turbo C Pro	169.00
Turbo Pascal Pro	169.00
Quattro	165.00
Sidekick Plus	135.00
Sprint	135.00
Paradox	479.00
BOURBAKI	
1 Dir Plus	49.00
BRIDGEWAY	
Fast Trax	35.00
BRIGHTBILL-ROBERTS	
Hyperpad	65.00
BRODERBUND	
Print Shop	39.00
Memory Mate	45.00
BUMBLEBEE	
DB Fast/DOS Plus	145.00
BUTTONWARE	
PC File DB	69.00
CALIFORNIA SCIENTIFIC	
Brainmaker	79.00
CENTRAL POINT	
PC Tools Deluxe	79.00
Copy II PC	24.00
CHRONOS	
Who-What-When	115.00
CLARION	
Professional Developer	409.00
COREL SYSTEMS	
Corel Draw 1.1	345.00
COMPUTER ASSOCIATES	
Supercalc V	305.00
Superproject Expert	449.00
CONCENTRIC DATA	
R & R Report Writer	109.00
CORE	
Corefast	69.00
CROSTALK	
Crosstalk Mark 4	145.00
Remote 2	115.00
DAC	
Lucid 3D	60.00
DAC Easy Bonus Pack	115.00
DAC Easy Accounting	59.00
DATEASE	
Datease 4.0	499.00
DATAFORM	
Procomm Plus	55.00
DELFINA	
Perform	172.00
DELTA TECHNOLOGY	
Direct Access	55.00
DIGITAL RESEARCH	
Gem Artline	285.00
Gem Presentation Team	285.00
DIGITALK	
Smalltalk V286	139.00
DYNAMIC MICROPROCESSOR	
PC Anywhere III	72.00
ELECTRONIC ARTS	
Backup Pro	62.00
Twist and Shout	65.00
FIFTH GENERATION	
Fastback Plus	109.00
FORMWORX	
Formworx w/Fill & File	89.00
FOX	
Foxbase Plus/LAN	295.00

FUNK	
Sideways	42.00
Allways (1-2-3 or symphony)	85.00
GAZELLE	
ODOS II	39.00
GENERIC	
Generic CADD Level 3	169.00
GIBSON	
Spinrite	49.00
GOLDEN BOW	
V Cache	45.00
HAVENTREE	
Interactive Easy Flow	109.00
HELIX	
Headroom	79.00
IBM	
DOS 4.01	125.00
Displaywrite IV	269.00
INDIVIDUAL	
101 Macros For WordPerfect	45.00
INSET	
Inset Plus	125.00
INSIGHT DEVELOPMENT	
Laser Control	85.00
Print-A-Plot	105.00
INTUIT	
Quicken	40.00
LASERGO	
Go Script	139.00
Go Script Plus	269.00
LEARNING COMPANY	
Reader Rabbit	25.00
LOTUS	
Agenda	275.00
1-2-3 v 3.0	CALL
MATHSOFT	
Mathcad	305.00
MECA	
Managing Your Money	119.00
MERIDIAN	
Carbon Copy Plus	109.00
MICROGRAFX	
Windows Graph Plus	329.00
Designer	449.00
MICROLOGIC	
Tornado	52.00
MICROLYTICS	
Gofor	45.00
MICROPROSE	
F19 Stealth Fighter	45.00
MICROTRIM	
RBase For DOS	489.00
MINDSCAPE	
Balance of Power 1990	29.00
MULTISOFT	
PC Kwik power pack	72.00
Super PC Kwik	49.00
MICROSOFT	
Quickbasic	67.00
Quick C	67.00
Windows 286	67.00
Windows 386	135.00
Quickpascal	57.00
Macro Assembler	99.00
C Compiler	299.00
Word	209.00
Flight Simulator	35.00
MICROTEK	
Spectrum	49.00
NANTUCKET	
Clipper	439.00
NEW ENGLAND	
Graph-In-The-Box	75.00
NOLO	
Willmaker	35.00
NORTH EDGE	
Timeslips III	169.00
NOVELL	
Advanced Net 2.15	1850.00
ELS 4 - user	419.00
OWL	
Guide	169.00
PAPERBACK	
VP Planner Plus	129.00
PATTON & PATTON	
Flowcharting II Plus	139.00
PAUL MACE	
Mace Utilities Gold	85.00
PEACHTREE	
Compte Acting W/Data Query	235.00
PERSOFT	
Ize	259.00
Smarterm 240	205.00
PERSONICS	
Ultravision	79.00
See More 1-2-3	49.00
PETER NORTON	
Norton Utilities	59.00
Norton Commander	52.00
Norton Utilities Advanced	85.00
POLARIS	
Packrat	259.00
PRECISION SOFTWARE	
Superbase 4	409.00
PRIME SOLUTIONS	
Disk Technician Advanced	115.00
PRIMETIME	
Prmetime	65.00
PROXIMITY TECHNOLOGY	
Choice Words	59.00

PUBTECH	
File Organizer	145.00
QUAID	
Copywrite	59.00
QUALITAS	
386 To The Max	55.00
386 To The Max Pro	95.00
QUARTERDECK	
Desqview	79.00
QEMM 386	37.00
REFERENCE	
Grammatik III	52.00
RIGHTSOFT	
Rightwriter	52.00
RIX	
Colorix VGA Paint	105.00
ROYKORE	
Opus One	265.00
SAMNA	
AMI Professional	319.00
SANTA CRUZ OPERATIONS	
SCO Operating System 386	469.00
SCITOR	
Project Scheduler 4	429.00
SIERRA ON-LINE	
Leisure Suit Larry #2	32.00
Kings Quest IV	32.00
Space Quest III	39.00
SIMON & SCHUSTER	
Typing Tutor IV	29.00
Webster Prof Thesaurus	75.00
SOFTCLONE	
Mirror III	55.00
SOFTLOGIC	
Disk Optimizer	45.00
SOFTWARE DIRECTIONS	
Print Q	85.00
SOFTWARE MASTERS	
Flash	49.00
SOFTWARE PUBLISHING	
Harvard Graphics	279.00
PFS 1st Publisher	79.00
PFS 1st Choice	99.00
PFS 1st Graphics	89.00
Professional Write	139.00
SOLUTION SYSTEMS	
Brief	165.00
SPECTRUM HOLOBYTE	
Tetris	24.00
Falcon-AT	32.00
STSC	
Statgraphics	569.00
STORAGE DIMENSIONS	
Speedstor	35.00
SUBLOGIC	
Jet	32.00
Scenery Disks	CALL
SYMANTEC	
Q & A	219.00
Timeline	369.00
Grandview	189.00
SYMOSOFT	
Hotshot Graphics	149.00
SYSTEMS COMPATIBILITY	
Perfect Exchange	50.00
Software Bridge	85.00
THREE D GRAPHICS	
Perspective Jr.	99.00
TIMWORKS	
Publish It!	115.00
TRAVELING SOFTWARE	
Laplank III	85.00
Viewlink	85.00
TURBO POWER	
Turbo BTree Filer	79.00
Turbo Professional	79.00
UNISON WORLD	
Printmaster Plus	35.00
VERSASOFT	
DB Man V	219.00
WHITE CRANE	
Brooklyn Bridge	75.00
WOLFRAM RESEARCH	
Mathematica 386	599.00
WORDPERFECT	
Word Perfect	239.00
Word Perfect Library	65.00
Word Perfect Network	349.00
WORDSTAR	

Wordstar Professional 5.5	239.00
WORDTECH	
Quicksilver Diamond	349.00
DBXL Diamond 1.3	145.00
XEROX	
Xerox Formbase	319.00
Ventura Publisher	499.00
Xerox Presents	309.00
XTREE	
Xtree Pro	75.00
XOR	
NFL Challenge	59.00
ZSOFT	
Publishers Paintbrush	159.00
PC Paintbrush IV	59.00

HARDWARE

AST RESEARCH	
5251/11 Enhanced Plus	599.00
Six Pack Plus 64k	129.00
ATI	
VGA Wonder 256	335.00
BELKIN/DATASPEC	
Cables/Switchboxes	CALL
CENTRAL POINT	
Copy II Option Deluxe	119.00
CURTIS	
Ruby Plus	65.00
EVEREX	
Internal 2400 Modem	149.00
Computers	CALL
FIFTH GENERATION	
Logical Connection 512k	579.00
HAYES	
Smartmodem 2400	449.00
HEWLETT PACKARD	
Font Cartridges/Soft Fonts	CALL
INTEL	
Above Board Plus 512k	449.00
Coprocessors	CALL
KENSINGTON	
Masterpiece Plus	109.00
LOGITECH	
Scanman PC	199.00
New Logimouse 89.00	
MICROSOFT	
Bus or Serial mouse w/paint	109.00
MICROSPEED	
Fast Trap Serial	95.00
MOUSE SYSTEMS	
Bus or Serial mouse II	89.00
NEC HOME	
Multisync 3D	699.00
ORCHID	
Pro Designer VGA Plus	409.00
PANASONIC	
KXP 1124 Printer	365.00
PARADISE	
VGA Plus	265.00
POLAROID	
EGA Palette	2399.00
PLUS	
Handcard 40	699.00
PRACTICAL PERIPHERALS	
2400 External Modem	179.00
SEAGATE	
Hard Disks	CALL
SUMMAGRAPHICS	
Summasketch Plus 12 x 12	399.00
SYSGEN	
Bridge File w/adaptor	289.00
TOUCHBASE	
Worldport 2400 Modem	255.00
Worldport 2496 Fax Modem	499.00
VIDEO 7	
Vram VGA 256k	459.00

We ship to
APO & FPO
PO
Boxes

WE
WELCOME
CORPORATE
ACCOUNTS AND
INTERNATIONAL
ORDERS

FAX YOUR
ORDER!
(818)347-9977

► IMMEDIATE SHIPMENT ON PURCHASE
ORDERS FROM GOVERNMENT AND STATE AGENCIES,
CITIES, COUNTIES, SCHOOL AND UNIVERSITIES.

► Prices subject to change without notice and while stocks last. ► We Ship the latest versions. ► We accept Visa, MasterCard, American Express. ► 2% Surcharge on American Express. ► Please call (818) 347-9400 for an Authorization # for defective goods or your return will not be accepted. ► Due to copyright laws we cannot take back any software where the seal has been broken. ► \$5 minimum shipping per item, less on bulk orders. ► \$9 Blue Label shipping, \$3.50 C.O.D charge. ► Heavier items are charged accordingly. ► We do not guarantee compatibility. ► Call for prices for any software item not included in this ad. ► Order desk open 7 a.m. to 5 p.m. (PST), Saturday 10 a.m. - 2 p.m. (PST). ► P.O. Box 10598, Canoga Park, CA 91309. Showroom: 7959 Deering Ave., Canoga Park, CA 91304 ► Customer Service 818 347 9400, General Office 347 7500

ORDERS CALL 800 733 3888



A COMPENDIUM OF OS/2 APPLICATIONS

A new OS/2 application guide lists hundreds of programs

This month, I come to you from Milan, Italy. I'm here to teach a seminar on OS/2. I don't speak Italian, however, so the whole class is wired up like at the United Nations. After I speak, the participants dial a language to listen to, whether Italian or French or whatever. I've thought of taking my shoe off and banging it on the table to make a point, but I'm not sure the joke would be in good taste.

Last month, I talked to OS/2 applications developers. But where are the OS/2 applications? They are finally starting to appear. I recently received my copy of IBM and Microsoft's new edition of the *OS/2 Application Guide*. (You can get a free copy by calling (800) 426-2468, ext. 120.) The guide shows about 800 applications, roughly half of which are currently (as of June) shipping.

What does this tell us about OS/2 applications? Well, they're out there—and in places that you wouldn't expect. They include many industry-specific applications (more of those, in fact, than anything else), one being a \$14,000 program that assists in designing microwave antennas. But OS/2 applications don't have to be expensive—one is under \$18.

What Do They Do?

OS/2 applications are a pretty diverse lot.

There's a bunch of accounting programs—general ledger, accounts payable and receivable, inventory, payroll, order entry, and job costing. Accounting packages are not inexpensive—from \$600 for the cheapest I could find (that's about 800,000 lira here in Milan) ranging up to a \$2500 package that helps you track bad checks.



The business category yielded a few surprises. Recently, a researcher in Great Britain wrote to me looking for a large mass-storage device that works under OS/2. I'm an Iomega Bernoulli Box fan from way back, but unfortunately Iomega hasn't released the OS/2 drivers for the Bernoulli Box yet. (The company actually has the drivers finished; I understand there are some legal niceties to get out of the way before the drivers see the light of day.) So I had to tell the researcher to wait a little longer.

Advanced Graphic Applications has a better solution: Discuss, a WORM (write once, read many times) controller board and drivers for OS/2. It's not cheap at \$3600—and you have to add the WORM drive itself to the package—but the nearly limitless storage it provides could make it worthwhile for someone with truly large mass-storage needs.

Everyone knows about the weakness of the OS/2 print spooler, but I had no idea that someone had done something

about the problem. Software Directions offers a "mainframe-style disk-based print spooler" (does that mean it requires lots of memory, needs a professional staff to maintain it, and you have to wait overnight for it to do anything?). It's called PrintQ and costs \$199. It supports serial printers, too.

Asynchronous Renaissance

Asynchronous communications was once an important branch of PC software, and discussions of whether to go with PC-Talk, Crosstalk, or Smartcom were common at users group meetings. The market has pretty much settled down, with several packages each holding onto its share. But OS/2 was really made for communications. One of the best parts of using OS/2 is downloading BIX traffic in the background with Logicom while working in the foreground on BRIEF. of these that I have mentioned Logicom before, although it's not in IBM's guide.

continued

ITEMS DISCUSSED

BBS \$80
 MichTron, Inc.
 576 South Telegraph Rd.
 Pontiac, MI 48053
 (313) 334-5700
Inquiry 981.

Discus \$3600
 Advanced Graphic Applications, Inc.
 90 Fifth Ave., Sixth Floor
 New York, NY 10011
 (212) 337-4200
Inquiry 982.

HyperAccess/5 \$199
 Hilgraeve, Inc.
 Genesis Center, Suite A
 111 Conant Ave.
 Monroe, MI 48161
 (313) 243-0576
Inquiry 983.

MsgVu \$35
 Dave Briccetti and Associates
 P.O. Box 1713
 Lafayette, CA 94549
 (415) 945-7565
Inquiry 984.

PrintQ \$199
 Software Directions, Inc.
 1572 Sussex Tpk.
 Randolph, NJ 07869
 (201) 584-8466
Inquiry 985.

Prolog \$650
 Arity Corp.
 29 Domino Dr.
 Concord, MA 01742
 (508) 371-1234
Inquiry 986.

There is a new group of asynchronous programs, as the old masters haven't made an appearance yet.

For simple terminal emulation, file transfer, and general-purpose communications, there are ChipChat (\$300), Hilgraeve's HyperAccess/5 (\$199), and Professional YAM (\$139). The only one of these that I have had a chance to try is HyperAccess. Matt Gray, president of

Hilgraeve, is very convincing when he pitches the product. "We've been using OS/2 ideas like threads for years. We've implemented multitasking in our DOS version of HyperAccess, so porting to OS/2 was quite easy."

Gray says that in communications you spend a lot of time waiting. The Hilgraeve people implemented a block-oriented file transfer protocol that employs

that waiting time to compress and decompress files on the fly. And it's pretty impressive. I consistently got 4000-bps throughput when using 2400-bps modems, even with the DOS version. As is the case with many companies, Hilgraeve ships both the DOS and OS/2 versions in a single package. This is a good idea in my opinion, at least for the time

continued

Simulators for Motorola Micros

The 2500 A.D. Software Simulators enable programs to be tested on the development system in a controlled environment. We offer simulators for the 6800, 6801, 6805, 6809 and 68c11, as well as for the Hitachi 6301 and Rockwell 6502. All simulators support the following features:

- Full screen symbolic debugging
- Break on address with pass count
- Full single stepping control
- Instruction undo capability
- File, printer and serial port output
- Expression evaluation capability
- Ram, Rom and Stack limit checking
- Break on register or memory value
- Subroutine step or execute control
- Interrupt simulation capability
- File and keyboard input
- Disassembly to screen or file

The Simulators are priced at \$150.00 for MSDOS and Xenix, \$500.00 for Ultrix. Also available are Macro Assemblers for the above parts, and C Compilers for the 6801, 6301, 6809 and 68c11.

To order call Toll Free:

1 800 843-8144

In Colorado: 1 719 395-8683
 Fax: 1 719 395-8206
 Telex: 752659/AD

2500ADSOFTWAREINC.

109 Brookdale Avenue
 P.O. Box 480
 Buena Vista, CO 81211



- CDW Sales
- CDW Services/Support
- CDW Product Knowledge
- CDW On Time Delivery
- CDW Frequent Buyers Program

WHY PAY RETAIL?

CDW™ Sells For Less

AND SERVICES YOU BETTER



CDW™ LETS YOU BRING THE FAMOUS EMERSON EC800 BUSINESS MACHINE HOME

Comes Ready to Use with a 30 Meg Hard Drive Loaded with the Following Software: Menu Magic, Home Accountant, Sidekick/Turbo Basic, Window Word, Silk, EuroGroup Pub, Arrays, Borland Intl., and Fontex

CDW™ price **\$849.53**
Your Choice of Color or Mono Monitor.
ADD:\$199.00 for Color, \$84.10 for Mono

NOVELL

- Entry-Level 286 Starter Kit, 4 Users\$429.99
- Entry-Level 286 Starter Kit, 8 Users899.89
- NOVELL 286 Software V. 2.151839.65
- NOVELL SFT Netware V. 2.152986.60
- NOVELL NETPRO1120.50



- S-330, 4.77/10 MHz, 640K, 6 Slots, Built-In CGA, DOS 3.3, Enhanced Keyboard S-330, 1 Floppy\$745.50
- S-330, 20 Meg/40 Meg994.95/1019.52
- S-550 AT Compatible, 8/12 MHz, 8 Slots, 256K/1 CGA, Built-In EGA, DOS 3.3, S-550, 1.2M Floppy\$1056.45
- S-550, 20 Meg/40 Meg 1425.80/1499.45
- S-800, 386 20 MHz, 8 Slots, 1 Mge, 1.2 & 720K Floppies\$2093.69
- S-800, 40 Meg/80 Meg 2498.01/2760.00

SAMSUNG



HARDWARE, SOFTWARE & PERIPHERALS AT DISCOUNT PRICES

COMPUTERS

- CALL SPECIALS**
- MDL 80AST CDW™ MDL 390CIN STOCK
 - MDL 140FOR ALL MDL 3150C& READY
 - MDL 300CAST MDL 386 25TO SHIP
 - MDL 340CPRICING MDL 386 33CALL
- WORKSTATIONS**
- AST 105XALL AST
 - AST 386SX Model 5 / Model 45WORKSTATIONS
 - AST BravoIN STOCK
 - SAMSUNG PC TERMINAL/286\$1054.60
 - EARTHSTATION V40 or 286, Arcnet or EthernetCALL

PACKARD BELL

- PB1000, 12 MHz\$1219.70
- PB800, 12 MHz\$1198.86
- PB1000, 40 Meg\$1641.61
- PB800, 16 MHz\$1368.70

IBM PS2

- MDL 30, 20 Meg \$1655.17
- MDL 55SX, 30 Meg \$2999.59
- MDL 60, 40 Meg \$340.15
- MDL 55SX, 60 Meg \$178.39
- MDL 60, 70 Meg \$644.52
- MDL 70, 60 Meg \$347.20
- MDL 30286, 1 Dr., 1412, 10
- MDL 70, 121 Meg \$259.84
- MDL 30286, 20 M \$199.50
- MDL 40, 40 Meg \$474.40
- MDL 50Z, 30 Meg \$2876.75
- MDL 80, 70 Meg \$569.37

COMPAG

- 286, MDL 1\$1548.35
- 386, 25MHz, M1000 \$895.99
- 286E, MDL 11899.50
- 386, 20E, 40 Meg \$565.12
- 286E, MDL 202172.45
- 386, 20E, 40 Meg \$564.22
- 386E, MDL 402453.41
- PORT. II, MDL 21858.10
- 386, 20 MHz, 130 \$718.33
- PORT. II, MDL 42697.42
- 386, 25 MHz 603683.90
- PORT. III, MDL 20 \$495.85
- 386S, MDL 12324.49
- PORT. III, MDL 40 \$999.35
- 386S, MDL 202783.12
- PORT. 386, MDL 40 \$426.24
- 386S, MDL 403092.84
- PORT. 386 MDL 100 \$689.74

TOSHIBA

- T-1000\$657.95
- T1600\$3237.60
- T1200, 2 Drive1455.74
- T51004238.78
- T1200, 20 Meg1932.80
- T5100, 40 Meg4943.87
- T3100E2688.76
- T5200, 100 Meg\$375.50
- T32003393.25
- CALL FOR ACCESSORIES

WYSE

- MDL 2108\$895.50
- MDL 2214\$1921.30
- MDL 21121271.20
- MDL 32162060.37

MINISPORT

- Supersport 88, 2 Dr/20 MegCALL CDW™
- Supersport 286, 20/40 MegFOR LOWEST
- Turboport 386, 40 MegZENITH
- Turboport 386, 40 Meg / w/modemPRICING

DRIVES, TAPES & CARDS

FLOPPIES, DRIVES & TAPES

- CONNER 40 Meg / 110 Meg\$445.29 / 995.80
- GENOA 60 Meg Int. Tape / Ext. Tape689.60 / 819.10
- GENOA 150 Meg Int. Tape1076.85
- OMEGA 20-20 External 8"1898.92
- OMEGA B1441998.65
- OMEGA B144X1299.10
- OMEGA B244X1990.25
- OMEGA B1200992.80
- OMEGA B22001619.40
- IRWIN 20 M / 40 M Internal Tape399.10 / \$539.20
- MOUNTAIN 4440 Int. / Ext.385.80 / 557.75
- MOUNTAIN 150M Filestar1398.99
- PLUS Passport 20 / 40479.10 / \$79.88
- PLUS 20 & 40 System Kit489.75
- PLUS PS/2, MC System Kit585.58
- PRIMA 40 Meg / 60 Meg669.55 / 749.95
- SYSGEN 5.25 Ext. Floppy225.25
- WELTEC 5.25 External Floppy207.77

MINISCRIBE

- MIN-8425\$239.40
- MIN-3085\$729.40
- MIN-8438299.85
- MIN-6085\$59.52
- MIN-3053599.95

SEAGATE

- SEAGATE 20 Meg \$265.58
- SEAGATE ST-251-0 \$299.56
- SEAGATE 30 Meg \$279.32
- SEAGATE ST-251-1 \$325.23
- SEAGATE 4096 80559.95

STORAGE DIMENSION

- 150 Meg\$1899.80
- 320 Meg Internal\$2317.88
- 320 Meg Subsystem 2995.72
- 520 Meg Internal5852.97

HARD DRIVE CARDS

- PLUS DEVELOPMENT 20 Meg\$527.44
- PLUS DEVELOPMENT 40 Meg677.80
- WESTERN DIGITAL 30 Meg399.37

PRINTERS

- EPSON**
- LX810CALL
 - L0510ALL EPSON
 - LB950CDW™
 - L0950MODELS
 - FX850FOR BEST
 - LC1050READY
 - FX1050PRICE EVER
 - TO SHIP
 - CDW™ stocks all cut sheet feeders and ribbons.
- NEC**
- P2200\$344.65
 - P5300\$695.63
 - P5200509.12
 - P650XL1039.24
- DICOMINIX by KODAK**
- 150P/300\$309.17 / 475.17
- TOSHIBA**
- 321SL\$486.95
 - Expresswriter 311\$377.16
 - 341SL392.84
 - Expresswriter 301328.84
 - 351SX949.95
 - CALL FOR ACCESSORIES
- brother**
- M-1724L\$579.64
 - M-1709\$384.47
 - HR20340.60
 - HR40629.12
- OKIDATA**
- ML 182 Turbo\$234.48
 - ML 321\$479.28
 - ML 172199.95
 - ML 390475.96
 - ML 380NEW
 - ML 391639.48
 - LASEPLINE 61292.69
 - ML 393995.90
 - ML320329.68
 - ML 393 Color1067.80
- Panasonic**
- 1124\$339.18
 - 1592\$142.44
 - 1595453.45
 - 3131318.30
 - 1180193.95
 - 1524562.10
 - 1191232.12
 - CALL FOR ACCESSORIES

LASER PRINTERS

- BROTHER HL-8E\$1799.90
- H-P LaserJet Model 2 / IID1699.95 / 2744.95
- H-P Deskjet599.00
- NEC LC8903095.60
- PACIFIC DATA 25 in 1 Cartridge263.86
- TOSHIBA Page Laser 122479.58

INTEL BOARDS & COPROCESSORS

- INTEL Above Board Plus\$410.88
- INTEL Inboard 386 PC\$693.93
- INTEL Visual Edge448.39
- INTEL Connect Co-processor712.43

MATH COPROCESSORS

- INTEL 8087-2\$149.90
- INTEL 8087-3\$112.20
- INTEL 80287-6137.30
- INTEL 80287-8208.55
- INTEL 80287-10223.55
- INTEL 80387-16389.60
- INTEL 80387-20380.65
- INTEL 80387-25\$411.92
- INTEL 80387-SX362.82
- INTEL 80387-33\$75.20
- INTEL 80C86A395.50

TERMINALS

- WYSE 50/60 Amber or Green\$373.40 / \$300.16
- WYSE 85 / 30 Amber375.90 / 294.10
- WYSE 99GT394.82

PLOTTERS, DIGITIZERS & SCANNERS

- CalComp**
- 1023\$3745.38
 - 12 x 12\$358.12
 - 1043\$477.15
 - 12 x 18719.10
 - 10449915.06
 - 36 x 483236.15
- HURTA**
- 1212IS1\$349.06
 - 4 Bufton\$2891.53
 - 12 x 17499.35
 - 4 Bufton Cursor75.00
- LOGITECH**
- Scanman PC\$168.89
 - Scanman PS/2\$225.50
- Summagraphics**
- 12 x 12\$367.40
 - 12 x 18\$599.50
- HEWLETT PACKARD**
- HP7740A\$968.30
 - HP7475A1389.89
 - HP77502925.58
 - HP7570 LOWEST PRICE
 - HP7576-EXLCALL
 - HP SCANJET +1049.66
- HOUSTON INSTRUMENT**
- HI DMP-52 / DMP-52MP\$395.50
 - HI DMP-56A\$215.00
 - HI DMP-61\$215.00
 - HI DMP-62\$215.00
 - Image Maker

NOVELL NETWORKING

- SOFTWARE STARTER KITS**
- Entry-Level 286 Starter Kit, 4 Users\$429.99
 - Entry-Level 286 Starter Kit, 8 Users899.89
 - NOVELL 286 Software V. 2.151839.65
 - NOVELL SFT Netware V. 2.152986.60
 - NOVELL NETPRO1120.50
- INTERFACE CARDS**
- 3COM ETHERLINK\$375.45
 - ARCNET PC110 LANboard PS/2412.50
 - ARCNET PC130 LANboard162.27
 - ARCNET PC130E LANboard169.50
 - ARCNET SMC 16-Bit File Server Board437.55
 - ARCNET SMC 16-Bit Workstation Board359.25
 - ETHERNET Interface Connector (NE1000)298.90
 - ETHERNET Plus Board (for 286) (NP600)635.35
 - G-NET Interface Card w/Cable298.52
 - NOVELL NE2000394.15
 - THOMAS CONRAD 16 Port Hub814.25
 - THOMAS CONRAD 8 Port Hub378.65
 - Ethernet Terminators39.50
- Novell trained and authorized sales and support.
See WORKSTATIONS under Computers.

MODEMS & COMMUNICATIONS

- EVEREX 1200B / 2400C\$97.90 / 184.15
 - EVEREX 2400 Ext. / 2400 PS/2199.80 / 205.45
 - THOMAS CONRAD 16 Port Hub814.25
 - THOMAS CONRAD 8 Port Hub378.65
 - Ethernet Terminators39.50
- HAYES**
- HAYES 1200\$278.60
 - 2400B\$378.45
 - 1200B108.45
 - 2400PS2387.15
 - 2400416.08
 - Personal Modem109.70

Robotics

- Courier 1200\$278.60
- 1200 External\$129.10
- Courier 2400279.60
- 2400B199.70
- 1200B120.05
- 9600 HST645.20
- Dual 9600 HST978.65

MHZ MEGAHERTZ CORPORATION

- 2400 for ZENITH\$167.10
- 1200 for COMPAQ SLT\$259.80
- 2400 for NEC225.68
- 2400 for TOSHIBA183.74

BATTERY BACKUP & SURGE

- AMERICAN**
- AME-1200VX\$911.45
 - AME-520ES\$409.48
 - AME-330XT257.72
 - AME-800RT699.19
 - AME-450AT395.82
- DataShield**
- 500 Watt\$555.05
 - SS700\$787.90
 - 800 Watt628.56
 - 1200 Watt962.75
 - S10059.55
 - 6 Outlet Surge27.85

BPS-300

- BPS-300\$330.10
- BPS-550\$499.85
- BPS-500465.11
- BPS-1200710.65

MISC. & ACCESSORIES

- A-B Switching Box (Parallel or Serial)\$39.95
- BASF 5 Pack of 10 DS/DD w/Case39.00
- INTELLICOM Long Link129.70
- KENSINGTON Masterpiece99.99
- KENSINGTON Masterpiece Plus123.40
- KEYTRONICS 5151 IBM or AT/XT133.95
- KEYTRONICS 10194.95
- 5TH GEN. Logical Connector 256K/512K447.72 / \$143.36
- Electronic 4-Way Switchbox94.85
- XT Power Supply 150 Watt59.00

FAX MACHINES AND BOARDS

- Complete Fax 9000\$399.50
- SHARP FAX P-220\$854.48
- Quadram JIFax 9000\$275.65
- SHARP FAX P-3301192.10
- Quadram JIFax Pro329.25
- SHARP FAX P-5001036.37

SOFTWARE

- WORDPERFECT 5.0 5.25" / 3.5"\$229.90 / 238.90
- ASHTON TATE dBase III+ / dBase IV424.00 / 476.10
- ASHTON TATE Multimate Advantage II288.12
- LOTUS 1-2-3 5.25" / 3.5"299.95 / 305.95
- LOTUS 1-2-3 V.3LOTUS Networker337.00
- 1592.20
- BORLAND Paradox 3.0439.17
- BORLAND Quattro / Sidekick +149.52 / 131.25
- MICROSOFT Excel / Windows 386252.50 / 129.05
- MERIDIAN Carbon Copy119.37
- SYMANTEC O&A217.40
- SOFTWARE PUB. Harvard Graphics274.71
- XEROX Ventura Software Version 2.0479.00

MONO MONITORS & CARDS

- CDW™ Color / Mono Cards w/P\$99.00 / 89.00
- HERCULES™ Color / Mono Cards w/P146.14 / 178.84
- AT&T Monochrome Monitor189.40
- AMEK 410A / 1280149.99 / 673.78
- COMPAQ Mono / VGA Mono177.00 / 209.95
- IBM PS/2 8503209.95
- SAMSUNG Amber84.10
- NEC Monograph1297.25
- FGS MAX 12E / MAX 15139.40 / 258.20
- PACKARD BELL Green or Amber89.95

COLOR GRAPHIC MONITORS

- IBM PS/2 8512\$449.40
- IBM PS/2 8513\$40.20
- SAMSUNG Hi-Color199.00
- MAGNAVOX 8762259.05

VGA & EGA PRODUCTS

VGA & EGA MONITORS

- COMPAQ VGA Monitor\$548.68
- MAGNAVOX 943EGA / 9CM02er365.40 / 372.52
- MITSUBISHI 1409 / 1410282.44 / 385.50
- MITSUBISHI 1391 Diamond Scan\$19.20
- NEC Multisync 14132090.40
- NEC Multisync XL 19-Inch2090.40
- NEC Multisync 2A / Multisync 3D499.85 / 695.85
- PACKARD BELL 8541 VGA319.20
- PACKARD BELL 8524 Enhanced VGA389.95
- PACKARD BELL 8526 Multisync477.40
- FGS Ultrasync 14116
- PGS Ultrasync 14519.66
- 887.77
- SONY Multiscan 1302 / 1303619.95 / 548.52
- ZENITH Z-1490620.80

VGA DISPLAY CARDS

- ATI VGA Wonder 256\$262.98
- ATI VGA VIP232.24
- GENOA S200 / S300305.55 / 273.20
- RENAISSANCE RVGA II / RVGA I239.89 / 192.05
- PARADISE VGA / VGA + 16220.68 / 288.33
- VIDEO 7 VGA257.15
- VIDEO 7 Fast Write / VRAM VGA312.15 / 434.25

EGA DISPLAY CARDS

- GENOA Super EGA Hi-Res 800 x 600\$243.40
- NEC MVA 1024950.50
- PARADISE Auto Switch EGA 480188.88
- VIDEO 7 Mega Deluxe219.74

CAD MONITORS & CARDS

- MITSUBISHI 690S 19-Inch\$3230.90
- MITSUBISHI 390S/60K1835.62
- MITSUBISHI 390S/80K1798.80
- SIGMA Laserview1687.18
- VERMONT Cobra2777.75
- METHEUS 11041039.00

MICE

- LOGITECH C9 Serial / PS/2\$89.95
- LOGITECH BUS94.99
- MICROSOFT Mouse (Bus Version)109.34
- MICROSOFT Mouse (Serial Version)117.25
- MICROSOFT Mouse w/Windows138.37
- MOUSE SYSTEMS (Serial Version)98.55
- MOUSE SYSTEMS (Bus Version)109.77

MOST ORDERS RECEIVED BY 5:00 P.M. C.D.T. SHIP SAME DAY. **PC Magazine says... "You may find a better deal here than anywhere else."**

WHY WAIT? CALL COMPUTER DISCOUNT WAREHOUSE™ NOW!

Open terms available to approved credit

(800) 233-4426

In Illinois FAX (312) 498-1426 (312) 291-1737
NEW AREA CODE 708 - EFFECTIVE 1/1/90

Credit card charges are not submitted until time of shipment.



BT89

Circle 61 on Reader Service Card

CDW™ EXTENDED HOURS
Sales 7:30-7:30 CDT Mon-Fri.
9:00-3:30 CDT Sat.
Tech Support 9:00-5:00 CDT Mon-Fri.



Credit Card charges are not submitted until time of shipment. Shipping and handling additional. (All card orders return under \$200.00 please add \$5.00 handling fee. Non-deliverable

when the market is undergoing the transition to OS/2.

Another example of how multitasking and communications go hand in hand is with BBSes. For years, BBS operators have looked for ways to run their BBSes (which are usually not very memory-intensive operations) in the background while they're doing other things in the foreground. Just such a thing is possible with MichTron's BBS software. It, of course, supports multiple serial ports, as any OS/2 communications application would by definition. At \$80, MichTron's product is already shipping and looks worth a try.

The final item in this category will appeal to members of electronic conferences, like BYTE's own BIX. When you start using BIX, you join a conference or conferences. For example, beekeepers might join the beekeepers conference (I don't know if there is such a conference, but there could be—there are many conferences), or writers might join the writers conference. Some conferences are quiet, like *ibm.at*, which generates about 20 messages a month tops. Writers, on the other hand, can generate 20 messages

an hour. Most of it is just chatter, but occasionally a nugget appears, like a useful phone number, book reference, or snippet of code.

When traffic is heavy, it would be nice to be able to save and categorize messages. Such a facility is offered by *MsgVu*. I tried an early version on BIX and truthfully didn't like it very much, but then I'm pretty crotchety about software. Once I find something I like, I tend to stay with it. *Logicomm* and *Mirror* serve me well in OS/2 and DOS, respectively. These programs *don't* keep track of messages, however—they just handle basic communications. *MsgVu* costs just \$35, making it almost as inexpensive as *Logicomm*.

Accounting for the Databases

Databases weigh in at 82 products. 82 products? Well, the number is a mite padded. Every accounting package on the market thinks it's a database. Even *PrintQ*, the OS/2 print spooler I mentioned earlier, groups itself here. Of course, all the big names are shipping already, except for *Ashton-Tate*.

Although, strictly speaking, *Prolog* is

not a database (I'll get letters on that one, but it's true), *Arity's Prolog* for OS/2 is good news. My DOS *Prolog* classes are often hampered by limited memory space, as *Prolog* does a lot of searching to get its work done and creates huge data structures—all of which live in RAM—in the process of that work. *Arity's* DOS-based compiler and interpreter are among the best, so the OS/2 product will no doubt be a useful tool for professional *Prologers*.

I see I've run out of space already. So many packages, so little time. I'm trying to get some specifics on the new *High Performance File System (HPFS)* that's going into OS/2 1.2. I hope to be able to tell you about it next month. See you then. ■

Mark J. Minasi is a managing partner at Moulton, Minasi & Company, a Columbia, Maryland, firm specializing in technical seminars. He can be reached on BIX as "mjminasi."

Your questions and comments are welcome. Write to: Editor, *BYTE*, One Phoenix Mill Lane, Peterborough, NH 03458.

5 Mbyte PROM/RAM CARD = IBM PC-compatible

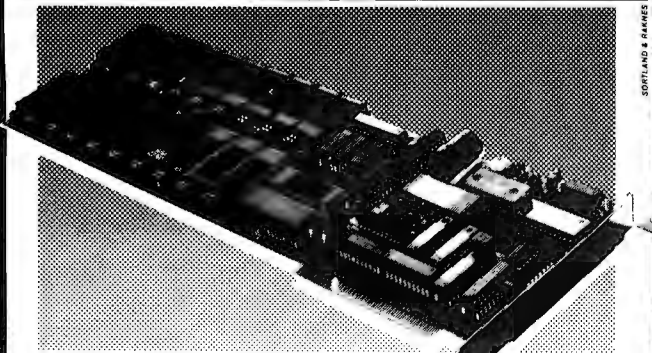

- Memory size: 1.25 Mbyte ROM/RAM 27512
2.5 Mbyte ROM/RAM 271024
5.0 Mbyte ROM/RAM 272048

- Additional 16K EEPROM
- On board PROM programmer for ordinary file handling
- Real time AT clock
- Timers for cyclic interrupting
- On board BIOS extension
- Battery backup for RAM and clock

STEINCO has developed a unique memory card which outranges all mechanical storage devices in hostile environment. On the board we have also utilized several other functions for use in data processing. With *MS-DOS* installed, the card will boot from *PiROM*, and data transfer between the card and the computer take place with standard *MS-DOS* function calls. It is also possible to edit and save files on the card. This can be done because the card holds a unique *PROM* programmer on board.



STEINCO

P.O. Box 113, N-5427 Urangsvåg, NORWAY.

Phone +4754-20888 Telefax +4754-21248 Telex 42255 stein n.

YOUR LAN CONNECTION ACCESSORIES LET "GOOD WAY" TO RESPOND

FACE PLATE & SURFACE MOUNT BOX FOR IBM TYPE 1 & 2



MAIN PRODUCTS:
NETWORK ACCESSORIES, COMPUTER CABLE, GENDER CHANGER,
DATA SWITCH, ARCNET PASSIVE HUB

GOOD WAY INDUSTRIAL CO., LTD.

P.O. Box 31-302, Taipei, Taiwan, R.O.C. Factory: No. 14-1, Dah Har Lima 2, Taichung, Taiwan, R.O.C.
Office: 3F, 30B, Fu Hsing N. Rd., Taipei, Taiwan, R.O.C. Fax: 886-4-2542648.
Tel: 1021737-7658 (Res.) Fax: 886-2-7189807.
Telex: 12445 BUWQ93.



BITWISE COMPUTERS -MORE THAN JUST A PRETTY FACE

Model	Model 212M	Model 212	Model 325	Model 333	Portable III-212	Portable III-325
CPU	12 Mhz 80286	12 Mhz 80286	25 Mhz 80386	33 Mhz 80386	12 Mhz 80286	25 Mhz 80386
RAM	512K 0 Wait	1 Meg 0 Wait	4 Megs Interleaved	4 Megs Cache	1 Meg 0 Wait	4 Megs Interleaved
DISPLAY	Monochrome	VGA color	VGA color	VGA color	Plasma CGA	Plasma CGA
PRICE	\$1,395	\$1,895	\$3,195	\$4,895	\$2,195	\$3,495

Prices are for complete systems, including Computer, Monitor, Keyboard, Hard Disk, DOS, Documentation, and 1 Year Warranty

All Desktop Systems Include:

- Compact Case 17" w x 7.25" h x 14" d
- 8 Expansion Slots, 5 Full Length Free
- 5 Drive Slots, 3 free
- Teac 1.2 or 1.4 Meg Floppy (add \$95 for both)
- Trident VGA Card, 100% register compatible, up to 1024x768
- Keytronics 101 Key US Made Keyboard
- 2 Serial Ports, 1 Parallel Port, 1 Game Port
- Seagate 40 Meg 28 ms MFM (ST-251-1) Hard Disk
- MS-DOS 3.3 or 4.01 with Manuals

Monitor Upgrades

Model	Monitor	Resolution	Dot Pitch	Price
VGA-41	Packard Bell	640x480	.41	Standard
VGA-31	CTX	640x480	.31	Add \$30
VGA-IIA	Nec-IIA	800x600	.28	Add \$290
VGA-3D	Nec-3D	1024x768	.24	Add \$425
Mono	Packard Bell	720x348	.29	Subtract \$450

All Portable Systems Include:

- Portable Case 15" w x 9" h x 8" d (20 lbs empty)
- High Contrast Plasma Screen (call for LCD prices)
- 5 Expansion Slots, 3 Full Length, 2 slots free in 2 drive system
- 3 Drive Slots, Teac 1.2 or 1.4 Meg Floppy (add \$95 for both)
- 40 Meg ST-251-1 Self Parking 28 ms hard disk standard
- ALL Hard Disk Upgrades available (see table)
- Simultaneous Display on screen and external monitor
- MS-DOS 3.3 or 4.01 with Manuals

Plasma Display Upgrades

Model	Screen	Resolution	Gray Scales	Price
CGA	640x400	640x200	4	Standard
EGA	640x400	640x350	4	Add \$290
VGA	640x480	640x480	16	Add \$540

Hard Disk Upgrades

Model	Size	Access Time	Controller Type	Price
ST-125-1	20 MB	28 ms	MFM 1:1	Subtract \$85
ST-251-1	42 MB	28 ms	MFM 1:1	Standard
ST-277N-1	66 MB	28 ms	SCSI 1:1	Add \$60
ST-277R-1	66 MB	28 ms	RLL 1:1	Add \$95
ST-296N-1	85 MB	28 ms	SCSI 1:1	Add \$245
Microscience	121 MB	28 ms	ESDI 1:1	Add \$700

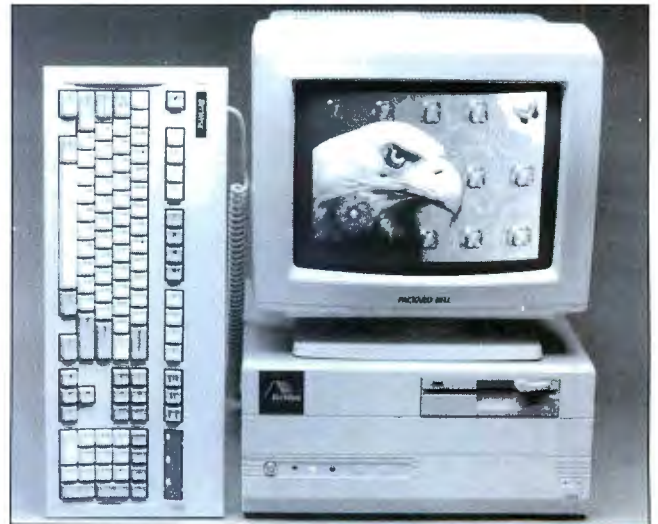

Bitwise — Building and servicing PCs since 1985. Questions? Call Us! we understand what we sell! Shipping — You pay UPS Shipping Charges only, F.O.B. Troy, NY, no surcharges. Full 1 Year Parts & Labor Warranty, 30-day money back guarantee. These are cash or check in advance prices. VISA, MC, DISCOVER, welcomed (2% surcharge). COD, add 1.5%. Personal Financing and Corporate Leasing Available.

1-800-367-5906
518-274-0755
Fax 518-274-0764

Bitwise Designs Inc.
701 River St.
Troy, NY 12180-1233



BITWISE
DESIGNS, INC.

NEW FROM PERISCOPE

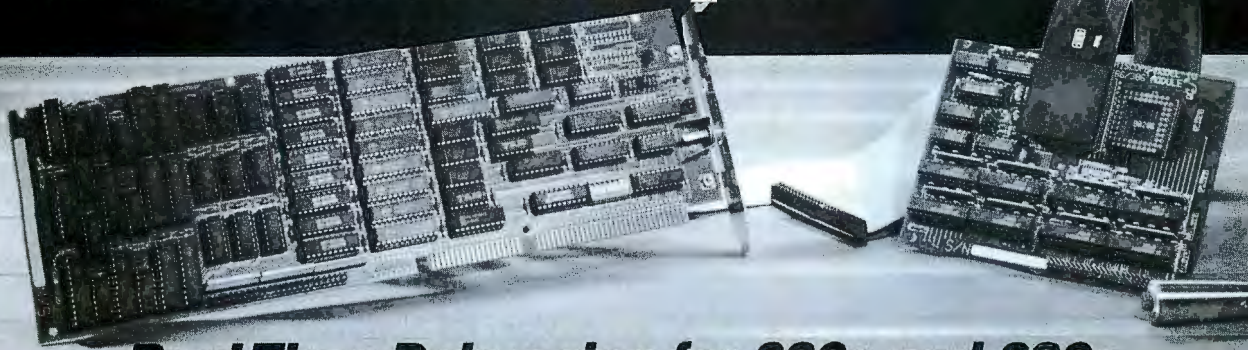

Real-Time Debugging for 386s and 286s

User Jeff Garbers, Crosstalk Communications' Director of Software Development, has been debugging with Periscope® Model IV and says, "The hardware really makes Periscope shine, especially when you've got timing-related problems. I can now track down changing pointers and altered buffers on my 386. I've been using it to debug Crosstalk® Mk. 4 and there's just no better way to do it."

Periscope IV gives you the ability to debug time-sensitive programs, hardware-interrupt routines, and programs with intermittent errors. You can run your program at full speed while tracking down unwanted memory overwrites. You can use the information captured in Periscope IV's real-time trace buffer to see EXACTLY what the system is doing, and to improve its performance.

Periscope manual, disk, quick-reference card, and 512K Plus board that provides write-protected RAM for Periscope Models I, III, and IV.



A New Generation of Hardware-Assisted Debugging

Compatible with virtually any 286 or 386 with an AT-style bus, Periscope IV works on machines running up to 25MHz with any number of wait states. Because it gets information directly from the CPU, instead of from the system bus, Model IV is not sensitive to bus compatibility issues.

Periscope IV collects CPU information in its hardware trace buffer while the CPU runs at full speed. Whether you tell Periscope IV to capture just selected information or to capture everything, you can use its powerful trace buffer commands to search for and display the execution history the way you need to see it. And you can use the CPU cycle count information to get the last bit of performance out of your code.

With Periscope IV you can set hardware breakpoints on memory accesses (within the first 16MB), I/O ports, and data. You can also set breakpoints on the occurrence of specific sequences of events, such as "watch for the routine FOO to begin executing, then while it is, watch for the variable BAR to be written." This capability, called sequential triggering, enables you to define complex conditions, then stop your program and examine what has happened when these conditions occur.

If you're developing a large application that needs all of the lower 640K, you can use the optional Plus board to keep Periscope totally out of normal DOS memory. The Plus board requires the use of a second slot.

The Periscope IV software is an extension of the software that comes with all models of Periscope. So, along with Periscope IV's powerful hardware, you get a full-function software debugger with source and symbol support for most popular PC compilers and linkers, Microsoft® Windows support, PLINK overlay support, dual monitor support, support for debugging device drivers and TSRs as well as regular programs, DOS independence, crash recovery, ease-of-use, and much more.

Prices on Periscope range from \$145 for software-only Model II-X to \$2,995 for a 25MHz 386 hardware-assisted Model IV. Call 800/722-7006 for pricing details, free information, to talk about your debugging needs, or to order your Periscope.

**Order Your Periscope, Toll-Free,
Today! 800-722-7006**

MAJOR CREDIT CARDS AND QUALIFIED
COMPANY PURCHASE ORDERS ACCEPTED



"No matter what your debugging needs, a single call to the Periscope Company has always sufficed..."

Ross Greenberg
"Best of 1988" (Development Tools)
PC Magazine, January 17, 1989

The
Periscope
Company, Inc.

1197 PEACHTREE ST.
PLAZA LEVEL
ATLANTA, GA 30361
404/875-8080
FAX 404/872-1973



CRIMES OF THE HEART?

Views on yesterday's follies and hopes for tomorrow's machines

I am writing this column not long after someone stole and disseminated the source code to some of Apple's Macintosh ROM. As bad as this crime is (and let's make no mistake about it, this is a *crime*), the real tragedy is what it does to the people who work at Apple. People, many of whom are my friends and who have been loyal Apple employees for years, have come under suspicion. Apple has always been a tough place to work: too much hurry up and wait; too many changes in product direction, development, and marketing; and too many reorganizations. This latest incident just makes life tougher for Apple employees.

I'm appalled at the idiots who stole and disseminated this code and then had the gall to link themselves with some greater good. A criminal act is just that, no matter what the intentions might have been. Cloaking themselves in the banner of "open software" and spouting off about "freedom from the tyranny of proprietary operating systems" is a load of rubbish, nothing more.

These criminals have represented themselves as members of the nuPrometheus League. My hope is that when they are caught (and they will be, after many innocent Apple employees are harassed in the process), their punishment fits the crime. Recall that the Greek god Prometheus was chained to a rock for eternity by Zeus, while a vulture picked over his liver. I hope the nuPrometheus League meets a similar fate.

Don's Wish-List Macs

By all signs, Apple expects to make a big marketing push during the first quarter



of its 1990 fiscal year, which will be starting about the time that you read this column. Rather than talk about the products that Apple expects to announce for 1990 availability, I want to push the discussion even further. It's time for me to unveil my Mac wish list. What do I want to see in new Mac products for 1990 and beyond?

The first Mac on my wish list is a natural: a new low-end computer designed to replace both the Plus and the SE. I've called this machine the Mac Classic before, and that's a name that befits its position in the product line.

The Mac Classic would have a modular design, based on the design-for-manufacturing (DFM) methods used in the IIcx. In order to make it easily transportable, it would consist of two units, one each for the CPU and the monitor, plus the keyboard. This could all be fastened together for carrying.

The CPU unit would contain a 16-MHz 68020 processor and single-in-line-

memory-module (SIMM) slots for up to 8 megabytes of RAM. This unit would be the size of the current 80-megabyte external Apple SCSI hard disk drive, but it would weigh less. Its basic configuration would have 2 megabytes of RAM, so that System 7.0 would run (albeit without virtual memory). It would also have an FDHD floppy disk drive and a 20-megabyte small-format hard disk drive. Two Apple Desktop Bus (ADB) ports, two serial ports, a floppy disk drive port, a SCSI port, and a sound port complete the unit.

Oh, yes, there would also be a processor expansion port. Not an internal expansion slot. Forget that nonsense. The Mac Classic would be an information appliance, just like the original 128K-byte Mac. When you want to slice tomatoes with your food processor, you don't have to open the case and install a new motor (possibly damaging the components inside). You simply install a new blade.

continued

Likewise, you shouldn't have to open up your Mac Classic to install some new gizmo, like a floating-point chip.

This processor expansion port allows expansion doodads to be attached as easily as hooking up a second floppy disk drive or an external hard disk drive. Apple should sell an externally powered expansion chassis to hold multiple expansion boards, and it should encourage third-party vendors to create stand-alone accessories that would connect to the expansion port.

The monitor unit would contain the monitor's analog driver board and a 9-inch monochrome monitor. You would attach the monitor to the CPU box through some sort of sliding/docking catch that would incorporate the power and data connections (although separate ports would be available if you wanted to separate the CPU from the monitor with a cable). The mouse and keyboard would be one of the standard ADB keyboards that Apple now provides.

The Mac Classic would not have color or gray-scale capabilities built in (though they could be easily added), nor would it have many configurations, keeping in

mind its price tag and its intended audience. The street price for the Mac Classic should be around \$900, with pricing for students falling around \$700.

This machine would replace the current Mac Plus and perhaps the SE, and it would likely sound the death knell for the Apple II line. Of course, these are all marketing reasons why Apple might not produce a Mac Classic or might delay its availability. Given IBM's premature dropping of its own AT system, Apple is likely to give market concerns more than mere lip service before unveiling any machine as tempting as my Mac Classic.

The Hyper Mac

OK, I admit it. I'm getting sick of Apple being handed its technological lunch by workstation vendors like NeXT and Sun. Don't get me wrong, I like the NeXT cube and the technology that it represents. And I wouldn't be able to get through a day without Midas, my trusty Sun-3/50NFS workstation. Then there are the new SPARCstations. These are impressive machines at impressively low prices. But they're still not Macs. The NeXT cube and the Suns won't run my

huge library of Mac software. And their interfaces, while sporting many new and clever features, aren't as battle-tested and easy to use as the Mac's.

It's time to unleash a Hyper Mac! This would be a single-user machine running the Mac OS. Apple doesn't need to get involved in fighting Sun on Sun's terms. Sun has the Unix expertise and experience to win that battle, as the current nonsales of A/UX sadly point out.

The Hyper Mac would be a high-end machine capable of running existing 32-bit clean Mac software. It would be a six-slot machine, based on a new DFM design center that would clean up the existing Mac II family chassis and motherboard designs. As many components as possible would be surface-mounted to the motherboard, including the CPU. The chassis would also incorporate a beefed-up power supply, providing enough juice to power six NuBus cards without even flinching.

Now to the Hyper Mac's guts. Naturally, this baby will need a new ROM. Apple might as well make it a full megabyte, even if its software aces don't need all that space for now. The Hyper Mac's heart will be a very fast CPU, one that can compete with the likes of Sun's SPARC chip. Better make it a 68040 running at 40 MHz. Apple will want to toss in some kind of static RAM cache to optimize the performance of this fast processor.

There's no point in having this kind of raw computing horsepower tied to a 10-MHz NuBus. So the Hyper Mac will have a NeXT-class NuBus, running at least at 25 MHz, faster if the hardware gurus can pull it off. And direct memory access. Lots of it.

DMA is sorely missing on existing Macs and is one reason that real-time computing applications aren't being written for the Mac. The Hyper Mac's DMA channels will fix that.

How about RAM? Lots of it, virtual memory notwithstanding. We're talking minimum disk paging here. Thus, the Hyper Mac will have 16 SIMM sockets, for 16 megabytes of RAM when using 1-megabit-density SIMMs. Using 4-megabit-density SIMMs, the Hyper Mac could pack in 64 megabytes of RAM, enough for serious computing, even real-time stuff like shaded color animations that pump out 75,000 polygon transformations per second. Apple shouldn't sell the Hyper Mac with anything less than 8 megabytes of RAM.

How about an optical disk drive? Not yet. Apple should let NeXT and Canon

continued

People are talking about us.

"Lahey F77L is definitely for the programmer's market, with features for the casual and professional user...*EDITOR'S CHOICE*" *PC Magazine*

"It is a fantastic product." *PC Australia*

"This is a very good implementation of FORTRAN, better than the one I use on my minicomputer system." *IEEE Software*

"It should be the last FORTRAN compiler you will need to buy..." *Your Computer*

"Lahey F77L was by far the easiest compiler to use..." *Programmer's Journal*

"Compilation speed is Lahey FORTRAN's most remarkable feature; it is unbelievably fast...Realistically, Lahey FORTRAN is the most efficient and productive FORTRAN development tool for the DOS environment..." *BYTE, Nov. '87, p.187—David W. Burleigh*



When people talk about FORTRAN the name mentioned most often is

Lahey
Computer Systems Inc.

Contact us to discuss our products and your needs. (800) 548-4778
Lahey Computer Systems, Inc. P.O. Box 6091, Incline Village, NV 89450
Tel: (702) 831-2500 FAX: (702) 831-8123 Tlx: 9102401256

You know
exactly what
your company
wants in a
color printer.

LightSpeed 9624E 9600 baud modem

LightFax 9624 superior fax/modem



shipping \$7.00

\$799.00

True 9600 bps modem, V.32, full duplex.
9600/4800/2400/1200/300 bps
MNP Class 5 error correction & data compression for data flow up to 19.2 Kbps
Fully CCITT V.32/V.22bis/V.22, Bell 212A/103J compliant.
Auto speed detection
Extended AT command set
Non volatile memory storage
Cable and software included (specify PC or MAC)
Synchronous and asynchronous modes



shipping \$7.00

\$499.00

° 9600 baud fax compatible with all Group 3 fax machines
2400 baud modem 100% Hayes™ compatible. Switch from fax to modem with one command
Excellent picture quality, superior to standard fax
Fax directly from application or from flexible text/graphics editor
Full status lights in fax or modem mode
Compatible with all PCs and MACs
Powerful software for scheduled sending, broadcasting, file queuing etc.
Complete with fax and modem software and cable (specify PC or MAC)

Never buy another ribbon! with Maclnker™

over 100,000 sold

Re-ink
ANY
fabric
ribbon

° Universal Cartridge Maclnker re-inks most cartridges with appropriate adapter. Universal Spool Maclnker re-inks all spools

Operation is very simple and automatic

Extra dark, lubricated ink yields better than new print quality

Ink's cooling and lubricating effect extends printhead life

Average cartridge can be re-inked 60-100 times at 5 cents/re-inking

Multicolor Adapters for multiband cartridges (Rainbow, Imagewriter, Epson, NECs, Okidata etc.)

Dedicated Maclnkers available for special cartridges and Band Printers

Customers vary from individuals to Fortune 500 Corporations, reporting documented savings of \$30,000/year with Maclnker



shipping \$4.50

Universal Cartridge Maclnker shown with Epson cartridge

\$68.50

Universal Cartridge Maclnker68.50

Multicolor Adapter (specify printer)40.00

Epson only Maclnker mod. 271EP42.00

Imagewr. only Maclnker mod. 234 IM..42.00

Universal Spool Maclnker68.50

Heat Transfer Adapter25.00

Extra Ink bottle, black3.00 pint.....18.50

Colored ink bottle4.00 ex. reservoir. 5.00

All Maclnkers delivered complete with bottle of ink, ink meter, reservoir, reservoir cover.

Go color !! Single & multicolor, standard and heat transfer cartridges available: red, green, blue, brown, purple, yellow, orange, white, silver and gold. Indelible and OCR ink cartridges available.

Call for free catalog

Satisfaction or 30 day refund - Immediate shipment - Major credit cards - POs from national accounts

Computer Friends, Inc.

Order Toll Free 1-800-547-3303

14250 NW Science Park Dr.
Portland OR 97229

in Oregon (503)626-2291
fax (503)643-5379 telex 4949559 CF

MACINATIONS

get those systems up to snuff in terms of speed and maybe include them in Hyper Mac II. For now, Apple should stick with small-format hard disk drives. The base configuration would come with one 160-megabyte unit, although the chassis could hold four, plus two FDHD floppy disk drives for quick backups and reading in data and software.

Anything else? The usual SCSI, serial, sound, and ADB ports. The SCSI port should have a faster transfer rate. Oh, and Apple should also throw in a better sound chip than its current Mac II sound chip, maybe a digital signal processor chip. In fact, I vote for a DSP chip.

And Ethernet. Not a NuBus slot-wasting Ethernet card, but built-in Ethernet on the motherboard. Make it thin and *thick* Ethernet, please (don't make NeXT's mistake on that one).

Is that it? Not quite. I'd also want built-in video. No more of this extra video-card expense. Apple should have built-in video with the same 8-bit high-resolution colors found on the SPARCstations. The built-in video should be capable of driving monochrome and RGB monitors, including full-page and two-page units. If you want 16- or 24-bit color, you could add a NuBus card loaded with video RAM.

Quite a machine, eh? Wait until you hear the price Apple should sell it for. Under \$10,000 for a base configuration (19-inch monochrome monitor, extended keyboard, mouse, 8 megabytes of RAM, and a 160-megabyte hard disk drive). I can hear the screaming in Cupertino now. But consider the competition: The NeXT cube sells at Businessland for under \$10,000, and SPARCstations can also be had in many versions for under \$10,000. Those are the real price points the Hyper Mac must attack.

OK, Apple. There you have it. Two new machines on my Mac wish list. Building either one would reassert your technological prowess in the marketplace and capture sales now going to your competitors. Building both of them might just put some of your competitors back where they started: as niche vendors. ■

Don Crabb is the director of laboratories and a senior lecturer for the computer science department at the University of Chicago. He is also a contributing editor for BYTE. He can be reached on BIX as "decrabb."

Your questions and comments are welcome. Write to: Editor, BYTE, One Phoenix Mill Lane, Peterborough, NH 03458.

Monet, not money.



The HP
PaintJet.
\$1395.*



Who says fine art is out of reach? The HP PaintJet color printer produces brilliant color for a price any business can afford.

So now there's no limit to what you can create



with your business communications. Surprise your audience with thousands of colors. Beamed up on an overhead. Or tucked neatly into a report. Persuading people up to 85% more effectively than black and white.

The PaintJet works with all your favorite graphics, presentation, spreadsheet and word processing software. Just hook it up to your IBM-compatible or Macintosh computer and start painting.

For only \$1395 (add \$125 for the Macintosh interface).

Call **1-800-752-0900 Ext. 711K** for your nearest authorized HP dealer and a free sample output. The HP PaintJet. It's what artists are starving for.

There is a better way.

 **HEWLETT
PACKARD**

Circle 118 on Reader Service Card

Our Swans make waves.



The Swan line of computers is creating waves of excitement among computer users. One reason is price. Swan computers are true bargains, offering you the most for your investment. But price doesn't tell the complete value story.

Swan computers are solid, reliable performers ... assembled by Tussey Computer Products, a solid, reliable company with a tradition of unsurpassed customer satisfaction.

Swan computers are highly compatible. In fact, all Swan computers feature the top-rated Phoenix ROM BIOS to assure 100% PC compatibility.

And the benefits keep coming, wave after wave . . .

30-Day Satisfaction Guarantee

If you're dissatisfied with any Swan brand name product, you can return it within 30 days from the date of shipment and get your money back. No questions asked.*

Toll-free Technical Support

When you own a Swan, you can call our toll-free number and be in touch with our expert technical and service staff. They'll answer your questions and help you take fullest advantage of your system's capabilities.

Full 1-Year Warranty

Every Swan brand name product is backed by a full 1-year warranty on parts and labor. A second year of coverage is available through the Swan Extended Warranty (SEW). Ask for details when you order your Swan.

Fast, Sure Delivery

You want your Swan up and running and doing its job for you. Fast. So any order we receive before 4 p.m. EST is shipped the same day. Even orders received after 4 p.m. are shipped within 24-hours.**

We also insure your order at no cost to you. And we don't charge your credit card until your order is actually shipped.

Convenient On-Site Service

Swan offers you the valuable option of on-site service from Sorbus®, a Bell Atlantic™ Company. When your computer needs serviced, an experienced technician will be dispatched to your site quickly, minimizing downtime, maximizing convenience and value.

Swans make waves in business and education.

Swan offers a full line of services tailored to the needs of educational and corporate computer users. Call our Educational & Corporate Sales Department toll-free at 1-800-468-9044. Learn how a Swan can be a business animal ... or a teacher's pet.

Swans make waves in the computer industry.

With their compatibility, reliability and performance, Swans add up to value for their owners. So it's no surprise that Swans are making waves in the computer industry. Waves that may make some competitors run for safer ground.

Read what computer journals are saying ...

"... If you enjoy getting the most performance for your dollar, the Swan ... is a good alternative" to showy, more expensive brand names.

— Computer Shopper, April 1989

"The excellent manual and 30-day money-back guarantee both indicate that Tussey Computer Products values customer service." — PC Resource



Swan 386/20D

"Tussey's Swan 386/20 flies."

— Computer Shopper, April 1989

Gracefully combining power and performance, this Swan has soared to the upper limits of today's technology.

- 80386-20 20/8 MHz Norton SI 22.0
 - MS-DOS*, OS/2* & UNIX* Compatible
 - Phoenix BIOS
 - 1MB of 32-Bit RAM Expandable to 16MB of 32-Bit RAM
 - Shadow RAM for Video & BIOS
 - Memory Interleave for near 0 Wait State
 - 80287 & 80387 Co-processor Socket
 - 200W Power Supply
 - 5 Device Bays: 3 Exposed, 2 Internal
 - 1.2MB 5.25" or 1.44MB 3.5" Floppy Drive
 - Dual Floppy/Dual H.D. Controller w/1:1 Interleave
 - Ports: 2 Serial, 1 Parallel
 - 8 Expansion Slots: 1) 32-bit, 4) 16-bit, 3) 8-bit
 - Enhanced 101 Key Keyboard
 - Clock Calendar w/Battery Backup
 - Swan Setup & Utilities Diskette
- Options:**
- 80287 or 80387 Co-processor
 - Upgrades: 2, 4, 8, 10 or 16MB
 - GW BASIC/MS-DOS add \$89

\$1899

Base System with Single Floppy, No Video

386/20D	VIDEO OPTIONS Include Monitor & Video Adapter			
	Mono	14" Flat Mono	VGA Mono	VGA Color
w/48MB (28ms) & 1:1 Interleave	\$2399	\$2448	\$2598	\$2898
w/80MB (28ms) & 1:1 Interleave	\$2749	\$2798	\$2948	\$3248
w/150MB (18ms) ESDI w/1:1 Interleave	\$3394	\$3443	\$3593	\$3893

Tower Case Option for 386/20 w/230W power supply add \$300

* Items returned must be as-new, without modification or damage. All warranty cards, manuals and packaging must be included. Return shipping must be prepaid and insured, bearing a RA (Return Authorization) on the shipping label. Sorry ... shipping charges and upgrade fees are not refundable.

** Custom configured systems may take longer.

S=BTJ1



Swan 386SX

This system gives you 386 compatibility, power and performance ... at a 286 price.

- 80386SX 16/18 MHz Norton SI 17.6
 - MS-DOS*, OS/2* & UNIX* Compatible
 - Phoenix BIOS
 - 1MB RAM Expands to 8MB on Systemboard
 - Shadow BIOS
 - Memory Interleave for near 0 Wait State
 - 80387SX Co-processor Socket
 - 200W Power Supply
 - 4 Device Bays: 3 Exposed, 1 Internal
 - 1.2MB 5.25" or 1.44MB 3.5" Floppy Drive
 - Dual Floppy/Dual H.D. Controller w/1:1 Interleave
 - Ports: 1 Serial, 1 Parallel
 - 8 Expansion Slots: 6) 16-bit, 2) 8-bit
 - Enhanced 101 Key Keyboard
 - Clock Calendar w/Battery Backup
 - Swan Setup & Utilities Diskette
- Options:**
- 80387SX Co-processor
 - Upgrades: 1.5, 2, 3, 4, 5, 6 or 8MB
 - GW BASIC/MS-DOS add \$89

\$1399

Base System with Single Floppy, No Video

386SX Drive Options	VIDEO OPTIONS Include Monitor & Video Adapter			
	Mono	14" Flat Mono	VGA Mono	VGA Color
w/32MB (40ms) & 1:1 Interleave	\$1799	\$1848	\$1998	\$2298
w/48MB (28ms) & 1:1 Interleave	\$1899	\$2048	\$2198	\$2498
w/80MB (28ms) & 1:1 Interleave	\$2249	\$2298	\$2448	\$2748
w/187MB (18ms) ESDI w/1:1 Interleave	\$2894	\$2943	\$3093	\$3393



Swan 286/12

You probably never thought you could get into a reliable business system this inexpensively. But with the 286/12, you can. Now.

- 80286 12.5/6.25 MHz Norton SI 12.3
 - MS-DOS* & OS/2* Compatible
 - Phoenix BIOS
 - 512K of RAM Expandable to 5MB
 - Shadow BIOS
 - 0 Wait State
 - 80287 Co-Processor Socket
 - 200W Power Supply
 - 5 Device Bays: 3 Exposed, 2 Internal
 - 1.2MB 5.25" or 1.44MB 3.5" Floppy Drive
 - Dual Floppy/Dual H.D. Controller
 - Ports: 1 Serial, 1 Parallel
 - 8 Expansion Slots: 6) 16-bit, 2) 8-bit
 - Enhanced 101 Key Keyboard
 - Clock Calendar w/Battery Backup
 - Swan Setup & Utilities Diskette
- Options:**
- 80287 Co-processor
 - Upgrade to 640K, 1, 2, 3 or 5MB
 - GW BASIC/MS-DOS add \$89

\$899

Base System with Single Floppy, No Video

286/12 Drive Options	VIDEO OPTIONS Include Monitor & Video Adapter			
	Mono	14" Flat Mono	EGA	VGA
w/32MB (40ms) & 1:1 Interleave	\$1299	\$1348	\$1698	\$1798
w/48MB (28ms) & 1:1 Interleave	\$1399	\$1448	\$1798	\$1898
w/80MB (28ms) & 1:1 Interleave	\$1749	\$1798	\$2148	\$2248



Swan XT10

The perfect budget-priced home computer. A solid, reliable, compatible performer.

- 10/4.77 MHz 8088-1
 - Phoenix BIOS
 - 640K of RAM
 - 0 Wait State
 - 8087 Co-Processor Socket
 - 150W Power Supply
 - 4 Device Bays: 2 Exposed, 2 Internal
 - Single 360K Floppy Drive
 - Ports: 1 Serial, 1 Parallel, 1 Game
 - 8 Expansion Slots
 - Enhanced 101 Key Keyboard
 - Clock Calendar w/Battery Backup
 - Swan Setup & Utilities Diskette
- Options:**
- 8087 Co-processor
 - 3.5" Floppy Drive
 - GW BASIC/MS-DOS add \$89

\$549

Base System with Single Floppy, No Video

XT10 Drive Options	VIDEO OPTIONS Include Monitor & Video Adapter			
	Mono*	CGA	EGA	VGA
Single Floppy	\$699	\$869	\$1098	\$1198
Dual Floppies	\$779	\$949	\$1178	\$1278
*w/32MB (40ms) Hard Drive	\$979	\$1149	\$1378	\$1478

* Includes Single 360K Floppy Drive
 † Upgrade from 12" to 14" Flat Screen, add \$49

To order: No surcharge on Discover, Visa, MasterCard or AMEX.
 • Your credit card is not charged until your order is shipped.
Shipping: 3% or \$5 minimum for UPS Ground. Call for shipping charges on Express Air, APO, FPO, AK, HI and all foreign orders.
 • If part of your order is backordered, the remainder will be shipped UPS Ground. • Allow 2 weeks for personal and company checks to clear. • Defective items replaced or repaired at our discretion. • PA deliveries add 6% sales tax. • Prices and terms subject to change without notice.



Open: 8a.m.-11p.m. M-F, 10a.m.-8p.m. Sat, 12p.m.-8p.m. Sun



Order Now Toll-Free

1-800-468-9044

FAX: 814-237-4450 • International: 814-234-2236

TUSSEY COMPUTER PRODUCTS

3075 RESEARCH DRIVE • STATE COLLEGE, PA. • 16801

Circle 307 on Reader Service Card

Make a mating

Get real compatibility. Call our toll-free number and our expert staff will mate you with hardware, software, or peripherals to fit your unique needs. And at a price you'll love.

And when you shop Swan, you'll get the benefits of a strong, supportive relationship:

- We won't charge your credit card until your order is shipped.
- Orders received before 4 PM EST will be shipped same day ... and each order is insured at no cost to you.
- You'll deal with a financially sound, respected company.
- We'll be here after the sale to help you.
- Software orders over \$100 and accessories under 6 pounds will be shipped Federal Express.



PRINTERS

Panasonic



1180 (192 cps, 80 col, 9-pin) \$179

- 1191 (240cps, 80 col, 9-pin) \$Call
- 1124 (192cps, 80 col, 24-pin) \$329
- 1595 (240cps, 132 col, 9-pin) \$449
- 1524 (240cps, 132 col, 24-pin) \$569
- 1624 (192cps, 132 col, 24-pin) \$Call
- 4450 (11ppm laser printer) \$1375

EPSON

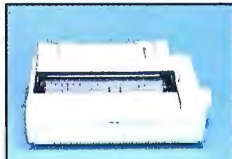

LX-810 (180 cps, 80 col, 9-pin) \$189

- FX-850 (264cps, 80 col, 9-pin) \$Call
- FX-1050 (264cps, 132 col, 9-pin) for
- LQ-510 (180cps, 80 col, 24-pin) Best
- LQ-850 (264cps, 80 col, 24-pin) Price
- LQ-1050 (264cps, 132 col, 24-pin) on
- LQ-2550 (400cps, 132 col, 24-pin) .. Epson

star



NX-1000 (144 cps, 9-pin) ... \$Call

- NX-1000 Rainbow (144cps, 80 col, 9-pin) \$229
- NX-15 (120cps, 132 col, 9-pin) \$349
- NX-2400 (170cps, 80 col, 24-pin) \$Call

OKIDATA

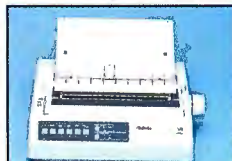

320 (300 cps, 80 col, 9-pin) \$339

- 172 (180 cps, 80 col, 9-pin) \$Call
- 182 Turbo (220 cps, 80 col, 9-pin) \$Call
- 321 (300cps, 132 col, 9-pin) \$469
- 390 (270cps, 80 col, 24-pin) \$469
- 391 (270cps, 132 col, 24-pin) \$659
- 393 (450cps, 132 col, 24-pin) \$Call

- Citizen**
- 120D (120 cps/9-pin) \$159
- 180D (180cps, 80 col, 9-pin) \$179

- Diconix**
- 150+ (180cps, 80 col) \$345
- 300 (300cps, 80 col) \$399

- Hewlett-Packard**
- Deskjet (240cps, 80 col) \$599
- Deskjet Plus (240cps, 80 col) \$Call
- Paintjet (167cps, 80 col) \$1049

- NEC**
- P2200 (170cps, 80 col, 24-pin) \$359
- P5200 (265cps, 80 col, 24-pin) \$529
- P5300 (265cps, 132 col, 24-pin) ... \$689



LASER PRINTERS

Panasonic

- KX-P4450 \$1375
- Hewlett-Packard**
- LaserJet Series II
- 8 ppm/512K \$1749
- LaserJet Series IID \$Call



MONITORS

TTL Monochrome

- Magnavox 7623 Amber \$99
- Packard Bell with tilt/swivel
- Amber or Green \$89
- Samsung 14" Mono Flat \$139
- Swan Monochrome SW525 \$89

RGB/CGA

- Magnavox 8762 \$249
- Magnavox 8515 \$289
- Samsung 5C452C \$219
- Swan RGB \$219

EGA

- Intec 1453 \$349
- Magnavox 9053 \$359
- Packard Bell 1431 \$349

Multisync

- Intec 1455N Multi \$419
- Mitsubishi Diamond Scan \$499
- NEC Multisync 3-D \$Call
- NEC Multisync Plus \$Call
- Sony 1304 \$699

VGA

- Amdek 732 \$429
- Intec 1453 Q \$349
- Magnavox 7749 (Grey Scale) \$129
- Magnavox 9082 \$429
- NEC Multisync 2a \$Call

PC ADD ON BOARDS

- Boca**
- RAM Card XT or AT \$Call
- I/O card XT or AT \$79

- Micron**
- RAM Card (MB-28-DH) populated w/2MB RAM \$699

- TOPS**
- TOPS/DOS 2.1 \$119
- Flashcard \$169
- Net Print \$119
- Teleconnector \$39

intel

- 8087 \$84
- 8087-1 \$159
- 8087-2 \$119
- 80287 \$129
- 80287-8 \$189
- 80287-10 \$214
- 80387SX \$297
- 80387-16 \$339
- 80387-20 \$379
- 80387-25 \$479
- 80387-33 \$Call

BOARDS

- AboveBoard Plus \$399
- AboveBoard Plus I/O \$449
- Connection Co-processor \$Call
- InBoard 386/PC \$589
- Call for Daughterboard Pricing

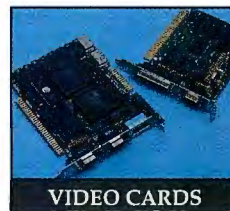

VIDEO CARDS

EGA

- ATI**
- EGA Wonder 800 \$239
- Paradise**
- Autoswitch 480 \$179

- Swan**
- EGA \$169

VGA

- ATI**
- VGA Wonder \$Call

- Orchid**
- Pro Designer VGA \$319
- Pro Designer VGA + \$Call

- Paradise**
- Paradise VGA + \$249
- VGA Professional \$Call
- VGA + 16 \$299

- Swan**
- VGA \$199

- Video 7**
- VEGA VGA \$279
- Fast Write VGA \$369
- VRAM VGA \$499

MISC.

- Swan**
- Switchable (Mono/CGA) \$69



FLOPPY DRIVES

- Mitsubishi**
- 3.5" (720K) \$89
- 3.5" (1.44MB) \$109

- Sony**
- 3.5" (720K) \$79
- 3.5" (1.44MB) \$99

Rotect 5.25"			
QTY	360K	1.2MB	
1-3	\$74	\$89	
4-9	\$62	\$73	
10+	- Call for Quote -		



PC HARD DRIVES

KLÖK

- KL320 20MB (40 ms) \$219/\$259*
- KL330 32MB (40 ms) \$249/\$299*

MiniScribe

- 8438 30MB (68 ms) \$249
- 3650 40MB (61 ms) \$299
- 3053 40MB (25 ms) \$449

Seagate

- ST-225 20MB (65 ms) \$219/\$259*
- ST-238 30MB (65 ms) \$249/\$299*
- ST-125 20MB (40 ms) \$249/\$299*
- ST-151 40MB (24 ms) \$439
- ST-157R 48MB (28 ms) \$349
- ST-251-1 40MB (28 ms) \$439
- ST-4096 80MB (28 ms) \$599

IMPRIMIS

- 80MB (28 ms) \$629
- 150MB ESDI (16.5 ms) .. \$1299/\$1495*

*Kit Price - includes cables, controller and mounting screws.

TOSHIBA LAPTOPS

- T1200 (10MHz) \$1379
- T1600 (12MHz/20MB) \$3259
- T3100e (12MHz/20MB) \$2749

Call for other Toshiba models

DISKS

BONUS	DS/DD	3.5"	5.25"
MAXELL	DS/DD	\$19.95	\$9.95
VERBATIM	DS/DD	\$19.95	\$9.95
SONY	DS/DD	\$19.95	\$10.95

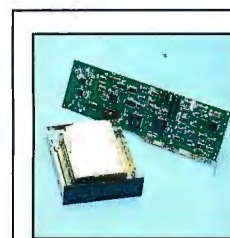

Seagate

- ST 157R Hard Drive**
- 48 MB formatted
- 3.5" Technology with Adaptec RLL Controller
- 1:1 Interleave
- Supports 2 Hard Drives & 2 Floppy Drives

\$489

Call Today & Ask For Our Free Catalog

Order Now Toll-Free
1-800-468-9044

FAX: 814-237-4450 • International: 814-234-2236

Open: 8a.m.-11p.m. M-F, 10a.m.-8p.m. Sat, 12p.m.-8p.m. Sun

TUSSEY COMPUTER PRODUCTS
3075 RESEARCH DRIVE • STATE COLLEGE, PA. • 16801

call. 1-800-468-9044



SOFTWARE

AMERICAN Design CAD 3.0 \$155 Design CAD 3-D \$209	LOGITECH Finesse \$89
ASHTON-TATE dBase III+/IV \$Call/\$459	LOTUS Agenda \$269 123 v 2.01/3.0 \$299/\$Call Freelance Plus \$339 Magellan \$Call Symphony \$439
BEDFORD Integrated Accounting \$139 Toolbox \$Call	MERIDIAN Carbon Copy Plus \$112
BLOC PUBLISHING Personal Lawyer \$39 Popdrop \$34 Formfiller \$89 Formtool \$55	MICROSOFT Excel \$Call Flight Simulator 3.0 \$35 MS-DOS & GW BASIC \$Call Quick BASIC \$67 Quick C \$67 Quick Pascal \$Call Windows 286/386 \$64/\$129 Word 5.0 \$Call Works \$99
BORLAND Paradox 3.0 \$449 Quattro \$169 Turbo C 2.0 \$107 Turbo C Professional \$159 Turbo Lightning \$69 Turbo Pascal 5.5 \$99 Turbo Pascal Professional \$169	PETER NORTON Norton Commander \$54 Norton Utilities \$55 Norton Advanced Utilities \$79
BRODERBUND Print Shop \$34 Print Shop Companion \$37	QUARTERDECK DESVIEW/DESVIEW 386 \$79/\$119 QEMM \$39
CENTRAL POINT Copy II PC \$27 Deluxe Option Board \$109 PC Tools Deluxe 5.1 \$49	REFERENCE SOFTWARE Grammatik III \$54
COMPUTER ASSOCIATES SuperCalc5 \$Call	SAMNA Ami/Ami Pro \$99/\$Call
COREL Corel Draw \$289	SOFTWARE PUBLISHING First Publisher \$79 Harvard Graphics \$Call PPS First Choice 3.0 \$89
DAC SOFTWARE Dac Bonus Pack \$119 Dac Easy Accounting \$59 Dac Easy Light \$45 Dac Easy Payroll \$59 Lucid 3-D \$69	SYMANTEC Grandview \$195 Q & A \$209 Q & A Write \$129 Timeline 3.0 \$359
<i>Call for Pricing on Tutors</i>	THREE D GRAPHICS Perspective Junior \$99
FIFTH GENERATION Fastback Plus \$104	WORD PERFECT Library \$69 Word Perfect 5.0 \$219
FOX Foxbase+/386 \$199/\$299	WORDSTAR Wordstar Professional v 5.5 \$199 Wordstar v 5.5 Upgrade \$Call
FUNK Allways for 123/Symphony \$89/\$89 Sideways \$42	XEROX Ventura Publisher 2.0 \$Call
GENERIC SOFTWARE Generic CADD Level 3 \$169	
INFUIT Quicken 3.0 \$44	



Swan Peripherals ... Feather your nest for less.

Top-quality Swan peripherals can make your PC an even better place to work and play ... and at prices that won't crack your nest egg.

Every Swan brand name product comes with a 30-day, money-back trial guarantee. And every Swan product is backed by a full one-year warranty on parts and labor. You also get toll-free technical support and customer service.

You'll be tickled when you discover what a reliable Swan add-on can do for your home or office PC system.



Swan Modems

Make the world your partner. With the Swan Modem, you'll be able to communicate with other PCs and information services around the world through your pulse or touch tone phone. You'll tap into a world of data and broaden your horizons. Every Swan Modem comes complete with communication software and full documentation.

- Hayes[®] compatible • Auto answer/dial
 - Include PC Talk III software
 - 2400 bd internal* \$99
 - 1200 bd internal \$69
 - 2400 bd external \$149
 - 1200 bd external \$89
- * includes Bit Com v 3.5 software

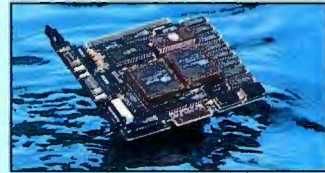

Swan Video Cards

Different people have different uses for their PC's ... from everyday uses like word processing and spreadsheets to today's more demanding applications, such as desktop publishing and presentation graphics. A Swan video card can help you better meet your needs today ... or help you ride the wave of technology into tomorrow.

- Switchable Card • Hercules[®] to CGA
- Parallel Port \$69
- EGA Card • EGA/CGA/TTL
- 640 x 480 Resolution \$169
- VGA Card • Register-level compatible
- 256K RAM • 17 VGA Modes \$199



Swan Tape Backups

Protect that nest of important data stored on your hard drive. Swan Tape Backups store 40MB on a single tape cartridge ... reliably, conveniently and economically. A Swan tape drive can be installed on any Swan computer and most XT- or AT-compatibles.

- 40MB XT or AT Internal \$299
- 40MB XT or AT External \$399



Swan Keyboards

It's important to have choices. So Swan gives them to you. You can depend on the Swan family of tactile keyboards for reliable typing with either the reassuring audible feedback of the "touch and click" or the quiet response of the "silent" keyboard.

- 101 Key Touch & Click or Silent \$79
- 84 Key Touch & Click \$69

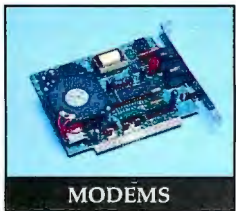

MODEMS

ATI 2400 etc Internal \$159
Hayes Smart Modem 1200 bd Internal/External \$259/\$289 2400 bd Internal/External \$Call
Practical Peripherals 2400 bd Internal/External \$149/\$199
Swan Technologies 1200 bd Internal \$69 1200 bd External \$89 2400 bd Internal \$99 2400 bd External \$149



MICE

IMSI Optical Mouse w/Dr. Halo III \$72
Microsoft Mouse \$109 Mouse with Windows \$139
Logitech NEW Bus Mouse (320 dpi) \$75 NEW Serial Mouse (320 dpi) \$79 with Paint add \$10 ScanMan \$199

To order: No surcharge on Discover, Visa, MasterCard or AMEX.
 • Your credit card is not charged until your order is shipped.
 Shipping: 3% or \$5 minimum for UPS Ground. Call for shipping charges on Express Air, APO, FPO, AK, HI and all foreign orders.
 • If part of your order is backordered, the remainder will be shipped UPS Ground. • Allow 2 weeks for personal and company checks to clear. • ALL SALES (except Swan products) ARE FINAL.
 • Defective items replaced or repaired at our discretion. • PA deliveries add 6% sales tax. • Prices and terms subject to change without notice.



TUSSEY COMPUTER PRODUCTS

WHETHER REPORT.

Whether you're a software developer writing new applications for the IBM or Mac, or a PC user securing proprietary data files, software and data protection has never had a brighter silver lining. For a number of very good reasons.

Beginning with the 'whether-expert' Rainbow Technologies. And ending with its Software Sentinel family of hardware keys. Starring five models that fit virtually any software program or data file you need to protect.

There's the best-selling SentinelPro for the IBM PC/XT/AT, PS/2 and compatibles, and even the Atari ST. Known worldwide for its virtually unbreakable security. And its ASIC technology. And its invisible operation. A close relation, the Sentinel-C stands at-the-ready for custom configurations and multiple software packages.

In the Apple market, security-minded Mac software developers turn to Eve. For completely transparent operation and world-class security of the protected software. Just by plugging Eve into the Mac ADB connector.

PC users wanting a low cost, user-friendly solution to the problem of securing sensitive data can call on the DataSentry. Using a proprietary Rainbow algorithm or DES, the DataSentry encrypts data files on individual PCs, protects modem transmissions and secures data on local area networks.

Rainbow's latest protection strategy is the SentinelShell—that lets users place a 'shell' around existing, off-the-shelf programs. Because access can be limited to those issued a key, libraries, universities and corporations can very simply guard their software investments.

Whatever your whether, Rainbow Technologies has the software and data protection products that make the difference. For more information, call 714-261-0228 in the U.S., or contact Rainbow Technologies Ltd. in the United Kingdom for the distributor nearest you. Whethercasters are standing by.

SentinelPro™

- Runs under DOS, OS/2 and Xenix
- Algorithm technique (Never a fixed response)
- External parallel port installation
- Minimal implementation effort
- Higher level language interfaces included
- 100 times faster than fixed-response devices (1 ms)
- ASIC design for reliability

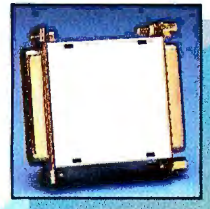

Sentinel-C™

- Protects multiple packages with one device
- 126 bytes of non-volatile memory programmed before shipment of the software
- Rainbow supplies a unique adapter for programming the unit
- Higher level language interfaces included
- Runs under DOS, OS/2 and Xenix
- External parallel port installation

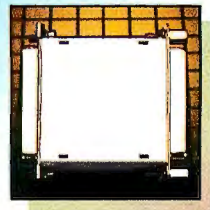

Eve™

- For the Macintosh SE and II
- Complies with Apple Desktop Bus Interface requirements
- Rainbow-assigned developer passwords to prevent tampering by other developers or sophisticated "hackers"
- 7 locks per key, usable individually or in combination, on one or up to seven applications



DataSentry™

- Completely user-installable
- Pocket-sized external device
- Menu-driven, user-friendly interface
- Single- or multi-user security system
- Audit trail, log-on identifiers and automatic encryption/decryption of entire directories
- Secures data transmitted by modems
- Prevents recovery of data by utility programs



SentinelShell™

- Runs under DOS on IBM PCs and compatibles
- Protects without requiring access to the source code
- Completely transparent to the end user
- User-friendly software
- Pocket-size key attaches quickly to any standard PC parallel port
- ASIC design for reliability



RAINBOW TECHNOLOGIES

18011-A Mitchell South, Irvine, CA 92714 • (714) 261-0228 • TELEX: 386078 • FAX: (714) 261-0260
Rainbow Technologies, Ltd., Shirley Lodge, 470 London Rd., Slough, Berkshire, SL3 8QY, U.K., Tel: 0753-41512, Fax: 0753-43610

© 1989 Rainbow Technologies. All product names are trademarks of their respective manufacturers.

Circle 235 on Reader Service Card (DEALERS: 236)



IBM'S VISION FOR YOUR OFFICE

Is OfficeVision a glimpse of the future, or a blast from the past?

When IBM announced its Systems Application Architecture last year, it was clear that the company had some sort of grand plan, but it wasn't clear what the plan was. With the announcement of OfficeVision, the first collection of software for SAA, the plan's outlines have begun to appear.

OfficeVision is a collection of programs that support common requirements, much like those supported by Borland's SideKick. Unlike SideKick, however, OfficeVision also supports E-mail through a LAN or a mainframe, and it has a programming interface that allows other vendors to integrate their software into OfficeVision. It also has an address book, a basic word processor, a phone dialer, and a filer.

Next year's version will add more features, including the ability to support outside software. OfficeVision will have the same graphical user interface as Presentation Manager (PM). Eventually, the product will be available on every computer that IBM sells.

So what does this tell us about IBM's plans for the future?

First, IBM is committed to the infusion of personal computers throughout its corporate base. Personal computers (IBM would prefer you to use PS/2s) are an integral part of OfficeVision. The indication is that future applications will require personal computers to reduce the load on the mainframe processor.

Second, IBM believes that the LAN is here to stay. LANs provide the bulk of the communications required by SAA, and the first version of OfficeVision will

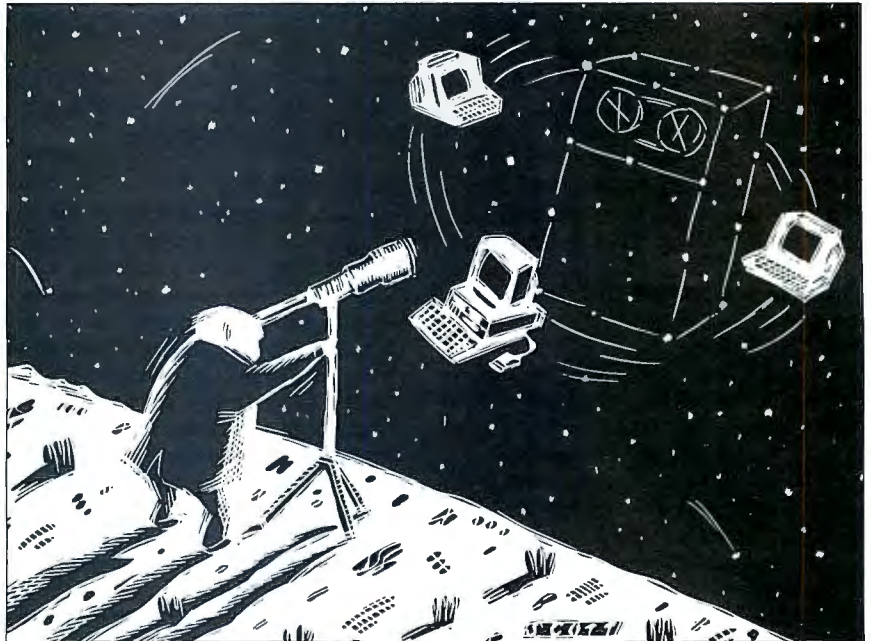

be a LAN product. In the future, LANs will be even more necessary to SAA than they are now.

Finally, IBM still has its eye on the continuation of the mainframe as the backbone of corporate computing. Ultimately, SAA depends on data residing on a mainframe. This means that IBM plans to have data managed centrally by a data-processing department.

Personal Processing

Even though there will eventually be versions of OfficeVision for IBM's mini-computer and mainframe lines, IBM introduced it first in the personal computer marketplace, partly because of OS/2, which was intended for this purpose. It's also because OfficeVision requires some hefty computing resources that are more readily available on personal computers.

The first versions of OfficeVision will look familiar to current users of PM or Windows. The graphical interface will be the same, and it will be controlled by a

mouse in the same manner. These processes are heavy users of the CPU, however, so it will take some time for IBM to tune them for use by terminals on their mainframes.

The first version of OfficeVision to be introduced will be called OfficeVision/2 LAN. The introduction for this version, scheduled for last month, should have taken place by the time you read this. This version is designed for machines using OS/2, and it will communicate with others using a Token Ring LAN. Later, there will be support for Ethernet when OS/2 Extended Edition 1.2 is shipped in January 1990.

LAN Connection

OfficeVision is designed to work with a LAN. The E-mail capability in the initial version depends on it, and future releases will depend on it more. As SAA and OfficeVision software progress through their development, they will depend on

continued

data stored on mainframes and mini-computers.

Currently, OfficeVision will support only IBM's Token Ring network. It's a safe bet that other companies, including 3Com and Novell, will find a way to support OfficeVision, too. In the meantime, OfficeVision/2 LAN will also quietly support DOS machines. IBM has worked with Consumers Software of Vancouver to develop MS-DOS workstation support for OfficeVision.

LAN usage becomes more critical with software such as Executive Decision/VM. This package is designed to run on both a mainframe running in a virtual machine environment and a personal computer running OS/2. Executive Decision is a true SAA application. It runs on the personal computer, but it uses a LAN to reach a mainframe where the data is actually stored. As a result, the personal computer never really has the data available internally. Instead, it extracts what it needs from the corporate database on the mainframe.

Central Storage

Eventually, this centralized storage is what IBM intends for the majority of the computing environment. There are some sound marketing and business reasons for this. Simply put, IBM's plan puts the corporate data-processing department in charge of the data again.

The concept is simply this: The personal computer would become an "intelligent workstation." Processing would be shared between the workstation and the central computer. While there may be some local data storage, most data would reside on the central mainframe. The SAA software on the workstation would find the data it needed, wherever it was. The user would never know where the data was kept or how it was found.

Let's say, for example, that you were working with employee records to determine pay raises for the next year. The information might come from personnel data on an AS/400, financial data from the corporation's 3090, and employee performance data from a database server on the LAN. The application would send out Structured Query Language (SQL) queries to each of the three databases.

When the response comes back, the software on the workstation will present it in a single picture. You would have no way to know that three computers were queried. In fact, you'd probably have no way to query those computers directly.

The data used for the queries would remain in its respective databases. It would not be transferred to the personal com-

ITEMS DISCUSSED

Executive Decision/VM \$7500
to \$45,000

OfficeVision/2 LAN

OS/2.....\$750
DOS.....\$210

OS/2 1.2

Standard Edition\$340
Extended Edition.....\$830

IBM Corp.

Old Orchard Rd.

Armonk, NY 10504

(914) 765-1900

Inquiry 1101.

puter, and the databases could not be manipulated unless that capability was given to a specific user.

Corporate Safety

From the viewpoint of the corporation's management, this change is a distinct improvement over today's situation, where the corporate data is spread among literally thousands of personal computers. There, the corporation has no way of ensuring that important data is safe and properly backed up. In addition, it has no assurance that the data is up-to-date or correct. Management decisions are being made with data that may be corrupted or outdated, and data vital to the operation of the corporation may be lost through something as minor as the failure of a \$200 hard disk drive.

Clearly, corporate management prefers greater control over the company's information than is frequently the case now. Unfortunately, until very recently, there has been no way to provide this. There simply weren't any good ways to consolidate the corporation's data so that it would be secure yet still available to personal computer users when needed.

Now that LANs and SQL have been teamed, that bottleneck is no longer a problem. Users can access a mainframe database almost as easily as they can access data on their personal computers. The only problem is that frequently the methods for doing so are proprietary.

The proprietary nature of these databases is, of course, part of IBM's plan. The idea is that you would have to buy an IBM brand of central computer along with your IBM PS/2. They would be linked by an IBM Token Ring LAN.

This process would continue as development of SAA continues. More and more applications would use central databases for all their data. This would include programs that today use mostly local storage, such as spreadsheets and

word processors. You would have the ability to draw from vast corporate resources, but you would be controlled by a central data-processing department.

From IBM's point of view, this is ideal. Companies would come to depend more and more on central mainframes, while at the same time buying more and more personal computers. Everybody benefits, except perhaps the user who may need something that IBM isn't selling. Particularly frustrated by this situation will be small businesses that don't have the resources to buy an IBM mainframe. Those users will simply be left out in the cold by IBM's solution.

Third Parties

Fortunately, there is a SQL world outside of IBM. SQL servers are available from Oracle, Ashton-Tate, Gupta Technologies, and WordTech. SQL databases are available for minicomputers and mainframes from a variety of sources besides IBM. In short, as the benefits of SAA become clear, there will be a way to achieve them outside of IBM.

In fact, most of the benefits of SAA can be achieved without using a central mainframe at all. LAN-based database servers will handle virtually all the same operations as a mainframe DBMS and will permit control of the database to remain with the individual department. New advances in data archiving will let these servers be protected and backed up in much the same way as a mainframe but without requiring a mainframe's staff.

Clearly, SAA has much to offer corporate users. Most important, it offers security of data. After all, the data does belong to the corporation, and it is in the corporation's interests to protect it. That this can be done without moving to IBM as a sole supplier probably ensures that it will happen all the faster. What is missing is a middle ground. Not everyone and not every company needs or can support a minicomputer or a mainframe. At this point, IBM's solution will freeze them out of SAA. ■

Wayne Rash Jr. is a contributing editor for BYTE and a member of the professional staff of American Management Systems, Inc. (Arlington, VA). He consults with the federal government on microcomputers and communications. You can contact him on BIX as "waynerash," or in the to.wayne conference.

Your questions and comments are welcome. Write to: Editor, BYTE, One Phoenix Mill Lane, Peterborough, NH 03458.



CompuStar II



IT EATS IBM'S LUNCH... AND SERVES DELL FOR DINNER!

Introducing Wells American's CompuStar II. It's one *hungry* machine. Feed it the toughest applications you can dish out and it's ready for "seconds" before IBM, Dell and all the others even get started.

IT FEEDS ON THE COMPETITION.

CompuStar II's enormous appetite for devouring the competition comes from its unique, modular design. Interchangeable, plug-in CPU "modules" are available in 80286, 80386SX and 80386 configurations.

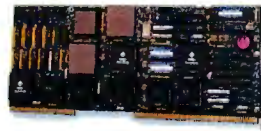

The modules are remarkably inexpensive — as little as \$750 for a '286 module, and incredibly powerful.* The 33MHz '386 module achieves a stunning MIPS rating! Best of all, for up to one full year after purchase, you can trade in the module you originally select toward the purchase of any of the other more powerful modules.

IT DEVOURS OTHER COMPACTS.

Unlike other small footprint micros, CompuStar II won't put your computer expansion needs on a diet. Each system features an amazing six bus slots — four of them available in a fully configured VGA system. That's 25% more than IBM or Dell gives you. Better yet, you can have up to 11 slots with CompuStar II's exclusive bus expansion chassis. No other compact system available offers this much room for growth. And no other comparably sized system can accommodate that growth better than CompuStar II.

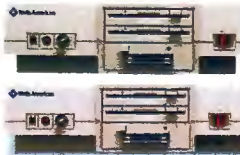

BUS EXPANSION CHASSIS

Its whopping 200 watt power supply gives you more than twice as much reserve power as IBM or Dell.

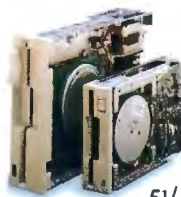

And CompuStar II has more room for disk/tape drives — *four* compartments in all; three accessible from the front panel. IBM and Dell give you just three compartments and only two are accessible from the front. CompuStar II also accommodates 5 1/4" and 3 1/2" disk drives. IBM and Dell restrict you to 3 1/2" drives only.

IT'S ALSO WELL-MANNERED.

Worried about quality and reliability? Don't! Wells American has been making PCs longer than IBM or Dell! Each CompuStar II is money back guaranteed for 31 days, factory warranted for a full year and can be field serviced from hundreds of locations worldwide.

When you think about it, buying an IBM or Dell system instead of our new CompuStar II is sort of like eating hamburger when you could have had steak — and paid less for it. CompuStar II. . .from Wells American. It makes "mincemeat" of everything else.

To receive a CompuStar II product information kit, call 1-803-796-7800. VAR inquiries also welcome.



Corporate Headquarters: 3243 Sunset Boulevard • West Columbia, South Carolina 29169 • 803/796-7800 • FAX 803/796-7029

IBM is a trademark of International Business Machines Corporation. Dell refers to Dell Computer Corporation.

*CompuStar II's CPU performance is so incredible you won't believe it! Call or write for complete benchmark information. Certified FCC Class A. For business use only.

Wells American Corporation 1989

Circle 286 on Reader Service Card (DEALERS: 287)



Is this your only route to mainframe information?



Escape to Autoware: NOW!

When you need mainframe access, why endure a frustrating labyrinth of screens? Especially when Attachmate software delivers simple single-menu access.

It frees you to select E-mail, transfer files and retrieve data with single-keystroke ease. It's so automated, we call it Autoware. So fast,

we had to call it NOW!

NOW! lets you customize menus for specific procedures or applications, such as



Attachmate Corporation 13231 S.E. 36th Street Bellevue, WA 98006 (206) 644-4010

NOW! and Autoware are trademarks of Attachmate Corporation

Circle 29 on Reader Service Card

unattended file transfer. Within minutes, even non-programmers can automate most repetitive mainframe chores.

Make mainframe access a direct path, not a mindless maze. Let Autoware do the work for you—NOW! Call for your free demo disk: 800-426-6283.



BREAKING DOWN THE BARRIERS

There are three approaches to linking PCs and Macs on a LAN—here's our favorite

There are many cultural barriers that make it difficult to integrate such diverse systems as Macintoshes, IBM PCs, Sun workstations, and DEC VAXes on a LAN. This month we look at a few of the issues you'll face and some products you might want to consider if you try to integrate the two most common types of microcomputers: PCs and Macs.

The first step toward PC-to-Mac communications is to connect the systems physically. You have two choices: You can use the Mac standard by buying LocalTalk boards for your PCs, or you can choose a common PC connection, Ethernet, and buy Ethernet adapters for your Macs.

Unfortunately, hooking up heterogeneous systems requires much more than just a physical connection. You've still got to make both systems speak the same language—which, in this case, is the same higher-level protocols. Those protocols are typically the ones that a LAN operating system provides.

Speaking the Lingo

A LAN operating system that integrates heterogeneous systems must follow one of three basic approaches.

In one method, the LAN can force one system to talk the lingua franca of the other. Apple's AppleShare PC follows this approach. You put a LocalTalk card in your PC and wire the PC to your Mac network, and then the PC can access files on the Mac AppleShare file server. The problem with this method is that one kind

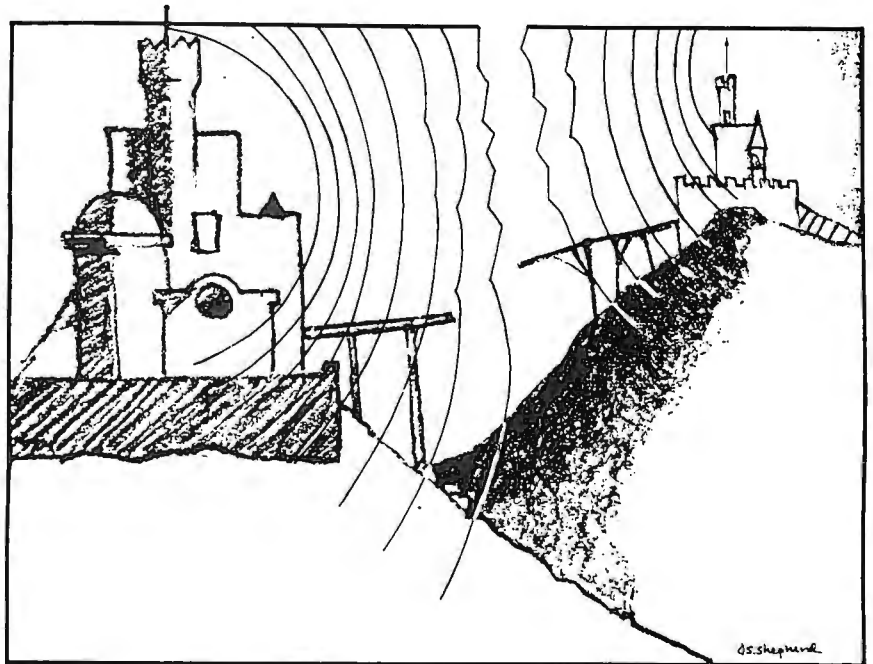

of system will need to abandon its native environment.

Another approach is to create a new LAN operating system, a sort of LAN Esperanto, and then implement that new system on both the Macs and the PCs. The TOPS LAN operating system, from Sun Microsystems, works this way. TOPS can run over either LocalTalk or Ethernet, and it doesn't require a dedicated server—both PCs and Macs can share files with the other systems on the LAN. The major drawback of this approach is that it typically doesn't use the native protocols of either system. TOPS, for example, doesn't presently support the AppleTalk Filing Protocol (AFP) on the Mac.

The third method is a compromise: Each system speaks its own "language," or native protocols, and a third party translates between those protocols. Novell's NetWare for Macintosh employs this technique. PCs use the NetWare LAN operating system, while Macs use

their standard AFP services.

We believe that this approach, which essentially says, "Stick with what you know, and let a translator do the work," is the right one for most applications. Since Novell has the best implementation of this approach so far, we'll take a closer look at NetWare for Macintosh.

NetWare for Macintosh

NetWare for Macintosh is a translator, or gateway, that runs in a NetWare 2.15 server. Because NetWare uses Novell's proprietary NCP (NetWare Core Protocol) protocols internally, this gateway translates between NetWare's IPX (Internet Packet Exchange) and the AppleTalk protocols that the Macs require. It has five main components.

The LAN board and its driver implement the LocalTalk or EtherTalk protocols and the actual hardware interface. While you install either board with NetWare's standard NETGEN program,

continued

neither one actually uses a valid NetWare LAN driver. Instead, NetWare never really sees the board. A NetWare Value Added Process (VAP) works with the board; NETGEN creates a stub for the hooks to that VAP.

The next component provides three of Apple's protocols—the Datagram Delivery Protocol (DDP), the AppleTalk Transport Protocol (ATP), and the AppleTalk Session Protocol (ASP)—on the NetWare server. NetWare for Macintosh needs these protocols to match the standard AppleTalk protocol stack. (See the July NetWorks column for more information on these protocols.) Next up the protocol stack is NetWare for Macintosh's AFP VAP. It uses these lower-level protocols to act just like any other AFP server. Macs on the LAN can't distinguish this AFP VAP from any other AFP server.

The final piece of the puzzle is the Service Protocol Gateway (SPG), which translates between AFP requests from the AFP VAP and requests in the NCP format. Once the requests are in the NCP format, NetWare NCP can handle them just as it would handle NCP requests from a PC.

Tracing the Path

The easiest way to understand how all these pieces work together is to look at an example. Consider a file request from a Mac. First, the Mac user brings up the Chooser, selects the NetWare for Macintosh server, and logs onto it. The server's icon appears, and the user treats it like any other disk; to get a server file, the user double-clicks on that file.

The Mac AppleShare client software then goes to work. It requests the contents of the file using AFP. The AFP packet flows down through the usual ASP, ATP, and DDP layers and finally ends up on the LocalTalk wiring.

When the packet reaches the NetWare server's NL1000 LocalTalk board, the server takes over. It sends the packet up through the driver, DDP, ATP, and ASP layers to the AFP VAP. The AFP VAP hands the request to the SPG, which translates it into an NCP request. NCP gets the file and sends the data back through the reverse path.

Icons and Resources

The beauty of this technique is that the Mac never knows that the file isn't on an AppleShare server. NetWare for Macintosh uses the standard AppleShare client software on the Mac.

Presenting that illusion isn't easy. One big difficulty stems from the way Macs

store files: A Mac file actually has two underlying files, a *data fork* and a *resource fork*. The data fork holds the file's data, while the resource fork contains such related items as icons and dialog boxes. Every Mac file must have these two components.

DOS files, of course, don't meet this requirement, and therein lies the problem. TOPS gets around this problem by using a Desktop file in every directory that contains the resource information for all the PC files in that directory. Similarly, NetWare for Macintosh uses a Desktop directory on the server to store the information for resource forks and icons for DOS files. Those files appear to the Mac user with a special DOS icon.

Print Services

AppleTalk also lets you share printers, so NetWare for Macintosh offers the same services. Instead of using an AFP VAP and SPG, however, it contains a corresponding AppleTalk Print Server (APS) VAP that lets a Mac user either queue print requests on the NetWare server or talk directly to the printer.

The APS VAP implements queuing by appearing to the Macs as a LaserWriter. When Printer Access Protocol packets from a Mac arrive at the server, they go up through the DDP and ATP layers to the APS VAP. The APS VAP then translates those requests into NetWare print queue requests. Then, when the NetWare print queue manager is ready to send a print request to the LaserWriter, it hands that request to the APS VAP. The APS VAP then acts like a Macintosh and sends the print job to the LaserWriter.

PCs can also use NetWare's standard printing facilities to queue up PostScript files for printing on the LaserWriter—so PCs and Macs can share a LaserWriter courtesy of NetWare's print queue.

Finally, Macs on the LAN can bypass the server and send print requests directly to the LaserWriter, although those requests will then not be in NetWare's print queue.

If a Mac user wants only the standard AppleShare client software features, then NetWare for Macintosh is happy to oblige. NetWare for Macintosh does, however, offer a few additional utilities for venturesome Mac users. The most interesting one is the Rights desk accessory, which lets Mac users manipulate NetWare's large set of file protections.

Almost There

With all these tools, you're almost done, but not quite. You still need applications that can either use files on both Macs and

PCs or at least translate files between the two systems. Currently, only a few such applications exist, although more are appearing all the time.

One such application is Microsoft Word. We had some PC Word files on our 80386-based Samsung NetWare server. We decided to go for the gold and started Word on the Mac on one of those files. No problem; the Mac Word program recognized that the file was from a PC version of Word, translated the file automatically—without losing any formatting—and we were in business.

Unfortunately, if we had tried opening a WordStar file from MacWrite instead, we wouldn't have been as lucky. The greatest integrated LAN operating system in the world isn't much good if your applications can't take advantage of files from different machines.

A Look Ahead

NetWare for Macintosh is impressive, but it does have a few problems. There are, for example, several bugs in the print spooling code. Other problems have prompted Novell to suspend product shipments temporarily. (The product would be shipping again by the time you read this.)

More frustrating, however, is the product's immediate future. The design of Novell's new NetWare 386 version 3.0 supports a cleaner integration of products, such as NetWare for Macintosh, than does the design of NetWare 2.15. Sadly, the initial release of NetWare 386 doesn't support NetWare for Macintosh. If you want both the new features of NetWare 386 and the power of NetWare for Macintosh, you'll have to wait.

Still, the next year should be a good one for products that link heterogeneous systems. Token Ring Mac boards are becoming available. Competition in the LAN operating-system arena will heat up as TOPS and 3Com bring out strong new offerings with AFP support. Finally, more and more major applications now offer both Mac and PC versions, with some way to share files between those versions. The barriers, it seems, are slowly falling down. ■

Mark L. Van Name, a BYTE consulting editor, and Bill Catchings are independent computer consultants and freelance writers based in Raleigh, North Carolina. You can reach them on BIX as "mvanname" and "wbc3," respectively.

Your questions and comments are welcome. Write to: Editor, BYTE, One Phoenix Mill Lane, Peterborough, NH 03458.



Our Printer Sharing Unit Does Networking!

An Integrated Solution

Take our **Master Switch™**, a sophisticated sharing device, combine it with **MasterNet™** networking software for PCs, and you've got an integrated solution for printer and plotter sharing, file transfer, electronic mail, and a lot more. Of course you can also share modems, minis, and mainframes or access the network remotely. Installation and operation is very simple.

Versatile

Or you can use the Master Switch to link any computer or peripheral with a serial or parallel interface. The switch accepts over 20 commands for controlling the flow of data. It may be operated automatically, by command, or with interactive menus. Its buffer is expandable to one megabyte and holds up to 64 simultaneous jobs. The

MasterLink™ utility diskette for PCs comes with every unit and unleashes the power of the switch with its memory-resident access to the commands and menus.

Other Products

We have a full line of connectivity solutions. If you just want printer sharing, we've got

it. We also have automatic switches, code-activated switches, buffers, converters, cables, protocol converters, multiplexers, line drivers, and other products.

Commitment to Excellence

At Rose Electronics, we're not satisfied until you're satisfied. That's why we have thousands of customers around the world including large, medium, and small businesses, factories, stores, educational institutions, and Federal, state, and local governments. We back our products with full technical support, a one-year warranty, and a thirty-day money-back guarantee.



ROSE
ELECTRONICS

Call now for literature or more information.
(800) 333-9343

Give a Rose to your computer

We develop products on the premise that



Page Laser12: 12 ppm, up to 3 paper bins, 750 sheet capability, Toshiba/Qume, Diablo, IBM & HP emulations.



T1000: 6.4 lbs, 4.77MHz 80C88, 512KB RAM expandable to 1.2MB. MS-DOS in ROM, 720KB 3 1/2" diskette drive. Built-in RGB, parallel, serial and external drive ports.



P341SL: Wide carriage (up to 270CPL), 216/72 cps, advanced paper handling, 4 part forms.



T1200FB: 9.8 pounds, 9.54MHz 80C86, 1MB RAM. 2 720KB 3 1/2" floppy drives, removable/rechargeable battery pack.

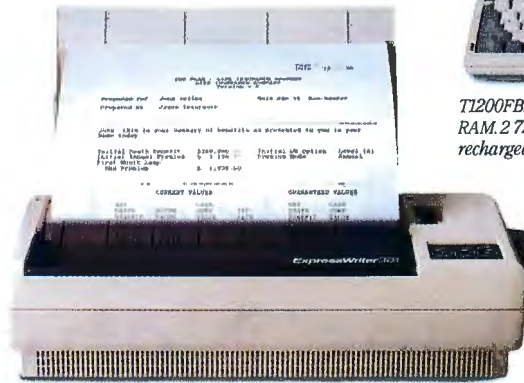

ExpressWriter 301: 4 lbs, letter-quality 24-dot print head, 60 cps, Toshiba/Qume and Epson LQ emulations, 5 resident fonts.



T3100e: 12MHz 80286, internal IBM slot, 20MB hard disk, gas plasma display, 1MB RAM expands to 5MB, 1.44MB 3 1/2" diskette drive.



T5100: 16MHz 80386 microprocessor, 40 or 100MB hard disk, 2MB RAM expandable to 4MB. 14.6 lbs. Built-in EGA display with high resolution gas plasma screen.



P351SX: 360/120 cps, 24-pin letter quality, color option, Toshiba/Qume and IBM emulations standard, Epson & Diablo emulations optional.

great minds don't think alike.



T1600: 11.6 lbs, Battery-powered 12MHz 286, 20MB hard disk, 1.44MB floppy, 1MB RAM expands to 5MB, backlit EGA LCD, removable/rechargeable battery packs.



T5200: 20MHz 80386 processor, 2 internal IBM compatible expansion slots, 40 or 100MB hard disk, VGA display with external VGA monitor port, 2MB RAM expandable to 8MB.



© 1989 Toshiba America Computer Systems Division

T3200: 12MHz 286, 2 IBM compatible slots, 40MB hard disk, 1.44MB floppy, 1MB RAM expands to 4MB, EGA screen.



Carrying cases: available in leather or fabric, make our portable PCs even more portable.



ExpressWriter 311: 24-pin dot matrix, 180 cps draft/60 cps letter quality, 3 resident emulations (Toshiba/Qume, Epson LQ, IBM Proprinter), 16K buffer, 5 resident fonts plus card slots, 11 lbs.

Numeric Keypad: full function, 15 or 17 keys, for many of our portable PCs.



T1200HB: 10.8 lbs, 9.54MHz 80C86, 20MB hard disk, 1MB RAM, includes 384KB LIM-EMS. Removable/rechargeable battery pack.



P321SL/SLC (color): 216/72 cps, 24-pin letter quality, up to 360x360 DPI graphics, Toshiba/Qume and IBM emulations standard, Epson and Diablo emulations optional, 32KB print buffer, front panel controls, advanced paper handling.

People have their own quirky ways of doing things. Some think fast. Some slow. Some are deliberate. Some intuitive. Some work from 9 to 5. Others never stop.

That's precisely why we offer so many different products.

Including the widest range

of truly portable PCs anywhere.

And a line of printers that includes everything from a high volume laser to a four-pound, letter-quality, battery-operated portable.

All of which can be easily networked. But all of which are designed to meet the specific needs

of each of our individual users.

Because the fact is, at Toshiba, we have an incredibly diverse and sophisticated customer base.

And from what we've been able to determine they have only one thing in common.

They're all different.

In Touch with Tomorrow **TOSHIBA**

Toshiba America Information Systems, Inc., Computer Systems Division

Circle 273 on Reader Service Card (DEALERS: 274)



The Optical Option

WORM and erasable optical drives offer practical solutions to large-scale storage requirements

Steve Apiki
and Howard Eglowstein

Optical storage technology sounds like science fiction, but using a laser beam to put hundreds of megabytes of data on a disk cartridge that fits into your hand has become a fact. Beyond the technology's Buck Rogers appeal lie practical, real-world devices that answer today's mass-storage requirements.

Optical drives—WORM (write once, read many times) and rewritable systems—are the most appealing, most elegant method yet devised for storing vast amounts of data. But these cutting-edge products have their limitations. Access times, while steadily improving, remain well behind those of magnetic drives. And the relatively high cost of optical drives has made them unacceptable for everyday use.

However, the current trend toward monstrous operating systems, shared databases, and more realistic visual images on disk may shift the economic balance in favor of optical storage. As files get ever larger, optical storage gets more and more appealing—no technology can compete with optical disks when you're measuring backup or even day-to-day requirements in gigabytes.

This month we focus on nine WORM and four rewritable optical disk drive sys-

tems available for both Macintosh and IBM PC-compatible computers (see table 1). All are full-height units that use 5¼-inch removable media cartridges with capacities of from 600 megabytes to more than 1 gigabyte. Many of the packages are resold versions of the same drive or controller bundled with different driver software. To make the most meaningful comparisons, we evaluated each product as a complete system.

WORMs vs. Erasables

WORMs and erasable optical drives both use lasers to pack information densely on a removable disk. But beyond that, they have little in common. The two technologies use different media, incorporate different recording and reading schemes, and have different uses (see the text box "Optical Technologies" on page 168).

WORM drives were the first type of writable optical storage device to become widely available; 5¼-inch drives were available as early as 1985. As the name implies, you can write to each disk only once, and you can't erase data stored on a WORM. This natural data permanence makes WORMs ideal devices for archival backups. They're well suited to situations in which permanent records are required by law; for example, an insurance company might use a WORM to save scanned reports. Another application might be at an engineering design firm that requires a permanent record of all design revisions.

Because of their huge capacity and relatively fast random-access retrieval capability, WORMs are also useful for general archival storage. While WORMs are, by nature, sequential write devices, vendors have gone to great lengths to make them emulate random-access write devices. As such, they're useful for incremental backups or for storing databases that must be regularly updated.

Erasable optical drives are a more recent development, and few are available. Erasable units are ideal for backups.

Since you can remove and reuse them, they provide virtually limitless storage capability. Although too slow to be direct replacements for magnetic disks, erasable optical drives are functionally equivalent, and you can use them with almost any applications software.

Unlike WORMs, where competing formats make data interchange a remote possibility, the prospects for a standard for rewritable optical disk technology look good. The International Standards Organization (ISO) is in the final stages of issuing a formal standard, and manufacturers are working toward conformance. ANSI has an identical standard on the table. Although standards will allow data interchange between different manufacturers' products, data interchange is all but impossible between currently available units.

The Speed of Light

We tested the WORM and rewritable drives on two platforms: a 20-MHz Compaq Deskpro 386 and an Apple Macintosh IIcx. We installed each drive according to the manufacturer's instructions. Some PC software provided for either a RAM or magnetic disk cache. Where possible, we accepted the manufacturer's default values for cache size.

Our tests examine optical drive performance in three areas: as a backup device, as a large general-purpose disk, and as a medium for document storage and retrieval. The raw results for each test are shown in table 2. Graphs of these results appear in the figure. The bars in each graph are normalized against magnetic drives running on the appropriate machine; on the DOS side, we used Compaq's 120-megabyte ESDI hard disk drive, and on the Mac we used the Mac IIcx's 80-megabyte internal hard drive.

For the backup test, we copied a large directory structure from the system's primary magnetic drive to the optical drive. The test data was a 25-megabyte

continued

**A collection of
WORM drives**

Left side: ISi 525GB,
LaserDrive 810-111

Center, top to bottom:
Maximum Storage APX-4200,
Pioneer DD-S5001, SDI
LaserStor 800, SDI LaserStor
for Macintosh, Corel 800

Right side: Corel 940,
LaserDrive 820-011



Table 1: Both WORM (write once, read many times) drives and rewritable drives are available in a range of capacities and prices. Unless otherwise noted, prices do not include media. Note that average access times provided by vendors didn't always correlate with our benchmark results in table 2.

	Operating platforms	PC subsystem price	Macintosh subsystem price	Cartridge price (double-sided)	Formatted capacity per side (megabytes)	Format method	Average access time (milliseconds)	PC utility software ¹
WORM devices								
Corel 800	PC, PS/2, Macintosh	\$3645 ²	\$3645 ²	\$145	400	CLV	168	Retrieval and backup
Corel 940	PC, PS/2, Macintosh	\$3695	\$3695	\$160	470	Modified CAV	90	Retrieval and backup
ISI 525GB	AT	\$6288	N/A	\$350	640	CAD	110	Retrieval and backup
LaserDrive 810-111	PC, PS/2	\$5495	N/A	\$200	405	CLV	175	None
LaserDrive 820-011	Macintosh	N/A	\$5995	\$200	405	CLV	175	N/A
Maximum Storage APX-4200	PC	\$4450	N/A	\$195	380	CAV	28	Version retrieval
Pioneer DD-S5001	PC, Macintosh	\$3895	\$3695	\$145	327	CAV	77	Retrieval and backup
SDI LaserStor for Macintosh	Macintosh	N/A	\$4999	\$150	366	CLV	168	N/A
SDI LaserStor 800	PC, PS/2	\$4495	N/A	\$150	393	CLV	168	Version retrieval, cache utilities
Rewritable devices								
AGA Discus Rewritable DR650	AT, PS/2, Macintosh	\$6495	\$6495	\$250	325	CAV	61	None
RACET Cosmos 600	AT, Macintosh	\$5645	\$5590	\$298	297	CAV	67	Security utilities
Sumo Systems RSSM600-B	PC, Macintosh, Sun, DEC VAX	\$4700	\$4500	\$260	297	CAV	50	N/A
Summus LightDisk-650	AT, Macintosh, Sun, DEC LSI, VAX, MicroVAX	\$6495 ²	\$5495 ²	\$250	297	CAV	132	None

CAD=Constant area density.
CAV=Constant angular velocity.
CLV=Constant linear velocity.
N/A=Not applicable.

¹ Utility programs in addition to drivers, format utilities, diagnostics, and other required software.

² Price includes media cartridge.

directory with many levels of subdirectories or folders and files of varying length scattered throughout. The PC tests used XCOPY to transfer the entire structure from the magnetic drive (see the backup write times in table 2).

Because WORMs can't erase data, they must use linked lists or similar schemes to point to file updates. This often results in longer read times for

successive versions of a file. Incremental backups, a typical use for WORMs, force this condition.

The backup read test incorporates incremental backups. It does a total of five XCOPYs from the optical drive to the magnetic drive, with a partial backup after each. The partial backup uses XCOPY/M to update the disk with 5 megabytes of unchanged files. We timed

each XCOPY of the full directory from the optical drive to the magnetic disk and averaged the results.

As a check on the efficiency of directories, we timed searches through the data structure for a nonexistent file, using the Whereis utility from Apple's Macintosh Programmer's Workshop (MPW) 3.0 on the Macintosh and a BYTE Lab utility on the PC.

Macintosh utility software ¹	Operating-system compatibility
Version retrieval	MS-DOS 3.0+, Mac OS
Version retrieval	MS-DOS 3.0+, Mac OS
N/A	MS-DOS
N/A	MS-DOS 3.0 - 3.3
None	Mac OS
N/A	MS-DOS 3.0+
Version retrieval	MS-DOS 3.0+, Mac OS, Novell
Version retrieval	Mac OS
N/A	MS-DOS 3.0-3.3, Compaq DOS 3.31
N/A	MS-DOS 3.0+, Mac OS, OS/2
Security utilities	MS-DOS 2.0+, Mac OS, TOPS, AppleShare, Novell Advanced NetWare/286 2.15
None	MS-DOS 2.0+, Mac OS, BSD Unix 4.0, VMS
None	VMS, VAXELN, Ultrix BSD UNIX 4.3, RT-11, RSX-11, RSTS/E MUMPS, Mac OS 4.2+, System V, MS-DOS 3.0+, Sun OS 3.5+

The Macintosh provided us with a particularly interesting challenge: The operating system has no equivalent to XCOPY. The Macintosh Finder has no provision for incremental copies. Simply clicking on the structure and dragging it from one disk to another will do the initial copy, but that's all.

The Finder still retains a few bugs that have been hanging around for some time.

Trying to click and drag on our 25-megabyte structure resulted in repeatable Finder errors; the Mac kept complaining that some files were unreadable. Checking back, we found that a Mac SE with System 4.1/Finder 5.5 produced the same results as our Mac IIcx's copy of System 6.0.3/Finder 6.1. We completed the backup tests with the Backup facility in MPW.

If you were to open a large database file on a magnetic disk and make updates to it, the modified file would take up the same amount of space as the original. WORMs, on the other hand, must allocate new storage sectors to replace the old. Despite the wasted sectors, judicious updates on a large file can still be a legitimate use for a WORM drive. We tested the random-access capability of both WORMs and magneto-optical drives with a 20-megabyte database and a test program written in dBASE III Plus 1.1.

For each of five iterations, we made simple modifications to every one-hundredth record and then performed a nonindexed search. After indexing the data, we performed the same search in indexed mode. Table 2 shows the times for the sequential search and the index; the indexed search is not shown because it took too little time to yield meaningful results. FoxBASE+/Mac 1.0 took the same script that we used on the PC and executed it flawlessly on the Macintosh.

Our third test simulates drive use in a storage/archival application. An example would be the archiving of digitized claim forms in an insurance company. We digitized a full page of graphics at 300 dots per inch and stored it on the drive as a TIFF file. Using the image editors that come with Hewlett-Packard's Scanning Gallery (for the PC) and the Apple Scanner (for the Mac), we made four simple modifications to the image, saving it under the same filename between each modification. We noted the times for each read and subsequent file write.

This test allowed us to try out another exciting feature of WORM technology: the ability to retrieve old versions of previously deleted or updated files. Those drives equipped with version-retrieval software made it possible to retrieve the original file as well as the intermediate modifications. Generally, getting these older versions back involved running a special utility to return the directory system on the drive to the state that it was in immediately after the desired version was written. Rewritable drives lack the capability to retrieve previous versions.

Our last test was a qualitative evalua-

tion of MS-DOS compatibility. The test program simply sequenced through a series of calls, trying each of the MS-DOS INT 21H disk functions. We'll discuss exceptions to the generally high degree of compatibility in the product overviews that follow.

The WORMs

In evaluating optical drives, capacity and speed are key considerations; but price, software capability, and efficient use of media often play important roles as well.

Your anticipated storage requirements are important; if you have a good idea of how much space you'll need, you'll be able to make an accurate price comparison based on cost per megabyte. If you plan to use an optical device for other than archival storage, consider whether you will need to back up the optical disk itself. Finally, if you need an optical device to back up your Macintosh, make sure that the backup software you select has the capabilities that you need.

Corel 800

Corel Systems is primarily a software company, but it bundles a variety of manufacturers' drives with its software and third-party interface cards to form complete drive subsystems. The Corel 800 subsystem uses the 800-megabyte Ricoh WORM drive and is available for both DOS and Macintosh environments; both versions cost \$3645.

On the PC, the system includes a Future Domain SCSI card and cable. Setup and installation are straightforward: Corel provides both a comprehensive, but generic, software and installation manual and a slim installation guide with Ricoh-specific details. The software manual also includes an in-depth programming section.

The Corel drive was the slowest WORM we tested on both the PC and the Macintosh, but it responded properly to all the DOS 3.3 disk calls we tried.

Corel's DOS driver maintains a small disk cache in system memory. We tested with the default cache size (four sectors), but the size is user-selectable. The driver takes care of the physical-to-logical-sector mapping required to make the optical drive look like a random-access write device. When DOS requests a sector write, the driver maps that sector to a physical sector and updates the translation tables. The translation tables make it possible to rewrite logical sectors even though you can't modify physical sectors. The software writes the translation tables to disk every so often as part of its *history*

continued

Table 2: Benchmark times (in minutes:seconds) for WORM (write once, read many times) drives and rewritable drives. We've included benchmarks for the Compaq Deskpro and Mac IICx magnetic drives for comparison. Optical drives, on average, took about twice as long as magnetic drives to complete the same task. (See the figure for corresponding graphs.)

	25-Mb backup write	25-Mb backup read	Directory search	50,000- record database search	50,000- record database index	1-Mb image write	1-Mb image read
PC tests							
WORM devices							
Compaq 120-megabyte ESDI disk drive	10:43	7:22	0:11	2:01	9:00	0:11	0:12
Corel 800	35:21	20:57	0:23	16:48	37:46	1:16	1:39
Corel 940	14:12	11:13	0:09	6:10	13:28	0:16	0:14
ISi 525GB	50:40	12:35	0:13	4:11	10:51	0:25	0:11
LaserDrive 810-111	21:16	17:37	0:19	16:23	24:49	0:23	0:22
Maximum Storage APX-4200	17:04	13:40	1:18	N/A	N/A	0:19	0:11
Pioneer DD-S5001	15:03	12:33	0:13	7:36	14:25	0:18	0:15
SDI LaserStor 800	46:02	33:51	0:14	18:17	29:34	1:37	0:20
Rewritable devices							
AGA Discus Rewritable DR650	26:29	8:22	0:05	3:35	8:39	0:15	0:11
RACET Cosmos 600	39:54	12:51	0:12	6:42	15:04	0:29	0:14
Summus LightDisk-650	34:55	14:26	1:00	17:24	45:04	0:16	0:10
Mac tests							
WORM devices							
Macintosh IICx 80-megabyte hard disk drive	12:26	3:56	0:09	1:26	2:52	0:11	0:01
Corel 800	30:07	7:50	3:36	13:03	15:05	1:44	1:37
Corel 940	12:39	4:48	1:02	5:18	6:10	0:21	0:18
LaserDrive 820-011	29:57	4:06	0:26	8:34	8:21	3:44	0:17
Pioneer DD-S5001	13:01	4:31	1:49	5:57	6:38	0:19	0:19
SDI LaserStor for Macintosh	29:54	7:36	2:28	12:56	14:07	1:47	1:31
Rewritable devices							
RACET Cosmos 600	25:29	5:50	1:46	3:51	4:48	2:52	0:13
Sumo Systems RSSM600-B	25:44	5:45	1:44	3:50	4:39	2:48	0:13
Summus LightDisk-650	19:02	4:06	0:25	3:39	4:31	1:01	0:13

N/A=Not applicable.

markers. It updates these markers after a given time interval or after a number of write requests have transpired.

History markers make it possible to recover older versions of updated files. Corel's History utility lets you return to old versions either by specifying filenames or by locating any previous history markers. While this allows you to read old versions, you can't write to the cartridge in that state. If you need write access to an old file, you must make the old history marker current; this returns all files on the disk to the state they were in when that history marker was written. Except for Maximum Storage's APX-4200, all WORM version utilities work in a similar fashion.

Corel also provides diagnostic, format, and miscellaneous drive utilities. DOS patch software lets you use large

partitions with larger sectors. Particularly useful is a set of programs that let you back up, restore, and verify directories. Corel saves all backups to single files on the optical drive. This is more efficient than using a series of small files, given the large cluster size.

The Corel 800 installs easily on the Macintosh as well. As with most Macintosh peripherals, you connect it to the Mac with a standard 25-pin-to-50-pin SCSI adapter. The required SCSI terminators are built into the drive itself, and the SCSI bus design lets you connect up to six external devices to the Mac's connector, as long as the devices have the two connectors required for daisy chaining peripherals. The Corel 800 has only one connector. If you plan to use the Corel drive in conjunction with other SCSI devices, plan on placing the Corel

at the very end of the daisy chain.

On the Macintosh, the WORM Tools utility provides the commands you need to reactivate the history markers. It gives you a list of all the markers by date, but it lacks the convenient list-by-file functions of the PC software.

Using the standard Mac interface, you simply select a point in time, and the software restores the disk to its earlier status. Your drive will reappear on the Mac Desktop in a write-protected state. You then copy the files you need back onto your hard disk and deactivate the history marker. Tools also gives you functions to set various operating parameters in the device driver.

Other software provided with the Corel Mac package includes WORM Format, the formatter and partition program;

continued

We Just Added Two New Dimensions To Erasable Optical.



Speed And Capacity.

Its speed is Winchester class.
Its capacity breaks the gigabyte barrier.
It's the new LaserStor™ Erasable Optical.
And its time is now.

No other erasable optical subsystem
can touch these specs. 35 ms average seek
time. 10 Mbits/sec average transfer rate.
One gigabyte removable cartridge capacity.

The reason? We've built LaserStor
around Maxtor's revolutionary Tahiti™ I
magneto-optical technology.

We've also built LaserStor to
work across the board. In PC/MS-DOS,
Macintosh® and Novell® environments.
In single- and dual-drive configurations.
Completely documented and supported,
plug-and-play, right out of the carton.

Get the added value you've been
expecting from erasable optical. With the
added dimensions only Storage Dimensions
can deliver. Call us at
(408) 879-0300.



STORAGE DIMENSIONS

A MAXTOR COMPANY

2145 Hamilton Avenue San Jose, CA 95125



LaserStor is a trademark of Storage Dimensions. Tahiti is a trademark of Maxtor Corporation. ©1989 Storage Dimensions

Circle 261 on Reader Service Card (DEALERS: 262)

OPTICAL DISK DRIVE BENCHMARK TESTS*

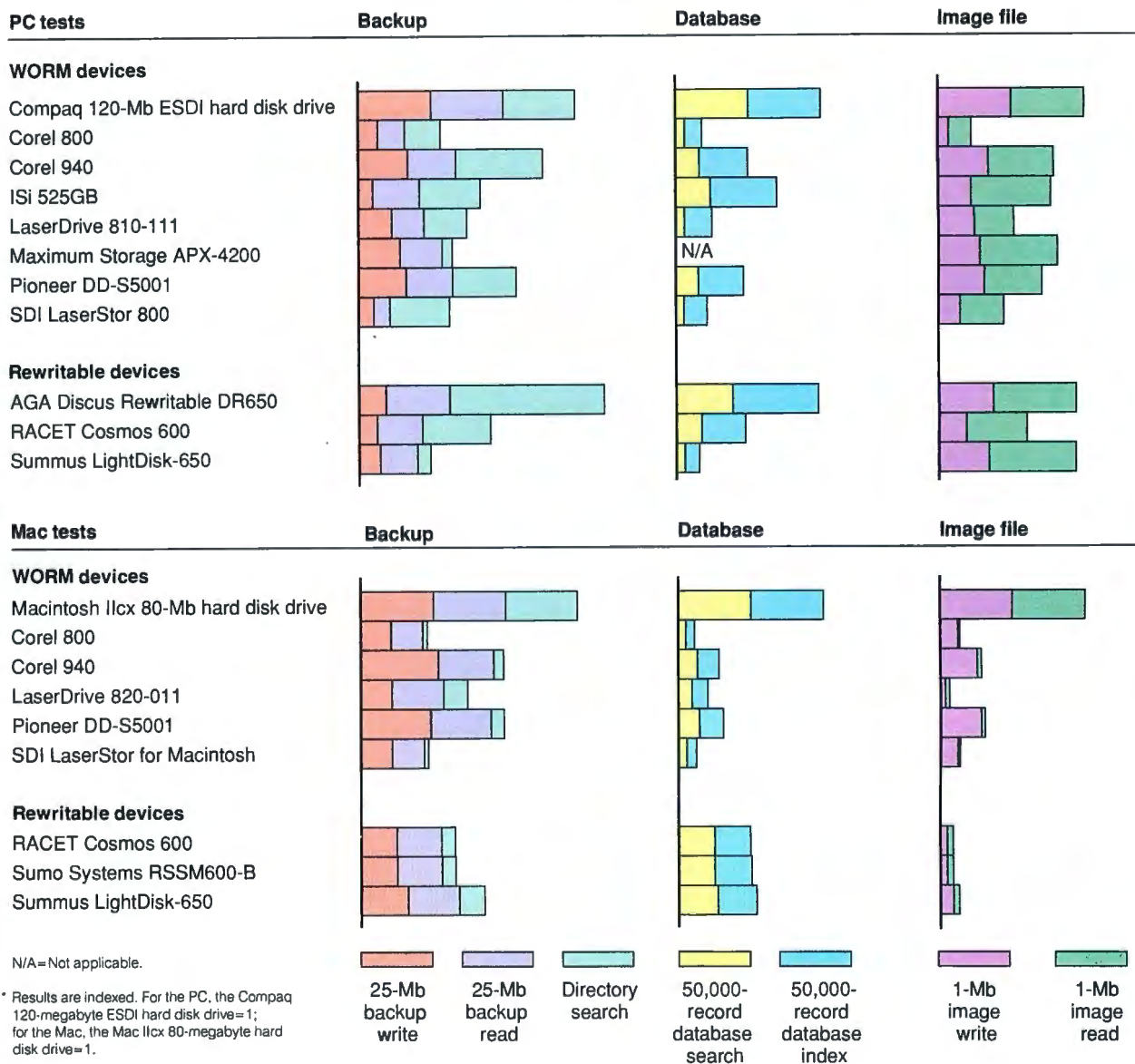

Graphs show each drive's relative performance in a suite of typical optical disk applications. We ran all tests on a Compaq Deskpro 386 and a Macintosh IIcx. For ease of comparison, we indexed our PC platform results to the Compaq's 120-megabyte ESDI hard disk drive, and the Macintosh platform results to the Mac IIcx's 80-megabyte internal hard disk drive. We stacked the results to conserve space; they do not represent a meaningful cumulative result. Shorter segments show better performance. The Corel 940 and the Pioneer WORM drives were consistently fast, while, among erasable drives, those from AGA and Summus split the PC and Macintosh environments.

WORM Diagnostics, for checking the operation of the WORM drive; and an INIT for the Mac's System Folder.

Corel 940

The Corel 940 is a 940-megabyte Panasonic WORM bundled with a Corel interface kit. Both the PC and Macintosh subsystems sell for \$3695. The Corel 940's

modified CAV format allows the drive to pack data at a high density without sacrificing speed. (For an explanation of CAV, CAD, and CLV formats, see the text box "Optical Technologies.")

While the software description for the Corel 800 is entirely applicable to the Corel 940, the hardware makes for a sharp contrast in performance. The

Corel 940, with far better seek-time ratings, easily outperformed the Corel 800. On the PC, in fact, the Corel 940 was often the fastest drive we tested.

This drive is also one of the fastest WORMs on the Macintosh. We liked the external SCSI selection switch on the back panel and the daisy-chainable dual

continued

Everything OS/2 can do for you...

OS/2™ includes a built-in graphical interface so it's easy to use.

OS/2 lets you run your DOS programs plus hundreds of programs DOS can't.

OS/2 lets you run programs larger than 640K, so you can use more powerful applications.

OS/2 lets you take full advantage of Micro Channel.™

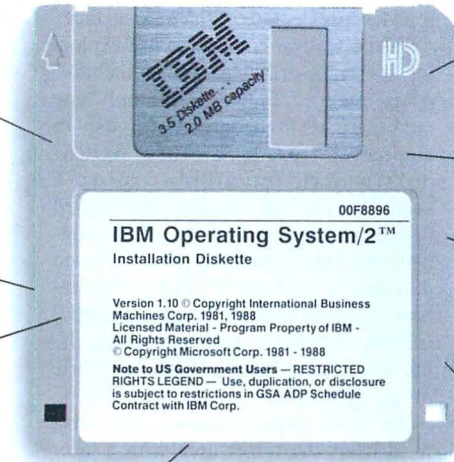

OS/2 provides an optional Communications Manager which allows easy networking.

OS/2 lets you keep two or more programs running at the same time, so you can do more.

OS/2 lets you take advantage of 386™ power.

OS/2 provides an optional Database Manager to make managing information easy.

This offer lets you do for less.

Right now, when you choose OS/2, you can get from \$100 to \$1,600 back on the kind of heavy duty memory that only OS/2 can handle. With this offer, the more memory you buy (up to 8Mb), the bigger your rebate.

Plus you can get thousands of dollars in rebates on over 100 different OS/2 programs. You can also get hundreds of dollars back on modems, accessory cards and hardware—all the things that help you do more work in less time with OS/2.

So if you're ready to move up to all the real advantages of OS/2, ask your IBM Authorized Dealer about these rebates today. To find the dealer nearest you call 1 800 IBM-2468, ext 128.



Optical Technologies

Ask several vendors how optical disk technology works, and you're likely to get several different answers. In addition to variations in disk format, vendors use a variety of media types, recording techniques, and rotation schemes, each of which has its own unique advantages and disadvantages. Here, in a nutshell, are the basic technologies used in WORM (write once, read many times) drives and rewritable optical disk systems.

WORM drives are made up of a layer of recording material sandwiched between two plastic plates. The double-sided disk requires two recording layers. WORMs in this review use one of two recording materials: tellurium alloy or dye-polymer. These have excellent life expectancies of from 10 to 15 years, but WORM media technology is too new to have proven its durability in real-world use. Tellurium alloy is by far the most common recording material; six of the nine WORM drives we tested use it. Dye-polymer, used in the units from Pioneer and Storage Dimensions, Inc. (SDI), is cheaper to manufacture than tellurium-based products, and projected lifetimes are slightly better.

All the WORMs we tested except the Corel 940 use a recording technology known as *ablative pit*. They record by focusing a high-powered laser through the plastic layer to burn a hole in the recording material. The presence or absence of these burned pits represents data bits. To read back the data, the same laser shines a low-power beam on the media, and a photosensor detects reflectivity changes between the pits and the untouched surface. This rather complex process requires an expensive and heavy head assembly, and these drives provide only one head each; to access different sides of the disk, you must remove the cartridge, flip it over, and reinsert it.

The Corel 940 WORM uses a similar technique, but instead of burning a hole, the drive laser modifies the structure of the recording medium so that it changes

the phase of reflected light. The drive detects phase changes in light from the read laser reflected off the disk surface.

While several companies are exploring different erasable optical technologies, magneto-optical is the only one currently refined enough for use in commercial products. Like WORM disks, magneto-optical disks consist of a layer of recording material sandwiched between two plastic disks. The magnetic recording material of an unused disk has a uniform magnetic orientation. At room temperature, the material is insensitive to normal magnetic fields, but at high temperatures (past its "Curie point") you can alter it magnetically.

To write on this material, the drive head heats the target area with a laser and applies a magnetic field to reverse the orientation of the target area. Once the material cools, it retains the reversed magnetic orientation; thus, the drives can represent data bits by varying magnetic orientations within the disk.

Erasing and rewriting data requires two passes. On the first pass, the head simply heats the target area and applies a uniform magnetic field to return the target area to its original orientation. The second pass writes the new data. The drive reads data by focusing a laser beam at the recording layer. The polarity of the reflected light changes according to the magnetic orientation of the disk (this is known as the *Kerr effect*). The drive detects reflected polarity and uses it to distinguish spaces from marks. Like WORM drives, magneto-optical drives can access only one disk side at a time.

Capacity vs. Speed

Optical drives use different rotation schemes and track organization to optimize access time or disk capacity. The two most common are constant angular velocity (CAV) and constant linear velocity (CLV). Like magnetic drives, CAV devices maintain a constant rotational speed. Since the data rate at the head is always constant, all tracks must

contain the same amount of information. Although the outer tracks are longer, they can contain only as much data as the shortest (innermost) track. As a result, CAV disks waste potential disk capacity.

CLV drives maximize capacity, but they're more complex and generally slower than those using CAV. They vary the rotational speed of the disk to maintain constant velocity of the head over the disk, whether on an inner or an outer track. CLV drives, therefore, can pack the entire drive at the highest data density that the disk can support.

Corel's 940 and Information Storage, Inc.'s (ISI) WORM drives use two other methods, modified CAV and constant area density (CAD), respectively. Modified CAV, a CLV-CAV hybrid, involves splitting the disks into several concentric regions. Within each region, the disk spins at a constant rate; the rate increases for regions located nearer the outside of the disk. This method achieves high data density, and control is not as complex as when using CLV.

ISI's CAD drive is essentially CAV, but it puts an interesting spin on the technique by interleaving data tracks. The result is a honeycomb pattern of data bits with nearly the same data density on outer and inner tracks. For the user, this means very high capacity combined with good performance.

In addition to different rotation methods, optical drives use different methods for organizing tracks. Only ISI, Maximum Storage, and the Corel 940 use the concentric tracks familiar to magnetic disk users. This scheme results in relatively short seek times but suffers when the drive must transfer large amounts of information (i.e., when there are multiple tracks). The rest of the manufacturers chose a spiral track organization, where all data is arranged in a long continuous groove, as on a phonograph record. While this method is more efficient for sustained transfer, it's also slower at finding a randomly selected sector.

SCSI connectors. Most of the WORM drives that we tested automatically ejected the cartridge when we dragged the drive's icon into the trash. The Corel 940 has a manual cartridge eject.

The Macintosh software is standard Corel fare—formatting, diagnostics, and

version-retrieval functions, as with the Corel 800. It's an excellent choice, especially if you want more storage.

ISI 525GB

At 640 megabytes per side, Information Storage, Inc.'s (ISI) 525GB was the larg-

est-capacity drive for the PC that we tested. For \$6288, the system includes a drive, a Western Digital SCSI controller card, and software. The unit also includes dual SCSI connectors for daisy chaining.

continued

Breakthrough \$899 Offer—Now You Can Drive CD-ROM

For a limited time Compact Disk Products (CDP) is packaging the state-of-the-art NEC CD-ROM drive with Microsoft's most popular CD-ROM software:

Package A—For \$899, includes **Microsoft Bookshelf**, a coupon to purchase both **Microsoft Stat Pack** and **Microsoft Small Business Consultant** for only \$50 each, a **FREE** copy of **CD-Play Demo** and **FREE** Federal Express delivery.*

Package B—For \$1189 also includes **Microsoft Programmer's Library**

YOU SAVE OVER \$750!

Buy CD-ROM now! CDP sells over 200 quality CD-ROM titles for libraries, schools, legal and medical professionals, programmers, and many others. Over 25 new titles are being published each month. With IBM, NEC, and HP announcing new CD-ROM based PC's or Mini's, a CD-ROM drive is becoming as necessary as a floppy drive.

"I believe more than ever that CD-ROM products will be a major force in the expansion of the information industry." **Bill Gates.**

CDP is the largest specialized supplier of CD-ROM products in the U.S. Since 1987, CDP has supplied you with prompt service and expert advice...at the best prices. CDP is committed to CD-ROM and it shows. Our Unconditional Guarantee is unmatched. Our free Federal Express delivery is an industry first. Call now and tomorrow you will be driving these power CD-ROM products.

Circle 55 on Reader Service Card

UNCONDITIONAL GUARANTEE

- 1) If FOR ANY REASON you are unhappy with your purchase you may return it within 30 days for a FULL REFUND.
- 2) During the 90-day NEC warranty period CDP will ship replacement drives overnight.

ORDER NOW! 800-MEGABYTE (634-2298)

(Order line open M-S, 9AM-9PM EST)

Fax Orders 212-737-8289 • Inquiries/Free tech. Support 212-737-8400

DEALER INQUIRIES WELCOME

FREE CD-ROM: Mail in your order coupon and receive the CD-ROM Source Disk FREE. Includes demos of many popular CD-ROM products and retails for \$89.

*Federal Express delivery free for phone/fax orders within continental U.S. only.

Please send the package I've checked below.

Package "A"—Complete NEC CD-ROM drive kit (internal or stand-alone) plus **Bookshelf** and **CD-Play Demo** (includes a coupon to purchase both **Stat Pack/Small Business Consultant** for \$50 each) for only \$899!

Package "B"—Complete NEC CD-ROM drive kit (internal or stand-alone) plus **Bookshelf**, **CD-Play Demo** and **Programmer's Library** (includes a coupon to purchase both **Stat Pack/Small Business Consultant** for \$50 each) for only \$1199!

Please send the following drive configuration with my order:

- Stand-alone NEC CDR-77; Select PC/XT/AT/386
or Microchannel

- Internal NEC CDR-80(PC/XT/AT/386 Only)



Microsoft

NEC

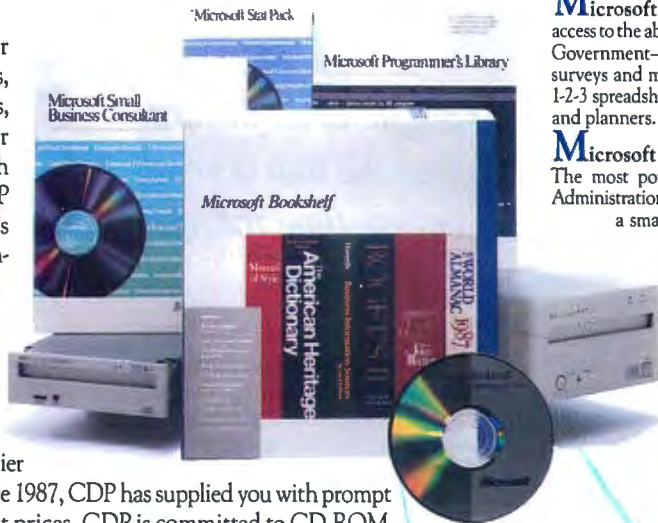

NEC CD-ROM drives (retail \$1198): Once again NEC has established an industry standard. Using 64K buffers (older drives use 8K) NEC delivers the speed users demand. Each drive includes full audio CD hardware (accessible with CD-Play Demo). The CDR-77 stand-alone drive also operates with Macintosh computers (\$99 interface kit required).

Microsoft Bookshelf (retail \$295): An indispensable collection of writers' references for word processor users. This is the most popular CD-ROM title published. You get instant access to: **The World Almanac, Chicago Manual of Style, Bartlett's Familiar Quotations, Roget's II: Electronic Thesaurus, American Heritage Dictionary, Business Information Sources, The U.S. Zip Code Directory, Houghton Mifflin Spell Checker and Usage Alert** and more! All Microsoft CD-ROM's are RAM resident and include powerful cut and paste features for popular word processing packages.

Microsoft Stat Pack (retail \$125): Now you have easy access to the abundance of statistics published by the Federal Government—census data, business statistics, agricultural surveys and much more, plus Microsoft Excel and Lotus 1-2-3 spreadsheet files for all tables. A must for marketers and planners.

Microsoft Small Business Consultant (retail \$149): The most popular publications of the Small Business Administration and Deloitte and Haskins and Sells on running a small business. Answer tax, accounting, legal, personal, and financing questions in an instant. A gold mine for businessmen, accountants, and consultants.

Microsoft Programmers Library (retail \$395): All the critics are raving "...a masterpiece of simplicity and function." **PC World**, May '89. A complete library (over 20,000 pages) of the latest releases of Microsoft's Technical Reference Manuals covering OS/2, Windows MS-DOS, C, MASM, etc. with 8 megabytes of source code.

Also includes **FREE CD ROM** Networking software. PC Professionals need this NOW!



Compact Disk Products, Inc.

223 East 85th Street, New York, New York 10028
(212) 737-8400

- Please send me a free CDP Encyclopedia of CD-ROM Products
 Corporate / personal check money order enclosed
Charge my (circle one) American Express Optima VISA
MasterCard Diner's Club

Acct. # _____ exp. date _____

Signature _____

Name _____

Company _____

Address _____

City/State/Zip _____

Phone _____

Prices include Federal Express shipping and handling.

New York residents add 8.25% sales tax.

Now! Get
Use Your CD-ROM Drive
as an Audio CD Player!

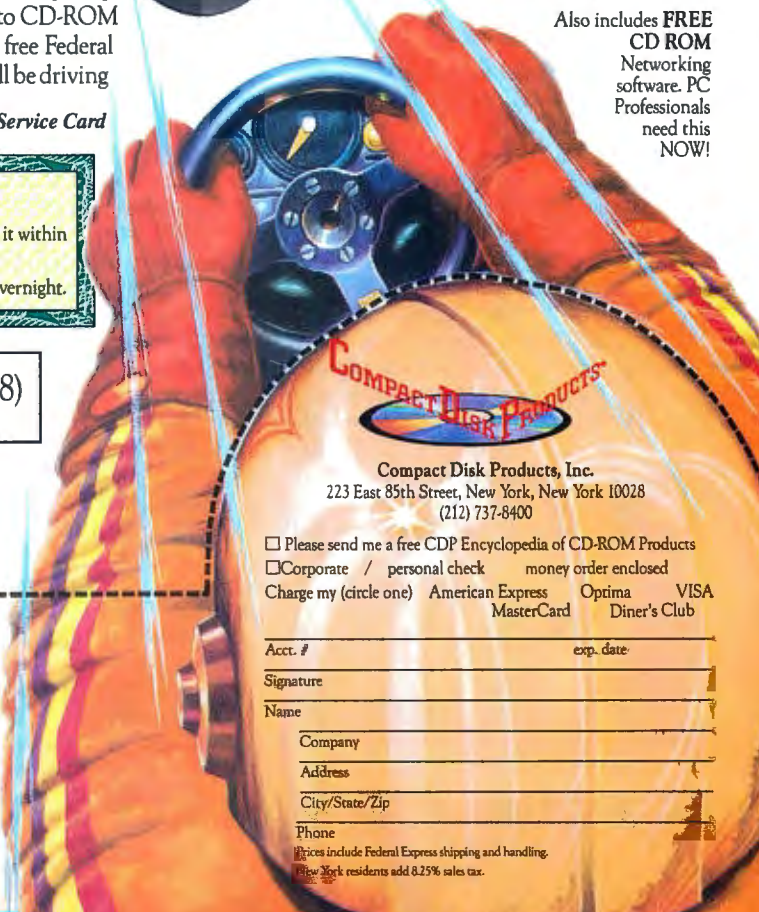

ISI's unique CAD format gives the unit a good access-time rating and respectable performance, especially considering its high capacity. The drive performed well on our benchmarks, often finishing at or near the top of the list.

The drive uses the DOS file system and simply looks like a logical block device to DOS. It maintains block-update information on disk, so you won't lose any data in a sudden blackout. All DOS disk-function calls worked smoothly.

ISI's WORM-TOS PLUS software includes a DOS patch (for larger sectors and partitions), a partition editor, and Back Track version utilities. The driver and patching software allow for up to 640-megabyte partitions. The Back Track utility suffers from a clumsy user interface but was able to recover older file versions without problems.

Overall, the 525GB is an excellent drive. It's fast and fully DOS-compatible, and it has outstanding capacity. Unfortunately, both the drive and media are relatively expensive.

LaserDrive 810-111

LaserDrive sells two nearly identical WORM drives, the 810-111 for DOS machines (\$5495) and the 820-011 for the Macintosh (see below). The LaserDrive 810-111 media offers 405 megabytes per side, with interface cards available for both PC and Micro Channel machines. A second SCSI connector and external-device-select thumbwheel allow you to daisy chain other SCSI devices off the LaserDrive.

The LaserDrive was the largest drive we tested. It stands about 15 inches tall. While most of the test units were designed for desktop use, the LaserDrive can stand comfortably on the floor, freeing up valuable desk space.

The 810-111 had the worst access-time specification of the units we tested. But the system as a whole outperformed several drives with better ratings, turning in a moderate performance overall.

The drive uses the DOS file system and acts like a standard device driver disk. It emulates random-access writes by keeping logical address markers with each sector on the disk. The drive keeps a logical history in a reserved area on disk to keep track of current versions. It executed all the DOS test functions perfectly.

Installing both the hardware and software components was simple, and we had no trouble operating the drive. The driver makes it possible to have disk partitions as large as one disk side. Other software for the LaserDrive 810-111 is

quite sparse; there are diagnostic and format utilities, but there is no provision for retrieving outdated versions.

LaserDrive 820-011

The \$5995 LaserDrive 820-011 for the Mac includes driver/utility software and a cable, and it uses the same cartridges and drive as the LaserDrive 810-111.

In our benchmark tests, the Laserdrive 820-011 did well on the backup read test, behind the Corel 940, the Pioneer DD-S5001, and the rewritable Sum-

 *Si's
unique CAD format
gives the unit a good
access-time rating.*

mus LightDisk. But the LaserDrive's poor performance on the 1-megabyte image retrieval tests suggests that it's best used for backups or for storing large files.

The Mac OS has some difficulty calculating the actual amount of remaining space because of rewritten sectors. The utility software provided with the drive includes a desk accessory that displays the amount of rewritable space remaining on the drive. Formatting cartridges is simple: You just click on INITIALIZE in response to the standard Macintosh "This disk is unreadable" alert box.

Maximum Storage APX-4200

The Maximum Storage drive for the PC (\$4450) is unique for two reasons. First, it uses an ESDI host adapter, so daisy chaining drives is out of the question. Second, and more important, its software approaches DOS compatibility from a radically different angle.

Unlike most other programs, which use the DOS file system, the APX-4200's MAXSYS software creates its own file system that's more appropriate for the drive's write-once capabilities. It traps all INT 21H calls, filters out those intended for the optical drive, and passes the remaining commands through to the standard INT 21H handler.

This high-level DOS interface makes for the slickest version-retrieval software of any of the WORMs that we tested. MAXSYS extends the standard MS-DOS naming convention from FILENAME-

.EXT to FILENAME.EXT#VN, where VN is the version number. By default, MAXSYS assumes the latest version, but you can specify any earlier one by simply putting the number at the end. This means that for functions that use ASCIIZ strings, you can explicitly specify the version number when you're calling the function. This won't work with DOS's COPY command, however, so Maximum Storage provides a COPY replacement. Other version utilities include LNK, which can effectively retrieve an old version of a file by linking it with a new directory entry, and XDIR, an expanded replacement for DIR that can handle version information.

Unfortunately, this software scheme also results in relatively poor DOS compatibility. The file system doesn't support hidden, system, or archive attributes, and our attempts to open a file by using a file control block failed. The APX-4200 was also unable to run our large database tests; Maximum Storage representatives confirmed the problem and are working on a solution.

The drive turned in excellent times on most of our other benchmarks, but it was slow on directory searches.

Pioneer DD-S5001

Pioneer Communications' DD-S5001 system includes a Pioneer WORM drive and a Corel interface kit for either PC compatibles (\$3895) or Macintosh (\$3695) computers. If you're working with DEC, Sun, or other machines or operating systems, contact Pioneer; several interfaces are available from third parties.

At 327 megabytes per side, the Pioneer drive has the lowest capacity of the WORMs we reviewed. But it's also the least expensive, and its media cost per megabyte is quite low.

The DD-S5001 performed exceptionally well in our benchmark tests. On the PC side, it earned the top composite score on the backup test, and it was near the top on both the database and image suites. It was fully DOS-compatible.

Difficult access to the SCSI switches inside the unit made installing the DD-S5001 on the Macintosh a cumbersome process. Fortunately, most people will need to set these switches only once. The cable attaches to standard SCSI connectors, and the unit includes two connectors for daisy chaining or connecting an external terminator.

Capacity and installation are only part of the story. The DD-S5001 is a fast WORM drive, and it consistently kept

continued



July 1989
VGA WONDER



VGA WONDER



Fabulous Offer

VGA WONDER Bundle Includes HARVARD Graphics

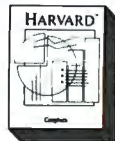

for an additional \$150.00*

While quantities last
*M.S.L. \$495.00

FASTER THAN THE AVERAGE BEAR

Are you asking yourself what a bear has to do with super speed, remarkable resolution and fabulous colors? We did, too. How can anyone bear to work with less than incredible speed, we asked ourselves. How can anyone bear to work without extraordinary resolution? Bear to work with less than 256 spectacular colors? We got so beared out, we decided to share one with you. Along with the bear facts about ATI's award-winning board.



Such as:

- high resolution 800x600 and 1024x768 graphics
 - fast 16-bit bus support
 - 100% register-level compatible in VGA®, EGA®, CGA®, MDA®, and Hercules® modes
 - analog and digital monitor support
 - easy, switchless installation
 - high resolution and 132 column drivers
 - Microsoft® compatible bus mouse and mouse port included
 - available in 256K and 512K versions
- Oh, and bear this in mind – when it comes to VGA WONDER®, you'll be getting a honey of a price!

For more information, contact your supplier or

ATI Technologies Inc.
3761 Victoria Park Avenue
Scarborough, Ontario
Canada M1W 3S2
Tel: (416) 756-0718
Fax: (416) 756-0720



Registered trademarks are as follows: ATI, VGA WONDER – ATI Technologies Inc.; Microsoft – Microsoft Corp.; Hercules – Hercules Computer Technologies Inc.; VGA, EGA, CGA, MDA – International Business Machines Corp.

Circle 27 on Reader Service Card

COMPANY INFORMATION

Advanced Graphic Applications, Inc.

(AGA Discus Rewritable DR650)
90 Fifth Ave.
New York, NY 10011
(212) 337-4200
Inquiry 1071.

Corel Systems Corp.

(Corel 800, Corel 940)
1600 Carling Ave., Suite 190
Ottawa, Ontario, Canada K1Z714
(613) 728-8200
Inquiry 1072.

Information Storage, Inc.

(ISi 525GB)
2768 Janitell Rd.
Colorado Springs, CO 80906
(719) 579-0460
Inquiry 1073.

LaserDrive Ltd.

(LaserDrive 810-111,
LaserDrive 820-011)
1101 Space Park Dr.
Santa Clara, CA 95054
(408) 970-3600
Inquiry 1074.

Maximum Storage, Inc.

(Maximum Storage APX-4200)
5025 Centennial Blvd.
Colorado Springs, CO 80919
(719) 531-6888
Inquiry 1075.

Pioneer Communications of America, Inc.

(Pioneer DD-S5001)
Optical Memory Products
Division
Sherbrooke Plaza
600 East Crescent Ave.
Upper Saddle River, NJ 07458
(201) 327-6400
Inquiry 1076.

RACET Computers Ltd.

(RACET Cosmos 600)
3150 East Birch St.
Brea, CA 92621
(714) 579-1725
Inquiry 1077.

Storage Dimensions, Inc.

(SDI LaserStor for Macintosh,
SDI LaserStor 800)
2145 Hamilton Ave.
San Jose, CA 95125
(408) 879-0300
Inquiry 1078.

Sumo Systems

(Sumo Systems RSSM600-B)
1580 Old Oakland Rd.,
Suite C103
San Jose, CA 95131
(408) 453-5744
Inquiry 1079.

Summus Computer Systems

(Summus LightDisk-650)
17171 Park Row, Suite 300
Houston, TX 77084
(713) 492-6611
Inquiry 1080.

SDI's LaserCache software maintains logical-to-physical-sector translation tables and communicates with DOS at the device driver level, as do most other WORMs. Our tests showed it to be completely DOS-compatible. LaserCache, however, keeps translation tables and data in a reserved caching area on the magnetic disk. It reads the translation tables from the WORM only once, when the cartridge is mounted; from that point, it makes all updates to the cache. The unit also caches both data reads and writes and flushes the cache only as it approaches capacity. Before removing a cartridge, the user must flush both data and index information from the cache.

In addition to the advantage of greater speed, the cache also uses the WORM more efficiently than does a direct-write scheme. Rewritten translation tables and user data often waste a great deal of space on a WORM, where any written data consumes space. With LaserCache, rewritten information replaces old information in the magnetic cache, and permanent writes happen only when the cache is flushed.

We tested the unit with an 11-megabyte hard disk cache. The system has no defaults, but you must set aside at least 1 megabyte for caching space. Overall performance was disappointing, especially when you consider the several minutes it took to flush the cache after we finished the tests.

The caching software also makes it more difficult to retrieve older file versions. If you need to save a file and guarantee its recoverability, you must flush the cache after you save the file. If you're running a scanning or CAD application, for example, this means you must save the file, exit the application, run the cache flush utility, and reenter the application. Once you've done that, you can recall the file using LaserCache utilities.

The Rewritables

Rewritable optical drives are **very new**. Only two vendors, Sony and Ricoh, manufacture the drive mechanisms used in the systems we reviewed. But don't let the underlying similarities fool you. Software and interface components can make for significant differences.

AGA Discus Rewritable DR650

Among the erasable optical units we reviewed, the champion is AGA's DR650. Its high capacity, trouble-free operation, and blinding speed make it ideal for AT or PS/2 users with large storage requirements. The system runs on a standard

continued

pace with the speedy Corel 940. The Corel software package provided with the drive handled the utility and driver functions.

Along with Corel's 940, this drive clearly proves that expensive is not always better.

SDI LaserStor for Macintosh

LaserStor for Macintosh, from Storage Dimensions, Inc. (SDI), sports dual SCSI connectors and internal SCSI address selection switches. For \$4999, you get the drive system, cabling, and driver/utility software.

It's no coincidence that the LaserStor and the Corel 800 displayed almost identical performance—both use Ricoh disk subsystems and Corel software. The vertically mounted LaserStor takes up less desk space than many other drives. It in-

stalled easily and worked without any surprises.

SDI LaserStor 800

The LaserStor 800 PC-based WORM takes an unusual approach to solving the problems of slow access times and inefficient disk use: It caches both data and directories on the system's hard disk drive. The optical drive itself is the same unit that SDI's Macintosh WORM uses; the company plans to port the caching scheme to the Macintosh disk drive, but the software is currently available for the DOS environment only. As with the Pioneer drive, other operating-system support is available from third parties. For \$4495, the PC system gives you the drive, cable, interface card, software, and a comprehensive combination user's and programmer's guide.

MicroWay Means Numerics!

MicroWay is your best source for the software and hardware you need to get true 32 bit performance from your 386. These include 32-bit tools, such as NDP Fortran, C, and Pascal, and the 32-bit applications that were developed with them (see last paragraph). These products run in protected mode under Unix, Xenix, or Phar Lap extended MS-DOS.

Starting with release 1.4VM, NDP Fortran, C and Pascal not only access 4 gigabytes of memory, but run with Phar Lap's new VMM extension which provides 386 protected mode virtual memory. Now you can run a program with a 30 MB array on a 2 MB system simply by having 30 MB of space on your hard disk.

MicroWay also offers transputer based parallel processing boards and languages that run in an XT, AT, or 386. Each of the T800 RISC processors on these boards packs the power

Dr. Robert Atwell, leading defense scientist, calculates that NDP Fortran-386 is saving him \$12,000 per month in rentals of VAX hardware and software while doubling his productivity!

Fred Ziegler of AspenTech in Cambridge, Mass. reports, "I ported 900,000 lines of Fortran source in two weeks without a single problem!" AspenTech's Chemical Modeling System is in use on mainframes worldwide and is probably the largest application to ever run on an Intel processor.

Dr. Jerry Ginsberg of Georgia Tech reports, "My problems run a factor of six faster using NDP Fortran-386 on an mW1167 equipped 386/20 than they do on my MicroVAX II."

of a 20 MHz 386/1167. Our best selling board, the Quadputer2™, has four T800s and boasts 40 MIPS/6 megaflops of processor throughput.

MicroWay manufactures Weitek 1167 and 3167 coprocessor cards that run with the 80386. Both cards include an 80387 socket. The 1167 is 2 to 4 times faster than the 80387. The 3167 runs 30% faster than the 1167 in double precision. The key to achieving this speed increase is our NDP Fortran or C and the new 32-bit applications that offer Weitek support. Either processor provides a dramatic increase in throughput for graphics intensive applications. These include VersaCad and Hoops 3D graphics, ANVIL 5000 CAD/CAM, SRAC and Swanson Analysis finite element packages, Mathematica and a host of other packages that were recently ported to the 386 using our NDP Fortran and NDP C. Please call (508) 746-7341 for more information.

32-Bit Compilers and Tools

NDP Fortran-386™, NDP C-386™, and NDP Pascal-386™ compilers generate globally optimized, mainframe quality code. Each runs in 386 protected mode under Unix, Xenix or Phar Lap extended MS-DOS. The memory model employed uses 2 segments, each of which can be up to 4 gigabytes. They generate code for the 80287, 80387, mW3167 or mW1167 and include high speed EGA graphics extensions written in C that perform BASIC-like screen operations. NDP Fortran-386™ is a full implementation of FORTRAN-77 with Berkeley 4.2 and Fortran-66 extensions. NDP C-386™ is a full implementation of AT&T's PCC with MS and ANSI extensions. NDP Pascal-386™ is a full implementation of ANSI/IEEE Pascal, with extensions from C and Berkeley 4.2 Pascal.

NDP Fortran/C/Pascal-386/DOS each \$595
 NDP Fortran/C/Pascal-386/VM..... \$695
 NDP Fortran/C/Pascal-386/UNIX..... \$795
 NDP C++ \$495

Phar Lap 386/VMM extensions are supported by the VM releases of NDP Fortran, C, and Pascal, making it possible to compile and run programs as large as the free space on your hard disk.

Phar Lap Virtual Memory Manager .. \$295

Phar Lap Development Tools \$495

NDP Windows™ — NDP Windows includes 80 functions that let you create, store, and recall menus and windows. It works with NDP C-386 and drives all the popular graphics adapters Library: \$125, C Source: \$250

NDP Plot™ — Calcomp compatible plot package that is callable from NDP Fortran. It includes drivers for popular plotters and printers. Works with CGA, MDA, EGA and VGA ... \$325

NDP/FFT™ — Includes 40 fast running, hand coded algorithms for single and double dimensioned FFTs which take advantage of the 32-bit addressing of the 386 or your hard disk. Callable from NDP Fortran with mW1167 and 80387 support \$250
 387FFT for 16-bit compilers \$250

NDP to HALO '88 Graphics Interface — Enables you to call graphics routines in HALO '88 from NDP Fortran, C or Pascal. \$100

Parallel Processing

Videoputer™ — The highest performance graphics card on the market. Uses a T800 and TI 34010 in conjunction with a 130 MHz Brook-Tree DAC. Includes one MB of system RAM, one meg of video RAM and a library of graphics primitives. Runs standalone or in conjunction with a transputer network and drives 32 and 64 KHz analog monitors \$4995

Monoputer™ — The world's most popular PC transputer development product now extends the memory available for developing transputer applications from 2 to 16 MB. The board features a DMA bus interface for fast I/O.

Monoputer with T414 (0 MB) \$995
 Monoputer with T800 (0 MB) \$1495

Quadputer™ — This board for the AT or 386 can be purchased with 2, 3 or 4 transputers and 1 or 4 MB of memory per transputer. Two or more Quadputers can be linked together to build networks of up to 100 or more transputers providing mainframe power from \$3495

Linkputer™ — Uses four Inmos C004 programmable cross bar switches. It allows the user to dynamically change the topology of the processors in a network. Using this board, it is possible to get 100% linkage among eight Quadputers and design larger, custom topologies. CALL

Transputer Compilers and Applications
 These Parallel languages are designed for use with Monoputer2 and Quadputer2.

Logical Systems Parallel C \$595
 3L Parallel C or 3L Parallel Fortran .. \$895
 COSMOS/M - Finite element analysis .CALL
 ParaSoft: Parallel Environment ... \$500
 Performance Monitor ... \$500
 C Source Level Debugger \$500

T800/NAG™ (See NDP/NAG) \$2750

387BASIC™ — Our 16-bit MS compatible compiler introduces numeric register variables to produce the fastest running 80x87 code on the market. \$249

386 Your AT

386/387 Turbo™AT — This board plugs into your 80286 socket, allowing your IBM AT to run 32-bit protected-mode code written for the 80386. Includes an 80387 socket. The most cost-effective AT upgrade!

386/387 Turbo AT/16MHz \$495
 386/387 Turbo AT/25 MHz \$695

Weitek-Based Coprocessor Boards

mW1167™ and mW3167™ coprocessor boards are built at MicroWay using Weitek components. Each includes an 80387 socket.

mW1167-16 \$895
 mW1167-20 \$1095
 mW1167 Microchannel-16/20 CALL

3167-20 \$995
 3167-25 \$1295
 3167-33 \$1695

mW3167/80387 Board \$150

Intel Coprocessors

8087 \$84	8087-2 \$120
80287-8 ... \$195	80287-10 ... \$220
80387-16 .. \$350	80387-16SX .. \$310
80387-20 .. \$400	80387-25 ... \$500
80C287A (CMOS) \$280	
287Turbo-12 (for AT compatibles) ... \$350	
RAMPak™ - one meg 32-bit memory module for Compaq 386 20/25 \$395	
RAMPak™ - four meg \$1495	

Multi-User Accelerators

MicroWay's AT8™ and AT16™ intelligent serial controllers run 8 to 16 terminals under Unix or Xenix without bogging down your AT, 80386 or PS/2 PC. AT8: \$895 AT16: \$1295

12 MHz PC Accelerators

FastCACHE-286 12 MHz \$299
 SuperCACHE-286 12 MHz \$399
 FastCACHE-286 9 MHz \$199

NUMERICS HOTLINE
 (508) 746-7341

MicroWay

World Leader in PC Numerics

Corporate Headquarters: P.O. Box 79, Kingston, MA 02364 USA (508) 746-7341
 32 High St., Kingston-Upon-Thames, U.K., 01-541-5466

USA FAX 508-746-4678 Italy 02-74.90.749 Holland 40 836455 Germany 069-75-2023

SCSI bus, and you can chain any SCSI device off the drive. Unfortunately, a Mac version of this product wasn't released in time for this review.

At \$6495, the DR650 isn't cheap, but it proved to be the best drive to use with DOS. It consistently turned in top performances, matched only by the Summus drive on the image tests. Although the device driver lets you configure a system RAM cache, we ran it in the default configuration without caching enabled. Adding the cache should further enhance performance.

The only difference in capacity between this drive and the other magneto-optical units is in the data cartridge. All four of the units we tested can use both 325-megabyte-per-side cartridges and the 297-megabyte-per-side variety. But while they can use the same physical media, proprietary formats mean you can't swap cartridges between different drives to share data.

The higher-capacity cartridge has 1024 bytes per sector and less overhead than the lower-capacity, 512-byte-per-sector disk. The current version of the ISO standard for magneto-optical media covers both 512- and 1024-byte sectors. AGA has chosen to sell and support 325-megabyte, 1024-byte-per-sector cartridges. Because the cluster size is so much larger, these cartridges will cost you more in data overhead if you store small files.

AGA's software includes the driver, format and partitioning utilities, and a DOS patch to enable large partitions. It ran all our tests and executed all DOS disk function calls without a hitch.

RACET Cosmos 600

RACET's Cosmos 600, based on Ricoh's 600-megabyte magneto-optical drive, is available for both PC and Macintosh platforms. It's the most network-oriented erasable unit we reviewed, with support for TOPS, AppleShare, and Novell's NetWare. The PC system sells for \$5645; the Macintosh version costs \$5590.

On our DOS test machine, the AGA unit consistently outperformed the RACET drive. But the Cosmos 600 was by no means slow; it bested the Summus system on two of the tests.

RACET's drive was completely compatible with DOS. The PCMS software that comes with the drive is adapted from programs shipped with RACET's tape drives. Utilities include formatting, partitioning, and diagnostic programs. PCMS also lets you assign passwords to partitions.

An external SCSI device-select switch

made Mac installation easier. Dual SCSI connectors let you connect the external terminator or another daisy-chained peripheral. Performance was solid—better than the Mac's internal hard disk drive on both the FoxBASE and MPW tests.

RACET's PCMS utility software works reliably, but it can be dangerous: It almost wiped out our hard disk drive. Most of the utilities search through the SCSI bus and bring up a screen with a list of the devices it finds. During the last phase of testing, we inadvertently se-

Among
*the erasable optical
units, the champion is
AGA's DR650.*

lected device 0 (the Mac's internal hard disk drive) instead of device 1 (the RACET drive). PCMS happily stomped the Macintosh driver on the hard disk and destroyed the partition table.

Sumo Systems RSSM600-B

The Sumo RSSM600-B uses the same internal subsystem as the Cosmos 600 and performed almost identically on all the tests. We tested the unit on the Macintosh, but Sumo began shipping a PC version as we went to press. Two SCSI connectors and an external SCSI address switch grace the back panel. Physically, the Sumo drive is the largest of the rewritables. It's approximately square and sized to fit beautifully under a classic Mac SE or Plus footprint.

Perhaps the Sumo's best feature is its price: \$4500 for the Mac drive (\$4700 for the PC) and \$260 per 600-megabyte (double-sided) cartridge makes it the cheapest of the rewritables.

Summus LightDisk-650

Like the AGA system, Summus's LightDisk-650 incorporates Sony's magneto-optical drive. Unfortunately, Summus's system can't touch the AGA when it comes to performance. What Summus has going for it is a standard SCSI connection and software that lets it fit comfortably with just about any system. The drive is available for an impressive lineup of machines and a host of operating systems (see table 1); PC kits sell for

\$6495, and Macintosh kits sell for \$5495. Installing the drive may require opening the case to get to the internal SCSI address switches.

The Summus drive for the PC doesn't come with any utility software. In fact, it doesn't come with any software at all. The driver card has a BIOS extension ROM that lets it recognize the LightDisk at boot time. You use a utility provided in the ROM to do a low-level format, and standard DOS FDISK and FORMAT commands for formatting and partitioning. All the DOS drive functions we tried worked correctly.

Although the Macintosh rewritables were close in terms of performance, the LightDisk edged out its two Ricoh-based competitors, RACET and Sumo.

The Disk Director 3.0 software (provided with the Macintosh version) handles the low-level formatting and partitioning. The LightDisk is unique in that the partitioning lets you split up the 297 megabytes into several partitions and have them all come up as different logical disk drives.

Buy or Wait?

Optical storage is a young technology, and compatibilities and specifications change rapidly; if you have an application in mind, call the vendor. If you're looking to an erasable optical drive as a medium for data distribution, you may do well to hold off on any purchase until these drives conform to a standard.

On the IBM PC-compatible side, several drives stand out. The ISi 525GB is fast and has an enormous capacity, but it's also quite expensive. The Maximum Storage APX-4200 has the best version-control software and performs respectably, but it has problems simulating random-access writes.

Our favorite WORM drives in both the DOS and Macintosh environments are the Corel 940 and the Pioneer DD-S5001. Both drives are excellent performers in all applications, and both are outstanding values.

The AGA Discus Rewritable DR650 is the obvious choice if you need a rewritable drive for DOS, but all four magneto-optical drives have strong points: the RACET Cosmos 600 has strong networking support, the Sumo RSSM600-B is relatively inexpensive, and the Summus LightDisk-650 delivers the best performance on the Macintosh. ■

Steve Apiki and Howard Eglowstein are testing editors for the BYTE Lab. You can reach them on BIX as "apiki" and "eglowstein," respectively.

Introducing the everything- but-the-kitchen sync.



Presenting a multiscanning color monitor so advanced it's compatible with virtually all the video standards to date. And with video standards to come, like SuperVGA and IBM® 8514/A.

It's the C1391 PanaSync™ color monitor. And whether your office PCs are running Hercules™, CGA, EGA or VGA, this 14" Panasonic® monitor will display each to its best advantage.

Of course, the PanaSync monitor is comfortable in virtually any IBM or [with an optional cable] Apple Mac™ II environment. And we've given as much thought to your comfort, as well. With an ergonomic design. Featuring front-mounted controls. Tilt/swivel stand. And text color switching from green to amber to paper white in TTL modes. The affordable PanaSync C1391 monitor. The future on display.

For more information, or the name of your authorized dealer, call toll-free **1-800-742-8086**.

Circle 201 on Reader Service Card

*Peripherals, Computers, Printers, Copiers
Typewriters and Facsimiles*

Panasonic
Office Automation 

PanaPro™ Monochrome Desktop Publishing Monitors



PanaSync™
Multiscanning Color
Monitor



IBM is a registered trademark of International Business Machines Corporation. Mac II is a trademark of Apple Computer, Inc. Hercules is a trademark of Hercules Computer Technology.

ACCESS MICRO SYSTEMS... CUSTOM ASSEMBLED.

THE POWER.

ACCESS--proven, powerful systems, with thousands in use today. **ACCESS** is the centerpiece of your computer-office management system. **ACCESS** reduces your workload--increases productivity.

Call CMO about the **ACCESS 386/20** Tower system, rated 32% faster than the Compaq 386/16.

800-233-8950



\$895

ACCESS 286/12

- 16-bit 80286 Main System Board Processor.
 - Dual 6/12 MHz switchable CPU speed.
 - 512K RAM, expands to 4MB on motherboard.
 - Eight slots: (6-16 bit, 2-8 bit).
 - Supports 80287 Math Coprocessor.
 - One parallel, serial and game port.
 - 102-key "AT" style enhanced keyboard.
 - 1.2MB Hi-density 5.25" floppy disk drive
 - Five 1/2 height drive bays.
 - Western Digital 2:1 interleave controller.
 - 220 watt high capacity power supply.
 - Desktop case with Turbo and Power LED Display, keyboard lock, hardware and Turbo switch.
 - Norton SI Rating V4.0: 15.3.
 - Industry standard Phoenix compatible BIOS.
 - One and Zero Wait State operations.
 - Clock/Calendar with Battery Back-up.
 - Monitor not included in above price.
- Also available in small footprint and Tower case.*
See chart for Video and Hard Drive Options.



\$1395

ACCESS 286/20

- 16-bit 80286 Main System Board.
 - Dual 10/20 MHz switchable CPU speed.
 - 1MB RAM, expands to 5MB on motherboard.
 - Eight slots: (6-16 bit, 2-8 bit).
 - Supports 80287 Math Coprocessor.
 - One parallel, serial and game port.
 - 102-key "AT" style enhanced keyboard.
 - 1.2MB Hi-density 5.25" floppy disk drive.
 - Five 1/2 height drive bays.
 - Western Digital 2:1 interleave controller.
 - 220 watt high capacity power supply.
 - Desktop case with Turbo and Power LED Display, keyboard lock, hardware and Turbo switch.
 - Norton SI Rating V4.0: 22.5.
 - Industry standard Phoenix compatible BIOS.
 - One and Zero Wait State operation.
 - Clock/Calendar with Battery Back-up.
 - Monitor not included in above price.
- Also available in Tower case.*

See chart for Video and Hard Drive Options.

CUSTOMIZE YOUR ACCESS 286.

Select any of the Video and Hard Drive options and allow us to CUSTOM CONFIGURE Your **ACCESS 286** System.
(Add to the base price above)

	40MB-28ms	80MB-28ms	159MB-23ms
Mono	\$599.00	\$799.00	\$1399.00
EGA	\$899.00	\$1099.00	\$1699.00
VGA	\$999.00	\$1199.00	\$1799.00

ASSEMBLED • TESTED • GUARANTEED

FREE **ACCESS** Software Utilities Provided.

THE FLEXIBILITY.

Your **ACCESS** system is custom-configured to fit your needs, your work style, and your budget. Your hand-assembled system is put through an exhaustive technical checklist and bench-tested a grueling 48-hours to insure that your system will work the first time--every time. To order call today:

800-233-8950



\$1595

ACCESS 286/25

- 16-bit 80286 Main System Board.
 - Dual 10/25 MHz switchable CPU speed.
 - 1MB RAM, expands to 5MB on motherboard.
 - Eight slots: (6-16 bit, 2-8 bit).
 - Supports 80287 Math Coprocessor.
 - One parallel, serial and game port.
 - 102-key "AT" style enhanced keyboard.
 - 1.2MB Hi-density 5.25" floppy disk drive
 - Five 1/2 height drive bays.
 - Western Digital 2:1 interleave controller.
 - 220 watt high capacity power supply.
 - Desktop case with Turbo and Power LED Display, keyboard lock, hardware and Turbo switch.
 - Norton SI Rating V4.0: 31.6.
 - Industry standard Phoenix compatible BIOS.
 - One and Zero Wait State operations.
 - Clock/Calendar with Battery Back-up.
 - Monitor not included in above price.
- Also available in Tower case.*
See chart for Video and Hard Drive Options.



Computer Mail Order. Since 1981—Low Prices, Large Selection, Fast Service.

MONEY BACK GUARANTEE 3 YEAR WARRANTY.

THE CONFIDENCE.

We offer what the competition doesn't--a 3-year limited warranty on parts, free technical support and computer consultant toll-free "hotlines"--where you'll receive clear answers to any **ACCESS** questions. Go ahead, give us a try:

800-233-8950



\$1695

ACCESS 386/16

- 32-bit 80386 Main System Board.
 - Switchable 6/8/16 MHz CPU speed.
 - 1MB RAM, expands to 10MB on motherboard.
 - Eight slots: (1-32bit, 5-16 bit, 1-8 bit).
 - Supports 80387 Math Coprocessor.
 - One parallel port, serial and game port.
 - 102-key "AT" style enhanced keyboard.
 - 1.2MB Hi-density 5.25" floppy disk drive.
 - Five 1/2 height drive bays.
 - Western Digital 1:1 interleave controller.
 - 220 watt high capacity power supply.
 - Desktop case with Turbo and Power LED Display, keyboard lock, and hardware switch.
 - Norton SI Rating V4.0: 18.7.
 - Industry standard Phoenix compatible BIOS.
 - Zero Wait State operation.
 - Clock/Calendar with Battery Back-up.
 - Monitor not included in above price.
- Also available in Tower case.*
See chart for Video and Hard Drive Options.



\$1995

ACCESS 386/20

- 32-bit 80386 Main System Board.
 - Switchable 6/8/20 MHz CPU speed.
 - 1MB RAM, expands to 10MB on motherboard.
 - Eight slots: (1-32 bit, 5-16 bit, 1-8 bit).
 - Supports 80387 Math Coprocessor.
 - One parallel, serial and game port.
 - 102-key "AT" style enhanced keyboard.
 - 1.2MB Hi-density 5.25" floppy disk drive.
 - Five 1/2 height drive bays.
 - Western Digital 1:1 interleave controller.
 - 220 watt high capacity power supply.
 - Desktop case with Turbo and Power LED Display, keyboard lock and hardware switch.
 - Norton SI Rating V4.0: 24.0.
 - Industry standard Phoenix compatible BIOS.
 - Zero Wait State operation.
 - Clock/Calendar with Battery Back-up.
 - Monitor not included in above price.
 - 32K Static Cache Memory (optional).
- Also available in Tower case.*
See chart for Video and Hard Drive Options.

CUSTOMIZE YOUR ACCESS 386.

Select any of the Video and Hard Drive options and allow us to CUSTOM CONFIGURE Your **ACCESS** 386 System.

(Add to the base price above)

	80MB-28ms	159MB-23ms	338MB-18ms
Mono	\$799.00	\$1399.00	\$1899.00
EGA	\$1099.00	\$1699.00	\$2199.00
VGA	\$1199.00	\$1799.00	\$2299.00

ASSEMBLED • TESTED • GUARANTEED
Free **ACCESS** Software Utilities Provided.

THE PRICE.

Check our features. Check our competition. You'll receive not only the amazing price, but a full 30-day money-back guarantee--no questions asked when you order an **ACCESS** Micro System, Call Today:

800-233-8950



\$3795

ACCESS 386/33

- 32-bit 80386 Main System Board.
 - Switchable 6/8/33 MHz CPU speed.
 - 1MB RAM expands to 16MB on motherboard.
 - Eight slots: (1-32 bit, 5-16 bit, 1-8 bit).
 - Supports 80387 or Weitek Math Coprocessor.
 - One parallel, serial and game port.
 - 102-key "AT" style enhanced keyboard.
 - 1.2MB Hi-density 5.25" floppy disk drive.
 - Five 1/2 height drive bays.
 - Western Digital 1:1 interleave controller.
 - 220 watt high capacity power supply.
 - Desktop case with Turbo and Power LED Display, keyboard/lock and hardware switch.
 - Norton SI Rating V4.0: 40.1.
 - Industry standard Phoenix compatible BIOS.
 - Zero Wait State operation.
 - Clock/Calendar with Battery Back-up.
 - Monitor not included in above price.
- Also available in Tower Case.*
See chart for Video and Hard Drive Options.



Computer Mail Order. Since 1981—Low Prices, Large Selection, Fast Service.

Circle 63 on Reader Service Card

A110

CMO And Access Micro Systems



ACCESS TURBO XT/10

- 8-bit 8088 Main System Board.
- Dual 4.77/10 MHz switchable CPU speed.
- 512KB RAM, expands to 640KB on motherboard
- Eight 8-bit slots.
- Supports 8087-10 Math Coprocessor.
- One parallel port, serial port and game port.
- 102-key "AT" style enhanced keyboard.
- 360KB 5.25" floppy disk drive.
- Four 1/2 height drive bays.
- Dual floppy controller, supports 720K format.
- 150 watt high capacity power supply.
- Desktop case with Turbo and Power LED Display, keyboard lock, hardware and Turbo switch.
- IBM XT compatible EROS BIOS.
- Clock/Calendar with Battery Back-up.
- Monitor not included.

30 Day Money Back Guarantee
1 Year Limited Warranty.

\$539

See chart below for Video and Hard Drive Options for ACCESS Turbo XT/10

	1 Floppy	20MB-65m	40MB-28ms
Mono	\$139.00	\$409.00	\$589.00
CGA	\$339.00	\$599.00	\$779.00
EGA	\$499.00	\$769.00	\$959.00

The Workstation

In addition to operating as a stand alone computer system, the **ACCESS Turbo XT/10** is an ideal solution for your multi-user applications. The **ACCESS Turbo** can be configured as a Workstation on the Novell, 3Com, Unix and Xenix environments. Call TOLL FREE **800-233-8950** and talk with our trained and authorized sales and support staff. Look at our Networking section for a sample of products offered in the Novell Networking Arena.

Power System Or File Server



ACCESS 386/20 TOWER

- 32-bit 80386 Main System Board.
- Dual 8/20 MHz switchable CPU speed.
- 1MB 32-bit DRAM subsystem.
- System memory expandable to 9MB.
- Eight slots: Two 32-Bit, Five 16-Bit, One 8-Bit.
- 8MHz bus clock, wait state selectable.
- Supports 80387 Math Coprocessor.
- One parallel port and two serial ports.
- 102-key "AT" style enhanced keyboard.
- 1.2MB Hi-density 5.25" floppy disk drive.
- Five 1/2 height drive bays.
- Western Digital 111 interleave controller.
- 200 watt high capacity power supply.
- Vertical Tower case with Turbo and Power LED Display, keyboard lock, hardware and Turbo switch.
- COMPAQ compatible, 32% faster than COMPAQ 386.
- Landmark V0.99: 26.5 - 27.3 MHz.
- Norton SI Rating V4.0: 22.5.
- 64K Bios, setup and diagnostic utility built-in.
- Zero Wait State Operation.
- Clock/Calendar with Battery Back-up.
- Monitor not included.

\$2099

See chart for Video and Hard Drive Options for ACCESS 386/20 Tower

	40MB-28ms	159MB-23ms	338MB-18ms
Mono	\$599.00	\$1399.00	\$1899.00
EGA	\$899.00	\$1699.00	\$2199.00
VGA	\$999.00	\$1799.00	\$2299.00

FREE ACCESS Software Utilities Provided.

NETWORKING

ACCESS 386/20 Tower File Server with 2MB, 10MHz, 512K Workstations, Monochrome Displays, Arcnet Interfaces, Loaded Novell Netware.

ASSEMBLED • TESTED • CERTIFIED

Ready to Turn ON!

- 4-User 40MB Server ELS I...\$6,899.00
- 6-User 80MB Server ELS II...\$9,699.00
- 8-User 159MB Server ELS II...\$12,499.00

For larger systems call us. We can custom configure any size network.

Novell Software

- ELS 4-User Level 1.....\$499.00
- ELS Level-II V2.15.....\$1,099.00
- Advanced NETWARE 286 V2.1...\$1,995.00
- SFT NETWARE 286 V2.15.....\$3,095.00

Interface Cards

- ARCNET (8-bit) PC/XT.....\$129.00
- ARCNET (16-bit) 286/386.....\$299.00
- ARCNET MCA PS/2.....\$299.00
- Active Hub.....\$299.00
- ETHERNET (8-bit) PC/XT.....\$239.00
- ETHERNET (16-bit) 286/386.....\$289.00
- ETHERNET MCA PS/2.....\$359.00
- Standard Micro Systems.....Call



Computer Mail Order. Since 1981—Low Prices, Large Selection, Fast Service.

...Price and Power!

**Great
Packages
Ready
To GO!**



**NO ONE HAS PROVIDED
BETTER SERVICE
TO MORE CUSTOMERS
FOR AS LONG AS CMO.**

**8 YEARS
AND STILL GROWING**

**AT CMO, GOOD SERVICE
AND LOW PRICE
ARE A TRADITION.**

THE COMPANY

CMO is proud to be one of the few companies approved to represent the **ACCESS** Micro System product line. Thousands of **ACCESS** Micro Systems have been sold and they have a proven record of performance in homes and offices just like yours.

Our **ACCESS** systems utilize state-of-the-art components and are custom-assembled to fit your needs, your workstyle, and your budget. Plus all 286's and 386's come with a 3 year limited warranty.

Each and every **ACCESS** system goes through an extensive quality control checklist and is burned-in a minimum of 48 hours, assuring you trouble free performance.

Whenever you have questions or need technical support, our toll free lines put you in touch with **CMO's** knowledgeable computer consultants.

**Call
CMO Today
800-233-8950**

THE COLLEGIAN	THE ACCOUNTANT
<p>ACCESS Turbo XT/10 Computer. 512K Ram installed on the Motherboard. Dual 360K 5.25" floppy disk drive. 102-key "AT" style enhanced keyboard. One parallel, serial, and game port.</p> <p>Epson LX-810 Printer. 9-Pin, impact dot-matrix.</p> <p>Collegian Monitor. Monochrome TTL display and adapter. 12" diagonal screen display.</p> <p>Collegian Software. PFs: First Choice.</p> <p style="text-align: right;">\$979</p>	<p>ACCESS 286/12MHz Computer. 512K RAM installed on the Motherboard. 40MB Hard Disk Drive w/controller. 1.2MB 5.25" floppy disk drive. 102-key "AT" style enhanced keyboard.</p> <p>Espon FX-1050 Printer. 264cps 136 column dot matrix.</p> <p>Accountant Monitor. Monochrome TTL display and adapter. 12" diagonal screen display.</p> <p>Accountant Software. Lotus 1-2-3</p> <p style="text-align: right;">\$2199</p>
THE SECRETARY	THE PUBLISHER
<p>ACCESS Turbo XT/10 8088 Computer. 512K RAM installed on the Motherboard. 20MB Hard Disk Drive w/controller. 360K 5.25" floppy disk drive. 102-key "AT" style enhanced keyboard.</p> <p>Brother HR-20 Daisywheel 20cps print speed.</p> <p>Secretary Monitor Monochrome TTL display and adapter. 12" diagonal screen display.</p> <p>Secretary Software. PFS: Write</p> <p style="text-align: right;">\$1299</p>	<p>ACCESS 386/16MHz Computer. 1MB RAM installed on the Motherboard. 40MB Hard Disk Drive w/controller. 1.2MB 5.25" floppy disk drive. 102-key "AT" style enhanced keyboard.</p> <p>Hewlett-Packard LaserJet II 8 Page per minute.</p> <p>Publisher Monitor. Monochrome VGA FlatSquare Display. 14" diagonal screen display.</p> <p>Publisher Software PFS: First Publisher</p> <p style="text-align: right;">\$4199</p>



Computer Mail Order. Since 1981—Low Prices, Large Selection, Fast Service.

Reaching New Heights

The MaxSys 386T/33 and 386MT/33

- 12 slots
- 10 half-height drives
- 400-watt power supply!



The MaxSys 386T (lower photo) and 386MT (upper photo) feature 12 slots to provide the systems with expandability.

At CSS, we've built a reputation for dependability, value, and performance. That's why we're pleased to unveil the latest addition to our line of computing solutions — The MaxSys 386T™ and 386MT™.

The architecture of the MaxSys 386T features 12 slots and a 400 watt power supply giving you mainframe capabilities at

a fraction of the cost. The five full-height drive capacity allows you to configure up to three gigabytes (formatted) storage including erasable, optical, Winchester, and removable disk drives, as well as 8mm and 1/4" tape and floppies.

Our smaller version, the 386MT, features 12 slots, five half-height drives, and a 200 watt power supply. Both MaxSys systems allow you to upgrade your original hardware and software investments to meet the standards

of today... and tomorrow. They're 100% IBM™ compatible and have an Adv Norton 4.0 SI rating of 40.0 — the highest for AT™ systems. Application options range from an ultra high-end personal computer to networked file/compute/print servers supporting diskless work-stations and ASCII terminals. Plus, the MaxSys systems run MS DOS™, Ethernet™, ARCnet™, Cheapernet, Helios™, Novell™, UNIX™/XENIX™, 3 Com™, Token Ring, OS/2™, or POSIX.

Both MaxSys systems are available in a variety of configurations and include full technical support, complete documentation, and a one year warranty.

Reach new heights — call us today.

	Norton 4.0 SI	Expansion Slots	Drive Capacity
CSS MaxSys	40.0	12	10 H/H
IBM Model 80	30.5	8	4 H/H
Compaq 386/25	30.5	8	4 H/H

Compared to IBM and Compaq the MaxSys 386T comes out on top.

A Solid Investment

CSS
LABORATORIES, INC.

CSS Laboratories, Inc. and CSS logo registered and CSS MaxSys are trademarks of CSS Laboratories, Inc. Ethernet is a trademark of XEROX Corp. Novell is a trademark of Novell, Inc. MS DOS and XENIX are trademarks of Microsoft Corp. UNIX is a trademark of AT&T. Helios is a trademark of Perihilion. ARCnet is a trademark of Datapoint Corp. 3-Com is a trademark of 3-Com Corp.

1641 McGaw Ave., Irvine CA 92714
Tel: 714-852-8161 Fax: 714-852-9464



MCA Meets SX

New machines from IBM and American Mitac pair the 80386SX with IBM's Micro Channel architecture

Mark L. Van Name
and Bill Catchings

The marketplace is still undecided about the 80386SX microprocessor and IBM's Micro Channel architecture (MCA), but that hasn't stopped two companies from introducing machines that incorporate both. The IBM PS/2 Model 55 SX and the American Mitac MPS2386 combine these two technologies in very different packages.

The mixture is in some ways an odd one. The 80386SX's main goal is to let you run 80386-specific software for little more than the cost of an 80286-based system. The MCA, on the other hand, boasts better performance, particularly for 32-bit peripherals, but at a higher cost.

The Model 55 SX base unit comes in two configurations: with a 30-megabyte hard disk drive (\$3895), and with a 60-megabyte hard disk drive (\$4295). The only standard software is the IBM Reference Diskette, which you use to tell the MCA bus about new peripherals. Our evaluation system had the 60-megabyte drive and came with an additional 2 megabytes of memory, an IBM 8513 VGA color monitor, and MS-DOS 3.3, for a total list price of \$6560. (Although the machine didn't come with a math coprocessor, we added one before running the benchmarks.)



The IBM PS/2 Model 55 SX and the American Mitac MPS2386 differ in price, expandability, and compatibility.

The standard American Mitac MPS2386 sells for \$2695. It includes more standard software than the Model 55 SX: MS-DOS and GWBASIC 4.0, the Phoenix Reference Diskette for MCA configuration, and an expanded memory emulator. Two 3½-inch hard disk drives are optional for the MPS2386: a \$650 40-megabyte drive and a \$1500 100-megabyte drive.

Our 40-megabyte evaluation system included a Mitac VGA monitor (Tatung is the OEM), a 16-MHz 80387SX (which Mitac does not sell), a total of 4 megabytes of memory, and a 1.2-megabyte 5¼-inch floppy disk drive. We tested the machine running DOS 3.3; however, Mitac now offers only version 4.0.

With these extras (assuming \$650 for

the 80387SX), our evaluation unit would cost \$5879. That puts it at almost \$700 less than the IBM unit, without the 5¼-inch floppy disk drive and 80387SX included in the Mitac unit. Toss out those two items and the price is \$5114, or over \$1400 less than the Model 55 SX. Clearly, price is a major reason to consider the MPS2386.

Architecture

Because both these machines use the 80386SX rather than its speedier cousin, IBM and Mitac were able to skimp a bit on their memory architectures. In particular, neither system uses a cache. The MPS2386 relies instead on a combination of two-way interleaving and paging

continued

IBM PS/2 Model 55 SX

Company

IBM Corp.
1133 Westchester Ave.
White Plains, NY 10604
(800) 426-2468

Components

Processor: 16-MHz Intel 80386SX
Memory: 2 megabytes of 85-ns DRAM in a 2-megabyte SIMM, expandable to 4 megabytes on the motherboard; 128K bytes of BIOS ROM
Mass storage: 1.44-megabyte 3½-inch floppy disk drive; 30-megabyte hard disk drive (Model 8555-031) or 60-megabyte hard disk drive (Model 8555-061)
Display: IBM 8513 VGA monitor; VGA circuitry; 256K bytes of display memory; DB-15 monitor connector on the motherboard
Keyboard: 101-key IBM Enhanced
I/O interfaces: RS-232C serial port with DB-25 connector; DB-25 parallel port; PS/2-style keyboard connector and mouse connector; three 16-bit MCA slots, one with IBM video adapter extension

Size

16 × 4 × 1½ inches; 19 pounds

Price

Base system: \$3895
System as reviewed: \$6560

Inquiry 854.

(with 2K-byte pages) to let it run without wait states most of the time with its 100-nanosecond DRAM. The Model 55 SX also uses paging (with 2K-byte pages), but it lacks the MPS2386's interleaving. Not surprisingly, this architecture makes the IBM unit slower, even though it uses faster 85-ns DRAM.

The MPS2386's DRAM comes on either 256K-byte or 1-megabyte single in-line packages. You install these SIPs in matched sets of four into the eight SIP slots, so the unit's memory can total 1, 2, 4, 5, or 8 megabytes. The base system uses four 256K-byte SIPs to make 1 megabyte.

The Model 55 SX has far fewer memory options. Its two single in-line memory module slots can hold either 1- or 2-megabyte SIMMs. The base models include one 2-megabyte SIMM; you can have configurations with 2, 3, or 4 megabytes.

Performance

The MPS2386's better memory architecture makes it about 15 percent faster than

American Mitac MPS2386

Company

American Mitac Corp.
410 East Plumeria Dr.
San Jose, CA 95134
(408) 432-1160

Components

Processor: 16-MHz Intel 80386SX
Memory: One megabyte of 100-ns DRAM in four 256K-byte SIPs, expandable to 8 megabytes on the motherboard; 128K bytes of BIOS ROM
Mass storage: 1.44-megabyte 3½-inch floppy disk drive; ST-506 hard disk drive controller card; 40-megabyte or 100-megabyte hard disk drive
Display: Mitac VGA monitor; VGA circuitry; 256K bytes of display memory; DB-15 monitor connector on the motherboard
Keyboard: Modified 101-key IBM Enhanced
I/O interfaces: RS-232C port with DB-25 connector; DB-25 parallel port; PS/2-style keyboard connector and mouse connector; six 16-bit MCA slots, one with IBM-compatible video adapter extension

Size

14½ × 6¼ × 16½ inches; 28 pounds

Price

Base system: \$2695
System as reviewed: \$5879

Inquiry 855.

the Model 55 SX on BYTE's CPU index and 10 percent faster on the FPU index. The Model 55 SX wins the video index handily, however. Its index of 2.42 bests the MPS2386's mark of 1.57.

The disk I/O performances of the two machines are nearly the same. Other drives, however, would probably yield far different results, since Mitac's 100-megabyte drive is faster than the 40-megabyte unit we tested. IBM, however, doesn't offer a larger drive for the Model 55 SX, and its 30-megabyte drive is even slower than the 60-megabyte system that we tested.

In the critical application index, the two machines were too close to call. Both lost by nearly a 20 percent margin to Compaq's AT-bus 80386SX machine. On the positive side, both the MPS2386 and the Model 55 SX are about 20 percent faster than IBM's 80286-based Model 50 Z.

Compatibility

As we expected, the Model 55 SX worked with all the MCA boards we

tried, including Computer Peripherals' Hook-Up PS2400 internal modem, Gateway Communications' G/Ethernet adapter, and Pixelworks' Ultra Clipper UM1280 graphics card (an interesting test because the board acts as a bus master). The Model 55 SX also had no trouble with Microsoft's Serial Mouse with driver version 6.11, nor with Xircom's Pocket Ethernet Adapter.

The MPS2386 didn't fare quite so well. It successfully ran all but the Gateway G/Ethernet board. We were unable to use that board with NetWare or Gateway's test programs. Because the board worked in the Model 55 SX, and because the MPS2386 ran NetWare over the Xircom Pocket Ethernet Adapter, we concluded that the MPS2386 had a problem with its MCA bus. A Mitac spokesperson said that the firm would investigate the problem and fix it in later production runs.

We also had a minor problem with the MPS2386's Reference Diskette program. On the surface, the MPS2386 seems to use the same Phoenix Reference Diskette (PRD) program as most MCA clones (including those from Tandy and ALR). As with the Model 55 SX, when you install a new board in the system, the machine tells you to run PRD. PRD then tells you that it can't find the .ADF file for that card.

Every MCA board comes with a floppy disk that contains configuration information for that board in a file with a name like 77F4.ADF. (The number identifies the board, while .ADF is the standard extension.) Because IBM's MCA machines use 3½-inch drives, these floppy disks are always 3½-inch.

Unfortunately, the MPS2386's PRD program checks drive B for the floppy disk with the .ADF file—but our evaluation unit's drive B was a 5¼-inch drive. We knew to copy the proper .ADF file to the PRD disk, but if you didn't know much about the PRD, you would be in trouble.

The Phoenix PRD program is also more complicated than IBM's. IBM's sacrifices some flexibility for its simplicity, but it never makes you figure out what to do; it just tells you what to do and then works like a charm.

Neither system had any software problems. Both systems flawlessly ran a wide range of applications, including Borland's Quattro 1.0, Reflex 1.14, Side-Kick Plus 1.00A, SuperKey 1.16A, Turbo C 2.0, and Turbo Pascal 4.0; Digitalk's Smalltalk/V 1.2; Kermit 2.32/A; Micro-Pro's WordStar 3.3 and 4.0; Lotus's

continued



IBM PS/2 Model 55 SX, Mitac MPS2386

APPLICATION-LEVEL PERFORMANCE

IBM PS/2 Model 55 SX **9.5***

WORD PROCESSING			DATABASE		
IBM	Mitac		IBM	Mitac	
XyWrite III+ 3.52	Med./Large	Med./Large	dBASE III+ 1.1		
Load (large)	:14	:14	Copy	1:07	1:01
Word count	:04/:28	:04/:30	Index	:20	:20
Search/replace	:07/:28	:07/:28	List	1:47	1:40
End of document	:02/:16	:02/:16	Append	2:28	2:07
Block move	:11/:10	:11/:11	Delete	:04	:03
Spelling check	:11/1:25	:12/1:27	Pack	2:06	1:35
Microsoft Word 4.0			Count	:17	:17
Forward delete	:19	:19	Sort	1:25	1:21
Aldus PageMaker 1.0a			Index:	1.21	1.36
Load document	:11	:12	SCIENTIFIC/ENGINEERING	IBM	Mitac
Change/bold	:35	:36	AutoCAD 2.52		
Align right	:28	:27	Load SoftWest	1:05	1:03
Cut 10 pages	:23	:23	Regen SoftWest	:49	:48
Place graphic	:06	:04	Load StPauls	:14	:13
Print to file	2:30	2:27	Regen StPauls	:08	:08
Index:	2.07	2.08	Hide/redraw	16:40	16:53
SPREADSHEET	IBM	Mitac	STATA 1.5		
Lotus 1-2-3 2.01			Graphics	:39	:28
Block copy	:04	:05	ANOVA	:17	:16
Recalc	:02	:02	MathCAD 2.0		
Load Monte Carlo	:29	:19	IFS 800 pts.	:21	:21
Recalc Monte Carlo	:07	:07	FFT/IFFT 1024 pts.	:22	:21
Load rlarge3	:07	:07	Index:	2.61	2.76
Recalc rlarge3	:01	:01	COMPILERS	IBM	Mitac
Recalc Goal-seek	:04	:05	Microsoft C 5.0		
Microsoft Excel 2.0			XLisp compile	5:21	5:28
Fill right	:07	:07	Turbo Pascal 4.0		
Undo fill	2:43	2:47	Pascal S compile	:07	:07
Recalc	:02	:03	Index:	1.67	1.67
Load rlarge3	:34	:32			
Recalc rlarge3	:02	:02			
Index:	1.97	1.82			

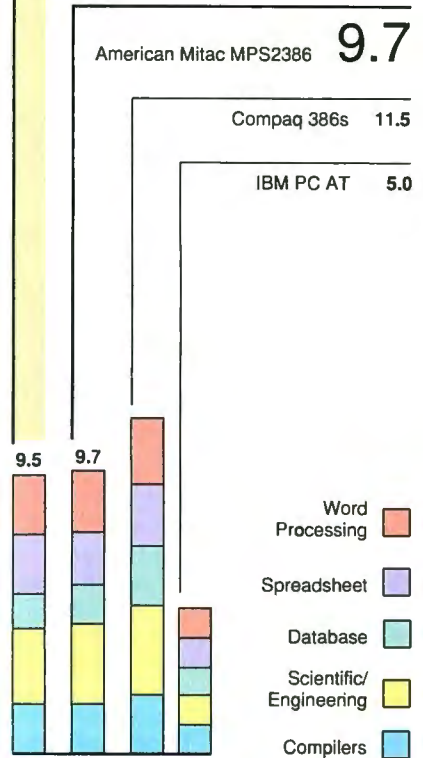

*Cumulative application index. Graphs are based on indexes at left and show relative performance.

All times are in minutes:seconds. Indexes show relative performance; for all indexes, an 8-MHz IBM PC AT = 1.

LOW-LEVEL PERFORMANCE¹

IBM PS/2 Model 55 SX

CPU			DISK I/O			VIDEO		
IBM	Mitac		IBM	Mitac		IBM	Mitac	
Matrix	7.08	7.36	Hard Seek³			Text		
String Move			Outer track	5.02	3.32	Mode 0	4.06	6.15
Byte-wide	52.93	38.46	Inner track	4.96	3.33	Mode 1	4.07	6.15
Word-wide:			Half platter	9.43	9.98	Mode 2	4.25	6.42
Odd-bnd.	49.62	40.90	Full platter	10.00	13.31	Mode 3	4.25	6.41
Even-bnd.	26.47	19.28	Average	7.35	7.49	Mode 7	N/A	N/A
DOS Seek			DOS Seek			Graphics		
Doubleword-wide:			1-sector	14.91	17.51	CGA:		
Odd-bnd.	33.08	28.25	32-sector	29.17	33.61	Mode 4	1.69	2.54
Even-bnd.	21.55	18.31	File I/O⁴			Mode 5	1.68	2.56
Sieve	37.42	34.98	Seek	0.23	0.16	Mode 6	1.87	2.80
Sort	31.99	33.85	Read	1.13	1.12	EGA:		
Index:	1.78	2.04	Write	1.13	1.00	Mode 13	2.74	4.45
FLOATING POINT			1-megabyte			Mode 14	3.11	5.05
Math			Write	5.75	5.64	Mode 15	N/A	N/A
Error ²	14.59	13.35	Read	5.10	5.49	Mode 16	3.08	5.00
Sine(x)			Index:	1.36	1.38	VGA:		
Error	3.90	3.55				Mode 18	3.26	5.27
e^x						Mode 19	1.89	2.84
Error	4.32	3.94				Hercules	N/A	3.81
Index:	4.02	4.41				Index:	2.42	1.57

N/A=Not applicable.

¹ All times are in seconds. Figures were generated using the 8088/8086 and 80386 versions (1.1) of Small-C.

² The errors for Floating Point indicate the difference between expected and actual values, correct to 10 digits or rounded to 2 digits.

³ Times reported by the Hard Seek and DOS Seek are for multiple seek operations (number of seeks performed currently set to 100).

⁴ Read and write times for File I/O are in seconds per 64K bytes.

⁵ For the Livermore Loops and Dhystone tests only, higher numbers mean faster performance.

CONVENTIONAL BENCHMARKS

	IBM	Mitac
LINPACK	284.30	279.46
Livermore Loops ⁵		
(MFLOPS)	0.09	0.10
Dhystone (MSC 5.0)		
(Dhry./sec.)	3474	3612

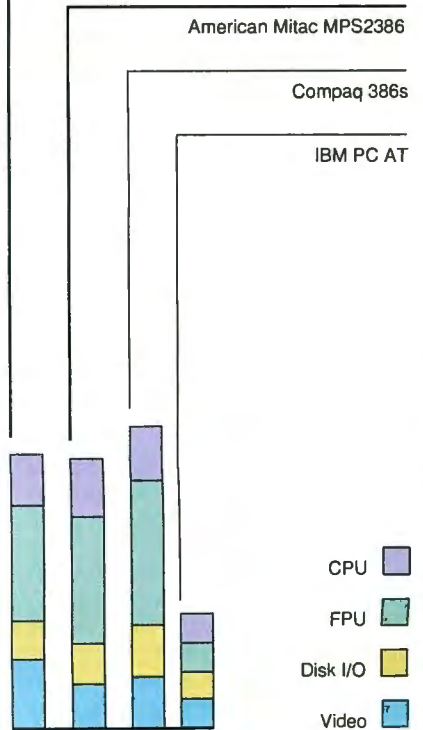

Symphony 2; Microsoft's PC Paintbrush 2.0, Windows/386 version 2.0, and Word 4.0; Norton Utilities 3.00; Novell's NetWare 2.15; and Symantec's Q&A 1.1.

Little Room to Grow

Neither of these systems gives you many mass storage options. The Model 55 SX offers only 30- and 60-megabyte hard disk drives and has only two drive bays. The drives are both anemic performers, with access times of 39 and 27 milliseconds, respectively. As for the two bays, one holds a Mitsubishi 1.44-megabyte 3½-inch floppy disk drive, and the other accommodates the hard disk drive. Even if there was more room for expansion, the skimpy 90-watt power supply probably wouldn't support another drive.

The MPS2386 gives you more initial capacity, with both 40- and 100-megabyte hard disk drive options. Those drives are also faster; a Mitac spokesperson said that future units will use NEC drives with access times of 28 and 19 ms, respectively. Our evaluation unit held a 40-megabyte Rodime drive with a 28-ms access time.

The MPS2386 also has more room to grow. You can buy an optional internal NEC 1.2-megabyte 5¼-inch floppy disk drive like the one in our evaluation unit. (The Model 55 SX has to use an external 5¼-inch drive.) Further, even with the 5¼-inch floppy disk drive installed, our system had one empty half-height 5¼-inch drive bay. Its 150-W power supply gives you enough power to support those additions.

The MPS2386 also offers six MCA expansion slots (one of which is occupied by the hard disk drive controller) to the Model 55 SX's three.

Cases and Innards

You get inside the MPS2386 as you would any AT clone: by undoing five screws on the rear of the case and sliding the cover forward. There's a lot of metal inside this unit, including a pair of support braces that run from the front to the back of the chassis.

The motherboard is 13½ inches square. Its many surface-mounted chips clash with the 19 wires and four resistors soldered on to fix late production problems (Mitac says the board will be cleaner in later production runs). Its 108 chips include the 80386SX-16, an 80387SX-16, and six Intel VLSI chips that perform most of the MCA functions. Removing the motherboard is slow but not difficult.

A Chips & Technologies VLSI chip provides VGA support. That chip uses eight 256K-byte DRAM VGA memory

chips, and there are sockets for eight more. A new C&T chip that will support higher display resolutions will be able to use those extra sockets. The MPS2386's memory consists of 36 100-ns, 1-megabit DRAM chips on four 1-megabyte, parity-checked SIPs on the motherboard. Its keyboard controller and ROM BIOS (version 1.02.00) are by Phoenix Technologies.

The Model 55 SX opens easily, as you would expect from a PS/2: You just undo one screw on each side, and you're done.

The Model 55 SX is a solid, compact machine aimed at the entry-level user who wants an 80386.

The screws even remain attached to the case. Once the case is open, you see a little of the famed PS/2 engineering.

The speaker enclosure forms the front of the card cage and pops out easily. The MCA slots are on a daughterboard that's mounted perpendicular to the motherboard. It and its plastic support brace also come out easily. To take out the drives, you only have to remove their cables, take off the front bezels, and slide them out.

Even IBM, however, makes compromises. The on/off switch on the system's front actually moves a metal bar that extends to another on/off switch on the power supply. The motherboard also was no easier to remove than the MPS2386's; it's held in place by eight little blue screws that were difficult to replace.

The motherboard itself looks great at first: It's the size of a sheet of paper (8½ by 11 inches) and has only 67 chips, not counting memory. Among those chips are the 80386SX-16, a socket for an 80387SX-16, six large IBM VLSI support chips, and eight VGA 256K-byte DRAM chips. There were also 28 chips, including 16 85-ns, 1-megabit DRAM chips, on each of the evaluation unit's two 2-megabyte SIMMs. Surprisingly, the motherboard had 16 wire fixes—almost as many as the MPS2386.

Both systems have respectable keyboards. The Model 55 SX uses the familiar IBM Enhanced keyboard, whose main deficiency is the small size of its Return key. It has a good feel, with mechanical feedback that you can both feel and hear, but it's a little noisy.

The MPS2386 uses a Chicony Electronics keyboard with the common modified IBM Enhanced keyboard. The Enter key is larger than that on the IBM, while the backslash key is to the left of the Backspace key. This keyboard also has a nice mechanical sound and feel, and it's quieter than IBM's.

Both machines include a one-year carry-in parts-and-labor warranty, with extended warranty service and on-site service available. Who services the IBM unit depends on who sells it to you; you go to either your dealer or IBM. Similarly, you get service for the MPS2386 either from your Mitac dealer or from TRW's Customer Service Division, Mitac's service representative.

Mitac provides unlimited telephone support. When the support people called us back, they were helpful, although not well informed about the newly introduced MPS2386. Mitac's phone support is not toll-free, however.

A Question of Need

The Model 55 SX is a solid, compact machine aimed at the entry-level user who wants an 80386. You pay a high premium for the IBM logo: Choose the Model 55 SX over the MPS2386, and you pay over \$1000 more and lose the ability to add more hard disk storage. If the IBM name is worth that much money to you, and if you're sure that you'll never need more disk storage, then the Model 55 SX might be the machine for you.

The big question is whether you need an 80386SX MCA machine at all (see "Battle of the Chips," March BYTE, for more on the 80386SX versus the 80286). Frankly, we don't recommend the combination unless you're wedded to MCA and you need to get into the 80386 world as cheaply as possible. If you just want an 80386SX, you'd be better off with an AT-bus Compaq or one of the less expensive compatibles. If, however, you've just got to have this odd combination of the 80386SX and the MCA, the Model 55 SX and the MPS2386 fill the bill. ■

Mark L. Van Name, a BYTE consulting editor, and Bill Catchings are independent computer consultants and freelance writers based in Raleigh, North Carolina. You can contact them on BIX as "mvanname" and "wbc3," respectively.

“Is there something we missed?”



Is there anything missing in the ACCEL-500 24-pin dot matrix printer?

Not performance. The ACCEL-500 can zoom through drafts at 480 cps. Print charts and graphs in dazzling color. And combine letter quality with high resolution color graphics.

Not versatility. The ACCEL-500 is compatible with most popular printers. So it's equally at home on Macintosh® and IBM®-compatible PCs. There's a paper-handling option for every office application, too.

Not convenience. The ACCEL-500's innovative Select-Dial™ makes paper handling a snap. And plug-in Intelli-Cards™ add fonts and printer emulations instantly.

Not reliability. The ACCEL-500 is a 'round-

the-clock workhorse that takes even the most demanding workload in stride.

And certainly not value. The ACCEL-500 is priced below leading printer brands that offer far less capability.

In fact, it seems that the only thing missing from the ACCEL-500 is you.

ACCEL-500™

Advanced Matrix Technology

765 Flynn Road, Camarillo, CA 93010

(800) 992-2264 (805) 388-5799

ACCEL-500, Select-Dial and Intelli-Card are trademarks of Advanced Matrix Technology, Inc. Macintosh is a trademark of Apple Computer, Inc. IBM is a registered trademark of International Business Machines Corporation. Drawing courtesy of Wingz.

Circle 15 on Reader Service Card

The New
804
Series

AFFORDABLE CONNECTIVITY

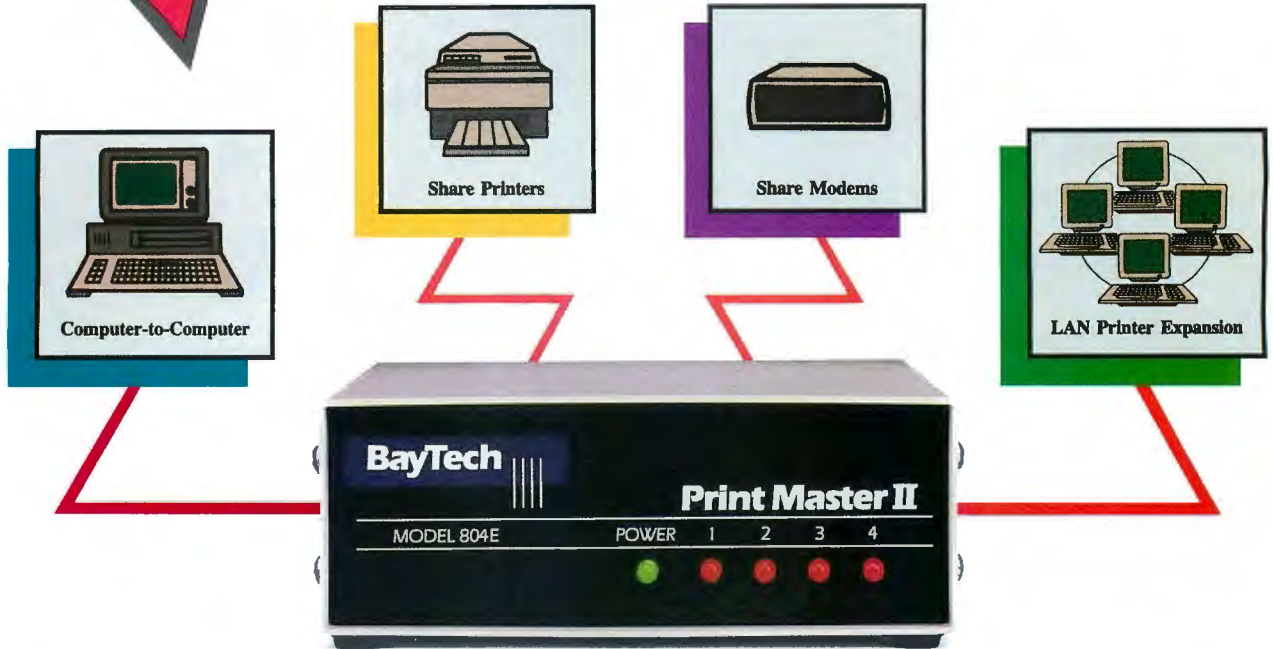

A VERSATILE LAN-ALTERNATIVE FOR \$395



THREE MODELS TO MEET YOUR APPLICATIONS

The Print Master® II 804 Series is BayTech's newest intelligent controller with four ports and a 256KB dynamically allocated buffer. Available in your choice of four serial ports (RS-232C or RS-422A), four parallel ports, or two serial and two parallel ports, the 804 Series offers affordable connectivity.

The 804 Series provides a cost-effective solution for users who want to maximize their resources. Each four port model allows you

to connect any combination of computers, printers, and plotters for:

- ▶ printer sharing
- ▶ plotter sharing
- ▶ buffering of data
- ▶ LAN printer expansion

Models with serial ports allow you to also connect modems or any other RS-232C device for computer-to-computer communication and modem sharing.

The 804 Series allows simultaneous data input from computers, output of print data and full duplex communication between pairs of computers.

LAN APPLICATIONS

The 804 Series is ideally suited for expanding the printing capabilities of a LAN system. By acting

as a printer server, it can off-load network traffic and provide port expansion and extra buffering.

BayTech products are covered by a one-year warranty and are supported toll-free by a team of application engineers.

Call us today to learn how the new Print Master® II 804 Series can become your connectivity solution.

BayTech

Bay Technical Associates, Inc.
Data Communications Products Division
200 N. Second Street, P.O. Box 387
Bay St. Louis, MS 39520 USA
FAX: 601-467-4551

Telex: 910-333-1618 BAYTECH
Phone: 601-467-8231 or toll-free

800-523-2702



Color Printer Quells Price-Tag Blues

ColorQuick offers Mac users a slow but effective alternative to pricey thermal printers

Tom Thompson

Volumes extol the color-imaging capabilities of Macintosh computers, but a single word describes printing those images: expensive. But people who balk at paying \$7000 to \$15,000 for laser and thermal wax-transfer color printers now have a new alternative, Tektronix's \$2495 ColorQuick ink-jet printer for the Mac II and Mac SE/30.

With a 216-dot-per-inch resolution, the ColorQuick doesn't rival high-end printers, but its output looks crisp and vibrant on coated paper. What's more, ink-jet prints are more durable than wax-transfer prints, so, for example, artists can fold proofs for mailing, and the ink won't flake or run if the paper accidentally gets soaked (as has happened to me).

The printer has some limitations, including sluggish text speed. But when you compare its price and operating costs to those of high-end printers, the ColorQuick can be a winner for some applications.

A Generous Host

Color printers are expensive because, in many instances, they come with their own microprocessor, RAM, and firmware to handle networking protocols and page-description-language commands. Rather than duplicating these components, ColorQuick opts to tap the host



computer to build page images into memory and transfer color data through the Mac's SCSI port to the printer. (This is the same approach that Apple's black-and-white LaserWriter IISC SCSI printer uses.)

This design trades cost savings for computer downtime: ColorQuick ties up the host for the entire printing operation. This can be especially annoying if you are printing large images or lengthy documents.

Nuts and Bolts

ColorQuick's bidirectional print head builds page images one band at a time as four ink jets simultaneously spray dots of cyan, magenta, yellow, and black ink. A levered cover on the print head allows easy access to ink tanks and seals the tanks securely during printing. Lamps on the top of the front of the printer show ink levels. The tanks that store the liquid inks sit on the print head. Also on the

print head is a cartridge containing an anticlogging fluid designed to keep the ink jets flowing smoothly. Easy-to-reach buttons let you select form- or line-fed paper, set the media type, and place the printer on-line.

The printer accepts plain paper, coated paper, and transparency film in cut-sheet, roll, or tractor-fed forms. Cut-sheet and roll feeders come standard; a tractor feeder is available as an option at a cost of \$300. Both standard feeders handle up to B-size (tabloid) or A3-size media; you can also hand-feed 12- by 18-inch sheets.

Two 50-pin SCSI ports and a Centronics port let Macs and PCs share the printer. The manual explains how to connect a PC, but you must first determine if your PC applications have the appropriate drivers.

The manual is complete and well illustrated. It points out that the printer

continued

ColorQuick

Company

Tektronix, Inc.
Graphics Printing and Imaging Division
MS 63-447
P.O. Box 1000
Wilsonville, OR 97070
(800) 835-6100

Features

Four-color ink-jet printer prints 16.8 million colors; drivers selected using Macintosh Chooser; two 50-pin SCSI ports and one Centronics port; includes sheet and roll feeders; supports Apple's 32-Bit QuickDraw

Size

5½ × 15 × 26 inches (without feeders);
28½ pounds (without feeders)

Hardware Needed

Mac II, IIfx, IIfx, or Mac SE/30 with at least 2 megabytes of RAM

Software Needed

System 6.0.3/Finder 6.1 or higher

Documentation

User manual

Price

\$2495

Inquiry 851.

doesn't have an internal SCSI terminator. This is nice to know if you're cabling the printer to an external SCSI hard disk drive. Many disk drives have hard-to-remove internal terminators and therefore should be placed at the end of a chain of SCSI peripherals (so the order would be, for example, the Mac, a printer, a tape drive, and then the hard disk drive). You set the printer's SCSI ID by means of a small rotary switch. A self-test switch and configuration DIP switches for PCs sit under a hinged front cover that protects them while keeping them readily accessible.

Although the printer is rated at 216 dpi, the Mac software you use determines the actual resolution. For example, most bit-map-based applications, such as MacPaint or PixelPaint, operate on pixels and will print only at the Mac's 72-dpi screen resolution. Vector-based applications, on the other hand, treat graphics as objects and use Color Quick-

Draw's drawing primitives for additional resolution.

To achieve this extra resolution with text, you must use a font that's three times larger than the document's font. This is because Color QuickDraw uses these larger characters (say, 30-point Courier) to draw the text at 216 dpi; the text actually appears as 10-point Courier on the page. If the larger font is not installed, you can end up with poorly formed text.

Standard ColorQuick disks provide the large fonts in 11 typefaces: Courier, Times, Helvetica, Helvetica Narrow, Palatino, Symbol, ITC Avant Garde Gothic, ITC Bookman, ITC Zapf Chancery, ITC Zapf Dingbats, and New Century Schoolbook. Although these fonts match the PostScript fonts, remember that they are bit-mapped screen fonts, not PostScript fonts. Also, these additional fonts take up space on your hard disk—over 2 megabytes' worth.

Putting It to Work

My review unit arrived with sheet and roll feeders, spare ink cartridges, and a box of 3½-inch floppy disks. The disks held system software, ColorQuick's printer driver, and the larger fonts. Unfortunately, the printer doesn't ship with a SCSI cable or terminator.

I used ColorQuick with a Mac II running System 6.0.3 with 5 megabytes of RAM and a SuperMac Spectrum/8 video board with a 19-inch color monitor. Although the ColorQuick driver can operate with 2 megabytes of RAM, most color applications require well over 1 megabyte. You might consider upgrading your system RAM to 4 megabytes.

The printer comes filled with ink, so the messiest part of the setup is removing the seal on the print head's ink tanks. You'll probably get ink all over your hands no matter how carefully you do this. However, refilling the ink tanks is easy and clean. Sealed ink cartridges are keyed to prevent you from emptying the wrong color into the wrong tank. One end of the cartridge goes into the appropriate well, breaking one seal; you break a second seal on the cartridge top to let the ink flow into the tank.

ColorQuick sports one of the best printer drivers I've seen because it gives plain-English messages (e.g., "Printer out of paper" and "Put the printer online"). When a problem is flagged, you have the choice of either correcting it and resuming the printing operation, or clicking a cancel button to abort the job. A status window graphically shows how much of the page had been printed before

the job halted. The window also indicates ink tank levels.

Smooth Color Blends

I printed images with PixelPaint 2.0, MacDraw 1.1, SuperPaint 2.0, and Cricket Graph 1.0. Line artwork, such as charts and graphs, reproduced best. Most PixelPaint artwork with color blends achieved similar quality. Colors blended in smooth gradations. Interestingly, ColorQuick handled some blends (red to yellow to green) better than others (purple to red), but this may be due to a combination of factors and not just the printer.

Although MacDraw 1.1, Cricket Graph 1.0, and SuperPaint 2.0 use the original eight QuickDraw colors, ColorQuick will accommodate those who still use these applications. The driver does require Color QuickDraw, however, so you can't coax colors out of, say, MacDraw 1.1 using a Mac SE or a Mac Plus.

PageMaker 3.0 documents, including the hairlines and colored text, printed fine. However, PageMaker and text-only documents printed slowly: It took nearly 2 minutes per page on low resolution (72 dpi) and over 3 minutes at high resolution (216 dpi). Speed is significant, since printing ties up your Mac. You can't even run the print job in the background under MultiFinder.

Scanned color images were hit-and-miss: Either the printed image looked good, or it didn't. I couldn't determine the cause of this inconsistent quality, especially when I printed two images with nearly the same set of colors, and one looked awful and the other looked sharp and colorful.

You should use coated paper for best results. Images printed on regular paper appeared muddy and flat. Tektronix estimates that coated paper costs 28 cents per sheet. You can expect to pay approximately 40 cents per sheet or more with thermal wax-transfer printers.

ColorQuick's sluggishness when printing text makes it a poor general-purpose printer. However, it shines with artwork, printing most of it at the rated 216-dpi resolution. The nearest price competitor, the \$1395 Hewlett-Packard PaintJet, prints at only 180 dpi.

For the right color-printing applications, such as artist's proofs or color transparencies for business presentations, ColorQuick is an affordable and effective choice. ■

Tom Thompson is a BYTE senior technical editor at large. He can be reached on BIX as "tom_thompson."

Designed for desktop graphics, priced to be personal.

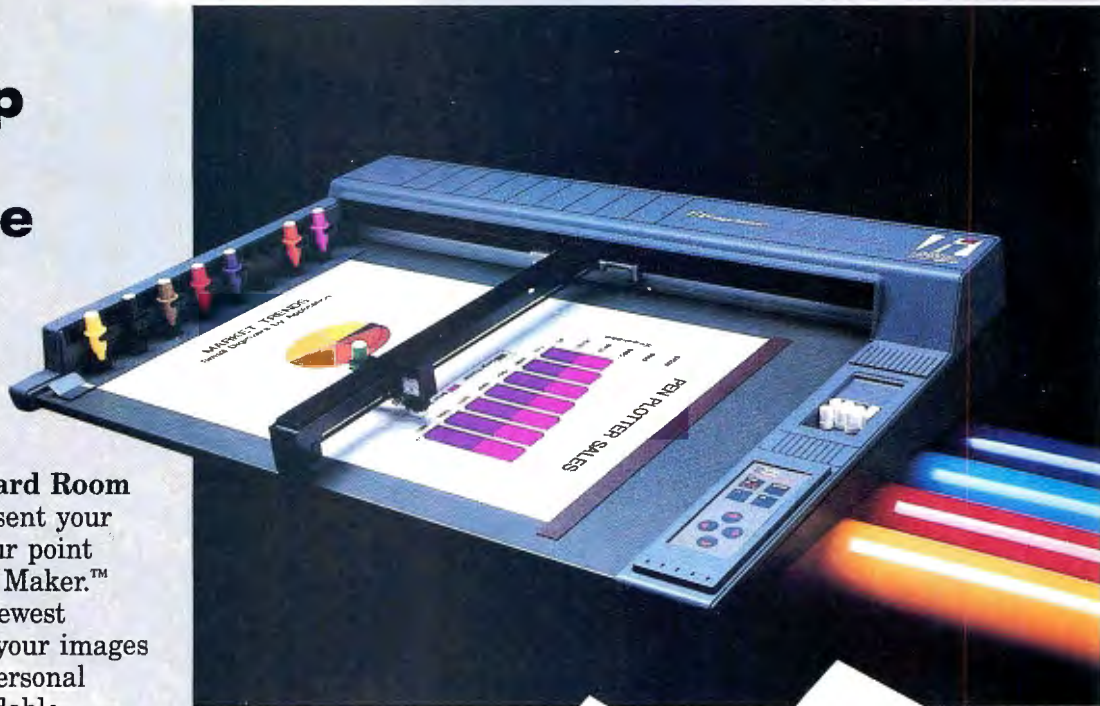

Drawing Board to Board Room

Plot your designs, present your plans, and illustrate your point with the new HI Image Maker.™ Houston Instrument's newest plotter can improve all your images at a price that makes personal productivity gains affordable.

Precision CAD or Graphic Presentations

Your HI Image Maker uses a variety of technical pens on vellum or presentation bond—and produces vibrant color graphics on transparencies, paper, or vellum. Drawings on media up to 11×17 inches can be produced quickly and beautifully at a resolution of one thousandth of an inch.

Confidence and Value

Industry experts agree, HI drafting plotters defined the price-performance standard for PC-based CAD plotters. The HI Image Maker is a product you can buy with confidence. Priced at only \$1295,* you can use this plotter throughout your company—or keep it for yourself!

For details, call 1-800-444-3425 or 512-835-0900.

**U.S. suggested retail price. Subject to change.*

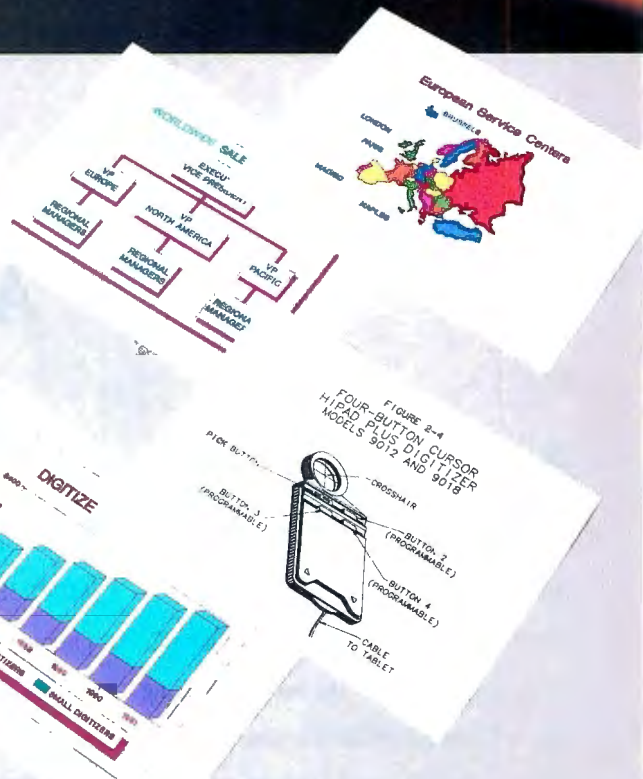

HOUSTON INSTRUMENT

A DIVISION OF AMETEK

8500 Cameron Road, Austin, TX 78753

*Houston Instrument and HI Image Maker
are trademarks of AMETEK, Inc.*

Circle 122 on Reader Service Card



Micro Channel and AT-bus 386SX Micros --Only From Mitac

Mitac is the first to give you a choice of architectures on the 386SX platform.

Whether you use the "industry standard" (AT) architecture or the up-and-coming Micro Channel of IBM's new PS/2s, Mitac's 386SX-based computers assure you the power of Intel's future-compatible 80386SX microprocessor. The power you need to affordably run today's (and tomorrow's) most advanced

32-bit applications. Of course, you don't need both the MPS2386 and the MPC2386, but whichever system you choose, you get a compact micro with 386 performance and a host of built-in features. On-board VGA-compatible graphics controller, space for both 5-1/4" and 3-1/2" diskette drives, room for four storage devices and a total of six expansion slots assure you maximum flexibility with room for growth.

And, as with all Mitac microcomputers, the MPS2386 and MPC2386 are backed by a one-year warranty and Mitac's complete service and support programs. For more information on Mitac's full range of AT- and Micro Channel-compatible computers and the name of your nearest authorized dealer, call today **800-648-2287 Extension 348.**

mitac
When reliability is a decisive factor

Mitac's microcomputers are distributed in the U.S. by Microamerica and Schweber Electronics. Canadian distribution is handled through TLS.



Speed Separates Two Portable Printers

Kodak and Toshiba take different routes to design printers for the road

Wayne Rash Jr.

Kodak and Toshiba recently introduced portable printers for laptop-toting business travelers. Kodak's printer shines as a compact and efficient touring companion; Toshiba's does not.

Kodak's success stems from the ink-jet printer head that it uses with the Diconix 150 Plus, an updated version of the Diconix 150 thermal printer. Toshiba opted for a thermal print mechanism in its Expresswriter 301, and the result is letter-quality output at an almost impractical speed.

To be effective, your portable printer should be as compact as your laptop computer. Ideally, the printer should fit into the computer's carrying case and run on batteries. Its print quality shouldn't embarrass you, even if it falls short of laser printer quality. The Kodak and Toshiba printers each fulfill some of these requirements, but when they're compared for speed and other practical matters, their similarities end.

Slow but Sure

The Expresswriter is misnamed. "Express" implies speed, and that's a quality missing entirely from this, the slowest printer I have ever reviewed.

Clearly, Toshiba optimized the Expresswriter for print quality at the expense of speed and ease of use. Fanfold paper won't work, so you must insert



Portable printing: The Toshiba Expresswriter 301 (left) and the Kodak Diconix 150 Plus.

each sheet individually. The paper-out indicator signals before the print head actually reaches the bottom of a page—but that's just as well, because the platen loses its grip on the paper at about that time, so if anything printed, it would be crooked.

The Expresswriter's actual per-line throughput is a dreadful 12.8 characters per second at regular speed, and 16.6 cps at "high" speed (see table 1). (Toshiba claims a high speed of 60 cps.) This rate grinds even more slowly over an entire page, because the head prints only in one direction. At the end of each text line, the head pauses, makes some internal click-

ing sounds, and then slowly returns to the left margin to begin a new line.

If you can accept this agonizingly slow speed, you'll be pleased with the crisp results from Toshiba's 24-pin thermal print head. It won't outshine a laser printer, but it's acceptable for most business uses. Unfortunately, that's about the only thing I found acceptable in the Expresswriter.

The unit promises Toshiba 321 SL and Epson LQ-850 compatibility. The Epson compatibility worked fine with WordPerfect 5.0 and WordStar 5.5. WordPerfect also handled the Toshiba emulation,

continued

Diconix 150 Plus

Company

Eastman Kodak Co.
Personal Printer Products
901 Elmgrove Rd.
Rochester, NY 14653
(800) 255-3434

Features

IBM Proprinter, Epson FX-80/85, and IBM Graphics emulation; 2000-character buffer; draft, near-letter-quality, and quality modes; condensed superscript/subscript print; noise: 45 dB
Power: AC adapter; five rechargeable C cell batteries (life: 12 hours standby, 1 hour printing)

Size

2 x 6½ x 10¾ inches; 3 pounds

Documentation

User's guide; reference manual

Price

Parallel model: \$499
Serial model: \$519

Inquiry 852.

Expresswriter 301

Company

Toshiba America Information Systems, Inc.
9740 Irvine Blvd.
Irvine, CA 92718
(714) 583-3000

Features

Toshiba 321 SL/Qume and Epson LQ emulation; 2000-character buffer; 24-dot print head; noise: 47 dB
Power: AC adapter built-in; rechargeable 1 hour of continuous printing

Size

3 x 5½ x 12¼ inches; 4 pounds

Documentation

User's manual

Price

\$489

Inquiry 853.

Table 1: Even at its slowest setting, Kodak's Diconix 150 Plus outpaces the Toshiba Expresswriter 301's printing speed. (Tests consisted of a 1000-character ASCII text file. Measurements are in characters per second for throughput at 10 pitch.)

Diconix 150 Plus	Expresswriter 301
Draft: 99	Regular speed: 12.8
Near-letter-quality: 33	High speed: 16.6
Quality: 24.2	

but WordStar did not. However, considering that virtually all software accommodates Epson printers in some way, LQ-850 emulation is acceptable.

For this review I used a Zenith Super-Port 286 portable computer. Its carrying case sports a 10- by 12- by 2-inch pocket into which I usually stuff the computer's power supplies, cables, software, LapLink cables, Ethernet cards, a Travis McGee mystery, and, if possible, the printer. Unlike the Diconix, the Expresswriter didn't fit into the pocket. But the Expresswriter is rugged enough to pack into your checked luggage. It survived a rail trip from Washington, D.C., to Philadelphia with no ill effects, although it was inaccessible for any in-transit work.

Jet-Propelled

In contrast to the Expresswriter, Kodak's Diconix 150 Plus is compact, easy to use, and reasonably speedy. Its acceptable print quality falls short of the Expresswriter's, but the text prints a great deal faster. The Diconix's ink-jet printing head provides the speed and size advantages. The updated Diconix also accepts single-sheet or continuous-form paper, so I didn't have to hover over the machine during an extended printout.

The printer appears to be a direct descendant of the old Hewlett-Packard ThinkJet. While the original had problems, such as ink splattering and an appetite for special paper, Kodak's version overcomes these shortcomings. Still irritating, however, is the Diconix's tenden-

cy not to print the last line of a text file unless it's followed by a formfeed character. This command, common for laser printers, is unusual for dot-matrix models. It proved tedious when I sent ASCII text to the printer using the MS-DOS COPY command. The command was unnecessary when I used word processor or spreadsheet applications.

Overall, the Diconix 150 Plus behaves well and prints quietly. It supports WordStar and WordPerfect, and both the Epson FX-80 and the IBM Proprinter emulation modes worked properly.

In draft mode, the Diconix runs at 99 cps average throughput for 10-pitch printing (Kodak promises 97 cps average). Draft mode is just that: The print is clearly ink-jet dot-matrix quality, which is fine for draft memos but not business letters.

Diconix also offers near-letter-quality and "quality" printing. Each adds print-head passes, so speed slows accordingly compared to draft printing. But the quality-mode output looks nearly as good as the Expresswriter's text, which takes nearly twice as long to print. More important, you don't suffer with a slower speed unless you choose higher-quality results.

The Diconix performs admirably as a travel printer. I took one to Honolulu, where I used it to create documents that I then faxed to my Washington, D.C., office. The printer was quiet enough to use in my hotel room without concern. Because it fit easily into my laptop's carrying-case pocket, I could work whenever I had the opportunity, including in a Honolulu airport lounge. The larger Toshiba would have been out of reach in my checked baggage.

Which Do You Need?

If you're considering buying either of these printers, first decide if you really need letter quality. The Expresswriter offers this, but it asks you to sacrifice performance and easy portability.

With only slightly lower print quality, the Diconix is fast, light, and practical. It travels easily and performs well where you're likely to use it. In short, it works in the real world of business travel, and the Expresswriter does not. ■

Wayne Rash Jr. is a contributing editor for BYTE and a member of the professional staff of American Management Systems, Inc. (Arlington, VA). He consults with the federal government on micro-computers and communications. You can contact him on BIX as "waynerash," or in the to.wayne conference.

Sample from an Epson 24-pin dot-matrix printer with *UltraScript PC*



Sample from an Epson 24-pin dot-matrix printer without *UltraScript PC*

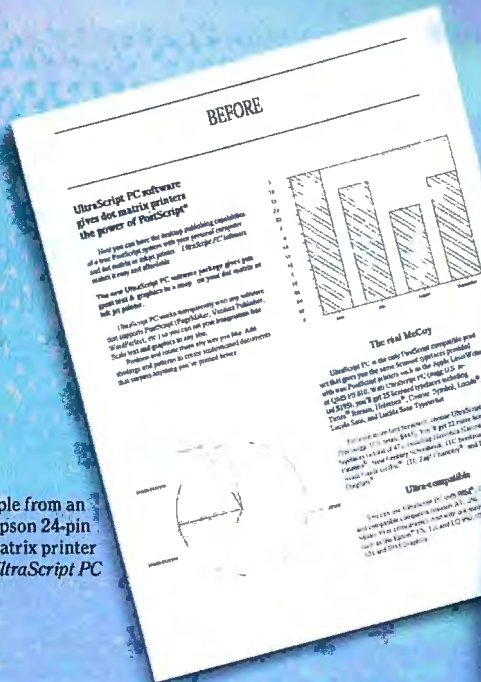

esktop publishing on a dot-matrix budget

UltraScript™ PC software gives dot-matrix printers the power of PostScript® printing at a fraction of the cost.

At last, the power of PostScript printing for thousands less. *UltraScript PC* software runs on your PC and gives ordinary dot-matrix and ink jet printers full desktop publishing capabilities. Create attractive documents that surpass anything you've printed before. It works with software that supports PostScript output, such as PageMaker®, WordPerfect®, Ventura Publisher® and Microsoft® Windows. And it works without forcing you to leave your application to print a document. Use it to scale text and graphics to any size, add shadings and patterns, and position them on the page however you like.

Top-quality typefaces

UltraScript PC is the only PostScript-compatible product that gives you the same licensed typefaces used by professional typesetters and provided with Adobe® PostScript printers such as the Apple® LaserWriter®.

With *UltraScript PC* (U.S. list, \$195), you'll get 25 licensed typefaces. For more font firepower, choose *UltraScript PC plus* (U.S. list \$445). You'll get 22 more for a total of 47.

Ultracompatible

You can use *UltraScript PC* with most IBM®, Compaq® and compatible computers (80286-based or higher with 1.5 MB of RAM recommended). And with dot-matrix printers such as the Epson® FX, LX and LQ 950, IBM Proprinter® X24 and IBM Graphics. Or ink jet printers such as the HP® DeskJet™ and Canon® BJ-130, or HP LaserJet™ Series II laser printers. And any printer that emulates them.

Join the desktop publishing revolution today—the smart way. Just contact QMS at **1-800-635-3997** and ask about *UltraScript PC*.

UltraScript PC software. Affordable PostScript compatibility for everyone.



QMS®

The following are trademarks or registered trademarks of their respective companies: QMS and UltraScript of QMS, Inc.; Adobe and PostScript of Adobe Systems, Inc.; Ventura Publisher of Xerox Corporation; Microsoft of Microsoft Corporation, Epson of Epson America, Inc.; PageMaker of Aldus Corporation; Compaq of Compaq Computer Corporation; IBM and Proprinter of International Business Machines Corporation; WordPerfect of ARTS Computer Products, Inc.; Canon of Canon, USA, Inc.; HP DeskJet, LaserJet of Hewlett-Packard Company, and Apple and LaserWriter of Apple Computer, Inc. ©1989 QMS, Inc.

Circle 224 on Reader Service Card (DEALERS: 225)

NO ADDED CHARGE ON CREDIT CARDS

EXECUTIVE PHOTO & SUPPLY CORP.

HOURS: Mon. Tru. Thurs. 9AM Till 6PM, Fri. 9AM Till 2:00PM, Sun. 9:30AM Till 5PM, Closed On Sat.

FOR COMPUTER & ACCESSORIES
CALL TOLL FREE: 1-800-882-2802
 FOR FAX, TYPEWRITERS & DICTATION EQUIPT.
CALL TOLL FREE: 1-800-223-7323
 IN N.Y. STATE CALL: 1-212-947-5290

LAPTOPS

EPSON



Equity LT
 10MHz, 640K, 2-3.5 720K Drives,
 Supertwist Backlit Display
 w/Free Laplink
1044.95

Equity LT w/20MB Hard Drive .1649.00

SPARK by Datavue
 Spark-EL, 640K, 2-3.5 Drives . . .1019.00
 2400 Modem I/Datavue CALL

MITSUBISHI

266L w/1.4 Drives1979.90
 266L w/20MB Hard Drive2299.00
 286L w/40MB Hard Drive2859.00

SHARP

PC-4502 w/640K, 2-Floppy Drives & Backlit
 Monitor894.75
 New! PC-4641 w/40MB H.D.2396.75

TOSHIBA (sold in Store Only)
 T-1000 CALL T-1200HB CALL
 NEW! T-1600 CALL
 NEW! T-5200 CALL

ZENITH

184-11399.00 184-22089.00
 Supersport 286 Model 20 w/20MB Hard
 Drive2789.75
 286 w/40MB Hard Drive3149.75

NEC

PROSPEED 3863997.00
 ULTRALIGHT 2MB2399.75
 PROSPEED 286 w/40MB CALL

BONDWELL

Bondwell Laptop 286, 10MHz, 20MB Hard
 Drive w/1200 Modem, Rechargeable Battery
 & Case2149.00

DESKTOPS

COMPAQ



New! DESKPRO 286e, 12MHz, 1.2 Floppy
 Drive, 40MB Hard Drive w/VGA. 2349.00
 COMPAQ Portable III with 40MB Hard
 Drive3849.00

AST



AST PREMIUM 286
 10 MHz, 512K, 1.2 Floppy Drive,
 Seagate 40MB Hard Drive (28ms)
1578.75

**NEW! AST BRAVO 286 8 MHz, 1.2 Floppy,
 40MB Hard Drive (28ms)1198.75**

EPSON

EQUITY II+, 1-1.2 Floppy Drive, 1-40MB
 Hard Drive CALL

COMPATIBLES

IBM-XT Compatible, 1-360 Floppy Drive,
 1-20MB Hard Drive699.95
 IBM-AT Compatible, 12MHz, 512K, 1.2
 Floppy Drive, Seagate 40MB Hard Drive
 (28ms)1114.75
 VENDEX Headstart III CALL

Laptop Accessories

WORLD PORT 2400 Modem235.00
 NEW! DIGICON 150 Plus Printer. 309.75
 TARGUS Nylon Case57.95

PRINTERS

EPSON

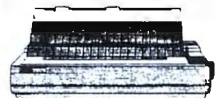

FX-1050
 9 Pin, Wide Carriage, 290 CPS
 Draft (10cpi), 60 CPS NLQ, Advanced
 Paper Handling Capabilities
469.75

New LX-910187.95
 LO-850543.50 LO-950542.50
 LO-1050767.95 LO-2550959.99
 FX-850352.00 LO-510 CALL

PANASONIC

KX-P 1181, 175.75 KX-P 1191, 203.75
 KX-P 1124308.75
 PANASONIC Laser Printer1319.00

CANON

NEC
 NEC 2200, 307.95 NEC P5200, 493.95
 NEC P5300648.95
 NEC LC-980 Postscript Laser3089.00

OKIDATA
 OKIDATA 320339.00
 OKIDATA 3301019.00
 OKIDATA Laserline 6 CALL

STAR
 NX-1000157.90 NX-1000C189.00

PRINTER SALE!
 CITIZEN Premiere 35 Daisywheel 499.75
 DICONIX 300 Narrow Printer349.75
 NEW! H.P. Deskjet Plus689.90
 H.P. Laserjet II w/Toner CALL
 APPLE Imagewriter II439.00

HARDWARE

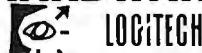

NEW! Logitech Bus Mouse69.99
 NEW! Logitech PS/2 Mouse64.75
 Logitech Scanman I/PS2199.75
 INTEL 80387-1214.75
 INTEL 80387-20369.99
 INTEL 80387-33MHz569.75
 DFI HS-3000 Plus Scanner155.75
 MICROSOFT Mach 20315.75
 MICROSOFT Mouse99.95
 PLUS 20MB Card523.75
 PLUS Impulse CALL
 TOSHIBA 3 1/2" 720K Drive w/KR79.75

Display Cards & Monitors

PARADISE VGA Plus OEM199.95
 PARADISE VGA Plus 16 OEM199.95
 PARADISE VGA Professional CALL
 VEGA V-Ram VGA 256K439.75
 VEGA VGA245.00
 MAGNACOX VGA Monitor 082334.75
 NEW! NEC Multisync IIA Monitor496.75
 NEC Multisync 3D599.00
 SEIKO 1430 Monitor515.75
 SONY 1302 Monitor w/Stand633.50
 SONY 1304 Multisync Monitor669.00

Modems/Fax Cards

EVEREX 2400B Modem CALL
 Zoom 2400 External Modem117.75
 SIERRA (Migent) Pocket Modem. 105.00
 US Robotics 9600679.75
 QUADRAM JI Fax Internal 4800 194.75
 COMPLETE PC 9600 Fax415.75

PRINTER RIBBONS

OKIDATA 292 Ribbon5.49
 EPSON Original EX-800/1000 Color/13.99
 NEC P7/P3 Ribbon4.59

DISKETTES

FUJI MF2/DD Rainbow10.49
 FUJI MF2 HD26.49
 MAXELL Diskettes CALL

SOFTWARE

WORDPERFECT223.95
 KO-Pilot I/Word Perfect56.75
 NEW! SAMNA AMI116.75
 NOTA BENE 3.0235.00
 WORDSTAR Pro 5.5129.95
 GRAMMATIK III48.99
 GO SCRIPT Plus234.75
 ADOBE Illustrator294.75
 BITSREAM Fonts CALL
 SOFTCREAT Font Solution Pack. 384.75
 New! PER: FORM Designer157.75
 New! COREL Draw 1.1329.95
 XEROX Presents295.75
 ALDUS Pagemaker445.00
 HARVARD Graphics288.75
 COMPUTER Support Arts & LettersCALL
 PFS First Publisher72.75
 NEW! LUCID 3D59.00
 IMPRESS77.95
 New! LOTUS 1-2-3 3.0339.75
 LOTUS Agenda247.75
 SYMANAC Grandview173.75
 Q & A205.75
 ASK Sam165.00
 D'Base IV187.75
 FOXBASE Plus167.75
 PARADOX 3.0436.75
 FRAMEWORK III419.00
 New! INTUIT Quicken 3.035.95
 DAC Easy Accounting 3.057.00
 ONE Write Plus84.75
 WEALTH Builder by Reality139.75
 PROCOM Plus42.95
 NO. 1 Mail Manager39.00
 BACK II by Gazelle58.75
 FASTBACK Plus99.75
 SPINRITE39.95
 386 MAX39.49
 NORTON Advanced Utilities79.75
 MICROSOFT Quick C W/Assembler. 133.75
 BORLAND Turbo C Pro157.00
 DESKVIEW75.00
 FAST by Future Computer67.75
 SUPER PC48.75
 TURBO EMS by Lantana51.75
 HYPERPAD by BrightHill66.75
 ACCOLADE Grand Prix23.75
 CHESSMASTER 210029.95
 SIERRA Space Quest III33.75

*After MFR Rebate of up to \$55

FAX MACHINES

PANAFAX



UF-135 CALL UF-140 CALL
 UF-145 CALL UF-150 IN STOCK
 UF-250 IN STOCK UF-280 IN STOCK

SHARP

FO-220 CALL FO-300 CALL
 FO-310 CALL FO-420 CALL
 FO-510 CALL FO-700 CALL

Canon FAXPHONE

FaxPhone 8 CALL FaxPhone 1 CALL
 FaxPhone 20 CALL FaxPhone 2x CALL
 FAX 225 CALL FAX 270 CALL
 FAX 350 CALL FAX 450 CALL
 FAX 630 CALL FAX 705 CALL

RICOH

FAX-26E CALL FAX-35 CALL
 FAX-65E CALL FAX-75E CALL

MURATA

M-900 CALL M-1200 \$29.90
 M-1400 CALL M-1800 \$29.90
 M-1800 CALL

PANASONIC

KX-F 80 CALL KX-F 100 CALL
 KX-F 120 CALL KX-F 220 CALL
 KX-F 320 CALL

TOSHIBA Price Break
 3300 CALL 3700 CALL
 Model 30100 CALL

BROTHER

FAX 200 CALL
 FAX 210 w/Answering Machine CALL

FAX PAPER

8 1/2"x98"49.95 8 1/2"x164"59.90
 8 1/2"x328"74.95
 FAX Cleaning Kit29.95

TYPEWRITERS & Word Processors

SMITH CORONA

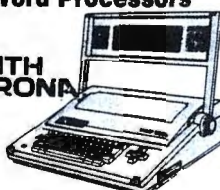

WORD PROCESSORS

PWP-2000 CALL PWP-3000 CALL
 PWP-5000 CALL PWP-100C CALL
 PWP-7000LT Laptop CALL

TYPEWRITERS

XL-1500 CALL XL-4600 CALL
 XD-5800 CALL XD-7900 CALL

WP & Typewriter Access.

PWP Start-Rite Kit39.95
 Typewriter Start-Rite Kit39.95
 Printwheelsea. 10.85
 Multi Strike FilmDz. 74.85
 Correctable FilmDz. 34.85
 Lift-Off Correcting CassetteDz. 44.85
 Cover-Up Correcting Cassette. Dz. 46.85
 Data-DisksDz. 34.95
 CoronaCalc44.95
 Sheet Feeder I/PWP-5000139.90

Panasonic

KX-W1000 Word Processor CALL
 KX-W1500 Word Processor. IN STOCK
 KX-W1510 WP w/Sheetfeeder CALL
 KX-R430 CALL KX-R440 CALL
 KX-R600 Word Processor TypewriterCALL
 Accessories CALL

brother

WP-60 Word Processor CALL
 WP-75 Word Processor CALL
 WP-90 Word Processor CALL
 AX-26 CALL AX-28 CALL
 Accessories CALL

Dictation Equipment

OLYMPUS Pearlcarder

L-200129.90 S-90735.90
 S-91159.90 S-93099.90
 T-1010 Transcriber169.90
 S-804119.95 S-811 CALL
 T-100 CALL T-2020 CALL

PANASONIC

RN-15119.80 RN-36179.90
 RN-8979.90 RN-105D29.90
 RN-106D34.95 RN-115D39.90
 RN-12559.90 RR-800179.90
 RR-970249.90 RR-980279.90

SANYO

TRC-6100 CALL TRC-588076.90
 TRC-2550 CALL149.90
 TRC-5200229.90 TRC-5200179.90
 TRC-4300227.90 TRC-4030178.90
 TRC-8000A227.90 TRC-8010A185.90
 TRC-8700239.90 TRC-8070185.90
 TRC-9100239.90 TRC-9010199.90

SONY

M-1005219.80 M-74035.90
 M-750V49.90 TCM-5000EV 369.90
 BM-12 CALL BM-17 CALL
 BM-580 CALL BI-500 CALL
 BM-75 CALL BM-80 CALL
 BM-815T CALL BM-820 CALL

NORELCO

58589.90 592119.90
 NT-file134.95 NT-V189.95
 NT-VI219.90 NT-VII247.90
 MC-III164.95 MC-IV199.95
 2595 CALL
 205287.90 505319.90
 510399.90 805629.90
 MC-3000299.90 MC-4000379.90
 2505399.90 2510334.95

COPIERS

Canon PC



PC-3 II349.90 PC-5 II453.90
 PC-5L II Legal Size619.90
 PC-6779.90 PC-6RE859.90
 NEW! PC-7 Zoom Copier CALL
 Black Cartridges79.95
 8 1/2x11 Paper (5000 sheets)49.50

CALCULATORS & DATABANKS

HEWLETT PACKARD

HP-10B Business38.45
 HP-12C Financial59.90
 HP-14B Business59.90
 HP-17B Business75.90
 HP-19B Business Consultant II125.90
 HP-20S Scientific39.90
 HP-22S Algebraic Scientific43.90
 HP-27S Scientific74.95
 HP-28S Advanced Scientific162.90
 HP-32S RPN Scientific52.95
 HP-41CV119.90 HP-41CX169.95
 HP-42S RPN Scientific69.90
 HP Infrared Printer99.90

PSION

ORGANISER II-XP198.90

SHARP

OZ-7000 WIZARD IN STOCK
 WIZARD Accessories CALL
 EL-6230 Auto Dialer39.90
 EL-6250H Dial Master53.90

CASIO

SF-4000 32K Digital Diary89.90
 SF-7000 B.O.S.S. 32K Digital Diary 179.90
 SF-7500 B.O.S.S. 64K Digital Diary 189.90
 SF-8000 B.O.S.S. 64K Digital Diary 199.90
 FC-1000 Financial Consultant CALL

TELEPHONES

Panasonic

Feature Telephones
 KX-T 2335 32.90 KX-T 2365 55.90
 Multi-Line Phones
 KX-T 3122 56.90 KX-T 3140 67.90
 KX-T 3155 75.90 KX-T 3170 139.90

INTEGRATED PHONES

KX-T 2385 82.90 KX-T 2630 105.90
 KX-T 2429 135.90 KX-T 2430 108.90
 VA-8045149.90

Answering Machines Special

KX-T 1412 59.90 KX-T 1418 69.90
 KX-T 1423 85.90 KX-T 1424 69.90
 KX-T 1427 LCD w/Time Announce 109.90
 KX-T 1600 69.90 KX-T 1720 109.90

CORDESS PHONES

KX-T 3000 119.90 KX-T 3807 59.90
 KX-T 3823 70.90 KX-T 3824 89.90
 KX-T 3832 93.90 KX-T 3880 125.90
 KX-T 4200 w/Keypads123.90
 KX-T 4200 w/Answering Machine 145.90

Freedom Phone

FF-1700 Cordless "Top Rated" 109.90

Business Key Systems

PANASONIC

2 Line Integrated Intercom System
 VA-9200 System (1-9210, 2-9230) 369.90
 VA-9210 Electronic Controller124.90
 VA-9230 2 Line phone w/Speaker 124.90

VA-614 4-Line System

VA-61410 Key Service Unit CALL
 VA-61421 Phone w/Speakerphone CALL
 VA-61422 Speakerphone w/LCD CALL
 VA-61423 Speakerphone w/BLF CALL

VA-208 2-Line System

VA



Four Debuggers in One

Logitech's MultiScope could be the debugging toolkit of choice for professional OS/2 programmers

Martin Heller

Event-driven, multitasking programming environments like the OS/2 Presentation Manager (PM) require good debugging tools. Until now, you had only one choice: Microsoft's CVP, a protected-mode version of the CodeView symbolic debugger. Now there's an alternative: Logitech's MultiScope.

Like CodeView, MultiScope works with multiple languages and helps you debug threads, child processes, and dynamic link libraries (DLLs), but it's more comprehensive. The MultiScope package comprises four debuggers: the PM Run-Time Debugger, PM Post-Mortem Debugger, Text Mode Run-Time Debugger, and Text Mode Post-Mortem Debugger.

The run-time versions, like most debuggers, monitor your program as it executes. The postmortem versions, in conjunction with a special utility that saves your program's state in the event of a crash, let you resurrect and examine the static context of a crashed program. The postmortem debuggers really set MultiScope apart, since you can easily spend hours sneaking up on a protection violation using a run-time debugger.

The MultiScope debuggers work during or after run time, under PM or in character mode, and on the same com-

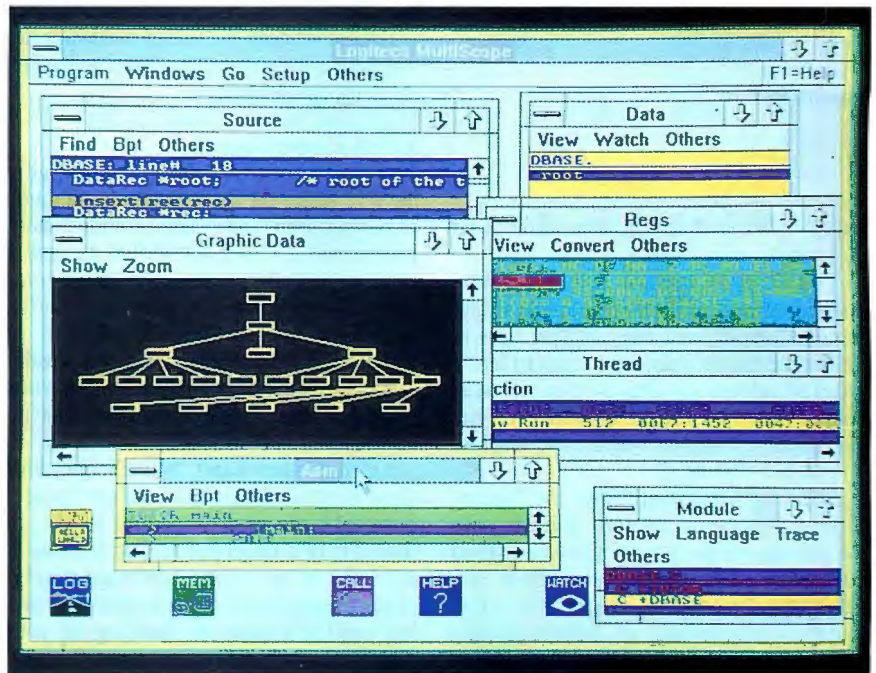

MultiScope's Graphic window builds pictures of structured data objects.

puter as the program being debugged or on a remote machine. That's quite a feat. Even better, Logitech has made the debuggers all look much the same, so that there is little transition to make when switching among them. Logitech has also kept its debuggers compatible with the format used by CodeView and generated by Microsoft C and Microsoft Link. And you can use MultiScope in conjunction with Logitech's own Modula-2 for OS/2.

The Big Picture Through Small Windows

The MultiScope debuggers are organized into as many as 14 windows. (Some windows don't apply to all situations.) Naturally, things look best under PM, but the windows appear in text mode, too. The Assembly window shows your disassembled and source code. At run time, you

can set breakpoints on the assembly code, get statement addresses, and jump to code lines.

The Breakpoint window (available only in the run-time debuggers) lists the line number, module location, and conditional expression for each breakpoint. You can modify breakpoints in this window; for instance, you can add a pass count to create a delayed breakpoint.

The Call window displays the chain of procedure calls in a thread. From the Call window, you can select a procedure to be displayed in the Source and Data windows.

The Data window displays global and local variables for the currently selected procedure in the current thread. It has facilities for modifying values (at run time), exploring arrays and structures, launching the graphical data display

continued

MultiScope

Company

Logitech, Inc.
6505 Kaiser Dr.
Fremont, CA 94555
(800) 231-7717

Hardware Needed

OS/2-capable PS/2 or AT compatible, 4 megabytes of RAM, and a hard disk drive; a mouse is recommended

Software Needed

OS/2 Standard Edition or Extended Edition 1.1 or higher

Price

\$299

Inquiry 885.

(under PM), and setting watchpoints (at run time).

The Graphic window displays a box-and-line graph of data structures, showing data objects as boxes and pointers as lines (see photo). In addition, different types of objects are displayed in different colors. As with the Data window, you can use the Graphic window to explore structured objects.

The Log window displays the history of your debugging session. You can save the contents of the Log window to a file if necessary. The Memory window displays memory contents in a variety of formats corresponding to different data types, and it has facilities for adding watchpoints, modifying data, and converting hexadecimal numbers to and from decimal.

The Module window displays the object modules that make up your program. You can set the source language and enable or disable tracing on a module-by-module basis. From the Module window, you can also control the Data and Source window displays.

The Output window displays the screen produced by the program being debugged. The Register window displays the register, flag, and coprocessor register values for the currently selected thread. You can modify the registers (at run time) and do hexadecimal-to-decimal conversions.

The Source window displays the source code of the currently selected module. You can set breakpoints (at run time), search for procedures and lines, jump to lines, and get statement addresses. The Thread window lists your program's threads of execution and their

status (e.g., runnable, frozen, blocked, and critical section), priority, stack location, and code location. You can freeze and thaw threads, as well as control the display of the Source, Data, Call, and Register windows.

The Watch window displays your (run-time) watchpoints, which are generally set in the Data or Memory windows. In the Watch window, you can control the "granularity" or frequency of MultiScope's watchpoint checking—each variable watched can be checked at every assembly instruction, every source statement, or every procedure entry. Given the overhead involved in checking data variables without the use of hardware debugging tools, procedure-level granularity is recommended.

Extra Conveniences

The run-time MultiScope debuggers have 11 different Go commands—a much richer set than CodeView provides. Both programs can trace individual assembly instructions and source code lines, trace into or over individual procedure calls, and run until the next breakpoint or watchpoint or the program's end. CodeView's Execute command, which runs your program in slow motion, has no equivalent in MultiScope.

On the other hand, MultiScope adds the ability to execute until the next procedure call, the next procedure return, or the start of a child process or session. It also adds a "go to end" message that ignores breakpoints and watchpoints, saving you the trouble of disabling all your diagnostics when you just want the program to terminate cleanly.

MultiScope's Go commands correspond well to the way I debug, so they save me time compared to the way I use CodeView. But I found the biggest time-saver to be MultiScope's MED (for monitor execution dump) and postmortem debugging facility.

Normally, when a program crashes under OS/2, the user gets a message that says "protection violation," along with some meaningless addresses. Why the program crashed remains a mystery; the OS/2 trap handler doesn't even provide a stack trace, much less a core dump. Sometimes the user can isolate the problem empirically by keeping track of key-strokes and mouse-clicks, but all too often the following dialogue ensues.

User: "Your program crashed."
Developer: "What were you doing?"
User: "Nothing. It just crashed."

With MED, the situation is a little dif-

ferent. The test version of the program is compiled with a call to MED's initialization routine. Until the program crashes, it runs at full speed, with no interference from MED. When the program crashes, MED takes over and saves the full state of the program in a memory-dump file. The user sends the developer a copy of the dump file, which the developer diagnoses with the Post-Mortem Debugger.

Since MultiScope's postmortem debuggers can do everything its real-time debuggers can do except run the program, finding the cause of the crash is fairly easy. For instance, you can unambiguously identify a null pointer (a common error in C programs and a common cause of protection violations) by double-clicking in MultiScope's Call window and then examining the highlighted line in the Data window.

MultiScope's graphical interface makes it much easier to learn than CodeView. You can learn to use MultiScope with a mouse and the menus in an hour or two. Learning all the mouse and keyboard shortcuts will take a little longer, but if you use the program a lot, you'll want to learn them.

With complex data structures, MultiScope again comes up a winner. You can see inside your structures to figure out what's going on by using the Graphic data window. It's a pity the Graphic window only works in the PM versions of the debuggers. I'd like to be able to use it on PM programs, but you can't run the PM debugger on a PM program; if you try, your machine will hang up.

A Few Problems

The conflict between a PM debugger and a PM program is serious, and it may not be soluble under OS/2 1.1. According to Logitech, the problem is that PM's message dispatcher has only one thread. If any PM application fails to respond to a message, the whole PM screen group grinds to a halt. Since the application being debugged *has* to be suspended at a breakpoint or watchpoint, it will not respond to messages. If the debugger is also running in the PM screen group, the debugger will not get any messages. Result: total hang-up. For now, developers can use either MultiScope's character-mode or remote debuggers for debugging PM applications.

The remote debugger lets you have a PM environment running on both the application and the debugger, but it requires two machines that run PM. It would be nice to do this with less of a hardware investment.

continued

DR DOS. THE CHOICE IS OBVIOUS, MORE OR LESS.

DR DOS

- Full DOS application support
- Large disk partitions - greater than 32 megabytes
- LIM 4.0 expanded memory support
- Graphical icon-based user interface
- Fully executable from ROM
- Quick and easy installation
- Password protection for files and directories
- Full screen text editor
- Multiple command line recall
- Built-in help for utilities
- Backed by the Digital Research commitment to quality service and support

THE OTHER DOS

- Full DOS application support
- Large disk partitions - greater than 32 megabytes (DOS 4 only)
- LIM 4.0 expanded memory support (DOS 4 only)
- Graphical character-based user interface (DOS 4 only)

You don't have to look too closely to see how DR DOS stacks up against the competition. With an added set of features and capabilities, DR DOS gives you proven capability *and* flexibility in a superior alternative for any system. Whether you use a hand-held computer, a laptop, a diskless workstation,



a portable or a powerful full-sized system with specialized applications, DR DOS gives you everything you need to make the right choice. Obviously.

For more information: Systems Integrators and OEMs call Digital Research at 800-443-4200.

 DIGITAL RESEARCH®

DR DOS™
THE BEST CHOICE.

THINK BIG

Phar Lap Virtual Memory Manager.

It will let you write applications up to 5, 10, 15 megabytes or more for any 386 PC running MS-DOS*. *Forget about RAM limitations.* Your application can run on a machine with as little as 1 or 2 megabytes of memory.

Only Phar Lap 386|VMM* gives you demand-paged virtual memory capability so you can write mainframe-sized applications for the PC. Applications your customers can run on their 386 PCs now with no additional memory. No kidding. All you need is 386|VMM and our family of 386 development tools. Existing programs developed with our 386|DOS-Extender can be easily expanded with 386|VMM too.

Our tools let you take full advantage of the 386 protected mode architecture. Break the DOS 640K limit in the language of your choice; C, Fortran, Pascal, or Assembler.

For fast compact code, use 386|ASM, our 80386 assembler that's upwardly compatible with the MASM* 8086 assembler. Existing DOS and mainframe applications written in a high level language are easily ported by recompiling. And 386|LINK, our 32-bit native mode linker, puts it all together.

Debugging is made easy too. With our 386 symbolic debugger you can debug applications written in assembler or any high level language. Best of all, with Phar Lap's 386|DOS-Extender* you can run your native mode program on any 386-based PC running MS-DOS. And you have full access to DOS system services through INT 21.

NO COMPATIBILITY PROBLEMS

Phar Lap's tools are compatible with the industry's leading systems: DESKPRO 386*, IBM Model 70/80*, 386 clones and accelerator boards. Not only will your new applications be compatible with the leading systems, they'll run alongside all other DOS applications.

NO ROYALTY PAYMENTS

Once your 386 application is complete, all you pay is a low one-time fee to license 386|DOS-Extender for redistribution.

386|VMM is also developer friendly. Call to find out about our flexible run-time pricing.

You can unlock the entire DOS market now. Don't wait for OS/3.

- \$495 386|ASM/LINK-Package includes 386 assembler, linker, MINIBUG debugger and the developer version of 386|DOS-Extender
- \$895 MetaWare 80386 High C* compiler
- \$595 MicroWay NDP Fortran-386* compiler
- \$195 386|DEBUG symbolic debugger
- \$295 386|VMM - developer version of the Phar Lap Virtual Memory Manager

(617) 661-1510

PHAR LAP SOFTWARE, INC.

60 Aberdeen Avenue, Cambridge, MA 02138

Fax: (617) 876-2972

"THE 80386 SOFTWARE EXPERTS"



Phar Lap and 386|DOS-Extender and 386|VMM are trademarks of Phar Lap Software, Inc. MS-DOS and MASM are registered trademarks of Microsoft Corp. DESKPRO 386 is a trademark of Compaq Corp. NDP Fortran-386 is a trademark of MicroWay, Inc. High C and Professional Pascal are trademarks of MetaWare Incorporated. IBM Model 70/80 is a trademark of IBM Corp.

Hardware is an issue, too, when simply running the debuggers. With 14 windows to look at, screen real estate is at a premium. Logitech has provided a partial solution in the form of a reduced-size screen font. But anyone who wants to see more than four or five windows at once would do well to look into high-resolution video cards for OS/2, such as the Video Seven VRAM VGA (which can display the PM screen at 800 by 600 pixels on a good multisync monitor) or the IBM 8514/A.

Another problem occurs when viewing variables in local scopes. In the following example, the third instance of *i* is inaccessible:

```
int i,j,k; // globals
main() {
    int i,l,m;
    // local to main()
    (intervening code)
    if(j>k) {
        int i;
        // i inaccessible to debugger
        for(i=0;i<m;i++)
            do_something_with
                (i,j,k,l,m);
    }
    (intervening code)
    exit(0);
}
```

This problem, which isn't serious, comes from the Microsoft C Compiler, which simply doesn't generate debugging information for variables in local scopes. You can always rename your variables and move them up to the function level.

A Worthwhile Investment for Professionals

Perhaps the most serious problem facing MultiScope is not technical at all: CodeView is supplied free with Microsoft C. Occasional OS/2 programmers who got CodeView for free might not want to pay for MultiScope.

On the other hand, serious OS/2 programmers can easily justify the \$299 cost of MultiScope by increased productivity. Just one workday saved—for instance, by using MED and postmortem debugging to identify a bug that only happens at a customer's site—should repay the cost of MultiScope. And continued use should pay back handsomely: Logitech has a good set of tools here, which should only improve with time. ■

Martin Heller develops software and writes about technical computer applications. He holds a Ph.D. in physics. He can be reached on BIX as "mheller."

NINE REASONS TO BUY CLIPPER WITHOUT A MOMENT'S HESITATION!

The Clipper language offers two compelling reasons to adopt it as your application development standard: open architecture and .EXE file generation. Clipper 5.0 boasts seven more. We think you'll be convinced before you reach number nine.

1 Open Architecture.

Clipper is both powerful and easy to use, with the most comprehensive command and function set available. Want more? Extend the Clipper language with user-defined functions written in Clipper, Assembler, C and other languages.

2 User-defined Commands.

Even more extensibility is available in Clipper 5.0. Support for user-defined commands allows you to tailor your command set to a specific business or industry.

3 .EXE File Generation.

Clipper's compiler yields stand-alone .EXE files for unrestricted distribution, requiring no LAN-PACKS™, no run-time modules and no licenses of any kind!

4 Break the 640K DOS Limit!

Improved memory management in Clipper 5.0, made possible by an exclusive version of Pocket Soft's .RTLink™, lets you run applications larger than 640K, without overlays!

5 Faster Development.

.RTLink features faster linking time and incremental linking, so only the changed object files get re-linked when you compile.



6 Faster, Smaller Code.

Compiler directives allow more efficient execution with less code needed to accommodate varying PC configurations.

7 Multi-dimensional Arrays.

Accurate modelling of actual circumstances is enhanced by the power of multi-dimensional arrays.

8 New Documentation, Including an On-line Guide.

New and expanded documentation will make you immediately productive in Clipper 5.0. And you can access it all on-line through the included Guide to Clipper™ and Norton Guides™ Engine.

9 You Can Get It First!

Buy the current version of Clipper after June 1, 1989, register your copy, and be among the first to get Clipper 5.0—Free! You'll even save \$100 off the suggested retail price of Clipper 5.0.

So, don't hesitate! Give us a call for the name of your nearest authorized dealer, and make your commitment to Clipper, today.

Clipper®

The Application Development Standard

213/390-7923

 **Nantucket**®

Nantucket Corporation, 12555 West Jefferson Boulevard, Los Angeles, CA 90066. 213/390-7923 FAX: 213/397-5469 TELEX: 650-2574125. Nantucket, the Nantucket logo and Clipper are registered trademarks of Nantucket Corporation. Other brand and product names are used for identification purposes only and may be trademarks or registered trademarks of their respective holders. Entire contents copyright © 1989 Nantucket Corporation.

Circle 187 on Reader Service Card

Now Available
Activator/M™
with
Programmable
Memory



Natural selection provides unique passive protection for the porcupine.

The Activator - Natural Selection For Software Protection



Inventor and entrepreneur Dick Erett explains how "The Activator" provides sane protection for your intellectual property.

By removing protection from the magnetic media we remove the constraints that have plagued legitimate users.

They simply attach our key to the parallel port and forget it. It is totally transparent, but the software will not run without it.

virtually impossible. It also presents an astronomical number of access combinations.

Full 100% Disclosure

Since The Activator is protected by our patent we fully disclose how it works. Once you understand it, endless methods of protection become evident.

"In any industry, just as in nature, the process of natural selection raises one solution above another. Natural selection is the most elegant of engineers.

In the area of software protection The Block has been selected by the marketplace as the solution that works. Over 500,000 packages are protected by our device.

For the past 4 years our philosophy has been; 'You have the right and obligation to protect your intellectual property.'

A New Ethic For Software Protection

In allowing end-users unlimited copies of a software package and uninhibited hard disk and LAN operation, The Block has created a new ethic for software protection.



A New Technology For Software Protection

Our newest model, The Activator, builds on our current patented design, and establishes an unprecedented class of software protection.

We have migrated and enhanced the circuitry of The Block to an ASIC (Application-Specific Integrated Circuit) imbedded in The Activator.

This greatly improves speed and performance, while reducing overall size. Data protection can also be provided.

Programmable Option

The Activator allows the software developer the option to program serial numbers, versions, or other pertinent data known only to the developer, into the circuit, and access it from the program.

Once you program your part of the chip, even we have no way to access your information.

The ASIC makes emulation of the device
Circle 257 on Reader Service Card

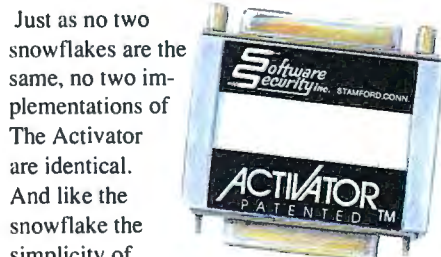

Just as no two snowflakes are the same, no two implementations of The Activator are identical. And like the snowflake the simplicity of The Activator is its greatest beauty.

We never cramp your programming style or ingenuity. Make it as simple or complicated as you desire.

Let us help safeguard what's rightfully yours. Please call today for additional information or a demo unit. *It's only natural to protect your software.*"

1-800-333-0407 ext.105
In Connecticut 203-329-8870
Fax 203-329-7428



870 High Ridge Road
Stamford, CT 06905



X Window System on the March

Interactive Systems' 386/ix X11 implements the graphical Unix standard with style

Tom Yager

The X Window System has emerged as a graphical user interface standard in the Unix world, for all the right reasons. It isn't owned by any one company, and it's highly portable. Interactive Systems Corp.'s X Window System product, 386/ix X11, works in conjunction with ISC's 386/ix, a port of AT&T's Unix System V release 3.2. The 386/ix package was the first commercially available 3.2 Unix for the 80386, and it remains the most widely accepted. It's efficient, stable, and rich with features. The 386/ix X11 package, the layered X Window product reviewed here, shares those qualities.

I tested the system using two SIVA 386/20 PCs from VNS America. Each had 8 megabytes of memory and a 300-megabyte SCSI hard disk drive connected to an Adaptec AHA-1540A/1542A controller. Each machine also had a 16-MHz 80387 math coprocessor. The network connection ran through a pair of Western Digital WD8003 Ethernet adapters.

One system sported an Orchid Pro-Designer VGA display adapter with 512K bytes of memory, and the other system had a Matrox PG-1281 34010-based graphics coprocessor. The Orchid VGA adapter drove a Seiko CM-1430 14-inch multifrequency monitor, and the Matrox was hooked to a 19-inch Mitsubi-

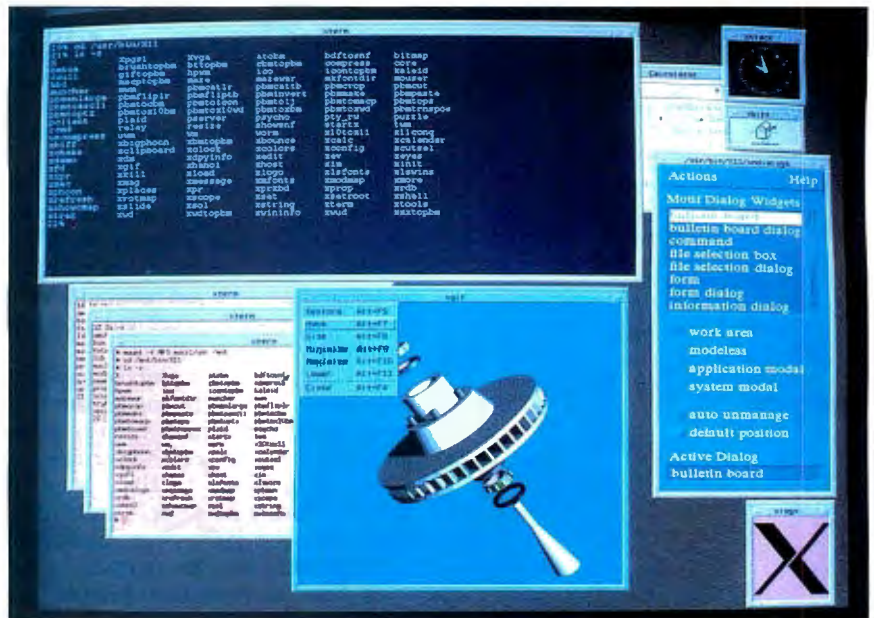

Interactive's 386/ix X11 with the Motif window manager.

shi Diamond Scan Model HL6905. Each system had a Logitech serial three-button mouse.

Taking the Plunge: Installation

Installing 386/ix X11 is simple and automatic. The command `sysadm installpkg` responds with a prompt for the first disk of the series, and then it's easy from there. The X11 package requires kernel (device driver) support, but this poses no difficulty even for the Unix novice. The installation process automatically rebuilds the Unix kernel to accommodate the new devices.

The installation process binds a set of interactive maintenance programs into the `sysadm` utility's menu tree. After the kernel support has been linked in, menus guide the administrator through setting up the environment. The device-dependent portions of the 386/ix X11 servers come in object form. You simply select from a list of supported servers, and each

is quickly linked together from the object files. Most can drive a wide range of adapters. The VGA server, for instance, only needs to be built once, even if you plan to use several cards and display geometries. You can build and install new servers anytime, so changing boards is no hassle.

The combination of an X11 server, a keyboard, and a mouse form a logical group called a *display*. The keyboard and mouse types are presented in menus; however, since each server supports so many different graphical configurations, you have to enter a string to identify the screen resolution, the size, and the number of colors.

The manual lists the appropriate configurations for each supported server type. The file `/usr/lib/X11/Xconfig` contains nearly all the specifics as well. Each logical display has one clearly marked adapter, keyboard, and mouse

continued

386/ix X11

Company

Interactive Systems Corp.
2401 Colorado Ave.
Santa Monica, CA 90404
(800) 346-7111
(213) 453-8649

Hardware Needed

80386-based AT compatible or PS/2 with 4 megabytes of RAM, a Hercules or VGA adapter, a two- or three-button mouse, and a 60-megabyte hard disk drive; an Ethernet adapter is required for networking

Price

Various configurations are available:

Workstation Starter (includes the 386/ix operating system and 386/ix X11): \$495 (single user); \$795 (multiuser)

Workstation Extender (adds the 386/ix TCP/IP, the 386/ix NFS, and the VP/ix): \$1095 (single user); \$1895 (multiuser)

Workstation Developer (adds development support for 386/ix and 386/ix X11): \$1995 (single user); \$2995 (multiuser)

Inquiry 883.

entry in this file, and all the configurations under each category appear in commented form.

Two levels of X11 are available from ISC. The most basic, the run-time system, comes with ISC's Run-Time System Guide, which describes the installation procedure and the commands. The development system adds another ISC manual to cover the development libraries, but the largest of the documents are the two Xlib (X function library) manuals. One acts as a guide, and the other is a reference. They both cover the X11 function library completely, and the guide doubles as a fair tutorial.

Starting and Running 386/ix X11

If you're an experienced X11 user, you'll find yourself on familiar ground. If a default server was specified during configuration, you need only type `xinit` to start. The screen clears, leaving an X-shaped mouse cursor in the center of the screen. The default for `xinit` is to create one black-on-white terminal window in the upper left corner of the screen. You

can, however, set your own color scheme and start up client programs.

Tailoring your environment is simple. When `xinit` starts, it tries to execute a shell script called `.xinitrc` in your home directory. The default terminal window, along with other terminals, applications, and visual toys, can be started from here.

The X11 server also allows the default server-specific behavior to be overridden through a similar mechanism, the file `.xserverrc`. This one-line script contains the name of the server (such as `Xvga` for the EGA/VGA server) and appropriate command-line arguments. Other X11-related configuration files are supported in the standard fashion, allowing you the freedom to change the appearance and behavior of any conforming X Window System application.

ISC also provides `xdm`, X11's own session manager. This program fires up the server and creates a log-in panel. It prompts for the user name and password and then starts up client programs based on settings in various configuration files located in `/usr/lib/X11/xdm`.

X11 itself does not enforce any policies regarding how to manipulate windows. In fact, the default setup gives you no way to move, resize, or otherwise maneuver them. A special client program, called a window manager, handles these functions, and ISC's X11 distribution supplies three: `uwm`, `wm`, and `twm`.

Of these, the most useful is `twm`. It is highly configurable and builds clean, readable frames around clients. At the top, `twm` adds a title bar with the client's name, along with boxes with symbols for resizing, iconifying (i.e., replacing the application window with a small box containing the client's title and, optionally, a graphical depiction of its purpose), and attaching keyboard input to the window. Optionally, you can create an icon box. This box lists each client program's name, and clicking the mouse's left button on a name toggles the program's iconified/expanded state.

The `twm` is one of dozens of user-contributed programs on seven disks. Many productivity-impeding toys are mixed in with the better utilities, but these programs make X11 a joy to use. In my view, no release would be complete without them. Many vendors ship only the core programs necessary for operating X11, along with a weak assortment of clients. ISC is sure to win points with X11 newcomers by including these programs.

Operation is generally smooth. The VGA server, running with the Orchid

board at 1024 by 768 pixels, drove the display with accuracy but with some performance problems. The sluggishness is most severe when moving large terminal or application windows. The window is repainted in its new position very slowly, from top to bottom, taking as much as several seconds to complete. Oddly, other operations involving large areas of display memory are not so slow. In fact, moving a window is the only operation that exhibits this problem. Creating, destroying, iconifying, and deiconifying work very briskly by comparison. It's obviously faster to re-create the window from scratch than it is to move it as an image.

Most of my complaints about X11 concern its performance. It is possible to get more from the hardware than ISC did. The Matrox board does not get pushed near its potential. X11 performs many operations a pixel at a time, rather than telling the board something like "draw a circle of diameter z at position x,y ." For example, the `xdemo` program, when drawing ellipses, runs hardly any faster on the Matrox board than on a VGA. Other shapes do better, and ISC designers trusted the Matrox board to handle the most common graphical element, the thin line.

This disparity between the finely tuned and the barely tolerable puzzles me the most. Engineers at ISC explained that they had to work within the boundaries of MIT's X11 server model. This model, they said, dictates that only certain graphics operations can be handled asynchronously, because the server needs to know when an operation is finished. Thin (default width) lines are a special case and can be handled by the hardware. Nearly everything else is drawn, one pixel at a time, by the X server itself.

In a similar vein, the specialized VGA cards are not used to their potential. The most obvious case is ISC's failure to support any VGA board in a 256-color mode. According to ISC, the change from 16- to 256-color mode is so drastic that a new server would have to be written to accommodate it. That's a lot of work, but I think it would be worthwhile for special cases, such as viewing and rendering artwork and for testing advanced user interface designs.

There are other oddities that need to be addressed as this product matures. For example, the servers seem to take up more and more memory as they run, causing problems in other parts of the system. And there's a problem with virtual terminals. The VGA server operates

continued

When 30MB just won't do...

Seagate's ST251 Family of 40, 60 and 80MB drives

If 30 megabytes just isn't enough to satisfy your disc storage requirements, then Seagate's 5.25" ST251 family offers the capacity, performance and interface options you need for any operating environment.

The cornerstone of our family is the best-selling ST251. Available in both ST412 and SCSI interfaces, with either 28 or 40 msec access time, this 42MB drive is perfect for demanding applications.

For 50% more capacity, our ST277 features 64MB of formatted storage, with the same access time options as the ST251. And for performance-driven, high-capacity applications, our 84MB

ST296 has a 28 msec access time and an SCSI interface.

Each drive in the family comes complete with utility software for easy installation and drive partitioning. You can configure the right solution for your computer system by choosing from Seagate's own line of controllers and adapters for the ST251 family.

No matter which model you choose, you'll receive the same high quality and reliability that have made Seagate the first name in disc drives worldwide. For more information on the ST251 family, contact your authorized Seagate Distributor, or call Seagate at 800-468-DISC.

 **Seagate**
The first name in disc drives



IEEE 488

Interfaces & Software

Hardware

IEEE interfaces for PC, AT, 386, PS/2, Macintosh, HP, SUN & DEC. Converters from IEEE to RS-232, RS-422, modem, Centronics, SCSI, digital I/O and analog I/O. IEEE extenders, expanders & buffers.

Software

IEEE device drivers for DOS, UNIX®, Macintosh & SUN. Drivers for Lotus 1-2-3 & Symphony. Macintosh IEEE desk accessory. PC menu-driven analysis.

Support

Free applications support. 30 day money-back guarantee. Two year warranty. IEEE seminars available.

Call for your **FREE** Technical Guide

Demo disks & application notes available



(216) 439-4091

Telex 6502820864 • Fax (216) 439-4093
 LOtech, Inc. • 25971 Canton Road • Cleveland, Ohio 44146
 London 10734180/287 • Paris 11734810378 • Milan 02/4120300
 Brussels 02/3948062 • Linköping 0163116140 • Helsinki 190/5215288
 München 089/7180220 • Zürich 0118219444 • Vienna 0222/253626
 Gießen 011830235333 • Oslo 02-649070 • Copenhagen 02/804200
 Madrid 9114027060 • Lisbon 01141013420
 Melbourne 0353793622 • Toronto 416/6740444



in a virtual terminal, one of several that you can switch to with a hot-key sequence. When the system starts, and for some time after, switching to other virtual terminals is quick and effective. After running for some time, however, and working with many complex clients (like Motif-based ones), the hot-key sequence stops working. The screen goes blank, the disk seeks for several seconds, and then the system beeps and puts the 386/ix X11 screen back up. To regain the ability to switch to virtual terminals, you must stop and restart the server.

Then there are the nits. ISC's servers, when sent a hang-up (HUP) signal, should release all their resources and reset. Instead, they exit, confusing programs such as *xdm* that expect to manipulate the server through this mechanism. Unix full-screen text applications don't resize themselves when the window size is changed. The Matrox server does not handle virtual terminal switching, even though the board is capable of it. Furthermore, it is not possible to run multiple VGA servers on the same machine and console. The hooks are there, and you should be able to switch between multiple X11 sessions with the hot-key sequence.

The Development System

Those who invest in the development system are mostly buying the libraries and header files that give X11 applications their interface to the window system. The simplest of X11 sample programs is the widely distributed *helloworld.c*. It effectively illustrates the basic requirements for every X11 program.

To build it, you link against two libraries: *Xlib* (*libX11.a*) and Berkeley network sockets (*libinet.a*). The socket library is necessary even on systems that are not networked. While it adds size to every X11 executable file, it enhances portability by adding networking capability to every application. This way, every client program runs just as well over a network connection as it does on the local machine. The combined libraries work together to sense their environment (network or local) and adjust transparently. If the optional TCP/IP networking software is not installed, Unix shared memory will be used instead to handle client-server and client-client communications. If it has been installed, TCP/IP will be used for local connections even if the network is not active (i.e., no other machines are connected).

A special class of window, called a *widget*, can simplify the writing of many kinds of applications. MIT provides the

standard set of widgets, the Athena widgets, and these are included with the 386/ix X11 package. By the time you read this, ISC expects to release widget sets to support two emerging interface standards—the Open Software Foundation's Motif and AT&T's Open Look. I experimented with a beta version of ISC's Motif, and I found it to be both attractive and functional.

Making the Connection: Networking

As mentioned before, every client program must have networking support compiled in. Combined with ISC's host-based TCP/IP, the real power of X11 becomes visible. A single command line can direct a client's code to be run on any CPU on the network, with its output directed to any configured screen on the network. This opens up new possibilities in terms of computation and graphics-server systems. The fastest box on the network can handle most of the computation-intensive applications, sending the graphics to whichever device is most convenient or capable.

It is all surprisingly easy to configure and manipulate. Any system that has its name listed in a certain host's */etc/X?.hosts* file (where the ? is replaced by the logical display number described earlier) can use that host's display. Other files control general network access for program execution, but once a network is set up, adding a *-display machine:?* argument to the command line of a conforming client is enough to have that client use the display, keyboard, and mouse of the specified console.

Tests proved that this worked flawlessly. I never had a case where something didn't work right, except that the problems I saw on local connections also prevailed over the network. Extremely complicated programs took slightly longer to start up and display, but not long enough to diminish the network's functionality. X11 applications only need to be directed to a valid logical display; they can be run from any machine on the network, even if that machine is not running X11.

The standards imposed by X11 extend to the format of network traffic, so that dissimilar (heterogeneous) hosts can exchange graphical data and share computing resources with ease. I wasn't able to connect to a network with other than 80386 machines, but colleagues tell me that it's quite a sight to see normally incompatible equipment working quietly together under the mentorship of X11.

A not-so-obvious fringe benefit of

continued

Low Price. Technical Support. Integrity!

... Talk to the Reliable Team at Warehouse Data!

HARDWARE

AT MACHINE

Hyundai 10MHz	\$839
Hyundai 12MHz	1065
MIT 12MHz 1MB + 1FDD	929
MIT w/40MB Seagate Drive	1359
MIT w/2MB + 40MB Seagate	1419

XT MACHINES

MIT w/640K + 1 FDD	\$539
MIT w/20MB Seagate Drive	819
MIT w/40MB Seagate Drive	959

VIDEO CARDS

ATI EGA 800 Wonder	\$169
ATI VGA Wonder w/512	345
Generic Color w/PTR	45
Orchid Pro Designer	299
Orchid Pro Designer Plus	385
Paradise EGA 480	179
Paradise VGA 16 Plus	299
Vega Fastwrite VGA	349
Vega VGA	255

MASS STORAGE

Everex 60MB Int	
Tape AT/PC	\$599
Miniscribe 30 MB Kit	289
Miniscribe 322MB	
ESDI Kit AT	1749
Miniscribe 40MB Kit	320
Refurb Seagate 40MB Kit	350
Refurb Seagate 65MB Kit	387
Refurb Seagate 85MB Kit	535
Seagate 20MB w/Cont	259
Seagate 30MB w/Cont	279
Seagate 40MB ST-251 40ms	369
Seagate 40MB ST-251-1	409

MEMORY BOARDS

AST Rampage 286 w/512K	\$339
DFI 2MB Above Board for AT	79
Everex 3MB Above Board AT	89

DIGITIZER

Kurta IS/One 12 x 12	\$295
----------------------	-------

MONITORS

Hyundai 12" Amber w/Tilt	\$79
Hyundai 14" CGA w/Tilt	249
Hyundai 14" EGA	335
Hyundai 14" VGA	339
Mitsubishi Diamond Scan	499
NEC Multisync 3D	679
Princeton Ultrasync 16	842
Seiko 1430 VGA	529
Zenith 14" Flat VGA	629

HAND HELD SCANNERS

DFI Handyscanner	
HS-3000 +	\$189
Logitech Scanman Hi-Res	179

I/O GAME, MULTI I/O CARDS

C&H XT & AT Game Card	\$45
Copy II PC Deluxe Option	109
DFI I/O AT P/S/G	45

386 MACHINES

MIT 33MHz 1MB + 1 FDD	\$3719
-----------------------	--------

PRINTERS

Citizen HSP 500	\$323
Citizen HSP 550	470
NEC P2200	329
NEC P5200	519
NEC P5300	669
Okidata 182i Turbo	235
Okidata 320	349
Okidata 321	479
Okidata 390	489
Panasonic 1124	329
Panasonic 1180	185
Panasonic 1592	539
Star NX 15	319
Star NX 1000	169
Star NX 1000 Rainbow	229

FLOPPY DRIVES

TEAC 1/2 HT 360K	\$79
TEAC 1.2 Floppy Black	99
Toshiba 3.5" 1.44MB	104
Toshiba 3.5" 720K	89

LAPTOPS

Toshiba T1000	\$699
Toshiba T1200 HB w/20MB	1999
Toshiba T1600	3299
Toshiba T3200 w/40MB	3525

MODEMS

Everex 2400B EV-941	\$139
Everex 2400B Int	159
Everex 300/1200B Int	69
US Robotics Courier 2400	289
US Robotics Courier HST 9600	609
US Robotics Sportster 1200B	102
US Robotics Sportster 2400B Ext	163

MATH CO-PROCESSORS

80287	\$142
80287-B (8MHz)	212
80287-10	247
80387-16	375
80387-20	427
8087-1 (10MHz)	179
8087-2 (8MHz)	137

SOFTWARE

ACCOUNTING

Dac Easy Accounting 3.0	\$59
Managing Your Money 5.0	119
Peachtree Complete	149
Peachtree w/PDQ	220
Quicken	36

CAD AND ENGINEERING

Design Cad 2D 3.0	\$219
Design Cad 3D	219
Generic Cad Level 3	159

INTEGRATED

Enable	\$415
Microsoft Works	99
PFS First Choice	89
Smart Software	439

WORD PROCESSING

Grammatik III	\$49
Microsoft Word 5.0	209
PFS Professional Write 2.1	129
Right Writer	49
WordPerfect 5.0	\$219
Wordstar 5.5	229

DOS

Microsoft DOS 3.3	\$85
Microsoft DOS 4.1	89

COMMUNICATION PROGRAMS

Carbon Copy PC Plus	\$106
Laplink III	79
PC Anywhere III	65
Pro Com Plus	51

DATABASE MANAGERS

Clarion Professional	\$379
Clipper	419
dBase IV	469
dBase IV Developer	819
Fox Base +	199
Paradox	439
Power Base	169
Q and A	209
RBase for DOS	459

DESKTOP PUBLISHING

db Publisher	\$499
Pagemaker	499
PFS First Publisher	73
Ventura Publisher	519

GRAPHICS

Corel Draw	\$275
Harvard Graphics	274
Printshop	34

LANGUAGES

Borland Turbo C 2.0	\$95
Borland Turbo C Pro	165
Borland Turbo Pascal 5.5	99
Microsoft Fortran	295
Microsoft Quick Basic	65
Microsoft Quick C	65
Microsoft Macro Assembler	99

PROJECT MANAGERS

Total Harvard Manager 3.01	\$369
Super Project Plus	255
Timeline Pro 3.0	364

SPREADSHEETS

Lotus 1-2-3 Ver. 3.0	\$349
Microsoft Excel	269
Quattro	159

UTILITIES

Always	\$85
Copy II PC	23
Fastback Plus	104
Form Worx	85
Microsoft Windows 286	63
Norton Advanced	79
PC Tools Deluxe 5.5	75
Sideways	39

SPECIAL THIS MONTH!

16 MHz AT COMPUTER

• 1 Year On Site (Home or Office) Warranty, Provided by TRW
• 30 Day Satisfaction Guarantee

All Of This For Only

\$1,699



SPECS:

- 80286 16 MHz CPU
- 1 MB Ram - Expandable to 8 MB
- 1.2 MB 5.25" Floppy
- FAST71 40 MB 28ms Hard Drive
- 8 Expansion Slots

- Parallel, Serial, Game ports included
- 200 Watt Power Supply
- 101 Key Enhanced Keyboard
- 640 x 480 EGA Card
- Entire System Burned in for 4 DAYS!

Call For Other Models



Order Status
Technical &
Other Info:

1-800-421-3135

Fax (602) 246-7805 / Call for items not shown.

FEDERAL EXPRESS
FREE!

Air Express Shipping
You Pay the Ground Shipping
We Pay the Air Difference.

WAREHOUSE DATA

PRODUCTS

A DIVISION OF AZ COMPUTER CORP. 2727 W. GLENDALE AVE. PHOENIX, AZ 85051

USER FRIENDLY TERMS & CONDITIONS:

- We welcome international accounts, please call for special pricing.
- Volume discounts for corporate and institutional orders.
- We do not charge your credit card until your order is shipped.
- Shipping minimum is \$5.00. Arizona orders + 6.7% sales tax.
- You pay our regular ground shipping rates (1-20 lbs.). We pay the air difference (excludes Alaska and Hawaii.) Free air applies only to orders over \$100.

- Personal/company checks allow fourteen (14) days to clear.
- All shipments insured at no extra cost.
- All prices are subject to change without notice.
- We do not guarantee compatibility.
- No charge for Visa or MasterCard



Technical Support: (602) 246-2222
FAX (602) 246-7805
Phone Hours:
Monday thru Friday 6:30 a.m. - 6:00 p.m. MST
Saturday 9:00 a.m. - 5:00 p.m. MST

BY 10

Circle 284 on Reader Service Card

Don't Let the Desktop Programming Revolution Start Without You.

Presenting Matrix Layout 2.0

The Desktop Programming revolution has begun. More and more people are maximizing the productivity of their desktop computers without learning to write a line of code. It began with Matrix Layout. And continues with Layout 2.0.

More Power to the People

Matrix invented Desktop Programming to let you create your own programs right on your own PC. Now, Layout 2.0 makes it even easier to create your own powerful, professional-quality applications.

Start with Layout's tools window. Everything you'll need to build your program can be accessed by mouse or keystroke.

Next, use Layout's graphics and text tools to build a flowchart model of your program. Create your own windows, icons, and buttons. Cut and paste functions from other Layout programs. Or use the BlackBox Manager to add a BlackBox—a pre-built capability such as telecommunications or dBase support—to your Layout program. All, without writing a line of code.

Layout 2.0 is also a hypertext tool, allowing you to build Hypercard®-like cards, with text and graphics, and link them to related cards in any file. Use it to create cards for your flowcharts or to

create hypertext applications that will run on any IBM-compatible PC.

Power to the Professional

Once your program is complete, Layout 2.0 can automatically create a ready-to-run .EXE file for use by any IBM PC. Or have Layout 2.0 write it in Turbo C, Lattice C, Microsoft C or QuickBASIC. The result: you've got a professional, stand-alone program that does exactly what you want it to. Use it, share it, modify it. You've got the power.

And a Powerful Bargain

For just \$199.95 you get the entire Layout 2.0 package, including free technical support, and more programming power than you've ever had on your desktop. For more information, the location of your nearest Matrix dealer, or a copy of the Matrix Layout 2.0 VHS demonstration video (just \$9.95 for shipping & handling), call today.

1-800-533-5644

(in Massachusetts, 617-567-0037)

Join the Desktop Programming revolution. Order Matrix Layout 2.0, today!

MATRIX
MATRIX SOFTWARE TECHNOLOGY

BT 89/10

Matrix Software Technology Corporation • One Massachusetts Technology Center • Harborside Drive • Boston, MA 02128 • (617) 567-0037

Matrix Software/UK • Matrix House, Derriford Business Park • Derriford, Plymouth • Devon PL6 5QZ, England • 0752-796-363.

Matrix Software/Europe • Geldenaaksebaan 476 • 3030 Leuven, Belgium • 016.302064

The following are registered and unregistered trademarks of the companies listed: Matrix Layout, Matrix Software Technology Corporation; Hypercard. Apple Computer; IBM, International Business Machines Corporation; dBase, Ashton Tate.

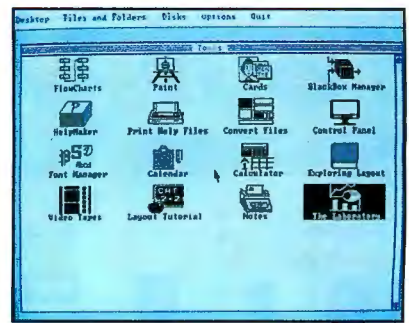

With Layout 2.0, getting started is as easy as choosing a tool.

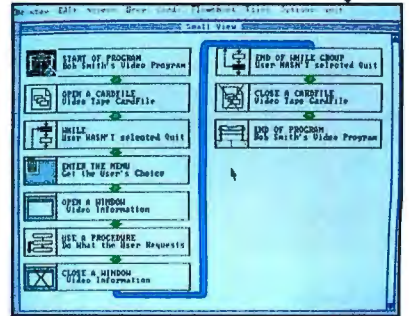

Design and build your programs by using a simple flowchart.



Create Hypercard®-like cards, linked to information in any file.

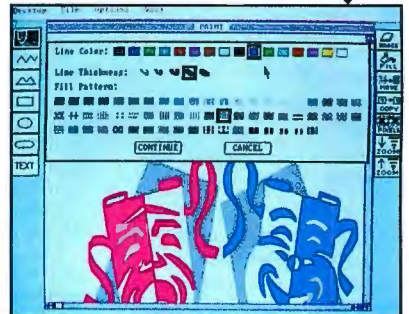

Use the Paint tool to create powerful graphics and buttons.

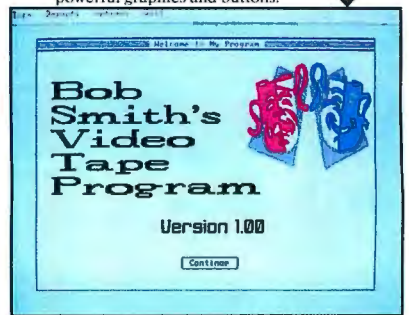

Layout creates finished, stand-alone programs for any IBM PC.

Your Low Price Leader

NETWORKING

CMO HAS THE BEST SOLUTIONS TO YOUR MULTI-USER APPLICATIONS.

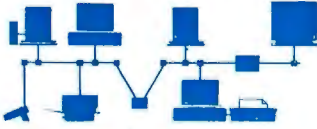

If you are looking for a **Complete Solution**, our trained staff of **Networking Specialists** can assist you in designing your multi-user system. We configure, test and provide on-going support for a full line of Networking software, hardware and connectivity products such as:

Novell Netware	
ELS Level-I 4-User	\$499
ELS Level-II V2.15	1099
Advanced NETWARE 286 V2.15	1999
SFT NETWARE 286 V2.15	3099
Orchid	
PCNet Adapter Card	339
Standard Micro Systems	
8-Bit Arcnet PC Boards	179
16-Bit Arcnet Board	399
Tiara	
8-Bit Arcnet Boards	129
16-Bit Arcnet Boards	299
8-Port Active Hub	299
MCA Ethernet Boards	389
Thomas Conrad	
8-Bit Arcnet Boards	179
16-Bit Arcnet Boards	329
16-Port Active Hub	795

Tops	
Tops for Dos 2.1	119
Tops for Mac	149
InBox Starter Kit	339

Western Digital	
EtherCard Plus	249

*Novell trained and authorized sales and support.

Our ACCESS family of 8088, 80286, and 80386 based computers can be configured around your needs for workstations and file servers.

Ask us how to design the ACCESS 386/20 Tower around your networking and/or multi-user application.

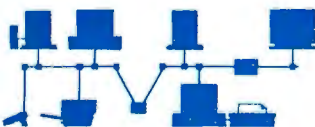

MULTIFUNCTION

AST	
Six Pak Plus Board	\$129
VGA Plus Adapter	389
Rampage/286 512K	399
Boca Research	
Boca TopHat 128K RAM	119
BocaRam/XT 0-1MB Board	119
BocaRam/AT 0-4MB Board	149
Boca.MCA Serial/Parallel	145
Boca Dual Graphics Adptr	69
Boca MultiEGA	149
DCA	
Irma Convertible 3	469
Irma 2 3278 Emulation	729
Emerald	
3XTwin Local 5251 Emulation	call
Everex	
Ram 3000 Deluxe 0-3MB Board	89
Micro Enhancer EGA	149
View Point VGA 256K	279
5th Generation	



5th Generation Logical Connection 256K \$419

Logical connection 512K	\$499
Headland	
Vega VGA Adapter	249
FastWrite 800x600	319
V-RAM VGA Adapter	399
Hercules	
Graphics Card Plus	169
VGA Card	199
Intel	
AboveBoard Plus w/512K	429
AboveBoard Plus I/O w/512K	499
Inboard 386/PC 80386 CPU	579
Visual Edge	449
8087 PC/XT Coprocessor	89
80287-8 8MHz Coprocessor	209
80387-16 16MHz Coprocessor	369
Orchid Technology	
TinyTurbo 286	229
TinyTurbo Xtra 12MHz	279
Designer 800VGA	269
ProDesigner VGA Adapter	319
Renaissance	
VGA1 640x480 256K Pal	179
VGAII 800x600 256K Pal	239
Sysgen	
Omni Board Controller	79

STORAGE DEVICES

Archive	
Archive/XL 40MB Internal	\$339
Archive VP60 External	979
Micropolis	
159MB 23Msec ESDI	1299
338MB 18Msec ESDI	1899
Miniscribe	
8425 20MB 3.5" 40Msec	249
3650 40MB 5¼" 61Msec	329
6085 70MB 5¼" 28Msec	599
Mountain Computer	
TD-4000 40MB Int. Tape	369
TD-8000 80MB Int. Tape	449
TD-7000 150MB Tape	1499
Plus Development	
20MB HardCard	519
Plus 40MB PassPort	579
Seagate	
ST-225 20MB w/cont	249
ST-238 30MB w/cont	289
ST-251-1 40MB 28ms	349
ST-177N 60MB 24Msec	589
ST-1096N 80MB 24Msec	699
Sysgen	
Bridge-File 5½" External	249
Bridge-Tape 40MB External	449
Reliant Model-215 60MB	469
Reliant Model-519 72MB	499
Toshiba	
1.44MB 3.5" Floppy Drive	99
WELTEC LapTop Sysystems	
360K 5.25" External Floppy	199
1.2MB 5.25" External Floppy	219
20MB Portable Hard Drive	849

COMPUTERS

AST	
Bravo 286 Model 5	888
Premium 286 Model 140X	1999
Premium 386/25 Model 5	call
Compaq	
DeskPro 286 Model I	1699
Deskpro 386/20e Model-110	5999
SLT-286 Laptop 40MB	4499
IBM	
PS/2 Model-30/286 w/20MB	1999
PS/2 Model-50Z 30MB	2499
PS/2 Model-60 70MB	3899
NEC	
ProSpeed Laptop 286/386	call
UltraLite Laptop	call
Panasonic	
Business Partner 1650	699
Business Partner 1750	839
Toshiba	
T1000 80C86 Laptop	639
T1200 Dual Floppy Backlit	1549
T200 20MB Backlit	2199
T1600 20MB 286	3499
T3200 40MB 12MHz	3599
T5200 40MB 20MHz 386	4999
Zenith	
MiniSport 1MB Laptop	NEW
SuperSport & SuperSport 286	call
Z-248/12Mhz Model-I	1599
Z-386/16MHz Model-40	4999

MONITORS

Amdek	
Video 210Plus TTL Amber	\$99
Video 410 TTL Monochrome	145
Color 732 Ps/2 VGA	399
Color 632 14" VGA	379
SmartScan 735 MultiScan	489
1280 15" Hi-Res White	699
Cornerstone	
Single Page Monochrome	699
Dual Page PC 16 Shade	2399
Magnavox	
78M623 12" TTL Amber	85
78M749 14" Flatsquare VGA	149
CM8762 14" Comp/RGB	249
8CM515 14" RGB Analog	279
9CM053 14"HiRes EGA	339
9CM062 14" VGA Color	349
9CM080 14" MAC II Color	489
Mitsubishi	
XC-1410C 14" EGA Display	349
XC-1429C 14" PS/2 VGA	439
DiamondScan 13" Display	499
NEC	
Multisync 2A	499
Multisync Plus 960x720	899



Packard Bell	
PB-1272 12" TTL Mono	\$85
PB-1422EG 14" HiRes EGA	359
PB-1472 14" TTL Mono	99
PB-8541 14" VGA Display	299
Polaroid	
Palette Plus	2199
Proxima	
EGA Data Display	999
VGA Data Display	1599
Seiko	
CM-1430 14" VGA Display	549
Taxan	
KX-119 12" Amber Comp.	79
Wyse	
Wyse-30 14" ASCII Display	329
Wyse-50 14" ASCII Display	399
Wyse-60 14" 7-page memory	349
Wyse-85 ANSI Data Display	429
Zenith	
ZFM-1490 14" VGA Analog	629

Call Today 800-233-8950



Computer Mail Order. Since 1981—Low prices, Large Selection, Fast Service.

...For Over 8 Years

COMMUNICATIONS

Anchor	
1200 Baud External	\$ 99
2400 Baud External	159
2400 Baud Ext. w/MNP 5	269
Everex	
Evercom 24+ 2400 Baud Int	149
Evercom 24E+2400 Baud Ext	269
Hayes	
Personal Modem 1200	129
SmartModem 1200 Baud	275
SmartModem 2400 Baud	419
Intel	
2400B Classic Internal	169
PS/2 2400B Internal	249
2400EX External	199
Murata	
MI200 Facsimile	599
Panasonic	
UF-140 Panafax	799
Practical Peripherals	
1200 Baud Internal	65
1200 Baud Stand Alone	84
2400 Baud Internal	135

PRINTERS

Alps	
ASP-1000 9-Pin Dot-Matrix	\$159
Allegro 24 24-Pin Flatbed	319
P2000 9-Pin 250cps 136 Col.	699
P2100 9-Pin400cps 136 Col.	1099
LPX-600 Laser Printer	1399
Brother	
M-1709 240cps, 132 Col.	369
M-1809 360cps, 80 Col.	399
M-1824L 24-Wire 80 Col.	499
HR-20 20cps Daisywheel	329
HL-8 Laser Printer	1999
Epson	
LX-810 200cps, 80 Col.	179
FX-850 264cps, 80 Col.	339
FX-1050 264cps, 132 Col.	call
LQ-510 180cps, 24-Wire	329
LQ-850 330cps, 24-Wire	call
LQ-1050 330cps, 132 Col.	Call
LQ-2550 500 cps, 24-Wire	call
Hewlett Packard	
ThinkJet 2225	329
Pacific 25-in-One HP Font	279
Pacific 1-2-4 HP-LJ Memory	339
NEC	
P2200 Pinwriter 24-Wire	359
P5200 Pinwriter 265cps	519
P5300 Pinwriter 136 Col.	669
LC-890 PostScript Laser	3295
Okidata	
ML-172 180cps, 80 Col.	199
ML-182 Turbo 220cps	239
ML-320 300cps, 80 Col.	359
ML-390 270cps, 24-Wire	499
ML-393 450cps 24-Wire	1049
Panasonic	
KX-P1180 192cps, 80 Col.	185
KX-P1191 280cps, 80 Col.	239
KX-P1124 192cps, 24-Wire	329
KX-P1524 24-Wire, 132 Col	559
KX-P4450 Laser	1399
Seikosha	
SP1600AI 160cps, 9-Pin	179
SK-3000AI 300 cps, 136 Col.	369
Star Micronics	
NX-1000 140cps, 80 Col.	165
NX-2400 24-Wire 170cps	349
Toshiba	
ExpressWriter 301	349
ExpressWriter 311	439

Super Savings Special



Epson LQ-950
254 CPS
24-Wire

\$499

Buyers Special



Practical Peripherals
2400 Baud Stand Alone
\$179

Sharp	
FO-220 Facsimile Machine	699
The Complete PC	
Complete Fax 4800 Board	259
Complete Answering Machine	229

I/O DEVICES

Chinon	
DS-3000 Flatbed Scanner	569
Houston Instruments	
9012 HiPad+ 12"x12"	399
PC695 4-Pen A&B Plotter	599
IMSI	
OptiMouse	75
Logitech	
New Logitech Mouse M9	79
ScanMan 400DPI HiRes	189
Microsoft	
Serial or Bus Mouse	119
MSC	
PC Mouse Serial	69
Seiko	
DT-3503 Digitizer	379
The Complete PC	
Complete PC Page Scanner	579

Hot Special



SummaGraphics
SummaSketch 12x12+
\$379

SOFTWARE

Aldus PageMaker	\$469
Ashton-Tate dBase IV	459
Ashton-Tate MultiMate II	289
BLOC Form Tools	55
Borland Paradox	449
Borland Quattro	159
Borland Turbo Pascal V5.5	99
Broderbund Print Shop	38
Central Pt. PC Tools Deluxe	50
Central Pt. PC-II Opt. Board	119
DAC-EASY Accounting	60
DataStorm ProComm Plus	49
Delrina Per: Form	159
5th Generation FastBack +	98
FoxBase+ Development	199
Funk Sideways	40
Harvard Graphics V2.1	\$289
IMSI TurboCAD	59
Intuit Quicken	33
Lotus 1-2-3	299
MECAManaging Your Money	119

SOFTWARE

Microcom CarbonCopy +	119
MicroPro WordStar 5.5	239
Microrim R:BASE For DOS	439
Microsoft Windows 286	70
Microsoft Quick Basic V4.5	69
Nantucket Clipper	419
Nolo Press For The Record	38
PaperBack VP-Planner +	119
Peachtree Accounting	169
Peter Norton Adv. Utilities	80
Peter Norton Commander	89
Quarterdeck DESQView 2.02	80
SPC: 1st Choice 3.0	90
SPC: Professional Write	149
SPC: 1st Publisher 2.0	80
Symantec Q & A	249
Traveling Lap-Link +	85
Lifetree Volkswriter	119
WordPerfect 5.0	219
WordPerfect Office	249
Xerox Ventura Publishing	459

Over 500,000 Satisfied Customers.



800-233-8950

In Canada call: 800-233-8949

All Other Areas call: 717-327-9575 Fax call: 717-327-1217

Educational, Governmental and Corporate Organizations

Call toll-free: 1-800-221-4283

CMO, 101 Reighard Ave., Dept. A1, Williamsport, PA 17701

POLICY: Add 3% (minimum \$7.00) shipping and handling. Larger shipments may require additional charges. Personal and company checks require 3 weeks to clear. Credit cards are not charged until we ship.

Pennsylvania and Maryland residents add appropriate sales tax. All prices are U.S.A. prices and are subject to change. All items are subject to availability. We cannot guarantee compatibility. We are not responsible for typographic or photographic errors.

MMC
MICROCOMPUTER
MARKETING COUNCIL

Computer Mail Order. Since 1981—Low Prices, Large Selection, Fast Service.

Circle 65 on Reader Service Card

A110



Numonics Untangles the Mouse!



The Cordless Manager Mouse

BUY IT...just \$149.95 (\$175 Value).

The mighty Manager Mouse has no tail to tie you down or hold it back. It's all pure untangled freedom. Plus variable resolution, from 10-1000 dpi, and the maintenance-free performance you'd expect from any well-bred Numonics mouse. Compatible with all popular application software.

BREAK FREE – GET MANAGER MOUSE!

Circle 194 on Reader Service Card



NUMONICS

Numonics Corporation, 101 Commerce Drive, Montgomeryville, PA 18936
FAX: (215) 361-0167 or Call: 1-800-247-4517

\$149.95

Plus \$4.50 shipping & handling per unit.
PA residents add 6% sales tax.

**The Cordless
Manager Mouse
from Numonics**

**LIMITED
OFFER**

of Units _____ Payment: VISA MC AMEX CHECK
Card No. _____ Expiration Date _____
Name _____
Company Name _____
Address _____
City _____ State _____ Zip _____
Daytime Telephone _____ Amount Enclosed _____



Visually Map Your Data

MapInfo turns raw data into meaningful presentation graphics

Stan Miastkowski

In today's confusing world of graphics software, MapInfo 4.0 is a unique program. It actually lets you do something eminently useful with any data that contains street addresses or other geographical information. Although its name suggests a simple map generation program, MapInfo is much more. By linking a wide range of data to map files, it gives you a surprisingly new and effective way to look at data.

In a nutshell, MapInfo presents a map (e.g., of a town, county, state, or country) that ties into your database. MapInfo can, for example, pinpoint precisely where a company's customers are located. Or you could have MapInfo show all customers within a 50-mile radius from Chicago, show all customers who bought red widgets, and so on.

Essentially, MapInfo provides a graphical representation of any sort or search you perform on your database. The end result of a MapInfo session is a visualization of "what if." The range of potential applications is almost limitless.

MapInfo's maker, Mapping Information Systems, also offers several hundred different maps onto which you can plot your ASCII or dBASE III data. MapInfo comes with maps of countries, states, and U.S. ZIP codes, and the company also sells digital street maps of thousands of U.S. cities, maps of counties, and demographic/census data. Prices range from \$95 to \$7000. If you're ambitious, you can even scan in your own map.



MapInfo can produce thematic data maps such as this one of Manhattan showing average household income in various locations around the city.

The Big Map

MapInfo is a large program; the minimum amount of hard disk space you'll need is 3 megabytes. Loading the national ZipInfo file that comes with the package requires another 2.2 megabytes. Then there are the optional maps, if you use them. Even though they're not bit-mapped graphical images (MapInfo stores its data in a dBASE-compatible file format), the very amount of data required means lots of megabytes. Individual map files take up as little as 1 megabyte to as much as 100 megabytes.

The basic MapInfo package comes on 10 packed 5¼-inch floppy disks. (Six 720K-byte 3½-inch floppy disks are also included.) MapInfo's automatic installation utility copies, combines, and unpacks the data. By the time I installed a tutorial, a demo package, and two maps

of Boston, Massachusetts, and Nashua, New Hampshire, MapInfo took up almost 20 megabytes of hard disk space.

Since MapInfo is a unique package, it takes a good deal of getting used to, and you have to learn many new terms and concepts. MapInfo's tutorial map package is well worth the trip, but it's only a small step along the way to getting comfortable with the package. The tutorial lessons are essential, but many of my questions were left unanswered, and I frequently got the message "This concept isn't covered in the tutorial."

After loading in maps of Boston and Nashua, I started up MapInfo and found that these cities weren't on the list of available maps. That's because MapInfo doesn't make maps available for use until it knows about them. You need to use an

continued

MapInfo 4.0

Company

Mapping Information Systems Corp.
Hendrick Hudson Building
200 Broadway
Troy, NY 12180
(800) 327-8627
(518) 274-8673

Hardware Needed

IBM PC, AT, PS/2, or compatible with 640K bytes of RAM, a hard disk drive with at least 3 megabytes of free space, and a CGA, EGA, VGA, or Hercules graphics adapter; a mouse is highly recommended

Software Needed

DOS 2.0 or higher

Documentation

User's guide; command reference

Price

\$750

Inquiry 884.

ADD command that's buried several menu levels down, and then the map will appear on the list. Surely the program's designers could have improved the user interface by having MapInfo automatically make new maps available.

Layers of Complexity

Although you see a complete map on the screen, the package actually stores data in four different kinds of files. More precisely, each map consists of four layers of different information.

Boundary files are areas on the map that are completely enclosed by connected line segments. The most common types of boundary files are states, cities, towns, and counties. But depending on the type of map you're using and what data you've added to it, a boundary file can also contain data such as ZIP code areas, sales territories, or census information (to name a few).

Map files contain information about line segments. Streets, highways, and rivers are the most common; specialized applications can contain segments such as utility lines, cable networks, and railroads.

Point files contain information about related points. You'll use this file regularly when you import your own data to MapInfo; the program uses it to locate a position. Depending on your application, a point can be something as simple as a building, a city, or a customer location; or something more esoteric such as a utility pole or even pothole locations. Point

files are stored in dBASE III format; each point is a record, and each field contains the additional data (e.g., a customer name) associated with a record.

Image files are the key to MapInfo's presentation graphics feature. Using MapInfo's image-generating features, you can add titles, legends, icons, identifications, and distance scales to your finished map.

Once all the files are put together, what you see on the screen is a complete map that incorporates all the individual features. Depending on the map, you can move the cursor around on it, magnify sections, and locate points, boundaries, and so forth.

dBASE and Geocoding

Although moving around MapInfo's existing maps is diverting, the key to the package's power is its ability to let you integrate your own data into a map. The MapInfo package includes MBase, a dBASE III-compatible database from FoxBASE. MBase is designed specifically for preparing data for use with MapInfo, and it doesn't include any programming capabilities. You also can't run conventional dBASE III programs in MBase. It does, however, let you use any dBASE III commands individually.

If you're familiar with dBASE III, you won't have any problems with MBase. If you're not, the learning curve for getting useful work out of MapInfo gets steeper. If the database you want to use with MapInfo isn't in dBASE III or ASCII format, you'll need to convert it. I used Paradox 3.0's export utility to convert a newsletter subscriber file to dBASE III format for use by MBase.

Just importing your data into MBase, however, doesn't make it usable by MapInfo. You still need to go through several steps of preparing the data for use with maps. The first step is creating a point file for the database. This involves adding *x*- and *y*-coordinate fields to each of the records in your database. Although the process isn't difficult, you have to be familiar with MBase to do it. (You can also incorporate the fields using your original database before importing it into MBase.)

Once your database contains a point file, the next and most crucial step is to "geocode" the point file. Geocoding, the primary tool for getting your data to actually appear on a map, is the process of assigning a coordinate (either latitude/longitude or *x*/*y*-coordinates) to each data point. In most cases, MapInfo automatically does the geocoding. Which field you choose to geocode on depends

on your context. If you're using one of MapInfo's optional city maps, you'll want to geocode on the street address. But if you have clients scattered around the country, you'll want to geocode on the ZIP code.

Once you've chosen which field to geocode on, MapInfo goes through your database and assigns values to the *x*- and *y*-coordinate fields you created in the database. Then you're ready to use your database. Once I geocoded my newsletter mailing list. I overlaid it on the U.S. map, and it showed me graphically where subscribers were located. I could also locate individual points by typing in other data (such as a subscriber name). Conversely, I could also indicate a point with my mouse and have the full related subscriber data pop up on the screen.

This is just a small example of how you can build and use custom applications with MapInfo. There are numerous variations, and one of the most interesting is thematic mapping. A thematic map displays some kind of data other than geographical locations. MapInfo can represent data themes using a variety of symbols, fill patterns, and colors. The photo shows a MapInfo map of Manhattan giving average household income in various locations around the city.

Once you've created a point file from your own data, you can use a variety of tools to turn a plain-vanilla map into a full-fledged, thematically based presentation graphic. The process is something between using a presentation graphics package and a desktop publishing package. (You can even design your own text fonts and icons or customize the ones that are already included.) But once again, MapInfo's steep learning curve comes into play.

A Resource-Intensive Program

With all the data it has to handle, MapInfo is a very disk- and processor-intensive program. It's especially strenuous on your system's hard disk drive. On my 10-MHz AT clone, I used it with both slow-access (65-millisecond) and fast-access (18-ms) hard disk drives. The difference in performance was very noticeable with the faster drive. On a 33-MHz machine with a fast hard disk drive, MapInfo flew.

MapInfo also uses any extended or expanded memory that it finds in your system. This speeds up the package's response time considerably. But I also found MapInfo to be more than a bit finicky. I used 2 megabytes of extended memory in my AT clone as a disk cache

continued

How To Bring
Minicomputer Power
To Your PC

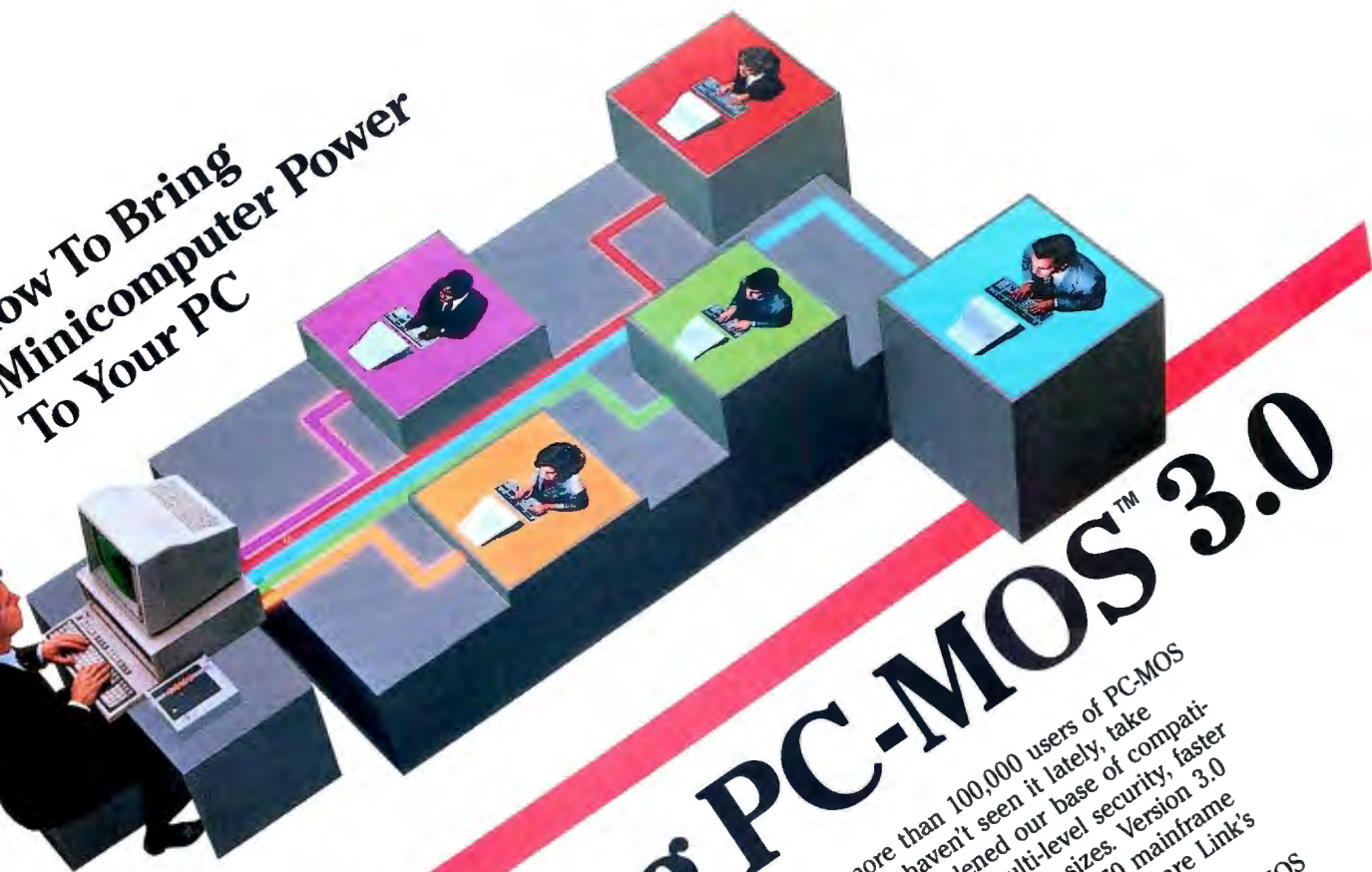

Introducing PC-MOS™ 3.0

A multiuser system no longer means only a mainframe or minicomputer. Today's 386- and 286-based PCs are more powerful than the minicomputers of just a few years ago. And they often provide more desktop power than one person can use effectively. That's why you need PC-MOS 3.0. It harnesses the power of your 386- or 286-based PC and turns it into a powerful multiuser, multitasking computer. PC-MOS is the multiuser operating system that lets you run popular DOS applications such as Windows™, Lotus 1-2-3™, dBase IV™ or WordPerfect™—without modification.

PC-MOS is the perfect solution for a small business or a department of a large company that needs users to easily and affordably share programs, databases or peripherals. It takes full advantage of the hardware's power—and saves you money in the process! For example, instead of replicating PCs, each user can have an expensive terminal or monitor that acts like a PC.

DOS Compatibility Means Minimal Training And Support
Since PC-MOS is DOS compatible—unlike UNIX™ or OS/2™—there's no need for users to learn a "new" operating system or be retrained on the application programs they already know. And unlike most LANs, PC-MOS is easy to install and even easier to maintain. No hassle, no expensive wiring and no network management headaches.

There are now more than 100,000 users of PC-MOS worldwide, but if you haven't seen it lately, take another look. We've broadened our base of compatible applications and added multi-level security, faster disk performance and larger task sizes. Version 3.0 also interfaces with Novell LANs, 3270 mainframe communications products and The Software Link's LANlink™ local area network.

Call us today for more information about PC-MOS 3.0 and the location of your nearest multiuser dealer. We'll show you how to easily and affordably turn your PC into a powerful multiuser system.

Terminals and Workstations Supported
Wyse 150™, Link MC5™, Kimtron KT-70™, IBM 3151™, AT&T 605 Business Communications Terminal™, Sun River Cygna/386™, Video Network Adapter™ and others.

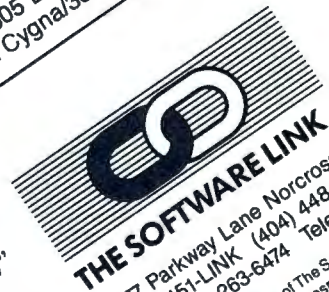

THE SOFTWARE LINK
3577 Parkway Lane Norcross, GA 30092
1-800-451-LINK (404) 448-5465
Fax: (404) 263-6474 Telex: 4996147 SWLINK

PC-MOS and LANlink are trademarks of The Software Link, Inc.
All other products referenced are trademarks of their respective companies.

**Your connection to
advanced technology**

Circle 255 on Reader Service Card (DEAL)

controlled by Future Computing Systems' Fast, and MapInfo repeatedly locked up. When I turned off the cache, I had no problems.

MapInfo works with a wide variety of graphics hardware. Software drivers are included for everything from Hercules monochrome graphics through CGA (in black-and-white mode) all the way up to EGA and VGA. But although you can use it with older graphics standards, I found that VGA is really the only choice for se-

rious MapInfo work. Additional drivers are available for the ultrahigh-resolution IBM 8514/A and other not-so-standard graphics adapters.

On the output side, printer drivers are included for industry-standard dot-matrix and laser printers, including PostScript devices. Since mapping applications lend themselves especially well to plotters, drivers are included for most popular pen plotters, including those from Houston Instrument, IBM, and

Hewlett-Packard. Like the graphics drivers, MapInfo also has a wide range of additional printer and plotter drivers available at an extra charge.

The company has announced a network node pack (\$595) that lets multiple users work on maps at the same time.

Following the Road Map

MapInfo is a unique and surprising package whose potential applications are limited only by the imagination. But like so many large applications, it is complex. One important difference between MapInfo and other applications is that it's virtually impossible to use just a part of it. To use MapInfo effectively, you must become familiar with the whole shooting match. That's not an easy job.

The program's designers could have made the learning process a bit simpler. There's no on-line help facility, and it's badly needed. In addition, MapInfo's user interface is quirky. Although some of the terms used in menus are initially daunting, they are necessary because of the singular nature of mapping concepts. However, main menus would be more useful if they dropped down instead of continually taking a large portion of the left side of the screen. (There's a full-screen option, but it's useful only for viewing a finished map.) A mouse isn't required for using MapInfo, but I found it a necessity for speeding up work.

The paradox of MapInfo is that the people who will find it the most useful are also the ones who are least likely to have the time and patience to live with its learning curve. A sales manager or city planner wants results immediately. Consequently, any office that's a serious MapInfo user will be better served by having one person who becomes the resident expert. For these real-world applications, MapInfo also sells MapCode (\$395), a programming package and compiler that can be used to generate custom (and easier to use) MapInfo applications. It could be the logical solution to MapInfo's problem.

Still, if you're willing to get past the learning curve and other oddities, you'll find MapInfo one of the most useful applications around. Early versions have found a loyal following in various fields. MapInfo has the capability of turning graphical "what if" into "that's it." ■

Stan Miastkowski is a BYTE consulting editor, managing director of K+S Concepts (a documentation and consulting firm) and editor of the OS Report newsletter. He can be reached on BIX as "stanm."

SUNDAY 10-5 **PROMPT DELIVERY**

SEAGATE DRIVES
20MB W/CHL 245.00
30MB W/CHL 269.00
40MB 28MB 294.99
40MB 40MB 399.99
Mini Sc 40MB 99.99
Tpn 3 1/4 720K 78.00

MITSUBISHI
286L 20 MB 2099.99
286L 40 MB 2099.99

NEC
NEC Ultralite 2 MB 2099.99
NEC Pro Speed 286/20 2049.99
NEC Pro Speed 386/40 2049.99

TOSHIBA
T-1000 1274.95
T-1200 1710
T-1200 2 F/D 1849.99
T-1200 Backlit 20 MB 3099.99
T-1200 20 MB w/ram 2549.99
T-1600 20 MB 4099.99
T-3100 40 MB 4899.99
T-3200 40 MB 4899.99
T-3200 80 MB 4899.99
T-3200 100 MB 4899.99

ZENITH
104-2 20 MB 1549.99
286 1470 20 MB 2799.99
286 1470 40 MB 3099.99

COMPUTERS
AST 286/16MB 1149.00
512K 1.2 F/40MB 1849.99
AST PREM 286 512K 1449.00
1.2 F/D 40 MB W/D
Dps 3.3 KVR40
AST PREM 386 C 2875.00
20MB 1 MB 1.2 F/D 3099.00
AST 386C/25 MHz 2MB Rem 1.2 F/D 4199.00
AST 386C/33 MHz 2MB Rem 1.2 F/D 4199.00

SOFTWARE
M.S. DOS 4.01 79.99
M.S. Windows 286 95.00
M.S. Excel IBM 2.1 219.99
Lotus 123 2.1 289.00
Lotus 123 2.1 35.99
PC Tools Deluxe 5.1 218.99
M.S. Word IBM 5.0 299.00
M.S. Word MAC 4.0 329.00
IBM OS/2 249.00
Lotus 123 V 3.0 399.00
Lotus Agenda 119.00
Lotus Symphony 72.00
Manag'Y Money 49.00
Norton Util. Adv. 219.99
Word Perfect 5.0 119.00
Word Perkt. Library 179.00
Carbon Copy Plus 259.00
Harvard Graphics 119.00
Slide Key Plus 99.00
Fast Base IV 199.00
Fontbase Plus 299.00
Fontbase 386 95.00
Multimate II 419.99
PFS First Choice 3.0 59.99
Paradox 3.0 49.00
Fast Lyrx 99.00
Fast Lyrx 99.00
L.E. Word Prog. 183.99
Lotus Magellan 89.99
MS 3000 Plus 89.99
OCR Software B/L 189.99
OCR Software B/L 189.99
Logitech for MAC 189.99
Logitech for MAC 189.99

MONITORS
Mish Dian Scan 259.00
NEC Multisync GS 259.00
NEC Multisync 2-A 604.99
NEC Multisync 3-A 604.99
NEC Mac Sync 499.00
Seko CM-1430 579.99
Zenith 14" Flat 579.99

PRINTERS
Dixxon 150 plus 299.99
Dixxon 300 329.99
Epson FX-1050 474.99
Epson LO-510 494.99
Epson LO-850 699.99
Epson LO-1050 814.99
Epson LO-1050 814.99
Epson LO-1250 844.99
Epson L38-B10 474.99
Fujitsu DL-3400 329.99
NEC 5200 454.99
OKI 5200 454.99
OKI 390 599.99
OKI 391 955.00
OKI 393 1180.00
Panax KXP 1180 109.99
Panax KXP 1191 199.99
Panax KXP 1524 399.99
Panax KXP 1592 409.99
Panax KXP 1595 314.99
Toshiba 301 139.95
Toshiba 311 179.95
8037/2 B MHz 229.99
8037/1 10 MHz 259.99
8038/1 10 MHz 279.00
8038/2 10 MHz 499.99

NOVELL
Adv. Network 1099.99
SL Network 299.99
ELS-1 399.99
ELS-2 399.99

NETWORK CARDS
Architel 16 Bit 89.99
Architel 8 Bit 149.99
Ethernet 8 Bit 149.99
Ethernet 16 Bit 149.99

FAX/MODEM
World Port 2486 449.99

MODEMS
Exetec 2400 W/HP 149.99
Exetec 2400 Ext. 189.99
U.S. Robotics 470.00
Counter HST-2400 247.99
World Port 2400 Baud 247.99

GRAPHIC CARD
Exetec EGA Plus 199.99
Parade VGA Plus 299.99
Para. VGA Plus 15 299.99
Parade VGA Pro 244.99
Video 7 Fast VGA 349.99
Vid. 7V Ram VGA 389.99
CANON COPIERS
PC-31 919.99
PC-1 919.99

HAND SCANNERS
Lotus Magellan 183.99
MS 3000 Plus 89.99
OCR Software B/L 189.99
OCR Software B/L 189.99
Logitech for MAC 189.99
Logitech for MAC 189.99

WORLDWIDE INQUIRIES PROMPTLY FILLED

GUARANTEED LOWEST PRICES
TOLL FREE 1-800-874-1235
N.Y.C. (212) 463-8330
IN CANADA TOLL FREE 1-800-666-1668 FAX # 212-463-8335

S & W COMPUTERS & ELECTRONICS
31 West 21 Street, New York, N.Y. 10010
HOURS: Sun. 10-5 Mon-Thurs 9-6 Fri 9-2 Sat. Closed

ALL MERCHANDISE SHIPPED IN FACTORY SEALED CARTONS, 100% GUARANTEED

Rupp Corporation Presents

Power Products Showcase No. 21

Circle 242 on Reader Service Card



LANtastic™ ARTISOFT INC.

Low Cost LAN: Now you can start with a \$399 2-user LAN and build up to a \$100,000 multi-topology Novell 286 LAN. LANtastic is Novell compatible so when your needs grow, your LAN can grow too.

Fast: For low budget connectivity, LANtastic's fast two-megabit-per-second transmission rate and its low price bring you powerful and affordable networking. The use of CSMA/CD and /CA makes it very reliable and safe for larger networks.

Expandable: LANtastic can connect up to

32 computers without repeaters using dual twisted pair cable. All network traffic is managed by an on board 10 MHz network coprocessor with its own 32 kbytes of buffer RAM.

All You Need: Each starter kit comes with 2 Half Slot Network Interface Adapters, NOS Software and a 15' Cable. Enough for a two station peer to peer network. It's easy to install and easy to use.

LANtastic Starter Kit **\$399**

Circle 241 on Reader Service Card

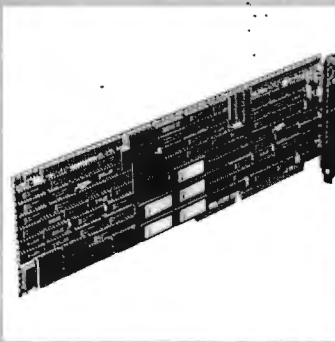

PM3011 CACHING CONTROLLER

Up to 16MB of hardware implemented cache for ESDI, RLL of ST506 drives.

Product Profile: The PM3011 caching controller is the single most effective performance improvement tool available for disk-intensive applications. The PM3011 accesses data in as little as 0.5ms; that's 50 to 150 times faster than a random disk access.

Advanced Caching Algorithms: Such advanced caching features as disk read ahead and elevator sorting during cache write-back increase disk performance to levels unattainable by non-caching controllers. The controller's on-board 68000 microprocessor enables it to access the disk

drive at the same time as the computer reads or writes to the controller cache.

Compatibility: Since PM3011 caching controllers operate transparently to the operating system, special software drivers or ROM BIOS changes are not required.

Up to 16MB of Cache: The PM3011 Cache RAM is expandable from the on-board 512KB to 16MB with the optional Cache Expansion board. The cache is totally independent from system memory and does not require device drivers.

PM3011/70 Caching Controller With 512KB cache. **\$1150**

Circle 240 on Reader Service Card

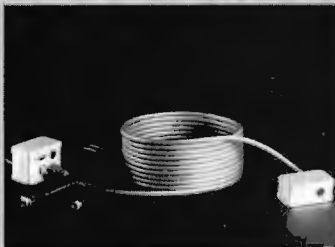

COMPANION

If you need access to data from a front desk and a back office, you need a Companion. Its unique circuitry lets you add a second keyboard and monitor to your existing computer using a single 3/8" diameter cable. Companion can be switched from "shared" allowing both keyboards and both screens to be active, to "private," when you don't want your remote screen visible. You can extend your keyboard and monitor from lengths of 25 to 150 feet.

Features:
Two mode capabilities shared and private.
Supports VGA, EGA, CGA and Monochrome.
Easy to install.
No external power required.
Works with all IBM PC/XT, AT and PS/2.
Extends up to 150 feet.

Companion **\$219 and up.**

*For pricing on RLL, ST506 controllers and other options please call

(303) 494-8078

Dealer Inquiries Welcome

Charge Cards Accepted: Amex, Visa, MC

Hours (EST) 9:00 to 5:00



Exceptional Computer Products

Rupp Corporation
835 Madison Avenue
New York City, NY 10021



Some of the smartest business decisions are made in the dark.

More and more business people are seeing the light and using the GENie™ service during non-prime time. That's the way to put GENie to work for just \$6 an hour. Which is less than half of what CompuServe® charges to access many of the same business features.

GENie, for example, lets you book hotel and airline reservations using the Official Airlines Guide.™ Get financial news with Dow Jones

News/Retrieval. Plus you'll get real-time quotes, fast on-line trading and discount commissions, all with Charles Schwab Brokerage Services. A valuable new package that's available on GENie.

And GENie makes signing up easy.

- (1) Set your modem for local echo (half duplex), 300 or 1200 baud.
- (2) Dial 1-800-638-8369. When connected, you just enter HHH.
- (3) At the U#= prompt simply enter

XTX99634, GENie then RETURN.

And have a major credit card or your checking account number ready. For information in the U.S. or Canada, call 1-800-638-9636. Or write GE Information Services, 401 North Washington St., Rockville, MD 20850.



We bring good things to life.

*Applies only to 1200 baud access in U.S. Mon.-Fri. 6PM-8AM local time and all day Sat., Sun., and nat'l holidays. Subject to service availability. Some services may be subject to a surcharge. Prices effective May 1, 1989.

Circle 110 on Reader Service Card



How Super Is SuperCard?

It has more features
than HyperCard,
but performance is slow

Richard D. Lasky

It sounded too good to be true. Here was a program that took HyperCard as a starting point and added on a veritable wish list of features: color support, multiple windows, object-oriented graphics, irregular button shapes, and even the ability to create stand-alone applications.

That's what Silicon Beach promised of its SuperCard, and it does, in fact, deliver all those enhancements and then some. Unfortunately, those enhancements come at the expense of performance. The trade-off may be worthwhile for some people, and for others, SuperCard's bounty of features is at least worth considering.

Like HyperCard, Only Different

The basic file unit in SuperCard is a *project*, and each project contains at least one window. Windows can be any size, and SuperCard supports all the common Macintosh window types. A SuperCard window is the equivalent of a HyperCard stack. Each window has one or more backgrounds, and each background has at least one card.

Cards may be any size, unlike those of HyperCard, which are limited to only what fits into the 9-inch Macintosh display. In HyperCard, for example, you might have to divide a large map among several different cards. With SuperCard, the whole map is on a single large card that you can view through a scrolling window.

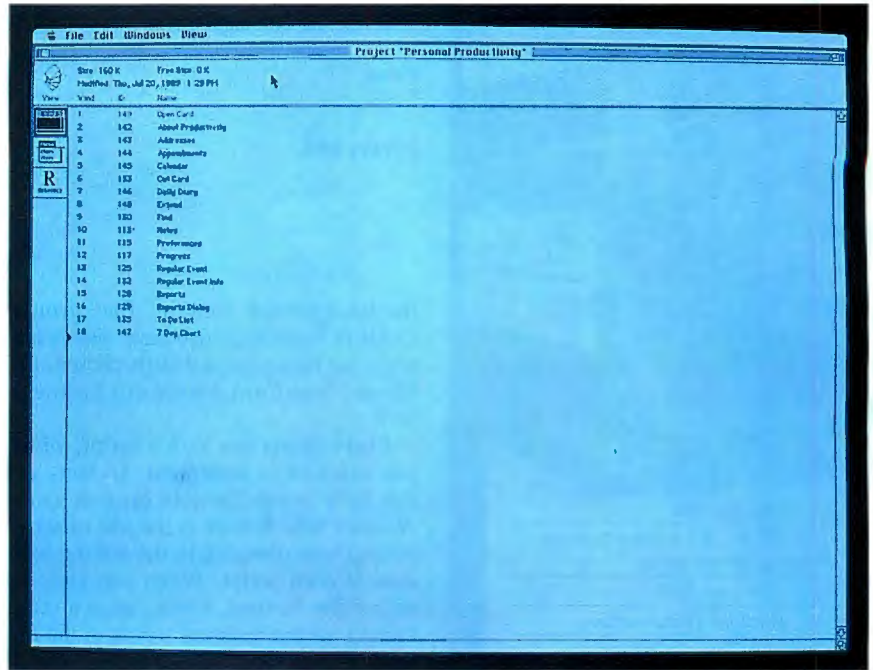

The user interface of SuperCard's SuperEdit is reminiscent of Apple's ResEdit.

Another major difference between SuperCard and Apple's product is the way graphics are handled. HyperCard has just two graphics layers; both are paint-type bit maps. SuperCard supports both paint- and draw-type graphics, and each graphics image is treated as a separate object with its own properties and script. Also, instead of a Home card, SuperCard has a file called SharedFile to store common resources.

Two Programs in One

The SuperCard package actually consists of two applications, SuperEdit and SuperCard. You use SuperEdit to create new projects, and you use SuperCard to run them. SuperEdit's user interface is reminiscent of that of ResEdit, Apple's resource editing program (see photo).

Each project displays a list of the windows, menus, or resources contained

in the project. The objects in the list are displayed by name, number, and ID number.

You can open any card in a window to get a visual display of the card's layout. Along the left side of the card layout window is a column of tool icons. You can toggle back and forth between card and background views.

Users familiar with HyperCard's treatment of background objects should be aware that SuperEdit handles things a bit differently. For example, in HyperCard's card view mode, you can move background buttons, but in SuperEdit—unless you explicitly select the background view—background objects remain inanimate. Although this takes getting used to, it's probably a good idea. I've often worked on a button or field in HyperCard and forgotten that it was in

continued

Rack & Desk PC/AT Chassis

Integrand's new Chassis/System is not another IBM mechanical and electrical clone. An entirely fresh packaging design approach has been taken using modular construction. At present, over 40 optional stock modules allow you to customize our standard chassis to nearly any requirement. Integrand offers high quality, advanced design hardware along with applications and technical support *all at prices competitive with imports*. Why settle for less?

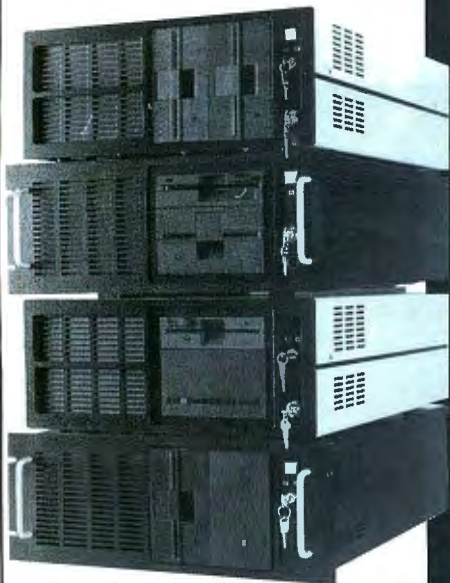

Rack & Desk Models

Accepts PC, XT, AT Motherboards
and Passive Backplanes

Doesn't Look Like IBM

Rugged, Modular Construction

Excellent Air Flow & Cooling

Optional Card Cage Fan

Designed to meet FCC

204 Watt Supply, UL Recognized

145W & 85W also available

Reasonably Priced

Now
Available

Passive
Backplanes



INTEGRAND

RESEARCH CORP.

Call or write for descriptive brochure and prices:
8620 Roosevelt Ave. • Visalia, CA 93291

209/651-1203

TELEX 5106012830 (INTEGRAND UD)

FAX 209/651-1353

We accept Bank Americard/VISA and MasterCard

IBM, PC, XT, AT trademarks of International Business Machines.
Drives and computer boards not included.

REVIEW

HOW SUPER IS SUPERCARD?

SuperCard 1.0

Company

Silicon Beach Software, Inc.
9770 Carroll Center Rd., Suite J
San Diego, CA 92126
(619) 695-6956

Hardware Needed

Mac Plus or higher with two 800K-byte floppy disk drives or a hard disk drive; 2 megabytes of RAM is required for color

Software Needed

System 6.0 or higher

Documentation

User manual; language guide

Price

\$199

Inquiry 886.

the background domain. Background fields in SuperEdit also have visible text when the background view is chosen, unlike in HyperCard. I liked this feature as well.

Every object can have a script, which you can edit in SuperEdit. In fact, you can have several scripts open at once. Another nice feature is the use of script editing aids provided in the editing window of each script. When you click on one of five buttons, a menu pops up containing all the reserved words in the SuperTalk language. For example, selecting mouseUp from the Sys Messages menu inserts the `on mouseUp...end mouseUp` message handler into the script window. The script-editing window is not modal, as it is in HyperCard. You have access to the menu bar as well as any other open windows, which I found very convenient and a big improvement over HyperCard.

You can also convert HyperCard stacks to new SuperCard projects using SuperEdit. It places the cards of the stack into a single window in the new project. (SuperEdit supports all the common button types found in HyperCard, and a few more to boot.) I converted two of my stacks. The first was a simple address-type stack of my customer base. This converted quite well and was fully functional (if a bit slower) in SuperCard. The second stack I converted was a demo version of a stack I developed for nutritional analysis. The calculations worked, but there was a major problem in the portion of the stack that created a bar graph.

That's when I learned that I could not convert HyperCard's drawing commands to SuperCard without some modification.

SuperCard has some nice features that make work easy for the project designer. When you're working in the background mode, for example, choosing the Gray Card command from the view menu causes SuperEdit to display a grayed image of card objects behind the background objects that you are editing. This is a great help in aligning objects in the background mode with card objects.

The text field types are identical to those found in HyperCard. However, the opaque field type found in HyperCard is not available. Text within a field may contain several different fonts and styles, a significant feature lacking in HyperCard. However, a card with many font styles on it may take significantly longer to open.

SuperCard supports 8-bit color on the Macintosh II models. This requires at least 1.5 megabytes of RAM. A total of 256 colors (out of a possible 16.8 million) are available at one time. The available colors are contained in a resource called CLUT, which stands for "color lookup table." The system supplies a default CLUT, but you can create a new CLUT resource.

For graphics objects, you can set the "ink effects," which determine what happens to the bit pattern when one object is on top of another. Combining various ink effects with different fill patterns can yield some interesting visual effects. Seven ink effects are available for colored objects.

Unlike most applications, SuperCard stores resources in the data fork of the program. You can create three kinds of resources in SuperEdit: icons, cursors, and CLUTS. In addition, you can import sounds, XCMDs, and XFCNs (external commands and functions).

Running Projects

To run a project created with SuperEdit, you can go directly into SuperCard by choosing the Run command under the File menu in SuperEdit. When you subsequently quit SuperCard, you are returned to SuperEdit. However, this doesn't work when running MultiFinder; SuperCard dumps you back to the Finder instead.

SuperCard has some limited editing abilities that make it a useful environment for fine-tuning your project once it is near completion. You can create and alter objects and their scripts, but the

continued

WHAT OUR REMOTE LAN BRIDGE CAN DO FOR YOUR WORLD.

Bringing people and information together is what a Microcom LAN Bridge is all about. And, with our unique MNP® Data Compression feature, remote LANs can be connected at unprecedented performance levels. MNP squeezes twice the performance out of your wide-area link compared to other bridges at a fraction of the price.

In fact, the Microcom LAN Bridge is the only remote bridge on earth that uses data compression to move oceans of data between LANs. And, it's the first

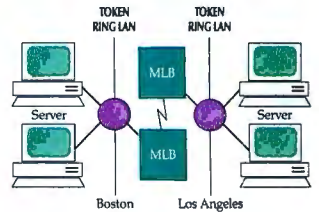

to support Token Ring networks, in addition to the Ethernet LAN standard.

Think about it. A fully integrated transparent MAC-level bridge built around the IBM PC/AT bus. In four fully upgradeable, multi-line models with speeds from 9600 bps to 1.544 Mbps (T-1). And with prices beginning at \$6,198, the only thing a Microcom LAN Bridge can't squeeze is your budget.

The Microcom LAN Bridge. It brings information and people closer together, no matter where in the world they are.

Call toll-free, 800-822-8224 for more information.

500 River Ridge Drive
Norwood, MA 02062
Telex:
710-336-7802 Microcom NWD.
U.S. FAX: 617-551-1006
Worldwide Distribution.
International FAX: 617-551-1007



MNP is a registered trademark of Microcom, Inc. Microcom LAN Bridge and MNP Data Compression are trademarks of Microcom, Inc. IBM Token Ring and IBM/AT are trademarks of International Business Machines Corp. Ethernet is a trademark of Xerox, Inc.

Circle 175 on Reader Service Card

EZ-DOS

An alternative, user-friendly Disk Operating System for PCs.

There is no comparison

	INSTALL generates CONFIG/AUTOEXEC files	EZ-DOS	DOS 3.3	DOS 4.01
File & directory password protection	Yes	No	Yes	
On-line help for command syntax & usage	Yes	No	No	
True graphic user interface (GEM Desktop)	Yes	No	No	
Command line editing	Yes	No	No	
Command history buffer up to 4K bytes deep	Yes	No	No	
Full screen text editor with on-line Help	Yes	No	No	
Maximum partition size (in megabytes)	512	32	512	

- EZ-DOS 4.0 \$79.00
- plus True BASIC..... \$99.00
- plus serial Mouse..... \$129.00
- plus T.BASIC & Mouse... \$149.00

2001 Sales, Inc.

16580 Harbor Blvd., Ste. D
Fountain Valley, CA 92708.

Tel: (714) 531-6551

Fax: (714) 531-8546

Dealer, Distributor & OEM Inquiries welcome.
VISA and Master Card accepted.

program lacks any advanced editing features. For example, you can reshape a polygon in SuperCard, but if you want to change its ink effect, you must use SuperEdit.

Instead of simply having SuperCard run your project, you can convert your project into a stand-alone application. The advantage is that its distribution is not limited to those people who already use SuperCard. The other side of the coin is that creating a stand-alone application adds some 350K bytes of SuperCard run-time code to the size of the project file. The resulting application works just as if you were running the project with SuperCard; there is no noticeable gain in performance.

You can edit an application in SuperEdit, but you cannot convert it back into a SuperCard project. Unfortunately, SuperCard does not give you the opportunity to change the name of a project being converted. As a result, the new stand-alone file replaces the project file.

Frustrating Performance

I have two major complaints about SuperCard. The first is its memory requirements and poor handling in low-memory situations. Although the company advertises the minimum memory requirement as 700K bytes, my experience is that even 1 megabyte of RAM is insufficient for getting acceptable performance on a Mac Plus.

When I began reviewing SuperCard, I was chiefly working on a 1-megabyte Mac Plus. My attempts to use the program were fraught with frustration and frozen screens. Even when running one of the tutorial projects, I frequently got the "SuperCard is out of memory" dialog box. What made matters even worse was that half the time the system locked up as soon as I dismissed the warning message.

I upgraded my Mac to 2.5 megabytes of RAM. This let me experiment under MultiFinder. Both SuperCard and SuperEdit are initially set to hog 1600K bytes under MultiFinder, but these values can be reset from the Finder by using the Get Info menu command. I set SuperCard's partition for 750K bytes to test the company's claims of a 700K-byte requirement. I opened the "Ramblin' Ruth" project, a cute little tutorial project that comes with SuperCard. When I tried to add a simple menu to the menu bar, I got the familiar "out of memory" dialog box. I clicked "OK," and the screen froze.

Silicon Beach acknowledges that SuperCard has problems with low-memory

situations. The company suggested removing my INIT files (such as QuicKeys and Suitcase) from my system folder to free up memory on my 1-megabyte Mac. But the company also agreed that it is unreasonable to expect Mac users to give up all their INIT utilities just to run SuperCard. (At least one INIT, called Boomerang, causes SuperCard to crash. It is the fault of Boomerang, and its author is correcting the problem.)

The other problem with SuperCard is the slowness of the screen refresh. This is most often experienced as a long delay going from card to card. Such a long pause would occur between the time I clicked the button and the time the screen auto-highlighted. Thinking nothing was happening, I would click the button a second or third time.

Even after upgrading my Mac to 2.5 megabytes of RAM, I found the response time unacceptably slow. For example, I compared HyperCard's Address stack and SuperCard's Productivity project—two Rolodex-like programs that let you "flip" through address cards. SuperCard took more than three times longer (nearly 3 seconds) than HyperCard just to go to the next card.

The company points out that SuperCard is not optimized for 342 by 512 bit-mapped cards, as HyperCard is. It suggests using STEP files for animation instead of flipping cards, and avoiding large bit-mapped graphics.

A Super Buy?

Before you rush out to buy SuperCard, carefully consider just what you expect to get. HyperCard users should bear in mind that many of the features in SuperCard are available as add-on XCMD or XFCN programs from third-party developers. For example, HyperWindows from Tulip Software (\$59) lets you access multiple windows of any type from within HyperCard, and it also supports color displays.

The bottom-line is that Silicon Beach has created a neat Mac erector set. SuperEdit has many exciting and powerful features, but you may be disappointed by SuperCard's slow performance. In addition, SuperCard is not appropriate for a Macintosh with only 1 megabyte of RAM. But if future versions of the program are better optimized for speedy performance, then SuperCard really will be a dream come true. ■

Richard D. Lasky is a biochemist and stackware developer living in Needham, Massachusetts. He can be reached on BIX c/o "editors."

PC BRAND Chosen # 1 For Customer Service and Support.

"PC BRAND is the LL Bean of the personal computer mail order.

PC BRAND wants no unhappy customers, and it's service and support policies help to insure that."

-Personal Computing's 10 Best Mail Order Companies, Feb, 1989



PC BRAND™

PC BRAND offers you more...

Welcome to PC Brand. Your *first* place to shop. Your *best* place to shop for top quality IBM compatible systems, custom configured to your exact specifications, and thousands of quality name brand peripherals and accessories.

Choose from over 10,000 items in stock... all at unbeatable prices!

Free Freight, Toll-Free Support, 5-Year Warranty and more...

Everyone promises you great service. We deliver the tangibles.

- Free freight • Fast delivery
- No credit card surcharges
- A 30-day Money-Back Guarantee on every system we sell
- Toll-Free Customer Service and Technical Support that will stay with you until your questions are answered and your problem is solved
- And our exclusive 5-Year Warranty on all PC Brand products, call for details.

Call PC Brand today.

For the best selection... the best products...at the best price, you can't do better than PC Brand.

Call PC Brand today!

TURN PAGE
FOR PC BRAND SYSTEMS
...AND NAME BRAND
PERIPHERALS

Outstanding Quality

PC BRAND Chosen #1 For Customer Service and Support.

"PC BRAND is the LL Bean of the personal computer mail order...PC BRAND wants no unhappy customers, and it's service and support policies help to insure that."

-Personal Computing's 10 Best Mail Order Companies, Feb, 1989

PC BRAND

Your Best Choice
for Quality Systems
Toll-Free Support
Toll-Free Service
Free Freight
5-Year Warranty



PCV20 AD-II \$539

15 MHz Throughput in an XT. Norton SI 4.0
512K, 360K Drive, 84-Keyboard

Standard System Features:

- 10MHz Nec V20 CPU with 1.5 times the power of the 8088!
- 512K RAM standard. Expandable to 640KB
- One 360K Floppy Drive • 84-key AT Style Keyboard
- 8 Slots. Serial, Parallel, Game Ports, and Clock Standard
- AT Style Case with Keylock, Turbo, Power and Hard Drive LEDs.
- Accommodates up to 4 HH Mass Storage devices
- Set-up & Operating instructions.

Standard Pre-Built Configurations:

PCV20 AD-II With 512K, Hard Disk Drive, Monitor & Video Card				
Drive Video	1 Floppy	2 Floppy	40MB-46MS	66MB-25MS
Mono	\$664	\$739	\$944	\$1094
VGA/Mono	\$824	\$899	\$1104	\$1254
EGA	\$1004	\$1079	\$1284	\$1434
VGA/Color	\$1054	\$1129	\$1334	\$1484

PC BRAND 286/12 \$799



Now Using C & T
"Neat" Chip Set

12 MHz Clock, Zero Wait Operation,
Norton SI 15.3 • Landmark™ Speed 15.1MHz
512K, 1.2MB or 1.44MB Drive, 101- Keyboard

Standard System Features:

- 80286-12 Processor Operating at 12MHz with Zero Wait States delivering 15.1MHz Effective Throughput
- 512K RAM expandable to 4MB on the System board using 256K or 1MB 100ns RAM
- 1.2MB 5.25" or 1.44MB 3.5" Diskette Drive
- 1:1 Interleaving Dual Hard Drive/Floppy Drive Controller
- Enhanced 101-key AT Style Keyboard
- High Capacity System Power supply
- Real Time Clock/Calendar with 5 Year Battery
- 80287 Co-Processor Support
- AMI BIOS with full MS/DOS, OS/2, XENIX, NOVELL, 3COM and PCNET compatibility
- Built-in System Board LIM 4.0 EMS hardware drivers
- User configurable I/O timing permitting compatible operation with older peripherals or faster I/O for newer devices
- 8 Slot motherboard design (5 16Bit & 3 8Bit)
- Medium foot print case with 5 Disk Drive bays

Options:

- Full size 5 drive case • Factory Installed RAM Upgrades
- Custom configurations w/Name Brand peripherals of your choice
- Compaq® Style LCD or Plasma Portable
- Full or Mini Size Tower® Case

Standard Pre-Built Configurations:

286/12 With 512K, Hard Disk Drive, Monitor & Video Card				
Drives Video	40MB-46MS 1:1 RLL	66MB-25MS 1:1 RLL	71MB-18MS 1:1 MFM	110MB-25MS 1:1 RLL
Mono	\$1207	\$1432	\$1572	\$1672
VGA/Mono	\$1402	\$1627	\$1767	\$1867
EGA	\$1547	\$1772	\$1912	\$2012
VGA/16Bit	\$1637	\$1862	\$2002	\$2102

Unbelievable Price

PC BRAND 286/20 \$999



Ideal Novell Server!

20 MHz Clock, Zero Wait Operation
NortonSI 23.0 • Landmark™ 26.7MHz
512K, 1.2MB or 1.44MB Drive, 101-Key-board

Standard System Features:

- 80286 Processor Operating at 20MHz w/Zero Wait States in interleave mode delivering 27MHz Effective Throughput
- 512K RAM expandable to 8MB on the System board using 256K and/or 1MB 100ns RAM
- 1.2MB 5.25" or 1.44MB 3.5" Diskette Drive
- 1:1 Interleaving Dual Hard Drive/Floppy Drive controller
- Enhanced 101-key AT Style Keyboard
- High Capacity 200 Watt System Power Supply
- Real Time Clock/Calendar with 5 Year Battery
- 80287 Co-Processor Support
- AMI BIOS with full MS/DOS, OS/2, XENIX, NOVELL, 3COM, and PCNET compatibility
- Built-in System Board LIM 4.0 EMS hardware drivers
- User configurable I/O timing permitting compatible operation with older peripherals or faster I/O for newer devices
- 8 Slot motherboard design (5 16Bit & 3 8Bit)
- Medium foot print case with 5 Disk Drive bays

Options:

- Full or Mini Size Tower ® Case
- Factory Installed RAM Upgrades
- Custom configurations w/Name Brand peripherals of your choice
- Compaq® Style LCD or Plasma Portable

Standard Pre-Built Configurations:

286/20 w/512K, Hard Disk Drive, Monitor & Video Card						
Video \ Drives	40MB-46MS 1:1RLL	66MB-25MS 1:1 RLL	71MB-18MS 1:1 MFM	110MB-25MS 1:1 RLL	150-17MS 1:1 ESDI	320-16MS 1:1 ESDI
Mono	\$1407	\$1632	\$1737	\$1862	\$2517	\$2817
VGA/Mono	\$1602	\$1827	\$1932	\$2057	\$2712	\$3012
EGA	\$1747	\$1972	\$2077	\$2202	\$2857	\$3157
VGA/16Bit	\$1837	\$2062	\$2167	\$2292	\$2947	\$3247

PC BRAND 386/SX-16 \$1099



16 MHz Clock, Zero Wait Operation
NortonSI 18.7 • Landmark™ 18.3MHz
512K, 1.2MB or 1.44MB Drive, 101-Key-board

Standard System Features:

- 80386SX Processor Operating at 16MHz delivering 18MHz Effective Throughput
- 512K RAM expandable to 8MB on the System board using 256K and/or 1MB 80ns RAM
- 1.2MB 5.25" or 1.44MB 3.5" Diskette Drive
- 1:1 Interleaving Dual Hard Drive/Floppy Drive controller
- Enhanced 101-key AT Style Keyboard
- High Capacity 200 Watt System Power Supply
- Real Time Clock/Calendar with 5 Year Battery
- 80387SX Co-Processor Support
- AMI BIOS with full MS/DOS, OS/2, XENIX, NOVELL, 3COM, and PCNET compatibility
- 8 Slot motherboard design (5 16Bit & 3 8Bit)
- Medium foot print case with 5 Disk Drive bays (Shown with optional Mini Size Tower ® Case)

Options:

- Full or Mini Size Tower ® Case
- Factory Installed RAM Upgrades
- Custom configurations w/Name Brand peripherals of your choice
- Compaq® Style LCD or Plasma Portable

Standard Pre-Built Configurations:

386SX-16 w/512K, Hard Disk Drive, Monitor & Video Card						
Video \ Drives	40MB-46MS 1:1RLL	66MB-25MS 1:1 RLL	71MB-18MS 1:1 MFM	110MB-28MS 1:1 RLL	150-17MS 1:1 ESDI	320-16MS 1:1 ESDI
Mono	\$1507	\$1732	\$1837	\$1962	\$2617	\$2917
VGA/Mono	\$1702	\$1927	\$2032	\$2157	\$2812	\$3112
EGA	\$1847	\$2072	\$2177	\$2302	\$2957	\$3257
VGA/16Bit	\$1937	\$2162	\$2267	\$2392	\$3047	\$3347

TURN PAGE FOR MORE PC BRAND SYSTEMS...
FOR NAME BRAND PERIPHERALS SEE OUR AD ON FOLLOWING PAGES...

To Order Call 1-800-PC BRAND

(Call 1-800-722-7263) In All 50 States FAX# 1-800-722-7392



PC Brand, Inc. 954 W. Washington St., Chicago, IL. 60607 Int'l Fax# 312-226-6841 Int'l Voice# 312-226-5200. Open Mon thru Fri.: 8am to 6pm Central. MasterCard, VISA, Discover, Checks, & Approved P.O.s Accepted. Prices and specifications subject to change. Customer Service Inquiries Call: 1-800-662-SERV BYTE 14-10

Amazing Performance

"Faster Than a Speeding Bullet!"

Computer Shopper Cover Story Nov, 1988

"PC Brand offers the best low cost alternative around"

-PC Magazine Feb.14, 1989

PC BRAND 386/20 \$1649



20 MHz Clock, Zero Wait Operation
Norton SI 23.0 • Landmark Speed 26.1MHz
1024K, 1.2MB or 1.44MB Drive, 101-Key Keyboard

Standard System Features:

- True 20MHz Intel 80386-20 CPU Operating with Zero Wait States delivering up to 26.1MHz Effective Throughput
- 1024K RAM standard expandable to 16MB via 32Bit RAM boards using 256K and/or 1MB 100ns RAM
- 1.2MB 5.25" or 1.44MB 3.5" Diskette Drive
- 1:1 Interleaving Dual Hard Drive/Floppy Drive controller, 977.6 KB/SEC Caching Controller w/ESDI Configurations
- Enhanced 101-key AT Style Keyboard
- High Capacity 200 Watt System Power Supply
- Real Time Clock/Calendar with 5 Year Battery
- 80287, 80387 Co-Processor Support
- Phoenix BIOS with full MS/DOS, OS/2, XENIX, NOVELL, 3COM and PCNET compatibility
- 8 Slot motherboard design (5 16Bit & 1 8Bit & 2 32/8Bit)
- Medium foot print case with 5 Disk Drive bays

Options:

- Full or Mini Size Tower @ Case
- 8MB 32Bit RAM Card Upgrade
- Custom configurations w/Name Brand peripherals of your choice
- Compaq® Style LCD or Plasma Portable • Weitek Co-processor

Standard Pre-Built Configuration:

386/20 With 1024K, Hard Disk Drive, Monitor & Video Card						
Drives	40MB-46MS 1:1 MFM	66MB-25MS 1:1RLL	71MB-18MS 1:1 MFM	110-25MS 1:1 RLL	150-17MS 1:1ESDI	320-16MS 1:1ESDI
Mono	\$2125	\$2225	\$2350	\$2460	\$3010	\$3455
VGA/Mono	\$2310	\$2410	\$2535	\$2645	\$3195	\$3640
EGA	\$2415	\$2515	\$2640	\$2750	\$3300	\$3745
VGA/16Bit	\$2555	\$2655	\$2780	\$2890	\$3440	\$3885

PC BRAND 386/25 \$1849



25 MHz Clock, Zero Wait Operation
Norton SI 28.2 • Landmark Speed 33.6MHz
Norton SI 31.6 • Landmark Speed 43.5 w/Cache
1024K, 1.2MB or 1.44MB Drive, 101-Key Keyboard

Standard System Features:

- Intel 80386 Processor Operating at 25MHz with Zero Wait States in interleave mode delivering 34 to 44 MHz Effective Throughput
- 1024K RAM standard expandable to 16MB via 32Bit RAM boards using 256K and/or 1MB RAM
- 1.2MB 5.25" or 1.44MB 3.5" Diskette Drive
- 1:1 Interleaving Dual Hard Drive/Floppy Drive controller, 977.6 KB/SEC Caching Controller w/ESDI Configurations
- Enhanced 101-key AT Style Keyboard
- High Capacity 200 Watt System Power Supply
- Real Time Clock/Calendar with 5 Year Battery
- 80287, 80387 or Weitek Co-Processor Support
- AMI BIOS with full MS/DOS, OS/2, XENIX, NOVELL, 3COM and PCNET compatibility
- User configurable I/O timing permitting compatible operation with older peripherals or faster I/O for newer devices
- 8 Slot motherboard design (5 16Bit & 3 8Bit & 2 32Bit)
- Medium foot print case with 5 Disk Drive bays

Options:

- 32KB or 64KB Cache Processor • Weitek Co-processor • Tower @ Case
- Custom configurations w/Name Brand peripherals of your choice
- Compaq® Style LCD or Plasma Portable • 8MB 32Bit RAM Card

Standard Pre-Built Configurations:

386/25 With Hard Disk Drive, Monitor & Video Card						
Drives	40MB-46MS 1:1MFM	66MB-25MS 1:1RLL	71MB-18MS 1:1 MFM	110MB-25MS 1:1RLL	150-17MS 1:1ESDI	320-16MS 1:1ESDI
Mono	\$2312	\$2462	\$2592	\$2722	\$3322	\$3572
VGA/Mono	\$2527	\$2677	\$2807	\$2937	\$3537	\$3787
EGA	\$2672	\$2822	\$2952	\$3082	\$3682	\$3932
VGA/16Bit	\$2762	\$2912	\$3042	\$3172	\$3772	\$4022

CRT display is courtesy of RIX Softworks, Inc. Irvine, CA.

Exceptional Support

386/33 CACHE

\$2799

*Worlds Fastest
Personal Computer!*



33 MHz Clock, Zero Wait Operation

Norton SI 45.9 • Landmark 58.7 MHz w/32K or 64K Cache
1024K, 1.2MB or 1.44MB Drive, 101-Key-board

Standard System Features:

- True 33 MHz INTEL 80386-33 CPU operating with Zero Wait States Delivering up to 58.7 MHz Effective Throughput
- Intel 82385-33 Cache Processor with 32K 25NS Static RAM Standard, Field Upgradable to 64K
- 1024K RAM Standard Expandable to 16MB
- 1.2MB 5.25" or 1.44MB 3.5" Diskette Drive
- 1:1 Interleaving Dual Hard Drive/Floppy Drive Controller, 977.6 KB/SEC Caching Controller w/ESDI Configurations
- Enhanced 101-key AT Style Keyboard
- High Capacity 200 Watt System Power Supply
- Real Time Clock/Calendar with 5 Year Battery
- 80387 or Weitek Co-Processor support
- Phoenix BIOS With Full MS/DOS, OS/2, XENIX, NOVELL, 3COM and PCNET compatibility
- 8 Slot motherboard design
- Full size case with 5 Disk Drive bays
(Shown with Optional Full Size Tower ® Case)

Options:

- Custom configurations w/Name Brand peripherals of your choice
- Weitek Co-Processor • Tower® Case • Factory Ram Upgrades

Standard Pre-Built Configuration:

386/33 With Hard Disk Drive, Monitor & Video Card						
Drives	40MB-46MS 1:1 MFM	66MB-25MS 1:1 RLL	71MB-18MS 1:1 MFM	110MB-25MS 1:1RLL	150MB-17MS 1:1ESDI	320MB-16MS 1:1 ESDI
Video						
Mono	\$3259	\$3454	\$3554	\$3679	\$4334	\$4634
VGA/Mono	\$3454	\$3649	\$3749	\$3874	\$4529	\$4829
EGA	\$3599	\$3794	\$3894	\$4019	\$4674	\$4974
VGA/16Bit	\$3689	\$3884	\$3984	\$4109	\$4764	\$5064

+ Norton SI 3.0

CRT display is courtesy of RIX Softworks, Inc. Irvine, CA.

PC BRAND

Your Best Choice
for Quality Systems
Toll-Free Support
Toll-Free Service
Free Freight
5-Year Warranty

286/386 PORTABLES from \$1745

286 & 386 Systems
*512K, 1.2MB Drive,
Combo Controller,
LCD Backlit Display
Optional EGA
Plasma Display



All feature:

- 640 x 400 Backlit Supertwist LCD by TOSHIBA (EGA Plasma version Available)
- Monographic & Color operating modes, EGA Optional
- External Monitor Support
- 2 Available expansion slots
- 86-key keyboard
- Accomodates two 5.25" or 3.5" Floppy/Hard Disk Drives
- 200 Watt 112/220 Autoswitch Power
- Serial, Parallel, Game Port, Clock/Calendar Standard



Standard Pre-Built Configuration:

Portable System Processor and Drive Options						
Drive	CPU	286-12	286-20	386/SX-16	386-20	386-25
1 Floppy		\$1745	\$1945	\$2045	\$2595	\$2795
40MB		\$2175	\$2375	\$2475	\$3025	\$3225
66MB		\$2275	\$2475	\$2575	\$3125	\$3325
150MB		\$3140	\$3340	\$3440	\$3990	\$4190

*386/20 and 386/25 Systems come with 1024K.

SAVE ON NAME BRAND PERIPHERALS... SEE OUR AD ON FOLLOWING PAGES...

To Order Call 1-800-PC BRAND

(Call 1-800-722-7263) In All 50 States FAX# 1-800-722-7392



PC Brand, Inc. 954 W. Washington St., Chicago, IL 60607 Int'l Fax# 312-226-6841 Int'l Voice# 312-226-5200. Open Mon thru Fri.: 8am to 6pm Central. MasterCard, VISA, Discover, Checks, & Approved P.O.s Accepted. Prices and specifications subject to change. Customer Service Inquiries Call: 1-800-662-SERV BYTE 14-10

Circle 220 on Reader Service Card

OCTOBER 1989 • B Y T E 225

Shop PC Brand Today.

LAPTOP COMPUTERS*

NEC	
Multispeed HD	\$1995
Ultralite w/1MB	Call
TOSHIBA	
1000; 512K, 80C88, 1 FDD	\$699
1600 BACKLIT, 80C86-12, 1MG, 20MB HD, FDD	3240
3100E GAS PLASMA 80C86-12, 1MB, 20MB HD, FDD	2805
3200; EGA, 80286-12, 1MB, 40MB HD, FDD	3595
5200/40 VGA, 80386-20, 2MB, 40MB HD, FDD, ...	6115
ZENITH	
Supersport 286, 20Meg	Call
Supersport 286, 40Meg	Call
Supersport 88, 20Meg	Call

Other Makes and Models Call

MONITORS *

MAGNAVOX

7BM623 12" Amber TTL Monochrome	\$79
7BM749 14" VGA White Flat Screen	135
CM8762 13" RGB (640x200) Color	230
CM9043 13" EGA (640x400) Color	339
9CM082 14" VGA (640x480) .31DP Color	415

MITSUBISHI

XC-1410 14" EGA (640x350)	\$369
AUM-1381 14" Diamond Scan	499
HL6605 15" CAD Monitor	1295
HL6905 19" CAD Monitor	2325

NEC

Multisync 2A 14" (800x600) VGA	\$499
Multisync GS 14" Mono	249
Multisync 3D 14" (1024x768) EGA/VGA	679
Multisync XL 19" (1024x768)	2150
Multisync 4D and 5D	Call

PRINCETON GRAPHICS

Max 15 15" Multifreq. Monochrome	\$249
Ultra 16 16" Multifreq. EGA/VGA	879
Ultrasync 14" Multifreq. EGA/VGA	520

PRINCETON PUBLISHING LABS

Multiview 15" Full Page Monitor w/adapt.	\$890
--	-------

RELISYS (Top Rated by Infoworld and PC World)

RE-9513 14" VGA (720x480).31DP Color	\$369
--	-------

SEIKO

CM1430 14" (1024x768) Dualfreq	\$549
--------------------------------------	-------

SONY

CPD1304 14".25DP (1024x768) Multiscan	\$689
CPD1320 13" (640 x 480) VGA	485

ZENITH

ZCM-1490 14" Flatscreen Enhanced	\$619
--	-------

NEC 14" Multisync 2A

800x600 Resolution Super VGA Monitor



\$499

Freight Free!

MODEMS

A.T.I.

2400ETC Internal Modem w/MNP5 ...	\$165
-----------------------------------	-------

2400ETC External Modem w/ MNP5 ...	205
------------------------------------	-----

HAYES

1200B Int. w/Smartcom	\$285
-----------------------------	-------

2400B Int. w/Smartcom	429
-----------------------------	-----

1200 Ext. Modem	285
-----------------------	-----

2400 Ext. Modem	429
-----------------------	-----

PC BRAND 100% Hayes Compatible!

1200 Baud Internal w/Bitcom	\$49
-----------------------------------	------

1200 Baud External	70
--------------------------	----

2400 Baud Internal w/Bitcom	89
-----------------------------------	----

2400 Baud External	129
--------------------------	-----

US ROBOTICS

Courier HST/9600	\$599
------------------------	-------

Courier V.32 9600 Baud Ext.w/MNP5 ..	889
--------------------------------------	-----

Courier HST Dual Standard Modem	995
---------------------------------------	-----

Courier HST/IX 9600 Modem	925
---------------------------------	-----

Internal Modems

100% Hayes Compatible. Free Software!

1200BPS

\$49

2400BPS

\$89

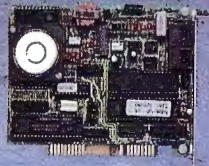

TAPE BACK-UP SPECIAL

80/40MB Internal Tape Back-Up*

\$279



Uses DC2000 Series Micro Cartridges
*When used with CMS Backup Software

VIDEO CARDS

ATI

VGA Wonder w/256K	\$279
-------------------------	-------

VGA Wonder w/ 512K	Call
--------------------------	------

PARADISE

Autoswitch 480 EGA	\$179
--------------------------	-------

VGA+	265
------------	-----

VGA+ 16 16 Bit Version NEW	299
----------------------------------	-----

VGA Professional w/512K	399
-------------------------------	-----

PC BRAND

Mono Graphics w/Printer Port	\$55
------------------------------------	------

Color Graphics w/Printer Port	49
-------------------------------------	----

EGA (640x480) Autoswitch	135
--------------------------------	-----

VGA	159
-----------	-----

VGA 16 Bit	195
------------------	-----

VIDEO SEVEN

Fastwrite VGA	\$279
---------------------	-------

VRAM VGA	450
----------------	-----

VRAM VGA w/512K	Call
-----------------------	------

DISK DRIVES

FLOPPY DISK DRIVES:

360K 5.25" HH Black	\$75
---------------------------	------

720K 3.5" HH w/5.25" Mounting	80
-------------------------------------	----

1.2MB 5.25" HH Grey	85
---------------------------	----

1.44MB 3.5" HH Grey w/5.25" Mounting 95	
---	--

PS/2 FLOPPY DRIVES

CMS 5.25" 360K/PS/2 Ext.Floppy	\$199
--------------------------------------	-------

HARD DISK DRIVES:

IOMEGA

B120I Single 5.25" 20MB Int.	\$765
-----------------------------------	-------

B144I Single 5.25" 44MB Int	995
-----------------------------------	-----

B244X Dual 5.25" 44MB Ext.....	1995
--------------------------------	------

MINISCRIBE

71MB 17MS M3085	\$595
-----------------------	-------

150MB 18MS M3180E ESDI 1/2 Hgt ..	1195
-----------------------------------	------

320MB 16MS M9380 ESDI Full Hgt.	1550
--------------------------------------	------

640MB 16MS M9760 ESDI Full Hgt.	3400
--------------------------------------	------

PRIAM

130MB 20MS ID130AT Full Height	\$1395
-------------------------------------	--------

160MB 28MS ID160EC ESDI w/CNTRL	1650
---------------------------------	------

330MB 20MS ID330PS INT. for PS/2 ...	1895
--------------------------------------	------

330MB 20MS ID330EC ESDI w/CNTRL	2250
---------------------------------	------

SEAGATE

20MB 65MS ST225 w/XT Controller ...	\$249
-------------------------------------	-------

20MB 65MS ST225	209
-----------------------	-----

20MB 35MS ST125 w/XT Controller	299
---------------------------------------	-----

20MB 35MS ST125	245
-----------------------	-----

30MB 65MS ST238 w/XT Controller	269
---------------------------------------	-----

30MB 35MS ST138	310
-----------------------	-----

30MB 35MS ST138 w/XT Controller	355
---------------------------------------	-----

40MB 28MS ST251-1	349
-------------------------	-----

40MB 24MS ST151	419
-----------------------	-----

80MB 28MS ST4096 Full Height	590
------------------------------------	-----

TOSHIBA

60MB 25MS MK134 RLL	\$429
---------------------------	-------

110MB 25MS MK72 RLL	669
---------------------------	-----

156MB 23MS MK-156FA ESDI Full Hgt ...	1095
---------------------------------------	------

If the drive you require is not listed here please contact our sales department for a quote!

TAPE BACKUPS

60MB Archive Int. or Ext. w/Cntrl.	\$590
---	-------

60MB Maynard Maynstream Portable ..	889
-------------------------------------	-----

150MB Archive Internal	925
------------------------------	-----

150MB Archive External	1250
------------------------------	------

150MB Maynard Maynstream Portable	1395
---	------

2.2GB Maynard Maynstream Portable	4350
---	------

PC BRAND 16Bit VGA

Ultra Hi-performance VGA Card, compatible w/ VGA, EGA, monochrome, and multisync monitors, Analog and Digital output, upgradable to 512K resolution to 1024x768, many software drivers



\$195

Save Time. Save Money.

SCANNERS/DIGITIZERS

Complete PC Half Page Scanner	\$189
Complete PC Full Page Scanner	575
DFI HS3000 Plus Gray Scale Hand Scan	219
Hewlett Packard Scanjet Plus	Call
Microtek MS II	Call
Microtek MSF300G	1785
Microtek MSF300Q w/64 Grey Level	1495
Summasketch 12X12	378
Summasketch 12X18	635

PRINTERS*

BROTHER

HL 8E Laser (HP LJII, HPGL) \$1875

EPSON

LX810 180/30.....	189	LQ510 180/60.....	329
FX850 330/88....	345	FX1050 264/54.....	445
LQ850 330/88...Call		LQ1050 330/88...Call	
LQ950 264/88...Call		LQ2550 400/108..Call	

KODAK DICONIX

150Plus 150/50 ..315 300WP 310/73 439

HEWLETT PACKARD

Deskjet Plus 710 Laserjet II 1720

LASER JET ACCESSORIES

CPI Superfont Cart. adds 150 fonts..... 295
CPI 1MB Memory Kit. 319 CPI 2MB MemoryKit. 549

PRINCETON PUBLISHING

PS-388 Postscript board 2250

Adds Postscript to your HP LASERJET!

NEC

P2200 170/55 335 P9XL 400/140 1030
P5200 265/90 530 P5300 Wide 675
LC890 Laser 3190 LC890XL Laser .. 4495

OKIDATA

ML320 300/62 .. 345 ML321 300/62 479
ML390 270/90 .. 475 ML391 270/90 655
ML393 450/120..995 ML393C 450/120..1069

PANASONIC (New Models Listed)

1180 192/38 189 1191 240/48 245
1124 192/63 339 1524 240/80 545

TOSHIBA

321SL 216/72 ... Call 341SL Wide Carr ... Call
351SX 360/120 .Call Express 311 Call

**PC BRAND-YOUR
#1 LAN SOURCE !**

Call for Custom Server Configurations

NOVELL NETWORKING

NOVELL

4 User ELS 286 Level 1	\$479
8 User ELS Level II (Version 2.15)	939
Advanced Netware 286 (Ver. 2.15)	1850
SFT Netware 286 (Ver. 2.15)	2850
Netware 386	Call
Disc Coprocessor Board	379
NE2000 Ethernet File Server Board	399
NE1000 Ethernet Card	299
GATEWAY (PC Magazines Editors Choice)	
G/ Ethernet AT	\$435
G/NET	269
G/ Ethernet for PS/2	Call

STANDARD MICRO

PC130 Arcnet Board	\$135
PC270 Twisted Pair Arcnet Card	130
PC500-WS 16 Bit Work Station Board	375
PC550-WS 16 Bit Twisted Pair Work Station Bd ...	395
PC550-FS 16 Bit Twisted Pair File Server Bd	495
PS110 Arcnet Board for PS/2	439
PC500-FS 16 Bit File Server Board	449
ARCNET Passive Hub	72
ARCNET Active Hub	359
ARCNET Twisted Pair Active Hub	429

TIARA

4 Port Passive Hub	\$49
8 Port Active Hub	285
Lancard/A 8Bit ARCNET Board	89
Lancard/E 8Bit ETHERNET Board	199
Lancard/E 8Bit Twisted Pair ETHERNET	329

WESTERN DIGITAL

Ethercard+ w/Novell Drivers	\$219
Ethercard+ Twisted Pair Ethernet Board.....	319
Ethercard+ A for PS/2	320

UNINTERRUPTABLE POWER

ELGAR

IDS1100 1000 Watt UPS	Call
IPS 500 Watt UPS	Call

PTI

DataShield Turbo/2 625 Watt	595
-----------------------------------	-----

PC BRAND™

Free Freight

30-Day Money-Back Guarantee

Toll-Free Service and Support

No Credit Card Surcharges

We carry over 10,000 different hardware and software products, Call for prices on products not listed.

SOFTWARE

ALDUS Pagemaker	\$479
ASHTON-TATE DBASE IV	449
BORLAND Quattro	149
CENTRAL POINT PC Tools Deluxe	42
FUNK SOFTWARE Sideways	42
LOTUS 123 3.0	295
MICROSOFT Excel 2.1	235
MICROSOFT Windows 386	125
MICROSOFT Word 5.0	205
WORD PERFECT Word Perfect 5.0	220
XEROX Ventura Publisher 2.0	479

SERIAL MOUSE

High Resolution (250DPI) Microsoft Compatible



CO-PROCESSORS/BOARDS

INTEL

Aboveboard Plus w/512K	\$419
Aboveboard Plus I/O 512K	469
Inboard 386 for PC w/IMB	595
Inboard 386 AT	859
8087-2	139
8087-1	189
80387-16	369
80287-10	259
80387-25	559
80387-20	449
80387-SX	359
80387-33	695

*Oversized Monitors, Laser Printers, Laptops and Plotters are excluded from free freight.

EPSON FX 1050

15" Carriage 264 CPS Draft 54 CPS Letter Quality

\$445

Other Epson models comparably discounted

To Order Call 1-800-PC BRAND

(Call 1-800-722-7263) In All 50 States FAX# 1-800-722-7392



PC Brand, Inc. 954 W. Washington St., Chicago, IL. 60607 Int'l Fax# 312-226-6841 Int'l Voice# 312-226-5200. Open Mon thru Fri : 8am to 6pm Central. MasterCard, VISA, Discover, Checks, & Approved P.O.s Accepted. Prices and specifications subject to change. Customer Service Inquiries Call: 1-800-662-SERV BYTE 14-10



IN DEPTH

Optical Technologies

-
- 231 Computing with Light**
by H. John Caulfield
- 239 The Nitty Gritty Optical Band:
Levels of Light**
by Joseph W. Goodman
Joining Forces
by Donald J. Channin
- 249 Reflected Light**
by Gary T. Forrest
- 259 Gigabytes On-Line**
*by James J. Burke
and Bob Ryan*
- 266 Read/Write Optical Subsystems**

The mystery of light has puzzled and intrigued man throughout the ages. Light forms the very basis of our existence. For the most part, living things, as evolved on this planet, need light to live. From the beginnings of recorded time, man held the sun, the visible source of light, in deep reverence. Whether you believe that ancient man worshipped the sun or that he worshipped the giver of light as represented by the sun, he obviously sensed his great dependence on light. Solar eclipses terrified him, simply because the light went away.

In our efforts to tame light and make it do our bidding, we have developed myriad light-generating and light-controlling devices from lamps to lasers. We may not fully understand the intricacies of light, but we have found many ways to use it. Today, lasers are stealing the headlines and the show.

This month, we focus on optical technologies and look at some of the ways in which laser light is affecting the computer industry. The concept of computing with nothing but light beams boggles the mind. In "Computing with Light," H. John Caulfield explains the concepts behind optical computing, as well as its limits as currently conceived: what it can and can't do. He also discusses holography and its uses in computers.

Next, a series article looks at the bits and pieces of optical technology that are beginning to come into being. "The Nitty Gritty Optical Band" looks at the inroads made in optical interconnections, packages, signals, and ICs. In the first part, "Levels of Light," Joseph W. Goodman discusses the various levels of interconnections, from the machine level to the on-chip level, and how well optics apply on each level. And in the second part, "Joining Forces," Donald J. Chan-

nin examines the marriage between electronics and optics down at the chip level and how this union delivers the best of both worlds.

Then, in "Reflected Light," Gary T. Forrest looks at lasers, the light that makes optics work. Laser technologies are in use for a variety of purposes, and different lasers have different uses. This article discusses the different lasers, how they work, and how they are used.

Although all these areas have elements of the present and the future in them, one optical technology we are all familiar with, if for entertainment only, is optical storage. In "Gigabytes On-Line," James J. Burke and Bob Ryan examine optical disks, from CD-ROMs to WORMs to erasable optical storage, and how they work. Our resource guide this month supports this article, listing sources for some of the read/write optical subsystems available.

Will optics replace electronics? Probably not, at least if present research findings continue to hold true. Will optics have a significant impact on our industry in years to come? Most resoundingly, yes! The advantages of optics over electronics in speed and freedom from interference alone are reason enough to fund its research. In more ways than one, lasers are indeed "the light at the end of the tunnel."

—Jane Morrill Tazelaar
Senior Technical Editor, *In Depth*



ROBERT
TINNEY

The New 25 MHz Executive 325ET combines all the latest technologies in the most advanced 386 computer available. And it's transportable.

MAINFRAME TO GO

\$10 PER MEGABYTE OF DRAM

The 325ET has a hard drive access speed almost undetectably different from that of dynamic memory. For the first time, the large capacity of a hard drive is accessible at an access time of **one millisecond (1 ms)**. Why limit yourself to 2, 8 or 16 megabytes of fast memory and pay \$500 per megabyte, when you can have up to 160 megabytes at a cost as low as \$10 per megabyte?

50 TIMES FASTER

Instead of waiting for the 65 millisecond (ms) access time of an MFM drive, or even the 17 ms of an ESDI drive, you can have instantaneous access to your data. The 325ET is blindingly fast with an average disk access time of 1 ms. In addition, the system architecture allows data transfer speeds that match drive capabilities. (That's really fast!). In fact, the overall read/write performance of the 325ET is 50 times faster (5,000%) than the Compaq® 386/25.

53,000 PORTABLE PAGES

The 325ET, when located along side of a monitor, takes little desk space. The compact design of the 325ET lets you carry it onto an airplane and easily stow it under your seat. Imagine bringing the equivalent of seven four-drawer filing cabinets worth of valuable information to your next meeting – accessible in just 1 ms.



The Executive 325ET is small enough and light enough to make it the most powerful transportable ever.



25 Mhz - 80386 1 ms HD ACCESS

EXECUTIVE 325ET

Standard features:

- Intel 80386 processor running at 25 Mhz.
- 0 wait state operation.
- Enhanced intelligent controller for **1 ms hard disk access** time and a transfer rate of 4 MB per second.
- 2 MB of RAM expandable to 16 MB (8 MB on board).
- High performance 16-bit VGA video adaptor.
- 3.5" 1.44 MB diskette drive.
- Sockets for 20 Mhz Intel 80387 coprocessor and 10 Mhz Intel 80287 coprocessor.
- 6 industry standard expansion slots (ISA).

\$3799 or just **\$114** per month

	Mono VGA	Color VGA
40 MB	\$4295[†]	\$4650[†]
80 MB	\$4645[†]	\$4995[†]
160 MB	\$5695[†]	\$5995[†]

[†]Includes system, monitor, Hard Disk and on-site warranty.

PRIORITY ONE COMPUTER SUPER STORE LOCATIONS

California: Bakersfield, Burbank, Fullerton, Irvine, San Jose, Sunnyvale, Westminster, Woodland Hills.
Kansas: Lenexa, Wichita
Missouri: St. Louis
Oklahoma: Stillwater
Tennessee: Memphis

AND THERE'S MORE...

1. Toll-Free Technical Support

Our friendly and knowledgeable factory trained engineers are just a phone call away. And we can solve most problems right over the phone.

2. Free on-site service

The 325ET comes with a full year warranty. Supported by Universal Protection Plan with a network of hundreds of service engineers, instant help is just a phone call away. Service is also available at any of our Super Stores, or at any of the hundreds of UPP service centers.

3. Trade up and save more

Now you can put that older and slower IBM®, Compaq®, or Apple® to better use. Your old system may be worth a thousand dollars or more. Our new Trade-Up program allows you to move up to the latest technology for less. Call one of our systems consultants for complete details.

4. 30 day money back guarantee

Your total satisfaction is our goal. If for any reason you are not completely satisfied with the 325ET you may return it within 30 days for a full refund.

5. Easy financing available

We offer both consumer credit for individual purchases, and leasing for business customers. Call us today and find out how easy it is to own the next generation of computers.

To Order or Inquire, Call:

800-423-5922

PRIORITY ¹ ONE COMPUTERS

©Copyright 1989 Priority One Computer Corporation. All rights reserved. Executive, 325ET, and the Priority One logo are registered trademarks. IBM is a registered trademark of The IBM Corporation. 386/25 is a registered trademark of Compaq Computer Corporation. 386 is a registered trademark of Intel Corporation. Apple is a registered trademark of Apple Computer, Inc.

Computing with Light

Optical computers can provide the massively parallel architectures that systems of the next century will need

H. John Caulfield

The eternal search for faster, smaller, more intelligent processors is what drives the development of new technologies. For the past 40 years, advances in computers have depended on advances in electronics, particularly in semiconductor-based electronics. Computers of the next century, however, may require a technology that would seem as radical now as semiconductors were in 1964. Perhaps the Japanese Ministry of International Trade and Industry (MITI) put it best: "Electronics is the science of the twentieth century, and optics is the science of the twenty-first."

The state of optical technology in 1989 resembles that of electronic technology in 1949. It is poorly developed, unreliable, unstandardized, and expensive. Why, then, would you ever dream of replacing ICs with optics? Quite simply, you wouldn't. Optics are so fundamentally different from electronics that they do not compete. However, optics can do important tasks that are impossible with electronics. Using the special and wonderful properties of light, optics can work together with electronics in new hybrid systems that are

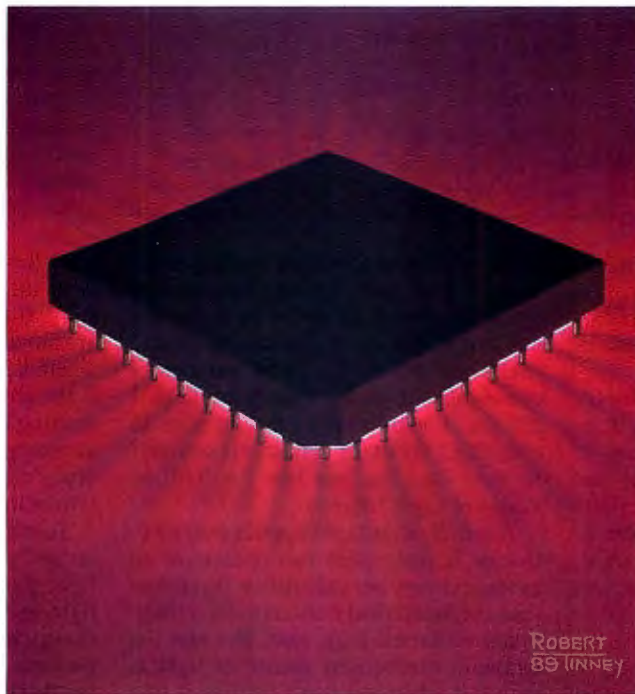

called (somewhat misleadingly) *optical computers*.

Properties of Light

Light, like electricity, is a quantum phenomenon. As such, you can't really understand it, but you can write equations that will at least partially predict its behavior. Sometimes it's convenient to think of light as a stream of particles;

light particles are called *photons* (electricity particles are called *electrons* or *holes*).

When the particle picture fails, you can think of light as a wave. In fact, depending on the experiment that you perform, light will demonstrate properties of either particles or waves, but not both at the same time. Of course, this doesn't exactly make sense, but this is what quantum mechanics tells us.

Although it may be impossible to understand the nature of light, you can—up to a point—get a handle on it mathematically. You can make essentially perfect predictions of average photon arrival rates and positions, but you'll still have no idea how to predict precisely when and where the next photon will arrive.

Photons belong to a class of particles called *bosons*. Bosons do not interact with other bosons. Thus, optical paths can crisscross in space without interfering with one another. Essentially all the strengths and weaknesses of optics come from this observation.

Electrons, on the other hand, are classed as *fermions*—particles that repel one another. Thus, electrons must be

continued

A Trillion Points of Light

Creating a processor with fan-in and fan-out values of 1 million is possible only with optical computers.

The inputs to such a processor consist of the transmission values (0 to 1) of a 1000- by 1000-element holographic mask. The data is written in real time to a spatial light modulator (SLM)—the actual input device. The output of the processor is a 1000- by 1000-element

detector array (see figure A).

The transmission of the k,l element of the SLM is called a_{kl} . Now, at the i,j detector element, you want to form

$$b_{ij} = \sum_{k,l} T_{ijkl} a_{kl}$$

where the sum b_{ij} is over all 1 million (10^6) SLM elements. You want to do this

for all 10^6 i,j values. Thus, there will be a trillion (10^{12}) values of T_{ijkl} all in use at the same time. Figure A demonstrates how this is done for one of the b_{ij} patterns. It is important to note, however, that all 10^6 b_{ij} patterns appear simultaneously.

The i,j hologram produces a pattern of illumination at the SLM input. At the k,l SLM element, you refer to the input intensity as T_{ijkl} . The transmission value of that element is a_{kl} , so the amount of light passing through the k,l SLM element from the i,j hologram is $T_{ijkl} a_{kl}$. The imaging lenses to the left and right of the SLM project the laser light from the i,j hologram onto the i,j detector element. Since it does this for all k,l values, you detect the sum of all $T_{ijkl} a_{kl}$ products at every element of the detector.

All holograms and all detectors in this system work in parallel. Thus, the k,l SLM element has a 10^6 fan-in and a 10^6 fan-out. Furthermore, the optical paths clearly crisscross in space both before and after the SLM without interference. The results are 10^{12} parallel, weighted (i.e., different T_{ijkl} values) interconnections in a single optical processor.

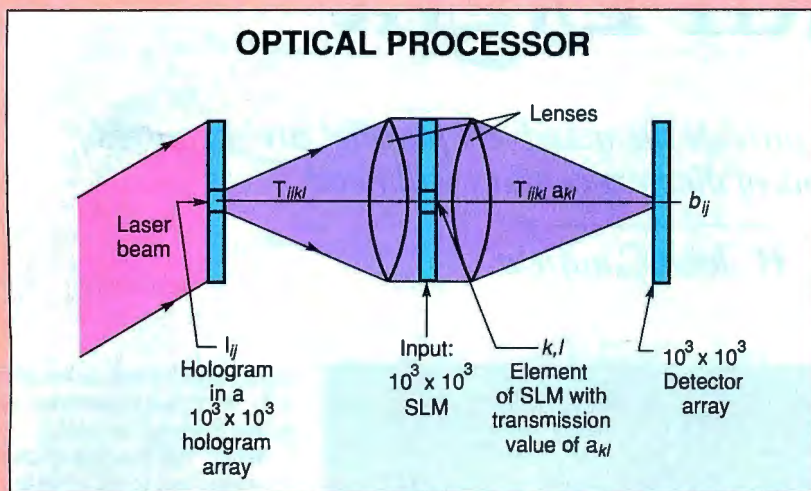

Figure A: Shown are the interconnections for one of the 1 million b_{ij} patterns.

confined in carriers (e.g., wires) to get them from one place to another reliably. These connecting carriers of electricity take up space that other carriers, therefore, cannot use.

Two conclusions follow immediately from these facts. First, optics is a wonderful way to provide large numbers of input connections (called a *fan-in*) and large numbers of output connections (called a *fan-out*) to a processor. Second, since light doesn't interact with light, you need electronics to get information on and off the beams of light.

Light Connections

To make a connection in electronics, you need a wire of some type and a bonding pad. To implement a fan-in and fan-out of 10 is no big trick, but larger numbers of connections are progressively harder to implement. With optics, you could have a million processors, each with a fan-in and fan-out of a million, all operating in parallel. You can't do this with electronics because of the pathways involved.

Imagine a million processing ele-

ments, each with 2 million bonding pads. The size of such an implementation would be absurd, as would be the power consumption, cost, and time required to solder the wires. The total number of connections in such a system would be 1 trillion. Electronically, this is silly to even think about. In optics, it is straightforward (see the text box "A Trillion Points of Light" above).

Another advantage of optics over electronics is that optics can operate at an average energy per calculation that is less than the theoretical minimum for a traditional electronic logic gate. Because the quantum mechanical nature of light is manifest when you don't confine it to a carrier (e.g., fiber-optic cable), you can make all intermediate calculations energetically free of charge and pay an energy price only for reading the final result.

For example, consider the optical calculation of b_{ij} discussed in the text box "A Trillion Points of Light." The calculation consists of 1 million multiplication operations and 1 million addition operations. When you detect the result and ap-

ply a threshold function to it, the quantity of information you extract is one bit: $b_{ij} = 0$ or 1. The atoms in the detector are moving with an average energy of kT , where k is the Boltzmann constant and T is the absolute temperature. Clearly, extracting information must require at least an energy of kT per bit. Indeed, kT is often considered the minimum "quantum of information."

To read out b_{ij} reliably, you must overcome "shot noise" by measuring many light particles or photons. For visible light and room temperature, the photon energy is about 100 kT . If you detect 100 photons, you spend about 10^4 kT to read out that one bit. The best low-power electronic computers operate at 10^4 kT per bit. Most operate at 10^7 kT or more.

But wait. You have measured the result of 10^6 calculations with 10^2 photons and only 10^{-2} kT per calculation. How is this possible? If you send even one photon to each of the 10^6 spatial light modulator (SLM) elements, you would need 10^6 , not 10^2 , photons. Or would you?

The answer to this lies in quantum

continued

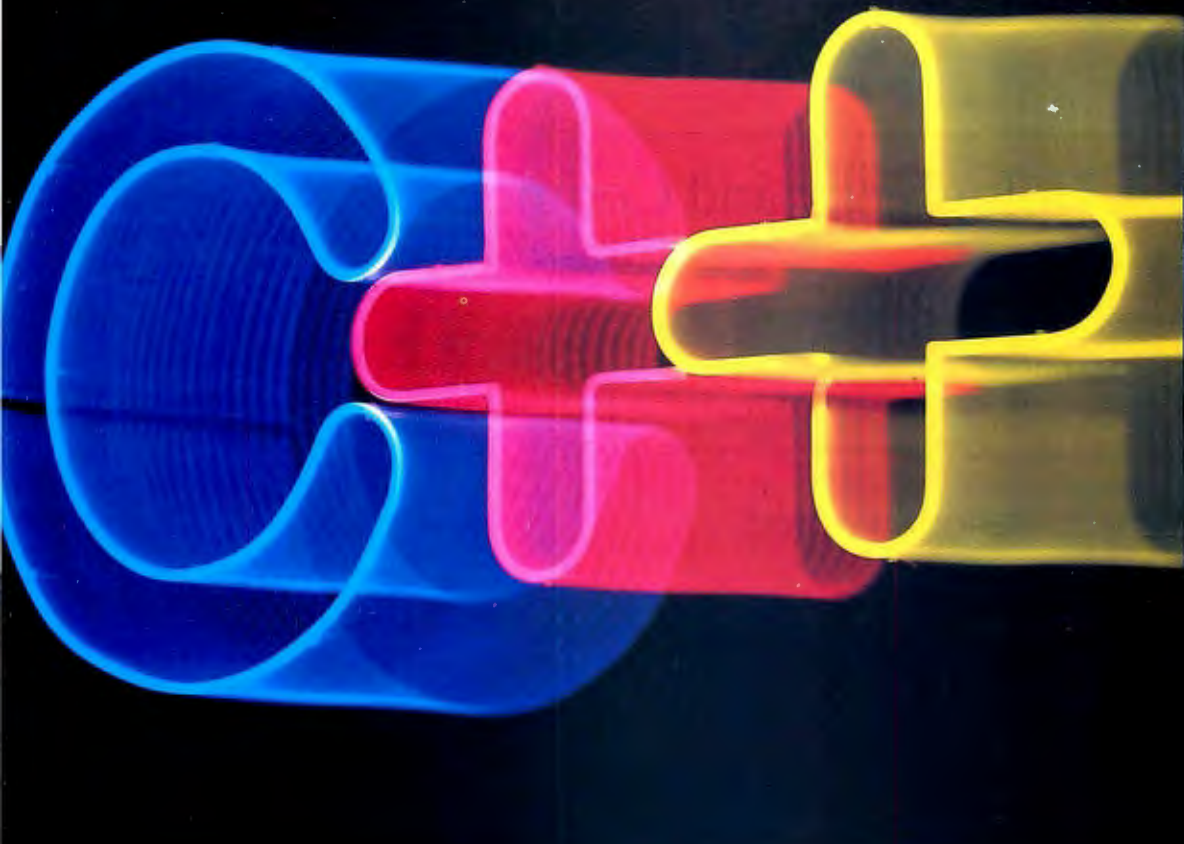

ZORTECH

Everyone agrees! C++ is the only logical way forward for the multitude of C programmers faced with the task of developing sophisticated applications for today's "Power Users".

C++ offers many advantages over all other languages, object oriented or not:

- ANSI C compatible
- Object oriented
- Major industry support
- Data-abstraction
- Strong type-checking
- User defined types
- Modular programming
- Data hiding

1 9 8 8



B Y T E

The Award Winning Zortech C++ Compiler has absolutely shaken the roots of the C compiler market by setting a new technological standard. It is the very first and only MS-DOS compiler to produce native code directly from C++ source files.

Zortech is at the forefront of C++ Compiler Technology with

an already impressive lead, maintained by continually enhancing product quality and support.

Since the launch of the C++ Compiler, Zortech has brought the power and efficiency of C++ to tens of thousands of users worldwide. We continue to develop tools for programmers of the next generation of high powered applications.

Please call or write for full details of our complete range of C++ products.

Zortech Incorporated 1165 Massachusetts Avenue, Arlington, MA02174
tel: 617-646-6703 fax: 617-643-7969

Zortech Limited 106-108 Powis Street, London SE18 6LU
tel: 01-316-7777 fax: 01-316-4138



Holography and Computers

Holograms have become a common sight. They appear on credit cards, paperback books, greeting cards, camera boxes, children's toys, and even magazine covers. Soon you'll be seeing them on your windshield as they let you check your speedometer without taking your eyes off the road. So just what are

holograms, and how do they relate to optical computers?

Before answering these questions, consider another one: How is it that light entering the pupils of your eyes and crudely focused on your retina causes you to see a multicolored, three-dimensional world "out there" and not in your

head? While no one can answer this basic question, the fact that you do see "out there" is critical to holography.

What you see is not a direct result of the scene you're viewing, but of the pattern of light the scene creates on your retina. Thus, you don't have to re-create the three-dimensional world in order to re-create a scene; all you need to do is cause the same pattern of light to enter your pupils. You don't need the real world at all—just a way of reconstructing the desired light pattern or *wavefront*.

Holography is a two-step process: wavefront recording and wavefront reconstruction. To reconstruct a pattern of light, you need a source of light. Consider the two wavefronts shown in figure B1. The object wavefront created by the object and the reference wavefront form an interference pattern, which can be recorded on a photographic plate. This recording is the hologram.

The hologram is a transducer from the simple, readily reproduced reference wavefront to the complex object wavefront. The hologram literally selects out of the reference wavefront the portion that looks like the object wavefront (see figure B2). The human eye intercepts this wavefront and sees the original scene behind the hologram.

The light doesn't actually come from where you see the image. This is a *virtual image*, just like the image in a mirror. But, by perfectly reversing the reference wavefront, you can perfectly reverse the object wavefront. Viewable from beyond the object position is an image of the object. This time, the light really does come from where you see the image. This is a *real image*.

This two-step recording and recon-

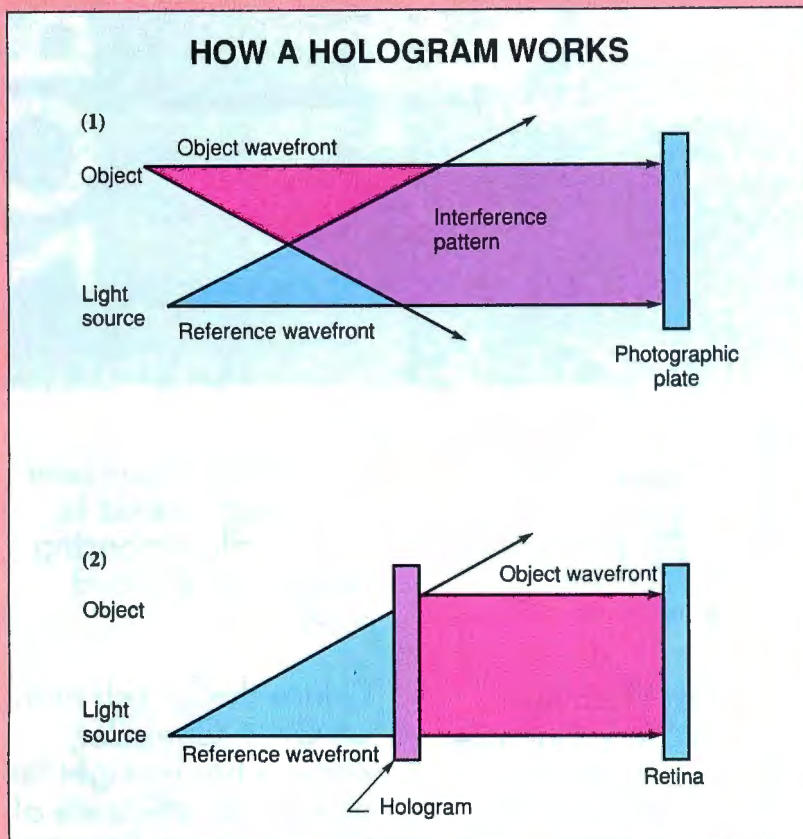

Figure B: (1) The interference between the reference wavefront and the object wavefront creates the hologram. (2) The hologram reconstructs the object wavefront from the reference wavefront.

mechanics. Each photon explores all 10^6 paths. In the wave domain, the light has no one path. Each photon, in effect, makes all 10^6 calculations! As long as you don't collapse the wave function by asking for the results of intermediate calculations, you can make the intermediate calculations without energy costs.

The average energy per calculation for a complicated calculation is therefore much less than the theoretical minimum for a logic gate. That theoretical minimum, in turn, is much less than the actual energy loss in even the most efficient logic gates.

Due to these properties of light, optical computers can feature massive parallel interconnections that are impossible physically and energetically with electronic computers. A representation of a generic optical computer is shown in figure 1.

Optical Components

The key component of an optical computer is the SLM. It is a discrete or continuous array of light modulators whose reflection or transmission properties can be controlled electronically or optically. This page is an SLM. It reflectively

modulates incident light in a spatial pattern. It is not a very useful SLM (at least not for optical computing), because you can't change the reflectivity pattern rapidly. Useful SLMs are changeable by either optical or electrical addressing.

About 25 different SLMs are available commercially (see table 1). SLMs are used as input devices, interconnection devices, scratch-pad memory devices, and processing devices. They are vital to optical computing.

The second most important component of an optical system is a hologram, which provides interconnections as well

struction concept was proposed by Denis Gabor in 1947, winning him a Nobel prize. The technique most used today was invented in the early 1960s by Emmett Leith and Juris Upatnieks. In this recording technique, both wavefronts are derived from a single laser beam split into two beams by a partially reflective, partially transmissive mirror. If you observe several simple precautions, the two beams form an interference pattern where they overlap. That is, where the two beams agree (i.e., are in phase), the light is bright (constructive interference). Where the two beams disagree (i.e., are out of phase), the light becomes dim (destructive interference).

By recording a photographic positive of the interference pattern, you produce exactly the hologram you want. This hologram will pass from the reference wavefront only those parts that could just as easily have come from the object wavefront.

Holography at Work

A hologram is the most versatile of optical elements—it can produce essentially any light pattern you choose. For example, suppose you have a two-dimensional array of small (1 to 2 millimeters) holograms on a single substrate. When illuminated at normal incidence with a collimated reference beam, each hologram can produce a real, two-dimensional image on a fixed output plane. By deflecting the laser beam to the proper hologram, you direct the corresponding “page” of data to the output plane. This is called a page-oriented holographic memory, or POHM (see figure C).

You can store from 10^4 to 10^6 holograms in a POHM, with each output

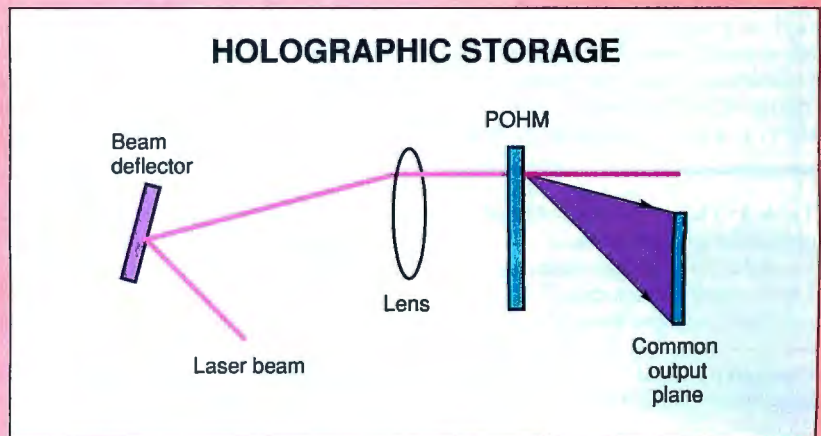

Figure C: Retrieving information from page-oriented holographic memory (POHM) involves deflecting the output of the read beam onto an output plane.

image containing from 10^4 to 10^6 binary bits. Thus, up to a gigabit of memory can be randomly accessed in the time it takes to deflect the beam (normally about a microsecond). This means you can access a gigabit of memory randomly at a rate of from 10^{14} to 10^{18} bits per second! That's serious RAM.

Work at the Georgia Institute of Technology and the Center for Applied Optics at the University of Alabama, Huntsville, is leading to compact, high-density POHMs with a parallel, optically addressable RAM in the output plane. If the output plane contains an optically addressable spatial light modulator (SLM), you can write the whole page onto a laser beam in parallel. Using a modification of the Fourier optical pattern recognizer, you can search that page in parallel for key words. This forms the basis for an optical DBMS that operates on 100,000 bytes at a time. This is a considerable advantage for large databases.

Perhaps the most dramatic application of holography to optical computing

is in neural networks. There are two distinctly different research approaches in this area. One exciting possibility is to make a “live” hologram that can continue to learn as it experiences its world. Although this area is quite complex and long-range, considerable advances have been made at Hughes Aerospace, California Institute of Technology, the University of Colorado, and elsewhere. A simpler and perhaps more desirable goal is to use holograms to build neural networks that employ fixed learning.

Even the lenses in optical computers are likely to be computer-generated holograms. They are far lighter and far cheaper than glass lenses and can be computer-optimized to outperform ordinary lenses. This work, pioneered at MIT's Lincoln Laboratory, is now being actively and widely developed.

Holograms are not only items of great wonder and beauty; they are also items of great practical utility in optical computing. They provide the type of storage required by massively parallel optical computing systems.

as memory capabilities. The text box “Holography and Computers” above discusses holograms in depth.

Optical Computations

Although optics is ideal for connections and storage, it is not well suited for computation. In fact, the best you can get from purely optical operations is about a 10 percent accuracy rate. This is the downside of optical computing and the reason that purely optical computers are not a realistic possibility. Hybrid electro-optical computers, however, are another story.

Many types of computations require some sort of nonlinear processing where the output signal intensity, I_o , is related to the input signal intensity, I_i , by a function like the ones shown in figure 2. The operation of all the functions in figure 2 can be performed “optically.” (Since light does not operate on light, some hidden or covert electronic manipulation must also be going on within the device or system.)

There is a great deal of worldwide research into the design and construction of two-dimensional arrays of nonlinear optical operators. Of the many diverse

approaches being investigated, most involve highly nonlinear feedback arrangements that lead to what mathematicians call *catastrophes*. Here, you create a device whose transmission increases nonlinearly with the incident light intensity. In addition, you couple some of the transmitted light back as input. This combination leads to the sudden onset of high transmission that the representative curves in figure 2 illustrate. Perhaps the most promising research on these nonlinear optical devices is being conducted at Bell Laboratories.

continued

Optical Research

Optical computers must emphasize the strong points of optical technology (e.g., interconnections and low energy) while tolerating or minimizing the bad points (mainly, low analog accuracy). At uni-

versities such as Carnegie Mellon, the University of Iowa, and the University of Alabama in Huntsville, the focus of research is on computers that marry a fast, low-accuracy optical processor (for computationally complex tasks) with a slower, higher-accuracy, digital part (to "ratchet" the accuracy). These machines are suited to problems such as algebraic equations (linear and nonlinear), eigenvector problems, matrix inversion, and heuristic linear programming.

For example, consider the simple analog optical multiplier shown in figure 3, which performs a parallel multiplication of an input vector with a matrix. You want to find x such that

$$Ax=b$$

where b is a given vector and A is a given matrix.

You can solve this problem crudely in parallel by adjusting x_1 in proportion to $y_1 - b_1$, x_2 in proportion to $y_2 - b_2$, and so on, all at the same time. With proper precautions, you can assure that x will relax continuously to the point where for all i ,

$|b_i - y_i| < \epsilon$, where ϵ is a small positive number.

Now, you read out this analog x , digitize it to the accuracy you need for the final result, and call it x_0 . You can now evaluate the residual

$$r_0 = b - Ax_0$$

digitally. If the norm (usually Euclidian) of r_0 is written $\|r_0\|$ and if $\|r_0\|$ is suitably small, you quit and output x_0 . If not, you solve the problem

$$A\Delta x_0 = r_0$$

optically, then digitize the result, and then calculate

$$x_1 = x_0 + \Delta x_0$$

and

$$\|r_1\| = \|b - Ax_1\|$$

digitally. You continue until you achieve the desired accuracy.

This approach fails for hard (ill-conditioned or singular) problems. To achieve guaranteed results, you must replace the given matrix A by a noisy version, $A + N$, during the optical operations. The system then achieves the desired minimum $\|r\|$ for all matrices. In addition, the time taken is independent of the problem size. Both of these features (guaranteed convergence and speed that is independent of problem size) are apparently unique to this bimodal optical computer.

You can also do general-purpose digital computing with optics. One promising approach, symbolic substitution, is being pursued at Bell Laboratories. Another approach, the operator method, is being developed at Opticomp. It amounts to a highly parallel programmable logic array that doesn't need to distinguish among multiple signal levels. It simply makes a light or no-light decision. Even at optical accuracy, this is not hard.

A large number of special-purpose optical computers use Fourier transforms to locate and identify objects in a scene. The systems depend on the fact that two successive Fourier transforms produce an image of the input (albeit upside-down and backward). First, you use a lens to form a two-dimensional display of the Fourier transform of an input pattern.

The interesting thing about the Fourier transform pattern is that its shape and location don't change as you move the input around. If you place a filter in the Fourier transform plane that favors the transform of A and tends to block the

Table 1: This shows the range of properties of commercially available spatial light modulators. Unfortunately, no single SLM combines all these features.

Characteristics of spatial light modulators

- Mode:** Reflection, transmission
- Addressing:** Optical, electronic
- Cost:** \$100 to \$50,000
- Information:** 64 by 64 elements to 25,000 by 25,000 elements
- Cycle time:** 10^{-6} seconds to 1 second
- Contrast:** 2-to-1 to 10^4 -to-1
- Resolution:** 0.002 cm to 0.10 cm
- Pattern:** Discretized, continuous

GENERIC OPTICAL COMPUTER

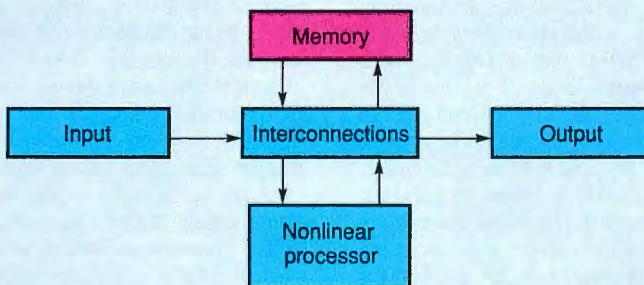

Figure 1: Holograms provide memory storage and interconnections, while spatial light modulators are commonly used for input, output, and processing units.

REPRESENTATIVE OPTICAL PROCESSING FUNCTIONS

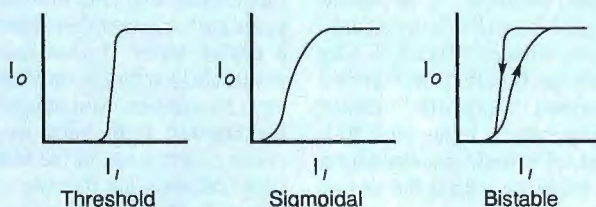

Figure 2: These functions represent the type easily implemented on optical processors, where I_i is the input signal intensity and I_o is the output signal intensity.

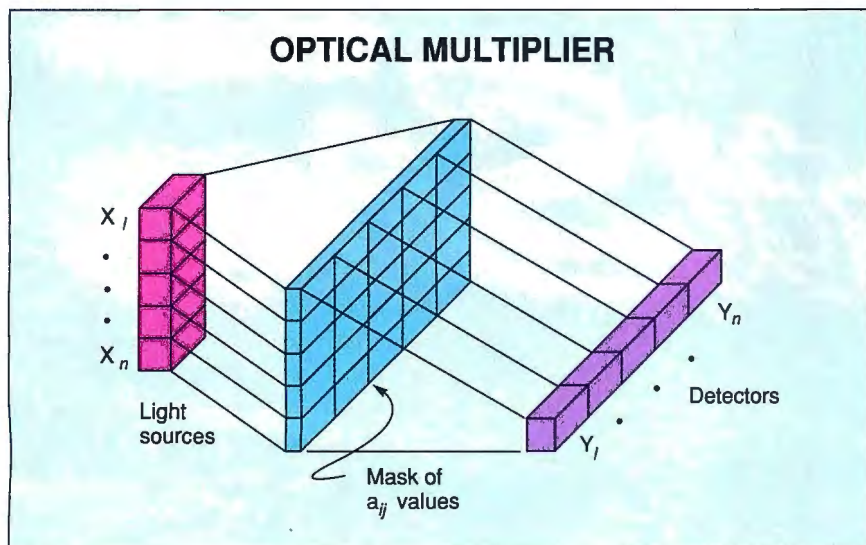

Figure 3: This analog optical multiplier evaluates the expression $y = Ax$.

transform of B, you will distort both images, but there will be much more light in the blurred A image than in the blurred B image. You use this difference to identify and locate objects in a scene.

Optics and Neural Networks

Of all the optical computing paradigms, the one that uses the interconnection and energy advantages of optics best is neural networks. (For more information on neural networks, see the In Depth section, August BYTE.)

Neural networks are attempts to build processors that work like the human brain. (Digital computers are not much like the brain.) You don't program a neural network; you train it to connect a certain output with a certain input. Unlike the deterministic, discrete, linear logic of digital computers, neural networks display traits like inference and intuition.

Neural networks use processing elements called *neurons*. These are found in layers and are connected to many neurons in both the layer above and the layer below. Thus, neural networks depend on large numbers of interconnections.

If you have n neurons in a layer of a fully connected neural network, each input neuron has a fan-out of n differently weighted interconnections, and each output neuron has a fan-in of n differently weighted neurons. When n approaches 30 or 40, for example, these fan-ins and fan-outs strain the capabilities of electronics. Biological neurons can have much higher fan-in and fan-out, about 10,000. With holography, you can connect a million neurons to each other in parallel with independently chosen weights. That's an incredible 1 trillion

independent, parallel interconnections.

Although neural networks are unlike digital computers, most current implementations are actually software simulations running on digital computers. Analog-electronic and optical neural networks will likely prove far more useful than these simulations in the future.

Some optical neural networks combine the learning and reaction in the same hardware like the brain does. These can be very powerful, but they are also very difficult to make. Other optical neural networks do the learning off-line in a digital computer and embody what is learned in a fixed hologram. These are simpler and therefore likely to be useful sooner.

Don't Throw Away Your Micro

These are but a few examples of optical computing. There are many more, with many applications of each.

Optical computers will add to, rather than replace, your microcomputer. The new applications they engender will affect your daily life early in the next century as the Information Age unfolds. ■

BIBLIOGRAPHY

Caulfield, H. J., and J. Shamir. "Wave-Particle Duality Considerations in Optical Computing." *Applied Optics*, vol. 28, 1989.

Yovits, M. C., ed. "Optical and Optoelectronic Computing." *Advances in Computers*, vol. 28, 1989.

H. John Caulfield is director of the Center for Applied Optics at the University of Alabama in Huntsville. He can be reached on BIX c/o "editors."

TALK IS CHEAP.

Have you heard? For less than \$90 your AT or XT-compatible computer can talk! All it needs is the HV-2000 Computer Voice Kit from Heathkit.

Reading letters, transcriptions and computerized instruction can be easier and quicker than you ever thought possible. Computer games gain a new dimension. Your computer can even entertain children with stories and songs.

\$89.95

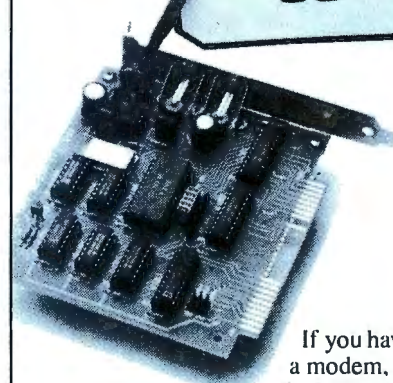

If you have a modem, the HV-2000

Computer Voice will allow your computer to recite reference and research information from time-sharing services. Or, speak radio transmitted ASCII information.

The HV-2000 Computer Voice Card, containing speech synthesizer and audio amplifier, plugs into any AT or XT-compatible computer's expansion slot. An external speaker is also included. Versatile, Heath-developed software gives you a wide variety of voices and easy interface to high and low level languages.

The HV-2000 Computer Voice. At less than \$90, talk IS cheap. To order, call toll-free 1-800-253-0570. Use your Visa, MasterCard, American Express or Heath Revolving Charge card. Use order code 218-001

For your **FREE** Heathkit Catalog call 1-800-44-HEATH

Heath Company

A subsidiary of Zenith Electronics Corporation

Prices, product availability and specifications are subject to change without notice.

☆☆☆☆☆ OptiStar

COREL OPTICAL SOFTWARE FOR ALL THE LEADING OPTICAL DISK DRIVES

SONY  PIONEER **Panasonic** **WANG**

Maxtor  MITSUBISHI  HARRIS **RICOH**

 **CHEROKEE DATA SYSTEMS, INC.**



LASER MAGNETIC STORAGE
INTERNATIONAL COMPANY

TOSHIBA

■ **Optical Drives Supported**

- WORM Drives
- ERASEABLE Drives
- JUKEBOXES

■ **Platforms Supported**

- IBM PC
- Macintosh
- Novell Fileservers

■ **Choice of Configuration**

- Software Interface Kits
- Complete Optical Subsystems

Corel OptiStar software is renowned for making optical disks as easy to use as floppy disks while maximizing speed and versatility. It is the top choice of the leading optical disk drive manufacturers and received the highest 5 star rating from PC Digest.

Make sure you get the most out of your optical disk system by using OptiStar software which is available as interface kits or in complete Corel optical disk subsystems.

Call us today.

 **COREL**
(613) 728-8200

The Nitty Gritty Optical Band

Optical packaging, interconnections, ICs, and signaling

Right now, we are bumping against the edges of the capabilities of electronics. We need to go beyond our electronic domain into a world that is faster, more secure, more parallel, and more densely interconnected but has less interference. Photonics has significant strengths in these areas.

Optical technology can help pull us into the next generation of computing. It is more secure than electronics: Generally, optical communications don't suffer from crosstalk. It is faster: Light travels faster than electricity and isn't constrained by factors, such as capacitance, that slow down signals in conductors. It is more parallel: Since thousands of dedicated light beams can simultaneously travel through a lens, an optical device can accept multiple inputs at the same time. And it provides advantages for interconnections because light rays do not interfere with each other.

Optoelectronics

Between the optical and nonoptical environments exists a hybrid domain called optoelectronics with one foot in electronics and the other in photonics. The com-

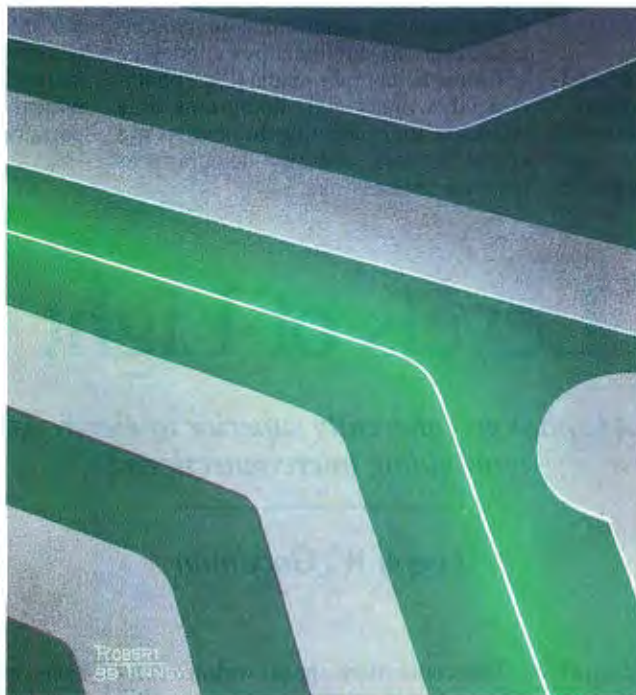

bination of these two technologies brings us advantages and performance capabilities that are not possible with either of them alone.

Here are some possible applications of new optoelectronic techniques: optical communications networks that rapidly transmit signals around the world and into outer space; optical ICs that promise to be able to combine serial and parallel

processing in a three-dimensional computer that can handle massive AI applications; and optical computers and other devices that can perform a thousand times faster than today's supercomputers.

These devices can take different forms: computers that think like we believe humans do, for example, and optical data storage disks that can hold orders of magnitude more information than their magnetic counterparts. In addition, other kinds of devices can easily and rapidly outperform current systems in areas such as pattern recognition, image processing, communications signal processing, voice recognition, and matrix manipulation.

Essential Elements

Domains like optical packaging, interconnections, ICs, and signaling are key to the future of computing. The technologies are essential elements in the progress of the overall optical environment.

Optical packaging encompasses the issues surrounding the various combinations of components on chips and boards and their interconnections and integration. Generally speaking, the major

continued

components all optical systems share are the transmitter, the receiver, and the medium. Overall, the aim is to embed more fundamental electronic functions into the light transmitter and receiver modules to create smaller packages that are easier to implement and use.

Packaging priorities are usually application-specific. The connection between the various components is a prime factor in whether or not the packaging is successful for that particular application. A recent development in *pigtail* technology has eliminated some of the interconnection problems in the packaging area. A pigtail is the optical fiber that is permanently attached to the active area of the LED or laser.

Cost is a constraining issue in optical packaging. Components and connections are still much more expensive than their electronic counterparts. But with improvements in, and wider use of, molded plastic optical elements (one of the developments that will make optical techniques viable), the economics of optical technology are gradually migrating into the range of affordability.

New Directions

Years of research are now paying off, and scientists in the areas of semiconductor, circuit, switching, and holographic technologies are beginning to see some outstanding results. These potentially viable

results include the use of materials such as gallium arsenide, copper chloride, indium antimonide, zinc selenide, and multiple quantum wells for semiconductors.

A new technology called optoelectronic integrated circuit (OEIC) uses elements such as diode lasers and optical photodetectors fabricated on the same chips that contain electronic circuit functions.

Self electro-optic effect devices (SEED) and quantum-well devices are being considered for switches. In addition, earlier this year, scientists at British Telecom's Research Laboratories achieved the first complete optical self-switching of ultrashort light pulses, known as *solitons*. The success of this process promises that optical fibers will play a major role in fundamental optical-processing elements of the future.

Holography is the basis not only for optical computing, but also for other applications such as storage using optical associative memory. Other interesting experiments are being carried out on holographic look-up tables in the digital optical-computing domain, holographic interconnections, architectures employing real-time holography media (e.g., photo-refractive materials), holograms as a technique for connecting the neurons in a neural network, and even holograms as communications links.

Optical devices and components have improved tremendously, as has the fiber we use as a medium. Researchers believe photonics will be of use in the AI field in the areas of optical database and knowledge-based machines, perception, and learning. Optical technology also appears to have a significant role in the emergence of neural networks.

Optical architectures useful for processing two-dimensional signals using acousto-optic (AO) devices have been developed and demonstrated for several applications. AO devices are one-dimensional spatial light modulators (SLMs). The areas of architectural considerations and scaling of algorithms and computation for the optical computing environment are also being studied.

Still a Few Years Away

When will we see an optical computer? Some working models already exist in today's research environments. At least one company has a digital optical computer up and running, and another firm has one on the drawing board, but a commercial model of an optical computer is still a few years away. In the meantime, better optical communications, optical storage, and optical displays and many optical techniques are already being incorporated into existing systems.

—Janet J. Barron
Technical Editor

Levels of Light

Are photons inherently superior to electrons in providing interconnections?

Joseph W. Goodman

On a fundamental level, a digital computer consists of a collection of nonlinear elements (the *gates*) within which signals interact, and interconnections among these elements or among groups of these elements. While attention most often focuses on the gates and their properties (e.g., switching speed and power dissipation), the interconnections are no less important. In fact, as the speed of transistors on chips increases, the interconnections become the limiting factor in overall chip performance.

Interconnections appear within a computer not only between gates at the chip level, but also at many other levels of an entire interconnect hierarchy:

Level 1: Machine-to-machine interconnections. Examples of interconnections at this level include the coaxial electrical cable of Ethernet, which transmits data at a rate of 10 million bps, and the optical fiber of the Fiber Distributed Data Interface (FDDI), which will soon replace Ethernet in many high-speed applica-

tions, at a data rate of 100 million bps. *Level 2: Module-to-module interconnections* within a single computer, where a module may consist of a unit of memory or a processor. With the increasing emphasis on multiprocessor computers as an architecture of choice, these interconnections are becoming more important. *Level 3: Backplane-to-backplane interconnections.* Large computers typically consist of a multitude of backplanes into which electronic boards are inserted. These backplanes must exchange infor-

mation, and therefore must be interconnected.

Level 4: Board-to-board interconnections on a backplane. The backplane supplies the bus or communications channel through which the boards communicate.

Level 5: Chip-to-chip interconnections on a board. A typical printed circuit board may contain a hundred or more chips. Data usually flows between these chips via metallic lines embedded in the board.

Level 6: Gate-to-gate interconnections on a single chip, representing the lowest level of the interconnect hierarchy. Interconnections at the chip level are part of the chip design and are typically achieved through extremely fine lines of polysilicon or metal fabricated on the chip itself.

Photons vs. Electrons

Physically, there is reason to believe that photons are inherently superior to electrons in providing interconnections. Electrons are charged particles and therefore influence one another through the forces that electrical fields exert. On the other hand, a photon carries no charge and therefore exerts no influence on other photons. Thus, optical beams in a linear medium pass through one another without interaction, an attribute that is ideal for interconnections.

As the speeds of electronic circuits increase, greater and greater difficulties are encountered in providing the required interconnections at all levels. Photonics has come to the rescue at level 1 of the hierarchy, with many large computer companies accepting the new FDDI standard; the prospect of a tenfold improvement over Ethernet speeds in the near future is now a certainty.

The success of photonics in interconnections stems from the low attenuation of optical fiber, which allows using long spans of fibers without repeaters, and the freedom of optical signals from electromagnetic interference. Equally important are the extremely high data transmission rates possible in optics. These rates are often limited not by the fiber itself, but by the electronic devices that convert electrons to photons at the optical transmitting end and photons back to electrons at the receiving end. The inherent bandwidth of the best fiber is sufficient in principle to allow digital data transmission at rates greater than 10 trillion bps, if only we could access that bandwidth through suitable optoelectronic devices.

A photonic interconnection requires converting electronic signals flowing on

wires to optical signals flowing on an optical channel. Electronic signals are most commonly converted to optical form with LEDs or semiconductor laser diodes, the latter being more efficient than LEDs but also having poorer reliability. Unfortunately, no efficient and practical method exists for generating light using silicon as the device material; virtually all semiconductor optical sources are based on gallium arsenide (GaAs) technology or its relatives. Photodetectors perform the actual conversion of optical signals to electronic form. Both silicon and GaAs make efficient detectors. Each of the conversion steps has less than perfect efficiency, but the detection step is generally far more efficient than the light-generation step.

Optical fibers provide the most widely recognized medium for transporting optical signals. However, when the interconnect distances are short, as they are within a single computer, other possibilities exist. You can construct optical waveguides in planar form on silicon or GaAs chips, and use them to carry optical signals at level 6 (gate to gate) of the hierarchy. Other types of optical waveguides can be fabricated at level 5 (chip to chip). You can also use holographic optical elements to transmit or reflect light to a prescribed set of locations, thereby creating a *free-space* optical channel. Each approach has its own particular strengths, with fibers generally being preferred at the higher levels of the hierarchy, and waveguides or possibly free-space interconnections at the lower levels.

The use of photonics to provide the highest-level interconnections (i.e., between computers, or between computers and high-speed peripherals) is already a proven technology, although many improvements are possible. At the opposite extreme, photonics is unlikely to provide a viable interconnect technology at level 6 (gate to gate), the lowest level of the hierarchy. The reason is complex, but to put it simply, the power efficiency of a photonic interconnection compares favorably with that of an electronic interconnection at the machine-to-machine level; however, the photonic solution compares unfavorably with the electronic solution at the gate-to-gate level.

On the Level

Connecting computers with optical fiber (level 1) is the purpose of the new FDDI standard. It is a proven technology.

One of the earliest examples of the use of photonic interconnections *within* a computer is the so-called Dialog.H com-

puter constructed at the Electrotechnical Laboratory in Tsukuba, Japan (which is funded by the Japanese Ministry of International Trade and Industry). This computer consists of a multitude of electronic processors (level 2), each having its own local memory. The processors are arranged like the spokes of a wheel around a central hub (see figure 1).

Each processor has an optical source and a photodetector. When one processor wishes to communicate with another, it broadcasts an optical signal through free space toward a convex mirror located at the hub of the wheel. The mirror spreads the light so that a portion of it falls on the photodetectors of all processors. Each message contains a header indicating its intended destination. Only the proper destination accepts the message, and when it does, another processor can use the optical channel. Thus, a time-shared communications bus is realized within the computer.

A second early example is the 5-ESS switching computer made by AT&T. This type of computer supplies, at many locations through the communications network in the U.S., the computational power needed to route messages to their proper destinations. The 5-ESS computer uses photonics and optical fibers to supply interconnections between its several backplanes (level 3). Optics was chosen for this task because of its ability to eliminate troublesome *ground loops*, or unwanted stray electrical paths that plague large electronic systems.

Several industrial organizations have active research projects investigating the use of optics for interconnecting multiple electronic boards (level 4). The so-called *optical backplane* must be capable of providing data rates in the range of 1 Gbps to 10 Gbps (1 gigabit per second = 1000 million bits per second) or higher.

Both industrial research laboratories and universities are investigating the use of optics at the lower levels of the interconnect hierarchy, including chip-to-chip interconnections on a board (level 5). Several U.S. companies, including Honeywell, Rockwell, and IBM, have significant development efforts to provide multi-Gbps optical channels into and out of GaAs chips. Many Japanese companies have similar efforts.

The one intrachip (level 6) interconnection where optics may provide a viable alternative to electronics is in clock distribution. Virtually all electronic chips must widely distribute a synchronizing signal called the clock, which serves as a time reference for the many

continued

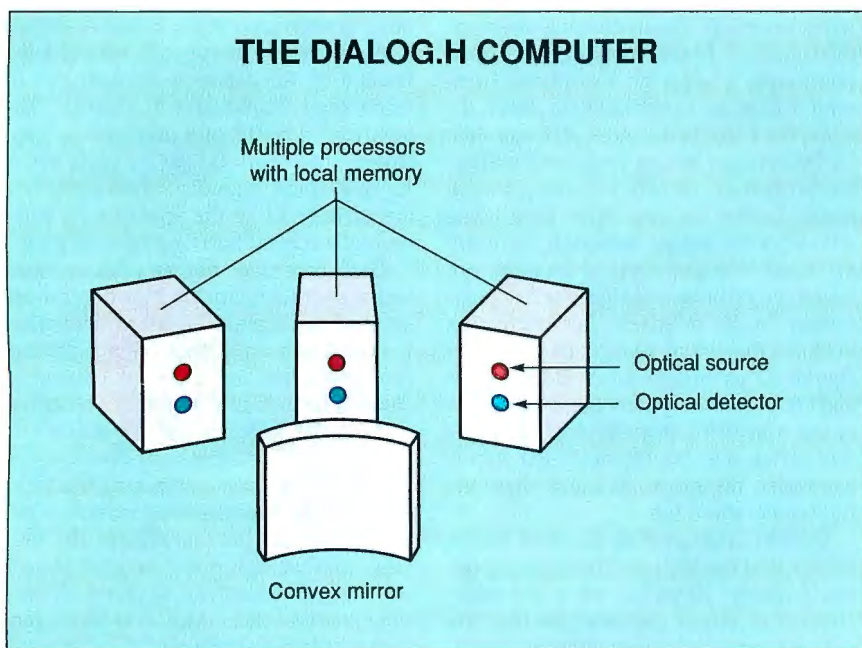

Figure 1: *The Dialog.H computer is one of the earliest examples of using photonic interconnections within a computer. It consists of a multitude of electronic processors, each with its own local memory.*

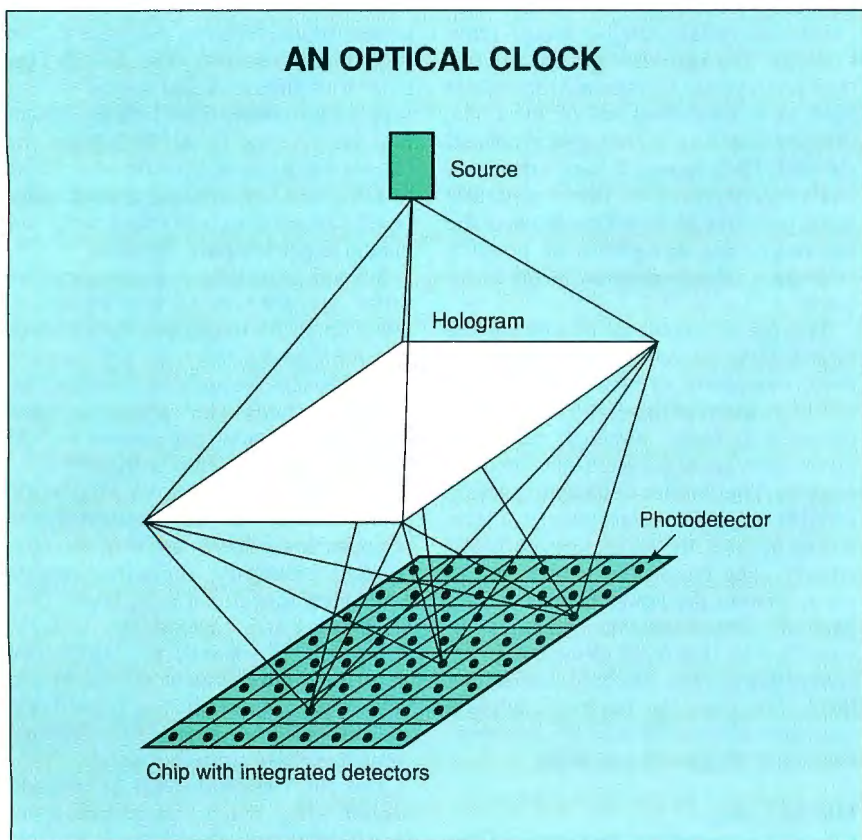

Figure 2: *Optical clock distribution to a chip via a holographic optical element. An off-chip semiconductor laser source generates an optical timing signal, which a holographic optical element then efficiently broadcasts to many photodetectors embedded in the chip.*

devices on the chip. The clock signal must be delivered to virtually all devices on the chip, and therefore suffers a high level of *fan-out*. That is, it is split many times so it can reach all the devices. Such splitting loads the clock lines so that it becomes hard to drive them with a high-speed electronic signal.

Stanford University has been working for several years on designing and fabricating chips that are clocked optically. As shown in figure 2, an off-chip semiconductor laser source generates an optical timing signal, which a holographic optical element then efficiently broadcasts to many photodetectors embedded in the chip. The optical signal is then converted to electronic form at many locations, and conventional chip wiring distributes each locally detected clock signal to nearby devices. Variations of this scheme incorporate many free-running clock oscillators on the chip, which an optical signal then synchronizes.

The Breaking Point

The use of photonics as an interconnect technology remains in its infancy. Electronic-systems designers have a natural tendency to select electronic (rather than photonic) solutions to problems simply because they are unfamiliar with the photonic approach.

However, in fairness, photonic devices need a great deal more development before they will be as reliable and flexible as electronic devices. Driven by the requirements of long-distance fiber-optic communications, this development will surely occur. When it does, photonics will gradually be incorporated into lower and lower levels of the interconnect hierarchy, especially in applications where the highest possible speed is essential.

The implication is that optics will probably provide viable interconnect solutions for the higher levels of the interconnect hierarchy but will eventually fall behind in competition with electronics on the lower levels. Where the breaking point will actually occur is at present the subject of considerable research. It appears highly likely that the typical computer of the future will depend on photonics, certainly for external interconnections, and probably for at least some of its internal interconnections.

Joseph W. Goodman is a professor and chairman of the department of electrical engineering at Stanford University, from which he also holds a Ph.D. He can be reached on BIX c/o "editors."

continued

\$299* GRAPHIC RESOLUTION SOLUTIONS.

1000 LPI. For CAD and other graphics applications,

nothing beats the IO DT-1000 graphics tablet. It emulates nine of the most popular tablets and out-performs any mouse. The DT-1000 is an "absolute" pointing device

...draw and trace as naturally as with pen and paper.



The DT-1000 is compatible with today's top CAD and paint software and comes with its own AutoCAD template.

It is complete and ready to go... all you provide are your computer and software. It interfaces with standard RS-232C ports. Best of all, the IO DT-1000 gives you twice

the features at less than half the price of tablets offered in the past.

1024 x 768.† Let us open your eyes to a

whole new world of color and resolution. The IO VGA 16 graphics card delivers resolutions, colors and features far beyond standard VGA. It offers truly hardware register-level compatibility with all

popular graphics modes, 16-Bit Data Bus, and both 9-Pin TTL and 15-Pin Analog output.

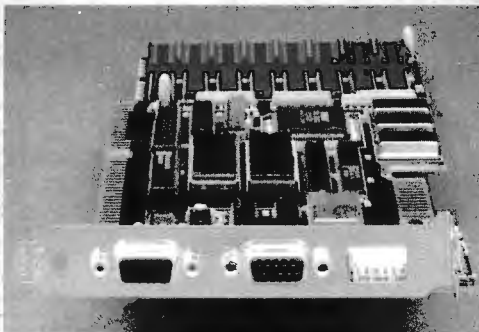

Included are software drivers for:

AutoCAD
Framework II
GEM Desktop
Lotus 1-2-3
Symphony
Microsoft Windows
286/Version 2.0
386/Version 2.1

Ventura Publisher
WordPerfect
WordStar

CALL NOW!

Dealer and distributor inquiries welcome.

*Each. Manufacturer's suggested retail price.

†With optional use of 512K DRAMS.

Specifications subject to change without notice.



12700 Yukon Avenue
Hawthorne, CA 90250

Phone (213) 644-6100 Fax (213) 644-6068

Joining Forces

Optics and electronics each have their shortcomings, but together they combine the best of both worlds

Donald J. Channin

As clock speeds push toward 100 MHz and beyond, and as word lengths increase beyond 32 bits, conventional electronic means of interconnection will be severely tested. Without an alternative, copper, not silicon, will limit the performance and cost of future advanced workstations and processors.

The integration of optics with electronics offers an alternate interconnection technology called optoelectronic integrated circuit (OEIC) technology. Optoelectronic elements such as diode lasers and optical photodetectors are fabricated together on the same chips with electronic-circuit functions.

What can we expect from computers based on these chips?

- Faster, more economical machinery.
- Broadband interconnections for high-density graphics and ultimately real-time video, as part of the workstation environment.
- New architectures for computing, as optics liberate interconnections from the confines of computer and backplane wiring.
- Processors whose architectures can be custom-configured by electrically controlled beam interconnections.

Silicon-based logic and memory offer so much flexibility and potential for future development that optical systems will probably replace them only in specialized applications. The more general use of optics won't be to replace silicon but to support it. Ultimately, the OEIC technology could look like this:

- Chips in which optoelectronic devices replace the conventional I/O pads and associated line drivers for sending and receiving optical signals.
- Signal connections based on beams of light, fiber-optic lightguides, or planar optical waveguides embedded in printed wiring boards, or combinations of these elements.
- Economical packaging that supports

the chips with their optical connections but doesn't need the hundreds of pins that now surround complex chips.

Why Go Optical?

The most obvious reason for these optical refinements is simply the number of pins on complex chips. Three hundred pins are common on processors today, and computer designers are anticipating packages with over a thousand pins in the early 1990s. This growth is a direct result of increasing complexity on the chip, which requires more I/O capability to support it.

Rent's Rule, an empirical rule for logic circuits, tells us that $N_c = K(N_g)^s$. N_c is the number of connections to a chip, and N_g is the number of gates the chip

will degrade and ultimately limit system performance.

Low-speed systems use unmatched electrical impedances and expend power-charging line capacitance. This power grows with frequency. To avoid committing excessive chip power to driving these capacitances, you must shift to matched impedances for transmission lines and terminations. This step turns system design into an exercise in radio-frequency (RF) engineering. Electromagnetic interference and compatibility become major design issues.

All these problems spell increasing cost and lower system reliability. Optical links, however, offer the multi-gigahertz bandwidths and noise immunity that have given them a commanding position in fiber-optic telecommunications.

Geometry, Plain and Simple

While the very architectures of present computers are based on the geometries of multilayer boards and backplanes, light is not limited to these geometries. Beams of light can pass through each other and don't need a controlling medium. Such a beam can use the shortest path between two points in a system as a signal path. Changing the direction of such beams can amount to rewiring the machine.

Guided propagation of light in fibers or films is not as flexible, but it can still support layouts and system geometries impossible with conventional interconnections. New computing methods, such as massively parallel and pipelined processing, appear well suited for implementation on machines with the architectural freedom optics can offer.

To make these optically connected computers possible, you will need a CMOS processor, DRAM, or other typical computer chip. However, one or more optical-interconnect subchips would replace the hundreds of bonding pads that normally surround such chips. These subchips act as transmitters and receivers for optical data that otherwise would pass to and from the circuit

The use
of optics won't be
to replace silicon
but to support it.

has. K and s are constants whose values are typically 2.5 and 0.6, respectively. If you put more logic on a chip, you must support it with more connections.

Packages with many pins devote most of their real estate to fan-out from the chip itself to the pins. Reliability drops and costs rise rapidly with increasing numbers of mechanical elements. By going to optics, single optical links can replace multiple pin connections.

Present printed wiring boards can handle current clock frequencies of about 30 MHz with little difficulty. But when clock speeds reach 100 MHz and beyond, as they undoubtedly will, the electrical characteristics of the board traces

through electrical connections.

Figure 1 shows the detail of the optical subchip. It is fabricated on GaAs, a semiconductor with properties different from those of silicon but capable of being grown directly on the silicon chip.

Data is sent in parallel to the subchip, converted to serial form by the signal processor, and used to drive a laser transmitter. Laser light modulated by the data is sent to another chip as an unguided beam or through an optical fiber. The receiver element accepts optical signals from other chips and converts them to electrical signals. Then the received signals are converted to parallel form and sent to the silicon master chip.

Signal Processing

Optoelectronic technology is based on using semiconductor devices for generating light signals from electrical inputs, transmitting them, receiving them, and converting them back into electrical form. Certain semiconductors, such as aluminum gallium arsenide (AlGaAs) for wavelengths of 0.8 to 0.9 micrometers (μm) and indium gallium arsenide (InGaAs) for wavelengths of 1.1 to 1.6 μm , generate these light signals by applying forward bias (i.e., low electrical resistance) to specially fabricated junctions.

Electrons and holes injected into the junction recombine there to create photons of light. These photons may be emitted directly to form incoherent light. Such a device (e.g., an LED) is easy to make but is slow and inefficient.

Laser diodes are made by incorporating the semiconductor junction into an optical cavity produced in the same material, so that optical feedback stimulates lasing action. Laser diodes can be efficient (more than 60 percent) and fast (more than 10-GHz bandwidth over which light intensity follows current modulation), and they use little current and power (less than 10 milliamps and less than 20 milliwatts). You can couple light from laser diodes into optical fibers for transmission or direct them into beams traveling in free space.

On the receiver side, photodiodes based on reverse-biased (i.e., with high electrical resistance) semiconductor junctions detect the light signals. Photons absorbed within the depleted regions of these junctions create electron-hole pairs that are swept out to create a small current that varies with the intensity of the light.

Simply switching the laser on and off with the drive current imposes information on the light beam. The photodetec-

tor current tracks this signal and can drive subsequent electronic stages.

A complete transmitter or receiver combines the lasers and photodetectors with electronic circuits that control their operation and provide an interface between them and the digital circuitry. You can also add digital circuitry to convert the parallel data into a single serial data stream to be transmitted over the optical link, and to reconvert the data to parallel form at the receiver. These multiplexing and demultiplexing (MUX/DEMUX) operations let you trade off the high-speed capabilities of optoelectronic devices against the greater chip area and power consumption of parallel optical-signal paths.

Assembling the Pieces

OEIC technology puts all these functions on a single semiconductor chip. Figure 2 shows an example of the type of chip now being developed (see reference 1). Conceptually, it makes sense to extend the functions on the chip to include logic, memory, and other signal-processing functions that the application needs. Three main issues are involved:

- Different device functions require different semiconductor materials.

Diode lasers can't be made in silicon, nor can photodetectors for the long wavelength optical bands (1.3 to 1.6 μm).

GaAs is excellent for short-wavelength (0.8 μm) lasers and detectors, and supports a growing field in high-speed logic. Unfortunately, it's not competitive with silicon for large-scale memory or logic.

InGaAs supports long-wavelength lasers and detectors. It also has a potential for even greater electronic speeds than GaAs, but it is still a relatively immature technology.

- Different devices require different and sometimes incompatible processing techniques.

Most laser structures are built up of semiconductor *heterojunctions*, which are crystalline layers of different compositions that are grown on top of each other with demanding requirements on the interface properties of the materials (see reference 2).

Electronic devices, by contrast, are usually made of single-composition materials with electrical properties modified by doping. Not only does fabricating a chip with both types of devices involve different processing for different system elements, but you must do it on a surface that has different elevations for different devices.

- Interfacing optical-transmission media (i.e., fiber optics) limits chip geometry and requires precise mechanical alignment in packaging.

continued

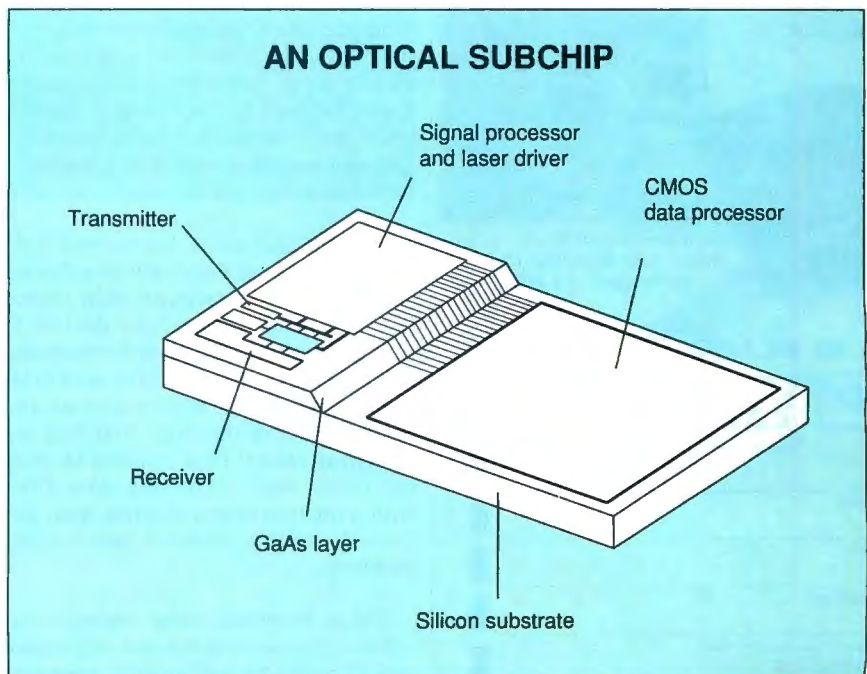

Figure 1: An optical interconnect subchip. Note that it is fabricated on GaAs, a substance with properties different from those of the silicon substrate but capable of being grown directly on it. The OEIC computer chip itself is fabricated of silicon.

Why the FREE Inmac catalog is the computer accessory you'll value most.

You get "a store in a drawer."

Page after page of PC products that make work easier, more effective. At your fingertips, when you wish.

Plain talk makes it all easy.

Spacesavers, workstations, cables, disks. All explained in simple language & pictured as you'd use 'em. Call with any questions: Our informed staff helps you get the right item, instant credit, fast delivery.

The final decision is yours.

Unlike some catalog firms, Inmac lets you decide when you're satisfied with a product. A promise we back up with ironclad guarantees.

Call now toll free:

1-800-547-5444

Use the resource that gives the world's sharpest business computer users an extra edge.



Call or send coupon to
Inmac, 2465 Augustine Dr.,
Santa Clara, CA 95054.

YES!

Send my first Inmac catalog today!

Name _____

Title _____

Company _____

Street Address/P.O. Box _____

City _____ State _____ Zip _____

Area Code _____ Phone No. _____ Code 5555

In Canada, Call Toll Free 1-800-387-2173

Search and Research

The most focused research work has been in the field of monolithic integration of electronic and optoelectronic devices. The first milestone was achieved in 1978 when Caltech reported a basic transceiver chip containing a laser, amplifier, and photodetector on a gallium arsenide (GaAs) substrate.

Progress to more complex chips required planar surfaces for photolithography. To achieve that, Honeywell and other companies developed techniques to grow the laser heteroepitaxial layers in a well that is etched into the GaAs substrate.

Since then, fast (1 gigabit per second) and complex (more than 500 gates) transceiver chips have been developed. Receivers using planar photodiode devices have grown in complexity to more than 2000 devices per chip and in speed to over 5 gigahertz. Extensive work has been done in Japan, culminating with the first commercial part (a receiver) offered in 1988 by Matsushita.

This impressive progress was made despite the lack of a compatible processing technique for all the devices on the chips. Without a compatible process, low-cost products are unlikely to appear. This need has been recognized: Examples of compatible optoelectronic integrations have recently appeared.

Fujitsu has shown an approach in which lasers, detectors, and transistors are processed by implanting a planar material containing a semiconductor multiple quantum well. Such quantum-

well structures are examples of how new semiconductor growth technologies can perform "atomic engineering" on materials. These technologies tailor the fundamental energy bands to the needs of the devices, rather than limiting device performance to the capabilities of bulk materials. With these techniques, development paths to economical fabrication of complete and complex optoelectronic IC parts are now open.

Another accomplishment in materials engineering addresses a problem involving computer chips and OEIC functions requiring different semiconductor materials. Now you can grow GaAs layers of device quality directly onto a silicon wafer. Originally, the objective was to provide a better substrate for GaAs electronic devices. But the same technology can allow islands of GaAs grown onto a silicon chip to add optoelectronic functions to conventional logic and memory.

The major technical issue is the crystalline quality of the GaAs as it grows on the different crystalline structure of silicon. Defects in the crystalline structure of the grown layers affect the performance and reliability of the devices fabricated on them. Although the quality of the GaAs must improve before reliable lasers can be manufactured, the goal of complete monolithic integration of optoelectronics to support the interconnection of electronic computing functions is now in sight.

Conventional diode lasers emit light from a tiny (about 2 μm) spot on a cleaved edge of the semiconductor chip (hence the term "edge emitter" for devices of this geometry). Special processing and handling are required, and the need to locate the lasers at the edges is a constraint on the layout of the chip. Coupling the light to an optical fiber requires locating the much larger (120- μm) glass fiber within microns of this emitting spot. Receivers present similar mechanical problems.

These problems make conventional optoelectronic components expensive and ill-suited for high-density computer hardware. However, a group of enabling technologies has emerged that makes OEIC development for computer applications feasible and timely. These technol-

ogies have come out of separate research efforts with very different objectives, but together they offer a realistic framework for OEIC design and fabrication (see the text box "Search and Research" above).

In the near term, the concept of multi-chip packaging now entering systems applications could allow GaAs and silicon chips to share the same package even before the technology for growing GaAs on silicon is perfected. Internal connections between the chips would still require electrical traces, but optics would carry signals outside the packages.

Interfacing OEIC chips for optical transmission has been made much easier with the recent development of surface-emitting diode lasers. Unlike the conventional edge-emitting lasers, these new devices have optical emission perpendicular to the chip surface. No longer must

OEIC layouts be constrained so the laser output comes from the cleaved and processed edge of the chip.

An example of such a device is the grating-surface-emitting (GSE) laser announced by the David Sarnoff Research Center (see figure 3 and reference 3). This device uses a diffraction grating processed into the laser to deflect light from the plane of the chip into a narrow

beam. This beam can then go directly into a receiver on another OEIC chip, be redirected with lenses or other optics, or be coupled efficiently into fiber optics. Other approaches to surface-emitting lasers use micromirrors etched into the chip to deflect light, or invert the laser itself so that it is oriented perpendicular to the chip surface.

continued

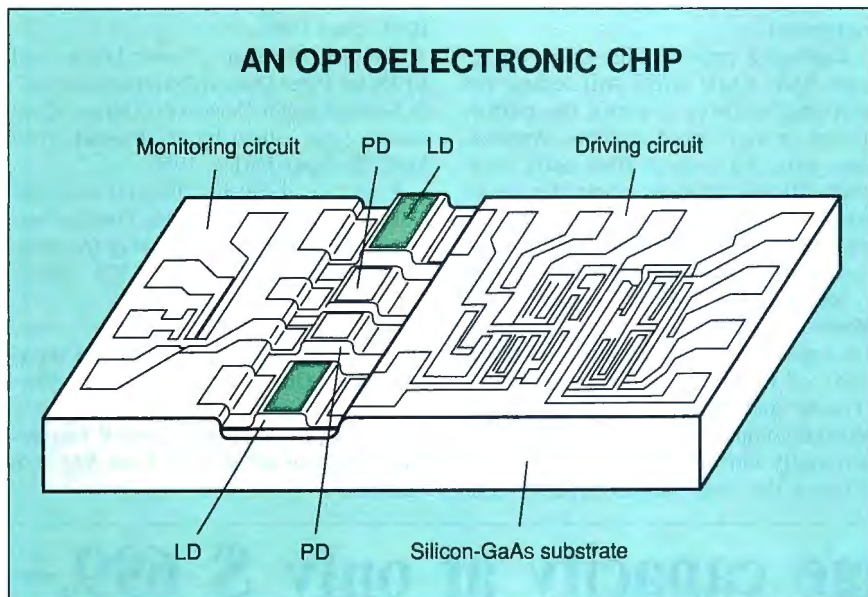

Figure 2: An example of the type of optoelectronic chip now being developed. It shows a typical OEIC structure containing laser diodes (LDs), photodetectors (PDs), and driving and monitoring circuits.

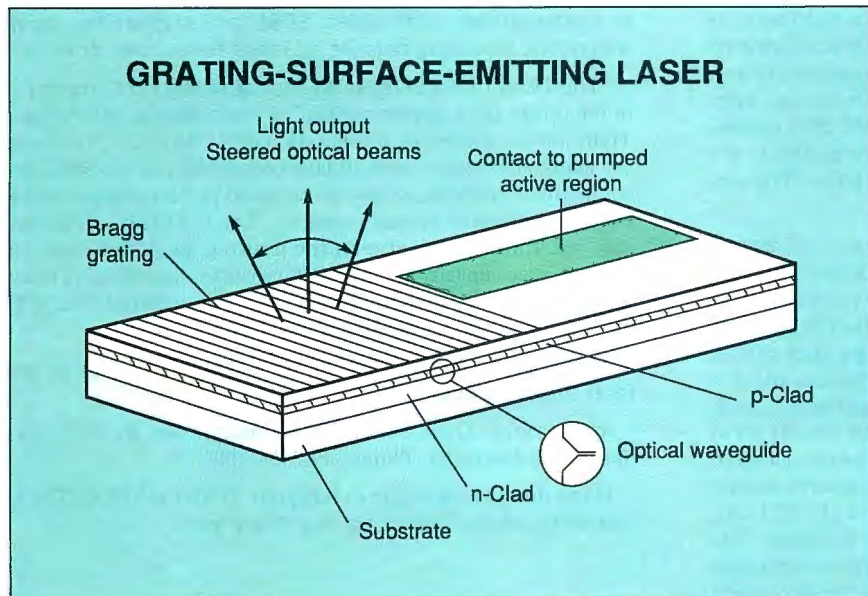

Figure 3: Grating-surface-emitting (GSE) laser structure. Light output is in the form of steered, focused, narrow optical beams from the surface of the diffraction grating. Current from the contact to pumped active region stimulates optical emission in the optical waveguide.

MARK 16

286-16 MHz AT COMPUTER WITH EGA COLOR MONITOR

LIQUIDATION

FACTORY NEW! FACTORY PERFECT!



AT, EGA SYSTEM w/ 40 MB HD!

Speed though your programs with the computer made for demanding work! This 286-AT Computer with EGA Color Monitor is lightning fast for all of your computing needs. Comes complete with 1 MB of RAM and a high speed 40 MB hard drive.

- 16 MHz 80286 computer.
- 1 MB RAM on motherboard (expandable to 4 MB).
- 14" EGA color monitor with EGA color adapter.
- 40 MB-38 millisecond hard drive.
- 5-1/4" floppy drive with 1.2 MB capacity.
- Six 16-bit and two 8-bit expansion slots.
- 100% IBM compatible.
- 80287 math co-processor socket.
- 4 extra half height disk drive cavities.
- Built-in real time clock/calendar.
- 1 Centronics parallel printer port.
- 1 RS232C serial communication port.
- 101 AT-style keyboard. • 200 watt power supply.
- Includes: MS DOS 3.21 & GW-BASIC 3.22.
- Dim.: 19.3" x 16.7" x 6.3".
- **One Year Warranty!** Manufacturer's

PUBLIC NOTICE
Due to a special deal, we were able to obtain a large inventory of these fantastic computers. As a result, we can now offer them to you at **HUGE SAVINGS!**

Suggested Retail
\$3,195.00

DAMARK PRICE:

\$1499

Item No. B-1412-126533
Insured Ship/Hand.: \$39.00

FOR FASTEST SERVICE CALL TOLL FREE

1-800-729-9000

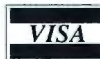

DAMARK INTERNATIONAL, INC.
6707 Shingle Creek Parkway, Minneapolis, MN 55430
Customer Service • 612-566-4940

Please rush me:
Mark 16 Computer(s)
@ \$1499 each, plus \$39.00 s/h each.
MN res. add 6% sales tax.

Name _____

Address _____

City, State, Zip _____

Check/MO VISA Master Card Discover

Card No. _____

Exp. Date _____ Ph. # () _____

Signature _____

Item No. B-1412-126533

DELIVERY TO 48 U.S. STATES ONLY

A special feature of the GSE laser approach is that the light beam can be electronically steered. Two optical processes combine to achieve this effect. First, the deflection angle of light from the grating changes with the light wavelength. Second, the electronic drive to the laser controls the light wavelength. Combining these two effects will make it possible to electronically change where the output beam points.

The Age of Optics?

What could we do with a steerable optical interconnection? To start with, we could eliminate a major bottleneck in processor performance by replacing current data bus architectures with direct connections between processors and memory. Such direct connections make sense only if you can switch them in real time, as you can with electronically steerable optics.

Going further, you could base architectures for parallel-processing machines on direct, equal access among all processing elements, rather than on the restricted access that electronic connections offer. Ultimately, we may have

workstations in which the processing system alters itself according to the application it is running or even the specific task it is carrying out.

Will we see such machines soon? Both technology and market issues will set the pace for the development of the OEIC chips around which they must be designed. The first users of OEIC devices will probably be not computer manufacturers but makers of telecommunications equipment.

Replacing present fiber-optic equipment with single chips will reduce the cost and probably improve the performance of high-speed systems. Applications will first come as fiber-optic interconnections between computer-room equipment and high-speed networks to replace the bulky electrical cables now used. Cost reduction is the driving force.

Meanwhile, organizations such as the Microelectronics Computer Consortium are exploring the architectural implications of optical interconnections for existing and new types of computers. Various companies are also working, individually and within industry groups, to advance the basic semiconductor tech-

nologies and prepare for production. With this activity, the 1990s should be the decade for introducing optics into computers. ■

REFERENCES

1. Nakano, H., et al. "Monolithic Integration of Laser Diodes, Photomonitors and Laser Driving and Monitoring Circuits on Semi-insulating GaAs." *Journal of Light-wave Technology*, vol. LT-4, page 574. IEEE, June 1986.
2. Kressel, H., et al. "Laser Diodes and LEDs for Fiber Optical Communications." *In Semiconductor Devices for Optical Communications*, edited by H. Kressel. New York, Springer-Verlag, 1980.
3. Evans, G. A., et al. "Two-Dimensional Coherent Laser Arrays Using Grating Surface Emission." *IEEE Journal of Quantum Electronics*, vol. 25, page 1525. IEEE, June 1989.

Donald J. Channin is a program manager at the David Sarnoff Research Center in Princeton, New Jersey. He has a Ph.D. in physics from Cornell University. He can be reached on BIX c/o "editors."

Unlimited storage capacity at only \$ 699.-!

New FLOPTICAL technology available now from microtronics Trade Service

One of the first disk drives based on the new FLOPTICAL technology developed by Insite Peripherals, California, is now available from microtronics Trade Service, West Germany: TESS I 325. This disk drive can store up to 20.8 megabytes of data on a 3.5 inch FLOPTICAL diskette. It is also able to read, write and format standard 3.5 inch diskettes in the IBM PS/2 compatible formats. The disk drive itself is physically compatible to the 3.5 inch standard. It contains a standard SCSI interface. The average seek time is as low as 65 ms.

Unlike the usual technology to store great amounts of data on magnetic media by using magnetic servo tracks, the FLOPTICAL technology combines optical and magnetic technologies to create a reliable storage device. Servo tracks are factory prepared on standard 3.5 inch high density diskettes, using a laser device. The servo tracks are burned into the surface of the diskette at a density of 1250 tracks per inch. The magnetic read/write head is positioned by a closed-loop servo following the optical servo tracks with an accuracy within 60 microinches. The optical servo tracks are indelible and not vulnerable to erasure as with magnetic encoded schemes. The care and handling of the FLOPTICAL diskettes is the same as for standard 3.5 inch diskettes. The FLOPTICAL diskette data blocks are written with a proprietary ECC capable of correcting single error bursts of up to 80 bits and multiple bursts of lesser total length.

A single FLOPTICAL diskette costs as little as \$ 19.-, that's 91 cents per megabyte media cost! microtronics Trade Service offers the TESS I 325 FLOPTICAL disk drive with one FLOPTI-

CAL diskette for \$ 699.-. Several accessories are available, such as a external case with cables, SCSI host adapters for various computers, mounting rails for 5.25 inch form factor drive bays.

"The TESS I 325 FLOPTICAL disk drive will play a major role in the future store device market," a spokesman of microtronics Trade Service said at the presentation of the drives. "It incorporates many advantages over today's technology, is available at a competitive low price, shows a very good performance and has a virtually unlimited storage capacity. The FLOPTICAL technology will fill the gap between the growing needs for more and more storage capacity and the high prices for this capacity today. And unlike other technologies recently announced, FLOPTICAL technology is available in our TESS I 325!"

The TESS I 325 FLOPTICAL disk drive is available at your local computer dealer.

microtronics Trade Service, Bettendorfer Str. 36, 5173 Siersdorf, West Germany, Phone: 49-2464-2147

If you don't know where to buy your TESS I 325 FLOPTICAL disk drive, please contact us. We'll help you!

IBM, PS/2 are trademarks of IBM Corp. Insite, Floptical are trademarks of Insite Peripherals, Inc.

microtronics Trade Service, TESS, TESS I 325 are trademarks of microtronics Trade Service

Idea: H. Bauer, Set by HGB Druck, Jülich

BYTE...The Perfect Gift

Reward the computer enthusiasts on your gift list with a year's subscription to BYTE — the definitive guide to personal computing.

Each gift will include 12 issues, plus a bonus issue dedicated to IBM PC's. Your first gift will cost only \$24.95 with additional gifts costing even less; only \$19.95 each — both great money saving rates when you consider that one year of BYTE purchased at the newsstand would cost \$42! (Canada: first gift C\$41.00, additional gifts C\$38.00 each.)

Don't get caught in the holiday rush, send us your gift list today or call 1-800-528-9150, ext. 845 and we'll do the rest.



YES! I want to send gift subscriptions to the following people and save money off the newsstand price!

TO: (1st Gift — \$24.95; Canada C\$41.00)

Name _____

Address _____

City/State/Zip _____

(Each additional gift — \$19.95; Canada C\$38.00 each)

Name _____

Address _____

City/State/Zip _____

Name _____

Address _____

City/State/Zip _____

Name _____

Address _____

City/State/Zip _____

FREE BONUS — A gift announcement will be sent in your name to the recipient.

FROM:

Name _____

Address _____

City/State/Zip _____

Payment enclosed* Bill me

Charge to: VISA MasterCard AMEX

Acct. * _____

Exp. Date _____

Signature _____

*Please send this order card with payment in an envelope to: P.O. Box 550, Hightstown, NJ 08520-9893

Please allow 6-8 weeks for processing.



BYTE...The Perfect Gift

Reward the computer enthusiasts on your gift list with a year's subscription to BYTE — the definitive guide to personal computing.

Each gift will include 12 issues, plus a bonus issue dedicated to IBM PC's. Your first gift will cost only \$24.95 with additional gifts costing even less; only \$19.95 each — both great money saving rates when you consider that one year of BYTE purchased at the newsstand would cost \$42! (Canada: first gift C\$41.00, additional gifts C\$38.00 each.)

Don't get caught in the holiday rush, send us your gift list today or call 1-800-528-9150, ext. 845 and we'll do the rest.

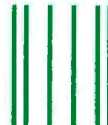

No Postage
Necessary
If Mailed
In the
United States

BUSINESS REPLY MAIL

First Class Mail Permit No. 42 Hightstown, NJ

Postage Will Be Paid By Addressee

BYTE

Computers and Communications Information Group
P.O. Box 550
Hightstown, NJ 08520-9886

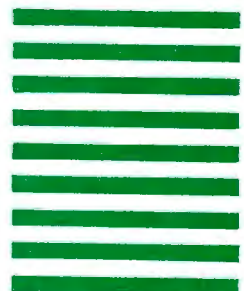

Order **BYTE** and **BIX** on disk Today!

Full Text of **BYTE** on Disk

Now you can order disks containing the full, machine-searchable text of articles. You can read and search the text with any word-processor. Excellent for reference and research! Disks can be ordered singly or by annual subscription. Full text of **BYTE** is available starting from September 1988.

BYTE Program Listings on Disk

BYTE listings on disk are the right choice if you want to compile or read the complete source code listings of programs. **BYTE** listings are available from December 1985 to present at the prices stated below.

Best of **BIX** on Disk

Receive highlights of each month's activities on **BIX**—**BYTE**'s world-class on-line conferencing system. You can read and search the text with any word processor. Each disk contains the most interesting and informative recent discussions specific to the machine you own. For example, order the **IBM** disk, and get the highlights from **IBM**-specific conferences. Disks can be ordered singly or by annual subscription.

BYTE also offers listings in print form. Order bound versions of the complete source code listings of programs excerpted from our articles. Handy for quick reference. Order singly or by annual subscription; with or without accompanying diskette version.

Call toll-free for more information: 800-258-5485.

ORDER FORM: To place your order, fill out the card and mail.

	IN USA		OUTSIDE USA	
	Single Month (1 disk)	Annual Subscription (13 disks)	Single Month (1 disk)	Annual Subscription (13 disks)
5-1/4 Inch: <input type="checkbox"/> IBM PC <input type="checkbox"/> Atari ST Other disk formats available. Call toll-free.	<input type="checkbox"/> Full Text of BYTE \$9.95 <input type="checkbox"/> BYTE Listings \$9.95 <input type="checkbox"/> Best of BIX \$9.95	<input type="checkbox"/> Full Text of BYTE \$79.95 <input type="checkbox"/> BYTE Listings \$79.95 <input type="checkbox"/> Best of BIX \$79.95	<input type="checkbox"/> Full Text of BYTE \$12.95 <input type="checkbox"/> BYTE Listings \$12.95 <input type="checkbox"/> Best of BIX \$12.95	<input type="checkbox"/> Full Text of BYTE \$99.95 <input type="checkbox"/> BYTE Listings \$99.95 <input type="checkbox"/> Best of BIX \$99.95
3-1/2 Inch: <input type="checkbox"/> Apple Macintosh <input type="checkbox"/> Atari ST <input type="checkbox"/> Amiga <input type="checkbox"/> IBM PS/2	<input type="checkbox"/> Full Text of BYTE \$10.95 <input type="checkbox"/> BYTE Listings \$10.95 <input type="checkbox"/> Best of BIX \$10.95	<input type="checkbox"/> Full Text of BYTE \$89.95 <input type="checkbox"/> BYTE Listings \$89.95 <input type="checkbox"/> Best of BIX \$89.95	<input type="checkbox"/> Full Text of BYTE \$13.95 <input type="checkbox"/> BYTE Listings \$13.95 <input type="checkbox"/> Best of BIX \$13.95	<input type="checkbox"/> Full Text of BYTE \$109.95 <input type="checkbox"/> BYTE Listings \$109.95 <input type="checkbox"/> Best of BIX \$109.95

FOR DIRECT ORDERING CALL TOLL FREE: 800-258-5485

Call: M-F, 8:30 a.m. to 4:30 p.m. Eastern Time
(603-924-9281 for New Hampshire residents)

For credit card orders only.



PLEASE COMPLETE IN FULL

OCTOBER

Name _____

Address _____

City _____ State _____ Zip _____

County or Parish _____ Country _____

Credit Card # _____ Exp. Date _____

Signature _____ Date _____

• Please indicate the issue date below. If you are beginning an annual subscription, note the starting issue.

Full Text of **BYTE**
 Month _____ Year _____

BYTE Program Listings
 Month _____ Year _____

Best of **BIX**
 Month _____ Year _____

Check enclosed
 MasterCard
 VISA
 U.S. funds enclosed
 (If ordering from outside the U.S. please remit in U.S. funds drawn on U.S. bank. Thank you.)

Please allow 4-8 weeks for delivery.



Order **BYTE** and **BIX** on disk Today!

Full Text of **BYTE** on Disk

Now you can order disks containing the full, machine-searchable text of articles. You can read and search the text with any word-processor. Excellent for reference and research! Disks can be ordered singly or by annual subscription. Full text of **BYTE** is available starting from September 1988.

BYTE Program Listings on Disk

BYTE listings on disk are the right choice if you want to compile or read the complete source code listings of programs. **BYTE** listings are available from December 1985 to present at the prices stated below.

Best of **BIX** on Disk

Receive highlights of each month's activities on **BIX**—**BYTE**'s world-class on-line conferencing system. You can read and search the text with any word processor. Each disk contains the most interesting and informative recent discussions specific to the machine you own. For example, order the **IBM** disk, and get the highlights from **IBM**-specific conferences. Disks can be ordered singly or by annual subscription.

BYTE also offers listings in print form. Order bound versions of the complete source code listings of programs excerpted from our articles. Handy for quick reference. Order singly or by annual subscription; with or without accompanying diskette version.

Call toll-free for more information: 800-258-5485.

ORDER FORM: To place your order, fill out the card and mail.

PLACE
POSTAGE
HERE

BYTE & BIX on Disk

One Phoenix Mill Lane
PO Box 809
Peterborough NH 03458-0809

Reflected Light

*Lasers are the way to go for brightness and sharpness
in a world dominated by speed and resolution*

Gary T. Forrest

A spot of light can never be too small or too bright. This emphasizes the two fundamental user advantages of *lasers* (light amplification by stimulated emission of radiation): sharpness and brightness.

Sharpness refers to a laser beam's ability to be focused to a *diffraction limited spot*—that is, a spot limited in size only by the wavelength of the light. *Brightness* refers to the amount of light delivered to a target area. It depends on the spot size and the amount of energy in that spot. With a 100-watt light bulb, you can read a book; with a 100-W laser, you can burn a hole in the book. Lasers come in many forms, including gas, solid-state, and semiconductor designs. Each form has its own range of output wavelengths and power (see figure 1 and the text box "Laser Power" on page 250).

Approaching its thirtieth birthday, laser technology has finally begun to have a major impact on our lives. Lasers are now in many of our homes inside compact disk players (with CD video coming soon). Laser bar code scanners tabulate prices and update inventories in our stores. Laser printers are used for

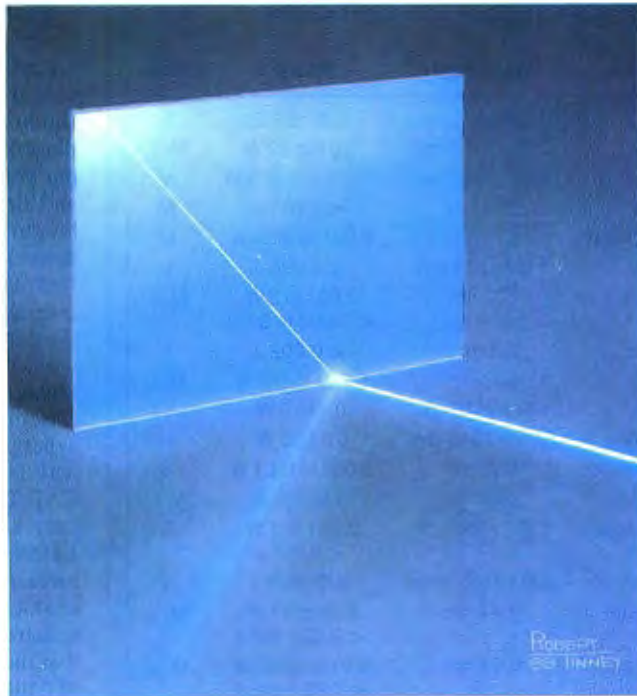

high-quality hard-copy output. And earlier this year, erasable optical data storage received a major boost when NeXT introduced a workstation with the Canon erasable optical disk drive. But these developments are just the beginning.

Resolution vs. Speed

The two fundamental properties, brightness and sharpness, determine the den-

sity and speed that a specific application is able to achieve. Take, for example, a laser printer that uses a semiconductor laser, like the one in figure 2. A shorter-wavelength laser diode (say, of 680 nanometers versus the 780 nm presently used) will print a smaller spot size on the paper, thereby increasing the resolution.

But the power delivered to the paper—the brightness—will determine the printing speed. Currently, 680-nm laser diodes are available commercially with up to 5 milliwatts of power; on the other hand, 780-nm laser diodes (a more mature technology), are available with powers of up to 100 mW. So 780-nm diodes currently dominate laser-printer and data-storage applications.

In the past, the available types of lasers often dictated the results of the resolution-versus-speed trade-offs. For example, you can find visible-output gas lasers using krypton gas with powers of several watts that have wavelengths shorter than 780 nm (see figure 1 and table A), so why not use them in laser printers? Gas lasers have been used in printers, but they range in size from a

continued

Laser Power

Lasers are generally characterized by their output wavelength, measured in nanometers, microns, or angstroms. For a given type of laser, the output wavelength can often be changed by altering the laser medium.

For example, an excimer laser can operate on mixtures of argon fluoride, krypton fluoride, xenon chloride, and xenon fluoride, with corresponding output wavelengths of 193, 248, 308, and 351 nm, respectively.

In other cases, such as argon-ion lasers, there are several possible lasing transitions, which (depending on the reflectivity of the optics coatings) can allow operation at 488 nm, 514.5 nm, and various other ultraviolet and blue/green wavelengths.

In the case of semiconductor lasers, the output wavelength is determined in part by the composition of the active re-

gion. The most common laser diodes are those used in compact disk players (780 nm) and for telecommunications (1300 to 1550 nm). Although a wide variety of laser-diode wavelengths is possible, economic considerations often limit those available commercially to relatively few.

Although the most commonly used solid-state lasers are neodymium-doped yttrium aluminum garnet (YAG), you can use other lasing hosts (including glasses and crystals) and dopants. Other hosts are actually preferable when you need specific wavelengths. In addition, you can convert the output of a laser to a different wavelength using various dyes and nonlinear materials.

Among the most popular of these conversions in recent years has been converting the infrared output of solid-state lasers at 1064 nm to 532 nm (in the

visible-spectrum region). Another example is generating ultraviolet output starting with frequency-doubled solid-state lasers (converting 532 nm to 266 nm) or argon-ion lasers (converting 488 nm to 244 nm).

In considering a laser for a particular application, the most important criteria are those in table A. (The lasers listed are only a fraction of the nearly 200 models and types of lasers listed in the *1989 Laser Focus World Buyer's Guide* [Tulsa, OK: PennWell Books].) Lasers often require significant adjustments to achieve various output wavelengths.

Similarly, the power available may depend on the specific wavelength. For example, dye lasers (not discussed here) use a liquid lasing medium, pumped by either a laser or a flash lamp. You can operate these lasers in either a pulsed or continuous-wave (CW) fashion with

Table A: The lasers are listed in order of their low-end wavelength (see figure 1 for a graphical description). Power measurements are given in watts (W) and joules (J), and size is given as small (S), medium (M), and large (L).

COMPARATIVE PROPERTIES OF COMMON LASERS

Laser	Type	Wavelength	Power	Size
Excimer	Gas	193 to 351 nm	0.01 to 1 J	L
Argon ion	Gas	257 to 514 nm	0.01 to 20 W	M, L
Helium cadmium	Gas	325 to 442 nm	0.001 to 0.075 W	M
Nitrogen	Gas	337 nm	< 0.001 J	M
Doubled diode	Semiconductor	432 nm	0.001 to 0.01 W	M
Copper vapor	Gas	510 to 578 nm	< 0.005 J	L
Doubled YAG ¹	Solid state	532 nm	0.001 to 2 W < 0.001 to 0.5 J	M, L
Gold vapor	Gas	628 nm	< 0.002 J	L
Helium neon	Gas	632 nm	0.001 to 0.1 W	M, L
Krypton ion	Gas	647 to 676 nm	0.1 to 5 W	M, L
Titanium sapphire	Solid state	670 to 1040 nm	0.1 to 3 W	L
InGaAlP ²	Semiconductor	680 nm	0.001 to 0.01 W	S
Ruby	Solid state	694 nm	1 to 100 J	M, L
GaAlAs ³ diodes	Semiconductor	780 to 880 nm	0.001 to 1 W < 0.001 J	S
GaAs ⁴ diodes	Semiconductor	890 to 1060 nm	< 0.0001 J	S
Neodymium YLF ⁵	Solid state	1047 nm	0.02 to 17 W < 0.001 to 2 J	M, L
Neodymium YAG	Solid state	1064 nm	0.01 to 1000 W < 0.001 to 2 J	M, L
InGaAsP ⁶ diodes	Semiconductor	1300 to 1550 nm	0.001 to 0.1 W < 0.000001 J	S
Carbon monoxide	Gas	5000 to 7000 nm	3 to 20 W < 0.01 J	M, L
Carbon dioxide	Gas	9000 to 11000 nm	1 to 5000 W 0.1 to 500 J	M, L

¹Yttrium aluminum garnet
²Indium gallium aluminum phosphide

³Gallium aluminum arsenide
⁴Gallium arsenide

⁵Yttrium lithium fluoride
⁶Indium gallium arsenide phosphide

foot long to several yards long, and they require air cooling and often water cooling.

Laser diodes have solved this problem. Laser diodes the size of a grain of sand are now packaged in small, hermetically sealed cans less than a centimeter in size. Building on the explosive success of CD players (going from a few hundred units per year to millions in just a few years, and driving the laser-diode price from hundreds of dollars down to single-digit prices), Canon was able to marry small, inexpensive laser diodes with low-cost personal copier designs. The result was the personal computer laser printer.

Designed by Computer

Lasers and computers have entered into a synergistic phase. At the simple mechanical-design level, the laser industry uses CAD/CAM systems to design and fabricate high-tolerance mechanical parts. Lasers require alignment tolerances of mere fractions of a wavelength, so mechanical precision is essential in their construction. For a typical visible laser, this means tolerance on the order of tens of nanometers.

Looking a little deeper, computers are used to optimize laser-cavity designs. This is accomplished by what-if iterative *ray tracing*, following the optical path of the light in the laser cavity as various design parameters change (see figure 3).

For example, one of the main factors contributing to the operating efficiency of a laser is matching the *pump-mode volume* (the area that the pump light illuminates) to the *lasing-mode volume* (the

powers up to 1.5 watts and energies up to 3.5 joules. By changing the lasing dye, you can adjust the output wavelength from 205 nm to 1000 nm, depending on the design of the laser and the pump or lamp used.

To accomplish a specific task, such as welding or writing to an optical disk, the power or energy of the laser is an important characteristic. CW lasers put out a constant power, usually indicated in watts, milliwatts, or microwatts. Pulsed lasers are rated in joules, millijoules, or microjoules.

You can pulse a laser with several different techniques, depending on its design. For example, you can pulse the flashlamp used to pump the laser, resulting in a pulsed laser output. You can also place a high-speed (i.e., where the speed is measured in nanoseconds) shutter inside the laser cavity and use it

to periodically interrupt the laser beam. This results in a pulsed output with a duration of a few tens of nanoseconds. For semiconductor laser types, you can pulse the input current with a TTL-type signal or very short picosecond pulses, again resulting in pulsed output.

The primary purpose of pulsing a laser is to achieve higher *peak powers*—that is, greater energy per unit time. Using these techniques, you can achieve gigawatts of peak power; in some specialized lasers (like those used for laser fusion), you can even achieve terawatts of output power. It is common for the same lasing material to come in either a CW or pulsed design. A few of the more common ones that come in both are neodymium YAG, carbon dioxide, and the semiconductor laser diodes.

Finally, the overall size of the laser can be important, as lasers are often

built into other equipment. For example, a laser-based air-pollution monitoring system that has to be carried in a small airplane must be small enough to fit in the plane and must be compatible with the electrical and water-cooling utilities available.

In table A, the classification of size is L for large (more than 1 meter in length, usually requiring water cooling and 220- or 440-volt electrical power), M for medium (roughly the size of a shoe box, often 110-V powered and air-cooled), and S for small (typically requiring low voltages for operation and packaged in electronics-type housings with dimensions measured in centimeters or less). The size is often dependent on the output power of the laser, as higher-power lasers require more active lasing area and typically generate more waste heat that needs to be removed.

active region of the lasing material). Design iterations done on a CAD system allow you to optimize these two volumes for maximum overlap and efficiency.

With laser diodes and electro-optic devices, you can model the simultaneous interaction of electric and optical properties. For example, Spectra-Physics (Mountain View, CA) made extensive use of a microcomputer-based CAD system in designing its new titanium-doped sapphire laser.

For their basic operation, lasers require optical coatings that have unique reflective properties. Virtually all lasers have a highly reflective rear-mirror surface as well as a partially reflective front surface that emits part of the laser light (see figure 3). Some surfaces need to be antireflective and allow light to be coupled into the laser or a device efficiently.

If lasers came in only one type and one wavelength, then designing coatings to achieve these reflectivities would be a one-time problem. But the wide range of wavelengths available requires almost as wide a range of materials for both reflective surfaces and coatings. As a result, multiple layers of materials are used to coat optics forming *stacks*. The thickness of each layer is a fraction of the wavelength of the light being reflected.

Computers now let you determine the physical parameters you want and then use a computer model to calculate the required coating geometry. In addition to coatings, CAD-generated optics let you draw and fabricate (by diamond turning)

continued

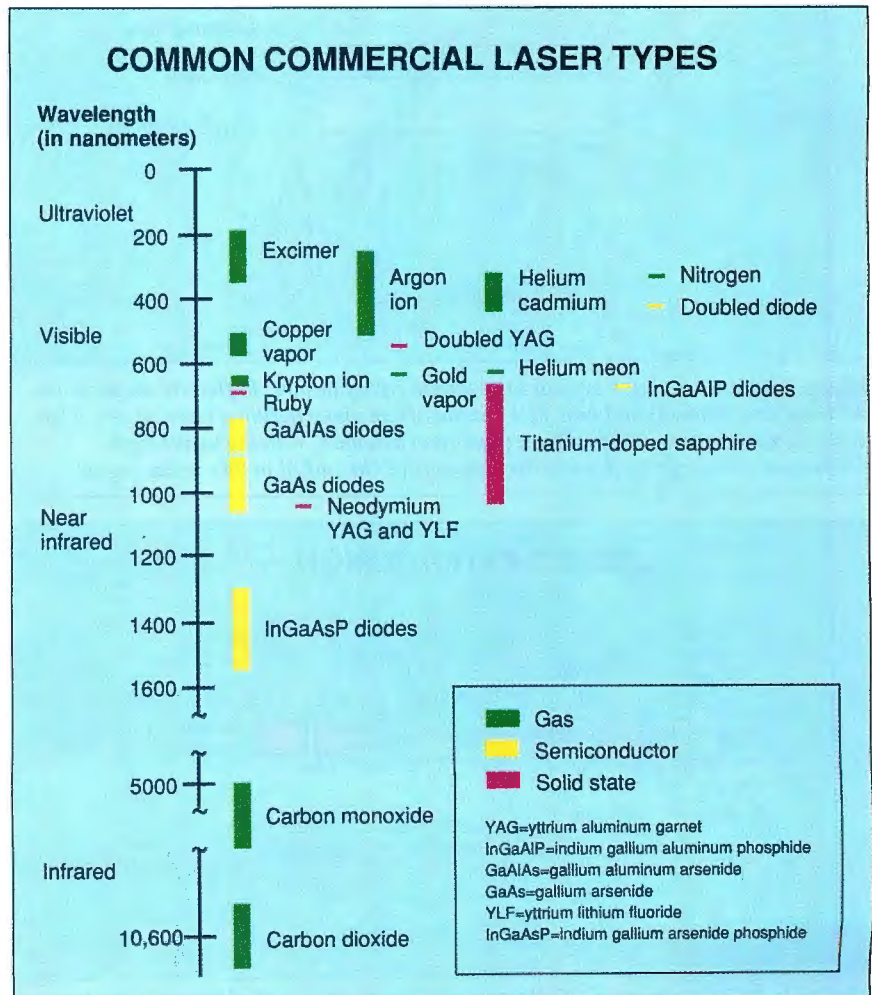

Figure 1: The three types of lasers shown here—gas, solid-state, and semiconductor—are all capable of generating visible light. (See table A.)

unique aspheric surfaces completely under computer control.

Controlled by Computer

For the laser's advantages of brightness and sharpness to be useful, you often need to manipulate the direction it points in. In addition to simple fixed and scan-

ning mirrors, scanning galvanometers and electro-optic deflectors are the most common ways of moving laser beams around. Or, instead of moving the laser, you can move the work piece with a motor.

Such computer-controlled systems can be as simple as an AT&T PC 6300 driv-

ing a motorized microscope stage under control of CAD Design 3 (see photo 1) or Harvard Graphics for micromachining. Or they can be as sophisticated as using a Personal Iris system from Silicon Graphics (Mountain View, CA) as the CAD/CAM interface to the Stereolithography Apparatus from 3-D Systems (Valencia, CA), which moves an ultraviolet laser beam under computer control through a polymer matrix to fabricate prototype plastic parts. 3-D Systems also offers 80286/DOS- and 80386/Unix-controlled systems for which you provide your own CAD/CAM interface.

In the most general sense of automated control, you can control lasers over conventional RS-232C and general-purpose interface bus interfaces and coordinate their action with other test and fabrication devices. For example, Questek (Billerica, MA) used National Instruments' (NI) LabView software to control the micromachining functions of its excimer-laser system, which you can interface with VersaCAD (see photo 2).

In the laser-equipment field, last year the Newport Corp. (Fountain Valley, CA), the leading optical-equipment catalog-supply company, became the exclusive catalog distributor for LabView and LabWindows (NI's software for optics applications, for Macintosh and IBM PC-compatible computers, respectively). In the laser community, this is tantamount to a major endorsement of computer control and coordination of lasers and test instruments (see photo 3). As a result, laser companies have begun to offer hardware and even customized software interfaces for computer control of laser functions.

At a more subtle level, lasers have had a dramatic impact on workstation performance. In 1988, during the DRAM shortage, availability of 1-megabit DRAMs made the difference between having and not having high-performance workstations. The long-time leader in using lasers for memory repair, Electro-Scientific Industries (ESI) (Portland, OR), dramatically improved chip yields through a process of removing defective memory cells.

ESI uses a new all-solid-state laser technology: Q-switched, diode-pumped, solid-state lasers that operate under the control of proprietary software running on a Hewlett-Packard 9000 Series 300 computer. These lasers cut specific links on the IC with a short laser pulse only tens of nanoseconds long. They have an operating period without maintenance 10 times longer than that of similar flash-lamp-pumped lasers. Using this laser-

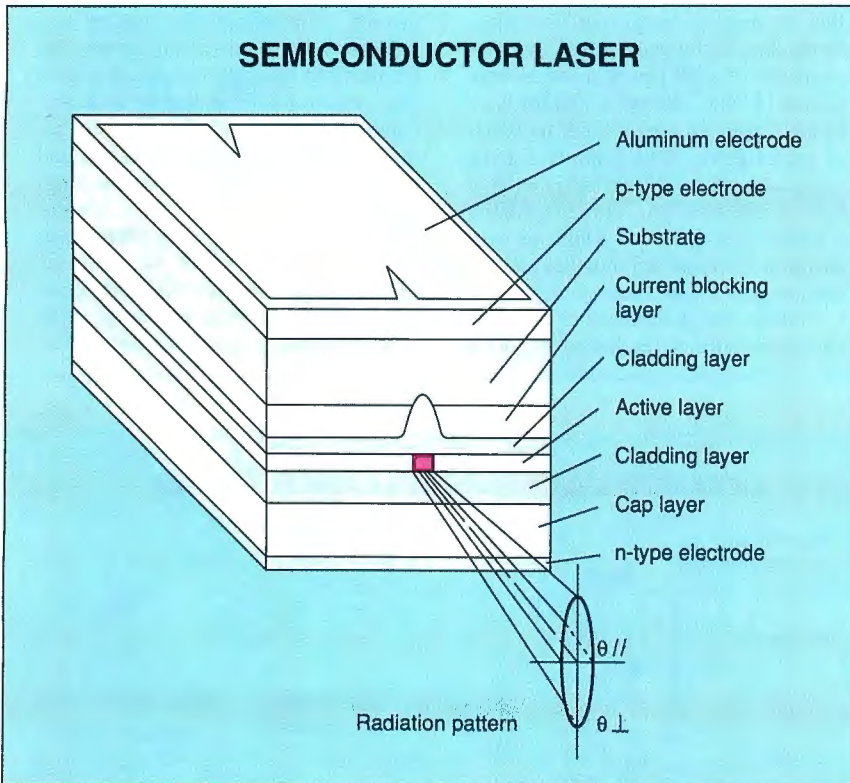

Figure 2: Illustration of a typical laser-diode cavity design. Reflective surfaces on the front face (shown) and rear face (hidden from view) define a laser cavity. The active layer is composed of gallium aluminum arsenide, with the wavelength determined primarily by the relative amounts of Ga and Al in this active region.

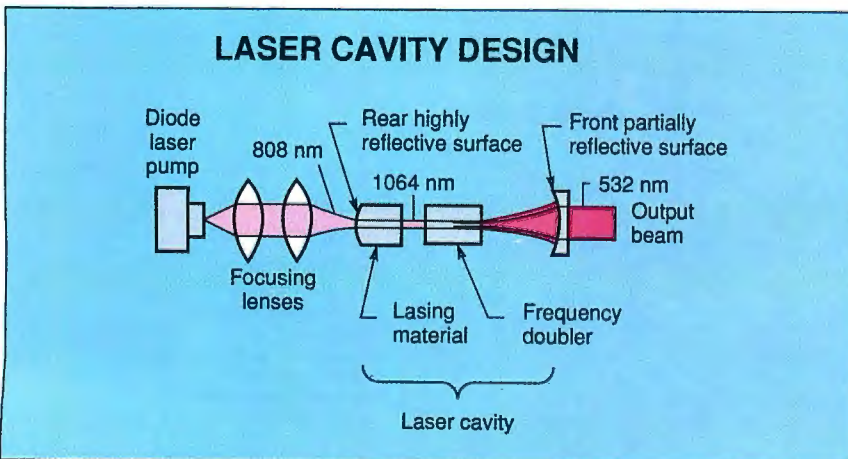

Figure 3: A CAD-generated, diode-pumped, frequency-doubled laser cavity. It illustrates the conversion of low-quality infrared diode-laser-pump light to high-quality infrared (1064 nm) and visible (532 nm) light in an all-solid-state design.

repair technology allowed the DRAM supply to catch up with demand.

Lasers have now become the de facto standard in testing IC devices as well; solid-state and xenon gas lasers operating in the infrared and green wavelength regions are preferred. At Semicon West in May in San Mateo, California, lasers appeared in all the failure-analysis stations displayed in the form of manual-probe stations. But powerful new automated computer verification and test software, such as Merlin's Workbench from Knights Technology (Cupertino, CA), allow the full integration of electrical testing and evaluation with laser processing—all operating under SunWindows.

As the electronics industry moves toward higher-resolution linear circuits and mixed analog and digital circuits, lasers are playing a critical role in fabricating thin-film resistors. High-precision resistor trimming allows higher-resolution D/A converters to be made with greater linearity. The laser trims the device by cutting a continuous groove (thus changing the resistance) during device testing.

In addition to ESI, such thin-film hybrid resistor-trimming systems using long-lived, Q-switched, diode-pumped, solid-state lasers are now offered by Teradyne Laser Systems (Boston, MA) and XRL, Inc. (Norwell, MA). Both of these companies use Sun-3 workstations as the primary user interface. In a closely related application, Micrion Corp. (Peabody, MA) has developed a large-screen LCD thin-film resistor-repair system that uses the same type of all-solid-state infrared laser, but now frequency-doubled from 1064 nm to 532 nm for green-light output. This is accomplished by using a nonlinear frequency-doubling crystal, potassium-titanyl phosphate.

Together with CAD systems, lasers are a major facilitating factor in the evolution of machines that are designed and built by other machines. Other examples include using helium-neon (HeNe) lasers in interferometers for precise distance measurement and in pointers for alignment, excimer lasers for high-density deep-ultraviolet semiconductor lithography, ultrafine printed-circuit-board hole drilling, surface-mount printed-circuit-board component attachment by tape-automated bonding, and laser cutting and soldering. The common element in these areas is the use of computers to precisely position and control the laser beam, allowing the application to make maximum use of the brightness and sharpness of the laser beam.

continued



Photo 1: A Q-switched, diode-pumped, neodymium yttrium-aluminum-garnet laser from Spectra-Physics, attached to a microscope. Under control of the AT&T PC 6300, a CAD Design 3 image is being scribed onto a coated plate. The two monitors show the CAD image (in color) and a section of the scribed image (in black and white). Nicknamed the "Laser Blade," this system is unique in that the diode laser-beam pump light is transported from a power-supply box to the neodymium YAG laser head via an optical fiber. This results in a very small, pencil-size laser head that you can attach directly to the microscope. (Photo courtesy of W. Scarvie, Spectra-Physics, Inc.)



Photo 2: An excimer laser interfaced with a CAD system, and the same laser controlled by a Mac II under LabView. (Photo courtesy of Questek, Inc.)



Photo 3: National Instruments software, controlling instrumentation for testing lasers. Notice the power meter and stage-positioning system integrated with an IBM PC under the control of LabWindows. The CRT display shows the laser-beam intensity. (Photo courtesy of Newport Corp.)



Photo 4: This image was generated using Pixar's RenderMan software and printed directly on color film using three visible wavelength lasers. (Photo courtesy of Pixar, Inc.)

Better Performance with Laser I/O

Laser technology has also had a major impact on computer input and output devices. High-resolution input scanners require the sharpness of lasers, and the *monochromaticity*, or single-color nature, of lasers has made them the standard for scanning documents for color separation and digitization. The most popular lasers for these applications have been red (632 nm) HeNe and blue/green (488 nm and 514.5 nm) argon-ion lasers. These lasers have beams that are visible to the human eye, so they are easy to align in scanning systems, and when focused to small spot sizes, printers and scanners can operate at high speeds.

Optical data storage in the form of CD-ROMs, WORMs, and now erasable optical data storage allow huge increases in storage capacity because of the small size of the laser beam spot. In the past, the lack of reliable high-power (more than 30 mW) laser diodes for the erasure cycle held back the development of erasable optical data storage. At lower powers, erasure was too slow for commercial acceptance. Now, high-power lasers (more than 50 mW) are available that can be focused to small spot sizes.

Much-higher-power lasers (over thousands of milliwatts continuously and tens of thousands of milliwatts when pulsed intermittently) are available from laser diodes, but the laser design results in much larger beam sizes, which negates a key reason for using the laser in the first place—a small spot size.

The next revolution in optical data storage is likely to occur quickly, with 680-nm laser diodes replacing 780-nm laser diodes to increase storage density. Although the shorter 680-nm wavelength can achieve a smaller spot, the output power of the 680-nm devices is currently limited to about 30 mW (and most suppliers will guarantee the lasers up to only about 5 mW).

One of the most easily recognized laser applications is bar code scanning: both the slot scanners used in stores and the hand-held scanners used for inventory control. Historically, these scanners, which measure the light reflected from the patterns of bars, have used HeNe gas lasers emitting at 632 nm.

The bars encode price and other information tied into an inventory-control system. Virtually all products sold to the U.S. government must have bar code identification labels. Manufacturers are upgrading production lines to track parts by bar codes and to automate warehouse storage of assembled products.

continued

The end of the terror message.

Each one of these PC screens is saying something different. But they're all telling you the same thing.

You and your data are in a whole lot of trouble.

Perhaps someone hit the wrong key and deleted your data by accident.

Perhaps it's simply lost somewhere on your disk.

Or perhaps the disk is corrupted and everything is lost.

Perhaps you should get the new Norton Utilities®

Because only the Norton Utilities can take the terror out of all these error messages.

If someone has accidentally

deleted your data, fear not.

Our legendary *UnErase*® can resurrect it with a few simple keystrokes.

If you've misplaced it—which, when you're dealing with a hard disk, is terrifyingly easy to do—our *File Find* will come to the rescue.

And what if worse comes to worst and your whole disk goes down?

Cheer up.

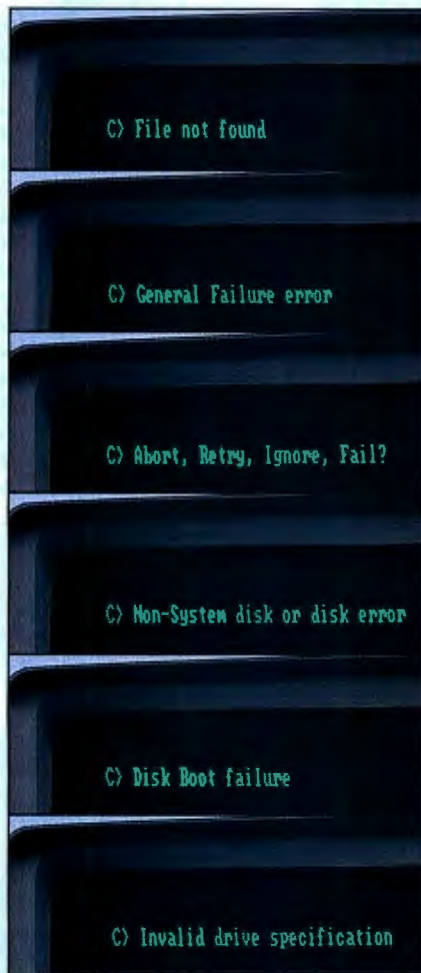

The extraordinary new *Norton Disk Doctor*™ will determine the exact nature of the problem, report it and, in most cases, fix it for you.

All by itself.

In fact, if the Doctor can't cure your corrupted floppy or hard disk, then Buster, you've got one corrupt disk.

In which case, you'll need to refer to *The Norton Trouble-*

shooter, a 158-page guide to finding and fixing most anything that could go wrong.

Don't worry, you don't have to go to the library or the bookstore to refer to it, because it's included in the Advanced Edition.

Along with 24 more organizational and disk management utilities we don't have space to mention.

PC Magazine calls the Norton Utilities "indispensable."

You'll want to call your local software dealer. Or call us at 1-800-365-1010.

Then you'll have nothing to fear but fear itself.

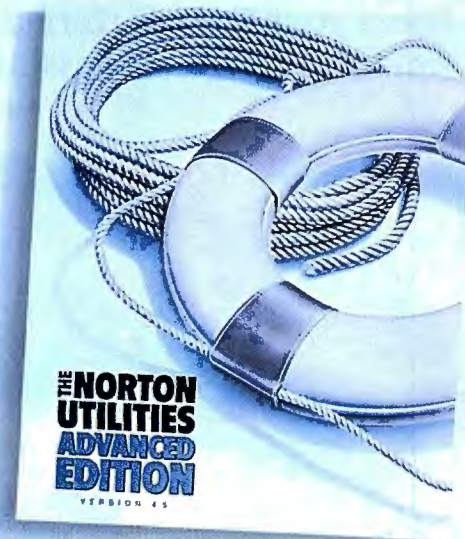

Peter Norton
COMPUTING

New red (680-nm) laser diodes are having a profound impact on hand-held bar code scanners. Laser diodes operate at much lower currents than HeNe lasers, making hand-held bar code readers possible. (780-nm laser diodes can read the bar codes, but some colors show poor contrast at this longer wavelength.) This change in technology will probably lead to using bar codes on even more products as bar code scanners become smaller and less expensive.

Color Is Coming

Perhaps the biggest change of all is yet to come: full-color laser-printed images. Pixar (San Rafael, CA) and Kodak (Rochester, NY) have invested in several levels of laser technology to demonstrate that three primary-color lasers can generate high-resolution color output.

Several years ago, the only lasers available were large, often water-cooled, gas lasers. Now, laser diodes have generated three new classes of laser devices: red (680 nm) laser diodes, frequency-doubled green (532 nm) diode-pumped solid-state lasers, and directly doubled blue-output (432 nm) laser diodes.

More recently, Kodak has pursued a pure infrared laser diode design, in which each laser diode represents the intensity information for one of the three primary colors. But the need for three closely spaced wavelengths in the 780-nm to 880-nm range severely limits this approach.

Pixar has used a more conventional concept based on three visible lasers, with a 532-nm frequency-doubled solid-state laser replacing the previous 528-nm argon-ion gas laser. The new solid-state laser occupies about one-tenth the space. More important, it has an output wavelength with less *spectral overlap* with the red light response of typical photographic film and papers. This means that the green exposure has less effect on the red emulsion layer, and the final result is a purer red color tone in the photograph (see photo 4).

The remaining missing link is a blue solid-state laser, but IBM, Amoco Laser (Naperville, IL), and Spectra-Physics have shown in the past year that such lasers can be made with powers of several milliwatts—and potentially much higher power.

Originally developed in the Industrial Light and Magic group at LucasFilm, the laser scanner (which can be used as both an input scanner and an output printer) is now part of the Pixar electronic-dark-room project. The system operates by simultaneously scanning three laser beams across the film to write (or read) information about the color tone and intensity at each pixel.

The premise is very simple: Whether the image is completely computer-generated (in the case of the Pixar RenderMan software) or originates from an electronic camera, at some point you'll want to show the results to someone else. The solution is hard-copy output that retains the color fidelity and sharpness of the original image. Of course, if you didn't like the original image, changes are only a few keystrokes away. ■

Gary T. Forrest is president of FYI Reports and provides writing and consulting services to companies in the laser and optoelectronics fields. He has a Ph.D. in chemistry from MIT, where he used lasers for biomolecular research. He can be reached on BIX c/o "editors."

AutoKey 400 programmable macro keys !

Simplify DOS, D-base, Lotus 1-2-3.
Boost your CAD performance.
Automate word processing.

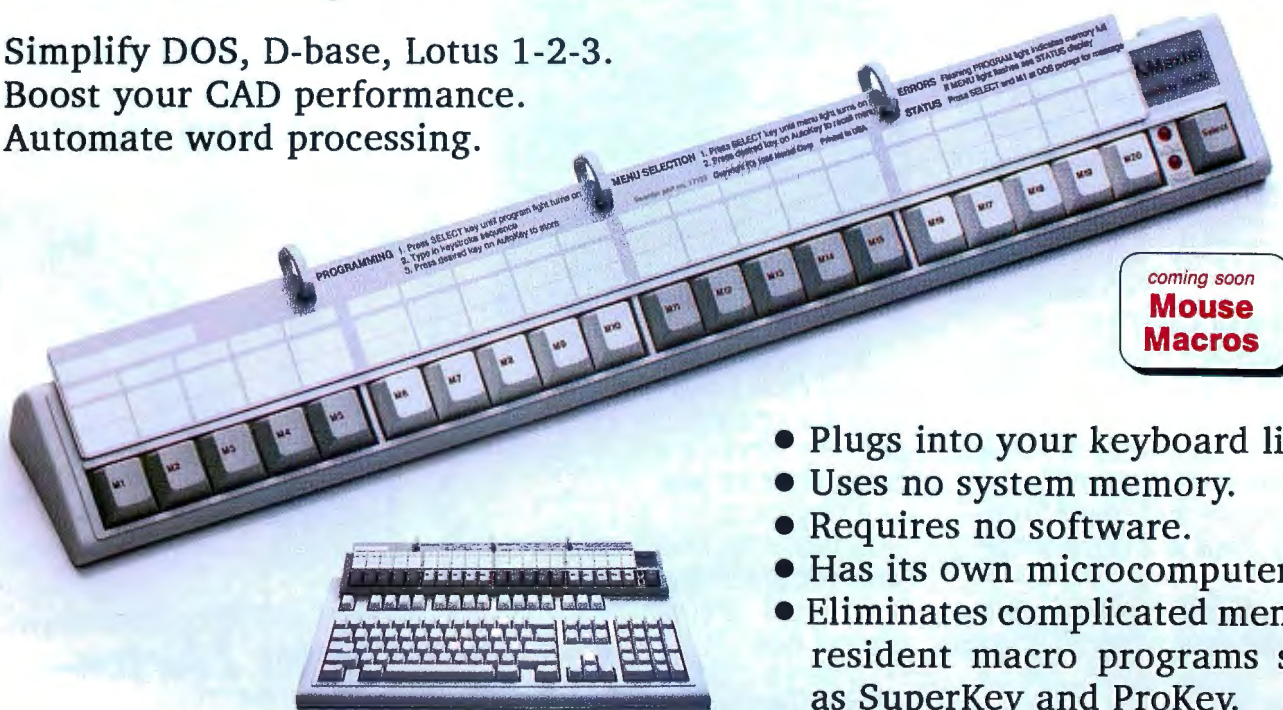

- Plugs into your keyboard line.
- Uses no system memory.
- Requires no software.
- Has its own microcomputer.
- Eliminates complicated memory resident macro programs such as SuperKey and ProKey.

Mextel Corp. 159 Beeline Road
Bensenville, Illinois 60106

AutoKey is trademark of Mextel Corp. All other product names are trademarks of their respective manufacturers. ©1989 MEXTEL CORP.

Call 1-800-888-4146
(inside IL call 312-595-4146)

AutoKey 40 \$139.00
AutoKey 20/20 \$289.00

Visa/MC/AmEx.

Things To Do, People To See, Places To Go.

Make friends. Buy a cockatoo. Make a million. Fly to Tahiti. Phone home. Shop 'til you drop. Get rich quick. Make a good impression. Get married. Fall in love. Go for broke. Meet "Sagebrush Sally." Improve yourself. Learn to cook. Bargain hunt. Invest wisely. Get smart. Talk back. Name that tune. Lighten up. Pontificate. Talk turkey. Get involved. Dress for success. Name drop.

When you join CompuServe, your computer becomes a time-saving, money-making, life-enhancing tool. Because CompuServe gives you access to a long list of services and resources that can help make your life easier, more profitable, and a whole lot of fun.

With CompuServe you can shop

in over 100 stores from the comfort of your favorite easy chair. We have personal investment information to help you feather your nest, and travel services to make it easier to fly south for the winter. We even have over 500,000 other CompuServe members for you to talk to (in your newly acquired spare time).

So become a member of CompuServe. And turn the time you spend with your computer into quality time.

To join CompuServe, see your computer dealer. To order direct or for more information, call 800 848-8199.

CompuServe

REMOVABLE. ERASABLE. OPTICAL. REMARKABLE!

REO-650 single-drive system
\$4,995

REO-1300 dual-drive system
\$9,990

650/600 Meg optical cartridges:
\$250 each

Interface kits for Macintosh,
Sun, HP, IBM-AT, XT, PS/2
and compatibles:
\$995 each

Pinnacle Micro is the world's leader in removable, erasable, optical storage systems for personal and workstation computers.

The REO-650 is a single drive, SCSI system. The REO-1300 is a dual-drive system. Up to 1.3 gigabytes of facts and figures at your fingertips!

Each optical cartridge holds up to 650 megabytes of precious memories. Graphics. CAD files. Databases. Images.

You can write, erase and rewrite data... file by file... a million times or more.

Interface kits give you the flexibility to use Pinnacle drives with the computer of your choice: Macintosh. Sun Microsystems. Hewlett Packard. IBM-AT, XT, PS/2 and compatibles.

Software provided with each kit supports a host of working environments: UNIX, Xenix, Novell Netware 2.1, and many more.

Removable, erasable, optical. The new standard in mass storage. Available now from Pinnacle Micro.

Call today for the location of your sales representative or authorized dealer.

 (800) 553-7070

Trademark owners: REO-650, REO-1300 and Pinnacle Micro of Pinnacle Micro, Inc. Sun of Sun Microsystems. HP of Hewlett Packard. AT, Xenix, IBM, PS/2 of International Business Machines Corporation. Netware of Novell. Macintosh of Apple Computer Inc.

PINNACLE MICRO

15265 Alton Parkway • Irvine, CA 92718 • In CA (714) 727-3300 • FAX (714) 727-1913

THE ERASABLE OPTICAL STORAGE COMPANY™

Circle 312 on Reader Service Card (DEALERS: 313)

Gigabytes On-Line

*Erasable optical storage
brings mass storage to the masses*

James J. Burke and Bob Ryan

Although backed by the likes of Sony, Philips, and Microsoft, optical storage has yet to catch on with most personal computer users, mainly due to the lack of a read/write capability. Now, with the introduction of rewritable optical disks, optical storage has become a potent rival to magnetic storage.

Rewritable optical technology is the most recent addition to the line of optical-storage products. CD-ROM—the original read-only optical-storage technology—has been available since the mid-1980s. And more recently, WORM (write once, read many times) technology has made an impact in areas requiring the random-access retrieval of permanent, non-erasable data and images. WORM “jukeboxes” with more than 1 terabyte (1 million megabytes) of storage have found their way into large government and business operations. With such a device, you can access any business document or engineering drawing in 10 seconds or less.

The Optical Advantage

All types of optical storage have certain advantages over magnetic storage. The



primary advantage is storage density: You can get a lot more information on an optical disk than on a comparably sized magnetic disk. Due to the precision with which a laser can be focused, recording tracks on an optical disk are much closer together than tracks on a magnetic disk. Also, the amount of space needed to record an optical bit is much smaller than that used by magnetic media.

Another advantage of optical recording is that it is a great deal less sensitive to deterioration or contamination than magnetic recording media. This is because nothing touches the active recording layer except for the beam of light. The transparent substrate keeps dust and dirt from the focal spot so they cannot change the reflected signal substantially.

Optical disks are also far less susceptible to head crashes than are magnetic disks. Typically, an optical disk head comes no closer than 1 millimeter from the disk substrate. In contrast, the high-performance head of the IBM 3380 magnetic drive flies just 0.25 micrometer (μm) from the surface of the disk.

It has taken 30 years of research and development to learn how to produce reliable devices with such flying heights. Even at that, head crashes still occur. For obvious reasons, any attempt to remove a high-performance hard disk from its drive would be the end of the useful life of both. Optical disks, on the other hand, are easily loaded and removed, thus enabling the massive storage capacity of jukeboxes.

continued

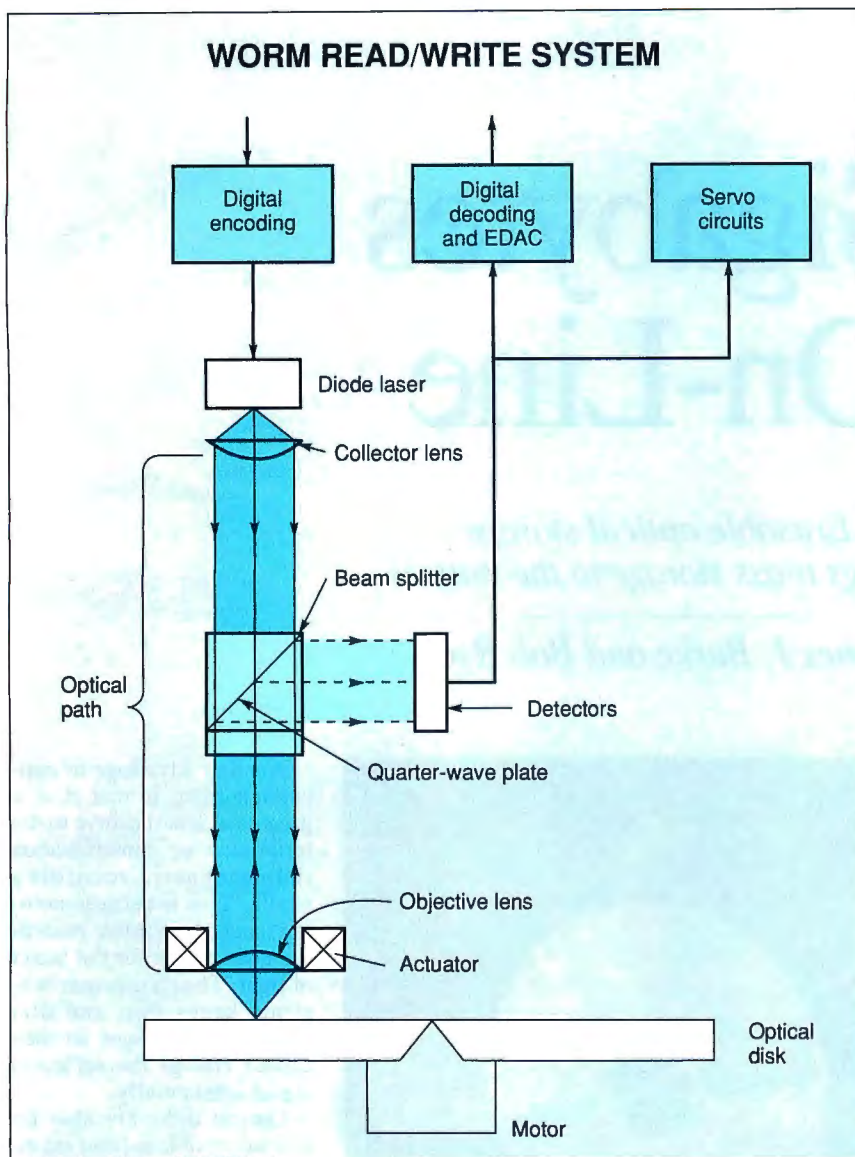

Figure 1: A strong laser pulse writes by creating a pit (or a bubble) at the recording layer. The reflectivity of the weaker read beam is analyzed to detect the presence or absence of pits. Compact-disk systems are very similar, except, of course, that they are read-only. (Figure courtesy of Paul Y. Hu)

Standards

Optical disks come in a variety of sizes and constitutions. You can buy 5¼-, 8-, 12-, and 14-inch WORM drives. Compact-disk media, whether carrying digitized audio, computer data, or both, are standardized to 120 mm (4.724 inches). Thanks to standards defined by Philips and Sony, CD-ROM disks from all suppliers use the same protocols and are thus readable in all players. They are becoming the medium of choice for publishing extensive documentation. The opposite is true with WORM drives: Data written on one vendor's WORM drive usually cannot be read by another's.

Most of the rewritable optical products announced thus far use 5¼-inch disks and promise to be interchangeable. It's too early to judge whether experience will bear this out. In addition, erasable optical disks with 3½- and 2-inch formats are also under development. Standards in this area are not as well developed as compact-disk standards.

Storage Variety

CD-ROM is the oldest and best-defined optical-storage technology. It is used primarily for publishing large amounts of information that don't require constant updating. Its major limitation, of course,

is that it is a read-only medium.

Compact disks are replicated in much the same way as phonograph records. The disks are injection-molded in dies wherein all the format and data marks appear as raised ridges or hills on one of the interior faces. The original (also called the *master*) disk is written with great precision in photoresist by an argon-ion laser. After development of the master, a negative *father* disk is formed by electroplating. The father is used as a stamper to form a *mother* disk, whose negative *sons* become one face of the dies used in the injection-molding process that yields the final product. Polycarbonate is the material of choice because of its strength and durability.

WORM technology is a step beyond compact disks. You can write your own data to a WORM disk, although you can't change what you have written. WORM storage is ideal for storing custom data that is not updated often.

WORM drives feature many different designs. In some, absorption of a strong laser pulse causes local vaporization on dye-polymer media (organic films containing absorbing dyes). This forms a bubble in a thin absorbing layer above the active layer. In other designs, the laser ablates a pit in the material, exposing a highly reflective metal film below the active layer. The resultant change in reflectivity experienced by the weaker read beam is used to sense the presence or absence of a pit or bubble.

Another common active material used in WORM media is semimetallic tellurium. A strong laser pulse writes in tellurium by melting it; the attendant surface tension opens a hole (or pit) in the film, which freezes when it cools.

Other material systems are in use and under study today as the industry looks for ways to produce media less expensively. WORM disks cost about \$100 in 5¼-inch format. Capacity varies from 300 to 600 megabytes per side. On 12-inch disks, capacity is typically 1 gigabyte per side. The 14-inch disks can hold more than 3 gigabytes per side.

Read/Write Technology

Figure 1 is a schematic illustration of the major components of a WORM read/write system. The left side of the figure shows the optical pathway. The read/write head contains a laser diode whose current is modulated electronically during writing to produce pulses of light. The beam of pulses travels through collimating optics, a polarizing beam splitter, and a quarter-wave plate to a focusing objective lens. The beam splitter is

designed to transmit light polarized in one direction and to reflect light polarized in the perpendicular direction. The quarter-wave plate changes the polarization of the beam; two passes through the plate produce a polarization that is perpendicular to the original.

The objective lens focuses the laser beam through a transparent plastic (usually polycarbonate) substrate onto the thin (100-nanometer [nm]) recording layer. Servo signals drive a mechanical actuator that moves the objective lens to keep the beam in focus and on track. The servo signals are derived from the reflected light received at the quadrant photodetector and converted to electrical signals delivered to the controlling servo circuits.

The reflected light collected by all four elements of the quadrant detector generates the signals to be decoded by the EDAC (for error detection and correction) and modulation-decoding circuits. The reflected beam reads binary 1s and 0s according to the presence or absence of a pit, bump, or reversed magnetic domain at a particular position. Most disks have thin (0.8- μm -wide) concentric grooves, spaced 1.6 μm apart, to enable optical tracking. The laser writes and reads in the "lands" between the grooves.

New Kid on the Block

Although ideal for certain applications, CD-ROM and WORM drives are not general-purpose storage devices. The first optical storage device to earn that distinction is the erasable optical disk.

You can now purchase rewritable magneto-optical (MO) disk drives that store up to 650 megabytes of information. You can even buy optical-disk jukeboxes that typically provide 30 to 50 gigabytes of on-line storage and provide access to any file in 10 seconds or less.

Rewritable optical disk drives use the standard 5¼-inch form factor and store data on optical media housed in removable cartridges. Although access times for rewritable disks are two to six times slower than those of high-performance (17-millisecond) hard disks, data rates are comparable because the disk spins at up to 3600 revolutions per second. The media should last at least 10 years without reconditioning and provide unlimited rewrites. Currently, rewritable disk drives cost in the neighborhood of \$5000 to \$6000, and disk cartridges sell for about \$250. These prices are steep, but you can expect them to come down as the technology matures. In fact, one manufacturer expects the prices of drives to

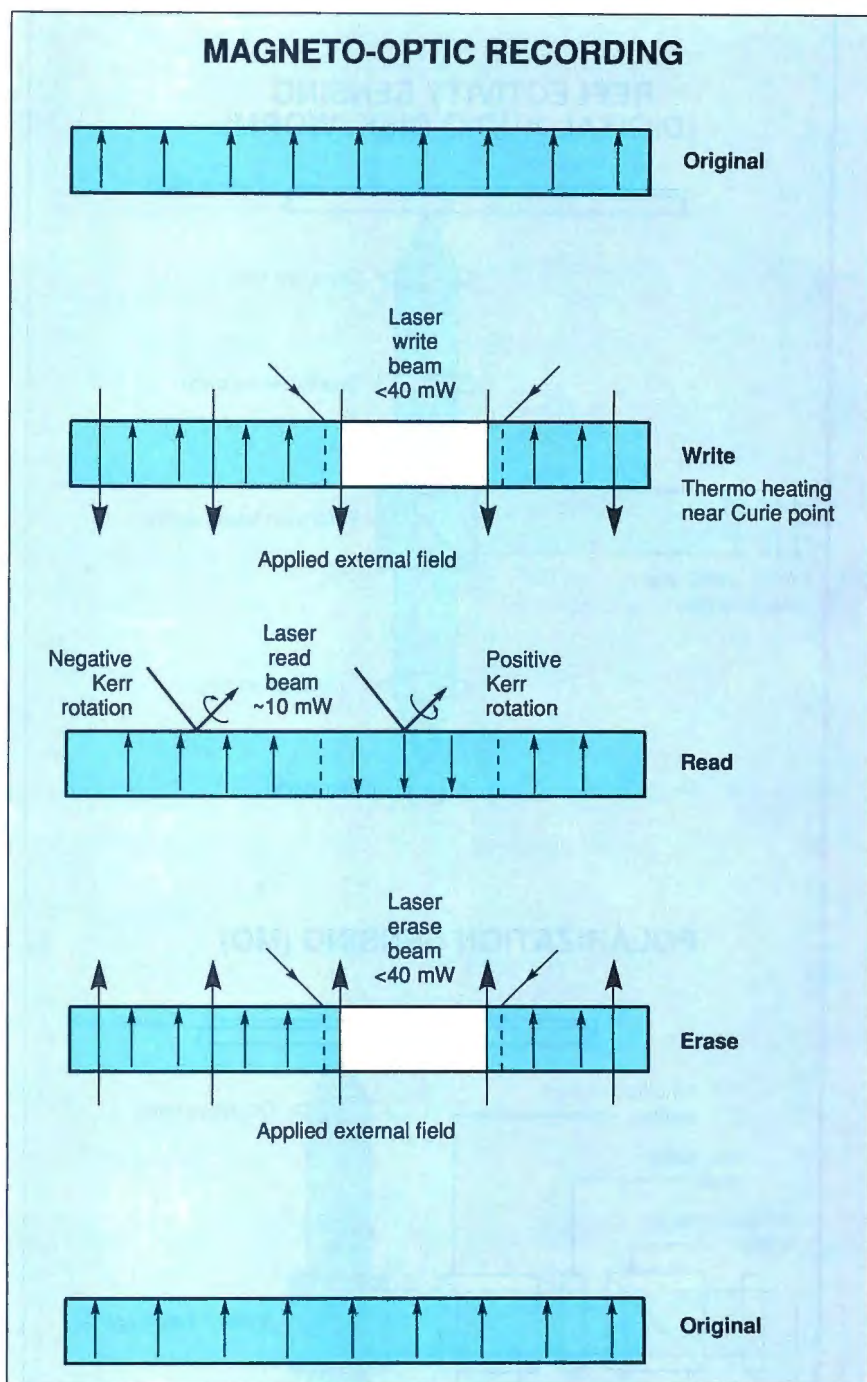

Figure 2: In synchrony with an external magnet, the strong write pulse fixes the magnetic orientation of a spot on the recording layer. The local magnetization imparts a positive or negative Kerr rotation to the reflection of the weak read beam. The magneto-optic head detects this rotation. (Figure courtesy of Paul Y. Hu)

drop by a factor of 10 by 1995.

Erasable optical disk drives hardly spell the end of magnetic storage. With their speed advantage, magnetic hard disks have the clear edge for large, multi-user applications, while magnetic tape is still the least expensive form of storage. For the foreseeable future, you will still

need a minimum amount of fast-access storage (perhaps 90 megabytes) to hold your computer's operating system and the applications that you use frequently, as well as workspace for those applications. Rewritable optical storage is ideal if you need a lot of on-line, random-

continued

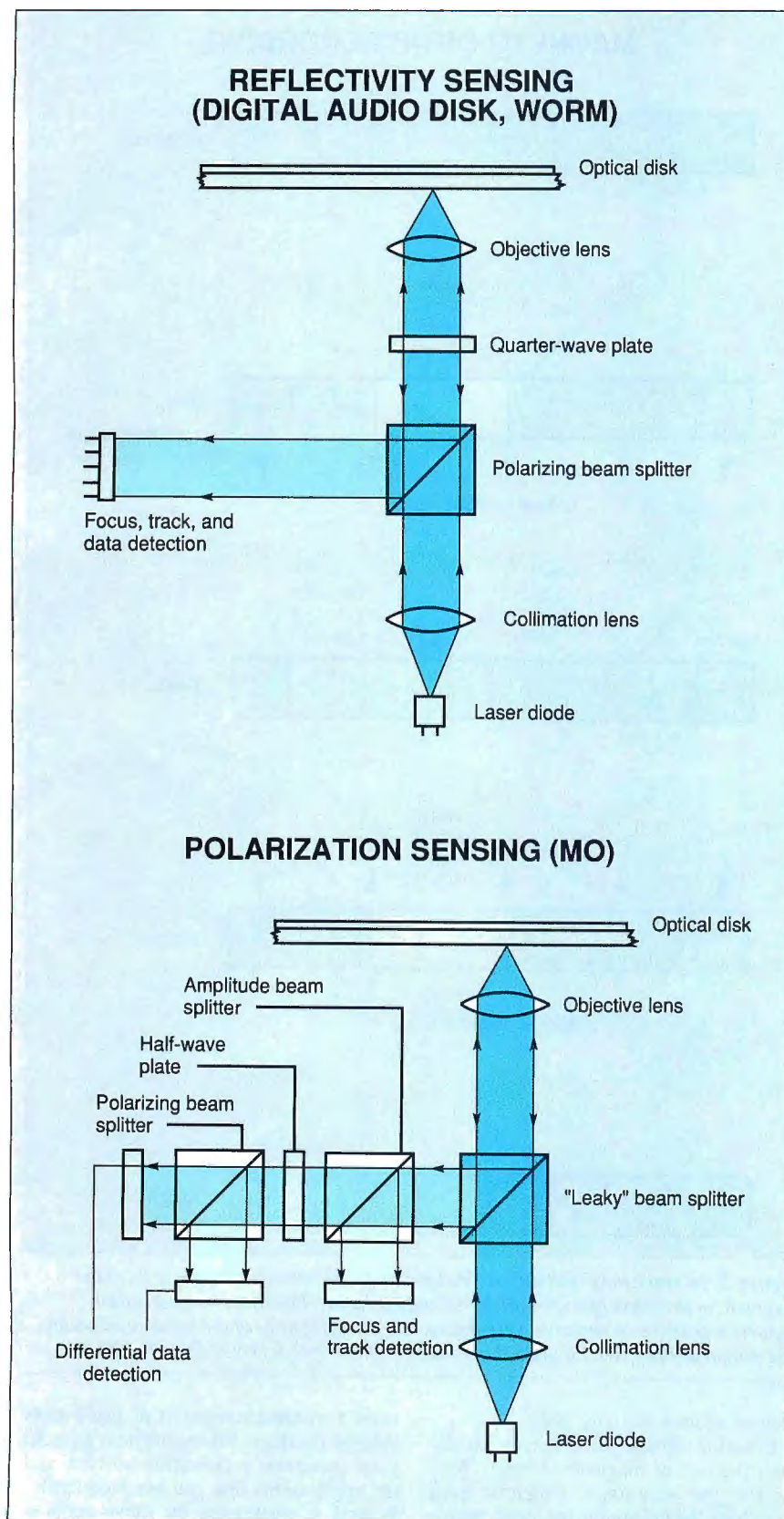

Figure 3: The size and complexity of magneto-optic heads result in their relatively slow access times. (Figure courtesy of Paul Y. Hu)

access storage at reasonable cost. Optical storage typically costs 25 cents per megabyte, or about 100 times less than magnetic disk storage.

Rewritable Media

Erasable disks typically have polycarbonate substrates, although some developers prefer hardened glass. With glass substrates, a layer of photopolymer, stamped with grooves and other formatting marks, covers the substrate. For polycarbonate disks, the grooves are formed in the injection-molding process that produces the substrate.

Above the grooves are three or four additional layers. One is the active recording layer, which usually consists of a rare earth/transition metal alloy such as terbium iron cobalt (TbFeCo). This layer is sandwiched between two transparent dielectric layers that provide optical enhancement of the polarization rotation as well as protection from oxygen and hydroxide ions, which would attack the metal alloy.

The active recording layer of an erasable optical disk is magnetized. The rotation of polarization of light reflected by this magnetic layer is known as the magnetic Kerr effect. Figure 2 illustrates how this effect is used in MO storage. Prior to its first use, an unwritten disk has a spatially uniform net magnetization illustrated by the upward-pointing arrows in the figure. These represent 0s at all bit positions.

To write a binary 1 at a particular location (or domain), you focus a 100-nanosecond pulse of laser light on the layer while a small magnet on the opposite side of the disk produces an external magnetic field opposite in direction to the original magnetization. The layer absorbs most of the laser pulse, which rapidly raises its temperature hundreds of degrees. At the locally high temperatures achieved, the magnetization of the layer is instantly reversed and then fixed with equally rapid cooling.

To erase a written domain, the field of the small magnet is reversed and the domain is pulsed a second time, returning the domain to its original magnetization. Note that written domains must be erased before they can be rewritten. This makes typical write times twice as long as read times.

To read a read/write disk, a weaker linearly polarized laser beam is focused on the recording layer. When reflected, this beam has its polarization rotated slightly (about 1 degree) clockwise or counterclockwise, depending on whether the local magnetization is pointing up or

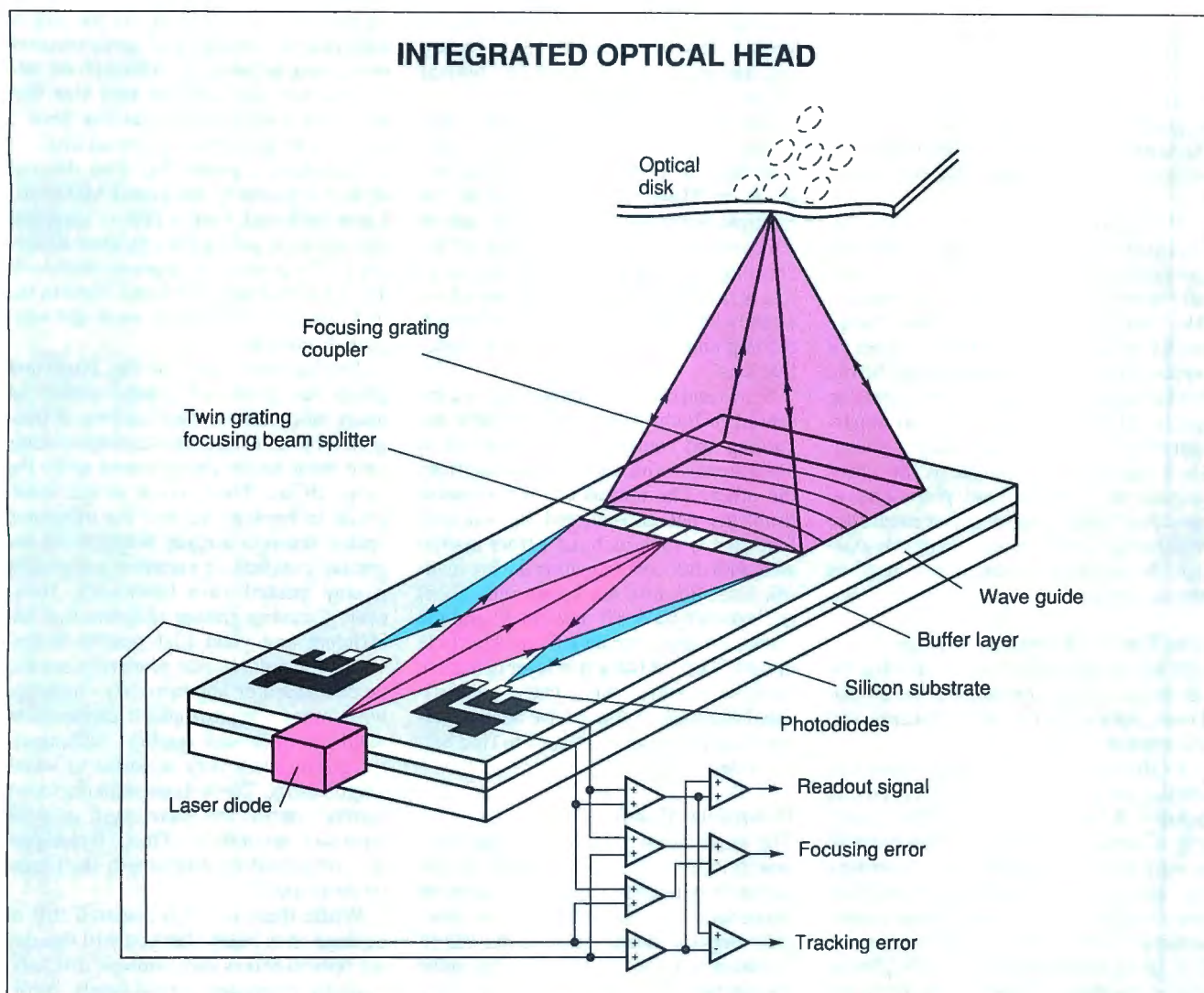

Figure 4: Developed at Osaka University, this device is substantially less massive than conventional optical heads. Work continues to improve its resolution. (Figure courtesy of Paul Y. Hu)

down. The direction of rotation indicates whether the bit read is a 1 or a 0.

Read/Write Heads

Most optical heads (containing the laser, beam splitter, wave plate, objective, and detectors) actually sit in a compact package below, rather than above, the disk. The head is moved from track to track by voice-coil linear actuators similar to those used in magnetic disk drives. The comparatively slow (about 100-ms) access times of optical disk drives is a consequence of the relative massiveness (100 grams) of the optical head. Research into integrated optical heads is expected to solve this problem.

Figure 3 illustrates the difference between MO heads and those used in digital-audio disk and WORM drives. In the MO head, the first beam splitter reflects

all light polarized perpendicular to the page, but it transmits only about 80 percent of the orthogonal polarization, reflecting the rest. Thus, light with both polarizations is reflected to the left after interacting with the media. The second beam splitter picks off a portion of this light to provide signals for the focus and track servos. Most of the light continues to the left, passing through a half-wave plate that rotates the polarization by 45 degrees, and then through a third polarizing beam splitter to two detectors whose photocurrents are differentiated electronically. This differential detection scheme removes the comparatively large DC photocurrent common to both detectors and sums their small AC currents, whose sign (positive or negative) indicates whether the MO layer imparted positive or negative rotation to the beam.

New Media

Because the optics that are needed to detect the small Kerr rotation in MO systems are much more complicated than those used in CD-ROM and WORM heads, research continues into substances that produce larger, easier-to-detect Kerr rotations. Bismuth-doped-garnet films and metal multilayers (or superlattices) are among the substances being developed for MO recording. At present, the garnets are too grainy (or noisy) to compete with rare earth/transition metal alloys. However, because they provide larger Kerr rotation and are much less susceptible to corrosion, work continues to improve their performance.

Other promising materials for rewritable optical media include *phase-change* layers that are made of amorphous alloys

continued

of tellurium, selenium, and other elements. When heated with a focused laser pulse of appropriate power and duration, these alloys crystallize locally, forming a spot of increased optical reflectivity. A more powerful pulse of shorter duration erases (or amorphizes) the crystalline mark.

Phase-change media are attractive for rewritable applications because the optical head required is simpler than with MO drives, and the signals are stronger. The problem with most phase-change media is that only a limited number of write and erase cycles are possible before performance degrades to unacceptable levels. At least one company has apparently overcome this limitation: Matsushita Electric has announced the introduction of a commercial phase-change system in Japan. Dye-polymer media are also being developed for rewritable storage. No working products have reached the market yet.

The Future of Optical Storage

The key technologies that are driving the advances in optical recording are media, lasers, optics, the recording channel, and electronics.

In the near term, the most important subject for research into media is how to achieve direct overwrite in MO recording. Currently available media must be erased before being rewritten, creating a two-pass process. Promising areas of research involve bilayer and trilayer combinations of active media. Direct overwrite has been demonstrated with phase-change media, although so far there are no products available in North America.

Lasers and Channels

The semiconductor laser diode has been central to all advances in both communication and recording (see "Reflected Light" on page 249). These tiny devices, 200 to 300 μm on a side, deliver up to 40 milliwatts of optical power into the optical path of MO drives. The wavelength of their emissions is typically 830 nm, although 780-nm lasers are also in use.

The wavelength and the focusing power of the objective lens determine the spot size at the active layer. In today's systems, the spot size is slightly larger than one wavelength. Obviously, shorter wavelength lasers would yield greater disk capacity.

Researchers have demonstrated 670-nm lasers in the gallium indium aluminum arsenide (GaInAlAs) system, and they are attempting to make blue lasers with group II-VI semiconductors. Optical frequency-doubling and frequency-

mixing devices have also been demonstrated, though not with the efficiency and compactness required for optical heads.

Surface-emitting diode lasers, and arrays of such lasers on a single chip, have been demonstrated by several laboratories. These lasers are candidates for multiple-beam optical recording, which is currently the most direct way of increasing data rates. In fact, edge-emitting arrays of four and five elements have already been demonstrated in multitrack reading and writing with a single objective lens.

Servo and channel technologies are essential to both optical and magnetic recording and continue to be advanced in both arenas, with each borrowing from the other. The optical channel presents problems not encountered in magnetic hard disks, such as burst errors associated with disk contamination during manufacture. Because marks are only about one wavelength apart on a track, and the tracks are separated by 1.6 μm , a particle of dust or dirt at the active layer can mask many contiguous bits. Thus, sophisticated modulation codes have been developed, and research continues to find better codes.

Downsized Heads

The most important area of optical research today is the optical head. At 100 grams, it is much too massive to meet the challenge of 17-ms random access. Integrated optical heads, such as the one illustrated in figure 4, may one day solve this problem.

The compact-disk head in the figure was proposed and constructed by Professor Hiroshi Nishihara and his colleagues at Osaka University in Japan. Although devices of this kind had been proposed before, this was the first functional demonstration. The device is built up on a 5-mm by 10-mm silicon chip that has an oxidized upper surface. A thin dielectric layer of a higher refractive index is deposited on the upper layer and serves as an optical wave guide. It confines the diode laser light introduced at its edge to within its walls and their immediate surroundings.

The laser beam expands laterally as it propagates toward a focusing grating coupler. The shallow curved grooves of the FGC are spaced closer together along its length. This changes the direction of the light radiated from them and focuses the light at the disk. Reflected light from the disk is diffracted back into the wave guide. There, a second wave-guide grating diverts it to tracking, focusing, and

signal detectors, built up on the silicon substrate by conventional semiconductor processing techniques. Although the device works, the smallest spot size that has been achieved thus far has been 2 μm —too large to read a compact disk.

Nishihara's group has also demonstrated a partially integrated MO head. Light reflected from a disk is launched into adjacent wave guides by three different FGCs and sent to separate detectors. The objective lens that sends light to the disk and the laser itself were not integrated, however.

The seminal work of the Nishihara group has provoked related studies in many laboratories. Applications of integrated optics to communications systems have been under development since the early 1970s. Thus, much of the waveguide technology needed for integrated optical heads is already available, as are grating couplers, a common component in any guided-wave laboratory. However, focusing grating couplers that are efficient and yield high-quality beams with good polarization properties need to be developed or appropriately combined with other "micro-optic" elements to yield the necessary quality. Additionally, gratings are very sensitive to wavelength shifts. Diode laser manufacturers cannot control the wavelength of peak emission accurately. Thus, techniques for compensating wavelength shift must be developed.

While there is much research still to be done, it is likely that you will one day see optical drives with multiple disks and multiple integrated optical heads, incorporating multiple lasers. The prospects of matching, and even exceeding, the performance of today's hard disks are excellent. Of course, magnetic technology will improve as well. You can expect to see both technologies working side by side in the foreseeable future. ■

ACKNOWLEDGMENT

We would like to thank Paul Y. Hu for the use of the figures. Paul is an adjunct professor in the Optical Sciences Center at the University of Arizona and a senior engineer at IBM's general products division in Tucson, Arizona.

James J. Burke is a professor in the Optical Sciences Center at the University of Arizona in Tucson and director of the Optical Data Storage Center there. He has a Ph.D. in optical sciences from the University of Arizona and can be reached on BIX c/o "editors." Bob Ryan is a BYTE technical editor. He can be reached on BIX as "b.ryan."

The Ultimate Business Computers



Model 212D 80286-12MHz / Model 210D 80286-10MHz
Model 316SX 80386SX-16MHz

Model 320 80386-20MHz

Model 325C 80386-25MHz

Model 325CT
80386-25MHz

"...When it comes to the basics, price, performance...capacity...CLUB American Technologies...delivers outrageous value."

PC WORLD September 1989

The Ultimate Business Computers

In 1986, CLUB American Technologies introduced the first personal computers designed for heavy industrial and commercial use. Since then, over 175,000 CLUB computers have been installed worldwide and have been well accepted by the **Fortune 500, Government Institutions and thousands of small businesses.**

This overwhelming success in CLUB's computers is a result of excellence in engineering during which no details are overlooked from the initial design to the final product. Also during manufacturing, each system is subject to an intensive SCBI process followed by In-Circuit Simulation Field Testing.

If your business computer that can in today's competitive and find out more about the



Sparrow I/16
80286-16MHz

is looking for a give you the edge marketplace, call today Ultimate Business Computers from CLUB American Technologies.

(415) 683-6600

In Canada, PC Centre: (416) 470-0560
International: (415) 683-6659
Technical Support: (415) 683-6580

CLUB
American Technologies, Inc.

Read/Write Optical Subsystems

Unlike CD-ROM, WORMs and erasable optical disks let you write and store massive amounts of your own data. The following is a list of WORM- and erasable disk-drive systems available to end users (as opposed to OEMs). Note that the capacity given combines the capacities of both sides of the media. For the amount of storage on-line at one time, divide the capacity by 2.

Advanced Graphic Applications, Inc.
90 Fifth Ave.
New York, NY 10011
(212) 337-4200

DISCUS Rewritable

DR650-SE \$6495

650-megabyte erasable optical disk system for the AT and PS/2s.

Inquiry 1181.

Alphatronics, Inc.
P.O. Box 13687
Research Triangle Park
Durham, NC 27713
(919) 544-0001

Inspire Desktop

Dual Drive \$13,900

1300-megabyte erasable optical disk drive for the AT. Also available for DEC and Sun systems.

Inspire Desktop

Single Drive \$7900

650-megabyte erasable optical disk drive for the AT. Also available for DEC and Sun systems.

Inquiry 1182.

Aquidneck Systems International, Inc.
650 Ten Rod Rd.
North Kingston, RI 02852
(401) 295-2691

Optical Archiving

System from \$23,000

Sophisticated read/write system capable of storing up to 1 terabyte of data. Supports many mainframes, minicomputers, and workstations.

Inquiry 1183.

Computer Upgrade Corp.
2910 East La Palma Ave.,
Suite A
Anaheim, CA 92806
(714) 630-3457

Optical Storage Subsystems

5¼-inch drives (450 to 1200 megabytes) from \$1595

12-inch drives (1000 to 6000 megabytes) from \$5995

Jukebox subsystems (25 to 141 platters per unit)..... from \$15,000

Complete line of optical storage systems for Macintosh, Apollo, DEC, Data General, IBM, Perkin/Elmer, and Sun computers.

Inquiry 1184.

Corel Systems Corp.
1600 Carling Ave.,
Suite 190
Ottawa, Ontario, Canada K1Z 8R7
(613) 728-8200

Corel 400

IBM PC and Macintosh

version \$2895

Novell NetWare version \$3995

400-megabyte SCSI WORM drive subsystem.

Corel 650

IBM PC and Macintosh

version \$3975

Novell NetWare version \$4995

654-megabyte SCSI WORM drive subsystem.

Corel 800 \$3645

800-megabyte SCSI WORM drive subsystem for the IBM PC and Macintosh.

Corel 940 \$3845

940-megabyte SCSI WORM drive subsystem for the IBM PC and Macintosh.

Inquiry 1185.

Delta Microsystems, Inc.
5039 Preston Ave.
Livermore, CA 94550
(415) 449-6881

SCSI WORM

Subsystem from \$6000

567-megabyte to 2000-megabyte optical disk drives for Sun systems.

Inquiry 1186.

Deltaic Systems
1977 O'Toole Ave.,
Suite B206
San Jose, CA 95131
(408) 954-1055

OptiServer 600 \$4499

594-megabyte SCSI erasable optical disk drive for the Macintosh.

Conforms to ISO standard.

WORMServer 1000 \$3599

940-megabyte SCSI WORM subsystem for the Macintosh. Also uses 400-megabyte disks.

Inquiry 1187.

Information Storage, Inc.
2768 Janitell Rd.
Colorado Springs, CO 80906
(719) 579-0460

ISI 525GB \$6288

1280-megabyte internal WORM

drive subsystem; external version also available for the AT.

Inquiry 1188.

Laserdrive Ltd.
1101 Space Park Dr.
Santa Clara, CA 95054
(408) 970-3600

810-111 (DOS version) \$5495

820-011 (Macintosh version).. \$5995

810-megabyte WORM drive subsystem.

Inquiry 1189.

Maximum Storage, Inc.
5025 Centennial Blvd.
Colorado Springs, CO 80919
(719) 531-6888

APX-4200 \$4450

760-megabyte WORM optical disk drive subsystem for DOS machines.

Inquiry 1190.

Micro Design International, Inc.
6985 University Blvd.
Winter Park, FL 32792
(407) 677-8333

LaserBank 400 \$2995

400-megabyte WORM drive system for DOS systems. Also available for Xenix and Unix.

LaserBank 940 \$4095

940-megabyte SCSI WORM drive system for DOS systems. Also available for Xenix and Unix systems.

LaserBank 600 R \$6995

600-megabyte erasable optical disk drive for DOS systems. Also available running under Xenix and Novell NetWare.

Inquiry 1191.

Mitsubishi Electronics America, Inc.
Computer Peripherals Division
991 Knox St.
Torrance, CA 90502
(213) 217-5732

MW-5D1 \$3400

600-megabyte internal SCSI WORM drive system for the IBM PC.

MW-5U1 \$4300

600-megabyte external SCSI WORM drive system for the IBM PC.

Inquiry 1192.

N/Hance Systems
908 Providence Hwy.
Dedham, MA 02062
(617) 461-1970

N/Hance 525

Internal version..... \$2750
External version..... \$2950
240-megabyte WORM drive system for DOS systems includes interface, driver, and Text.Scan software.

N/Hance 565

DOS versions:
Internal \$4295
External \$4495
Xenix versions:
Internal \$4975
External \$4995

654-megabyte SCSI WORM drive system with host adapter, driver, Text.Scan software, and Write Once File System (WOFS) software.

N/Hance 5120

PC versions:
Internal \$6188
External \$6388
2560-megabyte double drive..... \$11,695
Xenix versions:
External \$8195
2560-megabyte double drive..... \$13,495

1280-megabyte WORM drive with interface and driver.

Inquiry 1193.

Online Computer Systems, Inc.
20251 Century Blvd.
Germantown, MD 20874
(301) 428-3700

MDUfrom \$6000

Multimedia storage unit for DOS systems includes 400-megabyte WORM drive plus CD-ROM, hard disks, tape backup, and SCSI connector. Also supports OS/2, Unix, and VAX/VMS.

Inquiry 1194.

Panasonic Industrial Co.
2 Panasonic Way
Secaucus, NJ 07094
(201) 348-7000

LF-5010..... \$3299
940-megabyte external SCSI WORM drive system for the IBM PC and the Macintosh.

LF-5014..... \$2999
940-megabyte internal SCSI WORM

drive system for the IBM PC.
Inquiry 1195.

Peripheral Land, Inc.
47421 Bayside Pkwy.
Fremont, CA 94538
(415) 657-2211

Infinity Optical..... \$5695
635-megabyte erasable optical disk drive for the Macintosh.

Infinity Optical 1.2 \$11,995
1270-megabyte erasable optical disk subsystem (two drives).

Inquiry 1196.

Pioneer Communications
of America, Inc.
Optical Memory Products Division
Sherbrooke Plaza
600 East Crescent Ave.
Upper Saddle River, NJ 07458
(201) 327-6400

DD-S5001

PC version..... \$3895
Macintosh version..... \$3695

654-megabyte WORM drive subsystem.

Inquiry 1197.

RACET computes Ltd.
3150 East Birch St.
Brea, CA 92621
(714) 579-1725

Cosmos 600

AT version..... \$5690
Macintosh version..... \$5190

594-megabyte erasable optical disk subsystem.

Inquiry 1198.

Storage Dimensions
2145 Hamilton Ave.
San Jose, CA 95125
(408) 879-0300

LaserStor

AT and PS/2 version \$4495
Macintosh version..... \$4995

786-megabyte WORM drive subsystem.

LaserStor Erasable

Optical..... \$7995

876-megabyte SCSI erasable optical disk drive system for the AT, PS/2s, Macintosh, and Novell NetWare. Also uses 574-megabyte ISO-compatible cartridge.

Inquiry 1199.

Sumo Systems
1580 Old Oakland Rd.,
Suite C103
San Jose, CA 95131
(408) 453-5744

RSSM600-B..... \$4500

594-megabyte erasable optical disk system for the Macintosh.

Inquiry 1200.

Summus Computer Systems
17171 Park Row,
Suite 300
Houston, TX 77084
(713) 492-6611

Lightdisk-650

AT version..... \$6495
Macintosh version..... \$5495

594-megabyte erasable optical disk system. Also available for DEC and Sun machines.

Inquiry 980.

United Systems Co.
14701-B Myford Rd.
Tustin, CA 92680
(714) 832-3613

Spark L1200 \$19,000

2000-megabyte WORM storage system. Includes a powerful proprietary operating system that works in conjunction with MS-DOS.

Inquiry 981.

This resource guide is intended to provide a reasonable cross-section of available products, companies, and services; due to space limitations, we cannot list all companies and products. Inclusion in the resource guide should not be taken as a BYTE endorsement or recommendation. Likewise, omission from the guide should not be taken negatively. The information here was believed to be accurate at the time of writing, but BYTE cannot be responsible for omissions, errors, or changes that occur after compilation of the guide.

THE 25TH BIRTHDAY OF BASIC

*Everybody's first language is a quarter century old:
You've come a long way, BASIC*

Bill Gates

Since the first program ran on an English-built computer in 1948, computing has evolved by several orders of magnitude. In just 15 years, personal computers have grown from 8-bit, 4K-byte toys to powerful 32-bit, 16-megabyte tools for science and industry.

Amid all this growth in hardware, the BASIC language has quietly turned 25 years old, and the BASIC interpreter that opened up the microcomputer to millions of people has entered its fifteenth year.

BASIC didn't become the best-known and most accessible computer language simply because it comes free with every machine. BASIC's strengths—the simplicity of using an interpreter, its powerful string handling, the richness of the language, its English-like keywords and syntax, and the freedom it gives programmers to experiment—make it the ideal way for computer novices to explore the intricacies of their computers.

During this milestone year for BASIC, you can see how it may evolve by looking at the technology of operating systems like OS/2 and the promise of object-oriented programming.

BASIC was born out of a need to give nontechnical people a simple way to interact with a computer. In 1962, a math professor at Dartmouth College, Thomas Kurtz, proposed to the department chairman, John Kemeny, the radical idea that all Dartmouth students should learn about computers during their four-year stay. But the batch-oriented computers of the day made that prospect impossible, since it often took days to find out if a simple program would compile properly. Even then, the program could only calculate a result and return an answer; the person who wrote the program never actually saw it run.

Kemeny and Kurtz, expanding on research going on at MIT and Bell Labs, built a time-sharing operating system for a new computer that Dartmouth was about to receive. In the process, they decided that giving students a way to share the computer's hardware was of little use without a simple language for talking with the machine. FORTRAN and ALGOL didn't fill the bill for ease of use, so they created the Beginner's All-purpose

Symbolic Instruction Code as a simplified blend of the best of FORTRAN and ALGOL.

On May 1, 1964, Dartmouth students, greeted by the now famous `READY >` prompt on their teletype terminals, could write simple programs and send them off to be compiled and run. Listing 1 shows a simple program (a multiplication table) written in that first BASIC. Kemeny and Kurtz recount the birth of BASIC in their book *Back to BASIC* (Addison-Wesley, 1985).

And Then There Were Micros

The first microcomputers, sporting very small memories, came on the scene in 1975 from companies like MITS and Southwest Technical Products. These machines understood only machine language. Paul Allen and I sensed an opportunity and wrote a version of BASIC to run in those small memory spaces. Our first BASIC for the MITS Altair allowed a user to run programs on a 4K-byte machine. Memory was so precious that we even replaced the `READY >` prompt with `OK >` to save a few bytes. We built this BASIC as an interpreter.

Memory constraints partly guided our decision to implement BASIC as an interpreter. But another factor was our fascination with interpreters, and the immediacy and ease of use they give to the programming art. An interpreter lets a programmer tell the computer to perform a job, and then the computer gives immediate feedback and results, including the reporting of errors. This immediacy comes from the interpreter's being built as part of the language, not as a separate program like a compiler. First-time users would find working with a compiler difficult.

Drawing on experience I had obtained writing a BASIC interpreter for a PDP-8 while in high school, Paul and I made our original microcomputer BASIC a single-representation interpreter. This means that rather than storing the exact source code in text form, we translated it into a more compact form because of the memory constraints we faced.

We did tricks to let the programmer see his or her program

continued



exactly as he or she keyed it in while executing the program at a reasonable speed. Using the lower values of a byte and the upper 128 ASCII values to tokenize BASIC keywords was an innovation in that interpreter. We also coined the short commands TRON and TROFF to turn on and off BASIC's earliest built-in debugging tool, a trace facility. Fitting the language's reserved words, error messages, and floating-point library to run programs in a 4K-byte machine required a lot of tricks—it's still my favorite piece of code because it is so refined.

We chose to write a BASIC interpreter for several reasons. First, BASIC was simple enough that we thought we could squeeze it, plus user programs, into 4K bytes. We also liked

Listing 1: *The 1964 BASIC had no INPUT statement. Instead, you had to assign data to a variable with the LET or READ DATA statements.*

```
10 REM 1964 BASIC
20 LET N = 355/113
30 PRINT "MULTIPLICATION TABLE FOR",N
40 FOR I = 1 TO 10
50 PRINT I, N * I
60 NEXT I
70 PRINT "-----"
80 END
```

Listing 2: *The 1977 8K-byte BASIC had longer variable names, the INPUT statement, strings, and the IF...GOTO statement. This is a more flexible version of the program in listing 1.*

```
10 REM 1977 8K BASIC
15 PRINT "ENTER NUMBER FOR MULTIPLICATION TABLE"
20 INPUT NUMBER
25 INPUT "ENTER NUMBER OF LINES"; LINES
26 IF LINES < 1 GOTO 120
30 PRINT "MULTIPLICATION TABLE FOR",NUMBER
40 FOR I = 1 TO LINES
50 PRINT I, NUMBER * I
60 NEXT I
70 PRINT "-----"
80 PRINT "DO YOU WANT ANOTHER Y/N";
90 INPUT C$
100 IF C$ = "Y" GOTO 15
115 REM
120 REM ERROR HANDLING
130 PRINT "WRONG NUMBER OF LINES"
140 END
```

Listing 3: *The 1985 Microsoft QuickBASIC. It and other BASICs of the period eliminated line numbers and added subroutines and IF...THEN...ELSE statements.*

```
INPUT "File to be searched";F$
INPUT "Pattern to search for";P$
OPEN F$ FOR INPUT AS #1
WHILE NOT EOF
  LINE INPUT #1, TEST$
  CALL LINESEARCH(TEST$,P$)
WEND

SUB LINESEARCH(TEST,P$) STATIC
  STATIC NUM
  NUM = NUM + 1
  X = INSTR(TEST,P$)
  IF X = 0 THEN
    EXIT SUB
  ELSEIF X > 0 THEN
    PRINT "Line #";NUM;" ":";TEST$
  END IF
END SUB
```

being able to write a meaningful one-line program in BASIC; with other languages, you had so many variable and environment definitions to worry about, you had to write several lines of code just to print "hello" on the screen. And we liked BASIC's powerful variable-length string-handling functions.

Why Use BASIC?

We convinced the makers of the early microcomputers that they needed BASIC in their machines to let people use them. Otherwise, you could turn on the machine, but you couldn't do much with it. And until disk operating systems came along in about 1979, BASIC was the only way most people could use a personal computer. Our BASIC caught on because we encouraged people to write books about BASIC programming that contained lots of source code listings. We also promoted the idea of people writing programs in our BASIC and then selling or giving away those programs.

Other people were writing BASICs at that time: Li Chen Wang (Tiny BASIC), Steve Leininger (Radio Shack Level 1 BASIC), Steve Wozniak (Apple Integer BASIC), and Gordon Eubanks (BASICE and CBASIC). But Microsoft BASIC eventually appeared in the ROMs of over 50 types of machines and became a de facto standard.

That early BASIC was primitive compared to today's language. It forced you to use only two-letter variable names and required line numbers (see listing 2). But it proved to be an acceptable way to create useful programs for computers. It gave you instant feedback as you wrote a program, and its string-handling features let people write fairly sophisticated text-oriented applications. We invented new BASIC verbs like PEEK and POKE, and INP and OUT, to let people get at the resources of the machine. We devised a way to let programmers call machine language routines from BASIC so they could make critical parts of their programs faster.

Interpreters can be extended quite easily, so we frequently added new features to BASIC. We developed the music and graphics-string macro languages that used the verbs PLAY and DRAW. Many features that ended up in GWBASIC (short for Gee Whiz) came from our experience writing interpreters for Japanese machines.

BASIC hit a plateau when GWBASIC was put into the IBM PC ROM. Without IBM's updating the ROM, it was hard to popularize BASIC extensions beyond the interpreter. This BASIC became extremely popular, of course, and even today I'm amazed at what a high percentage of PC users have experimented with that BASIC because it is so simple to learn and use.

When BASIC faltered on the plateau of being an IBM PC-compatible standard, we created QuickBASIC. Other companies were extending BASIC, too—for example, BASIC's inventors, Kemeny and Kurtz, with True BASIC.

Not So Basic

When I show programmers the BASIC I use today, they say something like, "That looks a lot like Pascal." People who think of BASIC as the IBM PC's BASICA are surprised that it doesn't have to be a line-oriented language with little structure. BASIC has become very modern since 1983 (see listing 3).

In the mid-1980s, BASIC improved on three fronts: as a language, with the addition of long variable and label names, record structures, and better block-structuring tools; as an environment, with a built-in editor, debugger, and compile-run facility; and as a compiled language, with faster response in the classic compile/debug/edit/compile cycle while generating fast, high-quality code. BASIC also gained the ability to run

continued

High Performance Systems

Enjoy extra performance from your computer with Eltech!

Starting Price: \$2480

**"One of the
best numeric
performers
of the bunch"**

—MIPS Magazine,
August 1989



The Eltech 9870 386 computer utilizes the best technology available today. Featuring the Floating Point Processor 80387-25/Weitek 3167, Eltech is now offering one of the fastest affordable computers that can be shipped to you **TODAY!** The 9870 also includes Cache Memory: 64 or 256KB S-RAM ; Expansion RAM: 4 or 8MB on 32-bit Board; Maximum RAM: 16MB Data Bus Width: 32-bit; Zero Wait States and 1 Serial and 1 Parallel Ports.

30-Day Money-Back Guarantee.

Next Day Free On-Site Service.

Next day delivery available.

- One year free on-site service
- Consulting service program
- Leasing and financing program

ELTECH RESEARCH INC.

1725 McCandless Drive
Milpitas, CA 95035
Telephone: 408-942-0990
FAX: 408-942-1410

Technical Support: 408-942-1067

**Distributors & VAR inquiries welcome
Call for details.**

Seven ~~bit~~ Five easy ways to boost your BASIC

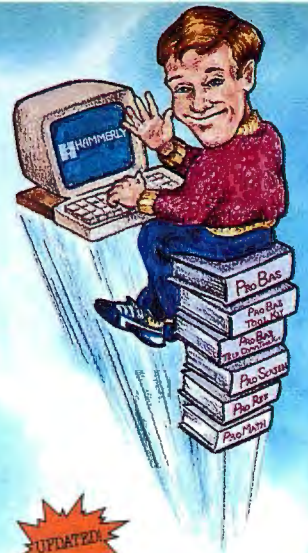

PROBAS™ Basic Programming Library

So who cares that BYTE magazine calls PROBAS a "Supercharger for QuickBASIC" or that PC Tech Journal says that PROBAS is a "high-quality, high-quantity package"? Who buys a product just because Jerry Pournelle said "Anyone doing serious QuickBASIC programming would do well to get [PROBAS]"? And who cares that Wayne Hammerly calls PROBAS "The greatest thing since sliced bread"?

Who?—Only those who want to write better, faster, slicker programs and save hundreds of programming hours in the process. With all of that hoopla out of the way, we are formally announcing the momentous release of PROBAS Version 3.1, now with over 400 assembly routines to make BASIC programs faster and more powerful than you ever dreamed with features like:

- A 1,000-page two-volume manual
- Full mouse support
- Extended and EMS memory support
- Full-featured windowing
- Moveable, resizable windows
- Screen snapshots (text & graphics)
- Virtual screens in memory
- Lightning-fast file I/O
- Critical error handling
- String, array, and pointer sorts
- Search directories and archives

Create dazzling screens in text, CGA, EGA, VGA, and Hercules graphics modes with windows that can overlay one another and be moved and resized on the fly. Store megabytes of string, data, or screen snapshots in extended or EMS memory. Draw complex text or graphic screens to memory and snap them on in an eyeblink. The PROBAS file I/O routines allow you to read or write huge chunks of data at a clip, far faster than with BASIC.

PROBAS also has over 300 other essential services, including handy string, date, time, directory, and array manipulation routines; string, screen, and data compression routines; valuable equipment and input routines; and faster replacements for many BASIC commands.

Whether you are a professional or a novice, PROBAS will boost your BASIC in ways you never thought possible. PROBAS allows the professional to write faster, tighter code in much less time and allows novices to quickly and easily write professional-quality programs that would be impossible with BASIC alone. The bottom line is PROBAS adds power and saves time. After all, how much is a few hundred hours of your time really worth?

For all DOS versions of QuickBASIC and BASCOM. **Just \$149.00!**



PROREF™ On-Line Help For PROBAS

PROREF provides on-line help for the routines in the PROBAS library. This hypertext manual links directly to the QB Advisor in QuickBASIC 4.5 so that the PROBAS reference becomes an integral part of your QuickBASIC on-line manual. Includes information and examples on PROBAS routines and helpful hints on programming in BASIC. **Just \$50.00!**



PROSCREEN™ Screen Management

PROSCREEN is a full-featured screen generator/editor that will save you more design and coding time than you ever thought possible. PROSCREEN treats screens like a word processor treats text to provide complete control over characters, colors, and placement. Design input screens with up to 130 fields, 19 pre-defined and 2 user-defined masks. Save screens to screen files or .OBJ files and use the tight BASIC/Assembly code that comes with PROSCREEN to access the screens. There's no kludgy code generator here! Access hundreds of input screens with less than 25k of total code. **Just \$99.00!**

PROMATH™ Mathematics Library

PROMATH is a collection of over 150 high-level routines that provide mathematical functions and operations for programmers who often work in mathematics, science, or engineering. Complex variables, real and complex matrices, real and complex trigonometric and hyperbolic functions and their inverses, solution of linear equations, integration, differential equations, Fast Fourier transforms, graphics support, and many other useful routines are provided.

For years Fortran has been the language of choice for scientific and engineering applications, but it lacks many of the useful features of QuickBASIC. PROMATH contains most of the Fortran mathematical and numeric functions and allows you to easily translate Fortran code to BASIC or write new programs in BASIC, while retaining Fortran's numerical prowess.

The PROMATH manual is over 200 pages and provides a complete description of each routine, including any algorithm and the mathematical formula the routine uses, shown in standard notation. For QuickBASIC 4 and BASCOM 6 only. **Just \$99.00!**

Circle 113 on Reader Service Card

PROBAS™ TOOLKIT

The TOOLKIT is a collection of high-level BASIC and assembly modules that use the routines in the PROBAS library to save you even more hours of grunt work. Why spend hundreds of hours re-inventing the wheel when you can just plug in TOOLKIT modules like:

- Super-fast B-Tree indexing
- Ring, Bar, Pop-Up, Pull-Down menus
- Scroll-bar tag windows
- Dialog boxes with radio buttons
- Two mini-editors with word wrap
- BCD math routines
- Julian date & calendar routines
- Patch .EXE files
- Protected memory storage area

The TOOLKIT now supports EGA and VGA graphics modes for menus, windows, editors, calendars, and more. Complete with BASIC source code and an all-new comprehensive manual. The TOOLKIT requires the PROBAS library and helps conserve your greatest asset of all—time! **Just \$99.00!**

PROBAS™ TELECOMM TOOLKIT

The PROBAS TELECOMM TOOLKIT is a collection of high-level communications modules that you plug into your code to provide popular file transfer protocols, terminal emulations, login scripts and baud rates up to 115,200 baud. You get:

- Xmodem/Modem7/Xmodem-1k
- Ymodem (single and batch)
- CRC-16 and Checksum
- VT52, VT100, ANSI, BBS etc.
- Auto Dialer & data base
- Documented BASIC source

Why use clumsy SHELLs to complex terminal programs when you can plug just the communications routines you need into your code? Implement just the features and commands you want. Requires PROBAS. **Just \$75.00!**

Our thirty-day, money-back guarantee assures you the highest quality and our technical support staff is always ready to help.

HAMMERLY
COMPUTER SERVICES, INC.

9309 JASMINE COURT • LAUREL, MD 20707

(800) 343-7484

INT'L. ORDERS: (301) 953-2191. FAX: (301) 725-8147
BBS: (301) 953-7738

Add \$5.00 per item (\$8.00 Canada) for shipping per order. Europe: \$39.00 for 1st item plus \$5.00 for each additional item. Visa, M/C, C.O.D. (US Only) checks and approved POs accepted. Trademarks PROBAS, PROREF, PROSCREEN, PROMATH: Hammerly Computer Services, Inc. QuickBASIC, BASCOM: Microsoft Corp.

recursive routines, to handle sophisticated structures such as B-trees, and to deal better with graphics.

About this time, BASIC became more structured, with the addition of DO WHILE, WHILE...WEND, DO UNTIL, LOOP WHILE, and LOOP UNTIL loops, and SELECT CASE constructs. BASIC today has facilities that permit creating data structures as rich as those of C or Pascal. BASIC also shed the

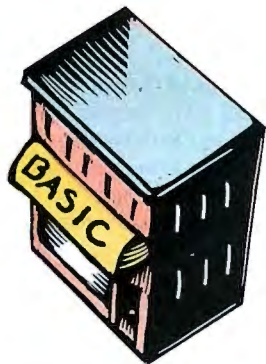

That early BASIC was primitive compared to today's BASIC.

shackles of 64K-byte limits on program size; today's BASIC programs are limited only by memory, and even individual arrays can be up to the limits of memory in size.

You can also use long (32-bit) integers in your programs. Record structures added the capability to let you define your own data structures, combining many different individual data types, such as strings and numbers.

The environment for BASIC programming has changed, too. In QuickBASIC 4.0 and 4.5, for instance, a built-in full-screen editor with automatic syntax editing, a built-in debugger, and context-sensitive help makes the program-creation process as fast and easy as possible. Borland also integrated a full-screen editor into Turbo Basic.

Another important change in the modern BASICs was a move from interpreters back to compilers: Indeed, Dartmouth BASIC has remained a compiled language since its inception. BASIC compilers for microcomputers appeared soon after disk operating systems became available, and were made possible, in part, by the availability of up to 64K bytes of memory.

These compilers included Microsoft products and Digital Research's CBASIC-86 compiler. Later, Better BASIC, QuickBASIC, True BASIC, ZBasic, and Turbo Basic were developed. But the major move to compilers needed to be made without sacrificing the instant feedback and quick detection of errors, features that made the BASIC interpreter so successful.

Advancements in compiler technology enabled the development of a BASIC compiler that gave the appearance of an interpreter, thus offering the best of both worlds. Single-pass compilers that could compile first hundreds—and then thousands—of lines of code in just a few seconds gave BASIC the appearance of an interpreter but let programs execute faster.

Later, we invented an in-memory scheme combining the features of an interpreter and a compiler. It uses a special intermediate threaded pseudocode that, when combined with an environment like the QuickBASIC editor, lets you write, debug, and change the code just like in an interpreter. When you are ready, you can compile the finished product to get maximum speed and compact size in an executable file.

Compiling BASIC also made it easier to call routines written in other languages from within BASIC. Because the compiler generates standard intermediate .OBJ files, you can link C or FORTRAN .OBJ files with your BASIC .OBJ files and call

continued



Unleash the BASIC Power of Hypertext!

Our latest BASIC-booster includes the first hypertext engine designed to be called from BASIC. With the **PROBAS HYPERHELP TOOLKIT** you can use the hypertext engine to put one or more manuals on-line with full hypertext search facilities. Imagine having one or more manuals on-line with all of the fantastic hypertext abilities in the QuickBASIC 4.5 compiler and then some:

- Choose single- or multi-window display
- Specify window colors and placement
- Move and resize windows with mouse or keys
- Sophisticated mouse and keyboard interface
- Up to 40 bookmarks to move between hyperlinks

In less than a dozen lines of code you can pop-up context-sensitive help at any time. Your users can then jump to related help, examples, or just browse the manual(s) in one or more windows that they can move or resize at will. The text will automatically wrap within the window to stay fully visible!

Create HyperCard Applications

Use the **HYPERHELP** engine to create full-blown hypercard applications. Create sophisticated multi-window, multi-thread hypercard stacks. Mix cards and manuals for total data integration. Moving from link-to-link or card-to-card is instantaneous and the speed will amaze you.

Adding hypertext to your applications takes less than about a dozen lines of BASIC code. Converting ASCII text to hypertext is just as easy—just put delimiters around keywords, hyperlinks, and items you want to display in boldface.

Multiple Help Subsystems

The hypertext engine is just a part of the **HYPERHELP TOOLKIT**. There is a wide selection of help subsystems with various displays, user interfaces, and memory requirements to suit almost any need. Want a small, window-oriented, keyword help system? It's in there! Need a Terminate & Stay Resident help system? It's in there! How about a lightbar indexing system that then pops-up the selected text? It's in there!

The **HYPERHELP TOOLKIT** gets its blinding speed by using the low-level routine in our **PROBAS** Professional Basic Programming Library. **HYPERHELP** requires the **PROBAS** Library. See our ad on the opposite page for information on **PROBAS**, shipping rates, and our thirty-day money-back guarantee.

Special Introductory Price—For a short time this powerful hypertext engine and collection of help subsystems is available for **just \$99.00!**

HAMMERLY
COMPUTER SERVICES, INC.

9309 JASMINE COURT • LAUREL, MD 20707

(800) 343-7484

INT'L. ORDERS: (301) 953-2191 FAX: (301) 725-8147
BBS: (301) 953-7738

Add \$5.00 per item (\$8.00 Canada) for shipping per order.
Europe: \$39.00 for 1st item plus \$5.00 for each additional item. Visa, M/C, C.O.D. (US Only) checks and approved P.O.s accepted. Trademarks ProBas, ProRez, ProScreen, ProMover, Hammerly Computer Services, Inc. QuickBASIC, BASCOM: Microsoft Corp.

BLAST... Complete Communications, ONE Software Package.

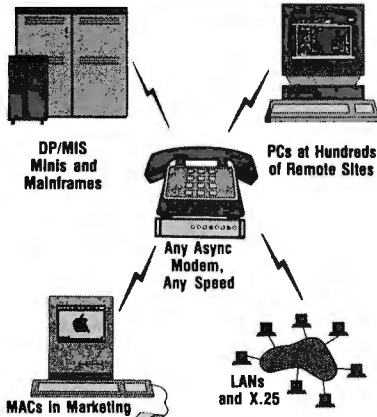

PC, MAC, UNIX, XENIX, VAX, and more. 30 popular operating systems. Connect and manage file transfers around the office or around the world.

RIGHT OUT OF THE BOX

Use regular modems, V.32, new high speed modems, X.25, LANs . . . BLAST makes them all compatible.

FOR INSTANT NETWORKS

Link two computers or 2000 . . . with

- One easy, identical interface
- One set of commands
- One powerful script language
- One reliable program

WITH ALL THE FEATURES

- Bulletproof file transfer
- Terminal Emulators - VT 100/220, etc.
- Scripting for customized routines
- PC to PC Remote Control
- Fully automated operation
- Unbeatable noise resistance

IN GOOD COMPANY

- Over 50,000 users worldwide
- Top-Notch technical support

Call 800-24-BLAST

APPLE	MACINTOSH
IBM PC, XT, AT, PS/2	MS-DOS, SCO XENIX, UNIX V
UNIX Systems	UNIX V3, 4.2, 386
DEC	VMS, RSX, RF-11, ULTRIX
DATA GENERAL	DOS, MPDS, RDOS, AOS/V5
HARRIS	VOS, UNIX, XENIX
HEWLETT-PACKARD	MPE, RTE, UNIX
IBM	VM/CMS/MVS/TSD
PRIME	PRIMOS
UNISYS	BTOS, CTOS, UNIX
WANG	VS OS, MS-DOS
. . . plus many more	

BLAST
Communications Research Group

5615 Corporate Blvd. • Baton Rouge, Louisiana 70808
(504) 923-0888

those "foreign" language routines from within your BASIC program.

With these improvements in compiler technology, BASIC's longtime reputation as a slowly executing language fell by the wayside. Today, many popular commercial applications are written in BASIC. For example, there's a speaker-design program called AccoustaCADD, a radio station playlist manager called Music Scan, and even a program for molecular biologists called DNA Inspector. Modern compiled BASIC programs run as fast as programs compiled in Pascal or C.

I'm still a big fan of BASIC. It handles many of the overhead tasks that other languages force you to deal with, thereby unleashing your programming creativity. I have challenged programmers to write code to solve any problem using any tool they choose; I wager that I can write the same program faster using QuickBASIC. In fact, there is a joke around Microsoft that says when an application is falling behind schedule, "Just give it to Bill and he'll write it in BASIC over the weekend."

Still, as powerful as BASIC is today, there are ways to make it even better.

The BASIC Clairvoyant

Even though BASIC gives you great freedom for writing programs, it still forces you to think procedurally; your programs become a series of linked, step-by-step procedures to perform certain actions. Programming this way becomes an exercise in project management: First do this, then do that if something else happens, and so on.

As programs become more complex, these "projects" get harder to manage. Structured programming concepts deal with this complexity by encouraging programmers to break up code into small chunks, and then tie the chunks together with the unfortunately error-prone convention of function calls within, and across, module and file boundaries. Object-oriented programming puts a new twist on that idea: Make each program chunk a self-contained package of data and the procedures for manipulating that data, and then have the chunks send and receive messages to interact with other chunks.

This scheme provides a "black-box" mentality for program pieces—the pieces become objects whose internal complexity stays hidden from other objects. But why do you need to think of programs as collections of objects?

The visual environments that are used on computers today give a clue as to why thinking about program objects is important and different. In a visual environment, you choose an action or event after you choose the data that is the target of the action or event. For example, delete character, delete word, delete paragraph, and delete page are simply one command applied to different objects. You must choose the object—a character, word, paragraph, or page—before you select the command delete.

Object-oriented design techniques package data and the methods of manipulating that data together: The package becomes an object. If you want an object to do things that it doesn't currently know how to do, you create a new object that inherits the capabilities of the old object and then add the new capabilities you want to define. In traditional procedural programming, you set up the action first and then identify the data and supervise every step in the action's manipulation of that data.

Object-oriented programming will influence the development of all languages, including BASIC, over the next several years. Objects contain both code and data, and they manage their own behavior while hiding their internal complexity.

continued

Discover Parallel Processing!

Monoputer/2™

*The World's Most Popular
Transputer Development System*

Since 1986, the MicroWay **Monoputer** has become the favorite transputer development system, with thousands in use worldwide. Monoputer/2 extends the original design from 2 to 16 megabytes and adds an enhanced DMA powered interface. The board can be used to develop code for transputer networks or can be linked with other Monoputers or Quadputers to build a transputer network. It can be powered by the 20 MHz T414 or T800 or the new 25 MHz T425 or T800.

Parallel Languages

Fortran and C Make Porting a Snap!

MicroWay stocks parallel languages from 3L, Logical Systems and Inmos. These include one Fortran, two Cs, Occam, Pascal, and our own Prolog. We also stock the NAG libraries for the T800 and Rockfield's structural and thermal finite element package. A single T800 node costs \$2,000, yet has the power of a \$10,000 386/1167 system. Isn't it time you considered porting your Fortran or C application to the transputer?

For further information, please call MicroWay's Technical Support staff at (508) 746-7341.

Micro Way

Quadputer™

*Mainframe Power
For Your PC!*

MicroWay's **Quadputer** is the most versatile multiple transputer board on the market today. Each processor can have 1, 4 or 8 megabytes of local memory. In addition, two or more Quadputers can be linked together with ribbon cables to build large systems. One MicroWay customer reduced an 8 hour mainframe analysis to 15 minutes with five Quadputers, giving him realtime control of his business.

World Leader in PC Numerics

P.O. Box 79, Kingston, MA 02364 USA (508) 746-7341
32 High St., Kingston-Upon-Thames, U.K., 01-541-5466
USA FAX 617-934-2414 Australia 02-439-8400 Germany 069-75-1428

Objects interact with other objects by passing messages back and forth. That way, any object can be changed without affecting other objects. Any programmer can create an object that can interact with any other object; all the programmer has to know is the message-passing syntax.

To adapt to this object-oriented emphasis in programming, BASIC will need the ability to create and manipulate classes and subclasses, which are the principal data abstraction devices of object-oriented programming. BASIC will also need a visual component. After all, the best way to design a form is to draw the form, not write code to reproduce it. With a mouse and a palette of predrawn graphics images, you should be able to combine lines, boxes, and buttons interactively on a screen to design a form for a program. That kind of interactive design of objects should also let you attach to or combine your creations within a program.

Future versions of BASIC will increasingly provide support for this kind of programming. The programs will look different from the BASIC we're used to. A visual BASIC program will be a mixture of code, programmer-written objects, and visually specified objects. With separate windows, you would be able to edit both the visual and code parts of the program.

HyperCard provides an interesting example of this combination of visual and more standard procedural programming. The screen display of the card, with its buttons and display areas, provides the visual field; the script language, HyperTalk, lets you create procedures that relate to the card and the information that the card links with. Although HyperCard is only a partial implementation of object-oriented programming, it forms an understandable intermediate step between procedural and object-level programming.

Another major change in BASIC's future will be its universality. This change will result from BASIC's becoming part of the overall computing environment. BASIC may soon become the equivalent of today's MS-DOS command interpreter, COMMAND.COM. If this happens, BASIC will play a role similar to the one it played in the earliest personal computers—as a universal "macro" language through which users interact with their computers and all the applications they run.

A universal BASIC would come in different flavors. One fla-

vor would serve as a central control language for the computing environment. As an environment control tool, BASIC would be a command-line adjunct to a visual user interface. Another flavor would serve as an embedded language within application programs. Embedded BASIC would allow power users to embellish the performance of their applications, as Lotus 1-2-3 users do today, without having to learn a new macro language for each application they use.

You would be able to use BASIC syntax to tell your application programs to perform their various functions in the order you want them performed. For example, if you needed a certain report each month, you'd be able to write a short BASIC program that tells the application to gather the relevant data, format it properly, and have it waiting for you at the appointed hour. BASIC can provide this power while remaining easy to learn and use. These kinds of changes will keep BASIC vibrant for a long time.

Perpetually Young

The next 25 years in BASIC's life will probably be even more exciting than the first 25. BASIC's development has mirrored the explosive growth of the personal computer industry: When the hardware was weak, BASIC was pretty cramped, too. The rapid improvements in hardware in the last 15 years have been matched by the growth of BASIC in both power and flexibility. If you haven't looked at BASIC in the last few years, you'll be surprised by how it's changed. Compare listings 1, 2, and 3 to see the evolution of BASIC from 1964 through 1985.

In the late 1970s, when C started becoming very popular, many people predicted the demise of the COBOL and FORTRAN languages. Pascal was supposed to sound the death knell for BASIC. But all these languages continue to survive. I believe that in the case of BASIC, the language is flourishing. If BASIC becomes a universal macro language, as I think it will, it may outlive all the procedural languages. BASIC may, in fact, outlive us all. ■

Bill Gates is chairman and CEO of Microsoft Corp. in Bellevue, Washington. He cofounded the company in 1975 with Paul Allen. He can be reached on BIX c/o "editors."

EDC Electronic Design Center

High Tech in Perfection
Transputer Products

Transputer Boards

EDC-B016	Motherboard for 1-16 TRAM
EDC-4T4MB-T414	Transputer board with 4 x T414
EDC-4T4MB-T800	Transputer board with 4 x T800
EDC-4T4MB-ITEM	Rack for 10 EDC-4T4MB cards
EDC-4T4MB-TDS	Software Development System

Transputer Module Series 501

EDC-501-128KS*	Transputer module with T414 or T800 and 128K SRAM
EDC-501-256KS*	Transputer module with T414 or T800 and 256K SRAM
EDC-501-1MD-T414-70	Transputer module with T414 and 1MB DRAM (70ns)
EDC-501-1MD-T414-100	Transputer module with T414 and 1MB DRAM (100ns)
EDC-501-1MD-T800-70	Transputer module with T800 and 1MB DRAM (70ns)
EDC-501-1MD-T800-100	Transputer module with T800 and 1MB DRAM (100ns)

All transputer modules pin-compatible with INMOS TRAMS.

Transputer Interface Module

EDC-UBX1	UNIBUS interface card
EDC-TVM1	VME-Bus interface card
EDC-TQB1	Q-Bus interface card.

Transputer Software

EDC-SWMS1	Mathematical and statistical package in OCCAM
EDC-SWVDOT	RAM-Disk for Transputer boards

EDC Memory Module

EDC-SX32-064	64K x 8 SRAM module
EDC-SX32-256	64K x 32 SRAM module
EDC-DX32-256	256K x 32 DRAM module
EDC-DX40-256	256K x 40 DRAM module

EDC GmbH, Taurusstr. 51/III, 8000 Munchen 40

Tel.: (89) 350 70 76 Fax: (89) 359-61-80 Tx.: 521 25 99

THE COMPUSTAR[®] THEORY OF SENSIBILITY

$$C = at + mca^2 + eisa$$

Okay, we admit it may not be as profound as Einstein's Theory of Relativity. But, if you're a computer user, we bet it's a bit more, shall we say, "relative" — not to mention a whole lot more sensible.

The "C" stands for CompuStar[®] — the world's first and only multi-processor, convertible bus[™] microcomputer. And, as the theory states, CompuStar means AT, MCA and EISA compatibility — all in a single system.

A CONVERTIBLE BUS?

Each CompuStar features snap-in bus "modules" that let you convert from one bus standard to another — a PC/AT¹ bus, a PS/2 (MCA) bus. . .or both!

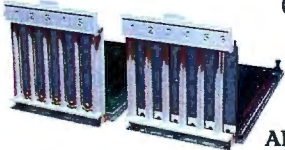

SNAP-IN PS/2
AND AT BUS MODULES.

Depending on configuration, you can have up to 13 AT and/or PS/2 bus expansion slots. Plus, when the new EISA bus becomes popular, we're licensed to offer it as well.

THREE COMPUTERS IN ONE.

Buses are not the only thing you can reconfigure in a CompuStar. Each system can be equipped with any of three CPU Modules — an 8086, an 80286 or an 80386. Since the modules are interchangeable, you won't have to worry about buying the *wrong* computer system. We'll even let you trade-in your CPU Module toward the purchase of any of

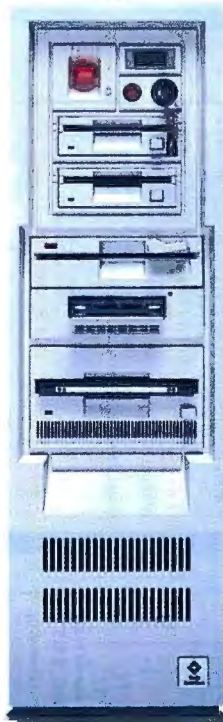

the other more powerful modules.* But that's not all. CompuStar features an incredible seven disk/tape compartments that we'll gladly custom configure for you at the factory. No matter what your application, we can tailor fit a CompuStar to match it precisely.

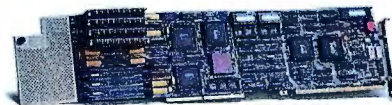

CPU MODULES ARE INTERCHANGEABLE.

IT'S NUMBER ONE RATED.

If you're thinking a computer with as much flexibility as CompuStar would have to compromise *something*, like performance — think again. The CompuStar is one of the fastest, most powerful systems available. In fact, CompuStar's performance and flexibility so impressed *InfoWorld* magazine they gave it the highest rating of all hardware products tested in 1988! That's astonishing when you consider you can buy a CompuStar for *thousands* of dollars less than a comparably equipped system from IBM or Compaq.

If you're shopping for the next generation in personal computers, why not call us today at 803/796-7800 to arrange an on-site no obligation 30 day CompuStar[®] trial in your office.* Relatively speaking, it's the only *sensible* thing to do.



Wells American

Circle 288 on Reader Service Card (DEALERS: 289)

Corporate Headquarters: 3243 Sunset Boulevard • West Columbia, SC 29169 • 803/796-7800 • FAX 803/796-7029

¹Personal Computer AT, AT, PS/2 and IBM are trademarks of International Business Machines Corporation. ²MCA is a trademark of IBM.
*Some restrictions may apply. Call us for details on our trade-in and total customer satisfaction programs.

Top Performers.



H.I.M.S. 386SX/16 MHz

- INTEL 80386SX MICROPROCESSOR RUNNING AT 16 MHz
- SOCKET FOR 16 MHz 80387SX MATH COPROCESSOR
- 5.25" 1.2 MB OR 3.5" 1.44 MB DISKETTE DRIVE
- DUAL DISKETTE AND HARD DISK DRIVE CONTROLLER (1:1 INTERLEAVE)
- 1 MB 80 NS MEMORY (OR 2 MB, 4 MB EXPANDABLE TO 16 MB)
- 40 MB HARD DISK 38 MS, 800 KB DATA TRANSFER RATE
- HI-SPEED 2 SERIAL PORT(S), 1 PARALLEL PORT
- 200 WATT SWITCHING POWER SUPPLY
- 8 EXPANSION SLOTS (2-FAST SLOTS/8 BIT, 1-8BIT, 5-16 BIT) OPTIONAL (1024 x 768)
- HI-PERFORMANCE 16-BIT VGA CARD (800 x 600) OR APPROVED
- 6 LAYER H.I.M.S. (U.S.A.) MOTHER BOARD
- LATEST AMI 386 BIOS (BUILT-IN DIAGNOSTICS, SETUP, AND HARD DISK FORMATTING UTILITY SOFTWARE)
- 10 YEAR BATTERY WITH CLOCK CALENDAR
- DISK CACHE AND EMS UTILITY SOFTWARE
- 5-BAY STURDY DESKTOP CASE (6 BAY VERTICAL CASE OPTIONAL)
- FCC CLASS B ON TOWER & DESKTOP

\$1895

H.I.M.S. 386SX 16 MHz WITH NO MONITOR

HARD DISK DRIVE	1 MB	2 MB	4 MB
68 MB 22 MS (800KB DTR)	1995	2150	2395
100 MB 22 MS (800KB DTR)	2195	2375	2595
120 MB 28 MS ESDI 1 MB DTR	2650	2795	3050



H.I.M.S. PAGE MODE SERIES 16 AND 20 MHz 386

- INTEL 80386 MICROPROCESSOR RUNNING AT 16 MHz (OR 20 MHz)
- SOCKET FOR 20 MHz INTEL 80387 OR 20 MHz WEITEK 3167 MATH COPROCESSOR
- 5.25" 1.2 MB OR 3.5" 1.44 MB DISKETTE DRIVE
- DUAL DISKETTE AND HARD DISK DRIVE CONTROLLER (1:1 INTERLEAVE)
- 1 MB OR (4 MB OPTIONAL) 80 NS PAGE MODE MEMORY
- 66 MB 23 MS HARD DISK, 800 KB DATA TRANSFER RATE
- HI-SPEED 2 SERIAL PORT(S), 1 PARALLEL PORT
- 101 ENHANCED TACTILE "CLICK" TOUCH KEYBOARD
- 230 WATT POWER SUPPLY (110/220V) FCC, UL, CSA, TUV APPROVED
- 8 EXPANSION SLOTS (2-32/8-BIT, 1-8-BIT, 6-16-BIT) OPTIONAL (1024 x 768)
- HI-PERFORMANCE 16-BIT VGA CARD (800 x 600) OR APPROVED
- 6 LAYER H.I.M.S. (U.S.A.) MOTHER BOARD
- LATEST AMI 386 BIOS (BUILT-IN DIAGNOSTICS, SETUP, AND HARD DISK FORMATTING UTILITY SOFTWARE)
- 10 YEAR BATTERY WITH CLOCK CALENDAR
- DISK CACHE AND EMS UTILITY SOFTWARE
- 5-BAY STURDY DESKTOP CASE (6 BAY VERTICAL CASE OPTIONAL)
- FCC CLASS B ON TOWER & DESKTOP

\$2295

ADD \$150 FOR 20 MHz

H.I.M.S. PAGE MODE 386/16 MHz WITH NO MONITOR

HARD DISK DRIVE	1 MB	4 MB
100 MB 22 MS 800 KB DTR	2395	2895
120 MB 28 MS 1 MB DTR ESDI	2750	3250
150 MB 16 MS 1 MB DTR ESDI	3095	3595
330 MB ESDI 14 MS 1 MB DTR	3950	4450



H.I.M.S. PROFESSIONAL SERIES CACHE PRO 386 20, 25 AND 33 MHz

- INTEL 80386 MICROPROCESSOR RUNNING AT 20 MHz (OR 25 AND 33 MHz OPTIONAL)
- SOCKET FOR 80387 OR WEITEK 3167 MATH CO-PROCESSOR
- 64 K 25 NS CACHE UPGRADEABLE TO 256 K, READ AND WRITE CACHE WITH WRITE BACK CACHE
- PAGE MODE MEMORY ARCHITECTURE
- 1 MB 80 NS MEMORY UPGRADEABLE TO 2, 4, 8 MB ON MOTHER BOARD, 16 MB WITH 32-BIT MEMORY CARD
- 5.25" 1.2 MB OR 3.5" 1.44 MB DISKETTE DRIVE
- DUAL DISKETTE AND HARD DISK DRIVE CONTROLLER, 1:1 INTERLEAVE
- HI-SPEED, 2 SERIAL, 1 PARALLEL PORT
- 250 WATT HEAVY DUTY POWER SUPPLY
- 101 ENHANCED TACTILE "CLICK" TOUCH KEYBOARD
- 8 EXPANSION SLOTS (1-32 BIT, 1-8 BIT, 6-16 BIT)
- LATEST AMI 386 BIOS (BUILT-IN DIAGNOSTICS, SETUP, AND HARD DISK FORMATTING UTILITY SOFTWARE)
- HIGH PERFORMANCE 16-BIT VGA CARD (800 x 600) OR OPTIONAL (1024 x 768)
- 6 LAYER H.I.M.S. 64/256 CACHE MOTHER BOARD
- 66 MB 23 MS HARD DISK 800KB DATA TRANSFER RATE
- 6 BAY VERTICAL OR 5 BAY DESKTOP CHASSIS (SUPER VERTICAL 10 BAY WITH 375 WATT POWER SUPPLY OPTIONAL)
- FCC CLASS B ON DESKTOP OR TOWER
- DISK CACHE, EMS UTILITY SOFTWARE

20 MHz \$2695 • 25 MHz ADD \$495

33 MHz ADD \$1295

CACHE PRO 386/20 MHz WITH NO MONITOR

HARD DISK DRIVE	1 MB	4 MB
100 MB 22 MS 800 KB DTR	2950	3495
120 MB (ESDI) 28 MS 1 MB DTR	3350	3895
150 MB (ESDI) 16 MS 1 MB DTR	3695	4450
330 MB (ESDI) 14 MS 1 MB DTR	4550	5150

COMPANY

H.I.M.S. TECHNOLOGIES has been manufacturing hi-performance computers in California under private label for a number of years, and now H.I.M.S. is manufacturing under its own label the same hi-performance computers, 286, 386SX, 386 Page Mode and Cache 386 to satisfy your needs in price, performance and after the sale service, which seems to be a missing feature with most of our competitors. Just compare our competition and you will find the obvious, then add our One Year On-Site Service at no extra cost.....SURPRISE!

PRODUCT

H.I.M.S. manufactures a complete breadth of 286, 386SX, Page Mode 386 and Cache 386 systems. H.I.M.S. is the only company currently supplying the industry with 386 Cache Pro in vehicle, super verticle or desktop with FCC Class "B" approval. How about our 256K Write Back Cache Design at down to earth pricing? You can actually afford the high speed luxury! All the H.I.M.S. Systems can be custom configured to fit your needs, so call our expert sales executives to discuss your specifications. All H.I.M.S. Systems come assembled, tested and burned-in from the Factory for 72 hours at 60p Centigrade. The Hard Disk is pre-comparted and formatted. H.I.M.S. carries a wide variety of options like: Video Cards for CAD/CAM and desktop publishing, printers, monitor's 14" to 25", Optio magneflo drives, math coprocessors, plotters, pointing devices and software.

SERVICE

All H.I.M.S. computers come with a One-Year On-Site Service included. This gives you an immediate back-up just in case a problem may arise a technician can be in your location within 4 to 8 hours from our 414 service locations, including Puerto Rico and Canada. All products are made in the U.S.A.!!!

H.I.M.S. TECHNOLOGIES is the Price, Performance and after sales service leader in the Fast Growth.



800-367-2924

H.I.M.S. TECHNOLOGIES
368 Montague Expressway • Millipitas, CA 95035
Phone: (408) 946-9711 • FAX: (408) 946-9744

IBM, COMPAQ, ALR, EVEREX, UNIX, XENIX, NOVELL ARE TRADEMARKS OF THEIR RESPECTIVE COMPANIES.

Circle 125 on Reader Service Card

Rock Solid. H.I.M.S.

OCCAM II

Companion and counterpart of the INMOS transputer, the Occam II programming language is designed for parallel processing

Dick Pountain

In the fourteenth century, the English philosopher/monk William of Occam gave science his famous "Occam's razor" principle, which states that assumptions should be kept to the minimum (or the simplest explanation is best).

The literal translation of the Latin *Entia non sunt multiplicanda praeter necessitatem* is "Entities should not be multiplied beyond necessity," which is still good advice even now in the era of floating-point coprocessors.

In the 1980s, INMOS introduced the transputer, a high-speed microprocessor designed for parallel processing. With it came Occam, the programming language designed especially for parallel programming on the transputer. Occam II is the latest version of Occam.

An Occam Machine

INMOS developed Occam and the transputer together in a way that few hardware/software combinations have been developed before. The transputer's hardware features (e.g., the on-chip serial links) were chosen to support the Occam model of concurrency, and the instruction set was devised to optimize execution of Occam programs. In turn, the features of the Occam language compiler were shaped by the hardware operations and performance, given the state of VLSI technology in the early 1980s. Although the transputer is perfectly capable of running programs written in C, FORTRAN, Pascal, or assembly language, it is an "Occam machine" in a real sense. To be more precise, the transputer embodies in hardware the Occam model of computation.

The Occam Philosophy

Since their inception in the 1940s, digital computers have been rather "introverted" entities. John von Neumann's great insight that a single memory space can hold both the data and the program that manipulates the data has governed the design of all computers to this day and, indirectly, of programming languages as well. A digital computer carries out its processing

activity in the small enclosed world of its RAM space. The outside world impinges only by exceptional means. The single-closed-world concept is the essential simplification that has allowed the science of computing to flourish so remarkably over the last 40 years. Only now is the computing community in a position to risk stepping away from it.

The demand for computing power, driven by applications like weather forecasting, real-time three-dimensional graphics, and numerical simulations, is growing exponentially. The pursuit of this extra power has made it clear that the basic von Neumann concept can be pushed only so far. The idea of a single (faster and faster) processor talking to a single (larger and larger) memory no longer has validity; the processor spends more time fetching instructions and data than it does processing. The speed of the bus that connects the memory and the processor has become a crucial bottleneck. Ever more elaborate layers of caching only postpone the inevitable crunch. It is generally agreed that the way to greater power and performance involves splitting up computations so they run on more than one processor concurrently—in other words, parallel processing. (See the In Depth section of the November 1988 BYTE.)

Unfortunately, while the von Neumann architecture has allowed the industry to make enormous strides in hardware optimization, it has also restricted the evolution of programming languages for distributed networks of processors. Conventional programming languages assume that the data is stored in main memory (if the data is stored externally, on magnetic disk, it must be brought into memory before it can be used). Languages like C and Modula-2 don't even have I/O instructions in their core language. They implement I/O operations as separate library routines. I/O instructions tend to be different in kind from the arithmetic and logical instructions that perform the processing. They frequently display complicated, ad hoc semantics imposed by the idiosyncrasies of communicating with external devices. What's more, the instructions for disk I/O are

continued

often different from those for screen I/O or serial port I/O. Consider, for example, the contortions involved in establishing an RS-232C link in BASICA.

The von Neumann architecture has also constrained programming language design in another way. It assumes a single processor sequentially executing a single list of instructions from the main memory. The most widely used programming languages display this assumption in their design fundamentals. Some languages, such as Modula-2, have added features to support concurrent execution, but, except perhaps in the case of Ada, these features feel more like optional extensions than integral parts of the language. When writing a concurrent program in these languages, the programmer often must become involved in the detailed mechanism of process synchronization.

Interprocess Communication and Concurrent Execution

In Occam the concepts of communication and concurrent execution are built into the core of the language itself rather than tacked on as afterthoughts. David May designed Occam at the INMOS research center in Bristol, England. Professor Tony Hoare of Oxford University greatly influenced the design of the Occam channel through his seminal paper "Communicating Sequential Processes" (*Communications of the ACM*, 1978). The key idea of CSP is that parallel computations can be implemented by a number of purely sequential von Neumann machines communicating with each other over a network of self-synchronizing channels.

The CSP idea infuses both the transputer hardware and the Occam language. The transputer acts as a whole computer-on-a-chip, complete with memory and four fast serial communication links. A network can be constructed by joining the links of several chips together. These links run concurrently with the main processor and have built-in hardware handshaking for synchronization. The transputer hardware also features an efficient time-slicing process scheduler that lets multiple processes run on the same chip. As I'll show below, it is crucial to the design that the same multiple processes can run *either* on multiple transputers *or* on a single one. (See "T800 and Counting," November 1988 BYTE, for more information on transputer hardware.)

In Occam, the abstract concepts of a *process* and a *channel* are equivalent to the elements of the CSP model; that is, the programmer can build closely linked multiprocessor networks by linking processes with channels. Occam channels support the underlying handshaking mechanism of the transputer *links* in a way that is totally transparent to the programmer. The crucial point is that an Occam program makes no initial assumptions about the actual hardware network it will run on. An Occam channel can eventually be implemented either as a real transputer link joining the separate memory spaces of two processors or as a shared memory location on the same processor without altering the program's logic. When coding a parallel-

process algorithm, you can concentrate solely on getting the logic correct and ignore hardware issues.

Multiprocessor development can actually take place on a single transputer. When the program logic is correct, you can map it onto a real network of transputers (of sufficient number to achieve the required performance) without altering its logical behavior. This intimate connection between Occam and the transputer hardware has given rise to much confusion about how "high-level" a language Occam is meant to be. I have devoted a section below to this issue.

Processes and Channels

The fundamental program element in Occam is the *process*. By definition, "a process starts, performs actions, and then terminates." This sounds very much like the definition of any computer program, but it forces you to think about things normally taken for granted, such as what is meant by "terminates." An Occam program can consist of many concurrent processes, and they can all terminate at different times; indeed, some may not terminate at all.

In Occam, there are only three primitive actions that a process can perform—namely, *assignment*, *input*, and *output*. Assignment is the same as it is in BASIC, C, or Pascal: It changes the value of a variable:

```
fred := 2 + x
```

Input and output involve passing a value to or from a *channel*. Channels are program entities that behave in some ways like variables; for example, they have a name and a type and must be declared before use (Occam II is a strongly typed language). A channel connects exactly two processes in only one direction; a bidirectional connection requires two channels. If a channel, *chan1*, connects two processes, *proc1* and *proc2*, that are running in parallel, then *proc1* may contain an output statement like this:

```
chan1 ! fred + 3
```

This means "output the value of variable *fred* + 3 on the channel *chan1*." The process *proc2* may contain an input statement like this:

```
chan1 ? tom
```

which means "input from channel *chan1* to the variable *tom*."

At first, it may help to think of input and output over channels as a way of assigning a value to a variable in another process. The net effect of the two statements above is rather like *tom* := *fred* + 3, except that *tom* exists inside a different process from *fred*. Shared global variables are forbidden in Occam. If a variable is assigned in process A, Occam will not allow you to use that variable in any other process running in parallel with A. (Compiler checks enforce this prohibition.) The only legal way to transfer a value from one parallel process to another is via a channel. You use variables only to store values, not transfer them. The rationale for this should become clear after some reflection. Logically it is the same problem as that of several users on a LAN accessing the same file—without record locking, chaos results. Occam uses the channel communication process instead of variable locking.

Both input and output processes are "patient"—that is, each will wait until the other is ready. So it is immaterial whether *proc1* reaches its output statement before or after *proc2* reaches its input statement; whichever arrives first waits for the

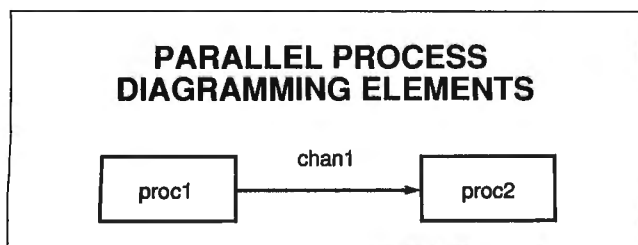

Figure 1: A process diagram of the simple program structure where *proc1* communicates to *proc2* through *chan1*.

other. A parallel Occam process runs completely asynchronously (i.e., at its own speed) until it must communicate with another process, at which point the two processes are forced into step while they exchange data, after which they go their separate ways again. Basically, this is the same idea as the "rendezvous" in Ada, but in Occam it is implicit and totally transparent to the programmer.

Because channels and processes are so fundamental to Occam, it's often useful to draw process diagrams that describe a

of A, B, and C terminates. You neither know nor care which process that may be. The simple communication example above looks like this when fully declared in Occam:

```
CHAN OF INT chan1:
INT fred, tom, jane:
PAR
  SEQ
    fred := 3
    chan1 ! fred + 2
  SEQ
    chan1 ? tom
    jane := tom * 20
```

The channel chan1 is declared to be able to carry integer values only (i.e., of type INT), and INT is said to be its protocol. This program results in fred=3, tom=5, and jane=100. Had you tried to use fred in the second SEQ as well, the compiler would have reported an illegal shared variable in a PAR. You could instead have declared the variables as local to their SEQs, in which case the problem can't even arise:

```
CHAN OF INT chan1:
PAR
  INT fred:
  SEQ
    fred := 3
    chan1 ! fred + 2
  INT tom, jane:
  SEQ
    chan1 ? tom
    jane := tom * 20
```

As a rule in Occam, it's best to keep all data local unless there's a pressing reason not to. You can name processes and give them parameters just as in C or Pascal, so you can go on to say

```
CHAN OF INT chan1:
PROC proc1(INT x)
  INT fred:
  SEQ
    fred := 3
    chan1 ! fred + x
:
PROC proc2(INT y)
  INT tom, jane:
  SEQ
    chan1 ? tom
    jane := tom * y
:
PAR
  -- main process starts here
  proc1(3)
  proc2(20)
```

Other Control Processes

In Occam, you have several other ways of combining primitive processes besides PAR and SEQ—for example, IF, WHILE, CASE, and ALT. The conditional process IF executes the first process whose test is true. The selection process CASE operates similarly but uses literal selector values instead of tests. WHILE provides a conditional loop like that of C and Pascal. The most interesting control process of all is ALT, the alternative process, which has no equivalent in sequential languages. Consider the following program fragment:

continued

Because Occam permits parallel execution, sequential execution cannot be taken for granted as it is in ordinary languages.

program's structure rather than flowcharts. Figure 1 shows how you might diagram the simple situation described above.

Occam Programs

Occam programs are built up from the three primitive processes just described (i.e., assignment, input, and output) by combining them into more complex processes. Or, looking at it the other way around, Occam lets you hierarchically decompose a problem into a collection of concurrent processes communicating via channels.

The syntax of Occam looks fairly conventional to anyone who is used to Algol-derived languages such as Pascal. Only two things immediately stand out as being unusual. First, Occam uses indentation not just for increased readability, as in C and Pascal, but also as the sole delimiter of subprocesses; there is no equivalent of BEGIN...END or {..}. Second, because Occam permits parallel execution, sequential execution cannot be taken for granted as it is in ordinary languages. In Pascal or BASIC, if you write statements one after the other, you expect them to be executed one after the other. In Occam, if you want a sequence, you have to ask explicitly for a sequence. Suppose you have three processes called A, B, and C. Then, in the Occam construct

```
SEQ
  A
  B
  C
```

indenting A, B, and C by two spaces under the keyword SEQ, defines a compound process consisting of the sequence A followed by B followed by C. This process terminates when C terminates, much as in BASIC or Pascal. However, if you say

```
PAR
  A
  B
  C
```

you have specified a new process consisting of A, B, and C running *at the same time*. This process terminates when the slowest

```

ALT
  right ? x
    out ! x
  left ? x
    out ! x

```

The ALT process watches channels `left` and `right` and executes the subprocess associated with whichever one produces a result first; it's like a first-past-the-post race between the channels. Here, the subprocess is the same for both, merely outputting the received value on the single channel `out`. If you iterate the ALT process, it has the effect of merging or time-multiplexing two input streams into one output stream. The process below merges two streams of complex numbers until you stop it by sending the Boolean value `FALSE` on channel `shutoff`:

```

PROTOCOL COMPLEX IS REAL64;REAL64:
PROC merge(CHAN OF COMPLEX right,
           left, out;
           CHAN OF BOOL shutoff)
REAL64 x.real, x.imag;
BOOL running;
SEQ
  running := TRUE
  WHILE running
    ALT
      shutoff ? running
        SKIP
      right ? x.real; x.imag
        out ! x.real; x.imag
      left ? x.real; x.imag
        out ! x.real; x.imag
:

```

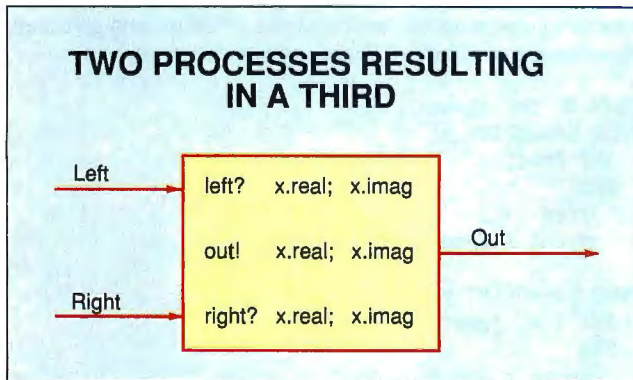

Figure 2: A process diagram of two input streams multiplexed into a single output stream. The Boolean value `FALSE` on channel `shutoff` will terminate the program.

Table 1: Occam II supports a full range of type conversion and IEEE rounding and the following data types:

```

BYTE
INT (size defined by executing hardware)
INT16
INT32
INT64
REAL32
REAL64
BOOL

```

Figure 2 shows the process diagram for this example.

This process illustrates several further points about Occam: It supports a 64-bit ANSI/IEEE floating-point data type `REAL64` (other supported data types are shown in table 1); channels can have structured rather than simple protocols; more than one variable can be changed by a single input or output; although Occam has structured channel protocols, it does not have corresponding structured variables or records, so a sequence of simple variables has to suffice.

Arrays

Occam supports arrays of both processes and channels in addition to plain data arrays. An array of SEQ processes is just a way of describing a counted loop similar to Pascal's `for` loop. To illustrate, here's a process that prints strings to a screen:

```

PLACE screen AT 8;

PROC writestr(CHAN OF BYTE stream; VAL []BYTE
             string)
  SEQ i := 0 FOR SIZE string
    stream ! string[i] : SEQ
    writestr(screen, "Hello world!")

```

`SIZE` is a built-in Occam function that returns the size of an array. Note that Occam does not support separate character or string types but treats them as bytes and arrays of bytes. The process uses `PLACE` to make `screen` a physical hardware channel (see below).

An array of PAR processes is a central construct in the Occam style of programming. It describes a pipeline of processes in which you can pass data from one process to another and subject it to the same operation at each stage. The simplest example of the use of such a "replicated" PAR is to implement a queue or buffer structure such as this terminal type-ahead buffer:

```

[21]CHAN OF BYTE buffer;
PROC keyboard.input()
  WHILE TRUE
    BYTE char;
    SEQ
      keyboard ? char      -- get a character from
                           the keyboard
      buffer[0] ! char     -- put it into the
                           pipeline
:
PROC terminal.output()
  WHILE TRUE
    BYTE char;
    SEQ
      buffer[20] ? char   -- get a character from
                           the pipeline
      screen ! char       -- display it
:
PROC type.ahead()
  PAR i := 0 FOR 20      -- 20 parallel
                        processes
  WHILE TRUE           -- all like this...
    BYTE char;
    SEQ
      buffer[i] ? char   -- pass the
                           character
                           on to...
      buffer[i+1] ! char -- ...the next stage
:

```

```
PAR
  keyboard.input()
  type.ahead()
  terminal.output()
```

The main process, `type.ahead`, is a replicated `PAR` that simply passes characters along the line of channels called `buffer` from the keyboard input process to the screen output process. All three processes run in parallel. The buffer is self-regulating thanks to the nature of Occam channel communication; it can't overflow or underflow but waits patiently in either case.

You can use an array of parallel processes for parallel sorting, vector arithmetic, or graphics ray tracing by performing computations on the data rather than just passing it along. Of course, to reap any performance benefit, you must assign a physical processor to each component of the replicated `PAR`, although you can develop and test the program by time slicing on a single processor.

Real-Time and Hardware Matters

Once you have debugged an Occam program to the point where the logic is correct, you can turn to matters of configuration and performance. Occam provides the means to assign processes to physical transputers and channels to physical transputer links. It also supports I/O ports (so you can write device drivers for conventional peripheral chips) and the absolute location of program objects in memory (for memory-mapped devices).

You use the keywords `PLACE` and `PLACED` to associate channels and processes with physical devices. The body of a pipelined ray-tracing program may contain declarations of this kind when configured to run on several transputers:

```
VAL number.transputers IS 50 :
PROTOCOL PIXELPACK IS INT::[ ]INT :
[ number.transputers ]CHAN OF PIXELPACK forward,
  return :
.....
```

```
PLACED PAR i := 0 FOR number.transputers
  PROCESSOR i T8
    PLACE forward[i] AT link0in :
    PLACE forward[i+1] AT link1out:
    PLACE return[i] AT link1in :
    PLACE return[i] AT link0out:
    calculate(forward[i], forward[i+1],
      return[i], return[i+1])
```

The user-defined process `calculate` performs ray-tracing computations on batches of "raw" pixels that are sent outward on the array of channels named `forward`; the processed results are sent back along the return channels. The protocol `PIXELPACK` is a 16-bit count followed by an array containing that number of 16-bit pixels. The `PLACED PAR` assigns an array of 50 parallel calculating processes to a pipeline of 50 T80 transputers (`PROCESSOR i T8`), and the `PLACE` statements assign the Occam channel names (`forward[i]`, and so on) to real transputer links (`link1in`, and so on). Figure 3 diagrams this process.

I have simplified this example drastically—a real ray-tracing program is much more complex. You can also use `PLACE` to put variables or arrays at absolute memory addresses, just like absolute variables in Turbo Pascal.

Performance in Occam programs is not just a matter of the number of processors employed; process priority can become an issue, too. In general, Occam discourages the use of priority, preferring to allow channels to self-synchronize. Although

you can develop most programs without prioritization, it may become unavoidable in real-time applications. The keyword `PRI` can be applied to both `PAR` and `ALT` processes to establish one component's priority over all the others. Thus, in

```
PRI PAR
  A
  B
  C
```

process A has priority, and processes B and C can proceed only when A is waiting on an input or output. A good example of the use of a `PRI ALT` is to mix a stream of serial data from a UART chip with data from an Occam channel; the UART is an "impatient" external device that can lose data if kept waiting:

```
TIMER clock:
... more declarations
SEQ
  clock ? time          -- get start time
  WHILE active
    SEQ
      time := time PLUS interval
    PRI ALT
      clock ? AFTER time -- is it time to check
                          the UART yet?
    SEQ
      get.UART(char)
      to.buffer ! char
    source ? char       -- otherwise get from
                          channel
      to.buffer ! char
```

The user-defined process `get.UART` checks the UART's status register and gets a character if one is ready; `clock` demonstrates another kind of Occam object, a timer that acts like a channel that delivers the current time. The operators `PLUS` and `AFTER` are used to do modulo arithmetic on time values. The value of `interval` would be set just short of the shortest possible time in which a new serial character can arrive (that time, in seconds, is about 10 divided by the baud rate). Thus, processor time is not wasted in a "busy wait" when no UART data is due.

Limitations of Occam

There has been much misunderstanding about how high-level the Occam language is. Occam is very intimately linked to the transputer instruction set, to the point where many Occam constructs compile to single instructions. In fact, INMOS intended Occam to be the assembly language of the transputer, the lowest level at which it can be programmed. Some assemblers are now available for the transputer, but parallel assembly pro-

continued

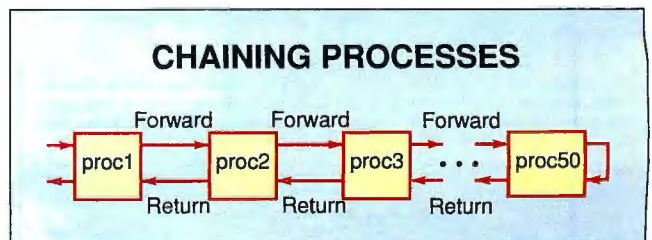

Figure 3: A simplified diagram of ray tracing using 50 parallel T80 transputers.

OCCAM II

**Protects
while you
type!**

- **Remains In Place** while you use your computer.
- **Avoids Costly Repairs.** Protects delicate electronics from dust, spills, smoke, ashes, staples.
- **Soft, Flexible,** retains normal keyboard feel.
- **Washable, Durable High-Tech Polymer** lasts years.
- **Hundreds of Models.** SafeSkin is available for most PCs, laptops, workstations and clone keyboards.
- **Office • Home • Factory • Classroom • Laboratory**

List Price \$29.95. Please call or write for free color brochure. Dealer inquiries encouraged.

SafeSkin™
KEYBOARD PROTECTOR

Merritt Computer Products, Inc. 5565 Red Bird Center Drive
Suite 150, Dallas, Texas 75234/(214) 339-0753 • FAX (214) 339-1313
In Canada call 1-800-663-1061

**W&T interfaces are so small
that they match the
following office furniture
perfectly:**

Stuart,
Victorian,
European,
Chinese,
Italian,
....



If interfaces don't match, you don't want them. W&T interfaces are almost invisible because they're integrated into the connector and look like a regular data cable or a stylish pocket calculator. Built-in simplicity and fully detailed instructions ensure straightforward installation.

PC & UNIX compatible products. Bus System, Error Correction, Interfaces, Printer Buffers, T-Switches.

- Wiesemann & Thels
Winchenbachstr. 3-5
D-5600 Wuppertal 2
West Germany
Tel.++49 202 505077
Fax:++49 202 511050
- (A) Basic Merton (0222) 9736360 (B) Brother Int. (02) 4674211 (CAN) Sicoatl (416) 670 1650 (CH) Weber & Co (01) 9302093 (D) Wiesemann & Thels (0202) 505077 (DK) Jalec (86) 479139 (F) Neol 88.62.37.52 (S) Thor (01) 681500 (MB) Telas 5184500 (N) RamTeo (09) 224620 (O) Ga & Korsch (010) 4507696 (S) Moresco (9) 1626812 (SGD) Overseas Trade 2726077
- W&T**
INTERFACES

programming is strictly for heroes. Viewed as an assembly language and compared to 8086 or 68000 assembly languages, Occam is very high-level indeed. But compared to Pascal or C, it is rather low-level, lacking, for example, record types and structures. Moreover, it is a static language (like FORTRAN), in which all the resources a program needs must be known and allocated at compile time. This means that it does not support a stack or a heap and so does not permit recursive procedures.

This was a deliberate, if radical, design decision by INMOS. The transputer was not designed to compete head-on with the Intel and Motorola chips as a general-purpose single CPU, but rather to be a programmable component for very high-performance parallel applications, often of the embedded type. Typical transputer applications have been distributed control systems, laser printer engines, graphics processors, image-processing arrays, and signal processors. For such applications, Occam needs to be efficient and secure. It must also be capable of running without an operating system, on the raw hardware, and, perhaps, using only the on-chip memory.

It would have been possible to make Occam a stack-based, block-structured language like C, but then every parallel process would have to have its own stack, which requires a dynamic memory-allocation scheme (like that in Unix) for which the transputer provides no hardware support. Such schemes mean large memory overheads and degraded context switching; a raw Occam process can be switched in about 1 microsecond compared to about 100 microseconds for Unix tasks.

Another point is that the static nature of Occam allows compiler checks to catch most logic errors (apart from deadlock) at compile time while reducing the number of possible run-time errors and making them cheaper to detect—important benefits for high-security applications. It seems likely that transputer users will be split into two camps for some time. Some will want a fuller operating system, such as the Helios system (see "A Personal Transputer," June 1988 BYTE). They'll also want a C compiler but will be prepared to accept reduced performance. Others will need the minimalism of Occam. Eventually, the camps could be reunited if INMOS is ready to produce a dynamic version of Occam when the next generation of transputers provides the needed hardware memory management.

A "Novel Calculus"

These few examples, I hope, have conveyed some of the feel of Occam programming. Designing Occam programs is certainly different from designing sequential programs; often it is more like designing electronic circuits where you "wire" together a number of active components, the wire being channels and the components being parallel processes.

While Occam is a safe, elegant, and efficient way to program transputer networks, it is also something more; it's a novel calculus or way of thinking about concurrent systems. The clean syntax of Pascal has made it the textbook language in which to express sequential algorithms. I believe that Occam can fulfill the same role for parallel algorithms. Occam has well-defined algebraic semantics that allows accuracy-preserving transformations to be performed on program text. INMOS design engineers have used a specification written in high-level Occam, via a transformation system, to verify the accuracy of the microcode that implements the FPU of the T800 transputer. In future designs for hardware, this microcode may be "compiled into silicon" from the Occam descriptions. ■

Dick Pountain is a BYTE consulting editor, technical author, and software consultant living in London, England. You can contact him on BIX as "dickp."

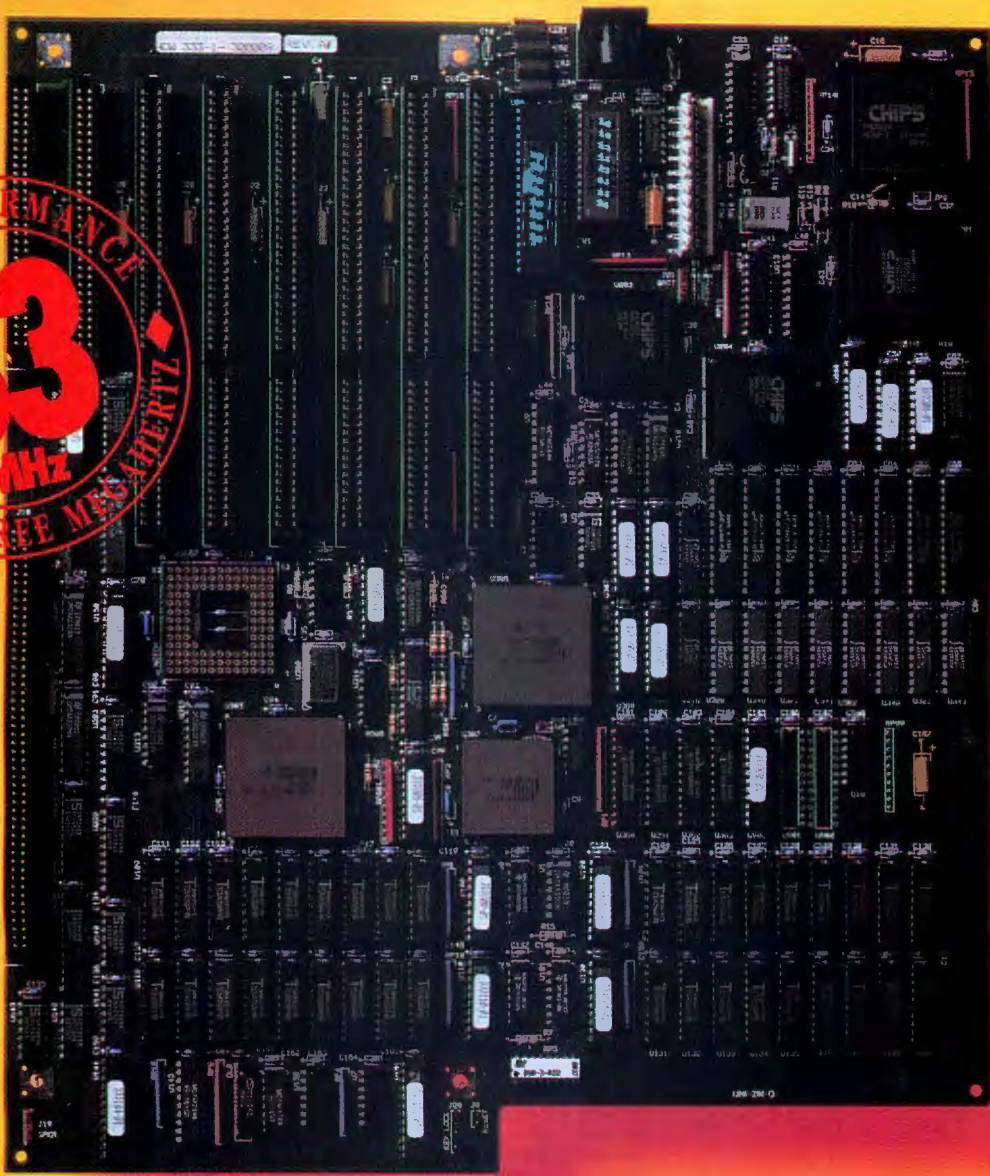

IT Hz SO GOOD!

INTRODUCING HAUPPAUGE'S 33MHz SYSTEM BOARDS. If your computer feels slow, we know where it hertz. For a fast cure, get our new 386 MotherBoard/33MHz. We've built in 4 Megabytes of high speed RAM, 64K of RAM cache, and both 387 Weitek math coprocessor sockets. This board makes your 386 computer the fastest PC available!

Network Savvy. With the 386 MotherBoard/33MHz, you can build a file server or workstation that makes Novell networks *scream*. Enjoy compatibility with Token Ring, Arcnet, Ethernet, and other network cards.

The UNIX Engine. Great for VARS, Systems Integrators and UNIX OEMs, the Hauppauge 386 MotherBoard/33MHz runs SCO Xenix, Interactive 386/ix and AT&T's UNIX System V. With its PC/AT compatible I/O system, our 33MHz board accommodates the latest in disk control, graphics, and network I/O cards.

CAD Capability. Do your AutoCAD and other CAD programs seem slow? The 386 MotherBoard/33MHz boosts your math and graphics applications, and supports the high speed 387-33 and 33MHz Weitek math coprocessors.

Technical Features. The 386 MotherBoard/33MHz includes:
■ 4 Megabytes of high speed 32-bit memory, expandable to 64 Megabytes
■ 64K of 20 nsec cache memory ■ Six 16-bit expansion slots, one 8-bit and one 8-bit/32-bit slot ■ PC/AT compatible I/O system for support of OS/2 and UNIX.

Yes, send me your product information!

Name _____

Company _____

Address _____

City, State, Country _____

Telephone _____ Zip Code _____

Mail Coupon to:

Hauppauge Computer Works, Inc.
175 Commerce Drive
Hauppauge, New York 11788, U.S.A.
Tel: 01-516-434-1600
Fax: 01-516-434-3198

or: Hauppauge Computer Works, GmbH
Hansaallee 201
4000 Dusseldorf 11, West Germany
Tel: 0211-594320
Fax: 0211-593908

For more information call Hauppauge,
(516) 434-1600. In Europe: (49) 211-594320.

Hauppauge Computer Works
Your high performance 386 Supplier

Hauppauge!



S Systems 10 MHz XT

- Intel 8088-1 CPU
- Phoenix BIOS
- 640K on board
- TEAC 360K floppy drive
- Multi I/O w/1P, 1S, 1G, fdc, clock
- Enhanced 101 key keyboard
- XT style case
- 165W power supply

XT/10 Drives	Video Options			
	Mono	CGA	EGA	VGA
Single	650	775	1045	1115
Dual	675	855	1125	1195
20MB	975	1150	1425	1495
40MB	1125	1305	1575	1645

S Systems 286/12

- Intel 80286-12 CPU
- Ami or Phoenix BIOS
- 1MB RAM on board
- TEAC 1.44 3.5" floppy drive
- Hard/floppy drive controller
- Enhanced 101 key keyboard
- Baby AT style case
- 200W power supply
- Multi I/O card w/1P, 2S ports

AT 286-12 Drives	Video options		
	Mono	EGA	VGA
Single	855	1305	1375
20MB	1190	1640	1715
40MB	1345	1795	1865

S Systems 286-16

- Intel 80286-16 CPU
- Award BIOS
- 1MB RAM on board
- TEAC 1.44MB floppy drive
- Hard/floppy drive controller
- Enhanced 101 key keyboard
- Baby AT style case
- 220W power supply
- 1P, 1S Port

AT 286-16 Drives	Video options		
	Mono	EGA	VGA
Single	1010	1455	1530
20MB	1345	1795	1865
40MB	1500	1950	2020
80MB	1765	2215	2285

S Systems 386-20

- Intel 80386-20 CPU
- Ami BIOS
- 1MB on board
- TEAC 1.44 & 1.2MB floppy drives
- Hard/floppy controller (1:1)
- Enhanced 101 key keyboard
- AT full style case
- 220W power supply
- 1P, 2S ports

AT 386-20 Drives	Video options		
	Mono	EGA	VGA
20MB	1795	2225	2305
40MB	2028	2475	2545
40MB	2325	2625	2700
80MB	2450	2885	2965

Monochrome Monitors

Amdek V210A	\$85
Amdek V410A	150
NEC Multisync GS	220
Samsung mono-12 flat	105
Samsung mono 14	105

Color/EGA Monitors

Amdek C732	\$445
Amdek C722	515
AST EGA	515
Mitsubishi 1410C	345
Mitsubishi 1430C	405
Samsung EGA 14	375

VGA/CAD Monitors

Mitsubishi 1381A	\$515
NEC Multisync 11A	505
NEC Multisync 3D	695
NEC Multisync plus	965
NEC Macsync	625
Sony 1302P	Call

Printers

NEC P2200	\$330
NEC P5200	525
NEC P5300	695
Okidata 320P	375
Okidata 321P	520
Okidata 390	520
Okidata 391	705
Okidata 393	1105
Okidata 393C	1185
Toshiba 301	315
Toshiba 311	380
Toshiba 341SL	650
Toshiba 351SX	985

Laser Printers

NEC LC 890	\$3405
Toshiba Pagelaser	2785
HP Laserjet 11/11D	Call

Plotters

HI DMP-52	\$2495
HI DMP-52MP	2945
HI DMP-61	3245
HI DMP-62	4000

Video Boards

Hercules Colorcard	\$155
Hercules Incolorcard	210
Hercules VGA	189
Paradise EGA-350	195
Paradise EGA-480	210
Paradise VGA-Plus	280
Paradise VGA-Plus-16	320
Paradise VGA-Prof	470
Quadram Quadega	250
Video 7 Vega Deluxe	225
Video 7 Vega VGA	300
Video 7 Fastwrite VGA	380
Video VRAM-VGA	475

Multifunction/Memory Boards

AST Rampage 2-256	\$290
AST Rampage-286	Call
AST Rampage Plus-286	420
Intel Above 286-Plus	435
Intel Above PS286 Plus	485

Floppy Drives

Toshiba 360K	\$70
Toshiba 1.2MB	85
Toshiba 720K	75
Toshiba 1.44MB	90
TEAC 360K	75
TEAC 1.2MB	90
TEAC 720K	80
TEAC 1.44MB	90

Accelerator Boards

AST Fastboard-386	Call
Intel Inboard 386-PC	650
Intel Inboard 386	900
Quadram Quad 386XT	Call

Hard Drives

Seagate 20MB	\$225
Seagate 40MB	410
Seagate 80MB	600
Plus Hardcard-20	535
Plus Hardcard-40	670
Plus Passport-20	415
Plus Passport-40	560

Tape Drives

Archive 5240	\$325
Archive 5540	345
Archive VP601	675
Mountain 4340	400

Math Co-processors

Intel 80287-8	\$225
Intel 80287-10	260
Intel 80387-16	415
Intel 80387-20	470
Intel 80387-25	590
Intel 80387SX	375
Intel 80c287	315

Software

Aldus Pagemaker	\$455
dBASEIV	450
Lotus 1-2-3 v. 2.01	295
Lotus Symphony	415
Microsoft Windows 286	70
Microsoft Windows 386	130
Microsoft Excell	285
Microsoft Word	215
Microsoft Works	105
Paradox 3.0	415
PFS First Publisher	70
Ventura Publisher	485
Word Perfect 5.0	220
Symantac Q&A 3.0	215
Symantac Q&A 386	Call

Mice

Logitech Serial Mouse	Call
Logitech Bus Mouse	Call
Microsoft Mice	Call

Modems

US Robotics 1200	Call
US Robotics 2400	Call
Okitel 1200B int	125
Okitel 2400B int	200
Okitel 2400B Plus int	285

Laptop Computers

Toshiba 1600	\$3250
Toshiba 3100E	2800
Toshiba 3200	3500
Toshiba 5200-40	Call
Zenith Supersport 286	Call

Scanners

HP Scanjet	Call
Logitech Scan Man	225
Niscan OCR	395

Surge Protectors

Curtis Diamond	Call
Curtis Emerald	Call
Curtis Ruby	Call
Kensington Masterpiece	100

Fax Machines

Sharp FO-220	\$750
Sharp FO-300	1025
Sharp FO-330	Call
Murata 1200	650
Murata 1600	875

To order call 1-800-837-3573; Fax # 312-495-2629

- Lease Available
- COD under \$500.00
- Certified & Cashiers Check
- Wire-Transfer, Money Orders
- Personal & Co. checks allow 10 days to clear.

- No returns without RMA#
- 30 Day Return Policy
- No returns on Software
- Prices subject to change without notice.

ELS ENTERPRISES, LTD.

15 E. Madison, Lombard, IL 60148

Hours: M-F, 8am-6pm
Saturday 10am-4pm

HANDS-ON PARALLEL PROCESSING

*An inexpensive way to set up your own hypercube system
using Macs and AppleTalk*

Geoffrey C. Fox, Alex W. Ho, Paul Messina, and Terry Cole

The promise of parallel computing is performance: unprecedented performance in large configurations and a better price/performance even in small systems. However, programming parallel systems to perform concurrent computations requires new techniques best learned through hands-on experience on real parallel computers.

Many wishing to learn or teach parallel programming cannot afford to buy a commercial parallel computer. We'll describe how to create a parallel computer (of a type known as a hypercube) using an ensemble of Apple Macintosh computers and AppleTalk. For more information about parallel computers in general, refer to the text box "The Drive for Parallel Systems" on page 288.

The Hypercube

A p -dimensional hypercube computer, also called a p -cube, has 2^p processors that can be thought of as being located at the vertices of a p -dimensional cube (see figure 1). The physical connections among the node processors lie along the edges of the hypercube. Each node processor of a p -cube is connected to p other processors. In the case of a three-dimensional cube, the total number of node processors is eight and each node is connected to three other nodes. Higher-dimensional cubes can be formed recur-

sively from lower-dimensional cubes. The maximum number of stages a message might have to traverse in a p -dimensional hypercube is p , as opposed to $2^{(p-1)}$ steps for a physical ring connection.

The hypercube architecture has the added advantage of being able to map conveniently to a wide range of simple topologies, such as a ring, a grid, a pyramid, or a binary tree, while requiring a modest number of physical connections at each node. In a 1024-node system, for example, 10 communication channels are needed. Currently available hypercube systems include the Caltech/JPL Mark Series computers and the commercial systems of Intel Personal Scientific Computer (iPSC), NCUBE, and Ametek.

In most of the current hypercube systems, the node processors are not connected to any I/O peripheral devices. To provide them with I/O capability, a computer called a control processor (CP) or cube manager is connected to one or more node processors (see figure 1).

A CP is a conventional computer with ordinary I/O devices. It is the only path from the outside world to the hypercube, and vice versa. Programmers can interact with the hypercube only via the CP. To run an application program on a hypercube, the program must be downloaded from the CP. When data has

continued

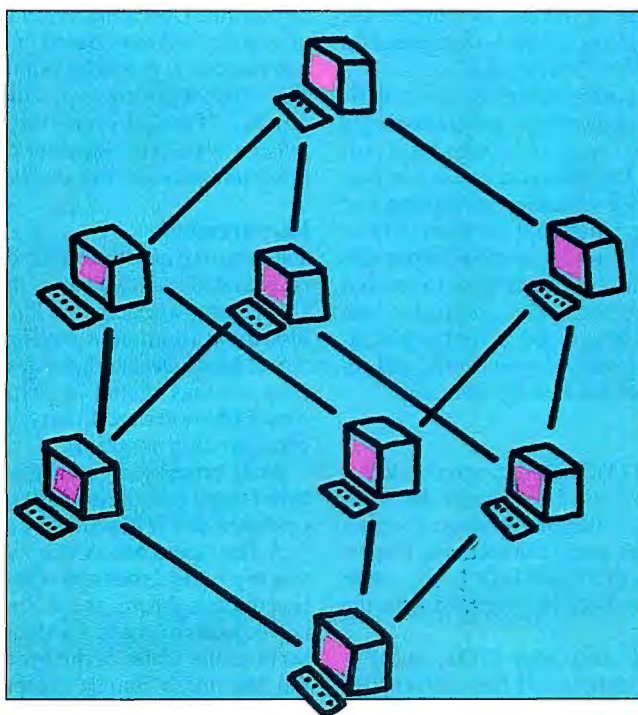

The Drive for Parallel Systems

Scientists, researchers, and engineers all over the world are clamoring for computer systems that will enable them to approach and solve large-scale problems realistically. For instance, to carry out a meaningful numerical study of quantum chromodynamics (a theory of fundamental particles) would require repeated recalculation of about 100 million values representing various field strengths in the four-dimensional space-time region near a proton. In the field of computational fluid dynamics, to adequately model the fine structures of three-dimensional high-Reynolds-number (turbulent) flow would consume an enormous number of computer cycles.

The demand for higher-performance computers is rising. But the performance of conventional supercomputers is approaching its fundamental physical limit, which is imposed by the speed of light (about 1 foot per nanosecond), the fastest possible speed a signal would be able to travel from one part of the computer to another (see reference 7 in the main text). Even if the physical size of a single-processor computer could be made very small and its components could send signals at the speed of light, such a computer still could not achieve more than a few billion instructions per

second, which is not enough for applications that are derived from various contexts such as physics, fluid dynamics, or real-time image and natural-language processing, just to name a few.

The advancement of semiconductor and VLSI technology will make individual processing units substantially cheaper but cannot improve their performance to a comparable extent. To obtain an appreciable increase in the throughput rate of a computer system, the system must be able to overcome the sequential bottleneck of the Von Neumann architecture.

To address this issue, new computer architectures are required that use many processors to work on the same problem at the same time. In other words, what we need is concurrent or parallel processing.

Most computers have only one processing unit, the CPU, that performs all the computational work. Computer programs, written in languages such as C or FORTRAN, are compiled (i.e., translated) into a sequence of machine instructions. These instructions must be executed sequentially by the computer. However, many applications are inherently parallel, as in most real-world phenomena. If we can capitalize on the parallelism of these applications by

using concurrent processing to overcome the sequential bottleneck of the conventional design, we can achieve faster execution and increase throughput.

In addition to providing a path to unprecedented speed, another strong motivation for designing and using parallel computers is the hope for better price/performance than sequential systems offer. Microprocessors of moderate speed are produced by the millions for personal computers and other applications. Their internal speeds and feature sizes do not require the most expensive fabrication techniques. While one microprocessor is not terribly powerful, dozens or hundreds of microprocessors organized as one computing system can perform sizable computations.

Combining 20 5-MIPS microcomputers could yield an equivalent of 100 MIPS, a speed that few sequential computers can achieve. The price of the components in the microcomputer-based system is much less than that of a sequential computer of comparable speed. Of course, programming the parallel system efficiently may be more difficult than programming the sequential one, particularly for those who have grown up in a serial programming environment.

to be written onto disk or tape, say at the end of a hypercube application, the node processors have to be programmed to send their data to the CP, where file I/O is possible.

Programming a hypercube concurrent computer isn't difficult, but it's also not as straightforward as programming a sequential machine, especially for those of us who have programmed sequentially for years. Hands-on experience in programming a hypercube is extremely valuable for learning and understanding how concurrent computers and programs work.

It may be extravagant to buy a small commercial hypercube computer just to learn about parallel processing or to teach a class in advanced computer architectures. One alternative is to assemble your own hypercube, the Mac-Cube, using the Macintosh family. This is especially desirable for academic and research environments in which Macs are already abundant.

The Mac-Cube

We have designed and fabricated a Mac-based hypercube with a companion operating system and named the group the Mac-Cube (see reference 1). It uses LocalTalk hardware and AppleTalk software as the medium for the nodal connections. Hypercube connectivity is emulated on the AppleTalk LAN, while the hypercube communications protocol is integrated with the AppleTalk software.

Available for use with the Mac-Cube is Mac-CrOS, an MPW C and assembly language implementation of the Caltech/JPL

Crystalline Operating System, also known as CrOS III (see reference 2). Software based on Mac-CrOS is portable across all commercial hypercubes running CrOS III. [Editor's note: *The Mac-CrOS software is available from several sources. See the text box "Parallel-Processing Resources" on page 293 for details on obtaining resources from Caltech. Also see page 5 for information about files available on BIX.*]

Requirements

The required hardware and software for setting up a Mac-Cube is separated into two parts: the CP and the node processors. A CP requires a Macintosh Plus, SE, or II; a 10-megabyte hard disk drive (minimum configuration); System 4.1 and Finder 5.5 (Mac-Cube has been tested with these versions, though later versions should be compatible); MPW 2.0; and the C^{3P} Mac-Cube software library (which contains Mac-CrOS and a configuration program).

Node processors require a Mac Plus, SE, or II; one 800K-byte floppy disk drive; System 4.1 and Finder 5.5; and a startup disk with C^{3P} Mac-Cube configuration software.

A functional Mac-Cube hypercube consists of $2^p + 1$ Macs, where p is the dimension of the hypercube. For the implementation discussed here, the p dimension is between 0 and 4, which corresponds to one to 16 Macs. Of the total $2^p + 1$ machines, 2^p serve as the nodes of the hypercube and can be any member of the Macintosh family except the Mac 128K. The additional

Parallel Processors

The performance of parallel processors is related to the underlying architecture of the system and the mode of processor coordination. There are two major categories of parallel architecture. In the SIMD (single instruction and multiple data stream) system, the processors perform the same instruction at each cycle, but each operates on different data. In an MIMD (multiple instruction and multiple data stream) system, the processors can run independently. Each processor can execute different portions of the same program or completely different programs.

An important aspect of multiple-processor architectures is how the processors are associated with memory. In *shared-memory* systems, all processors access the common physical memory by direct connections, by a network of connections, or by a memory bus. Shared-memory systems enable each processor to operate on data that is also accessible to other processors. Because all processors can modify stored data, care must be taken to avoid attempts by processors to gain access to data before the appropriate value has been stored.

One limitation of shared-memory architecture is that it appears to be expensive and difficult to produce massively

parallel systems—that is, systems with hundreds or thousands of processors. Examples of shared-memory parallel computers are Cray's Cray-2, ETA's ETA 10, Bolt Beranek and Newman's Butterfly, ELXSI's System 6400, and IBM's RP3, among others.

In contrast to the shared-memory model, there are the *distributed-memory* or *local-memory* systems. This form of processor/memory relationship exists when some amount of memory (local memory) is attached to each processor, and connections are established among the processor-memory pairs (also designated as node processors, or simply nodes). In a distributed-memory system, each processor has direct access to only its own local memory.

If a processor has to access or modify the value of a piece of data that does not exist in its local memory, message-passing via communication channels is the mechanism required to achieve the task. The communication channels are the actual physical linkages of the individual processors and can be arranged in an arbitrary network topology. A disadvantage of network communication is an increase in latency of memory access, because a request for information by a processor may have to traverse several stages of the connection network to get

to the particular memory unit that has the data.

Some Network Topologies

A simple scheme for connecting distributed processors is the ring topology in which each node processor is connected to two other processors. Another simple scheme is a rectangular grid. In this configuration, each processor is connected to the four other processors that are its nearest neighbors. A significant drawback of simple topologies such as these is that the number of processors involved in coordinating the sending of a message from one node processor to another could be very large. In the case of a ring, as many as half the total processors could be involved. The resources of a node processor will be wasted if it has nothing to do while waiting for a message to arrive.

In designing high-performance distributed-memory parallel processors, several criteria must be satisfied by the connection network: fast communication among nodes, simple connectivity for each node, and a connection topology that matches the natural geometry of applications. The hypercube topology discussed in this article is used by several vendors of commercial distributed-memory systems to meet these criteria.

Macintosh is used as the CP. Usually, the CP is used for developing applications. If this is the case, the CP must be capable of running the MPW. Mac-CrOS applications can be developed using C or Pascal inside the MPW environment. The minimum recommended configuration for the CP doing development work is a Mac Plus with a 20-megabyte hard disk drive.

All nodes of a Mac-Cube must be in the same AppleTalk zone. Any number of other Macs, as well as AppleTalk gateways, can also be in the same local zone without interfering with Mac-CrOS. Multiple Mac-Cubes can coexist in the same AppleTalk zone, as shown in figure 2. A 2-cube, five-Mac system (four nodes and a CP) and a 3-cube, nine-Mac system (eight nodes and a CP) are illustrated.

Mac-Cube as an Instructional Tool

Mac-Cube has several advantages over commercial hypercubes as an instructional or experimental tool for parallel processing. One major advantage is its low setup cost. Most university computer laboratories or research laboratories have numerous Macs in close proximity; very likely, they are already connected using the AppleTalk LAN. In this case, no additional hardware is needed to assemble a Mac-Cube. Using some of the Macs on the local AppleTalk network does not disturb other computers on the same network. In other words, while some students are using several Macs on an AppleTalk network in the normal sequential mode, others can configure a few of the remaining

Macs into a single or multiple Mac-Cube(s).

A second advantage is its ease of use. Nodes of commercial hypercubes are not equipped with I/O devices such as display monitors, yet each node of a Mac-Cube (i.e., a Macintosh computer) always has a graphics display monitor and input devices such as a mouse and a keyboard. The availability of a display device at each node enables users to see and to demonstrate how parallel algorithms function. Graphics display capability at the nodes has high educational value, as applications can display information in a spatially intuitive and descriptive manner. Moreover, Macintosh graphics are superior to those typically found on mainframe or minicomputer terminals.

Viewing the actions of an application at each node actually facilitates debugging, because errors can be pinpointed to specific nodes. In addition, taking advantage of the availability of I/O devices at each node makes it possible to implement multi-user applications, such as distributed expert systems and databases.

A Closer Look at CrOS

CrOS is a loosely synchronous message-passing system for hypercube-connected or hypercube-emulated environments. It is a channel-based, point-to-point *polled* communication system that enables directly connected nodes of a hypercube to communicate with each other. CrOS is efficient and well suited for

continued

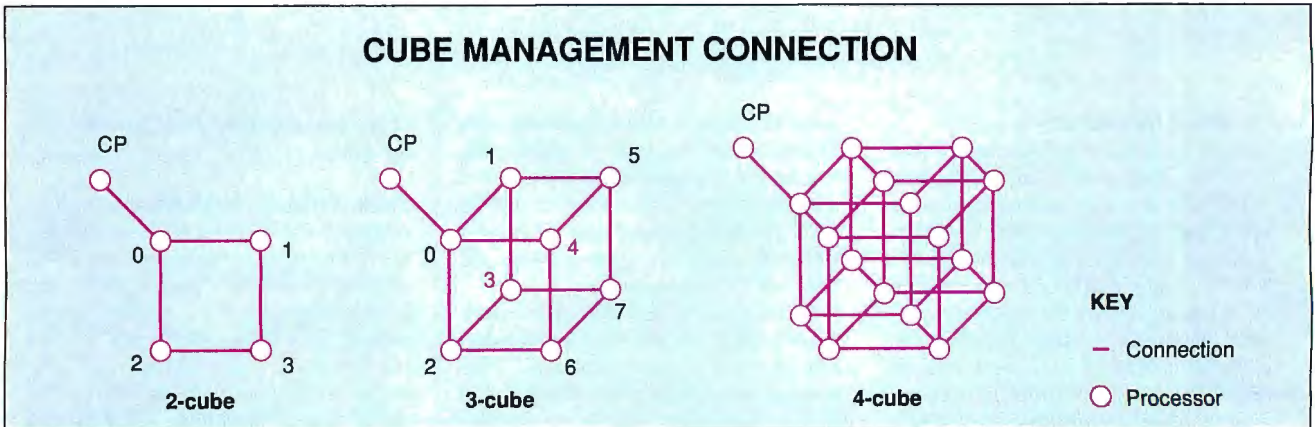

Figure 1: Hypercubes of dimensions 2, 3, and 4. Each cube has 2^p processing nodes and a single control processor, and each node is connected to p other processors. Thus, a 2-cube has four processing nodes and one control processor, and each processing node is connected to two other nodes.

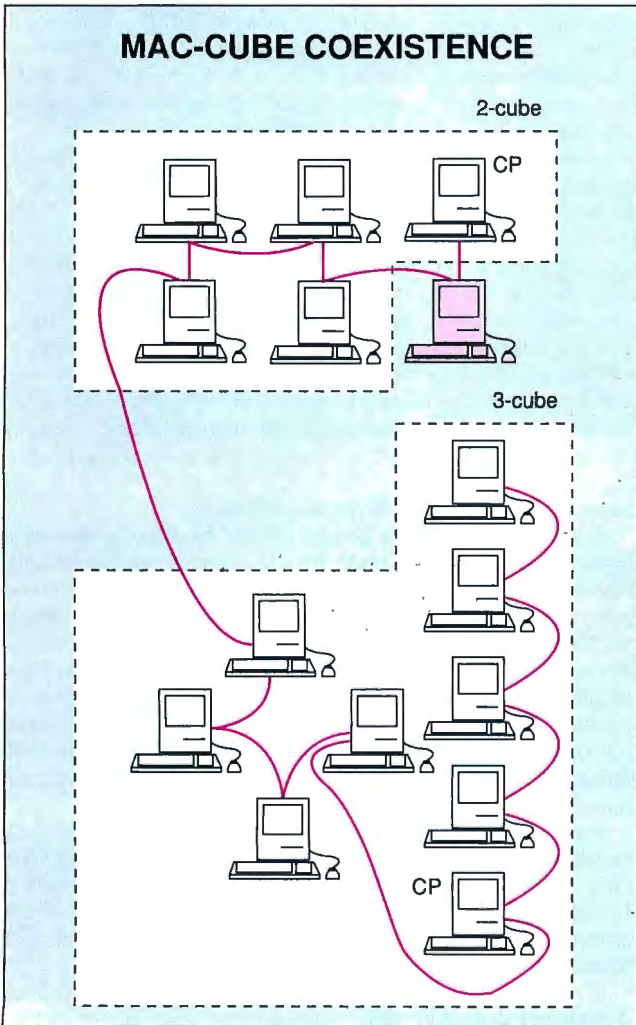

Figure 2: Sample Mac-Cube hypercubes on an AppleTalk network. Note that there are 2-cube and 3-cube systems on the same network and that the lone (shaded) user is undisturbed except for the network loading added by the Mac-Cubes. Also, the Macs that make up each cube do not need to be contiguous.

problems with regular or homogeneous domains—hence the name “Crystalline.”

When polled communication is used, the application program contains explicit read and write command pairs. For example, let’s assume that node 1 needs to write to node 3. When node 1 is ready to write to node 3, it must issue a “write to node 3” command. But before the write can proceed, node 3 must issue a “read from node 1” command. If node 3 is operating on other instructions when node 1 sends its request to write, node 1 will halt until node 3 finishes the instructions it already has. Only when node 3 replies with a “read from node 1” command can node 1 actually perform the write.

The reverse is also true. Should node 3 want to read from node 1, it will issue a “read from node 1” command, but it cannot continue until it receives a reply. Because the nodes cannot proceed until the write and read command pairs are exchanged, they move in lockstep through their programs, with each read and write command resynchronizing the processors.

Listings 1a and 1b show examples of the command pairing previously described. Listing 1a runs on the nodes and implements `dumpelt()`, which is a command that dumps data from the nodes to the CP. Listing 1b runs on the CP and implements `mdumpop()`, which also requests a data dump from the nodes to the CP.

Examples of rigorous scientific applications using CrOS on hypercubes can be found in fields such as neural-circuit simulation, protein dynamics, chemical reactions, chaos, computational fluid dynamics, earthquake engineering, convolution decoding, ray tracing in computer graphics, seismic waves, geodynamics, tomography, computational astrophysics, lattice gauge theory in high-energy physics, condensed matter, and granular physics (see reference 3). These algorithms are described in an excellent set of application papers (see reference 4), which contains 180 papers, including over 30 Caltech CrOS applications. Reference 5 contains public domain software with source code for the algorithms described in reference 3.

Developing CrOS applications for Mac-Cube is similar to developing applications for other commercial hypercubes. A CrOS application always contains a CP program and a node program pair. Generally, the CP program is used to download the node program—which is developed and compiled on the control processor—to the node processors. The CP program also distributes initial data to the appropriate node processors. Major computation, which can mostly be parallelized, takes

place on the node program running on the node processors. The CP will then receive computational results from the node processors and display them or save them for later analysis.

Executing CrOS Applications

Before starting an application, you must decide which computers will be the node computers and which computer will be the CP. It doesn't matter in what order the node and CP computers are connected by AppleTalk. The only requirement is that they are all on the same AppleTalk network. Not all computers on the network have to be assigned to one Mac-Cube or multiple Mac-Cubes; the unassigned computers can operate normally while some cubes are running.

Before running a CrOS application, you must "collect a hypercube" by running `boot` and `bootelt` on the CP and the nodes, respectively. These programs tell the CP computer how many node computers are available on the network and their addresses. After this procedure collects enough Macs and configures them as a Mac-Cube of a known dimension, the parallel application can be executed inside or outside the MPW shell.

The configured Mac-Cube remains intact after the execution of a program, so you can execute other applications without reconfiguring or rebooting for each application. If you want to change the dimension of a configured Mac-Cube (i.e., add or delete some nodes or change the CP), the Cube must first be "uncollected" by running the `unboot` program. To "re-collect" a new Mac-Cube configuration, the same procedures as described above apply. A sample Mac-Cube configuration session is displayed in figure 3.

Debugging CrOS Applications

Debugging concurrent applications on most commercial hypercubes can be difficult. Fortunately, having a graphics display monitor on each node makes debugging on Mac-Cube easier. Moreover, by virtue of the physical ring structure of LocalTalk, all the communications on a Mac-Cube can be easily monitored by watching the one LocalTalk line that physically connects all the nodes.

Two tools have proved useful in debugging CrOS applications: a Macintosh assembly-level debugger and AppleTalk Peek (from Apple Computer Network Systems Development). As distributed, Mac-CrOS code has been compiled with the source names option so that the name of the routine currently being executed is available from the debugger. It's easy to get some idea of what happens in a program by using a debugger. Breakpoints also can be inserted at key places in the programs.

AppleTalk Peek is a program that monitors packet activity at the lowest level. Each CrOS packet corresponds to at least four of the low-level AppleTalk packets. Additionally, each CrOS communication routine will use one or more of the CrOS packets. With a knowledge of the packet structure used by low-level CrOS routines (as documented in the CrOS source code), as well as a knowledge of which actual CrOS packets are sent, you can often determine the state of communications fairly easily.

AppleTalk Communications

Communication in Mac-Cube is implemented using LocalTalk, a baseband, ring-topology network that is inexpensive and widely used. Unfortunately, because only one message travels on the bus at a time, LocalTalk is ill-suited to efficiently emulate the hypercube topology that enables messages to travel in concurrent pathways. As a consequence, the Mac-Cube is a less efficient implementation than the PC-Cube (see reference 6), which is another "build-it-yourself" educational hypercube

continued

Listing 1: (a) This program runs on the Mac-Cube nodes to dump specific memory locations in each node to the control processor (CP). **(b)** This memory-dump code runs on the CP and is a complement to listing 1a. Both node and CP programs must run and be acknowledged by each other for the requested memory dump to occur.

(a)

```

/*
 * crosnode.c
 *
 * example CrOS NODE program : all the nodes do a
 * dumpelt() and check for errors. dumpelt() is a CrOS
 * function that dumps data from nodes to the CP. A call to
 * dumpelt() must be complemented by a call to mdumpcp() or
 * fdumpcp() in the CP.
 */

#include "croselt.h"

main()
{
    struct Cubenv env;
    int OKflag, isize;

    cparam(&env); /* gets run-time parameters */
    isize = sizeof(int);
    OKflag = dumpelt(&env.procnum, isize); /* dumps
                                           processor ID to CP */

    if (OKflag >= 0)
        printf("Communication OK.\n");
    else
        printf("Communication error.\n");
}

```

(b)

```

/*
 * croscep.c
 *
 * Example CrOS CP program: The CP does mdumpcp() and checks
 * for errors. mdumpcp() is a CrOS function that dumps
 * data from nodes to CP's memory. A call to mdumpcp() on
 * the CP must be complemented with a call to dumpelt() on
 * all the nodes.
 */

#include "croscep.h"

main()
{
    struct Cubenv env; /* contains run-time parameters */
    int OKflag, i, isize;
    int data[32], buf[32];

    printf("Downloading to Cube...\n");
    cubeld(2, "crosnode"); /* downloads node program to a
                           2-cube */
    (Press RETURN for more or ESC to cancel)
    printf("Downloading done.\n");
    cparam(&env); /* fills structure env */
    isize = sizeof(int);
    OKflag = mdumpcp(buffer, isize, buf);
    if (env.nproc != buf[0]) OKflag = -1;
    for (i = 0; i < env.nproc; ++i)
        if ((buf[i+1] != sizeof(int)) || (data[i] != 1))
            OKflag = -1;
    if (OKflag >= 0)
        printf("Communication OK.\n");
    else
        printf("Communication error.\n");
}

```

Figure 3: Procedures to configure a Mac-Cube of dimension 2 (four Macs, one CP) and execute a program named TestProgram. Then the nodes are released and used to configure a 1-cube (two Macs, one CP), execute TestProgram again on the 1-cube, and release all the nodes completely.

```

File Edit Find Mark Window Directory Build
Server:MPW:Worksheet

boot -d 2
This is Node 119 Net 14337
node is 39.
node is 77.
node is 68.

TestProgram
Hello from 0.
Hello from 1.
Hello from 2.
Hello from 3.

boot -f

boot -d 1
This is node 119 Net 14337
node is 66.
node is 68.

TestProgram
Hello from 0.
Hello from 1.

boot -q

MPW Shell

```

* Gather four nodes for the cube.
 * The node numbers are the Appletalk ID numbers. They are only for diagnostic purposes.
 * A test program that gets a message from each node.
 * Free the nodes used in the cube. They can still be used for another cube.
 * Gather two of them for another cube.
 * Release the nodes for good.

system, based on IBM PCs or compatibles.

Communications under AppleTalk were designed with the International Standards Organization standard for network communications in mind. The highest level (called the transport level in the ISO model) of "guaranteed datagram delivery" is implemented through the AppleTalk Transaction Proto-

col. It would be easy to implement hypercube communications using ATP. However, ATP is designed to handle a more sophisticated networking environment than is needed for CrOS, and thus it would introduce an additional level of inefficiency into an already inefficient environment.

In order to get higher communication efficiency, the ATP routines were bypassed for CrOS, and communication was implemented using the AppleTalk Link Access Protocol. At this level, next to the physical or hardware level, communication is streamlined, but packets are no longer "guaranteed" to reach their destinations. Because of this, the implementation of Mac-CrOS software is intelligent in its interactions with the hardware and the operating system to monitor packet activity. It is also more efficient.

Mac-CrOS is implemented in terms of the low-level, Mac-Cube-specific `cread()`, `cwrite()`, `vread()`, and `vwrite()`, in addition to the generic higher-level routines. The low-level Mac-CrOS routines consist of assembly language code that interacts in real time with the asynchronous AppleTalk drivers at a very low level. Global data structures are used to share information between this low-level code and the higher-level, synchronous C language codes that are used to implement the other Mac-Cube-specific CrOS routines.

Certain global data structures are initialized when the first Mac-CrOS routine in a program is called. However, basic information, such as the maximum hypercube dimension, the registered name of the CP, the AppleTalk addresses of all the nodes of the hypercube, and the address of the CP, cannot be gathered effectively at run time.

For this reason, a "boot-up" program is used to gather the node computers that will be used coherently and cooperatively as a hypercube. The boot-up program stores its data in the system heap as a system resource so that the hypercube will remain intact between program runs. This program is also used to release nodes from a Mac-Cube and to verify that all the nodes are still in place after a program has been run. The boot-up program enables multiple hypercubes per AppleTalk network. This program uses the higher-level ATP routines as well as the

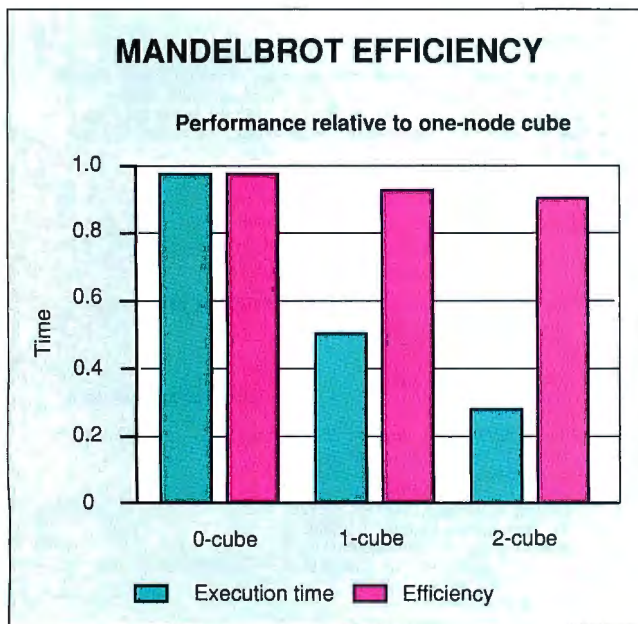

Figure 4: Efficiency versus execution time of a 0-, 1-, and 2-cube Mac-Cube, which translates to one, two, and four Macs, respectively. Because the communication overhead also increases as nodes are added, the efficiency declines slightly. For example, adding three more processors to a single-processor node (for a total of four) reduces execution time to a little more than one-fourth of the single processor's time.

Parallel-Processing Resources

In this article, we have described the Mac-Cube, an excellent low-cost system that emulates more sophisticated parallel computers. *Solving Problems on Concurrent Processors* (see reference 3) and its software supplement (see reference 5) provide an introduction to parallel processing and a large selection of tutorial software. Much of this is in the public domain and can be obtained from Caltech using c3plib, an electronic distribution system for software and documentation from C^{3P} (Caltech Concurrent Computation Program), described below.

Mac-Cube-related software is available from c3plib and on BIX (see page 5 for further details). Another small tutorial system is based on the IBM PC-Cube (see reference 6), for which soft-

ware can be obtained from c3plib. The PC-Cube is also commercially supported by Parasoft of Mission Viejo, California. Other elegant tutorial systems are built around add-on boards for Macs, Suns, and PCs. The most modern of these use transputers, each of which has a 10-MIPS performance. CrOS software for these add-on boards is discussed in reference 5 and can be obtained commercially from Parasoft at 27415 Trabuco Cir., Mission Viejo, CA 92692, (714) 380-8375.

Software Distribution: c3plib

The c3plib system is a file server at Caltech for the distribution of concurrent computation software, documentation, and reports from C^{3P}. It's essentially a program that answers E-mail requests

by responding with the appropriate material by E-mail. Requests should be addressed to "c3plib@caltech.edu" (for INTERNET users) or "c3plib@caltech.bitnet" (for BITNET users).

The file server understands several commands, and each command must be the first word on a line. The principal command is send. For example, the server will respond to a one-line send help message by sending a help file with detailed instructions about using the file server. A send index message will get the requester an index file that gives an overview of directory and file structure. If you don't have access to the network, requests for information should be sent to C^{3P} Requests, Caltech Concurrent Computation Program, 206-49, Pasadena, CA 91125.

Name Binding Protocol to enable the nodes to find the CP.

Code Compatibility and Cube Efficiency Mac-CrOS has been tested on the Mac SE and the Mac II. Two CrOS III applications were taken from the Caltech/JPL Mark Series hypercube and ported to Mac-Cube. The algorithms used are described in detail in the book *Solving Problems on Concurrent Processors* (see reference 3). The two applications solve the Mandelbrot set in the complex plane, and a two-dimensional Laplace equation using finite-difference methods. Except for the graphical enhancements possible only on the Mac-Cube, the CrOS-based parts of the programs did not require any modifications to run in the Macintosh environment.

Although Mac-Cube is not designed for high performance, it does provide a speedup relative to the number of node computers. Figure 4 shows that the efficiency for solving the Mandelbrot set on a 1-cube (i.e., two Macs) is approximately 97 percent (speedup about 1.94 times) over that of a single Mac. This efficiency drops to 90 percent (speedup roughly 3.6 times) on a 2-cube (four-Mac) system.

Evaluating Value

Mac-Cube is valuable for learning hypercube programming and concurrent computation in general. It's inexpensive to set up and easy to install. The graphics and I/O capabilities of the nodes are particularly important for gaining insights into application development and problem solving, as well as for enabling users to actually look at each node of the hypercube in action.

The ability to watch the operation of each node also provides a good way to study parallel algorithm operation and makes debugging a simpler task. Applications implemented on the ark II/III series hypercube at Caltech/JPL have been ported to Mac-Cube with no relevant modification, demonstrating the compatibility of Mac-Cube's software environment with other hypercubes that use the Crystalline Operating System. ■

ACKNOWLEDGMENT

The system described here was developed by Caltech students funded by the Caltech Summer Undergraduate Research Fel-

lowship (SURF) program. The students were Matt Breaden, Stanley Chen, Allen Knutson, and Sho Kuwamoto. This work is based on research supported by the Department of Energy grant DE-FG03-85ER25009 and by the Program Manager of Joint Tactical Fusion Office.

REFERENCES

1. Ho, A. W., G. C. Fox, D. Walker, T. Cole, M. Breaden, S. Chen, A. Knutson, and S. Kuwamoto. "Mac-Cube: A Macintosh-based Hypercube." *Proceedings of the Third Conference on Hypercube Concurrent Computers and Applications*. Edited by G. C. Fox. New York: ACM, 1988 (Caltech report C^{3P} 573).
2. Kolawa, A., and B. Zimmerman. *CrOS III Manual*. Caltech Report C^{3P} 253B, 1986.
3. Fox, G. C., M. A. Johnson, G. A. Lyzenga, S. W. Otto, J. K. Salmon, and D. W. Walker. *Solving Problems on Concurrent Processors*, vol. 1. Englewood Cliffs, NJ: Prentice Hall, 1988.
4. Fox, G. C., ed. *Proceedings of the Third Conference on Hypercube Concurrent Computers and Applications*. New York: ACM, 1988.
5. Angus, I., G. C. Fox, J. S. Kim, and D. Walker. *Software Supplement: Solving Problems on Concurrent Processors*, vol. 2. Englewood Cliffs, NJ: Prentice-Hall, 1989.
6. Ho, A. W., G. C. Fox, D. Walker, T. Cole, S. Snyder, D. Chang, S. Chen, and M. Breaden. "PC-Cube: An IBM PC-Based Hypercube." *Proceedings of the Third Conference on Hypercube Concurrent Computers and Applications*, 1988 (Caltech report C^{3P} 587).
7. Fox, G. C., and P. Messina. "Advanced Computer Architectures." *Scientific American*, October 1987.

Geoffrey C. Fox is a professor of theoretical physics at Caltech and editor of the *Journal of Concurrency: Practice and Experience*. Alex W. Ho is a member of the research staff at Caltech in the *Concurrent Computation Program*. Paul Messina is director of Caltech Concurrent Supercomputing Facilities. Terry Cole is chief technologist at the Jet Propulsion Laboratory. They can be reached on BIX c/o "editors."



COMPUTER DIRECT

WE WON'T BE UNDERSOLD!*

Expires 10/31/89



THE RAM CRISIS IS OVER!



Monitor Shown Not Included

Now, A Complete XT® Compatible Computer For Under \$500!!

640K 10MHZ TURBO XT COMPUTER

For Only **\$499⁹⁵** List \$899.95

Don't Pass Up The Wise Buy, Buy Wise Now And SAVE!

LOOK AT ALL YOU GET!!!

- ☆ High Tech IBM® XT® Compatible With Front Panel LCD Display, Switchable Turbo Mode, And Security Keylock
- ☆ Full 640K RAM, Installed And Tested
- ☆ Parallel, Serial, And Game Ports Standard
- ☆ CGA, RGB, MGA Card Included
- ☆ Clock/Calendar
- ☆ 150 Watt Power Supply
- ☆ 101 Key AT® Style Keyboard
- ☆ 360K Floppy Drive And Controller
- ☆ 32K ROM
- ☆ Completely Assembled, Tested, And Burned In!
- ☆ PLUS—Free Quality Word Processor "Ability"



FREE! DOS
A \$69⁹⁵ Value

TRIPLE THE VALUE!!!

1. We want you to be the first to take advantage of this opportunity. VIP Computer Inc. has made Computer Direct your source for the best deal in the country!
2. If this computer fails due to workmanship or quality during the first year, we will replace it.
3. **NO RISK! 30 Day Home Trial!!!**

Throw Away Those Keys!!! 1 MB 16 Mhz* 0 Wait Computer

Here's What You Get...

- 8 Or 12 Mhz Switchable Turbo
- 80286 Microprocessor
- 1 MEG Standard, Expandable To 4 MB
- Compatible With All Video Cards
- Dual Floppy/Hard Drive Controllers
- 1 Parallel, 2 Serial, 1 Game Port
- 101 Key AT® Style Keyboard
- 1.2 MEG Floppy Drive
- Built-in Math Co-processor Slot
- 200 Watt Power Supply
- Operation Speed Indicator
- IBM®, OS/2, Novell, Unix Compatible
- 110/220 VAC Switch
- Santic Chip-set Technology
- EMS 4.0 Software Included

QUICK 12
\$999⁹⁵ LIST \$1299.95



NEW! State Of The Art Soft Touch Security Keypad.

*16 Mhz Throughput On Norton Performance Rating

Monitor Shown Not Included

© IBM, AT, and XT are Registered Trademarks of International Business Machines, Inc.

The 12.5 Mhz* 286 Computer With EGA, CGA, MGA Video Outputs Built Right In!

Look At All These Features...



- 8, 10, 12 Switchable Turbo
- 80286/12.5 Intel Microprocessor
- 512K Standard, Expandable To 4MB
- EGA, MGA, CGA, Hercules, and Plantronics Compatible
- 101 Key AT® Style Keyboard
- 1.2 Meg Floppy Drive
- Phoenix BIOS
- Dual Floppy/Hard Drive Controllers
- PS/2 Compatible Mouse Port
- 1 Parallel and 2 Serial Ports
- Built-in Math Co-processor Slot
- DOS Included
- 32K Buffer Hard Disk Cache
- Small Footprint Case
- Western Digital Motherboard



LOOP 286
\$899⁹⁵ LIST \$1299.95

1 Year Immediate Replacement Warranty

*12.5 Mhz Throughput On Norton Performance Rating

Monitor Shown Not Included
For Standard Size Case - Add \$40

IMMEDIATE ANSWER

800-BUY-WISE EXT. 38

800-289-9473 EXT. 38

Outside Service Area call 312 382 5058

We Love Our Customers

COMPUTER DIRECT
22292 N. Pepper Rd.
Barrington, IL 60010

BEST SERVICE IN THE USA

PRICE IS NOT ENOUGH!

- 90 Day Immediate Replacement
- Experts in Customer Satisfaction

- Free Technical Assistance
- Bulletin Board Service

- Fast, Low Cost Delivery
- No Credit Card Fees

- 15 Day Home Trial
- Free Catalogs

LOWEST PRICES EVER!

SEAGATE Hard Drives & Hard Cards

20 MEG Half-Height Drive Kit

\$229⁹⁵ List \$499 Model ST-225

40 MEG Half-Height Drive **\$324⁹⁵** List \$699 Model ST-251

40 MEG Super Fast Drive **\$378⁹⁵** List \$799 Model ST-251-1

80 MEG Hard Drive **\$599⁹⁵** List \$799 Model ST-4096

20 MEG Hard Card **\$294⁹⁵** List \$399 Model ST-125

30 MEG Hard Card **\$334⁹⁵** List \$499 Model ST-138RL

180 CPS With NLQ Printer



\$149⁹⁵ List \$399.95

No one can sell this printer for less!

720 CPS 6 Head Printer

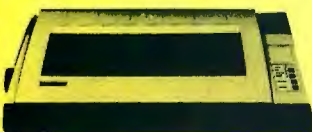

15" Carriage **\$699⁹⁵** List \$1995

The fastest printer you'll ever need.

SAVE 1% with

The Computer Direct Credit Card

Special Introductory Offer

No Annual Fee For the First Year

CALL TODAY!

1200 Baud Internal Modem

100% Hayes Compatible Modem Software Included --- a \$29.95 Value!

\$44⁹⁵ List \$129.95

Everyday low price!

1200 Baud External Modem

100% Hayes Compatible



\$59⁹⁵ List \$238.90

Fits in the palm of your hand!

Magnavox 8762 Color RGB Monitor



\$234⁹⁵ List \$399

5 1/4" DSDD Disks As Low As...

Qty of 2519¢ each
w/sleeves21¢ each
Qty of 100 w/sleeves & labels24¢ each
19¢ ea
Lowest Price in the Country!

5 1/4" High Density Disks

As Low As...
Qty of 2545¢ each
Qty of 25 w/sleeves47¢ each
Qty of 100 w/sleeves & labels48¢ each
45¢ ea
★ Made in the USA! ★

3 1/2" DSDD Disks

As Low As...
Lots of 10 **59¢ ea**
59¢ ea

No Limits - Lifetime Warranty!

Bondwell Laptop Computer 100% IBM® Compatible



The B-300 is a 286 based unit that gives you the power of an AT® at only 15lbs. With its built-in 20 MB hard drive and 1200 Baud Hayes compatible modem, this is the one you've been waiting for!

\$2195⁹⁵ List \$2495

High Speed Ultra-Compact PC with Supertwisted Display

2400 Baud Internal Modem Made in the USA!

100% Hayes Compatible Modem Software Included --- a \$29.95 Value!

\$89⁹⁵ List \$129.95

More Baud - Less Bucks!

2400 Baud External Modem 100% Hayes Compatible



\$99⁹⁵ List \$349

Made in the USA!

VISA
MASTERCARD
COD

COMPUTER DIRECT will match any current (within 30 days), valid nationally advertised delivered price on specially marked items of the exact same product with a comparable payment method, excluding any applicable sales taxes. Verification Required.

Prices do not include shipping charges. Call to get your lowest delivered cost. We insure all shipments at no extra cost to you! All packages are normally shipped UPS Ground. 2nd Day or Overnight Delivery available. Minimum shipping charge per order is \$3.75. Illinois residents add 6.5% sales tax. We ship to all points in the U.S., Canada, Puerto Rico, Alaska, Hawaii, Guam, and APO & FPO (Color Monitors shipped in Continental USA only). PRICES AND AVAILABILITY SUBJECT TO CHANGE WITHOUT NOTICE.

We'll give you 30 days to plug our product.



Try our multi-user/multi-channel communication boards (and our promises) for 30 days with no risk.

You're looking at multi-user systems. You want high performance. High reliability. Great service and technical support. And real value. Trouble is, that's what every board company promises.

But whose promises can you afford to stake your reputation on? Ours. Because only DigiBoard dares to let you try us in the real world. With no risk.

With DigiBoard you can order any DigiCHANNEL multi-channel communications board and evaluate its performance

DigiBoard
Plugging you into tomorrow

for a full 30 days. Choose basic boards or the industry's fastest intelligent boards. PC-Standard or Micro Channel. Four, eight or 16 ports. Even a Synchronous option on some models.

While you're evaluating the performance of our boards, we hope you'll benchmark our technical support too. Customers tell us it's as great as our engineering. But enough talk. The only way to see how good we are is to try

us. And now, you can plug us in without risking a penny. Just plug into your nearest DigiBoard distributor.

Ask your DigiBoard distributor for our FREE booklet, *How to Do Multi-User Right*.

NATIONAL DISTRIBUTORS

SOFTSEL COMPUTER PRODUCTS, East 800-645-7779, Central 800-645-7775, West 800-645-7778;
ARROW ELECTRONICS INC., COMMERCIAL SYSTEMS DIVISION, 800-323-4373 U.S., 516-391-1762 NY.;
INGRAM-MICRO D, 800-642-7631; ROBEC DISTRIBUTORS, 800-223-7081 Request Ann Brady

CANADIAN DISTRIBUTORS

CDI COMPUTER DISTRIBUTION, 604-984-0641; EMJ DATA SYSTEMS LIMITED, 519-837-2444;
SOFTSEL COMPUTER PRODUCTS, 800-268-1220; INGRAM-MICRO D, 416-738-1700

REGIONAL DISTRIBUTORS

MULTI COMPUTER PRODUCTS, South East Region, 800-456-8584
ICOM SYSTEMS INC., Central Region, 312-506-1444;
MP SYSTEMS, Central & Western Regions, 800-624-1688 U.S., 800-322-6411 CA
AIS INC., Central Region, 800-950-2471;
COMPUTER SOURCE INTERNATIONAL, North East Region, 800-222-5022;
TRICOM, North East Region, 800-TRICOM-1; REDLAW, South East Region, 305-791-5459

DigiBoard Inc., U.S. 800-344-4273, MN 612-922-8055

Circle 306 on Reader Service Card

DISK CACHING

Here's how to evaluate different disk-caching schemes

Personal computers have at last evolved to the point where computational speed is not the major source of delays. In most applications, the CPU spends the majority of its time waiting for one of two things: user input or peripherals (particularly disk transactions). It's unlikely that computer designers will be able to do anything to speed up the former, but they have done something about the latter. Taking advantage of increasingly inexpensive and quick DRAM, engineers are speeding up disk access by implementing hard disk caching.

RAM Caching vs. Disk Caching

A cache is a small amount of fast memory that holds the same information as some part of a slower storage medium, so that the information can be obtained quickly when it's needed. Most of the same terminology applies to RAM and disk caches: *hits*, *misses*, *lines*, and *associativity*. But because the physical and electrical characteristics of a hard disk are very different from those of a RAM chip, the optimal caching strategies are different as well.

The most important difference between disk and RAM caches, other than raw speed, is that not every byte of disk data is as easy to get to as every other byte. In most RAM systems, access times are the same for every byte. On a disk, the time it takes to retrieve an arbitrary byte can vary by two orders of magnitude (see the text box "What Affects Access Time?" on page 298).

Another important difference between disk caching and RAM caching is the size of the transfers involved. A

RAM access on a typical microcomputer can retrieve as little as 1 byte; disk data must be accessed as whole sectors (typically 512 bytes, although some disks have 256-byte or 1K-byte sectors). This means that the minimum practical *line size* of a disk cache (i.e., the smallest chunk of data it can save for future access) is an order of magnitude larger than for a RAM cache.

Finally, there is the problem of maintaining *coherence*: keeping the contents of the slower storage medium the same as (or, in Unix parlance, in sync with) the cache. RAM is generally expected to be volatile. If you turn off the power switch on a machine with a RAM cache, you don't expect the contents to be preserved when you turn the machine back on. Thus, if a RAM cache doesn't get a chance to update main memory before the machine shuts down, it's not a problem. But it *is* a problem if your disk cache doesn't update the disk before you switch off. Whole files—and, worse yet, the directory structure of the disk itself—can be damaged or utterly lost.

Write-Through vs. Write-Back

Most cache programs used in microcomputers are *write-through* caches, maintaining coherence by sending write requests to the disk controller immediately. This is the most fail-safe method. But the cache can often save time and head motion if it delays writes. This is the idea of a *write-back* cache, which consolidates writes destined for the same track and does several at one time. If two write requests come in for the same sector, the cache can detect the situation and do only one write.

Delayed writes can cause problems, however. Early versions of Unix had a built-in disk cache that could delay writes for long periods. In fact, a sector that was written to frequently might not be updated for hours. If such a machine was shut down without a special command (called *sync*) or if it crashed suddenly,

the file system could require major repairs. Fortunately, newer versions of Unix automatically do a *sync* at frequent intervals to avoid this problem.

Many cache programs that do delayed writes on other machines use a similar approach. The cache program I use on my IBM PC AT clone always flushes its cache after 2 seconds. It also intercepts the Ctrl-Alt-Del soft reset sequence and the INT 19 (Reset) vectors, and it makes sure that the disk gets updated before the machine is reset. It's not possible to trap a hard reset, however. Thus, if the machine crashes so badly that you need to reach for the big red switch or if you turn it off too quickly, you may lose data.

Read-Ahead

Just as it may be able to consolidate write operations by introducing a delay, a disk cache may be able to save time by implementing *read-ahead*—that is, reading into the cache for future use the sectors immediately after those requested by the operating system. Since disk access is often sequential, there's a good chance that this strategy will pay off.

The most simpleminded read-ahead algorithms do nothing more than increase the line size of the cache (i.e., always reading some additional number of sectors after the one requested). But smarter caches have more clever strategies. There's always a chance that an anticipatory read won't have any benefit, so it doesn't make sense to keep "extra" sectors in the cache until a least recently used (LRU) algorithm kicks them out. Instead, many caches reserve a separate portion of RAM exclusively as a read-ahead buffer and transfer only sectors that are really used to the main cache area.

Concurrent Operation

One thing that a cache can do—whether it's implemented as a caching controller or as software—is let disk operations

continued

What Affects Access Time?

Many factors influence the amount of time it takes a disk drive to retrieve data. They include *seek time*—the amount of time it takes the head to move to the right track, *settling time*—the time it takes for the head to stop vibrating after it gets to that track, *latency*—the amount of time it takes for the desired sector to come around to the disk head, and *transfer time*—the amount of time it takes to get the data off the disk, through the controller, and into the appropriate RAM buffer.

The most common number that you will be quoted when you ask the speed of a hard disk drive is the average track-to-track access time. This is the average time it takes the disk head to move one track during a relatively long seek (typi-

cally across a third of the total number of tracks). But latency is also an important factor; an incorrect interleave can cause the controller to wait many revolutions of the disk to get the data that it wants. And the *skew*, which is the angle between the first sectors on adjacent tracks, can also make a difference.

To understand why skew is important, imagine that the controller wants to read the data from several adjacent tracks in succession (i.e., it reads the first track, steps the head, reads the second track, and so on). Unless the system is smart enough to read sectors out of order, it must wait after each step until the first sector of the new track passes under the head.

How long does the controller wait? If

the skew is set so that the head will arrive at the new track just before the needed sector passes under it, there will be a minimum amount of latency. Unfortunately, most controllers format with no skew at all. In this case, you will get optimal performance when the seek time is slightly shorter than the time it takes the disk to spin once (16 milliseconds on a hard disk that spins at 3600 revolutions per minute).

A smart cache program can sometimes reduce the effect of a nonoptimal skew angle by reading and caching every sector that passes under the head, even if it hasn't been requested yet. Since many accesses are sequential, there's a good chance that the sector data will be useful shortly.

proceed concurrently with other tasks. For instance, when the operating system instructs the disk to move the head to a particular track, there is generally no

need to wait until the head has finished moving before returning control to the system. However, the IBM PC ROM BIOS, among others, does wait, thus

causing unnecessary delays.

Many disk caches take care of performing seeks in the background so that the system can run faster—or they simply

The most powerful expanded memory software available.

TURBO EMS
Version 4.3

With Added
386 Support



Turbo EMS 4.3 now includes 386 support, "Automatic Spillover" and special support for Windows, Excel, DESQview, and Ventura.

- 386 features include "VCPI" support, relocating TSR and device drivers, increasing DOS memory, shadowing ROM, large page mode, discontinuous extended memory support, and supports Lotus 3.0
- Provides "Automatic Spillover" between any combination of expanded memory, extended memory and disk file space
- Simulates LIM 4.0 expanded memory with LIM 3.2 hardware
- Allows customized individual configuration files for multiple software applications
- Supports the LIM XMS 2.0 specification for extended memory
- Provides up to 32 megabytes of LIM 4.0 expanded memory

Turbo EMS 4.3 \$99.95 Sugg. retail

4393 Viewridge Avenue, Suite A • San Diego, CA 92123 • 619/565-6400 • FAX 619/565-0798

don't do them if the destination track is in the cache. (If you use a disk benchmark program on a system that is running this kind of cache, the figure that you will be given for track-to-track access time will not be a meaningful one.)

Caches in multitasking systems and single-tasking systems with write-back

In a disk cache, speed may be less critical than RAM space.

often use *elevator seek* algorithms. The head is moved between tracks the same way an elevator moves between floors in a building, continuing in a given direction until there are no more outstanding requests for access to tracks in that direction. It then turns around and makes a pass back across the disk. The resulting access pattern is orderly and usually close to optimal.

Finally, as I mentioned earlier, a system with a write-back cache must update the disk every so often in the event that the machine crashes or is turned off. This process should be handled as a background task.

Associativity in Disk Caches

Most RAM caches are direct-mapped or two-way associative. It usually isn't practical to provide a higher degree of associativity because the hardware required becomes too complex; it's less expensive to reduce cache misses by adding more cache memory.

In a disk cache, however, speed may be less critical than RAM space. A software disk cache usually uses storage taken from the pool of RAM normally available to other parts of the system; a caching disk controller can use only the amount of RAM that's available on the board. (Remember that sectors must always be cached as a whole; a single-byte read requires 512 bytes of cache.)

Also, since RAM and the CPU are faster than the disk mechanism, it pays to take more time to manage the cache well. The penalty for doing a binary search through a list of available sector numbers is small compared to the penalty incurred when an important sector—say,

part of the file allocation table (FAT)—is thrown out of a direct-mapped cache.

For all these reasons, it pays to use a fully associative caching algorithm for a hard disk cache.

Replacement Strategies

Many disk caches use a strict LRU algorithm to choose a slot for new data. Other techniques are biased for amount as well as time of use—a sector that was once used a lot will "age" more slowly

than one that wasn't used much. Some more-complex algorithms, especially in multitasking systems, factor in the difficulty of getting the data back. If the disk head is far from the data, it may be best to keep the data in the cache. Still other algorithms take into account special knowledge of the file system. For instance, it's a good idea for a DOS cache to keep the FAT—and possibly the root directory—in the cache at all times.

continued

8051 68HC11
THE LEADING IN-CIRCUIT EMULATOR TECHNOLOGY.

See us at
Systems '89, Munich
Hall 014, Stand D02
and at
Westcom '89
Booth 902

Nohau EMUL-PC,
the PC based in-
circuit emulators
which find bugs
other emulators
can't.

- Very easy to learn and use.
- Source Level Debugging in C or PL/M.
- 48 bits wide 16K deep trace buffer.
- Complete 8051 family and 68HC11 family support.

CALL TODAY
FOR YOUR
FREE VIDEO
AND SOFTWARE DEMO
(408) 866-1820.

NOHAU
Nohau Corporation
51 E. Campbell Ave.
Campbell, CA 95008
Tel. (408) 866-1820
Fax. (408) 378-7869

Australia (02) 654 1873, Austria (0222) 38 76 38, Benelux +31 1858-16133, Denmark (02) 65 81 11, Finland 90-452 1255, France (01)-69 412 801, Great Britain 0962-73 31 40, Israel (03) 48 48 32, Italy (011) 771 00 10, Korea (02) 784 784 1, New Zealand (09) 392-464, Portugal (01) 83 56 70, Sweden, Norway (040) 92 24 25, Singapore 065 743-2086, Spain (93) 217 2340, Switzerland (01) 740 41 05, Taiwan (02) 7640215, West Germany 01831-1687, USA FAX (408) 378-7869.

Know Thy System

A good cache will take advantage of special knowledge of the operating system under which it runs. A DOS cache, for instance, may recognize that sectors are allocated in groups called *clusters* and

A *disk cache*
 is more essential
 in some operating
 environments
 than in others.

try to cache whole clusters (since that's the way DOS allocates and uses them). It should also know about and be able to use the different methods of allocating memory outside the limited 640K-byte DOS area, including LIM/EMS memory and the extended memory specification.

Familiarity with the file system is also useful. For instance, if a file is fragmented, read-ahead operations may be of no help; the next sector of the disk won't be the next sector of the file. But if the cache understands the file system well enough to find and read the sector that really *does* come next, it can do the right thing.

A disk cache is more essential in some operating environments than in others. The Amiga file system, for instance, is organized in such a way that reads and writes are relatively quick, but building a directory or locating a file can be very slow, even with the new, fast file system. A disk cache is important for good performance in this system.

As the user of a disk cache, you will need to know about the operating system as well, so that you can tune the machine for optimal performance. For instance, if you're running MultiFinder on the Macintosh, you may find it necessary to reduce the size of the cache to run many programs at once. Otherwise, the Resource Manager may continually purge resources from memory and then reread them from the cache, bogging down the system in the process.

Caching and Networks

If you're running a LAN, you will almost certainly want to use a hard disk

Listing 1: *The 8086 assembly language source code for capturing a record of all the disk reads and writes.*

```
; *****
; SNOOP.ASM Created 6/24/1989 by L. Brett Glass
; *****
; This TSR logs all hard disk reads and writes that pass through
; the IBM PC BIOS to a RAM buffer. The sector, cylinder, head, drive,
; operation, and number of sectors are recorded.
;
; Usenet: apple|well|rogue
; ARPANET: well|rogue@APPLE.COM
; BIX: glass
; CompuServe: [72267,3673] (Also reachable from MCI Mail)
;
; This program may be freely redistributed for noncommercial purposes
; only. It may not be made part of any hardware or software product
; without the express written consent of the copyright owner. This
; program is supplied on an "as is" basis. The author assumes no
; responsibility for its correctness or its fitness for a given
; purpose, nor for consequential damages that may arise from its use.
;
; *****
DISKINT equ 13h ; Disk I/O interrupt number
DOS equ 21h ; Interrupt number for: DOS function
TSR equ 27h ; Terminate/stay resident
GETVEC equ 35h ; DOS function numbers: Get interrupt vector
SETVEC equ 25h ; Set interrupt vector
PRINTMSG equ 9 ; Print message
HARD equ 80h ; Mask to test for hard disk number
DISKREAD equ 2 ; BIOS functions: Read
DISKWRITE equ 3 ; Write
GETBUFADDR equ 99Aah ; Special Int 13h request for snoop buffer address
BADCMD equ 1 ; Bad command result code for BIOS call
SENTINEL equ 4321h ; Sentinel value to signal that SNOOP is present

MAXTRANSACTIONS equ 8 * 1024 ; Log 8K disk transactions
BUFFERSIZE equ 6 * (8 * 1024) ; Each transaction is 6 bytes

Code segment
assume cs:Code,ds:Nothing
org 100h

Entry: jmp near ptr Init ; Jump to transient portion of program
;
; Store the original vector here
;
DiskIO label dword ; Make a label for the whole vector
DiskIOofs dw 0 ; Now make labels for segment and offset
DiskIOSeg dw 0
;
; Define constants that indicate where buffer starts and ends
;
BufferStart equ (offset NextLoc) + 2
BufferEnd equ (offset NextLoc) + 2 + BUFFERSIZE
;
Snoop proc far
test dl,80h ; Is it a call to the hard disk?
jz Chain ; Nope, let it through
cmp ah,DISKREAD ; Is it a read request?
je Log ; If so, log it
cmp ah,DISKWRITE ; Is it a write request?
```

cache on the server. Novell's NetWare has caching built in, and some NetBIOS-based networks (e.g., the Network-OS) come with a disk-cache program that's relatively easy to install. Novell also has drivers for caching controllers.

Caches on network workstations are another matter. There is a great danger of losing coherency if two workstations have access to a file at the same time. To prevent this problem, most software hard disk caches will refuse to cache a network disk, leaving this task to the network software. The network software, which understands the protocols and file sharing conventions, generally takes a conservative approach as well—usually,

it won't let a file be cached locally unless it's marked read-only or opened for the exclusive use of one workstation.

Hardware or Software?

If you're buying a new computer system, you may be faced with the dilemma of whether to buy a caching disk controller (like recent offerings from Distributed Processing Technology or Mylex) or simply use a software caching program.

Caching controllers certainly have some advantages: They add dedicated processing power to the system and usually don't take much (if any) RAM away from the host system. Unfortunately, they don't always deliver performance

```

je Log
cmp ax,GETBUFADDR ; Is it a buffer address request?
jne Chain ; If not read or write or addr request, pass on
GetAddr: mov ax,cs ; Get address
mov es,ax
mov bx,offset WrapFlag
mov dx,SENTINEL ; Tell program SNOOP is present on the sly
mov ah,BADCMD ; Look like bad command
stc ; Generate apparent error
ret 2 ; Do not restore original flags when returning
Log: push di ; Use di as a pointer into the buffer
mov di,cs:NextLoc ; Get the next position to be written
mov cs:[di],dx ; Store DX there
add di,2
mov cs:[di],cx ; Then CX
add di,2
mov cs:[di],ax ; Then AX
add di,2
cmp di,BufferEnd ; End of buffer?
jb @F
mov di,BufferStart ; If so, wrap to beginning
mov cs:WrapFlag,1 ; And set a flag so we know we've wrapped
@@: mov cs:NextLoc,di
pop di
Chain: jmp cs:[DiskIO] ; Jump to disk BIOS
Snoop endp
;
; Labels used by TSR portion of program
;
WrapFlag db 0 ; Flag to indicate buffer has wrapped at least once
NextLoc label word ; Next location to store disk info
;
; "Transient" area (also used for logging transactions) begins here
;
Message db 'Hard Disk Log Utility'
db 0dh,0ah,'Copyright (C) 1989 by L. Brett Glass'
db 0dh,0ah,'Reboot to remove this TSR.'
db 0dh,0ah,'$'
;
; assume cs:Code,ds:Code
;
Init proc near ; This code executed on entry
mov ax,(GETVEC shl 8) + DISKINT ; Get interrupt vector from DOS
int DOS ; DOS call
mov [DiskIO0fs],bx ; Save the old vector
mov [DiskIOSeg],es
mov dx,offset Snoop ; Get ready to add our own routine
mov ah,SETVEC ; Set interrupt vector through DOS
int DOS ; DOS call
mov dx,offset Message ; Prepare to print message
mov ah,PRINTMSG ; Print message through DOS
int DOS ; DOS call
mov NextLoc,BufferStart ; Start from beginning of buffer
mov dx,BufferEnd ; Reserve space for buffer
int TSR ; Terminate and stay resident
Init endp
Code ends
end Entry

```

commensurate with their price tags, especially under single-tasking operating systems like DOS, where a software cache may be as good or better.

Hardware caches usually have their own pool of RAM for the cache, and you may need to buy special boards or chips from the manufacturer to expand the cache. (Software caches, by contrast, use the same kind of memory the rest of your machine uses, and you can usually decide how much RAM goes to the cache and how much to the system.) A caching controller may also prevent you from using low-level disk maintenance packages like SpinRite and Disk Technician. Caching controllers may prevent you

from running operating systems that don't use the BIOS (e.g., Unix and OS/2) unless they're register-compatible with the original AT controller or come with a special software driver.

When evaluating a caching controller, beware of manufacturers' claims of "0.5-millisecond access time" or less. These figures are usually produced by benchmark programs designed to measure the time it takes for a hard disk drive to physically move its heads—not controller performance or overall system throughput. Since most caching controllers don't actually move the head in response to a seek command or do seeks in the background after the call has re-

turned, the figure you'll get from one of these programs has little bearing on the performance you'll get on a day-to-day basis. If you wish to do a benchmark, use a set of tests that corresponds to the kinds of disk transactions you're likely to use in your work.

A Hard Disk Snoop

How would different disk-caching strategies affect performance on your machine? To demonstrate how hard disk caching could speed up your system, I've included a program that will let you find out. It consists of two parts: a TSR *snoop* module, which invisibly logs the last 8192 requests your machine has made onto the IBM PC disk BIOS, and a *simulator*, which shows how much time could be saved by different caching strategies. Listing 1 shows the assembly language source code for the TSR module.

SNOOP.COM installs itself between the Int 13h interrupt vector and the disk BIOS, and it logs all hard disk read and write requests. (It detects and ignores requests that go to floppy disk drives.) It saves 6 bytes of information about each request—including the action, the head, the track, and the sector—in a circular buffer for use by the simulator.

EVAL.PAS, the simulator, is written in Turbo Pascal 5.5. It looks through RAM and extracts the relevant information from the buffer maintained by SNOOP.COM and then analyzes it to see how a cache could speed up the system. You can enter different drive characteristics (e.g., interleave factors and access times) to see how the system will perform under different conditions.

EVAL.PAS is designed to make it easy for you to try your own disk-caching algorithms to see how well they would work with your machine and access patterns. If you have a clever idea for a replacement strategy, head-motion strategy, or some other improvement to disk-caching technology, here's your chance to find out how well it will work. Add the algorithm to the simulator and watch the results! ■

Editor's note: *The source code listing for SNOOP.ASM and EVAL.PAS is available in several formats. See page 5 for details.*

L. Brett Glass is a freelance programmer, author, and hardware designer residing in Palo Alto, California. He can be reached on BIX as "glass."

Your questions and comments are welcome. Write to: Editor, BYTE, One Phoenix Mill Lane, Peterborough, NH 03458.

BEST PICTURE OF THE YEAR*

*Readers Poll, Data Based Advisor, February 1989

BUSINESS GRAPHICS FOR 'C' USERS

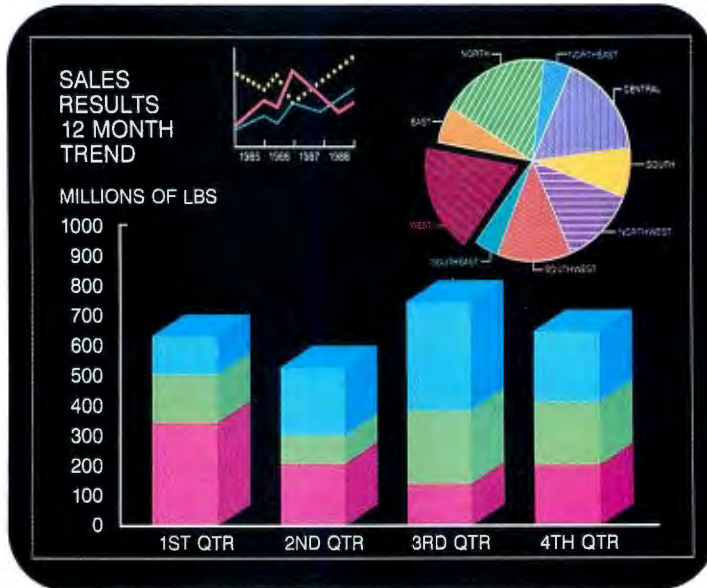

CATEGORY: BEST DATABASE MANAGEMENT GRAPHICS PACKAGE.

dGE the most powerful database graphics package on the market, has just been voted the "best graphics tool for a database manager," according to the readers of Data Based Advisor.

If you think that's impressive, consider this: the vote was based on dGE 2.0.

Now dGE 3.0 is here.

dGE 3.0 is better than ever.

The Graphics Design Center, included in the new 3.0 version, supports the creation of graphic charts and pictures in a free-form menu driven environment.

So instead of requiring you to program in dBASE source code, the Graphics Design Center writes the code for you after you've designed the image using pull-down menus and WYSIWYG editing screens.

There's more good news. Version 3 also adds a font editor, expanded printer support, 3-D bar graphs and more.

Impress your boss, your clients, and yourself. Easily.

dGE does what you want. And it does it with the dialect of your choice. Consider the possibilities:

GRAPHS:

- Bar
- 3-D Bar
- High-low-close
- Pie
- Polar
- Polyline figure
- Polyvector
- Time series
- Cartesian

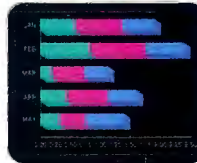

DIALECTS:

- dBASE III+
- dBASE IV
- Clipper
- FoxBASE+
- R:BASE
- Compiler
- Quicksilver
- dBFast
- Eagle
- Microsoft C
- Quick C
- Turbo C

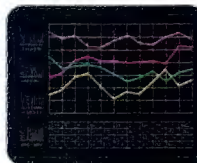

dGE comes complete with interface to all dialects listed.

What's more, dGE 3.0 works with: CGA, EGA, VGA and Hercules monitors, IBM PC, XT, AT, PS/2 and compatibles. Supports the most popular printers and plotters including HP-G/L language plotters. PCX/PCC support now also included.

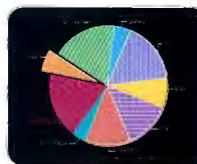

For more information and your **FREE DEMO DISK** just call 1-800-231-1293 or 1-206-941-2300 or write Pinnacle Publishing, P.O. Box 8099, Federal Way, WA 98003.

When you're ready for the best, you're ready for dGE.

Price: \$195.00; contact Pinnacle Publishing or your local software dealer.



GUARANTEE

dGE is backed by a thirty-day money back guarantee.

Pinnacle Publishing Inc. P.O. Box 8099
Federal Way, WA 98003
206/941-2300
800/231-1293
FAX 206/946-1491
© 1989 Pinnacle Publishing, Inc.

The Database Enhancement Expert™

dGE is a trademark of Bits Per Second. Other brand and product names are trademarks of their respective holders.

Come Visit Us At Comdex Booth #C-740

Part 1

TWO TIN CANS AND SOME STRING



A two-part series on AppleTalk and NetBIOS, and how each works with a file transfer program

Networks have snuck up on us. I can't remember how many times I've read or heard about "The Year of the LAN." I don't think there ever will be a Year of the LAN; the invasion moves like a sluggish tide: imperceptible but overwhelming. Here at BYTE, there are at least three LANs in operation (that I'm aware of), and they were all installed without fanfare or massive work interruptions: A phone man showed up one day to put a red sticker on my new outlet; a board and some cables showed up the next day. I was connected before I knew what was going on.

What has amazed me most about networks is how underutilized they often are. It wasn't until more than a year after installing AppleTalk that I finally shouldered my way into the *Inside AppleTalk* manual and realized that I already had services available for creating applications beyond simply sharing the laser printer. Later, after I'd installed one of the serial-card-based LANs (EasyLAN, to be exact) in two of my PC clones, I discovered that I could put together NetBIOS applications. It was like learning two languages that had sprung from a common ancestor but had developed in separate cultures (Apple and IBM).

I decided that the best way to present AppleTalk and NetBIOS was to concoct a real-world application as a common denominator and then build software to perform the task—one program using AppleTalk, the other using NetBIOS.

The job—simple and useful—is transferring a file from one machine on a network to the other. Not a contest, more like a shared stage. And I'll start the performance with the AppleTalk program.

What's Your Address?

When you think about what a network is—a bunch of computers and printers sharing some form of common communications medium—you realize that one logistical problem that crops up is how to give users the ability to recognize one another. This boils down to providing each user with a unique address that other users can identify. On an AppleTalk network, each machine is assigned a unique, 8-bit *node* number. (I'll reveal which program does this assigning later.) Notice I said "each machine," not "each computer." A machine on a network can be an unmanned peripheral (e.g., a laser printer) as well as a manned Macintosh.

On a single Mac, I might run more than one application that's using the network. For example, I might run a DBMS program reading a shared database on some remote server to generate a sales report on the office laser printer. How does the network keep records arriving from the database server from getting mixed up with acknowledge packets from the printer, even though both are being sent to the same node (i.e., my machine)?

Sockets is the network term for the answer. A socket is a kind of logical node within a node, a post office box within an apartment number. Each application wishing to communicate across AppleTalk must first obtain an 8-bit socket number that is unique within the node. For this reason, a program that communicates across the network is often called a *socket client* (used interchangeably with the term *network-visible entity*). So, in the example above, my DBMS program might be communicating with the server via socket 64, while the print job

is talking to the LaserWriter through socket 65. Messages coming back from the server say "Deliver me to socket 64," while acknowledge packets from the printer say "Deliver me to socket 65."

Finally, AppleTalk permits you to connect networks via bridges to form internets. AppleTalk allows up to 254 unique nodes on a single network. If bridging were not allowed, some large installations would quickly reach the limits of AppleTalk. To distinguish one network from another, AppleTalk defines a 16-bit network number associated with each network on an internet.

These three coordinates—network number, node number, and socket number—combine to form a socket client's *internet address*. This address is unique for each socket client on an internet.

Level Out

The components of AppleTalk are stratified in clearly defined layers (see the figure on page 149 of the July BYTE). Each layer is really nothing more than a set of functions. But it's convenient to speak of layers, because this helps you visualize the fact that functions of higher layers embody more complex activities. Also, functions in higher layers stand on the shoulders of those below: Functions of one layer can only call functions beneath them. It's important to point out, however, that layers are not opaque; those above do not hide those below. Programmers have full access to all layers, so if you don't like the way Apple has done things, you can literally write your own network operating system from the ground up.

- *ALAP*. The lowest of these layers is AppleTalk's Link Access Protocol. ALAP is the gateway through which everyone must pass to get to the actual network. It's also the AppleTalk traffic cop; since AppleTalk is physically a CSMA/CD network, it's ALAP's job to

continued

resolve collisions on the network. Basically, this means that everyone talks along the same wire, and if two users talk simultaneously, a collision occurs. ALAP, in the case of AppleTalk, detects the collision and handles retransmission.

Recall that machines on an AppleTalk network are recognized by unique node numbers; ALAP enforces that uniqueness. Packets traveling along the network are referred to as ALAP frames. These frames contain source and destination node numbers so that every machine can determine who's talking to whom.

ALAP is described as a "best effort" delivery system. This means that if you send a data packet from one node to another using ALAP calls, you're not guaranteed that the message will arrive safely at its destination. If some transmission error occurs along the way, the destination node will detect the error (since ALAP attaches a 16-bit frame check sequence). However, ALAP contains no accommodations for retransmitting the bungled packet—that's the job of higher-level protocols. ALAP makes certain only that it got sent—not that it arrived.

• *DDP*. Next up the ladder is the Datagram Delivery Protocol, which manages communications between sockets on an internet. DDP recognizes sockets within nodes, but, as with ALAP, it only provides a one-shot attempt; if the packet's contents are somehow fouled, DDP will make no attempt to resend. This is where ATP comes in.

• *ATP*. The AppleTalk Transaction Protocol, as its name implies, provides a controlled means of carrying out a complete transaction between two socket clients on the network. A *transaction* is AppleTalk for a dialog: the exchange of a request and a response between two application programs (see figure 1). A response can actually consist of up to eight transmissions. So, a single requesting transmission might be a message like "Send me the first eight 512-byte blocks from file BOB." The response would consist of eight actual packets that are consecutive 512-byte blocks from BOB.

ATP guarantees delivery. Application developers don't have to worry about calculating cyclic redundancy checks or what to do if one end drops a packet. This month's sample program uses ATP for that reason. The guarantee is possible because of the transaction ID that ATP attaches to outgoing request packets. When a respondent services the request, the response packets sent back to the requester carry that same transaction ID.

The ATP driver also holds a retry timer and maximum retry count. Once a request datagram is sent, ATP starts the retry timer. If the requester doesn't receive a response before the timer runs out, ATP retransmits the request. The retry count specifies how many times ATP should attempt retransmission. If you're bound and determined to get a request to its destination, you can specify a retry count of 255, which tells ATP to continue retransmission forever, until you explic-

itly tell it to stop (or until it succeeds).

ATP provides two classes of service: ALO (for "at least once") and XO (for "exactly once"). If you flag an ATP request as being ALO, then *anytime* the request is received by the responder, the responding system's ATP driver will deliver that request to whatever application is calling ATP. So, even if the requester's ATP driver retransmits the same packet as part of a retry operation, that packet is delivered to the responder. This is useful for time-critical applications where one machine is monitoring a rapidly changing value (such as a timer) on another machine.

XO transactions allow only one copy of the request packet to make it to the responder's end, no matter how many times a request may have been retransmitted. (XO transactions are sufficient for most applications; this month's program uses them exclusively.) Each responder's ATP driver maintains a list of recently received XO transactions, so ATP can determine which transactions have already been sent to the calling application.

You Name It

Now that you've learned what facilities are available for setting up communications between two Macs, there's probably a question nagging at you: "How does a program on one Mac 'find' a program on some other Mac in order to set up communications?" Well, remember

continued

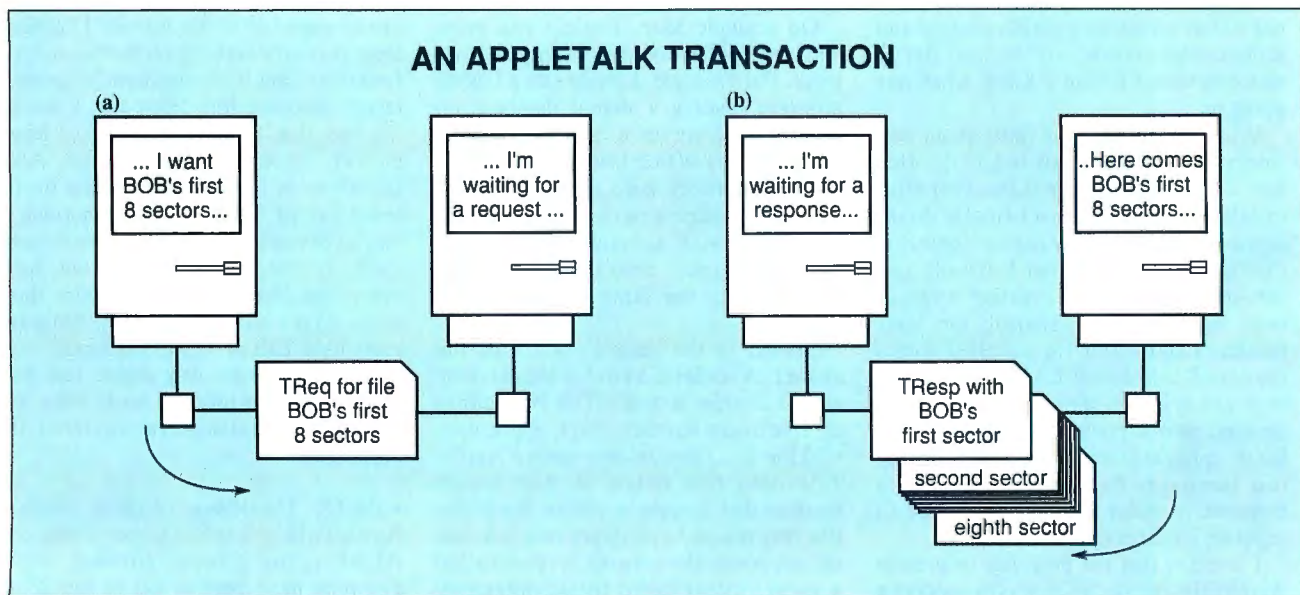



Figure 1: The anatomy of a transaction. (a) The system on the left sends a request (TReq) to the system on the right. The request is for the first eight sectors of a file. (b) Since a single request can be answered with up to eight responses, the system on the right is able to satisfy the request with eight response (TResp) packets.

How to create high-performance programs without wasting your time or money





The High-Performance C Compiler



C Source Window

```

30  addr->zip = 76442;
31  printf("The structure memb
32  printf("%d\n",addr->zip);
33  addr->street, addr->ci
34  size = sizeof(struct ADDR
35  printf("The structure size
36  printf("addr->street start
37
38
39  pe
          
```

Watch Point Window

A watchpoint has matured.

size > 8

Old value was 8

New value is 122

Space bar will clear notice & watchpoint

Output Window

Space for struc starting at address 5416:0000 assigning values to members.

The structure member values ...

Joe Bob's Texas
1251 Cow Chip Trail
Fort Worth TX 76442

Variables Window

addr	far ptr	8x516:0000
addr->name	array	"Joe Bob's Texas"
addr->street	array	"1251 Cow Chip Trail"
addr->city	array	"Fort Worth"
addr->state	array	"TX"
addr->zip	array	76442
size		122
job[0]	pointer	0x02cb
job[1]	struct	00x02cb
job[1]	pointer	0x02ed

Power C Trace Debugger

Step 1: The \$19.95 Power C compiler

Power C is the new ANSI compatible C compiler that runs faster than Microsoft C[®] and has more functions than Turbo C[®]. Power C combines high-performance software with superb documentation, all for less than the price of most C books alone. It's your fast route to fast programs without the fast bucks.

The quality of the Power C documentation makes it easier to learn C. The manuals that accompany our competitor's products are terse at best. They contain little or no information about C, and very few examples. In contrast, the Power C book includes a step-by-step tutorial and is chock-full of example programs. Most of our customers are saying that it's the best C book they've ever used.

The quantity of functions in the Power C library makes it easier to accomplish your programming tasks. The Power C library contains more than 420 functions, a superset of the functions in Microsoft C[®] 4.0 and Turbo C[®] 1.0. In addition, Power C includes a large number of video and graphics functions. You get super-fast functions for drawing lines, boxes, circles, ellipsis, pie charts, and more.

The speed of the Power C compiler makes programming fast. Power C's integrated *Make* utility saves you time and effort by automatically managing your large programming projects. If you modify your program, Power C makes a new version by recompiling only the files that have changed. The compiled programs are equally fast. Just check out the performance chart. See how much time and money you save with Power C.

Performance / PriceChart

(execution times in seconds)

	Power C	Quick C ^a	Turbo C ^a
1) fib	23.8	53.4	26.4
2) sieve	27.6	43.2	25.5
3) tdbl	3.5	9.0	9.6
4) diskio	13.5	14.4	14.3
5) report	11.0	71.7	60.7
6) drystone	36.6	41.6	31.8
Compile/Link	73.9	113.5	81.4
EXE File Size	25120	32092	27184
Compiler/Debugger	\$39.90	\$99.00*	\$149.95*
Library Source	\$10.00	\$150.00	\$150.00
Total Cost	\$49.90	\$249.00	\$299.95

* Includes limited debugger only
Benchmark programs used by Dr. Dobbs's Journal
and Computer Language Magazine.

Step 2: The \$19.95 Power C Trace debugger

Power C Trace is the new state-of-the-art C debugger that makes Microsoft's Codeview[®] look like old technology. Power C Trace reduces the time you spend debugging your C programs by at least a factor of 10. With Power C Trace, you work smarter instead of harder. Actually, using Power C Trace is so much fun that debugging doesn't even feel like work anymore.

Power C Trace shows you 7 windows of program information: 1) C source statements, 2) screen output, 3) variables, 4) watch points, 5) memory, 6) symbols, and 7) assembly instructions. You can view a single window or as many as 4 windows at the same time (as shown on the screen above). Eight predefined window arrangements are available at the press of a key, or you can design your own.

Power C Trace is loaded with many other advanced features. Power C Trace automatically displays all of your variables (including arrays and structures), saving you from having to remember and type their names. The virtual output window lets you see the screen output from your program while simultaneously viewing any of the other windows. Interruptible input allows you to get control even while your program is reading input from the keyboard. Backwards tracing gives you the ability to trace backwards through the execution path.

With all its advanced features, the single most important feature of Power C Trace is simple operation. With Power C Trace, you won't waste any time trying to understand or remember cryptic commands. A single keystroke is all it takes. Help screens show you which key to press and pop-up menus list your options. Invest just 10 minutes of your time with Power C Trace now, and you'll save hours from now on.

Order Line: 1-800-333-0330

Technical: 1-214-783-6001

1132 Commerce Dr., Richardson, TX 75081

60 day money back guarantee

Name _____
 Street _____
 City _____
 State _____ Zip _____
 Telephone _____
 Paying by: Money Order Check
 Visa MC AX Discover
 Card # _____
 Card Expiration Date _____
 Computer Name _____ Disk Size
 5 1/4" 3 1/2"

Product(s) (Not Copy Protected)

<input type="checkbox"/> Power C compiler (\$19.95)	\$ _____
<input type="checkbox"/> Power C Trace debugger (\$19.95)	\$ _____
<input type="checkbox"/> Library Source Code (\$10.00)	\$ _____
(includes assembler & library manager)	
<input type="checkbox"/> BCD Business Math (\$10.00)	\$ _____
Add Shipping (\$5 USA - \$20 Foreign)	\$ _____
Texas Residents add 8% Sales Tax	\$ _____
Total amount of your order	\$ _____

(Requires DOS 2.0 or later)

that it's ALAP's job to assign unique node numbers to machines on the network. When you activate AppleTalk on your Mac, your local ALAP driver chooses the node number for your machine dynamically. It picks a random node number, say 88, and broadcasts onto the network a message like "I want to be node 88; are there any objections?" If a machine is already node 88, your ALAP driver keeps picking random numbers until there are no complaints.

Even though the node numbers are random, your machine locates your partner's machine thanks to the Name Binding Protocol. The NBP makes socket clients visible on the network. It provides a means by which a socket client's internet address can be tied (*bound*, in network terminology) to a name. Most important, once you've bound your internet address to a name, you can register that name in a kind of network-wide directory that all network users have access to. Then anyone who knows your internet name can find your internet address.

A name consists of three components: zone, type, and object. Each component can be up to 32 characters long. The zone portion lets you partition an AppleTalk internet into subnets—handy for setting up departments in a large, company-wide network. The type component lets you identify the kind of service an entity provides. Finally, the object portion lets you distinguish between members of the same type in the same zone.

Here's an example: This month's program runs on two machines—the one

sending the file and the one receiving the file. Both machines call NBP and register their types as "BYTEFTRANS." However, the sender's object name is "ByteSend," and the receiver's object name is "ByteRecv."

Once a program registers its name on the network, applications on other machines can use NBP to locate the internet address of that program. Notice I said *program* and not *computer*. Remember that machines are associated with nodes, while programs are associated with sockets within nodes. So, a single machine may have several names registered on the network, each name attached to a particular application program running on that Macintosh.

Establishing a Dialogue

To make all this clear, I'll step through the AppleTalk calls that a program would use to send a file across the network. Imagine that you want to send a document from your Mac Plus to a colleague's Mac II across the office. In keeping with ATP terminology, assume your machine is the requesting end and your comrade's is the responding end, and assume both ends are running the same program. (This program is general enough to act as either sender or receiver.)

The program's first task is to make each end of the conversation visible to the other. This is a job for NBP, but before you can call it, you have to have an internet address with which to bind the name. On the responder's side, the program calls the `OpenATPSkt` function to open a

socket for receiving requests. You must supply this function with two arguments: the internet address from which to expect requests, and the socket number on your node (the local socket) that will receive them. If you give the function a 0 for the local socket number, ATP will pick the socket number for you.

The internet address argument defines the requester's side of the transaction and acts as a filter for incoming requests. Remember that an internet address consists of network number, node, and socket. If you enter a nonzero number for any component of the internet address, your program receives only those transactions matching that value in that component. If you've constructed a networked database server, you might set its local socket to 89 and set the requester's socket to 89, and all network traffic pertaining to your database will occur only between applications talking through socket 89.

A zero in one of the requester's internet fields matches all requests in that field. Thus, if you pass `OpenATPSocket` all zeros for the requester's internet address, you've told ATP that the local socket will accept requests from anyone on the network. (Sockets 64 through 127 are available for applications to use. ATP uses socket numbers between 128 and 254 when it picks the number. Sockets 0 through 63 are reserved by Apple.)

Moving up to NBP

Now that the responder has opened a socket, the program can call the NBP

continued

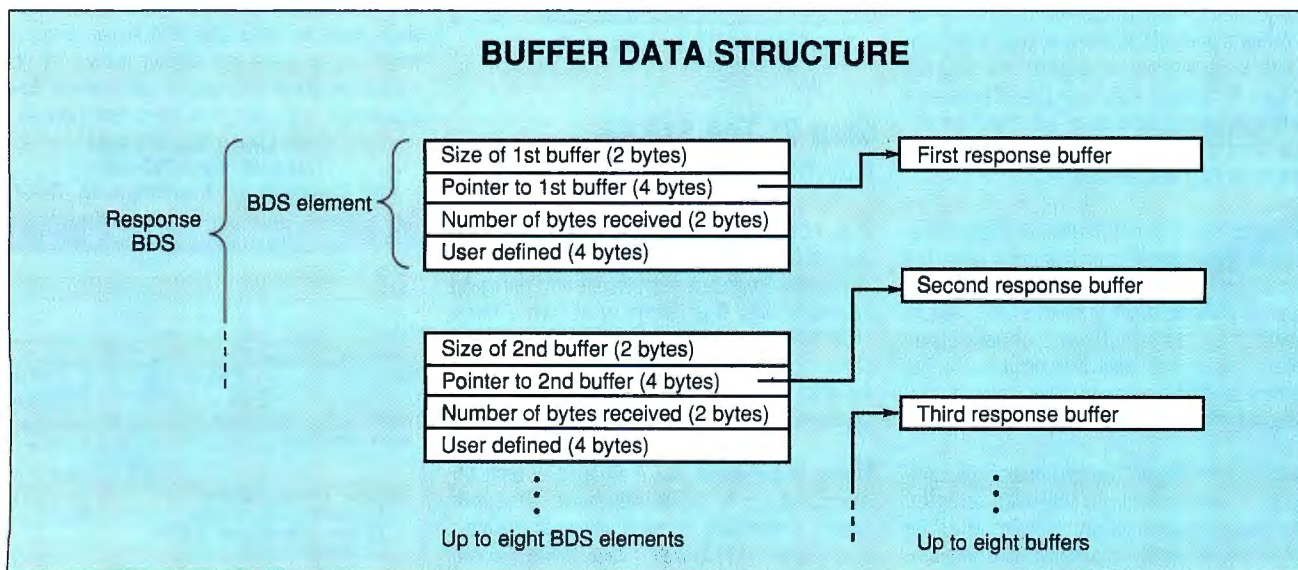

Figure 2: The response buffer data structure (BDS) tells the AppleTalk Transaction Protocol where incoming responses can be placed. A single response BDS can consist of up to eight BDS elements of 12 bytes each. A BDS element governs a response buffer, where the actual response data goes.

Listing 1: Pseudocode for a program to send and receive a file on an AppleTalk network.

```

IF receiving THEN direction:=1
    ELSE direction:=0;
{ Prompt user for filename.
IF direction=1 THEN
BEGIN
    Display an SFPutFile Dialog Box;
    fname := entered filename;
END
ELSE
BEGIN
    Display an SFGGetFile Dialog Box;
    fname := selected filename;
END
}
{ Open an ATP socket.
Following lines tell OpenATPSocket that the local
socket (selected to be 89) will receive requests from
all network addresses, nodes, and sockets. Hence zeros
in each field.
IN Parameterblock DO
BEGIN
    receive_network_address = 0;
    receive_node_number = 0;
    receive_socket_number = 0;
    mysocket = 89;
END
CALL OpenATPSocket(Parameterblock);

{ Register your name on the network.
zone := "*"; { Local zone
type := "BYTEFTRANS";
IF direction=1 THEN object := "ByteRecv"
    ELSE object := "ByteSend"
mysocket := 89;
Build a Names Table Element;
IN Parameterblock DO
BEGIN
    Set pointer to Names Table Element;
    retry_interval = 10; { Retry every 1.3 seconds
    retry_count = 50;
    verify_flag = TRUE; { Check for duplicate names
END
CALL NBPRRegisterName(Parameterblock);

{ Look up the other station's name.
zone := "*";
type := "BYTEFTRANS";
IF direction = 1 THEN object := "ByteSend"
    ELSE object := "ByteRecv";
Build an Entity Name;
IN Parameterblock DO
BEGIN
    retry_interval = 10; { Retry every 1.3 seconds.
    retry_count = 50;
    Set pointer to Entity Name;
    { Set aside 40 bytes to receive response from
    { LookupName().
    ret_buffer = NewPtr(40);
    ret_buffer_size = 40;
    max_to_get = 1; { Looking for 1 name.
END
CALL LookupName(Parameterblock);
{ LookupName returns numGotten in Parameterblock.
IF numGotten = 0 THEN
BEGIN
    Display(" **No answer")
    CALL REMOVE_MY_NAME;
    EXIT
END
{ If LookupName() was successful, the other
side's internet address is in ret_buffer.
EXTRACT his_address from ret_buffer;
Free(ret_buffer); { Dispose of memory used by ret_buffer.

{ Both ends must build a response buffer data
structure-referred to as a BDS. See text for
details.
Build a response BDS;
IF direction = 0 THEN
BEGIN
    Open(fname);
    offset := 0;
    WHILE (fname NOT at end-of-file)
    BEGIN
        { Read 512 bytes from file fname into buffer, leave
        { the first 2 bytes of buffer empty.
        Read(fname,buffer[2],512);
        { Set the first 2 bytes of buffer to the number
        { of bytes actually read by Read().
        buffer[0..1]=number_actually_read;
        IN Parameterblock DO
        BEGIN
            Set exactly_once bit;
            addr_block := his_address;
            req_length := 514;
            req_pointer := buffer;
            Set bds_pointer to our response BDS;
            { We expect only 1 response.
            num_of_buffs := 1;
            timeout_val := 15; { Retry every 15 seconds.
            retry_count := 4; { Retry 4 times.
            END
            CALL SendRequest(Parameterblock);
        END { End of WHILE loop }

    ELSE { direction = 1 }
    BEGIN
        Create(fname); { Create the file.
        REPEAT
        { Get a request.
        IN Parameterblock DO
        BEGIN
            atp_socket := 89; { Receive on socket 89.
            req_pointer := buffer;
            req_length := 514;
            END
            CALL GetRequest(Parameterblock);
            { GetRequest() returns a transaction ID in the
            { Parameterblock...I'll call it transaction_ID.

            { The number of bytes sent is in the first 2 bytes
            { of buffer.
            num_bytes := buffer[0..1]...;
            IF num_bytes <> 0 THEN
                Write(fname,num_bytes,buffer[2]);
            { Send a response.
            IN Parameterblock DO
            BEGIN
                atp_socket := 89;
                { Show that this is the last response
                { to the current request.
                atp_flags := atpEOMBit;
                addr_block := his_address;
                Set bds_pointer to our response BDS.
                { Only 1 response to send.
                num_of_buffs := 1;
                bds_size := 1;
                trans_ID := transaction_ID.
            END
            CALL SendResponse();
            UNTIL (num_bytes <> 512); { End of REPEAT.
            END

        { Finish up.
        Close(fname);
        Display("Done");
        CALL REMOVE_MY_NAME;
        EXIT;

REMOVE_MY_NAME:
zone := "*"; { Local zone
type := "BYTEFTRANS";
IF direction=1 THEN object := "ByteRecv"
    ELSE object := "ByteSend"
{ An entity_name is simply a concatenation
{ of zone, type, and object, with each string
{ preceded by a byte count.
entity_name := zone + type + object;
IN Parameterblock DO
    entity_pointer := address of entity_name;
CALL RemoveName(Parameterblock);

RETURN;

```

function RegisterName to attach a name to that socket and make the name visible on the network. You don't have to explicitly tell NBP your node or network num-

ber; it can find that out itself.

The requester doesn't need to make all the calls to ATP or NBP that I've mentioned. Strictly speaking, the requester

can sit back and watch the network for the responder's name to appear and then begin transmitting requests at the responder's internet address.

However, in my file transfer program, I opted to have the requester call OpenATPSocket to capture a socket for the sole purpose of having one to give to RegisterName. In this way, both ends of the conversation can see that the other is on the network. So the requester's name serves merely as a semaphore to the responder's program, telling it that the requester is active and communication can commence.

The NBP routine LookupName allows a program to see visible entities on the network. You pass this routine a pointer to a data structure containing the three components (zone, type, and object) of a target name, and LookupName rummages around on the network and returns another data structure containing the internet address of all entities that match. Each component can contain wild-card characters: "*" in the zone field means the caller's local zone (similar to a default directory in a file open command); "=" in the type or object field tells LookupName to match all possible values for that field. This lets you locate all network entities in your zone of type "Database," for example.

In my file transfer program, the requester calls LookupName to search in zone "*" for type "BYTEFTRANS" and object "ByteRecv." The program then examines the data structure that LookupName returns to determine the responder's internet address. Once the requester knows the responder's address, the requester opens the file you've selected for transmission and calls SendRequest to begin passing data sectors over the network.

As I mentioned earlier, the responder calls LookupName merely to convince itself that the requester is on-line. Once that's done, the responder calls GetRequest to receive the data transmitted by the requester's SendRequest call. The rest is a dance choreographed by AppleTalk: The request packet passes from requester to responder, and the responder writes the data to the disk and issues a SendResponse call to inform the requester to send the next packet. This process—SendRequest, GetRequest, and SendResponse—continues until the entire file has been transmitted.

The Job Is Done

Once the job is done, both sides close things down in an orderly fashion: Both

continued on page 357

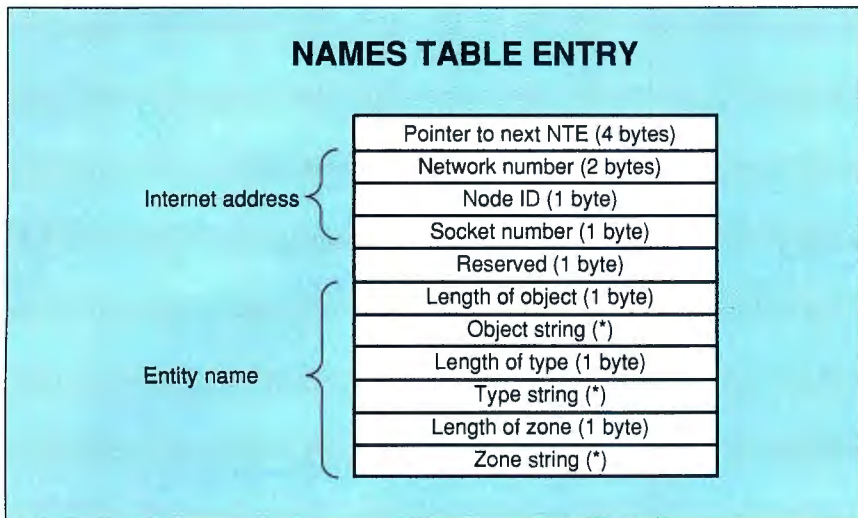

Figure 3: The names table entry (NTE) list is the Name Binding Protocol's in-memory notebook of what names are currently active on the network. Each NTE is composed of two parts, the entity's internet address and name. (Fields with asterisks are variable-length, with size determined by a preceding count byte.)

Definitions on disk

Language Master gives you instant access to more than 80,000 dictionary definitions plus 470,000 synonyms from Merriam-Webster—the English language authority.

The dictionary contains definitions, usage notes and hyphenation points. The thesaurus contains synonyms, meanings for each synonym group and properly inflects all responses.

Language Master, formerly Choice Words for the IBM PC, works with most popular MS-DOS word processors and is now available for the Apple Macintosh.

Whether you're writing, reading, or simply want to explore the English language in a new and exciting way, Language Master is for you.



LANGUAGE MASTER™

\$99

Available at Egghead Discount Software Stores Nationwide During September

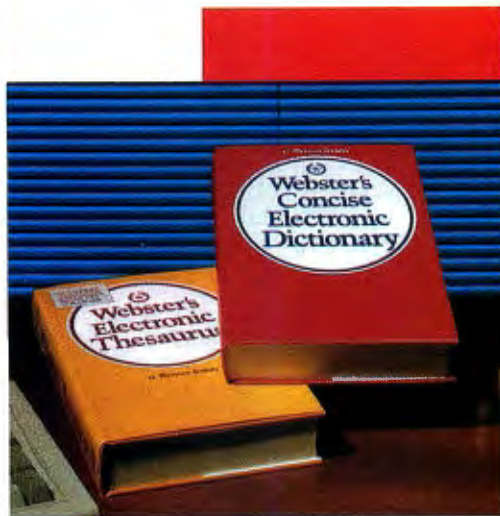

See your local software dealer. Or order directly by calling 1-800-323-0023, (305 566-3511 in FL) or write: Franklin Software, 3511 N.E. 22nd Avenue, Fort Lauderdale, FL 33308

Franklin™
Software

PRODUCT SHOWCASE

■ BUYER'S MART
■ BYTE BITS

■ PRODUCT SPOTS
■ MICRO PRODUCT CENTER



THE BUYER'S MART

A Directory of Products and Services

THE BUYER'S MART is a monthly advertising section which enables readers to easily locate suppliers by product category. As a unique feature, each BUYER'S MART ad includes a Reader Service number to assist interested readers in requesting information from participating advertisers.

RATES: 1x—\$525 3x—\$500 6x—\$475 12x—\$425
Prepayment must accompany each insertion. VISA/MC Accepted.

AD FORMAT: Each ad will be designed and typeset by BYTE. Advertisers must

furnish typewritten copy. Ads can include headline (23 characters maximum), descriptive text (250 characters is recommended, but up to 350 characters can be accommodated), plus company name, address and telephone number. Do not send logos or camera-ready artwork.

DEADLINE: Ad copy is due approximately 2 months prior to issue date. For example: November issue closes on September 8. Send your copy and payment to THE BUYER'S MART, BYTE Magazine, 1 Phoenix Mill Lane, Peterborough, NH 03458. For more information call Brian Higgins at 603-924-3754.

ACCESSORIES

CUT RIBBON COSTS!

Re-ink your printer ribbons quickly and easily. Do all cartridge ribbons with just one ink! For crisp, black professional print since 1982. You can choose from 3 models: Manual E-Zee Inker — \$39.50
Electric E-Zee Inker — \$94.50
Ink Master (Electric) — \$189.00
1000s of satisfied users. Money-back guarantee.

BORG INDUSTRIES

525 MAIN ST., JANESVILLE, IA 50647
1-800-553-2404 Fax: 319-887-2521

Inquiry 576.

ACCESSORIES

HP LASERJET II M-E-M-O-R-Y

1MB-2MB-4MB MEMORY EXPANSION BOARDS

Save 50%-60%

2-YEAR WARRANTY

STARION CORPORATION

(800) 782-8297 CA: (714) 750-2627

Inquiry 581.

BAR CODE

PORTABLE READER

Battery-operated, handheld reader with 64K static RAM, 2x16 LCD display, 32-key keyboard, Real-Time-Clock. Wand or laser scanner. Program prompts and data checking thru its own keyboard. Easy data transfer by RS-232 port or PC, PS/2 keyboard. Doubles as On-Line Reader. 30-day \$\$ back.

Worthington Data Solutions

417A Ingalls St., Santa Cruz, CA 95060
(800) 345-4220 In CA: (408) 458-9938

ARTIFICIAL INTELLIGENCE

MANA

Intelligent Computing for 286/386

Transform your PC into an AI-based workstation. Expert systems, AI, knowledge base applications, rapid prototyping, object oriented, multi-tasking, virtual memory, LISP/PROLOG etc. modes in multi-language compiler, mouse driven, multi-windowed, fully integrated environment.

BMS, Inc.

700 E. Ogden Avenue, Westmont, IL 60559
Tel: (312) 789-9180 Fax: (312) 789-0253

Inquiry 582.

COMPANION AND EXTENDER

Place a keyboard and monitor up to 600' from your CPU with EXTENDER and COMPANION products. Keep a second Keyboard/Monitor at the CPU with COMPANION. Supports MDA, CGA, EGA, VGA, PS/2. Uses single 3/4" cable.

Prices start at \$149.00 for EXTENDER and \$219.00 for COMPANION 25 ft. unit complete.

CYBEX CORPORATION

2800-H Bob Wallace, Huntsville, AL 35805
205-534-0011 International Fax #205-830-1947

Inquiry 577.

PRINT BAR CODES AND BIG TEXT

On EPSON, IBM, OKI dot matrix or LaserJet. Flexible design on one easy screen. Any format/size. Up to 120 fields/label. 13 text sizes to 1" readable at 50'. AIAG, MIL-STD, 2 of 5, 128, UPC/EAN, Code 39. File Input & Scanned logos/symbols (PCX)—\$279. Other programs from \$49. 30-day \$\$ back.

Worthington Data Solutions

417A Ingalls St., Santa Cruz, CA 95060
(800) 345-4220 In CA: (408) 458-9938

FREE CATALOG

A complete source for computer supplies at low prices. Fast Service. Call, write or circle inquiry card for a FREE CATALOG.

Use your VISA, MC or COD to order the following bulk diskettes

5.25" DS/DD (Min 50) 26¢

5.25" DS/HD (Min 50) 62¢

3.5" DS/DD (Min 30) 89¢

GAAN COMPUTER SUPPLIES

186 B East Sunnyparks Ave., Campbell, CA 95008
(800) 523-1238, In Calif. (408) 370-6747

Inquiry 578.

NATURAL LANGUAGE C LIBRARY

Increase your market share! Use JAKE to add a natural language front end to your application. JAKE translates English queries and commands into C function calls and data structures. JAKE offers context-sensitive semantic processing; interfaces easily; <64K mem.

JAKE \$495. INTERACTIVE DEMO \$10

ENGLISH KNOWLEDGE SYSTEMS, INC.

5525 Scotts Valley Dr. #22, Scotts Valley, CA 95068
(408) 438-6922

Inquiry 583.

BAR CODE READERS

For PC, XT, AT, & PS/2, all clones, and any RS-232 terminal. Acts like 2nd keyboard, bar codes read as keyed data. With steel wand—\$399. Top rating in independent reviews. Works with DOS, Xenix, Novell, Alloy, ALL software. Lasers, magstripe, & slot badge readers. 30-day \$\$ back.

Worthington Data Solutions

417A Ingalls St., Santa Cruz, CA 95060
(800) 345-4220 In CA: (408) 458-9938

REFILL LASER PRINTER & COPIER CARTRIDGES

Don't throw away that used laser printer or copier cartridge. Refill it and save over 75%, it's easy. For use with Canon EP & EPS cartridges, HP LaserJet & LaserJet II, Apple Laserwriter & Laserwriter II, Canon LPB, FAX, and many others. Also kits for Canon Copiers. We have colors for laser printers. Dealers Welcome. VISA/MC

COMPLETE REFILL KIT \$29.95

Includes toner, fill pad, and instructions.

VIDEO TAPE PROGRAM \$45.00

Shows disassembly, cleaning, and remanufacture.

MORACK INC.

9132 Windsor Dr., Paloo Hills, IL 60465
For order or information (708) 598-0580 FAX: (708) 598-8203

Inquiry 579.

NanoLISP \$99.99

An MS-DOS Common LISP interpreter that supports most Common LISP operations and strictly adheres to the standard. Numerous advanced and extra features, excellent debugging facilities, sample AI programs, fully-indexed manual, free technical support.

Microcomputer Systems Consultants

P.O. Box 8646, Santa Barbara, CA 93160
(805) 967-2270

Inquiry 584.

BAR CODE SOLUTIONS

Bar coding is so easy with our complete line of readers. Our PC-Wand readers emulate your PC keyboard or ASCII terminal, and are carried around taking inventory, entering road sales and clocking time. Our bar code label printing software packages work with DOS and most matrix or laser printers. We also sell pre-printed labels. Our hardware can work with nearly every computer in the world.

International Technologies & Systems Corp.

635-C North Berry St., Brea, CA 92621
(714) 990-1880 FAX: (714) 990-2503 TLX 6502824734 MCI

Inquiry 584.

BAR CODE

PRINT BAR CODES/BIG TEXT FROM YOUR PROGRAM

Add bar codes and big graphics characters to your program. Print from ANY MS-DOS language. Bar codes: UPC, EAN, 2 of 5, MSI, Code 39. Epson, OkI, IBM dot matrix text up to 1/2". LaserJet up to 2". Font cartridges not required. \$179-\$239. 30-day \$\$ back.

Worthington Data Solutions

417A Ingalls St., Santa Cruz, CA 95060
(800) 345-4220 In CA: (408) 458-9938

Inquiry 585.

BAR CODE SOFTWARE SOLUTIONS

ISD has software solutions that allow you to use bar codes for most anything. Like identifying products. Labeling packages. Or even managing assets and paperwork. You'll be able to speed and simplify data collection. Track products dock-to-stock. Streamline inventory control. And more.

Integrated Software Design, Inc.

171 Forbes Blvd., Mansfield, MA 02048
TEL: (508) 339-4928 FAX: (508) 339-2257

©1989 Integrated Software Design, Inc.

Inquiry 585.

PC UPS BREAKTHRU

Our patented technology provides on-line (no-break) / sinewave Uninterruptible Power Supplies at standby / squarewave unit prices!

15+ minutes of blackout operation time.

250W UPS \$490 U.S.

500W UPS 790 U.S.

(International models also available)

SinePower Corporation

Box 820130 Houston, TX 77282-0130

Inquiry 580.

BAR CODE

WHEN EASE-OF-USE COUNTS

Reading bar codes should be as easy as a "quick flick of the wrist." But many bar code readers require you to flick and flick and Flick and FLICK until the bar code label is finally read. PERCON designed bar code readers that *really are* as easy as a "quick flick of the wrist."

PERCON

2190 W. 11th Ave., Eugene, OR 97402

Phone: (800) 873-7266 FAX: (503) 344-1399

PERCON: THE BAR CODE SPECIALISTS

If you have questions about bar code technology, it's nice to know an experienced, friendly bar code specialist is only a phone call away. Want to know where to start or where to find hard-to-find bar code accessories? Call PERCON for answers.

PERCON

2190 W. 11th Ave., Eugene, OR 97402

Phone: (800) 873-7266 FAX: (503) 344-1399

5-YR. WARRANTY AT PERCON

PERCON decoders are now covered by a five-year limited warranty. That means you won't spend one cent replacing your PERCON bar code decoder for five full years. That's reliability you can count on!

PERCON

2190 W. 11th Ave., Eugene, OR 97402

Phone: (800) 873-7266 FAX: (503) 344-1399

PC BAR CODE SPECIALISTS

Bar code readers designed for fast, reliable, cost effective data entry. Looks just like keyboard data! Choose from stainless steel wand or laser interface. Also, powerful Bar Code and Text printing software. Great warranty. Dealer inquiries welcome.

Seagull Scientific Systems

15127 N.E. 24th, Suite 333, Redmond, WA 98052
206-451-8966

BAR CODE READERS

Among the best and most widely used bar code decoders. Reads all major codes (39, 1 2/5, S 2/5, UPC/EAN/JAN, CODABAR, MSI). Connects between keyboard and system. IBM, PS/2, MAC, DEC-VT compatible. OS & software independent. Same day ship. 2 Year Warranty (pen incl).

Large Reseller Discounts.

Solutions Engineering

4705 Langdrum Lane, Bethesda, MD 20815
(800) 635-6533 (301) 652-2738

Inquiry 586.

DATA INPUT DEVICES

Bar Code, Magnetic Stripe Readers & SmartCard Encoder/Reader for microcomputers & terminals, including IBM PS/2 & others, DEC, Macintosh, AT&T, CT, Wyse, Wang. All readers connect on the keyboard cable & are transparent to all software. UPC & 39 print programs, magnetic encoders, & portable readers are also available.

TPS Electronics

4047 Transport, Palo Alto, CA 94303

415-856-6833 Telex 371-9097 TPS PLA
FAX: 415-856-3843

Inquiry 587.

BAR CODE

VARIANT MICROSYSTEMS BAR CODE READERS DELIVER

WAND/LASER/MAGNETIC CARD CONNECTIVITY
• Keyboard wedges (Internal/External) for IBM PC/XT/AT, PS/2 and portables.

- RS232C wedges for WYSE, Link, Kimtron terminals
- Bar code and label printing software
- Full two-year warranty
- 30-Day Money-Back Guarantee
- Extensive VAR/Dealer Discounts

3140 De La Cruz Blvd., Suite 200/Santa Clara, CA 95054/(408) 980-1880
FAX: (415) 823-1372

Inquiry 588.

BBS/PUBLIC DOMAIN

MedCom BBS

Use your modem to call

800/445-4BBS (800/445-4227)

81 lines, 3/12/24, 8N1

Group & private chat. Many games, including the new multi-player, fast-action full-color graphics & sound, "Flash Attack" from Galacticom! Chess/Checkers/Othello. E-Mail, 1000s of dt, message base, online news & entertainment. Free time & downloads.

6312 E. Santa Ana Cyn Rd #361, Anaheim, CA 92807
Voice (714) 998-9999

CASE

STATE OBJECT ORIENTED COMPILERS

The COMPEDITOR's use finite state and object oriented programming techniques to design, develop and document source programs in: Ada, Basic, C, Fortran and Pascal. IBM DOS 2. + 250K RAM.

Prices: \$200-\$300 (With Primer and Debugger)
Sampler \$75 (With All manuals & Credit)

AYECO 5025 Nassau Circle, Orlando
INCORPORATED FL 32808 (407) 295-0930

Inquiry 589.

CD-ROM

CD-ROM Drives & Titles

Largest selection for PC & Mac.
Microsoft Programmers Library & Drive \$995
Computer Library \$695 • Public Domain SW \$99.

Drives from \$699. Hundreds of titles from \$29.

MC/VISA/AMEX, Money-back Guarantee.

Call or write for free 100-page catalog.

Get it all from "The Bureau"

Bureau of Electronic Publishing

121 Norwood Ave., Upper Montclair, NJ 07043
(201) 746-3031

Inquiry 590.

Hitachi CD ROM 3500 PC/XT/AT Internal kit.....	\$639
Hitachi CD ROM 1503S PC/XT/AT external kit.....	\$679
NEC CD ROM PS/2 Internal Kit.....	\$799
NEC CD ROM Macintosh external kit.....	\$799
Laser Drive 510 WORM kit (654MB).....	\$3,995
REO-650 Magneto-optical kit (650MB).....	\$5,795
County Statistics by Slater/Hill (IBM Title).....	\$1200
Grolier Encyclopedia (IBM or Mac Title).....	\$299
MicroSort Bookshelf (IBM).....	\$249
Geophysics of North America by NASA (IBM Title).....	\$600

Free Brochures, Databases and Databases of DISKS

CD ROM, INC.

1120-B 10th St., Golden, CO 80401
303-278-8550

Inquiry 591.

CD-ROM/WE'LL BEAT ANY PRICE

All IBM/MAC drives/titles. Call for price list, monthly specials, POs, international orders welcome. Special library, school, government pricing. COD, Visa, MC, Amex

CD-ROM SHOPPER

(201) 290-8288

1168 Elm Street

Rahway, NJ 07065

24-HR AUTO ORDER LINE

Inquiry 592.

CD-ROM

CD-ROM Publishing Services

Complete CD-ROM publishing services including custom software interface. Reasonable rates, fast turnaround. Call for quote.

Titles published: Food/Analyst, Econ/Stats, Consu/Stats, Agri/Stats.

Hopkins Technology

CD-ROM Publisher

421 Hazel Lane

Hopkins, MN 55343-7117

(612) 931-9376 CIS 74017,614

Inquiry 593.

COMPUTER INSURANCE

INSURES YOUR COMPUTER

SAFEWARE provides full replacement of hardware, media and purchased software. As little as \$39 a year provides comprehensive coverage. Blanket coverage; no list of equipment needed. One call does it all. Call 8 am-10 pm ET. (Sat. 9 to 5)

TOLL FREE 1-800-848-3469

(Local 614-282-0559)

SAFEWARE, The Insurance Agency Inc.

Inquiry 594.

COMP. MAINT. CHEMICALS

Buy Direct

A full line of Computer Maintenance chemicals: Pressurized Duster, CRT Screen Cleaner, Hood & Housing, Anti-Static, Head & disc, Freon T.F. Solvent, Cleaning Diskettes, Wipes, Swabs. All at wholesale prices. Call Data-Chem at:

1-800-FON-6698

Inquiry 595.

COMPUTER PRINTERS

LAPTOPS * APPLE * IBM

COMPAQ SLT

ZENITH

SHARP

TOSHIBA

NEC

PLOTTERS

HARD DRIVES

IBM PS2

MACINTOSH

LASERWRITER

IMAGEWRITER

HP LASERJET

EPSON

FAX MACHINES

Call UCC 213-921-8900 For Prices
13738 E. Artesia Blvd. 150, Cerritos, CA 90701
Fax 213-902-0831 International Orders Welcome

Inquiry 596.

COMPUTER SUPPLIES

COLOR RIBBONS

COLORS: Black, Red, Blue, Green, Brown

	BLACK	COLOR
NEC P2200	\$7.75	\$12.00
Okidata 5903391	7.00	6.00
Panasonic KXP-1124	6.75	7.75
Toshiba P351	6.00	6.00

PRICE & SPEC. SUBJECT TO CHANGE W/O NOTICE.

FOR OTHER RIBBONS CALL FOR CATALOG

RAMCO COMPUTER SUPPLIES

P.O. Box 475, Manteno, IL 60950
(USA) 800-522-8922 * (CANADA) 800-621-5444 * 615-468-8061

Inquiry 597.

CROSS ASSEMBLERS

CROSS ASSEMBLERS

Universal Linker, Librarian

Targets for 36 Microprocessors

Hosts: PC/MS-DOS, micro VAX, VAX 8000

ENERTEC, INC.

BOX 1312, 811 W. Fifth St.

Lansdale, PA 19446

Tel: 215-362-0966 Fax: 215-362-2404

Inquiry 598.

THE BUYER'S MART

CROSS ASSEMBLERS

68000 CROSS ASSEMBLER

Assembles 68000/68010 code on a PC Compatible

- Very High Speed—2MB source code assembled per minute • Macros
- S-Records

Knowledge Based Systems, Inc.
2746 Longmire • College Station • Texas • 77840
Phone: (409) 696-7979 • Fax: (409) 696-7277
BBS: (409) 696-7055

Inquiry 599.

Professional Series

PseudoCode releases its PseudoSam professional Series of cross assemblers. Most popular processors. Macros, Conditional Assembly, and Include Files. Virtually unlimited size. For IBM PCs, MS-DOS 2.0 or greater. With manual for \$50.00. (MI res. 4% tax). Simulators and disassemblers also available. Shipping \$5, Canada \$10, Foreign \$15. Visa/MC.

KORE Inc.

3510 Plainfield NE, Grand Rapids, MI 49505 616-361-3666
30-Day satisfaction guaranteed or purchase price refunded.

Inquiry 600.

CROSS ASSEMBLERS/SIMULATORS

Brand new full-function simulator for the 8086 controller, supporting ALL MODES of Interrupts plus the HSI, HSD, A/D, and Serial features, with full disassembler; just \$300.00! Our superb simulators for the 8048, 8051, and 8085 sell for \$200.00, and those for the 8052 and Z80 for \$250.00 each. Our line of cross assemblers for all above target CPUs are also full PC compatible and sell for \$100.00 each. We offer discounts for simulator plus assembler packages.

Lear Com Company

2440 Kipling St./Ste. 206, Lakewood, CO 80215
303-232-2226

Inquiry 601.

MACINTOSH CROSS ASSEMBLERS

μASM™—available for most 8-bit MPUs. Fast. Full Mac interface. S or Hex output downloads to most EPROM programmers. Features macros, conditional ass'y, local and auto labels, symbol table cross-reference, module sectioning. Editor included. \$129.95 each plus S/H. MC/V/AE. Technical bulletin available.

MICRO DIALECTS, INC., Dept B

P.O. Box 30014, Cincinnati, OH 45230
(513) 271-9100

Inquiry 602.

CROSS ASSEMBLERS

Macros, PC Compatible, Relocatable, Conditionals, Fast, Reliable from \$150

also: Disassemblers

EPROM Programmer Board

MICROCOMPUTER TOOLS CO.

Phone (800) 443-0779
In CA (415) 825-4200
912 Hastings Dr., Concord, CA 94518

Inquiry 603.

6800-Family Development Software

Our C Compilers for the 6800, 6801, 6809, & 68HC11 feature a complete implementation (excluding bit fields) of C as described by K&R and yield 30-70% less code than other compilers. Our Assemblers feature macros and conditional assembly. Linker & Terminal Emulator included.

Wintek Corporation

1801 South St., Lafayette, IN 47904
(800) 742-6809 or (317) 742-8428

Inquiry 604.

312 B Y T E • OCTOBER 1989

DATA CONVERSION

MEDIA CONVERSION/DATA TRANSLATION

More than just a straight dump or ASCII transfer! Word Processing, DBMS, and Spreadsheet data on Disks or Tapes transferred directly into applications running on Mainframes, Minis, Micros, Dedicated Word Processors, Typesetters, and Electronic Publishing systems. IBM PS/2 & Macintosh supported. #1 in the translation industry!

CompuData Translators, Inc.

3325 Wilshire Blvd., Suite 1202, Los Angeles, CA 90010
(213) 387-4477 1-800-825-8251

Inquiry 605.

DATA/DISK CONVERSION

RESULTS

You Can Depend On!

- Data Conversion
- Disk Duplication
- Optical Scanning

Computer Conversions

9380 Black Mountain Rd., Suite J, San Diego, CA 92126
619-693-1697

Inquiry 606.

DISK CONVERSIONS

Media transfer to or from: IBM, Xerox, DEC, Wang, Lanier, CPT, Microm, NBI, CT, Exxon, WRDPLEX also WP, WS, MS/WRD, DW4, MM, Samna, DEC DX, MAS 11, Xerox-Writer, ASCII.

FREE TEST CONVERSION CONVERSION SPECIALISTS

531 Main St., Ste. 835, El Segundo, CA 90245
(213) 545-6551 (213) 322-6319

Inquiry 607.

FROM MACs TO MAINFRAMES . . .

Our 12 conversion systems support over 1000 formats

DISK INTERCHANGE SERVICE COMPANY

2 Park Drive • Westford, MA 01886
(508) 692-0050

Inquiry 608.

BUY YOUR OWN CONVERSION SYSTEM!

With nearly a decade of experience in data conversion, you can work with the industry leader in 9-track tape, cartridge tape and diskette conversion systems. Enjoy the convenience of your own conversion system. Call today to discuss your application!

Flagstaff Engineering

1120 Kalbab Lane, Flagstaff, AZ 86001
(602) 779-3341

MasterCard—Visa— American Express Accepted

Inquiry 609.

THE #1 CHOICE

in disk & tape conversion

for many leading corporations, government agencies, law firms, and companies in every industry—world-wide.

Free test • Satisfaction guaranteed

Call the helpful conversion experts . . .

Graphics Unlimited Inc.

3000 Second St. North, Minneapolis, MN 55411
(612) 588-7571

Inquiry 610.

DATA/DISK CONVERSION

10x FASTER EASIER TO USE

IBM PC ◀ TO ▶ HP FILE COPY

Update version uses windows: Call for free demo! IBM PC to HP File Copy allows IBM PCs, PS/2, compatibles to interchange files with Hewlett-Packard Series 70, 80, 200, 300, 1000, 9000s.

Oswego Software

Box 310
Oswego, IL 60543

312/554-3567

FAX 312/554-3573
Telex 858-757

Inquiry 611.

CONVERSION SERVICES

Convert any 9-track magnetic tape to or from over 2000 formats including 3 1/2", 5 1/4", 8" disk formats & word processors. Disk-to-disk conversions also available. Call for more info. Introducing OCR Scanning Services.

Pivar Computing Services, Inc.

165 Arlington Hgts. Rd., Dept. #B
Buffalo Grove, IL 60089 (800) HI-Pivar

Inquiry 612.

DATABASE MGMT. SYSTEMS

dBASE file access from C

Code Base 4 is a library of C routines which gives complete dBASE or Clipper functionality and file compatibility. Use DOS, Unix, OS/2 or MS Windows.

\$295 with Source! FREE DEMO

Sequiter Software Inc.

Call (403) 439-8171 Fax (403) 433-7460

Inquiry 612.

DEMOS/TUTORIALS

INSTANT REPLAY III

Build Demos, Tutorials, Prototypes, Presentations, Music, Timed Keyboard Macros, and Menu Systems. Includes Screen Maker, Keystroke/Time Editor, Program Memorizer, and Animator. Record Great Reviews! Simply the BEST. Not copy protected. No royalties. 60-day satisfaction money-back guar. IBM and Compatib. \$149.95 U.S. Chk/Cr. Crd. Demo Diskette \$5.00.

NOSTRADAMUS, INC.

P.O. Box 9252
Salt Lake City, Utah 84109 (801) 272-0671

Inquiry 613.

DISASSEMBLERS

80x86 .EXE/.COM to .ASM

- Accurately reconstruct, study & modify [84K+] programs with a minimum of input or editing of output.
- Assembly language output is MASM 5.x-compatible.
- Exhaustive flow-trace distinguishes code from data.
- Best formats for each. Commented BIOS calls/DOS functions. SEGMENT/PROC/other vital pseudo-ops.

PC-DISnDATa (5 1/4" disk & manual) \$165

PRO/AM SOFTWARE

220 Cardigan Road, Centerville, OH 45459
(513) 435-4480 (9 A.M.—5 P.M. EST M-F)

Inquiry 614.

SOFT-X-PLORE

See "BYTE's May '88 issue pg. 78" Disassemble 500 kb (*) program at 10,000/min. (*) In any file, ROM/RAM memory up to 80386 instruction set (*). SOFT-X-plore:

- * Is for MS/DOS 2.0+ systems
- * uses 20 algorithms and seven passes (*)
- * only \$99.95 plus S&H w/30-day guarantee.

To order call (800) 446-4656 or info (203) 853-0236

Or write:

RJSWANKE INC.

178 Brookside Rd., Newington, CT 06111
* best on the market MCVISA accepted

Inquiry 615.

THE BUYER'S MART

DISK DRIVES

PS/2 DRIVES FOR PCs ATs

CompatiKit/PC \$279
 CompatiKit/AT \$219
 Built-in floppy controllers—no problem.
 Supports multiple drives and formats. Lets your computer use IBM PS/2 1.4M diskettes plus more!
 Call for further information or to place an order.
 VISA/MC/COD/CHECK.

Micro Solutions Computer Products
 132 W. Lincoln Hwy., DeKalb, IL 60115 815/756-3411
 See our ad on page 74.

Inquiry 616.

DISK DUPLICATION

SOFTWARE PRODUCTION

- Disk duplication
- All formats
- EVERLOCK copy protection
- Label/sleeve printing
- Full packaging services
- Warehousing
- Drop shipping
- Fulfillment
- 48-hour delivery
- Consultation & guidance

Star-Byte, Inc.
 2880 Bergey Rd., Hatfield, PA 19440
 215-997-2470 600-243-1515

Inquiry 617.

DUPLICATION SERVICES

SOFTWARE DUPLICATION

- One-Stop Shopping
- Custom Packaging
- Copy Protection
- Technical Support
- Drop Shipping
- Fast Turnaround
- Competitive Pricing

SATISFACTION GUARANTEED
 800-222-0490 NJ 201-462-7628

MEGAsoft

P.O. Box 710, Freehold, NJ 07728

Inquiry 618.

EDUCATION

B.Sc. & M.S. in COMPUTER SCIENCE

The American Institute for Computer Sciences offers an in-depth correspondence program to earn your Bachelor of Science and Master of Science degrees in Computer Science at home. BSc. subjects covered are: MS/DOS, BASIC, PASCAL, C, Data File Processing, Data Structures & Operating systems. MS program includes subjects in Software Engineering and Artificial Intelligence.

AMERICAN INST. FOR COMPUTER SCIENCES
 1704-BY 11th Ave. So., Birmingham, AL 35205
 TOLL FREE 1-800-872-AICS

Inquiry 619.

Gradebook emulation
 for
 micro-computers

Da Poma GB

First dedicated gradebook
 on the Macintosh
 available since 1984

Da Poma, Inc.

P.O. Drawer H, Hondo, Texas 78861 (512) 426-5932

Inquiry 620.

ENTERTAINMENT

NEMESIS™ Go Master®

Go, a game of strategic elegance, has been a way of life in the Orient for over four thousand years. Many consider Go to be the secret of the Japanese businessman's success. *"While chess is a game of war, Go is a game of market share"* [President of Nikko Hotels].

"If you are interested in Go, buy this program."
 Game of the Month J. Pournelle BYTE 7/87

Toyogo, Inc. The Leader in Computer Go.
 76 Bedford St. #34-Y, Lexington, MA 02173, (617) 861-0488

Inquiry 621.

FLOW CHARTS

Flow Charting II+

For IBM and compatibles. It will amaze you with its speed, power and simplicity. 26 standard shapes with over 120 sizes — 10 text fonts — 4 line styles. Place text, lines and shapes anywhere on your chart. For only \$229 you'll never draw another chart by hand.

Patton & Patton

81 Great Oaks Blvd., San Jose, CA 95119
 1-800-525-0082 Ext. 42 (Outside CA)
 408-629-5376 Ext. 42 (CA/Int'l)
 See our ad on page 118.

Inquiry 622.

WINDOWS FLOWCHARTER \$79

RFFlow is a professional drawing tool for flowcharts & org charts (requires Microsoft® Windows). 75 shapes automatically adjust in size. Move, copy, delete groups of objects. 7 levels of zoom. Move flowcharts to other applications via the Clipboard. Supports Windows printers, plotters, and cartridge or soft fonts. Call for free trial disk.

RFF ELECTRONICS

1053 Banyan Court, Loveland, CO 80538
 (303) 663-5767

Inquiry 623.

STRUCTURED FLOW CHART

NSChart creates Nassi-Shneiderman (structured) flowcharts from a simple PDL. Key words define structures & text strings appear in the chart. Easy to create, even easier to revise! Automatic chart sizing, text centering. Translators from many languages available. For Mac and IBM PC.

SILTRONIX, INC.

P.O. Box 82544, San Diego, CA 92138
 1-800-637-4888

Inquiry 624.

FOREIGN LANGUAGES

LEARN SPANISH! LEARN JAPANESE!

A new, easy way to learn a foreign language. Complete interactive learning environment with pop-up dictionary, hypertext language reference, and full mouse support. Conversational emphasis. IBM compatible. Each course includes disks, manual, and pronunciation tape. Call for Demo disk or free brochure!

Traveler's Guild

315 W. Washington St. Dept B9, Marquette, MI 49855
 24-hour order desk: (906) 228-5030

Inquiry 625.

FORTRAN TOOLS

TAME YOUR FORTRAN CODE! Programming tools for MS-DOS

FORWARN—an invaluable aid to Fortran program development! Finds common programming errors such as mismatched parameter lists and common blocks, and uninitialized variables. Prints detailed cross-references and call-tree diagrams. \$329
FORTRAN DEVELOPMENT TOOLS—includes Pretty (idents, renumbers, changes GOTOs to IF-THEN-ELSE, etc.) and 6 more tools. \$128.

Qulbus Enterprises, Inc.

106 N. Draper Avenue, Champaign, IL 61821
 (217) 356-8878

Inquiry 626.

GRAPHICS

35mm SLIDES—In 24 Hours

We transform your PC-Graphics files into full-color high-resolution, 35mm slides and ship within 24 hours. Harvard, Pixie, Lotus, Freelance, and others supported. Files accepted by modem. Free Federal Express on all orders of 20+ slides. Only \$8 per slide. Call for literature or circle reader service number shown below.

Accent Presentations, Inc.

990 Highland Drive, Ste. 202, P.O. Box 1303, Solana Beach, CA 92075
 1-800-222-2592

Inquiry 627.

GRAPHICS

RAINDROP™

FAST, compact PrtScrn Utility for end users AND developers. Hardcopy as fast as 10 secs. Average binary size - 6 kbytes. 12 video graphic standards. Scale, rotate, colorize and more. 'CALL' from user-written programs. Complete 9- & 24-pin dot-matrix, inkjet, and laserjet library \$39.95+\$3 s/h.

RAINBOW TECHNOLOGIES

8106 St. David Ct., Springfield, VA 22153
 (703) 440-0064

Inquiry 628.

HARD DRIVE REPAIR

DISK DRIVE REPAIR DATA RECOVERY

SALES of new, remanufactured and removable disk drives
FULL TECHNICAL SUPPORT
ROTATING MEMORY SERVICE

1506 Dell Avenue, Campbell, CA 95008
 (408) 370-3113

We buy used drives good or bad

Inquiry 629.

HARDWARE

CHIP CHECKER

- 74/54 TTL + CMOS
 - 14/4000 CMOS
 - 14-24 Pin Chips
 - 8000 Nat. + Signetics
 - 8000 TTL
 - .3" + .8" IC widths
- Tests/Identifies over 650 digital chips with ANY type of output in seconds. Also tests popular RAM chips. IBM-compatible version \$259. C128 + C64 version \$159.

DUNE SYSTEMS

2803 Willa Dr., St. Joseph, MI 49085
 (616) 983-2352

Inquiry 630.

LATEST AWARD BIOS! PC/XT ☆ 286 ☆ 386

- Support for:
- Enhanced Keyboards
 - EGA & VGA Graphics
 - 3.5 inch Floppies
 - Custom Drive Tables

Authorized AWARD Distributor

1-800-423-3400 or (412) 782-0384

KOMPUTERWERK, INC.

851 Parkview Blvd., Pittsburgh, PA 15215

Inquiry 631.

Macintosh® Parts & Repairs

Programs for the corporate, government, dealer and educational buyer. Call for kit.

Save up to 55% on Mac II CPU

800-274-5343 / 617-891-6851

Pre-Owned Electronics, Inc.

30 Clematis Ave • Waltham, MA 02154
 Macintosh is a registered trademark of Apple Computer, Inc.

Inquiry 632.

NEED AN EXTRA SLOT FOR YOUR 8-BIT PC?

- Add: LAN MODEM, Accelerator Card or Fixed Disk and/or 3 1/2" Diskette
RMT's 2001-F2H2 Single Card Controller:
- Uses only one expansion unit
 - Supports two 3 1/2" and/or 5 1/4" diskette drives
 - Supports two fixed disk drives (up to 140 MB each)
 - On-board BIOS, automatically handles any comb. of drives

RMT 2001-F2H2 THE SPACE ODYSSEY
RMT SYSTEMS, INC. (714) 863-1092

Inquiry 633.

THE BUYER'S MART

HARDWARE/ADD-ONS

The World's First Highest Density Module

- 18 Meg on the smallest surface
- Organization: 2x1024Kx9 bit
- Package: DIL 64 pin Jedec-Standard
- Technology: CMOS, hybrid, 18x1HMS1100JP-10
- Compatibility: With two Hitachi HB56A 19-10
- Suitable for extension of basic memory
- Engineers take notice. This product can be manufactured on large scale.

For more information please write or call:

TermoTrol Corp.

1888 Century Park East, Suite 1900, L.A., CA 90067
Tel: 213-284-3242

Inquiry 634.

HARDWARE/COPROCESSOR

DIGITAL SIGNAL PROCESSOR

DSP products for the IBM PC/XT/AT based on the TI TMS32010 and TMS320C25 up to 12 MIPS operation. Designed for applications in communications, instrumentation, speech, and numeric processing. Offered with 12 bit 110 KHz A/D and D/A and continuous-to-disk data acquisition & playback option. From \$650.

DALANCO SPRY

89 Westland Ave., Rochester, NY 14618
(716) 473-3610

Inquiry 635.

SC/FOX™ PARALLEL COPROCESSOR

PC/XT/AT/386 plug-in board with Fort software. 10 MIPS operation, up to 50 MIPS burst. 64K to 1M byte memory. Uses Harris RTX 2000™ RISC real-time CPU with 1-cycle multiply, 1-cycle 14-priority interrupts, two 256-word stacks, three 16-bit timer/counters, 16-bit I/O bus. Ideal for real-time control, signal and image processing, and multiple board operation. From \$2,295.

Optional SC/FOX Single Board Computer version for stand-alone operation. Eurocard size with software, starting at \$1,495.

SILICON COMPOSERS, INC. (415) 322-5783
210 California Ave., Suite K, Palo Alto, CA 94306

Inquiry 636.

IMAGE PROCESSING

ZIP Image Processing

ZIP brings affordable, sophisticated image processing to the PC. Capture video from camera/VCR. Versions for ImageWise, Willow Pubs VGA, HRT 612x512, serial ImageWise (for PC/laptop/PS2) frame grabbers.

Call (314) 962-7833 to order (VISA/MC). ZIP starts at \$79, frame grabbers, \$398. 30-day money-back guarantee.

Hogware Company

470 Belleview, St. Louis, MO 63119
(314) 962-7833

Inquiry 637.

INVENTORY MANAGEMENT

STOCK-MASTER 4.0

Commercial grade inventory management software at micro prices.

- Supports all 12 transaction types
- Trend Analysis
- Quality Control
- Multiple Locations
- Purchase Order Tracking
- Open Order Reporting
- Serial/Lot # Tracking
- Stock Status Reporting
- Activity History Analysis
- Bill of Materials
- Purchase Order Writing
- Order Entry
- Material Requirements
- On Line Inquiry

Applied Micro Business Systems, Inc.

177-F Riverside Ave., Newport Beach, CA 92663 714-759-0582

Inquiry 638.

dFELLER Inventory

Business inventory programs written in modifiable dBASE source code.

dFELLER Inventory \$150.00

Requires dBASE II or III, PC-DOS/CPM

dFELLER Plus \$200.00

with History and Purchase Orders

Requires dBASE III or dBASE III Plus (For Stockrooms)

Feller Associates

550 CR PPA, Route 3, Ishpeming, MI 49849
(906) 488-8024

Inquiry 639.

LANs

The \$25 Network

Try the 1st truly low-cost LAN

- Connect 2 or 3 PCs, XTs, ATs
- Uses serial ports and 5-wire cable
- Runs at 115K baud
- Runs in background, totally transparent
- Share any device, any file, any time
- Needs only 14K of ram

Skeptical? We make believers!
Information Modes

P.O. Drawer F, Denton, TX 76202
817-387-3339

Inquiry 640.

LAPTOP COMPUTERS

Laptop Savings

Laptops: Toshiba • Zenith • Nec • Sharp
• Epson • Mitsubishi • Compaq

Also Laptop Accessories: Modems, Fax Modems, External Drives, Portable Printers, Memory, Key Pads, Hard Drives, Batteries, and Auto Adapters.

Computer Options Unlimited

12 Maiden Lane, Bound Brook, NJ 08805

Phone: 201-469-7678 (Fax: 201-469-7544)

Hours: 9am/10pm 7 days Worldwide sales

Inquiry 641.

Laptop Connection

2PC — THE File Transfer Utility

- Lap to Lap, Lap to Desk
- Super Easy to Use
- Breaks the "Bridge-Link" Price Barrier
- Desk to Desk, PC to PC
- No Installation Required
- 115 K Baud

\$55 w/universal cable, \$45 w/o cable
See Jan. 89 Issue—"What's New" Column—p.84

PLUS . . . Quality Cables at FAIR Prices:

- Null Modem (6') . . . \$12
- Kbd Ext (6') . . . \$12
- Par Print (6') . . . \$10
- Centronics (6') . . . \$12
- Mon Ext (8') . . . \$12
- Serial (8') . . . \$10

MANY MORE CABLES AVAILABLE, Mac & PC (VISA MC)
Thompson Computing—687 F.N. Ventu Park Rd., Ste. 306,
Newbury Park, CA 91320, (805) 498-7653 FAX (805) 498-8104

Inquiry 642.

LAPTOP PERIPHERALS

LAPTOP BACKLIGHTS

Factory Installed • 90-Day Warranty

Toshiba, Amstrad, Sanyo, DG,
Kaypro, IBM, HP, etc. \$295

The Portable Peripherals People

Axonix Corporation

(801) 466-9797

Inquiry 643.

TOSHIBA PERIPHERALS	T1000	T1200	T3100	T3100e
Battery Adapter (12V)	FX25T	FX3T	P80	P80+
Vehicle Battery Adapter	X2.5		AS0	AS0+
Built-in 2400bps Modem		M24B1		
Internal 2400bps Modem	M24IC		M24E3	M24E5
Single COMMS Port Card	S232T		S232E	
Dual COMMS Port Card			D232E	
SCSI Interface Card			SC3IE	

PRODUCT R&D Corporation

1194 Pacific St., Suite 201, San Luis Obispo, CA 93401
(805) 548-9713 or (800) 234-5584

Inquiry 644.

MAC PROGRAMMING TOOLS

MAC DEVELOPMENT TOOLS

Professional Programmers Extender: Standard Mac interface, lists, printing, graphics, tiling. Extender GraphPac: Quality color graphics. Line, bar, semi-log, customizable symbols.

INVENTION Software

(313) 996-8108

Inquiry 645.

MEMORY BOARDS

MEMORY EXPANSION

Intel Above Boards w/LIM 4.0

8 MHz PC/ATs

IBM, Compaq, Zenith etc.

1MB \$299.00

2MB \$399.00

10 + MHz ATs

1MB \$499.00

Prices subject to change

COUNTERTRADE (303) 530-5433

Inquiry 646.

MEMORY CHIPS

MEMORY CHIPS

41258-15-12-10 Call 51000 (1 Meg) Call

4184-15 Call 51258 for Compaq 386. Call

4184-12 Call 8087-3-2 Call

41128 Piggy Back for AT Call 80287-6-8-10 Call

41484-12 (84Kx4) Call 80387 Call

414256 (256Kx4) Call NEC-V20-8 Call

2764,27128,27256,27512 Call Mouse Call

Prices subject to change

ESSKAY 718-353-3353

Inquiry 647.

FREE INFORMATION DRAM-SIMMS-MATH CO-PROCESSORS

TOLL FREE 24 HRS.
7 DAYS A WEEK
1-800-338-1531

DEDICATED TOLL FREE
FACSIMILE LINE
24 HRS.—7 DAYS A WEEK
1-800-242-5751

DIRECT LINE MON-FRI 9-8 CST.

1-402-691-8248

Best Prices in U.S.A.

McDonald and Associates

WHOLESALE DISTRIBUTOR THE CHOICE OF INDUSTRY PROFESSIONALS

Inquiry 648.

MEMORY PRODUCTS

LOW LOW PRICES

256K DRAM 256x8 SIM/SIP

1 Meg DRAM 1 Megx9 SIM/SIP

256x9 SIM/SIP 1 Megx8 SIM/SIP

All Speeds

INTEL

8067 - 80287 - 80387

All MHz

R & R Electronics

1-800-736-3644

Inquiry 649.

MONITOR INTERFACE

COMPUTER VIDEO GENERATOR

Test EGA, VGA, Multisync & Data Projectors with handheld monitor tester. From 15.7 KHz to 64.0 KHz, battery powered, 4 patterns, all plug-in with no adapter cables.

NETWORK TECHNOLOGIES INC.

800-RGB-TECH In OH: 216-843-1848

UK: 0244-880478 Paris: 01331-476-32789

See our Ad on page 342.

Inquiry 650.

YOUR SALES MESSAGE

about the special computer product or service that you provide belongs in print.

THE BUYER'S MART

can help you reach computer professionals and produce valuable inquiries for your company!

Call Brian Higgins for more information

603-924-3754

Inquiry 651.

THE BUYER'S MART

NETWORKING

NETWORK BUSINESS SYSTEMS

Keypad Eliminator.....\$99.
 D C B Eliminator.....\$99.
 ELS Utilities.....\$59.
 Netcrack (lose password?).....\$99.
 Getdisk (get BIOS drives).....\$59.
 BIOS Tools (patch drive tbls).....\$99.

NETWORK BUSINESS SYSTEMS

1215 Woodhollow Drive, Suite 1104, Houston, TX 77057
 (713) 783-4457

Inquiry 652.

PROGRAMMERS TOOLS

Screen Master

Screen designer & program generator for C, dBASE & Clipper. Full color control, eight box types + shadowing, line drawing, supports .DBF files directly, alignment, many editing features, writes code for any menu type, mouse support, demo available. \$69.95 (+ S&H)

(508) 435-0585

Athena Technologies, Inc.
 P.O. Box 1261, Westboro, MA 01581

Inquiry 658.

PROGRAMMERS TOOLS

TURBO PLUS \$149.95

Programming tools for use with Turbo Pascal 5.0 & 5.5. Screen Painter, Code Generator, I/O Fields, Dynamic Menus, Programming Unit Libraries, OOP Support, and Sample Programs included. All routines work in both text and graphics modes! 60-day money-back guarantee! Demo Disk avail. For IBM and compatibles.

Nostradamus Inc.

P.O. Box 9252, Salt Lake City, UT 84109-0252
 (801) 272-0671

Inquiry 664.

So Far Your Computers Have Been Talking to Each Other NOW Your Staff Can as Well

CHAT — ACCESS

A Complete Chatting and Messaging Solution for 3Com, Novell, and Other Netbios Networks. CHAT-ACCESS is the ultimate in user friendly software, enabling you to send messages, receive them and engage other logged-in users in full scale conversation. Using only 1 Kbyte of your workstation RAM (for TSR program), CHAT-ACCESS provides a list of logged in users and sends one or all of them a brief message. It also enables you to "CHAT" with another workstation through interactive windows that simultaneously display both sides of the conversation. CHAT-ACCESS operates on 3Com's 3PLUS, 3+ OPEN (MS-DOS workstation), Novell NetWare and all other PC LANs that support NetBIOS.

Shany Computers Ltd.

Rechter Building, 4 Smilansky St., Natanya, Israel 42304
 Tel: (972) (53) 333931 Fax: (972) (53) 342418

Inquiry 653.

HYPERINTERFACE™

Menu Creator™ — A program generator for menu-driven user interface. Excellent for complex menu systems. \$99.95. Advanced Library — Extended capability for data entry and advanced text-display control from your programs. \$99.95. FORTRAN, Pascal, C, BASIC supported. HYPERMATH™ — An application of Menu Creator™ and the Advanced Library. FREE

Avanpro Corp.

P.O. Box 969, Pacific Palisades, CA 90272
 (213) 454-3866

Inquiry 659.

Get INSIDE!

The best PC software performance tool is now better than ever with source line timing, caller timing and arbitrary event timing—all with microsecond accuracy and without source modification. The expanded DOS analysis mode identifies I/O bottlenecks. \$125
 Call today for a free brochure and the latest list of supported compilers. 30-day guarantee. VISA/MC/COD

Paradigm Systems

P.O. Box 152, Milford, MA 01757
 (800) 537-5043 In MA: (508) 478-0499

Inquiry 664.

SHANY COMPUTERS, SOFTWARE THAT MAKES YOUR NET... WORK

CO/FILE+

An essential expansion to your MS-DOS and Network operating system so that you can run your existing single user applications with no modifications on multi-user applications running on your network. Using only 1/2 Kbytes of your workstation RAM, COFILE+ enables your single user applications to share common files on any MS-DOS 3.10 and higher LANs. Data is protected by automatic file or record level locking and unlocking. FEATURES/BENEFITS + Supports all the MS-DOS 3.10 and higher Local Area Networks. + Consumes only 2Kbytes of RAM at each workstation for the TSR program. + Supports 3 levels of file sharing + Read Only Sharing. + Write Sharing. + Create Sharing. + Supports automatic record or file level locking and unlocking for Write and Create Sharing.

Shany Computers Ltd.

Rechter Building, 4 Smilansky St., Natanya, Israel 42304
 Tel: (972) (53) 333931 Fax: (972) (53) 342418

Inquiry 654.

TLIB™ 4.12 Version Control

"TLIB" is a great system™ — PC Tech Journal 3/88. Full-featured configuration mgmt for software professionals. All versions of your code instantly available. Very compact, only changes are stored. Check-in/out locks, revision merge, branching, more. Mainframe deltas for Panasonic, ADR, IBM, Unisys. Only \$99.95 + S&H, or 5-station LAN \$299.95 + S&H. MS-DOS VISA/MC

BURTON SYSTEMS SOFTWARE

P.O. Box 4156, Cary, NC 27519 (919) 856-0475

Inquiry 660.

FREE BUYER'S GUIDE

Programmer's Connection is an independent dealer representing more than 450 manufacturers with over 1000 software products for IBM personal computers and compatibles. We have serviced the professional programmer since 1984 by offering sound advice and low prices. Call or write today to receive your FREE comprehensive Buyer's Guide.

Programmer's Connection US 800-336-1166
 7249 Whipple Ave. NW Canada 800-225-1166
 North Canton, OH 44720 International 216-494-3781

Inquiry 665.

OBJECT ORIENTED TOOLS

OBJECT-ORIENTED TOOLKIT

TRIPLE your productivity with Complete C™ The only object-oriented development utility for C with pre-compiler, foundation classes (source code included), integrated make, real-time debugger, Documentation Generator, Application Streamliner. Versions for DOS (\$449), SCO-XENIX (\$495), QNX (\$449) with full technical support. Other ports available upon request.

Complete Computer Corporation

111 West 57th St., Suite 1400, NY, NY 10019
 212-582-2635

Inquiry 655.

Have Same 'C' Source for UNIX and DOS

D-ISAM—Unix standard indexed file management library for UNIX DOS and NETWORKS. Manages all locking. UNIX/DOS source \$595 (for both), DOS lib* \$145.

W—Character windowing with COLORS, Line Graphics, Bells and more. You need not modify DOS code to work WELL on any UNIX terminal. UNIX/DOS source \$295 (for both), DOS lib* \$95.

BYTE DESIGNS

P.O. Box F195-76, Blaine, WA 98220
 1-800-663-8547 or (604) 278-5200

(*DOS libs available for Microsoft or Borland 'C' compilers)

Inquiry 661.

OBJECTIVE-C 4.0 MS-DOS

Object-Oriented Language used by over 800 companies. Now on affordable hardware! For PC-AT, PS/2 w/2MB, 20MB HD & MS C 5.1.

Includes — Objective-C Compiler, Runtime Library, ICpsk101 Library with 16MB extended memory support.
 \$249 - 30-Day Money-Back VISA/MC/AMEX/Check

THE STEPSTONE CORPORATION

75 Glen Road, Sandy Hook, CT 06482
 (800) 289-6253 (203) 426-1875

Inquiry 666.

OS/2 UTILITIES

INTEGRATED OS/2 PACKAGE

- Protected mode • Hot-key activated
- Background/foreground • Multi-sessioned shell
- Lightning fast text/binary forward/backward file lister
- Search directory trees for multiple strings
- Where file finder • Disk usage reports
- EGA/VGA mode support • Configurable colors
- Pop-up clock, calendar • On-line help

\$29.95 Check/MC/VISA

SASNAK SOFTWARE

P.O. Box 58, Dept. B, Lansing, KS 66043
 (913) 651-1728

Inquiry 656.

Async Executive™ & Tutorial

Interrupt driven transmit & receive. Supports up to eight ports. Buffered I/O to 64K. 50 to 19200BPS. XON/XOFF. DTE/DCE. Modem controls. Transfer characters or blocks. Millisecond timing. Universal language interface. BIOS/DOS extension capabilities. XMODEM w/CRC. 300+ page comprehensive manual. Sample programs include a spooler written in C. For IBM PC/XT/AT & all compatibles. Software Developer's Kit: \$195. NO ROYALTIES

Shipping \$5, Canada \$10, International \$15
 CA residents must add sales tax. Checks/MO only.

CIRRUS SOFTWARE, INC.

P.O. Box 51924, Dept. B, Palo Alto, CA 94303
 (415) 949-1470

Inquiry 662.

OBJECTIVE-C 4.0 OS/2

Workstation-Class Object-Oriented Technology on OS/2! For PS/2 M50 and up, w/2MB RAM, 20MB HD, OS/2 1.1 & MS C 5.1.

Includes — Objective-C Compiler, Runtime Library and ICpsk101

\$495 — 30-Day Money-Back
 VISA/MC/AMEX/Check

THE STEPSTONE CORPORATION

75 Glen Road, Sandy Hook, CT 06482
 (800) 289-6253 (203) 426-1875

Inquiry 667.

PROGRAMMERS TOOLS

LAN Application Development

NPPC: High performance library routines callable from C and Assembler. High level interface permits rapid development of peer-to-peer, client/server, or multi-server NetBIOS applications under DOS. Synchronous or Asynchronous message control. Compact Code. Source Avail. No Royalty. NPPC \$495

Applied Software Technology

P.O. Box 397, Dpt. N, Los Gatos, CA 95031
 (800) 678-1111 ext. N1

Inquiry 657.

ProPak 2.0

The Programmer's Productivity Pack

The most useful programmer's tools and utilities, smoothly integrated into a single package. Ideal for professional programmers, software developers, and students, tool Versions for MS-DOS, DESQview and OmniView included. Powerful, flexible, and easy to use. Fully customizable! Full 30-day money-back guarantee! Only \$79.95 plus S&H

Falk Data Systems

5322 Rockwood Ct., El Paso, TX 79932
 (800) 326-5615

Inquiry 663.

OBJECT-ORIENTED TRAINING

Industry's Object-Oriented Technology trainer since 1986. Over 120 seminars & workshops conducted. Public courses nationwide & corporate on-site courses available. Offerings include:

- Essentials of Object-Technology: \$625
- Object-Oriented Design: \$1,000
- Programming in Objective-C: \$1,000

THE STEPSTONE CORPORATION

75 Glen Road, Sandy Hook, CT 06482
 (800) 289-6253 (203) 426-1875

Inquiry 668.

THE BUYER'S MART

PUBLIC DOMAIN

\$3.00 SOFTWARE FOR IBM PC

Hundreds to choose from, word processors, databases, spreadsheets, games, lotto, communications, business, music, bible, art, education, language and useful utilities for making your computer easier to learn. Most programs have documentation on the disk.

Free 125-page catalog.

BEST BITS & BYTES

P.O. Box 8245, Dept-B, Van Nuys, CA 91409

In CA: (818) 764-9503

800-245-BYTE

Inquiry 669.

\$1 per DISK Sale 20 TOP IBM PC PD/SW DISKS (360K) ONLY \$20 + \$3 S&H

QubeCalc, EDRAW, AutoMenu, Math Tutor, PC-DOS Help, Baker's Dozen, Languages, EZ-Form, PC-Style, PackDisk, PC-Stock, KidGames, Best Games, Home Inventory, PC-Outline, Form Letters, ImagePrint, SideWriter, PC-Prompt, Best Utilities.

BRIGHT FUTURES INCORPORATED

P.O. Box 1030, East Windsor, CT 06088

FREE CATALOG (\$1.50 per disk)

Inquiry 670.

FREE CATALOG PUBLIC DOMAIN/SHAREWARE

- 400 IBM PC & compatibles disks •
- 200 Amiga disks • 125 Atari ST disks

PC disks as low as \$1.25 each, Amiga & ST as low as \$1.60 each! Rent or buy. Free shipping! Call toll free, write or circle reader service for FREE BIG CATALOG with full descriptions. Please specify computer—48-hr. turnaround!

Computer Solutions

P.O. Box 354—Dept. B, Mason, Michigan 48854

1-800-874-9375 (M-F 10-6 EST) 1-517-628-2943

Inquiry 671.

FREE IBM SOFTWARE

FREE CATALOG also contains SHAREWARE. 5 1/4 and 3 1/2-inch. All categories. ENGINEERING, CAD, DESKTOP PUBLISHING, LANGUAGES, UTILITIES, BUSINESS, GRAPHICS, SPREADSHEETS, WORD PROCESSORS, CHURCH, MEDICAL, HEALTH, EDUCATION, HOME.

SECTOR SYSTEMS COMPANY, INC.

Dept. B10, 416 Ocean Avenue, Marblehead, MA 01945

(617) 639-2625

Inquiry 672.

FREE CATALOG

\$1 IBM SOFTWARE

For your free 32-page Master Edition catalog featuring the best of IBM Shareware from just \$1 each, call or write today!

1-800-338-2118

SOFSOURCE

Box 828, East Lansing, MI 48826

Inquiry 673.

FREE SOFTWARE CATALOG

Low as \$1.20/disk

Over 1000 quality IBM software

On 5.25" and 3.5" format

From outside U.S.A., except Canada, please send US \$2.00 refundable with order.

For fast service, write to

SOFTSHOPPE

P.O. BOX 3678, Ann Arbor, MI 48106-3678

313-761-7638

Inquiry 674.

316 B Y T E • OCTOBER 1989

PUBLIC DOMAIN

TOP 10 IBM SOFTWARE - FREE

10 disk set — PC Write, PC Calc+, TreeView, DanCad, FileExpress, Moraff's Revenge, HGCIBM, Novatron, Home Base, Spacewars plus our 1800+ disk catalog

We accept Visa/MC/Amex

PAY ONLY \$5.00 shipping/handling

limited introductory offer

INTERNATIONAL SOFTWARE LIBRARY

511 Encinitas Blvd. • Sta. 104 • Encinitas, CA 92024

order today toll free 800 669-2669

Inquiry 675.

16 and 32 BIT MICROS

EDUCATIONAL TRAINING SYSTEMS in a notebook with power supply — for the Motorola 68000/68020/68881, TMS32010 DSP, Intel 8088/8087, A/D-D/A Converters, cross assemblers, serial interfaces with software, complete systems, documentation, schematic, operating system, cables, Starting Prices — \$230.00

Phone URDA, Inc.

1-800-338-0517

Inquiry 676.

SECURITY

EVERLOCK COPY PROTECTION

- * Thwarts ALL Bit-copy Software
- * Protects any COM/EXE w/o Source changes
- * Shut down Debug Tracing & Disassemblers
- * Install to Floppy, Hard Disk, or LAN
- * Remotely reset Program Install-Count, Expire-Date or #Executes
- * No damaged media or I/O plugs

For IBM and clones. \$195 & up. Free Info.

Az-Tech Software, Inc.

305 East Franklin, Richmond, MO 64085

(800) 227-0644

(816) 776-2700

FAX: (816) 776-8398

Inquiry 677.

THE ULTIMATE COPY PROTECTION

- Completely Menu Driven
- Defeats all Hardware/Software Copiers
- No Source Code Changes
- Multiple Layering
- No Damaged Media
- Full Hard Disk Support
- Unlimited Metering
- FREE Demo Disk

Quite

Simply

The Best

Way To

Protect

Your Valuable

Software Investment

STOPCOPY™ \$325**

STOPCOPY PLUS™ \$450**

BBI COMPUTER SYSTEMS® (301) 871-1094

14105 Heritage Ln., Silver Spring, MD 20906 FAX: (301) 460-7545

Inquiry 678.

COP's Copylock II

- Protect on standard diskettes
- Cannot be copied by any device incl. Option Board
- Fully hard disk installable
- Normal back-up of protected programs
- LAN-support
- Creates safe demo version of your software

Start Pak \$450

Standard Version \$975, Automatic Version \$1950

DANCOTEC Computer

In US: 2635 Sierra Rd., San Jose, CA 95122 408-729-8182 or 1-800-344-2545

Int'l: 2801 Baggaard, Denmark Phone +45-44440322 Fax: +4440722

Inquiry 679.

ALL-IN-ONE PROTECTION!

TOTALSAFE gives you total security: access control, virus protection, data encryption, secure directories, and lots more! Req. PC, HD, 1 slot (or socket). Completely transparent. Introductory price: \$12000 + \$800 SH (U.S.). 30-day guarantee. Also available a complete line of PC access and data security products. Call/write for info. MC/VISA/AMEX. Gamma Security Products, 710 Wilshire Blvd., Ste. 609, Santa Monica, CA 90401 TEL: 213-394-8622 FAX: 213-395-4214

Ellashim Inc.

520W Hwy 436, Suite 1180-30, Altamonte Spgs., FL 32714

TEL: 407/682-1587 FAX: 407/774-8103

Inquiry 680.

SECURITY

BIT-LOCK® SECURITY

Piracy SURVIVAL 5 YEARS proves effectiveness of powerful multilayered security. Rapid decryption algorithms. Reliable/serial port-transparent security device. PARALLEL or SERIAL port. Complemented by economical KEY-LOCK™ and multifeatured COMPUTE-LOCK™ including countdown, timeout, data encryption, and multiproduct protection. (Dos/Unix/Mac)

MICROCOMPUTER APPLICATIONS

3167 E. Otero Circle, Littleton, CO 80122

(303) 922-6410/770-1863

Inquiry 681.

PC Security "Password"

With All the Computer Security Talk, PASSWORD is the Perfect Security Lock.

Password is a software program providing security for your PC. Password is Easy to understand and Simple to install, requires no reformatting. The boot limit option secures your hard disk. Password provides for up to 100 users with the supervisor controlling access to protected directories. Password is menu-driven with pop-up windows and help screens. The program provides an audit trail of users, and a screen blanking feature.

Nasdec International Inc.

2704-85 Garry Street, Winnipeg MB Canada R3C 4J5

PH: (204) 956-2798 FAX (204) 943-3702

Inquiry 682.

COPY PROTECTION

The world's leading software manufacturers depend on Softguard copy protection systems. Your FREE DISKETTE introduces you to SuperLock™—invisible copy protection for IBM-PC (and compatibles) and Macintosh.

- Hard disk support
- No source code changes
- Customized versions
- LAN support

• New upgrades available

(408) 773-9680

SOFTGUARD SYSTEMS, INC.

710 Lakeway, Suite 200, Sunnyvale, CA 94086

FAX (408) 773-1405

Inquiry 683.

HANDS OFF THE BOARD™ 1/2 SIZE SECURITY BOARD

Stop floppy boot — Require password to boot PC Real-time disk encrypt — prevent boot sector virus Prevent DOS FORMAT/FDISK and low-level formats Set hard disk READ ONLY or turn ON/OFF Turn floppies, printers and COM ports ON/OFF IBM XT, AT Bus — DOS V3.0+ — \$149.95 + \$500 S/H

SYSTEMS CONSULTING INC.

PO BOX 111209, Pittsburgh, PA 15238

(412) 963-1624

Inquiry 684.

SOFTWARE ENTERTAINMENT

BE MORE ENTERTAINING!

With the new, improved Humor Processor Version 2 you can add humor to your speeches, newsletters, or everyday conversation. Create original jokes or select from the indexed, expandable 500-joke database. Only \$49.95 + \$5 S&H. IBM PC or Compatible. 30-day money-back guarantee. Call today for special offer!

Responsive Software

1901 Tunnel Rd., Berkeley, CA 94705

800-669-4611 VISA/MC

Inquiry 685.

SOFTWARE FORTRAN

EXPAND & EXTEND LIBS

122 FORTRAN callable routines. EXPAND allows DOS compilers access to LIM/EMS 3.2 or 4.0 expanded memory. EXTEND provides CGA, EGA, VGA, Hercules, HP, Tektronix, AutoCAD DXF graphics, access to BIOS/DOS functions plus additional utilities. EXPAND \$119, EXTEND \$149, both \$218.

DESIGN DECISIONS, INC.

P.O. Box 12884, Pittsburgh, PA 15241

(412) 941-4525

Inquiry 686.

SOFTWARE/ACCOUNTING

PC TIME CLOCK

AutoTime is an Employee Management System that allows you to turn any PC into an Electronic Time Clock. AutoTime provides Time & Attendance, Job Costing, Payroll Interface, and Labor Distribution reporting. Network compatible. Prices start at \$495. Other Business Products: Network FAX, Absence Call-In, db-EDI.

Chase Technologies

1617 Kingman Ave., San Jose, CA 95128
(408) 998-2917

Inquiry 687.

dbASE BUSINESS TOOLS

- GENERAL LEDGER
- ORDER ENTRY
- JOB COSTING
- BILL OF MATLS
- PAYROLL
- PURCH ORD/INVENTORY
- ACCOUNTS RECEIVABLE
- JOB ESTIMATING
- SALES ANALYSIS
- ACCOUNTS PAYABLE

\$99 ea. + S&H

DATAMAR SYSTEMS Cred. Card-Check-COD
4876-B Santa Monica Ave.
San Diego, CA 92107 (619) 223-3344

Inquiry 688.

SOFTWARE/BUSINESS

DATA ENTRY POWERFULLY SIMPLE

Full featured, heads-down data entry with two-pass verification. Designed for the PS/2[®], PC, XT, AT or compatibles. Standalone \$335 LAN version available.

FREE trial.

Computer Keyes Tel: 206/776-6443
21929 Makah Rd. Fax: 206/776-7210
Woodway, WA 98020 USA: 800/356-0203

Inquiry 690.

LOW COST/HIGH QUALITY

Established, Powerful, Complete, Business Management Software Systems. Point-of-Sale/Inventory Control "SALES-PRO", Service and Repair, Video/Rental Store Management, Church Management, Accounting and Many more starting at \$39. For IBM PC Compatibles and the Atari ST.

HI-TECH ADVISERS

P.O. Box 7524, Winter Haven, FL 33883-7524
1-800-882-4310 FOR TECHNICAL INFO (813) 293-3986
Florida (813) 294-1885 24 HOUR FAX (813) 325-0375

Inquiry 691.

LOCATE HARD-TO-FIND BUSINESS AND STATISTICAL SOFTWARE

Econometrics • Biometrics • Cluster Analysis • Multivariate Analysis
• Marketing Statistics • Experimental Statistics • ANOVA • Regression
• Linear Programming • Project Planner • Forecasting & Time Series
• Sales & Market Forecasting • Quality Control and Industrial Experiments • Parameter and Tolerance Design • And Many More!
SEND FOR FREE PRODUCT GUIDE!

Lionheart Press, Inc.

P.O. Box 379, Alburg, VT 05440
(514) 933-4918 FAX: (514) 939-3087

Inquiry 692.

SOFTWARE/BUSINESS

DATA ENTRY

KeyEntry II[®], a complete Data Entry System that provides all the capabilities for designing data entry applications, controlling data flow, & monitoring/reporting operator activity & performance. Supports LAN and stand-alone environments. Evaluation copy (all programs & documentation) available. Call today for information!

Southern Computer Systems, Inc.

2732 Seventh Avenue South
Birmingham, AL 35233
(800) 533-6879/(205) 251-2985

Inquiry 693.

SOFTWARE/DEVELOPMENT

Moby Words™

On 5 1/4" floppies
Moby Words
530,000 unique words & phrases
The largest word list in the world
\$78
Moby Part of Speech
150,000 words with parts of speech
For razor-sharp language parsing
\$148
Moby Hyphenator
150,000 syllabified words
Never give the user a bad break again
\$128
Moby Pronunciator
150,000 words with standard IPA marks
For perfect text-to-speech
\$198

All Royalty free. Send check or MO (CA add 6%) to:

Illumind Unabridged

571 Belden St., Ste. A-13, Monterey, CA 93940-1307
COD/Info: 1-408-373-1491

Inquiry 694.

SOFTWARE/ENGINEERING

Affordable Engineering Software

FREE APPLICATION GUIDE & CATALOG

Circuit Analysis • Root Locus • Thermal Analysis • Plotter Drivers • Engineering Graphics • Signal Processing • Active/Passive Filter Design • Transfer Function/FFT Analysis • Logic Simulation • Microstrip Design • PC/MS-DOS • Macintosh • VISA/MC

BV Engineering Professional Software

2023 Chicago Ave., Suite B-13, Riverside, CA 92507
(714) 781-0252

Inquiry 695.

Analog Circuit Simulation

- Schematic Entry
- SPICE Simulator
- Model Libraries
- Monte Carlo Analysis
- Parameter Sweeps
- Plotting/Graphics Output

Intusoft

The leader in low cost, full featured CAE software
P.O. Box 6807, San Pedro, CA 90734
(213) 633-0710 FAX (213) 831-3958

Inquiry 696.

SIMULATION WITH GPSS/PC™

GPSS/PC™ is an MS-DOS compatible version of the popular mainframe simulation language GPSS. Graphics, animation and an extremely interactive environment allow a totally new view of your models. If you are contemplating the creation or modification of a complex system you need GPSS/PC to help you predict its behavior. Call now.

MINUTEMAN Software

P.O. Box 171/Y, Stow, Massachusetts, U.S.A.
(508) 897-5662 ext. 540 (800) 223-1430 ext. 540

Inquiry 697.

Circuit Analysis — SPICE

Non-linear DC & Transient; Linear AC.
• Version 3B1 with BSIM, GaAs, JFET, MOSFET, BJT, diode, etc. models, screen graphics, improved speed and convergence.
• PC Version 2G6 available at \$95.
Call, write, or check inquiry # for more info.

Northern Valley Software

28327 Rothrock Dr., Rancho Palos Verdes, CA 90274
(213) 541-3677

Inquiry 698.

SOFTWARE/ENGINEERING

FREE ENGINEERING MAGAZINE

Personal Engineering is a monthly magazine sent free of charge (USA only) to scientists/engineers who use PCs for technical applications. Topics each month include Instrumentation • Data Acq/Control • Design Automation. To receive a free sample issue and qualification form either circle below or send request on letterhead to:

Personal Engineering Communications

Box 300, Brookline, MA 02146

Inquiry 699.

ECA-2 Analog Circuit Simulation

ECA-2 Electronic Circuit Analysis is a high performance, interactive, analog circuit simulator. Available for a wide range of computers and operating systems.

- AC, DC, Transient, Fourier, Temperature
- Worst-case, Monte-Carlo
- 2 to 60 times faster than SPICE—Now with multiple plot!

ECA-2 Others
• Over 500 nodes
• Full nonlinear simulator
• Built-in real time graphics

ECA-2 2.40 IBM PC \$775 FREE DEMO.

Tatum Labs, Inc.

3917 Research Park Dr. B-1, Ann Arbor, MI 48108
313-663-8810

Inquiry 700.

SOFTWARE/GEOLOGICAL

GEOLOGICAL CATALOG

Geological software for log plotting, gridding/contouring, hydrology, digitizing, 3-D solid modelling, synthetic seismogram, fracture analysis, image processing, scout ticket manager, over 50 programs in catalog. Macintosh tool! Please call, or write, for Free Catalog!

RockWare, Inc.

4251 Kipling St., Suite 595, Wheat Ridge, CO 80033 USA
(303) 423-5645 Fax (303) 423-6171

Inquiry 701.

SOFTWARE/GRAPHICS

QuickGeometry Library

Many powerful math subroutines for CAD/CAM and graphics; LINES, ARCS, CIRCLES, ELLIPSES, NON-UNIFORM RATIONAL B-SPLINES WOFFSET (NURBS); INTERSECTION (even splines), ROTATE, SCALE, TRANSLATE, MIRROR, OFFSET, BREAK, TRIM; ENDPOINTS, TANGENTS, CURVATURE; DXF I/O; lists. IBM PC comp MS-DOS 2+, \$195.00 + no S&H; incl C source, manual, support, 30-day guarantee.

Building Block Software

P.O. Box 1373, Somerville, MA 02144

(617) 628-5217

Inquiry 701.

PROFESSIONAL GRAPHICS FOR SCIENTISTS AND ENGINEERS

PC/MS-DOS • Macintosh

FREE 48-page Catalog

Linear/Log Scaling • Graphs with error bars • AUTO PLOT • BATCH Mode • Multiple Y-axes • Multiple data files • Auto/Forced Scaling • Full labeling • Built-in editor • 1-2-3 Interface • Curve fitting • Statistics • CGA, EGA & Hercules Compatible. 40 pen plotters supported.

BV Engineering Professional Software

2023 Chicago Ave., Suite B13, Riverside, CA 92507

VISA/MC (714) 781-0252

Inquiry 702.

TurboGeometry Library 3.0

New 3.0 upgrade! Now over 300 2D & 3D routines. Surfacing, Solids, HiddenLine, Volumes, Areas, Transforms, Perspectives, Tangents, Clipping, Decomp, & more. IBM PC/Comp. MS-DOS 2.0+. Turbo Pascal, Turbo C, MSC. Manual. 30-Day guar. \$199.95 w/source. Foreign S&H extra. VISA, MC, PO. USA funds only.

Disk Software, Inc.

2116 E. Arapaho Rd., #487, Richardson, TX 75081
214-423-7288/FAX 214-423-4465/800-636-7760

Inquiry 703.

THE BUYER'S MART

SOFTWARE/GRAPHICS

TECHNICAL GRAPHICS

FROM ANY LANGUAGE

- Logarithmic, Time/Date & Linear Axes.
- Easy Curve Fitting and Data Smoothing.
- Supports all Video & Device Standards.
- 10 Curves with up to 8000 points each.
- Plus much much more...

Only \$95 Call Today 800-284-3381

Edmond Software, Inc.

5900 Mosteller Dr. #1125, Oklahoma City, OK 73112

Inquiry 704.

PEN PLOTTER EMULATOR

FPLot turns your dot matrix or laser printer into an HP pen plotter. Fast hi-res output. No jagged lines. Vary line width, color. Works with Autocad, Draftx, etc. Supports NEC P5/P6, IBM Proprinter, Epson LQ/FX, Toshiba, HP Laserjet, Okidata 29x/39x, Hercules/CGA/EGA/VGA. \$64 check/m.o.

Fplot Corporation

24-16 Steilway St., Suite 805, Astoria, NY 11103
718-545-3505

Inquiry 705.

POPULAR HGRAPH

SCIENTIFIC 2D & 3D graphic routines for IBM PC, VAX, SUN and Macintosh. Powerful, easy to use. Multiple fonts, device and machine independent. Uses max resolution. Links with FORTRAN, Pascal, C, Modula-2 and QuickBasic. \$119.00

Custom software development.

UGraph—the graphics editor available now!

HeartLand Software, Inc.

234 S. Franklin, Ames, IA 50010
(515) 292-8216

Inquiry 706.

GRAPHICS PRINTER SUPPORT

AT LAST! Use the PrtSc key to make quality scaled B&W or color reproductions of your display on any dot matrix, inkjet, or laser printer (incl. PostScript). GRAFPLUS supports all versions of DOS with IBM (incl. EGA, VGA, Super VGA), Hercules, or compatible graphics boards. Linkable/OEM versions available. \$99.95.

Jewell Technologies, Inc.

4740-44th Ave. SW, Seattle, WA 98116
800-628-2828 x527 (206) 937-1081

Inquiry 707.

FORTRAN PROGRAMMER?

Now you can call 2-D and 3-D graphics routines within your FORTRAN program.

GRAFATIC: screen routines \$135.
PLOTATIC: plotter driver 135.
PRINTATIC: printer driver 135.

For the IBM PC, XT, AT & compatibles. We support a variety of compilers, graphics bds., plotters and printers.

MICROCOMPATIBLES

301 Prelude Dr., Dept. B, Silver Spring, MD 20901 USA
(301) 593-0683

Inquiry 708.

GRAPHIC TOOLS LIBRARY

NOVA XGLIB: High speed, Window/viewport, arcs, splines, figure fill, borders, text scale, rotate, align, bitmaps, bitblt, pens, keyboard, mouse, image capture and processing. Animation. Over 150 functions. \$75.

PC_VDI: High speed text at any angle, size and position, outline fillable font factory, plots, charts and curve fit. Free Demo Disk. \$395. Both products ANSI compatible. Free drivers for printers, plotters, lasers. Hercules, CGA/EGA/VGA/VGA256, most boards. For all "C" compilers, FORTRAN, MS QuickBASIC. Manual.

NOVA INC.

P.O. BOX 68976, Schaumburg, IL 60168
312-882-4111

Inquiry 709.

318 BYTE • OCTOBER 1989

SOFTWARE/INVESTMENT

MIDNIGHT ENGINEERING™

A new publication for entrepreneurial hardware and software engineers that will encourage and challenge you to personally develop and market your own products.

- PRACTICAL ARTICLES
- INSIGHTFUL INTERVIEWS
- DETAILED PRODUCT REVIEWS

call or write for a FREE copy of the premiere issue of *Midnight Engineering*.

DATArx

111 E. Drake Rd., Suite 7041, Fort Collins, CO 80525
303-223-2120

Inquiry 710.

SOFTWARE/LANGUAGES

FORTH with DRUMA FORTH-83

Break the 64K barrier without speed/space penalty. Well designed, attractively priced, '83 Standard.

- 1Mb+ automated memory management
- On-line documentation, ASCII/block files
- Many powerful and useful features
- Other products: windows, modules, profiler
- IBM PC/XT/AT & all compatibles

Write or call for FREE example diskette.

DRUMA INC.

8448 Hwy. 290 East E103, Austin, TX 78723
Orders: 512-323-0403 BBoard: 512-323-2402

Inquiry 711.

SOFTWARE/MATHEMATICS

MATH EDITING FOR THE PC

$$x_i^2 = \sum_{k=0}^{\infty} [x_k^{2n} \binom{2n}{k}] + \left(\frac{F ds}{\sqrt{\alpha \pm \beta x}} \right)$$

- MathEdit constructs math equations to be inserted into WordPerfect Text and Manuscript documents.
- User-friendly interface—no word processor needs to be learned.
- MathEdit—\$149

K-TALK COMMUNICATIONS

50 McMillan Ave., Suite 100
Columbus, Ohio 43201
(614) 294-3535

Inquiry 712.

Derive™

A Mathematical Assistant

Makes math more inspiration and less perspiration! Combines the power of computer algebra with 2D & 3D plotting and a friendly menu-driven user interface. Does equation solving, calculus, trigonometry, vector & matrix algebra, and more. Derive requires a PC compatible computer & 512K memory.

Soft Warehouse, Inc.

3815 Harding Ave., Suite 505, Honolulu, HI 96818
(808) 734-5801

Inquiry 713.

SOFTWARE/MEDICAL

Medical Systems with ECS

PPM offers a complete line of medical software ranging from simple insurance claims processing to comprehensive APR management.

PC CLAIM PLUS—claims processing with ECS to over 100 major insurance carriers—30-day money-back guarantee
THRESHOLD—complete APR, patient billing, comprehensive practice management statistics

CLAIM NET—Nationalwide electronic claims clearinghouse transmits claims to over 100 insurance carriers
Software prices start at \$459.00. Dealer Inquiries welcome.

Physicians Practice Management

350 E. New York, Indianapolis, IN 46204
800-428-3515 317-634-8080

Inquiry 714.

SOFTWARE/PACKAGING

HARD TO FIND COMPUTER SUPPLIES FOR SOFTWARE DEVELOPERS & POWER USERS

Cloth binders & slipcases like IBM's. Vinyl binders, boxes, and folders in many sizes. Disk pages, envelopes, & labels. Low quantity imprinting. Bulk disks. Everything you need to bring your software to market. Disk and binder mailers. Much more! Low Prices! Fast service. Call or write for a FREE CATALOG.

Anthropomorphic Systems, Limited

378-B E. Saint Charles Rd., Lombard, IL 60148
1-800-DEAL-NOW 312-629-5160

Inquiry 715.

SOFTWARE/PACKAGING

SAVE SAVE SAVE SAVE LET'S TALK PACKAGING

From Disk Labels to Manuals to Shipping Boxes—We are a complete packaging service. Everything you need to market your software. Call for our free catalog.

SOFCOM Printing and Packaging

10305 Reading Rd., Cincinnati, OH 45241
513-563-7136

Inquiry 716.

SOFTWARE/PRINTING

PRINTER GENIUS

Powerful memory-resident printer management • Control printer features from menus or within documents • Print spool-to-disk files or memory • Background print • File & directory browse • Edit small text • and more... • User friendly pop-up screens • 92-page manual • Preset for all printers • Completely flexible • PC MS-DOS • \$89 + \$4 S/H + VISA/MC

Nor Software Inc.

527 3rd Ave., Suite 150, New York, NY 10016
(212) 213-9118

Inquiry 717.

SOFTWARE/SCANNERS

Optical Character Recognition

Stop retyping: PC-OCR™ software will convert typed or printed pages into editable text files for your word processor. Works with HP ScanJet, Panasonic and most other scanners. Supplied with 18 popular fonts. User trainable: you can teach PC-OCR™ to read virtually any typestyle, incl. foreign fonts. Proportional text, matrix printer output, Xerox copies OK. \$385. Check VISA/MC/AmExp/CCD

Essex Publishing Co.

P.O. Box 391, Cedar Grove, NJ 07009
(201) 783-6940

Inquiry 718.

SOFTWARE/SCIENTIFIC

TableCurve—TableCode

Curve-Fit 211 Equations in a Single Step

TableCurve™ generates printed reports and Lotus, dBase, Quattro, Harvard Graphics, and Pagemaker/Ventura output. TableCode™ generates functions and calling code for C, Pascal, BASIC, FORTRAN, Modula-2 and dBASE languages.

Demo \$5, TableCurve \$159, TableCode \$149 MC/VISA

AISN Software

P.O. Box 32277, Phoenix, AZ 85064
602-266-1925

Inquiry 719.

Chaos/Nonlinear Dynamics

* Ordinary and Delay Differential Equation Solvers * Bifurcation Diagrams * 2- and 3-D Plotting, Sequential Magnification, Poincaré Sections * Next Maximum, 1-D & Circle Maps * Phase Portraits with Multiple Initial Conditions * Spectral Analysis, Fractal Dimensions, Lyapunov Exponents

DS:I \$250.00 DS:II \$350.00

CHAOS IN THE CLASSROOM \$49.95

DYNAMICAL SYSTEMS, INC.

P.O. Box 35241, Tucson, AZ 85740, 602-825-1331

Inquiry 720.

C SCIENTIFIC LIBRARY

Extensive library of matrix, mathematical, and statistical routines. Developed and documented for use by technical specialists and C programmers in research, education, engineering, and scientific applications. Over 550 functions, superior documentation—four manuals, including Tutorial, Function Pages, and Example Programs. Includes Real and Complex Linear Algebra, Eigensystems, Differential Equations, Quadrature, Smoothing, Filtering and Prediction, Multivariate Statistics, Multi-Dimensional Optimization, Linear Programming, Curve Fitting and Interpolations, etc. \$295 object only and \$365 with C source code.

EIGENWARE TECHNOLOGIES

13090 La Vista Dr., Saratoga, CA 95070 (408) 867-1184

Inquiry 721.

THE BUYER'S MART

SOFTWARE/SCIENTIFIC

LARGE MATRICES

Invert a 235 x 235 REAL*8 non-sparse matrix in 3.5 min on your 640K DOS based 16 MHz 386/387 (13 min on 12 MHz 286/287) using LU decomp with back subst. Also large matrix capability for matrix multiply, transpose, scale, add, simul eq, etc. 80 bit precision. No added memory boards required. Use with Microsoft or IBM Pro FORTRAN unformatted matrix files. Full featured demo disk can generate and run large random matrices \$20.

JOYCE NUMERICS INC.

500 Chesterbrook Blvd., Suite 15 C-6, Wayne, PA 19087
(215) 993-9013

Inquiry 722.

Free catalog includes technical application notes

1-800-942-MATH

MicroMath Scientific Software
Salt Lake City, Utah 84121-3144

Inquiry 723.

SOFTWARE/SECURITY

HANDS OFF THE PROGRAM® OPERATING SYSTEM SECURITY

Secures subdirectories, files, printers and floppies
Keyboard lock — automatic or manual
Log PC boot, program exec, file opens, login/logouts
Prevents DOS FORMAT and most viruses
Drive A: Boot Protection / Hard Disk Lock
IBM PC or 100% comp. — DOS V3.0+ — \$89.95 + \$3.75 S/H

SYSTEMS CONSULTING INC.

PO BOX 111209, Pittsburgh, PA 15238
(412) 963-1624

Inquiry 724.

SOFTWARE/SORT

OPT-TECH SORT/MERGE

Extremely fast Sort/Merge/Select utility. Run as an MS-DOS command or CALL as a subroutine. Supports most languages and file types including Btrieve and dBASE. Unlimited file sizes, multiple keys and much more! MS-DOS \$149. OS/2, XENIX, UNIX \$249.

(702) 588-3737

Opt-Tech Data Processing

P.O. Box 678 — Zephyr Cove, NV 89448

Inquiry 725.

STATISTICS

SX STATISTIX

PC Magazine Editors Choice!

- Easy to learn and use • Fast Free Support
- Money-Back Guarantee

At \$179 SX outperforms higher priced programs!
If you value your time and money,
call today for FREE SX demo disk

612-631-2852

Analytical Software Box 13204, Roseville, MN 55113

Inquiry 726.

The BASS System™

Why use up 8 meg and 640K just to run a data step on your PC? Now you can run your data step code and statistical procs with a system that takes only 1 meg and 400K (and costs only \$399)! Free information:

BASS Institute, Inc.

P.O. Box 349, Chapel Hill, NC 27514
(919) 933-7096 or BB: (919) 968-6755 (N,8,1)

Inquiry 727.

STATISTICS

SOLO 3.0 from BMDP

Popular statistics and excellent graphics for the PC. Quick and easy to use. For business professionals, researchers, or students. From the leader in statistical software for over 25 years. Top-notch support. Satisfaction guaranteed! \$199 complete with graphics. Call today, VISA or MC.

BMDP Statistical Software, Inc.

1440 Sepulveda Blvd., Suite 318, Los Angeles, CA 90025
(213) 479-7799

Inquiry 728.

STATA

Stata 2.05 Now Available. More statistics, graphics and an all-new manual. Still only \$590. Quantity Discounts Available. New, lower academic price. \$20 Demo. Call toll-free for more information.

1-800-STATAPC

Computing Resource Center

10801 National Boulevard, Los Angeles, CA 90064
(213) 470-4341

Inquiry 729.

DBMS/COPY

CONVERTS YOUR DATA INTO INFORMATION

Now your favorite stat package can access any database. DBMS/COPY can directly convert any database or spreadsheet file (ORACLE, PARADOX, dBASE, LOTUS etc.) into any stat package file (SAS, SPSS, SYSTAT, etc.) and vice versa. The PLUS version allows sorts, selections, and recalculations. \$195. 30-day guarantee. VISA/MC/AMEX/PC/COD.

CONCEPTUAL SOFTWARE INC.

P.O. Box 56827, Houston, TX 77256
(713) 667-4222 FAX: (713) 667-3FAX
1-800-STATWOW

Inquiry 730.

THE SURVEY SYSTEM

An easy-to-use package designed specifically for questionnaire data. Produces banner format, cross tabs & related tables, statistics (incl. regression) & bar charts. Codes and reports answers to open-end questions. All reports are camera-ready for professional presentations. CRT interviewing option.

CREATIVE RESEARCH SYSTEMS

15 Lone Oak Ctr., Dept. B, Petaluma, CA 94952
707-765-1001

Inquiry 731.

MINITAB's a PC of cake!

MINITAB's intuitive commands are easy to use and remember. Features descriptive statistics, regression, time series, chi-square, hi-res graphics, much more. PC version incl. LOTUS interface, data editor, network pricing. Call for FREE brochure.

Minitab, Inc.

3081 Enterprise Dr., State College, PA 16801
(814) 238-3280

Inquiry 732.

NCSS

Professional, easy to use, menu-driven statistical system. Used by over 5,000 researchers.

- 5.0 Statistical System —\$99
- 5.1 Graphics (2D & 3D)—\$59
- 5.3 Power Pac Supplement—\$49
- 5.4 Exp. Design/QC—\$49
- 5.5 Survival Analysis—\$59
- 5.6 Forecasting—\$69

We accept checks, P.O.s, Visa, MC. Add \$3 s/h.

NCSS-B 801-546-0445

865 East 400 North, Kaysville, UT 84037

Inquiry 733.

STATISTICS

SCA STATISTICAL SYSTEM

The only statistical software encompassing Forecasting & Time Series Analysis Quality and Productivity Improvement General Statistical Analysis

Available on both DOS and OS/2 operating systems.
Call today for more information

Scientific Computing Associates

4513 Lincoln Ave., Suite 106, Lisle, IL 60532, USA
Phone: (312) 960-1698 FAX: (312) 960-1815

StatPac Gold™

StatPac Gold is the award-winning statistics and forecasting package that delivers. It's fast, flexible, easy to use and dependable. Time-tested and loaded with features. You be the judge. Get the facts! Call for your FREE brochure.

1-800-328-4907

Walonic Associates, Inc.

6500 Nicollet Ave. S., Minneapolis, MN 55423
(612) 866-9022

Inquiry 734.

UNINTERRUPTABLE POWER

HOW TO PROTECT YOUR COMPUTER

And Make It Last Longer

FREE money-saving literature. What you need to know about UPS—uninterruptible power supply. How to get complete protection from power line problems. 350VA through 15KVA models from the world's largest manufacturer of single-phase UPS.

Best Power Technology, Inc.

P.O. Box 280, Necedah, WI 54646
(608) 565-7200 ext. 3737
TOLL FREE (800) 368-6794 ext. 3737

Inquiry 735.

UTILITIES

COPY AT TO PC—BRIDGE-IT 3.5

"CPVAT2PC" RELIABLY writes 360KB floppies on 1.2 MB drives, saving a slot for a second hard disk or tape back-up. Only \$79.00 + S/H
"BRIDGE-IT 3.5" is a DEVICE DRIVER supporting 3 1/4" 720KB/1.44MB drives for PC/TXT without upgrading DOS/BIOS. Only \$39.00 + S/H
BRIDGE-IT 3.5 BUNDLED WITH INTERNAL 1.44MB DRIVE AT \$129.00 + S/H VISA/MC/COD UPS B/R

MICROBRIDGE COMPUTERS

655 Sky Way Suite 113, San Carlos, CA 94070
1-415-593-8777(CA) 1-415-593-7875 (FAX)
1-514-845-0818 (CANADA) 1-800-523-8777

Inquiry 736.

DELTA, the better text file comparison tool. Scrollable windowed presentations of file or directory comparisons, with a built-in editor window. Ideal for programmers! Requires DOS 2.0 or higher with at least 384K RAM. A hard disk is recommended. Order now. \$79.

DEMO available on our BBS

OPENetwork

POWER TOOLS FOR POWER USERS

215 Berkeley Pl. (B-1), Brooklyn, NY 11217
718-638-2240 BBS: 718-638-2239

Inquiry 737.

Recover deleted files fast!

Disk Explorer now includes automatic file recovery. You type in the deleted file's name, Disk Explorer finds and restores it. Disk Explorer also shows what's really on disk; view, change or create formats, change a file's status, change data in any sector. MS-DOS \$75 U.S. Check/Credit card welcome.

QUAID SOFTWARE LIMITED

45 Charles St. E. 3rd Fl.
Toronto, Ontario, Canada M4Y 1S2
(416) 961-8243

THE BUYER'S MART

UTILITIES

DATABASE UTILITIES

NORTAK Software Ltd. now offers a menu-driven ASSIST-like file utility for dBASE, Clipper, and FoxBASE. Self-contained (.EXE file), fast and simple to use.

SINGLE VERSION—\$35; 3-VERSION PACKAGE—\$60.
To order call:

SHOSHIN Systems Inc.

USA 1-800-267-0755 Canada 1-800-267-8856

Info Only 613-235-2310

VISA and MC accepted

Inquiry 738.

WORD PROCESSING

We can read 130 languages from Armenian to Zulu

Use SPOT OCR Software with an image scanner and your PC to read 130 foreign languages, typed pages, typeset material, magazines and books into standard text files. Flagstaff Engineering can provide any OCR solution. Call today to discuss your application!

Flagstaff Engineering

1120 Kaibab Lane, Flagstaff, AZ 86001

(602) 778-3341

MasterCard—Visa—American Express Accepted

Inquiry 741.

WORD PROCESSING

DuangJan

Bilingual word processor for English and: Armenian, Bengali, Burmese, Euro/Latin/African, Greek, Gujarati, Hindi, Khmer, Lao, Punjabi, Russian, Sinhalese, Tamil, Telugu, Thai, Ukrainian, Viet. . . . Only \$109+\$5 s/h (foreign + \$12 s/h). Font editor included. For any IBM compatibles with dot-matrix & LaserJet printer. Demo \$9+\$1 s/h. Visa/MC

MegaChomp Company

3438 Cottman Ave., Philadelphia, PA 19149-1806

(215) 331-2748

FAX: (215) 331-4188

Inquiry 743.

AppleWorks ↔ IBM

CROSS-WORKS transfers both ways between Apple IIe/IIc/IIgs and IBM PC/XT/AT/PS-2 & compatibles. Exchange AppleWorks with WordPerfect (keeps formatting), Lotus 1-2-3 (keeps formulas), and dBase II/III. Included cable plugs in serial ports for 19,200 baud transfers. Easy menu operation.

Phone (919) 878-7725 for free info packet.

SoftSpoken Co., PO Box 97623, Raleigh, NC 27624

Inquiry 739.

FARSI / GREEK / ARABIC / RUSSIAN

Hebrew, all European, Scandinavian, plus either Hindi, Punjabi, Bengali, Gujarati, Tamil, Thai, Korean, Viet, or IPA. Full-featured multi-language word processor supports on-screen foreign characters and NLQ printing with no hardware modifications. Includes Font Editor. \$355 dot matrix; \$150 add'l for laser; \$19 demo. S/H in U.S. incl'd. Req. PC, 840K, graphics. 30-day Guarantee. MC/VISA/AMEX

GAMMA PRODUCTIONS, INC.

710 Wilshire Blvd., Suite 609, Santa Monica, CA 90401

213/394-8622 Tlx: 5106008273 Gamma Pro SNM

Inquiry 742.

PC-Write 3.0 — Shareware

Fast, full featured word processor for IBM PC. Now edits large files & multiple columns. Also spell check, mailmerge, networking, ASCII, and macros. Easy-to-use, optional menus. Supports 500 printers incl. lasers. Software, guide and tutorial on disk: \$19. Registration with manual, support newsletter and 2 free updates: \$99.

90-day money-back guarantee. VISA/MC.

Quicksoft

1-800-888-8088

219 First Ave. N., #224-BYTC, Seattle, WA 98109

Inquiry 744.

SAVE TIME and MONEY

with the RED Utilities. Programs include: Batch file compiler speeds batch files. Disk cache speeds hard and floppy disks. Printer spooler. Path command for data files. Wild card exceptions. Sort directories. Over 10 more programs. Only \$79.95. Order today! 30-day money-back guarantee. IBM PC. Visa/MC.

The Wenham Software Company

5 Burley St., Wenham, MA 01984 (508) 774-7036

Inquiry 740.

YOUR SALES MESSAGE

about the special computer product or service that you provide belongs in print.

THE BUYER'S MART

can help you reach computer professionals and produce valuable inquiries for your company!

Call Brian Higgins for more information

603-924-3754

Subscription Problems?

We want to help!

If you have a problem with your BYTE subscription, write us with the details. We'll do our best to set it right. But we must have the name, address, and zip of the subscription (new and old address, if it's a change of address). If the problem involves a payment, be sure to include copies of the credit card statement, or front and back of cancelled checks. Include a "business hours" phone number if possible.



BYTE

Subscriber Service, P.O. Box 555, Hightstown, NJ 08520



Pay Less \$\$ for more Memory

■ SIMM MODULES

AST • APPLE • DELL • EVEREX • PS2 • COMPAQ	
1 Meg x 8 – 10 (Macintosh)	\$108.00
1 Meg x 9 – 10	\$119.00
1 Meg x 9 – 80	\$129.00
PS II 2 meg Simm Module	\$495.00

■ EXPANSION BOARDS

COMPAQ • PS2 • HP LASERJET

■ MEMORY CHIPS

64K • 256K • 1MG

■ INTEL MATH COPROCESSORS – FULL LINE



call: 714-855-0411

(FAX) 714-855-8504

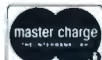

23552 Commerce Center Drive, Suite L,
Laguna Hills, CA 92653

ESTABLISHED 1985 • LOW, LOW PRICES • VISA
MASTERCARD • SAME DAY SHIPPING •
CORPORATE & SCHOOL P.O.'S WELCOME

Dynamic Electronics

STOCKING DISTRIBUTOR OF SEMICONDUCTORS

DOS IN EPROM

Or any other code, for that matter! **PromKit** allows you to create Eproms that look like read-only disk drives in your PC-compatible systems. Use PromKit **even if you're not a programmer**. Just use PromKit to convert any disk into EPROM images for your Prom blaster! Copy system files, batch files, data files, or anything else you want. Use Proms for read-only, SRAMS for read-write! **Includes source code in C.** Over 180 pages, including disk, only \$179.

FREE

We'll include a free copy of the pocket-sized **XT-AT Handbook** by **Cholsser and Foster** with each PromKit if you mention this ad when you order. Of course, this \$9.95 value is also available by itself. Or buy five or more for only \$5.00 each.



(619) 271-9526



Annabooks

12145 Alta Carmel Ct Suite 250-262
San Diego, California 92128

Money-back guarantee

REEL 9-TRACK GENIUS

OVERLAND DATA will bring out the GENIUS IN YOU when it comes to connecting your PC to the mini/mainframe world. OUR ENGINEERS DESIGNED the most successful tape drives, controllers and software in use today. Call the experts...ODI!

- PC/XT/AT/386/PS2 & Compat.
- DOS, XENIX, UNIX, NOVELL
- 800, 1600, 3200, & 6250 BPI
- Outstanding Customer Support
- 24-hour delivery available on Cipher, Qualstar, Anritsu & M4



"See us at Comdex #W604"



Overland Data

"Experience Makes The Difference"

CALL TODAY AT 1-800-PC-9TRAK!

5600 Kearny Mesa Road • San Diego, CA 92111
TEL: 619/571-5555 • FAX: 619/571-0982



OLIVETTI
We Print Better

PRINT SAMPLES

ABCDEFGHIJKLMN OPQRSTUVWXYZ #123456789
 abcdefghijklmnopqrstuvwxy z #123456789
 ABCDEFGHIJKLMN OPQRSTUVWXYZ #123456789
 abcdefghijklmnopqrstuvwxy z #123456789
 abcdefghijklmnopqrstuvwxy z #123456789

PRINT SPEED

- 240 cps in high speed draft mode
- 180 cps in draft mode
- 60 cps in letter quality mode

LINE LENGTH

- DM 250: 80 columns at 10 cpi
- DM 250L: 136 columns at 10 cpi

EMULATIONS

- IBM Graphics Printer
- IBM Proprinter XL
- Epson FX 80/100 (Subset)
- Epson JX 80 (Subset)

BIT IMAGE MODE

- Horizontal resolution: 60, 72, 80, 90, 120, 240 dpi
- Vertical resolution: 180 dpi

C
O
L
O
R

**PRINTERS
As Low As
\$289**

FUJACORP INC.
473 SAPENA COURT #2
SANTA CLARA, CA 95054
FAX: 408-496-5877
To order, please call:
800-345-4408 or
408-980-8181

We accept Visa and Master Card

Connectivity Solutions

DCB

Universal converter; high capacity 64KB to 1 MB printer buffer with

parallel / serial input and output ports.

Frees computer while doing printing. Converts data if required. Connects more than 1 computer to more than 1 printer.

DCI

Internal converter printer buffer for IBM or compatibles computers.

Built in microprocessor frees computer while printing. Serial and parallel outputs. Features include using any type of printer or using 2 printers software selectable.

MOP

Parallel interface card for PC, XT or AT with up to 4 output ports

Connect up to four different printers or plotters. Software selectable.

DCU

Universal data converter serial/parallel, parallel/serial.

Completely programmable with software protocol.

MOS

Multi-serial interface for IBM or compatibles. Up to 8 serial ports. Interconnects computers, modems, printers, plotters, etc.

MIP

Multi-parallel input ports for PC, XT or AT with 8 ports. Allows up to 64 external data lines, 24 input/output control lines.

MAX-E-CON

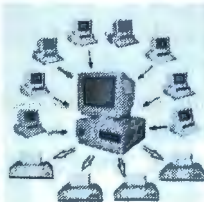

Up to 24 serial / parallel input/output ports. System capacity : 512 KB RAM with 20 or 40 MB fast access hard disk. Basic model comes with 512 KB, 8 input ports (serial or parallel) and 4 output ports (parallel). Each port is completely independent and can use different speeds, protocols, etc. System status display (optional).

Ultra high storage capacity suitable for LANs and multiple stand alone computers. Share or switch computers, printers, plotters, modems, etc



Maxcina Corporation
970 Terra Bella Ave. Bldg. 3
Mountain View, CA 94043

Call today for details
Phone (415) 968-8404
FAX # (415) 968-8390



Dealer's Inquires welcome

9600bps MODEM



~~+FAX~~

\$299

2400 bps MODEM \$95 30 DAY FREE TRIAL
ECONOFAX™ OR MNP-5...CALL

Many low cost modems are faulty or very error prone....**Not ours!!!**
PERFORMANCE "I have recently had a lot of trouble getting 2400 BAUD MODEMS to work...this one is working perfectly." R.T., Moreno Valley CA. **SUPPORT** "I get the impression that your company, indeed, bends over backwards to provide service to its customer." M.F., Selma CA. **SUPERIOR TECHNOLOGY**...The phone connection is the main source of data errors. **DYNAMIC IMPEDANCE STABILIZATION™, DIS™** (invented by CompuCom) improves signal quality and reduces these errors by up to 95% compared to a standard modem. Model 2400 (without DIS) at \$95 outperforms the low cost alternatives, the 24DIS at \$119 outperforms the challengers, regardless of cost. IBM internal, Hayes compatible, made in USA, 6 COM ports, internal speaker, five year warranty, EasyCom software, dealers inquire. *If you aren't totally satisfied, return within thirty days for a full refund!*

CompuCom Corporation "Real deal...worked fine...quite a bargain!"
March '89 p102 BYTE MAGAZINE
CALL (408) 732-4500 (800) 228-6648

386SX Performance is as easy as π



Upgrade to 386SX Power with 2 MB Ram for only \$795.00!

Featuring:

- Fits XT, Baby or Full AT's and Towers
- 387SX and Shadow BIOS Support
- Your choice of Award™ or Phoenix™ BIOS
- SXD (2 MB DIP) or SXS (8 MB SIMM) versions
- Three year parts & labor warranty
- 45 day trial offer period
- 20, 25 and 33 Mhz 386DX motherboards, RAM, Drives, Cases, P/Ss, and Add-in Cards
- Professional Workstations available



™ To Order, Call 800-666-9248

Pi Computer Corporation

Beyond the Standards

1030 Earlysville Forest Drive, Earlysville, VA 22936
Fax: 804-978-3906 Information: 804-978-3917
Visa, MC and AMEX Accepted

* Since 1983

© 1989 Pi Computer Corp.

COMPARE OUR NEW LOWER PRICES AND SUPERIOR QUALITY

PCI-286-12

- 80286-12
- 1.2 MB Floppy Drive
- 640K RAM
- Serial / Parallel / Game
- 101-Key Enhanced Key Board
- SI = 13.3 (1 Wait)
- SI = 15.2 (0 Wait \$100 Option)
- 6/12 MHz Key Board Switchable
- WA2 HD & FD Controller
- 80287 SOCKET
- 200W POWER SUPPLY

MONO SYSTEM
 • W/Mono Monitor
 • 20 MB Hard Disk

\$1095

VGA COLOR SYSTEM
 • W/VGA Card + Monitor
 • 20 MB Hard Disk

\$1580

EGA COLOR SYSTEM
 • W/EGA Card + Monitor
 • 20 MB Hard Disk

\$1480

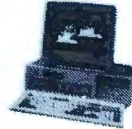

PCI-386-20

- 80386-20
- W/40 MB HD
- Mono System **\$1795**
- VGA **\$2295**

GAS PLASMA 286-12 ___ \$1895

- 80286-12 CPU
- SI = 13.3
- 3 1/2" FD 1.44 MB
- 20 MB HD ST-138
- LCD Screen (640 X 400)
- I/O Card Parallel/Serial/Game
- 640K RAM



GAS PLASMA 286-20

\$1995

- CPU 80286-20
- SI = 23

LCD-286-10 PORTABLE ___ \$1349

- 10 MHZ 80286 SI = 10.3
- 12 MHZ SI = 13.3 (Option \$50.00)
- 16 MHZ SI = 18 (Option \$250.00)
- 640K RAM
- LCD Screen 640 X 200 (Option 640 X 400 \$180.00)
- Super Twist & Back Lighting
- 86 Key Board
- External / Parallel / Game
- 1.2 MB Floppy drive
- 20 MB Hard Disk
- 80287 Socket
- 200 W Power Supply
- Side 15 1/4" X 9 1/2" X 8"
- 23 LBS



LCD-386-16 ___ \$2095

- 80386-16 MHZ
- 40 MB Hard Disk
- 80387 Socket

LCD-386-20 ___ \$2195

- 80386-20 MHZ
- 40 MB Hard Disk
- 80387 Socket

CRT-PORTABLE-286 ___ \$1249

- Compaq Type
- 80286 (10 MHZ or 12 MHZ)
- 12 MHZ SI = 13.3 (Option \$50.)
- 16 MHZ SI = 18 (Option \$250)
- One 1.2 MB Floppy Drive
- 200 W Power Supply
- TTL Disply 9" Amber
- AT Key Board
- Serial / Parallel / Game
- WA2 HD & FD Controller
- 20 MB Hard Disk



CRT-386-16

\$1795

CRT-386-20

\$1895

- 80386-16

PCI PACIFIC COMPUTER

702 S. Del Mar Ave., #B,
 San Gabriel, California 91776
 (FAX) 818-286-8662

(818) 571-5548 (Technical support)

(800) 421-1102 (IN CA) ORDER ONLY
 (800) 346-7207 (OUT CA)

Mon - Sat
 9:00 AM - 6:00 PM



*ALL SYSTEMS COME WITH ONE YEAR PARTS & LABOR WARRANTY

IIT's 287 Coprocessor

- Twice the speed of Intel's 80287 - 10 Mhz
- 100% Intel Compatible
- CMOS/NMOS Compatible
- Lower power for your laptop

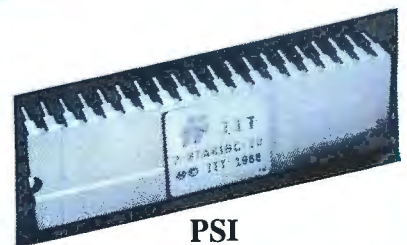
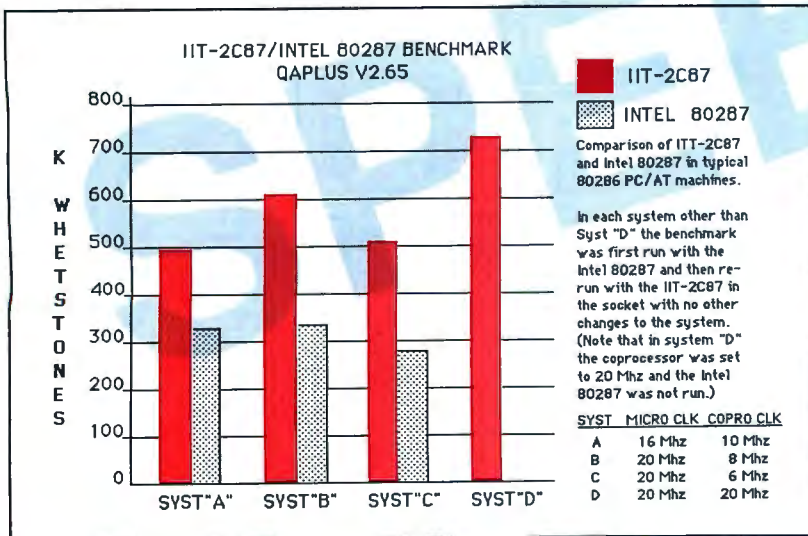

PSI
 2005 Hamilton Ave. #220
 San Jose, CA 95125
 800-622-1722
 408-559-8544

Mail-Order Electronics • Worldwide

24 HOUR ORDER HOTLINE

415-592-8097

Mail-Order Electronics

IC Clearance Sale!

NEC V20 & V30 CHIPS

Replace the 8086 or 8088 in your IBM PC and increase its speed by up to 30% and 40%
Part No. **1-9** **10x** **Part No.** **1-9** **10x**

7400

7400	SALE	15	7474	SALE	25
7402	SALE	19	7475	SALE	49
7404	SALE	15	7476	SALE	45
7405	SALE	35	7483	SALE	69
7406	SALE	29	7485	SALE	45
7407	SALE	25	7486	SALE	29
7408	SALE	35	7489	SALE	1.95
7410	SALE	15	7490	SALE	49
7411	SALE	19	7493	SALE	45
7414	SALE	25	7495	SALE	29
7416	SALE	19	74107	SALE	13
7417	SALE	19	74121	SALE	25
7420	SALE	29	74123	SALE	35
7427	SALE	13	74125	SALE	35
7430	SALE	15	74147	SALE	1.49
7432	SALE	39	74150	SALE	1.10
7438	SALE	25	74151	SALE	13
7442	SALE	29	74154	SALE	1.35
7445	SALE	59	74161	SALE	29
7446	SALE	89	74173	SALE	59
7447	SALE	89	74174	SALE	35
7448	SALE	1.95	74175	SALE	35
7473	SALE	39	74193	SALE	.79

74LS

74LS00	SALE	15	74LS139	SALE	29
74LS02	SALE	15	74LS151	SALE	29
74LS04	SALE	15	74LS153	SALE	25
74LS05	SALE	19	74LS154	SALE	1.19
74LS06	SALE	59	74LS157	SALE	45
74LS07	SALE	59	74LS163	SALE	25
74LS08	SALE	28	74LS164	SALE	35
74LS09	SALE	15	74LS165	SALE	.75
74LS10	SALE	19	74LS166	SALE	.59
74LS11	SALE	29	74LS173	SALE	35
74LS14	SALE	29	74LS174	SALE	29
74LS20	SALE	15	74LS175	SALE	29
74LS21	SALE	19	74LS191	SALE	39
74LS27	SALE	19	74LS192	SALE	.69
74LS30	SALE	15	74LS193	SALE	.69
74LS32	SALE	19	74LS194	SALE	.59
74LS38	SALE	25	74LS221	SALE	.49
74LS42	SALE	49	74LS240	SALE	.45
74LS47	SALE	89	74LS241	SALE	.49
74LS73	SALE	25	74LS244	SALE	.49
74LS74	SALE	19	74LS245	SALE	.59
74LS75	SALE	39	74LS257	SALE	.29
74LS76	SALE	29	74LS259	SALE	.99
74LS83	SALE	59	74LS273	SALE	.89
74LS85	SALE	59	74LS279	SALE	.49
74LS86	SALE	29	74LS367	SALE	.29
74LS90	SALE	29	74LS373	SALE	.59
74LS93	SALE	29	74LS374	SALE	.49
74LS123	SALE	19	74LS383	SALE	.69
74LS125	SALE	49	74LS441	SALE	.99
74LS132	SALE	29	74LS590	SALE	5.95
74LS138	SALE	49	74LS588	SALE	2.99

74S/PROMS

74S00	SALE	19	74S188	SALE	1.49
74S04	SALE	19	74S189	SALE	1.49
74S32	SALE	19	74S240	SALE	1.39
74S74	SALE	19	74S244	SALE	.75
74S112	SALE	19	74S253	SALE	1.19
74S124	SALE	1.25	74S288	SALE	1.49
74S138	SALE	49	74S373	SALE	.99
74S153	SALE	25	74S374	SALE	.99
74S163	SALE	75	74S387	SALE	1.29
74S174	SALE	25	74S472	SALE	2.49
74S175	SALE	25	74S571	SALE	2.49

CD-CMOS

CD4001	SALE	19	CD4051	SALE	.59
CD4002	SALE	19	CD4052	SALE	.59
CD4007	SALE	25	CD4053	SALE	.59
CD4011	SALE	19	CD4060	SALE	.65
CD4012	SALE	29	CD4066	SALE	.29
CD4013	SALE	29	CD4069	SALE	.19
CD4015	SALE	29	CD4070	SALE	.29
CD4016	SALE	29	CD4071	SALE	.22
CD4017	SALE	49	CD4072	SALE	.22
CD4018	SALE	59	CD4073	SALE	.22
CD4020	SALE	59	CD4081	SALE	.22
CD4021	SALE	59	CD4093	SALE	.35
CD4024	SALE	35	CD4094	SALE	.89
CD4027	SALE	45	CD4096	SALE	.39
CD4028	SALE	49	CD4511	SALE	.69
CD4029	SALE	69	CD4518	SALE	.75
CD4030	SALE	69	CD4520	SALE	.75
CD4040	SALE	65	CD4522	SALE	.79
CD4042	SALE	59	CD4528	SALE	.69
CD4043	SALE	59	CD4538	SALE	.79
CD4046	SALE	65	CD4543	SALE	.79
CD4047	SALE	29	CD4584	SALE	.49
CD4049	SALE	65	CD4585	SALE	.69
CD4050	SALE	29			

EPROMS

2816A	2048x8	350ns	(9V-15V) 5V Read/Write	5.25
2816A	2048x8	250ns	(9V-15V) 5V Read/Write	5.49
2817A	2048x8	350ns	5V Read/Write	7.95
2864A	8192x8	250ns	5V Read/Write (P1) No R.B.	12.95
2864A	8192x8	300ns	5V Read/Write (P1) No R.B.	13.95
2865A	8192x8	250ns	5V Read/Write	12.95
52B13	2048x8	350ns	(21V) 5V Read Only	1.49

MICROPROCESSOR COMPONENTS

Z80, Z80A, Z80B, SERIES

Z80	1.19
Z80A	1.29
Z80A-CTC	1.65
Z80A-DART	4.46
Z80A-PIO	1.89
Z80A-SIO/C	3.95
Z80B	2.75
Z80B-CTC	3.95
Z80B-PIO	3.95
Z8681B1	8.95

8000 SERIES Continued

8031	3.49
80C31	8.95
80C35	1.95
80C39	1.95
80C52AHBASIC	24.95
80B0A	2.26
80B5A-2	2.49
80B7	1.59
80B7-1 (10MHz)	99.95
80B7-2 (2MHz)	134.95
80B8 (5MHz)	4.95
80B9-2 (8MHz)	6.95
8116	4.95
8155	2.49

8000 SERIES Continued

8155-2	3.49
81C55	3.95
8156	2.95
8205	8.95
82C11	9.49
8212	2.29
8216	1.39
8224	1.76
8228	1.96
8237-5	4.26
8241	3.95
8250B (For IBM)	5.95
8251A	1.69
8253	1.89
8253-5	1.95
8254	3.95
8254-5	2.95
82C55A-5	3.49
8259-5	2.25
8272	3.96
8274	5.96
8279-5	2.96
8282	3.49
8284	1.75

8000 SERIES Continued

8286-10 (10MHz)	139.95
8287-5 (5MHz)	109.95
80287-8 (8MHz)	203.95
80287-10 (10MHz)	259.95
80386-16 PGA	279.95
80387-16 (16MHz)	395.95
80387-20 (20MHz)	459.95
80387-25 (25MHz)	569.95
82284 (8MHz)	8.49
82288 (8MHz)	9.95

8000 SERIES Continued

82284 (8MHz)	8.49
82288 (8MHz)	9.95

8000 SERIES Continued

82284 (8MHz)	8.49
82288 (8MHz)	9.95

8000 SERIES Continued

82284 (8MHz)	8.49
82288 (8MHz)	9.95

8000 SERIES Continued

82284 (8MHz)	8.49
82288 (8MHz)	9.95

8000 SERIES Continued

82284 (8MHz)	8.49
82288 (8MHz)	9.95

8000 SERIES Continued

82284 (8MHz)	8.49
82288 (8MHz)	9.95

MISC. COMPONENTS

TM1/35	1µf @ 35V	.19	TM4/735	4.7µf @ 35V	.45
TM1/35	1µf @ 35V	.19	TM6/835	6.8µf @ 35V	.49
TM2/235	2.2µf @ 35V	.25	TM10/35	10µf @ 35V	.59

POTENTIOMETERS

Values available (insert ohms into space marked "XX"):
 500Ω, 1K, 2K, 5K, 10K, 20K, 50K, 100K, 200K, 1MEG
43PX3 3/4 Watt, 15Turn .99 63PXX 1/2 Watt, 1Turn .89

TRANSISTORS AND DIODES

PN2222	.13	PN2907	.13	1N4004	.12
2N2222A	.29	2N4401	.12	1N4148	.07
2N3055	.65	1N270	.25	1N4735	.29
2N3904	.12	1N751	.15	1C106B1	.49

SWITCHES

JMT123	SPDT, On-On	1.19	206-8	SPST, 16-pin DIP	1.25
MPC121	SPDT, On-Off	1.19	MS102	SPST, Momentary	.39

D-SUB CONNECTORS

DB25P	Male, 25-pin	.69	DB25S	Female, 25-pin	.75
-------	--------------	-----	-------	----------------	-----

LEDS

XC556R	T1 ³ , Red	.13	XC556Y	T1 ³ , Yellow	.17
XC556G	T1 ³ , Green	.17	XC556C	T1 ³ , Clear/Red	.17

IC SOCKETS

8LP	Low Profile	.11	8WW	Wire Wrap (Gold) Level 2	.59
14LP	Low Profile	.12	14WW	Wire Wrap	.65
16LP	Low Profile	.13	16WW	Wire Wrap	.69
24LP	Low Profile	.25	24WW	Wire Wrap	1.19
28LP	Low Profile	.29	28WW	Wire Wrap	1.39
40LP	Low Profile	.79	40WW	Wire Wrap	1.89

74HC HI-SPEED CMOS

74HC00	SALE	17	74HC175	SALE	59
74HC02	SALE	17	74HC221	SALE	69
74HC04	SALE	17	74HC244	SALE	79
74HC08	SALE	17	74HC253	SALE	69
74HC10	SALE	19	74HC254	SALE	39
74HC14	SALE	29	74HC285	SALE	69
74HC30	SALE	19	74HC293	SALE	49
74HC32	SALE	25	74HC373	SALE	69
74HC74	SALE	29	74HC4050	SALE	59
74HC75	SALE	29	74HC595	SALE	1.29
74HC85	SALE	55	74HC688	SALE	1.25
74HC86	SALE	25	74HC943	SALE	7.95
74HC123	SALE	49	74HC4040	SALE	7.95
74HC125	SALE	49	74HC4049	SALE	25
74HC132	SALE	25	74HC4050	SALE	25
74HC138	SALE	49	74HC4060	SALE	69
74HC139	SALE	35	74HC4511	SALE	99
74HC154	SALE	1.49	74HC4514	SALE	1.79
74HC163	SALE	39	74HC4538	SALE	99
74HC174	SALE	59	74HC4543	SALE	99

74HC-CMOS TTL

74HC00	SALE	15	74HC139	SALE	29
74HC02	SALE	15	74HC157	SALE	19
74HC04	SALE	17	74HC174	SALE	25
74HC08	SALE	15	74HC244	SALE	25
74HC10	SALE	17	74HC244	SALE	59
74HC14	SALE	17	74HC244	SALE	49
74HC16	SALE	25	74HC245	SALE	49
74HC18	SALE	15	74HC273	SALE	45
74HC20	SALE	15	74HC373	SALE	45
74HC22	SALE	39	74HC374	SALE	45

LINEAR

LM7

SPECIAL! Monochrome Text Card

Sperry Monochrome Display Adapter

- IBM PC/XT Compatible
- Use for Text only
- Great for Network Servers and Dedicated Work Stations

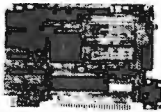

TEXT.....\$12.95

COMPUTER ACCESSORIES

DFI Handy Scanner

and 3 Button Mouse

for IBM PC/XT/AT

FREE DPE Software

with HS3000!

The HS3000 offers a full 4 inch window at 400dpi resolution. Scan photos, logos, drawings, etc. Can be used with today's most popular applications.

HS3000 Pictured

Handy Scanner\$179.95

200DPI 3-Button Ser. Mouse\$39.95

200DPI 3-Button Ser. Mouse with Dr. Halo Software\$59.95

IBM Compatible Cases and Power Supplies

JE2010 Pictured



JE1030 Pictured



Flip-Top Standard PC/XT Case.....\$39.95

Side Baby AT Case.....~~\$69.95~~ \$59.95

150 watt PC/XT Power Supply.....\$59.95

200 watt Baby AT Power Supply.....\$89.95

Tower Case w/250 watt Pwr. Supply.....\$279.95

Flip-Top Baby XT Turbo Case.....\$69.95

Flip-Top Baby AT Case.....\$69.95

Datronics 2400/1200/300 Baud Pocket Size Modems

2400 Baud Pocket-Size Modem...Only \$149.95!

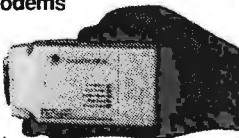

1200P 1200/300 Baud Pocket Size Modem With ProComm Software.....\$89.95

2400P 2400/1200/300 Baud Pocket Size Modem With ProComm Software.....\$149.95

TEST EQUIPMENT

Metex Digital Multimeters

Metex General Specs:

- Handheld, high accuracy
- AC/DC Voltage, AC/DC Current, Resistance, Diodes, Continuity, Transistor hFE • Manual ranging w/overload protection

M3650/B & M4650 only:

- Also measures frequency and capacitance

M4650 only:

- Data Hold Switch
- 4.5 Digit



M4650 Pictured

M3610 3.5 Digit Multimeter.....\$49.95

M3650 3.5 Digit w/Freq. & Capacitance \$69.95

M3650B Same as M3650 w/Bargraph.....\$79.95

M4650 4.5 Dig. w/Freq., Capacitance and Data Hold Switch.....\$99.95

Jameco 16MHz 80286 NEAT Computer Kit With 2 Megabyte RAM

- Fully IBM AT Compatible
- Free! QAPLUS Diagnostic Software Included!
- Free! PC Write Word Processing Software Included!
- 2Mb RAM Included, Expandable to 8Mb
- 8 or 16MHz Operation
- AMI BIOS ROMs Included
- Flip-Top Case w/200 Watt Power Supply
- 1.2Mb Disk Drive
- 18.0 Norton SI Rating
- 101-Key (Enhanced) Keyboard



SAVE \$190.55

Shown with VGA Option (not included)
JE2055 Monitor and Adapter Card.....\$599.95
(See Below)

JE3013 16MHz IBM AT Comp. Kit...\$1199.95 \$949.95

EZDOS EZ-DOS: MS/PC-DOS Comp. Operating System.....\$49.95

EZDOSP Same as above with TrueBASIC.....\$69.95

IBM COMPATIBLE DISPLAY MONITORS

- AMBER 12" Amber Monochrome\$99.95
- HD55H 14" RGB 640x240\$249.95 \$239.95
- TM5154 EGA 14" 720x350.....\$399.95 \$369.95
- JE1059 EGA Monitor & Card.....\$649.95 \$479.95
- TM5155 14" Multiscan 800x560\$649.95 \$479.95
- QC1478 14" VGA 720x480.....\$449.95 \$399.95
- JE2055 VGA Monitor & Card.....\$649.95 \$599.95

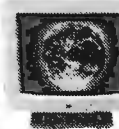

SALE!

QC1478 Pictured

JAMECO IBM PC/XT/AT COMPATIBLE CARDS

- JE1043 360K/720K/1.2Mb/1.44Mb Floppy Disk Controller Card (PC/XT/AT).....\$49.95
- JE1050 Monochrome Graphics Card w/Parallel Printer Port (PC/XT/AT).....\$59.95
- JE1052 Color Graphics Card w/ Parallel Printer Port (PC/XT/AT).....\$49.95
- JE1055 EGA Card w/ 256K Video RAM (PC/XT/AT).....\$169.95 \$149.95
- GC1500 Orchid 8-Bit VGA Card w/256K Video RAM (PC/XT/AT).....\$269.95 \$249.95
- GC1501 Orchid 8/16-Bit VGA Card w/256K Video RAM (PC/XT/AT).....\$349.95 \$329.95
- JE1060 I/O Card w/ Serial, Game, Printer Port & Real Time Clock (PC/XT).....\$59.95
- JE1061 RS232 Serial Half Card (PC/XT).....\$29.95
- JE1062 RS232 Serial Half Card (AT).....\$34.95
- JE1065 I/O Card w/ Serial, Game and Parallel Printer Port (AT).....\$59.95
- JE1071 Multi I/O Card w/ Controller & Monochrome Graphics (PC/XT).....\$119.95
- JE1077 Multi I/O Card w/ 360K/720K/1.2Mb/1.44Mb Floppy Controller (AT).....\$79.95
- JE1081 2Mb Expanded or Extended Memory Card (zero-K on-board) (AT).....\$99.95

SEAGATE HALF-HEIGHT HARD DISK DRIVES

- ST225 20Mb Drive only (PC/XT/AT) \$224.95
- ST225XT 20Mb w/Controller (PC/XT).....\$269.95
- ST225AT 20Mb w/Controller (AT).....\$339.95
- ST238 30Mb Drive only (PC/XT/AT) \$249.95
- ST238XT 30Mb w/Controller (PC/XT).....\$299.95
- ST238AT 30Mb w/Controller (AT).....\$389.95
- ST251 40Mb Drive only (PC/XT/AT) \$379.95
- ST251XT 40Mb w/Controller (PC/XT).....\$419.95
- ST251AT 40Mb w/Controller (AT).....\$489.95
- ST251-1 40Mb Fast 28ms (Drive only) \$469.95

Your One-Stop Center for Hard Disk Drive Needs!



ST225XT Pictured

Seagate 60Mb, 80Mb & 120Mb Hard Disk Drives Also Available!

HARD & HARD/FLOPPY DISK CONTROLLERS

Computer Type	MFM Hard		RLL Hard		MFM Hard/Floppy		RLL Hard/Floppy	
	Part No./ Price	Part No./ Price	Part No./ Price	Part No./ Price	Part No./ Price	Part No./ Price	Part No./ Price	
8088 (PC/XT) 3:1 Interleave	XTGEN \$79.95	ACB2072 \$89.95	JE1044 \$129.95	
80286 (AT)/386 2:1 Interleave	1003VMM1 \$129.95	1003VSR1 \$189.95	1003VMM2 \$149.95	1003VSR2 \$199.95	
80286 (AT)/386 1:1 Interleave	1006VMM1 \$149.95	1006VSR1 \$199.95	1006VMM2 \$179.95	1006VSR2 \$219.95	

IBM PC/XT/AT COMPATIBLE 3.5"/5.25" DISK DRIVES

- 352KU 3.5" 720Kb (PC/XT/AT).....\$109.95
- 356KU 3.5" 1.44Mb (PC/XT/AT).....\$129.95
- JE1020 5.25" 360Kb (PC/XT/AT) Black.....\$89.95
- JE1021 5.25" 360Kb (PC/XT/AT) Beige.....\$89.95
- JE1022 5.25" 1.2Mb (PC/XT/AT) Beige.....\$99.95



JE1022 Pictured

MOTHERBOARDS

20MHz 386 Only \$749.95!

All w/ OK RAM (except JE3027)

JE3520 Pictured

- JE1001 Jameco 4.77/8MHz 8088 (PC/XT).....\$89.95
- JE1002 Jameco 4.77/10MHz 8088 (PC/XT).....\$99.95
- JE3005 Jameco Baby 8/12MHz 80286 (AT).....\$279.95
- JE3010 Jameco Baby 8/16MHz 80286 (AT).....\$379.95
- JE3020 AMI Baby 16MHz 80386 (AT).....\$999.95
- JE3025 AMI Baby 20MHz 80386 (AT).....\$1199.95
- JE3026 AMI Full-Size 25MHz 80386 (AT).....\$1999.95
- JE3027 AMI Full-Size 33MHz 386 w/4Mb (AT)\$4299.95
- JE3520 Jameco Baby 20MHz 80386 (AT).....\$749.95
- JE3525 Jameco Baby 25MHz 80386 (AT).....\$1499.95

SUPER SONY SALE

720Kb 3.5" Floppy Drive

- For use with IBM PC/XT/AT and compatible computers • Double-sided, double density • 135TPI • 160 tracks • Rotation speed: 300rpm • Size: 4"W x 6"D x 1"H

MPF11 720Kb Drive.....\$59.95

SMK 5.25" Mounting Kit.....\$14.95

PROTOTYPING PRODUCTS

Jameco Solderless Breadboards

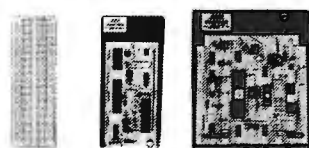

JE23

JE24

JE27

Part No.	Dim. L" x W"	Contact Points	Binding Posts	Price
JE21	3.25 x 2.125	400	0	\$4.95
JE23	6.5 x 2.125	830	0	\$7.95
JE24	6.5 x 3.125	1,360	2	\$12.95
JE25	6.5 x 4.25	1,660	3	\$19.95
JE26	6.875 x 5.75	2,390	4	\$24.95
JE27	7.25 x 5.75	3,220	4	\$34.95

COMPUTER ACCESSORIES

Jameco IBM PC/XT/AT Compatible Keyboards



JE2017 Pictured

- JE1015 84-Key Standard AT Layout.....\$59.95
- JE1016 101-Key Enhanced Layout.....\$69.95
- JE2016 111-Key Enhanced w/Solar Calculator...\$79.95
- JE2017 104-Key Enhanced w/Trackball.....\$99.95

Colorado Memory 40Mb Tape Back-Up for IBM PC/XT/AT

- DJ10 40Mb Tape Back-Up and Tape.....\$299.95
- TB40 40Mb Tape Cartridge.....\$24.95

ENGINEERING/DATA BOOKS

- 21035 Sams TTL Cookbook (88).....\$14.95
- 21398 Sams CMOS Cookbook (88).....\$19.95
- 22453 Sams Op-Amp Cookbook (88).....\$21.95
- 270645 Intel 8-bit Controller Hndbk. (89).....\$19.95
- 270646 Intel 16-bit Controller Hndbk. (89).....\$19.95
- 270647 Intel 32-bit Controller Hndbk.(89).....\$19.95
- 400041 NSC Linear Data Book Vol 1 (88).....\$14.95
- 400042 NSC Linear Data Book Vol 2 (88).....\$9.95
- 400043 NSC Linear Data Book Vol 3 (88).....\$9.95
- ICM89 1989 IC Master (3 Volume Set).....\$119.95

1355 Shoreway Road
Belmont, CA 94002
24 Hour Order Hotline (415) 592-8097
FAX's (415) 592-2503 or (415) 595-2664
Telex 176043 - Ans. Back: Jameco Blmt
IC Data Sheets - 50c each
Send \$2.00 Postage for a FREE 1989 Catalog
© 1989 Jameco Electronics 10/89
IBM is a registered trademark of International Business Machines



\$20.00 Minimum Order - U.S. Funds Only
CA Residents Add 6%, 6.5% or 7% Sales Tax
Shipping - Add 5% plus \$1.50 Insurance (May vary according to weight)
Terms: Prices subject to change without notice.
We are not responsible for typographical errors.
We reserve the right to substitute manufacturers.
Items subject to availability and prior sale.
Products pictured may only be representative.
Complete list of terms/warranties is available upon request.

24-Hour Order Hotline (415) 592-8097 • The Following Phone Lines Are Available From 7AM - 5PM P.S.T.:

• Customer Service (415) 592-8121 • Technical Assistance (415) 592-9990 • Credit Department (415) 592-9983 • All Other Inquiries (415) 592-7108

LAPTOPS \$385 FAX

TOSHIBA T1000 ... \$635	NecUltralite 2meg . \$2289	CANON Fax 20 ... \$949	AVATEX 110/220V .. \$625
" T1200F \$1299	Prospeed 286/20 . \$3049	" Fax 225 \$1545	NISSIE 320 \$495
" T1200FB \$1385	" 286/40 \$3399	" Fax 270 \$1795	" 303 \$495
" T1200H \$1795	" 386/40 \$4395	" Fax 350 \$1995	MURATA 1200 ... \$569
" T1200HB \$1895	Mitsubishi 286-219 \$1995	" Fax 450 \$2349	" 1600 \$669
" T1600 \$3045	" 386-290 \$2299	" Fax 630 \$2699	" F30 \$1399
" T3100E \$2565	" 386-240 \$2795	" Fax 705 \$2999	RICOH RF800 ... \$649
" T3200/40 \$3299	SHARP 7241/40mb \$1999	" Fax 730 \$3499	" Fax 15 \$1155
" T5100 \$4099	" 4602 \$1445	PANASONIC	" Fax 25 \$1295
" T5200 40 \$4795	" 4641 \$2295	KXF 100 \$825	" Fax 35 \$1545
" T5200 100 ... \$5299	" 5541 \$3599	KXF 120 \$975	" Fax 65 \$1595
ZENITH Z-184-10 . \$1495	PANASONIC PRINTERS	PANAFAX UF 135 . \$799	SHARP FO 220 ... \$699
" Z-184-20 \$2129	KXP1180 \$179	" UF 145 \$895	" FO 300 \$849
" Z-286-20 \$2949	KXP1191 \$229	" UF 250 \$1299	" FO 330 \$999
" Z-286-40 \$3388	KXP1124 \$325	" UF 260 \$1549	" FO 550 \$Call
" Z-384-40 \$4799	KXP1592 \$395	SANYO SF 100 ... \$765	" UX 350 \$1099
COMPAQ 286-20mb \$call	LASER KXP 4450 \$1369	" SF 200 \$929	TOSHIBA 30100 ... \$745
" 286 40 MB \$call	KXP1595 \$425	" SF 515 \$1145	T3300 \$799
NEC MLTSPD HD . \$1949	KXP1524 \$509	SHARP UX 50 ... \$535	T3600 \$965
" MLTSPD EL ... \$1499	CANON Fax 8 \$619	Remfg. UX 30 ... \$385	T3700 \$1099

PREPAY PRICES: VISA/MC/COD + 2.9% Restock 20% Handling Chg. 5.95 No Exchange/Returns.

T.P.C. 12603 Hoover St.
Garden Grove, CA 92641

714/898-8262
FAX 714/891-1202

1-800-383-3199

BYTE BACK ISSUES FOR SALE

	1987	1988	1989
January			
February			
March			
April			
May			
June			
July			
August			
September			
October			
November			
December			
Inside the IBM PCs			
Applications Software Today			

Issues Available

Rates (postage and handling included):

1987-'89 BYTE Issues	\$6.00*	BYTE 1988 Index	\$4.00
BYTE '83-'84 Index	\$4.00	1985 Inside The IBM PCs	\$4.00
BYTE 1985 Index	\$4.00	1986 Inside The IBM PCs	\$5.00
BYTE 1986 Index	\$4.00	1988 Inside The IBM PCs	\$6.00
BYTE 1987 Index	\$4.00	Applications Software Today Special	\$4.00
*June 1988 (Benchmarks) \$3.00			

The above prices include postage in the US. Please add \$.50 per copy for Canada and Mexico; and \$2.00 per copy to foreign countries (surface delivery). European customers please refer to Back Issue order form in International Advertising section of book.

Please indicate which issues you would like by checking (✓) the boxes. Send requests with payment to:

BYTE Back Issues, One Phoenix Mill Lane, Peterborough, NH 03458 (603) 924-9281

Check enclosed Charge: VISA MasterCard

Card # _____

Exp. Date _____

Signature _____

Name _____

Address _____

City _____

State _____ Zip _____

All orders must be prepaid. Please allow four weeks for domestic delivery and twelve weeks for foreign delivery by surface mail.

We've Built Our Reputation on These Factors for 10 Very Successful Years.

CLONE 386
\$1999



Clone 386 20MHz monochrome system pictured.

- 20MHz, 32MB HARD DRIVE, 1 MB 0 WAIT RAM, AND 14" MONOCHROME MONITOR.
- 20MHz, 1MB RAM, base system... **\$1499**
- 20MHz, 1MB RAM, 32K cache, base system... **1786**
- 25MHz, 1MB RAM, 32K cache... **2094**
- 33MHz, 1MB RAM, 32K cache, base system... **2729**

With MS-DOS 3.3 or 4.01 and GWBASIC \$79 or \$99 Extra.

CLONE 386 STANDARD FEATURES:
 • Genuine 80386 - 20/25/33 CPU's
 • 1MB Fast 0 Wait State RAM (32K Cache on some models, see chart).
 • High Performance 1:1 Interleave, 800 Kb/sec 2 Floppy/2 HD Controller.
 • 1.2M 5.25" or 1.44M 3.5" Floppy Drive (your choice).
 • 101 Key "Click-Tactile" Keyboard
 • 1 Parallel, 1 Serial, 1 Joystick Port
 • 200/220 Watt Power Supply
 • 80387/Weitek Coprocessor (Except Base 20MHz)
 • On-board Clock/Cal w/Battery Backup 8 Expansion Slots
 • Setup Utility in ROM.
 • System Reset Switch on Front Panel.
 • LIM EMS 4.0 Driver
 • CPU Speed Switchable.
 • Fully Expandable to 16MB RAM.
 • FCC Certified.
 • Novell and OS/2 Compatible.
 • One Year Parts & Labor Warranty.
 • Complete Software Pack Including: PC-Write - QModem - ExpressCalc AutoMenu - HomeBase - MoneyMaster Findex - Hard Disk Cache - Clone Utilities.

CLONE 286
\$1279



- 12MHz, 32MB HARD DRIVE, 1 MB 0 WAIT RAM, AND 12" MONOCHROME MONITOR.
- 12MHz, 1MB RAM, base system... **\$784**
- 16MHz, 1MB RAM, base system... **983**

With MS-DOS 3.3 or 4.01 and GWBASIC \$79 or \$99 Extra.

CLONE 286 STANDARD FEATURES:
 • 1MB Fast 0 Wait State RAM.
 • High Performance 1:1 Interleave, 800 Kb/sec 2 Floppy/2 Hard Disk Controller.
 • 1.2M 5.25" or 1.44M 3.5" Floppy Drive (Your Choice).
 • 101 Key Enhanced Keyboard.
 • 1 Parallel, 1 Serial, 1 Joystick Port.
 • 200 Watt Power Supply
 • 80287 Math Coprocessor Socket
 • On-board Clock/Cal. w/Battery Backup.
 • 8 Expansion Slots
 • Setup Utility in ROM
 • System Reset Switch on Front Panel.
 • CPU Speed Switchable
 • Fully Expandable to 4/8MB.
 • FCC Certified.
 • Novell Compatible.
 • One Year Parts & Labor Warranty.
 • Complete Software Package including: PC-Write - QModem - ExpressCalc AutoMenu - HomeBase - MoneyMaster Findex - Hard Disk Cache - Clone Utilities.

CLONE VALUE CHART

CLONE 286	12" MONOCHROME	14" EGA COLOR	14" VGA COLOR
12MHz CPU, 32MB 40MS SEAGATE HD	\$1279	\$1690	\$1813
16MHz CPU, 32MB 40MS SEAGATE HD	1479	1890	2013

Add \$20 for "Click/Tactile" 101-key Keyboard. Add \$20 for 14" Monochrome Monitor.

CLONE 386	14" MONOCHROME	14" EGA COLOR	14" VGA COLOR
20MHz CPU, 32MB 40MS SEAGATE HD	\$1999	\$2393	\$2516
20MHz CPU, 32K CACHE, 32MB, 40MS SEAGATE HD	2299	2693	2816
25MHz CPU, 32K CACHE, 32MB 40MS SEAGATE HD	2604	2998	3121
33MHz CPU, 32K CACHE, 32MB 40MS SEAGATE HD	3240	3634	3757

OPTIONS FOR CLONE 286/386 COMPUTERS:

- Add \$27 for 32MB, 28MS Seagate HD. Add \$495 for 122MB, 28MS Seagate HD.
- Add \$42 for 48MB, 40MS Seagate HD. Add \$30 to VGA price for 18 bit VGA card.
- Add \$148 for 65MB, 40MS Seagate HD. Add \$49 to VGA price for 14" Multi-frequency Monitor.
- Add \$173 for 85MB, 28MS Seagate HD. Add \$203 for 85MB, 28MS Seagate HD.
- Add \$125 for 6 drive lower case.

OPTIONAL EQUIPMENT FOR CLONE COMPUTERS

- Star NX-1000 Printer, 144/36cps, NLQ, \$179
- Star NX-1000 Rainbow Printer, same as above w/color 239
- Star NX-2400 Printer, 170/57 cps, LQ, 24 pin, 339
- Star XR-1000 Printer, 300/76 cps, NLQ, 8 fonts 359
- 192/63 cps, LQ, 24 pin, \$349
- Panasonic KX-P1191 Printer, 240/48 cps, NLQ 259
- Star XB-2410 Printer 240/80 cps super LQ, 24 pin, 16 fonts 469
- Star XB-2415 Printer (same as above with wide carriage) 599
- 1200/300 baud int. modem 59

SATISFACTION GUARANTEED!

You get a rock-solid one year guarantee on parts and labor, plus a 30 day money-back satisfaction Assurance guarantee (except in software and shipping).

SERVICE AFTER THE SALE!

Your Clone equipment will be promptly and expertly serviced by our specially trained, knowledgeable technicians who know what they are doing.

FAST DELIVERY!

Clone Computers are custom-manufactured to their buyers' specifications, burned-in and shipped within one week of their order, in most instances.

Buy with Confidence! Our Guarantee Removes All the Risk from Your Buying Decision!

The Clone guarantee is simple and straightforward. You have 30 days after receipt of your Clone to see if you and it are going to be compatible. If you are not satisfied with your Clone for any reason within that time, you may return it for a full refund, less shipping charges.



NO ORPHANED CUSTOMERS

We have been supplying our customers with high quality hardware and software since 1980. We enjoy an excellent industry-wide reputation built on providing top quality merchandise, a no-risk guarantee, low price, expert service and fast delivery. Our customers expect and receive no less.



SOFTWARE SALE!

LOWEST PRICES - FAST DELIVERY
 This list is only a small portion of our inventory! Call us for all of your software needs!

MS-DOS® BUSINESS SOFTWARE	Carbon Copy - (need two copies) .. \$114
Aldus Pagemaker 3.0 .. \$549	Copy II PC .. 25
Always .. 87	Copy II PC Option Board Deluxe .. 118
Borland Graphics (P-3 Clone) .. 169	Fastback Plus .. 113
Borland Reflex 2.0 .. 179	Grammatik III .. 53
Borland Sprint, Word Processor .. 139	Microsoft C Compiler 5.1 .. 209
DAC Easy Accounting (all version 3) .. 81	Microsoft Macro Assembler 5.1 .. 99
DAC Easy Payroll .. 81	Microsoft Quick Basic Compiler .. 67
DAC Easy Bonus Pack (includes accounting, payroll, both tutors) .. 470	Microsoft Quick C Compiler .. 67
DAC Easy Light .. 42	Microsoft Windows 286 .. 127
dBase IV .. 129	Norton Commander .. 53
Design CAD .. 162	Norton Utilities 4.5 Advanced Edit .. 66
Design CAD 3D .. 214	PC Tools Deluxe 5.5 .. 79
Desquiv .. 79	Procomm Plus .. 46
Desquiv with OEM# 386 .. 114	SideWAYS .. 42
Formtool .. 55	X Tree Professional .. 78
FrameMaker .. 399	
Generic CADD, Level 3 (includes DoITPlot and DeskConvert) .. 172	Algo Blaster .. \$28
Lotus 1-2-3 version 3.0 .. 269	Chess Master 2100 .. 32
Lotus Agenda .. 285	F-19 Stealth Fighter .. 44
Lotus Symphony .. 459	Falcon AT .. 32
Microsoft Multiplan .. 126	Kings Quest (I, II, III or IV) .. 31
Microsoft Word 5.0 .. 235	Leisure Suit Larry II .. 30
Paradox 3.0 .. 446	Math Blaster Plus .. 28
Peachtree Complete System II .. 174	Mavis Beacon Teaches Typing .. 32
Peachtree Double Bonus Bundle .. 239	Rover Rabbit .. 27
pts: First Choice .. 81	Where in U.S.A. is C. San Diego? .. 24
pts: First Publisher .. 83	
pts: Professional Write .. 144	BOOKS
Printshop Bundle .. 36	Take advantage of our volume discounts and save a bundle! Buy any 3 books and earn an additional \$3 discount. Buy 4 and deduct \$4. Buy 5 and deduct \$5, etc.
Public III .. 120	Using 1-2-3, Special Edition .. \$18
O & A .. 215	dBase III Plus Handbook .. 17
QuickDraw .. 120	Managing Your Hard Disk .. 16
Rightwriter .. 51	MS-DOS Users Guide .. 21
Wordperfect 5.0 .. 242	Running MS-DOS .. 19
Wordstar Professional Release 5.5 .. 218	Using Autocad .. 17
MS-DOS LANGUAGES/UTILITIES	Using Managing Your Money .. 15
Autotech Enhanced .. \$ 99	Using Microsoft Word .. 16
Borland Turbo Basic .. 89	Using Symphony .. 19
Borland Turbo C .. 96	Using Wordperfect 5.0 .. 18
Borland Turbo Pascal .. 103	
Bor. Turbo Assembler/Debugger .. 99	

Save Your Data and Money, Too! Peripherals Sale!

Easy to Install! This is the fastest floppy interface tape drive around!

60MB TAPE DRIVES

Up to 150MB Capacity

40MB Tape \$18
60MB Tape \$30

\$279

External model now available for only \$99 extra!

Works on PC, XT, AT's and 100% compatibles. Connects to the internal floppy (B:) connector or the optional adapter card (\$77). Comes complete with installation instructions and the data compression software that allows up to 100MB data storage on a 40MB tape - 150MB on a 60MB tape. Easy to install. Order now at this low price and save.

TURBO CLONE
 AT Style Keyboard **\$699** Save Now!

Standard Features:
 • 8088 @ 4.77 -
 • 10MHz Turbo-speed Mainboard
 • 640K RAM standard
 • 8037 Super Cache
 • 150-watt power sup
 • 380K Floppy Drive with Disk Controller
 • Hercules® Compatible Video Card
 • Hires TTL monitor (green or amber)
 • 2-Parallel print ports
 • 1-Serial port (2nd optional at \$29)
 • Game-Joystick port
 • Clock/Calendar
 • Fully Expandable
 • PC-Write - QModem ExpressCalc - Home Base - MoneyMaster - Findex - Clone Utilities - AutoMenu
 • FCC Class B Certif
 • Keyboard Lock
 • LED's for Power, Turbo and Hard Disk Access
 • 1 yr parts, lab war

Limited Time Only! Fantastic Prices Now On **LOW COST HARD DRIVES**

For IBM and Tandy

48.1MB 40ms ST-157R RLL Bare 28ms Optional	52MB 90ms ST-500 MFM XT KH	214MB 65ms ST-225 MFM XT KH
\$319	\$149	\$239
63.5MB 40ms ST-277R RLL XT KH 28ms Optional	32.7MB 60ms ST-230 12XL XT KH	42.8MB 40ms ST-251 MFM XT KH 28ms Optional
\$419	\$259	\$369
48.1MB 40ms ST-157R RLL Bare 28ms Optional	63.5MB 40ms ST-277R RLL XT KH 28ms Optional	122.1MB 28ms ST-614R RLL Bare
\$319	\$419	\$639

We provide the best low cost, high quality, fast access hard drives for your IBM, 100% compatible or Tandy computer. Our XT and SCSI kits are complete with drive, controller, cables and installation instructions. We use only brand new genuine Seagate drives so you can be assured of long trouble-free drive life. Data transfer rates as fast as 500KB per second MFM, 800KB RLL and 1MB using SCSI. We provide software to park the heads (some drives self-park). Tandy 100k requires DMA and ROM 1.01+ Not for EX/HX. Please specify the computer brand and model when ordering. ST 506, 4096 and 4144R are full size 5.25" and ST 157R is 3.5". All others are half height 5.25". Sizes listed are after formatting. One year parts and labor warranty. Satisfaction guaranteed or your money back, less shipping.

UNINTERRUPTABLE POWER SUPPLY

As Low As **\$279** 250 Watt Model
 Add \$23 shipping in the lower 48 states.

250 Watt	120 Volt	\$ 279
300 Watt	120 Volt	399
500 Watt	120 Volt	499
600 Watt	120 Volt	639
1200 Watt	120 Volt	1099
1600 Watt	120 Volt	1444*

230 volt units also available. Specify exact input voltage. Shipped motor freight collect.

Protects Against:
 • Brownouts
 • Blackouts
 • Overvoltage.
 • Overload.
 • Spills/Surges.
 • EMI

Features:
 • Two Audible Alarms.
 • LED Displays.
 • Optional Network Port.
 • Transfer Times As Fast As 1 Millisecond (Depends on Model).

Save on Low Cost Floppys!

Select the drive or drives you want, pick the enclosure and appropriate cables, and we will assemble and test at no additional cost to you! All drives are brand new, not factory seconds, and carry a full one year part and labor warranty. Add \$5 shipping and handling per drive.

360K 5.25" TEAC 55B bare	569
720K 5.25" TEAC 55F bare	85
1.2M 5.25" TEAC 55FGH bare	79
360K 3.5" TEAC 35B bare	59
720K 3.5" TEAC 35B bare	85
1.44M 3.5" TEAC 35FGH bare	79
5.25" mounting bracket for 3.5" drives	10
(Includes rails, signal and power adapter. Specify beige or black faceplate).	
Dual 3.5" external case/power supply. Use with one or two 3.5" drives (horizontal)	\$49
Dual 5.25" same as above except vertical	59
IBM external floppy cable for C/D. DB37 required	39

(Add \$10 for brushed Stainless Steel cover)

VISA, MasterCard, AMERICAN EXPRESS, TeleCheck

ORDER TOLL FREE!
 Mon.-Fri. 9-7; Sat. 10-3
 Call from anywhere in the lower 48 states and Hawaii.

1-800-527-0347

Save on 32MB & 49MB Hard Cards

32.7MB 40ms RLL **\$329**
 49.1MB 40ms RLL **\$429**

These units are completely assembled with brand new drives and come ready to install. For IBM XT's, 100% compatibles and Tandy 1000/1000A, SL, SX, TL, TX. Please specify the exact make and model of your computer. One year parts and labor warranty.

Circle 52 on Reader Service Card

clone
 Reg. U.S. Pat. Off.

SERVING YOU SINCE 1980

CLONE COMPUTERS • 2544 W. Commerce St. • Box 223957
 Div. of Anology Corp.
 Dallas, Texas 75222-3957 • Telex: 882761 • Fax: 214-634-8303

For professional technical assistance on Clone products, call 214-638-8826.

©1989 by Clone Computers. All rights reserved. Prices and specifications subject to change without notice. All prices are in U.S. Dollars. Payments must be in U.S. funds drawn on a U.S. bank.

MEMBER
 MICRO COMPUTER
 ASSOCIATION

VIDEO FRAME GRABBERS



MODEL	RESOLUTION	
HRT 256-4	256 x 256 x 4	495
HRT 256-8	256 x 256 x 8	795
HRT 512-8	512 x 512 x 8	995
HRT 512-24	512 x 512 x 24	1995

- IBM PC/XT/AT COMPATIBLE
- DIGITALIZE IN REAL TIME
- COMPOSITE VIDEO IN
- 24 BIT RGB OUT except model HRT 256-4
16 level gray scale out
- SOFTWARE LIBRARY OF IMAGE ANALYSIS ROUTINES
- FREE SOFTWARE UPGRADES TO REGISTERED OWNERS
- FULL CREDIT ON UPGRADE PURCHASE IN FIRST YEAR
RETURN OLD BOARD AND JUST PAY DIFFERENCE

HRT HIGH RES TECHNOLOGIES
P.O. BOX 76
LEWISTON, N.Y. 14092
PHONE 416-497-6493 FAX 416-497-1988

Circle 119 on Reader Service Card

5218 Printer Interface for PS/2 and AT

Qua Tech interface cards connect IBM 5218 Display-Writer printer to PS/2 and AT*. Available now. Hundreds installed.

For order info, call:
1-800-553-1170

QUA TECH

QUA TECH, INC.
478 E. Exchange Street
Akron, OH 44304

IBM, DisplayWriter, PS/2, and AT are trademarks of IBM Corp.

Circle 226 on Reader Service Card

THE GENERAL STORE RETAIL OPERATIONS SYSTEM

The premier system for retail store management. Supports cash drawers, barcode readers, receipt printers, customer displays, digital scales and complete online credit card authorization. Controls all types of retail stores both hardgoods and apparel with complete size/color matrix management and reporting. Easy to install and use. Field proven for speed and reliability. Provides all the features needed for today's retail merchant at a price far below comparable systems. Demo system available.



Accounts Receivable
Point of Sale
Inventory Control
Accounts Payable
General Ledger
Mailing List
...Multituser/Network Ready...

\$995 Complete system.
Dealer inquiries invited.

Crichlow Data Sciences, Inc.
(804) 471-0500
P.O. Box 6420 - Virginia Beach, VA 23456

Circle 74 on Reader Service Card



5.25" DS/HD 1.2 MB DK. BLUE - 69¢
PACKED IN LOTS OF 100 WITH TYVEC SLEEVES & TABS

5.25" DS/HD 1.2 MB, sleeves & tabs - BLACK
Lots of 100 - 49¢ Lots of 50 - 59¢

5.25" DS/DD 360K, Sleeves & Tabs
Lots of 1,000 - 21¢ Lots of 200 - 25¢

3.5" DS/DD 720K (1MB) 55% Clip, Level
Lots of 100 - 79¢ Lots of 50 - 85¢

3.5" DS/DD 720K (1MB) 70% Clip, Level
Lots of 500 - 89¢ Lots of 25 - 99¢

3.5" DS/High Density 1.44MB (2MB)
Lots of 100 - \$2.50 Lots of 25 - \$3.00

AMERICAN GROUP

800-288-8025

12132 Sherman Way

N. Hollywood CA 91605 • VISA-MC

Circle 21 on Reader Service Card

2 parallel, 2 serial, 1 board

Qua Tech DSDP-402 for PC-AT has two parallel ports, and two serial ports for any combination of RS-232, 422, and 485 communication. All ports address selectable. Interrupts sharable and selectable.

For order info, call:
1-800-553-1170

QUA TECH

QUA TECH, INC.
478 E. Exchange Street
Akron, OH 44304

Circle 227 on Reader Service Card

CACHE CONTROLLER

WORLDS FASTEST ACCESS TIME 0.3 MB

And you already have the drive!

Perfect for CAD CAM and Desktop

Publishing

hyperSTORE 816 SPU

REVIEW IN THIS ISSUE

SIMMS

BEST PRICES • 2 YEAR WARRANTY

CALL FOR PRICES

8087	64K	256x9
80287	256K	256x8
80C287A-12	4464	1 MEG x 9
80387DX	VIDEO	1 MEG x 8
80387SX	1 MEG	LOW PROFILE

Dealer and OEM Inquiries Welcome

Tel: (213) 383-9701

FAX: (213) 383-3423

G. Reed, Inc.

258 South Western Avenue, L.A., CA 90004
Shipping and handling charges may apply.

Circle 26 on Reader Service Card

PAL/EPROM PROGRAMMER for PC

VERSION 2 of Software and Hardware \$475

- Programs 20 and 24 pin MMI, NS, TI, Altera, Cypress, Ricoh/ Panatoc P.A.L. EPLD (UV erasable), polarity, and RA types.
- Functions Include: read, write, verify, program, edit, print, and file load and save of program.
- JEDEC files supported.
- 2716-27512 EPROMs.
- Functions Include: read, write, verify, blank check, Hi/Lo split, edit in ASCII, HEX, or Decimal.
- INTEL Hex and Motorola 'S' Record file support.



200/100 MHz LOGIC ANALYZER for PC



LA27100

\$1299

LA27200

\$1899

- 24 Channel mode with 4K/channel • 6 Channel mode with 16K/channel
- Internal Rates from 200MHz(LA27200) or 100MHz(LA27100) to 250 Hz
- External Clock from DC to 50 MHz • 16 Level Triggering Sequence
- Threshold Voltage Level at TTL, BCL, or -5V to +14V variable • Data Display as Timing Diagram or State List • Save/Load Data and Setup Info.

(201) 994-6669

Link Computer Graphics, Inc.

4 Sparrow Dr., Livingston, NJ 07039

Circle 155 on Reader Service Card

Turn your old XT/AT into a WARPSPEED/386

386SX MotherBoard

\$ 395.00



- Intel 16 MHz 80386 SX CPU
- Socket for Intel 80387 SX Coprocessor
- Shadow RAM Support
- 8 Expansion Slots 6-16 bits, 2-8 bits
- I/O Speed at 8 MHz to use existing cards
- Interleave w/1Mb RAM
- Fully AT Compatible

386/20 w/OK...\$ 595.00

386/25 w/OK...\$ 975.00

386/25Cache...\$1495.00

HomeSmart Computing

1(800) 627-6998

Circle 121 on Reader Service Card

ICs PROMPT DELIVERY!!!

SAME DAY SHIPPING (USUALLY)
QUANTITY ONE PRICES SHOWN FOR AUG. 27, 1989

OUTSIDE OKLAHOMA: NO SALES TAX

DYNAMIC RAM

SIMM (1) 256Kx36	80 ns	\$400.00
SIMM 1Mx9	70 ns	185.00
SIMM (2) 1Mx9	80 ns	145.00
SIMM 256Kx9	100 ns	50.00
1Mbit 1Mx1	100 ns	12.75
41256 256Kx1	60 ns	7.25
41256 256Kx1	80 ns	6.25
41256 256Kx1	100 ns	3.95
41256 256Kx1	120 ns	3.50
4464 64Kx4	120 ns	4.50
41264 (3) 64Kx4	120 ns	9.75

EPROM

27C1000 128Kx8	200 ns	\$22.00
27512 64Kx8	200 ns	9.50
27256 32Kx8	150 ns	7.25
27128 16Kx8	250 ns	4.50
STATIC RAM		
62256P-10 32Kx8	100 ns	\$19.95
6264P-12 8Kx8	120 ns	5.95
6116AP-12 2Kx8	120 ns	4.50

OPEN 6 1/2 DAYS, 7:30 AM-10 PM: SHIP VIA FED-EX ON SAT.

SAT DELIVERY INCLUDED ON FED-EX ORDERS RECEIVED BY: The 2nd AM, 8:00 P. M. P-1 SAT \$125.00 (1) (2) (3) (4) (5) (6) (7) (8) (9) (10) (11) (12) (13) (14) (15) (16) (17) (18) (19) (20) (21) (22) (23) (24) (25) (26) (27) (28) (29) (30) (31) (32) (33) (34) (35) (36) (37) (38) (39) (40) (41) (42) (43) (44) (45) (46) (47) (48) (49) (50) (51) (52) (53) (54) (55) (56) (57) (58) (59) (60) (61) (62) (63) (64) (65) (66) (67) (68) (69) (70) (71) (72) (73) (74) (75) (76) (77) (78) (79) (80) (81) (82) (83) (84) (85) (86) (87) (88) (89) (90) (91) (92) (93) (94) (95) (96) (97) (98) (99) (100)

Circle 176 on Reader Service Card

Up to date. Down to earth.

Changing the world. UNIX is changing the world of computers, the world of business — quite simply, changing the world. It's revolutionizing office automation. It's required for U.S. government computer contracts. It's the backbone of information strategies worldwide.

The information you need. That's why you need *UNIXWORLD* — the magazine that keeps you up to date on the rapidly changing world of open systems computing. Each issue brings you the latest product trends and technical advances that can affect your business. The inside story on some of the world's

biggest high-tech companies. Easy-to-understand programming tips and tutorials that can help you and your company use UNIX to its fullest. And unbiased hardware and software reviews to help you invest wisely when you buy.

The whole UNIX-verse.

UNIXWORLD's in-depth features go beyond dry technical facts, to show how the pieces fit together — to tell you what's important about the advances and the strategies that are changing your world. And *UNIXWORLD* consistently offers the freshest, most down-to-earth writing you'll find in any computer publication.

Subscribe and Save. Subscribe today, and receive the next 12 issues of *UNIXWORLD* for just half the regular newsstand price. Save even more by ordering for two or three years. You can't lose — every subscription to *UNIXWORLD* comes with a no-risk guarantee.*

1 year \$18.00 (save 50%)
2 years \$32.00 (save 55%)
3 years \$42.00 (save 60%)

**Subscribe now! Call toll-free:
1-800-341-1522**

UNIXWORLD

If you're into UNIX, you need *UNIXWORLD* MAGAZINE.

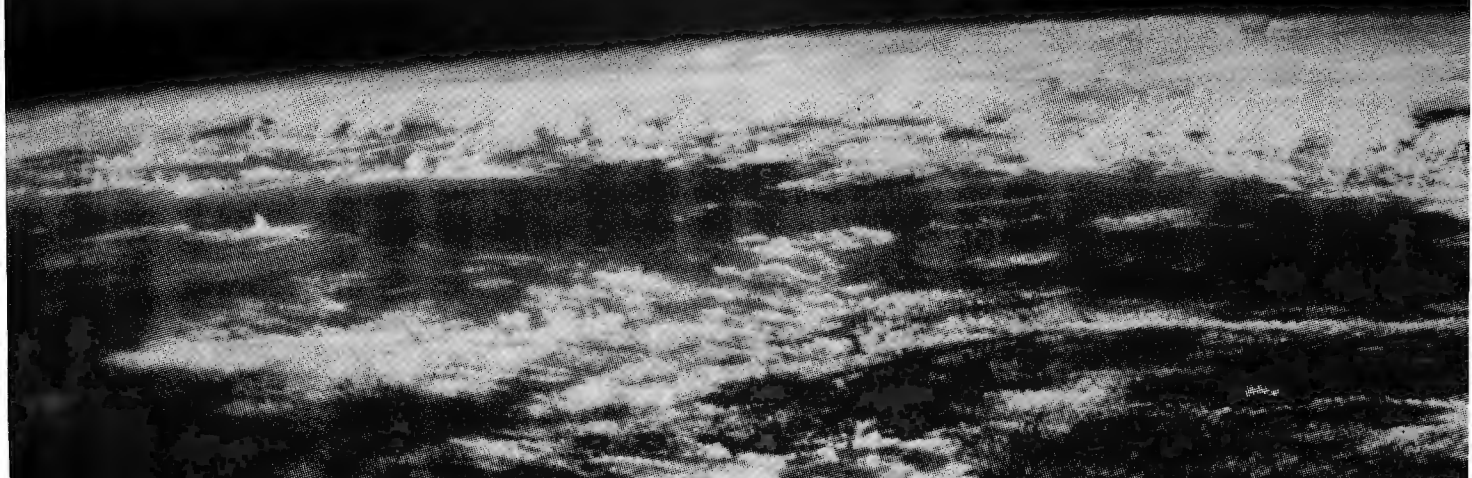

*No-risk guarantee: If not satisfied, full refund for the entire subscription.



PS/2 model 30/286	1895
PS/2 model 50/30 meg	2395
PS/2 model 70/60 meg	3695
PS/2 model 80/40 meg	4395
PS/2 model 70/120 meg	5595
PS/2 model 80/115 meg	Call
Call for other models	



386 S 40 meg	Call
386 20E - 40 meg	4295
286E 40 meg	Call
386 110 meg/25 MHz	7295
386 60 meg/25 MHz	5895
Portable III 40 meg/12 MHz	3995
CARD & MONITOR EXTRA	
Call for other models	

Macintosh

Mac IICX/80 Meg, 40 Meg RAM	5095
Mac-II/40 Meg	4095
Mac-SE 30/40 Meg	3695
Call for 60 and 100 Meg	
Lazer NT	3595
Lazer NTX	4895

LOW PRICE LEADER

SINCE 1983

Compaq SLT 286-20/40	3795/Call
Toshiba T1000	Call
T1200F	Toshiba Call
T1200HB	Salel Call
T1600-20/40 Meg	Call for all
T3100E	Call
T3200-40 Meg	Call
T5100-40/100	Call
T5200-40/100	Call
Zenith 286-20 Meg	3195/Call
Zenith 8088-20 Meg	Call
Mitsubishi 286-20/40	2449/Call

Pacific Data (For HP)

25-N-1 Cartridge	265	Pacific Page	459
1 Meg. Memory Board	295	Plotter Cartridge	239

Everex

Step 286 - 12 & 16 MHz & 20 MHz
1 Meg RAM
Set up utility in ROM
S/P, C/C
Enhanced keyboard
1.2 MB floppy
DOS/BASIC

Call! for your configuration

Everex

Step 386-20 MHz & 16 MHz & 25 MHz & 33 MHz
Up to 256K cache of very high speed RAM
2 Meg RAM, expandable to 16 Meg
S/P, C/C
Enhanced keyboard
1.2 MB floppy
DOS/BASIC

Call!



AST 286 model 140X	Call
AST 286 model 80	1495
AST 386 model 300c	Call
AST 386 40 Meg	3195

CARD & MONITOR EXTRA
CALL FOR OTHER MODELS

WE STOCK

CITIZEN
OKIDATA
EVEREX
GOLD STAR

TOSHIBA
NEC
WYSE
HITACHI

PRINCETON GRAPHICS
SONY
ACER
HOUSTON INSTRUMENTS

AMDEK
HAYES
SAMSUNG
CALCOMP

PC MOUSE
MICROSOFT MICE
LOGITECH
MITSUBISHI

IRWIN & ARCHIVE
TAPE BACK
TAXAN
MAGNOVOX

BOARDS

Paradise VGA +	239
Vega VRAM	449
ATI VGA Wonder	285
Everex EGA	159
Tatung 16 bit	249

SOFTWARE SPECIALS

dBase IV	455
Wordperfect	229
Aldus Pagemaker	495
Ventura Publisher	495
Clipper	435
WordStar 5.5	219



NOVELL Authorized Dealer

Intel Coprocessors

8087-3	105
8087-2	145
80287-8	225
80287-10	249
80387-16	395
80387-20	425
80387-25	495
80387-33	599

PRINTERS

EPSON

LX-810/LQ-510	199/339
LQ-850/1050	545/749
FX-850/1050	359/479

OKIDATA

320/321	359/490
390/391	490/649

TOSHIBA

321-SL/341-SL	439/595
351-SX 350 CPS	929

BROTHER

1709-9 PIN	425
1724-24 PIN	595

LASER PRINTERS

HP Laser II	1695
HP Desk Jet ±	695
Panasonic 4450	1395
Brother HL-8-E	1895
Nec LC 890	3195
PageLaser 12	\$\$\$\$\$
Canon Laser	Call

MONITORS

Nec Multisync IIA	525
Nec Multisync 3D	649
Magnavox EGA	339
Nec Multisync XL-19"	1995
Samsung EGA	359
Goldstar VGA	375

FAX MACHINES

Sharp FO 220	795
Sharp UX 350	1249
Canon	Call
Brother	Call
Richo	Call
Murata	Call

MODEMS

Everex 1200 Int	89
Everex 2400 Int	159
Hayes 1200 B	299
More in Stock	Call

WE ACCEPT CASHIER CHECKS, MONEY ORDERS, VISA, MC, AmEx
3% charge on VISA, MC & 5% on American Express

EXPORTS Available

COMPUTERLANE

HOURS:
M-S 9-6

1-800-526-3482 (Outside CA)
(818) 884-8644 (In CA)
(818) 884-8253 (FAX)

22107 ROSCOE BLVD.
CANOGA PARK
1/2 BLOCK W. OF TOPANGA
CA 91304

CORPORATE ACCOUNTS WELCOME
CALL FOR VOLUME DISCOUNTS
CONSULTANTS CALL FOR PRICING

Prices subject to change without notice

Compaq is a Registered Trademark of Compaq
IBM is a Registered Trademark of International Business Machines

THE DXFHandler II

The global editor for all DXF files!

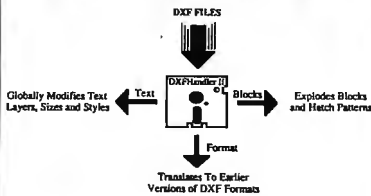

ELIMINATE THE HOURS OF PAINSTAKING LABOR INVOLVED IN EDITING AND IMPORTING DXF FILES INTO YOUR PRESENT CAD SOFTWARE!

With the "DXFHandler II", you can globally modify text layers, sizes and styles; explode blocks and hatch patterns globally, no matter how deeply they are nested; and you can also translate/convert later versions of DXF files, (e.g., AutoCAD Version 10) into earlier DXF versions (e.g., AutoCAD Version 9) so they can be read into any CAD system. "DXFHandler II" can process DXF Files on any DOS-based PC with or without AutoCAD or any other CAD software.

\$149.95

IMAGENET
SYSTEMS, INC.

200 Brevard Avenue Cocoa, Florida 32922
(407) 632-4333 Fax (407) 632-7632

Note: AutoCAD is a registered trademark of Autodesk, Inc.

EPROM PROGRAMMER CROSS ASSEMBLERS

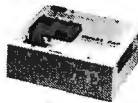

MODEL
SX151

RS232C OR STAND ALONE (all models), Communication protocol; XMODEM, HEX, and BIN. Programs: EEPROMS, 2716 - 27512 and CMOS. Programs (w/adapter); 25XX, 27101 (and above), 68701, 68705, 68764/6, 87412, 8744, 8748/9, 87512, 8755, 8752, 870751, 870752 and CMOS. More available soon. Model SX151 \$214 (assembled with case). Other models are available from \$49 (kit).

Cross assemblers by Pseudocorp for IBM-PCs, \$50. Z80, 1802, 8502, 68001/123/5/8/9/11, 68000/8/10, 8048/9, 80512, 8080/5, 8096, and more soon. Simulators and disassemblers also available.



KORE, Inc.

3150 Plainfield, N.E.

Grand Rapids, MI 49505

(616) 361-3666

\$5 for shipping (USA), plus \$3.00 COD.



Circle 127 on Reader Service Card
(DEALERS: 128)

80386-20 COMPUTER \$1989



- Intel 80386-20 CPU, 16/20/24 MHz clock rates, 0 wait states.
- 1 MB SIMM RAM, expandable to 8 MB on board, total 16 MB system.
- 40 MB hard disk and 1.2 MB floppy drive with controller.
- SuperEGA Card, AMI Bios.

- Two serial ports and one parallel printer port.
- 6 expansion slots.
- Socket for 80287/80387/Weltek 1167.
- 200 Watts power supply, case, and enhanced 101-key keyboard.
- DOS2, WINDOW386 UNIX compatible.

386-25 COMPUTER CALL FOR PRICE

- Intel 80386-25 CPU with 32 KB CACHE memory.
- 20/25 MHz clock rates.
- 1MB/16MB DRAM module on board.
- 8 expansion slots.
- VGA Legal BIOS, DOS2, WINDOW386 UNIX compatible.
- 80 MB hard disk, 1.2 MB floppy controller.
- EGA/VGA card, 200 watts power supply, case, enhanced 101-keyboard.
- Socket for 80287/80387/Weltek 1167.

OTHER PRODUCTS

KDS208 SINGLE-BOARD CONTROLLER \$275.00

Intel 8032 based single-board controller with 10 bit 8 channel A/D converter, 40 KB memory, 24 PIO

KUSTEM DATA SERVICES, INC.

4 HUDSON COURT, CRANBURY, NJ 08512

TEL: (609) 799-2963 FAX: (609) 799-5416

Circle 149 on Reader Service Card

Advertise your computer products through
BYTE BITS
(2" x 3" ads)

For more information call Mark Stone at
603-924-6830

BYTE

One Phoenix Mill Lane
Peterborough, NH 03458

Circle 46 on Reader Service Card

Circle 148 on Reader Service Card

Complete PC Systems

For Complex Stand-Alone Applications



- Now Available! Systems that are functionally equivalent to large PC's, in compact packages. Our systems are based on single board CPU's and include all hardware, software, and support needed to run your special applications.
- Run DOS applications without a disk using our BIOS. Store DOS and user programs in EPROM's.
- Debug Monitor, BIOS for disk capability, utilities, and source code are available.
- Compatible with PC systems. Run 8088 code and DOS applications. Use standard PC/AT cards in passive backplanes for expansion.
- Our CPU cards use V40/V50 micros and drive PC/AT bus. Options: 1meg RAM, 256K ROM, 5 serial ports, SCSI, CMOS, floppy, printer, graphics. CPU Cards \$249 (q25) Systems \$499 (q1) Customization available (303)444-7737



655 Hawthorne Ave. Boulder, CO 80304 FAX (303) 786-9983

Circle 144 on Reader Service Card

IEEE 488 Solutions

- Hardware & software interfaces for PC, AT, 386, PS/2, Macintosh, SUN, HP & DEC.
- IEEE converters to SCSI, RS-232, RS-422, modem, Ceatronics, digital I/O & analog I/O
- IEEE extenders, expanders & buffers.
- IEEE drivers for DOS, UNIX, Lotus 1-2-3, Symphony & Quattro.

Call or send for your
FREE Technical Guide

Demo disks and application notes available

Please see our ad on page 204.

Lotek

(216) 439-4091

Telex 6502820864 • Fax (216) 439-4093
Lotek, Inc. • 25971 Cannon Road
Cleveland, Ohio 44146

Circle 135 on Reader Service Card

LOW COST INTERFACE CARDS FOR PC/XT/AT

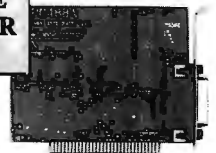

RS-485/422 Card [PC485] \$95/125

- Serial Async. Communication up to 4,000ft; 2 or 4 wires; NS16450 UART.
- Can be configured as COM1-COM4; Maximum Baud Rate 56Kb.
- Flexible configuration options: RTS or DTR control of transmission direction.
- Full/Half duplex operation. Supports hardware handshaking (RTS,CTS).
- Dual drivers/receivers; Handles 64 devices; Compatible with most comm. software.
- High speed version available (supports baud rates up to 256Kb) - \$165

Dual-Port RS-485/422 [PCL743] \$175

- Two independent channels / UARTs; 2 or 4 wire operation. Max. Baud 56Kb.
- Dipswitch configurable as COM1-4 (IRQ2-7). On board terminator resistor.

IEEE-488 Card [PC488A] \$145

- Includes INSTALLABLE DOS DEVICE DRIVERS and support for BASIC.
- Additional libraries for C, Pascal, FORTRAN, Assembly available - \$50 (all).
- Additional Support for ASSEMBLY, C, Pascal and FORTRAN - \$ 50.
- IRQ (1-9), DMA channel 1 or 2. Up to 4 boards per computer.
- Compatible with most IEEE-488 Software packages for IBM-PC (e.g. ASYSTANT-GPIB, Lotus Measure). Compatible with NT's GPIB-PC1A.

IEEE-488 Card [PC488B] With Built-In Bus Analyzer \$345

- Software Support for BASICA, QuickBASIC and GWBASIC.
- Additional libraries for C, Pascal, FORTRAN, Assembly available - \$50 (all).
- Full range of Talker, Listener, Controller, Serial/Parallel Poll, SRQ, etc.
- Powerful menu-driven BUS ANALYZER can be run in the background while 488 programs or commands are executed; Features Program Stepping, Break points, Real Time Bus Data Capture (4K buffer), Instant Screen Toggling.
- Complete Controller / Talker / Listener capability. Based on TI's TMS-9914.
- Memory-resident Printer Port Emulation Utility included. (LPT1-3).
- NEC-7210 based card (compatible with NT's GPIB-PC1) - \$445.

DIGITAL I/O Card [PCL720] \$175

- Input: 32 TTL compatible channels; Input load is 0.2 mA at 0.4V.
- Output: 32 TTL compatible channels; Sinks 2mA @ 0.5V; Sources 15mA @ 2.0V
- Counter/Timer: PC to 2.6MHz; 3 channels; 16 bit counters; 6 counting modes.
- Breadboard area for prototyping. Dipswitch I/O port selection (200-378 hex).

LOW COST DATA ACQUISITION & CONTROL CARDS FOR PC/XT/AT



12 BIT A/D & D/A [PCL711s] \$295

- A/D converter: 8 single-ended channels; Device: AD574; Conversion time less than 25µsec; Input range: ±5V; Software Trigger and DMA control circuitry.
- D/A converter: 1 channel; 12 bit resolution; Output Range 0-5V/0V Output Range.
- Digital I/O: 16 Input / 16 Output channels; All I/Os TTL compatible.
- External Wiring Terminal Board with mounting accessories included.
- Utility Routines and Demo/Sample Programs for BASIC and Quick-BASIC.

12 BIT A/D & D/A [PCL812] \$375

- A/D converter: 16 single ended inputs; Device: AD574; Conversion time less than 25 µsec; Built-in programmable prescaler; Input ranges: ±10V, ±5V, ±1V.
- D/A converter: 2 channels; 12 bit resolution; Output Range 0-5V.
- Digital I/O: 16 Input / 16 Output channels; All I/Os TTL compatible.
- Counter: 1 channel programmable interval counter/timer; Uses Intel 8254.
- DMA and interrupt capability. Utility software for Basic included.

FAST 12BIT A/D/A [PCL718] \$895

- A/D converter: 16 single ended or 8 differential channels; 12 bit resolution; Programmable scan rate; Built-in interrupt and DMA control circuitry; Conversion speed 60,000 samples/sec (standard), 100,000 samples/sec (optional).
- Input ranges: Bipolar ±10V, ±5V, ±2.5V, ±1V, ±0.5V; Unipolar 10.5, 2.1V.
- D/A converter: 2 channels; Resolution: 12 bits res; Settling time: 5µsec; ±5V
- Digital I/O: 16 OUT, 16 IN; TTL compatible; All I/Os TTL compatible.
- Counter: 16 bit prog. interval counter/timer; Uses Intel 8254. Precise clock.
- Software: Utility software for BASIC and QuickBASIC included. Supported by LabDAS (\$195/495), ASYST, LABTECH, UnkelScope

6 Channel 12 bit D/A [PCL726] \$495

- Output Ranges: 0 to +5V, 0 to +10V, ±5V, ±10V or sink 4-20mA.
- Settling time: 70µs. Linearity: ±1/2bit Voltage output driving capacity: ±5mA
- Digital I/O: 16 digital inputs and 16 digital outputs; TTL compatible.

STEPPER MOTOR CARD \$395

- Capable of independent and simultaneous control of up to 3 stepper motors.
- Speed: Programmable from 3.3 PPS to 3410 PPS; Built-in acceleration control.
- Output Mode: One clock (Pulse, Direction) or two clock (CW, CCW pulses)
- Step position Read-back; Opto-isolated outputs; Crystal based timing.
- Includes 8 bit digital input/output port. Order P/N [PCL-738B]

MC / VISA / AMEX

Call today for datasheets!



B&C MICROSYSTEMS INC.

355 WEST OLIVE AVE., SUNNYVALE, CA 94066
TEL: (408) 738-5511 FAX: (408) 738-5521

Circle 49 on Reader Service Card

Every Order Over \$500 Receives a FREE Gift Certificate*

CAT™ 10MHZ

BASE SYSTEM

- 256K (Opt. 640K) • 150 Watt Power Supply • AT Style Keyboard & Case • 4.77 or 10 MHz Keyboard Selectable • Floppy Disc Controller • 8087 Socket • 360K Floppy Drive • 1 Year Warranty

\$39900

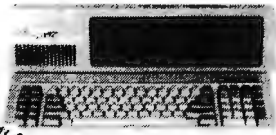

CAT 386 SYSTEM

- 12" Amber Monitor with Graphics Interface Card • 1.2 Meg Floppy Drive (expandable to 8 Meg) • 1 Meg of Memory • Parallel, Serial & Clock

Xenix, Unix, Novell Compatible

20MHz **\$169500**

CAT™ 286-10MHZ

BASE SYSTEM

- 512K Exp. to 1 MEG • 200 Watt Power Supply • AT Style Keyboard • Western Digital Controller • 1.2 Meg Floppy • Legal Bios w/manuals • Systems Documentation • 1 yr war. • Clock/Calc • 10MHz DTK Motherboard

\$79900



11.3 MORTONS SL

8088 XT Compatible

640 K Upgrade	129 ⁰⁰	Clock Calendar	24 ⁰⁰
12" Amber Monitor w/Interface	139 ⁰⁰	Parallel & Serial Ports	39 ⁰⁰
DOS 4.01 w/GW BASIC	89 ⁰⁰	Additional Drives	See Below

SYSTEM OPTIONS

640 K Upgrade	49 ⁰⁰	14" EGA Monitor w/Interface	549 ⁰⁰
512K Upgrade	109 ⁰⁰	Novell Network. Call 12 Mhz add	109 ⁰⁰
12" Amber Monitor w/Interface	139 ⁰⁰	14" Color Monitor w/Interface	289 ⁰⁰

COPROCESSORS

8087	5MHz or less	89 ⁰⁰
8087-2	6MHz	129 ⁰⁰
8087-1	10MHz or less	179 ⁰⁰
80287	6-8MHz	139 ⁰⁰
80287-8	8-10MHz	209 ⁰⁰
80287-10	10MHz	239 ⁰⁰
80C287-12	12MHz	259 ⁰⁰
80387-16	16MHz	369 ⁰⁰
80387-20	20MHz	439 ⁰⁰
80387-25	25MHz	549 ⁰⁰
90387-33	33MHz	649 ⁰⁰
80387SX	16MHz	399 ⁰⁰

MORE UPGRADES

Description	150MS	120MS	100MS	80MS
64 x 1	27 ⁰⁰	29 ⁰⁰	32 ⁰⁰	49 ⁰⁰
64 x 4	47 ⁰⁰	53 ⁰⁰	57 ⁰⁰	67 ⁰⁰
256 x 1	3 ⁰⁰	4 ⁰⁰	4 ⁰⁰	5 ⁰⁰
1 Meg x 1	12 ⁰⁰	13 ⁰⁰	14 ⁰⁰	15 ⁰⁰
256 x 4	12 ⁰⁰	14 ⁰⁰	15 ⁰⁰	17 ⁰⁰
64x4 Video	6 ⁰⁰	7 ⁰⁰	8 ⁰⁰	11 ⁰⁰
1 Meg Video	—	24 ⁰⁰	—	—
8K x 8 Static	7 ⁰⁰	8 ⁰⁰	9 ⁰⁰	11 ⁰⁰

The above Memory Upgrades come in DIP Form. Please specify if you need ZIP - Soj - PLCC - Flat Pack or if you need Nibble Mode

RAM UPGRADES FROM THE RAM SPECIALISTS

IBM PS2

Description	Part #	For Model #	Meds	Low Price
128K Upgrade	78 x 8955	25	59 ⁰⁰	
512K Upgrade	30F 5348	30/286	189 ⁰⁰	
2MB Upgrade	30F 5360	30/286	589 ⁰⁰	
1MB Module	6450603	70-E61 & 121	239 ⁰⁰	
2MB Module	6450604	70-E61 & 121	579 ⁰⁰	
2MB Mem. Board	6450608	70-A21	89 ⁰⁰	
1MB Mem. Board	6450375	80-041	419 ⁰⁰	
2MB Mem. Board	6450379	80-111 & 311	89 ⁰⁰	
8MB Mem. Bd.w/OK	1497259	50Z & 60	429 ⁰⁰	
8MB Mem. Bd.w/OK	6450605	70 & 80	1289 ⁰⁰	

COMPAQ

Description	Equip. Part #	For Model #	Meds	Low Price
1MB Add-on Module	113131-001	Deskpro 386/20/25/20E/286E	359 ⁰⁰	
1MB Add-on Module	113646-001	Deskpro 386S	369 ⁰⁰	
4MB Add-on Module	113132-001	Deskpro 386/20/25/20E/286E	899 ⁰⁰	
4MB Add-on Module	112534-001	Deskpro 386S	959 ⁰⁰	
1MB Memory Exp. Bd.	113644-001	Deskpro 386/20E	499 ⁰⁰	
1MB Memory Exp. Bd.	113633-001	Deskpro 386S	499 ⁰⁰	
4MB Memory Exp. Bd.	113645-001	Deskpro 386/20E	1399 ⁰⁰	
4MB Memory Exp. Bd.	113634-001	Deskpro 386S	1399 ⁰⁰	
1MB Mem. Upgrade Kit	107651-001	Portable 386	499 ⁰⁰	
1MB Memory Exp. Bd.	117428-001	286E	499 ⁰⁰	
4MB Memory Exp. Bd.	117429-001	286E	1399 ⁰⁰	
1MB Upgrade Bd.	110235-001	SLT/286	589 ⁰⁰	
4MB Upgrade Bd.	108070-001	386/16	1399 ⁰⁰	

IBM & Compaq boards & Modules come with 1 year warranty and are manufactured on a 2nd party board.

HARD DRIVES



ST125 20Meg 40 Mil 1/2 Ht 3 1/2" Drive only	259 ⁰⁰
ST138 30Meg 40 Mil 1/2 Ht 3 1/2" Drive only	299 ⁰⁰
ST225 20Meg w/cont. & Cables	259 ⁰⁰
ST238 30Meg w/cont. & Cables	289 ⁰⁰
ST251 40Meg 1/2 HT 40 Mil w/software, Drive only	349 ⁰⁰
ST251-1 40Meg, 28 Mil Sec. Drive only	379 ⁰⁰
ST277R 60MB 40 Mil 1/2 Ht	469 ⁰⁰
ST4026 20Meg Full Ht 40 Mil	299 ⁰⁰
ST4038 30Meg 40 Mil Full Ht	399 ⁰⁰
ST4053 40MB 28 Mil Full Ht	519 ⁰⁰
ST4096 80Meg Full HT w/software	639 ⁰⁰

WESTERN DIGITAL CONTROLLERS

WX-1 8 Bit 1/2 Sized for XT	79 ⁰⁰
MM2 16 Bit Full Sized Hard/Floppy	119 ⁰⁰
WD-27X 8 Bit RLL 1/2 Size	89 ⁰⁰
WAH 16 Bit Hard Drive Controller	129 ⁰⁰
RA2 16 Bit RLL Hard/Floppy for AT	159 ⁰⁰
MEAD Floppy Disk Controller for XT	199 ⁰⁰
MEAD 1.2 Meg & 360K Controller for XT, 720K-1.44	69 ⁰⁰
Cable Set for Hard Drive Only	5 ⁰⁰

Mitsumi FLOPPY DRIVES

360K 1/2 Ht. PC Compatible — Mitsumi	69 ⁰⁰
1.2 Meg Black Face — Mitsumi	89 ⁰⁰
720K 3 1/2" Drive w/5 1/4" mounting — Mitsumi	89 ⁰⁰
1.44 Meg 3 1/2" Drive w/5 1/4" mounting — Mitsumi	109 ⁰⁰
360K Tandon TM100-2 Full Ht (The Original IBM)	89 ⁰⁰
160K Tandon TM100-1 Full Ht	59 ⁰⁰
External Case w/Power Supply 2, 1/2 HTs or 1 Full	149 ⁰⁰

EVEREX™ TAPE BACKUPS

40MB Mini Cartridge, 1.8MB/min, XT (DC 2000)	339 ⁰⁰
40MB Mini Cartridge, 3.6MB/min, AT (DC 2000)	339 ⁰⁰
60MB Streaming Cassette, 5MB/min w/cont (CT600)	649 ⁰⁰
60MB Streaming 600A, 5MB/min w/Full cont (DC600)	849 ⁰⁰
125MB Streaming Cartridge, 5MB/min w/Full cont	1119 ⁰⁰
DC2000 24"	External Add 195 ⁰⁰
DC600 24"	

MODEMS BY EVEREX™

EV-923 EverCom 12 300/1200 bps Bitcom Software	69 ⁰⁰
EV-941 EverCom 24 2400 Baud Int. Bitcom Software	139 ⁰⁰
EV-945 External 2400 Baud	199 ⁰⁰
EV-942 2400 PS2	229 ⁰⁰
EX-955 Fax Card	349 ⁰⁰

MORE MODEMS...

1200 Baud Internal w/Software CPI	54 ⁰⁰
1200 Baud External fully Hayes Compatible, Everex	99 ⁰⁰
2400 Baud Internal 1/2 card w/software CPI	99 ⁰⁰
2400 Baud External Fully Hayes Compatible, Zoom	129 ⁰⁰

Imtec/SAMSUNG MONITORS

1256A 12" Amber w/Tilt & Swivel Base	89 ⁰⁰
1257 12" Amber Flat Screen 720 x 350	109 ⁰⁰
1454 14" Color 640 x 200, 16 colors	239 ⁰⁰
1453 14" EGA 640 x 350, 64 colors, 31"	369 ⁰⁰
1455N EGA 720x480 Multisync Compatible	449 ⁰⁰

VIDEO CARDS BY EVEREX™

EGA EV659, 640 x 350	119 ⁰⁰
VGA Viewpoint 16 Bit 256	269 ⁰⁰

MORE VIDEO CARDS...

MonoGraphics or Color Graphics (Hercules Compatible)	44 ⁰⁰
--	------------------

SIMM MODULES (add \$20 for SIPP Version)

Description	150MS	120MS	100MS	80MS
64 x 9 IBM & Compatibles	19 ⁰⁰	29 ⁰⁰	34 ⁰⁰	39 ⁰⁰
256 x 8 For Apple Products	39 ⁰⁰	44 ⁰⁰	49 ⁰⁰	59 ⁰⁰
256 x 9 IBM & Compatibles	42 ⁰⁰	48 ⁰⁰	54 ⁰⁰	74 ⁰⁰
1Meg x 8 For Apple Products	132 ⁰⁰	148 ⁰⁰	164 ⁰⁰	189 ⁰⁰
1Meg x 9 For IBM & Compatibles	149 ⁰⁰	159 ⁰⁰	169 ⁰⁰	189 ⁰⁰

Liquidation Below Dealer Cost — New With Warranties

LETTER QUALITY PRINTER

DAISYWHEEL PRINTER MANUFACTURED BY C.I.TOH

STARWRITER™ F-10

When our 40 cps letter quality daisywheel printer from the same manufacturer is only

\$39900 ea.



OPTIONS

• 6 ft. Serial Cable	\$ 19 ⁰⁰
• Bidirectional Tractor	149 ⁰⁰
• Cut Sheet Feeder	199 ⁰⁰
• Serial to Parallel Converter	99 ⁰⁰

STANDARD FEATURES

- 40 CPS • Accepts Paper to 15 inches • Form Length and Pitch Set from Control Panel
- Industry compatible ribbon, printwheels and control commands • RS232 Serial Interface

MICROSOFT MOUSE



- In Port with Bus Interface
- Fully IBM Compatible (of course)
- Includes Showpartners and Paint Brush

List \$199 Mead **\$7900** 10 for \$740

KRAFT MONITOR



- 14" Flat Screen • Paper White Phosphorus
- TTL Monochrome & Composite Interface

List \$199 Mead **\$9900** 10 for \$950

MEAD HOTLIST

PRINTER IXP 1124 Panasonic	329 ⁰⁰
MONITOR/NEC Multisync 2A	498 ⁰⁰
MODEM Hayes Smartmodem 2400 Int.	388 ⁰⁰
SYSTEMAST Premium 286 Model 70	1398 ⁰⁰
BOARDS Paradise VGA Plus	248 ⁰⁰
SOFTWARE Fastrax The Disk Organizer	29 ⁰⁰

AT STYLE / XT CASE

150 WATT PWR SUPPLY For XT	39 ⁰⁰
200 WATT PWR SUPPLY For AT	47 ⁰⁰

• 2 Bay Standard AT Style Case
• Keylock Power and Hard Drive LED's
List 99⁰⁰ Mead 29⁰⁰ 10 for \$240

WESTERN DIGITAL

WD1003/RAH — RLL HDC For AT 16 Bit.	List 199 ⁰⁰ Mead 99 ⁰⁰
WD1005-WAH — 16 Bit Ecdl Controller for AT 2 to 1 Interleave	List 269 ⁰⁰ Mead 99 ⁰⁰

PARADISE MONO EGA
Auto Switch Monochrome EGA Card, 640x350 EGA, MDA, CCA, Herc. List 319⁰⁰ Mead 99⁰⁰

CLOSEOUTS/OVERSTOCK

Wordstar Professional 5.0	149 ⁰⁰
Epson Universal Printer Stand	9 ⁰⁰
DC300A Used	5 ⁰⁰
SideKick Plus 1.0 by Borland	69 ⁰⁰
10Meg w/controller & cables	159 ⁰⁰
WD Controller 27X or WX1	49 ⁰⁰

800-654-7762

SALES: 7 a.m.-6 p.m. PST
702-294-0204

TECHNICAL / CUSTOMER SERVICE / ORDER STATUS:
9 a.m.-4 p.m. PST

FAX 702-294-1168

WE ALSO PURCHASE EXCESS INVENTORY— FAX LIST



- Quantity Pricing Available — CALL
- We Accept International Orders
- Purchase Orders from Universities, Government Institutions, Fortune 1000 and Qualified Firms.

NO SURCHARGE FOR MC/VISA

TERMS:

MC • VISA • COD • CASH
Purchase Orders from Qualified Firms
Personal Checks • AE add 4% • COD add \$3.00
20% Restocking Fee on Non-Detective Returns within 15 days



*October Orders Only — \$50.00 Value

1000 Nevada Hwy. • Unit 101 • Boulder City, NV 89005

ALLCON Alarm/Control System

Less than one \$ per channel for PC-AT

- 176 ch. TTL/sig. 1 board \$199
- 320 ch. TTL/sig. 1 board \$399
- 656 ch. TTL/sig. 2 boards \$599

3 ch. TTL/sig. compos. alarm output.
Standard connector board can be used.
Prog. time 600 signals about 15 hours.
Signal name 24 characters.
Ten operators, 7 key level authority.

ALLregulator AB

Dagj.gat. 9, S-415 09 Gothenburg, Sweden
Fax +46 31 43 47 30 Tel +46 31 48 01 80
US office Mesa AZ Tel (602) 649 1202
Estab. 1967 VISA MC CHECK

SAME-DAY SHIPMENT! MONEY-BACK GUARANTEE!

"RS-232C TO CURRENT LOOP
BI-DIRECTIONAL
CONVERTER"
Model 232CL2
only \$39.95

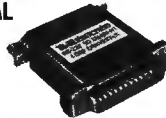

Interface your RS-232 port to existing current loop system. Model 232CL2 couples and isolates Transmit and Receive Data through high speed optical isolators. Powered from pins 4, 5, 6, 8 and 20 on the RS-232 side; one pin must be high, one must be low.

No power required if current loop port is active. Model 232PS-12V DC Power Supply required if current loop port is passive; only \$14.95.

Order direct from manufacturer TODAY and SAVE!

Request your FREE copy of B & B ELECTRONICS' Catalog which lists a host of interface and monitoring equipment for RS-232 ports.



*Terms: Visa, MC, cash orders postpaid; P.O.'s from qualified rated firms accepted. IL residents add 6 3/4% sales tax.

B & B electronics

4002K Baker Road, P.O. Box 1040 • Ottawa, IL 61350
Phone: 815-434-0846



NEW!
Made in USA!

PC BASED UNIVERSAL DEVICE PROGRAMMER \$595-845

- Programs EE/EPROMs, PALs, GALs, DPLs, EPLDs, MICROs, BIPOLARS.
- Software drives pin drivers. D/A generated programming voltages.
- Upgradeable for virtually any future programmable devices up to 48 pins.
- Self-sustained operation. No additional modules or plug-in adapters required.
- Includes user friendly MEMORY BUFFER FULL SCREEN EDITOR.
- Friendly Menu-Drives interface. Device selection by P/N and manufacturer.
- Supports 8/16/32 bit word, Intelligent I & II, Quick Pulse programming.
- Functional testing, Register-Preload, FUSEMAP EDITOR for logic devices.
- File formats accepted: Intel Hex 86/88, Tektronix Hex, Motorola S, JEDEC.
- Customer support via voice line, dedicated BBS or fax. Full 1 year warranty.
- Base price includes Interface card, cable, Memory device library and 1 year free updates. Additional Device Libraries (Logic, Micros, Bipolars) \$95 ea.
- Libraries updates available every 6 mo. and can be received via floppy or BBS.

Circle 18 on Reader Service Card
(DEALERS: 19)

8051 68HC11 EMULATORS



For info call:

- Australia (02) 654 1873
- Austria (0222) 39 76 38
- Benelux +31 1858-16133
- Denmark (02) 65 81 11
- Finland 90-452 1255
- France (01) 69 412 801
- Great Britain 0962-73 3140
- Israel (03) 484832
- Italy (011) 7710010
- Korea (02) 784 7841
- New Zealand (09) 392464
- Portugal (01) 83 56 70
- Scandinavia +46 40922425
- Singapore 665 743-2086
- Spain (93) 217 2340
- Switzerland (01) 740 41 05
- Taiwan (02) 764-0215
- West Germany 08131-1687
- U.S.A. FAX (408) 378-7869

See us at Wescon '89, booth 902

NOHAU CORPORATION 51 E. Campbell Ave.,
Campbell, CA 95008
(408) 866-1820
See our ad on page 299

Circle 31 on Reader Service Card

EVEREX COMPUTER SYSTEMS DIVISION

Step 386/25/20/16MHz • Step 286/20/16/12MHz
IN STOCK
Call for best price

INTEC 386/25MHz Motherboard \$1495.00

- Intel 386-25MHz CPU • 64K cache upgradeable to 256K • Up to AMEG on board with SIMM • AMI High speed BIOS • LANDMARK 43.5MHz. P.M. - 6.2MIPS • 80387 and Wdettek support • As Fast as Northgate 386/25 • Call for quantity discount

AGI System from Everex

- 386 3000D 20MHz/0w/1M \$1895
- 3000A 16MHz/0w/1M \$1695
- 3000G SX/16MHz/0w \$1470
- 286 1800R 8MHz/512K \$780
- 1700A 10MHz/512K Baby \$800
- 1800A 10MHz/512K \$850
- 1800B 10MHz/512K \$1090
- 1700C 12MHz/1M Baby \$1125
- 1800C 12MHz/1M \$1195

We carry full line of Everex products,
Hard disk and monitors, CALL

Schwab Computer

"Authorized Dealer of Everex System Division"
7300 E. El Camino Real, Sunnyvale, CA 94087
408-245-6666 FAX 408-241-1279

PC BASED 8-SOCKET GANG PROGRAMMER \$595

- Handles all memory devices to 32 pins. (Upgradeable up to 8 megabit parts).
- FULL SCREEN BUFFER EDITOR plus all applicable features from above.
- Customer support via voice line, dedicated BBS or fax. Full 1 year warranty.
- Includes PC Interface card, Memory device library and 1 year free updates.



Made in USA!

UNIVERSAL RS-232 PROGRAMMER \$345-595

- Programs EE/EPROMs, FlashEPROMs, ZPROMs, Intel Micros, Memory Cards.
- Stand-Alone Mode for EE/EPROM and Memory Card Duplication / Verify.
- All 24/28/32 pin EE/EPROMs to 4 MBits (upgradeable to 32 megabits).
- Micros 8741A, 2A, 4, 8, 9, 51, CS1, CS1FA/B, 52, 53, 55, CS21, CS41, 9761.
- Memory Cards: Seiko/Epson, Fujitsu (Integrated Adapter included)
- Modular design. Firmware easily upgradeable; 4 socket Gang module available
- On-Board Programming capability; Custom interface modules available
- User friendly Menu-Drives Interface Program for IBM-PC and Macintosh.
- Can be operated with any computer containing an RS-232 serial port.
- Optional built-in Eraser/Timer module (\$50); Top cover conductive foam pad.
- OEM open board programmer configurations available (from \$245).
- Customer support via voice line, dedicated BBS or fax; Full 1 year warranty.

Circle 193 on Reader Service Card

UNIVERSAL PROGRAMMER

@programs E(E)PROM, PAL, EPLD, GAL, PEEL, FPL, BIPOLAR, 8748/51 SERIES.
@tests TTL, CMOS and DS RAM.

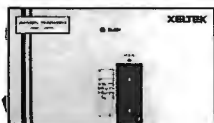

- \$ 545 Complete. (u.s. only)
- programs E(E)PROMs upto 2MBits and 16 Bit wide.
- 16Bit- and 32Bit- WORD SPLIT & 4-GANG adaptor.
- programs PALs (22V10) from AMD, MMI, TINS, SAMSUNG.
- supports PALASM2/CUPL/ABEL/ORCAD JEDEC files.
- supports VERIFICATION using TEST VECTORS.
- programs GALs & FPLs from LATTICE, SIGS, NS, SIGNETICS.
- supports RALs in GAL (16V8, 20V8) devices.
- programs EPLDs from INTEL, ALTERA, ATMEL, CYPRESS.
- programs PEELs from ICT, HYUNDAI, GOULD (253, 273).
- programs BIPOLAR PROMs.
- programs SINGLECHIPS 8748, 8751, 87C51 SERIES including 87C451, 87C751, 63701X/Y/V, 63705V with adaptors.
- tests ICs (TTL, CMOS) & MEMORYs (upto 1MB) with USER-DEFINABLE TEST PATTERN GENERATION.
- High-Speed, Parallel Interface & S/W Upgradeable for New Parts.

XELTEK 1-800-541-1975 (Toll Free Order)
473 SAPENA CT. #26 TEL: (408) 727-6995
SANTA CLARA, FAX: (408) 727-6996
CA 95054 COD, VISA, MC, AMEX

Circle 249 on Reader Service Card

Computers for the Blind

Talking computers give blind and visually impaired people access to electronic information. The question is how and how much?

The answers can be found in *The Second Beginner's Guide to Personal Computers for the Blind and Visually Impaired* published by the National Braille Press. This comprehensive book contains reviews, written by blind users, of software that works with speech.

Send orders to:

National Braille Press Inc.
88 St. Stephen Street Boston, MA 02115
(617) 266-6160

\$12.95 for braille or cassette
\$14.95 for print

NBP is a nonprofit braille printing and publishing house



Made in USA!

INTELLIGENT PC ROM EMULATOR \$395

- Emulates 2716 through 27512 EPROMs (2k to 64k bytes) with a single unit.
- Connects to the standard parallel printer port. Uses standard printer cable.
- Intelligent features include: Reset Output, Address Compare, Address Snapshot, Trigger Input. Memory buffer editing capability. Selectable word sizes.
- User friendly software. Command set includes: Load, Write, Display, Run, Type, Edit, Fill, Run-Command-File, Monitor, Port, Reset, Help, Calculator.
- FAST data loading via parallel printer port (65k bytes in less than 10 seconds).
- Cascadeable up to 8 units. Includes interface cable with Trigger and Reset clips.
- CMOS model with NiCad rechargeable 9V battery backup - \$495.
- Built-in battery recharging circuitry. After code downloading from the host computer, this model can be disconnected and used in stand-alone mode.
- File formats accepted: Binary, Intel Hex, Motorola S.

MC / VISA / AMEX Call today for datasheets!



B & C MICROSYSTEMS INC.

355 WEST OLIVE AVE. SUNNYVALE, CA 94086
TEL: (408) 730-5311 FAX: (408) 730-5321

Circle 292 on Reader Service Card

VOICE MASTER KEY[®] VOICE RECOGNITION SYSTEM FOR PC/COMPATIBLES & TANDY 1000 SERIES A FULL FEATURED VOICE I/O SYSTEM

GIVE A NEW DIMENSION TO PERSONAL COMPUTING. . . The amazing **Voice Master Key System** adds voice recognition to just about any program or application. Voice command up to 256 keyboard macros from within CAD, desktop publishing, word processing, spread sheet, or game programs. Fully TSR and occupies less than 64K. Instant response time and high recognition accuracy. Voice recognition tool-box utilities are included. **A genuine productivity enhancer!**

SPEECH RECORDING SOFTWARE. . . Digitally record your own speech, sound, or music to put into your own software programs. Software provides sampling rate variations, graphics-based editing, and data compression utilities. Create software sound files you can add to macros for voice recognition verification response. **A complete, superior speech and sound development tool.**

SOFTWARE CONVERSION CODES. . . The **Voice Master Key System** operates a growing list of third party talking software titles using synthesized phonetics (text-to-speech) or digitized PCM, ADPCM, and CVSDM encoded sound files. **Voice Master Key System** does it all!



EVERYTHING INCLUDED. . . **Voice Master Key System** consists of a plug-in card, durable lightweight microphone headset, software, and manual. Card fits any available slot. External ports consist of mic inputs and volume controlled output sockets. **High quality throughput, easy and fun to use.**

ONLY \$149.95 COMPLETE

**ONLY \$89.95 FOR TANDY 1000 SL/TL MODELS—
SOFTWARE PACKAGE ONLY.**

Requires Tandy Brand Electret microphone.

ORDER HOTLINE: (503) 342-1271

Monday-Friday, 8AM to 5PM Pacific Time

Visa/MasterCard, company checks, money orders, CODs (with prior approval) accepted. Personal checks subject to 3 week shipping delay. Specify computer type and disk format (3 1/2" or 5 1/4") when ordering. Add \$5 shipping charge for delivery in USA and Canada. Foreign inquiries contact Covox for C & F quotes. **30 DAY MONEY BACK GUARANTEE IF NOT COMPLETELY SATISFIED. ONE YEAR WARRANTY ON HARDWARE.**

CALL OR WRITE FOR FREE PRODUCT CATALOG



COVOX INC. 675-D Conger St.
Eugene, Oregon 97402 U.S.A.
TEL: 503-342-1271 • FAX: 503-342-1283

PC MAGAZINE EDITOR'S CHOICE

MULTI-LINE VOICE MAIL

- ◆ Voice Mail System
- ◆ Call Processing
- ◆ Telemarketing
- ◆ Order Processing
- ◆ Call Distribution
- ◆ Programmers Tool Kit

Complete Systems
BIG MOUTH \$295
Starting at PLUS 6 S/H
(415) 652-9600

TALKING TECHNOLOGY, INC. TTI
4383 PIEDMONT AVE., OAKLAND, CA 94611

Circle 269 on Reader Service Card

Z-WORLD
Z80 Specialists
Embedded Systems

**C Compiler Assembler/Linker
Remote Debug
Realtime Kernel
Emulator
PC Coprocessors
Proto Board**

Integrated Software/Hardware Targeted
for Z80/64180 Development on PC/XT/AT

2 NEW PRODUCTS

- * C Compiler-Version 2 (ask for free tech brief)
- * ICEPROM-In Circuit Debugger (Cost effective alternative to ICE)

Assembler/linker (only)	\$195.00
In-circuit Emulator	\$995.00
Source/symbolic debugger	\$195.00
Standalone Proto Board (64180uP)	\$295.00

Z-World Engineering
1340 Covell Blvd. Suite 101
Davis, CA 95616
(916) 753-3722
fax: 753-5141

FLASH C'm - Interactive C program environment.
Test Drive it WISDOM 89 (#225)

Circle 294 on Reader Service Card

MARYMAC[®]

13th year of Discounting Computers, FAX & Cellular Phones

Radio Shack[®] Tandy[®] SCO

We will meet or beat . . .
GUARANTEED LOWEST PRICES

MARYMAC INDUSTRIES INC.
22511 Katy Fwy.
Katy (Houston), TX 77450
1-713-392-0747 FAX (713) 574-4567
Toll Free 800-231-3680

Circle 164 on Reader Service Card

E/EPROM & MICRO PROGRAMMER

Special offer
~~\$495~~
\$395
VISA ACCEPTED

MICRO-BURNER System 512

The MICRO-BURNER sets a new price performance standard in programmers adaptable to all single-chip micros with on-chip EPROM. Features include reverse EPROM detection/protection and 12 volts dc operation for portable applications. 30-day money-back offer.

Dealers Welcome **BARADINE Products Ltd.**
(604) 988-9853 P.O. Box 86757
24 hours/7 days. North Vancouver, B.C.
CANADA V7L 4L3

Circle 32 on Reader Service Card

INSTANT PRODUCT!

*** just add software ***

Forth control computer
TDS 9090

Powerful 4" x 3" s.b. computer based on the CMOS HD6303Y. High-level Forth language. 30 K RAM, 16 K RAM/PROM 2K EEPROM. Attach keyboard, lcd, I2C peripherals. Built-in interrupts, multitasking, watchdog timer, editor and assembler. 32 I/O lines, two RS-232 ports. 6 - 16 volts operating at 3 ma. Optional 10 channel, 10 bit A/D, 128K RAM, D/A, date/time clock. Program with PC-compatible. Includes lots of ready-made software solutions. Made in England. Over 3000 in use in Europe for machine control, data-logging, robotics, factory automation, inspection, remote monitoring, etc. **ONLY \$219 (25qty)**

The SAELIG Company 1193 Moseley Rd Victor NY 14564 (716) 425-4367 or fax (716) 425-7381

Circle 309 on Reader Service Card

4-MEGABIT PROGRAMMER

for IBM XT/AT. . . . \$245

30-day money back guarantee
2716 to 274001 incl. EEPROM/CMOS
High speed programming algorithm
Intel/Motorola/Binary files utilities
87C51/51 & 41/42/48/49 adaptors (Optional)
Eprom emulator adaptor 2716-27256
Industrial Model \$398

4 Meg eproms available 879 E. Hastings, Vancouver
B.C. CANADA V6A 1R8
(Concom Restriction) 2370 Midland Ave.
One per customer Unit A-28, Scarborough
Ont. CANADA M1S 1P8

K.E.M. Tel (804) 251-1514
Tel (416) 754-7565
Fax (416) 754-7431

Circle 150 on Reader Service Card

LANtastic!

Cost Effective—Power Based LAN/RAN Solutions

CERTIFIED
COMPATIBLE



DISPLAY

VIDEO SEVEN FastWrite VGA™

- Maximum Resolution 1024x 768 • 256 Color Palette
 - VGA/EGA/CGA/MDA/Hercules
 - Supports 1 or 2 Monitors
 - Drivers for Most Popular Software
 - Works in AT/XT/386
- \$199***
Including VGA Color Monitor Now \$499*

FAX SYSTEMS

FAX + MODEM

4800 Baud Internal Includes
Group III Broadcast FAX
PLUS Hayes Compatible
2400 Baud Modem. Xlnt Software, Was \$395.

Now **\$99***
Only

JT/FAX by Quadram

- 4800 Baud JT/FAX Int. \$199*
- 4800 Baud JT/FAX Ext. 339*
- 9600 Baud JT/FAX w/Modem 499*

PC Magazine Editor's Choice

IMAGING

INTEGRATED IMAGE BOARD

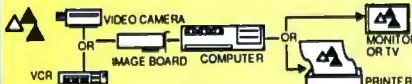

Tap the rich graphics sources of your TV, VCR or video camera with the push of a button. In less than 10 seconds you can make high resolution video snapshots and turn them into sharp halftone graphics. The program's quick editing utilities let you retouch, crop, and rotate images for use in virtually any graphics or desktop publishing application.

- NTSC/PAL Input and Output
 - High Resolution 512 x 480
- \$199***

WORLD'S LARGEST MODEM DEALER...

...AND WITH PRICES LIKE THESE ON HIGHEST QUALITY HAYES COMPATIBLE MODEMS YOU'LL SEE WHY.

		Internal Version	External Version
Fast	2400 BAUD	FULLY HAYES COMPATIBLE \$69*	\$99*
Faster	4800 BPS	HAYES COMPAT. W/ LEV. 5 SFT \$99*	\$129*
Fastest	9600 V.32	TRUE INDUSTRY STANDARD \$399*	\$499*

All modems are top quality, famous brand OEM models offering savings of up to 80%. Each features auto fallback to slower speeds. Two year warranty.

AWARD WINNING SYSTEMS

386 MICRO TOWER

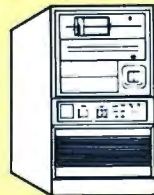

IBM/OS2 COMPATIBLE

\$995 Full Cash Price

While Special Supply Lasts!

386/25 Mhz 65 MB



HARD DISK

\$1995 Full Cash Price

Also: 33 Mhz Now Available!

PORTABLES TO GO

PORTABLE 286/386



- 6 Expansion Slots
- 640 x 400 Backlit LCD
- Handsome Carry Case
- High Speed Processor
- 2400 Baud Modem

- 286 Processor, 40 MB Hard Disk, 640K \$1495*
- 386 Processor, 65 MB Hard Disk, 1 MB 1895*

TOSHIBA T-1000 LAPTOP

- Battery/AC • IBM Compatible

LOWEST PRICES ANYWHERE!

\$639*

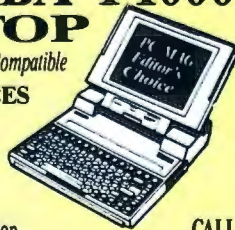

- 20 MB Hard Drive Option CALL
- T-3100 20 MB HD, Gas Plasma \$2495*
- T-1200FB Dual FD, Batt/AC 1495*

BEST MULTI-USER

386 POWER BASED MULTI-USER SYSTEM



4 WORKSTATIONS

For the cost of most stand alone 386 computers, you can have the processing speed and power of a 130MB, 386 network file server with four workstations, modem, plus BBS software for password protected remote access.

\$3995 Full Cash Price

Complete System Now Only
On-Site Installation & Support Now Available in Most Areas!

ALL *PRICES SHOWN ARE WHOLESALE AND REFLECT AN ADDITIONAL 3% CASH DISCOUNT. THE ON-LINE STORE'S WHOLESALE + 7% PURCHASER'S PAY JUST 7% ABOVE THE WHOLESALE PRICE, PLUS SHIPPING AND HANDLING. Minimum shipping: \$5 per order. International orders: call for rates. Prices subject to change. Products subject to availability and may be private label versions. WE ALSO SERVE LARGE CORPORATE ORDERS: call for information. This ad supersedes all previous.

CALL NOW! 24 HOUR ORDER LINE:
805/650-0188

BBS 805/650-0193
FAX 805/650-0195
CUSTOMER SERVICE 805/650-0188
3037 Golf Course Dr., Ventura, CA 93003

ONLINE STORE

Your International Headquarters for BBS

A-BUS™ MAGIC

Classroom to advanced industrial applications.

Be a Wizard in your Lab, Factory, College, Home...

It used to be difficult and costly to do process control, robotics, data acquisition, monitoring and sensing with your computer. Now the low-cost A-BUS system makes it easy to do almost any project you can imagine.

Versatility. A-BUS cards handle most interfacing, from on/off switching, to reading temperatures, to moving robot arms, to counting events, to sensing switches...

Adaptability. The A-BUS is modular, allowing expansion well beyond your needs. It works with almost any computer, or even as a remote data station with the new serial adapters.

Simplicity. You can start using the A-BUS in minutes. It's easy to connect, and software is a breeze to write in any language.

Reliability. Careful design and rugged construction make the A-BUS the first choice in specialized I/O.

An A-BUS system consists of: - An A-BUS adapter plugged into your computer - A cable to connect the adapter to 1 or 2 A-BUS function cards. - The same cable will also fit an A-BUS Motherboard for expansion to up to 25 cards in any combination.

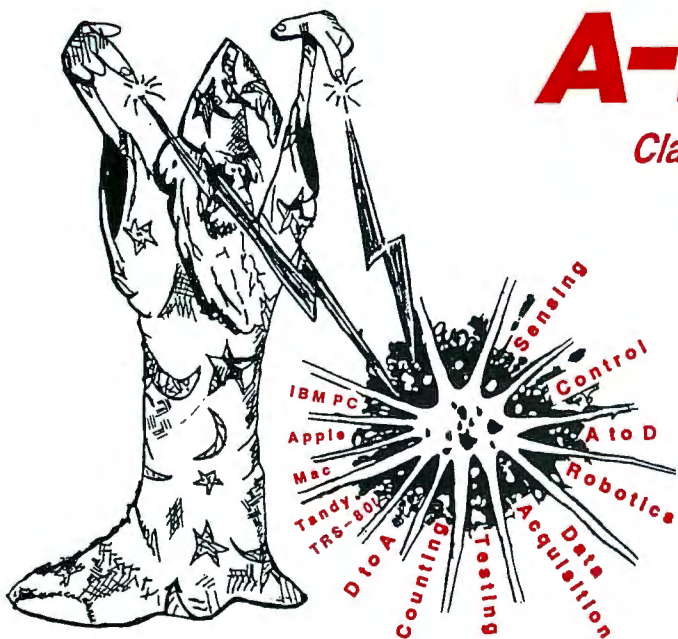

NEW: REMOTE A-BUS! Use the new Serial (RS-232) Adapter or Processor to control any A-BUS system. Cards can be up to 500 ft away using phone type cable, or off premises using a modem. Call or send for the new A-BUS Catalog which covers all the products.

Important

All A-BUS Systems: ♦ Come assembled and tested ♦ Include detailed manuals with schematics and programming examples ♦ Can be used with almost any language (BASIC, Pascal, C, assembler, etc.) using simple "IN" and "OUT" commands (PEEK and POKE on some computers) ♦ Can grow to 25 cards (in any combination) per adapter ♦ Provide jumper selectable addressing on each card ♦ Require a single low cost unregulated 12V power supply ♦ Are usually shipped from stock. (Overnight service is available.)

About Alpha Products

Founded in 1976 for the purpose of developing low cost I/O devices for personal computers, Alpha has grown to serve over 70000 customers in over 60 countries. A-BUS users include many of the Fortune 500 (IBM, Hewlett-Packard, Tandy, Bell Labs, GM...) as well as most major universities. A-BUS products are U.S. designed, U.S. built, and serviced worldwide. Overseas distributors: England: Cady Science Assoc. Ltd., Merseyside, 051 342 7033. Australia: Brumby Technologies Pty. Ltd., NSW, 759 1638. France: Coserm, Rungis, 46 86 64 75

Inputs, Outputs, etc.

Analog Input: 8 analog inputs. 0-5.1V in 20mV steps (8 bits). 0-100V range possible. 7500 conversions/second. **AD-142: \$142**

12 Bit A to D: Analog to digital converter. Input range -4V to +4V, expandable to 100V. On-board amplifier. Resolution 1mV. Conversion time 130ms. 1 channel. (Expand to 8 channels with the RE-156 card.) **AN-146: \$153**

Relay Card: 8 individually controlled industrial relays each with status LED's (3A at 120VAC contacts, SPST). **RE-140: \$142**

Reed Relay Card: 8 reed relays (20mA at 60VDC, SPST). Individually controlled and latched, with status LEDs. **RE-156: \$109**

D/A converter: 4 Channel 8 Bit D/A converter with output amplifiers and separate adjustable references. **DA-147: \$149**

24 line TTL I/O: Connect 24 input or output signals (TTL 0/5V levels or switches). Variety of modes. (Uses 8255A) **DG-148: \$72**

Digital Input: 8 optically isolated inputs. Input can be 5 to 100V voltage levels or switch closures. **IN-141: \$65**

Digital Output Driver: 8 outputs: 250mA at 12V. Drive relays, solenoids, stepper motors, lamps, etc. **ST-143: \$78**

Clock with Alarm: Powerful clock/calendar. Battery backup. Timing to 1/100 sec. Alarm relay, LED and buzzer. **CL-144: \$98**

Touch Tone Decoder: Each tone is converted into a number which is stored on the board. **PH-145: \$87**

A-BUS Prototyping card: 4x4.5" card. Will accept up to 10 I.C.s. With power & ground bus. **PR-152: \$16**

Counter Timer: Three 16 bit counters/timers. Use separately or cascade for long (48 bit) counts. **CT-150: \$132**

Motion Control

Smart Quad Stepper Controller: The world's finest. On board microprocessor controls four motors simultaneously. Uses simple English commands like "MOVE ARM 10.2 (INCHES) LEFT". For each axis, you control coordinates (absolute or relative), ramping, speed, units, scale factors, etc. Many inputs for limit switches, etc. On the fly reporting of speed, position... Built in drivers for small motors (such as MO-103 or 105). **SC-149: \$299**
Options: ▶ 5 amp/phase power booster for 1 motor: **PD-123: \$49**
▶ Remote "teach" keypad for direct motor control: **RC-121: \$54**

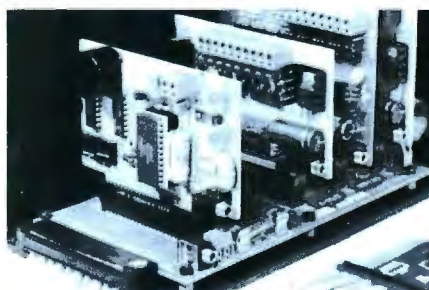

A large A-BUS system with two Motherboards Adapter in the foreground plugs into PC, XT, AT type slot.

Stepper Driver Kit: For experimenting with stepper motors. Includes 2 MO-103 motors and a ST-143 dual driver **PA-181: \$99**

Stepper Motors: (4 phase, unipolar)
MO-103: 2 1/4" dia, 1/4" shaft, 7.5°/step, 12V, 5 oz-in torque. **\$15**
MO-104: 2" dia, 1/4" shaft, 1.8°/step, 5V, 60 oz-in torque. **\$45**
MO-105: 1.7" square, .2" shaft, 3.75°/step, 12V, 6 oz-in. **\$15**

A-BUS Adapters

- ▶ Can address 64 ports and control up to 25 A-BUS cards.
- ▶ Require one cable. Motherboard required for more than 2 cards.

A-BUS Parallel Adapters for:

IBM PC/XT/AT & compatibles. Uses one short or long slot. **AR-133: \$69**
Apple II, II+, IIe Plugs into any slot inside. **AR-134: \$52**
Commodore 64, 128 Plugs into Expansion Port on back. **AR-139: \$48**
TRS-80 Model 102, 200 Uses 40 pin "System bus". **AR-136: \$76**
Model 100 (Tandy portable) Plugs into socket on bottom. **AR-135: \$75**
TRS-80 Model 3, 4, 4D Y-Cable available if 50 pin bus is used. **AR-132: \$54**
TRS-80 Model I Plugs into 40 pin expansion bus. **AR-131: \$39**
Tandy Color Computers Fits ROM slot. Multipack or Y-Cable **AR-138: \$49**

A-BUS Cable: Necessary to connect any parallel adapter to one A-BUS card or to first motherboard. 50 pin, 3 ft. **CA-163: \$24**
Special Cable for two A-BUS cards **CA-162: \$34**

Serial Adapter: Connect A-BUS systems to any RS-232 port. Allows up to 500 ft from computer to A-BUS. **SA-129: \$149**

Serial Node: To connect additional SA-129/A-BUS systems to a single RS232 serial port (max 16 nodes). **SN-128: \$49**

Serial Processor: same as above plus built in BASIC for off-line monitoring, logging, decision making, etc. **SP-127: \$189**
Use SA-129 or SP-127 with modems for remote data acquisition.

Motherboard: Holds up to 5 A-BUS cards in sturdy aluminum frame with card guides. A sixth connector allows (using cables CA-161: \$12) additional Motherboards to be added. **MB-120: \$108**

Power Supply: Power pack for up to 4 cards. **PS-126: \$12**

Complete Catalog Available

For Orders and Info call (203) 656-1806

Weekdays from 9 to 5 EST or FAX 203 656-0756

Call our application engineers to discuss your project.

Ordering Information: We accept Visa, Mastercard, Checks, and M.O. C.O.D. is \$4 extra. Purchase orders are subject to credit approval. CT residents add 7.5% sales tax. Shipping: \$4 per order (usually UPS ground). UPS 2nd Day Air: \$4 extra. Next Day service available. Canada: \$6 per order (Airmail). Outside US and Canada: Add 10% of order total.



ALPHA Products

242-B West Avenue, Darien, CT 06820

Circle 20 on Reader Service Card

EZ-WRITER

(E)EPROM Multiprogrammer™
DATA I/O 212* Performance
For Only **\$995.**

100% USA Made



- Supports (E)EPROMs up to 40-pins.
- Stand-alone or Remote.
- 40-pin Micros Opt.
- SET/GANG 4 (E)EPROMs Opt.
- Parallel port for Fast Up/Down Load.
- 256K bytes, expandable to 16 megabits.



1-800-523-1565

In Florida (407) 994-3520

Fax: (407) 994-3615

* DATA I/O is a registered trademark of DATA I/O Corporation

Circle 47 on Reader Service Card

a complete 80386 system for only

\$1995

- ☞ 1 meg ram
- ☞ 40 meg. hard drive
- ☞ TTL mono. monitor
- ☞ Parallel & Serial Ports
- ☞ Expand to 16 meg.
- ☞ 1 year warranty
- ☞ 30 day moneyback

Call for other systems and configurations at similar savings.

Scioto Computers

1-800-283-8616

Circle 253 on Reader Service Card

6800/6809 Micro Modules

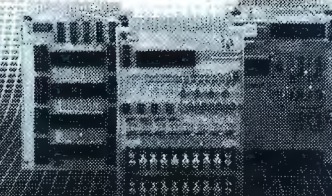

OEM 6800/6809 MICROCOMPUTER MODULES for dedicated control and monitoring. Interfaces for sensors, transducers, analog signals, solenoids, relays, lamps, pumps, motors, keyboards, displays, IEEE-488, serial I/O, floppy disks.



Wintek Corp.
1801 South Street
Lafayette, IN 47904
317-742-8428

Circle 324 on Reader Service Card

Terminal Emulation

TEK 4105/4010

- Tektronix 4105
- Tektronix 4010/4014
- VT220, VT102
- Picture files
- VGA and EGA support
- High resolution hardcopy

VT220

- VT220, VT102 emulation
- File transfer
- 132 column modes
- Color support
- Hot key

■ ■ ■ Diversified Computer Systems, Inc.

3775 Iris Avenue, Suite 1B
Boulder, CO 80301 (303) 447-9251
FAX 303-447-1406

Trademarks: VT102, VT220 — DEC, Tektronix — Tektronics Inc.

Circle 90 on Reader Service Card

DYNAMIC RAMS

SIMM	80/100	\$CALL
1MBIT	100ns	\$11.25
514256	100ns	\$11.75
41464	150ns	\$ 3.95
41256	120ns	\$ 3.65
✓ 41256	150ns	\$ 3.50
✓ 51258	100ns	\$ 4.50
✓ 4164	150ns	\$ 2.35

* For high-speed, Zip, Ploc, Simm Please Call!

■ MATH COPROCESSORS

80387-33	33MHz	\$560.00
80387-25	25MHz	\$455.00
80387-20	20MHz	\$360.00
80387-16	16MHz	\$305.00
80387SX		\$295.00
80C287A	12MHz	\$275.00
80287-10	10MHz	\$209.00
80287-8	8MHz	\$186.00
8087-1	10MHz	\$160.00
8087-2	8MHz	\$125.00

■ E PROMS

27C101	250ns	\$ 23.00
27C512	200ns	\$ 13.00
27S12	250ns	\$ 8.00
27C256	250ns	\$ 6.25
27S26	250ns	\$ 4.75
27128A	250ns	\$ 4.50
27C256A	200ns	\$ 4.25
2784	250ns	\$ 3.50
■ CPU		
V-30	8MHz	\$ 12.75
V-20	8/10MHz	\$ 8.915

I.C. EXPRESS

15358 Valley Blvd. City of Industry, CA 91746 Tel: 818-309-2688
ORDER TOLL FREE (Mon-Fri 8-5 PST)
(800) 892-8889 • (800) 882-8181
Outside California

CALL FOR CURRENT PRICES & VOLUME DISCOUNTS
Price shown for cash. MasterCard and Visa. Prices are subject to change.
Minimum order \$10.00. Shipping & handling: L.P.S. Ground \$5.00 Air \$7.00 (if S.)
ALL MERCHANDISE IS 100% GUARANTEED WITH PROMPT DELIVERY.

Circle 126 on Reader Service Card



New, Gridless, 100% Autorouting
Create schematics and PCBs quickly and simply with **HiWIRE-Plus®** and your IBM PC. With the new, gridless, multilayer autorouter (AR) for HiWIRE-Plus, creating printed-circuit layouts is even faster. AR and HiWIRE-Plus are each \$895 and come with 30-day money-back guarantees. Credit cards welcome.



Corporation
1801 South St., Lafayette, IN 47904
(800) 742-6809 or (317) 742-8428

Circle 291 on Reader Service Card



5 1/4 DD	5 1/4 HD
6²⁵	11³⁰
PER BOX	PER BOX
3 1/2 DS	3 1/2 HD
11⁹⁵	25⁹⁵
PER BOX	PER BOX



3.5 DS	5 1/4 DS	3.5 HD
9⁹⁵	6⁴⁰	22⁹⁵
PER BOX	PER BOX	PER BOX
	5 1/4 HD	
	10⁹⁵	
	PER BOX	

LASER TONER

- HP LaserJet 2 & 2D
- CANON 2
- HP LaserJet Plus & 500+
- CANON LPB
- APPLE LaserWriter

84⁹⁵
ea

Ricoh Toner Kit 80 "CALL"
Ricoh OPC 80,81 or 150 \$139⁹⁵

Qume Toner
KYOCERA F100A, F101
BROTHER LP 10
UNISYS 37 **21⁹⁵**

the Diskette Connection™

Delaware 1-800-451-1849
P.O. BOX 10247, WILMINGTON, DE. 19850
Oklahoma 1-800-654-4058
P.O. BOX 1674, BETHANY, OK. 73008
Nevada 1-800-621-6221
P.O. BOX 12396, LAS VEGAS, NV. 89112

Minimum order \$20.00 "No Surcharge on Visa MasterCard." COD orders add \$3.00 Surface. Shipping UPS add \$4.00 per 100 for 3 1/2" or 5 1/4", add \$4.00 per 100 for 8". U.S. Mail delivery add 9% "Prices subject to change without Notice."



FAX: 405-495-1598

GraphicTM

"gives you all the C language routines you need to write an impressive scientific graphing program of your own. Highly recommended.*" PC Magazine

Fresnel Integrals

$$C(x) = \int_0^x \cos(\frac{1}{2}t^2) dt$$

$$S(x) = \int_0^x \sin(\frac{1}{2}t^2) dt$$

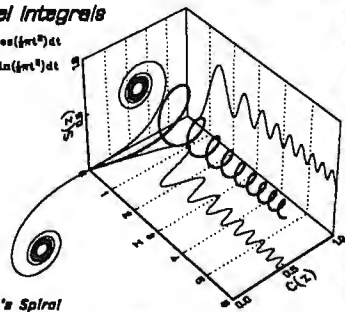

Cornu's Spiral

IBM® PC version
(with source code) \$395
Circle 250 on Reader Service Card

Macintosh® version
(no source code) \$295
Circle 251 on Reader Service Card

For personal use only.

VTEKTM 4.3

DEC® VT100/102/52 & Tektronix®
4010/4014/4105
Terminal Emulator

"its ease of use, high resolution graphics, emulation, and price make it a more attractive purchase than the other products.*"

MINI-MICRO Systems
Only \$150

Circle 252 on Reader Service Card
* Full reprints on request

Scientific Endeavors
508 North Kentucky Street
Kingston, TN 37763
(615) 376-4146

New, Improved!

8051/8052 BASIC COMPILER!

Now with integer, byte and bit extensions.
Fully compatible with MCS BASIC 52
Runs on IBM-PC or compatible

\$ 449.00

Call Now! 603-469-3232

Binary Technology, Inc.
Main Street • P.O. Box 67 • Meriden, NH 03770

Circle 37 on Reader Service Card

Data acquisition • process control • mathematical and statistical analysis • data generating • libraries for GPIB, RS-232 and plug-in cards • high-performance graphics and presentation • PC/XT/AT compatible

Acquisition, Control, Analysis and Presentation

Take it easy with

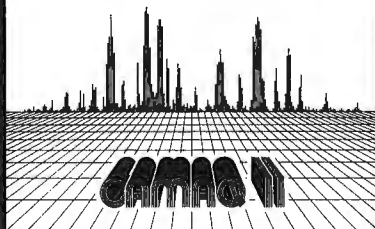

Dealer welcome!

IMES GmbH West-Germany
Nebelhornstr. 38 Phone 49-8141-80403
D-8031 Eichenau FAX 49-8141-80358

Circle 129 on Reader Service Card

ULTIMATE COMPUTER AIDED PCB DESIGN



The ULTIMATE PCB layout package featuring:

- Real-Time Design Rule Check
- Curved and angular traces
- Trace Show and Rotate-While-Move
- Full SMT support
- Autoroute by window, component or net
- Powerful placement tools
- 32 layer supports: blind & buried vias
- Backannnotations: pin/gate swap

Extended memory versions with unlimited design size and 32 bit performance are available.
USA/Canada: ULTIMATE Technology Corp. • Tel: (408) 43 98944 • Fax: 439-9006
UK/Ireland: ULTIMATE Technology (UK) Ltd. • Tel: (0734) 812030 • Fax: 812323
Int. Headquarters: ULTIMATE Technology B.V. • Tel: (+31)2159-44424 • Fax: 43545

ULTIMATE ASK FOR YOUR FREE DEMO DISK

See us at Wescon,
San Francisco, Booth 1546

Circle 281 on Reader Service Card

Add some FUN to your PC!

EYE-GARD is a great novelty for your home or office! The EYE-GARD vision sensor detects anyone simply walking up to your PC. Then it . . .
... displays any PCX-format picture.
... displays any message YOU choose.
... plays music or sound effects.
... requests a password before letting anyone use your PC.

EYE-GARD can even run other programs. It is perfect for sales or software demos!

EYE-GARD runs on all IBM-compatible computers. Comes with EYE-GARD sensor, software, sound and picture files.

EYE-GARD is a great gift for you . . . or anyone! . . . who uses personal computers.

Order NOW for Christmas!
Only \$19.95
(plus \$3.50 p/h)
VISA/MasterCard Accepted

Circle 99 on Reader Service Card



PC/XT/AT BUS DATA ACQUISITION

Free Catalog!

- | | |
|----------------------------------|-------------|
| AD1000 12-Bit A/D, DIO, Counters | \$295 |
| ADA300 8-Bit A/D, D/A, DIO | \$239 |
| DG24/96 8255-based DIO | \$95/\$239 |
| TC24 Am9513 Counter, DIO | \$189 |
| DA600 2/4 Channel 12-Bit D/A | \$179/\$239 |

All cards made in USA!
We offer a wide range of A/D, D/A, DID, counters, prototype, extender cards, interfacing books & accessories. 30 day NO RISK return and 1 year warranty on all cards.

Real Time Devices, Inc.

rtdd 531 E. Marylyn Avenue
P. O. Box 906
State College, PA 16804 USA
814/234-8087

Circle 237 on Reader Service Card

SuperSound

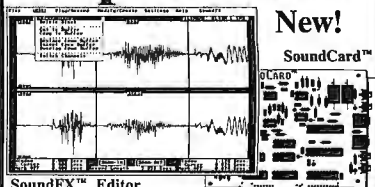

SoundFX™ Editor
Add SOUND EFFECTS, VOICE, MUSIC to IBM-PC/XT/ATs from \$69.95!

- Best Digital Audio Software/Hardware**
SuperSound - Stereo Version \$339 - Mono \$239
30 Day Money-Back Guarantee if not Satisfied
- With SoundFX™ - Friendly GUI / Graphical Editor for Fast Easy Record, Play and Special Effects (Lips, Mouse or Key-board) and 1W/Ch SoundCard™
 - Full Fidelity - Adjustable Sampling Rate / Recording Time - VLST AD D/A's
 - 82 Functions / Special Effects - 94 Page Manual w/ Digital Audio Tutorial
 - 4 Diskette Starter Set of SoundBytes™ - 14 Sample Sounds
 - For Business: Training, Point-of-Sale Shows - Works with Grasp, Olibac, etc.
 - For Engineering: Built-in Function Generators, Make Clear Voice Alarms, etc.
 - For Fun: Create Your Own Mac-ike Boot-up Sounds, Error Messages...

Silicon Shark

5120 Campbell Ave. #112, San Jose, CA 95130
PH: (408) 446-4521 VISA - MasterCard

Circle 254 on Reader Service Card

BEST BUYS FOR 14 YEARS!

JADE COMPUTER



\$498

—A PROVEN BEST SELLER—

- 8088 microprocessor running at 10 MHz or 4.77 MHz
- 640KB
- 5.25" 360KB RAM Drive
- Dual diskette drive controller
- Parallel printer port
- Eight XT expansion slots
- 150 watt power supply
- 8087 socket
- Front panel display
- 101 Key enhanced keyboard
- Serial RS-232C port
- Game Port
- Clock/Calendar

Monitor & Hard Drive Options

Floppy Only	20 Megabyte	30 Megabyte
\$648	\$798	\$848
Complete Monographics System		
\$748	\$898	\$948
Complete Color System		
\$998	\$1148	\$1198
Complete VGA System		

JADE COMPUTER

PRO-286



12 MHz **\$798**
20 MHz **\$998**

Monitor Optional

—286 POWERHOUSE—

- 80286 processor running at 12 MHz or 20 MHz
- Zero wait state
- 512K RAM expands to 4 MB
- 1.2 MB or 1.44 MB drive
- Hard/Floppy controller
- Six 16-Bit & Two 8 Bit expansion slots
- 80287 socket
- Clock/Calendar
- 101-key enhanced keyboard
- 200 watt power supply
- Norton S.I. 13.7/20.3
- Landmark 16/25.9
- One Year Warranty

Monitor & Hard Drive Options (12 MHz)

Floppy Only	40 Megabyte	80 Megabyte
\$928	\$1278	\$1498
Complete Monographics System		
\$1298	\$1648	\$1898
Complete VGA System		

For 20 MHz System Add \$198

JADE COMPUTER

Super-386



20 MHz **\$1578**
25 MHz **\$1878**

Monitor Optional

25 MHz Cache **\$2498**

—FIRE BREATHING 386—

- 80386 processor running at 20 MHz or 25 MHz
- 1 MB RAM expands to 6 MB
- 384K Shadow RAM
- 1.2 MB or 1.44 MB drive
- 1:1 Interleave Hard Disk
- /Floppy Disk controller
- 80387 socket
- Full size case
- One 32-Bit. Five 16-Bit Two 8-Bit slots
- 101 key enhanced keyboard
- 200 watt power supply
- Clock/Calendar
- Norton S.I. 23/31.6/31.6
- Landmark 25.5/32.6/43.5

Monitor & Hard Drive Options (20 MHz)

Floppy Only	40 Megabyte	80 Megabyte
\$1698	\$2058	\$2298
Complete Monographics System		
\$1998	\$2398	\$2678
Complete VGA System		

For 25 MHz add \$298 25 MHz Cache add \$898

EPSON

LX-810	\$188
FX-850	Call
FX-1050	Call
LQ-510	\$328
LQ-850	Call
LQ-950	Call
LQ-1050	Call
LQ-2550	Call

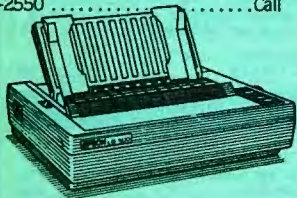

Panasonic

KX-1180	\$178
KX-1191	\$238
KX-1124	\$318

Daisywheel Printer **\$199**
40 CPS

Plotter **\$688**
List Price \$1796

Roland DXY-980

- 8 PEN 230mm/SEC
- .05mm Resolution
- HPGL Compatible
- Electrostatic Hold Down
- Parallel and Serial Input
- Digitizing Capacity

Surge Protector

S.L. Weber 6 outlet	\$18
Isobar 4 outlet	\$48
Isobar 8 outlet	\$68
Isobar modem protector	\$24

TrippLite Line Stabilizer

600 Watt Line Conditioner	\$98
1200 Watt Line Conditioner	\$158
1800 Watt Line Conditioner	\$188

TrippLite Battery Back-up

450 Watt UPS	\$398
750 Watt UPS	\$498
1200 Watt UPS	\$698

intel

8087	\$88	80287-12	\$278
8087-2	\$118	80387-SX	\$318
8087-1	\$158	80387-16	\$348
80287	\$128	80387-20	\$388
80287-8	\$198	80387-25	\$488
80287-10	\$228	80387-33	\$598
IIT Coprocessors In Stock Call			

Modems

1200 internal w/software	\$48
2400 internal w/software	\$88
1200 baud external	\$88
2400 baud external	\$148
2400 PS/2 internal	\$198
Intel 2400B for PS/2	\$278

Mouse

Opto Mechanical
With Software

\$29

Logitech

LogiMouse Serial	\$68
LogiMouse Hi-Rez, Bus	\$88
LogiMouse Hi-Rez Serial	\$98

Full Page Scanner
With OCR Software

\$359

Scanner

Complete Hand Scanner	\$98
LogiTech Scan Man	\$248
Diamond Flower HS-3000 Plus	\$228



California

Torrance, Costa Mesa, Woodland Hills
Kearny Mesa, Sunnyvale

Texas

Addison, Houston

Georgia Arznoa
Smyrna Phoenix

Not all items in stock at our nine retail locations.

JADE COMPUTER

4901 W. Rosecrans Ave. Box 5046 Hawthorne, California 90251-5046 213-973-7707

Continental U.S.A. 1-800-421-5500

Inside California 1-800-262-1710



We accept checks, credit card or purchase orders from qualified firms and institutions. No surcharge on credit card orders. CA., TX. GA. & AZ. residents add sales tax. Prices and

availability subject to change without notice. Shipping and handling charges via UPS ground 50¢/lb. UPS air \$1.00/lb. Minimum charge \$4.00. Fax machine 1-213-675-2522



Established 1976

Now Open in Las Vegas!
California Residents call:

1-800-843-8414

and save 6% SALES TAX

located at 4025 S. Industrial Blvd.

Las Vegas, NV

(702)732-8689

SIMM/SIPP MODULES 1 MG X 9- for IBM TYPES 1 MG X 9-120NS\$165 1 MG X 9-100NS\$145 1 MG X 9- 80NS\$160 1 MG X 9- 70NS\$299 256 X 9- for IBM TYPES 256 X 9-120NS\$49 256 X 9-100NS\$40 256 X 9- 80NS\$45 256 X 9- 60NS\$75 APPLE SIMM MODULES 1 MG X 8-120NS\$149 1 MG X 8-100NS\$165 256 X 8-120NS\$45 256 X 8-100NS\$59 PS 2 SIMMS 256 X 9 (FOR PS2) 256 X 9-120NS\$79 (30F3348)(KIT-2EA.)\$154 MODEL 30 286 1 mg x 9-100\$235 (30F3360)(KIT-2EA.)\$478 PS-2 MODEL 70 & 80 SIMM 1 MG X 9-100NS\$249 1 MG X 9-80NS\$299 2 MG X 9-80NS\$485 (8450608) (For 70A21) 2 MG X 9-80NS\$549 (8450604) (For 70E61/70-121/all models) 1 MG X 9-80NS\$299 (8450603) (For 70E61/70-121)	DIP ZIP SIMM SIPP PS-2 SIMM MATH-CO ZENITH 386 MODULES 1 MG X 9-80 NS\$299 1 MG X 9-70 NS\$329 AST 386 MODULES 1 MG X 9-80 NS\$299 1 MG X 9-70 NS\$329	D-RAM 1 MG X 1 1 MG X 1-120NS\$12.00 1 MG X 1-100NS\$12.50 1 MG X 1- 80NS\$12.95 1 MG X 1- 70NS\$18.80 256 X 1 256 X 1-150NS\$3.95 256 X 1-120NS\$4.20 256 X 1-100NS\$4.50 256 X 1- 80NS\$4.80 256 X 1- 70NS\$4.50 256 X 1- 60NS\$7.20 256 X 4 256 X 4-120NS\$13.50 256 X 4-100NS\$14.00 256 X 4- 80NS\$18.00 64 X 1 4164-150NS\$1.40 4164-120NS\$2.10 4164-100NS\$2.40 64 X 4 4464-150NS\$5.80 4464-120NS\$4.50 4464-100NS\$5.80 4464- 80NS\$4.50 256 X 4 STATIC COL 514258-100NS\$25 256 X 1 STATIC COL 51258-100NS\$5.50 51258- 80NS\$4.50 51258- 70NS\$7.80	MATH-CO-PRO 8087-3(5MHZ)\$88 8087-2(8MHZ)\$118 8087-1\$165 80287-6\$120 80287-8\$125 80287-10\$218 80C287-12\$295 80387-16\$310 80387-20\$360 80387-25\$450 80387-33\$629 CPU CHIPS 8088\$5.00 80286-9\$49 80286-10\$59 80286-12\$69 80386-16\$180 80386-20\$240 80386-25\$330 V-20 (8MHZ)\$7.50 V-20 (10MHZ)\$12.80 VIDEO RAM FOR VGA CARDS 64 x 4(150NS)\$7 64 X 4(120NS)\$10 64 X 4(100NS)\$13 RAM TESTER only \$139 Tests the following memory chips: 64K X 1 256 X 1 64K X 4 256 X 4 4M X 1 1M X 1 The RTI can help anyone come through the frustrating process of identifying bad (or good) D-RAM chips.
--	---	---	---

BOCA RESEARCH BOCARAM 50Z- Up to 3 MG\$169 for model 50-50Z-60-0 wait state+ Expanded, extended and base memory+ Uses 1MG D-RAM (DIP) BOCARAM 50/60 - Up to 4 MG\$169 for model 50-60-0 wait state expanded, extended and base memory+ Uses 1MG D-RAM (DIP) BOCARAM AT PLUS - Up to 8 MG\$159 for all AT (80286) Computer Expanded, extended and base memory can be used w/ LIM, EMS 4.0, OS/2, UNIX, 16 BIT BD and operates up to 33 MHz + Uses 1 MG D-RAM (DIP) BOCA MCA Parallel Card (for PS/2)\$99 BOCA MCA Serial Card (for PS/2)\$199 IBM 1497250 - For PS-2 MOD 50/60 with OK Expands to 8MB Uses 256K SIMMS (IBM only)\$439 8458885 - For PS-2 MOD 70/80 with 2 MG Expands to 8 MB Uses 2MG SIMMS (IBM only)\$1299 8458283 - For AT - Has SER/PAR/CLK/Game port Uses 64K D-RAMS\$129	ORCHID RAMQUEST HZ - Up to 2MB of D wait state memory for the IBM PS/2 Models 50, 50Z & 60 + Guaranteed EMS 4.0 and OS/2 Compatible+ Easy 4-keystroke installation + Uses 1MG Dip +\$199 RAMQUEST EXTRA - The only multifunction card that provides up to 8MB and two serial ports on one board for the IBM PS/2 Models 50, 60 and 80. + Guaranteed EMS 4.0 and OS/2 Compatible. + Easy to install with only 4 keystrokes. Uses 256 and/or 1MB SIMM'S\$319 RAMQUEST EXTRA 1MB/2- The only 0-8MB, 0 wait state card for PS/2 Models 50, 50Z, 60, 70 and 80 which fully supports both 16-bit and 32-bit memory access. Includes one serial and one parallel port plus a free serial cable. Guaranteed EMS 4.0 and OS/2 Compatible. Easy 4-keystroke installation. Uses 256 and/or 1MB SIMM'S\$319 RAMQUEST XT/AT - A full size, 0-8 MB, zero wait state card for IBM PC, XT, AT, PS/2 25, 30 and compatibles. Uses 256K and/or 1MB SIMM'S. Automatically supports either 8 or 16-bit bus.\$259 RAMQUEST XT/AT with UD - Same as above plus 1-serial and 1-parallel port\$319																																				
UNITEX 3MG Multifunction - for AT\$129 Expands to 3MG - has SER/PAR PORT 256K D-RAM 384 Multifunction Card for PC/XT\$89 Expands to 384K has SER/PAR/CLK/Game port Uses 64K D-RAMS	ACCELERATORS TINY TURBO 286 Low-cost High-speed Half-slot PC/XT - Accelerates your PC/XT with an 8 MHz 80286 Microprocessor. 80287 math chip socket\$239 TINY TURBO XT m High-speed Half-slot accelerator for PC/XT - Accelerates your PC/XT up to 4.5X faster with a 12 MHz 80286 microprocessor. 80287 math chip socket.\$299 JET 386-HyperSpeed Accelerator Card for AT's - Accelerates your AT up to 3X faster with a 16 MHz. 80386-Socket for math chip\$895																																				
COMPAQ MEMORY <table border="1"> <tr> <th>ADD-ON MODULES</th> <th>1MG</th> <th>4MG</th> </tr> <tr> <td>386/20</td> <td>\$349</td> <td>\$999</td> </tr> <tr> <td>386/25</td> <td>\$349</td> <td>\$999</td> </tr> <tr> <td>386/20E</td> <td>\$349</td> <td>\$999</td> </tr> <tr> <td>386/8</td> <td>\$399</td> <td>\$1349</td> </tr> <tr> <td>286 E</td> <td>\$349</td> <td>\$999</td> </tr> </table> <table border="1"> <tr> <th>MEMORY EXPANSION BOARDS</th> <th>1MG</th> <th>4MG</th> </tr> <tr> <td>386/20E</td> <td>\$549</td> <td>\$1349</td> </tr> <tr> <td>386/8</td> <td>\$549</td> <td>\$1349</td> </tr> <tr> <td>386/16</td> <td>-</td> <td>\$1429</td> </tr> <tr> <td>286 E</td> <td>\$549</td> <td>\$1329</td> </tr> <tr> <td>8L7286</td> <td>\$579</td> <td>-</td> </tr> </table> 386/16(8MG EXPANDS TO 16MG)\$2999 PORTABLE 386 (1MG MEMORY UPGRADE)\$529	ADD-ON MODULES	1MG	4MG	386/20	\$349	\$999	386/25	\$349	\$999	386/20E	\$349	\$999	386/8	\$399	\$1349	286 E	\$349	\$999	MEMORY EXPANSION BOARDS	1MG	4MG	386/20E	\$549	\$1349	386/8	\$549	\$1349	386/16	-	\$1429	286 E	\$549	\$1329	8L7286	\$579	-	EVEREX RAM 3088 DELUXE-Up to 3 MB. Selectable memory addresses. Expanded Memory Specifications (EMS)4.0/OS/2. Can be used to backfill base memory up to 640K and the rest as either Expanded or Extended or both. Uses 256K D-RAM\$99.00 RAM 8008-Up to 8MB capacity/supports base, extended or expanded memory in any combination. Fully compatible with Lotus/Intel/Microsoft EMS 4.0/EMS. Supports multitasking and DMA multitasking in hardware. Software configurable (no dip switches to set). Full 16MB window for future expansion of Lotus/Intel/Microsoft EMS 4.0. 0 wait states, uses 1MG D-RAM (DIP)\$279 RAM 10008-Up to 10 MB capacity/supports base, extended or expanded memory in any combination. Compatible with Lotus/Intel/Microsoft EMS 4.0. Operates with no additional wait states. Uses 1MG D-RAM (DIP)\$179 MINI-MAGIC - (EV138)-Up to 576K. For PC-AT. Uses 256K & 64K\$59
ADD-ON MODULES	1MG	4MG																																			
386/20	\$349	\$999																																			
386/25	\$349	\$999																																			
386/20E	\$349	\$999																																			
386/8	\$399	\$1349																																			
286 E	\$349	\$999																																			
MEMORY EXPANSION BOARDS	1MG	4MG																																			
386/20E	\$549	\$1349																																			
386/8	\$549	\$1349																																			
386/16	-	\$1429																																			
286 E	\$549	\$1329																																			
8L7286	\$579	-																																			

VIDEO ADAPTER ATI SUPER WONDER BASIC EGA\$189 Supports MDA, CGA, EGA & Hercules EGA WONDER\$239 Supports MDA, CGA, EGA & Hercules VP VGA\$275 Supports VGA, CGA, MDA, EGA & Hercules ORCHID Designer 800 VGA\$229 800 X 600 - 16 Colors ProDesigner VGA\$319 Supports 1024 X 768 - 16 Colors Pro Designer VGA Plus\$390 Same as ProDesigner Has downloadable fonts	UNITEX MONOCHROME GRAPHICS CARD\$41 With Par port + MGA/ Hercules COLORGRAPHICS CARD\$41 RGB Color with Par Port + EGA/ MGA/ CGA/ Hercules EGA CARD\$149 640 X 480, 16 Colors, EGA/ MGA/ CGA/ Hercules VGA CARD\$199 600 X 800, 16 Colors, VGA/ EGA/ MGA/ CGA NO SLOT CLOCK Clock for PC & XT Computers Plugs into empty ROM Socket on Mother Board. Accurate 1/100 th of a second Only \$34.95
---	---

TERMS AND CONDITIONS

No Surcharge for MC / VISA Terms: MC • VISA • COD • CASH • AMEX add 4%
 Purchase Orders from qualified firms • 20% restocking fee on non-defective returns
 Prices Subject to Change

ZUCKER P82 - 2MG MB - Up to 2 MG for microchannel PS/2 and Compatibles. Uses 256 X 9 SIMM\$49 P82 - 2 MG Multifunction BD- Up to 2 MB- Has serial and PAR PORT Software. Uses 256 X 9 SIMM\$99	MODEMS Everex EverCom 12 300/1200 bps Bitcom Software\$74 EverCom 24 2400 Baud Internal Bitcom Software\$139 External 2400 Baud\$199 Hayes Compatible 1200 Baud Internal w/Software\$59 1200 Baud External Fully Hayes Compatible\$99 2400 Baud Internal 1/2 card w/Software\$199 2400 Baud External Fully Hayes Compatible\$129
---	--

Unitex, Inc
 A Publicly Traded Company
 Corporate Headquarters
 2852 F Walnut - Tustin, CA 92680
 Phone: 714/730-5232 • FAX#: 714/838-8593
Customer Service #: 714/730-9527

TOLL FREE OUTSIDE CA: 1/800/533-0055

We Accept
AMERICAN EXPRESS
4% Handling

Mon-Fri 7am - 5pm
Sat 8am - 2pm

E/EPROM & MICRO PROGRAMMER

\$895



- EP-1140 includes: software, cable, user's manual, 2 free software update coupons, toll-free technical support, one-year warranty & a unconditional 30-day money back guarantee
- Programs 24, 28-, 32- & 40-pin E/EPROMs
- Supports 874X & 875X series microcontrollers
- Connects to a standard parallel port
- 32-pin model, EP-1132, available for \$695

The Engineer's Programmer™

CALL TODAY 800-225-2102

BP MICROSYSTEMS

10681 Haddington, #190, Houston, TX 77043
713/461-9430 FAX 713/461-7413

IMAGING CARD

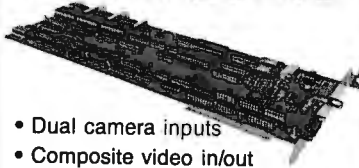

- Dual camera inputs
 - Composite video in/out
 - 256 x 240 resolution
 - Digitize/display at frame speed
 - 16 Meg. color palette out (DV-02)
 - External trigger input option
 - PC/XT/AT compatible
 - Complete with software & library
- DV-02 8-bit 256 gray levels . \$849**
DV-03 6-bit 64 gray levels . \$549
VISA/MC Demo disk available

Control Vision

PO Box 596 Pittsburg KS 66762
800/292-1160 316/231-6647

Circle 69 on Reader Service Card

DATA ACQUISITION

ALL needs! ANY computer!

- PC Software Included
- Serial, Modem, & Bus
- Stand Alone Ability
- Laptop & Handheld
- PC & MAC Cards
- Inexpensive
- OEM & VAR
- RTU's



Call for FREE DEMO DISK!

Specialists in portable and battery backed up as well as PC compatible modular systems.

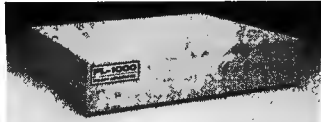

Call for applications info: (201) 299-1615
P.O. Box 246; Morris Plains, NJ 07950

ELEXOR

Circle 93 on Reader Service Card

800 Pixel Windows with your EGA and the WinTerm™ EGA800

The WinTerm™ EGA800 daughterboard and driver will give your standard EGA 800 pixel resolution when running Microsoft® Windows 286.

Think of it — 56,000 more pixels with a standard EGA and enhanced color display.

Special Introductory Offer
\$59.00

KEA KEA Systems Ltd.

2150 West Broadway, Suite 412
Vancouver, B.C. CANADA V6K 4L9
Tel: 604-732-7411 Fax: 604-732-0715
Toll Free Order Desk: 800-663-8702
WinTerm is a trademark of KEA Systems Ltd.

Circle 143 on Reader Service Card

A Real Breakthrough—No Bull!

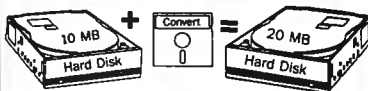

20 MB HARD DRIVE \$89

- Turn your 10 MB Hard Drive into a real 20 MB Hard Drive!
 - Our easy to use software is not a file compression program and it's not memory resident!
 - Use it once. It actually changes the physical characteristics of your 10 MB Hard Drive and makes it a permanent 20 MB Hard Drive.
 - Your programs will work normally
 - Works on any 10 MB hard Drive.
 - It's true—Money Back Guarantee!
- Order CONVERT® today!
We pay S & H. Mail \$89 to:

SWIRLISOFT®

3240 Dueber Ave. S.W. Canton, OH 44706
216-484-5320

Circle 266 on Reader Service Card

3M

DS-DD	Quantity Discounts Available	DS-HD
5.69*	... 5.25" 3M Diskettes 10/Box ...	10.99
10.99	... 3.50" 3M Diskettes 10/Box ...	25.49
17.99	... 8.00" 3M Diskettes 10/Box ...	19.99

DC-2000	14.49	DC-600A	20.49
DC-300XLP	18.49	DC-6150XTD ..	21.49

3M Compac Tape™ 1/2" DEC TK-50 Tape-min 10 ... **25.95**
IBM 3480 Tape Cartridge-min 30 ... **5.85**
3M Mag. Tape with seal 2400'-min 10 ... **12.70**



BASF

DS-DD	Quantity Discounts Available	DS-HD
4.79	... 5.25" BASF Diskettes 10/Box ...	7.79
9.29	... 3.50" BASF Diskettes 10/Box ...	22.99

.32 ... BASF 5.25" DS-DD No-Logo Bulk with Tyvek sleeves, labels & W/P
.29 ... BASF Branded 5.25" 1S/2D/48PT Diskettes
BASF Mag. Tape 2400' ... **10.50**



Verbatim DataLifePlus
Teflon/Preformatted

DS-DD		DS-HD
5.89	5.25" DataLifePlus 10/Box	11.29
10.95	3.50" DataLife Plus 10/Box	23.79
6.49	Verbatim DataLife Color Disks 5.25" 2S/2D 10/Box	

DYSAN PRECISION

6.29	5.25" DS/DD 10/Box	3.39
10.49	5.25" DS/HD 10/Box	6.39
10.95	3.50" DS/DD 10/Box	8.99
23.79	3.50" DS/HD 10/Box	20.99

MAXELL *FREE Audio Cassette

5.25" DS/DD	5.25" DS/HD	3.50" DS/DD	3.50" DS/HD
5.79	11.39	11.59	26.99

3M HIGHLAND

5.25" DS/DD	3M Highland Diskettes 10/Box	5.25" DS/HD	
3.69		6.79	
3.50" DS/DD		3.50" DS/HD	
8.99	Brand Name 10/Box	20.99	

KAO Color Diskettes

5.25" DS/DD	5.25" DS/HD	3.50" DS/DD	3.50" DS/HD
.32*	.72*	.79	21.99

*5.25" Color add 4¢ for Tyvek sleeves & labels

No-Logo Bulk Diskettes

5.25" DS/DD	5.25" DS/HD	3.50" DS/DD	3.50" DS/HD
.27*	.49*	.68	1.79*

*Bulk diskettes include sleeves, labels and w/p tabs

TERMS: No surcharge on VISA, Mastercard or AMEX. COD only add \$3.00. PO's accepted from recognized institutions on Net 30. Bank draft, T/T or L/C acceptable. **Shipping:** \$4/100 or fewer disks. Reduced shipping charges on large quantities. Price quoted for case (100 disks) quantities less than a case add 5%. (Min. order \$25.00 Min. order on PO's \$150.00.)

Toll Free Order Line: **1-800-523-9681**
Information Line: **1-801-255-0080**
TLX-9102404712 FAX-801-572-3327

DISK COTECH

DISKCO TECHNOLOGIES, INC.
213 Collage Avenue
P.O. Box 1339 Sandy, Utah 84091

Sure it's insured?

SAFWARE® Insurance provides full replacement of hardware, media and purchased software. As little as \$39/yr. covers:

- Fire • Theft • Power Surges
- Earthquake • Water Damage • Auto Accident

For information or immediate coverage call:

1-800-848-3469

In Ohio call 1-614-262-0559

SAFWARE

SAFWARE, The Insurance Agency, Inc.

Circle 246 on Reader Service Card

ALL NEW !!!
9 TRACK TAPE SUBSYSTEM
 for IBM PC/AT/386
 complete for only
\$2,595.00
1 YEAR WARRANTY

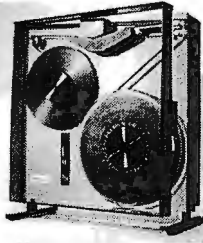

- IBM/ANSI compatible at 800*/1600/3200 bpi
- Controller, cables and software included
- Interfaces for PS/2*, Xenix* and DEC*
- SCSI*, AT or MCA* Bus I/O at 25/50/100 ips.
* optional

AKSystems Inc.
 20741 Marilla St. Chatsworth CA 91311
 TEL: 818/709-8100 FAX: 818/407-5889

Circle 17 on Reader Service Card

SIMMS

1 MB X 9 - 80/100NS
256K X 9 - 80/100NS
 1Mbit, 41256, 4164, 41464
 Get The Memory You Need
 At The Price You've Waited For.

FAST SERVICE
LOWEST PRICES IN USA

914-565-7080

VISA C.O.D. M/C

VOLUME DISCOUNTS AVAILABLE
 CALL TODAY FOR LOW PRICE QUOTE

DELTA COMPUTING TECH. CORP.
 292 North Plank Rd. Via L. Landucci No 26
 Newburgh NY 12550 50138 Florence Italy
 PH# 914-565-7080 PH# 39 55 676 045
 FAX 914-565-7082 FAX 39 55 668 942

**UPGRADE YOUR
 386 TODAY!!**

Circle 82 on Reader Service Card



**This real time
 MULTITASKING KERNEL**
 simplifies real life
 product development

- No royalties
- Full source code included
- C interface
- Preemptive scheduler
- Intertask messages
- Terminal Handler
- Dynamic memory allocation
- Event Manager
- Semaphore Manager
- Resource Manager
- Buffer Manager

AMX 68000 operates on any 68000/10/20 system

Manual only \$75 US
 AMX 68000 \$1800 US
 * Options - ask for price list
 (Shipping/handling extra)
 Also available for 8086, 286, 8086/186/286

KADAK Products Ltd.
 205 - 1847 W. Broadway
 Vancouver, B.C. Canada V6J 1Y5
 Telex 04-55670
 Fax (604) 734-8114
 Telephone (604) 734-2796

Circle 142 on Reader Service Card

**16-BIT RESOLUTION
 ANALOG-TO-DIGITAL
 CONVERTER**
12,000 SAMPLES/SEC
 for IBM PC, XT & AT
SINGLE PIECE PRICE
\$475

We manufacture a broad line of data acquisition and control hardware and software for Apple and IBM computers.

Call for quotes on custom hardware or complete systems.

LAWSON LABS, INC.

5700 RAIBE ROAD
 COLUMBIA FALLS, MT 59912
 800-321-5355 or 406-387-5355



Circle 154 on Reader Service Card

9-Track Tape Subsystem
 for the IBM PC/XT/AT

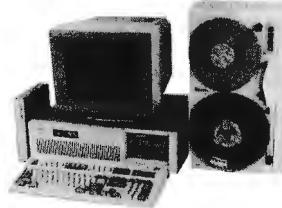

Now you can exchange data files between your IBM PC and any mainframe or mini-computer using IBM compatible 1600 or 6250 BPI 9-Track tape. System can also be used for disk backup. Transfer rate is up to 4 megabytes per minute on PCs and compatibles. Subsystems include 7" or 10 1/2" streaming tape drive, tape coupler card and DOS compatible software. For more information, call us today!

QUALSTAR®

9621 Irontdale Ave., Chatsworth, CA 91311
 Telephone: (818) 882-5822

Circle 228 on Reader Service Card

25MHZ 80386 MOTHERBOARD

Faster Than The Everex Step™ I
6.2 Mips! \$1499 (OK) QTY 1

Features:

- *64K/256K Write Back Cache
- *Dual Read/Write Cache
- *Transparent Refresh
- *8MB maximum on motherboard
- *Supports 80387/Weitek
- *Compatible with UNIX, OS/2, and Novell
- *1 Year Full Warranty
- *72 HR In-Circuit Burn-In!

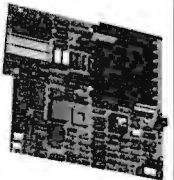

20 MHz also available @ 4.9 MIPS

SIMM Modules

256Kb x 8, 100ns-\$48
 1Mb x 8, 100ns-\$150

Same Day Shipping!

Technology Power Enterprise, Inc.
 46560 Fremont Blvd., Suite 118,
 Fremont, CA 94538
 TEL (415) 623-9162 FAX (415) 623-9462
 Novell, OS/2, and UNIX are registered trademarks

Circle 270 on Reader Service Card

**5.4 Gigabytes
 Unattended
 Backup**

Store up to 5.4 Gigabytes of data on a single T-120 VHS video cartridge. Error rate is less than 1 in 10¹⁹ bits. High speed search gives average access time of three minutes.

Use GIGASTORE™ to backup your largest disk drive on off-hours without an operator.

GIGASTORE is a trademark of Digi-Data.



DIGI-DATA CORPORATION
 8580 Dorsey Run Road
 Jessup, MD 20794-9990
 (301) 498-0200
 Telex 87-580
 e... First In Value

Circle 86 on Reader Service Card

PC PRODUCTIVITY

NEW

EMU-TEK™
4200 Plus

Turn your PC into a
Tektronix Graphics Terminal

FTG DATA SYSTEMS

(800) 962-3900

10801 Dale St., Stanton, CA 90680

Circle 105 on Reader Service Card

**KEYBOARD & MONITOR
 500 FEET AWAY - ALSO
 DRIVE MANY MONITORS
 AT ONCE - CALL FOR
 FREE CATALOG**

NTI NETWORK TECHNOLOGIES, INC.

19145 Elizabeth St., Aurora, OH 44202
 US 216-543-1646 or 800-RGB-TECH
 UK 0244-880478
 PARIS 331-47632789
 GENEVA 022-431124
 CANADA 416-677-6500
 MUNICH 0130811234

Circle 191 on Reader Service Card

Buy with

Confidence

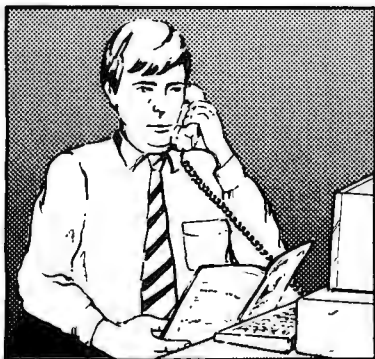

In an effort to make your telephone purchasing a more successful and pleasurable activity, The Microcomputer Marketing Council of the Direct Marketing Association, Inc. offers this advice, "A knowledgeable buyer will be a successful buyer." These are specific facts you should know about the prospective seller before placing an order:

Ask These Important Questions

- How long has the company been in business?
- Does the company offer technical assistance?
- Is there a service facility?
- Are manufacturer's warranties handled through the company?
- Does the seller have formal return and refund policies?
- Is there an additional charge for use of credit cards?
- Are credit card charges held until time of shipment?
- What are shipping costs for items ordered?

Reputable computer dealers will answer all these questions to your satisfaction. Don't settle for less when buying your computer hardware, software, peripherals and supplies.

Purchasing Guidelines

- State as completely and accurately as you can what merchandise you want including brand name, model number, catalog number.
- Establish that the item is in stock and confirm shipping date.
- Confirm that the price is as advertised.
- Obtain an order number and identification of the sales representative.
- Make a record of your order, noting exact price including shipping, date of order, promised shipping date and order number.

If you ever have a problem, remember to deal first with the seller. If you cannot resolve the problem, write to MAIL ORDER ACTION LINE, c/o DMA, 6 E. 43rd St., New York, NY 10017.

This message is brought to you by:

the MICROCOMPUTER
MARKETING COUNCIL
of the Direct Marketing
Association, Inc.
6 E. 43rd St.,
New York, NY 10017

MMCG
MICROCOMPUTER
MARKETING COUNCIL
of the Direct Marketing Association, Inc.

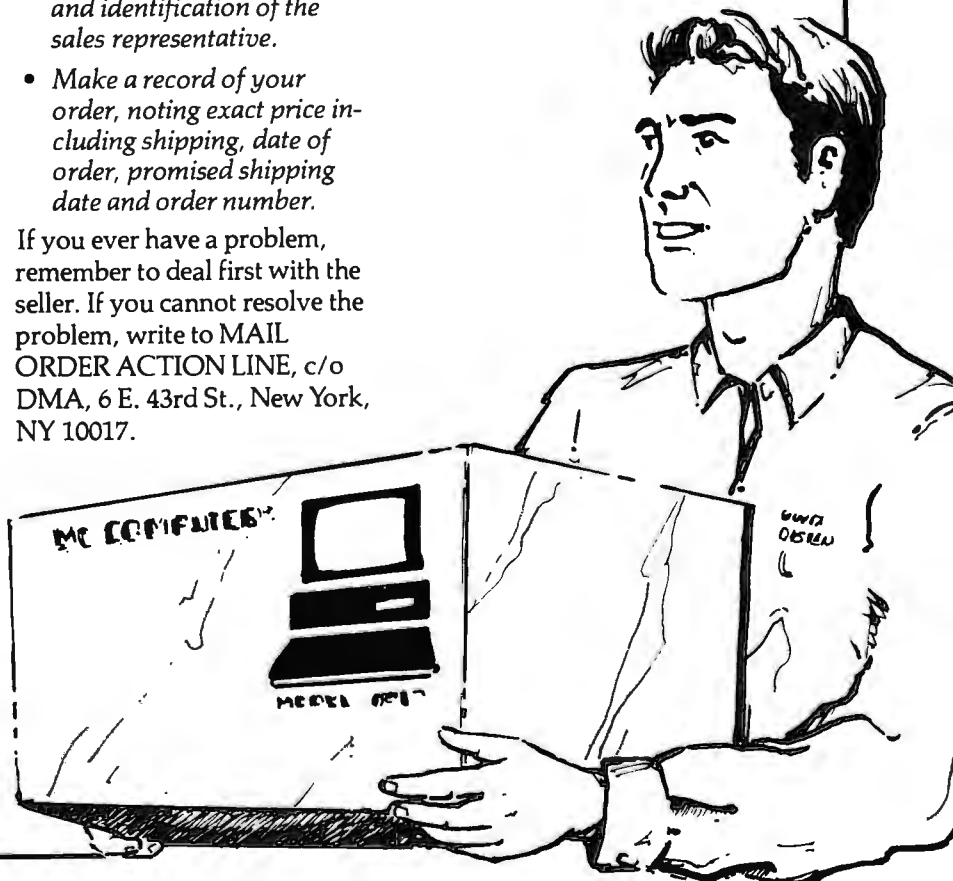

**STAND-ALONE UNIVERSAL
PLD PROGRAMMER**
Costs Less, Performs More



Palpro-2x™ is an intelligent programmer supporting PLDs from a wide variety of sources. Works with any PC or computer using a serial port. FREE one year device update and warranty. Price \$795.00.

**LOGICAL
DEVICES, INC.**

1201 N.W. 65th Place
Ft. Lauderdale, FL 33309
(305) 491-7404
1-800-331-7766

Circle 157 on Reader Service Card
(DEALERS: 158)

**LOW COST, RELIABLE
EPROM
PROGRAMMER**



1 Year
Warranty

Operates stand-alone or PC based. Shooter™, an intelligent EPROM programmer, uses serial port for communications. No modules to buy. Now includes 512K buffer; \$395 price includes cable, software and manual.

**LOGICAL
DEVICES, INC.**

1201 N.W. 65th Place
Ft. Lauderdale, FL 33309
305-974-0967
1-800-331-7766

Circle 159 on Reader Service Card
(DEALERS: 160)

Complete Telephone Management System

TeleGenie™

Sophisticated Voice Mail and Call Processing with High Quality REAL VOICE Digital Recording for your PC, XT, AT or Compatible

CALL PROCESSING

- Unlimited Phonebook Database • Autodial/Redial Search/Sort • Caller Computer Touch-Tone Interaction • User-Definable Voice Prompted Menus • Call Forward/Call Distribution • In/Out Call Logging • Outbound Timed Calls • Automatic Attendant

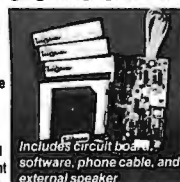

This Unique System Also Features...

VOICE MAIL

• Forwards to Extensions/Beepers/Cellulars • Individual Greetings and Passwords • Multi-User Box-Capacity • Remote Touch-Tone Access • Replay/Delete/Record/Edit

Includes circuit board, software, phone cable, and external speaker

Enjoy the same benefits and features of systems costing thousands for only

\$279⁹⁵
800-637-3861
In CA 408/438-2378



Multiple Unit Discounts • Dealer Inquires
250 Technology Circle, Scotts Valley, CA 95066

Circle 11 on Reader Service Card

**SAVE ON
9 TRACK
TAPE SYSTEM**

FOR IBM PC/XT/AT
& PS-2



- Mainframe to PC Data Transfer
- High Speed Backup
- All Software, Complete System
- Service and Support, easy Installation

call (818) 343-6505 or write to:

CONTECH Computer Corp.
P.O. Box 153 Torrance, CA 91356

CONTECH

Circle 68 on Reader Service Card

TurboFlow \$69

Flowchart drawing for IBM PC/XT/AT/PS2

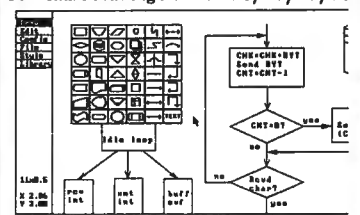

\$89 with Logitech mouse!

- Pop-up icon menus
- Variable size symbols
- Paper size to 34" x 44"
- Hercules mono, CGA, EGA
- HP-GL, DM/PL, SweetP Plotters
- Automatic PANning to scan drawing quickly
- IBM/EPSON, NEC, OKIDATA, HP LaserJet Daytron Electronics Inc.

610 S. Sherman #104, Richardson, Tx 75081

Ad add s&h (\$4 USA, \$15 foreign), Texas residents add 8% sales tax
for technical information call 214-669-2137

Order Today! 1-800-882-5822

Money-back guarantee

Circle 79 on Reader Service Card

nagan

SEAGATE

ST-225 KIT\$220
ST-238 KIT\$255
ST-251-0\$311
ST-251-1\$327

FAX

Toshiba 3300\$798
Toshiba 30600 ..\$1035
Panafax F100\$835
Sharp UX\$817

OTHERS

KEYBOARD 102 AT STYLE\$35
KEYBOARD 102 AT STYLE W/CLICK\$44
HAND SCANNER D.F.I. HS3000 PLUS\$171
HAND SCANNER LOGITECH\$169
SERIAL MOUSE LOGITECH\$67
BUS MOUSE LOGITECH\$72
MOUSE D.F.I.3. BUTTONS W/SOFTWARE...\$37
MOUSE D.F.I.3. BUTTONS NO SOFTWARE...\$31

10 pieces or more, except fax,
all products are 100% IBM compatible.
Check for more items.
1-800-683-2255

Nagan Corporation
8021 N.W. 14th St.
Miami, FL 33126

Tel: (305) 477-3929
Fax: (305) 477-4326
TLX: 159292NAGAN UT

Circle 186 on Reader Service Card

LOW-LOW-LOW

hp Laserjet Printer Series II \$1650
hp Scanjet Scanner + interface kit \$1355

IBM COMPAG **Apple** **ACER**
EVEREX **AST** & other

XT/AT Compatibles & 386 Computers
CALL for LOW PRICES

Gov't, Corporate, Schools, Dealers,
& Export INQUIRIES WELCOME.

SURAK inc.

44862 Osgood Road, FREMONT, CA 94539
PH: (415) 651-5101 FAX: (415) 651-5241
1-800-543-1001
VISA, Master Card accepted. w/sc

Circle 265 on Reader Service Card

**Statistical
Navigator™**

An expert system using AI strategies in helping to determine appropriate statistical analysis.

Version 1.1 - \$99.95

(plus shipping and handling)

VISA, MC, AMEX, PO and Personal Checks accepted.

The Idea Works, Inc.

Call toll-free

1-800-537-4866

Missouri residents call

314-445-4554

FAX 314-445-4589

IDEA WORKS

Circle 271 on Reader Service Card

8051 SBC \$99 oem qty 1

Single Board Computer

FEATURES: 8031, RAM and ROM Sockets, 8 bit I/O, RS 232 port, optional UART, and Expansion Bus. Size: 3.5" x 6.0", +5Vdc only.
OPTIONS: 8032, CMOS, 18 MHz, NV Memory, Monitor Firmware and High Level Languages.
Development Board.....\$199

8031 ICE \$199

Our emulator provides most of the features of an 8031 In-Circuit-Emulator at a significantly lower price. It assists in integration, debug and test phases of development. Commands include: disassembly, trace, breakpoints, alter register/memory, and load Intel Hex file.

8051 Simulator Program..... \$99
IBM PC/XT/AT Software simulation of 8051 μC.

HTE HiTech Equipment Corporation
9400 Activity Road
San Diego, CA 92126
(619) 566-1892

Circle 120 on Reader Service Card

California Digital

17700 Figueroa Street • Carson, California 90248



OPTICAL WORM

\$895

~~\$295~~

Write Once Read Many... California Digital has just purchased from **PRIM Corporation**, 300 hundreds of Information Storage's ISI/525WC optical WORM drive. The WORM's were manufactured for Prim and bare the Prim logo. Chosen "Editors Choice" by PC Magazine, (March 29, 1988) the 525 provides 230 megabytes of random accessible data on each doubled sided floppy cartridge. (manually flipped). Optical storage is the perfect medium for maintaining "on line" programs or other static data. Ideal for catalogs, part lists or any application where random accessibility is required. The ISI/525 is available in IBM internal configuration but an external enclosure may be added. Supplied with one cartridge, ESDI/PC controller, cable and transparent optical software. For additional information, contact Steven in our technical support department (213) 217-1947. The ISI/525 is a current production drive.

Dest Scanner

\$559

~~\$395~~

Image scanning for OCR text, photographs, and line art. High resolution 300 DPI, the DEST PC Scan Plus/651 is capable of rendering photographs to 32 halftone shades. Also inputs text directly from printed pages to ASCII files or directly into most word processing programs. Electronic status display. Available for both the Macintosh (SCSI) or the IBM/PC. Please specify 115 or 230 volt. Original price was over \$3000, now is your chance to purchase a DEST scanner for only \$559.

NEC/890 Laser

\$3095

PC Magazine has chosen the NEC-890 best laser printer of the year. (Jan. 12, 1988). And its obvious why... the printer is Postscript, Hewlett Packard, and Apple compatible, and comes standard with three megabytes of memory. The 890 accepts data from parallel, serial and Apple-Talk devices.

Hitachi "B" Plotter

\$795

~~\$2455~~

FAST... 22 inches per second. Size "B" four pen with auto pen capping and 128K/byte buffer. HPGL compatible, 19 built-in character fonts and automatic sheet feeder make the Hitachi 673 a super buy at only \$795. RS/232C and centronics parallel.

CD-ROM Complete Kit

\$539

Doctor, lawyer, indian chief... Virtually every industry and profession is disseminating information on CD-ROM. One compact disk, the same size as an audio disk, can store over 500 megabytes of data in High Sierra format. Below is a listing of some of the CD-ROM drives currently available from California Digital. The best value is the Eclipse 430 external drive. The CDS/430 includes PC/XT interface, cables, sampler software and MS/DOS extension. It also offers an audio output feature for multimedia presentations. The system is manufactured in Japan by one of the Worlds largest producers of magnetic storage equipment. A super value at only \$539.

Eclipse 430 external system\$539
 Hitachi 1500S External system695
 Hitachi 3500 Internal system595
 Hitachi internal drive only519
 NEC CDR/77 External drive only695
 NEC CDR/80 Internal drive only639

NEC interface kit for above159
 Sony CD/510 internal drive only559
 Sony 6101 external drive only795
 Sony 230B interface kit159
 Panasonic LF5000 "write once"1895
 Panasonic interface kit for above359

Saba Scanner

\$359

~~\$1299~~

The Saba Scanner inputs a printed page of evenly spaced text in less than three seconds. Included OCR software allows your computer to transfer printed pages into ASCII files or directly to spreadsheets and most word processing programs. Archival data, legal briefs... No problem. Simply insert the page into the Saba and in seconds the document is digested into your computer and ready for editing. Also does line drawings that do not require gray tones. Limited quantities available. Original price \$1299; now only \$359.

PRINTERS

HEWLETT PACKARD Laser Printer II, 300x300	2595	1659
Laser Printer II/D double sided	3995	2995
QMS PS/810 2 Meg., 35 fonts, Post/S. 5495	3879	
APPLE Laser Writer NT	4550	3659
NEC890 Postscript, 3 meg	4975	3095

DIGITIZERS

HITACHI HDG 1212 Puma 12x12"	595	359
HDG 1515 15x15	969	659
Tiger 1111C, 12x12 stylus extra	727	487
HDG 3648, 36x48"	5357	3995

SUMMAGRAPHICS

Summa 1201 plus 12x12"	599	379
TE 3648, 36x48"	4748	3729
KYE Genius Tablet w/4 but. mouse	599	279

CALCOMP

25180, 12x18"	1275	999
91480, 36x48"	4118	3389

PLOTTERS

HOUSTON INSTRUMENTS

DMP 41 single pen, 3 ips, C&D	2995	2295
DMP 52 single pen, 16 ips, C&D	3295	2495
DMP 56C size A-E, 16 ips	5695	3095
DMP61 single pen, 32 ips, A-D	4295	3095
PC695A 4 pen, size "B" 3 ips	799	595

CALCOMP PLOTTERS

1023 Arisan A-D, 8 pen, 30 ips	4895	3795
1043GT size A-E, 8 pen, 24 ips	7995	5495
7475A 6 pen size "B"	1895	1495
7550A 8 pen size "B" 32 ips	3900	2995
7595A 8 pen, size A-E, 24 ips	9990	7595

HITACHI PLOTTERS

673/8M 4 pen, size "B" auto feed	2455	795
675 size "A-D" 8 pen	5600	2695
FUJITSU Imagegraph, 6 pen, 11x32	1295	895

IOLINE PLOTTERS

LP3700 size E, 10 ips	4195	3195
LP3700MP 8 pen size "E" 10 ips	4695	3495

ROLAND PLOTTERS

DPX2000 size "C" 8 pen with stand	2995	2195
DPX3300size "D" 8 pen with stand	4995	3495

ENTER COMPUTER

SP600 size "B" 6 pen	995	659
SP1000 single pen size A-D	3995	2795
JDL 850, size "C" one meg. memory	3845	2399
VERATEC 8524 Electrostatic	16,900	13799

NUMONICS

5460 size "A-D"	2495	1859
5860 size "A-D" 8 pen	7495	5759

SCANNERS

SABA SCANNERS

page scanner with OCR software	1299	359
hand held scanner with OCR soft.	799	159

DEST SCANNERS

PC/651 scan+ 32 shades	3995	559
2000 edge feed scanner	935	719
MICROTECH300G 256 gray scales	2195	1759
DFI HandiScan 300 with Halo	359	199
PRINCETON GRAPHICS LS-300	1095	789

PANASONIC

RS505 Image page scanner	1499	999
RS506 Page scanner	1899	1259

MicroSoft Mouse

Your choice, MicroSoft "Input Buss Mouse" or "Serial Mouse". The industry standard, list price \$150, now available for only \$59. Includes software and manual. Packaged in OEM boxes.

\$59

CD SOFTWARE

AUTODESK AutoCad version 10	2995	2195
AutoSketch Std & Enhanced 2.0	99	79
VERACAD Designer	2995	1995
GENERIC CAD level 1	49	35
AMERICAN SM. BUS' N. Design Cad.	299	179

40 Meg. Tape Back-up

\$179

~~\$659~~

Head Crash, Power Spikes or just poor disk maintenance... Don't loose data because you didn't back up. The Alloy/40 is an inexpensive way to save and restore files in the event that your data has been destroyed. This 40 megabyte half height tape back up is manufactured by North America's largest producer of data retrieval equipment. No need to purchase a separate tape controller... the Alloy/40 attaches directly to your existing floppy disk controller. Supplied software allows your computer to back up any time Day or Night. Come back in the morning and 40 megabytes of irreplaceable data has been stored on one Scotch DC/2000 data cassette. Back up entire hard disk, modified files only, or by file name. Loss of data is inevitable but when you are backed up on an Alloy/40 its not a catastrophe. Model 250 for PC/XT \$179; Model 500 for AT \$239.

EGA Color Monitor

\$219

Ideal for CAD/CAM and Desk Top publishing applications. The Roland CD/240 color monitor has a resolution of 720 pixels by 400/480 lines on a .31mm dot pitch 12" non-glare screen. VGA specifications in text mode EGA in graphic mode. California Digital has made a special purchase and is able to offer the CD/240 EGA/VGA RGB color monitor for only \$219. Full featured, 132 column, multi-resolution video color adapter card available for only \$139 additional. Comparable card package would retail for \$1095.

40 Megabyte Hard Disk Kit

\$359

Forty megabyte internal hard disk drive, controller and cables all for only \$359. The kit includes the a 40 millisecond Miniscribe 3650 drive and a half slot Western Digital controller.

DISK DRIVES

5" DISK DRIVES

TEC501 1/2 height sgl.sided	39
TEC504 1/2 ht. double sided	59
TANDON 101/4 full ht. 96 TPI	39
TEAC FD55BR half height	89
TEAC FD55FR 96 TPI, half ht.	119
TEAC FD55GFR for IBM AT	109
PANASONIC 455 Half Height	89
PANASONIC 475 1.2 Meg./AT	99
Fujitsu 514" double sided	69
Dual enclosure for 5 1/4" drives	69

3 1/2" DISK DRIVES

SONY MP-73W, 1.44 Meg	139
TEAC 235HF 1.44 Meg	99
5 1/4" Form Factor Kit	20

8" DISK DRIVES

QUME 842 double sided	189
QUME 841 single sided	189
SHUGART 851R dbl.sided	319
SHUGART 801R sgl.sided	259
SIEMENS 475 1.2 Meg	119
REMEM RFD4000 dbl. sided	189

Color Graphics Terminal

Lear Siegler 7107

\$659

~~\$3995~~

Thirteen inch color graphic terminal is both VT-100/51 and Tektronix 4010/4014 compatible. The 7107 offers a palette of 4,096 colors on a 640 pixel by 480 line non-glare black screen. Horizontal pan and image zoom, to 16 times original size make the 7107 the ideal terminal for CAD/CAM applications.

Five Inch Winchester Disk Drives

Price does not include controller. each two+

SEAGATE 225 20 Meg. 1/2 HI.	239	229
SEAGATE 238 30 Meg. RLL	259	249
SEAGATE 251/1 51 M. 28mS.	459	445
SEAGATE 4096 96 M. 35mS.	559	539
MINISCRIBE 8425 25 M. 65ms	239	227
MINISCRIBE 3650 50M 61 ms.	319	309
MINISCRIBE 6065 90 meg.	459	435
MINISCRIBE 3053 25 ms. 1/2 ht.	359	339
FUJITSU 2242 55 M. 35mS.	1299	1229
FUJITSU 2243 86 M. 35mS.	1695	1619
RDDIME RO-204E 53 Meg.	895	859
MAXTOR XT1140 140 Meg.	1495	1450
MAXTOR XT190 192 Meg.	1919	1875
TOSHIBA MK5670 M. 30mS.	1289	1229
CONTROL DATA WREN "V"	call	

Winchester Controllers for IBM/PC

DTC 6280 AT/ESDI 1:1 interleave	229
DTC 5150 XT/MFM hard drive	69
DTC 7280 AT/MFM 1:1 interleave	189
ADAPTEC 2072 RLL controller	89
ADAPTEC 2372A 1:1 interleave	159
WESTERN DIGITAL WD1002GEN	89
WESTERN DIG. 1006VMM2 1:1 & Ipy.139	
WESTERN DIGITAL 1007VMM2 ESDI 239	

SCSI/SASI Winchester Controllers

ADAPTEC 514" foot print	259
WESTERN DIGITAL 1002-05E 5 1/4"	229
OMTI 20L	89

Winchester Accessories

Dual floppy enc. and powersupply	59
Winchester enclosure and supply	139
Switching power supply	49

Microcomputer Marketing Council
Direct Marketing Association

8:00 AM to 5:00 PM Pacific Time

Every year since 1973, customers from virtually every nation in the free World have chosen California Digital for their data processing requirements. If **your computer, California Digital has it...** complete minisystem or just one microchip. California Digital offers over 10,000 unique computer products. Regardless of how specialized your data processing requirements... California Digital is your one stop shopping solution.

TECHNICAL & CALIFORNIA
(213) 217-0500
 TOLL FREE ORDER LINE
(800) 421-5041
 Telefax • (213) 217-1951



JDR Microdevices[®]

MMC
MICROCOMPUTER
MARKETING COUNCIL
of the Direct Marketing Association, Inc.

30 DAY MONEY BACK GUARANTEE • 1 YEAR WARRANTY ON ALL PRODUCTS • TOLL-FREE TECHNICAL SUPPORT

MEMORY DYNAMIC RAMS

PART#	SIZE	SPEED	PINS	PRICE
4116-150	16384x1	150ns	16	.99
4164-150	65536x1	150ns	16	2.49
4164-120	65536x1	120ns	16	2.89
4164-100	65536x1	100ns	16	3.39
TMS4464-12	65536x4	120ns	16	8.95
41256-150	262144x1	150ns	16	4.49
41256-120	262144x1	120ns	16	4.99
41256-100	262144x1	100ns	16	5.49
41256-80	262144x1	80ns	16	5.99
41256-60	262144x1	60ns	16	7.99
414256-100	262144x4	100ns	20	14.95
414256-80	262144x4	80ns	20	16.95
1 MB-120	1048576x1	120ns	18	13.95
1 MB-100	1048576x1	100ns	18	14.95
1 MB-80	1048576x1	80ns	18	15.95

SIMM MODULES

PART#	SIZE	SPEED	FOR	PRICE
41256A9B-12	256K x 9	120ns	PC	59.95
41256A9B-90	256K x 9	80ns	PC	69.95
421000A9B-10	1MB x 8	100ns	MAC	169.95
421000A9B-10	1MB x 9	100ns	PC	169.95
421000A9B-80	1MB x 9	80ns	PC	179.95

STATIC RAMS

PART#	SIZE	SPEED	PINS	PRICE
TMM2016-150	2048x8	150ns	24	3.25
HM6116LP-2	2048x8	120ns	24	5.49
HM6264LP-15	8192x8	150ns	26	8.95
HM6264LP-12	8192x8	120ns	26	9.95
HM43256LP-15	32768x8	150ns	28	19.95
HM43256LP-12	32768x8	120ns	28	21.95
HM43256LP-10	32768x8	100ns	28	24.95

MATH COPROCESSORS

8-BIT COPROCESSORS

8087	5 MHz	89.95
8087-2	8 MHz	129.95
8087-1	10 MHz	169.95

16-BIT COPROCESSORS

80287	6 MHz	139.95
80287-8	8 MHz	209.95
80287-10	10 MHz	239.95

32-BIT COPROCESSORS

80387-15	16 MHz	359.95
80387-SX	16 MHz	319.95
80387-20	20 MHz	399.95
80387-25	25 MHz	499.95
80387-33	33MHz	649.95

intel[®] 5 YEAR WARRANTY



INCLUDES MANUAL & SOFTWARE GUIDE

74 SERIES LOGIC

7400	.19	74LS32	.18	74LS245	.79
74LS00	.16	74LS73	.29	74LS273	.79
74LS02	.17	7474	.33	74S289	1.69
7404	.19	74LS74	.24	74LS322	3.95
74LS04	.16	74574	.49	74LS367	.39
74S04	.29	74LS138	.39	74LS373	.79
7406	.29	74LS155	.59	74LS374	.79
7409	.29	74LS163	.39	74LS383	.79
74LS06	.18	74LS240	.69	74LS682	3.20
7432	.29	74LS244	.69	74LS688	2.40

C.P.U.'s

8000	
8052AH	
BASIC	34.95
8088	5.99
8250	6.99
8251A	1.69
8253-5	1.95
8254	9.95
8255-5	2.49
8741	9.95
8748	9.95
8749	9.95
8755	14.95
6500	
65C02*	7.95
6522	2.95
V-20	
V20	6.95
V20-9	8.95
V20-10	11.95
V30	13.95

MISC

DAC0800	3.29
1793	9.95
COM8116	8.95
MC146818	5.95
MM55107	9.95
IN89250	5.95
NS16450	10.95
LM317T	.69
NEM55	.29
LM741	.29
7812T	.49
7805T	.49
7812T	.49
75150	1.95
75154	1.95
14411	9.95

CRYSTAL OSCILLATORS

1.0MHz	5.95
1.8432	5.95
20.0	4.95
24.0	4.95

PALS

16L8	2.95
16R4	2.95
16R6	2.95
16R8	2.95
20L4	4.95
20R4	4.95
20R8	4.95
20R8	4.95
20X8	4.95

PAL KIT

AN ENTRY-LEVEL COMPLETE PAL DEVELOPMENT KIT FROM CUPL. FULL SUPPORT FOR 16L8, 16R4, 16R8, 16R8, 20L8, 20R4, 20R6, 20R8, AND 20X8.
MOD-MPL-SOFT \$99.95



Derick's HIGH-TECH SPOTLIGHT

Call our BBS: [408] 559-0253 for more info in SIG file "Hitech"

This month's topic is floppy drive compatibility. There are 360K 5-1/4", 720K 3-1/2", 1.2Meg 5-1/4" and 1.44Meg 3-1/2" drives, any of which can be used on most PC's and PC clones. Recent improvements in floppy controllers make using high density drives on 8088-based machines a viable option.

To simplify, we'll eliminate the redundant choices. A 1.2Meg drive can work with both high density 1.2Meg floppies and low density 360K floppies. A high density 3-1/2" 1.44Meg drive can use both the high density 1.44Meg and the low density 720K disks. Unless you know that you will never need high density capability, a good universal standard is one 3-1/2" and one 5-1/4" high density drive.

Now for the bomb! Big Blue uses a different method to distinguish between 720K and 1.44Meg drives. While most of the manufacturers look for and detect the High Density hole in a high density diskette, they read the data to make that determination. This causes a problem when a Low Density disk without the hole is written in the high density mode. So if you get a 3-1/2" disk that a friend says is formatted at 1.44Meg, make sure it has a High Density hole or it probably won't read in your clone.

Derick Moore, Director of Engineering

*An infrequent problem can occur when a 360K drive is written in a 1.2Meg drive and is then read in a 360K drive.

EPROMS

PART#	SIZE	SPEED	Vpp	PINS	PRICE
2708	1024x8	450ns	25V	24	4.95
2716	2048x8	450ns	25V	24	3.49
2716-1	2048x8	350ns	25V	24	3.95
2732A	4096x8	250ns	21V	24	3.95
2784	8192x8	450ns	12.5V	28	3.49
2784-250	8192x8	250ns	12.5V	28	3.69
2784-200	8192x8	200ns	12.5V	28	4.25
27C64	8192x8	200ns	12.5V	28	4.95
27128	16384x8	250ns	12.5V	28	4.25
27128A-200	16384x8	200ns	12.5V	28	5.95
27256	32768x8	250ns	12.5V	28	4.95
27256-200	32768x8	200ns	12.5V	28	5.98
27C256	32768x8	250ns	12.5V	28	5.95
27512	65536x8	250ns	12.5V	28	8.95
27C512	65536x8	250ns	12.5V	28	9.95
27C101-20	131072x8	250ns	12.5V	32	29.95

EPROM ERASERS

DATARASE II \$39.95!
• SHIRT POCKET SIZE!
• ALL SIZES UP TO 4 AT A TIME
• ERASES MOST EPROMS IN 3 MINUTES



SPECTRONICS CORPORATION

Model	Timer	# of Chips	Intensity (uW/Cm ²)	Unit Cost
PE-140	NO	9	8,000	\$ 89
PE-140T	YES	9	8,000	\$139
PE-240T	YES	12	9,600	\$189
PL-265T	YES	30	9,600	\$255



POWER SUPPLIES

135 WATT POWER SUPPLY	
• UL APPROVED	
+5V @15A, +12V @ 4.2A, -5V @.5A, -12V @.5A	
PS-135	\$59.95
PS-150 150W SUPPLY	\$69.95
200 WATT POWER SUPPLY	
• UL APPROVED	
+5V @ 20A, +12V @ 7A, -5V @.5A, -12V @.5A	
PS-200	\$89.95
APPLE TYPE SUPPLY	
• WITH APPLE CONNECTOR	
+5V @ 6A, +12V @ 3A, -5V @ 1A, -12V @ 1A	
PS-A	\$59.95



PROTOTYPE CARDS

FR-4 EPOXY GLASS LAMINATE WITH GOLD PLATED EDGE CARD FINGERS AND SILK SCREENED LEGENDS



FOR XT		
JDR-PR1	WITH +5V AND GROUND PLANE	27.95
JDR-PR2	ABOVE WITH I/O DECODING LAYOUT	29.95
JDR-PR2-PK	PARTS KIT FOR JDR-PR2 ABOVE	8.95
FOR AT		
JDR-PR10	BIT WITH I/O DECODING LAYOUT	34.95
JDR-PR10-PK	PARTS KIT FOR JDR-PR10 ABOVE	12.95
FOR PS/2		
JDR-PR32	32 BIT PROTOTYPE CARD	69.95
JDR-PR16	16 BIT WITH I/O DECODING LAYOUT	49.95
JDR-PR16-PK	PARTS KIT FOR JDR-PR16 ABOVE	15.95
JDR-PR16V	16 BIT FOR VIDEO APPLICATIONS	39.95
EXTENDER CARDS		
SIMPLIFY PROTOTYPING AND TESTING		
EXT-8088	8-BIT FOR 8088 MOTHERBOARDS	29.95
EXT-80286	16-BIT FOR 286/386 MOTHERBOARDS	69.95
EXT-16	MICROCHANNEL 16-BIT	39.95
EXT-32	MICROCHANNEL 32-BIT	99.95

PC BREADBOARD-ON-A-CARD



- 62 BUS LINES
- USE UP TO 24 14-PIN ICs
- 1940 TIE POINTS
- DB25 D-SUB CONNECT. PDS-604 \$49.95



SOLDER STATION

- UL APPROVED
- ADJUSTABLE HEAT SETTING
- TIP TEMPERATURE READOUT
- REPLACEMENT TIPS @ \$2.95

168-3C \$59.95

IC SOCKETS/DIP CONNECTORS

SOLDERTAIL	WIREWRAP	ZIF SOCKETS
8 PIN ST .11	8 PIN WW .59	ZIF-14 5.95
14 PIN ST .11	14 PIN WW .69	ZIF-16 5.95
16 PIN ST .12	16 PIN WW .69	ZIF-20 6.95
18 PIN ST .15	18 PIN WW .99	ZIF-24 7.95
20 PIN ST .18	20 PIN WW 1.09	ZIF-28 7.95
24 PIN ST .20	24 PIN WW 1.49	ZIF-40 10.95
28 PIN ST .22	28 PIN WW 1.69	
40 PIN ST .30	40 PIN WW 1.99	

VOLUME DISCOUNTS CALL!

SOLDER-CUP D-SUBS

MALE	FEMALE	IDC'S
DB09P .45	DB09S .49	IDE20 .55
DB15P .59	DB15S .69	IDE34 .89
HDB15P 1.49	HDB15S 1.59	IDS20 .65
DB19P .69	DB19S .75	IDB09P 1.39
DB25P .69	DB25S .75	IDB09S 1.45
DB37P 1.35	DB37S 1.39	IDB25P 2.25
DB50P 1.85	DB50S 2.29	IDB25S 2.35

CABLES AND GENDER CHANGERS

MOLDED; GOLD-PLATED CONTACTS; 100% SHIELDED

CBL-PRINTER	6 FT. PC PRINTER CABLE	9.95
CBL-PRINTR-25	25 FT. PC PRINTER CABLE	15.95
CBL-PRINTR-RS	RIGHT ANGLE PRINTER CABLE	15.95
CBL-DB25-MM	DB25 MALE-DB25 MALE 6 FT.	9.95
CBL-DB25-MF	DB25 MALE-DB25 FEMALE 6 FT.	9.95
CBL-9-SERIAL	DB9 FEMALE-DB25 MALE 6 FT.	6.95
CBL-KBD-EXT	6 FT. KEYBOARD EXTENSION	7.95
CBL-CNT-MM	36-PIN CENTRONICS-MM	14.95
CBL-FDC-EXT	37-PIN EXT. FLOPPY CABLE	8.95
CBL-MNT-9	9-PIN MONITOR EXTENSION	6.95
CBL-MNT-15	15-PIN MONITOR EXTENSION CABLE	9.95
CBL-MODEM	MODEM-DB25-DB25 FEMALE	6.95
GENDER-VGA	DB9-DB15 ADAPTOR	4.95
GENDER-Q25	DB9-DB25 SERIAL ADAPTOR	4.95

PARTIAL LISTINGS ONLY—CALL FOR FREE 84-PG CATALOG!



FULL SIZE SLIDE CASE **\$89**

- DESIGNED FOR FULL SIZE 286/386 MOTHERBOARDS
- USES STANDARD AT-COMPATIBLE POWER SUPPLIES
- DRIVE MOUNTS FOR THREE FLOPPY AND TWO HARD DRIVES
- RESET SWITCH AND KEYLOCK
- POWER-ON, TURBO AND DISK LEDS
- INCLUDES ALL MOUNTING HARDWARE

CASE-70

CASE-50 FOR 8088 OR MINI-86 MOTHERBOARDS **\$59.95**

CASE-FLIP FLIP-TOP XT-STYLE CASE **\$39.95**

CASE-SLIDE SLIDE TYPE XT-STYLE CASE **\$39.95**

CASE-JR **\$149.95**

WITH 150W POWER SUPPLY. FOR 8088 OR MINI-286 BOARDS.

CASE-JR-200 **\$189.95**

WITH 200W POWER SUPPLY. FOR 8088 OR MINI-286 BOARDS.

UPRIGHT CASE

\$299⁹⁵

SLEEK DESIGN SAVES DESK SPACE, ADDS STYLE!

- ACCOMMODATES ALL SIZES OF MOTHERBOARDS
- INCLUDES 250 WATT POWER SUPPLY
- MOUNTS FOR 3 FLOPPY AND 4 HARD DRIVES
- TURBO AND RESET SWITCHES
- SPEED DISPLAY, POWER, DISK LEDS
- MOUNTING HARDWARE, FACEPLATES AND SPEAKER INCLUDED

CASE-100



"I just had to write and express our gratitude for your fine, service oriented business. We have found your firm to be very friendly, prompt and professional!"

— Tim Brown, Galesburg, IL



intel INBOARD 386 **\$649**

RUN YOUR XT COMPATIBLE UP TO 10 TIMES FASTER! REPLACES YOUR 8088 PROCESSOR WITH AN 80386 WHILE STILL USING YOUR EXISTING COMPONENTS.

- 16 MHZ 80386 MICROPROCESSOR • 1 MB RAM INSTALLED
- SOCKETED FOR 80387 MATH COPROCESSOR • OPTIONAL 1 MB OR 2 MB PIGGYBACK MEMORY BOARD

PCIB1200

PCIB1210 1 MB PIGGYBACK MEMORY BOARD **\$475.00**

PCIB1220 2 MB PIGGYBACK MEMORY BOARD **\$895.00**

EPROM PROGRAMMER

\$129⁹⁵

- PROGRAMS 27XX AND 27XXX EPROMS UP TO 27512
- SPLIT OR COMBINE CONTENTS OF SEVERAL EPROMS OF DIFFERENT SIZES

- SUPPORTS VARIOUS PROGRAMMING FORMATS AND VOLTAGES

- READ, WRITE, COPY, BLANK CHECK AND VERIFY
- SOFTWARE FOR HEX AND INTEL HEX FORMATS

MOD-EPROM



MODULAR CIRCUIT TECHNOLOGY

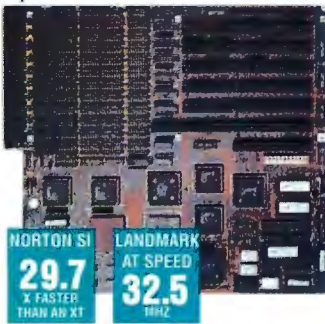

NORTON SI
29.7
X FASTER
THAN AN XT

LANDMARK
AT SPEED
32.5
MHZ

25MHZ 386

\$1049

THE INTELLIGENTLY DESIGNED BOARD INCORPORATES THE BEST FEATURES OF CURRENT 386 TECHNOLOGY.

- ACCELERATED 80386 MPU RUNS AT 25MHZ • 10MHZ/25MHZ KEYBOARD SELECTABLE SPEEDS • 16MB RAM CAPACITY: 8MB ON BOARD, 8MB USING OPTIONAL RAM CARD (0KB INSTALLED) • USES 256K OR 1MB DRAMS (80NS FOR 1 WAIT, 60NS FOR 0 WAIT STATES) • SHADOW RAM FOR BIOS AND VIDEO • 8 EXPANSION SLOTS (ONE 32-BIT, FIVE 16-BIT, TWO 8-BIT) • ADJUSTABLE BUS SPEEDS • INTERLEAVED MEMORY • NEAR ZERO WAIT STATE OPERATION • AMI BIOS

MCT-386MB25

MCT-386MB20 20MHZ VERSION **\$849.00**

MCT-386-M 8MB RAM CARD (0KB) **\$149.95**



LANDMARK
AT SPEED
15.5
MHZ

NORTON SI
13.8
X FASTER
THAN AN XT

12MHZ 286

\$299

- AT COMPATIBLE OPERATES AT 8/12 MHZ • KEYBOARD SELECTABLE CLOCK SPEEDS • NOW EXPANDABLE TO 4MB ON BOARD USING 1MB DRAMS (0KB INSTALLED) • USES 256K OR 1MB DRAMS (100NS FOR 1 WAIT, 80NS FOR 0 WAIT STATES) • SIX 16-BIT AND TWO 8-BIT SLOTS, 8MHZ BUS SPEED • AMI BIOS • AUTO RECHARGING NICAD BATTERY • SUPPORT FOR POWER-ON AND SPEED INDICATORS • KEYLOCK AND RESET SWITCHES • 8-1/2" X 13" WITH XT HOLE SPACING

MCT-M286-12

MCT-M286 10 MHZ VERSION **\$269.95**

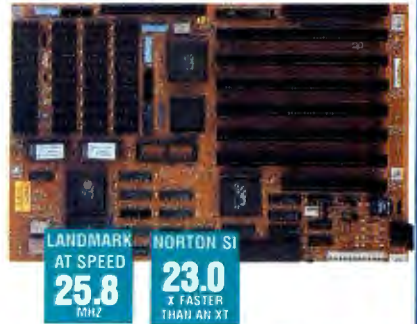

LANDMARK
AT SPEED
25.8
MHZ

NORTON SI
23.0
X FASTER
THAN AN XT

20MHZ 286

\$589⁹⁵

- BENCHMARK SPEEDS UP TO 25.8MHZ • EXPRESS RAM SLOT FOR 8MB OF 0 WAIT STATE RAM USING AN OPTIONAL RAM CARD • 10MHZ/20MHZ KEYBOARD SELECTABLE SPEEDS • 1MB ON-BOARD RAM CAPACITY (0KB INSTALLED) • USES 256K DRAMS (60NS FOR 0 WAITS, 80/100NS FOR NEAR ZERO WAITS) • 8 EXPANSION SLOTS: ONE EXPRESS RAM SLOT, ONE 8-BIT AND SIX 16-BIT SLOTS • PHOENIX BIOS • 8MHZ BUS SPEED • SOCKETED FOR 80287 COPROCESSOR

MCT-M286-20

MCT-M286-16 8MHZ/16MHZ VERSION **\$489.95**

MCT-M286-M 8 MB RAM CARD (0KB) **\$119.95**

MCT-M286-MIO **\$149.95**

8 MB RAM CARD WITH PARALLEL AND SERIAL PORTS (0KB INSTALLED)



NORTON SI
17
X FASTER
THAN AN XT

10MHZ 8088

\$99⁹⁵

- GET IMPROVED RELIABILITY AND LESS POWER CONSUMPTION WITH THIS "SINGLE CHIP" DESIGN!
- XT COMPATIBLE; OPERATES AT 4.77/10MHZ • KEYBOARD SELECTABLE CLOCK SPEEDS • SOCKETED FOR 8087-1 COPROCESSOR • 8 EXPANSION SLOTS • MCT BIOS • 840K RAM CAPACITY (0KB INSTALLED) • SUPPORTS KEYLOCK, RESET AND TURBO SWITCHES • POWER-ON & TURBO-MODE LEADS SUPPORTED • ONLY 8-1/2" X 9"

MCT-TURBO-10

MCT-TURBO 4.77/8 MHZ TURBO MOTHERBOARD **\$95.95**

MCT-XMB 4.77 MHZ MOTHERBOARD **\$67.95**

MODULAR PROGRAMMING SYSTEM

OUR INTEGRATED MODULAR SYSTEM EASILY EXPANDS! ALL THE MODULES USE A COMMON HOST ADAPTOR CARD—USE JUST ONE SLOT TO PROGRAM EPROMS, PROMS, PALS & MORE!

COMMON HOST ADAPTOR CARD **\$29.95**

- UNIVERSAL INTERFACE FOR ALL THE PROGRAMMING MODULES!
- SELECTABLE ADDRESSES PREVENTS CONFLICTS
- MOLDED CABLE
- MOD-MAC



UNIVERSAL MODULE **\$499.95**

- PROGRAMS EPROMS, EEPROMS, PALS, BI-POLAR PROMS, 8748 & 8751 SERIES DEVICES, 16V8 AND 20V8 GALS (GENERIC ARRAY LOGIC) FROM LATTICE, NS, SGS • TESTS TTL, CMOS, DYNAMIC & STATIC RAMS • LOAD DISK, SAVE DISK, EDIT, BLANK CHECK, PROGRAM, AUTO, READ MASTER, VERIFY AND COMPARE • TEXT TOOL SOCKET FOR .3" TO .6" WIDE IC'S (8-40 PINS)
- MOD-MUP



EPROM MODULE **\$119.95**

- PROGRAMS 24-32 PIN EPROMS, CMOS EPROMS & EPROMS FROM 16K TO 1024K • HEX TO OBJ CONVERTER • AUTO, BLANK CHECK/PROGRAM/VERIFY • VPP 5, 12.5, 12.75, 13, 21 & 25 VOLTS • NORMAL, INTELLIGENT, INTERACTIVE & QUICK PULSE PROGRAMMING ALGORITHMS

MOD-MEP

MOD-MEP-4 4-EPROM PROGRAMMER **\$169.95**

MOD-MEP-8 8-EPROM PROGRAMMER **\$259.95**

MOD-MEP-16 16-EPROM PROGRAMMER **\$499.95**

DIGITAL IC MODULE **\$129.95**

- TESTS TTL, CMOS, DYNAMIC & STATIC RAM
- AUTO SEARCH FOR UNKNOWN PART NUMBERS
- USER-PROGRAMMABLE TEST PROCEDURES

MOD-MIC

PAL MODULE **\$249.95**

- PROGRAMS MMI, NS, TI 20 & TI 24 PIN DEVICES
- BLANK CHECK, PROGRAM, AUTO, READMASTER, VERIFY & SECURITY FUSE BLOW

MOD-MPL

CUPL SOFTWARE **\$99.95**

- COMPLETE ENTRY-LEVEL PAL DEVELOPMENT KIT.
- MOD-MPL-SOFT



ORDER TOLL-FREE 800-538-5000



MON.-FRI. 7 A.M. TO 5 P.M., SATURDAY, 10 A.M. TO 3 P.M. (PST)

COPYRIGHT 1989 JDR MICRODEVICES

JDR MICRODEVICES 2233 BRANHAM LANE,
SAN JOSE, CA 95124 (408) 559-1200
FAX (408) 559-0250 TELEX 171-170

RETAIL STORE: 1256 S. BASCOM AVE.,
SAN JOSE, CA (408) 947-8881
HOURS: M-F 9-7, SAT. 9-5, SUN. 12-4



JDR Microdevices®

MMC
MICROCOMPUTER
MARKETING COUNCIL
of the Direct Marketing Association, Inc.

30 DAY MONEY BACK GUARANTEE • 1 YEAR WARRANTY ON ALL PRODUCTS • TOLL-FREE TECHNICAL SUPPORT



RELISYS VGA MONITOR \$359

14" ANALOG VGA MONITOR WITH GLARE-RESISTANT SCREEN • 720 X 480 MAXIMUM RESOLUTION • TILT/SWIVEL BASE • CONTRAST AND BRIGHTNESS CONTROLS
VGA-MONITOR

SAMSUNG FLAT \$129.95

ONE OF THE BEST MONOCHROME MONITORS! • 12" FLAT SCREEN REDUCES DISTORTION • AMBER DISPLAY • 720 X 350 RESOLUTION
MONO-SAMSUNG

RELISYS MULTISYNCH \$429

AN EXCEPTIONAL VALUE ON AN OUTSTANDING DISPLAY! • 14" NON-GLARE SCREEN • 1024 X 768 MAXIMUM HIGH RESOLUTION • CGA/EGA/VGA COMPATIBLE • TTL OR ANALOG MODE OPERATION
JDR-MULTI

NEC MULTISYNCH 3D \$649.95

• 1024 X 768 MAX RESOLUTION • CGA/EGA/VGA/MCGA/PGC COMPATIBLE • HERCULES AND OTHER STANDARD ADAPTORS
NEC-MULTI

RGB COLOR \$239.95

CGA MODE DISPLAYS UP TO 16 COLORS, MONOCHROME MODE FOR TEXT • 14" GLARE-RESISTANT SCREEN • 840 X 200 MONOCHROME • 320 X 200 COLOR RESOLUTION
JDR-RGB

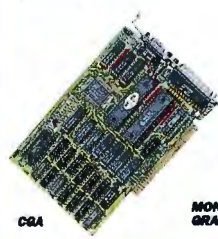

CGA CARD \$49.95

IBM-COMPATIBLE ADAPTOR FOR RGB MONITORS • 640 X 200 MONO, 320 X 200 COLOR RESOLUTION • DISPLAYS 4 COLORS SIMULTANEOUSLY • LIGHT PEN INTERFACE
MCT-CG

MCT-CGP WITH PRINTER PORT \$59.95

CG-COMP COMPOSITE ADAPTOR \$4.95

MONO GRAPHICS \$59.95

XT AND AT-COMPATIBLE • HERCULES COMPATIBLE MONOGRAPHICS • SUPPORTS LOTUS 1-2-3 • HIGH RESOLUTION 720 X 348 DISPLAY • VLSI CHIPS • CONFIGURE THE PARALLEL PRINTER PORT AS LPT1 OR 2
MCT-MGP



NEED IT TOMORROW?

No problem! Just place your order by 10:00 (PST) today, and ask us to ship it Federal Express® overnight delivery.



VGA PACKAGE \$499

VGA COLOR AND CLARITY AT AN EGA PRICE! • 8-BIT VGA CARD IS FULLY COMPATIBLE WITH IBM VGA • 720 X 540 MAXIMUM RESOLUTION, 640 X 480 IN 18 COLORS • 528 X 480 RESOLUTION IN 256 COLORS • IBM STYLE, HIGH RESOLUTION ANALOG MONITOR • EGA/CGA/MONCHROME AND HERCULES COMPATIBLE • DRIVERS FOR WINDOWS, GEM, 1-2-3, SYMPHONY, AUTOCAD AND VENTURA
VGA-PKG

EGA MONITOR \$339.00

• 14" NON-GLARE SCREEN WITH 640 X 350 MAXIMUM RESOLUTION • DISPLAY 16 COLORS SIMULTANEOUSLY
EGA-MONITOR

LARGE SCREEN MONO \$139

• GLARE-RESISTANT 14" SCREEN WITH AMBER DISPLAY • 720 X 350 RESOLUTION • TILT/SWIVEL BASE • FRONT MOUNTED CONTROLS
GM-1488

PAPER WHITE VGA \$119.95

GRAY SCALE MONITOR— PERFECT FOR DESKTOP PUBLISHING! • ULTRA HIGH-RESOLUTION 800 X 480 • 14" GLARE RESISTANT SCREEN • TILT/SWIVEL BASE
MONO-VGA

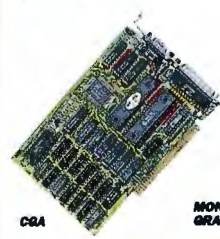

MONO GRAPHICS \$59.95

XT AND AT-COMPATIBLE • HERCULES COMPATIBLE MONOGRAPHICS • SUPPORTS LOTUS 1-2-3 • HIGH RESOLUTION 720 X 348 DISPLAY • VLSI CHIPS • CONFIGURE THE PARALLEL PRINTER PORT AS LPT1 OR 2
MCT-MGP

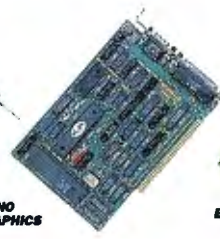

EGA CARD \$149.95

• 640 X 350 HIGH RESOLUTION • DISPLAYS 16 COLORS AT A TIME • COMPATIBLE WITH HERCULES, CGA AND IBM MONOCHROME • SOFTWARE DRIVERS FOR WINDOWS, LOTUS, CAD, AND MORE • 256K VIDEO RAM.
MCT-EGA

16-BIT VGA \$249.95

• 1024 X 768 RESOLUTION • 256K VIDEO RAM EXPANDABLE TO 512K • 64 LEVELS OF GRAY SCALE
MCT-VGA-16

MCT-VGA-8 8-BIT VERSION \$199.95

MCT-VGA-8 8-BIT VERSION \$199.95

CALL OUR 24-HR BBS
(408) 559-0253
• ON-LINE ORDERING • CONFERENCING • TECHNICAL INFORMATION •

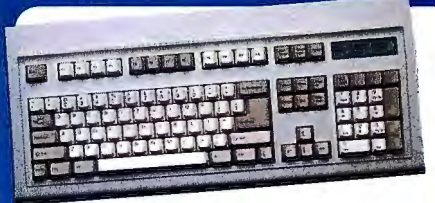

ENHANCED 101-KEY KEYBOARD \$69.95

• ENHANCED 101-KEY LAYOUT • EXTRA LARGE SHIFT & RETURN KEYS • AUTO-REPEAT • XT OR AT COMPATIBLE • LEDS FOR SCROLL, CAPS AND NUM LOCK

BTC-5339R COMPACT 101-KEY \$79.95
MAX-5339R MAXI-SWITCH 101-KEY \$84.95
K103-A AUDIBLE "CLICK" 101-KEY \$84.95

STANDARD 84-KEY KEYBOARD \$59.95

• AUTO ADJUSTS FOR XT OR AT • AT STYLE LAYOUT • EXTRA LARGE SHIFT AND RETURN KEYS • AUTO REPEAT • LEDS FOR SCROLL, CAPS AND NUM LOCK

BTC-5060 MAXI-SWITCH 84-KEY \$64.95
BTC-5150 XT-STYLE 83-KEY \$59.95

MODULAR CIRCUIT TECHNOLOGY

DRIVE CONTROLLERS

FLOPPY DISK CONTROLLER \$29.95

• INTERFACES UP TO 4 FLOPPY DRIVES TO IBM PC OR COMPATIBLE • DS/DD AND DS/DQ COMPATIBLE
MCT-FDC

1.44MB FLOPPY CONTROLLER \$49.95

• SUPPORTS 2 FLOPPY DRIVES (360K, 720K, 1.2MB & 1.44MB) • ELIMINATES THE NEED FOR SOFTWARE DEVICE DRIVERS
MCT-FDC-HD

MCT-FDC-HD4 4 DRIVE CONTROLLER \$59.95

HARD DISK CONTROLLER \$79.95

• SUPPORTS 16 DRIVE SIZES INCLUDING 10, 20, 30 AND 40MB • CAN DIVIDE 1 LARGE DRIVE INTO 2 LOGICAL DRIVES
MCT-HDC

RLL CONTROLLER \$89.95

• SUPPORTS 2 RLL HARD DRIVES • 50% FASTER DATA TRANSFER • DESIGNED FOR XT-COMPATIBLES
MCT-RLL

286/386 F/H CONTROLLER \$149.95

• FLOPPY/HARD DISK CONTROL IN AN AT DESIGN • FOR UP TO 2 FLOPPIES (360K/720K/1.2MB/1.44MB) & 2 HARD DRIVES
MCT-AFH

286/386 RLL CONTROLLER \$199.95

• IMPROVES AT COMPATIBLE'S SPEED & STORAGE • FOR UP TO 2 RLL HDD'S & 2 FDD'S (360K/720K/1.2MB 1.44MB)
MCT-AFH-RLL

MULTIFUNCTION I/O CARDS

MULTI I/O FLOPPY CONTROLLER \$79.95

• SUPPORTS UP TO 2 360K FLOPPIES • SERIAL, PARALLEL, GAME PORT AND CLOCK/CALENDAR
MCT-MIO

MULTI I/O CARD \$59.95

• SERIAL PORT • CLOCK/CALENDAR WITH BATTERY • PARALLEL PORT IS ADDRESSABLE AS LPT1 OR LPT2
MCT-IO

286/386 MULTIFUNCTION \$139.95

• ADDS 1.5MB TO YOUR AT 3MB W/ OPTIONAL PIGGYBACK CARD (ØK INSTALLED) • SERIAL, PARALLEL PORTS.
MCT-AMF

MCT-AMF-MC 1.5MB PIGGYBACK BOARD \$29.95

286/386 MULTI I/O CARD \$59.95

• SERIAL, PARALLEL AND GAME PORTS • USES 16450 SERIAL SUPPORT CHIPS FOR HIGH SPEED OPERATION
MCT-AIO

MONOGRAPHICS MULTI I/O \$119.75

• CONTROL 2 FLOPPIES • SERIAL, PARALLEL, GAME PORT, CLOCK/CALENDAR • RUNS COLOR GRAPHICS SOFTWARE ON YOUR BLACK AND WHITE MONITOR.
MCT-MGMIO

\$99⁹⁵

**1.44MB
3-1/2" DRIVE**

- 80 TRACKS • 135 TPI • ULTRA HIGH DENSITY
- READ/WRITE 720K DISKS, TOO
- INCLUDES ALL NECESSARY MOUNTING HARDWARE

- FDD-1.44X BLACK FACEPLATE
- FDD-1.44A BEIGE FACEPLATE
- FDD-1.44SOFT SOFTWARE DRIVER \$19.95
- FDD-3.5X 3-1/2" 720K (BLACK) \$97.95
- FDD-3.5A 3-1/2" 720K (BEIGE) \$97.95
- MF355A 3-1/2" MITSUBISHI 1.44MB, BEIGE \$129.95
- MF355X 3-1/2" MITSUBISHI 1.44MB, BLACK \$129.95

**5-1/4" FLOPPY
DISK DRIVE \$69⁹⁵**

- FDD-360 5-1/4" DOUBLE-SIDED DD 360K \$69.95
- M2551A 5-1/4" FUJITSU DOUBLE-SIDED DD 360K \$89.95
- FD-55B 5-1/4" TEAC DOUBLE-SIDED DD 360K \$99.95
- FDD-1.2 5-1/4" DOUBLE-SIDED HD 1.2M \$95.95
- M2553K 5-1/4" FUJITSU DOUBLE-SIDED HD 1.2M \$119.95
- FD-55G 5-1/4" TEAC DOUBLE-SIDED HD 1.2M \$129.95
- FD-55F 5-1/4" TEAC DOUBLE SIDED, QD720K \$119.95

ARCHIVE TAPE BACK-UPS

- AR5240X 40 MB TAPE DRIVE FOR XT'S & AT'S \$369.95
- AR5540A FAST 40 MB TAPE DRIVE AT'S ONLY \$369.95
- AR2020 EXTERNAL CHASSIS & INTERFACE \$159.95
- AR20A ADDITIONAL INTERFACE CARDS \$89.95
- AR340 40 MB TAPE CARTRIDGE \$24.95

**HANDY SCANNER 3000 PLUS
DFI \$219⁹⁵**

**NEW IMPROVED!
NOW WITH
PAINTBRUSH
PLUS AND
IMAGE TOOLS!**

- NEW IMPROVED IMAGE CLARITY
- NEW ERGONOMIC DESIGN • NOW 2 MORE ROLLERS FOR STRAIGHT TRACKING • NEW SPEED OVERRUN WARNING LIGHT • SCANNER CARD HAS BUILT-IN OPTIONAL MOUSE PORT • INCLUDES ZSOFT'S PC PAINTBRUSH PLUS AND IMAGE TOOLS • QUICKLY SCANS IMAGES UP TO 4" WIDE AT 100, 200, 300, OR 400 DPI IN BOTH DIRECTIONS • B&W AND THREE HALF-TONE MODES • 32 LEVELS OF GRAY SCALE
- HERCULES, EGA AND CGA COMPATIBLE
- DON'T MISS THIS EXCELLENT VALUE!
- HS-3000
- OCR-SOFT CHARACTER RECOGNITION SOFTWARE \$99.95

SERIAL MOUSE \$39⁹⁵ DFI

- 3-BUTTON OPTO-MECHANICAL
- 200 D.P.I. • 5-1/2" CABLE
- USES SERIAL PORT COM 1/2
- INCLUDES SOFTWARE DRIVERS
- DMS-200E
- MOUSE & HALO-DPE SOFTWARE.
- DMS-200 \$59.95

LOGITECH MICE

- LOGITECH • THREE-BUTTON SERIES 9
- 320 DPI RESOLUTION
- SERIAL PS/2 COMPATIBLE.

- LOGC9 SERIAL MOUSE \$98.95
- LOGC9-C SERIAL MOUSE* \$79.95
- LOGC9-P SERIAL MOUSE WITH PAINTSHOW \$109.95
- LOGC9-PC SERIAL MOUSE WITH PAINT/CAD \$154.95
- LOGB9 BUS MOUSE \$89.95
- LOGB9-P BUS MOUSE WITH PAINTSHOW \$104.95
- LOGB9-PC BUS MOUSE WITH PAINT/CAD \$149.95
- *NOT PS/2 COMPATIBLE

HARD DISKS

- 20 MB \$199
- 30 MB \$219
- 40 MB \$319
- 28 MS \$389
- 60 MB \$389
- 80 MB \$569



KITS INCLUDE HARD DRIVE, DRIVE CONTROLLER, CABLES & INSTRUCTIONS.

SIZE	MODEL	AVG. SPEED	FORM FACTOR	DRIVE ONLY	XT KIT	AT F/H KIT
20MB	ST-225	65 MS	5-1/4"	\$199	\$249	\$309
30MB RLL	ST-238	65 MS	5-1/4"	\$219	\$279	\$379
40MB	ST-251	40 MS	5-1/4"	\$319	\$369	\$429
40MB	ST-251-1	28 MS	5-1/4"	\$389	\$439	\$499
60MB RLL	ST-277	40 MS	5-1/4"	\$389	\$449	\$549
80MB	ST-4096	28 MS	5-1/4"	\$569	—	\$679
120MBRLL	ST-4144R	28 MS	5-1/4"	\$699	\$759	\$859
20MB	ST-125	40 MS	3-1/2"	\$259	\$299	\$373
30MB RLL	ST-138	40 MS	3-1/2"	\$289	\$339	\$429

KITS

- 20 MB \$249
- 30 MB \$279

JDR's exclusive detailed manual makes installation worry-free!

NEW LOW PRICES!

Seagate SCSI DRIVES

SIZE	MODEL	AVG. SPEED	FORM. FACTOR	PRICE
21.5MB	ST-125N	40MS	3-1/2"	\$299
32.2MB	ST-138N	40MS	3-1/2"	\$339
48.6MB	ST-157N	40MS	3-1/2"	\$389
21.3MB	ST-225N	65MS	5-1/4"	\$329
43.1MB	ST-251N	40MS	5-1/4"	\$419
64.9MB	ST-277N	40MS	5-1/4"	\$469
85MB	ST-296N	28MS	5-1/4"	\$499

**MODULAR CIRCUIT TECHNOLOGY
4800/2400BAUD
FAX/DATA MODEM**

new!
\$119

2400/4800 BAUD
COMBINED DATA/FAX
MODEM FOR LESS
THAN MOST
2400 BAUD DATA

MODEMS ALONE! BY SACRIFICING THE FAX RECEIVE FUNCTION WE CAN OFFER THIS REMARKABLE PRICE!

- 4800 BAUD FAX TRANSMISSION CAPABILITY TO ANY GROUP III FAX MACHINE • 2400 BAUD V.22BIS DATA MODEM • XT/AT COMPATIBLE HALF CARD
- CONVERTS DOS TEXT, PCX, AND TIFF FILES FOR FAX GROUP III TRANSMISSION • MENU DRIVEN SOFTWARE
- PHONE BOOK • MULTIPLE FAX TRANSMISSIONS TO GROUPED ADDRESSES • PROFAX FAX SOFTWARE
- MCT-FAXM

2400 BAUD MODEM \$89⁹⁵

- 2400/1200/300 BAUD • FULL HAYES COMPATIBILITY
- BUILT-IN SPEAKER • CONFIGURABLE AS COM1, COM2, COM3 OR COM4 • AUTO FUNCTIONS INCLUDE WAIT-FOR-DIAL TONE & AUTO-REDIAL ON BUSY • PROMCOM M COMMUNICATIONS SOFTWARE • MADE IN USA
- MCT-24I
- MCT-12I 1200 BAUD VERSION \$59.95

**MICROPOLIS HIGH SPEED
HIGH DENSITY HARD DRIVES**

150MB 5-1/4" DRIVE \$949

- FULL HEIGHT ESDI DRIVE, 23MS AVERAGE ACCESS TIME. 1355
- 1355-PKG DRIVE WITH ESDI CONTROLLER ... \$1049.00
- FULL HEIGHT SCSI DRIVE, 23MS AVERAGE ACCESS TIME. 1375
- 1375-PKG DRIVE WITH SCSI CONTROLLER ... \$999.00
- 1375-PKG DRIVE WITH SCSI CONTROLLER ... \$1099.00

340MB 5-1/4" DRIVE \$1619

- FULL HEIGHT ESDI DRIVE, 18MS AVERAGE ACCESS TIME 1558
- 1558-PKG DRIVE WITH ESDI CONTROLLER \$1799.00
- FULL HEIGHT SCSI DRIVE, 18MS AVERAGE ACCESS TIME 1578
- 1578-PKG DRIVE WITH SCSI CONTROLLER ... \$1619.00
- 1578-PKG DRIVE WITH SCSI CONTROLLER ... \$1799.00

680MB 5-1/4" DRIVE \$2499

- FULL HEIGHT ESDI DRIVE, 16MS AVERAGE ACCESS TIME. 1588
- FULL HEIGHT SCSI DRIVE, 16MS AVERAGE ACCESS TIME. 1588
- 1588-PKG DRIVE WITH SCSI CONTROLLER ... \$2499.00

PROMETHEUS

new!

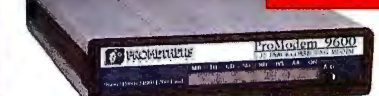

9600 BAUD MODEM \$699⁹⁵

- HIGH SPEED MODEM FEATURES MICROCOM NETWORK PROTOCOL (MNP) AND V.32 COMPATIBILITY • 9600/4800/2400/1200 BPS OPERATION • FULL DUPLEX • CALL BACK SECURITY • NON-VOLATILE RAM STORAGE FOR 10 PHONE NUMBERS • ASYNCHRONOUS/SYNCHRONOUS • FULLY COMPATIBLE WITH CCITT V.32/V.22BIS/V.22, BELL/121A • MNP-5 FOR 100% ERROR FREE TRANSMISSIONS
- DATA COMPRESSION FOR THROUGHPUT TO 19.2K BAUD
- COMPATIBLE WITH MNP OR NON-MNP MODEMS
- PRO-96E

**INTERNAL
2400 BAUD
\$99⁹⁵**

- AUTO DIAL/ANSWER
- SELF-TEST ON POWER-UP
- FULL OR HALF DUPLEX • TOUCHTONE OR PULSE DIALING
- HAYES AND BELL SYSTEMS COMPATIBLE • HALF CARD SIZE • MIRROR II COMMUNICATIONS SOFTWARE
- PRO-24I
- PRO-12I 1200 BAUD 1/2 CARD \$69.95

EXTERNAL 2400 BAUD \$149⁹⁵

- 2400/1200/300 BAUD • 8 STATUS LIGHTS • REQUIRES SERIAL PORT AND CABLE
- PRO-24E
- PRO-12E 1200 BAUD EXTERNAL MODEM \$99.95

**JIM'S BARGAIN
HUNTERS CORNER**



\$39⁹⁵

**DFI SERIAL MOUSE
PLUS HALO-DPE
SOFTWARE**

- REGULARLY \$59.95
- THREE-BUTTON OPTO-MECHANICAL MOUSE WITH 200 DPI RESOLUTION • USES SERIAL PORT COM1 OR COM2 • WITH SOFTWARE DRIVERS, 5-1/2 FT. CABLE • INCLUDES HALO-DPE, A SOPHISTICATED DESKTOP PUBLISHING EDITOR
- DMS-200
- EXPIRES 10/31/89



ORDER TOLL-FREE 800-538-5000

MON.-FRI. 7 A.M. TO 5 P.M., SATURDAY, 10 A.M. TO 3 P.M. (PST)

Terms: minimum order \$10.00. For shipping & handling include \$3.50 for ground and \$4.50 for air. Orders over 1 lb. and foreign orders may require additional shipping charges — contact the Sales department for the amount. Ca residents must include applicable sales tax. Prices subject to change without notice. We are not responsible for typographical errors. We reserve the right to limit quantities and to substitute manufacturer. All merchandise subject to prior sales. A full copy of our terms is available upon request. Items pictured may only be representative.

EDITORIAL INDEX BY COMPANY

Index of companies covered in articles, columns, or news stories in this issue
Each reference is to the first page of the article or section in which the company name appears

INQUIRY #	COMPANY	PAGE	INQUIRY #	COMPANY	PAGE	INQUIRY #	COMPANY	PAGE	
1141	AAPPS	49	1187	DELTAIC SYSTEMS	266	1074	LASERDRIVE	160, 266	
989	ACCOLADE	115	1154	DIGITAL COMMUNICATIONS ASSOCIATES	49	1189	LOGITECH	64, 115, 195	
982	ADVANCED GRAPHIC APPLICATIONS	133, 160, 266	1134	DIGITAL EQUIPMENT	49	885	LOTUS DEVELOPMENT	17	
1071			852	EASTMAN KODAK	191	991			
1181			994	ELECTRONIC ARTS.....	115	1102			
1147	ADVANCED PRODUCTS & TECHNOLOGIES	49		ENVIRONMENTAL PROTECTION AGENCY.....	17				
	AGILIS	17		EPSON	17	988	MAGIC 7 SOFTWARE	115	
1124	AJIDA TECHNOLOGIES	64		FIFTH GENERATION SYSTEMS...	17	884	MAPPING INFORMATION SYSTEMS.....	211	
1002	ALDUS.....	81	1148	FRANKLIN COMPUTER	49		MATE	17	
1182	ALPHATRONICS	266		FUJITSU.....	17	1075	MAXIMUM STORAGE	160, 266	
1121	AMERICAN IMAGING SYSTEMS.....	64	1123	GENERIC SOFTWARE.....	64	1190	MEGAGRAPHS	49	
855	AMERICAN MITAC	181	1143	GENESYS	49	981	MICHRON.....	133	
	AMETEK.....	287		GEORGE MORROW.....	17	1191	MICRION	249	
	AMOCO LASER	249		GEORGIA INSTITUTE OF TECHNOLOGY	231		MICRO DESIGN INTERNATIONAL.....	266	
1105	ANNABOOKS.....	64	990	GROLIER ELECTRONIC PUBLISHING.....	115	998	MICROHELP	115	
	APPLE COMPUTER	98, 139, 149, 287		995	HAMMERLY COMPUTER SERVICES	115	1192	MICROSOFT	17
1183	AQUIDNECK SYSTEMS INTERNATIONAL.....	266	1133	HEADSTART TECHNOLOGIES	49	1193	MITSUBISHI ELECTRONICS AMERICA	17, 266	
986	ARITY.....	133	1115	HEM DATA.....	64		N/HANCE SYSTEMS.....	266	
	ASHTON-TATE	17	983	HEWLETT-PACKARD	17, 49, 81	1129	NARDONI ASSOCIATES.....	64	
	AST RESEARCH.....	17	1005	HILGRAEVE.....	81, 133		NATIONAL EDUCATION COMPUTING CONFERENCE	17	
	AT&T UNIX SOFTWARE OPERATION	17		HITACHI/MAXWELL.....	17		NCR	17	
	ATARI.....	17	854	IBM.....	17, 145, 181, 249		NCUBE	17, 287	
1116	BIOPAC SYSTEMS.....	64	1101	IMC NETWORKS.....	17	1137	NEC HOME ELECTRONICS (U.S.A.).....	17, 49	
	BIPOLAR INTEGRATED TECHNOLOGY	17	1136	IMPRIMIS TECHNOLOGY	49		NEWPORT	249	
1104	BLAISE COMPUTING	64	1188	INFORMATION STORAGE	160, 266		NEXT	17	
860	BORLAND INTERNATIONAL.....	111		INTEL.....	17, 287	1135	NORMEREL USA	49	
1131	BUSINESS FORECAST SYSTEMS.....	64	883	INTERACTIVE SYSTEMS	201		NOVELL.....	149	
	CALTECH/JPL MARK	287	1130	ISOGON	64	1113	OCEAN ISLE SOFTWARE	64	
	CANON	17		JAPANESE ELECTRONICS INDUSTRY & DEVELOPMENT ASSOCIATION	17		OKI ELECTRIC.....	17	
1118	CIMTECHNOLOGIES.....	64	1103	JENSEN & PARTNERS INTERNATIONAL.....	17, 64		OLIVETTI.....	17	
	COMPUTER PROFESSIONALS FOR SOCIAL RESPONSIBILITY	17		KNIGHTS TECHNOLOGY	249	1194	ONLINE COMPUTER SYSTEMS.....	266	
1184	COMPUTER UPGRADE	266	1112	KODAK	249	993	OXFORD UNIVERSITY PRESS	115, 360	
1072	COREL SYSTEMS.....	160, 266		KORN INDUSTRIAL CONSULTANTS	64	1195	PANASONIC INDUSTRIAL.....	266	
1152	CORVUS SYSTEMS	49	1151	LAN SYSTEMS	49		PAUL MACE	17	
997	CRESCENT SOFTWARE	115	1120	LANDCADD.....	64	1008	PERCEPTIVE SOLUTIONS	81	
1139	CUMULUS.....	49				1196	PERIPHERAL LAND.....	266	
	DATA GENERAL	17					PHOENIX TECHNOLOGIES.....	17	
	DATA TRANSLATION.....	17				1150	PHOTONICS	49	
984	DAVE BRICCETTI AND ASSOCIATES	133				1076	PIONEER COMMUNICATIONS OF AMERICA	160, 266	
	DAVID SARNOFF RESEARCH CENTER	239				1197	PIXAR	249	
1006	DAYNA COMMUNICATIONS	81					POQET	17	
1144	DAYSTAR DIGITAL	49					PRIME	17	
1186	DELTA MICROSYSTEMS.....	266				1155	PROTEON	49	

INQUIRY #	COMPANY	PAGE
	QUESTEK	249
1077	RACET COMPUTERS	160, 266
1198		
992	ROBERTA J. POURNELLE	115
1145	RUPP	17, 49
987	SAMNA	115
1138	SEIKO INSTRUMENTS USA	49
1000	SELECTIONS	115
	SEMICON WEST	249
	SHARP	17
886	SILICON BEACH SOFTWARE	217
	SILICON GRAPHICS	249
1125	SOFTPRO	64
985	SOFTWARE DIRECTIONS	133
	SPECTRA-PHYSICS	249
	STANFORD UNIVERSITY	239
1078	STORAGE DIMENSIONS	160, 266
1199		
980	SUMMUS COMPUTER	
1080	SYSTEMS	160, 266
1079	SUMO SYSTEMS	160, 266
1200		
	SUN MICROSYSTEMS	17, 149
1003	SYMANTEC	81
	SYMBOLICS	17
851	TEKTRONIX	187
1149	TELESYSTEMS SLW	49
	TERADYNE LASER SYSTEMS	249
	TEXAS INSTRUMENTS	17
996	THE PROICON GROUP	115
	3-D SYSTEMS	249
	TOPS	149
853	TOSHIBA AMERICA INFORMATION	
	SYSTEMS	17, 191
999	TRAVELER'S GUILD	115
1128	TSM ASSOCIATES	64
	U.S. COMMERCE	
	DEPARTMENT	17
	UNISYS	17
981	UNITED SYSTEMS	266
	UNIVERSITY OF ALABAMA	231
1153	VADIS	49
1132	WELLS AMERICAN	49
1001	WORDSTAR	
	INTERNATIONAL	17, 115
	WORDTECH	17
	XRL	249
	ZENITH DATA SYSTEMS	17

COMING UP IN BYTE

Scheduled to appear in forthcoming issues of **BYTE**, the following list of articles represents work in progress.

PRODUCTS IN PERSPECTIVE:

With TIGA-based graphics just around the corner, we test a number of graphics coprocessor boards using the Texas Instruments 34010 chip in the November **Product Focus**.

Diskless workstations are becoming popular for use in LANs. We compare two new units from Wyse Technology and TeleVideo Systems in **system reviews**.

In a **peripheral review**, we evaluate two high-speed network nodes from Dayna Communications and TOPS that claim to quadruple data transfer rates on Apple networks.

Software reviews look at the following two products: ExperTelligence's Action! is an applications development program that runs on the Macintosh II/Texas Instruments MicroExplorer combination, and Alpha Four from Alpha Software is a relational database designed for nonprogrammers.

IN DEPTH:

The November Expanded In Depth will explore the hardware and software capabilities, challenges, and problems associated with **32 bits and above**. This may sound futuristic, but it isn't, because 32-bit hardware is here in 80386, 68020, and 68030 machines. And as the 80486 is here now, can the 68040 be far behind? What are some of the challenges associated with bringing software to these machines that actually use their 32-bit capabilities? How do 32-bit systems handle memory? And where will they go from here? Is the direction onward and upward? 64 bits? 128 bits? Is there a limit? Do we reach a point of diminishing returns? These are some of the questions that will be answered.

FEATURES:

We'll take a look at **helical scan technology**, a method of storing data on magnetic tape that owes a great deal to the VCR. Additionally, we'll explore **Intel's new 80860 chip**, take a guided tour of the **NeXT machine's Mach operating system**, and get an overview of the activities at **MIT's Media Lab**.

In **Under the Hood**, Brett Glass takes a look at EISA, the newest industry bus standard; in **Some Assembly Required**, Rick Grehan continues his "Two Tin Cans . . ." article on network interfaces with a look at NetBIOS.

As always, our columns, **Computing at Chaos Manor**, **The Unix /bin**, **Down to Business**, **Macinations**, **OS/2 Notebook**, and **NetWorks**, offer **Expert Advice** on a whole raft of problems, from the exotic to the mundane.

Industry news and the latest information on hardware and software are the core of our **Microbytes**, **What's New**, and **Short Takes** sections. These departments, written by **BYTE** reporters and editors, provide a focus on the important events in microcomputing that is unequaled by any other source.

READER SERVICE

To get further information on the products advertised in BYTE, fill out the reader service card by circling the numbers on the card that correspond to the inquiry number listed with the advertiser. This index is provided as an additional service by the publisher, who assumes no liability for errors or omissions.

* Correspond directly with company.

Alphabetical Index to Advertisers

Inquiry No.	Page No.	Inquiry No.	Page No.	Inquiry No.	Page No.	Inquiry No.	Page No.	
8	2001 SALES	220	92	EDC GMBH	276	179	MICROSPEED	34
9	2001 SALES	220	93	ELEXOR	341	180	MICROSPEED	34
10	2500 AD SOFTWARE	144	94	ELLITE MICROSYSTEMS INC	117	181	MICROTRON TRADE SERVICE	248
11	ACS COMMUNICATIONS	344	95	ELLIS COMPUTING	133		MICROWAY	173
13	ADVANCED LOGIC RESEARCH	2,3	304	ELS ENTERPRISES, LTD	286	182	MICROWAY	275
14	ADVANCED LOGIC RESEARCH	2,3	96	ELTECH RESEARCH	271	22	MITAC	190
15	ADVANCED MATRIX TECH	185	97	EMERALD COMPUTERS, INC.	35	184	MIX SOFTWARE	305
16	ADVANTAGE SOFTWARE	119		EPSON	20,21	185	MKS	123
17	AK SYSTEMS	342	98	EXECUTIVE PHOTO & SUPPLY	194		MONTGOMERY GRANT	130
16	ALL REGULATOR AB	333	314	EXSEL	357	186	NAGAN CORP.	344
19	ALL REGULATOR AB	333	99	FOCUS RESEARCH, INC.	338	187	NANTUCKET	199
20	ALPHA PRODUCTS	336	100	FORESIGHT RESOURCES	23	188	NATIONAL INSTRUMENT	C111
21	AMERICAN GROUP	328	101	FORESIGHT RESOURCES	23	189	NEC HOME ELECTRONICS	38,39
23	AMERICAN SMALL BUS. COMP.	114	102	FORTRON	37	190	NEC HOME ELECTRONICS	41
	AMPRO	124	103	FORTRON	37	191	NETWORK TECHNOLOGIES	342
25	ANNABOOKS	321	213	FRANKLIN/PROXIMITY	308	192	NOHAU CORPORATION	299
	ANTHRO	42	214	FRANKLIN/PROXIMITY	308	193	NOHAU CORPORATION	333
27	ATI TECHNOLOGIES	171	104	FRANKLIN SOFTWARE	86		NORTHGATE COMPUTER	134,135
29	ATTACHMATE CORP.	154	105	FTG DATA SYSTEMS	342		NORTHGATE COMPUTER	136,137
30	A/SOFT DEVELOPMENT, INC.	132	106	FRANKLIN SOFTWARE	321		NORTHGATE COMPUTER	138,139
31	B & B ELECTRONICS	333	107	G-TEK, INC.	48D		NORTHGATE COMPUTER	140,141
32	BARADINE PRODUCTS	334	108	G-TEK, INC.	48D	194	NUMONICS	210
33	BAYTECH	186	109	GATEWAY 2000	10,11	195	NU-MEGA TECHNOLOGIES	121
34	BAYTECH	186	110	GE INFO SERVICES	216	196	ON LINE STORE	335
35	BE AWARE INC.	86	112	GOODWAY	144B		ORACLE	57
38	BE AWARE INC.	86	26	G. REED, INC.	328	197	OVERLAND DATA, INC.	321
37	BINARY TECHNOLOGY	338	113	HAMMERLY COMPUTER SERV.	272	198	PACIFIC COMPUTERS	323
38	BIT WISE	144C	114	HAMMERLY COMPUTER SERV.	273	199	PACIFIC DATA PRODUCTS	89
39	BIT WISE	144C	303	HAUPPAUGE COMPUTER	285	200	PACIFIC DATA PRODUCTS	89
450	BIX	358,359	115	HEATH COMPANY	237	201	PANASONIC	175
41	BLAISE COMPUTING	48C	116	HEWLETT-PACKARD PERIPH.	14,15	202	PARA SYSTEMS	79
42	BORLAND INTERNATIONAL	13	117	HEWLETT-PACKARD PERIPH.	144G	203	PARSONS TECHNOLOGY	87
43	BORLAND INTERNATIONAL	13	118	HEWLETT-PACKARD PERIPH.	145	204	PATTON & PATTON	118
44	BP MICROSYSTEMS	341	119	HIGH RES. TECHNOLOGIES	328	205	PERISCOPE	144D
45	BP MICROSYSTEMS	341	120	HITECH EQUIPMENT CORP.	344	206	PERISCOPE	144D
	BUYERS MART	310-320	121	HOME SMART COMPUTING	328	319	PETER NORTON	255
	BYTE BACK ISSUES	326	122	HOUSTON INSTRUMENT	189	207	PHAR LAP	198
46	BYTE BITS	331	123	HYPERKINETIX	110	216	PI COMPUTER CORPORATION	322
	BYTE SUB MESSAGE	42	124	HYPERKINETIX	110	312	PINNACLE MICRO	258
47	BYTEK COMPUTER CORP.	337	125	H.I.M.S. TECHNOLOGIES	278	313	PINNACLE MICRO	258
	BYTE PUBLICATIONS	72,73		IBM OS/2	167	315	PINNACLE PUBLISHING	302
	BYTEWEEK/NEWSLETTER	363		IBM PS/2	48-48A	209	PRIORITY ONE COMPUTER	230
46	B&C MICRO	331	126	IC EXPRESS	337	210	PROGRAMMER'S PARADISE	80,61
49	B&C MICRO	331	127	IMAGENET SYSTEMS	331	211	PROTECH MARKETING	59
323	B&C MICRO	333	128	IMAGENET SYSTEMS	331	212	PROTECH MARKETING	59
28	CADRE TECHNOLOGIES INC.	31	129	IMES GMBH	338	208	PSI	323
	CALIFORNIA DIGITAL	345	130	INMAC	246	217	P.C. NETWORK	43
50	CH PRODUCTS	125	131	INTEGRAND	218	218	P.C. BRAND	221
51	CH PRODUCTS	125	132	INTELLIGENCEWARE	71	219	P.C. BRAND	222,223
52	CLONE COMPUTER	327	133	IO COMM	243	220	P.C. BRAND	224,225
318	CLUB AMERICAN TECH.	265	134	IO TECH	204	221	P.C. BRAND	226,227
53	COMMUNICATION RESEARCH GR	274	135	IO TECH	204	222	QMS	107
54	COMMUNICATION RESEARCH GR	274	136	JADE COMPUTER PRODUCTS	339	223	QMS	107
55	COMPACT DISK PRODUCTS	169	137	JAMECO	324,325	224	QMS	193
58	COMPUCALCLASSICS	142	138	JB TECHNOLOGIES	133	225	QMS	193
57	COMPUCOM	322	139	JB TECHNOLOGIES	133	226	QUA TECH	328
59	COMPUSERVE	257		JENSEN & PARTNERS	127	227	QUA TECH	328
60	COMPUTER ASSOCIATES	28,29	140	J.D.R. MICRODEVICES	346,347	228	QUARTAR CORP.	342
305	COMPUTER DIRECT	294,295	141	J.D.R. MICRODEVICES	348,349	229	QUANTUM SOFTWARE	69
81	COMPUTER DISC WAREHOUSE	144A	142	KADAK	342	230	QUARTERDECK	128,129
62	COMPUTER FRIENDS	144H	143	KEA SYSTEMS	341	231	QUARTERDECK	128,129
63	COMPUTER MAIL ORDER	176,177	144	KILA SYSTEMS	331	232	QUARTERDECK	128,129
64	COMPUTER MAIL ORDER	178,179	145	KNOWLEDGE GARDEN	361	233	QUARTERDECK	128,129
65	COMPUTER MAIL ORDER	208,209	148	KORE, INC.	331	234	RADIO SHACK	CIV
322	COMPUTER PERIPHERALS INC	75	149	KUSTEM DATA SERVICES	331		RAIMA	53
	COMPUTER PROFESSIONALS	112A-B	150	K.E.M. ELECTRONICS	334		RAIMA	112
268	COMPUTER PROFESSIONALS BK113		151	LAHEY COMPUTER SYS.	144F	235	RAINBOW TECHNOLOGIES	150
66	COMPUTERLANE	330	152	LANTANA TECHNOLOGY	298	236	RAINBOW TECHNOLOGIES	150
87	COMPUTRADE	78	153	LANTANA TECHNOLOGY	298	237	REAL TIME DEVICES	338
68	CONTECH COMPUTER CORP.	344	154	LAWSON LABS	342	238	ROSE ELECTRONICS	157
69	CONTROL VISION	341	155	LINK COMPUTER GRAPHICS	328	239	ROSE ELECTRONICS	157
70	COREL	236	156	LOGIC VISION	74	240	RUPP CORPORATION	215
71	CORPORATE COMPUTERS OF IOWA	77	157	LOGICAL DEVICES	344	241	RUPP CORPORATION	215
72	CORPORATE COMPUTERS OF IOWA	77	158	LOGICAL DEVICES	344	242	RUPP CORPORATION	215
73	COVOX	334	159	LOGICAL DEVICES	344	243	RUPP CORPORATION	215
74	CRASHLOW	328	160	LOGICAL DEVICES	344	244	RUPP CORPORATION	215
75	CSS LABORATORIES INC	180	161	LOGITECH	54,55	245	RUPP CORPORATION	215
76	CSS LABORATORIES INC	180	162	LOGITECH	54,55	309	SAELIG COMPANY	334
	CLUB CORPORATION	44	310	LOGITECH	46	246	SAEFARE	341
	DAMARK	247	311	LOGITECH	46	301	SAMSUNG	66,67
78	DATA TRANSLATION INC.	45	163	MAP INFO	32	302	SAMSUNG	66,67
79	DAYTRON	344	164	MARYMAC	334	248	SANTA CRUZ OPERATION	63
80	DELL COMPUTER	C11,1	165	MATHSOFT	51	249	SCHWAB COMPUTER	338
	DELL COMPUTER	64A-B	166	MATRIX	207	250	SCIENTIFIC ENDEAVORS	338
81	DELL COMPUTER	65	167	MAXCIMA	322	251	SCIENTIFIC ENDEAVORS	338
82	DELTA COMPUTING TECH.	342	169	MEAD COMPUTER	332	252	SCIENTIFIC ENDEAVORS	338
306	DIGIBOARD	296	170	MEGATEL	88	253	SCIOTO COMPUTERS	337
83	DIGITAL RESEARCH	197	171	MERRILL COMPUTER	284	254	SEAGATE	203
84	DIGITAL RESEARCH	197	172	MEXTEL	256		SILICON SHACK	338
85	DIGITALK	24,25	173	MEXTEL	256		SMALL COMP BOOK CLUB	32A-B
86	DIGI-DATA	342		MICROCOMPUTER MKTG CNCL	343		SMALL COMP BOOK CLUB	33
88	DISKOTEC	341	174	MICRO SOLUTIONS COMP. PROD.	74		SOFTWARE DEVELOPMENT SYS	83
89	DISKETTE CONNECTION	337	175	MICROCOM	219	255	SOFTWARE LINK	213
90	DIVERSIFIED COMPUTER	337	176	MICROPROCESSORS UNLTD	328	256	SOFTWARE LINK	213
87	DOCUBASE SYSTEMS	206		MICROSOFT	6,7	257	SOFTWARE SECURITY	200
91	DYNAMIC ELECTRONICS	321		MICROSOFT	19	258	SPECTRUM	103
	ECOSOFT	70	178	MICROSOFT	85	259	STATSTRUM	47
260	STEINCO A/S	144B	261	STORAGE DIMENSIONS (N.AMER)	165	262	STORAGE DIMENSIONS (N.AMER)	165
316	STORAGE DIMENSIONS (INT'L)	165	317	STORAGE DIMENSIONS (INT'L)	165	283	STSC	27
264	SUPERSOFT	80	285	SURAH, INC.	344	286	SWIRL SOFT	341
270	TECHNOLOGY POWER	342	271	THE IDEA WORKS	344	272	TMI, INC.	88
273	TOSHIBA	158,159	274	TOSHIBA	158,159	277	TOUCHBASE SYSTEMS, INC.	36
278	TRACE, INC.	109	279	TRAVELING SOFTWARE	105	307	TUSSEY COMPUTER PROD.	146,147
308	TUSSEY COMPUTER PROD.	148,149	308	TUSSEY COMPUTER PROD.	148,149	280	T.P.C.	326
281	ULTIMATE TECHNOLOGY	338	282	UNIX	340		UNIXWORLD	329
	VERMONT CREATIVE	16	284	WAREHOUSE DATA	205	285	WATCOM	120
286	WELLS AMERICAN (N.AMER)	153	287	WELLS AMERICAN (N.AMER)	153	320	WELLS AMERICAN (INT'L)	153
321	WELLS AMERICAN (INT'L)	153	321	WELLS AMERICAN (INT'L)	153	288	WELLS AMERICAN	277
289	WELLS AMERICAN	277	290	WIESEMANN & THEIS	284	400	WINTEK	9
291	WINTEK	337	292	XELTEK	333	294	Z-WORLD	334
295	ZENITH DATA SYSTEMS	48B	296	ZEOS INTERNATIONAL	90,91	297	ZEOS INTERNATIONAL	92,93
298	ZEOS INTERNATIONAL	94,95	299	ZEOS INTERNATIONAL	96,97	300	ZORTECH	233

INTERNATIONAL SECTION 80 IS 1-72 No North American Inquiries please.

401	06 SOFTWARE CENTRE EUROPE	IS-58
402	06 SOFTWARE CENTRE EUROPE	IS-59
403	ABC COMPUTER CO. LTD	IS-61
404	ACER, INC.	IS-44,45
405	ACME TECHNOLOGY CORP.	IS-38
409	ADVANTEK INT'L LTD	IS-10
406	AGC ELECTRONICS CORP.	IS-51
407	ALADDIN KNOWLEDGE SYS.	IS-55
408	AQUARIUS SYSTEMS INC.	IS-39
410	BIX	IS-71
411	BLUE CHIP TECHNOLOGY	IS-56
469	BRITISH TELECOM	IS-2,3
	BYTE BACK ISSUES	IS-68
	BYTE PUBLICATIONS	IS-70
	BYTE PUBLICATIONS	IS-72
412	CLARION SOFTWARE	IS-29
413	CLARION SOFTWARE	IS-29
414	CLEO COMMUNICATIONS	IS-33
468	COBALT BLUE	IS-46
415	CONTROL TELEMETRY	IS-38
416	COPAM ELECTRONICS CORP.	IS-67
417	C&D TECHNOLOGY, INC.	IS-36
	DATA COMMUNICATIONS IS-48A-B	
	DATA COMMUNICATIONS	IS-49
418	D-LINK SYSTEM, INC.	IS-16
419	DIETRIX	IS-52
	ELONEX	IS-19
421	FAST ELEKTRONIK GMBH	IS-42
470	FASTFAME CO., LTD	IS-40
422	FOCUS ELECTRONIC CO., LTD	IS-57
	FORTE COMMUNICATIONS	IS-14
424	GALAXY MICROCRAFT SYS.	IS-52
425	GAMMA	IS-12
426	GENOA SYSTEMS	IS-4
427	GREY MATTER	IS-65
428	GTCC	IS-20
429	GTCC	IS-20
430	HWA HSIN ELECTRONIC CO.	IS-24
431	I X I LTD.	IS-56
432	INES	IS-48
434	INTERQUADRAM	IS-7
435	INTERQUADRAM	IS-9
436	INWIN DEVELOPMENT INC.	IS-40
437	KAYPRO	IS-37
438	MAYFAIR MICROS	IS-63

READER SERVICE

Inquiry No.	Page No.	Inquiry No.	Page No.	Inquiry No.	Page No.	Inquiry No.	Page No.
440 MICROMINT	IS-34	* SIGS PUB/JOURNAL OF OBJEC	IS	533 DRAGONSLAYER SYSTEMS	NE-33	Pacific Coast	
441 NOVELL	IS-25	* SOFTWARE EXCITEMENT	IS	534 EDI	NE-20	80 PC1-16	
442 ORCAD SYSTEMS CORP.	IS-15	* TELETEK	IS	535 EDI	NE-20	499 3-F ASSOCIATES	PC-8
443 PERICOM	IS-31	* TOUCHBASE	IS	536 ELECTRIFIED DISCOUNTERS	NE-25	502 B-LINK	PC-7
444 PHILIPS MONITORS	IS-11	* TRIPP LITE	IS	537 FOUNTAIN TECHNOLOGIES, INC.	NE-15	* BYTEWEEK/NEWSLETTER	PC-4
445 PRICE TREND	IS-6	REGIONAL SECTIONS		538 FUTURA SYSTEMS	NE-4	503 CDS	PC-9
446 PROCOMP, USA INC.	IS-48	Midwest		539 FUTURA SYSTEMS	NE-4	* DATA COMMUNICATIONS	PC-16
447 PROCOMP, USA INC.	IS-48	80 MW1-8		540 HALSKAR SYSTEMS	NE-8	504 DATAMAG, INC.	PC-2
448 QUOTHA 32	IS-46	Southwest		541 HALSKAR SYSTEMS	NE-8	505 DATAMAG, INC.	PC-2
449 SAMSUNG ELECTRONICS	IS-53	* BYTEWEEK/NEWSLETTER		542 HARMONY COMPUTERS	NE-1	506 HEALD INSTITUTE OF TECH.	PC-13
* SCANDEC TRIBUTOR	IS-69	* COMP. FOR THE BLIND		543 HARMONY COMPUTERS	NE-1	507 KEYBOARD COMEDY	PC-11
451 SCOTTSDALE SYSTEMS	IS-13	* DATA COMMUNICATIONS		544 HARVARD INFO SYSTEMS	NE-6	508 ORCAD SYSTEMS, INC.	PC-15
* SOFTLINE CORPORATION	IS-35	476 DAKOTA COMPUTER		545 HERTZ	NE-7	509 PEOPLESMITH SOFTWARE	PC-13
452 SOFTWARE CONSTRUCTION	IS-43	* MW-3		546 HY-TEC	NE-12	510 SOFTWARE ENGINEERING STR.	PC-12
453 SOFTEK COMPUTER	IS-56	* MW-8		547 HY-TEC	NE-12	511 TELETEK	PC-3
454 STONY BROOK SOFTWARE	IS-27	477 HALSKAR SYSTEMS		548 LAPTOS ETC.	NE-28	512 TELETEK	PC-3
455 STONY BROOK SOFTWARE	IS-27	* MW-6		549 L&W MICROCOMPUTING	NE-23	513 TRAN COMPUTER NETWORK	PC-1
456 SUPERTRON ELECTRIC CO. LTD.	IS-41	478 HALSKAR SYSTEMS		550 L&W MICROCOMPUTING	NE-23	514 TRAN COMPUTER NETWORK	PC-1
458 TOPLINK COMPUTER CO. LTD.	IS-32	* MW-1		551 MINTA TECHNOLOGIES	NE-9	515 WINTIME TECH.	PC-14
459 TRIANGLE DIGITAL SERVICES	IS-46	479 NEXT WORKS, THE		552 MPM	NE-36	516 ZERICON	PC-10
461 TRITON TECHNOLOGIES	IS-8	* MW-1		553 MPM	NE-36	South	
462 TRITON TECHNOLOGIES	IS-8	481 Y.E.S. SYSTEMS CORP.		554 M.S.C.	NE-29	80 SO1-12	
463 TWINHEAD INT'L CORP.	IS-50	* MW-5		555 NOCONA ELECTRONICS	NE-22	486 A-TRONIC COMPUTER	SO-11
464 UNIBIT	IS-47	483 ZERICON		556 ON LINE COMPUTER	NE-27	* BYTEWEEK/NEWSLETTER	SO-4
465 UNITECH COMP. CO. LTD.	IS-26	Northeast		557 ON LINE COMPUTER	NE-27	487 COMPUTER WHOLESALERS	SO-5
466 USA SOFTWARE	IS-23	80 NE1-36		558 ONLINE PRODUCTS CORP.	NE-17	* COMPUTER WHOLESALERS	SO-5
471 WORLD WIDE COPIER PARTS	IS-52	523 ADTECH		559 ONLINE PRODUCTS CORP.	NE-17	* DATA COMMUNICATIONS	SO-12
		524 ADTECH		560 PC LINK	NE-16	489 MIGHTY MICRO	SO-1
		521 ADVANCED DIGITAL CORP.		561 PC PLUS TECHNOLOGIES	NE-19	490 MIGHTY MICRO	SO-1
		* NE-3		562 PC PLUS TECHNOLOGIES	NE-19	491 OCTAGON TECHNOLOGIES	SO-7
		522 ADVANCED DIGITAL CORP.		563 RENEGADE CORP.	NE-35	492 OCTAGON TECHNOLOGIES	SO-7
		* NE-3		564 SUMMA COMPUTER	NE-34	493 SQUAREFIELD	SO-2
		525 A-TRONIC COMPUTER		565 TELETEK	NE-11	494 SQUAREFIELD	SO-2
		* NE-21		566 TELETEK	NE-11	495 SUMMA COMPUTER	SO-3
		526 BLUE CIRCLE GROUP, INC.		567 TRANS-M CORP.	NE-13	496 ZERICON	SO-8
		* NE-6		568 TRANS-M CORP.	NE-13	<i>* Correspond directly with company.</i>	
		527 BLUE CIRCLE GROUP, INC.		569 TRANS-M CORP.	NE-13		
		* NE-6		570 TRANS-M CORP.	NE-13		
		528 COMPFAX		571 ZEPHYR SERVICES	NE-2		
		* NE-5					
		530 COMPUTER EXPERT, INC.					
		* NE-32					
		531 COMPUTER EXPERT, INC.					
		* NE-32					
		* DATA COMMUNICATIONS					
		* NE-24					
		532 DAYTRON ELECTRONICS, INC.					
		* NE-22					

INT'L DIRECT RESPONSE POSTCARDS

- * BYTE INTERNATIONAL IS
- * BYTEWEEK IS
- * C GAZETTE MAGAZINE IS
- * ITC INC IS
- * METRABYTE IS
- * MICRO SIM IS
- * REASONABLE SOLUTIONS IS

BYTE ADVERTISING SALES STAFF:

Steven M. Vito, Associate Publisher/V.P. of Marketing, One Phoenix Mill Lane, Peterborough, NH 03458, tel. (603) 924-9281
 Arthur Kossack, Eastern Regional Sales Manager, 645 North Michigan Ave., Chicago, IL 60611, tel. (312) 751-3700
 Jennifer L. Bartel, Western Regional Sales Manager, 8111 LBJ Freeway, Suite 1350, Dallas, TX 75251, tel. (214) 644-1111
 Liz Coyman, Inside Sales Director, One Phoenix Mill Lane, Peterborough, NH 03458, tel. (603) 924-2518

NEW ENGLAND
 ME, NH, VT, MA, RI, ONTARIO
 CANADA & EASTERN CANADA
 John C. Moon (617) 262-1160
 McGraw-Hill Publications
 575 Boylston Street
 Boston, MA 02116
 FAX: (617) 262-6430

ATLANTIC
 NY, NYC, CT, NJ (NORTH)
 Kim Norris (212) 512-2645
 McGraw-Hill Publications
 1221 Avenue of the Americas—
 28th Floor
 New York, NY 10020
 FAX: (212) 512-3520

EAST
 PA, NJ (SOUTH),
 MD, W. VA, DE, D. C.
 Thomas J. Brun (215) 496-3833
 McGraw-Hill Publications
 Three Parkway
 Philadelphia, PA 19102
 FAX: (215) 496-3828

SOUTHEAST
 NC, SC, GA, FL, AL, TN, VA, MS
 Thomas Tolbert (404) 252-0626
 McGraw-Hill Publications
 4170 Ashford-Dunwoody Road
 Suite 420
 Atlanta, GA 30319
 FAX: (404) 252-4056

MIDWEST
 IL, MO, KS, IA, ND, SD, MN,
 KY, OH, WI, NB, IN, MI
 Kurt Kelley (312) 751-3740
 McGraw-Hill Publications
 Blair Building
 645 North Michigan Ave.
 Chicago, IL 60611
 FAX: (312) 751-3767

**SOUTHWEST,
 ROCKY MOUNTAIN**
 CO, WY, OK, TX, AR, LA
 Karl Heinrich (713) 462-0757
 McGraw-Hill Publications
 7600 W. Tidwell Rd.—Suite 500
 Houston, TX 77040
 FAX: (713) 462-5626

SOUTH PACIFIC
 SOUTHERN CA, AZ, NM,
 LAS VEGAS
 Ron Cordek (714) 557-6292
 McGraw-Hill Publications
 3001 Red Hill Ave.
 Building #1—Suite 222
 Costa Mesa, CA 92626
 FAX: (714) 557-2219

Tom Harvey (213) 480-5243
 McGraw-Hill Publications
 3333 Wilshire Boulevard #407
 Los Angeles, CA 90010
 FAX: (213) 480-5249

NORTH PACIFIC
 HI, WA, OR, ID, MT,
 NORTHERN CA,
 NV (except LAS VEGAS),
 W. CANADA, UT
 Christine Kopec (415) 362-4600
 McGraw-Hill Publications
 425 Battery Street
 San Francisco, CA 94111
 FAX: (415) 954-9786

Bill McAfee (408) 879-0371
 McGraw-Hill Publications
 1999 South Bascom Ave.
 Suite #210
 Campbell, CA 95008
 FAX: (408) 879-9067

BYTE BITS (2x3)
 Mark Stone (603) 924-6830
 BYTE Publications
 One Phoenix Mill Lane
 Peterborough, NH 03458

The Buyer's Mart (1x2)
 Brian Higgins (603) 924-3754
 BYTE Publications
 One Phoenix Mill Lane
 Peterborough, NH 03458

Regional Advertising
 Larry Levine (603) 924-4379
 BYTE Publications
 One Phoenix Mill Lane
 Peterborough, NH 03458

Barry Echevarria (603) 924-2574
 BYTE Publications
 One Phoenix Mill Lane
 Peterborough, NH 03458

National Sales
 Scott Gagnon (603) 924-4380
 Mary Ann Goulding
 (603) 924-2664
 Elisa Lister (603) 924-2665
 BYTE Publications
 One Phoenix Mill Lane
 Peterborough, NH 03458

BYTE Deck Mailings
 Ed Ware (603) 924-6166
 BYTE Publications
 One Phoenix Mill Lane
 Peterborough, NH 03458

A/E/C Computing Deck
 Computing for Engineers
 Dan Harper (603) 924-2598
 BYTE Publications
 One Phoenix Mill Lane
 Peterborough, NH 03458

Peterborough, NH Office
 Advertising Fax: 603-924-7507

International Advertising Sales Staff:

Frank Tanis, European Sales Manager, BYTE Publications,
 Batenburg 103, 3437 AB Nieuwegein, The Netherlands, tel: 31 34 02 49496, fax: 31 34 02 37944

Karen Lennie
 McGraw-Hill Publishing Co.
 34 Dover St.
 London W1X 4BR
 England 01 493 1451
 FAX: 01 493 9896

Ros Weyman
 Serving Germany, Austria, & Switzerland
 McGraw-Hill Publishing Co.
 34 Dover St.
 London W1X 4BR
 England 01 493 1451
 FAX: 01 493 9896

Alessandro Coari
 McGraw-Hill Publishing Co.
 Via Flavio Baracchini 1
 20123 Milan, Italy
 (2) 89010103
 FAX: (2) 879 400

Mrs. Maria Sarmiento
 Pedro Teixeira 8, Off. 320
 Iberia Mart 1
 Madrid 4, Spain
 1 45 52 891

Masaki Mori
 McGraw-Hill Publishing Co.
 Overseas Corp.
 Room 1528
 Kasumigaseki Bldg.
 3-2-5 Kasumigaseki,
 Chiyoda-Ku
 Tokyo 100, Japan
 3 581 9811
 FAX: 81-3-581-4018

Seavex Ltd.
 303 Wilson House
 19-27 Wyndham St.
 Central, Hong Kong
 Tel: 5-260149
 Telex: 60904 SEVEX HX
 FAX: 852 5 810 1283

Seavex Ltd.
 400 Orchard Road, #10-01
 Singapore 0923
 Republic of Singapore
 Tel: 734-9790
 Telex: RS35539 SEAVEX
 FAX: 65 732 5129

Mr. Ernest McCrary
 Empresa Internacional de
 Comunicacoes Ltda.
 Rua da Consolacao, 222
 Conjunto 103
 01302 Sao Paulo, S.P., Brasil
 Tel: (11) 259-3811
 Telex: (100) 32122 EMBN

READER SERVICE

To get further information on the products advertised in BYTE, fill out the reader service card by circling the numbers on the card that correspond to the inquiry number listed with the advertiser. This index is provided as an additional service by the publisher, who assumes no liability for errors or omissions.

* Correspond directly with company.

Index to Advertisers by Product Category

Inquiry No.	Page No.	Inquiry No.	Page No.	Inquiry No.	Page No.	Inquiry No.	Page No.
HARDWARE							
800	ADD INS						
404	ACER, INC. IS-44,45	47	BYTEK COMPUTER CORP. 337	94	ELITE MICROSYSTEMS INC. . . 117	406	AGC ELECTRONICS CORP. . IS-51
521	ADVANCED DIGITAL CORP. . NE-3	49	B&C MICRO 331	434	INTERQUADRAM IS-7	*	AMPRO 124
522	ADVANCED DIGITAL CORP. . NE-3	323	B&C MICRO 333	189	NEC HOME ELECTRONICS . 38,39	408	AQUARIUS SYSTEMS INC. . IS-39
20	ALPHA PRODUCTS 336	148	KORE, INC. 331	201	PANASONIC 175	38	BIT WISE 144C
27	ATI TECHNOLOGIES 171	150	K.E.M. ELECTRONICS 334	444	PHILIPS MONITORS IS-11	39	BIT WISE 144C
31	B & B ELECTRONICS 333	155	LINK COMPUTER GRAPHICS . 328			502	BI-LINK PC-7
411	BLUE CHIP TECHNOLOGY . . IS-56	157	LOGICAL DEVICES 344			503	CDS PC-9
526	BLUE CIRCLE GROUP, INC. . NE-6	158	LOGICAL DEVICES 344			318	CLUB AMERICAN TECH. 265
527	BLUE CIRCLE GROUP, INC. . NE-6	159	LOGICAL DEVICES 344			67	COMPUTRADE 78
48	B&C MICRO 331	160	LOGICAL DEVICES 344			416	COPAM ELECTRONICS CORP. . IS-67
69	CONTROL VISION 341	292	XELTEK 333			71	CORPORATE COMPUTERS OF IOWA . 76,77
73	COVOX 334					72	CORPORATE COMPUTERS OF IOWA . 76,77
417	C&D TECHNOLOGY, INC. . . IS-36	804	INSTRUMENTATION			80	DELL COMPUTER CII,1
78	DATA TRANSLATION INC. 45	18	ALL REGULATOR AB 333			*	DELL COMPUTER 64A-B
92	EDC GMBH 276	19	ALL REGULATOR AB 333			81	DELL COMPUTER 65
105	FTG DATA SYSTEMS 342	93	ELEXOR 341			96	DELTECH RESEARCH 271
425	GAMMA IS-12	237	REAL TIME DEVICES 338			470	FASTFRAME CO., LTD IS-40
426	GENOA SYSTEMS IS-4					102	FORTRON 37
107	G-TEK, INC. 48D	805	KEYBOARDS/MICE			103	FORTRON 37
108	G-TEK, INC. 48D	50	CH PRODUCTS 125			537	FOUNTAIN TECHNOLOGIES NE-15
115	HEATH COMPANY 237	51	CH PRODUCTS 125			538	FUTURA SYSTEMS NE-4
119	HIGH RES. TECHNOLOGIES . 328	422	FOCUS ELECTRONIC CO. . IS-57			539	FUTURA SYSTEMS NE-4
121	HOME SMART COMPUTERS . 328	*	FORTE COMMUNICATIONS . IS-14			424	GALAXY MICROCRAFT SYS. IS-52
432	INES IS-48	428	GTCO IS-20			109	GATEWAY 2000 10,11
435	INTERQUADRAM IS-9	429	GTCO IS-20			303	HAUPPAUGE COMPUTER 285
133	IO COMM 243	172	MEXTEL 256			545	HARTZ NE-7
134	IO TECH 204	173	MEXTEL 256			120	HITECH EQUIPMENT CORP. . 344
135	IO TECH 331	179	MICROSPEED 34			430	HWA HSIN ELECTRONIC CO. IS-24
143	KEA SYSTEMS 341	180	MICROSPEED 34			125	H.I.M.S. TECHNOLOGIES 278
154	LAWSON LABS 342	*	NORTHGATE COMPUTER 138,139			*	IBM PS/2 48,48A
167	MAXCIMA 322	194	NUMONICS 210			437	KAYPRO IS-37
440	MICROMINT IS-34	806	MASS STORAGE			144	KILA SYSTEMS 331
190	NEC HOME ELECTRONICS . . . 41	17	AK SYSTEMS 342			149	KUSTEM DATA SERVICES . . . 331
192	NOHAU CORPORATION 299	68	CONTECH COMPUTER CORP. 344			170	MEGATEL 88
193	NOHAU CORPORATION 333	504	DATAMAG, INC PC-2			551	MINTA TECHNOLOGIES NE-9
205	PERISCOPE 144D	505	DATAMAG, INC PC-2			22	MITAC 190
206	PERISCOPE 144D	86	DIGI-DATA 342			*	NORTHGATE COMPUTER 134,135
216	PI COMPUTER CORPORATION 322	138	JB TECHNOLOGIES 133			*	NORTHGATE COMPUTER 138,137
445	PRICE TREND IS-8	139	JB TECHNOLOGIES 133			*	NORTHGATE COMPUTER 140,141
446	PROCOMP, USA INC. IS-48	174	MICRO SOLUTIONS COMP. PROD. 74			491	OCTAGON TECHNOLOGIES . SO-7
447	PROCOMP, USA INC. IS-48	181	MICROTRON TRADE SERVICE 248			492	OCTAGON TECHNOLOGIES . SO-7
208	PSI 323	558	ONLINE PRODUCTS CORP. NE-17			556	ON LINE COMPUTER NE-27
227	QUA TECH 328	559	ONLINE PRODUCTS CORP. NE-17			557	ON LINE COMPUTER NE-27
240	RUPP CORPORATION 215	197	OVERLAND DATA, INC. 321			561	PC PLUS TECHNOLOGIES . NE-19
241	RUPP CORPORATION 215	312	PINNACLE MICRO 258			562	PC PLUS TECHNOLOGIES . NE-19
242	RUPP CORPORATION 215	313	PINNACLE MICRO 258			216	PI COMPUTER CORPORATION 322
243	RUPP CORPORATION 215	228	QUALSTAR CORPORATION 342			445	PRICE TREND IS-6
244	RUPP CORPORATION 215	261	STORAGE DIMENSIONS (N.AMER) 165			234	RADIO SHACK CIV
245	RUPP CORPORATION 215	262	STORAGE DIMENSIONS (N.AMER) 165			563	RENEGADE CORP. NE-35
254	SILLICON SHACK 338	318	STORAGE DIMENSIONS (INT'L) 165			309	SÆLING COMPANY 334
260	STEINCO A/S 144B	317	STORAGE DIMENSIONS (INT'L) 165			449	SAMSUNG ELECTRONICS . IS-53
263	STSC 27	807	MISCELLANEOUS			253	SCIOTO COMPUTERS 337
495	SUMMA COMPUTER SO-3	33	BAYTECH 186			458	SUPERTRON ELECTRIC CO. IS-41
565	TELETEK NE-11	34	BAYTECH 186			270	TECHNOLOGY POWER 342
566	TELETEK NE-11	419	DIETRICH IS-52			272	TMI, INC. 88
511	TELETEK PC-3	99	FOCUS RESEARCH, INC. 338			458	TOPLINK COMPUTER CO. . IS-32
512	TELETEK PC-3	131	INTEGRAND 218			273	TOSHIBA 158,159
801	DRIVES	436	INWIN DEVELOPMENT INC. . IS-40			274	TOSHIBA 158,159
55	COMPACT DISK PRODUCTS . 169	171	MERRITT COMPUTER 284			459	TRIANGLE DIGITAL IS-46
181	MICROTRON TRADE SERVICE 248	226	QUA TECH 328			307	TUSSEY COMPUTER PROD. . 148,147
*	SEAGATE 203	*	SCANDEC TRIBUTOR IS-69			308	TUSSEY COMPUTER PROD. . 148,149
802	FACSIMILE	278	TRACE, INC. 109			464	UNIBIT IS-47
528	COMPFAX NE-5	290	WIESEMANN & THEIS 284			286	WELLS AMERICAN (N.AMER) . 153
529	COMPFAX NE-5	515	WINTIME TECH. PC-14			287	WELLS AMERICAN (N.AMER) . 153
803	HARDWARE PROGRAMMERS	808	MODEMS/MULTIPLEXORS			320	WELLS AMERICAN (INT'L) . . . 153
32	BARADINE PRODUCTS 334	414	CLEO COMMUNICATIONS . IS-33			321	WELLS AMERICAN (INT'L) . . . 153
44	BP MICROSYSTEMS 341	57	COMPUCOM 322			288	WELLS AMERICAN 277
45	BP MICROSYSTEMS 341	322	COMPUTER PERIPHERALS INC 75			289	WELLS AMERICAN 277
		277	TOUCHBASE SYSTEMS, INC. . 36			400	WINTEK 9
		809	MONITORS			295	ZENITH DATA SYSTEMS 48B
		404	ACER, INC IS-44,45			296	ZEOS INTERNATIONAL 90,91
						297	ZEOS INTERNATIONAL 92,93
						298	ZEOS INTERNATIONAL 94,95
						299	ZEOS INTERNATIONAL 96,97
						810	NETWORK HARDWARE
						469	BRITISH TELECOM IS-2,3
						75	CSS LABORATORIES INC 180
						76	CSS LABORATORIES INC 180
						*	CUBIX CORPORATION 44
						306	DIGIBOARD 296
						418	D-LINK SYSTEM, INC IS-16
						112	GOODWAY 144B
						549	L&W MICROCOMPUTING . NE-23
						550	L&W MICROCOMPUTING . NE-23
						175	MICROCOM 219
						191	NETWORK TECHNOLOGIES . 342
						301	SAMSUNG 66,67
						302	SAMSUNG 66,67
						567	TRANS-M CORP. NE-13
						568	TRANS-M CORP. NE-13
						569	TRANS-M CORP. NE-13
						570	TRANS-M CORP. NE-13
						811	PRINTERS/PLOTTERS
						15	ADVANCED MATRIX TECH . . 185
						*	EPSON 20,21
						106	FUJACORP INC 321
						118	HEWLETT-PACKARD PERIPH. . 14,15
						117	HEWLETT-PACKARD PERIPH. . 144G
						118	HEWLETT-PACKARD PERIPH. 145
						122	HOUSTON INSTRUMENT 189
						222	QMS 107
						223	QMS 107
						224	QMS 193
						225	QMS 193
						483	ZERICON MW-7
						496	ZERICON SO-8
						518	ZERICON PC-10
						812	PRINTERS RIBBONS
						199	PACIFIC DATA PRODUCTS . . . 89
						200	PACIFIC DATA PRODUCTS . . . 89
						471	WORLD WIDE COPIER PARTS . IS-52
						813	SCANNERS/IMAGE PROCESSORS
						161	LOGITECH 54,55
						162	LOGITECH 54,55
						493	SQUAREFIELD SO-2
						494	SQUAREFIELD SO-2
						814	SOFTWARE SECURITY
						407	ALADDIN KNOWLEDGE SYS. IS-55
						415	CONTROL TELEMETRY IS-38
						421	FAST ELEKTRONIK GMBH . IS-42
						156	LOGIC VISION 74
						211	PROTECH MARKETING 59
						212	PROTECH MARKETING 59
						235	RAINBOW TECHNOLOGIES . . 150
						236	RAINBOW TECHNOLOGIES . . 150
						238	ROSE ELECTRONICS 157
						239	ROSE ELECTRONICS 157
						257	SOFTWARE SECURITY 200
						815	SYSTEMS
						403	ABC COMPUTER CO, LTD . . . IS-61
						405	ACME TECHNOLOGY CORP . IS-38
						523	ADTECH NE-31
						524	ADTECH NE-31
						13	ADVANCED LOGIC RESEARCH 2,3
						14	ADVANCED LOGIC RESEARCH 2,3
						409	ADVANTEK INT'L LTD IS-10
						816	TERMINALS
						97	EMERALD COMPUTERS, INC. . . 35
						465	UNITTECH COMP. CO, LTD . . IS-26

READER SERVICE

Inquiry No.	Page No.	Inquiry No.	Page No.	Inquiry No.	Page No.	Inquiry No.	Page No.	
817	UPS	825	IBM/MSDOS — GRAPHICS	832	OTHER — LANGUAGES	540	HALSKAR SYSTEMS NE-8	
202	PARA SYSTEMS 79	79	DAYTRON 344	104	FRANKLIN SOFTWARE 86	541	HALSKAR SYSTEMS NE-8	
SOFTWARE		532	DAYTRON ELECTRONICS NE-22	294	Z-WORLD 334	542	HARMONY COMPUTERS NE-1	
818	APPLE/MAC APPLICATIONS Scientific/Technical	127	IMAGENET SYSTEMS 331	833 DESKTOP PUBLISHING		543	HARMONY COMPUTERS NE-1	
70	COREL 238	128	IMAGENET SYSTEMS 331	166	MATRIX 207	544	HARVARD INFO SYSTEMS NE-6	
819	IBM/MSDOS APPLICATIONS Business/Office	163	MAP INFO 32	834 EDUCATIONAL/ INSTRUCTIONAL		546	HY-TEC NE-12	
412	CLARION SOFTWARE IS-29	315	PINNACLE PUBLISHING 302	410	BIX IS-71	547	HY-TEC NE-12	
413	CLARION SOFTWARE IS-29	250	SCIENTIFIC ENDEAVORS 338	* BYTE BACK ISSUES 326	* BYTE BACK ISSUES IS-66	126	IC EXPRESS 337	
60	COMPUTER ASSOCIATES 28,29	251	SCIENTIFIC ENDEAVORS 338	46	BYTE BITS 331	130	INMAC 246	
132	INTELLIGENCEWARE 71	252	SCIENTIFIC ENDEAVORS 338	* BYTE PUBLICATIONS 72,73	* BYTE PUBLICATIONS IS-70	136	JADE COMPUTER PRODUCTS 339	
187	NANTUCKET 199	826	IBM/MSDOS — LAN	* BYTE PUBLICATIONS IS-72	* BYTE SUB MESSAGE 42	137	JAMECO 324,325	
441	NOVELL IS-25	533	DRAGONSLAYER SYSTEMS NE-33	* BYTEWEEK/NEWSLETTER 363	* BYTEWEEK/NEWSLETTER MW-2	140	J.D.R. MICRODEVICES 346,347	
* ORACLE 57		* ELONEX IS-19	533	DRAGONSLAYER SYSTEMS NE-33	* BYTEWEEK/NEWSLETTER PC-4	141	J.D.R. MICRODEVICES 348,349	
509	PEOPLESMTIH SOFTWARE PC-13	453	SOFTTEK COMPUTER IS-56	10	2500 AD SOFTWARE 144	548	LAPTOPS ETC. NE-28	
* RAIMA 53		564	SUMMA COMPUTER NE-34	42	BORLAND INTERNATIONAL 13	164	MARYMAC 334	
* RAIMA 112		827	IBM/MSDOS — LANGUAGES	43	BORLAND INTERNATIONAL 13	438	MAYFAIR MICROS IS-63	
271	THE IDEA WORKS 344	85	DIGITALK 24,25	43	BORLAND INTERNATIONAL 13	169	MEAD COMPUTER 332	
820	IBM/MSDOS APPLICATIONS Scientific/Technical	95	ELLIS COMPUTING 133	85	DIGITALK 24,25	* MICROCOMPUTER MKTG CNCL. 343		
25	ANNABOOKS 321	* ELLIS COMPUTING 133	151	LAHEY COMPUTER SYS. 144F	95	ELLIS COMPUTING 133	176	MICROPROCESSORS UNLTD. 328
35	BE AWARE INC. 86	* JENSEN & PARTNERS 127	* MICROSOFT 19	184	MIX SOFTWARE 305	* MICROWAY 173		
36	BE AWARE INC. 86	151	LAHEY COMPUTER SYS. 144F	454	STONY BROOK SOFTWARE IS-27	182	MICROWAY 275	
83	DIGITAL RESEARCH 197	455	STONY BROOK SOFTWARE IS-27	455	STONY BROOK SOFTWARE IS-27	489	MIGHTY MICRO SO-1	
84	DIGITAL RESEARCH 197	285	WATCOM 120	285	WATCOM 120	490	MIGHTY MICRO SO-1	
165	MATHSOFT 51	300	ZORTECH 233	289	ATTACHMATE CORP. 154	* MONTGOMERY GRANT 130		
* MICROSOFT 6,7		828	IBM/MSDOS — UTILITIES	41	BLAISE COMPUTING 48C	552	MPM NE-36	
188	NATIONAL INSTRUMENT CIII	29	ATTACHMATE CORP. 154	28	CADRE TECHNOLOGIES INC 31	553	MPM NE-36	
204	PATTON & PATTON 118	468	COBALT BLUE IS-46	28	CADRE TECHNOLOGIES INC 31	554	M.S.C. NE-29	
258	SPECTRUM 103	79	DAYTRON 344	468	COBALT BLUE IS-46	186	NAGAN CORP. 344	
259	STATSOFT 47	113	HAMMERLY COMPUTER SERV. 272	79	DAYTRON 344	479	NEXT WORKS, THE MW-1	
821	IBM/MSDOS APPLICATIONS Miscellaneous	114	HAMMERLY COMPUTER SERV. 273	113	HAMMERLY COMPUTER SERV. 272	480	NEXT WORKS, THE MW-1	
123	HYPERKINETIX 110	431	I X I LTD. IS-56	114	HAMMERLY COMPUTER SERV. 273	555	NOCONA ELECTRONICS NE-22	
124	HYPERKINETIX 110	129	IMES GMBH 338	431	I X I LTD. IS-56	196	ON LINE STORE 335	
507	KEYBOARD COMEDY PC-11	152	LANTANA TECHNOLOGY 296	129	IMES GMBH 338	198	PACIFIC COMPUTERS 323	
571	ZEPHYR SERVICES NE-2	153	LANTANA TECHNOLOGY 298	152	LANTANA TECHNOLOGY 296	560	PC LINK NE-16	
822	IBM/MSDOS APPLICATIONS Word Processing	310	LOGITECH 46	153	LANTANA TECHNOLOGY 298	209	PRIORITY ONE COMPUTER 230	
213	FRANKLIN/PROXIMITY 308	311	LOGITECH 46	310	LOGITECH 46	217	P.C. NETWORK 43	
214	FRANKLIN/PROXIMITY 308	178	MICROSOFT 85	311	LOGITECH 46	218	P.C. BRAND 221	
823	IBM/MSDOS — CAD	184	MIX SOFTWARE 305	310	LOGITECH 46	219	P.C. BRAND 222,223	
23	AMERICAN SMALL BUS.COMP. 114	185	MKS 123	178	MICROSOFT 85	220	P.C. BRAND 224,225	
100	FORESIGHT RESOURCES 23	195	NU-MEGA TECHNOLOGIES 121	184	MIX SOFTWARE 305	221	P.C. BRAND 226,227	
101	FORESIGHT RESOURCES 23	203	PARSONS TECHNOLOGY 87	185	MKS 123	448	QUOTHA 32 IS-46	
127	IMAGENET SYSTEMS 331	509	PEOPLESMTIH SOFTWARE PC-13	195	NU-MEGA TECHNOLOGIES 121	249	SCHWAB COMPUTER 333	
128	IMAGENET SYSTEMS 331	319	PETER NORTON 255	203	PARSONS TECHNOLOGY 87	451	SCOTTSDALE SYSTEMS IS-13	
442	ORCAD SYSTEMS CORP. IS-15	207	PHAR LAP 198	509	PEOPLESMTIH SOFTWARE PC-13	* SOFTLINE CORPORATION IS-35		
508	ORCAD SYSTEMS CORP. PC-15	230	QUARTERDECK 128,129	207	PHAR LAP 198	510	SOFTWARE ENGINEERING PC-12	
281	ULTIMATE TECHNOLOGY 338	231	QUARTERDECK 128,129	230	QUARTERDECK 128,129	265	SURAH, INC. 344	
291	WINTEK 337	232	QUARTERDECK 128,129	231	QUARTERDECK 128,129	287	S'N'W COMPUTER 214	
324	WINTEK 337	233	QUARTERDECK 128,129	232	QUARTERDECK 128,129	513	TRAN COMPUTER NETWORKPC-1	
400	WINTEK 9	452	SOFTWARE CONSTRUCTION IS-43	233	QUARTERDECK 128,129	514	TRAN COMPUTER NETWORKPC-1	
824	IBM/MSDOS COMMUNICATIONS	264	SUPERSOFT 80	452	SOFTWARE CONSTRUCTION IS-43	280	T.P.C. 326	
11	ACS COMMUNICATIONS 344	266	SWIRLISOFT 341	264	SUPERSOFT 80	282	UNITEX 340	
53	COMMUNICATION RESEARCH GR 274	279	TRAVELING SOFTWARE 105	310	LOGITECH 46	466	USA SOFTWARE IS-23	
54	COMMUNICATION RESEARCH GR 274	* VERMONT CREATIVE 16	829	OTHER APPLICATIONS Business/Office	178	MICROSOFT 85	284	WAREHOUSE DATA 205
90	DIVERSIFIED COMPUTER 337	829	OTHER APPLICATIONS Business/Office	74	CRICHLAW 328	481	Y.E.S.SYSTEMS CORP. MW-5	
143	KEA SYSTEMS 341	74	CRICHLAW 328	87	DOCUBASE SYSTEMS 206	482	Y.E.S.SYSTEMS CORP. MW-5	
443	PERICOM IS-31	87	DOCUBASE SYSTEMS 206	829	OTHER APPLICATIONS Business/Office	836 MISCELLANEOUS		
269	TALKING TECHNOLOGY 334	830	OTHER APPLICATIONS Scientific/Technical	74	CRICHLAW 328	* ANTHRO 42		
461	TRITON TECHNOLOGIES IS-8	30	A/SOFT DEVELOPMENT,INC. 132	87	DOCUBASE SYSTEMS 206	246	SAFEWARE 341	
462	TRITON TECHNOLOGIES IS-8	37	BINARY TECHNOLOGY 338	830	OTHER APPLICATIONS Scientific/Technical	463	TWINHEAD INT'L CORP. IS-50	
		831	OTHER — CROSS DEVELOPMENT	30	A/SOFT DEVELOPMENT,INC. 132	837ON-LINE SERVICES		
		* SOFTWARE DEVELOPMENT SYS. 83			37	BINARY TECHNOLOGY 338	450	BIX 358,359
				831	OTHER — CROSS DEVELOPMENT	59	COMPUSERVE 257	
				* SOFTWARE DEVELOPMENT SYS. 83			110	GE INFO SERVICES 216
						82	DELTA COMPUTING TECH. 342	
						88	DISKOCOTECH 341	
						89	DISKETTE CONNECTION 337	
						91	DYNAMIC ELECTRONICS 321	
						534	EDI NE-20	
						535	EDI NE-20	
						536	ELECTRIFIED DISCOUNTERS NE-25	
						304	ELS ENTERPRISES, LTD 286	
						98	EXECUTIVE PHOTO & SUPPLY 194	
						314	EXSEL 357	
						427	GREY MATTER IS-65	
						26	G.REED, INC. 328	
						477	HALSKAR SYSTEMS MW-6	
						478	HALSKAR SYSTEMS MW-6	

REQUEST FREE INFORMATION BY FAX

Attention BYTE Readers!! Now you can fax your requests for free product and advertiser information featured in this issue.

Just fax this page to 1-413-637-4343. You'll save time because your request for information will be processed as soon as your fax is received.

- 1** Circle the numbers below which correspond to the numbers assigned to advertisers and products that interest you.
- 2** Check off the answers to questions "A" through "C".
- 3** Print your name, address, and fax number clearly on the form.
- 4** Remove this page or copy this page clearly and fax it to the number above.

Fill out this coupon carefully. PLEASE PRINT.

Name _____

Title _____

Company _____

Address _____

City _____

State/Province _____ Zip _____

Country _____

(_____) (_____) _____
Phone Number Fax Number

- A. What is your level of management responsibility?**
- Senior-level Management
- Other Management
- Non-Management

- B. What is your primary job function/principal area of responsibility? (Check one.)**
- Administration
- Accounting/Finance
- MIS/DP/Information Center
- Product Design and Development
- Research and Development
- Manufacturing
- Sales/Marketing
- Purchasing
- Personnel
- Education/Training
- Other: _____

C. Please indicate your organization's primary business activity: (Check one.)

- Computer-Related Businesses:**
- Manufacturer (Hardware, Software)
- Computer Retail Stores
- Consultants
- Service Bureau/Planning
- Distributor/Wholesaler
- Systems House/Integrator/VAR
- Other: _____

- Non-Computer-Related Businesses:**
- Manufacturing
- Finance, Insurance, Real Estate
- Retail/Wholesale
- Education
- Government
- Military
- Professions (Law, Medicine, Engineering, Architecture)
- Consulting
- Other Business Services
- Transportation, Communications, Utilities
- Other: _____

- I already subscribe to BYTE.
- Please send me one year of BYTE Magazine for \$24.95 and bill me. Offer valid in U.S. and possessions only.

1	2	3	4	5	6	7	8	9	10	11	12	13	14	15	16	17	18	19	20
21	22	23	24	25	26	27	28	29	30	31	32	33	34	35	36	37	38	39	40
41	42	43	44	45	46	47	48	49	50	51	52	53	54	55	56	57	58	59	60
61	62	63	64	65	66	67	68	69	70	71	72	73	74	75	76	77	78	79	80
81	82	83	84	85	86	87	88	89	90	91	92	93	94	95	96	97	98	99	100
101	102	103	104	105	106	107	108	109	110	111	112	113	114	115	116	117	118	119	120
121	122	123	124	125	126	127	128	129	130	131	132	133	134	135	136	137	138	139	140
141	142	143	144	145	146	147	148	149	150	151	152	153	154	155	156	157	158	159	160
161	162	163	164	165	166	167	168	169	170	171	172	173	174	175	176	177	178	179	180
181	182	183	184	185	186	187	188	189	190	191	192	193	194	195	196	197	198	199	200
201	202	203	204	205	206	207	208	209	210	211	212	213	214	215	216	217	218	219	220
221	222	223	224	225	226	227	228	229	230	231	232	233	234	235	236	237	238	239	240
241	242	243	244	245	246	247	248	249	250	251	252	253	254	255	256	257	258	259	260
261	262	263	264	265	266	267	268	269	270	271	272	273	274	275	276	277	278	279	280
281	282	283	284	285	286	287	288	289	290	291	292	293	294	295	296	297	298	299	300
301	302	303	304	305	306	307	308	309	310	311	312	313	314	315	316	317	318	319	320
321	322	323	324	325	326	327	328	329	330	331	332	333	334	335	336	337	338	339	340
341	342	343	344	345	346	347	348	349	350	351	352	353	354	355	356	357	358	359	360
361	362	363	364	365	366	367	368	369	370	371	372	373	374	375	376	377	378	379	380
381	382	383	384	385	386	387	388	389	390	391	392	393	394	395	396	397	398	399	400
401	402	403	404	405	406	407	408	409	410	411	412	413	414	415	416	417	418	419	420
421	422	423	424	425	426	427	428	429	430	431	432	433	434	435	436	437	438	439	440
441	442	443	444	445	446	447	448	449	450	451	452	453	454	455	456	457	458	459	460
461	462	463	464	465	466	467	468	469	470	471	472	473	474	475	476	477	478	479	480
481	482	483	484	485	486	487	488	489	490	491	492	493	494	495	496	497	498	499	500
501	502	503	504	505	506	507	508	509	510	511	512	513	514	515	516	517	518	519	520
521	522	523	524	525	526	527	528	529	530	531	532	533	534	535	536	537	538	539	540
541	542	543	544	545	546	547	548	549	550	551	552	553	554	555	556	557	558	559	560
561	562	563	564	565	566	567	568	569	570	571	572	573	574	575	576	577	578	579	580
581	582	583	584	585	586	587	588	589	590	591	592	593	594	595	596	597	598	599	600
601	602	603	604	605	606	607	608	609	610	611	612	613	614	615	616	617	618	619	620
621	622	623	624	625	626	627	628	629	630	631	632	633	634	635	636	637	638	639	640
641	642	643	644	645	646	647	648	649	650	651	652	653	654	655	656	657	658	659	660
661	662	663	664	665	666	667	668	669	670	671	672	673	674	675	676	677	678	679	680
681	682	683	684	685	686	687	688	689	690	691	692	693	694	695	696	697	698	699	700
701	702	703	704	705	706	707	708	709	710	711	712	713	714	715	716	717	718	719	720
721	722	723	724	725	726	727	728	729	730	731	732	733	734	735	736	737	738	739	740
741	742	743	744	745	746	747	748	749	750	751	752	753	754	755	756	757	758	759	760
761	762	763	764	765	766	767	768	769	770	771	772	773	774	775	776	777	778	779	780
781	782	783	784	785	786	787	788	789	790	791	792	793	794	795	796	797	798	799	800
801	802	803	804	805	806	807	808	809	810	811	812	813	814	815	816	817	818	819	820
821	822	823	824	825	826	827	828	829	830	831	832	833	834	835	836	837	838	839	840
841	842	843	844	845	846	847	848	849	850	851	852	853	854	855	856	857	858	859	860
861	862	863	864	865	866	867	868	869	870	871	872	873	874	875	876	877	878	879	880
881	882	883	884	885	886	887	888	889	890	891	892	893	894	895	896	897	898	899	900
901	902	903	904	905	906	907	908	909	910	911	912	913	914	915	916	917	918	919	920
921	922	923	924	925	926	927	928	929	930	931	932	933	934	935	936	937	938	939	940
941	942	943	944	945	946	947	948	949	950	951	952	953	954	955	956	957	958	959	960
961	962	963	964	965	966	967	968	969	970	971	972	973	974	975	976	977	978	979	980
981	982	983	984	985	986	987	988	989	990	991	992	993	994	995	996	997	998	999	1000
1001	1002	1003	1004	1005	1006	1007	1008	1009	1010	1011	1012	1013	1014	1015	1016	1017	1018	1019	1020
1021	1022	1023	1024	1025	1026	1027	1028	1029	1030	1031	1032	1033	1034	1035	1036	1037	1038	1039	1040
1041	1042	1043	1044	1045	1046	1047	1048	1049	1050	1051	1052	1053	1054	1055	1056	1057	1058	1059	1060
1061	1062	1063	1064	1065	1066	1067	1068	1069	1070	1071	1072	1073	1074	1075	1076	1077	1078	1079	1080
1081	1082	1083	1084	1085	1086	1087	1088	1089	1090	1091	1092	1093	1094	1095	1096	1097	1098	1099	1100
1101	1102	1103	1104	1105	1106	1107	1108	1109	1110	1111	1112	1113	1114	1115	1116	1117	1118	1119	1120
1121	1122	1123	1124	1125	1126	1127	1128	1129	1130	1131	1132	1133	1134	1135	1136	1137	1138	1139	1140
1141	1142	1143	1144	1145	1146	1147	1148	1149	1150	1151	1152	1153	1154	1155	1156	1157	1158	1159	1160
1161	1162	1163	1164	1165	1166	1167	1168	1169	1170	1171	1172	1173	1174	1175	1176	1177	1178	1179	1180
1181	1182	1183	1184	1185	1186	1187	1188	1189	1190	1191	1192	1193	1194	1195	1196	1197	1198	1199	1200

FREE INFORMATION

Want More Information About the Products and Advertisers Featured in this Issue?

1 Circle numbers on reply card which correspond to numbers assigned to items of interest to you.

2 Check all the appropriate answers to questions "A" through "C".

3 Print your name and address and mail.

Fill out this coupon carefully. PLEASE PRINT.

Name _____
 Title _____ (_____) Phone _____
 Company _____
 Address _____
 City _____ State _____ Zip _____

A. What is your level of management responsibility?
 Senior-level Management
 Other Management
 Non-Management

B. What is your primary job function/principal area of responsibility? (Check one.)
 Administration
 Accounting/Finance
 MIS/DP/Information Center
 Product Design and Development
 Research and Development
 Manufacturing
 Sales/Marketing
 Purchasing
 Personnel
 Education/Training
 Other: _____

C. Please indicate your organization's primary business activity: (Check one.)
 Manufacturer (Hardware, Software)

Computer-Related Businesses:
 Computer Retail Stores
 Consultants
 Service Bureau/Planning
 Distributor/Wholesaler
 Systems House/Integrator/VAR

Non-Computer-Related Businesses:
 Manufacturing
 Finance, Insurance, Real Estate
 Retail/Wholesale
 Education
 Government
 Military
 Professions (Law, Medicine, Engineering, Architecture)
 Consulting
 Other Business Services
 Transportation, Communications, Utilities
 Other: _____

OCTOBER
IRSD002

1	2	3	4	5	6	7	8	9	10	11	12	13	14	15	16	17	18	19	20	21	22	23	24	25	26	27	28	29	30
31	32	33	34	35	36	37	38	39	40	41	42	43	44	45	46	47	48	49	50	51	52	53	54	55	56	57	58	59	60
61	62	63	64	65	66	67	68	69	70	71	72	73	74	75	76	77	78	79	80	81	82	83	84	85	86	87	88	89	90
91	92	93	94	95	96	97	98	99	100	101	102	103	104	105	106	107	108	109	110	111	112	113	114	115	116	117	118	119	120
121	122	123	124	125	126	127	128	129	130	131	132	133	134	135	136	137	138	139	140	141	142	143	144	145	146	147	148	149	150
151	152	153	154	155	156	157	158	159	160	161	162	163	164	165	166	167	168	169	170	171	172	173	174	175	176	177	178	179	180
181	182	183	184	185	186	187	188	189	190	191	192	193	194	195	196	197	198	199	200	201	202	203	204	205	206	207	208	209	210
211	212	213	214	215	216	217	218	219	220	221	222	223	224	225	226	227	228	229	230	231	232	233	234	235	236	237	238	239	240
241	242	243	244	245	246	247	248	249	250	251	252	253	254	255	256	257	258	259	260	261	262	263	264	265	266	267	268	269	270
271	272	273	274	275	276	277	278	279	280	281	282	283	284	285	286	287	288	289	290	291	292	293	294	295	296	297	298	299	300
301	302	303	304	305	306	307	308	309	310	311	312	313	314	315	316	317	318	319	320	321	322	323	324	325	326	327	328	329	330
331	332	333	334	335	336	337	338	339	340	341	342	343	344	345	346	347	348	349	350	351	352	353	354	355	356	357	358	359	360
361	362	363	364	365	366	367	368	369	370	371	372	373	374	375	376	377	378	379	380	381	382	383	384	385	386	387	388	389	390
391	392	393	394	395	396	397	398	399	400	401	402	403	404	405	406	407	408	409	410	411	412	413	414	415	416	417	418	419	420
421	422	423	424	425	426	427	428	429	430	431	432	433	434	435	436	437	438	439	440	441	442	443	444	445	446	447	448	449	450
451	452	453	454	455	456	457	458	459	460	461	462	463	464	465	466	467	468	469	470	471	472	473	474	475	476	477	478	479	480
481	482	483	484	485	486	487	488	489	490	491	492	493	494	495	496	497	498	499	500	501	502	503	504	505	506	507	508	509	510
511	512	513	514	515	516	517	518	519	520	521	522	523	524	525	526	527	528	529	530	531	532	533	534	535	536	537	538	539	540
541	542	543	544	545	546	547	548	549	550	551	552	553	554	555	556	557	558	559	560	561	562	563	564	565	566	567	568	569	570
571	572	573	574	575	576	577	578	579	580	581	582	583	584	585	586	587	588	589	590	591	592	593	594	595	596	597	598	599	600
601	602	603	604	605	606	607	608	609	610	611	612	613	614	615	616	617	618	619	620	621	622	623	624	625	626	627	628	629	630
631	632	633	634	635	636	637	638	639	640	641	642	643	644	645	646	647	648	649	650	651	652	653	654	655	656	657	658	659	660
661	662	663	664	665	666	667	668	669	670	671	672	673	674	675	676	677	678	679	680	681	682	683	684	685	686	687	688	689	690
691	692	693	694	695	696	697	698	699	700	701	702	703	704	705	706	707	708	709	710	711	712	713	714	715	716	717	718	719	720
721	722	723	724	725	726	727	728	729	730	731	732	733	734	735	736	737	738	739	740	741	742	743	744	745	746	747	748	749	750
751	752	753	754	755	756	757	758	759	760	761	762	763	764	765	766	767	768	769	770	771	772	773	774	775	776	777	778	779	780
781	782	783	784	785	786	787	788	789	790	791	792	793	794	795	796	797	798	799	800	801	802	803	804	805	806	807	808	809	810
811	812	813	814	815	816	817	818	819	820	821	822	823	824	825	826	827	828	829	830	831	832	833	834	835	836	837	838	839	840
841	842	843	844	845	846	847	848	849	850	851	852	853	854	855	856	857	858	859	860	861	862	863	864	865	866	867	868	869	870
871	872	873	874	875	876	877	878	879	880	881	882	883	884	885	886	887	888	889	890	891	892	893	894	895	896	897	898	899	900
901	902	903	904	905	906	907	908	909	910	911	912	913	914	915	916	917	918	919	920	921	922	923	924	925	926	927	928	929	930
931	932	933	934	935	936	937	938	939	940	941	942	943	944	945	946	947	948	949	950	951	952	953	954	955	956	957	958	959	960
961	962	963	964	965	966	967	968	969	970	971	972	973	974	975	976	977	978	979	980	981	982	983	984	985	986	987	988	989	990
991	992	993	994	995	996	997	998	999	1000	1001	1002	1003	1004	1005	1006	1007	1008	1009	1010	1011	1012	1013	1014	1015	1016	1017	1018	1019	1020
1021	1022	1023	1024	1025	1026	1027	1028	1029	1030	1031	1032	1033	1034	1035	1036	1037	1038	1039	1040	1041	1042	1043	1044	1045	1046	1047	1048	1049	1050
1051	1052	1053	1054	1055	1056	1057	1058	1059	1060	1061	1062	1063	1064	1065	1066	1067	1068	1069	1070	1071	1072	1073	1074	1075	1076	1077	1078	1079	1080
1081	1082	1083	1084	1085	1086	1087	1088	1089	1090	1091	1092	1093	1094	1095	1096	1097	1098	1099	1100	1101	1102	1103	1104	1105	1106	1107	1108	1109	1110
1111	1112	1113	1114	1115	1116	1117	1118	1119	1120	1121	1122	1123	1124	1125	1126	1127	1128	1129	1130	1131	1132	1133	1134	1135	1136	1137	1138	1139	1140
1141	1142	1143	1144	1145	1146	1147	1148	1149	1150	1151	1152	1153	1154	1155	1156	1157	1158	1159	1160	1161	1162	1163	1164	1165	1166	1167	1168	1169	1170
1171	1172	1173	1174	1175	1176	1177	1178	1179	1180	1181	1182	1183	1184	1185	1186	1187	1188	1189	1190	1191	1192	1193	1194	1195	1196	1197	1198	1199	1200

Please send me one year of BYTE Magazine for \$24.95 and bill me. Offer valid in U.S. and possessions only.



NO POSTAGE
NECESSARY
IF MAILED
IN THE
UNITED STATES

BUSINESS REPLY MAIL

FIRST CLASS MAIL PERMIT NO. 176 PITTSFIELD, MA

POSTAGE WILL BE PAID BY ADDRESSEE



READER SERVICE
PO Box 5110
Pittsfield, MA 01203-9926
USA



FREE INFORMATION

Want More Information About the Products and Advertisers Featured in this Issue?

- Circle numbers on reply card which correspond to numbers assigned to items of interest to you.
- Check all the appropriate answers to questions "A" through "C".
- Print your name and address and mail.



NO POSTAGE
NECESSARY
IF MAILED
IN THE
UNITED STATES

BUSINESS REPLY MAIL
FIRST CLASS MAIL PERMIT NO. 176 PITTSFIELD, MA

POSTAGE WILL BE PAID BY ADDRESSEE



READER SERVICE
PO Box 5110
Pittsfield, MA 01203-9926
USA



Fill out this coupon carefully. PLEASE PRINT.

Name _____
 Title _____ (_____) Phone _____
 Company _____
 Address _____
 City _____ State _____ Zip _____

- A. What is your level of management responsibility? (Check one.)**
- 1 Senior-level Management
 - 2 Other Management
 - 3 Non-Management
- B. What is your primary job function/principal area of responsibility? (Check one.)**
- 4 Administration
 - 5 Accounting/Finance
 - 6 MIS/DP/Information Center
 - 7 Product Design and Development
 - 8 Research and Development
 - 9 Manufacturing
 - 10 Sales/Marketing
 - 11 Purchasing
 - 12 Personnel
 - 13 Education/Training
 - 14 Other: _____
- C. Please indicate your organization's primary business activity: (Check one.)**
- 15 Manufacturer (Hardware, Software)
 - 16 Computer Retail Stores
 - 17 Consultants
 - 18 Service Bureau/Planning
 - 19 Distributor/Wholesaler
 - 20 Systems House/Integrator/VAR
 - 21 Other: _____
- Non-Computer-Related Businesses:**
- 22 Manufacturing
 - 23 Finance, Insurance, Real Estate
 - 24 Retail/Wholesale
 - 25 Education
 - 26 Government
 - 27 Military
 - 28 Professions (Law, Medicine, Engineering, Architecture)
 - 29 Consulting
 - 30 Other Business Services
 - 31 Transportation, Communications, Utilities
 - 32 Other: _____

1	2	3	4	5	6	7	8	9	10	11	12	13	14	15	16	17	18	19	20	21	22	23	24	25	26	27	28	29	30
31	32	33	34	35	36	37	38	39	40	41	42	43	44	45	46	47	48	49	50	51	52	53	54	55	56	57	58	59	60
61	62	63	64	65	66	67	68	69	70	71	72	73	74	75	76	77	78	79	80	81	82	83	84	85	86	87	88	89	90
91	92	93	94	95	96	97	98	99	100	101	102	103	104	105	106	107	108	109	110	111	112	113	114	115	116	117	118	119	120
121	122	123	124	125	126	127	128	129	130	131	132	133	134	135	136	137	138	139	140	141	142	143	144	145	146	147	148	149	150
151	152	153	154	155	156	157	158	159	160	161	162	163	164	165	166	167	168	169	170	171	172	173	174	175	176	177	178	179	180
181	182	183	184	185	186	187	188	189	190	191	192	193	194	195	196	197	198	199	200	201	202	203	204	205	206	207	208	209	210
211	212	213	214	215	216	217	218	219	220	221	222	223	224	225	226	227	228	229	230	231	232	233	234	235	236	237	238	239	240
241	242	243	244	245	246	247	248	249	250	251	252	253	254	255	256	257	258	259	260	261	262	263	264	265	266	267	268	269	270
271	272	273	274	275	276	277	278	279	280	281	282	283	284	285	286	287	288	289	290	291	292	293	294	295	296	297	298	299	300
301	302	303	304	305	306	307	308	309	310	311	312	313	314	315	316	317	318	319	320	321	322	323	324	325	326	327	328	329	330
331	332	333	334	335	336	337	338	339	340	341	342	343	344	345	346	347	348	349	350	351	352	353	354	355	356	357	358	359	360
361	362	363	364	365	366	367	368	369	370	371	372	373	374	375	376	377	378	379	380	381	382	383	384	385	386	387	388	389	390
391	392	393	394	395	396	397	398	399	400	401	402	403	404	405	406	407	408	409	410	411	412	413	414	415	416	417	418	419	420
421	422	423	424	425	426	427	428	429	430	431	432	433	434	435	436	437	438	439	440	441	442	443	444	445	446	447	448	449	450
451	452	453	454	455	456	457	458	459	460	461	462	463	464	465	466	467	468	469	470	471	472	473	474	475	476	477	478	479	480
481	482	483	484	485	486	487	488	489	490	491	492	493	494	495	496	497	498	499	500	501	502	503	504	505	506	507	508	509	510
511	512	513	514	515	516	517	518	519	520	521	522	523	524	525	526	527	528	529	530	531	532	533	534	535	536	537	538	539	540
541	542	543	544	545	546	547	548	549	550	551	552	553	554	555	556	557	558	559	560	561	562	563	564	565	566	567	568	569	570
571	572	573	574	575	576	577	578	579	580	581	582	583	584	585	586	587	588	589	590	591	592	593	594	595	596	597	598	599	600
601	602	603	604	605	606	607	608	609	610	611	612	613	614	615	616	617	618	619	620	621	622	623	624	625	626	627	628	629	630
631	632	633	634	635	636	637	638	639	640	641	642	643	644	645	646	647	648	649	650	651	652	653	654	655	656	657	658	659	660
661	662	663	664	665	666	667	668	669	670	671	672	673	674	675	676	677	678	679	680	681	682	683	684	685	686	687	688	689	690
691	692	693	694	695	696	697	698	699	700	701	702	703	704	705	706	707	708	709	710	711	712	713	714	715	716	717	718	719	720
721	722	723	724	725	726	727	728	729	730	731	732	733	734	735	736	737	738	739	740	741	742	743	744	745	746	747	748	749	750
751	752	753	754	755	756	757	758	759	760	761	762	763	764	765	766	767	768	769	770	771	772	773	774	775	776	777	778	779	780
781	782	783	784	785	786	787	788	789	790	791	792	793	794	795	796	797	798	799	800	801	802	803	804	805	806	807	808	809	810
811	812	813	814	815	816	817	818	819	820	821	822	823	824	825	826	827	828	829	830	831	832	833	834	835	836	837	838	839	840
841	842	843	844	845	846	847	848	849	850	851	852	853	854	855	856	857	858	859	860	861	862	863	864	865	866	867	868	869	870
871	872	873	874	875	876	877	878	879	880	881	882	883	884	885	886	887	888	889	890	891	892	893	894	895	896	897	898	899	900
901	902	903	904	905	906	907	908	909	910	911	912	913	914	915	916	917	918	919	920	921	922	923	924	925	926	927	928	929	930
931	932	933	934	935	936	937	938	939	940	941	942	943	944	945	946	947	948	949	950	951	952	953	954	955	956	957	958	959	960
961	962	963	964	965	966	967	968	969	970	971	972	973	974	975	976	977	978	979	980	981	982	983	984	985	986	987	988	989	990
991	992	993	994	995	996	997	998	999	1000	1001	1002	1003	1004	1005	1006	1007	1008	1009	1010	1011	1012	1013	1014	1015	1016	1017	1018	1019	1020
1021	1022	1023	1024	1025	1026	1027	1028	1029	1030	1031	1032	1033	1034	1035	1036	1037	1038	1039	1040	1041	1042	1043	1044	1045	1046	1047	1048	1049	1050
1051	1052	1053	1054	1055	1056	1057	1058	1059	1060	1061	1062	1063	1064	1065	1066	1067	1068	1069	1070	1071	1072	1073	1074	1075	1076	1077	1078	1079	1080
1081	1082	1083	1084	1085	1086	1087	1088	1089	1090	1091	1092	1093	1094	1095	1096	1097	1098	1099	1100	1101	1102	1103	1104	1105	1106	1107	1108	1109	1110
1111	1112	1113	1114	1115	1116	1117	1118	1119	1120	1121	1122	1123	1124	1125	1126	1127	1128	1129	1130	1131	1132	1133	1134	1135	1136	1137	1138	1139	1140
1141	1142	1143	1144	1145	1146	1147	1148	1149	1150	1151	1152	1153	1154	1155	1156	1157	1158	1159	1160	1161	1162	1163	1164	1165	1166	1167	1168	1169	1170
1171	1172	1173	1174	1175	1176	1177	1178	1179	1180	1181	1182	1183	1184	1185	1186	1187	1188	1189	1190	1191	1192	1193	1194	1195	1196	1197	1198	1199	1200

Please send me one year of BYTE Magazine for \$24.95 and bill me. Offer valid in U.S. and possessions only.

OCTOBER
IRSD002

SOME ASSEMBLY REQUIRED

continued from page 308

requester and responder delete their names from the network by calling `RemoveName`, and the responder releases the socket used for servicing requests by calling `CloseATPSocket`.

The requester had actually opened two sockets, one to pass to `RegisterName` and another with which to carry out a transaction during the `SendRequest` call. The program doesn't explicitly open the second socket; ATP does that automatically in `SendRequest`. When the request arrives at the responder's end, the `GetRequest` function passes a "return address" to the responder's application program, so it knows where to send the response packet. The requester never really knows, nor needs to know, its own socket number.

Now You're Talking

Communicating with AppleTalk is more or less a matter of filling entries in a parameter block (a block of memory of predefined fields), loading register A0 with a pointer to the parameter block, and calling the proper function. A general road map of the parameter block would be difficult to construct, since it changes depending on whether you're calling NBP or ATP. Your best bet is to keep a copy of *Inside Macintosh* on hand. The pseudocode in listing 1 indicates those locations where the program is filling the fields of the parameter block with an `IN Parameterblock DO` structure (vaguely similar to Pascal's `WITH` construct). I have tried to keep the field names as close to the mnemonics given in *Inside AppleTalk* as possible.

The pseudocode follows the process I outlined above. Each side (sender and receiver) opens a socket, registers a name on the network, and then performs a `LookupName()` to locate the other side. The program branches to one of two processes, depending on whether it's sending or receiving.

The sender begins reading the file, transmitting 512-byte blocks via `SendRequest()`. The receiver reads the requests with `GetRequest()`, writes the data to the destination file, and then acknowledges its receipt with a `SendResponse()`. (Note that there's no real content to the response; it serves as an acknowledgment signal.) When the last block is transmitted (signaled by a block smaller than 512 bytes), both sides close their files and remove their names from the name table.

There are two data structures of special note that are too complex to describe in the pseudocode. The first is the buffer

data structure (BDS). Before a program can send a request, it has to get its house in order for the response(s) it's certain to receive. (Remember that a given request can trigger up to eight responses.) ATP's `SendRequest` routine requires that you construct a BDS describing where incoming responses are routed.

Each element of a BDS—there can be up to eight—contains a pointer to available memory for the associated response, a byte count telling how big that memory is, and another byte count for how many bytes were actually received (see figure 2). When the first response comes in, it looks in BDS element 0 to figure out where to put the response data. When the second response comes in, it looks in BDS element 1, and so on. Since my program expects only one response consisting of a doubleword, this requires a single BDS element pointing to a 4-byte buffer.

The second data structure is used exclusively by NBP and is described in figure 3. The names table entry (NTE) is a member of a linked list that NBP keeps in memory. Each member corresponds to a name on the network associated with your node. NBP knows what names go with what network number, node, and socket. Whenever you register a name, you have to set aside memory space for that name's NTE. Furthermore, the NTE's memory block must be locked as long as that name is active (or it could get lost if memory moves during a heap compaction).

Done Talking

This concludes my romp through AppleTalk. Next month, I'll do the same for NetBIOS. The source code for this month's program is available via the usual routes under filename `ATTRANS` (see page 5 for details). It's written in Palo Alto's Mach 2 Forth but should be readily adaptable to any other Forth dialect (and, with the help of the pseudocode, to other languages).

I plan to take a look at AppleTalk's Extended Protocol Package (XPP) in this column sometime in the near future. Stay tuned. ■

Rick Grehan is the director of the BYTE Lab. He has a B.S. in physics and applied mathematics and an M.S. in computer science/mathematics from Memphis State University. He can be reached on BIX as "rick_g."

Your questions and comments are welcome. Write to: Editor, BYTE, One Phoenix Mill Lane, Peterborough, NH 03458.

EXSELTM INC.

We Buy NEW/USED Computer Equipment



EXSELTM INC.

...when you are buying
a computer.



EXSELTM INC.

...when you need a
better trade-in.



EXSELTM INC.

...when you are selling
your computer.



EXSELTM INC.

...when you are upgrading
your system.



EXSELTM INC.

...when you are looking for
that extra terminal.



EXSELTM INC.

...when you need an outlet
for your used equipment.

EXSELTM INC.

"The Alternative Source
for the Future"

716-272-8770
Rochester, NY
800-624-2001

BIX CALENDAR

OCTOBER

Display this month's
BIX activities

O C T O B E R

Let the interactive games begin!

BIX's newest exchange, the *Interactive Game Exchange*, is dedicated to interactive recreation on line. Action continues every night, and you can access it via your computer and BIX. Just as you can access all the other BIX exchanges—*Bulletin*, *IBM*, *Macintosh*, and *User's Group*—and all the BIX conferences.

SUNDAYS, 9 PM EST. Poetic Liberties

Poetry, art, music and stories from by gone days to yet-to-come days are featured in this conference. (join fun.n.games/game.room)

SUNDAYS, 9:30 PM EST. School Night

Learn about role-playing games on line and off line at Fantasy Foundation College. (join ff/ff.col)

MONDAYS, 9 PM–Midnight EST. Check into the Meade & Mirth Inn

A free-form game set in the Middle Ages or far into the future. (join mnm/inn)

TUESDAYS & WEDNESDAYS, 9:30 PM EST. As the Ledinworld Turns

Ledinworld is the advanced D&D center of the Exchange. Enjoy real-time fantasy role-playing games as well as message-based player interaction. (join lworld/ledinworld)

THURSDAYS, 9 PM EST. Meanwhile, Back at the Inn . . .

. . . the free-form, role-playing games continue as the mead and mirth flow. (join mnm/inn)

THURSDAYS, 10:15 PM EST. Pandemonium

Contemporary parlor games and social activities. (join fun.n.games/game.room)

FRIDAYS, 9 PM EST. Trivia . . .

Begin your T.G.I.F. nights in the pursuit of trivia. (join fun.n.games/game.room)

FRIDAYS, 9:30 PM EST. . . . & Other Pursuits

. . . such as "*Argonauts*," the futuristic role-playing game. (join encounters/new.worlds)

SATURDAYS, 8:30 PM EST. Fantasy Meeting You Here

Play "*One Night In Waterdeep*" and other real-time fantasy role-playing games. (join lworld/ledinworld)

SATURDAYS, 9 PM EST. More Meade & Mirth

And you can add to the mirth every Saturday night. (join mnm/inn)

All-Month Conferences and Special Events

Macintosh Exchange—We expand BYTE's optical-devices product focus and in-depth coverage in the Macintosh Exchange this month by looking at some of the available optical-storage devices for the Mac. With rewritable optical media routinely able to store 600 megabytes, what can the Mac user expect to use such devices for? (join mac.hack)

Blue Tuesdays—Every Tuesday in October (9PM EST), join Barry Nance, IBM Exchange Editor, and the IBM conference moderators as they discuss issues and answer your questions about IBM and workalike computers. (join the main CBix area, channel 1, band B)

Wizards of OS.9—You're off to meet the wizards in this

special focus on CD-I/CD-RTOS with guest experts. (join os.9)

New Conferences

journalism—Let practicing journalists show you how, what, when, where and why. (join journalism)

journalism.pro—A closed conference for professional journalists. Contact 'janziff' or 'jonhall' for details on how to join this conference.

sfwa—A closed conference for members of the *Science Fiction Writers of America*. Contact 'mike__banks' for details.

mac.macappda—Join with members of the *Macintosh Applications Developers Association* as they create new software for the Macintosh series. (join mac.macappda)

Finally. An on-line service that doesn't nickel and dime you.

It's BIX's flat-fee service.

BIX is short for BYTE Information Exchange. The on-line information service that's yours for an unheard-of flat fee of just \$39 for three months*—an amount you could easily waste in just two to four hours with an *hourly rate*, on-line service. (Not to mention the fact that you'd be nickel-and-dimed for its monthly minimums.)

And here's another distinction: BIX is strictly for microcomputer pros; it contains no "fluff." As a subscriber, here's what you've got coming to you:

- All the information and ideas exchanged in more than 150 microcomputer-related conferences—a give-and-take in which you can participate.
- Microbytes Daily*—up-to-the-minute industry news and new

product information.

- Plus support from hardware vendors and software publishers, access to extensive software libraries, and the use of our electronic mail service—which allows *binary attachments*.

Subscribe to BIX right now— using your computer and modem.

Set your telecommunications program for full duplex, 8 bits, no parity, 1 stop bit, or 7 bits, even parity, 1 stop bit. Now dial BIX at 617-861-9767, hit the return key, and respond as follows:

Prompt:	You Enter
login (enter "bix"):	bix
Name?	bix.flatfee

You can charge your BIX subscription to major credit cards, or have it billed to your company. You may also purchase unlimited off-peak access via Tymnet for just \$15 per month, or \$2 per off-peak hour, in the continental US**. For

more information, including your local Tymnet access number, call 800-227-2983 (in New Hampshire and outside the United States, call 603-924-7681).

**Based on a \$156 annual fee, billed quarterly — a subscription you may cancel at any time without future charges. You may also subscribe for a 3-month trial at just \$59.*

***For international rates, please consult your local PTT. Our international packet network address is 310690157800.*

BIX

One Phoenix Mill Lane
Peterborough, NH 03458
800-227-2983. In NH 603-924-7681.



PRINT QUEUE

Hugh Kenner

Curtains for Lady Buxley

THE HUMANITIES COMPUTING YEARBOOK: 1988

edited by Ian Lancashire and Willard McCarty

The Macintosh requests a decision. You are Denis Marin, born 1638, and in the French society of that era, your aim is (what else?) to maximize family prestige. Economic, political, marital opportunities abound. A flow of correspondence has kept you informed. You want a wife who will bring fortune and connections. Propose to Mlle. X? Ah, best check her status. If yours is lower, a refusal would ghettoize you for years. Such were seventeenth-century French realities.

In fact, you are an undergraduate studying the ancien régime. You are running a program called The Would-Be Gentleman, which lets you guide the Marin family through two generations, to 1715. A sort of pedagogical Zork, it calls for some 154 decisions (buy? sell? marry? beget?), and “when students act from twentieth-century motivations rather than from seventeenth-century assumptions, they fall neatly into traps set for them. A common way of losing the game is to arrive at 1715 with loads of cash and a high status but without any children to inherit them.” That’s no way to set up a dynasty.

This program, available for a mere \$7, engages students in “historical concepts otherwise very difficult to teach”; they learn, interactively, what it was like to live at that level of ambition in those years. It’s described on page 150 of *The Humanities Computing Yearbook*, a work indispensable for anyone engaged in the field. (A huge field; in a moment, I’ll try to describe it.) This first volume attempts a comprehensive survey from earliest times (the 1960s) through 1988. Hereafter, annual updates are promised.

All right, the “field”: nearly anything that turns on “our writing system, the printing press, the public library,” also art history, biblical studies, creative writing, editing and publishing, history, languages and literatures, text analysis. . . on and on. It’s easier to say what’s not included: no business applications, no engineering

ones. To this broad domain, some 400 pages of fairly small print now offer a well-organized annotated bibliography, plus lists (with sources) of available software.

There are many surprises. Two decades ago, David Packard, a classicist who happens to be a Hewlett-Packard Packard, was reflecting that much of classical scholarship has always amounted to numb pattern-matching. (Find, in the corpus of Greek literature, every instance of the word *oinope*. Bleary-eyed insomniacs, century after century, fingered parchment to accomplish chores like that.)

Packard’s ruminations (I’m simplifying) led to section 19.7.1, “The A.P.A. Corpus: a repository of Greek and Latin texts in machine-readable form,” developed by the Packard Humanities Institute and described in *Classical Journal* as long ago as 1977. (A.P.A. is the American Philological Association.) Since “Greek and Latin literature” can be rather strictly

defined, it’s possible to claim that the “Corpus” is virtually complete. So the humanities discipline long deemed the very stuffiest got computerized ahead of all the rest.

No trick now to turn up all those instances of *oinope*. Homer applied it 10 times to the sea—hence the familiar translation, “wine-dark.” But he also used it once for oxen, and Sophocles used it for a human forearm. A wine-dark arm? Perhaps we’d best rethink. Oxen sweat; so do arms. The sea too flashes back light from its fluent surface. May that word point not to color but—ah—to gleam?

The work with *oinope* was long since done, by hand. It’s also had to be checked by repeated redoing; human eyes wander, human memories leak. So, post-Packard, we find machines dedrudging processes centuries-long defined. To deduce what old words may connote requires collections of instances to scrutinize. No better collector than a PDP-11.

continued



Knowledge Processing

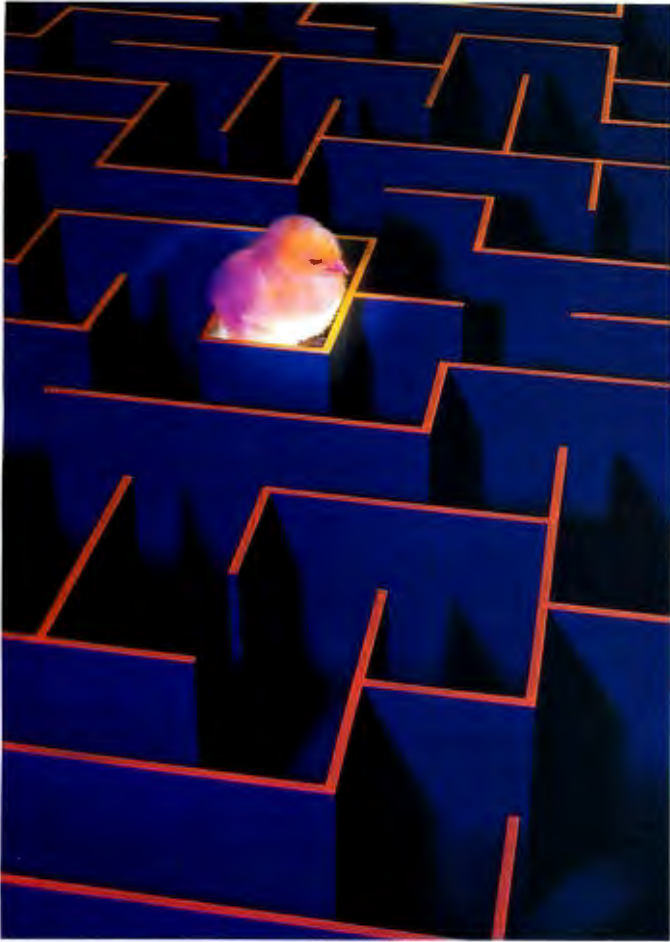

**Don't leave your users
lost in a maze of
information!**

A knowledge processor communicates knowledge - the natural extension of everything we do on a computer.

It's the intelligent integration of everyday resources like data, text, logic, graphics, and video that turns information into knowledge.

KnowledgePro is the first knowledge processor. It combines a high-level, object-oriented programming language with hypertext and expert systems technology.

KnowledgePro gives you a total development environment with the tools you need to create intelligent multi-media applications.

PC Magazine, Holland... *"KnowledgePro is the first of a new generation of software, the knowledge processor...it has the power of, for example, Pascal or PROLOG, but the programmer isn't troubled with the technical details."*

PC Week, USA... *"It's rare, but every so often a PC application comes along that breaks new ground and creates a fundamentally different way to use computers. According to its corporate users...KnowledgePro does just that."*

Infoworld... *"We don't live in a computational world. If we're going to move knowledge around we need tools...The same person who will learn macros in Lotus can learn this."*

KnowledgePro costs \$495 with no runtime fees. It runs on IBM PC, XT, AT and PS/2 compatible machines with 640k of memory and a hard disk. A working demo with a 100 page manual is available for \$33 including shipping (\$38 foreign) with credit towards purchase of the full system.

Find out what knowledge processing is all about. Call 518-766-3000 (FAX 518-766-3003) or write to Knowledge Garden Inc., 473A Malden Bridge Rd., Nassau, NY 12123, USA. Amex, Visa or M/C accepted.

KnowledgePro®
The intelligent way out

Circle 145 on Reader Service Card

Another
intelligent
tool from



Technology doing what was long done by hand: That's the story in field after field. Databases, unsurprisingly, are everywhere. Art historians use them, lexicographers, philologists. There's even one of Texas cave paintings, with digitized images. Archaeology, keeping track of countless sites and objects (e.g., pots, bones, and buttons), enjoys not only relational databases but a shareware program to analyze them.

At this moment, some humanities computing seems to be in a state of free-fall. It's tool-driven, a bad way to be. Better, be situation-driven.



And some things now get done that our parents could never have thought of. When NASA's land-mapping techniques for digital image processing were turned on the *Mona Lisa*, they spotted areas where it had been altered.

Amid literary studies, though, things can get murky. No denying it, some things there are stably quantifiable. Think of letter- and word-frequency distributions. And there are writers whose manner we soon learn to recognize at a glance; Henry James comes to mind. So what it is that we're recognizing: might *that* be described by statistics? It's long been a tempting thought, and now we have computers. . . .

Computerized procedures, I'm serenely convinced, could well distinguish the prose of James from that of Mickey Spillane. I'm less certain that they could sort out—oh, three George Bush speechwriters; there, surely, the style of the genre swamps nuances of personality? Yet that's the kind of question some historian may one day be asking.

So we find section 25.1, "Authorship Analysis," a controversial procedure indeed that looks for a writer's "fingerprint" by number-crunching measures of vocabulary and syntax and then offers decisions about texts of unknown authorship. One problem area is the sheer impossibility of verifying its findings. Trajectory calculations we can verify by firing a bullet. Unknown authorship, by whatever means we guess, must remain, alas, unknown.

The procedure is amusingly spun off in section 12.2, "Tools for Composition," where an outfit called Glatt Plagiarism Services helps instructors put "the suspected student" into the hot seat while a paper gets fingerprinted for plagiarism.

You want to know how that's done? Well, it assumes (1) the uniqueness of your "fingerprint," and (2) no one's ability to emulate a fingerprint as well as its owner. You're presented with your paper, every fifth word blanked out. You're timed while you sweat at filling in the blanks. The result goes off to Glatt, where they combine time with total correct responses to

estimate a PPS (plagiarism probability score). For this, the instructor pays \$500 annually. A longtime instructor, I'm willing to trust hunches.

Or, if you've heard about text generators, over in section 7.3 there's Automatic Novel Writer, to generate 2100-word murder stories (which seem long enough) beginning, for example, "Wonderful smart Lady Buxley was rich. Ugly oversexed Lady Buxley was single." Or (7.4) Returner, "A program that analyzes Alberta T. Turner's poem 'Return' and simulates stanzas of a like kind." Spare me. One "Return" is enough.

Alberta T. Turner aside, I'm persuaded that interesting texts can be somehow spun out of existing texts. Charles Hartman and I have a book of poems in press; it fascinates us that you'd never guess what the computer derived them from (sentences for schoolchildren to analyze and parse). Somehow, a human core lingers. What constitutes it is a mystery. And the feel of our output differs from what's spawned by word lists plugged into sentence patterns. There's a great deal to be learned hereabouts.

Yes, some of this research seems trivial. Trivial too, if you had them all spread out before you, might be many of the findings of computer science. We're still learning what best to ask of our wondrously literal-minded slave. When a keystroke will give you a count of the letter *q* in a text, well, you're apt to request it, never mind what to think next. At this moment, some humanities computing seems in a state of free-fall. It's tool-driven, a bad way to be. Better, be situation-driven, the way the following narrative illustrates.

Fifty-some years ago, it occurred to Miles Hanley at the University of Wisconsin that James Joyce's *Ulysses* was one book for which a word index would be uniquely valuable, so deliberate had been Joyce's employment of isolate words. (He crossed them off long lists.) But, in 1936, a word index to a quarter-million-word text? Improbably, it got done, with cards and student slave labor and minuscule grants, and was circulated by mimeograph. And it made intellectual history, still not wholly reckoned, when its statistical tables—a seeming afterthought—caught the eye of a fanatic, Harvard's George Kingsley Zipf.

Zipf noted what has since been known as Zipf's law: an exact inverse correlation between frequency and appearance. There had been no statistics for a text of this size before. And lo, if the commonest word (*the*) occurred 16,000 times, then—as if to compensate—the count of *Ulysses* words that occurred but once was 16,000! And so on. A log-to-log graph of frequency versus occurrence is a straight slanting line. It gets pondered yet. Trying to lend it mathematical rigor was the effort of Benoit Mandelbrot's first published paper, and chapter 38 of *The Fractal Geometry of Nature* shows that line of thought pointing him toward what he's famous for.

The moral seems to be that Hanley knew what he wanted, an index to a unique text, and Zipf knew what he wanted, a pattern, and Mandelbrot knew what he wanted, a taxonomy of patterns. The tool-driven often don't quite know what they want, and they generate Automatic Writers of "novels" that no one is likely to dream of reading. I promise not to report another sentence about ugly oversexed Lady Buxley. ■

Oxford University Press, New York: 1988, 404 pages, \$59

Hugh Kenner is a professor of English at Johns Hopkins University. His reviews have appeared in publications like the New York Times and Harper's. His recent books include A Sinking Island and Mazes. He can be contacted on BIX as "hkenner."

Your questions and comments are welcome. Write to: Editor, BYTE, One Phoenix Mill Lane, Peterborough, NH 03458.

Quality In... Quality Out



No matter how well acquainted you are with making important personal computing decisions—decisions that may involve hundreds of thousands of dollars—the value of those decisions is only as good as the value of your information. Without quality information—it's hard to make quality decisions.

BYTEweek, McGraw-Hill's new weekly newsletter for professionals in the personal computer industry, is devoted to giving you that quality information through its timely and compact one-stop news format.

This new publication provides you with short, easy-to-read selections of the most important news and technological developments of the past week. And BYTEweek interprets this news with in-depth commentary and analysis.

Subscribe to BYTEweek for quality information. Remember, quality in...quality out.

Subscribe now and take advantage of the special one-year charter subscription rate of \$395 (\$495 outside the U.S. and Canada). This special price represents a savings of \$100 off the regular rate. Your subscription includes 50 issues plus a free three-month subscription to BIX—a \$49 value. Through BIX you can directly access the Microbytes Daily news service and communicate with other BIX users.

Don't miss this opportunity! In the U.S., call BYTEweek's toll-free number: **1-800-258-5485**, in N.H. and outside the U.S., call: 1-603-924-9281.

BYTEweek offers a *money-back guarantee* if you're not completely satisfied.

BYTEWEEK 

News and Analysis for Professionals in the Personal Computing Industry
One Phoenix Mill Lane, Peterborough, NH 03458



GOODBYE, MR. CHIPS

The computer revolution is a success, and nothing will ever be the same

When I was in seventh grade in 1976, my friends and I discovered the phone number to access the nation's research network, ARPANET. We found an unattended teletype with a modem in a science lab of our forward-thinking junior high school and dialed away. ARPANET asked for a password, but we soon discovered that it didn't matter what we typed—the network would always let us in. Back then, life was free and easy in the world of computers, and nobody worried about security.

My friends and I spent the rest of the school year playing computer games, talking to people at MIT, experimenting with the software, and trying to find our way around a toy that was as big as all of the U.S. We never did anything damaging, and no one seemed to worry or even care that we were there.

In an earlier frontier—the American west—there was a sheriff, but he had plenty of ground to cover. The peace was kept by an unofficial code of what was good and bad. And just as the old gunfighter never shot anyone in the back, a hacker would never erase someone else's files. He or she might hide them or play some other clever prank that made him or her the most awesome weenie around, but the actions were never fatal. It was a wild West with a sense of humor, a Sergio Leone movie with Robin Williams instead of Clint Eastwood.

Now, though, the frontiers are closing in. As time goes by, there will be fewer and fewer leisurely raft trips through the electronic rivers for the Huck Finns among us who would rather avoid being

civilized. Computer shenanigans are big news, and the people judging the mug shot in the paper are rarely going to relish the technical bravado. They are more likely to have a chip on the shoulder from the last time a computer screwed up one of their bills.

In the old days, the computer weenie caught slipping into forbidden machines was rarely dealt with in court. Although the crime was usually the equivalent of breaking and entering, the laws were vague and generally predated the transistor. The victims usually settled with the hacker out of court, in return for learning about the security holes in the system. Now, several years after the movie "War Games" hit the screens, prosecutors see electronic cat burglars as an interesting evolving part of the law—but not a technical problem beyond understanding.

In Syracuse, the story of Robert Morris, America's computing cover boy, continues to unwind. Morris is charged with creating the virus that brought ARPANET to its knees last November. The federal government will attempt to prosecute Morris under a 1986 law prohibiting unauthorized use of federal computers. This is an important case to the government; it doesn't want the case to end in an acquittal, thereby sending the wrong message to all the budding young computer geniuses out there.

Getting a conviction in this case will be difficult. The prosecution will have to deal successfully with the philosophical question of whether a person who programs a virus to invade a computer is guilty of invading the computer. And what constitutes evidence that the mastermind did it all? There is also the problem of intent; the law prohibits destroying or copying information, but the virus that crippled ARPANET was only out for a Sunday drive, albeit at light speed.

When the automobile was introduced, those who could afford to buy one were overcome by an incredible feeling of liberation. The automobile gave people the

freedom to go anywhere. Henry Ford wasn't a great success because he built a clever assembly line, but because he turned the dream of being able to hop to the next town on a whim into reality. Unfortunately, too much of this four-wheeled freedom has come to mean smog, traffic jams, auto insurance, speed limits, and long lines at the Department of Transportation. Is California still known for being the untamed land at the end of the frontier? No; it's now just the home of the freeway.

Will the same thing happen with computers? I'm afraid so. It will take a while, but the power of civilization is too strong to resist. The computer revolution is threatened with the curse of succeeding. Once everyone starts using some new machine, the temptation to make everything right by regulation comes creeping in. One minute you're on the cutting edge of technology, and the next minute, there's a large, gray building in Washington overseeing your actions.

There really is no other way. When things get big and everyone gets involved, keeping the peace must be made more efficient. I guess that's what computer scientists would want if we were organizing the world the way they try to organize their software: justice completely and rigorously defined.

But somehow, it doesn't seem the same anymore. ■

Peter Wayner, a consulting editor for BYTE and a graduate student at Cornell University, recently completed a summer internship at Xerox Palo Alto Research Center. He can be reached on BIX as "pwayner."

Stop Bit is an open forum for informed opinion on topics related to personal computing. The opinions expressed are those of the author and not necessarily those of BYTE or its staff. Your contributions and comments are welcome. Write to: Editor, BYTE, One Phoenix Mill Lane, Peterborough, NH 03458.

DOS + QuickBASIC or C + Instrumentation Code Generation = ?

There's only one solution...

LabWindows



VXI

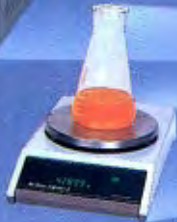

RS-232



GPIB



Plug-in Boards



Are you using a DOS-based personal computer for controlling instrumentation? Do you want the best available software tools for acquiring and analyzing data using standard DOS programming languages? If your answer to these questions is *yes*, LabWindows® is just the solution you're looking for. The unique LabWindows function panel interface lets you interactively control your instrumentation hardware and collect data, as well as automatically generate Microsoft® C or QuickBASIC program code for your application.

With LabWindows you can control GPIB, RS-232, or VXI instruments, or plug-in data acquisition cards for PS/2 and PC-AT computers. For standalone instrument users, the LabWindows instrument library has over 50 ready-to-use instrument drivers so you can program your instrument using intuitive instrument-specific function panels, without knowing the instrument inside-out.

Because acquiring data is only one element of your application, LabWindows has a complete set of QuickBASIC and C compatible libraries for data analysis, presentation, and storage. Manipulate arrays, create a histogram, or use the optional Advanced Analysis Library to perform operations such as Fast Fourier Transforms, digital filtering, and curve

fitting. Give your programs a big performance boost using the specially optimized LabWindows analysis routines for computers with an 80387 numeric coprocessor. For your data presentation and storage needs, use the LabWindows Graphics Library to create multiplot graphs, bar charts, or scatter plots, and use the Data Formatting Library for data logging and file operations.

If you're looking for the right tools to take maximum advantage of your DOS computer using QuickBASIC or C for data acquisition and analysis, there is only one solution...LabWindows. Call National Instruments at (800) IEEE-488 to speak with a sales or applications engineer about how LabWindows can help you.

Ask for a *FREE* Catalog



NATIONAL INSTRUMENTS®

The Software is the Instrument™

12109 Technology Blvd.
Austin, Texas 78727-6204
(512) 794-0100

Circle 188 on Reader Service Card

NATIONAL INSTRUMENTS OF JAPAN (03) 788-1922 •
NATIONAL INSTRUMENTS OF FRANCE (1) 486 53370 •
NATIONAL INSTRUMENTS UNITED KINGDOM (06) 355-23545 •
ARGENTINA (1) 46-5776 • AUSTRALIA (2) 736-2888 • BELGIUM (2) 466-8199 • CANADA
(416) 890-2010, (613) 596-9300, (514) 747-7878, (403) 295-0822, (604) 988-2195 • CHILE (2) 225
3689 • DENMARK (2) 251-122 • FINLAND (0) 372 144 • GREECE (1) 361-1283 • HONG
KONG (2) 0426-2707 • IRELAND (846) 661414, (3) 427-2282 • ISRAEL (3) 324 298 • ITALY
(2) 984-91071-2-3 • KOREA (2) 776-5340 • MEXICO (5) 660-4323 • THE NETHERLANDS (7)
099-6360 • NEW ZEALAND (9) 444-2645 • NORWAY (2) 53-1250 • PORTUGAL (1) 545-313 •
SINGAPORE (65) 336-4713 • SOUTH AFRICA (011) 787-0473 • SPAIN (1) 455-8112 •
SWEDEN (8) 792-1100 • SWITZERLAND (6) 552-8949 • TAIWAN/THE REPUBLIC OF
CHINA (02) 703-6280 • THAILAND (2) 234-9330 • WEST GERMANY (89) 80-7081

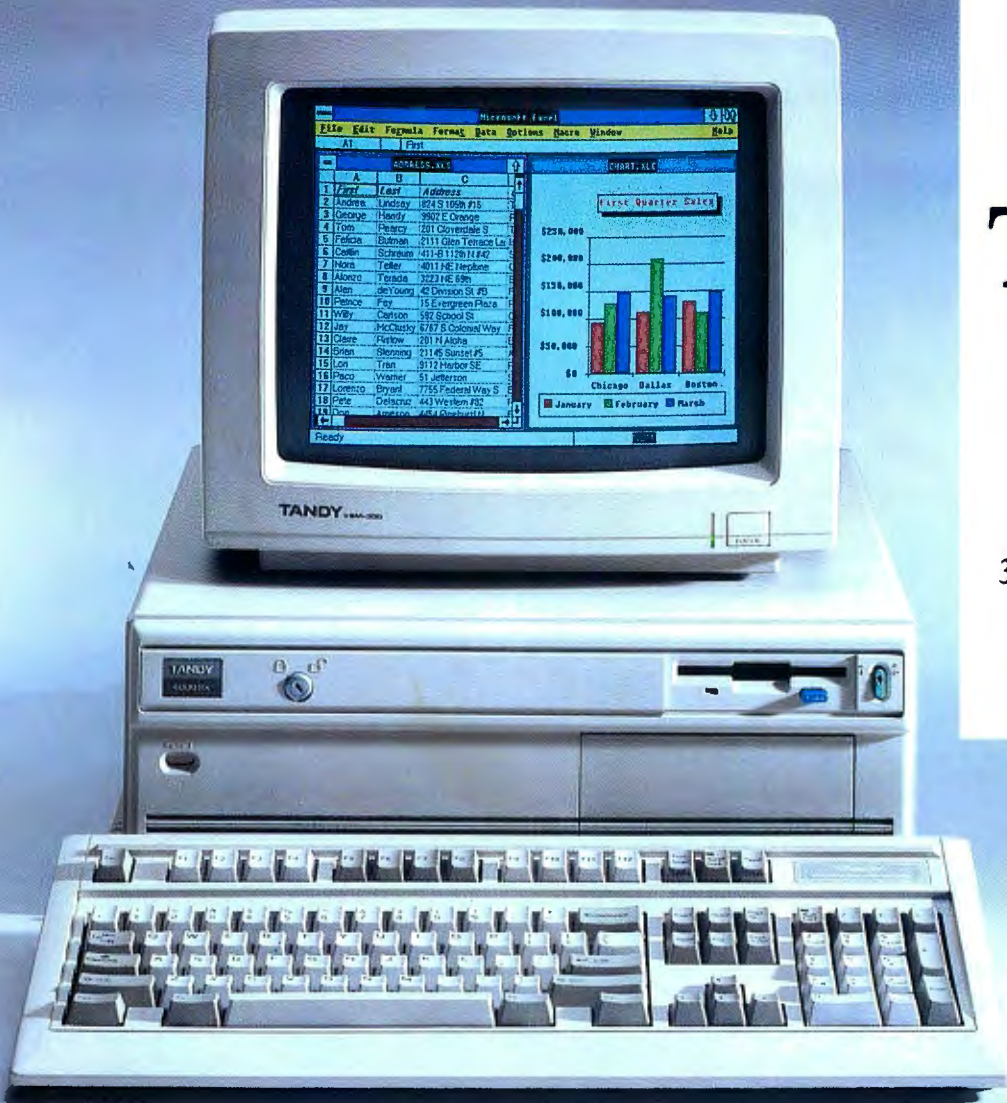

The New Tandy® 4000 SX

386™ performance
at a price you'd
expect from a
286 system.

A price/performance breakthrough for 386-based systems, the new Tandy 4000 SX combines more integrated features than ever in a machine at this price.

The Intel® 80386SX microprocessor combines the ability to run high-performance 80386 based software, as well as current 80286 and 8088 based software. You get the best of both worlds—32-bit performance with 16-bit hardware compatibility.

This means the Tandy 4000 SX insures your computer investment for the future. As a low-cost alternative to an expensive 386 system, you won't be left behind when you want to move on to more advanced 386 based applications, like MS® OS/2.

Built-in VGA graphics give you beautifully detailed, high-resolution displays. Add a color analog monitor and create astonishing graphics in up to 256 colors (from a

palette of 256,000) for near-photographic clarity.

The 4000 SX's SmartDrive™ Integrated Drive Electronics (IDE) technology allows you to add high-performance hard disk drives without the need or expense of installing a separate disk controller.

Innovative technology. Quality engineering. Competitive pricing. Come see the new Tandy 4000 SX today. From the best-selling family of PC compatibles made in America.

Tandy Computers: Because there is no better value.™

SmartDrive™ Tandy Corp. Intel and 386™ licensed from Intel Corp.
MS/ licensed from Microsoft Corp.

Radio Shack®
COMPUTER CENTERS
A DIVISION OF TANDY CORPORATION

Circle 234 on Reader Service Card