

BYTE®

APRIL 1983 Vol. 8, No. 4
\$2.95 in USA
\$3.50 in Canada/£2.10 in U.K.
A McGraw-Hill Publication

the small systems journal

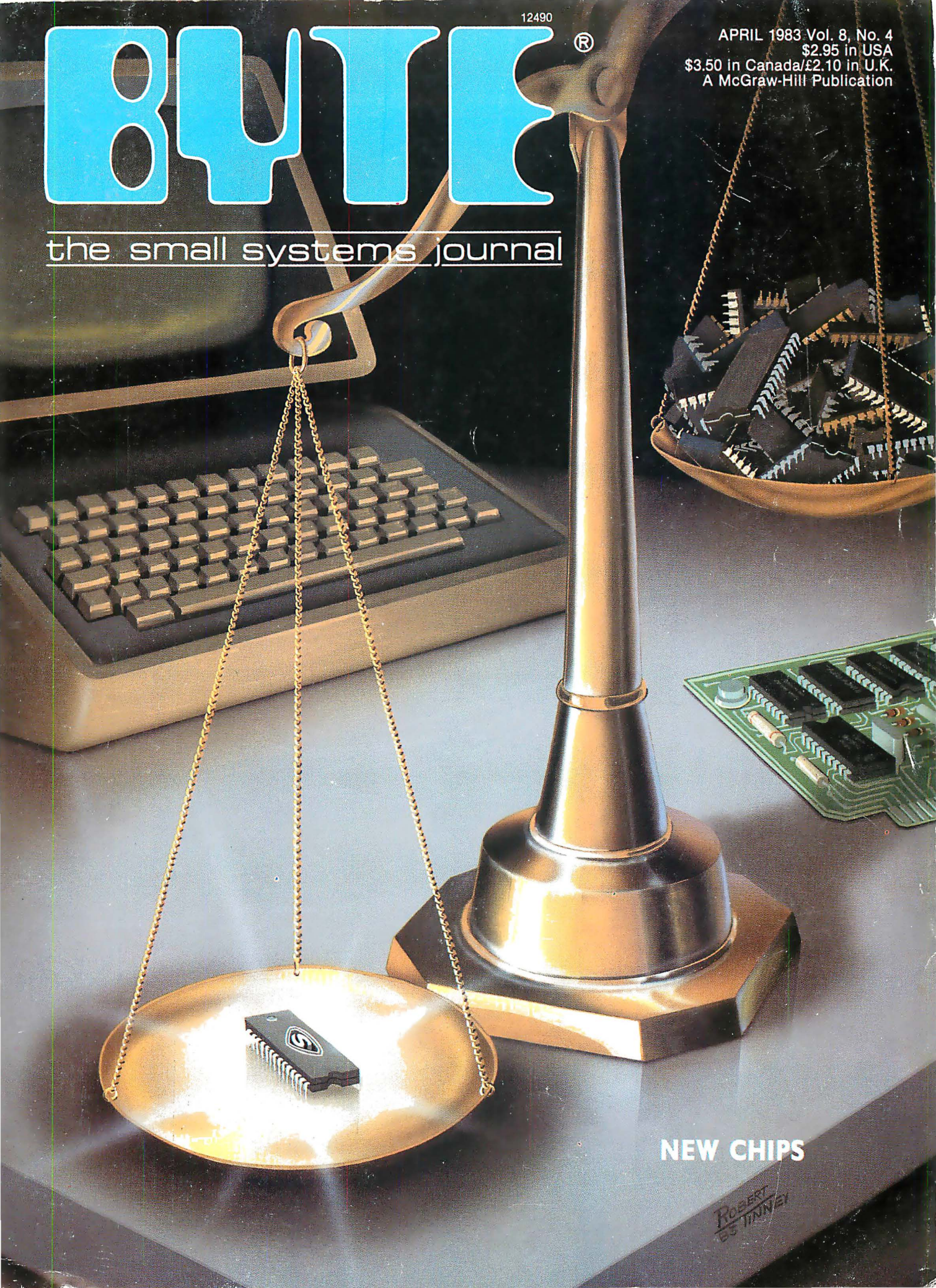

NEW CHIPS

ROBERT
ES TINNEY



Inside Apple

Apple Computer Inc., 20525 Mariani Avenue, Cupertino, California 95014

Vol. 1 No. 2

For the authorized Apple dealer nearest you, call 800-538-9696 (800-662-9238 in California.)

Fruitful Connections.

There are more people in more places making more accessories and peripherals for Apples than for any other personal computer in the world.

Thanks to those people—in hundreds of independent companies—you can make the humblest 1978 Apple II turn tricks that are still on IBM's Wish List for 1984.

But now we're coming out with our very own line of peripherals and accessories for Apple® Personal Computers.

For two very good reasons.

First, compatibility. We've created a totally kluge-free family of products designed to take full advantage of all the advantages built into every Apple.™

Second, service and support.



Now the same kindly dealer who keeps your Apple PC in the pink can do the same competent job for your Apple hard-disk and your Apple daisywheel printer.

So if you're looking to expand the capabilities of your Apple II or III, remember:

Now you can add Apples to Apples.

A joy to behold.

The new Apple Joystick II is the ultimate hand control device for the Apple II.

Why is it such a joy to use?

With two firing buttons, it's the first ambidextrous joystick—just as comfortable for lefties as righties.

Of course, it gives you 360° cursor control (not just 8-way like some game-oriented devices) and full X/Y coordinate control.

And the Joystick II contains high-quality components and switches tested to over 1,000,000 life cycles.

Which makes it a thing of beauty. And a joystick forever.

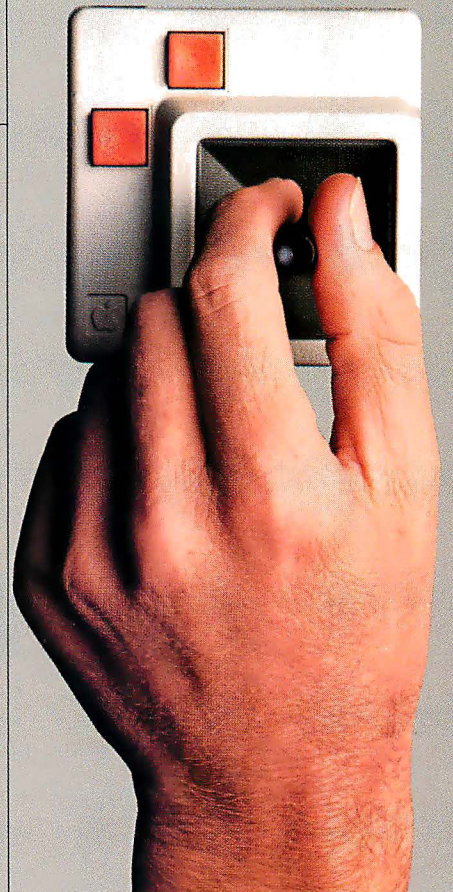

Gutenberg would be proud.

Old Faithful Silentype® has now been joined by New Faithfuls, the Apple Dot Matrix Printer and the Apple Letter Quality Printer.

So now, whatever your budget and your needs, you can hook your Apple to a printer that's specifically designed to take advantage of all the features built into your Apple. With no compromises.

The 7x9 Apple Dot Matrix Printer is redefining "correspondence quality" with exceptional legibility. With 144x160 dots per square inch, it can also create high resolution graphics.

The Apple Letter Quality Printer, which gets the words out about 33% faster than other daisywheel printers in its price range, also offers graphics capabilities. See your authorized Apple dealer for more information and demonstrations. Because, unfortunately, all the news fit to print simply doesn't fit.





Up the creek without a paddle?

Or lost in space? Or down in the dungeons?

Whatever your games, you'll be happy to know that someone has finally come out with game paddles built to hold up under blistering fire. Without giving you blisters.

Apple Hand Controller II game paddles were designed with one recent discovery in mind:

People playing games get excited and can squeeze very, very hard.

So we made the cases extra rugged. We used switches tested to 3,000,000 life cycles. We shaped them for holding hands and placed the firing button on the right rear side for maximum comfort.

So you'll never miss a shot.

A storehouse of knowledge.

If you work with so much data or so many programs that you find yourself shuffling diskettes constantly, you should take a look at Apple's ProFile™, the personal mass storage system for the Apple III Personal Computer.

This Winchester-based 5-megabyte hard disk can handle as much data as 35 floppies. Even more important for some, it can access that data about 10-times faster than a standard floppy drive.

So now your Apple III can handle jobs once reserved for computers costing thousands more.

As for quality

and reliability, you need only store one word of wisdom:
Apple.



Launching pad for numeric data.

Good tidings for crunchers of numerous numbers:

Apple now offers a numeric keypad that's electronically and aesthetically compatible with the Apple II Personal Computer.

So you can enter numeric data faster than ever before.

The Apple Numeric Keypad II has a standard calculator-style layout. Appropriate,

because unlike some other keypads, it can actually function as a calculator.

The four function keys to the left of the numeric pad should be of special interest to people who use VisiCalc®. Because they let you zip around your work sheet more easily than ever, adding and deleting entries.

With one hand tied behind your back.



How to buy a computer by the numbers.

Introducing the Cromemco C-10 Personal Computer. Only \$1785, including software, and you get more professional features and performance for the price than with any other personal computer on the market. We've got the numbers to prove it.

The C-10 starts with a high-resolution 12" CRT that displays 25 lines with a full 80 characters on each line. Inside is a high-speed Z-80A microprocessor and 64K bytes of on-board memory. Then there's a detached, easy-to-use keyboard and a 5¼" disk drive with an exceptionally large 390K capacity. That's the C-10, and you won't find another ready-to-use personal computer that offers you more.

But hardware can't work alone. That's why every C-10 includes software — word processing, financial spread sheet, investment planning and BASIC. Hard-working, CP/M[®]-based software that meets your everyday needs. Software that could cost over \$1000 some-

where else. FREE with the C-10. There's really nothing else to buy.

But the C-10's numbers tell only part of the story. What they don't say is that Cromemco is already known for some of the most reliable business and scientific computers in the industry. And now for the first time, this technology is available in a personal computer.

One last number. Call **800 538-8157 x929** for the name of your nearest Cromemco dealer, or to request literature. In California call 800 672-3470 x929. Or write Cromemco, Inc., 280 Bernardo Avenue, P.O. Box 7400, Mountain View, CA 94039. In Europe, write Cromemco A/S, Vesterbrogade 1C, 1620 Copenhagen, Denmark.

CP/M[®] is a registered trademark of Digital Research, Inc. All Cromemco products are serviced by TRW.

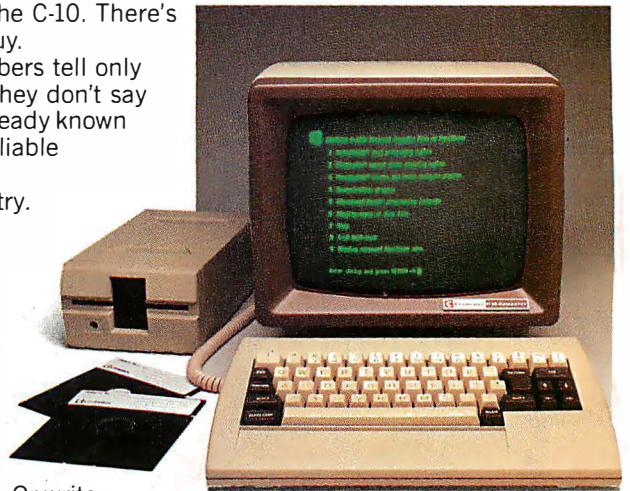

Cromemco
Tomorrow's computers today

Circle 123 on inquiry card.

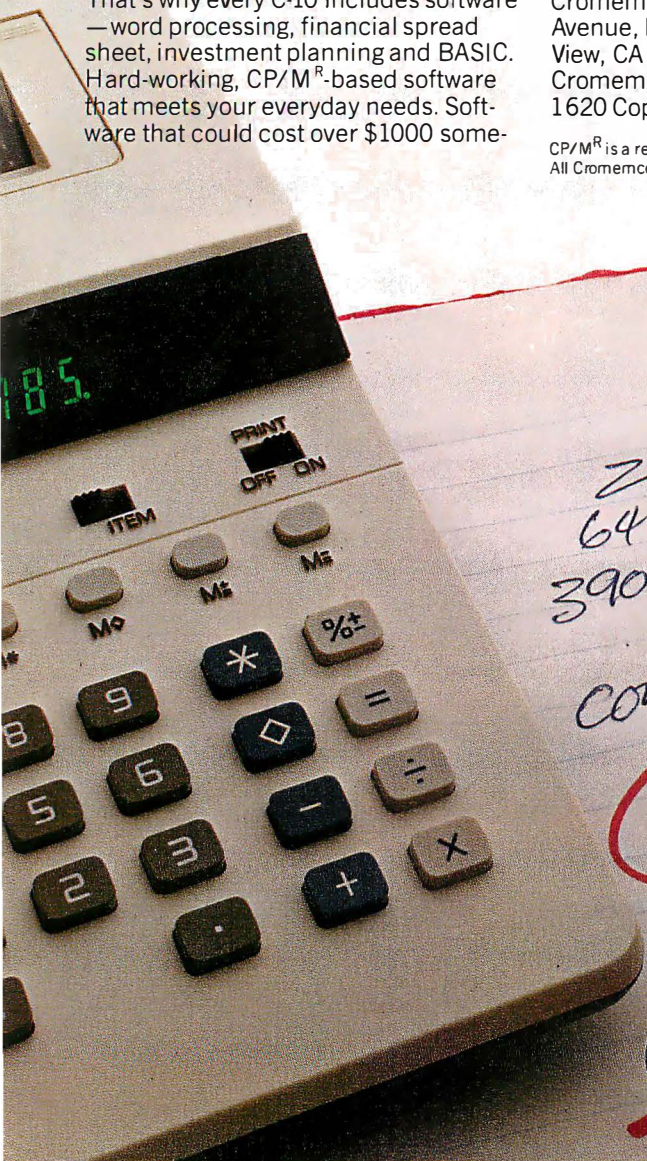

Z-80A
64 K RAM
390 K DISK DRIVE
12" CRT
COMPLETE SOFTWARE

\$1785

CROMEMCO

Features

28 Build an RS-232C Breakout Box by Steve Ciarcia / This diagnostic tool can help you make working serial connections.

53 The National Semiconductor NS16000 Microprocessor Family by Glenn Leedy / The 16000 brings to microcomputers features formerly available only on much larger systems.

70 Design Philosophy Behind Motorola's MC68000, Part 1 by Thomas W. Starnes / This 16-bit processor with multiple 32-bit registers is considered by many experts to be the most powerful, yet easy-to-program microprocessor available.

96 The CRT 9007 Video Processor and Controller by Brian Cayton and Mort Herman / Explore the heart of a smart terminal.

110 New Japanese Microcomputers by Phil Lemmons / A first look at the new wave of advanced computers.

132 Intel's 80186: A 16-Bit Computer on a Chip by Tony Zingale / The 80186 is the first integrated circuit that attacks the cost problem in 16-bit microcomputers.

154 The Intel 8087 Numerics Processor Extension by R. B. Simington / This chip lets you perform mathematical operations with 18 decimal digits of accuracy.

176 Super Graphics Hardware from NEC by Steve Levine / The NEC 7220 GDC is a new item of sophisticated graphics hardware for microcomputers.

190 NAPLPS: A New Standard for Text and Graphics, Part 3: Advanced Features by Jim Fleming / NAPLPS can draw irregular lines, compress repeated code segments, define new text characters, and divide the display screen into separate fields.

210 Virtual Memory for Microcomputers by Stephen Schmitt / A brief review of virtual-memory concepts, including an examination of four new memory-management chips.

242 BYTE West Coast: Hard Choices for Software Houses by Phil Lemmons / Advances in hardware, specifically microprocessors and storage devices, are forcing software houses to make some far-reaching decisions.

258 50 and 100 Years Ago in BYTE / The microcomputer industry has made great strides in the past 100 years. Read about what the industry looked like just a short century ago.

260 The Enhanced VIC-20, Part 3: Interfacing an MX-80 Printer by Joel Swank / How to connect a parallel-port printer to the VIC-20.

304 Building a Hard-Disk Interface for an S-100 Bus System, Part 2: The Hardware by Andrew C. Cruce and Scott A. Alexander / This installment covers choosing the disk drive, the disk controller, and the power supply and building the host computer adapter.

324 User's Column: Terminal Solutions, Manual Madness, BASIC Bits, and Info Helpers by Jerry Pournelle / Terminal concerns for Wordstar users, BASIC comments, and a bunch of useful utilities are reviewed by the lord of Chaos Manor.

360 Build This Memory, Part 2: Constructing the Memory Card by Cameron Spitzer / Take advantage of the low cost of dynamic memory.

385 Modula-2 by Joel McCormack and Richard Gleaves / Niklaus Wirth, creator of Pascal, brings us a general-purpose systems implementation language based on modules.

398 The Design of an Advanced Logic Simulator by Robert M. McDermott / Macrocircuits and time-saving features make this new simulator easy to use.

442 Information Hiding: A Brief Example by Gregg Williams / Consider this helpful alternative to structured programming and modular design.

Review

290 Two Ways to Use CP/M-80 on the IBM PC by Phil Lemmons

Nucleus

- 6 Editorial: The New Generation of Human-Engineered Software
- 12 Letters
- 457 BYTELINES
- 461 Clubs and Newsletters
- 463 Ask BYTE
- 466 Event Queue
- 477 Books Received
- 478 BYTE's Bits
- 479 Software Received
- 484 What's New?
- 541 Unclassified Ads
- 542 BOMB, BOMB Results
- 543 Reader Service

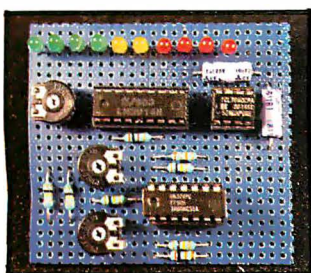

Page 28



Page 110

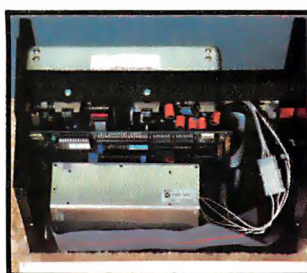

Page 304

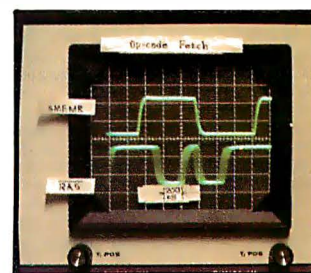

Page 360

Editor in Chief

Lawrence J. Curran

Managing Editor

Pamela A. Clark

Senior Editor

Gregg Williams

Technical Editors

Richard S. Shuford, Curtis P. Feigel, Stanley Wszola, Arthur A. Little, Richard Malloy, Bruce Roberts; Philip Lemmons, West Coast Editor; Steve Ciarcia, Mark Dahmke, Consulting Editors; Jon Swanson, Drafting Editor

Copy Editors

Beverly Cronin, Chief; Faith Hanson, Warren Williamson, Anthony J. Lockwood, Hilary Selby Polk, Elizabeth Kepner, Nancy Hayes, Cathryn Baskin, Tom McMillan; Margaret Cook, Junior Copy Editor

Assistants

Faith Kluntz, Beverly Jackson, Lisa Jo Steiner

Production

David R. Anderson, Assoc. Director; Jan Muller, Virginia Reardon, Michael J. Lonsky; Sherry McCarthy, Chief Typographer; Debi Fredericks, Donna Sweeney, Valerie Horn

Advertising

Deborah Porter, Supervisor; Marion Carlson, Rob Hannings, Vicki Reynolds, Cathy A. R. Drew, Lisa Wozmak; Patricia Akerley, Reader Service Coordinator; Wai Chiu Li, Advertising/Production Coordinator; Linda J. Sweeney

Circulation

Gregory Spitzfaden, Manager; Andrew Jackson, Asst. Manager; Agnes E. Perry, Barbara Varnum, Louise Menegus, Jennifer Price, Sheila A. Bamford; James Bingham, Dealer Sales; Deborah J. Cadwell, Asst; Linda Ryan

Marketing Communications

Horace T. Howland, Director; Wilbur S. Watson, Coordinator; Timothy W. Taussig, Graphic Arts Manager; Michele P. Verville, Research Manager

Controller's Office

Kenneth A. King, Asst. Controller; Mary E. Fluhr, Acct. & D/P Mgr.; Karen Burgess, Jeanne Cilley, Linda Fluhr, Vicki Bennett, L. Bradley Browne, Vern Rockwell

Business Manager

Daniel Rodrigues

Traffic

N. Scott Gagnon, Manager; Scott Jackson, Kathleen Reckart

Receptionist

Jeanann Waters

Publisher

Gene W. Simpson;
John E. Hayes, Associate Publisher;
Cheryl A. Hurd, Publisher's Assistant

Officers of McGraw-Hill Publications Company: John G. Wrede, President; Executive Vice President: Paul F. McPherson; Senior Vice President-Editorial: Ralph R. Schulz; Vice President: Kemp Anderson, Business Systems Development; Shel F. Asen, Manufacturing; Harry L. Brown, Special Markets; James E. Hackett, Controller; Eric B. Herr, Planning and Development; H. John Sweger, Jr., Marketing.

Officers of the Corporation: Harold W. McGraw Jr., Chairman and Chief Executive Officer; Joseph L. Dionne, President and Chief Operating Officer; Robert N. Landes, Senior Vice President and Secretary; Ralph J. Webb, Treasurer.

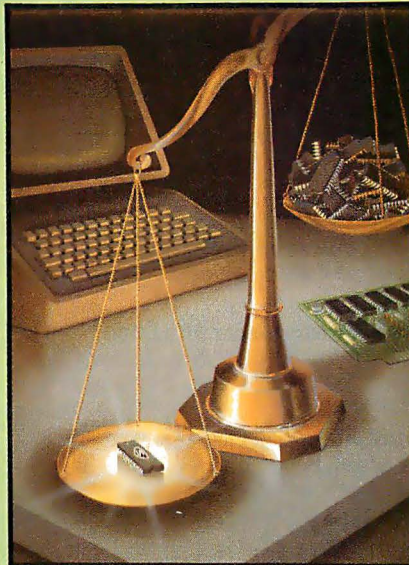

In This Issue

Innovations in microprocessor and support chips are closing the gap between the speed and power of minicomputers and that of micros. As Robert Tinney's cover illustrates, the scales are tipped in favor of the 16-bit chips. "The National Semiconductor NS16000 Microprocessor Family" by Glenn Leedy introduces you to the NS16032 processor and its related chips. "Design Philosophy Behind Motorola's MC68000" by Thomas W. Starnes begins a multi-part study of the heart of machines such as the Lisa and the Radio Shack Model 16. In "Intel's 80186," Tony Zingale describes this new chip that combines the functions of the 8086 and several support chips in one device. "The CRT 9007 Video Processor and Controller" by Brian Cayton and Mort Herman discusses a sophisticated chip that greatly simplifies the design of smart terminals. Steve Levine looks at "Super Graphics Hardware from NEC." "The Intel 8087 Numerics Processor Extension" by R. B. Simington describes the theory and use of this coprocessor chip to speed up numeric computations on 8086/8088-based computers. In the first BYTE West Coast report, Phil Lemmons brings us news of the way in which software houses are responding to the new advances in hardware. Steve Ciarcia tells you how to "Build an RS-232C Breakout Box." Plus our regular features.

BYTE is published monthly by McGraw-Hill, Inc., with offices at 70 Main St. Peterborough NH 03458, phone (603) 924-9281. Office hours: Mon-Thur 8:30 AM - 4:30 PM, Friday 8:30 AM - Noon, Eastern Time. Address subscriptions, change of address, USPS Form 3579, and fulfillment questions to BYTE Subscriptions, POB 590, Martinsville NJ 08836. Second class postage paid at Peterborough, N.H. 03458 and additional mailing offices. USPS Publication No. 528890 (ISSN 0360-5280). Postage Paid at Winnipeg, Manitoba. Registration number 9321. Subscriptions are \$21 for one year, \$38 for two years, and \$55 for three years in the USA and its possessions. In Canada and Mexico, \$23 for one year, \$42 for two years, \$61 for three years. \$53 for one year air delivery to Europe. \$37 surface delivery elsewhere. Air delivery to selected areas at additional rates upon request. Single copy price is \$2.95 in the USA and its possessions, \$3.50 in Canada and Mexico, \$4.50 in Europe, and \$5.00 elsewhere. Foreign subscriptions and sales should be remitted in United States funds drawn on a US bank. Printed in United States of America.

Address all editorial correspondence to the editor at BYTE, POB 372, Hancock NH 03449. Unacceptable manuscripts will be returned if accompanied by sufficient first class postage. Not responsible for lost manuscripts or photos. Opinions expressed by the authors are not necessarily those of BYTE. Entire contents copyright © 1983 by BYTE Publications Inc. All rights reserved. Where necessary, permission is granted by the copyright owner for libraries and others registered with the Copyright Clearance Center (CCC) to photocopy any article herein for the base fee of \$1.00 per copy of the article or item plus 25 cents per page. Payment should be sent directly to the CCC, 21 Congress St. Salem MA 01970. Copying done for other than personal or internal reference use without the permission of McGraw-Hill is prohibited. Requests for special permission or bulk orders should be addressed to the publisher.

BYTE® is available in microform from University Microfilms International, 300 N Zeeb Rd, Dept PR, Ann Arbor MI 48106 USA or 18 Bedford Row, Dept PR, London WC1R 4EJ England.

Subscription questions or problems should be addressed to:

BYTE Subscriber Service
P.O. Box 328
Hancock, NH 03449



WE HAVE THE JUMP ON THE COMPETITION

10 YEAR WARRANTY



Kangaroo™

in QUALITY and PRICE!

Kangaroo—the best disk at **any** price!

- CERTIFIED 100% ERROR FREE
- REINFORCED HUB RINGS
- ALL **KANGAROO** DISKS ARE PACKAGED IN A HARD LIBRARY CASE
- 10 YEAR WARRANTY

Suggested List Price

5¼ inch Single Sided/Double Density **\$29.95**

5¼ inch Double Sided/Double Density **\$39.95**

Try A Box Of Kangaroos On Us!

We are so convinced **Kangaroo** is the best disk you can buy that we make this offer. Buy a box of **Kangaroos**, if for any reason you are not satisfied with the quality of **Kangaroos**, return them within 30 days for a full refund—no questions asked.

EXCLUSIVE NORTH AMERICAN
DISTRIBUTOR:

MICROCOMPUTER
BUSINESS
INDUSTRIES
CORPORATION

MBI

ADMINISTRATIVE OFFICES: 1019 8TH STREET, GOLDEN, COLORADO 80401 (U.S.A.)
TELEPHONE: (303) 279-8438
TWX: 910-934-0191

Circle 106 on inquiry card.

COMPILE A BIBLIOGRAPHY - AUTOMATICALLY.

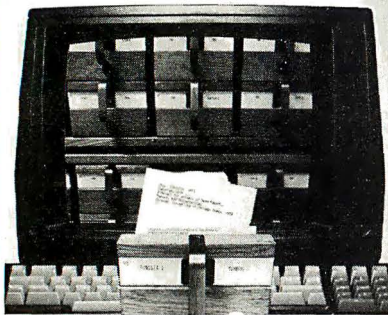

If you're a professional writer, we've just made your job easier.

BIBLIOGRAPHY™ compares citations in a manuscript with the entries in your own card catalog and constructs a bibliography of all entries cited.

Entries are added to the catalog using your text-editor. Each catalog entry has a keyname (for example, author and year of publication), followed by bibliographic information such as the author's name, the title and annotations. The entries can be of any length and format.

When preparing the manuscript, just type in the keyname for each reference. BIBLIOGRAPHY constructs a bibliography of all works cited - alphabetized or numbered, with annotations included or excluded.

BIBLIOGRAPHY can handle references to meet the requirements of virtually any professional journal, publisher or style manual.

Price is \$125. For more information, see your computer dealer or contact Digital Marketing.

BIBLIOGRAPHY requires CP/M® 2.2, CP/M-86™ or IBM PC DOS and a minimum of 48K RAM. It will work with most word processors including WordStar™, Spellbinder™, PeachText™ and SuperWriter™.

SOFTWARE
SOFTWARE
DIGITAL MARKETING
DIGITAL MARKETING™



DIGITAL MARKETING CORPORATION

2670 CHERRY LANE • WALNUT CREEK • CALIFORNIA • 94596
(415) 938-2880 • Telex 17-1852 (DIGMKTG WNCK)

Dealer Inquiries Invited. Dealers outside California call
(501) 442-0804. Inside California call (415) 938-2883

Trademarks:
Bibliography - ProTem Software; CP/M and CP/M-86 - Digital Research, Inc.; WordStar - MicroPro International; Spellbinder - Lexisoft; PeachText - Peachtree Software; SuperWriter - Sorcim.

A PRODUCT OF
PRO TEM

Editorial

The New Generation of Human-Engineered Software

Gregg Williams, Senior Editor

Apple's new Lisa epitomizes the state of the art in computer sophistication and ease of use. Its integrated software and mouse make this machine a harbinger of what's in store for microcomputers. These new advances mean serious business.

Software companies, for one, appear to be staking their future on products that feature video windows, which allow various projects to appear on the video screen simultaneously, and the mouse, a hand-held box-shaped device that provides an alternative to the computer keyboard. Many new products announced in the past few months are incarnations of what has become known as integrated software. The microcomputing industry is at the threshold of a new trend in user-friendly, human-engineered software—a trend spurred by new technologies and rising product development costs.

New technologies, particularly 16-bit processors and inexpensive computer memory, make more sophisticated software possible. Increased sophistication, however, means higher development costs, which are inevitably passed on to the consumer. Manufacturers, however, see a solution in easy-to-use software. By making such software, they expect to reach a boarder market base; with more potential buyers, the price per unit remains generally affordable.

Why Human-Engineered Software?

This move toward easy-to-use software is the result of a chain of events and influences. We begin with the 16-bit microprocessors, which have been around for several years. Their main contribution is that they have given the ambitious programmer some elbow room. Eight-bit processors are inherently limited by their 64K-byte address space and this in turn imposes restrictions on a programmer's creativity. Granted, clever hardware design and programming can often get around this storage problem, but only up to a point. On the other hand, with 16-bit (and larger) microprocessors capable of addressing millions of bytes of data, programmers have ample room in which to do their work.

The second link in this chain of events is the decreasing cost of mass storage devices and, in particular, computer memory. Only within the last year has memory become inexpensive enough to be used without manufacturers worrying too much about how additional memory will increase the price of the unit. Now that larger memories are affordable and are becoming standard, software companies must decide how they'll use the extra memory to its maximum potential. This brings us to the third link in this chain, which involves a choice to be made by software developers: they can create either computationally more powerful programs or easier-to-use programs. Both options have their advantages, but most companies are going with the latter for one reason: they are courting the average person who is being introduced to computers and their many uses through advertisements on television and in the print media. These people are the new computer users.

Why is this new computer user so important? First of all, the general public is just becoming aware of software and how it can make a computer work for them. Thinking that a lucrative software market is

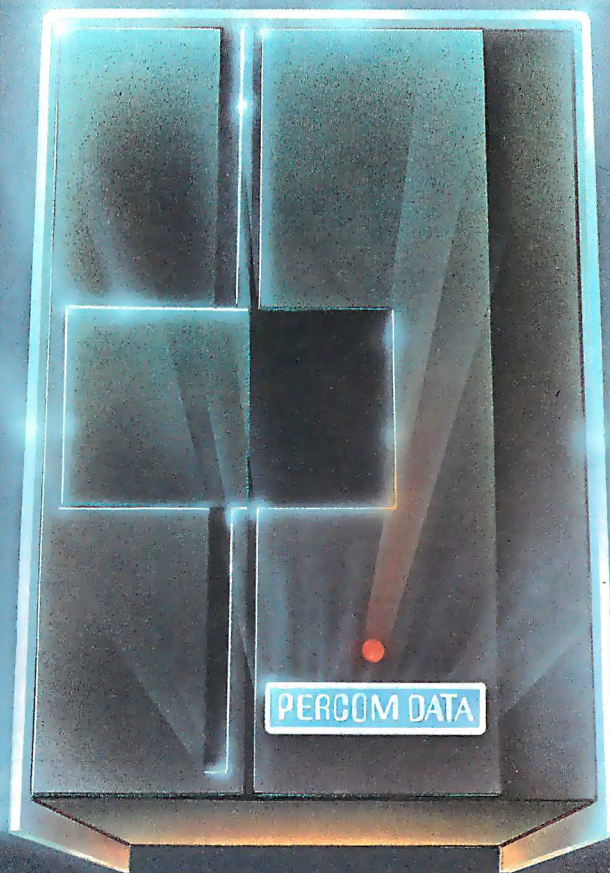

We've Got More Than A Fond Attachment For Your ATARI

We've Got A Disk Drive For \$488.

Percom Data Corporation believes your Atari® home computer is more than just fun and games. We believe you should be able to get a single-density, floppy-disk-system for your Atari 400 or 800 at a price that will take you into the future without knocking you into the next galaxy.

Percom Data has been manufacturing disk-drive systems, and other accessories for personal computers since the mid-1970's and is the industry standard to follow when it comes to data separation and system compatibility.

The Percom Data AT-88 combines Percom Data quality and reliability at a price that is not a budget-buster.

The Percom Data AT-88 offers 88 Kbytes (formatted) in single-density, with plug-in ease of attachment to your Atari. The AT-88 has integral power supply, "no-patch" to Atari DOS and critical constant speed regulation.

Take advantage of this low introductory price of \$488 by calling Percom Data now to get more information, or the name of an authorized dealer nearby. Call toll-free

1-800-527-1222

PERCOM DATA
CORPORATION

Expanding Your Peripheral Vision

DRIVES • NETWORKS • SOFTWARE

11220 Pagemill Road Dallas, Texas 75243 (214) 340-7081
1-800-527-1222

Editorial

beginning to open, each company understandably wants to get its foot in the door first with these new users. These companies are hoping that once people buy one of their packages, they are likely to consider them for their future software needs.

The far more compelling reason for courting this new user via easy-to-use software is cost. As the complexity of software goes up, so do the costs associated with designing, programming, testing, and documenting it. To keep these added costs from increasing the product's price and decreasing its potential market, software houses have realized that they must expand their market. Programs using current software technology will sell to only those people who currently use microcomputers. If, on the other hand, software designers use this extra power to make programs that are both powerful and easy to use, they can expect to sell to the potentially huge market of "software-hungry" users, thus vastly increasing the market for their product. The extra production costs would (they hope) be spread over such a large group that the extra cost per program sold would rise only slightly.

The Big Question

The big question is "What makes software easy to use?" Microsoft and Visicorp are firmly committed to the mouse and the desktop-manager concept as the



Prototype of Visicorp's *Visi On* integrated applications environment. Note the multiple video windows and mouse. Since this photo was taken, Visicorp has changed to a two-button mouse.

answer. Microsoft will incorporate a mouse and window-management system into advanced versions of its Multitool series of packages (Multiplan is its first such package). Visicorp stole some of Apple's thunder when it previewed Lisa-like features on the IBM Personal Computer at Comdex last fall with a package called *Visi On* (see photo). *Visi On*, which is billed as an "integrated applications environment," has a two-button mouse and can support multiple tasks running in separate windows. Note that these software companies are putting great emphasis on a hardware device (the mouse) that will add between \$150 and \$250 to the cost of some of their products; this fact alone indicates the depth of these

companies' commitment to the future.

However, the real answer to the question posed in the previous paragraph is that nobody knows what will make software easy to use. Apple, Microsoft, and Visicorp each has its own option. Other companies, of course, have other solutions (for an excellent discussion of some different plans, see Phil Lemmons' *BYTE West Coast*, "Hard Choices for Software Houses," on page 242).

The air is already filled with claims and promises about the merits of each company's products, but nobody knows what makes software easy to use; the final answer will be in what the people buy. ■

C compilers

HOST	6809 TARGET	PDP-11*/LSI-11* TARGET	8080/(Z80) TARGET	8088/8086 TARGET
FLEX*/UNIFLEX* OS-9*	\$200.00 \$350.00 <small>WITHOUT FLOPPY WITH FLOPPY</small>	500.00	500.00	500.00
RT-11*/RSX-11* PDP-11*	500.00	200.00 350.00 <small>WITHOUT FLOPPY WITH FLOPPY</small>	500.00	500.00
CP/M* 8080/(Z80)	500.00	500.00	200.00 350.00 <small>WITHOUT FLOPPY WITH FLOPPY</small>	500.00
PCDOS*/CP/M86* 8088/8086	500.00	500.00	500.00	200.00 350.00 <small>WITHOUT FLOPPY WITH FLOPPY</small>

PCDOS is a trademark of IBM CORP. MSDOS is a trademark of MICROSOFT. UNIX is a trademark of Bell Labs. RT-11/RSX-11*/PDP-11 is a trademark of Digital Equipment Corporation. FLEX*/UNIFLEX is a trademark of Technical Systems consultants. CP/M & CP/M86 are trademarks of Digital Research. OS-9 is a trademark of Microware & Motorola.

• FULL C

• UNIX* Ver. 7 COMPATABILITY

• NO ROYALTIES ON GENERATED CODE

• GENERATED CODE IS REENTRANT

• C AND ASSEMBLY SOURCE MAY BE INTERMIXED

• UPGRADES & SUPPORT FOR 1 YEAR C SOURCE AVAILABLE FOR \$2500⁰⁰

408-275-1659

TELECON SYSTEMS

1155 Meridian Avenue, Suite 218
San Jose, California 95125



TOUGH TO OUTGROW

It's no surprise so many businesses today are using our CompuStar® multi-user microcomputer. All sorts of businesses, those at the top and those on the way, know that only CompuStar can give them the big system performance they'll need as they grow. And they know that *only* CompuStar can deliver that performance at a fraction of the cost of most other systems.

CompuStar® solves the small business computer dilemma. It's ideal for those first time business users who need only single-user capability. But it's also perfect when those small businesses grow into large corporations. That's because CompuStar is *truly* expandable... all the way up to 255 workstations, each with its own processor and internal computer memory. And that means fast, fast response, even when many users are on-line at the same time.

Whether you're a small business with big plans or a big business with an eye for economy, CompuStar® has the performance and versatility that's tough to outgrow... the price/performance ratio that's impossible to beat!

STANDARD FEATURES

- 350K/750K/1.5 MB workstation disk capacities
- 64K RAM and twin processors in each workstation
- An easy-to-read 12-inch non-glare screen
- Operator convenience features—numeric keypad and visual text highlighting
- Microsoft® Basic
- CP/M+ operating software
- Truly multi-user and multi-processor

STORAGE OPTIONS

- 10 MB—compact, low-cost and tabletop
- 96 MB—80 fixed and 16 removable megabytes
- 144 MB—reliable, rugged Winchester storage

CompuStar® is built and backed by the company that's been in the microcomputer business as long as microcomputers have been in business. Would you trust *your* business to anything less? CompuStar®. Tough to beat. Tough to outgrow!

*Microsoft is a trademark of Microsoft Corp.
†Registered trademark of Digital Research

Circle 215 on inquiry card.

**INTERTEC
DATA
SYSTEMS®**

CORPORATE HEADQUARTERS: 2300 BROAD RIVER ROAD • COLUMBIA, SOUTH CAROLINA 29210 • (803) 798-9100 • TWX 810-666-2115

Microstuff's CROSSTALK \$119

ASHTON TATE	
dBASE II.....	\$529.00
BOTTOM LINE STRATEGIST.....	279.00
C. ITOH	
PROWRITER PARALLEL.....	\$489.00
PROWRITER SERIAL.....	639.00
F-10 55.....	1799.00
F-10 PARALLEL.....	1399.00
F-10 SERIAL.....	1449.00
GRAPPLER INTERFACE.....	140.50
PROWRITER II.....	789.00
TRACTOR FOR F10.....	229.00
CALIFORNIA COMPUTER SYSTEMS	
ASYNCHRONOUS INTERFACE ..	\$129.00
SYNCHRONOUS INTERFACE	149.00
CALENDAR CLOCK.....	105.00
RS232 INTERFACE.....	124.00
PROGRAMMABLE TIMER (FOR APPLE)	99.00
COMSHARE TARGET MARKETING	
PLANNER CALC.....	\$79.00
TARGET FINANCIAL MODELING.....	249.00
CONTINENTAL SOFTWARE	
HOME ACCOUNTANT FOR APPLE	\$69.00
HOME ACCOUNTANT FOR IBM.....	129.00
DICTRONICS, INC.	
RANDOM HS. ELE. THESAURUS.	\$129.00
PROOF READER.....	50.00

EAGLE	
MONEY DECISIONS.....	\$119.00
FORCE II	
MATH*.....	\$99.00
FOX & GELLER	
dUTIL.....	\$68.00
QUICKSCREEN FOR dBASE II.....	129.00
QUICKCODE FOR dBASE II.....	249.00
INTEGRAL DATA SYSTEMS	
IDS MICROPRISM 480 PRINTER.	\$599.00
IDS PRISM 132 PRINTER.....	1299.00
IDS PRISM 80 PRINTER.....	999.00
INTERACTIVE STRUCTURES	
PKASSO.....	135.00
INNOVATIVE SOFTWARE, INC.	
TIM III.....	\$369.00
GRAPHMAGIC.....	69.00
MATHEMAGIC.....	79.00
INFORMATION UNLIMITED SYSTEMS	
EASYFILER.....	\$349.00
EASYSPELLER.....	159.00
EASYWRITER II.....	279.00
MAXELL	
FD-1 or FH-1-32 8" SINGLE SIDED....	\$41.50
FD-2 8" DOUBLE SIDED.....	48.95
MD-1 or MH-1 5 1/4" SINGLE SIDED.....	31.25
MD-2 or MH-2 5 1/4" DOUBLE SIDED.....	47.10

MICROPRO	
CALCSTAR.....	\$99.00
DATASAR.....	194.00
DATASAR.....	165.00
MAILMERGE.....	149.00
SPELLSTAR.....	174.00
SUPERSORT I.....	174.00
SUPERSORT II.....	174.00
WORDSTAR.....	279.00
WORDSTAR/MAILMERGE.....	369.00
WORDSTAR TRAINING GUIDE.....	11.25
MICROSOFT	
128K RAM FOR IBM PC.....	\$599.00
ALDS.....	105.00
BASIC 80 COMPILER.....	299.00
BASIC 80 INTERPRETER.....	279.00
BASIC COMPILER FOR APPLE II.....	315.00
128K RAMCARD.....	599.00
192K RAMCARD.....	699.00
256K RAMCARD.....	799.00
64K RAMCARD.....	399.00
64K RAMCHIPS.....	175.00
TIME MANAGER.....	119.00
TYPING TUTOR.....	23.00
MICROSOFT Z80 PREMIUM PACK	619.75
MICROSOFT Z80 SOFTCARD.....	279.00
muLISP/muSTAR.....	169.00
MULTIPLAN.....	219.00
muSIMP/muMATH.....	199.00
TASC APPLESOFT COMPILER.....	149.00

NORTH AMERICAN BUSINESS SYSTEMS	
THE ANSWER.....	\$249.00
NEC	
NEC 3550 LOP.....	\$2149.00
OASIS	
WORDPLUS.....	\$149.00
PEACHTREE	
ACCOUNTS PAYABLE.....	\$375.00
ACCOUNTS RECEIVABLE.....	375.00
GENERAL LEDGER.....	375.00
INVENTORY.....	375.00
PAYROLL.....	187.50
SALES INVOICING.....	375.00
PERFECT SOFTWARE	
PERFECT CALC.....	\$139.00
PERFECT FILER.....	279.00
PERFECT SPELLER.....	139.00
PERFECT WRITER.....	239.00
QUADRAM	
128K MEMORY EXPANSION.....	\$380.00
192K MEMORY EXPANSION.....	475.00
64K MEMORY EXPANSION.....	280.00
64K MEMORY UPGRADE.....	129.00
DUAL PORT EXPANSION KIT.....	49.00
MICROFAZERS ALL MODELS.....	CALL!
MICROFAZER POWER SUPPLY.....	17.00
QUADBOARD 64K.....	499.00
QUADBOARD 128K.....	649.00
QUADBOARD 192K.....	749.00
QUADBOARD 256K.....	829.00

MICROHOUSE™
CALL TOLL-FREE
1-800-523-9511
IN PENNSYLVANIA
1-215-868-8219

Micropro's INFOSTAR \$279

RANA	
CONTROLLER FOR ELITE I.....	\$99.00
RANA ELITE I.....	379.00
RANA ELITE II.....	559.00
RANA ELITE III.....	729.00
SMITH-CORONA	
SMITH-CORONA TP-1.....	\$599.00
SORCIM	
PASCAL M.....	\$131.25
SUPERCALC BY SORCIM.....	209.00
SPELLGUARD.....	189.00
SUPERSOFT	
ADA.....	\$269.00
DIAGNOSTICS I.....	65.50
DIAGNOSTICS II.....	84.00
DISK DOCTOR BY SUPERSOFT.....	84.00
FORTAN.....	279.00
PERSONAL DATABASE.....	99.00
SCRATCHPAD.....	259.00
STACKWORKS FORTH.....	149.00
STATSGRAPHS.....	169.00
C COMPILER.....	175.00
SSS FORTAN IV.....	218.75
SUPER M LIST.....	65.00
TERM I.....	131.00
TERM II.....	150.00
TEXT FORMATTING.....	75.00
UTILITIES I . UTILITIES II.....	52.50

SORENTO VALLEY ASSOCIATES	
8" FLOPPY SYSTEM (1 MEG) ..	\$1995.00
8" FLOPPY SYSTEM (2 MEG)....	2599.00
10 MEG WINC. FOR APPLE.....	3399.00
128K RAM BOARD.....	649.00
192K RAM BOARD.....	845.00
256K RAM BOARD.....	949.00
T/MAKER COMPANY	
T/MAKER III.....	\$249.00
VIDEX	
ENHANCER II.....	\$119.00
VIDEX KEYBOARD ENHANCER.....	105.00
VIDEX VIDEOTERM FOR APPLE II.	299.00
VISICORP	
DESKTOP PLAN APPLE II.....	\$184.00
DESKTOP PLAN IBM.....	228.00
VISICALC.....	184.00
VISICALC ADVANCED VERSION ..	339.00
VISICALC BUSINESS FORECASTING	89.00
VISIDEX.....	184.00
VISIFILE APPLE II.....	184.00
VISIFILE IBM.....	228.00
VISILINK.....	184.00
VISIPACK.....	619.00
VISILOT FOR APPLE.....	159.00
VISISCHEDULE.....	228.00
VISITERM.....	80.00
VISITREND/VISILOT.....	228.00

We want you to know...

MICROHOUSE, because we don't just answer phones, we answer questions.

We want you to know...

MICROHOUSE continues to feature great prices and quality softwares and hardware.

We want you to know...

MICROHOUSE introduces new products:

THE ANSWER

NORTH AMERICAN BUSINESS SYSTEMS, INC.

Now you can truly have information at the touch of a button from the world's first self-teaching database system. THE ANSWER uses "electronic cards" or computerized versions of index cards. These cards hold all your pertinent information in the sequence you want it. With THE ANSWER's report generation feature, you can also do mailings, business reports, math, and high level searching.

List Price: \$295.00

MICROHOUSE PRICE \$249.00

FAST GRAPHS

INNOVATIVE SOFTWARE

FAST GRAPHS is a complete graphics and plotting program designed for the IBM-PC with a color or high resolution black and white monitor. Completely menu driven, FAST GRAPHS automatically scales axes, titles, and creates graph legends; using manual data input or direct data input from Visicalc, or most other spread sheet and database programs. Special draw mode with painting and erasing feature allows you to creatively edit your graphs and charts.

List Price: \$295.00

MICROHOUSE PRICE: \$189.00

CALSTAR

CALIFORNIA COMPUTER SYSTEMS, INC.

CALSTAR is a brand new, expandable, single board computer system which is ideally suited to business applications. It combines high priced benefits at a cost any business can afford. Calstar offers 2-8" double sided-double density disc drives (2 meg capacity!). Software included in every CALSTAR: CP/M, PERFECT WRITER, PERFECT SPELLER, PERFECT CALC, and PERFECT FILER. CALL MICROHOUSE FOR DETAILS!

List Price: \$2995.00

MICROHOUSE PRICE: \$2695.00

PRINTMASTER F-10

C. ITOH

The PRINTMASTER is built on an aluminum base and uses high quality metal parts for reliability and dependability. It streams along at 55 LQcps (letter quality characters per second) with all the qualities of a STARWRITER. MICROHOUSE is an authorized C. ITOH repair center.

MICROHOUSE PRICE: \$1749.00

We want you to know...

MICROHOUSE has a 24 hour computerized order system called **MICROLINE** which enables you to access specific product information and place an order if you wish. **MICROLINE** can be reached at 1-215-868-1230

P.O. BOX 499/1444 LINDEN ST., DEPT. 201.. BETHLEHEM, PA 18016

IBM IS A REGISTERED TRADEMARK OF INTERNATIONAL BUSINESS MACHINES. CP/M IS A REGISTERED TRADEMARK OF DIGITAL RESEARCH, INC., APPLE IS A REGISTERED TRADEMARK OF APPLE COMPUTERS, INC., PERFECT WRITER, PERFECT SPELLER, PERFECT CALC ARE TRADEMARKS OF PERFECT SOFTWARE, INC. THE ANSWER IS A TRADEMARK OF NORTH AMERICAN BUSINESS SYSTEMS. FAST GRAPH IS A TRADEMARK OF INNOVATIVE SOFTWARE MARKETING, INC. CROSSTALK IS A TRADEMARK OF MICROSTUFF. INFOTAR IS A TRADEMARK OF MICROPRO. PRICES, SPECIFICATIONS AND AVAILABILITY SUBJECT TO CHANGE WITHOUT NOTICE. NOT ALL PROGRAMS AVAILABLE IN ALL FORMATS. PLEASE CALL FOR ADDITIONAL PRODUCT INFORMATION. DEALER INQUIRIES WELCOME.

WE WANT YOU TO KNOW...

MICROHOUSE

Circle 282 on Inquiry card.

Your Micro-computer People

New Chips for Dynamic Memory Fans

I enjoyed Rob Belics's excellent article, "Practical Dynamic Memory System Design" (December 1982 BYTE, page 372). Your readers may like to know about two newer chips that have made dynamic memory much easier to use: the 4164 and the 6883.

The 64K- by 1-bit 4164 costs about the same per bit as the 16K- by 1-bit 4116 but requires only a single +5-V supply and uses less power and board space. The single power supply feature eliminates the need, in most systems, for an expensive three-voltage power supply and the chance that chips might be fried by application of supply voltages in the wrong order. The smaller memory cells make the 4164 more sensitive to alpha-radiation-induced random bit changes, but this happens infrequently enough that it is not much of a problem for most applications.

The Motorola 6883 synchronous address multiplexer makes interfacing dynamic memory to the 6809 microprocessor almost as easy as hooking up static memory. It handles all CAS and RAS timing, address multiplexing, and memory refresh. It can also interface the 6809 to Motorola's 6847 video display generator (as in the Radio Shack Color Computer) and provides all system timing so that dynamic memory refresh and display refresh are transparent.

Both the 4164 and the 6883 are well worth knowing about for anyone interested in dynamic-memory system design.

David Nye
209 West Lowe's Creek Rd.
Eau Claire, WI 54701

Turning on the 4116

I feel I must point out an important omission from Rob Belics's article "Practical Dynamic-Memory System Design" in regard to power supplies for the 4116 DRAM (dynamic random-access read/write memory) chip. Mr. Belics briefly describes these as "three separate power-supply voltages that must first be applied in a certain order." I searched the article carefully, and Mr. Belics never tells us in what order these supplies must be turned on and off.

In the April 1981 "Ask Byte" column (page 328), Steve Ciarcia states, "The most important thing to remember when designing any computer that uses 4116s is that the power-supply voltages must be turned on and off in sequence. To keep from blowing the 4116 on power-up, the -5-V supply must be turned on before the +5-V and +12-V supplies. On power-down, the -5 and +12 are removed. . . the sequence can be accomplished through the time constants of the power supply itself. . . ."

Charles Reeves Jr., Physicist
Nuclear Division
Union Carbide
270 Park Ave.
New York, NY 10017

Multidos Update

Once again, the work of a software developer has outstripped the publishing process and an update is needed to my review "Multidos: A New TRS-80 Disk Operating System" (December 1982 BYTE, page 392).

The price of Multidos has increased from \$79.95 to \$99.95. There is also a new, \$39.95 version called ZDOS; although not as full-featured as Multidos, it provides double-density support and SUPERBASIC (write to Cosmopolitan Electronics, 5700 Plymouth Rd., Ann Arbor, MI 48105, for full details). The additional \$20 charge for Multidos buys you a disk sector and file editor or ZAP utility, a disk-drive timer utility, a tape-to-disk conversion utility, and a RAM (random-access read/write memory) test utility. The DOS part of Multidos version 1.6 now includes two-sided drive support, a PATCH command, a RESTOR command to recover a file deleted with the KILL command, a CAT (catalog) command that reads the directory of almost any Model I or III disk, and many additional options for the original commands.

Multidos is now claimed to support disk I/O (input/output) at 4.7 MHz, if you have a clock speedup that allows this.

SUPERBASIC, the disk BASIC that comes with Multidos, has added commands to remove REM statements; pack BASIC program lines together while preserving program logic; and save the current BASIC program in memory while working on another program, then return to

the original program (or append it to the new one).

Vernon Hester, the author of Multidos, has released one newsletter so far and promises to publish patches in 1983 that will enable some popular software to run under Multidos.

Let me close by saying that I have found Multidos to stand up very well to over a year's use; it is fast and reliable and provides a very flexible BASIC development environment.

Rowland Archer Jr.
5420 Loyal Place
Durham, NC 27713

MDBS Takes Issue with User's Column

In the December 1982 BYTE "User's Column" (page 222), Jerry Pournelle notes that Micro Data Base Systems Inc. is working on enhancing the BDS Compiler. This new C compiler, called C', has been available for several months. Perhaps its most notable traits are its production of extremely compact object code and its relatively fast execution and compilation.

I would like to correct several misimpressions conveyed in Dr. Pournelle's column. First, Micro Data Base Systems Inc. is not a "bunch of Purdue University people." The company's management and staff of over 100 persons are not employees of Purdue University. While a number of our employees hold bachelors, masters, and doctorate degrees from Purdue, many others received training at other equally fine institutions.

A second error pertains to our database management product, MDBS. Dr. Pournelle states that "MDBS and the CODASYL database systems are *hierarchical* in structure." This is incorrect. Systems based on the CODASYL approach are not at all limited to hierarchical architectures. Indeed, the flexibility provided by CODASYL-network structures was a major advance over hierarchical systems. Furthermore, MDBS should not be confused with either CODASYL-network systems or hierarchical systems. MDBS is a post-relational system of the extended-network variety, which means that it overcomes many limitations of the old-time hierarchical, relational, and CODASYL-network approaches to database management.

Bored Waiting? Here's The Board You've Been Waiting For.

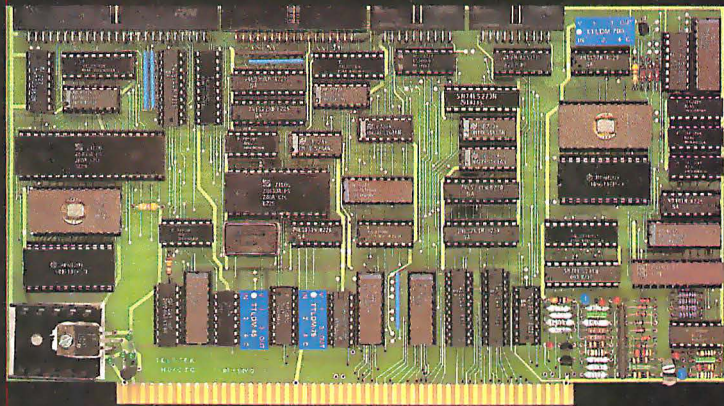

A hard disk and cartridge tape controller together on one board? Magic? Not really. It's Teletek's HD/CTC. The hard disk and cartridge tape drive controller provide the support necessary to interface both rigid-disk drives and a cartridge tape deck to the S-100 bus.

- A Z-80A CPU (optionally Z-80B) providing intelligent control of the rigid-disk and cartridge tape drives.
- Support of 5 1/4" rigid-disk drives with transfer rates of

5 megabits per second. Minor changes of the on-board components allow the support of other drive types/sizes and transfer rates up to 15 megabits per second. (Interface to disk drive is defined by software/firmware on-board.)

- Controller communications with the host processor via 2K FIFO at any speed desirable (limited only by RAM access time) for a data block transfer. Thus the controller does not

constrain the host processor in any manner.

- Two 28-pin sockets allowing the use of up to 16K bytes of on-board EPROM and up to 8K bytes of on-board RAM.
- Individual software reset capability.
- Conforms to the proposed IEEE-696 S-100 standard.
- Controller can accommodate two rigid-disk drives and one cartridge tape drive. Expansion is made possible with an external card.

Teletek's HD/CTC Offers A Hard Disk
Controller, Plus Cartridge Tape Controller,
All On One Board.

TELETEK



UNIX, with change.

Idris is a trademark of Whitesmiths, Ltd. / UNIX is a trademark of Bell Laboratories.

Put off by the UNIX price tag and licensing restrictions? If you are, take a closer look at Idris.

Idris gives you all the power of UNIX at a fraction of the cost—and they're highly compatible—even pin-for-pin in some cases. Upfront expenses are much lower, you only pay for the parts you ship, and the end-user licenses can be transferable.

What's more, we wrote Idris ourselves—from the ground up—so you'll have fewer licensing hassles. We wrote it almost entirely in C, for maximum portability across a wide range of processors. And we kept it small.

Idris can run comfortably where UNIX can't even fit: On an MC68000 with no memory management hardware, for example. On a bank-switched 8080 or Z80. Or on any LSI-11 or PDP-11 with memory management. A very big Idris plus.

Find out how you can put Idris to work in your favorite configuration today. Write Whitesmiths, Ltd., 97 Lowell Road, Concord, MA 01742. Or call (617) 369-8499, TLX 951708 SOFTWARE CNCM.

With Idris, you pocket the change.

Whitesmiths, Ltd. Crafting Software Tools for your Trade.

Distributors: **Australia**, Fawnray Pty. Ltd. P.O.B. 224 Hurstville NSW 2220 (612) 570-6100
Japan, Advanced Data Controls, Corp., Chiyoda-ku, Tokyo (03) 263-0383
United Kingdom, Real Time Systems, Newcastle upon Tyne 0632 733131

Letters

It should also be pointed out that, unlike MDDBS, the many microcomputer file handlers that are very loosely referred to as relational databases have little in common with usual, long-established notions of what constitutes database management. These file handlers do not even begin to approach systems such as IBM's SQL/DS, the de facto standard for relational systems. The limitations of file management are not overcome merely by referring to files as databases.

With respect to MDDBS documentation, it must be noted that "A Primer on Data Base Management Systems" by Dr. Clyde Holsapple, cited in the article, is not a component of the MDDBS reference manual. It is a separate tutorial that is routinely and quite successfully used in introductory university courses on database management systems at the undergraduate level. We have distributed thousands of copies of the primer in the last few years, and the feedback has been overwhelmingly favorable.

Gary J. Koehler, Ph.D.
President and Chief Executive Officer
Micro Data Base Systems Inc.
POB 248
Lafayette, IN 47902

Video Displays and Elimination of Health Risks

The letter in the December 1982 BYTE from John C. Villforth of the U.S. Bureau of Radiological Health attempted to reassure VDT (video display terminal) users that these machines do not emit harmful levels of radiation. In reality, there are very good reasons for suspecting that the current generation of cathode-ray tube VDTs are hazardous and are causing cataracts and other diseases. Fortunately, however, VDTs can be built by several other methods that reduce or eliminate radiation emissions.

In cathode-ray tubes (CRTs), a high-speed beam of electrons is abruptly decelerated as it slams into the face of the tube. It is a basic fact of physics that this process produces x-rays and microwave and ultraviolet radiation. Mr. Villforth writes that the government has done studies showing that CRT x-ray emissions under "normal" conditions are not "significantly above the natural background radiation to which we are all exposed." Just exactly what does this mean? Why



TECMAR
\$1795⁰⁰

complete with
controller & cartridge

**FIRST
FROM
TECMAR**

**NEW
REMOVABLE
CARTRIDGE
WINCHESTER**

This is the breakthrough in storage that IBM PC people have been waiting for, as Tecmar engineering keeps you moving ahead.

- the new SyQuest 5 Megabyte removable cartridge Winchester disk drive
- complete, easily installed in IBM PC or available in IBM-compatible Tecmar expansion chassis
- new Tecmar superspeed controller
- Tecmar disk sharing for up to 4 IBM PCs
- your best solution for mass storage, and the most sensible back-up system available.

We believe this is the future in storage because we have proved its **reliability** and its advantages. The new removable cartridge gives you unlimited memory at a lower price tag than the basic Winchester at comparable speed.

\$1795 complete with controller & cartridge
AVAILABLE NOW AT YOUR TECMAR DEALER



**TECMAR COMPATIBILITY, VERSATILITY,
RELIABILITY, AFFORDABILITY,
RESPONSIBILITY**

The first and only complete line of fully compatible expansion options for IBM PCs, including every type of disk drive

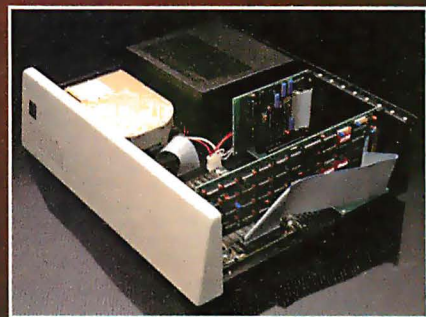

NEW SHARED WINCHESTER PC-MATE™

Our new GT subsystem upgrades our original with 3 times faster speed, sharing for up to 4 IBM PCs . . . Controller Board available for upgrade on trade-in.



PC-MATE™ FLOPPY

Controller Board will handle 5 1/4" and 8" disks. Winchester's can be installed in our floppy subsystem cabinet.

Write for new Tecmar Information Kit.

TECMAR

Personal Computer Products Division
23600 Mercantile Road
Cleveland, Ohio 44122
Phone 216-464-7410/Telex 241735

doesn't he tell us some actual measurements, in millirads per hour at a point 1 foot from the screen, so we can make up our own minds about just how dangerous they are?

Radiation emissions from CRTs may indeed be low, but it does not follow that they are not hazardous. With radiation, there is no threshold—all exposures, no matter how low, carry with them some additional risk of cancer and leukemia, genetic damage, and depressed function-

ing of the body's immunological system. Radiation to the eye in particular increases the likelihood of cataracts and eye damage. Furthermore, the x-rays, microwaves, and ultraviolet radiation may act together, in synergy, to do many times more damage than each by itself.

It is fundamentally unscientific to assert that measurements of radiation emitted from CRTs show that this radiation is safe. The only real way to tell is to analyze carefully controlled, long-term

epidemiological studies of the rates of cataracts and radiation-caused diseases in people using CRTs versus the rates of these diseases in people not using CRTs. These studies should be started immediately (because cataracts and cancer can take many years to become manifest), and they should be carried out by truly independent scientists. The federal cover-ups of the cancers among GIs and residents of Utah and Nevada caused by fallout from atomic-bomb tests show clearly that no federal agency—including the Bureau of Radiological Health—can be trusted to tell us the truth about radiation.

Fortunately, video display terminals can be built in a manner that eliminates radiation exposure. Liquid-crystal or light-emitting-diode displays emit no radiation. Another method is to have the operator look through glass at the image from a CRT reflected from a mirror. IBM already makes such terminals. Even the use of a lead-glass shield over the CRT screen should make a big difference.

Those of us who must use the ordinary computer CRTs can do several things to minimize the radiation risk. First, don't sit too close to the thing. (Radiation levels decrease with the square of the distance from the screen.) Second, turn the brightness (the voltage through which the electron beam is accelerated) down as low as you can without decreasing readability. Careful adjustment of room lighting to eliminate screen glare will enable the brightness to be turned down even lower, as does the highly visible amber screen, which is mandated by law in several European countries. And third, do investigate products such as lead-glass shields, which are claimed to have radiation shielding capabilities.

I'm not arguing for a risk-free society. I only point out that in this case we're taking a risk—one that may turn out to be quite severe—for no corresponding benefit. Radiation-free VDTs can easily be built to emit no radiation. But it's up to us, the computer users, to demand that such machines be built. No market, no product.

For those interested in further information, I strongly recommend the book *Radiation and Human Health* by John W. Gofman, M.D. and Ph.D., and one of the world's foremost authorities on the health dangers caused by ionizing radiation (Sierra Club Books, 1981). Another excellent book, which focuses in particular on microwaves, is *The Zapping of Ameri-*



Vista DaVinci

GREAT INNOVATORS

In Italy in the 15th century Leonardo Da Vinci was a multi-talented genius. Leonardo's ideas and designs were endless. He was always creating new devices to solve the world's problems. Pictured here are many studies for military arms and armor and battlements.

Today Vista is developing many high technology computer peripherals for use with IBM[®] and Apple Computers. The final evolutionary stage in Apple disk storage. Quartet offers you the capacity of 4 Apple Disk Drives in the volume of one. Quartet's low profile styling has been developed to blend in with the profile and style of your Apple II Computer.

Quartet uses 2 Double Sided Thinline disk drives to give you over 640K of storage. With the included Quartet Controller & Software, your Computer can handle much larger tasks than before. When using protected software, the Quartet operates just like 2 Apple Disk Drives, and will operate with ALL Apple compatible software.

The Quartet system is the COMPLETE, one-stop solution to your storage requirements on the Apple or Apple Compatible Computer. No other two-drive package offers as much value at any price. And the Quartet offers all this with a price comparable to single drive, single sided systems.

Features:

- Thinline Drives for low profile
- 2 Double Sided Drives for 640K Storage
- Quartet Controller for Single/Double Sided Operation
- Emulates Apple Disk II under a single sided mode
- Boots & Runs All Apple Software
- Double Sided, 40 track Patch software for DOS, CP/M[®], & Pascal
- Full Vista 120 Day Warranty

Contact Your Local Vista Dealer or Call our Vista Hotlines.



Vista

COMPUTER COMPANY, INC.

13 17 East Edinger / Santa Ana, CA 92705
(714) 953-0523 / (800) 854-8017

Distributors

Callander Group (8) Electronics (215) 973-2844 (408) 232-3507	Faxon, P. Systems (314) 385-8885	Louisiana Digital & Service Inc. (504) 466-0893
Colonial MicroD (781) 647-0205	New York Computer & Peripherals Inc. (516) 437-6661	Eastern Canada Peripherals Plus (514) 819-6555

Vista Quartet

© 1983 Vista trademarks of Digital Research, Inc.
IBM is a registered trademark of International Business Machines.

HERE'S THE PERSONAL COMPUTER AD OUR COMPETITION DOESN'T WANT YOU TO READ.

It's an ad for NEC's APC™ Advanced Personal Computer. A solutions-oriented system that solves business problems in the simplest, most cost-effective way. The APC supports both CP/M-86™ and MS-DOS™. It can store more information than any system in its price range. In short, it's got the best price/performance of any personal computer. That's why our competition would prefer that you never see our system.

We asked some business men who sell systems why they preferred us. The reasons were clearly and simply. They said the APC was the only personal computer on the market that could power a 6-bit microprocessor disk drive, a floppy disk drive, a printer, an application program, and a communications device. For that price, they said, these systems were hard to afford. They said they saw a lot of good

... couldn't
any that
well as
... em that
s in the

"That APC of yours is the most powerful computer of any I saw. I don't know how you did it for that price."

"Now that I've used it for a while, I see why you named it the Advanced Personal Computer."

And that from businessmen who have tested the competition! When you see the APC, you'll understand why, at the time others, all of these businessmen picked NEC.

Our business software was optimized to take advantage of the APC's unique hardware features. That makes system operation faster and easier.

Our software includes a full set of general accounting packages, word processing, mailing list management, business planning, database management, and communications. And we're readying many more.

We're the only company to back our software with a unique unconditional guarantee. It will work or you get your money back.

Our high-resolution color graphics run circles, arcs and lines around everybody else. The APC's screen images—lines, characters, pictures—are unprecedented in their clarity. Colors against resolution competitive systems often must.

... compar... the APC
... for pla... analysis,
... data... manager... word
... proce... As part... al
... commu... work, a
... the A... al fo...
... e... n... ces.
... 32... a
... proce...
... A un... n give

The APC's high-resolution color graphics run circles, arcs and lines around everybody else. The APC's screen images—lines, characters, pictures—are unprecedented in their clarity. Colors against resolution competitive systems often must.

See for yourself the personal computer our competition wishes had never been invented. The Advanced Personal Computer from NEC. Return the coupon to NEC Information Systems, Inc., 5 Militia Drive, Lexington, MA 02173.

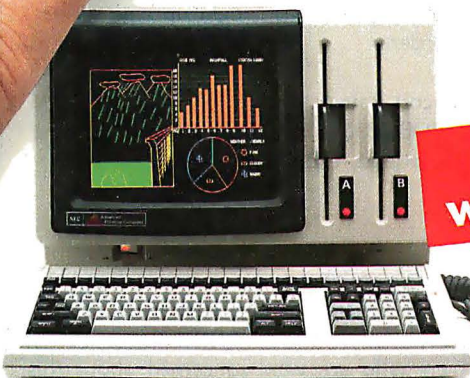

**Now available
with NEC hard disk.**

APC is a trademark of Nippon Electric Co., Ltd.
CP/M-86 is a trademark of Digital Research, Inc.
MS-DOS is a trademark of Microsoft, Inc.

Name _____
Title _____
Company _____

Send me more information on the Advanced Personal Computer. BE0483

Address _____
City, State, Zip _____
Telephone _____

NEC
NEC Information Systems, Inc.
5 Militia Drive, Lexington, MA 02173

The Benchmark in World Class Computers

Circle 300 on inquiry card.

PRINTER OPTIMIZER[®]



Why buy a mere "spooler" when you can have THE PRINTER OPTIMIZER?

- * 64k to 256k spooling buffer
- * adapts different brands - can mix Serial and Parallel
- * character conversion: 1 to 1, 1 to many, many to 1, ignore
- * pushbutton automated access to your printer's various type styles and printing modes
- * several ways to PAUSE printing
- * access any character, graphic design or printer "trick" from any program at any time
- * special features for use as a MODEM buffer

ETI²

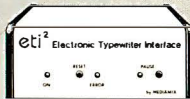

The cost effective alternative. Converts IBM, Adler/Royal, Olympia and other Electronic Typewriters into letter quality printers.

- * 2K memory buffer
- * access all typewriter characters and automated features
- * Serial or Parallel versions
- * Many proprietary features and commands insure compatibility with your system and software
- * Typesetting capability!

PETI²



Super low cost adaptor for new inexpensive portable Electronic Typewriters can yield typewriter and letter quality printer combination for around \$500 total!

- * perfect for "personal use"
- * easy "plug-in" Parallel connection to most computers
- * compatible with popular word processing programs

**APPLIED
CREATIVE
TECHNOLOGY** INC.

2723 Avenue E East, Suite 717
Arlington, Texas 76011
(817)-261-6905
(800)-433-5373

Letters

ca by Paul Brodeur (W. W. Norton and Company, 1977).

Edward M. Gogol
407 South Dearborn, Suite 930
Chicago, IL 60605

Open Correspondence on JRT Pascal

At our local users group meeting of December 16, 1982, a show of hands was called on the subject of JRT Systems' \$29.95 Pascal offering.

Of the 12 people present who had ordered JRT Pascal, only 3 had actually received the product, yet 11 had already had their checks processed and returned. I myself have been waiting for more than four months. My check was processed over three months ago. I have called the factory twice; once I was put on hold for 15 minutes, the second time I was told that my product had been shipped three weeks prior and that I should wait another week. At the end of an additional two-week wait, I wrote the factory, and three weeks later wrote again. I received my third direct-mail offering for JRT Pascal two weeks ago, and again I wrote the company to ask that they ship my product immediately. Because so many other people share my experience with JRT Systems, I urge you to suspend the firm's advertising privileges until it can show proof that it has caught up with all back orders.

Scott Rainey
POB 6530
Portland, OR 97228

We are having delays in the shipping of JRT Pascal to our customers. I have received a number of letters from customers who are very concerned about this. Similar letters have been sent to the editors of the magazines in which JRT Systems advertises.

It has always been our policy to immediately cancel any order on request or make an immediate refund if payment has been processed and shipment not yet made.

As of today we have shipped 10,000 Pascals and have 7000 orders on backlog. About 6000 of those are less than six

weeks old. A six- to eight-week shipping delay is not unprecedented in the computer industry, but it is not acceptable to JRT Systems.

How did this backlog develop, and what am I doing to correct it? In May 1982 I cut the price of JRT Pascal from \$295 to \$29.95. I tested this formula by mass mailings of 100, then 400, then 1000, brochures. Sales response was excellent—10 to 15 percent—on the early mailings. I was able to rapidly expand the mass mailings and advertising leading to these approximate sales figures: May, 100; June, 350; July, 700; August, 1400; September, 2000; October, 4000; November, 3000; December, 5000.

In August, JRT Systems moved from my home to a small office on Irving Street in San Francisco. By October this office was severely crowded with six people, three phones, and two computers. In mid-December we leased 6000 square feet of space in Mill Valley. The shipping department has now moved into 1600 square feet of the new space. In the past two weeks, the shipping staff has grown from one to four full-time people. In this same period we completed installation of a sophisticated set of new shipping programs that automate, log, and validate every aspect of the shipping operation. Last week we exceeded 500 Pascal shipments per day. With our new system we can exceed 1000 per day.

We still have delays in obtaining copied disks rapidly enough, especially in 5¼-inch formats. Changes planned for the near future will eliminate this problem.

In short, the delay in shipping JRT Pascal is due to our staggering sales growth. We are moving as fast as possible to expand production capacity. [Letter is dated January 2, 1983].

J. R. Tyson, President
JRT Systems
550 Irving St.
San Francisco, CA 94122

As Mr. Tyson points out in his letter, shipping delays are not uncommon in the computer industry, as in all industries. Our readers should be aware of this situation when dealing with any firm. You have the right to demand a full refund if a product you have ordered is not shipped within thirty days of receipt of the order, or you may elect to wait for it to be delivered. The choice is yours. . . . P. C.

Check The Chart Before You Choose Your New 16-Bit Computer System.

Columbia Data Products' New Multi-Personal® Computer, Featuring IBM-PC® Compatibility, Excels In Professional, Business And Industrial Applications. Check it out.



Columbia Data Products' MULTI-PERSONAL® COMPUTER can use software and hardware originally intended for the IBM® Personal Computer . . . while enjoying the flexibility and expandability of all Columbia Data's computer systems.

Available operating system software includes single-user MS-DOS® or CP/M 86® or multi-user, multi-tasking MP/M 86® or OASIS-16®! with XENIX® available soon, providing users with a host of compatible software packages for personal and professional business and industrial applications. A large selection of higher level languages are also available, including BASIC, FORTRAN, COBOL, PASCAL and MACRO Assembler.

Our standard 16-Bit 8088 hardware configuration provides 128K RAM with parity, two RS-232 serial ports, Centronics parallel printer port, interrupt and DMA controllers, dual floppy disks with 640K storage, Winchester disk and keyboard interfaces, and eight IBM-PC compatible expansion slots . . . and lists for only \$2995. Winchester hard disk configurations, featuring cache buffer controllers for enhanced disk access performance are also available, starting at \$4995.

So, when you need to grow, why gamble and hassle with independent third party hardware and operating system vendors which may or may not be compatible . . . not to mention the hidden expense and frustration of implementing peripheral drivers in the different operating systems and upgrades? Who needs the finger-pointing when things don't work out?

After you review our chart, you will agree . . . for overall 16-Bit microprocessor superiority, expandability, flexibility, compatibility and real economy, Columbia Data is your *total source*.

Our Multi-Personal Computer . . . the 16-Bit system born to grow!

Get yours now.

Circle 81 on Inquiry card.



MAIN FEATURES	CDP-MPC	IBM-PC*	OTHERS
Microprocessor	16-Bit 8088 8-Bit Z-80 (Opt)	16-Bit 8088	?
USER Memory	128K-1 Mbytes	16K-256 Kbytes	?
IBM-PC Compatible Expansions Slots Beyond Professional Configuration ¹	8 Slots	0	?
Resident Floppy Disk Storage	Dual 320K (std)	Dual 180K (Opt) Dual 320K (Opt)	?
Resident Cache Buffer	5M/10M	—	?
Hard Disk Storage	—	—	?
OPTIONAL OPERATING SYSTEMS (Supported by Company)²			
MS-DOS (PC-DOS)	Yes	Yes	?
CP/M 86	Yes	Yes	?
MP/M 86	Yes	—	?
OASIS-16	Yes	—	?
XENIX	Soon	—	?
OPTIONAL HARDWARE EXPANSION BOARD (Supported by Company)			
RS-232 Communications	Yes	Yes	?
B/W and Color Display Controller	Yes	Yes	?
Expansion Memory	Yes	Yes	?
Z-80 CP/M-80 Board	Yes	—	?
Cache Buffer Hard Disk	Yes	—	?
Time/Calendar Board	Yes	—	?
IEEE Bus Controller	Yes	—	?
8" Floppy Disk System	Yes	—	?
8" Hard Disk System	Up to 40 Mbytes	—	?
Tape Cartridge System	Yes	—	?

¹For comparison purposes, typical professional configurations consist of 16-Bit 8088 Processor, 128K RAM with Parity, Dual 320K 5-inch Floppies, DMA and Interrupt Controller, Dual RS-232 Serial Ports, Centronics Parallel Port and Dumb Computer Terminal or Equivalent.

²Columbia Data Products also supports CP/M 80* with an optionally available Z-80 CP/M Expansion Board.

*As advertised in BYTE Magazine, August 1982.

COLUMBIA
DATA PRODUCTS, INC.

Home Office:
8990 Route 108
Columbia, MD 21045
Telephone 301-992-3400
TWX 710-862-1891

West Coast:
3901 MacArthur Blvd.
Suite 211
Newport Beach, CA 92663
Telephone 714-752-5245
Telex 277778

Europe:
P.O. Box 1118
450 Moenchengladbach 1
West Germany
Telephone 02161-33159
Telex 852452

CAST BETTER, FASTER SPELLS WITH OUR CI-C86 C COMPILER



Weave
a spell with
the CI-C86 C Compiler,
especially designed for use with:

- CPM86 and MPM86
- MS-DOS
- IBM Personal
- IBM Displaywriter
- DEC Rainbow
- Victor 9000
- Sirius
- NEC APC
- Zenith Z100
- Lomas 8086
- Altos 8600
- Compupro 86/87
- Seattle
- Eagle
- Columbia 1600
- And Many More

CI puts all the magic of C at your fingertips with all of K&R, a full support library, 8087 support and much more.

Merlin would approve!

Disk and documentation \$395.
Overseas airmail \$20.

For further information, please contact:



Computer Innovations, Inc.
75 Pine Street
Lincroft, New Jersey 07738
Telephone: (201) 530-0995



C86 and CI-C86 are trademarks of Computer Innovations, Inc.
CPM and MPM are trademarks of Digital Research.
MS-DOS is a trademark of Microsoft.
IBM is a trademark of International Business Machines.
DEC is a trademark of Digital Equipment Corp.

Letters

Another Atari Character Editor

In his article "Character Editor for the Atari" (December 1982 BYTE, page 167), Tim Kilby says, "While several character editors are available commercially, none are specifically designed for use with ANTIC 4 and ANTIC 5 modes." That's not quite accurate.

I am the author of *The Next Step*, published by Sierra On-Line. It is an Atari graphics package centered around the idea of redefined character sets and has been on the market for about a year. Among other features, it contains explanations and example programs similar to those found in Mr. Kilby's article. *The Next Step* contains a powerful, easy-to-use character editor that fully supports ANTIC modes 4 and 5. As a matter of fact, it is the character editor that John Harris used for both the ANTIC mode 4 background and the player-missile graphics in his Atari version of *Frogger*.

As Tim Kilby says, redefined character sets are one of the most powerful features of the Atari computers. When teamed with custom display lists, as supported by *The Next Step*, impressive graphics are well within the reach of the BASIC programmer. Thank you for your help in spreading this knowledge.

Bob Stewart
The Logic Smiths
Pine Trail
Groton, MA 01450

Problems with FORTRAN-86

The problem with microcomputer FORTRAN compilers is more widespread than indicated by the letters from David Dunthorn and T.M. Putnam criticizing Microsoft's FORTRAN-80 and IBM Personal Computer FORTRAN, respectively (December 1982 BYTE, page 22). Version 1.0 of Intel's FORTRAN-86 (for Intel's 8086-based microprocessor development systems) incorrectly compiles data statements that use repeat factors, generates numerical error codes that are not documented in the Intel *FORTRAN-86 User's Guide*, frequently creates bad object code for operations involving 4-byte integers, and recently refused to compile an 8-line subroutine whose only executable statements were a type-conversion, an integer multiply, and RETURN.

The Enhancer II™ Proudly Presents
**A Whole New Cast
of "Key" Characters!**



Recognize some of these "key" characters? You've seen them all before on your Apple® II screen, but now the Enhancer II has given them all new identities!

The Enhancer II uniquely gives your Apple II user-definable keys. So you can define any key to become what you want it to be. That means phrases, paragraphs or commands that you use frequently (up to 510 characters!) can be remembered by the Enhancer II and then called up at the touch of a single key.

Besides that, the Enhancer II gives your Apple II typewriter mode, with each key assuming the

identity of a conventional typewriter key. Not only will you recognize all the characters; you'll positively rejoice at having upper and lowercase letters, auto repeat, shift and shift lock again! The Enhancer II also has a type-ahead buffer of 128 characters, so you can keep sending messages to your Apple II even while it's busy with something else.

And if you want to meet even more new characters, the optional Function Strip™ will introduce you to 16 brand-new keys across the top of your keyboard which are yours alone to define. (These characters will never get mixed up with characters from the keyboard!)



We may be prejudiced, but we think you're going to like these new "key" characters from Enhancer II. In fact, we'll bet that once you've seen them perform, they'll become the stars of your screen.



Suggested retail prices:
Enhancer II, \$149
Function Strip, \$79
Combined Package, \$215



897 NW Grant • Corvallis, OR 97330
(503) 758-0521

The Enhancer II and Function Strip can be used with any Apple with a keyboard encoder board.

Apple and the Apple logo are registered trademarks of Apple Computer, Inc.

Circle 429 on inquiry card.

Letters

Intel had promised a July 1982 release date of a revised compiler, but as of mid-December 1982, I haven't seen so much as an updated bug list.

Meanwhile, the list price of this remarkable piece of software is a mere \$4300.

Jay Reynolds Freeman
POB AJ
Belmont, CA 94002

Disclaimers and the Law

I found the letters from David Dunthorn and T. M. Putnam regarding Microsoft's FORTRAN interesting. Unfortunately, both parties are mistaken in their belief that nothing can be done.

IBM's program license stating that the FORTRAN "is provided 'as is' without warranty of any kind . . . including . . . implied warranty of merchantability and fitness for particular purpose" may not be worth the paper it is printed on. If we can assume that the software is "goods" then it comes under Article 2 of the Uniform

Commercial Code (UCC).

Article 2 deals with the law of sales, warranties, disclaimers, remedies, etc. It has been substantially adopted by every American jurisdiction except Louisiana. While the specific question of whether software is "goods" has been not been answered, two different courts have ruled that it is "goods" when sold in a turnkey operation. (See *Triangel Underwriters Inc. v. Honeywell Inc.* (1978 E.D. NY) 457 F. Supp 765, 24 UCCRS 1088, affd in part and revd in part (1979, CA2 NY) 604 F2d 737, 26 UCCRS 1162, later app. *Triangel Underwriters Inc. v. Honeywell Inc.* (1981, CA2 NY) 651 F2d 132 and *W. R. Weaver Co. v. Burroughs Corp.* (1979, Tex Civ App 8th Dist) 580 SW2d 76, 26 UCCRS 64.)

Under the UCC, the implied warranties of merchantability and fitness for a particular purpose cannot be disclaimed after the sale. If the disclaimer first appears in the manual after it is bought, it is not worth the paper it is printed on (see *Zoss v. Royal Chevrolet*, (1972 Ind. Super) 11 UCCRS 527).

Furthermore, the states of Kansas,

Maine, Maryland, Massachusetts, Michigan, Minnesota, Mississippi, Vermont, Washington, and West Virginia all limit a seller's or manufacturer's right to disclaim or limit the implied warranties.

Many warranties have limitation-of-damages provisions (e.g., "In no event shall the ACME Computer Company be liable for loss of profits, or benefits, indirect, special, consequential or other similar damages arising out of any breach of this warranty or otherwise.") These limitations are often upheld because the seller or manufacturer will repair the goods. However, in those cases where the seller or manufacturer refuses or cannot make the repair, a judge may rule that the original warranty "has failed in its essential purposes" and the full array of UCC remedies become available to the consumer. These remedies could include all actual, consequential, and incidental damages that the consumer suffered. Recovery could include such things as time spent trying to program around the bug, lost income because the program would not work, and the like.

In addition the UCC requires good faith

Circle 425 on inquiry card.

Introducing automatic dialing, 300/1200 baud for \$599*

- 300/1200 Baud—Bell 103/113/212 compatible
- Auto Dial—compatible, Hayes dialing protocol
- Full or Half duplex
- Audio Monitor signals busy line, no-answer, etc.
- Two year limited warranty

Our newest modem does all this with 3 LSI chips—about one seventh of the usual integrated circuits. Its simplicity, an achievement of advanced micro-processor design, promises two major benefits. The first is outstanding reliability—that stands to reason. The second is a cost low enough to inspire skepticism. Be skeptical: shrewd comparisons may save you \$100 or more.

Intelligent design also makes this modem uncommonly easy to use. Lights and switches let you test and correct installations without technical experience—including some that require special interfaces or rewiring with most modems.

The shrewd modem. If it's not at your dealer's yet, write or call for complete specifications.

*Suggested list for model 212A Auto Dial.



U.S. ROBOTICS INC.
1123 WEST WASHINGTON BOULEVARD
CHICAGO, ILLINOIS 60607 [312] 733-0497



64K STATIC RAM MEMORY

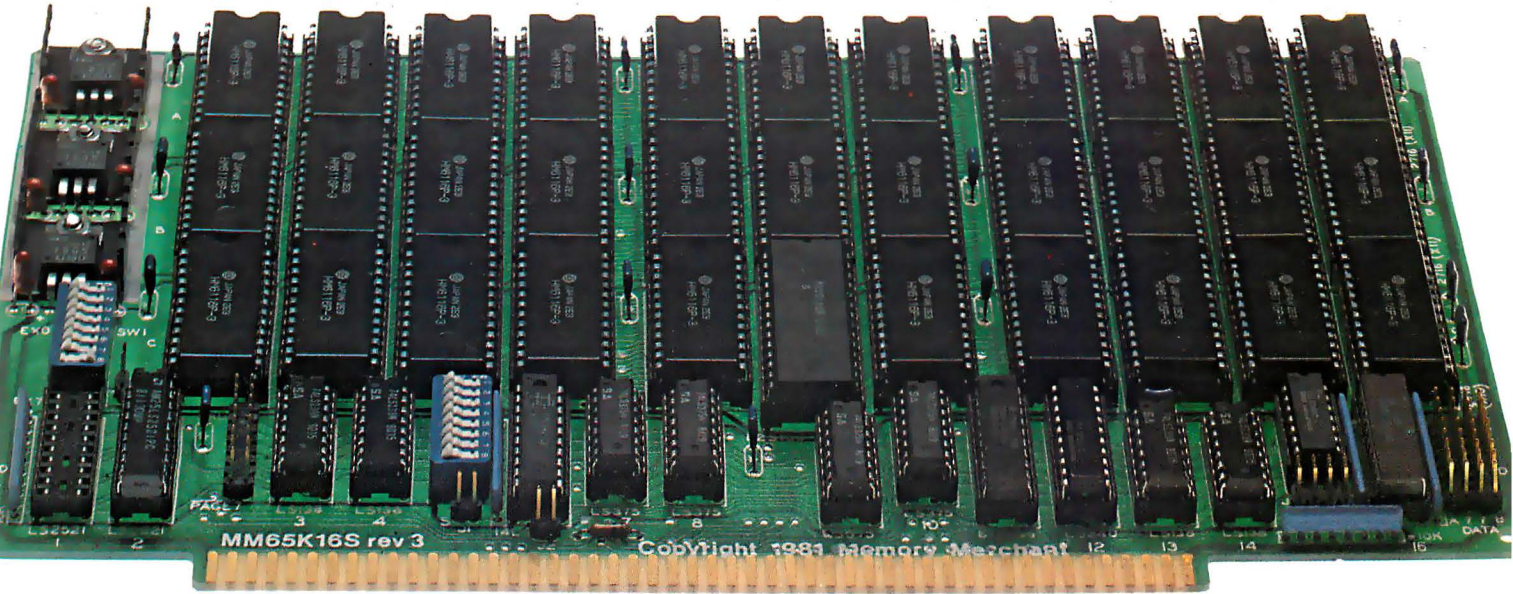

S-100 STATIC MEMORY BREAKTHROUGH

Finally, you can buy state-of-the-art S-100/IEEE 696 static memory for your computer at an unprecedented savings.

Memory Merchant's memory boards provide the advanced features, quality and reliability you need for the kind of operational performance demanded by new high-speed processors.

Completely Assembled.

These memory boards are not kits, nor skeletons — but top-quality, high-performance memories that are shipped to you completely assembled, burned-in, socketed, tested and insured with one of the industry's best warranties.

Superior Design & Quality.

Memory Merchant's boards are created by a designer, well known for his proven ability in advanced, cost-efficient memory design. Innovative circuitry provides you with highly desired features and incredible versatility.

Only first-quality components are used throughout, and each board is rigorously tested to assure perfect and dependable performance.

No Risk Trial.

We are so convinced that you will be absolutely delighted with our boards that we extend a no-risk trial offer. After purchasing one of our boards, you may return it (intact) for any reason within 15 days after shipment and we will refund the purchase price (less shipping).

NEW S-100 PRODUCTS COMING SOON:

- * DUAL 8/16 BIT CPU BOARD
- * 128K 8/16 BIT STATIC RAM
- * 256K 8/16 BIT DYNAMIC RAM

\$629.

48K PARTIALLY POPULATED \$519.
32K PARTIALLY POPULATED \$409.

64K RAM, MODEL MM65K16S

- 64K x 8-bit
- Speed in excess of 6 MHz
- Uses 150ns 16K (2K x 8) static RAMS
- Ultra-low power (435 Ma. max. — loaded with 64K)
- Bank Select **and** Extended Addressing
- A 2K window which can be placed anywhere in the 64K memory map
- Four independently addressable 16K blocks organized as:
 - Two independent 32K banks **or**
 - One 64K Extended Address Page **or**
 - One 48K and one 16K bank for use in MP/M¹ (option)
- Each 32K bank responds independently to phantom
- 2716 (5V) EPROMS may replace any or all of the RAM
- Field-proven operation in CROMEMCO CROMIX* and CDOS*.
- Compatible with latest IEEE 696 systems such as Northstar, CompuPro, Morrow, IMS, IMSAI front panel, Altair and many others.

OEM and DEALER inquiries invited.

**Memory™
Merchant**

14666 Doolittle Drive
San Leandro, CA 94577
(415) 483-1008

Circle 260 on inquiry card.

FULL TWO-YEAR WARRANTY.

The reliability of our boards, through quality-controlled production and proven performance, has enabled us to extend our warranty to a full two years. That's standard with us, not an option. This includes a 6-month exchange program for defective units.

Shipped direct from stock.

All Memory Merchant's boards are shipped direct from stock, normally within 48 hours of receipt of your order. Call us at (415) 483-1008 and we may be able to ship the same day.

16K RAM, Model MM16K14

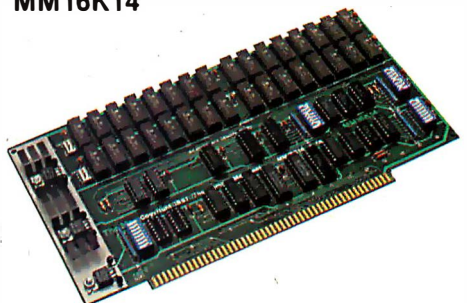

16K STATIC RAM \$169.

16K x 8 Bit
Bank Select & Extended Addressing
Four independently addressable 4K blocks
One 4K segment equipped with 1K windows
Uses field-proven 2114 (1K x 4) RAMS
Low Power (less than 1.2 Amps)
Runs on any S-100 8080, 4 MHz Z-80 or 5 MHz 8085 system.

Prices, terms, specifications subject to change without notice.

*Cromix and CDOS are trademarks of CROMEMCO.
¹ MP/M is a trademark of Digital Research

among the parties. If Microsoft knew of the bug in its FORTRAN-80 package and refused to correct it or failed to put an adequate disclosure of it in its packaging, then punitive damages could also arise on the basis that it fraudulently and knowingly refused to repair a program with a bug (cf. *Hibschmann Pontiac Inc. v. Batchelor*, 266 Ind. 310, 362 NE2d 845 (1977)).

The fact that FORTRAN-80 went through three more releases with the same bug could indicate bad faith on the behalf of Microsoft and this by itself could allow punitive damages (see *Cantrell v. Amarillo Hardware Co.*, 266 Kan. 681, 602 P2d 1326 (1979)).

Finally, I am surprised that Microsoft would admit in a letter that it "has no intention of fixing the bug in FORTRAN-80 regarding FORMAT re-use." Such a letter will be deemed an admission against interest and would greatly ease any punitive damage claim against Microsoft.

As a final point, if Microsoft or IBM advertises its program as in full compliance with the ANSI (American National Standards Institute) Standard FORTRAN X3.9-1966 or any other ascertainable standard, then it has created an express warranty that the product will meet that standard. This express warranty cannot be disclaimed.

L. J. Kutten, Attorney at Law
201 South Central
POB 16185
St. Louis, MO 63105

Don't Blame Pascal

Jerry Pournelle's User's Column is stimulating, provoking, and sometimes misleading. He is appalled by the difficulties that Alex Pournelle has experienced in developing his introductory Pascal package (December 1982 BYTE, page 222). I sympathize with Alex, but from what Dr. Pournelle has written it appears that his problems have more to do with bad implementations of Pascal than with the language itself. It is unreasonable, for example, to blame Pascal for poor diagnostics, poor error recovery, collapsing compilers, and failure of nonstandard functions.

We all need strings, and it is unfortunate that they are not part of the standard language. Pascal implementors have added string handling in various ways,

none of which is completely satisfactory. Pournelle says that no Pascal compiler allows you to concatenate a single character to a string (page 226). This is not so, because Pascal/Z does this and other string operations in a fairly clean and consistent way.

The standard proposed, but not yet ratified, by the International Standards Organization for Pascal specifies two levels of compliance, level 0 and level 1. A level-1 compiler must support *conformant array parameters* (CAP) that permit the size of an array to be passed to a procedure or function. The ratification of the standard has been delayed by the United States representatives, who have refused to accept CAP in Pascal. I do not know of a microcomputer compiler that supports CAP, but some mainframe compilers do.

Pascal uses nested scoping, which may have been a great idea for ALGOL-60 but is somewhat passé today. Strict nested scoping does not support static variables in procedures. PL/I and C provide static variables, but, contrary to widespread belief, FORTRAN does not. (The FORTRAN standard does not mention stacks but is worded in such a way that stack allocation of variables is permitted.) Some versions of ALGOL-60 allow statically allocated *own* variables, but this seems to have been a kludge.

SIMULA-67 introduced *classes*, and many languages developed subsequently, including Ada, have a similar feature. A class is a collection of variables and procedures, some of which are private to the class and some are visible outside it. You can simulate packages in Pascal or C, but neither language supports them properly. As Lori Clarke et al. pointed out at the 1980 Ada Conference, if you have packages, "nesting is for the birds."

Wirth clearly recognized the weakness of Pascal's loop constructions, because his next language, Modula-2, allows loop exits. It is possible to code quite elegant loops in Pascal using loop variables. The method was introduced by L. V. Atkinson; here is a simple example:

```
VAR state : (searching, found, fail);
state := searching;
REPEAT
  IF end-of-list
    THEN state := fail
  ELSE IF item-matches
    THEN state := found
  ELSE get-next-item
UNTIL state <> searching;
```

```
CASE state OF
  found : . . .
  fail : . . .
END
```

The three-valued state variable allows us to distinguish normal and abnormal loop termination clearly and explicitly.

I have written this letter reluctantly because I find that debates about programming languages (and operating systems) are usually acrimonious and unhelpful. Most of these debates tend to be over such trivia as where the semicolons go and how many symbols you need to implement your favorite algorithm. We can compare languages meaningfully only if we agree beforehand on the environment in which they will run and the applications for which they will be used.

Peter Grogono
Metonymy Productions
4125 Beaconsfield Ave.
Montreal, Quebec H4A 2H4
Canada

Software Boycott

Software piracy has been a concern to software vendors for some time. To protect their investment, vendors resort to copy protection and limiting the number of backup copies that can be made. Unfortunately, this often precludes the use of hard-disk storage and makes the system fragile. Businesses find it frustrating to have their systems down for a few weeks until the vendor ships a new disk. BYTE and other magazines have presented all sides of the pirating issue in the past.

Our business relies on our computer systems. Although we are sympathetic to the problems that vendors have with piracy, we will not tolerate products that jeopardize the reliable operation or the high performance of our computer systems.

Micro Development Inc. and its affiliate companies have agreed to boycott all software products that seriously restrict portability, use with hard-disk storage, backup procedures, human factors, etc. We encourage other business computer users to do the same.

Ed Sawicki, President
Micro Development Inc.
Lake Oswego, OR 97034 ■

The new COMPAQ Portable Computer. IBM compatibility to go.

Simple, isn't it? The COMPAQ™ Portable Computer can do what the IBM® Personal Computer does. To go.

It runs all the popular programs written for the IBM. It works with the same printers and other peripherals. It even accepts the same optional expansion electronics that give it additional capabilities and functionality.

There's really only one big difference. The COMPAQ Computer is designed to travel.

Carry the COMPAQ Computer from office to office. Carry it home on the weekend. Or take it on business trips.

If you're a consultant, take it to your client's office.

If you use a portable typewriter, you can use the COMPAQ Computer as a portable word processor instead.

If your company already uses the IBM Personal Computer, add the COMPAQ

you'd probably need to buy an additional display screen because the built-in screen is too small for certain tasks, like word processing. The COMPAQ Computer's display screen is nine inches diagonally, big enough for any job, and it shows a full 80 characters across. And the built-in display offers high-resolution graphics and text characters on the same screen.

The bottom line is this. The COMPAQ Computer is the first uncompromising portable computer. It delivers all the advantages of portability

In the standard configuration, the COMPAQ Computer has three open slots for functional expansion electronics as your needs and applications grow. It accepts standard network and communications interfaces including ETHERNET™ and OMNINET™.

If you're considering a personal computer, there's a new question you need to ask yourself. Why buy a com-

puter that isn't portable?

For more information on the COMPAQ Portable Computer and the location of the Authorized Dealer nearest

you, write us. COMPAQ Computer Corporation, 12330 Perry Road, Houston, Texas 77070. Or call 1-800-231-9966.

without trading off any computing power capability.

And what do those advantages cost?

Nothing.

The COMPAQ Portable sells for hundreds less than a comparably equipped IBM or APPLE® III. Standard features include 128K bytes of internal memory and a 320K-byte disk drive, both of which are extra-cost options on the IBM. Memory and additional disk drive upgrades are available options to double those capacities.

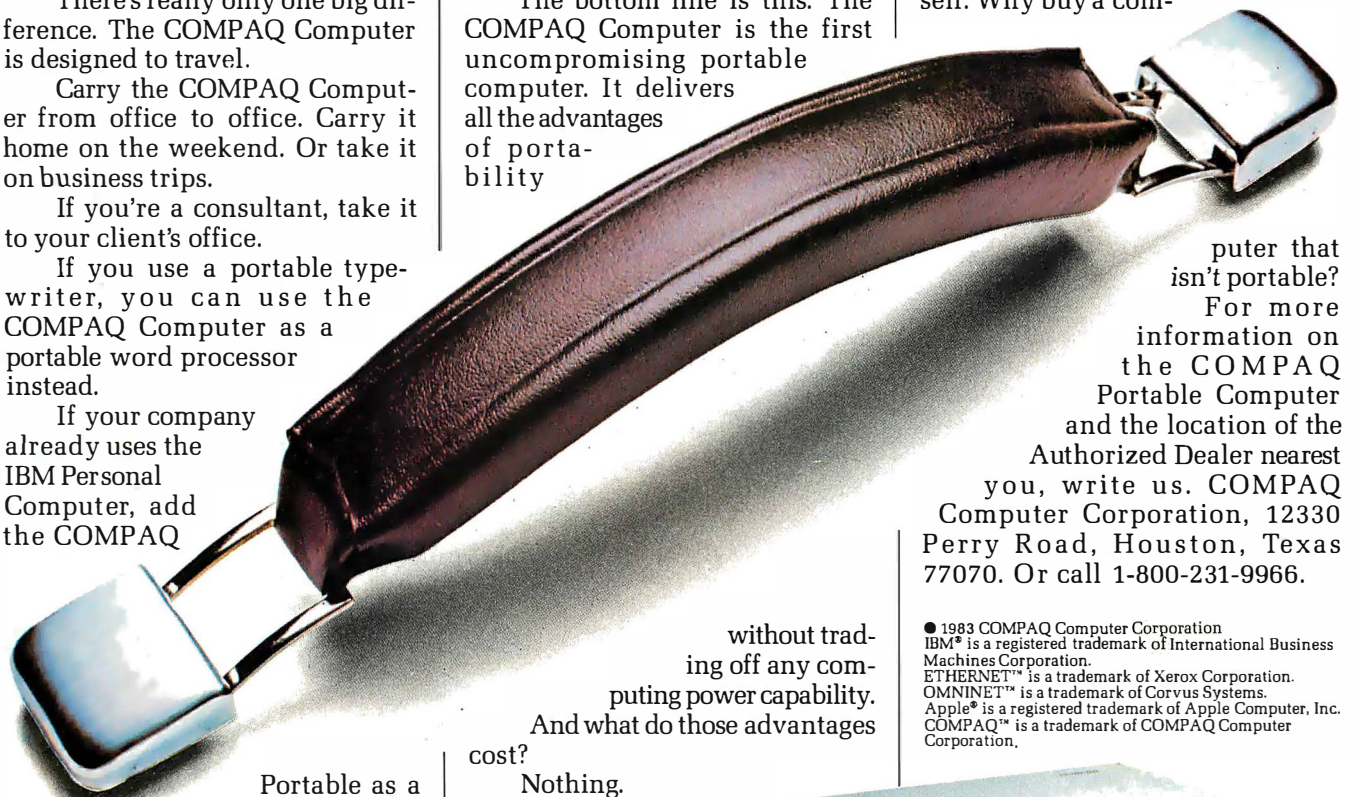

Portable as a mobile unit that can use the same programs, the same data disks, and even the same user manuals.

There are more programs available for the COMPAQ Computer than for any other portable. More, in fact, than for most non-portables. You can buy them in hundreds of computer stores nationwide, and they run as is, right off the shelf.

With most other portables



© 1983 COMPAQ Computer Corporation
IBM® is a registered trademark of International Business Machines Corporation.
ETHERNET™ is a trademark of Xerox Corporation.
OMNINET™ is a trademark of Corvus Systems.
Apple® is a registered trademark of Apple Computer, Inc.
COMPAQ™ is a trademark of COMPAQ Computer Corporation.

COMPAQ™

PORTABLE COMPUTER

The most computer you can carry Circle 86 on inquiry card.

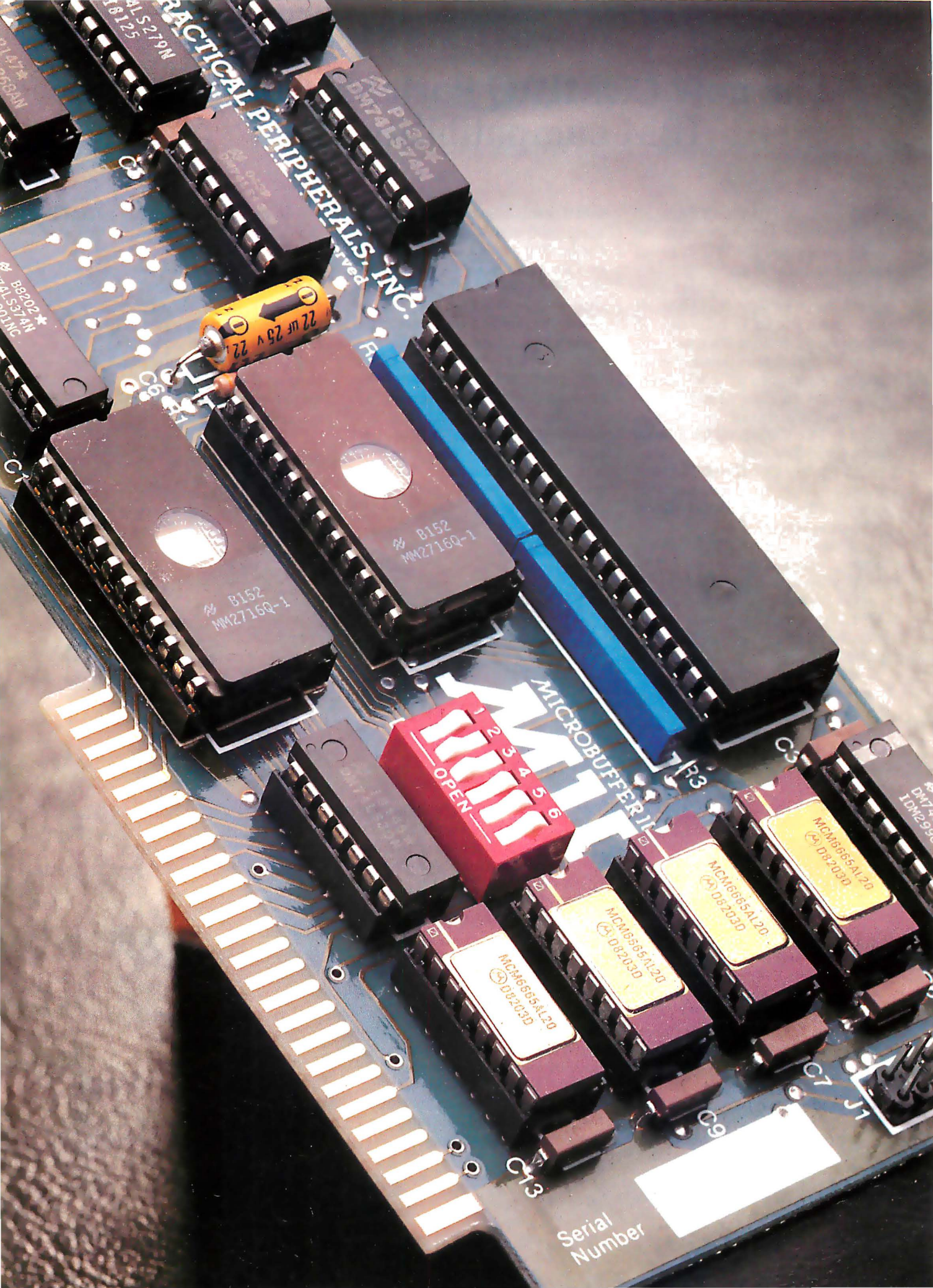

PRACTICAL PERIPHERALS, INC.

B152
MM2716Q-1

B152
MM2716Q-1

MICROBUFFER I

1
2
3
4
5
6
OPEN

MCM6865AL20
DR203D

MCM6865AL20
DR203D

MCM6865AL20
DR203D

MCM6865AL20
DR203D

Serial Number

ALS279N
18125

DM74ALS74N

BB202*
ALS5374N
1011C

C6
R1

C5

J3

C7

C9

C13

J1

YOU WILL NEVER AGAIN HAVE TO WASTE TIME WAITING FOR YOUR PRINTER.

MICROBUFFER™ ALLOWS YOU TO PRINT AND PROCESS SIMULTANEOUSLY.

Microbuffer will instantly increase your efficiency — and eliminate the frustration of waiting for your slowpoke printer.

Now you can simply dump your printing data directly to Microbuffer and *continue processing*. Microbuffer accepts the data as fast as your computer can send. It stores the data in its own memory buffer, then takes control of your printer.

THERE IS A MICROBUFFER FOR ANY COMPUTER/PRINTER COMBINATION.

Whatever your system, there is a specific Microbuffer designed to accommodate it.

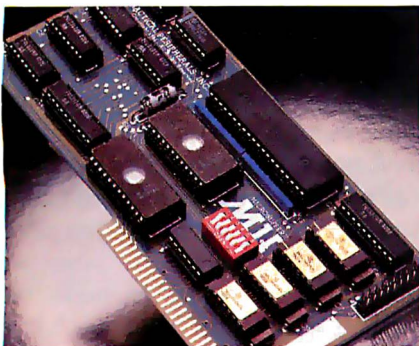

FOR APPLE II COMPUTERS, Microbuffer II features on-board firmware for text formatting and advanced graphics dump routines. Both serial and parallel versions

have a power-efficient low-consumption design. Special functions include Basic listing formatter, self-test, buffer zap, and transparent and maintain modes. The 16K model is priced at \$259 and the 32K, at \$299.

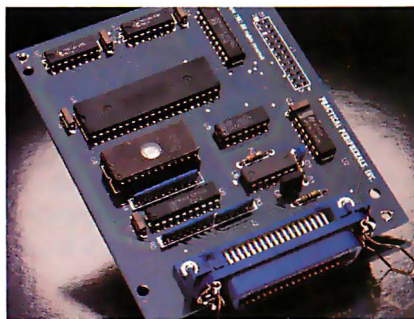

FOR EPSON PRINTERS, Microbuffer/E comes in two serial versions — 8K or 16K (upgradable to 32K) — and two parallel versions — 16K or 32K (upgradable to 64K). The serial buffer supports both hardware handshaking and XON-XOFF software handshaking at baud rates up to 19,200. Both interfaces are compatible with standard Epson commands, including GRAFTRAX-80 and GRAFTRAX-80+. Prices range from \$159 to \$279.



ALL OTHER COMPUTER/PRINTER COMBINATIONS are served by the stand-alone Microbuffer In-line.

The serial stand-alone will support different input and output baud rates and different handshake protocol. Both serial and parallel versions are available in a 32K model at \$299 or 64K for \$349. Either can be user-upgraded to a total of 256K with 64K add-ons — just \$179 each.

SIMPLE TO INSTALL.

Microbuffer II is slot-independent. It slips directly inside the Apple II in any slot except zero.

Microbuffer/E mounts easily inside the existing auxiliary slot directly inside the Epson printer.

The stand-alone Microbuffer is installed in-line between virtually any computer and any printer.

MICROBUFFER FROM PRACTICAL PERIPHERALS.

So what are you waiting for? Write to us for more information or ask your dealer for a demonstration.

When you see how much freedom Microbuffer will allow, you'll understand why it's so silly to be without one.

PRACTICAL PERIPHERALS, INC.™
31245 LA BAYA DRIVE
WESTLAKE VILLAGE, CA 91362
(213) 991-8200

Circle 336 on inquiry card.

Build an RS-232C Breakout Box

*This diagnostic tool
can help you make working serial connections.*

Steve Ciarcia
POB 582
Glastonbury, CT 06033

Hundreds of exhibit-goers swirled around me as I elbowed wearily, yet warily, through the computer-convention crowd. Like Frodo Baggins approaching Mount Doom, I had to go to a place I feared to be: the BYTE booth. If I stayed anywhere near it, I was certain to be accosted by someone asking technical questions. (When your picture is plastered all over books sold at half a dozen booths, it's hard to remain incognito.)

Just as I started to take refuge behind the wall of 6000 boxed magazines in the BYTE booth, a voice behind me called out, "Steve, Steve! Help! I was going to send you an 'Ask BYTE' letter, but I need an answer right now on how to interface one of your projects to my computer."

I turned to respond as a man in his early thirties, carrying a briefcase and two shopping bags, hurriedly approached the counter. Panting a bit, he spoke with overtones of nervous anxiety combined with a note of triumph. I shrugged and responded, "Sure, I'll be glad to help if I can."

Most questions of this kind require minimal effort: at worst, digging out a few sheets of scratch paper and scribbling a schematic diagram or two. After all, most computers use similar parallel or serial interfaces.

"I have this computer. . . ." As

the man started to speak, he cleared about four feet of counter space with one elbow, leaned over to one of his shopping bags, and started pulling out pieces of equipment and cables. "Here, hold this . . . um . . . somewhere in here are the monitor, recorder, and this other junk . . . and, wait, here it is! I want to connect it to this here Microvox of yours. Can you do it for me? I've made some homebrew modifications to my computer, but that shouldn't keep it from working."

I've been told that, to be perceived as a good teacher, you have to be able to leave everything as an exercise for the student. Here I was, in the middle of a convention with 50,000 people, and this guy had dragged in his whole computer system. Mind you, I've spent hours talking shop with computer hobbyists in public places, and I've designed as much circuitry on the back of napkins as you see in this column each month. This, however, was a new twist.

His computer? It was an off-the-shelf budget model that I'd used before but hadn't tried with the Microvox speech synthesizer. It had a serial output, so I presumed it would work easily. As we shall see, that assumption was a mistake.

On the surface, it seemed a simple task. The unit had a four-wire serial interface that was described as conforming to the RS-232C specification established by the Electronic Indus-

tries Association. The connections in the interface were defined for transmit, receive, status, and ground lines. The Microvox can be connected in that way or through various other handshaking protocols. Inside the Microvox are jumper connections to reverse the functioning of the transmit and receive lines so that the Microvox can be set up as either kind of RS-232C device—data terminal equipment (DTE) or data circuit-terminating equipment (DCE). Given that there were only four wires, it should have been duck soup, right?

My first surprise came in finding that my querist's computer used a DIN (Deutsche Industrie-Norm) connector rather than the DB-25 connector typically used for RS-232C links. But by referring to his computer's instruction manual, we were able to attach the Microvox, set up as a DCE device, and hard-wire the computer's status input so it would see a "ready" condition all the time. The computer was set up as a DTE device, receiving data on pin 2 and transmitting on pin 3.

To our disappointment, when we executed the program to make the synthesizer talk, his computer transmitted nothing that could be received by the Microvox. I grumbled, "OK, maybe there's a typo in the Microvox manual." We reversed pins 2 and 3, setting the Microvox as a DTE device, and tried again. No luck. Still bending down over the hobbyist's machine, I looked over the top of my

INFORMA X

The software system from tomorrow. Beyond DBMS ... beyond user-friendly ...true multi-user.

The first information management system created from its inception for the multi-user.

The first truly professional system created for the programmerless environment. INFORMA X™ brings even to the first time user programming capabilities never before thought possible with microcomputers.

Worlds beyond in speed, security, capability and flexibility:

SPEED. The first information management system for micros that is fast enough to accommodate full operational interactive online computing.

SECURITY. The first micro system providing the total security necessary for any business computing situation to function properly. INFORMA X™ provides full transaction recording for audit purposes and individual security to the field level.

CAPABILITY: Functions far beyond all current micro systems with its unlimited number of files; multiple screens per record; interactive

file sharing of data; extensive calculation and math computations.

FLEXIBILITY: INFORMA X™ permits complete modification of any file, record or field previously entered with no damage or loss to existing data; change fields (key or non-key) or change calculations at will; and much, much more.

If you have not experienced INFORMA X™, you are worlds removed from the leading edge of microcomputing's true Information Management capability.

ABACUS DATA is totally dedicated to helping your business move into the creative future of software. We welcome your questions and comments. Please call our toll free numbers - available for service, not just sales: **1-800-874-8555**. In Florida call collect, **0-904-398-9547**.

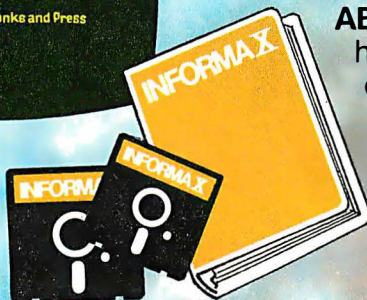

abacus data, inc.™

1920 San Marco Boulevard
Jacksonville, Florida 32207

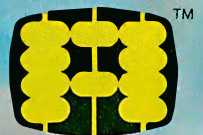

Current Equipment Specifications

NOW AVAILABLE for TeleVideo®, BOS®, IBM PC®, MuSYS®, DEC®, NEC®, and others with Z80, 8088, 8086 CPU's using CP/M®, CP/M-86®, MmmOST®, TurboDOS®, dpc/OS®, operating systems. Minimum memory 52K. Call for others.

wire-rimmed glasses and asked as politely as I could, "Are you sure the serial output on this thing works?"

The subsequent discussion revealed that one of the modifications he had installed was a 20-mA (milliampere) current-loop output. But a serial printer attached to it had worked just prior to his bringing the computer to the show.

Because he had serial data coming out, we decided that it must be the Microvox that wasn't communicating. But how to test it at the show? Hmm. . . .

As I pondered that question, my gaze came to focus 20 feet across the aisle in another exhibit booth, on a computer system demonstrating a printer. As I looked closer, I saw an RS-232C cable connecting the computer and printer. Certain ideas came quickly into my mind. Gathering up the Microvox, my inquirer and I squeezed across the aisle and approached the booth's proprietor.

Fast footwork and a smooth tongue are necessities in such circumstances.

You have to put off saying the phrases "have a problem," "test," and "your computer" as long as possible. So, as I slipped the Microvox onto his serial printer cable, I distracted the exhibitor's attention by saying something like, "Hi, we have a booth over there, and we saw that you were demonstrating this neat printer, and we were wondering if we could try something on your system. . . . Can I put this here? . . . Do you mind if I just plug this in your computer . . . to test just one little thing?"

I had the cable connected before the potential horror of what I was proposing had time to sink in. In fact, the exhibitor was a bit amused as the Microvox started speaking the text that was intended for the printer.

A half hour later, after explaining the theory of text-to-speech algorithms to the curious exhibitor, we went back to the BYTE booth and the original problem. Finding that the Microvox worked, and while not directly suggesting that my shopping-bag computer hobbyist's RS-232C

output did not, I searched for a new strategy to make him happy.

Clearly, the problem was not simply one of making the right connections. I needed some way to take a better reading of what was happening. Even a mere bent paper clip and a light-emitting diode (LED) would have helped.

Again we went on the prowl for equipment. Three aisles away I found an exhibitor selling certain RS-232C diagnostic tools called breakout boxes who felt that he could trust me enough to lend me one of his less expensive models for a while. We took it back to the BYTE booth and set to work. We attached the breakout box to the serial output connector and watched for activity on the LED indicators. The transmit LED flickered as the data went to the Microvox, but I was still suspicious.

Back into the throng. Another aisle over I borrowed a DVM (digital voltmeter) and used it to check the voltage levels on the RS-232C output. Serial data appeared to be present, but it ranged from -0.7 to $+6.8$ V (volts) rather than from $+12$ to -12 V, as you typically find. The cheap (\$150) breakout box was responding to the $+6.8$ -V level, but it had no way of indicating negative voltage levels or open circuits.

Armed with this information, I checked some of the modifications that my comrade in debugging had made. Apparently the 20-mA current-loop circuit was at fault. It was optically isolated, as it should have been, but the optoisolators and other components were being powered directly from the RS-232C signals. The LEDs and protective shunting diodes were shorting out half the data! I disconnected the current loop, and two hours after the computer was first slipped out of its shopping bag, the Microvox spoke.

"Standard" RS-232C

Among the most exasperating experiences in any computer user's career is connecting two serial devices. I don't mean a terminal and a modem—making that connection is a piece of cake—but any other connection can be real trouble.

BYTEWRITER®

DAISY WHEEL PRINTER

- Full Olivetti typewriter warranty
- U.L. Listed

FEATURES

- Typewriter operation with nothing to disconnect
- 10, 12 or 15 characters per inch switch selectable
- Portable with carrying case
- Entire interface mounted internally in the Olivetti Praxis 30 typewriter
- Underlining
- Cables available for most computers
- Service from Olivetti dealers
- Centronics compatible parallel input
- Built in self test
- Cartridge ribbon
- 2nd keyboard switch selectable.



\$695

plus shipping

BYTEWRITER

125 NORTHVIEW RD., ITHACA, N.Y. 14850
(607) 272-1132



Every week,
2500 more people like
you are going to work
with an Osborne®
personal business
computer.

They're moving faster than they were before.

Today, the Osborne 1 Personal Business Computer sells for \$1795. Complete. Including software.

The Osborne is portable, because your ideas don't always happen at the office.

The Osborne is affordable, so there's no reason to wait.

The Osborne is complete.

Dollar for dollar, no other computer comes close.

The Osborne is easy to learn, fun to use, and quickly becomes indispensable.

A visit to your local authorized Osborne computer retailer will convince you that today, more than ever, how fast you go up depends on which buttons you are pushing.



\$1795. Complete. Including Software.

For your nearest dealer,
call (in California) 800 772-3545
ext. 905; (outside California) call
800 227-1617
ext. 905.

OSBORNE
COMPUTER CORPORATION™

The \$1795 suggested retail price for the Osborne 1 (a registered trademark of Osborne Computer Corporation) includes a full business keyboard, built-in CRT display, two built-in floppy disk drives, CPU and 64 kilobytes of RAM memory, RS-232 and IEEE 488 interfaces, and the following software packages: WORDSTAR® word processing with MAILMERGE® (a trademark and a registered trademark of MicroPro International Corporation of San Rafael, California); SUPERCALC® electronic spreadsheet system (a trademark of Sorcim Corporation); CBASIC® (a registered trademark of Compler Systems); MBASIC® (a registered trademark of Microsoft); and CP/M® (a registered trademark of Digital Research).

For instance, every time I buy a new piece of equipment, things seem to work this way: I spend five minutes reading the sales brochure, five minutes executing the financial transaction, and five hours trying to figure out how to make the new equipment communicate with my computer.

If you scan through product advertisements and equipment data sheets, frequently you see claims that products have "standard RS-232C interfaces." The people who perpetrate these lies have probably never connected two pieces of equipment together in their lives. What this phrase really means is that both ends of the communication line will probably be voltage-compatible and won't incinerate each other. Both will send and receive asynchronous or synchronous serial data following a specific timed sequence (bit rate) known by both ends. Beyond that, virtually nothing is reliably standard.

The only sure way to connect two serial devices is to examine the documentation for each and deter-

mine the proper connections of inputs and outputs, with lines crossing if need be. If the manuals are not available, then voltage-sensing and status-display devices must be used to examine individual lines. Depending on DTE or DCE convention, the same pin number may be either an input or output. And, generally speaking, in a

One of the most useful pieces of test equipment is the RS-232C breakout box.

fully implemented handshaking configuration, single-point signal monitoring is not enough. Frequently, multiple lines must be monitored to observe dynamic relationships.

I don't intend to spend too much time discussing RS-232C handshaking or interfacing. That subject has been covered in numerous other articles in BYTE, most recently by Dr. Ian Wit-

ten (reference 7). In my experience, simply knowing the conventions hasn't helped one bit. I always have to study the manuals for each interface and often have to verify voltage levels with a meter. When all the handshaking signals are used, it can be a prolonged task.

Ultimately, successful serial interconnection depends more on your ability to measure, cross-connect, and jumper-connect signal lines until *some* combination works. And sometimes you have to deal with a case wherein the lines might be connected properly but, as in the example above, operating at the wrong voltage levels.

The point of this month's article is to describe some of the hardware involved in testing the RS-232C connection. We'll look at various circuits that make voltage measurements, including two kinds of breakout boxes. Finally, to allow dynamic testing of the data communication on the transmit and receive lines, we will see how to build a terminal simulator, which

Circle 219 on inquiry card.

The Most Promising Duet For An Orchestra.

Our duet is perfect for a single user system.

The same duet performs even better in a multi-user orchestra.

MCM ★ 80:

S-100 Single Board Computer ■ Single or multi processor capability ■ Programmable master or slave selection ■ Redundant processor manipulation ■ 4MHz Z80A or 6MHz Z80B CPU ■ 64K RAM and 2K EPROM with monitor ■ 2 serial, 2 parallel, 4 timer ports ■ Bi-directional inter-processor channel ■ Dual mode serial ports interface ■ Multi-layer PCB construction.

\$495.



DCM ★ 80: S-100 Disk Controller Module ■ 8" and/or 5 1/4" floppy disk controller ■ SASI (ANSI, SCSI) hard disk host adapter ■ Single and double density, single and double side ■ Software implementation on CP/M¹ 2.2 and TurboDOS²

¹ TM of Digital Research, Inc.
² TM of Software 2000, Inc.

\$345.



JC SYSTEMS

1075 Hiawatha Ct.
Fremont, CA 94538
(415) 657-4215

SAGE TECHNICAL BRIEFING

SYSTEM DESIGN, SAGE IV

The challenge was to create a computer having room for a megabyte of RAM, a built-in Winchester with floppy backup, and the ability to perform 2,000,000 instructions per second.

A small miracle, in other words.

And small is exactly what it turned out to be. In fact, the 16-bit Sage IV, including all of the above attributes, takes up less than 1/2 cubic foot.

What made such a breakthrough possible? System design.

It took the latest in memory and processor technology, plus Winchester technology. And it took a highly integrated, closely packed, low power, high speed design incorporating a proprietary bus.

Now the Sage IV is ready for you. Actually, you can choose from three different Sage IV models to meet your exact needs—configurations with a 5 megabyte Winchester plus 640K floppy right on up to a combination of four fixed or removable Winchesters plus one or two floppies (200 megabytes of disk capacity in all).

Because of the Sage IV's no-compromise system design you can load a 16K program in 1/10 second from Winchester disk.

What's more, there are over 120 sources for existing popular programs for the Sage IV. The incredible p-System operating system, standard on every Sage IV converts software that was originally written for 8-bit com-

puters in Pascal, BASIC and Fortran. Optionally, CP/M, Modula, and Hyper-Forth are also available.

Better yet, our small miracles come with prices to match.

So give us a call or write today for more Sage IV information and the name of your nearest dealer.

Sage Computer Technology,
35 North Edison Way, #4, Reno,
NV 89502 (702) 322-6868.

In Europe: TDI LTD, 29 Alma
Vale Road, Clifton, Bristol
BS8-2HL Tel: (0272) 742796.

SAGE
COMPUTER TECHNOLOGY®

Circle 375 on Inquiry card.



COMDEX/SRING '83

April 26 to 29, 1983* Georgia World Congress Center • Atlanta, Georgia.



MicroSpooler[®] Saves Time

MicroSpoolers mean an end to waiting. The MicroSpooler stores data and feeds it to your printer as fast as it can handle it. You don't lose valuable computer time waiting for the printer to do its job.

Easy to install. Easy to use. Easy on the budget. These stand-alone MicroSpoolers can be installed in-line between virtually any printer and any computer.

Features:

- 16K memory (user expandable to 32K or 64K)
- Status readout
- Internal power supply
- Vertical mount configuration
- Independently selectable baud rates and handshaking
- Satisfaction guaranteed
- Priced from \$199.00



Send or call toll free for literature on our complete Spooler lines.

CONSOLINK CORPORATION

Dept. 2-48
1840 Industrial Circle
Longmont, CO 80501
(303) 651-2014
800-525-6705

Pin	EIA	CCITT	Signal	Source
1	AA	101	Protective (Earth) Ground	
7	AB	102	Signal Ground	
2	BA	103	Transmitted Data (TD)	DTE
4	CA	105	Request to Send (RTS)	
20	CD	108.2	Data Terminal Ready (DTR)	
23	CH	111	Data Signal Rate Selector (DTE source)	
24	DA	113	Transmitter Signal Element Timing (DTE source)	
14	SBA	118	Secondary Transmitted Data	
19	SCA	120	Secondary Request to Send	
3	BB	104	Received Data (RD)	DCE
5	CB	106	Clear to Send (CTS)	
6	CC	107	Data Set Ready (DSR)	
22	CE	125	Ring Indicator (RI)	
8	CF	109	Received Line Signal Detector (or Carrier Detect—CD)	
21	CG	110	Signal Quality Detector	
23	CI	112	Data Signal Rate Selector (DCE source)	
15	DB	114	Transmission Signal Element Timing (DCE source)	
17	DD	115	Receiver Signal Element Timing (DCE source)	
16	SBB	119	Secondary Received Data	
13	SCB	121	Secondary Clear to Send	
12	SCF	122	Secondary Received Line Signal Detector	

Table 1: RS-232C signals listed by function and source.

sends and receives ASCII (American National Standard Code for Information Interchange) characters at any standard data rate.

The RS-232C Breakout Box

One of the most useful pieces of test equipment is the RS-232C breakout box. This device is essentially a 25-line extension cable with apparatus attached that allows you to perform experiments on the serial link by inserting cross-connections, jumpers, and open circuits between the various signal lines. The most common use of the breakout box is to switch the Transmitted Data and Received Data lines (pins 2 and 3 in the commonly used connectors, abbreviated TD and RD). Another typical use is to make various combinations of connections between Request to Send (RTS, pin 4), Clear to Send (CTS, pin 5), Data Set Ready (DSR, pin 6), Carrier Detect (CD, pin 8—its official name is Received Line Signal Detector), and

Data Terminal Ready (DTR, pin 20). The more expensive units can also monitor voltage levels or decode serial data. Table 1 identifies the RS-232C signals by source.

A variety of commercial breakout boxes, ranging in price from \$100 to \$1000, are on the market. The more expensive products include such additional features as bilevel or trilevel signal monitoring, absolute voltage sensing, and signal-injection capabilities. Some of these features may or may not be important in your application.

When you are choosing a breakout box, be sure you get your money's worth. In some of the \$100 units, it appears that \$99 of the cost is for the case. The mechanical features are similar at all price levels, and only the addition of electronic bells and whistles adds to the cost.

In any breakout box, you find two 25-pin type-D subminiature (DB-25) connectors, two sets of 25 connection

GREAT IDEAS... Down to Earth Products



(Available Soon)



SDS-ZS10/4
4 RS232 Channels
Full Duplex
Real Time Clock



SDS-HARD DISK INTERFACE
Micropolis 1220 Series
or ST-506
Interface Adapter

A Shining New Star

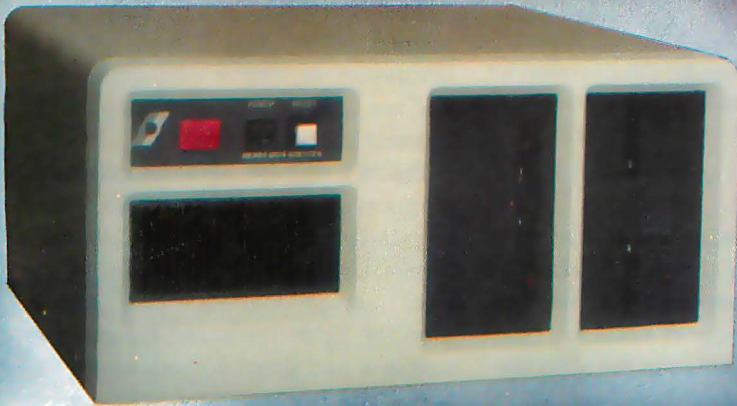

- 5 1/4" Hard Disk
- 96 TPI Floppy

- 6 Slot S-100 Mainframe

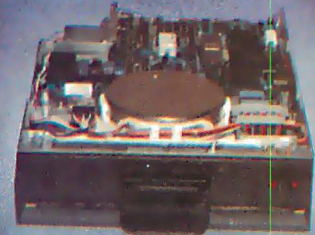

NEC-FLOPPY DISK DRIVE
Double Sided
Single Density/Double Density
Up to 2.4 Megabyte
(Qume Now Available)

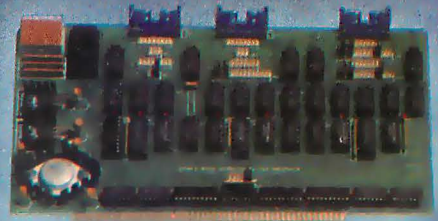

SDS-MULTIPLEXER/DISPLAY
Three RS232C 1 to 2 Switches
Two Seven Segment Status Display
(Can be used as a line monitor for data
communications link)
(route RS232 to one of two devices)

* TURBODOS TANDEM



SDS-MASTER

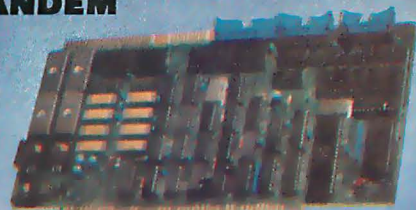

SDS-SLAVE

SDS-SINGLE BOARD COMPUTERS

Z80 CPU 64K Bank Switch Memory
2 RS232 Channels 4 Timers IEEE 696 Bus
4 Parallel ports
NEC 765 FDC with PLL to all Shugart
compatible drives (SDS-Master only)
*CP/M 2.2 & 3.0

*CP/M Registered trademark of
Digital Research

*TurboDOS Registered trademark of
Software 2000

HARDWARE
SOFTWARE



SIERRA DATA SCIENCES

Fresno CA/Marketing Division
25700 First St., Westlake, OH 44145
(216) 892-1800 Telex. 980131 WDMR

Circle 378 on Inquiry card.

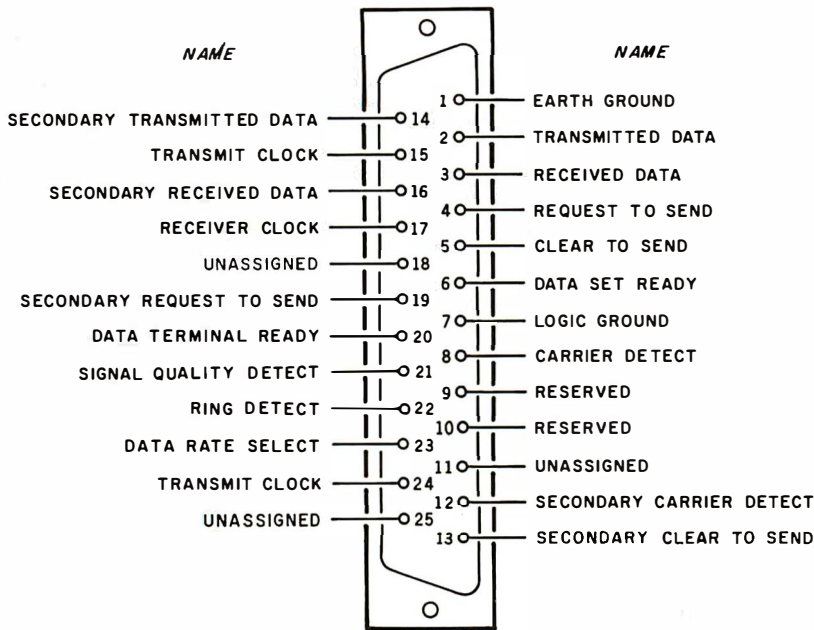

Figure 1: Pinout specifications of the RS-232C interface. The popular DB-25 connector is most often used for RS-232C connections, but it is not required by the EIA standard.

posts, and 24 or 25 switches. To begin testing, you connect the breakout box in series between the two pieces of equipment. The 25 lines on the first side go to 25 connection posts (often wire-wrap pins are used), and then 24 of the lines go into one side of three 8-pole DIP (dual-inline pin) switches. (Pin 1, the protective ground line, is directly routed to the output connector.) The 24 lines are directed through the DIP switches to another set of connection posts and then to the output connector. Figure 1 shows the pinout specification of the connectors.

To test the connection between two DTE-type RS-232C devices when no handshaking is involved, you merely insert the breakout box in the link; then, with all the switches closed except the two connected to pins 2 and 3, insert crossed jumpers between the connection posts to interchange the two signals. After you've made sure this works, you can permanently wire a cable to do the same job.

While most commercial breakout boxes connect and switch 24 of the 25 lines, most common RS-232C applications involving printers, low- and medium-speed modems, and video-

display terminals generally use only connector pins 1 through 8, plus pin 20. For these applications, we can construct a bare-bones breakout box, such as the one shown in the schematic diagram of figure 2 on page 38.

This simple construction will give you all the necessary features of a \$150 box for about \$15. Besides a signal-switching capability, this circuit incorporates passive voltage monitoring. Three components—a blocking diode, a constant-current diode, and an LED—indicate the presence of a potential of +4 V or greater on any signal line. The LED does not light for open circuits or negative voltages. Many low-priced RS-232C monitors use this type of circuit, and some cautions regarding its use are appropriate. Such an indicator draws its power from the signal itself (requiring about 4 mA), and in marginal situations it might kill the signal being measured.

For the RS-232C status signals, a line potential anywhere between +3 V and +15 V is logic 1, and a potential from -3 V to -15 V is a logic 0. If these signals are generated from low-power operational amplifiers (op amps) rather than RS-232C

drivers, there may not be enough oomph to communicate and light LEDs simultaneously. (Op amps are frequently used as a cost-cutting measure in budget equipment.) Finally, this cheap monitor senses only positive voltages (unless the circuit is reversed in polarity and duplicated everywhere) and gives no indication of negative voltages or ground potential. For example, you couldn't tell the difference between a broken cable lead and a logic-0 (inactive) status signal. Remember that RS-232C is a bipolar signal. As much happens (or doesn't) at negative potentials as at positive.

A Functional, Low-Cost Breakout Box

The previous point may have seemed minor, but it leads us to a discussion of better voltage sensors and use of active, rather than passive, monitoring techniques.

Figure 3 on page 38 is the schematic diagram of a much better indicator circuit for sensing RS-232C voltage levels. Using its own op amp to reduce signal loading, this bilevel monitor lights up in red for positive voltages and green for negative voltages. The feedback and gain-setting resistors are chosen so that the LEDs trigger at approximately +3 V and -3 V, respectively (internal current-limiting provides a relatively constant light level and protects the LEDs). Voltages between those values or open circuits light neither LED.

The indicator-circuit sections, one for every signal line, each use one section of an LM324 quad op amp. They present a virtually unnoticeable 100-kilohm load to the signal lines, can operate on any voltage with an absolute value between 4.5 V and 18 V, and can be powered easily from a battery of 6 AA cells for portability. I chose to use integrated two-color LEDs, but two regular LEDs (one red and one green) can be wired anode-to-cathode in parallel.

My idea of a reasonably useful breakout box is shown in figure 4. It combines the 24-switch-and-header portion of the commercial breakout boxes with the sensitive bilevel monitoring circuits just described.

TIME-PROVEN PERFORMANCE

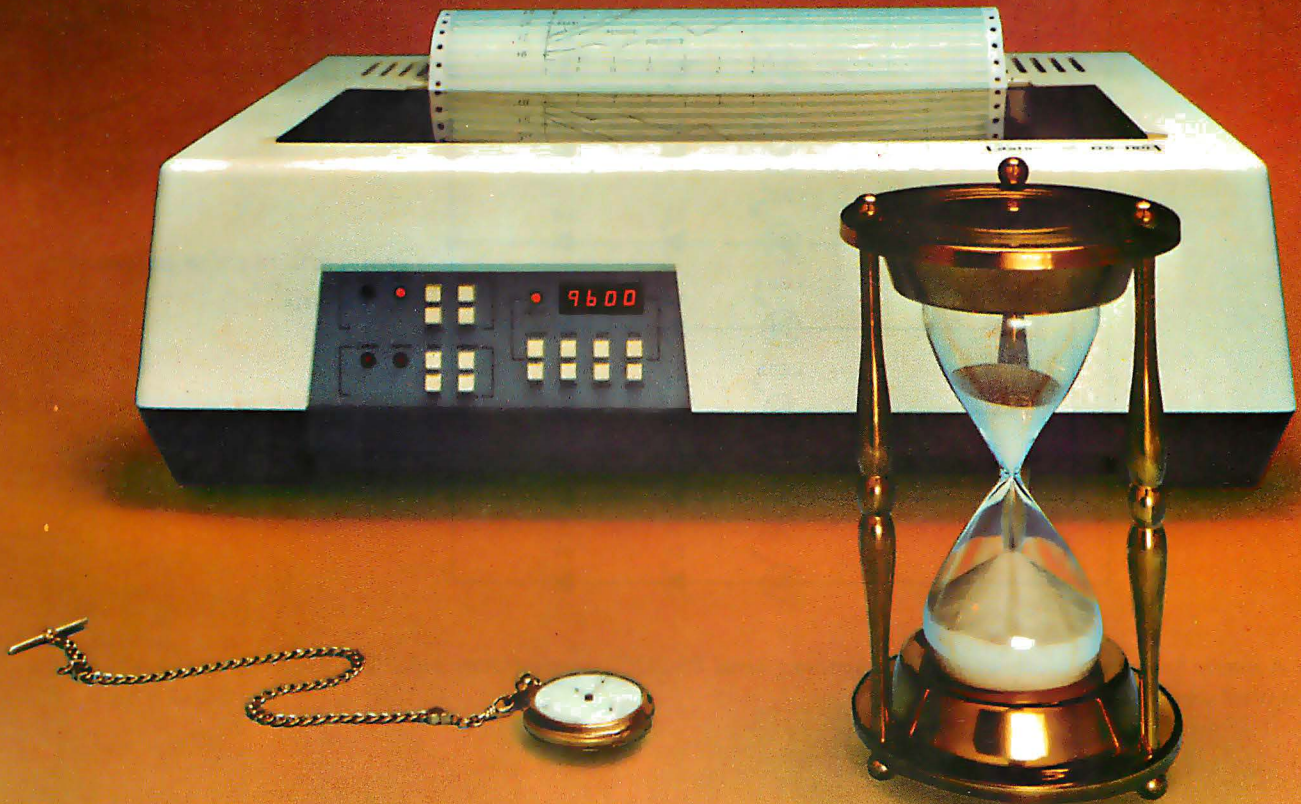

While new printers with impressive specifications are introduced on an almost daily basis, only time will tell the true quality of the product. Over the past 2 years our customers have continued to buy the DS180 printer, not only because of its impressive performance and competitive price, but also because of our outstanding track record for product reliability and customer support.

We have continually improved on the performance of the DS180 by incorporating such enhancements as dot addressable graphics, 6 user-selectable print sizes and a 2000 character buffer. These features coupled with 180 cps printing, parallel and serial interfaces, adjustable tractor feed and over 40 other programmable features, make the DS180 one of the most versatile matrix printers available today.

Before you select your next printer, why not take a look at a time-proven performer—the Datasouth DS180.

The DS180 printer is available nationwide through our network of sales/service distributors.

datasouth computer corporation
P.O. Box 240947 • Charlotte, NC 28224 • 704/523-8500
Telex: 6843018 DASOU UW

Circle 133 on Inquiry card.

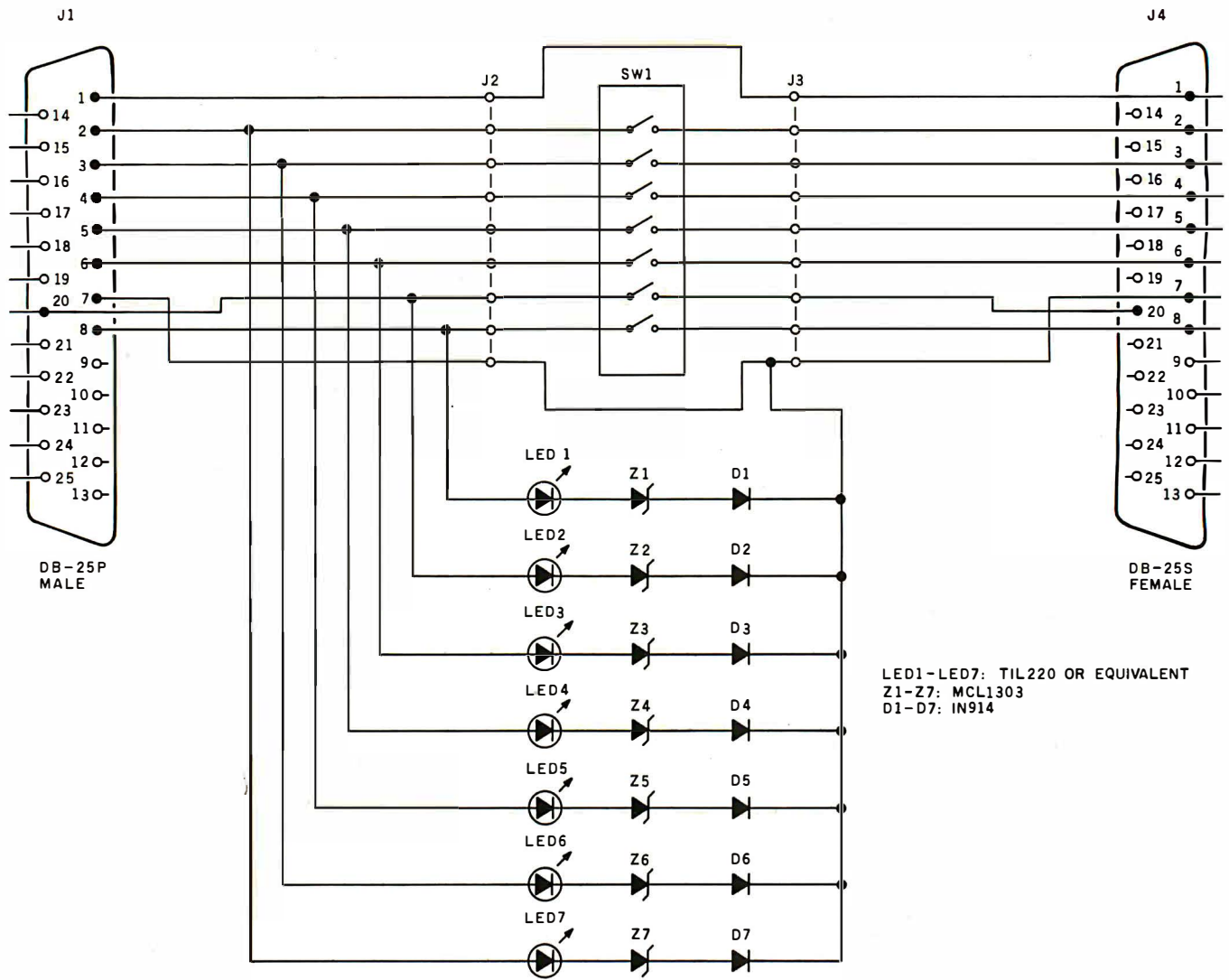

Figure 2: A simple homebrew breakout box for diagnosing serial RS-232C communication links. The 9 lines connected here are the ones most often used.

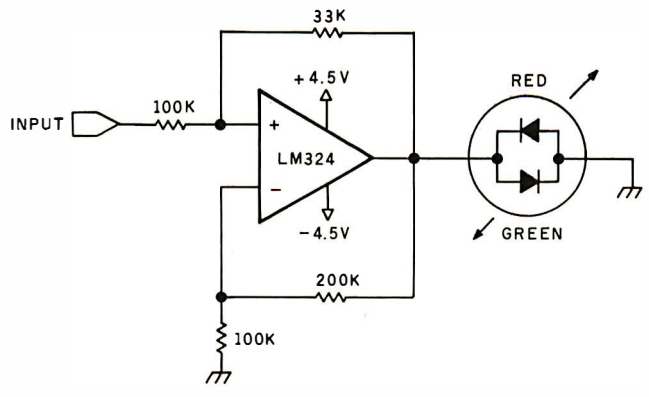

Figure 3: A line-state status indicator that incorporates an op amp to keep line loading to a minimum. The dual-LED component will glow red for positive voltages and green for negative.

Voltage indicators are hard-wired on the 11 most frequently used signal lines (2, 3, 4, 5, 6, 8, 15, 17, 20, 21, and 22), and the twelfth sensor can be connected to any line. A prototype of this circuit is shown in photo 1.

A Decade Voltage-Level Indicator

If you think back to my experience at the convention, you'll see that the problem was eventually detected as being voltage-related. It was undetectable with the cheap LED circuit, but it would have been caught by the circuit of figure 4. However, on some occasions even two levels are inadequate, and more precise measurements are necessary.

One extra indicator section was



MDBS III™

Mainframe-quality DBMS from
Micro Data Base Systems, Inc.
International Software Enterprises—USA
(312) 981-9200



ACCOUNTING PLUS™

A comprehensive microcomputer
business accounting system.
SOFTWARE DIMENSIONS, INC.
(916) 722-8000



QUICK CHECK™

Instant Answers for Money Matters,
Bookkeeping/Accounts/Inventory
CHUCK ATKINSON PROGRAMS
(817) 249-0166



INMASS™

Integrated Manufacturing and
Accounting Software System
MICROCOMPUTER CONSULTANTS
(916) 756-8104



DATA COMMUNICATIONS SOFTWARE

ASYN, BISYN & SNA-SDLC protocol
data communications software.
IE Systems, Inc. & Micro-Integration, Inc.
(603) 659-5891



PC/FORTH™

Program development systems for Z-80
and 8086/88 microcomputers
Laboratory Microsystems, Inc.
(213) 306-7412

WHEN YOU BUY THE RIGHT SOFTWARE, YOU CAN'T GO WRONG ON THE HARDWARE.

CP/M® compatible software — for maximum
work power on more than 600 computer models.

All the computers in the world won't help you without smart software. That's why we're showing some of the best software products you can buy, from solid, innovative companies. They're shown here together because they're all CP/M compatible. CP/M is the universally accepted operating system created by Digital Research that allows software products like these to run on more than 600 different computer models including the biggest names in hardware. So, to get smart software for your system, call one of the fine Independent Software Vendors listed above or to find out how CP/M can increase productivity in your world, contact Digital Research at (408) 649-5500.



**DIGITAL
RESEARCH™**
The creators of CP/M™

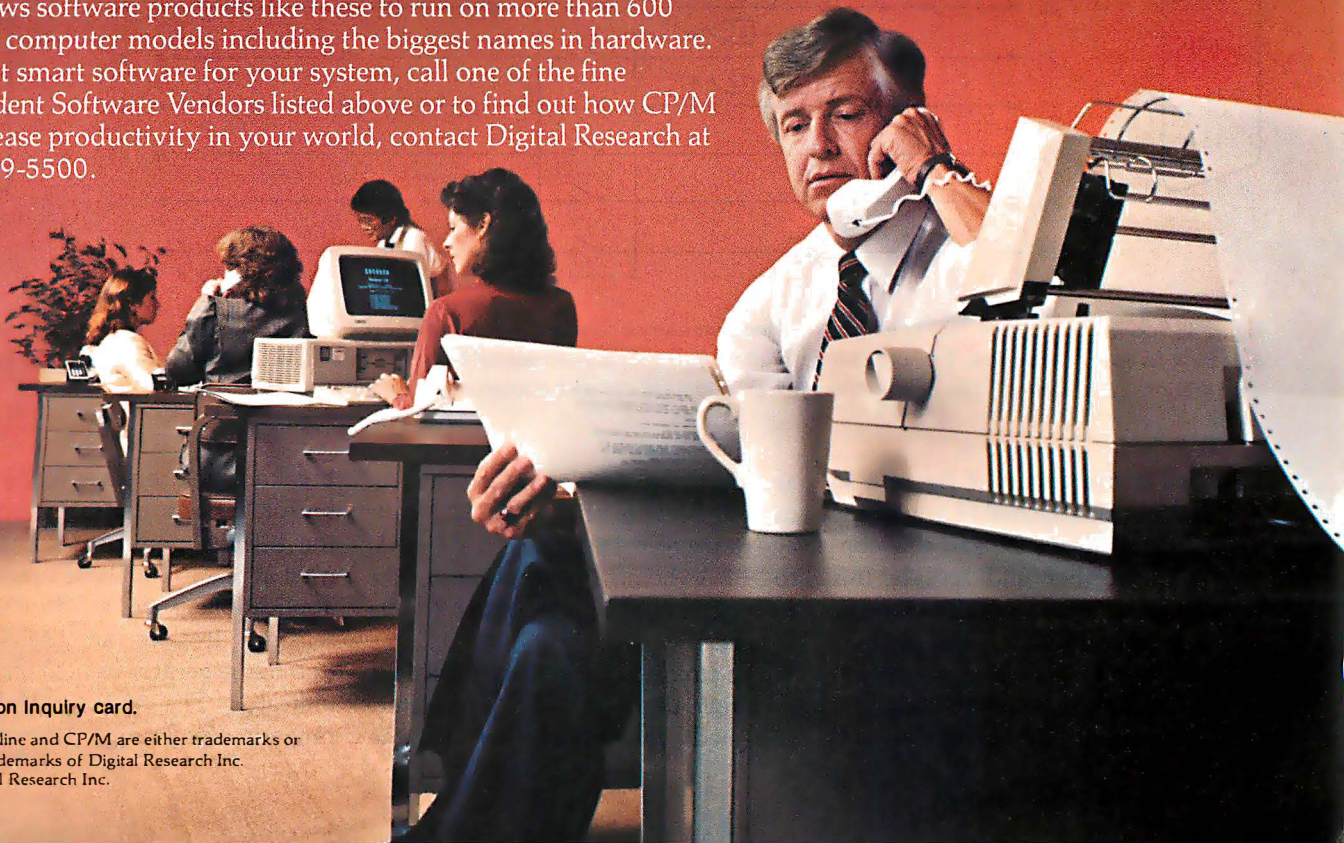

Circle 142 on Inquiry card.

The logo, tagline and CP/M are either trademarks or
registered trademarks of Digital Research Inc.
©1982 Digital Research Inc.

(4a)

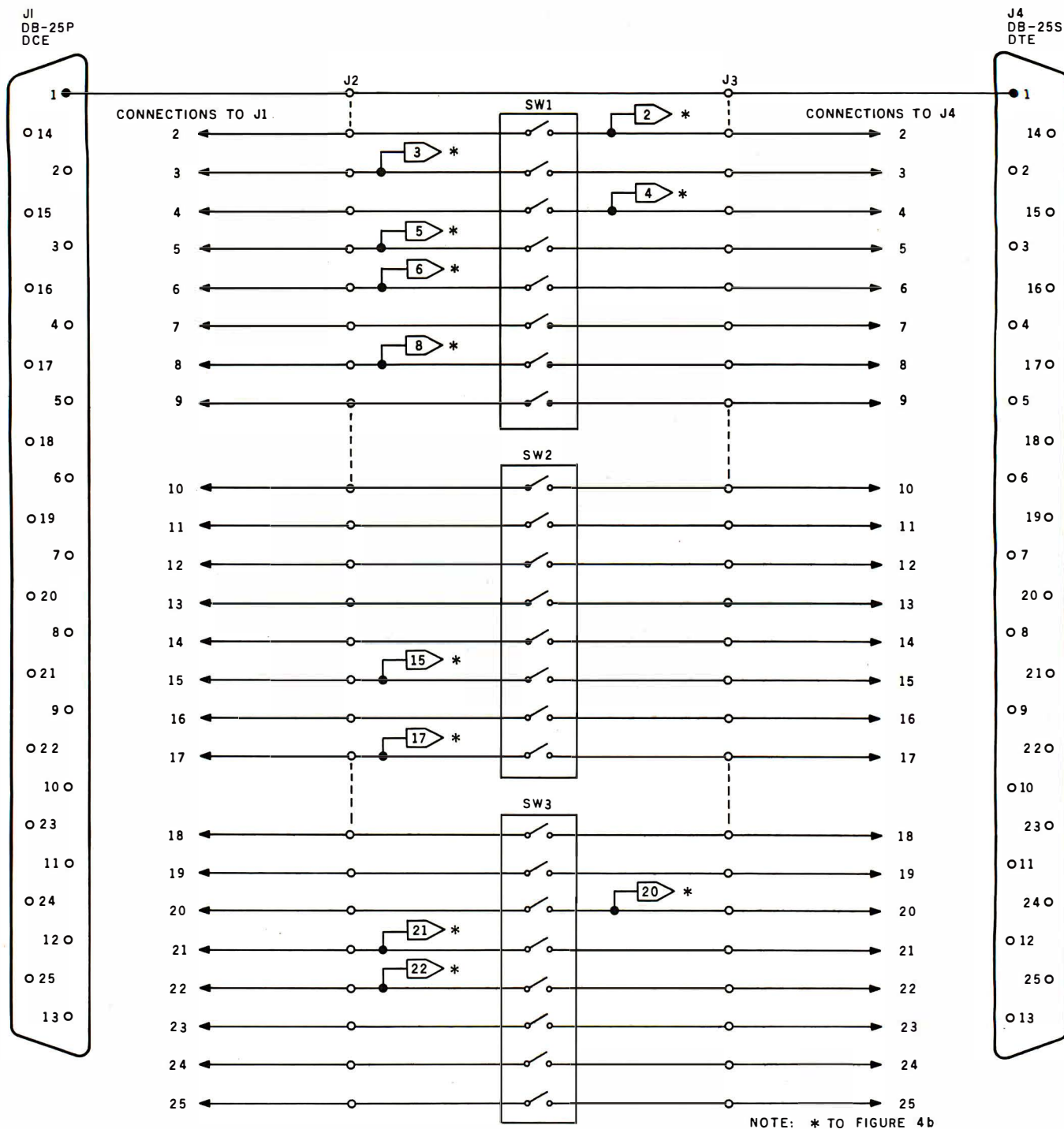

Figure 4: Schematic diagram (4a) of a breakout box that allows constant monitoring of the 11 most used lines, plus another line selectable by a jumper connection. The indicator circuit of figure 4b is reproduced 12 times; three LM324 packages, each containing 4 op-amp sections, are needed. The connections for each section are also shown in figure 4b.

provided in the circuit of figure 4 so that it could be attached to any of the 25 input pins. If we expand this concept a bit further and replace this bipolar sensor with something having a little more resolution, we could take a better reading of voltage excursion. Granted, a DVM could be used, but such instruments are expensive and

are much more elaborate than required. Because of the RS-232C voltage range of -15 V to $+15\text{ V}$ (-3 V to $+3\text{ V}$ being no-man's-land), the resolution need be only about 3 volts at best.

The circuit in figure 5 on page 44 is a single-digit decade voltmeter. Designed for installation in the

breakout box in place of the floating sensor, it has a higher resolution than the bilevel monitor, and it can be used in place of a DVM in less critical applications such as RS-232C level sensing. It uses an LM3914 LED dot/bar generator as a 10-step analog indicator. The 30-V ($\pm 15\text{ V}$) input range is divided into 10 incremental

(4b)

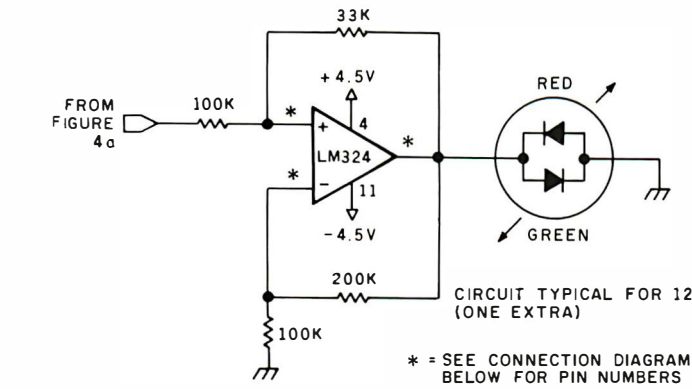

LM324
CONNECTION DIAGRAM

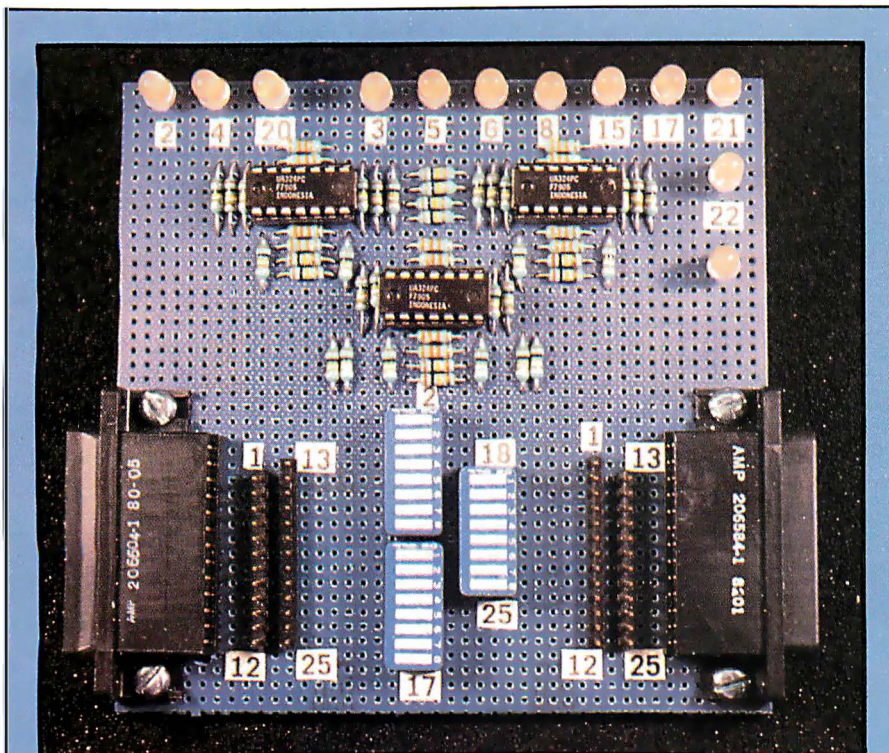
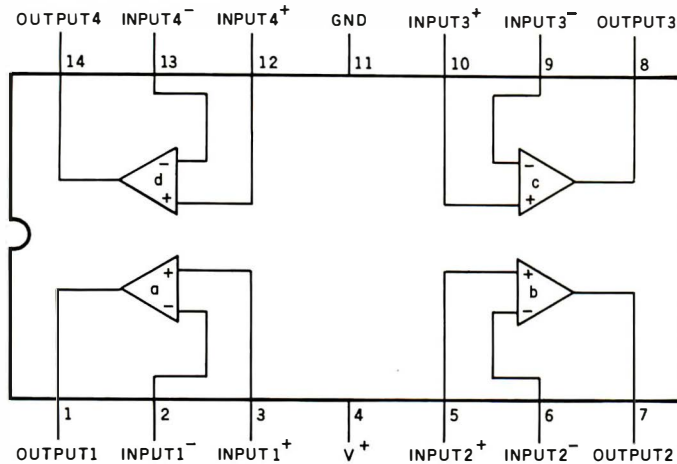

Photo 1: Breadboard prototype of the simple breakout box of figure 4.

steps of 3 V. Different-color LEDs provide a quick visual indication of relative magnitude and polarity of the line states. A prototype of the circuit is shown in photo 2.

The decade-voltmeter circuit uses 2 or 3 integrated circuits. IC1a (an LM324 op amp section) scales the input voltage range from ± 15 V to ± 2.5 V (adjust potentiometer R1 to set the gain for 1/6). Another section, IC1b, shifts the resulting ± 2.5 V scaled signal to a 0-V to +5-V range at its output (adjust R2 for the proper shift magnitude). IC2, the LM3914 dot/bar generator, is configured to respond to a range of 0 V to +5 V.

When -15 V is applied to the circuit's input, LED1 lights; when +15 V is applied, LED10 lights. For an intermediate active voltage, such as +9 V, LED8 will light up. In the range of from -3 V to +3 V, which includes ground or open states, LED5 or LED6 will be lit. Using the same color convention as in figure 4, voltages greater than +3 V are shown on red LEDs; those less than -3 V are on green LEDs; in the inactive area between +3 V and -3 V, I used yellow. Any single input signal that swings between a red and green indicator is therefore at valid levels.

The decade-voltmeter circuit requires power at about +7.5 V (or greater) and -5 V (or less) for operation. Two 9-V battery cells (to provide ± 9 V) work very nicely. Or using a single +7.5-V source and the ICL7660 voltage inverter (IC3) allows the unit to be battery-operated (for some reason, the 7660 didn't seem to like inverting +9 V when I tried it).

Build a Terminal Simulator

The final thing to check when testing an RS-232C serial link is the existence of properly formatted data bits coming over the wire at the correct data rate. Voltage-level indicators make only quantitative measurements. It is necessary to take a *qualitative* measurement if the integrity of the transmission is in question. Most often the quality of the link can be ascertained with the transmission and reception of a single character.

One way of testing a suspect communication line is to drag around a

Number One Add-On

Communications

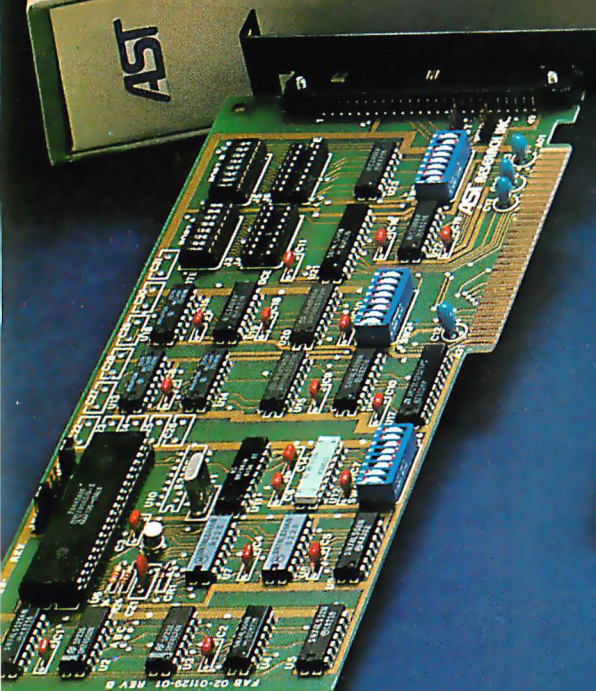

Advanced Comm. Card (CC-232)

- Programmable to communicate in Bisync, SDLC, HDLC, and Async protocols.
- Two Ports of RS 232

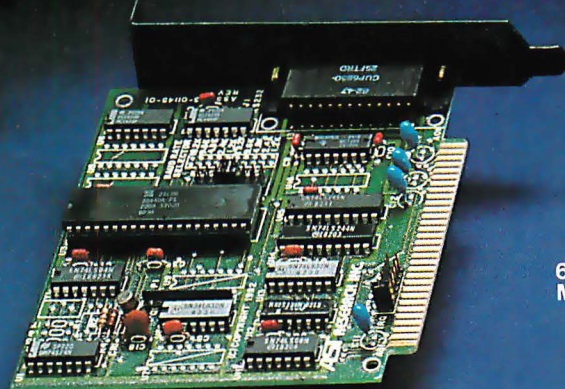

CC-332 For use with AST-3780

- An IBM 2780/3780 RJE Emulator • Supports Bisync point-to-point communications protocol • Allows file transfer between Host & IBM PC • Ideal for IBM System 34, 38, 4300

AST-SNA

- Emulates IBM 3274 Model 51C Control Unit
- Emulates 3278 Display Station
- Emulates 3287 Type Printer
- Optional 3770 Emulation
- Cluster Controller Operation
- Protocol Converter Support

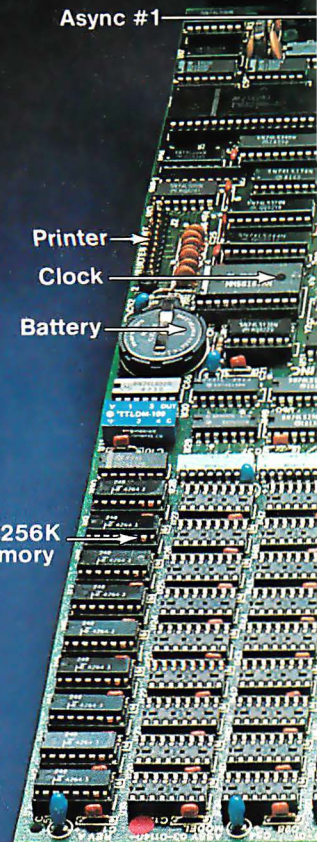

ComboPlus™

- Features 64K-256K Memory
- One Clock Calendar (opt.)
- One IBM Compatible Parallel Port (opt.)
- One IBM Compatible Parallel Printer (opt.)
- Battery Backed-up Clock Calendar (opt.)

AST products are available from Computerland, Entre', ComputerMart and selected dealers worldwide.

Products for **IBM** PC

Multifunction Cards

All Multifunction Products include:

- SuperDrive™ – a Disk Emulator Utility Program
- SuperSpool™ – a Printer Buffer Utility Program

Optional: New **ConnectALL™** Connector Mounting Bracket

I/O Plus™
Maximum 6 Functions (no memory) • Clock Calendar (std.) • IBM Compatible Async Port #1 (std.) • IBM Compatible Async Port #1 (opt.) • IBM Printer Port (opt.) • SuperDrive (disk emulator prog.) • SuperSpool (print spooler prog.)

MegaPlus™
• 64K-512K (with MegaPak) • Two IBM Compatible Async Ports (1 std., 1 opt.) • One IBM Parallel Printer Port (opt.) • One Battery Backed-up Clock Calendar (std.) • Ideal for Concurrent CP/M, MBA, VSI Series software packages.

ConnectALL™
NEW! AST Proprietary Connector Mounting Bracket (does not include cables shown in illustration)

AST
RESEARCH INC.
Dealer Inquiries Welcome

2372 Morse Avenue
Irvine, Calif. 92714
(714) 540-1333

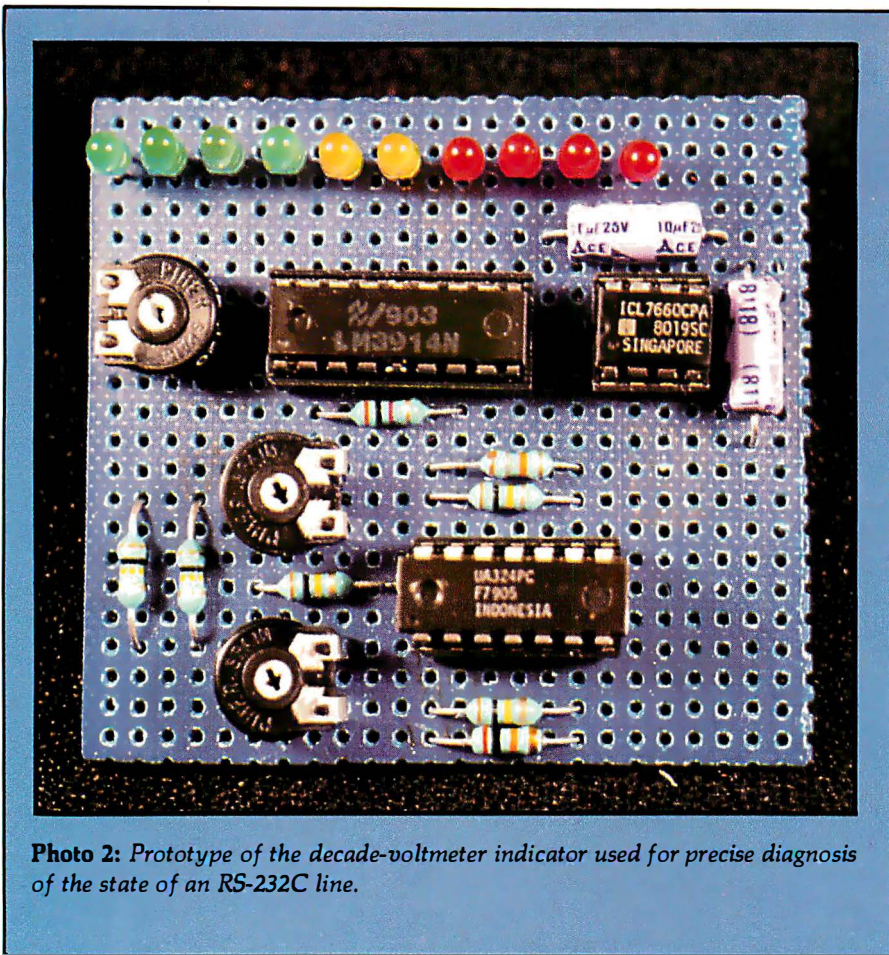

Photo 2: Prototype of the decade-voltmeter indicator used for precise diagnosis of the state of an RS-232C line.

big video-display terminal. Also the idea of adapting the single-chip terminal from the February article did occur to me. However, that was a relatively expensive item for a tester, and it couldn't cover all the data rates in common use, so I did some head-scratching and invented yet another circuit.

Figure 6 is the schematic diagram of my single-character terminal simulator. The prototype is shown in photo 3 on page 48. Using 5 chips, it can send, receive, and display (in hexadecimal form) single ASCII characters at any of the 16 commonly used data rates between 50 and 9600 bps (bits per second). By switching pins 2 and 3, you can set it to appear on the line as either a DTE or DCE device. Have you got a suspect device on the line? Set your data rate and desired character code on the DIP switches and then press a button each time you want the character transmitted. Granted, a video-display terminal might be faster, but my simulator circuit is a lot lighter.

The terminal simulator uses a UART (universal asynchronous re-

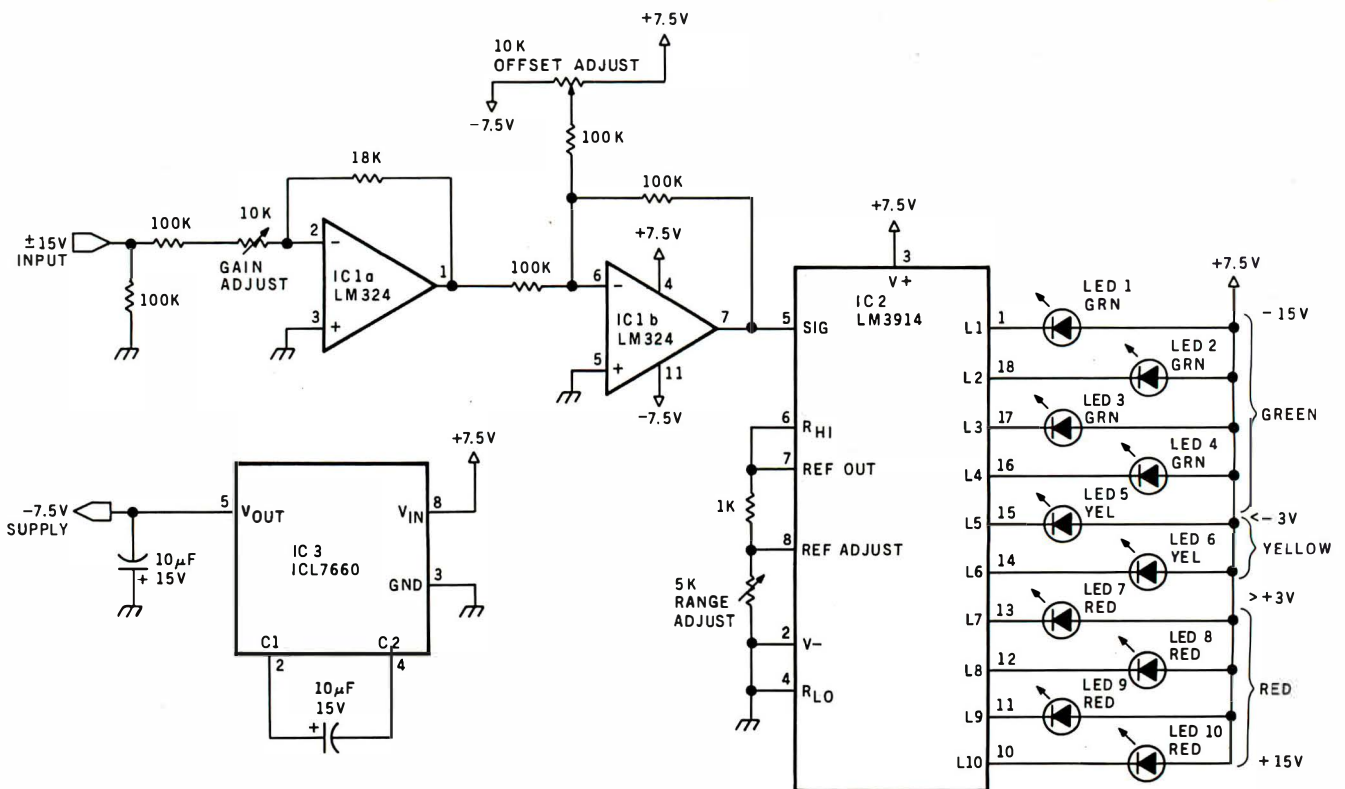

Figure 5: A decade-voltmeter circuit. This more precise indicator may be substituted for the twelfth indicator in the breakout box of figure 4a. It lights up in one of three colors depending on the voltage present on its input.

Now! A 60 MHz Tektronix scope built for your bench.

Wide-range vertical sensitivity: Scale factors from 100 V/div (10X probe) to 2 mV/div (1X probe). Accurate to $\pm 3\%$. Ac or dc coupling.

Two high-sensitivity channels: dc to 60 MHz bandwidth from 10 V/div to 20 mV/div; extended sensitivity of 2 mV/div at > 50 MHz.

Sweep speeds: from 0.5 s to 50 ns. To 5 ns/div with X10 magnification.

Delayed sweep measurements: Accurate to $\pm 3\%$ with single time-base 2213; to $\pm 1.5\%$ with dual time-base 2215.

Complete trigger system. Includes TV field, normal, vertical mode, and automatic; internal, external and line sources; variable holdoff.

Probes included. High-performance, positive attachment, 10-14 pF and 60 MHz at the probe tip.

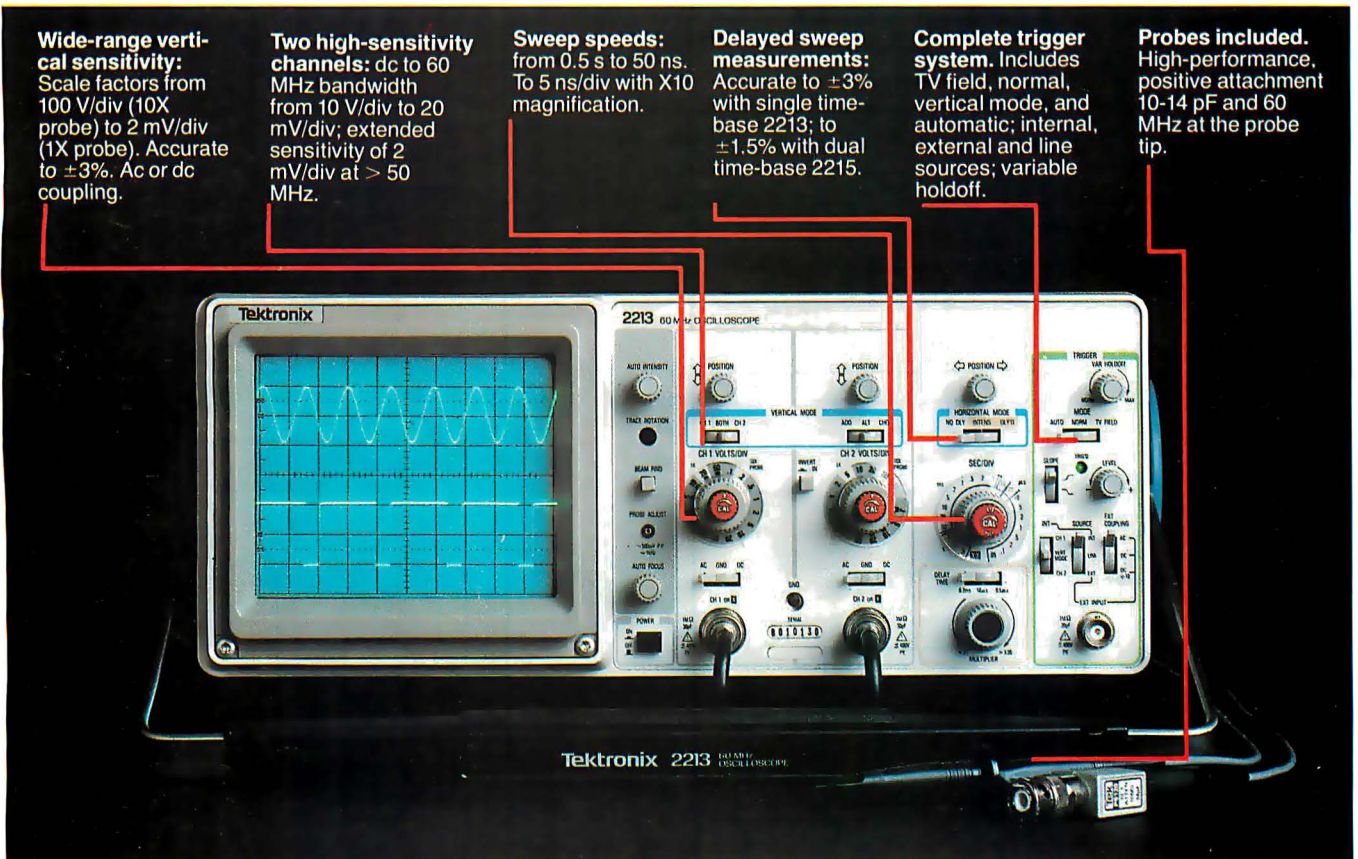

In 30 years of Tektronix oscilloscope leadership, no other scopes have recorded the immediate popular appeal of the Tek 2200 Series. The Tek 2213 and 2215 are unapproachable for the performance and reliability they offer at a surprisingly affordable price.

There's no compromise with Tektronix quality: The low cost is the result of a new design concept that cut mechanical parts by 65%. Cut cabling by 90%. Virtually eliminated board electrical connectors. And eliminated the need for a cooling fan.

Yet performance is written all over the front panels. There's the bandwidth for digital and analog circuits. The sensitivity for low signal measurements. The sweep speeds for fast logic families. And delayed sweep for fast, accurate timing measurements.

The cost: \$1200* for the 2213. \$1450* for the dual time base 2215.

You can order, or obtain more information, through the Tektronix National Marketing Center, where technical personnel can answer your questions and expedite delivery. Your direct order includes

probes, operating manuals, 15-day return policy and full Tektronix warranty.

For quantity purchases, please contact your local Tektronix sales representative.

**Order toll free:
1-800-426-2200
Extension 51**

In Oregon call collect:
(503) 627-9000 Ext. 51

*Price F.O.B. Beaverton, OR. Price subject to change.

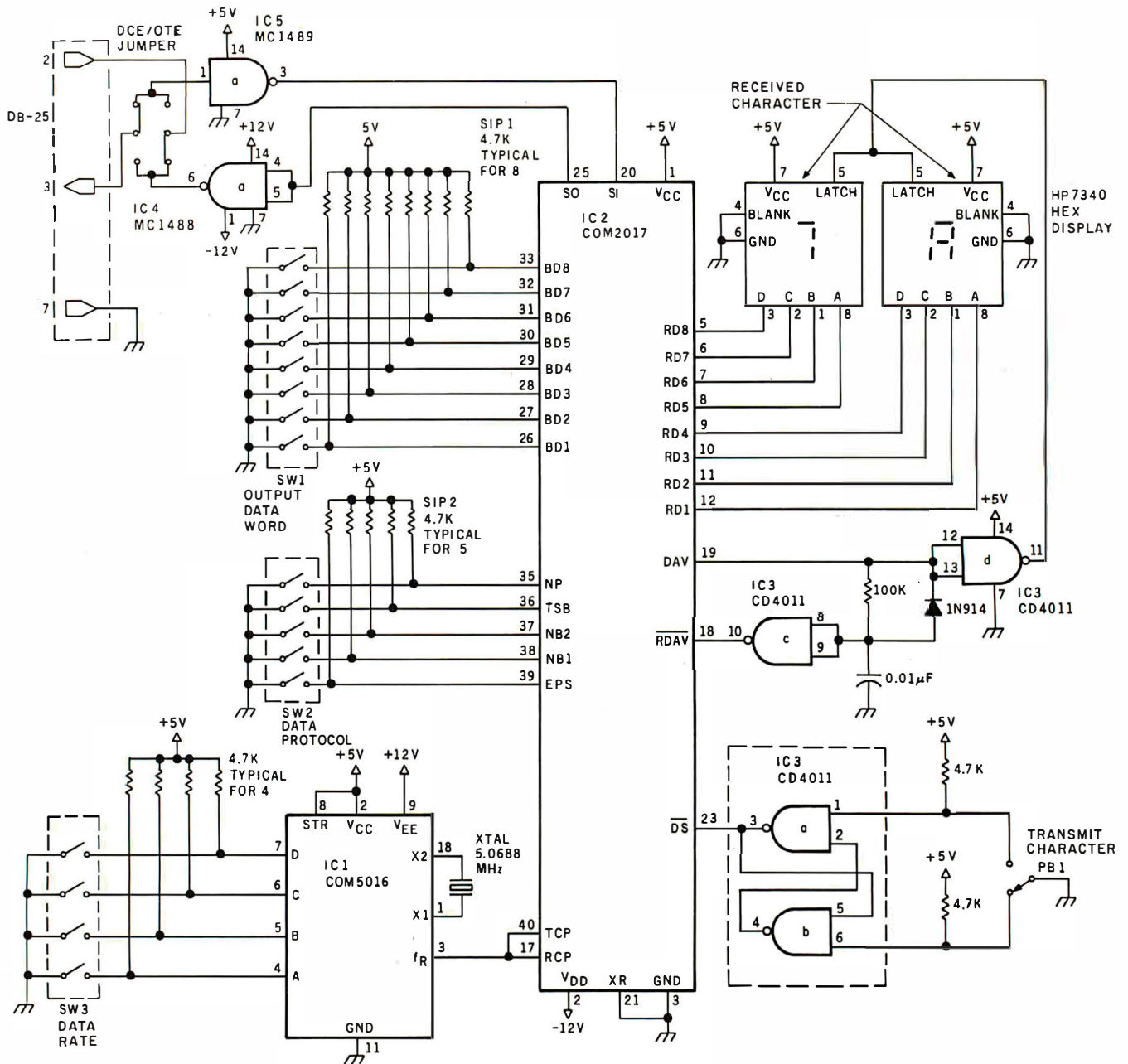

Figure 6: A terminal-simulator circuit used to test the functioning of an RS-232C communication link. This simple-minded device transmits a single, switch-selected ASCII character on demand or receives a single character for display in hexadecimal form.

ceiver/transmitter), IC2, to generate and accept data on the RS-232C line. (Because I have written elsewhere about the functioning of UARTs, I won't take the time now. See reference 2 for more information.) IC1 is a crystal-controlled data-rate generator. Depending on the settings of SW3, the clock rate of the UART will be set for one of the 16 data rates. Both the transmitter and receiver are set to the same rate.

The transmitter section is very sim-

ple. SW2 sets the status inputs to the UART for parity, word length, and stop bits. The character to be transmitted is set on SW1 (the most significant bit is BD8) in hexadecimal or binary format. It is transmitted each time pushbutton switch PB1 is pressed.

Data reception is just as easy. When a character has been received, the DAV (data available) output line of the UART goes high, and the received character can be read from the

output lines RD1 through RD8. The DAV signal is delayed, inverted and used to reset itself through the $\overline{\text{RDAV}}$ input. This same logic signal is used to latch the 8 data bits onto a 2-digit hexadecimal LED display. Each time a character is received, the display will be updated, although you won't be able to read a continuous data stream.

Of course, more sophisticated commercial terminal simulators exist that incorporate some processing power,

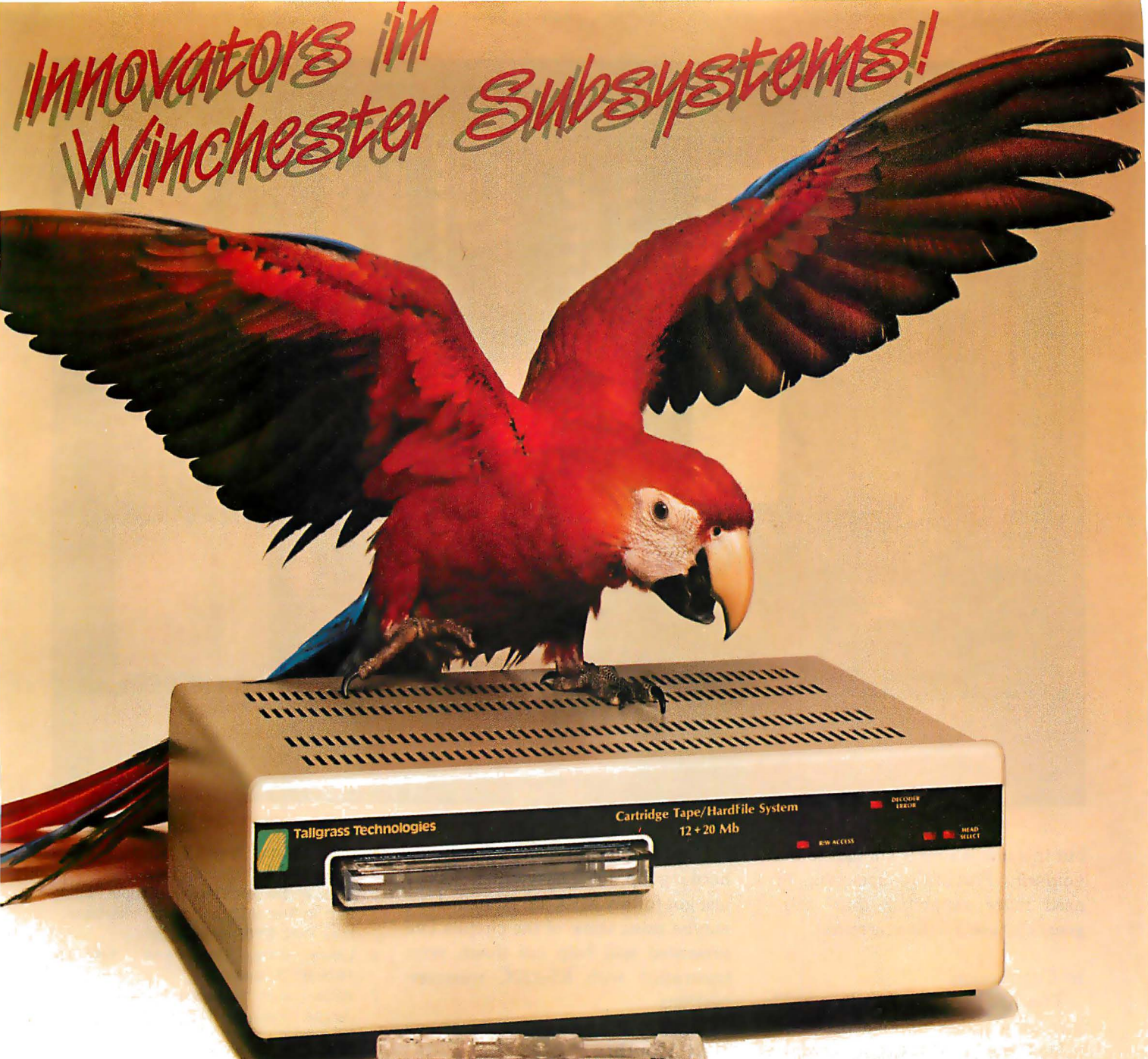

**INNOVATORS in
Winchester Subsystems!**

**TALLGRASS AND
YOUR IBM® PC**

Tallgrass Technologies is the industry leader in Winchester HardFile™ and streaming tape subsystems for the IBM® PC. Fortune 500 corporations, banks, governmental agencies, and small businesses throughout the world depend on Tallgrass HardFile subsystems for their mass storage and backup requirements.

Tallgrass offers formatted capacities from 6.25 Mb to 70 Mb with integral streaming tape back-up. Our proprietary disk/tape controller with integral 10K track buffer optimizes read/write activity and, coupled with our DMA host interface, offers high performance previously unavailable with 5¼" disk systems.

WHAT ABOUT DATA INTEGRITY?

Tallgrass offers backup on ANSI standard ¼" tape cartridges, instead of the usual floppies, video cassettes, or low-capacity removable Winchester devices. The Tallgrass 12.5 Mb formatted Hardfile can back itself up on a \$39.95 data cartridge in less than 10 minutes!

Circle 400 on inquiry card.

All Tallgrass Hardfiles are equipped with a dedicated landing zone where the read/write heads land. This protects against incidental damage and data loss during power-downs and transportation.

TALLGRASS IS UNSURPASSED

We've done our homework in engineering and building a reliable HardFile subsystem with remarkable performance and convenient backup for the most stringent on-line mass storage and off-line archival requirements.

From \$3095 including integral tape backup. Available from COMPUTERLAND® and other participating computer dealers.

Exclusive Canadian Distributor:
Micro-Ware™
440 Phillip St.
Waterloo, Ontario N2L 5R9
(519) 884-4690

Exclusive European Distributor:
CPS Computer Group, Ltd.
Birmingham,
England B27 613H
(021) 7073866



**Tallgrass
Technologies**
Corporation

11667 W. 90th, Overland Park, KS 66214, (913) 492-6002
TWX: 215406 TBYT

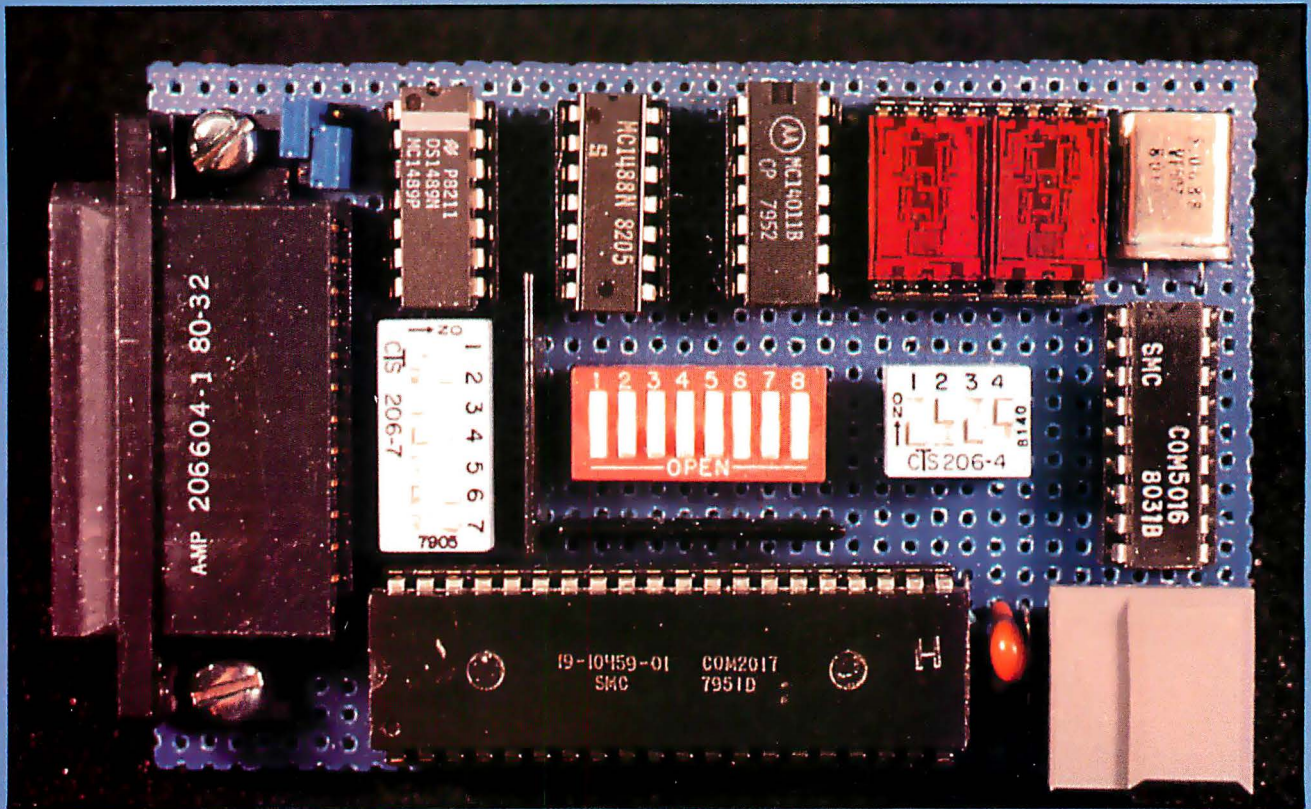

Photo 3: Prototype of the terminal simulator of figure 6.

but this one is simple enough to build yourself. Practically speaking, if I need more capability than this, I generally use a video terminal.

In Conclusion

This has been a rather long soliloquy on a rather oblique problem. I helped our shopping-bag computer hacker understand a little more about RS-232C, but a similar disaster might happen to him the next time he attempts to attach two serial devices.

As Dr. Witten has observed, most of the problems we find in using the RS-232C interface result from its being employed in ways never intended when it was invented.

For some of us, however, there's a light-emitting diode at the end of the tunnel. We can just whip out our little breakout boxes with all the pretty lights, decipher what's in or out, simulate all the handshaking signals, jumper everything to everything else, and make it communicate by brute force.

I'll probably still spend a few hours hooking up the Daisywriter 2000 I just got for my MPX-16. Nonetheless, maybe using some of the circuits I've presented will help cut down your frustration with RS-232C interconnections.

Next Month:

Build an RS-232C code-activated peripheral-device switch. ■

References

1. Ciarcia, Steve. "Build a Handheld LCD Terminal." February 1983 BYTE, page 54.
2. Ciarcia, Steve. *Build Your Own Z80 Computer*. New York: BYTE Books/McGraw-Hill Book Company, 1981. (See page 138).
3. *EIA Standard RS-232-C: Interface Between Data Terminal Equipment and Data Communication Equipment Employing Serial Binary Data Interchange*. Washington, DC: Electronic Industries Association Engineering Department, 1969.
4. Folts, Harold C. *McGraw-Hill's Compilation of Data Communications Standards*,

2nd edition. New York: McGraw-Hill Publications Company, 1982.

5. Leibson, Steve. "The Input/Output Primer, Part 4: The BCD and Serial Interfaces." May 1982 BYTE, page 202.
6. Liming, Gary. "Data Paths." February 1976 BYTE, page 32.
7. Witten, Ian H. "Welcome to the Standards Jungle." February 1983 BYTE, page 146.

Editor's Note: Steve often refers to previous *Circuit Cellar* articles as reference material for each month's current article. Most of these past articles are available in reprint books from *BYTE Books*, McGraw-Hill Book Company, POB 400, Hightstown, NJ 08520.

Ciarcia's *Circuit Cellar*, Volume I, covers articles that appeared in *BYTE* from September 1977 through November 1978. Ciarcia's *Circuit Cellar*, Volume II, contains articles from December 1978 through June 1980. Ciarcia's *Circuit Cellar*, Volume III, contains the articles that were published from July 1980 through December 1981.

To receive a complete list of Ciarcia's *Circuit Cellar* project kits available from the Micromint, circle 100 on the reader service inquiry card at the back of the magazine.

VEDIT-THE CLEAR CHOICE FOR PROGRAMMING

PLUS FEATURES FOR FAST, EFFICIENT WORD PROCESSING

Increasing your productivity is what a good text editor is all about. VEDIT excels with a unique combination of powerful and easy to use editing features, customizability and complete hardware support. Compare VEDIT - you'll find everything you expect in a good editor plus many time saving features which only VEDIT offers.

VEDIT fully utilizes all function keys, or configures to any keyboard layout you are familiar with. VEDIT has helpful aids such as directory display, and you won't lose text if you run out of disk space - you can delete files or change disks.

Powerful TECO style command macros let you perform editing tasks you might otherwise not even attempt. Nearly impossible tasks for other editors (such as translations or extensive search/replace on many files), can be done automatically from a command file.

For program development VEDIT surpasses any other editor - with more extensive file handling, powerful command macro capability and special features for Pascal, PL/1, 'C', Cobol, Assembler and others. VEDIT reduces program editing time by 30% as compared to the best word processor.

For word processing, VEDIT has word wrap, adjustable margins, paragraph reformatting, word and paragraph functions, simple printing and more.

VEDIT supports practically every CRT terminal, video board, 8080, Z80 and 8086 computer. We have been consistently first to support new computers. And we support you with any technical assistance you need.

Please specify your microcomputer, video board or the CRT terminal version, 8080, Z80, or 8086 code, operating system and disk format.

Compare VEDIT's features:

- True Full Screen Editing
- Edit files one disk in length
- Automatic Disk Buffering
- Compact and Fast
- Display of line and column #
- Set/Goto text markers
- 'Undo' key to restore line
- Automatic Indent/Unindent
- Adjustable Tab positions
- Repeat function key
- Text Move and Copy
- 10 Scratchpad Buffers
- Load/Save buffers on disk
- Powerful command macros
- Directory display
- Edit additional (small) files simultaneously
- Insert another disk file
- Unlimited file handling
- Recovery from 'Full Disk'
- Change disks while editing
- Word Wrap, format paragraph
- Simple Printing
- Menu driven installation
- Startup command file
- Setup CRT function keys
- Support newest CRT terminals
- Support smart CRT functions
- Customizable keyboard layout

IBM PC, Displaywriter ° Zenith Z100 and Z89 ° NEC APC ° DEC VT180 ° Televideo 802
TRS-80 I, II and 16 ° Apple II Softcard ° SuperBrain ° NorthStar ° Xerox 820 ° Cromemco
MP/M ° CP/M-86 ° Concurrent CP/M-86 ° MSDOS ° PCDOS

VEDIT - Disk and Manual
8080, Z80 or IBM PC. . . . \$150
CP/M-86 or MSDOS. . . . \$195
Manual only \$18



CP/M and MP/M are registered trademarks of Digital Research Inc. Apple II is a registered trademark of Apple Computer, Inc. MS-DOS and Softcard are trademarks of Microsoft. TRS-80 is a trademark of Tandy Corporation. IBM is a trademark of International Business Machines.

CompuView
PRODUCTS, INC.

Circle 112 on Inquiry card.

1955 Pauline Blvd., Suite 200 ° Ann Arbor, Michigan 48103 ° (313) 996-1299

If you want it fast, call us first.

Chances are, we have just what you want right in our warehouse.
So we can ship it out right now. At the right price.

16K RAM KITS.....13.95

Set of 8 NEC 4116 200 ns. Guaranteed one year.
FOR IBM-PC, set of 9.....15.75

DISKETTES

ALPHA DISKS.....21.95
Single sided, certified Double Density 40 Tracks,
with Hub-Ring. Box of 10. Guaranteed one year.

SCOTCH 3M

S.S.D.DEN 40 TRK.....23.50
D.S.D.DEN 40 TRK.....36.50

VERBATIM DATALIFE

MD 525-01, 10, 16.....26.50
MD 550-01, 10, 16.....44.50
MD 557-01, 10, 16.....45.60
MD 577-01, 10, 16.....34.80
FD 32 or 34-9000.....36.00
FD 32 or 34-8000.....45.60
FD 34-4001.....48.60

DISKETTE STORAGE

5 1/4" PLASTIC LIBRARY CASE.....2.50
8" PLASTIC LIBRARY CASE.....3.50
PLASTIC STORAGE BINDER w/ Inserts.....9.95
PROTECTOR 5 1/4" (50 Disk Capacity).....21.95
PROTECTOR 8" (50 Disk Capacity).....24.95
DISK BANK 5 1/4".....5.95
DISK BANK 8".....6.95

NEC PERSONAL COMPUTERS

Call Alpha Byte for our low NEC prices.

ALTOS COMPUTER SYSTEMS

Call Alpha Byte for our low Altos prices.

ATARI

See Apple & Atari Software.

SIGNALMAN MODEM.....85.00
ATARI 800 (48K).....\$CALL
ATARI 400 (16K).....\$CALL
ATARI 1200.....\$CALL
ATARI 810 DISK DRIVE.....445.00
ATARI 850 INTERFACE.....169.00
IN-HOME KEYBOARD ATARI 400.....107.00
ATARI 410 PROGRAM RECORDER.....75.00
EPSON CABLE.....35.00
JOYSTICK CONTROLLER.....10.00
PADDELE CONTROLLERS.....17.50
STAR RAIDERS.....32.00
DONKEY KONG.....\$CALL
GALAXIAN.....32.00
DEFENDER.....32.00
PACMAN.....32.00
CENTIPEDE.....32.00
TAX ADVANTAGE.....38.97
FILE MANAGER 800.....79.16
VISICALC.....189.00
HOME ACCOUNTANT.....59.97
WICD TRACKBALL.....59.00

INTEC PERIPHERALS RAM MODULES

48K FOR ATARI 400.....145.00
32K FOR ATARI 800.....67.00

PRINTERS

STAR MICRONICS GEMINI 10.....\$CALL
STAR MICRONICS GEMINI 15.....\$CALL
RIBBONS FOR MX-80.....8.95
RIBBONS FOR MX-100.....24.00
C-I-TOH F-10 40 CPS PARALLEL.....1390.00
C-I-TOH F-10 40 CPS SERIAL.....1390.00
C-I-TOH F-10 55 CPS PARALLEL.....1639.00
C-I-TOH F-10 55 CPS SERIAL.....1639.00
C-I-TOH PROWRITER PARALLEL.....410.00
C-I-TOH PROWRITER SERIAL.....590.00
C-I-TOH PROWRITER II PARALLEL.....715.00
C-I-TOH PROWRITER II SERIAL.....767.00
EPSON MX-80 W/GRAFTRAX PLUS.....\$CALL
NEW! EPSON FX-80.....\$CALL
EPSON MX-100 W/GRAFTRAX PLUS.....\$CALL
EPSON GRAFTRAX PLUS.....60.00
COMREX CR-1 PARALLEL.....799.00
COMREX CR-1 SERIAL.....829.00
COMREX TRACTOR FEED.....109.00
NEC 8023A.....485.00
NEC SPINWRITER 3530 P. RO.....1995.00
NEC SPINWRITER 7710 S. RO.....2545.00
NEC SPINWRITER 7730 P. RO.....2545.00
NEC SPINWRITER 7700 D SELLUM.....2795.00
NEC SPINWRITER 3500 SELLUM.....2295.00
OKIDATA MICROLINE 82A.....460.00
OKIDATA MICROLINE 83A.....700.00
OKIDATA MICROLINE 84.....1170.00
OKIGRAPH 82.....49.95
OKIGRAPH 83.....49.95
MICROBUFFER IN-LINE 32K.....299.00
MICROBUFFER IN-LINE 64K.....349.00
MICROBUFFER 64K EXPANSION MOD.....179.00

BOOKS

THE CUSTOM APPLE.....24.95
BASIC BETTER & FASTER DEMO DISK.....18.00
THE CUSTOM TRS-80.....24.95
MICROSOFT BASIC FASTER & BETTER.....24.95
CUSTOM I/O MACHINE LANGUAGE.....24.95
TRS-80 DISK & MYSTERIES.....16.95
MICROSOFT BASIC & DECODED.....24.95

APPLE HARDWARE

SUPER 5 SLIMLINE DRIVE w/ Controller.....375.00
QUENTIN APPLEIMATE DRIVE.....269.00
SUPER CLOCK II.....129.00
VERSA WRITER DIGITIZER.....259.00
ABT APPLE KEYPAD.....119.00
SOFTCARD PREMIUM SYSTEM.....517.00
MICROSOFT Z-80 SOFTCARD.....249.00
MICROSOFT RAMCARD.....79.00
VIDEX 80x24 VIDEO CARD.....260.00
VIDEX KEYBOARD ENHANCER II.....129.00
VIDEX FUNCTION STRIP.....74.00
M & R SUPERTERM 80x24 VIDEO BD.....315.00
M & R CODLING FAN.....44.95
M & R UNIVERSAL MOD.....54.95
T/G JOYSTICK.....44.95
T/G PADDELE.....29.95
T/G SELECT-A-PORT.....54.95
T/G TRACKBALL.....47.50
KRAFT JOYSTICK.....48.00
VERSA E-Z PORT.....21.95

THE MILL-PASCAL SPEED UP.....270.00
PROMETHEUS VERSACARD.....165.00
MICROBUFFER II# 16K W/GRAPHICS.....259.00
MICROBUFFER II# 32K W/GRAPHICS.....299.00
SUPERFAN II.....62.00
SUPERFAN II W/ZENER.....84.50
RANA CONTROLLER.....104.00
RANA DRIVE ELITE I.....335.00
SNAPSHOT.....119.00
GRAPPLER+.....145.00
7710A ASYNCHRON. SER. INTERFACE.....149.00
7712A SYNCHRON. SER. INTERFACE.....159.00
7742A CALENDAR CLOCK.....99.00
7728A CENTRONICS INTERFACE.....105.00
VISTA VISION 80-80 COL CARD.....259.00
VISTA 8" DISK DRIVE CONTROLLER.....549.00

MONITORS

USI AMBER 9".....145.00
USI AMBER 12".....160.00
NEC 12" GREEN MONITOR.....169.00
NEC 12" COLOR MONITOR.....399.00
BMC GREEN MONITOR.....89.00
AMDEK COLOR I.....365.00
AMDEK RGB COLOR II.....774.00
AMDEK RGB INTERFACE.....169.00
TAXAN RGB.....359.00
TAXAN 12" AMBER.....125.00

MOUNTAIN HARDWARE

CPS MULTIFUNCTION BOARD.....154.00
ROMPLUS W/ KEYBOARD FILTER.....165.00
ROMPLUS W/O KEYBOARD FILTER.....125.00
KEYBOARD FILTER ROM.....49.00
COPYROM.....49.00
MUSIC SYSTEM.....369.00
ROMWRITER.....149.00
EXPANSION CHASSIS.....580.00
RAMPLUS 32K.....160.00

S-100 HARDWARE

CALIFORNIA COMPUTER SYSTEMS

2200A MAINFRAME.....459.00
2065C 64K DYNAMIC RAM.....539.00
2422 DISK CONT. & CP/M®.....359.00
2710 4 SERIAL I/O.....279.00
2719 2 SERIAL / 2 PARALLEL I/O.....289.00
2720 4 PARALLEL I/O.....219.00
2810 Z-80 CPU.....259.00

QT PRODUCTS

MF+DD8.....682.00
MF+DD12.....718.00

COMREX

"THE TIMEPIECE" S-100 CLOCK.....125.00

MODEMS

NOVATION J-CAT.....125.00
NOVATION SMARTCAT 212.....499.00
NOVATION SMARTCAT.....209.00
NOVATION D-CAT (1200 Baud).....619.00
NOVATION APPLE-CAT (300 Baud).....310.00
NOVATION APPLE-CAT (1200 Baud).....605.00
UDS 212 LP (1200 Baud).....429.00
UDS 103 JLP AUTO ANS.....209.00

HAYES MICROMODEM II.....289.00
MICROMODEM W/ TERMINAL PKG.....309.00
HAYES 100 MODEM (S-100).....325.00
HAYES SMART MODEM (300 Baud).....227.00
HAYES SMART MODEM (1200 Baud).....540.00
HAYES CHRONOGRAPH.....199.00
SIGNALMAN MODEM W /RS-232C.....85.00

TERMINALS

HAZELTINE ESPRIT.....510.00
VISUAL-50 GREEN.....690.00
TELEVIDEO 910.....630.00

TRS-80 MOD I HARDWARE

PERCOM DATA SEPARATOR.....27.00
PERCOM DOUBLER II W /DOS 3.4.....159.00
4 DRIVE CONTROLLER P/S.....259.00
TANDON 40 TRK DISK DRIVE W/P.S.....289.00
LNW DOUBLER W/DOSPLUS 3.3.....138.00
LNW 5/8 DOUBLER W/DOSPLUS 3.4.....181.00
LNW EXPANSION INTERFACE.....350.00

IBM HARDWARE

SEATTLE 64K RAM +.....355.00
QUADBOARD 64K.....430.00
64K MEMORY UPGRADE.....80.00
APPARAT COMBO BOARD.....175.00

ALPHA BYTE IBM MEMORY EXPANSION BOARDS

256K W /RS-232C.....349.00
256K W /RS-232C & SUPERCALC.....529.00
512K W /RS-232C.....579.00
512K W /RS-232C & SUPERCALC.....749.00

IBM DISK DRIVES

Alpha Byte's add-on drive kits for the IBM-PC —
each kit includes installation instructions
Tandon TM100-1 Single head 40 trk.....195.00
Tandon TM100-2 Double head 40 trk.....262.50

ISOLATORS

ISO-1 3-SOCKET.....49.95
ISO-2 6-SOCKET.....49.95

BARE DRIVES

TANDON 5 1/4 INCH
100-1 SINGLE HEAD 40 TRK.....195.00
100-2 DUAL HEAD 40 TRK.....262.50
100-3 SINGLE HEAD 80 TRK.....250.00
100-4 DUAL HEAD 80 TRK.....369.00

TANDON THINLINE 8 INCH
848-1 SINGLE SIDE.....379.00
848-2 DUAL SIDE.....490.00

MICRO PRO

APPLE CP/M®
WORDSTAR†.....279.00
SUPERSORT†.....179.00
MAILMERGE†.....174.00
DATASTAR†.....207.00
SPELLSTAR†.....174.00
CALCSTAR†.....109.00

MICROSOFT

APPLE	
FORTRAN*	150.00
BASIC COMPILER*	296.00
COBOL*	550.00
Z-80 SOFTCARD	249.00
RAMCARD	79.00
TYPING TUTOR II	17.95
OLYMPIC DECATHLON	24.95
TASC APPLESOFT COMPILER	125.00
ALDS	95.00
MULTIPLAN NATIVE OR CP/M	209.00
TIME MANAGER	117.00
PREMIUM PAK	517.00

IBM SOFTWARE

HOWARD SOFT TAX PREP	209.00
VOLKSWRITER V 1.2	145.00
WRITE ON	90.00
EASYWRITER II	247.00
EASY SPELLER	149.00
EASY FILE	285.00
HOME ACCOUNTANT+	105.00
FIRST CLASS MAIL	85.00
SUPERCALC	179.00
WORDSTAR	279.00
MAILMERGE	174.00
DATASSTAR	207.00
SPELLSTAR	174.00
SUPERSORT	179.00
d BASE II	429.00
SPELLGUARD	145.00
CALCSTAR	199.00
THE WORD PLUS	117.00
T.I.M.	379.00
JFORMAT	39.00
MOVE IT	109.00
THE TAX MANAGER	188.00
VISICALC / 256K	189.00
VISITREND / VISIPLLOT	235.00
VISIDEX	192.00
VISIFILE	249.00
VISISCHEDULE	229.00
VERSA WRITER GRAPHICS TABLETS	270.00
CONCURRENT CP/M* 86	315.00
GRAPHICS HARD COPY SYSTEM	19.50

Call for additional IBM software prices.

IBM GAME SOFTWARE

ZORK I, II, III	28.00
STARCROSS	28.00
DEADLINE	35.00
GALAXY	19.50
MIDWAY CAMPAIGN	17.00
THE WARP FACTOR	31.16
LOST COLONY	23.36
CONQUEST	23.36
GALACTIC ATTACK	25.00
APPLE PANIC	23.61
TEMPLE OF ASPHAL	34.95
CROSSFIRE	24.95
FROGGER	27.26
M'SOFT FLIGHT SIMULATOR	38.95

If you don't see the software you want, call. Our software stock is constantly expanding.

APPLE SOFTWARE

HOWARD SOFT TAX PREP	189.00
MAGIC WINDOW II	117.00
MAGIC WINDOW	79.00
MAGIC WORDS	59.00
MAGIC MAILER	59.00
DB MASTER	169.00
DB MASTER UTILITY PACK I OR II	69.00
DATA CAPTURE 4.0/80	59.95
PFS GRAPH	89.95
PFS (NEW) PERSONAL FILING SYSTEM	85.00
PFS REPORT	79.00
Z-TERM*	89.95
Z-TERM PRO*	129.95
ASCII EXPRESS PRO	98.00
EASY WRITER PRO	136.00
EASY MAILER-PRO	117.00
A-STAT COMP. STATISTICS PKG	99.00
BEAGLE BROTHERS UTILITY CITY	23.00
APPLE MECHANIC	23.00
TIP DESK #1	15.95
BEAGLE BAG	23.00
SUPER TEXT 40/56/77	97.50
LISA 2.5	59.95

TRANSCEND II	115.00
SCREENWRITER II	99.00
DICTIONARY	79.00
GENERAL MANAGER	179.00

CONTINENTAL SOFTWARE

G/L	165.00
A/R	165.00
A/P	165.00
PAYROLL	165.00
PROPERTY MGMT	325.00
THE HOME ACCOUNTANT	59.95
F.C.M. w/form letter	75.00
TAX ADVANTAGE	45.00

FORTRAN	239.00
DISK DOCTOR	78.00

MICROPRO

WORDSTAR	279.00
SUPERSORT	179.00
MAILMERGE	174.00
DATASSTAR	207.00
SPELLSTAR	174.00
CALCSTAR	109.00

MICROSOFT

MULTIPLAN	209.00
BASIC 80	249.00

MASK OF THE SUN	31.16
A.E.	23.72
PINBALL SUBLOGIC	24.50
SNACK ATTACK	23.36
BUDGECO PINBALL CONST. SET	31.61
THIEF	24.95
THE WARP FACTOR	31.16
COSMO MISSION	23.36
WIZARDRY	37.95
NIGHT OF DIAMONDS	27.26
STARBLAZER	24.95
CRISIS MOUNTAIN	26.32
EVOLUTION	33.80

SIRIUS SOFTWARE

SPACE EGGS	23.36
GORGON	31.16
SNEAKERS	23.36
PHANTOMS FIVE	22.00
BANDITS	25.00

EDU-WARE

PERCEPTION PKG	19.95
COMPU-MATH: ARITHMETIC	39.95
COMPU-SPELL (REQ. DATA DISK)	24.95
WIZARDRY DATA DISKS 4-8, ea.	17.95
RENDEZVOUS	28.50

ON-LINE SYSTEMS

ULTIMA II	42.00
MISSILE DEFENSE	27.26
LUNAR LEEPER	23.36
TIME ZONE	77.96
CRANSTON MANOR	25.95
CANNON BALL BLITZ	25.95

MUSE SOFTWARE

ROBOT WARS	32.95
THREE MILE ISLAND	31.61
A.B.M.	19.46

1983 Word Processor Special

**FRANKLIN ACE
1000** 1395.00

**FRANKLIN ACE SYSTEM
DISK DRIVE W/ CONT** ... 539.00

**ACE WRITER
WORD PROCESSOR** ... 129.00

EPSON MX-80 645.00

B.M.C. GREEN 285.00

SCOTCH 3M DISKETTES .44.00

**APPLE TO EPSON
INTERFACE & CABLE** ... 129.00

~~\$2960~~

Now \$1983

* * FRANKLIN 1200.....CALL * *

This system may be modified to your needs. Call for special price quote.

VISICORP

DESKTOP PLAN II	189.00
VISIPLLOT	158.00
VISITREND/VISIPLLOT	229.00
VISIDEX	189.00
VISITERM	79.00
VISICALC	189.00
VISIFILES	189.00
VISISCHEDULE	229.00

BASIC COMPILER	299.00
FORTRAN 80	359.00
COBOL 80	585.00
MACRO 80	156.00
mu MATH/mu SIMP	200.00
mu LISP/mu STAR	165.00

APPLE & ATARI GAMES

ZAXXON	31.16
--------	-------

BRODERBUND

APPLE PANIC	23.61
MIDNIGHT MAGIC	27.26
CHOPFLIFTER	27.20

AUTOMATED SIMULATIONS

INVASION ORION	20.95
STAR WARRIOR	31.35
CRUSH, CRUMBLE AND CHOMP	24.95
TEMPLE OF APASHAI	31.35
HELLFIRE WARRIOR	31.35
RESCUE AT RIGEL	23.36

ON-LINE SYSTEMS

WIZARD AND PRINCESS	27.26
SOFT PORN ADVENTURE	23.36
THRESHOLD	31.16
JAW BREAKER	23.36
CROSSFIRE	24.95
ULYSSES & GOLDEN FLEECE	25.95
FROGGER	24.50

INFOCOM

ZORK I, II, III	28.00
STARCROSS	28.00
DEADLINE	35.00

EDU-WARE

COMPU-READ	24.95
COMPU-MATH FRACTIONS	34.95
COMPU-MATH DECIMALS	34.95

MORE GREAT APPLE GAMES

DARK CRYSTAL	31.61
TUBEWAY	27.26
ARCADE MACHINE	44.38
TUES. MORNING QUARTERBACK	25.95
THE SPACE VIKINGS	38.50
COMPUTER QUARTERBACK	31.16
SEA FOX	24.00
THE SHATTERED ALLIANCE	49.95
POOL 1.5	27.26
ULTIMA	31.16
RASTER BLASTER	23.36
FLIGHT SIMULATOR	26.61
INTERNATIONAL GRAND PRIX	25.95
SARGON II	28.95

To order or for information call

In New York:
(212) 509-1923

In Los Angeles:
(213) 706-0333

In Dallas:
(214) 744-4251

By Modem:
(213) 991-1604

CALL OUR MODEM LINE FOR WEEKLY SPECIALS.

Alpha Byte COMPUTER PRODUCTS

31245 LA BAYA DRIVE
WESTLAKE VILLAGE, CA 91362

We guarantee everything we sell for 30 days — no returns after 30 days. Defective software will be replaced free, but all other software returns are subject to 15% restocking fee and must be accompanied by RMA slip. No returns on game software, unless defective. We accept VISA and MasterCard on all orders; COD orders, up to \$300. Shipping charges: \$3 for all prepaid orders, actual shipping charges for non-prepays; \$3 for COD orders under 25lbs; (\$6 for over) plus a \$4 surcharge; add 15% for foreign. FPO and APO orders. Calif. add 6% sales tax, in L.A. County add 6 1/2%. Prices quoted are for stock on hand and are subject to change without notice.



LAST NIGHT, COMPU SERVE TURNED THIS COMPUTER INTO A TRAVEL AGENT FOR JENNIE, A STOCK ANALYST FOR RALPH, AND NOW, IT'S SENDING HERBIE TO ANOTHER GALAXY.

NO MATTER WHICH COMPUTER YOU OWN, WE'LL HELP YOU GET THE MOST OUT OF IT.

If you've got places to go, CompuServe can save you time and money getting there. Just access the Official Airline Guide Electronic Edition—for current flight schedules and fares. Make reservations through our on-line travel service. Even charter a yacht through "Worldwide Exchange."

If your money's in the market, CompuServe offers a wealth of

prestigious financial data bases. Access Value Line, or Standard and Poor's. Get the latest information on 40,000 stocks, bonds or commodities. Then, consult experts like IDS or Heinold Commodities. All on line with CompuServe.

Or if, like Herbie, intergalactic gamesmanship is your thing, enjoy the best in fantasy, adventure, and space games. Like MegaWars, the ultimate computer conflict.

To get all this and more, you'll

need a computer, a modem and CompuServe. CompuServe connects with almost any personal computer, terminal, or communicating word processor. To receive an illustrated guide to CompuServe and learn how you can subscribe, contact or call:

CompuServe

Consumer Information Service
2180 Wilson Road, Columbus, Ohio 43228
800-848-8199
In Ohio, call 614-457-8650

An H&R Block Company



SUBSCRIBE

BYTE



THE SMALL SYSTEMS JOURNAL THAT KEEPS YOU ON-LINE.

Every issue of BYTE is filled with stimulating, timely articles on computer hardware, software, applications and reviews of computer products. There is also tutorial information for both the beginner and experienced computer user.

Read your first copy of BYTE, The Small Systems Journal. If it is everything you expected, honor our invoice. If it isn't, just write "cancel" on the invoice and mail it back. You won't be billed, and the first issue is yours at no charge.

Please print 4J43

Name

Address

City State/Province/Country Code

United States

One year \$21 (12 issues) 2 years \$38 3 years \$55

Canada or Mexico

One year \$23 (12 issues) 2 years \$42 3 years \$61

Foreign Rates (to expedite service, please remit in U.S. funds drawn on a U.S. bank)

- Europe, one year, air delivered, \$53.
 All other countries, one year, surface delivered, \$37
 (Air delivery available upon request)
 Check enclosed (entitles me to 13 issues for price of 12, North America only)
 Bill VISA Bill Master Charge Bill me (North America only)

Card Number Expires

Signature Allow 6 to 8 weeks for processing your subscription



NO POSTAGE
NECESSARY
IF MAILED
IN THE
UNITED STATES

BUSINESS REPLY CARD

FIRST CLASS PERMIT NO. 39 MARTINSVILLE, NJ

POSTAGE WILL BE PAID BY ADDRESSEE

BYTE

Subscription Dept.
P.O. Box 590
Martinsville, NJ 08836



The National Semiconductor NS16000 Microprocessor Family

The NS16000 family offers features formerly available only in much larger systems, but in a combination not available on any one system.

Glenn Leedy
National Semiconductor
Microprocessor Systems Division
2900 Semiconductor Drive
Santa Clara, CA 95051

The advent of extremely fast VLSI (very-large-scale integration) technology is quickly eradicating the gap between 8-bit small computer systems and 32-bit mini/mainframes. This decreasing gap means that many users now expect the performance and capacity of a large and costly mainframe to be combined with the flexibilities and economies of a microprocessor. The National Semiconductor Corporation has developed the NS16000 family of 16-/32-bit microprocessors to meet that expectation. (See table 1.)

The NS16000 is the only microprocessor with full 32-bit capability in

Virtual memory is the expansion of the computer's capability to include both physical or main memory and external or secondary memory.

the arithmetic logic unit (ALU) and internal data paths; the other major microprocessors with 32-bit capability, those in the MC68000 family, have 32-bit registers but a 16-bit arithmetic logic unit and data path.

The NS16000 fully supports demand-paged virtual memory addressing, totally implemented by memory-management hardware. Transparent to both programmer and user, who see just an extension of the microprocessor instruction set, the NS16000's memory-management unit (MMU), the NS16082, is capable of providing a uniform 16 megabytes of virtual

memory per user, eliminating the disadvantages of memory segmentation schemes.

Virtual memory allows you to combine a minimum of expensive primary storage (main memory) with lower-cost secondary memory. In this way, you can take full advantage of extremely large operating-system software and applications programs (now offered on large mainframes) without worrying about the hardware limitations of your system.

The "symmetrical" architecture of the NS16000 means that any data type can be used with any instruction (where appropriate), any addressing mode, and any operand source or destination. Because of this, you may be able to accomplish a given task with fewer instructions than you would with a microprocessor that has a less regular instruction set.

Additionally, the NS16000 has high-level language architecture, which means that it can execute high-level language instructions at speeds and code densities approaching as-

About the Author

Glenn Leedy is the marketing manager of external software products for the National Semiconductor NS16000 family. He has worked as a systems-software development engineer at IBM, Sycor, and Digital Equipment Corporation. At DEC he also served on the VAX software design team and as strategic market planner for low-end and fault-tolerant/high-availability systems.

(1a)

System

- A total 32-bit high-performance computer system with slaved 32-bit and 64-bit floating-point processing and 16-megabyte uniform virtual-memory management
- This family of chips will be offered at 6-MHz and 10-MHz processing rates during 1983, and 12-MHz and 14-MHz in 1984

Hardware

Central Processing Unit

- True 32-bit instruction (registers, arithmetic logic unit, and data paths)
- Symmetrical architecture
- High-level language support
- Modular programming support
- Powerful instruction set:
 - Over 100 instructions
 - Addressing modes optimized for high-level language references
 - General two-address capability
 - Expansion via slave processors
- 48-pin package

NS16082 Memory-Management Unit

- Full hardware support for 16-megabyte uniform demand-paged virtual memory
- Dynamic address translation
- 32-entry translation cache
- Automatic instruction "abort" and "retry"
- Program debugging support:
 - Program-flow traceback
 - Two breakpoint registers
 - Break-on-branch mode
- Security implemented through access-level checking and dual-system and user address-space mapping
- 48-pin package

NS16081 Floating-Point Unit

- Both 32-bit and 64-bit operation
- 8 general-purpose 32-bit registers
- Direct memory-to-memory operation
- High-speed instruction execution:

	32 bit	64 bit
Add	7.4 μ S	7.4 μ S
Multiply	4.8 μ S	6.2 μ S
Divide	8.9 μ S	11.8 μ S

- Conforms to IEEE FPU format
- 24-pin package

sembly language. [This is an ambitious claim that will be verified only after advanced compilers have been written for this microprocessor and benchmarked. . . . G. W.] Traditionally, high-level language programs have taken up to three times longer or more to execute than assembly-language programs and have required substantially larger memory space. Information from users of NS16000-based systems leads us to believe that code produced by NS16000-based compilers averages 40 percent longer than that produced by a human assembly-language programmer. We have also found that such code is considerably more compact and runs faster than that produced by compilers for the other major microprocessors.

Consistent with its high-level language capability, the NS16000 family supports modular programming techniques that allow you to divide complex programs into simpler, independent tasks and routines, each of which you can easily link for maximum efficiency. The NS16000 microprocessors even let you dynamically reconfigure and link together ROM-based software modules meant for any NS16000-based system. This can be done by using the NS16000 *link table* facility (to access both external software modules and global variables) along with the "external" addressing mode available to all NS16000 instructions.

For more powerful performance in using high-level language programs,

(1b)

Microprocessor Characteristics

	NS16008	NS16032	NS16C032	NS32032	NS32132
registers	32 bit	32 bit	(low-power	32 bit	32 bit
arithmetic logic unit	32 bit	32 bit	CMOS	32 bit	32 bit
internal data path	32 bit	32 bit	version	32 bit	32 bit
external data path	8 bit	16 bit	of	32 bit	32 bit
real memory address	24 bit	24 bit	NS16032	24 bit	29 bit
virtual memory capabilities (with MMU support)	none	24 bit address (16 megabytes)	with same characteristics)	24 bit address (16 megabytes)	32 bit address (4 gigabytes)

Table 1: An overview of the NS16000 family hardware (table 1a) and various configurations of the microprocessor (table 1b).

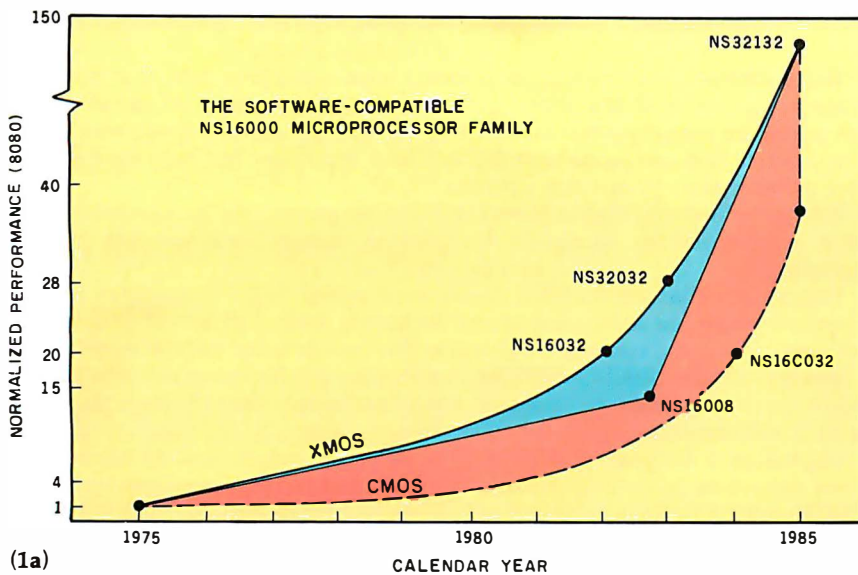

(1a)

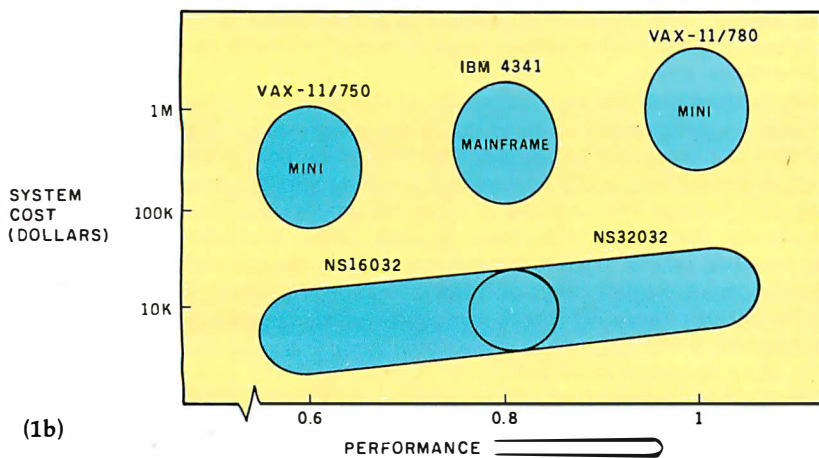

(1b)

Figure 1: The NS16000 family facts and performance. Figure 1a shows the performance of various members of the NS16000 family, while figure 1b compares the performance of the NS16032 and NS32032 with that of several minicomputers and mainframes.

the NS16000 features an instruction set with over 100 instructions, each of which is able to operate on up to five operand types. There are nine addressing modes, five of which enhance the use of high-level languages. In addition, all the code produced by the NS16000 instruction set is totally relocatable.

The NS16000 can execute operations (including all shift, logical, and arithmetic instructions) with both values in memory—known as a “two-address” capability. Combined with such features as multiple-way branching, a check instruction (to see if a value is within given limits), and

string instructions, it becomes easy to write compact programs in both high-level and assembly languages.

To carry out floating-point processing, memory management, or any other customized function for that matter, the NS16000 gives these operations to dedicated hardware. Such operations are made even faster by the use of special control and status lines that allow multiplexed inter-processor communication at speeds above normal processor-peripheral data-interchange rates. For example, the NS16081 floating-point unit (FPU) can carry out a divide operation in only 8.9 microseconds

(32-bit) and 11.8 microseconds (double-precision 64 bit) at 10 MHz, from 3 to 10 times faster than competitive units now on the market.

A comparison of the NS16000 family with popular minicomputers and mainframes now on the market shows how you can benefit from the high price/performance ratio of these microcomputers (see figure 1).

True Mainframe Performance

In order for a small microprocessor system to expand to the full capability of a mainframe, its architecture—the interface between the computer and its software—must optimize performance without compromising user protection. The system must accommodate the largest of user applications and yet remain cost-effective. Above all, it must be able to use the enormous software inventory now available on mainframes to avoid obsolescence and minimize cost. At National Semiconductor, we decided that the most effective way to achieve these design criteria was by implementing the following features: a highly symmetrical architecture, high-level language support, modular software support; a powerful instruction set, demand-paged virtual-memory support, and a memory-management unit.

Symmetrical Architecture

In the context of machine architecture, *symmetry* is the degree to which any data type can be used with any instruction, with any addressing mode, and with any operand source or destination. Symmetry is of paramount importance when implementing space- and time-efficient high-level languages.

High-Level Language Support

Programming in a high-level language (C, Pascal, PL/I, BASIC, FORTRAN, and COBOL, for example) is far more productive than programming in assembly language, which can be extremely tedious and time-consuming. A high-level language programmer often can produce the same number of debugged lines of code per day as an assembly language programmer; however, a line of high-

level language code usually performs a far more complex operation than a line of assembly-language code.

In the past, code generated by high-level languages required larger amounts of memory and took longer to execute. Depending on the compiler, computer, and applications, a compiled program might be well over three times longer and slower than the best assembly-language program. The basic reason: most contemporary architectures were not designed to support compilers.

The NS16000 family, with its symmetrical architecture, general-purpose registers, and other features, has eliminated these architectural deficiencies. Designed specifically to support high-level language compilers, the NS16000 family enables even relatively unsophisticated compilers to produce efficient code.

Because they can more efficiently translate high-level languages, compilers on the NS16000 can actually generate instruction-code densities approaching those of assembly language.

Another feature of the NS16000 is its *expanded addressing* capability. In addition to four standard addressing modes common to other microprocessors—register, immediate, absolute, and register relative—the new NS16000 has an additional five unique addressing modes oriented toward high-level languages: top-of-stack, memory, memory-relative, external, and scaled-index.

The *top-of-stack (TOS) mode* is useful for evaluating arithmetic expressions in a high-level language quickly and with a minimum number of instruction bytes. Any operand, or both operands, of an instruction may be referred to by the top-of-stack addressing mode. The operand is pushed onto the current stack, popped from it, or referenced without modifying the stack pointer. Most other microprocessors, which limit top-of-stack addressing to a small number of instructions, require several instructions to achieve the same result as one NS16000 family instruction.

The *memory mode* is similar to the standard register-relative mode,

Move instructions (5 instruction groups, 3 single instructions; total 18 instructions): These instructions move data among memory locations and registers. As with all instruction groups, the instructions that are part of an instruction group have three forms: byte (8 bits), word (16 bits), and double word (32 bits). Here, this means that many move instructions will work on 8-, 16-, or 32-bit quantities.

Integer arithmetic instructions (14 instruction groups; total 42 instructions): This group includes addition, subtraction, multiplication, division, remainder, and modulus operations.

Packed decimal instructions (2 instruction groups; total 6 instructions): The two operations are packed addition and packed subtraction. When used with 32-bit operands, this gives addition and subtraction instructions that work on 8-digit decimal numbers.

Integer comparison instructions (3 instruction groups; total 9 instructions): One instruction allows a comparison of a value with a 4-bit constant; normally, operands can be 8, 16, or 43 bits wide.

Logical and Boolean instructions (7 instruction groups; total 21 instructions): These instructions perform logical and, or, xor (exclusive or), and complement functions.

Shift instructions (3 instruction groups; total 9 instructions): This group includes a rotate instruction and both arithmetic and logical shift instructions.

Bit-manipulation instructions (7 instruction groups, total 21 instructions): This group includes various test, set, clear, and invert operations.

Bit-field instructions (4 instruction groups, 1 single instruction; total 13 instructions): This is a very useful group of instructions that allows you to interpret a series of bytes as a record of bits and manipulate arbitrarily placed subfields within this record.

Array instructions (2 instruction groups; total 6 instructions): One instruction checks a value to see if it is within an acceptable range of values; the other is used to help index into multidimensional arrays.

String instructions (3 instruction groups, 3 single instructions; total 12 instructions): This versatile set of instructions allows you to compare, skip over, or move strings. Various options allow the operations to take place starting at the end of the strings, working backward, and to continue until a match either occurs or doesn't occur.

Jump and linkage instructions (2 instruction groups, 16 single instructions; total 20 instructions): This set of instructions includes jumps, subroutine calls, case-like multiway branches, returns, jumps to external routines, and debugging-related instructions.

Microprocessor register instructions (5 instruction groups, 3 single instructions; total 18 instructions): These instructions manipulate the microprocessor's registers.

Miscellaneous instructions (3 single instructions): This group includes a wait, a no-operation, and a diagnostic instruction.

Floating-point instructions (4 instruction groups of 6 instructions each, 8 instruction groups of 3 instructions each, 4 single instructions; total 52 instructions): This group includes various floating-point arithmetic operations and instructions to convert to other forms. These instructions are available only if the NS16081 floating-point unit is connected.

Memory-management instructions (2 instruction groups, 4 single instructions; total 10 instructions): These instructions are available only if the NS16082 memory-management unit is connected.

Custom slave instructions (20 instruction types, most with more than one form): These open-ended instructions allow you to interact with an unspecified "slave" processor connected to the NS16000 family microprocessor. This scheme allows the NS16000 family to interact with performance-enhancing processors yet to be designed.

Table 2: An overview of the NS16000 family instruction set.

which allows memory to be accessed relative to one of four special-purpose registers. This mode simplifies many constructs needed by high-level language interpreters and compilers.

The *memory-relative mode* is used to manipulate fields in a record and allows pointers located in memory to be used directly without having to be loaded into registers, as with other microprocessors.

The *external mode*, unique to the NS16000, supports a modular soft-

ware concept (to be explained later), allowing modules to be relocated without traditional code modification in linkage editing.

The *scaled-index mode* is used to access elements in byte, word, double-word, or quadruple-word arrays. It computes the operand address from one of the general-purpose registers and a second addressing mode, which allows automatic indexing into tables of 1-, 2-, 4-, or 8-byte entries.

In general, high-level language programs reduce software obsolescence, one of the major problems facing the computer user, because these programs can be used on other systems with different architectures. In contrast, assembly languages are tailored to a specific computer instruction set and are rarely transportable.

Modular Software Support

Because the very complexity of large programs is one of the major factors contributing to software unreliability, decreasing the complexity increases reliability. Modular programming accomplishes this by dividing complex programming tasks into smaller and simpler subtasks, or modules, each of which performs a well-defined portion of the overall task.

You can develop each module independently of all other modules, without concern for inter-module addressing or *linking*. Using this approach, you can significantly reduce both software development costs and programming time. You can also increase program flexibility and simplify operating-system design.

Until the NS16000, microprocessors could not easily implement the concept of modular programming in ROM (read-only memory) because program code had to be modified to access specific data blocks and external procedures in a system. This significantly limited the use of programs written in ROM, which is unfortunate because if modules *could* be put into ROMs, you could build a very helpful library of ROM-based modules that could be used as needed in various applications.

Software modularity is an important issue because it is included in the structure of many high-level languages. For example, programs in Ada (a new Department of Defense high-level language) are composed of one or more subprograms, packages, or tasks, each of which can be compiled separately. In Pascal, program modules may refer to variables, functions, or procedures contained in another module by the use of extensions to the language.

Modular programs are more likely

to be correct and are easier to understand; hence, they are readily modified, maintained, and documented. And because inter-modular communication can be accomplished through well-defined interfaces, the inner operations of a module do not have to be known to another module.

An important part of modular programming, especially to the software designer, is the operating system. National Semiconductor realizes that one operating system, however successful, is not a sufficient software base for a new microprocessor. Because of this, the NS16000 will be supported by several choices in operating systems. The Pick operating system is a generic system already in use at nearly 20,000 facilities on a variety of computer systems. In the

**One of the
critical decisions
made by designers of
computer memory
organizations concerns
the "swapping" of
data in and out
of main memory.**

future, the following operating systems will also be available for the NS16000 family: Xenix (Microsoft's extended, licensed version of Bell Laboratories' Unix); Oasis-16 (Phase One Systems); CP/M, Concurrent CP/M, and CP/NET (Digital Research Inc.); and the UCSD p-System (Softech Microsystem's version, modified to use the NS16000's larger address space). Through these operating systems, you will have available a variety of application programs and programming languages.

A Powerful Instruction Set

In addition to symmetrical architecture, modular software, and expanded addressing, high-level languages on the new National Semiconductor microprocessor family are supported by a sophisticated instruction set, which determines computing capability and programming effectiveness.

In the NS16000, there are over 100 instructions (see table 2), all chosen on the basis of their frequency of use, and each able to operate on up to five operand types. Because the set is symmetrical, instructions can be used (where appropriate) with any length operand, in any addressing mode, and with any general-purpose register.

Demand-Paged Virtual-Memory Support

While large-address-space programs and multitask/multiuser environments have always existed, microprocessors have had a hard time servicing them. Developed over a decade ago, the microprocessor was designed as a general-purpose device that was software programmable and therefore an alternative to a prohibitively expensive special-purpose chip. In addition, early microprocessors were rarely capable of exceeding a memory address of 16K bytes. Even today, many microprocessor systems are limited to 64K bytes of total memory or memory segments.

Basically, there are three aspects of memory organization: the entire memory structure, which is how the logical memory looks to the user and program; the mapping of logical memory to actual (physical) memory, called *address translation*; and finally, *virtual memory*, which is the expansion of the computer's capability to include both physical or main memory and external secondary memory such as disk-drive systems, with switching between the two being handled automatically.

The NS16000 uses a virtual memory organization. This organization solves two problems: the need for logical address spaces larger than physical memory, and the expense incurred by adding main memory. With virtual memory, the NS16000 stores only a minimum of logical-address information in physical memory, with the remainder located in low-cost disk memory until that information is needed to carry out a program instruction.

The architecture of this memory

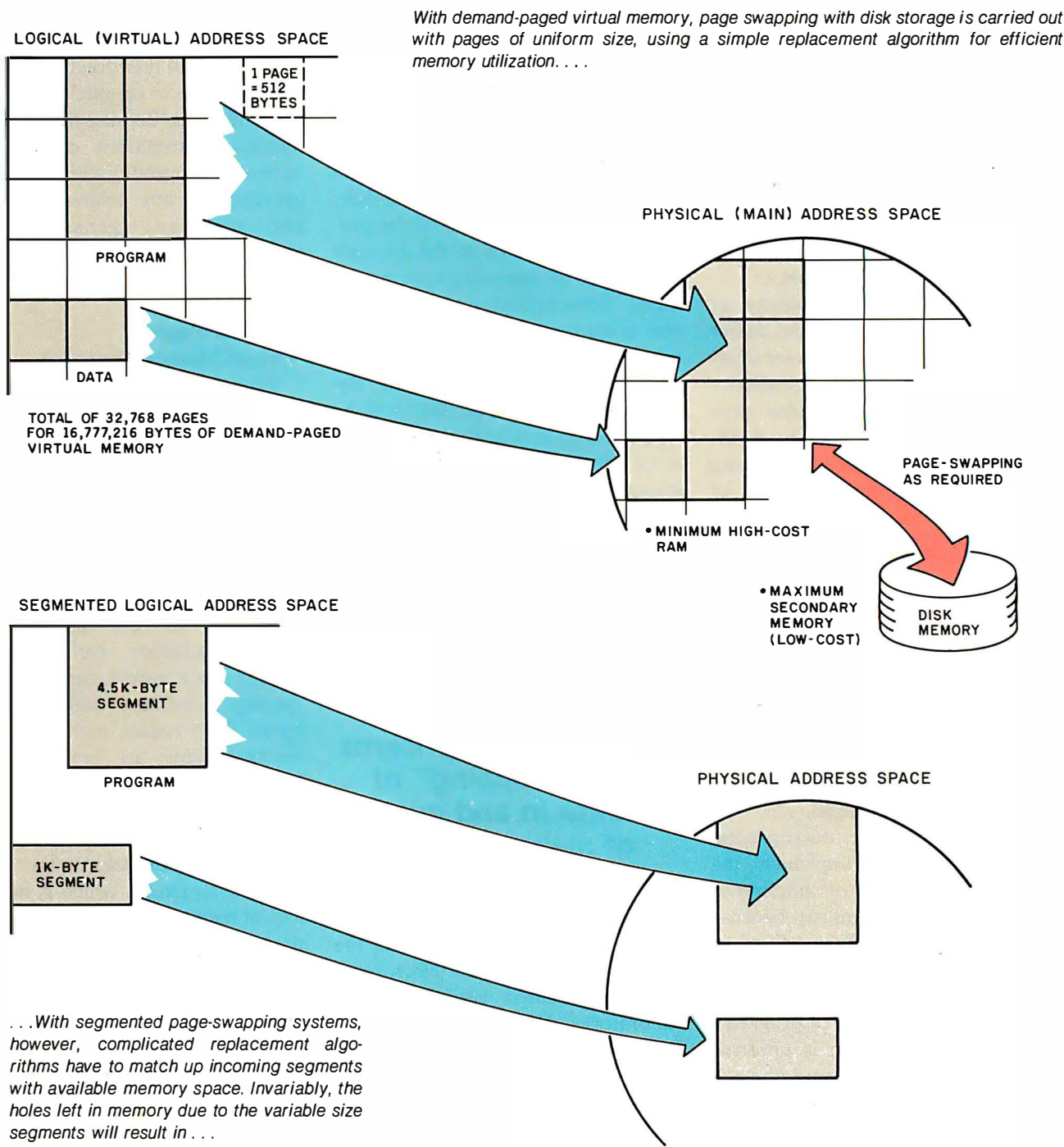

Figure 2: Fragmentation plagues segmented address space schemes.

organization is uniform rather than segmented. In a uniform address space, addresses start at location zero and proceed uniformly until the entire logical space is filled. A segmented address space consists of a collection of smaller uniform address spaces. (See figure 2 for some of the problems with segmented address space schemes.) One of the critical decisions made by designers of computer memory organizations concerns

the "swapping" of data in and out of main memory. This task must be accomplished quickly to carry out a program instruction, but additionally, the swap should contain as little unusable data as possible. The size of this swap is called a page, and in a uniform memory space, it can be any size the designer wants it to be. In a segmented memory system, the size of the swap is already determined by the size of the segment. The NS16000

has the entire 16-megabyte virtual memory divided into 32,768 pages of 512 bytes each.

The NS16082 Memory-Management Unit
 Successful management of the virtual-memory system is the function of the NS16082 memory-management unit. In addition to translating the logical (virtual) addresses generated by the NS16032/NS16C032/NS32032

SEGMENTED
PHYSICAL ADDRESS SPACE

...fragmentation. This occurs when—as page segments are swapped—larger segments begin to be replaced by smaller segments, creating unused free space. . . .

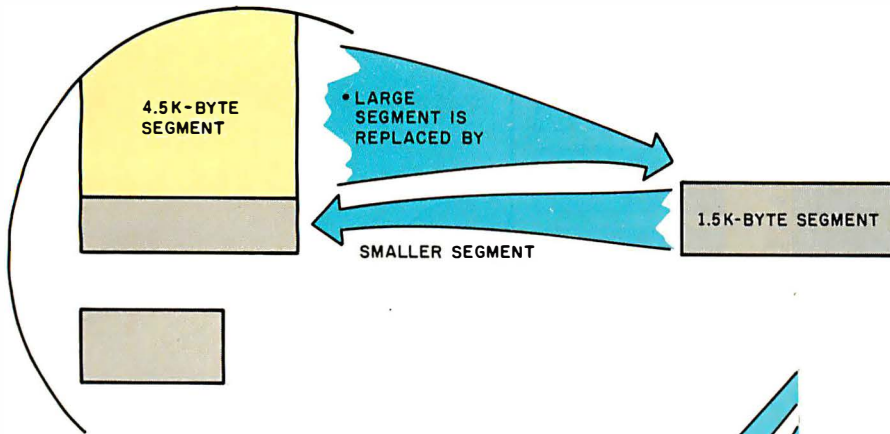

...Eventually, as memory begins to fill up and enough smaller segments replace large segments, there will not be enough space to accommodate larger segments. . . .

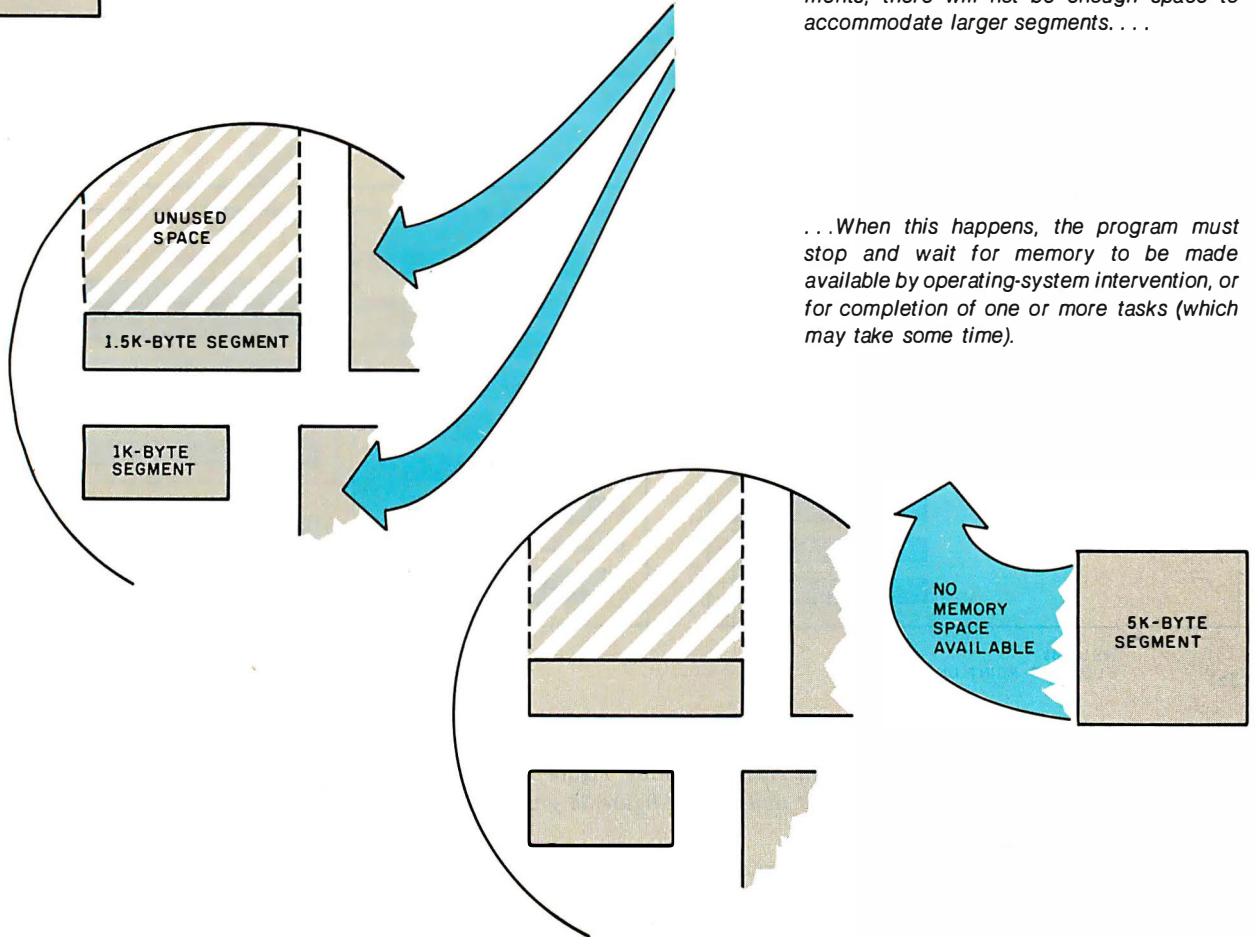

...When this happens, the program must stop and wait for memory to be made available by operating-system intervention, or for completion of one or more tasks (which may take some time).

Figure 2 continued

microprocessors into physical addresses, the memory-management unit can abort an instruction during execution by the microprocessor to load a nonmemory resident page and retry the same instruction immediately afterward. This feature is unique to the NS16000 system and is fully implemented in hardware.

Figures 3a and 3b give the logical and physical interconnections of the microprocessor and its memory-man-

agement and floating-point units. Important functions carried out by the memory-management unit are dynamic address translation using memory-page tables, on-chip cache for most recently used page-table entries, instruction abort and retry, and system debugging.

In *dynamic address translation*, the memory-management unit keeps track of the logical address requested by the microprocessor and its corre-

sponding values in physical memory at all times. To do this, it uses page tables containing pointers that indicate where to go in physical memory (see figure 4). Surprisingly, both page and pointer tables do not require large amounts of memory. An entire 16-megabyte virtual-memory map will use only one 1024-byte page table to point to 256 pointer tables of 512 bytes each for a total of 132,096 bytes devoted to mapping, or approximate-

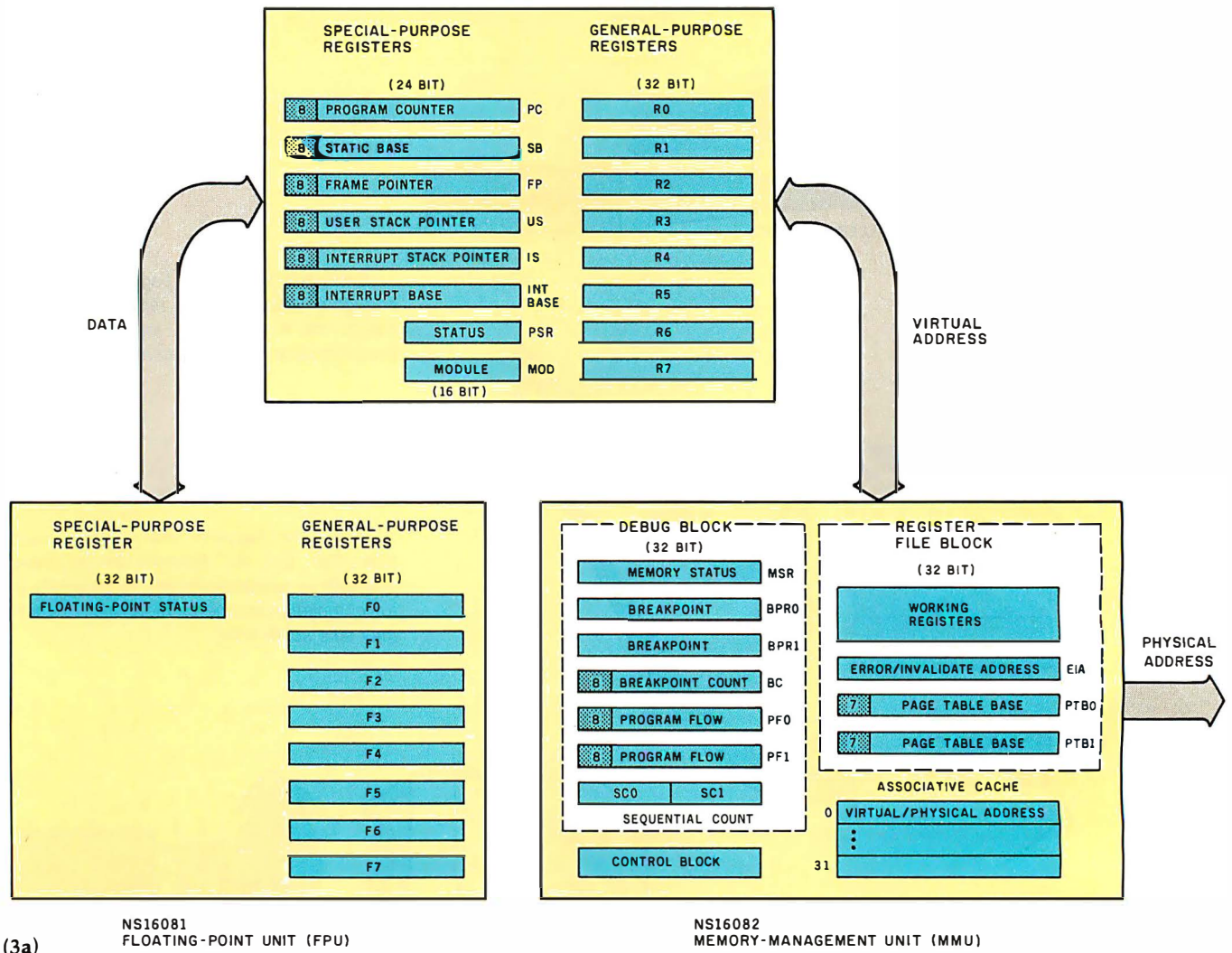

Figure 3: Component interconnection in the NS16000 family. Figure 3a shows the logical interconnection of the microprocessor and its memory-management and floating-point units, while figure 3b gives an overview of the physical interconnections.

ly 0.8 percent memory overhead. The memory-management unit NS16082 provides an entire 16-megabyte virtual address space for each user.

The address space itself is divided into fixed pages of 512 bytes each, which enables the NS16000 to transfer data into and out of memory quickly.

When the microprocessor passes a virtual address to the memory-management unit, the latter first attempts to match it with a special *associative cache* contained on the chip. This cache contains the 32 most recently accessed virtual addresses, as well as their translated physical addresses. If

the address requested by the microprocessor matches one of the 32 cache entries, the microprocessor is allowed access to the physical address immediately (see figure 5a). This virtual-to-physical address translation can occur in just one clock cycle, or 100 nanoseconds with a 10-MHz microprocessor clock. However, if the requested address is not present in the cache, the memory-management unit must fetch both page and pointer table entries from memory before address translation can be performed (see figure 5b). This can take up to 20 clock cycles, or 2 microseconds with a 10-MHz microprocessor clock.

The memory-management unit's associative cache, which operates transparently to the user, is an extraordinarily powerful tool in enhancing processing speeds. We have calculated that an address will be present in the cache about 97 percent of the time. This means that 97 percent of the data can be addressed with a typical virtual delay overhead of only one clock cycle.

The memory-management unit's *instruction abort and retry* features are perhaps its most significant. After fetching and decoding an instruction, the microprocessor sends the virtual addresses of the operand to the mem-

SYSTEM CONNECTION
DIAGRAM

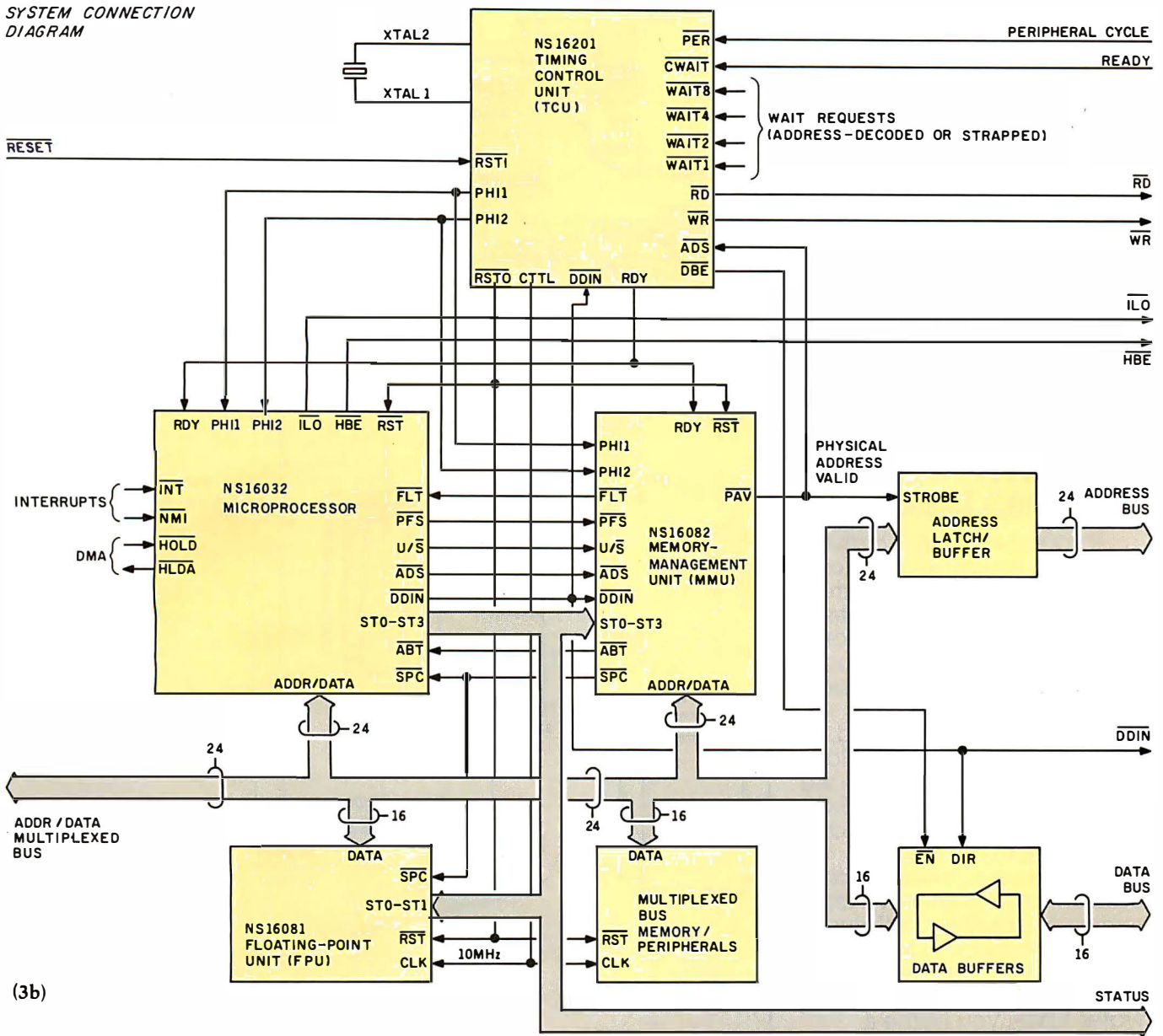

(3b)

ory-management unit. If the memory-management unit decides that the information resides in main memory, it translates the virtual address to the physical address directly, allowing the microprocessor to operate directly on the memory.

However, if the data does not reside in one of the pages of main memory, the memory-management unit will initiate a *page fault* and send a signal to the microprocessor to abort its instruction. (A memory-access abort will also occur if the microprocessor tries to access a protected section of memory.) Once the instruction has been stopped, any

register that had been altered by the instruction will be returned to its original state.

A page fault is a hardware-generated trap that, in essence, tells the operating system to bring in the missing page containing the data from disk memory. (To signal whether a page or pointer-table entry is present in main memory or not, the page entry contains a "valid bit" for that purpose.)

Once a page fault is detected and an instruction aborted, the microprocessor then calls up the virtual-memory operating system routine, which locates the proper page con-

taining the data in peripheral memory and loads it into main memory (see figure 5c). If no room exists in main memory, it is swapped with a page that is determined to be the most expendable (or least likely to be recalled). If the operating system can do multitasking, it is free to do other tasks while pages are being loaded. When the operating system has completed its page swap, it executes a "return from trap" instruction and the aborted instruction resumes.

Debugging is handled by the memory-management unit with *breakpointing* and *flow-tracing* techniques. Breakpointing is a tool used to test if

INDUSTRIAL BUILDING COSTS.

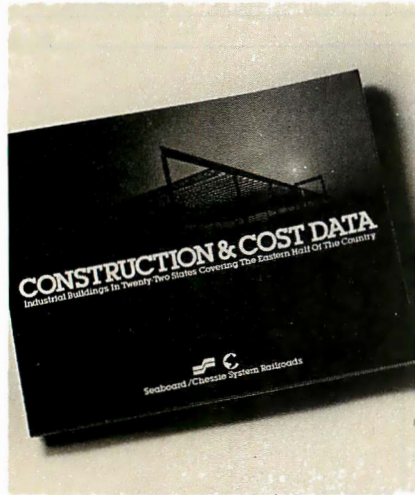

Write For Our 1983 Brochure.

If your company is actively seeking a rail-served site for a new manufacturing or warehousing operation, your best single source for information is the CSX Corporation's railroads.

Our rail units, the Chessie System Railroads and the Seaboard System Railroad, serve 22 states across the East, Midwest and Southeast. So we can help you find the site that suits you best, with impartial and in-depth information.

We offer you construction costs on a representative cross section of industrial buildings, the facts on more than 5,000 different sites, plus the latest data on transportation, labor, water, taxes, you name it.

For your free copy of our 1983 Construction & Cost Data brochure, write: J.R. LeGrand, Vice President Industrial Development, CSX Railroads, Dept. CS-13, 500 Water Street, Jacksonville, Fla. 32202.



CSX Corporation



Chessie System Railroads



Seaboard System Railroad

Chessie System Railroads and Seaboard System Railroad are units of CSX Corporation. © 1983 CSX Corporation

LOGICAL (VIRTUAL) MEMORY
32,768 PAGES

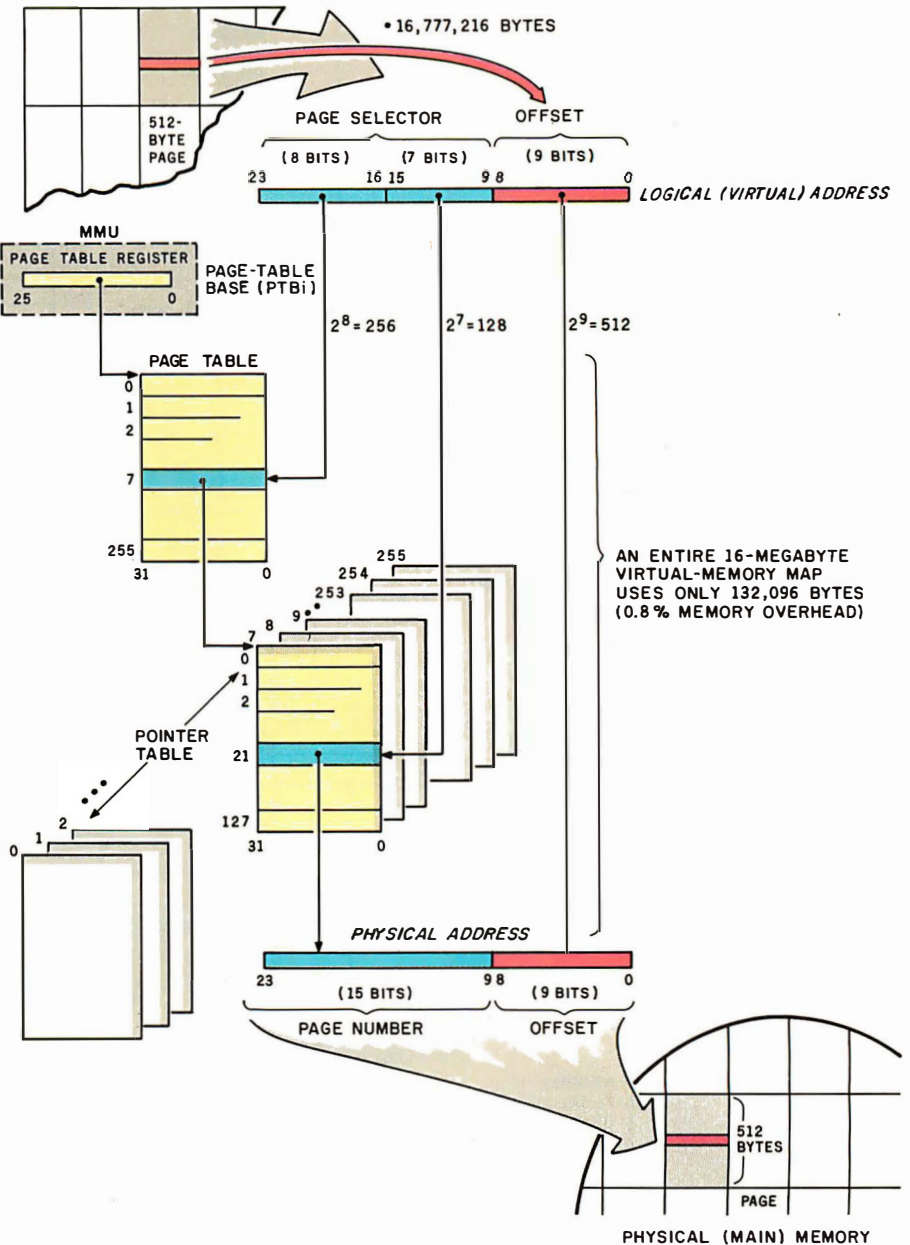

Figure 4: Dynamic address translation in the NS16000 family.

program execution is proceeding as planned. It can also be used to monitor data access. Often, a programming error may cause control to pass to a known location for some unknown reason. By using program flow tracing, the memory management unit follows the chronology of a program so that you can determine what went wrong. And because the memory-management unit's debugging facilities use hardware rather than software, they do not add to program execution time; therefore, these facilities can be used in a pro-

duction and a development environment.

The NS16081 Floating-Point Unit

To understand how a floating-point unit can enhance an application area, you must first realize the advantages a floating-point unit brings to a microprocessor. First, all floating-point units allow a microprocessor system the flexibility of handling a great numeric range (either large or small) beyond the normal range of a microprocessor's registers.

Several factors must be considered

How Dow Jones News/Retrieval[®] Helps You Take Control Of Your Investments

Successful investing takes more than instinct and hard work. To really take control of your investment future, you need fast, accurate information from a reliable source. The kind of information that comes from Dow Jones, the world's leading provider of business and financial news. Now the publisher of The Wall Street Journal and Barron's gives you instant, electronic access to this exclusive information in the convenience of your home or office.

Here's All You Need To Take Control

All it takes is a personal computer, a telephone, a modem to hook them up, and Dow Jones News/Retrieval[®]. The same service that's the number one choice of active investors and major corporations, including the top 15 U.S. banks and most brokerage firms.

Track Stock Quotations

Current stock quotes during market hours (delayed 15 to 30 minutes from the floor of the exchange) for over 6,000 companies. Yesterday's closing. Today's opening. Plus high/low data, volume traded, and historical quotes back to 1978.

A Powerful Investment Research Tool

Review news that could affect your current and future holdings. Receive constantly updated news items from the Dow Jones News Wire (as recent as 90 seconds). Check news stories from The Wall Street Journal and Barron's as far back as 1979. Examine corporate and industry profiles, SEC data; corporate earnings forecasts; detailed current and historical financial statistics; weekly economic updates; and other important financial data.

And now Dow Jones has introduced software you can bank on. Dow Jones Software helps you get on-line fast and makes it easier for the serious investor to analyze and manage data gathered from the News/Retrieval Service.

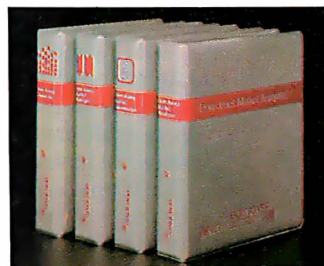

It's Easy And Inexpensive

You need no specialized computer skills or technical know-how and it's surprisingly inexpensive. The cost of the service is even tax deductible in many cases. Check your tax advisor for more information.

Ask for a free demonstration at your nearest computer store or call the toll-free Dow Jones Hotline.

CALL TOLL FREE
1-800-345-8500, Ext. 5
(Canada, Alaska & Foreign call 1-215-789-7008, Ext. 5)

DOW JONES
NEWS/RETRIEVAL[®]

The following are trademarks of Dow Jones & Company, Inc.:
Dow Jones News/Retrieval[®] and Dow Jones Software[™]



How to Support Personal Computers in an SNA/SDLC Network.

When it comes to supporting Personal Computers in the SNA/SDLC world, we wrote *the* book: PCI's compendium including glossary, diagrams, explanations of how the PCI 1076 protocol converter provides SNA/SDLC 3270 support, brings information on your SNA host to the Personal Computer's diskettes - and more.

- Send me the PCI Personal Computer Support book.
- Send me information on the software packages that permit transfer of files between PC diskette and SNA/SDLC mainframe host:
- PCI 7887+ for 3270 emulation
- PCI 5156+ for Sys 34/38 emulation
- Send information on all PCI Products.
- PCI 1076

Name _____
 Company Name _____
 Address _____
 City _____ State _____ Zip _____
 Phone _____

PCI **PROTOCOL**
 COMPUTERS, INC.

6150 Canoga Avenue, Suite 100
 Woodland Hills, CA 91367-3773
 (800) 423-5904 (213) 716-5500
 (In California)

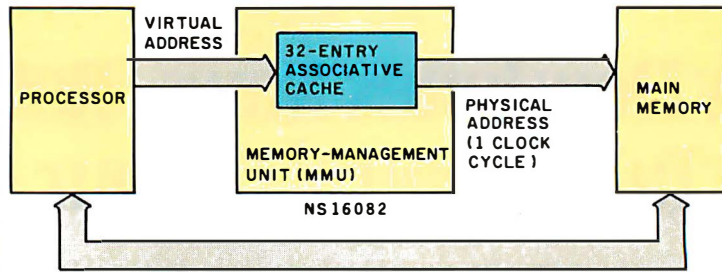

(5a)

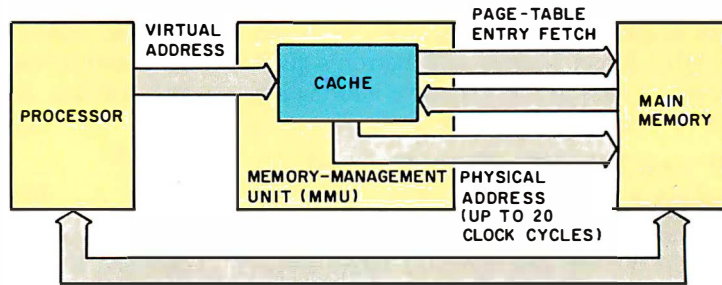

(5b)

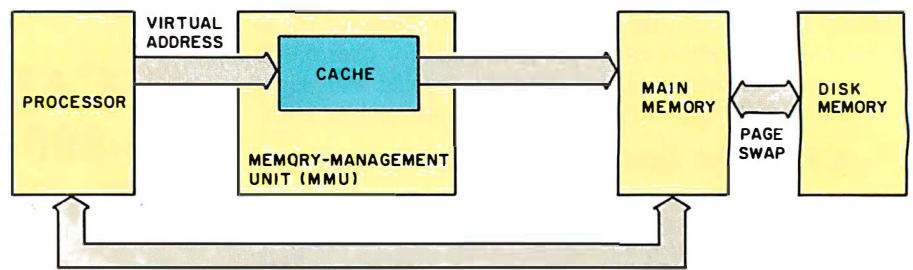

(5c)

Figure 5: Memory access through the NS16082 memory-management unit. If the page-table entry (PTE) is in the cache memory of the memory-management unit and the program page is in memory (figure 5a), data addressing is completed in only one clock cycle (100 nanoseconds with a 10 MHz system clock). If the page is resident in main memory but the PTE is not in the cache memory, a page-table entry must be fetched from main memory (figure 5b), normally requiring up to 20 clock cycles (2 microseconds). If the page is resident in disk memory, it must first be swapped into main memory (figure 5c), after which it is treated as in figure 5b.

when designing a floating-point unit into a system. These include the method for handling a specific operation or instruction, the permissible length of actual data (operands), the amount of support that the floating-point unit expects from the rest of the system, and the interconnection schemes to enhance data communications to and from the chip.

The design of the NS16000 family fully supports 32-bit and 64-bit precision floating-point calculations through its NS16081 floating-point unit (FPU); the unaugmented microprocessor will handle 8-, 16-, and

32-bit fixed-point calculations. The NS16081 contains eight general-purpose onboard 32-bit registers, which you may use to provide either a single-precision (32-bit) or double-precision (64-bit) number (see figure 6).

While the eight general-purpose registers are reserved for actual data, a ninth 32-bit status register holds both control and error information. Control options include enabling microprocessor traps and floating-point error conditions and setting the operand rounding mode. Error conditions include traps for overflow, underflow, illegal division (division

TODAY'S PRODUCTIVITY IS TOMORROW'S PROFIT.

That's why Quark designs office automation software to increase your productivity. With programs that will dramatically enhance your Apple[®] III or IIe. So you'll do more work—more efficiently—in less time—for less money.

And all Quark programs are extremely friendly. So you can devote your efforts to using them, not learning them. Yet you'll discover many sophisticated features no other software can offer.

Find out for yourself. See your dealer today for a complete demonstration of our Word Juggler[™] word processing system. And innovative utilities programs, such as our Catalyst[™] hard disk boot.

Because tomorrow belongs to the productive. And who wants to be left behind in yesterday?

Quark Incorporated,
2525 West Evans, Suite 220,
Denver, Colorado 80219,
(303) 934-2211.



Quark[™]
INCORPORATED
Office Automation
Software

Circle 358 on inquiry card.

*Apple is a registered trademark of Apple Computer, Inc.

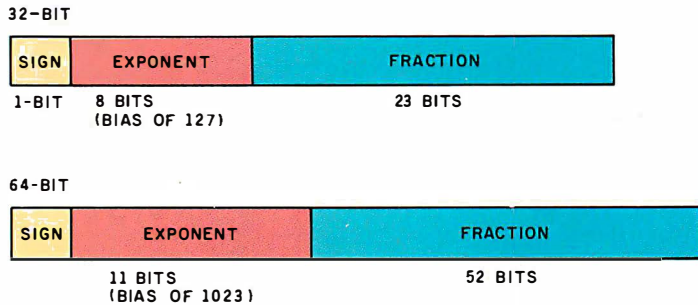

(6a)

FPU SYSTEM IMPLEMENTATION

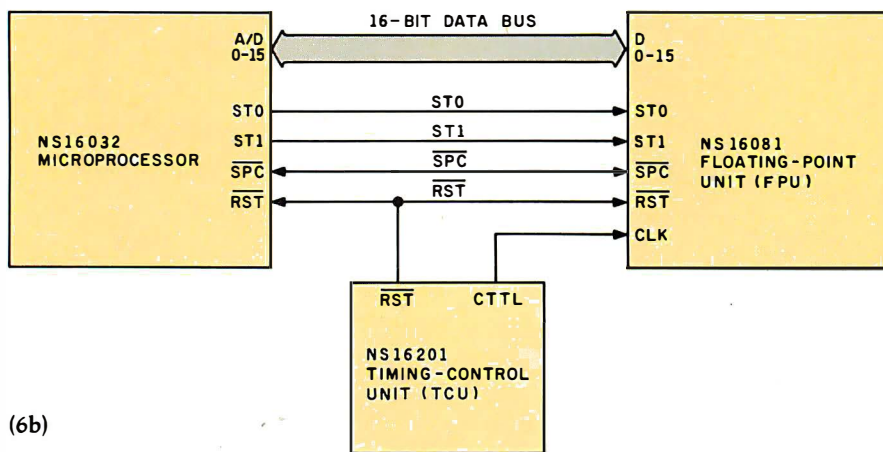

(6b)

Figure 6: Floating-point numbers in the NS16000 family. Figure 6a shows the NS16000 format for standard (32-bit) and long (64-bit) floating-point numbers. Figure 6b shows an overview of the physical interconnection between the microprocessor and the floating-point unit.

by zero), illegal instructions, inexact results, and undefined operand (for example, all-zero or all-one exponents). The programmer can individually enable or disable all the traps.

Unlike other microprocessor systems that support floating-point operations, the NS16000 architecture makes available to the floating-point unit all the system addressing modes, which aids efficient data handling. For example, in a scaled-index mode, an entry in a large array of floating-point data elements may be addressed by its logical index rather than by its physical address. This not only facilitates finding the data, but eliminates

wasting time with unnecessary programming schemes.

Used in conjunction with the NS16082 memory management unit to simplify large-memory management and data retrieval, the NS16081 floating-point unit becomes an even faster and more efficient data cruncher. For example, not only are a full 16 megabytes of virtual memory available for data storage, but all of the data-retrieval, dynamic-address, and memory-protection capabilities of the memory management unit become part of floating-point routines.

The instruction set of the NS16081 floating-point unit is compatible with

the proposed IEEE floating-point standard; its instruction set is summarized in table 2. The floating-point instructions use the same addressing modes as the other NS16000 instructions.

For greater speed, separate processors in the floating-point unit operate on each of the three principal segments of a number residing in either a 32-bit or 64-bit register—all under control of microcode. The first segment (containing 1 bit) is reserved for the sign, the second segment (8 or 11 bits) for the exponent, and the third segment (23 or 52 bits) for the fraction or mantissa.

Conclusions

The simplicity and efficiency of some of the concepts discussed here might lead you to believe that popular large computer systems would have integrated these features into their designs long ago. Not so. The IBM 360, 370, 43xx, and 30xx, for example, well known for their number-crunching abilities, do not possess symmetrical architectures, nor do they show much support of high-level languages and modular software. And—despite their high cost—these large systems currently offer no more than 16 megabytes of virtual memory. In these systems, sophisticated functions are carried out by slow, complex software, with lost time being made up by speedy (and costly) parallel-processing hardware techniques.

Digital Equipment Corporation's VAX minicomputer systems, on the other hand, do have a high degree of symmetrical architecture and support virtual memory. As a result, they offer a full 32-bit, 4-gigabyte virtual memory but at a cost some 20 to 30 times that expected for systems now being developed by manufacturers using National Semiconductor's new 16-/32-bit NS16000 family.

In short, the NS16000 family offers features formerly available only in much larger systems but in a combination not available on any one system. This family of microprocessors promises to be the foundation of a new generation of high-performance, low-cost computers. ■

Disk Storage Needn't Double The Cost Of Your Apple III*™



Expanding disk storage on your Apple III*™ can be an expensive proposition.

But Micro-Sci has a better proposition for you, because our disk drives for the Apple III give you greater capacity and performance for every dollar spent.

And no compatibility problems. The A3 is a direct replacement for Disk III drives, and the 70-track A73 and 140-track A143 are supplied with a driver that is easily added to the SOS driver module, affording extra storage and fast seek rates for all of the programs that run under that operating system.

All three are the same 5¼" size as your built-in drive and use the same diskettes.

They also use your Apple III's controller and



power, saving an expansion slot and no AC power cord. And they can be mixed in any combination on the daisy-chain. At 572 KBytes, the A143 makes a truly viable backup device for the ProFile Hard Disk.

At 286 KBytes, the A73 gives you a lot more capacity than a Disk III drive.

The A3 offers identical capacity — and is an excellent choice for second drive compatibility in the Apple II emulation mode.

So see your Micro-Sci dealer today.

He'll show you how to up your Apple III's performance the affordable way.

μ-SCI

MICRO-SCI

Micro-Sci is a Division of Standun Controls, Inc.

2158 SOUTH HATHAWAY STREET • SANTA ANA, CALIFORNIA 92705 • 714/662-2801 • TELEX: 910-346-6739
International Dealer Inquiries.... IMC International Markets Corp. Telephone: 714/730-0963 • Telex: 277782-ROBY UR

*Registered Trademark of Apple Computers, Cupertino, California.

Circle 276 on inquiry card.

ONLY

THE NEW ATARI 1200XL HOME COMPUTER MAKES SOPHISTICATED GRAPHICS AND SOUND SO EASY TO PROGRAM.

ONLY the new ATARI 1200XL Home Computer combines custom microchip technology with 64K RAM computing power to deliver graphics and sound capabilities that are so easy to program. The ATARI 1200XL has 11 graphics modes and 5 text modes. (The Commodore 64 and Apple II-e have only 2 graphics modes and 1 text mode.) Additional text and graphics modes allow users to easily program sophisticated graphics effects with relatively few commands, taking full advantage of the 256 color variations available. The sound capabilities of the ATARI 1200XL are also easy to program. Four distinct "voices" spanning 3½ octaves are controlled by a separate microchip, leaving the principal microprocessor chips free to perform other tasks.

ONLY the ATARI 1200XL offers a keyboard featuring 8 programmable function keys controlling 16 functions in a 64K computer. (That's twice as many as the Commodore 64). Four new function keys enable you to lock and unlock the keyboard electronically, disable the screen DMA for faster processing time, generate European language or graphics characters, turn the keyboard sound on and off or access the one-touch cursor control. The unique user-definable "help"

THE NEW

key permits users to self-test ROM, RAM, audio-visual circuitry and keyboard functionality or call up assistance within complex programs. For even more help, Atari gives you a toll-free number to call for product and technical information (800) 538-8543; in California 1-(800) 672-1404.

ONLY the ATARI 1200XL offers you a home computer compatible with virtually all ATARI Computer peripherals and software (compatibility that other new computers like the Commodore 64 don't offer). There are over 2,000 programs and seven programming languages currently available for the ATARI 1200XL. New programs like AtariWriter™ and languages like ATARI Microsoft BASIC, Assembler Editor, PILOT, Pascal, ATARI BASIC, Forth, and Macro Assembler offer you even greater programming challenges and flexibility.

ONLY Atari puts so much more in the new 1200XL Home Computer so you get so much more out of it.



ATARI® 1200XL™

HOME COMPUTER

Design Philosophy Behind Motorola's MC68000

Part 1: A 16-bit processor with multiple 32-bit registers.

Thomas W. Starnes
Motorola Inc., Microprocessor Division
3501 Ed Bluestein Blvd.
Austin, TX 78721

In the mid 1970s at Motorola, a new idea was taking shape. As more and more demands were being made on the MC6800 family of microprocessors, the push was on toward developing greater programmability of a 16-bit microprocessor. A project to develop the MC68000, known as Motorola's Advanced Computer System on Silicon (MACSS), was started.

The project team began with the freedom to design this entirely new product to best fit the needs of the microprocessor marketplace. Developers at Motorola explored many possibilities and made many difficult decisions. The result can be seen in the MC68000, viewed by most industry experts as the most powerful, yet easy to program, microprocessor available. In this first of four articles, I will discuss many of the philosophies behind the design choices that were made on the MC68000.

Many criteria can qualify a processor as an 8-, 16-, or 32-bit device. A manufacturer might base its label on the width of the data bus, address bus, data sizes, internal data

paths, arithmetic and logic unit (ALU), and/or fundamental operation code (op code). Generally, the data-bus size has determined the processor size, though perhaps the best choice would be based on the size of the op code. I'll talk a bit about these features and then show how the MC68000 is both a 16- and 32-bit microprocessor.

Shaping a Design

Designers must make hundreds of decisions to shape the architecture of a new microprocessor. The needs of the users of the new product must be considered as the most important factors. After all, the users are the ones who really need a functional product, and if they are not happy with the features or performance, they will keep looking for a better alternative.

Unfortunately, it may be impossible to meet all of the needs of the users due to certain design limitations. The design must be inexpensive enough to produce in mass quantity. Also, current technology will permit only certain types and numbers of circuits to be manufactured on a silicon chip. These are the foremost factors that dictate the upper limits of the capabilities of a microprocessor.

In planning the new 16-bit MACSS, designers had to make a decision

concerning the general architecture first. What should it look like? A great deal of software written for the MC6800 family already existed. A processor that provides enhancements over an older processor, yet can run all of the programs for the older processor, has a real asset: it can capitalize on the existing software base. This may attract users by ensuring that they won't have to rewrite at least some of their programs.

Unfortunately, architectures, such as the early 8-bit microprocessors, were rather crude. Because they were designed to replace logic circuits, not enough thought was put into the software aspect of the parts. Their instruction set was oriented toward hardware. The designers did not consider carefully the future of these products, their expandability and compatibility. To try to design a microprocessor to be compatible with the older 8-bit parts was limiting.

Designers at Motorola decided that the new MACSS should be the fastest, most flexible processor available. They would design it for programmers, to make their job easier, by providing functions in a way that most programmers could best use them.

Early on, it appeared that to have a really powerful new generation of microprocessors, a totally new

About the Author

Thomas Starnes is an electrical engineer who has spent the last five years helping to plan the direction of the MC68000 family of processor products for Motorola.

FRANKLIN'S BAKER'S DOZEN!



13 Good Reasons to Buy the **ACE1200**

1. **Apple® II-compatible**
2. **CP/M®-compatible**
3. **128K of RAM**
4. **Built-in floppy disk drive**
5. **Disk controller**
6. **80 column card**
7. **Serial interface**
8. **Parallel interface**
9. **Upper and lower case**
10. **VisiCalc® keys**
11. **Cursor control pad**
12. **Numeric pad**
13. **Auto repeat keys**

Extras can more than double the price of your personal computer. Not so with the Franklin ACE 1200. It's the professional computer system that includes the extras—and a long list of exclusive Franklin features that make it the most extraordinary value on the market today.

The ACE 1200 has everything you'll need to add a color or black and white monitor, modem, printer, back-up disk drive and other accessories. You can choose from the enormous selection of Apple programs and peripherals because the ACE 1200 is hardware- and software-compatible with

the Apple II. And, with the built-in CP/M card, you can run both Apple II and CP/M programs. Franklin's CP/M operates three times as fast as many competing systems, drastically reducing processing time for most business applications.

The Franklin ACE 1200—the most extraordinary value on the market today. Call or write today for the name of your local authorized Franklin dealer.

Franklin ACE is a trademark of Franklin Computer Corporation. Apple is a registered trademark of Apple Computer Inc. CP/M is a registered trademark of Digital Research Inc. VisiCalc is a registered trademark of Visi Corp.



FRANKLIN
COMPUTER CORPORATION

7030 Colonial Highway, Pennsauken, NJ 08109 609-488-1700

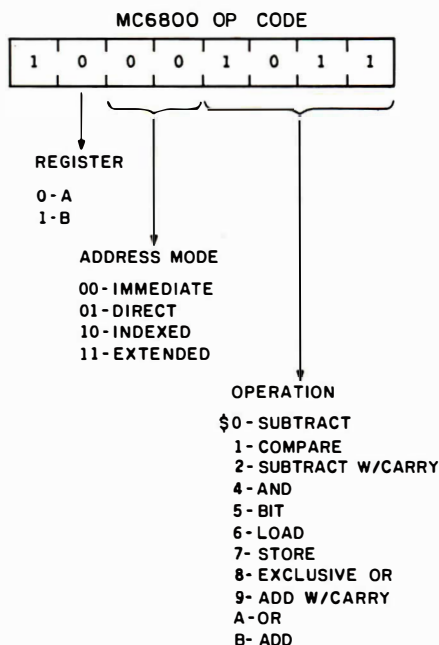

Figure 1: Op code organization for the MC6800. This processor is limited in its abilities because of its 8-bit size.

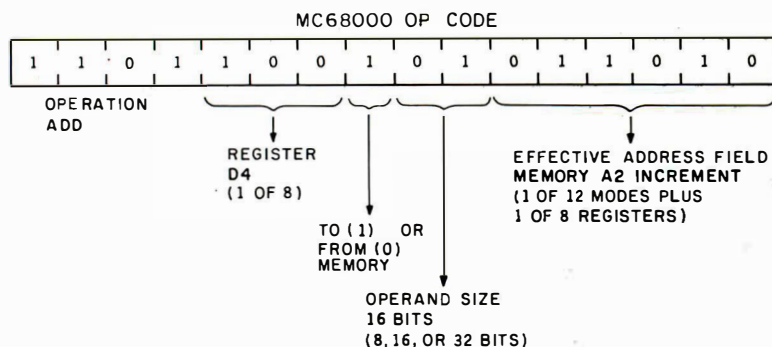

Figure 2: The MC68000 ADD instruction op code shows the power available with 16-bit operations. Multiple registers with variable operand sizes and a large address field give a programmer tremendous flexibility in programming.

architecture should be used and that earlier designs should be considered as examples rather than as models. This gave the MC68000 designers the freedom to introduce completely new concepts into microprocessors and to optimize the functionality of the new chip.

The planners decided there was one area in which ties to the 8-bit product family would be advantageous without exception. That area was in peripherals. Motorola decided that this new 16-bit microprocessor would directly interface to the 8-bit

collection of MC6800 peripherals. Because so many input/output (I/O) operations are 8-bit oriented, it seemed logical to retain this compatibility even though the 8-bit microprocessor interface would naturally be about half as fast as a comparable 16-bit. Compatibility with 8-bit MC6800 peripherals had the added benefit of immediately ensuring support of the new microprocessor with a complete family of peripheral chips, rather than requiring a wait of perhaps years for 16-bit versions to become available.

Expanded Capabilities

A properly designed 16-bit microprocessor has many advantages over the most sophisticated 8-bit microprocessor, especially to the programmer (see figures 1 and 2). The 8 bits of op code for the smaller processor provide only 256 different instruction variations. This may seem to be a lot at first glance, but consider the following.

If the microprocessor has two registers from which to move and manipulate data, those two registers require 1 bit for encoding the op code. If four different addressing modes are offered for accessing memory data, these require 2 more bits for encoding. This leaves the microprocessor with only 5 bits with which to encode the operation to be performed. Only 32 different operations can be performed.

Now admittedly this is plenty of operations for most applications, but realize that only two data registers and four memory-addressing modes are not very many to someone doing serious programming. Registers are there for fast data manipulation, and constantly swapping the contents of too few registers is not very fast. A more powerful microprocessor would have many registers, and they would all have to be accessible by the different operations.

Additionally, the more addressing modes you have for accessing memory data, the more efficiently you can get values in memory. Obviously, 8 bits of op code cannot give the microprocessor both the variety and the number of operations that a good 16-bit microprocessor can. With 64,000 different instructions possible in a 16-bit op code, you can perform far more complex operations.

This, then, is the real advantage of 16-bit over 8-bit microprocessors to the programmer. A 16-bit microprocessor will have twice the data-bus width of the 8-bit version. This wider bus allows twice as much information to go in and out of the processor in the same amount of time. This can, with proper internal design, almost double the rate at which operations take place over the rate of a similar 8-bit machine. Sixteen-bit micropro-

Performance Breakthrough...

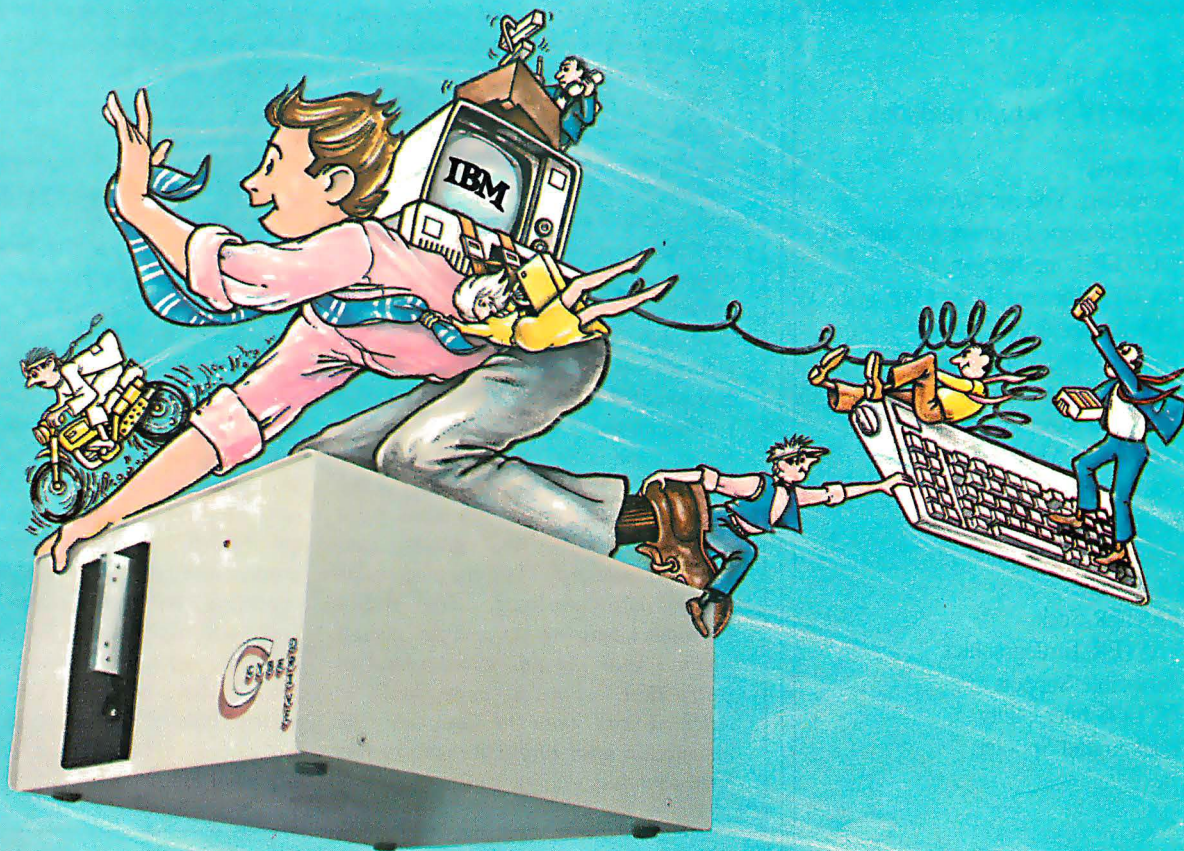

... the **CYBERDRIVE™** for the IBM Personal Computer 13.5 or 27 million bytes of disk capacity in a single cabinet with an integrated mini-cartridge tape for secure data backup.

Setting an exciting new microcomputer standard, the **CYBERDRIVE**¹ combines a full package of features.

It offers new, higher performance levels, with an integrated business-oriented backup device.

As the **CYBERDRIVE** is made available for other systems, media transfer is assured regardless of the host hardware or Operating System.

The **CYBERDRIVE** slashes the seek time dramatically—e.g. the usual 5 Megabyte stepper-motor Winchester disk offers average seek time typically in the range of 100 to 200 milliseconds (incl. head settling).

With the **CYBERDRIVE**, the average seek time across more than five times as much data is only 33 milliseconds (incl. head settling).

This basic speed, coupled with disk cache buffering and a peak transfer rate of 1 million bytes per second, make the **CYBERDRIVE** a performance champ!

The integrated mini-cartridge tapes used for backup of data allow dumping of (for example) 10 million bytes of data in about 10 minutes... much faster than other tape or floppy disk backup techniques. Hardware read-after-write error checking is incorporated in the tape device.

... And don't fail to ask about our superb lineup of serious business software (also offered in **CYBERDRIVE** format) including:

RM/COBOL² compiler—the micro industry standard.

MBSI³ **RM/COBOL** general business applications (derived from **MCBA**⁴ minicomputer packages)... thousands in use... money back guarantee... source program license.

CRT!¹ from Cybernetics (**COBOL Reprogramming Tool!**)—Program generator for **RM/COBOL** to ease program development and maintenance... an alternative to a Data Base System.

CBASIC2⁵ & **CBASIC86**⁵ compilers... for aficionados of a useful BASIC.

The software is available on a variety of industry-standard Operating Systems including **CP/M**⁵-**MP/M**⁵ (both -80 & -86), **OASIS**⁶, **PCDOS**, and **UNIX**⁷. Inquire for specific details and prices.

Trademarks of:

1. Cybernetics, Inc. 2. Ryan-McFarland Corp. 3. Micro Business Software, Inc.
4. Mini-Computer Business Applications, Inc. 5. Digital Research, Inc. 6. Phase One Systems, Inc. 7. Bell Laboratories

© Copyright 1982 by Cybernetics Inc. All rights reserved.
Prices and specifications subject to change without notice.

CYBERNETICS
INC.

8041 NEWMAN AVE., SUITE 208
HUNTINGTON BEACH, CA 92647
714/848-1922

IBM
personal computer
UCSD
p-System™
Version IV.1

NCI now offers
 Version IV.1 which includes:

- RAMdisk
- Subsidiary Volume Support
- 8087 Numeric Coprocessor Support
- FASTER Long Integers (2x)
- FASTER Floating Point (3x)
- 25% greater floppy storage
- Floppy Write Verification
- Asynchronous Serial I/O
- Extended memory codepool
- 8086/87/88 Macro Assembler
- 8087 Native Code Generator
- program caller unit
- generalized sort unit
- 32 bit seek
- FASTER Seek
- FASTER Turtlegraphics
- Adaptable Support
- PC DOS Filer Utility
- Background Spooler

Also available

- PFAS Pascal File Access System
- Hard Disk Support
- Advanced Systems Editor
- Sprinter text formatter
- QuickISAM/PascalISAM/SuperDB
- QuickForm/PascalForm

Available for

- IBM pc
- Victor 9000

TM Regents University California
 TM IBM Corporation

For more information call

Network Consulting Inc.
 Discovery Park
 Suite 110-3700 Gilmore Way
 Burnaby, B.C. Canada V5G 4M1
 604-430-3466

MC68010

Motorola has recently developed an improved version of the MC68000: the MC68010. It is completely compatible with object codes of earlier versions of the 68000 and has added virtual memory support and improved loop instruction execution.

By using virtual memory techniques, the 68010 can appear to access up to 16 megabytes of memory when considerably less physical memory is available to a user. The physical memory can be accessed by the microprocessor while a much larger "virtual" memory is maintained as an image on a secondary storage device such as a floppy disk. When the microprocessor is instructed to access a location in the virtual memory that is not within the physical memory (referred to as a page fault), the access is suspended while the location and data are retrieved from the floppy disk and placed into physical memory. Then the suspended access is completed. The 68010 provides hardware support for virtual memory with the ability to suspend an instruction when a page fault is detected and then to complete the instruction after physical memory has been updated.

The MC68010 uses instruction continuation rather than instruction restart to support virtual memory. When a page fault occurs, the microprocessor stores its internal state on the supervisor stack. When the page fault has been repaired, the previous internal state is reloaded into the microprocessor, and it continues with the suspended instruction. Instruction continuation has the additional advantage of handling hardware support for virtual I/O devices.

As mentioned in the body of this article, the 68000 uses a prefetch queue to improve the speed of instruction execution. The 68010 goes one step further by making the prefetch queue more intelligent. Detection of a three-word looping instruction will put the microprocessor into a special mode. In this loop mode, the microprocessor will need only to make data transfers on the bus, because it latches up the queue and executes the instruction repeatedly out of the queue. Once the termination condition for the loop is reached, normal operation of the prefetch queue is resumed. This operation is invisible to the programmer and provides efficient execution of program loops.

processors should give the programmer far greater flexibility in coding and perform similar operations in less than half the time of an 8-bit microprocessor.

Memory Accessing

Users of the 8-bit microprocessors originally had difficulty imagining what kind of programs could fill up 64K bytes of memory. Many systems had no more than 8K bytes of ROM (read-only memory) and RAM (random-access read/write memory). But as time went on and the general software base grew, systems with up to 64K bytes of memory became more prevalent. Either code had to become more efficient or ways of fitting more than 64K bytes of memory in a system had to be developed. Sixteen-bit microprocessors could make code more efficient.

In planning MACSS, designers foresaw that the 16-bit, 64K-byte addressing range of popular 8-bit micro-

processors would be quickly outgrown by the newly proposed microprocessor. Each additional bit of address could double the addressing range of the processor.

Look at the techniques of expanding beyond a 16-bit addressing range and analyze the design trade-offs (see figure 3). You could extend the addressing range of early computers and minicomputers simply by appending some additional bits to the most significant of the 16 address bits. These additional bits were usually stored in an additional register, the page register. This method is called *paging*, because you work out of one page at a time. The page is set manually, and the lower 16-bits of address are included in the instruction stream or registers.

Paging has the advantage of being quite simple to implement in the processor. No real circuit change is needed over the straightforward 16-bit addressing, because all the

**NEW SOFTCARD IIe
AVAILABLE FOR THE APPLE IIe**



Microsoft SoftCard systems introduce your Apple to thousands of new programs.

More powerful Apples. When you plug a SoftCard™ system into the Apple® II, II Plus, or IIe, you're adding the ability to run thousands of CP/M®-80-based programs. Word processing, data-base management, analysis and forecasting programs—SoftCard gives your Apple access to thousands of software tools for use in your business or home.

Premium capabilities. Apple II or II Plus owners who want even more can add the Premium System. In addition to CP/M-80, it provides 80-column upper-and-lower case video and a 16K RAMCard. Apple IIe owners can have all this on a single card—the Premium SoftCard IIe.

Two computers in one. Any of these systems turns your Apple into two computers. One that runs Apple software and another that runs CP/M-80. Which means you'll double the utility of your computer.

Complete solutions. The SoftCard, Premium System, and Premium SoftCard IIe have everything you need. Easy-to-install circuit boards. The CP/M-80 operating system. Microsoft® BASIC. And the utilities you need to manage CP/M-80 files.

Why Microsoft? Microsoft was the first microcomputer

software manufacturer. The very first. Today, Microsoft software is running on well over a million computers, worldwide.

With a reputation for dependability and consistent product enhancement.

Ask your dealer. Ask about the superior application programs the SoftCard and Premium System make available to your Apple—high quality programs for almost every area of home, business and professional use. Then ask for a demonstration of the complete SoftCard, Premium System, or SoftCard IIe. And introduce your system to some of those thousands of new programs.

BETTER TOOLS FOR MICROCOMPUTERS

MICROSOFT™

MICROSOFT CORPORATION
10700 NORTHUP WAY
BELLEVUE, WASHINGTON 98004

Microsoft is a registered trademark, and SoftCard and the Microsoft logo are trademarks of Microsoft Corporation.

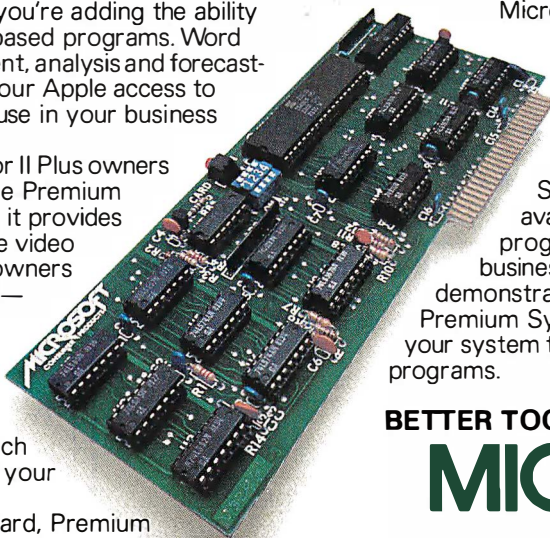

Rent a universal development system today!

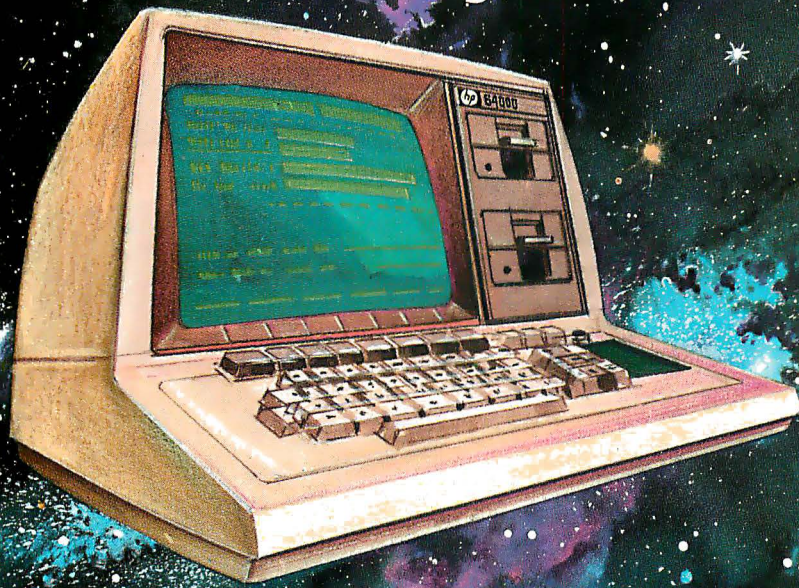

You can rent Hewlett Packard's 64000 Logic Development System . . . including logic state analysis plus timing analysis . . . off-the-shelf throughout North America! You can develop products based on virtually any 8-bit or 16-bit microprocessor in existence. Quickly. Inexpensively. Rental periods as short as 30 days. Or as long as you want. Call now.

GSA Contract #GS-04S-23560.

GENSTAR

Rental Electronics, Inc. (800) 227-8409

In California (213) 887-4000 • (415) 968-8845 • (714) 879-0561

The HP 64000 is out of this world! Tell me more immediately!

- It sounds great. Tell me more! Call me at _____
- Send me your new Rental Catalog.
- I'd like a copy of your "like new" equipment for sale catalog, too.
- I'm particularly interested in the following equipment: _____

NAME _____ TITLE _____

ORGANIZATION _____

ADDRESS _____ MAIL STOP _____

CITY/STATE/ZIP _____

TELEPHONE _____

Please complete coupon and mail to: Genstar Rental Electronics, Inc., 6307 De Soto Avenue, Suite J, Woodland Hills, CA 91367 B483

© Genstar Rental Electronics, Inc. 1982

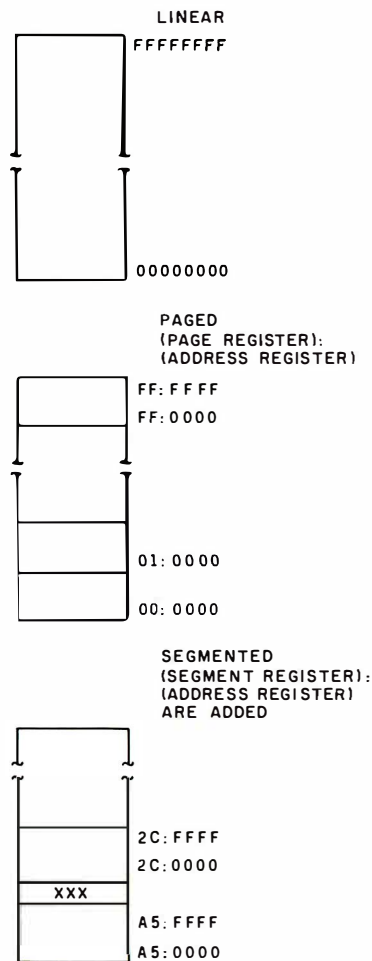

Figure 3: Three methods of addressing memory. The Linear method arranges a contiguous memory area. The Paged method organizes memory into blocks or pages of a prescribed length. The Segmented method gives each user or program a specific area in memory. Both the Paged and the Segmented method give the programmer access to only a small portion of memory.

expansion is done simply by appending bits to the core. It also has the advantage of having fairly dense code, because only 16 bits of address are carried around in the instructions.

However, there are many disadvantages to paging. The programmer is limited to accessing only the particular page of memory that happens to be set in the page register. To be assured that the right page is being used requires a check to see what is currently in the page register, possibly saving that page number, and loading the register with the desired page number. This takes time and requires both additional thought by the programmer and additional

Text continued on page 80

BASF QUALIMETRIC™ A TOTALLY NEW DIMENSION OF QUALITY.



From BASF comes a totally new level of excellence in magnetic media—the Qualimetric standard, a standard so advanced that BASF FlexyDisks® are confidently backed by an extraordinary new lifetime warranty.* The Qualimetric standard is maintained without compromise through every step of BASF design, production, inspection, and testing...reflecting an unwavering BASF commitment to media fidelity and durability.

Our FlexyDisk jacket incorporates a unique two-piece liner that not only traps damaging debris away from the media surface, but also ensures precise media-to-head alignment. The result—certified 100% error-free performance, backed by BASF's exclusive lifetime warranty.*

For information security, tomorrow and beyond, look for the distinctive BASF package with the Qualimetric seal. Call 800-343-4600 for the name of your nearest supplier.

Circle 47 on Inquiry card.

ENTER TOMORROW ON BASF TODAY



Compute While You the Buffer that

Your computer is a real whiz when it comes to time. Like you, it works fast. But most printers don't. Most printers are *slow*. If you ever have to wait for your printer you are wasting time. Valuable time.

But with Microfazer, there's no more waiting.

Microfazer is the print buffer that frees your computer. That lets it work fast. That helps you work faster, too.



any data processing environment, it's truly the "any computer any printer" buffer. With models for any data transmission need. Serial or parallel. Or to interface incompatible devices. And

there's always the traditional Quadram Quality.

The assurance you are getting the finest buffer available.

MICROFAZER REMEMBERS IT ALL Microfazer stores data from your computer in its own memory, then sends it to the printer at a rate the printer can handle. And Microfazer can be expanded at any time to meet all your future requirements.

The print buffer that offers 512K of memory—a full half-megabyte—Microfazer can handle *any* buffer task.

Word Processing.
Accounting.
Graphics.

THE "ANY COMPUTER ANY PRINTER" BUFFER

Microfazer goes with anything. Printers. Plotters.

Even modems.
Perfect for



See us at Comdex, Booth 2536,
In Atlanta, April 26-29.

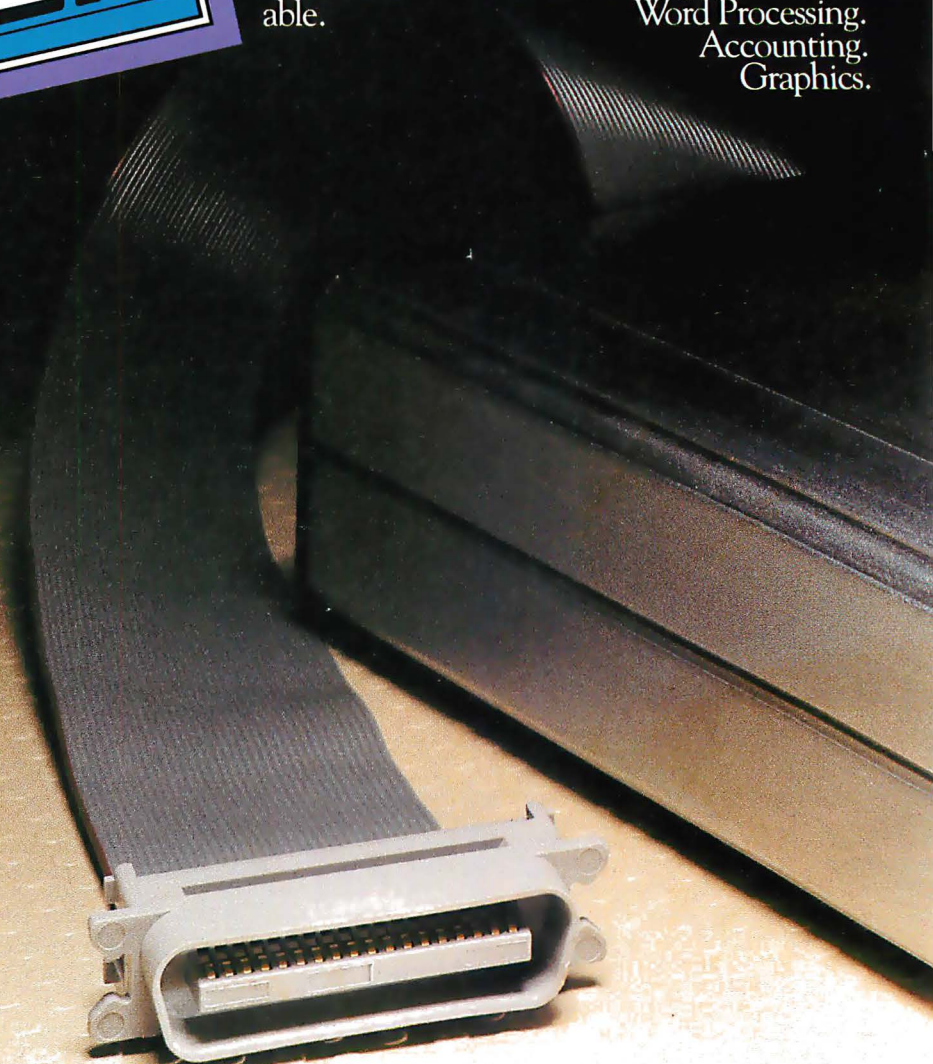

Available at retail stores worldwide.

Print with Microfazer,TM Remembers It All.

You name it.

So stop worrying about losing vital data because you run out of buffer space. Whatever the job—no matter *what* the size—Microfazer remembers it all.

BUT MICROFAZER REMEMBERS MORE...

Microfazer remembers to give you the hardware features you're looking for in a print buffer. Features that include a Ready LED, manual Reset and Pause/Copy buttons. And Microfazer comes in a variety of convenient sizes. To

stand alone or stack with other peripherals. To snap onto the back of the popular Epson printer. There's even a model that plugs *inside* an Epson!



AND PRICED RIGHT, TOO

And with Microfazer you don't have to wait because of price. Parallel to parallel versions start at \$159 (8K), serial to parallel and parallel

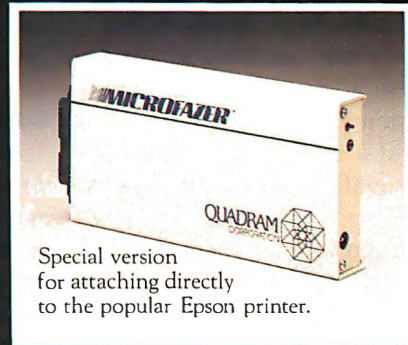

Special version for attaching directly to the popular Epson printer.

to serial versions start at \$199 (8K with cable), and serial to serial versions start at \$229 (8K with power supply).

Available in models from 8K to 512K.

So stop waiting on your printer. Compute while you print with Microfazer. You'll never have to wait again.



MICROFAZER.
THE PRINT BUFFER.
THAT REMEMBERS IT ALL.

Circle 356 on inquiry card.

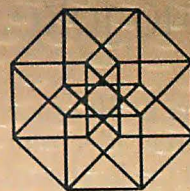

QUADRAM
CORPORATION
A Division of Intelligent Systems.

4357 Park Drive / Norcross, Ga. 30093 / (404) 923-6666
TWX 810-766-4915 (QUADRAM NCRS)

code in the software. This additional code typically takes up the room saved by carrying around only 16 bits of address.

One way to get around the single-page limitation of paging is to provide many page registers. Other characteristics that determine which register will be active on a particular bus cycle include instruction fetch, data read/write, and stack access. While these additional registers give the programmer access to more than one page at a time, there is still only one page available for each type of access.

Some extensions to paging came out to compensate for some of the losses experienced in paging. *Segmentation*, for example, follows the same general principles of pagination. The key difference in segmentation is that the page number becomes a segment number and the segment number is essentially added to the core 16-bit address. This allows some relocation of the core address but still forces the programmer to check that the desired segment is

loaded, and limits the range of any segment to only 64K bytes of memory.

To a programmer, the simplest address technique is a direct addressing of any memory location. This would be without regard for whether the wanted data is near recently accessed data or whether it is miles away. The programmer wants a linear view of data, that is, the ability to specify a very simple, albeit long, address that will access any data.

Now, beyond the processor's memory-addressing method, memory management is sometimes used. With it more sophisticated systems dynamically relocate or control the various blocks of memory. This is done for protection purposes in larger systems. The advantage is that you can protect one user's work space from the devastating effects of another user's poor programs running amuck. To this end, a separate memory management unit (MMU), in conjunction with the operating system, performs some addition to or translation of an address. This technique may sound

similar to paging and segmenting memory, but this is done to serve a completely different purpose, and in a different way. The application program writer never sees this memory management and writes code as though the entire memory were available.

To expand the memory space on the MACSS, the best option, though not the easiest to implement on the chip, is a linear address space. This space is not broken up by paging, segmentation, or banking schemes. It is a very simple addressing technique, requiring the least effort by the programmer, while still allowing more advanced operations such as memory management.

A *linear address* is simply a straightforward 32-bit, for example, address. The address space is not broken up into blocks; and it is contiguous. Accessing such an address merely requires the expression of the 32-bits in the instruction or using a single address register. For convenience, if the upper 16 bits of the address are either all 0s

Did You Hear the One About the Computer That Talks?

It's no joke.

With the ECHO speech synthesizer from Street Electronics whatever you type on the keyboard, your computer can say. The ECHO's text-to-speech system gives your computer an unlimited vocabulary while using a minimum of memory. And now a diskette of fixed, natural sounding words is available to enhance the ECHO II's voice output.

Nearly 400 language rules are contained in the ECHO's text-to-speech algorithm. These rules enable the computer to pronounce most correctly spelled words. When in the text-to-speech mode the user can select any of 63 different pitch levels, and have words spoken either monotonically or with intonation by using simple control character sequences. The rate of speech can be fast or slow; words can be spoken in their entirety or spelled letter by letter. The ECHO's also pronounce punctuation and numbers. Words can be encoded using phonemes and diphthongs when the text-to-speech or fixed vocabulary is not required.

Applications are unlimited, ranging from phone answering, educational and training programs, to games and aiding the sight and speech impaired. The ECHO is a complete stand alone unit which is compatible with most any computer; it sells for \$299.95. The ECHO II, which plugs into the Apple II, is priced at \$149.95.

Contact us about the new ECHO/PC for the IBM/PC.



Street Electronics Corporation
1140 Mark Avenue, Carpinteria, CA 93013
Telephone (805) 684-4593

Call toll free for demonstration (800) 221-0339

ShareNet™ is Now

Others Talk of Tomorrow



The Only Complete Personal Computer Local Area Network

Others are just talking about tomorrow's technology . . . **ShareNet** has it now!

With power and capabilities found only in minicomputers and mainframes;

Best of all it can be yours today.

ShareNet Local Area Network gives you a true multi-user system enabling you to link up to 24 personal computers, five printers and use . . .

Multiple Operating Systems	Print Spooling
Extensive Data Security	Redundant Directories
Hierarchical Directory	Cartridge Disk Back-up
Default File Locking	Public & Private Directory
Concurrent File Sharing	Electronic Mail

Network Interface Cards available for IBM/PC.

Soon available: APPLE, VICTOR, DEC RAINBOW, OSBORNE, & Others.

For tomorrow's technology, today . . . call 1-800-453-1267.

ShareNet™

The Local Area Network of the Future Today

TELEX: 669 401 AIR COURS PHX

Novell Data Systems, Inc. 1170 N. Industrial Park Drive Orem, Utah 84057 Phone: 801-226-8202

Circle 307 on inquiry card.

or all 1s, then a shorter, 16-bit form of the address can be sign-extended to automatically provide the correct address. This is the way the MC68000 accesses memory and I/O.

How big an address space should a 16-bit microprocessor address? The natural address sizes greater than 16 bits are 24 and 32 bits, which are 3 and 4 bytes long, respectively. For a 16-bit microprocessor, the odd number of bytes becomes slightly unwieldy. Looking a little further into the future, it seemed that even the 16

megabytes of a 24-bit address might not meet the needs of large systems.

While 32 bits of address, reaching 4 gigabytes of memory, seems tremendous, once the need for more than 16 bits is established, 32 bits is the next most convenient size. It takes exactly two 16-bit bus transfers to move an address into the processor, and once the second transfer is needed, as it would be even for an 18-bit address, it is just as well to use the whole 16 bits brought in. Thus, engineers selected a virtual-memory address

space of 32 bits for the MC68000.

Now, from a practical packaging standpoint, 32 address signal lines are quite a few. The placement of integrated circuits (ICs) in dual inline packages (DIPs) with greater than 40 leads was rare before 1980. With only a few systems in the early '80s requiring more than 16 megabytes of memory, it seemed a reasonable trade-off to bring only the 24 least significant address bits to the outside world. That way fewer pins would be required, and MACSS could fit within a 64-pin DIP. Still, all 32 bits of address are maintained within the processor, and there are simple means of determining the upper 8 bits' values.

Multiple Registers

With the size of the memory address space determined, it was easier to settle on the register scheme of the new processor. The size and the number of registers had to be decided.

Designers originally envisioned onboard registers for a processor because operating on memory data requires a time-consuming transfer across the external bus. It just happens that in programming most data is operated on a number of times in succession before a result is obtained. Often many combinations with many different data pieces are used. The merging of these two observations leads to onboard or on-chip registers for fast manipulation of frequently used data.

It seems that from the day registers were brought into the processor, programmers have wanted more registers for their use. The goal, then, when designing processors, is to provide as many registers as possible for the programmer. In the MC6800, only two registers (A and B) were available for data manipulation, and one index register (X) to point to non-stack data. These few registers are being loaded and saved almost as often as the data within them is manipulated.

The loading and saving of registers is usually wasted time. The amount of time spent bringing data into on-chip registers for fast manipulation

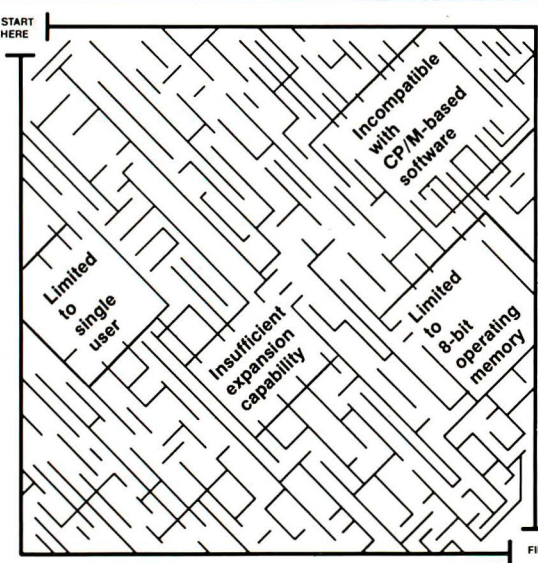

PROBLEM: Confusion caused by growing number of computer companies promising solutions to industrial and scientific problems.

SOLUTION: since 1978 Pragmatic has integrated systems based on a powerful combination of hardware and software spanning from single to multi-user operation and running BOTH 8 and 16 bit software.

RESULT: a solution that solves your problem NOW and anticipates your future computing requirements.

The Pragmatic solution runs CP/M, CP/M 86, 26, and MP/M compatible software. All systems include Wordstar™ for word processing, SuperCalc-86™ for business and financial planning and Ashton-Tate's dBase II™ for data base management.

The Pragmatic solution gets you through the microcomputing maze with complete solutions for today and tomorrow. Sound Good? Call Jerry Hall for the Pragmatic representative nearest you.

pragmatic designs
INC.

Pragmatic Designs, Inc. 950 Benicia Avenue Sunnyvale, CA. 94086
(408) 736-8670 TLX: 171627



Pragmatic Designs is an authorized CompuPro Systems Center.
Trademarks: Wordstar of MicroPro, SuperCalc of Sorcim, dBase II of Ashton Tate, CP/M of Digital Research, CompuPro of Godbout Electronics.

THE GIANT KILLER

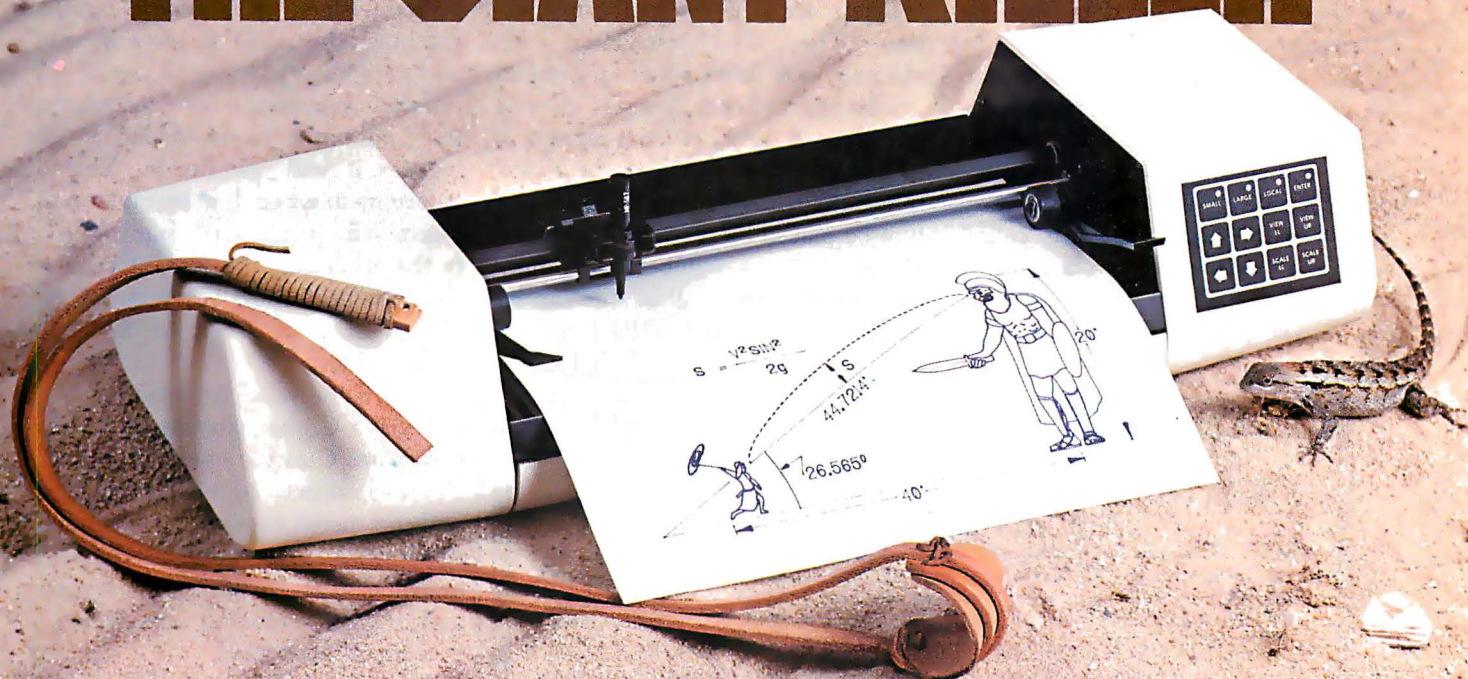

Vanquishes The High Cost Of Plotters

Small, smart and cost effective, the DMP-40 single-pen plotter puts big-plotter power at the command of the small-system user. With this amiable and competent aid at your side, you can create colorful 8½ x 11" and 11 x 17" graphics—images of professional quality for stand alone use, binding into reports or as overhead transparencies for group presentations.

Circles, arcs, ellipses and general curves are automatically generated by robust internal firmware, freeing you and your computer from wasteful low-level busywork.

By plotting in increments of only 0.005", you are assured of virtually step-free traces. The result is precisely defined graphics of high accuracy and solid repeatability.

Standard RS-232-C interfacing matches the DMP-40 to all current computers.

Multicolor plots on the DMP-40 are a simple matter since built in firmware and most commercial software provide 'pause' commands for pen changing.

These and more big-plotter capabilities are yours at small-plotter cost.*

For the name and location of your nearest distributor, call 512-835-0900 or 1-800-531-5205 outside Texas, or write Houston Instrument, 8500 Cameron Rd., Austin, Texas 78753. In Europe contact Bausch & Lomb NV, Rochesterlaan 6, 8240 Gistel, Belgium, Tel 059-27-74-45, Tlx 846-81399.

*US retail \$995.

BAUSCH & LOMB 
houston instrument division

Circle 48 for literature. Circle 49 to have representative call.

depends upon the exact use of that data. However, the more registers available, the more likely it is that a register will not have to be saved just so that some other data can be operated on in that register.

The design of the internal execution of instructions through a microprocessor will determine many things about the suitability of the chip for programming. Instructions may operate either on what are called *dedicated registers* or on a *general register set*. Each of these methods has advantages and disadvantages.

In a microprocessor that uses dedicated registers, an instruction includes the address of the data to be worked on in specific registers. These registers are inherent in the instruction. The ADD instruction, for example, will add only from a memory location to, say, register A—not to register B, and not from register A to memory. If the value to be added to is not already in register A, it must first be placed there. Before it can be placed there, a number in A may have to be saved. All of this can be quite troublesome. This is not very

different from the situation in which there simply are not enough registers.

Contrast this with the example of a processor that uses true general-purpose registers. In a general-register machine, the ADD instruction may add data from memory to any of the internal registers. The instruction must contain information on which register it will operate on. This is determined when the instruction is assembled. If there were four registers in the processor, the ADD operation could be performed in register A, B, C, or D, as selected by the programmer.

Now if the value to be added to is in register C, the programmer simply designates C as the operand register. There is no need to shuffle registers and no need to save any register contents. The general-register machine, then, is easier to program and typically requires less time to execute an operation.

As it always happens, this ease of programming does not come free. You will see later that allowing a selection of registers requires bits in the op code for encoding and, therefore, more bits of the op code. Also, it is typically more difficult for the microprocessor designer to implement the circuitry that incorporates various registers because it takes time to determine which register is to be used and to activate that register. Streamlining internal operations so that this time is not detectable requires quite a bit of planning.

So while fewer registers or dedicated registers may be easier for the microprocessor designer to implement, they make programming the new chip more cumbersome and less flexible. But the extra time, effort, and expense of implementing general-register principles pays off by easing the programming of these devices.

Therefore, the MC68000 was designed with general-purpose registers. Any instruction may select any register for use as a source or destination operand or as a pointer in any allowable addressing mode. This tremendous flexibility gives programmers the ultimate in data and pointer placement.

A close observation of the use of

*** * WE ARE BYTE MAGAZINE'S THIRD OLDEST ADVERTISER * ***

COMPLETE SYSTEMS FOR A WIDE RANGE OF APPLICATIONS, FOR VARIED LEVELS OF SOPHISTICATION. 8 & 16 BIT, S-100 AND NON S-100, SINGLE AND/OR MULTI USER, FLOPPY AND HARD DISK CAPABILITY, SOFTWARE, PERIPHERALS, SERVICE AND SUPPORT.

MASTER MAX: Z80, S-100 with dual 8" drives (Winchester option). Uses Intercontinental Micro CPZ48000 single card computer. 4 DMA channels & universal interrupt controller give great versatility and speed. \$2,540 includes CP/M. OPTIONS: double sided drives, TURBODOS, ICMS slave cards, 220v/50HZ operation.

IMS MULTI USER SYSTEMS WITH TURBODOS: Z80, S-100 CP/M compatible. Slave cards give each user Z80 CPU. 64K RAM, 2I/O. No speed degradation as users are added! On site service for NY quad state area.

EPSON QX10: The first truly user-friendly system. For under \$3,000 you get 256K RAM plus 128K video, extensive software package (CP/M compatible) HASCI keyboard.

NEC APC: 8086 system with 8" drives, MS-DOS or CP/M 86. Corrects all the deficiencies of the IBM PC. Beautifully designed.

OTRONA ATTACHE PORTABLE COMPUTER: full 80 x 24 screen. Software includes WORDSTAR, MULTIPLAN spread sheet, HP calculator emulator. Dual dble density drive.

ESQ 1: Legal time and billing software implemented on our MASTER MAX or IMS system. We provide on site training (quad state area) and complete support.

GODBOU DUAL PROCESSOR 816: 8085/8088. Multi or single user. Unique version of MP/M allows simultaneous use of both processors.

CROMEMCO DUAL PROCESSOR: Z80/68000. Also Z80 C10 personal computer.

LOMAS and SEATTLE 8086 S-100 systems: 10 MHZ option, dynamic or static RAM.

GRAPHICS: MICROANGELO (S-100) OR MIRAGE (RS232). Monochrome or color. AUTOCAD: Interactive graphics software for architects, engineers, others. HOUSTON INSTRUMENTS digitizer and plotters.

ACT SINGLE OR DUAL WINCHESTER SUBSYSTEMS: Dual version solves back up problems! Implemented for CP/M, Turbodoss, TRS 80, IBM PC, Osborne, Apple, many others.

MODEMS: US ROBOTICS DC Hayes compatible modems at lower prices.

SPECIAL INVENTORY SALE: (while they last) IMS boards at 25% off list price.

PERIPHERALS: CRTS (Televideo, WYSE, Hazeltine); dot matrix and letter quality printers, S-100 boards & mainframes, floppy disk subsystems (Shugart, Qume, Tandon, Per Sci). Full line of RAM and accessories for IBM PC.

3270 NETWORK: Teletype controllers, printers and terminals. Cost effective.

WE EXPORT Overseas Callers: Phone (212) 448-6298
TWX 710 588 2844 or Cable: OWENSASSOC

JOHN D. OWENS Associates, Inc.

12 Schubert Street, Staten Island, New York 10305
(212) 448-6283 (212) 448-2913 (212) 448-6298

the monitor that stands alone



 **TAXAN** manufactures a complete line of high quality monochrome (green and amber), as well as medium and high resolution RGB color monitors. Our monitors are in use around the world on IBM and Apple as well as most other personal computers.

See your local  **TAXAN** dealer, or call us for details.

 **TAXAN**

TSK Electronics Corporation
18005 Cortney Court
City of Industry, CA 91748
(213) 810-1291

registers indicates they usually have one of two purposes: they may retain data for manipulation, or they may contain an address that points to a memory location. The use of a register for each of these purposes is quite different.

When data is moved into or out of a register or is manipulated within the register, all types of conditional information from the operation are important. Thus, you typically would like all condition codes to be properly set after a data operation. This way these condition codes may be used to branch or with other data operations.

On the other hand, an address might be placed in or taken from a register, or modified by incrementing or decrementing. Rarely is it important whether a carry comes out of the ALU or whether the result is negative (i.e., has a 1 in the most significant bit). In fact, a programmer would prefer manipulation of an address to have no effect on the condition codes.

Often in the middle of a complex data operation, you must bring in a new address or increment an address. To have this operation modify the condition codes most of the time will foul up the data operation in progress, and so is undesirable.

Therefore, two generic register types emerge: a data register (D0 through D7) and an address register (A0 through A7). The MC68000 has both types. In a data register, any operation will affect the condition codes of the microprocessor as is appropriate for the operation and the data used. However, in an address-register operation, condition codes will not be changed, but the codes from previous data operations will be retained. This way you can have address and index pointer changes made, without affecting the accuracy of the results, in the middle of a complex data operation that requires many instructions and transfers from memory.

What size and how many of each

type of register should be included in the microprocessor? The more registers there are, the better it is for the programmer. Unfortunately, the more register and control circuits in the chip, the more expensive it is. A good balance must be attained.

Two registers are too few, four are nice, but it is difficult to imagine even a complex routine requiring more than eight different memory pointers. The encoding of eight registers requires an even three bits. Because it seemed that eight was a good upper bound, the MC68000 has eight address registers and also eight data registers.

With 16 registers available, divided half and half for data and address, almost any sizable routine will never require the temporary storing of a value in a register just so that the register can be used for something else. And, within the routine, manipulations of memory pointers in address registers will not interfere with an ongoing data calculation,

PICK A

SYSTEM!

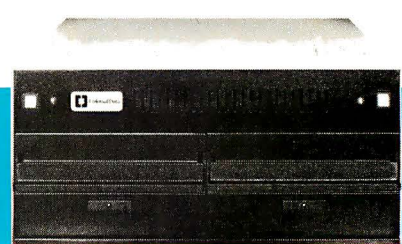
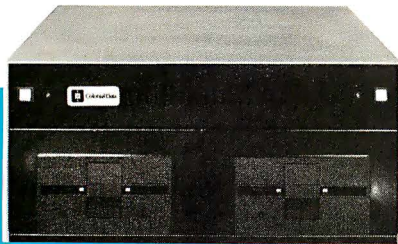

\$2295.
.5 MB STORAGE

◀ COMPLETE ▶

\$2795.
1.2 MB STORAGE

We're offering you our SB-80 system in either 5 1/4" or 8" disk drives, your choice. Either way your system comes with a full size (12" diagonal) non-glare tiltable green screen with 24 lines by 80 character format. Its multi-character set offers blinking cursor, underlining, reverse video, and half and zero intensity. The movable, detachable keyboard has a numeric pad with cursor control and function keys.

- Single Board Technology ■ CP/M® Operating System
- 4 MHz Z80A CPU ■ 64K 200ns Main Memory
- 8-Inch Dual Density Floppy Drives
- 5 1/4-Inch Dual Density Floppy Drives
- 2-Serial Ports ■ 2-Parallel Ports
- 4-Counter/Timers ■ Expandable

For further information about this limited offer call or write:



Colonial Data

Nationwide on-site and depot repair service through the professionals at INDESERV.

©CP/M is a registered trademark of Digital Research, Inc.

Colonial Data Services Corp., 105 Sanford Street, Hamden, Conn. 06514 • (203) 288-2524 • Telex: 956014

Color for the Price of Black and White



Transtar 315 Color Printer for only \$599 suggested retail price

- New technology four-hammer print head
- Unique diagonal ribbon provides simpler and more reliable operation
 - Prints 7 colors plus more than 30 shades
- All colors and shades are printed in a single pass of the print head
- Built by Seikosha, the oldest manufacturing company of the famous Seiko group—providing precision products since 1892.

Transtar · Box C-96975 Bellevue, Washington 98009

Circle 417 on Inquiry card.

because of the distinction of how the condition codes work for the different register types. It is easy to see how the MC68000 is easier to program.

Earlier I explained that MACSS would handle all of its addresses as 32-bit quantities. Anyone who has ever programmed 8-bit microprocessors, which have 8-bit accumulators and 16-bit index registers, has seen the difficulty with the two different sizes. Once programmers figure out how to put the 16-bit value in both 8-bit accumulators, things get tougher when they try to get arithmetic carries from the lower half to

the upper half of the value.

A little of this experience led the MC68000 designers to decide that using data that is the same size as the address register could make some software design significantly easier. In order to handle a linear 32-bit virtual-address space, the MC68000 needed to have 32-bit address registers. How would 32-bit data registers fit into a 16-bit microprocessor?

You would expect a 16-bit microprocessor to process 8- and 16-bit data, but does it make sense for it to also process 32-bit data? Obviously, the addresses will have to be handled

in that size. Designers recognized that in 8-bit microprocessors the ability to handle 16-bit data came in quite handy for more advanced applications. The 8-bit processors soon had to be upgraded to handle 16-bit operands, and users of 16-bit mini-computers needed 32-bit operations.

Once a few 32-bit operations become necessary in a microprocessor, you need a whole array of operations. If a multiplication operation generates a 32-bit result, in order to do anything with that result, other 32-bit operations are needed. For consistency, again, Motorola decided that the data registers would be 32 bits wide and operations on all 32 bits could take place with a single instruction.

Three Arithmetic Units

The exact manner of processing data and addresses through the MC68000 came about later, with careful analysis of the internal architecture and the need for address and data in the sequence of instructions. The chip ended up with three separate arithmetic units, which could work in parallel. I'll describe their purpose to give some insight into how the machine works.

The MC68000 has a 16-bit-wide ALU that essentially performs all data calculations and provides single-pass evaluation of the 16-bit data, for which the MC68000 is primarily designed. There are also two other internal arithmetic units. Both are 16 bits wide and are generally used in conjunction with each other to perform the various address calculations associated with operand effective addresses. This makes sense because all addresses are 32 bits wide. An effective address (EA) is the calculated result based on a selected addressing mode of the processor. In the MC6800, for instance, if an "index-register-plus-offset" address mode were used, the EA would be the result of adding the contents of X with the given offset. Because EA evaluation takes time and can be a significant portion of the instruction, it is important to perform this quickly.

At one time, then, one 32-bit address and one 16-bit data calcula-

Commodore 64 Computer

over \$300 Free Professional Software
when you buy a Commodore 64 computer

COMMODORE 64

PROFESSIONAL SOFTWARE

Name	List	Sale
word processing pack	\$89.00	\$69.00
complete Data Base pack (includes Mailmerge)	\$89.00	\$69.00
Electronic spreadsheet pack (like visicalc)	\$89.00	\$69.00
Accounting pack (personal & business)	\$59.00	\$49.00
Programmers Helper	\$79.00	\$59.00
Programming Reference guide	\$20.95	\$18.95
Basic Tutor	\$24.95	\$19.95
Typing Tutor	\$24.95	\$19.95

80 column BOARD

80 characters per line on the screen at one time. Includes word processing pack (list \$89.00), complete data base pack (list \$89.00), Electronic spreadsheet pack (list \$89.00). **ALL FOR ONLY \$275.**

We have over 300 Programs for
the Commodore 64 Computer

- 10 day free trial • We have the lowest prices
- One day delivery express mail • Free Catalogs

WE LOVE OUR CUSTOMERS

PROTECTO
ENTERPRIZES (FACTORY-DIRECT)

BOX 550, BARRINGTON, ILLINOIS 60010
Phone 312/382-5244 to order

tion can take place within the MC68000. This speeds instruction execution time considerably by processing addresses and data in parallel. The MC68000 also operates on 32-bit data. This is usually done by taking two passes of 16-bit data, one for the lower word and one for the upper word. This is reflected in the execution time of many 16- and 32-bit instructions.

Prefetch Queue

Another way designers made the MACSS faster was to include what is called a *prefetch queue*. This prefetch queue is more intelligent than other microprocessor queues; its control varies according to the instruction stream contents.

The prefetch queue is a very effective means of increasing microprocessor performance; it attempts to have as much instruction information as possible available before a particular instruction begins execution. The microprocessor uses an otherwise idle data bus to prefetch from the instruction stream. This keeps the bus active more of the time, increasing performance because processing of instructions is often limited by the time it takes to get all the relevant information into the processor.

The part of memory from which instructions are fetched, the program space, contains op codes and addressing information. The prefetch queue can contain enough information to execute one instruction, decode the next instruction, and fetch the following instruction from memory—all at the same time.

Exactly what is in the queue is very dependent upon the exact instruction sequences. The queue is intelligent enough to stay fairly full without being too wasteful.

For instance, when a conditional branching instruction is detected, the prefetch is ready to either branch or not by the time a decision is made. The queue tries to fetch both the op code following the branch instruction and the op code at the calculated branch location. Then, when the condition codes are compared and a decision is made whether to branch,

the processor can begin immediate decoding of either instruction. The other unnecessary op code is ignored.

You can use the prefetch queue in many other special ways as well. One example is in speeding up the repetitious Move Multiple Registers instruction, where it is used to accelerate successive data transfers. The prefetch queue allows many frequently used instructions to execute in exactly the time it takes to fetch the op code (actually, the time to prefetch the next op code).

Microcoding

One other significant implementation feature from the MACSS project emerged from the choice between a *random logic design* versus a *microcoded design*. Both techniques have advantages and disadvantages. Earlier microprocessors were largely of random logic design. Advanced techniques of very large scale integration (VLSI) and the increasing complexity of the chips have made

microcoding more attractive.

Random logic design of a microprocessor or other logic device is the building of the device from discrete components—gates, buffers, and transistors. This limits the components to those that are essential. There are no unused gates, duplicated circuits, or clever uses of otherwise unused components. The design is usually packed as tightly as possible and is quite fast.

The difficulty is that, as the design becomes more and more complex, as VLSI has, the planning and layout of the components and signal traces become exponentially more difficult and often impossibly so. This means that it takes exorbitant amounts of time to design the circuits.

Another problem with the use of random logic in very complex circuits occurs in modeling and testing. Before such circuits are finally placed in silicon, they must be modeled and simulated on computers because of the great difficulty in running down



Leap into
a new
dimension
with
Aztec C!

C COMPILERS-COMMON FEATURES:

- UNIX VER 7 compatibility • standard float, double, and long support • run time library with full I/O and source • fast compilation and execution • full language • cross compilers available

AZTEC C II CP/M (MP/M) \$199

- produces relocatable 8080 source code • assembler and linker supplied • M80 interface • SID/ZSID debugger interface • library utility • APPLE requires Z80 and 16K card

AZTEC C II APPLE DOS \$199

- relocating assembler supplied • APPLE SHELL • VED editor • library and other utilities • produces relocatable 6502 source code • requires 16K card

AZTEC C86 IBM PC MSDOS CP/M-86 \$249

- produces relocatable 8088/8086 source code • assembler and linker supplied

Manuals—\$30 ORDER BY PHONE OR BY MAIL—Specify products and disk format

MANX
software systems

Box 55, Shrewsbury, N.J. 07701 (201) 780-4004



CP/M FORMATS: 8" STD. HEATH, APPLE, OSBORNE, NORTHSTAR, . . . OUTSIDE USA-Add \$10 In N.J. add 6% sales tax

bugs once the chip is in silicon compared to debugging a wire-wrap board. The entire circuit must be modeled all at once to ensure that one combination of signals affects only the expected section of the device.

Similarly, once the circuit is in silicon, the pass/fail testing of the components in a random logic chip is quite difficult. You typically have only a few lines to send sequences of patterns through for testing. Because a particular section of the circuit may be exercised only by a very few given inputs, a normal test may not detect a stuck gate or other error caused by some strange combination of inputs.

On the other hand, in much the same way that microprocessors made designing systems with medium-scale integration/large-scale integration (MSI/LSI) easier, microprogramming has come to ease the complications in the design of microprocessors. Microprogramming is to a microprocessor what a microprocessor is to a logic design of a system. A microprocessor has central components that can be

considered black boxes with inputs and outputs. For each given operation (instruction, interrupt condition, etc.), the microprocessor can route certain information to these black boxes as inputs, and the outputs can be routed to other components. The control of this routing is performed by a microcontroller or microsequencer.

Similar to a microprocessor, the microsequencer directs the flow of data through the various components (ALU, registers, condition flags, shifters, buses, etc.) according to microprogrammed instructions. Each instruction has its own microroutine, or sequence of microwords, which routes the associated data to the proper component in the proper order. Conditions and branches may redirect the microroutines.

Microcoding a complex circuit simplifies design mostly because it makes the circuit modular. It takes a controller, a block of microprogram, and the components through which data is to flow. Each of these elements

may be modeled, built, and tested with individual inputs and outputs. Microcoding is a big step toward simplifying the design process because it breaks up the design into manageable blocks, thereby easing the testing of the finished product.

Another advantage of microcoding is that it allows tremendous flexibility in the exact operation of the circuit. Its microwords allow more combinations of the inputs through the components than most random logic would allow. Microcoding's programmability makes it especially attractive to silicon designers because random logic in silicon is not easily changed.

Last-Minute Changes Possible

You can change the microROM of the microcoded device right up to the minute before the masks for the device are processed. To change a small facet of an operation may mean altering a few bits in the microROM, but this changes only whether or not there is a gate on the bit's transistor—a simple alteration. Similarly, after the silicon is cast, should a change be necessary, it will likely be just a microcode change, which would be much easier than random logic modification in silicon.

The disadvantage of a microcoded circuit lies primarily in its generality. Because it is made up of modules and is programmed, the microcoded circuit is more wasteful of transistors and therefore makes a larger circuit. This may add up to 20 percent more board space or chip area than a tight random logic design. But microcoding has advantages that make up for this disadvantage, making it the design choice for modern VLSI circuits.

There are two types of microprogramming, horizontal and vertical (see figure 4). *Horizontal microcoding* is the more direct form. It is unencoded, so that, for instance, 1 bit in each microword would enable each register. For 16 registers, then, 16 bits of microcode must be dedicated. Horizontal microwords tend to be quite long, and because the size of the microcode directly affects chip size, they can quickly increase chip cost.

INTRODUCING BABY TEX™ THE "PLUG IN" ANSWER TO SOFTWARE FOR THE NEW TI PROFESSIONAL COMPUTER

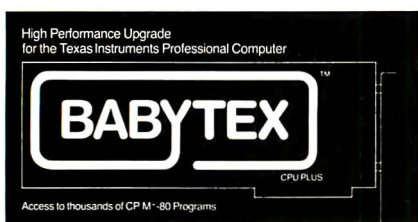

SOFTWARE SELECTION: BABY TEX™ upgrades your TI Professional Computer and allows you to run nearly 3000 popular CP/M® software programs.

SOFTWARE VERSATILITY: The BABY TEX™ package includes three special "utility" software programs at no additional cost, making your computer more versatile.

SOFTWARE SAVINGS: BABY TEX™ is now available bundled with WordStar™, MailMerge™, Personal Pearl™ and WonderCalc™ for only \$995. That's four applications programs plus BABY TEX™ for only \$995.

ADDITIONAL MEMORY: BABY TEX™ gives your computer 64K of additional main memory.

If you are looking for software . . . BABY TEX™ is the answer!

Buy BABY TEX™ at your Authorized Texas Instruments Dealer.



Xedex Corporation
222 Route 59, Suffern, NY 10901
(914) 368-0353
West Coast Sales Office
7700 Edgewater Drive Suite 360
Oakland, CA 94621 (415) 569-3100

Xedex is a subsidiary of
Terminals Unlimited International, Inc.
Dallas, TX (NASDAQ: TUII)

BABY TEX is a trademark of Xedex Corporation.
WordStar and MailMerge are trademarks of MicroPro International Corporation.
Personal Pearl is a trademark of Relational Systems International Corporation.
CP/M is a registered trademark of Digital Research Incorporated.



TI's new Compact Computer. It takes over your work, not your desk.

The ordinary personal computer occupies too much of the ordinary desk.

Now Texas Instruments brings you a cordless compact computer that solves the same sort of problems as the Apple™ or IBM™ personal computer. It has enough memory and power for complex problems in business and science, yet the whole thing is smaller than a magazine page.

Sophisticated software is available right now for finance, statistics, production planning, graphics—and spreadsheet and wordprocessing are just around the corner.

For most personal computer tasks, its 6K RAM and 34K ROM are ample. The system is easily, economically expanded.

The TI Compact Computer 40 has peripherals that make it even more useful:

a 4-color printer/plotter; an RS-232 interface for talking with other computers or running a larger printer; and TI Wafertape™ drive for program or data storage. TI Solid State Software™ cartridges offer you a choice of convenient, foolproof programs.

Its built-in language is TI Enhanced BASIC, which allows you to write programs in everyday words. The integrated liquid crystal display shows 31 characters, which can be scrolled to show up to 80 per line. It operates on four AA alkaline batteries that give up to 200 hours of service.

The TI Compact Computer 40 offers solutions anywhere you go. Yet it retails for less than 1/3* the price of Apple™ or IBM™ personal computers. The TI Compact Computer—compact in price and size, but not in power. See it soon at your Texas Instruments retailer.

Creating useful products
and services for you.



TEXAS INSTRUMENTS

Copyright © 1983 Texas Instruments

Circle 410 on Inquiry card.



*Based on published manufacturer's suggested retail price.

Apple is a registered trademark of Apple Computer, Inc. IBM is a registered trademark of International Business Machines Corp.

The Spelling Bee Is Over

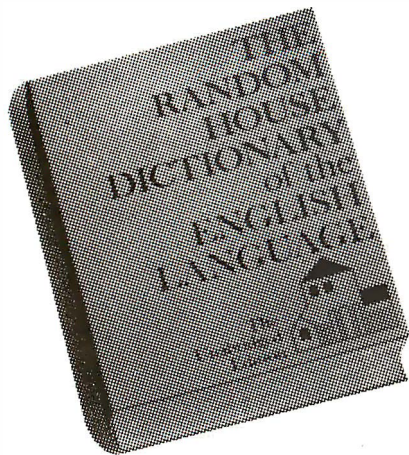

The Random House ProofReader™ \$50

The best spelling checker at any price - it just happens to cost much less.

For any CP/M® 2.2, MS-DOS® or IBM PC-DOS® Word Processor.

32,000 words on 1 sided 5¼" disks
 50,000 words on 2 sided 5¼" or 8" disks
 80,000 words optional

For orders or information, call 505-281-3371.
 VISA, MasterCard accepted.
 Or write Random House ProofReader,
 Box 339-B, Tijeras, N.M. 87059
 Please enclose \$50 and specify your computer model, disk size and memory.

Random House and the House designs are registered trademarks of Random House, Inc. CP/M is a registered trademark of Digital Research, Inc. IBM and IBM Personal Computer are registered trademarks of IBM.

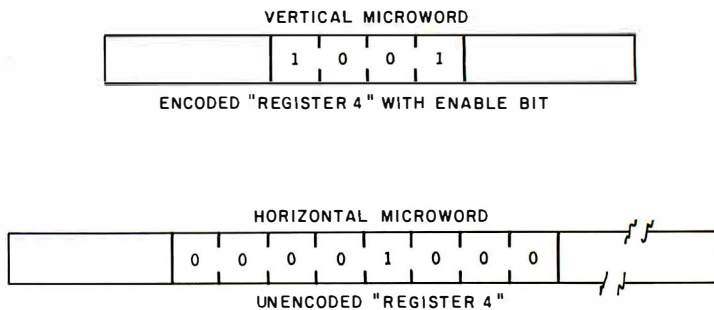

Figure 4: Comparison of horizontal and vertical microcode patterns.

A denser but slower form of microcoding is *vertical microcoding*. Here, control functions are encoded, so that only 4 bits of microcode are required to select one of 16 registers. While it needs a much shorter microword, vertical microprogramming is potentially slower than horizontal microprogramming. Vertical microprogramming will take at least one level of logic gates to decode the encoded signals. This level of gates may just throw the total gate propagation delay over the threshold of the clock pickets, forcing an additional clock cycle into the instruction.

In the MACSS project, the MC68000 was selected to be micro-coded. In retrospect this was a very wise decision. The first silicon prototype worked well enough so that the major circuits in the device could be tested, and subsequent "fixes" were often just microcode corrections. The instruction set was not firm until just before the masks went to wafer fabrication, allowing some late decisions to be made to improve the performance of the chip.

A combination of horizontal and vertical microcoding was used on the MC68000 to gain the optimum advantages of both. Essentially, a microcode and a nanocode were developed. The microcode is a series of pointers into assorted microsub-routines in the nanocode. The nanocode performs the actual routing and selecting of registers and functions, and directs results. This combination is quite efficient because a great deal of code can share many common routines and yet retain the

individuality required of different instructions.

Decoding of an instruction's op code generates starting addresses in the microcode for the type of operation and the addressing mode. Completion of an instruction enables interrupts to be accepted or allows access to the prefetch queue for the next op code. The prefetch queue actually keeps bus use at 85 to 95 percent, i.e., the bus is idle only 5 to 15 percent of the time!

Conclusion

Let's look back now at the MC68000 and see what parts of it might qualify it as a 16-bit device. The internal data ALU is 16 bits. It processes 32-bit addresses, though only 24 bits are brought off chip. The op code that tells the processor what operation to perform is 16 bits wide. The data bus is 16 bits wide. The microprocessor will operate on either 8, 16, or 32 bits of data automatically. There are 16 general-purpose 32-bit-wide registers in the chip.

The MC68000 is generally considered a 16-bit microprocessor, though it uses 32-bit addresses and contains 32-bit registers. It also can operate on 32 bits of data as easily as 8 and 16. Many users of the MC68000 consider it a 32-bit just as much as a 16-bit processor. Whatever you consider it there is no doubt that the MC68000 is indeed a powerful microprocessor. In coming articles, I will discuss in more detail exactly what operations are available in the MC68000 and will illustrate examples of MC68000 code. ■

cdex™ Training Programs

Cdex™ Training Programs
are available for:

Application Programs

The VisiCalc® Program —
IBM® Personal Computer Version
Apple® //e Version
Apple® II Plus Version
The WordStar™ Program
The SuperCalc™ Program
The EasyWriter II™ Program

Hardware Programs

The IBM® Personal Computer
The Apple® //e Personal Computer



The best, most comprehensive programs written and every personal computer made, still take a considerable amount of time to learn how to use. That is... until now!

Cdex Training Programs are computer-assisted training programs that make learning straight-forward and efficient. In an hour, you can master the material on the Cdex disks and begin using the intended product.

It's tough to learn about computers from a book. That's why all Cdex Training Programs are on disk and are:

Highly Interactive...

Creating a dialogue with you and serving as your personal tutor.

Completely Self-paced...

You set your own learning time.

Graphically Oriented...

Remember, a picture is worth a thousand words.

Use Them Now and Later...

Clear and concise training and reference programs for the first-time or experienced user.

Cdex Training Programs run on the same Apple® II Plus, Apple® //e or IBM® Personal Computer as your other programs. See how effective a Cdex Training Program can be; ask your dealer for a demonstration.

Cdex™ Training Programs
We make it easy.

cdex™

Cdex Corporation
5050 El Camino Real
Los Altos, CA 94022
415 964 7600

How to get the best out of (and into) your computer.

You've invested in your computer to get data accurately, intelligibly. The modem is no place to compromise and slip in a weak link.

With Novation Cat[®] modems you don't. Our Cat line is a full one. At one end—our small, handy J-Cat. It purrs along at 300 bps, excellent for home use. At the other end, with all the features and conveniences you want for business—our full blown smart, automatic communication systems that can roar along at 1200 bps.

All have one thing in common—unique, highly advanced LSI chips. Our engineers have designed these little marvels, eliminating

the complexity and costs of typical modems, and producing instead modems elegantly simple in execution with absolutely state-of-the-art reliability and features.

There's nothing quite like working with the latest and the best. Come see.

The Cats are at leading computer stores.

There's another good reason to buy right now.

Tucked inside every Cat package, you'll now see a special "get acquainted" subscription to **The SourceSM**. You might as well get started right.

J-CATTM MODEM

It's smaller. 1/5th the size of an ordinary modem. Easy to stick-on, tuck-in, put anywhere you want. Auto-answer. Also, no fussing to get into the right mode, answer or originate—J-Cat does it automatically. \$149*



103 AND 103/212 SMART-CAT™ MODEMS



They do more, do it easier and do it in less space. And with LSI technology they run better and cooler—and will for years. Built-in dialer, redialing on busy signal, auto answer, plus extensive software command set.

103 Smart-Cat (300 BAUD, full duplex) \$249*
103/212 Smart-Cat (300 or 1200 BAUD full duplex) \$595*

212 AUTO-CAT™ MODEM

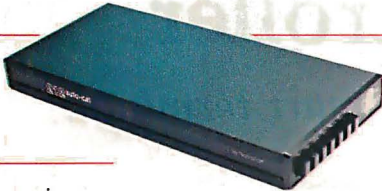

You get all the options of a full duplex Bell 212A compatible modem and more. It's an advanced modem with custom micro-processors and LSI circuits that have let us cut parts count and costs drastically—while improving performance in every way. Auto-answer and auto selection of 1200 bps or lower speed. Both synchronous and asynchronous. \$695*

APPLE®CAT™ II WITH 212 OPTION

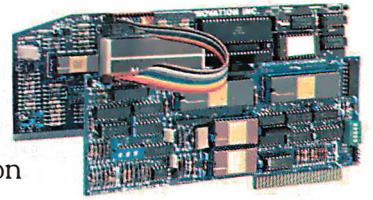

Complete communication system for Apple owners.

Modular design lets you grow into—not out of—the system. Comes with excellent software—our own Com-Ware™ is a simple-to-use, menu driven terminal program. Full range of speeds up to 1200 bps. All auto functions—phone directory with auto configuration and auto dial, redial, answer, disconnect. Binary or text modes. VisiCalc™ and CP/M™ compatibility—and the list is growing. Installation can still be just one slot in your Apple II, even with optional 212 card. \$389* and up.



The recognized leader in personal communications.

Novation, Inc., 18664 Oxnard Street, Tarzana, CA 91356
(800) 423-5419 · In California: (213) 996-5060

Cat is a registered trademark of Novation. VisiCalc is a trademark of Personal Software, Inc. CP/M is a trademark of Digital Research Inc. Apple is a registered trademark of Apple Computer Inc. *Suggested retail

Circle 306 on inquiry card.



The CRT 9007 Video Processor and Controller

Explore the heart of a smart terminal.

Brian Cayton and Mort Herman
Standard Microsystems Corp.
35 Marcus Blvd.
Hauppauge, NY 11788

The CRT 9007 VPAC (video processor and controller) is a powerful new "next-generation" CRT (cathode-ray tube) controller that features advanced memory-addressing techniques and flexible video-timing parameters.

To better understand the virtues of the VPAC, we should first review the function of the basic CRT controller. Characters are "painted" by the scan of a modulated electron beam across the screen phosphors. All CRT displays demand continual readdressing of a video memory to refresh the screen before the characters fade. This screen addressing must be synchronized to the raster scan (via the horizontal and vertical sync pulses) to ensure that the characters are in the same screen position every *frame* or refresh period. In the most elementary sense, a CRT controller is nothing more than a memory-address generator to refresh and synchronize the video screen.

If a CRT controller is to gain acceptance, users must be able to program its screen parameters and format (i.e., the number of characters per row, the

number of rows, the character cell size, sync pulse widths, and so on). Moreover, the controller should offer other characteristics desirable in a display system. These include cursor generation, retrace blank generation, and interlace capability.

The first-generation LSI (large-scale integration) controllers all fit this description. Some of them differ architecturally in the techniques of addressing data and so on, but they all provide much the same function. The first-generation CRT controllers revolutionized the terminal marketplace by reducing the chip count of earlier CRT terminals built with SSI (small-scale integration) and MSI (medium-scale integration) techniques by some 50 to 60 chips. As a result, they substantially reduced both cost and board space and made relatively inexpensive multifeature terminals possible. The CRT controllers also removed much of the black magic associated with CRT display design, bringing the design of CRT displays within the reach of most engineers.

Although the first-generation CRT controller chips were very successful in reducing hardware costs by reducing component counts, they did nothing to improve the actual terminal performance. Over the last few years, however, the terminal market-

place has changed. Computer manufacturers, wanting to enhance their powerful new mini- and microcomputers with powerful new displays, were forced to surround the first-generation CRT controllers with the discrete circuitry needed to provide smooth scrolling and more transparent memory-contention schemes. In addition, they overburdened CRT processors with the software required to provide editing features.

A New Generation

When Standard Microsystems Corporation began on a next-generation CRT controller to replace the first generation CRT 5037 (introduced in 1977), the company decided that a true next-generation CRT controller should not only simplify hardware design decisions but carry out software tasks previously relegated to the system's processor. The designers also felt that the CRT controller should not dictate the hardware architecture of the CRT terminal. The controller should be versatile enough to give the terminal designer maximum freedom in specifying components.

The result was the CRT 9007 VPAC and a family of ancillary circuits. Four LSI circuits resulted from this project: the CRT 9007 VPAC, the CRT 9006 SRB (single-row buffer),

About the Authors

Brian Cayton is the marketing manager (standard products) for Standard Microsystems Corporation. Mort Herman is the product marketing manager (display products) for SMC.



october fest
 MENU (disk directory)
 educational section
 tourist map - historical facts
 gourmet guide - german vocabulary
 game section
 beer drinkers contest
 haunted house - play old organ
 quiz
 quiz training - form

Win a free trip to MUNICH

from september 23 through october 2

visit the wonderful bavarian city

with its traditional, but also progressive places. Get the taste of both charming provincial and eccentric cosmopolitan life! What is Munich, the capital of southern Germany most associated with: Of course not just October Fest, Hofbrauhaus and Beer... but also see the Olympic Stadium, the National Theatre, the Nymphenburger Castle, the Statue of King Ludwig II. Look at paintings of Kandinski and Klee. AGFA, BMW, SIEMENS and, and, and...

The winner of the special QUIZ will get not only a free roundtrip ticket from the international airport nearest his home, but also ten paid days in one of Munich's finest hotels, in the most attractive part of town like the "Munchner Freiheit," surrounded by a lot of nightlife (jazz clubs, bars, cabaret, dancing). Plus 50 US\$ per day to spend as you please during Octoberfest. YOU MAY BE THE WINNER!!! Twenty 2nd prizes: magnificent photo collection "Octoberfest," free diskette.

CONTEST RULES:

Prize winners will be selected at random from successful quiz applicants under the supervision of certified public accountants. This offer is valid except in states where prohibited by law.

- "THE OCTOBER FEST" A SUPERIOR EDUCATIONAL PROGRAM and a lot of fun DISKETTES for APPLE II 48K DOS 3.3 5 1/4" US\$ 37.50*
- and compatible equipment
- IBM PC 64K SS 160K 5 1/4" US\$ 43.50*
- and compatible equipment
- !both with lot of highres colorgraphics, sound, animation US\$ 32.50*
- CP/M VERSION SD 256K 8"
- reduced graphics, no sound

to participate in the QUIZ (getting a quizform as self-maller) order your preferred diskette format now by sending your check or money order to:

artel® art & electronics, p.o. box 8280, santa fe, nm 87504 usa

VISA or MASTERCARD pse call (505) 988-9296
 * foreign orders pse add US\$ 7.50 for shipping
 Entry for QUIZ must be in before August 1, 1983
Munich is waiting for YOU + + +
 Circle 32 on inquiry card.



Auxiliary ICs

CRT 9006 single-row buffer: contains RAM, an address counter, and data latches. Two versions are available: CRT 9006-135 (up to 135-column display) and CRT 9006-83 (up to 83-column display). Both versions can be cascaded for longer data rows.

CRT 9212 double-row buffer: essentially two single-row buffers in one package. One buffer fills with character data while the other provides screen refresh. It has separate clocks for reading and writing the buffers to allow for different input and output data rates.

CRT 9021B video attributes controller: controls video attributes (blink, blank, reverse video, underline, and intensity along with double height/double width and programmable cursor) and graphic attributes (wide and thin modes). Contains 28.5-MHz video shift register.

Table 1: The three auxiliary ICs developed by Standard Microsystems Inc. to support the CRT 9007 VPAC.

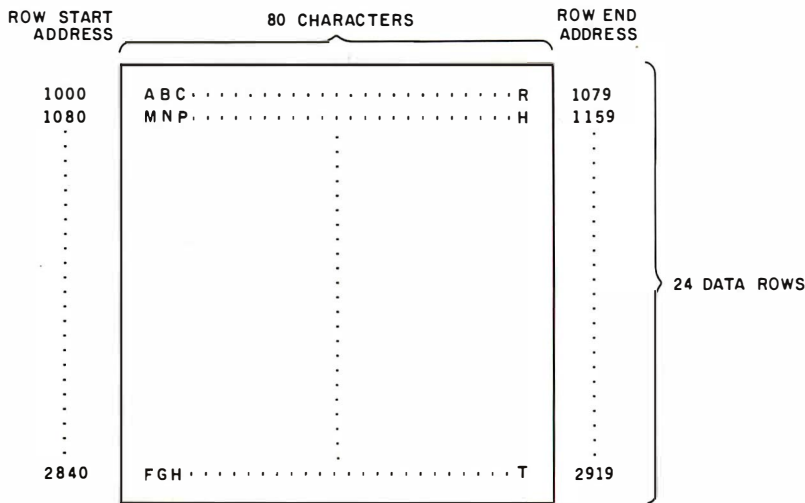

Figure 1: A typical (80 by 24) display employs sequential memory addressing for its 1920 bytes of video memory.

the CRT 9212 DRB (double-row buffer), and the CRT 9021B VAC (video attributes controller). See table 1.

VPAC Design

The CRT 9007 contains 30 registers, 12 of which contain the *vital screen parameters*, the data that determines the screen format. The remaining registers provide for cursor control, light-pen operation, and the software features that are unique to the VPAC.

Traditionally, video memory is addressed sequentially. In sequential addressing, the characters on the display screen are located in suc-

cessive memory locations. As each character is read out for display refresh, an internal video-address counter is incremented by one, to point to the next character to be accessed. For example, an 80-character by 24 data-row display will require 1920 sequentially located bytes that represent all character locations on the screen (see figure 1).

Intelligent terminals must provide on-screen data manipulation through editing functions. Typically, such designs also include display features such as double-height and double-width characters, bidirectional variable-speed smooth scrolling, and

multiple-width screens (83 and 135 columns).

With sequential memory addressing, inserting and deleting single characters within a row are relatively trivial examples of data manipulation. However, when whole lines are inserted or deleted, large blocks of data must be moved rapidly to avoid screen flashing, "garbage" displays, or undesirable blanking of the entire screen. A single-line insertion in an 80-column display requires that every succeeding memory byte be moved forward by 80 address locations. On a 24-row display, this can involve moving up to 2K bytes of data. The microprocessor manipulating this data must also be able to service the various interrupts coming from data-communication ports, the keyboard, and possibly even a magnetic-storage medium.

Nonsequential Memory Addressing

To take some of the burden off the microprocessor, the VPAC provides not only sequential memory addressing but two modes of *row-table* oriented nonsequential memory addressing to assume the duties of moving data from the host processor.

The row table, a list of starting addresses for the rows, resides in memory for addressing by the VPAC. Row-table addressing links each data row by pointers, eliminating the need to locate the rows in sequential memory addresses. Instead of manipulating entire data rows, only the pointers need be moved. Two formats for the row-table organization are provided—*contiguous* and *linked list*. In the contiguous format, a start address register in the VPAC points to the first entry of the row table (see figure 2). In the linked-list format, the start address register points to the beginning of the linked list. The first 2 bytes of each data row point to the starting address of the following data row, as shown in figure 3.

To insert a data row using a row table, the VPAC modifies the row table by entering the starting address of the new data into the table. To delete a data row, the VPAC deletes the existing entry in the row table.

TIME SPECTRUM[®]

AN INNOVATIVE CONCEPT IN MODULAR EXPANSION

Only the new TIME SPECTRUM brings you a galaxy of expansion options for your IBM-PC[®]...with VERSAPAK[®].

VERSAPAK SERIAL EXPANSION MODULE -
Adds a second standalone serial asynchronous port with **COMPAK**.

VERSAPAK SYNCHRONOUS EXPANSION MODULE - Adds two standalone serial synchronous ports with **SYNCPAK**.

VERSAPAK MEMORY MODULE - Memory expansion from 256KB to 512KB in 64KB increments, with optional second serial asynchronous port with **RAMPAK**.

CLIFFHANGER[®]-
Proprietary connector mounting hardware simplifies installation of I/O lines.

PERSYST

TIME SPECTRUM FOUNDATION MODULE -

Contains a Real Time Clock, 64KB RAM (expandable to 256KB), serial asynchronous port, and optional parallel printer port

Watch for new **VERSAPAK** modules to be introduced soon.

For more information on the revolutionary new **TIME SPECTRUM** and **VERSAPAK** expansion modules, see your nearest IBM-PC authorized dealer or contact:

PERSYST

15801 Rockfield, Ste. A, Irvine, CA 92714
714-859-8871

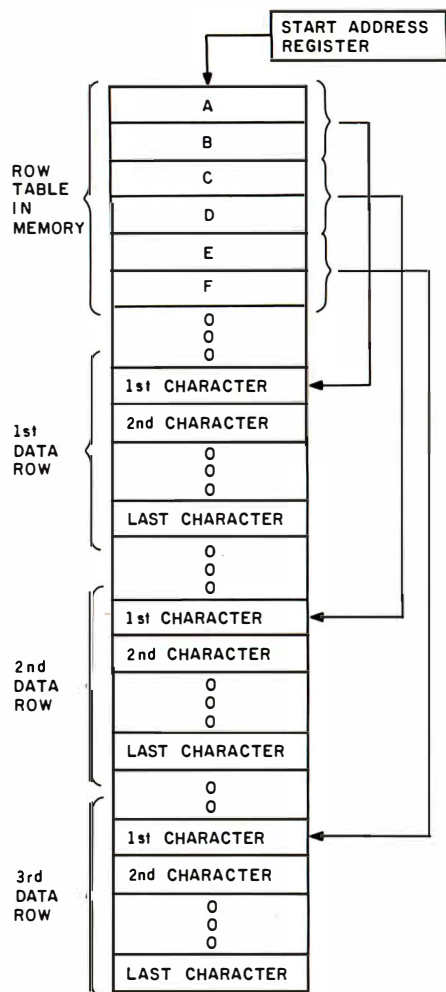

Figure 2: Contiguous row-table format. Each data row (screen line) is stored contiguously within memory. The start address register points to the first row table.

Additional Features

Another addressing feature of the VPAC is the provision of *sequential break* and *auxiliary address* registers.

When a break is encountered in the sequential addressing mode, the VPAC begins addressing the memory locations indicated by a starting address stored in one of two auxiliary address registers. This enables you to scroll a portion of the screen while keeping the rest fixed. The position of the sequential breaks is defined in sequential break registers 1 and 2 and programmed with the data-row number that starts the particular break.

You can combine a row-driven screen for the top portion of the display with a sequential screen for the bottom portion of the screen (i.e., split screen) by specifying a row-driven format in the table start

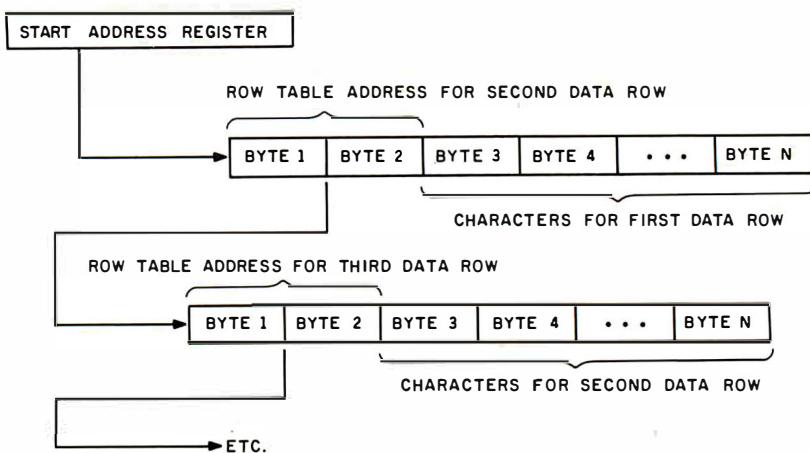

Figure 3: Linked-list row-table format. The start address register points to the address for the second data row. The first 2 bytes of that data row point to the address of the next data row, and so on.

register and then using sequential break register 1. If sequential break register 1 is programmed within the displayable screen parameters, the row address for that data row will be overridden and the remainder of the screen will be addressed sequentially, starting at the address specified in auxiliary address register 1.

Combining a row-driven screen with a sequential screen could be useful in some communications applications. A high-priority message to the terminal could be stored sequentially. As more of the message came in, sequential break register 1 would be decremented to allow the message to overlay the row-driven screen one data row at a time. By programming sequential break register 1 outside the display range, the original row-driven screen is restored.

Display Formatting

To allow the terminal designer maximum freedom, nine registers are used to store the horizontal and vertical timing parameters that are output to the monitor.

Horizontal timing is determined by four registers (R0-R3). Both R0 and R1 are 8-bit registers that contain, respectively, the number of character time periods per horizontal period (i.e., 1 scan line) and the number of displayable characters per horizontal period (i.e., the active display time). R2 is a 6-bit register that can be pro-

grammed for the time between the beginning of horizontal sync and the end of horizontal blanking. R3 is a 7-bit register that defines the horizontal sync width. When you program these registers, sync widths can be generated narrow enough for so-called *sync monitors* or wide enough for *drive monitors*. The sync pulse can be extended well into the active video portion of the horizontal time or kept within the blank time.

Vertical timing capabilities are as broad as the horizontal, with five registers used to store the vertical timing parameters: R4 defines the vertical sync pulse width, R5 the delay between the leading edge of vertical sync and the end of the vertical blank, R7 the number of data rows per frame, R8 the number of scan lines per data row, and R9 (an 11-bit register) the number of scan lines per frame. An 11-bit register enables the designer to program the VPAC for as many as 2048 scan lines per frame so that it can be used in systems ranging from low-cost terminals to high-resolution word-processing and graphics applications.

Some Hardware Configurations

An intelligent terminal must allow both the CRT controller and the host processor contention-free access to the video memory. Unless the CRT controller has continuous memory access, the display will flicker. The

A COMPUTER MONITOR SHOULDN'T BE A SITE FOR SORE EYES.

Some people buy a computer monitor the same way they buy a TV—for the esthetics of it. It *looks* good. But after looking at its screen for a good half hour, their eyes begin to wonder—and burn.

Other people would give the monitor no mind even if they went blind—they're buying a *computer*.

At USI, we have nothing against computers, we have a lot for them. But we know that the thing you interface with most is the monitor, not the computer. And we design and build monitors as if your computing depends on it.

WE'VE THOROUGHLY RESEARCHED WHAT HAPPENS TO EYES THAT STARE AT MONITORS. The result: we adopted the same screen colors many European countries recommend for health and safety.

We found that the color of the display is not just a matter of preference, it's a matter of visual acuity and comfort. We saw amber (we were the first to see it) as the wave of the future. And the response from the marketplace has made others amber with envy. For people who prefer a green screen, we have it, too, but with higher resolution than any other green monitor.

USI makes a full range of 9" and 12" amber and green monitors for personal and small business computing. All offer 1000 lines at-center resolution, the sharpest you'll see anywhere. All have non-glare screens. And all have an inverse video switch. If your eyes should begin to get fatigued, switch for a while (graphics look great this way).

We also make a 14" color monitor that's noticeably sharper than any TV screen. Move your game over to our field and enjoy it more. And we're about to introduce our RGB (red-green-blue) monitor for business graphics. It will bring you color clarity like you've never experienced: 720 lines horizontal resolution and .31mm dot pitch.

USI IS DEDICATED TO MONITORS THAT ARE DEDICATED TO COMPUTERS.

Use them with Apple, Atari, Commodore, IBM, Osborne and most others. We make monitors to ease your workday or please your playnight. Or both.

Here's a letter we got recently.

"Dear USI. I just did the ultimate test. I looked at you 24 hours straight. After that, I could still see!"

Do you want to look into our monitors more deeply? We've put out a colorful brochure which goes

into them in detail, and tells about our other computer accessories. We'll be happy to send it to you; just mail us the coupon.



For USI's free guide to computer monitors and accessories, mail to:

USI Computer Products

71 Park Lane
Brisbane, California 94005
Telephone: 415/468-4900

Name _____

Title _____

Company _____

City _____

State _____ Zip _____

Phone (____) _____

MEMORY ADDRESS (TYPICAL)	MEMORY DATA (8 BITS)
0D00	ATTRIBUTE 0
0D01	CHARACTER 0
0D02	ATTRIBUTE 1
0D03	CHARACTER 1
⋮	⋮
⋮	⋮
2N	ATTRIBUTE N
2N+1	CHARACTER N

Figure 4: The Attribute Assemble mode lets the programmer create a pseudo 16-bit word that describes both the character and its attributes (see text).

processor cannot, however, be denied access to memory.

The simplest and most common terminal configurations may be referred to as *repetitive memory addressing*. In the repetitive addressing configurations, the microprocessor and the VPAC share memory. The VPAC will repeat the sequence of video addresses for every scan line of every data row. To allow the processor access to the memory, you can use one of several schemes. In one approach, *retrace intervention*, the processor is given memory access during the blanked portion of the display and the VPAC has priority during active video.

The retrace-intervention approach, although simple, does reduce microprocessor throughput by denying the host processor access to memory during active video. An alternate—and more expensive—variety of repetitive memory addressing uses double-speed memory. In double-speed memory addressing, both the processor and the VPAC are allowed video-memory access during alternating time slots within one character time.

Single-Row Buffer Operation

By using the VPAC's DMA mechanism and SMC's CRT 9006 single-row buffer, efficient sharing of the video memory results in systems that have high throughput. In this system, data is loaded into the single-row buffer during the first scan line of

every data row. The CRT 9006 also allows this data to be simultaneously sent to the character generator and the CRT 9021B. During all subsequent scan lines, the display is driven by the row buffer, which frees up the video memory. In a display with 12 scan lines per data row, the processor will have uncontested access for 11 scan lines, or 92 percent of real time.

In a single-row buffer arrangement, the processor must be idle for one entire scan line, which could be for 50 to 60 microseconds. This delay means that the processor's ability to respond swiftly to real-time events is compromised. A second DMA device within the system, if needed, might create restrictive timing conflicts. The processor itself might not be able to tolerate a DMA cycle of 50 to 60 microseconds.

Double-Row Buffer Operation

The use of the VPAC with the CRT 9212 double-row buffer lets the user overcome such restrictions by evenly distributing the DMA requests for each data row throughout all scan lines within the data row. With a double-row buffer, while one buffer is fully loaded and supplying data to the character generator for the data row currently being painted, the other buffer is being loaded with the data for the next data row. In the double-row buffer mode, the user can program the number of DMA cycles for each burst and the delay between each DMA burst. In this way, the processor and other DMA devices can perform their tasks more quickly.

Attribute Assemble

In addition to the 7 or 8 bits used to provide character or graphic data, 8 bits may be used to provide attributes such as color, reverse-video, blink, blank, underline, and intensity. This will typically result in 16 bits per character. There are, however, many reasons to keep the video memory 8 bits wide while still providing all the advantages of wide-memory terminals. First, an 8-bit processor might be all that you need to meet the CRT system's design goal. Second, the most inexpensive memory devices, dynamic RAMs (random-access

read/write memories), are all 1 bit wide. An 8-bit-wide video memory requires 8 devices; a device must be added for each bit increase in memory-data width.

The Attribute Assemble mode lets the user maintain an 8-bit-wide video memory but "assemble" a 16-bit-wide word for the CRT display. By arranging an 8-bit-wide memory as shown in figure 4, the user can sacrifice time to gain memory-bit width. In other words, for 80 characters per data row, instead of accessing 80 locations of 16 bits each, the VPAC accesses 160 locations of 8 bits each. The VPAC "assembles" the first 8 bits in an internal attribute latch during the first access and outputs these 8 bits while accessing the second 8 bits. At this time the VPAC causes a 16-bit word to be loaded into two double-row buffers every other video-memory fetch.

Double-Height Double-Width Display

The VPAC will enable double-height/double-width characters to be displayed on a row-by-row basis as a function of the two most significant bits of the particular row-table entry. When a particular scan line is to be painted in double height or double width, the VPAC activates the CURS output during the retrace interval (CBLANK). (See figure 5.) This allows logic external to the VPAC to divide the character and dot clocks to produce the desired visual effect. Proper phasing of the divided character clock with respect to CBLANK is necessary so as not to cut the first visible character on the data row in half. The CRT 9021B video attributes controller will automatically perform the division and phasing of the character and dot clock as required to display the double-height or double-width data rows with no additional hardware.

Smooth Scrolling

When a page is filled in a typical CRT system, the entire display jumps up one row, making room for more data to be entered on the bottom row. When *jump* scrolling takes place on a frequent basis, the display is hard to



Every Executive Needs an Organizer Like T.I.M.®

Your valuable business information needs to be organized. T.I.M. can do it easily and quickly on your IBM-PC. As the executive's data base management system, T.I.M. makes it easy for you to assemble all your information so it can be ordered, changed or retrieved and then printed to suit a variety of circumstances. From phone lists through

complex sales reports, T.I.M. helps you put it all together using plain English commands — no programmerese to confuse you. Plus T.I.M. interfaces with all of the most popular word processing systems as well as powerful tools like Visicalc® ... T.I.M. is the executive's solution that's simple to use, easy to learn and pays off in bottom line efficiency for you and your

organization. For more information see your local IBM-PC dealer or contact Innovative Software for the name of the T.I.M. dealer nearest you.



developers of practical businessware for the executive.

T.I.M. III is sold at Computerland®, Sears Business Centers, The Xerox Stores, Computer Marts, Entre' Computer CentersSM, CompuShops® and other independent dealers.

Circle 201 on Inquiry card.

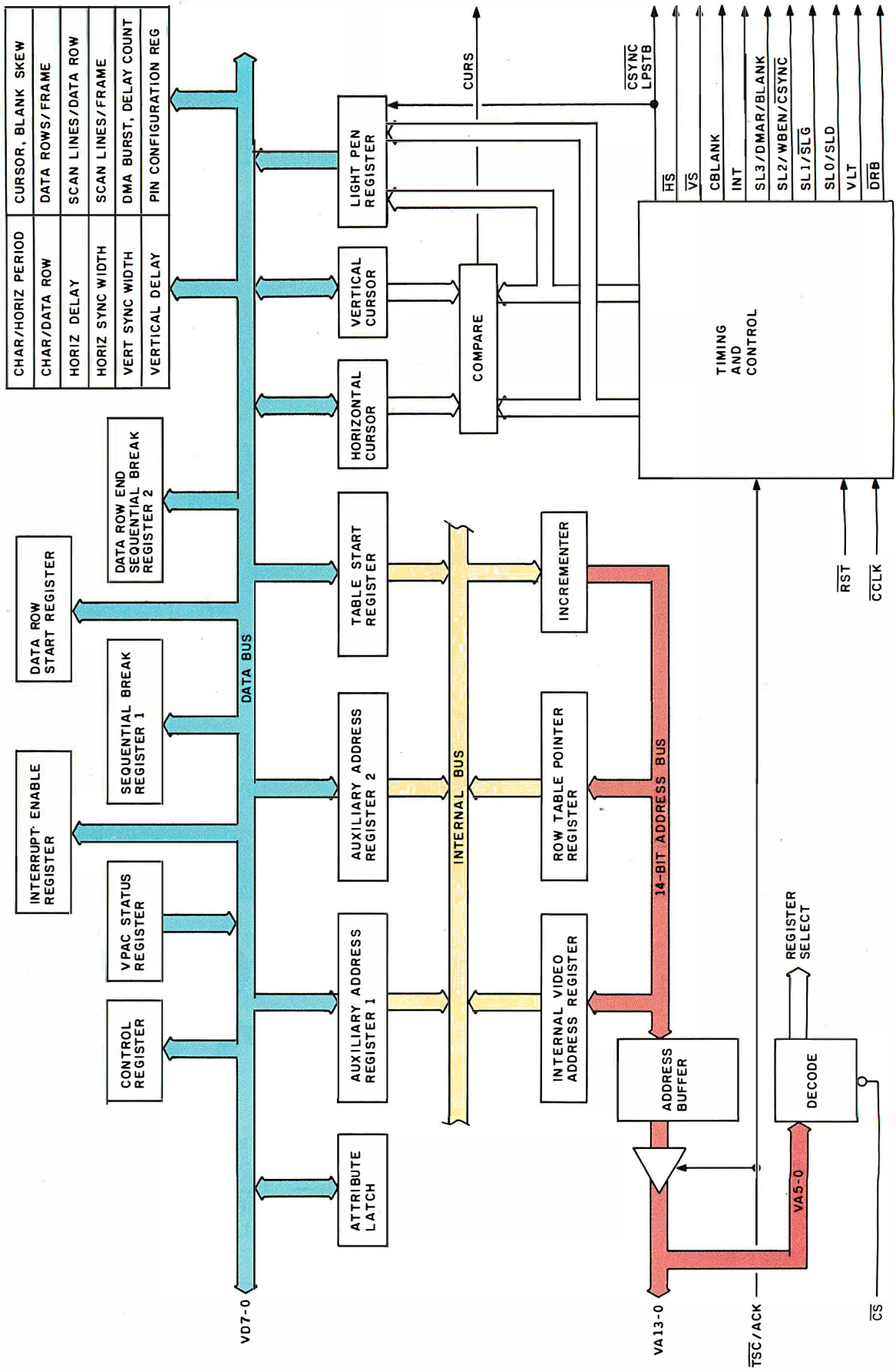

Figure 5: A block diagram of the CRT 9007 VPAC.

"I built this 16-bit computer and saved money. Learned a lot, too."

Save now by building the Heathkit H-100 yourself. Save later because your computer investment won't become obsolete for many years to come.

Save by building it yourself. You can save hundreds of dollars over assembled prices when you choose the new H-100 16-Bit/8-Bit Computer Kit – money you can use to buy the peripherals and software of your choice.

H-100 SERIES COMPUTER SPECIFICATIONS:

USER MEMORY:
128K-768K bytes*

MICROPROCESSORS:
16-bit: 8088
8-bit: 8085

DISK STORAGE:
Built-in standard
5.25" disk drive,
320K bytes/disk

KEYBOARD:
Typewriter-style,
108 keys, 13
function keys,
18-key numeric pad

GRAPHICS:
Always in graphics mode.
640h/225v resolution;
up to eight colors
are available**

COMMUNICATIONS:
Two RS-232C Serial
Interface Ports and
one parallel port

*128K bytes standard.
**Optional.

DIAGNOSTICS:
Memory self-test
on power-up

AVAILABLE SOFTWARE:
Z-DOS (MS-DOS)
CP/M-85
Z-BASIC Language
Microsoft BASIC
Multiplan
SuperCalc
WordStar
MailMerge
Data Base
Manager
Most
standard
8-bit CP/M
Software

The H-100 is easy to build – the step-by-step Heathkit manual shows you how. And every step of the way, you have our pledge – "We won't let you fail." Help is as close as your phone, or the nearest Heathkit Electronic Center.†

And what better way to learn state-of-the-art computing techniques than to build the world's only 16-bit/8-bit computer kit? To run today's higher-speed, higher-performance 16-bit software, you need an H-100. It makes a big difference by processing more data faster.

Dual microprocessors for power and compatibility. The H-100 handles both high-performance 16-bit software and most current Heath/Zenith 8-bit software.

Want room to grow? The H-100's standard 128K byte Random Access Memory complement can be expanded to 768K bytes – compared to a 64K standard for many desktop computers.

And the industry-standard S-100 card slots support memory expansion and additional peripheral devices, increasing future upgradability of the H-100.

High-capacity disk storage, too. The H-100's 5.25" floppy disk drive can store 320K bytes on a single disk. The computer also supports an optional second 5.25" and external 8" floppy disk drives. And an optional internal Winchester disk drive will be available soon.

For more information, circle the reader service number below. Better yet, visit your Heathkit Electronic Center for a demonstration!

The H-100 gives me the most for my computer dollar!



Heathkit
Heath
Company

Heathkit Electronic Centers are units of Veritechnology Electronics Corporation.
Heath Company and Veritechnology Electronics Corporation are subsidiaries of Zenith Radio Corporation.

Circle 186 on Inquiry card.

LISP

For The
IBM
Personal Computer

THE PREMIER LANGUAGE
OF ARTIFICIAL INTELLIGENCE
AVAILABLE
FOR YOUR IBM PC

► DATA TYPES

Unlimited Precision Integers
Floating Point Numbers
Character Strings
Multidimensional Arrays
Files
Machine Language Functions

► MEMORY MANAGEMENT

Dynamic Allocation
Compacting Garbage Collector
Full Memory Space Supported

► FUNCTION TYPES

Call-By-Name/Call-By-Value
Fixed/Variable Number Of
Arguments
Macros
Machine Language/Interpreted
Over 150 Primitive Functions

► IO SUPPORT

Multiple Display Windows
Cursor Control
All Function Keys Supported
Read And Splice Macros
Disk Files

► POWERFUL ERROR RECOVERY

► 8087 SUPPORT

► LISP LIBRARY

Editor And Formatter
Package Support
Debugging Functions
.OBJ File Loader

► RUNS UNDER PC-DOS

IQLISP

from

∫ *q* *Integral Quality*

P. O. Box 31970
SEATTLE, WA 98103-0070
(206) 527-2918

5¼ diskette and manual 125.00
manual only 25.00

(Wash. State residents add sales tax)
VISA and Mastercard Accepted

read. If the increments occur one scan line, rather than one data row, per frame time, the scroll is smoother and easier to read. The CRT 9007 VPAC provides smooth scrolling at variable rates. Furthermore, bidirectional smooth scrolling may take place over any selected portion of the display rather than the whole display.

Smooth scrolling adds some interesting requirements to system design. You can no longer assume that a particular scan line (usually the first or last one within a data row) has an absence of dots as defined by the character generator. Smooth scrolling can define *any* scan line as the first one in a data row. In any given frame, fractions of full data rows will be displayed when the display is in the process of scrolling. Thus the data row that is defined to start a smooth scroll interval and the data row one less than the data row defined to end a smooth scroll interval can show fractional data rows. The first and last data row for a partial-page smooth-scrolling operation is defined in the *data row start* and *data row end* registers respectively. Because a constant number of scan lines is painted on each frame, as one data row loses scan lines, another must appear to take up the extra scan lines. Because of this, it is necessary to maintain an extra data row within the row table. Once the display is scrolled, a portion of the extra data row must enter the display at the appropriate place. If 24 data rows are defined, then for an unscrolled display 24 data-row boundary (DRB) signals are generated, all equally spaced in time as defined by the number of scan lines per data row. In this case, the data-row boundary signals will coincide with scan line count 0. Once the display is scrolled, an extra DRB will appear, and some DRBs will not be equally spaced.

A smooth scrolling operation involves a data-row insertion at the point defined by the data-row end register when it goes from an unscrolled frame (no offset) to a scrolled frame. In each successive frame, the offset is updated. If the software updates the offset by 1 scan line each

frame, the display will scroll smoothly at the rate of 1 scan line per frame. Under software control, it is possible to update the offset register by any number of scan lines to produce a variable-speed smooth scroll. When the offset register is again loaded with 0, it means that the smooth scroll of a single data row has concluded.

A smooth scroll-down operation is accomplished by reversing the process. The offset register is decremented and a data row is inserted at the data-row start position when going from an unscrolled to a scrolled display section. A data row can be deleted in a similar fashion.

Conclusion

The use of LSI circuitry in the CRT 9007 video processor and controller has two major consequences for manufacturers of video terminals. First, because so many functions are integral to the chip, the component count can be substantially reduced—to less than 20 chips in some applications. As the chip count decreases, the costs of design and manufacturing decrease. Second, some of the features of the VPAC, such as Standard Microsystems' scheme of nonsequential memory addressing, were not previously available on a cost-effective basis. The primary benefit of nonsequential memory addressing is data-row insertion/deletion without moving large blocks of data. Therefore the terminal processor is not overworked and the video display is free from flickering and blanking. The other major feature is bidirectional smooth scrolling.

For the end user, these improvements mean the next generation of smart terminals will contain even more features at a reduced cost—a trend to be encouraged. ■

For Further Information

For those who want more information on the VPAC and its support chips, Standard Microsystems Corporation has published a data sheet, two technical notes, and two application notes covering the VPAC's programming and use. For copies, contact SMC at 35 Marcus Blvd., Hauppauge, NY 11788.

Extend your reach ...make the knowledge connection.



Use your personal computer to reach Knowledge Index, and you've tapped into a wealth of information on business, personal money management, education, consumer products, medicine, current affairs, computers. And much more.

It's a special service for personal computer users from Dialog, the world's leading online information retrieval service. Now, the same information used by thousands of corporations, libraries and professionals is available to you nights and weekends at special low rates.

Knowledge Index offers you millions of summaries of articles, books, reviews, reports, and news items. Plus unique databases like Micro-

computer Index and International Software Database. You can even order complete documents and software packages right from your terminal.

A one-time initiation fee of only \$35 gets you your password, a complete, self-instructional user manual, and two free hours of Knowledge Index—a value of over \$50! One low cost—40¢ a minute—covers it all, and a typical inquiry takes only a few minutes. There is no monthly minimum—you pay only for what you actually use.

So, use Knowledge Index to extend your reach. Call or write for complete information.

KNOWLEDGE INDEX
A Service of Lockheed Dialog.

3460 Hillview Avenue, Palo Alto, CA 94304 • 800/528-6050 x 415 (in Arizona 800/352-0458 x 415)

Circle 234 on inquiry card.

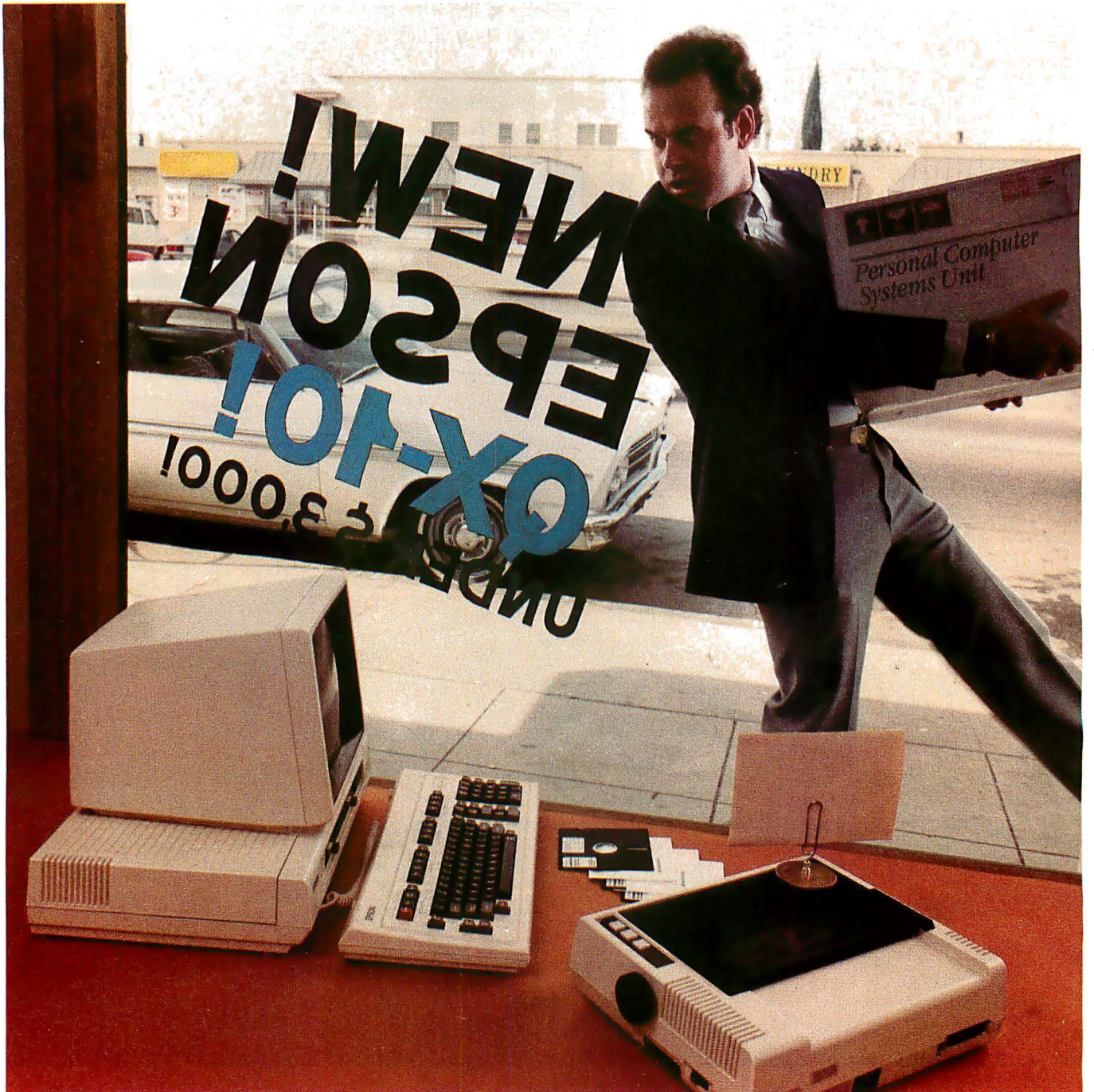

If you just bought another computer,
boy are you gonna be sorry.

Epson.

The new Epson QX-10 is unlike any personal computer you've ever seen. It's a computer for people who don't have the time to learn computers; a computer you can be using within minutes.

And fortunately, you don't have to take our word for it. Here's how *Byte*, one of the computer industry's most prestigious magazines, describes the QX-10.

The first anybody-can-use-it computer.

"The Epson QX-10 (is) a computer for less than \$3000 that may well be the first of a new breed of anybody-can-use-it 'appliance' computers ... In addition to being a highly integrated word processing/computer system that offers as much usable processing power as almost any existing microcomputer, the QX-10 ... system is designed to be used by people with minimal technical knowledge. We've certainly heard that claim before, but Epson has delivered on this promise in a way and to an extent that *no* microcomputer manufacturer has done."

That's nice to hear from a magazine like *Byte*, of course, but it doesn't surprise us. It's just what we intended the QX-10 to be all along.

More computer. Less money.

But useability isn't the only thing the QX-10 has going for it. As *Byte* says, "the QX-10 gives you a great deal for your money.

"Help is available at any time through the HASCI (Human Application Standard Computer Interface) keyboard Help key ... Text can be entered at any time just as you would in a conventional word processor. The Calc key turns the system into a basic

4-function calculator. Graphics can be created via the Draw key. The Sched (schedule) key gives you access to a computer-kept appointment book, a built-in clock/timer/ alarm, and an event scheduler."

Advanced hardware for advanced software.

As for hardware, *Popular Computing*, another industry leader, says: "The QX-10 includes ... a number of advanced hardware features ... The basic components of the system are a detachable keyboard, a high resolution monochrome display, and a system unit containing two 5¼ inch disk drives. The drives use double-sided, double-density disks (340K bytes per disk) and are amazingly compact ... The QX-10 uses an 8-bit Z80A microprocessor. The system contains 256K bytes of RAM. Some of the RAM is ... battery powered ... which lets the computer retain information when the power is off."

You won't have to wait much longer.

The new Epson QX-10 may very well be the computer you've been waiting for. And fortunately, you won't have to wait much longer — it will be appearing soon in computer stores all across the country. In the meantime, write Epson at 3415 Kashiwa Street, Torrance, CA 90505, or call (213) 539-9140. We'll be happy to send you copies of our reviews.

After all, as *Popular Computing* puts it, the QX-10 will "do for computing what the Model T did for transportation."

And we couldn't have said it better ourselves.



EPSON
EPSON AMERICA, INC.
COMPUTER PRODUCTS DIVISION

3415 Kashiwa Street
Torrance, California 90505
(213) 539-9140

Circle 165 on inquiry card.

New Japanese Microcomputers

A Report from the Japan Data Show and Electronics Show

Phil Lemmons
West Coast Editor

The Japanese will make mistakes in the process, but sooner or later they will make some excellent personal computers. That is the lesson of the Japan Data Show '82, held October 19 through 22 at the Tokyo International Trade Center Exhibition Site on Harumi Island. The Japan Electronics Show, held at the same site during the following week, confirmed this impression and also revealed more about the intentions of the Japanese consumer-electronics companies. In short, most of the major Japanese electronics manufacturers are now or soon will be offering every type of microcomputer from hand-held units to extremely powerful desktop systems. Most of the Japanese companies have chosen the Intel 8088 and 8086 microprocessor chips for their top-of-the-line personal computers. In addition, the consumer-electronics companies are beginning to produce home computers of a type not yet seen in the United States: sleek, consumer-oriented machines that will enter the home as part of an advanced video-entertainment system.

In this article I'll describe the most

impressive machines I saw in Tokyo. I'll also touch on some interesting new developments such as an infrared modem, both infrared and fiber-optic local networks, and the continuing spread in Japan of high-resolution video graphics and dot-matrix and inkjet printers.

The Japanese offer broad product lines aimed at all segments of the world market.

Japanese 16-bit Microcomputers

At least twenty 16-bit microcomputers were on view at the Japanese electronics shows. I will report on the machines of greatest interest to personal computer owners and shoppers. (The order of the following presentation is random.)

National Mybrain 3000: This is the personal computer that you would expect from Matsushita, whose brand names in the United States include Panasonic, National, and Quasar. As photo 1 shows, the Mybrain 3000

comes in four separate units: detached keyboard with eight programmable function keys, a numeric pad, cursor keys, editing keys, and palm rest; a system unit; a video monitor for high-resolution color graphics; and disk drives.

The Mybrain 3000 has an 8088 central processor, a minimum of 96K bytes of user RAM (random-access, read/write memory), and 32K bytes of additional video RAM, plus a 16K-byte ROM (read-only memory). Video RAM can be increased to 128K bytes. Video graphics have a resolution of up to 640 by 400 dots. The available floppy-disk drives include 3-inch, 5¼-inch (160K-byte), and 8-inch (1.2-megabyte) drives, all in separate vertical units. An RS-232C serial input/output (I/O) port is standard, and an IEEE-488 port, a light-pen, joysticks, and a graphics tablet are available.

National is offering both MS-DOS (from Microsoft) and CP/M-86 (from Digital Research) as operating systems, along with many of the languages available with these operating systems in the United States. Applications software can be expected to ap-

A NEW CONCEPT IN STATIC CONTROL

YOU'LL NEVER TOUCH A "NAKED" COMPUTER AGAIN!

A "naked" computer is any computer that sits on a bare table or desk top, without a **TouchMat™** static dissipative table mat directly under it.

"NAKED" COMPUTERS ARE VULNERABLE to some of the most frustrating static-related problems a computer user can encounter — erratic or erroneous data transmission, loss of programs or data, damage to discs or accessory cards, component failure, or "unexplained" down time.

During the dry winter heating season, you are probably more aware of static electricity because you can *feel* it. However, your computer is vulnerable to a much smaller ZAP than you can possibly feel, and that level of static may occur at *any time of the year*. Even air conditioning can aggravate the problem by drying the air.

IT ONLY TAKES ONE ZAP to make your perfectly logical computer act irrational and temperamental. Experienced computer users know that static electricity cannot be completely eliminated from the environment or the microcomputer, since *people* are prime generators of static. The best solution is to channel static charges harmlessly away before they have a chance to spark to sensitive components and accessories.

THE TOUCHMAT SITS ON THE TABLE, directly under the computer, within easy reach of your hands and fingers. To discharge static from your body, simply touch the mat before turning on the computer, and then periodically during operation.

Discharging takes less than a second, does not produce a spark, and is absolutely assured by the simple fact that your skin contacts the mat directly. (The sweat layer of the human skin is a primary conductor of electricity.) Anytime your hands or wrists rest on the mat, static discharge is automatic.

A DRAMATIC IMPROVEMENT OVER CONDUCTIVE FLOOR MATS, the TouchMat does not require users to wear leather-soled shoes for effective static discharge. A floor mat may be rendered virtually ineffective by today's popular synthetic and rubber-soled shoes, which insulate the user.

TouchMat INSTEAD.

THE BEST THING NEXT TO YOUR COMPUTER, the cushioning material of the TouchMat also serves to dampen noise and vibration, and prevents your computer from sliding around on the desktop. Available in a computer-compatible beige, 24" x 26", it accommodates all popular micros.

IF YOU'RE UNCOMFORTABLE NOW, ABOUT YOUR "NAKED" COMPUTER — you should be. Static problems cost you time and money. Prudent computer users in offices, homes and schools everywhere are protecting their computer investment with a TouchMat.

Get your hands on a TouchMat now! For the name of your nearest TouchMat dealer, call toll-free:

1-800-328-0223 outside Minnesota only.

If not yet available in your area, you may order direct for a limited time only. Allow 2-4 weeks for delivery. Visa and MasterCard accepted. Shipping and handling charges extra.



Suggested retail price— \$89.
Dealer inquiries welcome.



TouchMat is a trademark of, and is manufactured exclusively by:

Computerware Inc.
315 South Third Street
Stillwater, Minnesota 55082
(612) 430-2060

© Computerware Inc, 1983

Circle 111 on inquiry card.



Photo 1: National Mybrain 3000.



Photo 4: NEC PC-9800.



Photo 2: Mitsubishi Multi16.



Photo 3: Toshiba Pasopia 16.

pear by the time the Mybrain 3000 reaches the United States, probably in mid-1983.

With two 5¼-inch disk drives, a video monitor, an 80-column dot-matrix printer, an operating system, and BASIC, the system lists for 783,500 yen (about \$3000 at the exchange rate of 265 yen per dollar, which I will use throughout). With one 5¼-inch floppy-disk drive and no printer, the cost in Japan is about \$2000. Of course, shipping the machines to the United States and marketing them here should add to the cost.

Mitsubishi Multi16: Since the Multi16 has already been introduced in the United States, I'll be brief. The Multi16 looks like an "all-in-one" microcomputer (all the components in one box), but the combined monitor/disk-drive unit is detachable from the system unit/keyboard combination (see photo 2). The Multi16 has an 8088 processor and an optional 8087 coprocessor, standard memory of 128K bytes expandable to 576K, 640- by 400-dot video resolution, one or two 300K-byte 5¼-inch floppy-disk drives, an RS-232C port with optional GP-IB, a general-purpose parallel bus, and the CP/M-86 operating system. Several different disk drives and several different printers are also available.



Photo 5: NEC N5200. It is marketed as the Advanced Personal Computer in the U.S.

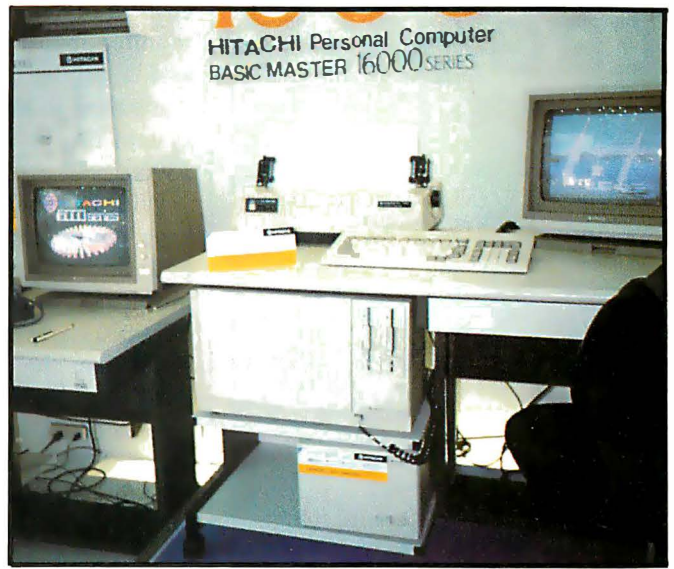

Photo 6: Hitachi BASIC Master 16000.

Microsoft BASIC, Multiplan, and Supercalc-86 are among the available software, as well as a Japanese word processor with the intriguing name Multiword-J. Could this be related to Microsoft's rumored Multiword?

Toshiba Pasopia 16: The Toshiba personal computer, sold in the United States as the T100, is called the Pasopia in Japan, and the Pasopia 16 is its big brother. (In the United States, the Pasopia 16 will be called the T300.) A variety of video monitors is available with resolution ranging from 320 by 200 to 640 by 500 dots. The monitor rests on its own pedestal or on the top of the compact system unit, which contains two thin-line 5¼-inch disk drives holding a total of 640K bytes. Photo 3 shows the Pasopia 16 with an optional 80-column dot-matrix printer resting on the system unit. Eight-inch floppy disks are also optional. The slender detached keyboard has a cursor diamond, numeric pad, editing keys, and programmable-function keys. The processor is an 8088; an 8087 math coprocessor is optional. Standard memory is 4K bytes of ROM and 192K bytes of RAM expandable to 512K. Users can also add video RAM of 128K or 256K bytes. Standard equipment includes one RS-232C port and one parallel printer port.

MS-DOS is the only operating system available for the Pasopia 16. Toshiba offers T-BASIC 16 and other Microsoft languages.

In addition to the Pasopia 16, Toshiba showed the Tosbac UX-300, based on the Toshiba 88000 processor, which has segment registers and seems to be very much like an 8086. The UX-300 runs Unix and has a vertically oriented video monitor resting on a pedestal, 512K bytes of RAM, two RS-232C ports, and an 8-inch disk drive holding 1 megabyte and resting horizontally in the separate system unit. With a 10-megabyte hard disk, the UX-300 costs about \$9300.

NEC PC-9800 and Advanced Personal Computer: One of the surprises at the Japan Data Show was the NEC (Nippon Electric Company) PC-9800 (see photo 4), a personal computer based on the Intel 8086—the true 16-bit version. The PC-9800 surprised people because NEC introduced its 8086-based Advanced Personal Computer (APC) in the United States in mid-1982. In Japan, the APC machine sells under the name N5200 (see photo 5). How many American companies make two 16-bit microcomputers based on the same processor?

In Japan, the APC (N5200), with 128K bytes of RAM, two 8-inch floppy disks holding 1 megabyte



Photo 7: Hitachi PT-1 Personal Terminal.



Photo 8: Sanyo MBC-55.

ERG/68000

MINI-SYSTEMS

- Full IEEE 696/S100 compatibility

HARDWARE OPTIONS

- 8MHz, 10MHz or 12MHz 68000 CPU
- Memory Management
- Multiple Port Intelligent I/O
- 64K or 128K STATIC RAM (70 nsec)
- 256K Dynamic RAM, with full parity (150 nsec)
- 8" D/D, D/S floppy disk drives
- 5MB-40MB hard disk drives
- Full DMA host adaptor
- 20MB tape streamer
- 10 to 20 slot backplane
- 30 amp power supply

SOFTWARE OPTIONS

- 68KFORTH¹ systems language with MACRO assembler and META compiler
- Fast Floating Point package
- Motorola's MACSBUG
- IDRIS² operating system with C, PASCAL, FORTRAN 77, 68K-BASIC¹ compilers
- CP/M—68K³ O/S with C, Assembler, 68K¹-BASIC, + 68K¹-FORTH

Trademark ¹ERG, Inc.

²Whitesmiths

³Digital Research

30 day delivery

with valid Purchase Order

OEM prices available

For CPU, Integrated Card Sets
or Systems.

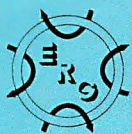

Empirical Research Group, Inc.

P.O. Box 1176

Milton, WA 98354

206-631-4855

each, a high-resolution monochrome monitor (640 by 475), a serial port, and a printer port, has a list price equivalent to about \$2800. The same system lists in the United States for \$3900.

With its separate keyboard (cursor keys, programmable keys, numeric pad, and editing keys), system unit, monitor, and disk drives, the PC-9800 looks more like a home machine than the APC does. The standard memory is 128K bytes expandable to 640K. However, the PC-9800 also has a 96K-byte ROM containing NBASIC-86, and you can get another 96K bytes of video RAM. NEC offers monitors for the PC-9800 with resolution as high as 640 by 400 dots and also an assortment of disk drives. Both MS-DOS and CP/M-86 are available. With two 8-inch drives storing a megabyte each, the keyboard, and the system unit containing 128K bytes of RAM, the PC-9800 costs the equivalent of about \$2600 in Japan. When the PC-9800 reaches the United States (and the NEC spokesmen would not say whether or when that will happen), the list price will probably be about the same as that of the APC.

When I pressed the hosts in the NEC booth about the differences between the APC and the PC-9800, they would say only that the PC-9800 lacks the software power-down that the APC has. There's also the BASIC in ROM, of course, and the PC-9800 system unit is clearly too small to hold the boards that go in the APC's large card cage. (I was not allowed to look inside the PC-9800 or any other machines at the Japanese shows.) The last obvious difference is that the APC has 22 programmable-function keys to the PC-9800's ten.

Both the APC and the PC-9800 are impressive machines. NEC deserves praise for basing both of its top personal computers on the 8086 rather than imitating IBM and choosing the less powerful 8088.

Hitachi BASIC Master 16000 and PT-1 Personal Terminal: Like NEC, Hitachi is offering two 16-bit personal computers, the BASIC Master 16000 (photo 6) and the PT-1 Personal Terminal (photo 7). The BASIC Master

16000 has an 8088 processor, runs MS-DOS, and has 320K bytes of RAM as standard equipment. Video resolution is 640 by 400. The system unit, unlike most of the other modular Japanese microcomputers, is taller than it is deep. Two 5¼-inch floppy disks hold 320K bytes. The Hitachi booth had no brochures about the BASIC Master 16000, and information about it was limited, but the price quoted was 490,000 yen, or about \$1850. I was unable to determine for certain whether that included the video monitor and two disk drives, but it seems hard to believe that it could.

The PT-1 also uses the MS-DOS operating system. Video resolution is 720 by 520, and each of the 8-inch floppy disks holds a megabyte of data. The Hitachi exhibits of office automation equipment showed the PT-1 communicating with larger Hitachi systems.

Both the PT-1 and the BASIC Master 16000 have detached keyboards. Besides the numeric keypad, cursor keys, and editing keys, the PT-1 has 24 programmable-function keys. The BASIC Master 16000 has 10 programmable-function keys besides editing and cursor keys and a numeric pad.

Sanyo MBC-55: Sanyo's top-of-the-line personal computer is the 8088-based MBC-55. The compact system unit contains two thin-line 5¼-inch floppy disks holding 160K bytes each. Although a Sanyo representative in the booth at the Electronics Show said the disk format used is not the same as the IBM PC's, he also said that the hardware bus is compatible. Buyers should, therefore, be able to use boards made for the IBM PC in the Sanyo MBC-55 when it reaches the United States.

The MBC-55 runs CP/M-86, Concurrent CP/M-86, and MS-DOS. Standard memory is 64K bytes expandable to 256K. A 4K-byte "boot" ROM (which contains instructions for reading the operating system from a floppy disk) is standard. An 8087 coprocessor is optional. The MBC-55 will go on sale in the United States in June or July 1983. Although the exact price in the United States has not been

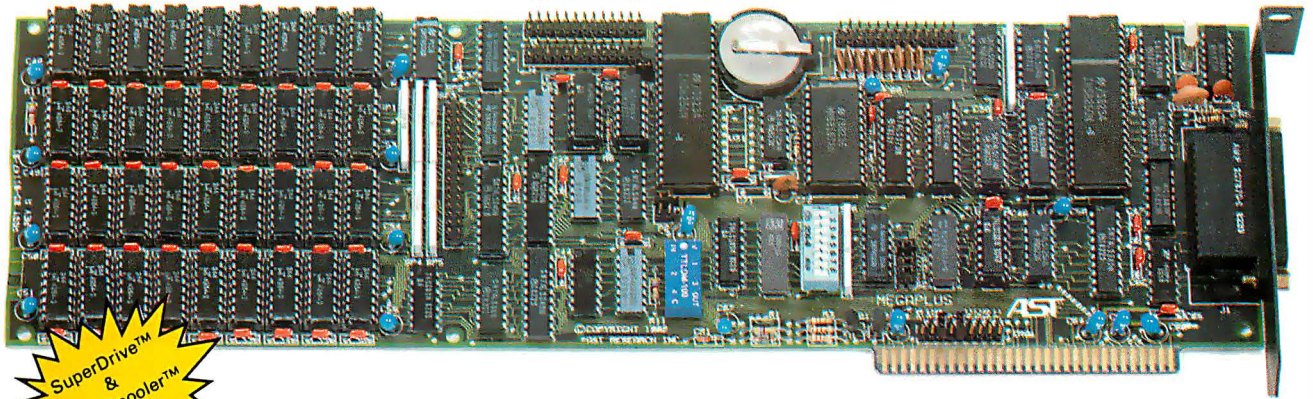

**SuperDrive™
&
SuperSpooler™
included**

Do any QUAD function IBM PC expansion boards measure up to MegaPlus™?

This may really be the only board you need to expand your IBM personal computer. We've now added the most wanted feature on a quad function board: two asynchronous ports along with memory, clock/calendar, and parallel printer port. And unlike most big memory boards, you don't have to sacrifice multiple functions to get 512k of add-on memory in a single slot.

THE BASICS

The main board has three functions standard: Parity checked and fully socketed memory up to 256k in 64k increments, clock/calendar with battery back-up, asynchronous communication port (RS232C serial) which can be used as COM1 or COM2, (DCE for a printer, or DTE for a modem). Optional is a 100% IBM compatible parallel printer port, and a second async port for another \$50 each. Also included are: SuperDrive™ disk emulation and SuperSpooler™ printer buffer software.

NO CORNERS CUT

We didn't lower the quality to give you all this. The board is a four layer design with solder masking, silk screened locations, and gold plated edge connectors. Components are premium grade and meet or exceed IBM specifications. Each board is burned in and tested prior to shipment.

CLOCK/CALENDAR & CLIP-ON BATTERY

Our clock is powered by a simple \$4 lithium watch battery available at your corner drug store. It is clipped on, not soldered like some other clock boards. How useful is a battery warranty that requires you to send your board to the manufacturer to replace it? We send you a diskette with a program that sets the time and date when you turn on your computer. Now your programs will always have the correct time and date on them without you ever having to think about it. (Just which version of that program you were writing is the latest one?)

MEGAPAK OF MEMORY

The picture in the inset shows the optional 256k MegaPak™ board mounted "piggy-back" on the main board. This expandability feature gives those who need it 512k of add-on memory in a single slot. Now you can create disk drives in memory up to

320k, set aside plenty of space for print spooling, and still have plenty of memory for your biggest programs. An exclusive design allows the memory to be split at two memory addresses to take full advantage of the memory disk feature of concurrent CP/M™.

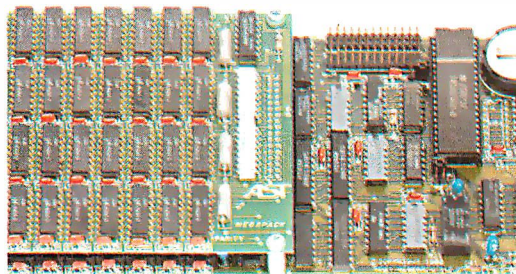

FREE SOFTWARE

The disk emulation software creates "disk drives" in memory which access your programs at the speed of RAM memory. The print spooler allows the memory to accept data as fast as the computer can send it and frees your computer for more productive work. Some manufacturers sell hardware printer buffers that do only this for hundreds of dollars. SuperSpooler™ eliminates the need for these slot robbing products.

CHEAP SOFTWARE TOO

What good is great hardware without some great software to use it with? We offer some terrific prices on some of the popular programs you will want to use your board with. How about the cream of the spreadsheet programs, SUPERCALC, for just \$176. Or maybe dBASE II by Ashton-Tate for just \$419.

WHY BUY IT FROM US?

Because we provide the service and support most companies just talk about. We realize how integral this board is to the use of your computer. What good is a warranty if it takes weeks for repairs to be made? We offer 48 hour turnaround or a replacement board on all warranty repairs. Do you hear anyone else making this promise? If you still are not convinced, and want to compare prices, remember we don't charge extra for credit cards, shipping, or COD fees. If you still want to buy elsewhere, ask them if they will face the acid test.

THE ACID TEST

Qubie say (Q - B - A) gives you a 30 day satisfaction guarantee on all board purchases. If you are not completely satisfied we will refund the entire amount of your purchase. If you can get any of our competitors to give you the same guarantee, buy any other board you think compares and return the one you don't like. We know which one you will keep. One year parts and labor warranty included.

TO ORDER BY MAIL SEND

- Your name and shipping address
- Memory size, and options requested
- Software and cables needed
- Daytime phone number
- California residents add 6% sales tax
- Company check or credit card number with expiration date (personal checks take 18 days to clear)



TO ORDER BY PHONE

In California (805) 482-9829
 Outside California (800) 821-4479
PRICES: 64k \$349 192k \$469
 128k \$409 256k \$529
 512k \$928

(Includes async port, memory, clock/calendar, SuperDrive™, and SuperSpooler™ software)

OPTIONS:

Parallel Printer Port	\$35
Second Async Port	\$35
MegaPak™ with 256k of memory	\$399
Cable to parallel printer	\$35
Cable to modem or serial printer	\$25
Memory Diagnostics Program	\$10
SUPERCALC by SORCIM	\$176
bBASE II by Ashton-Tate	\$419

SHIPMENT

We pay UPS surface charges. UPS 2 day air service \$5 extra. Credit card or bank check orders shipped same day.

**QUBIE'
DISTRIBUTING**

4809 Calle Alto
 Camarillo, CA 93010



Photo 9: Sord M-343.

decided, the Sanyo booth attendant said that the MBC-55 with 64K bytes and one floppy will cost about \$1000. That does not include the video monitor.

As photo 8 shows, the MBC-55 is very compact and seems aimed at the home market. Sanyo did not exhibit the machine at the Data Show, saving it for the more consumer-oriented Electronics Show. Sanyo showed a great deal of video-recording equipment, and the MBC-55 looks as if it might be part of the same family of products. The MBC-55's system unit is only $4\frac{1}{3}$ inches (11 cm) thick, just deep enough to accept boards made for the IBM PC. To keep the keyboard as small as possible, Sanyo chose to supply only four programmable-function keys. The numeric keypad, as on the IBM PC, doubles as a cursor-control pad. Although no Sanyo spokesman said so, I would not be surprised to see the MBC-55 sold as part of a home-video system and used to control video storage systems and to mix computer graphics with video images. (See the section on the Sharp X1 microcomputer later in this article.) The marketing approach would be to say, "Since you're buying a new color television, why

not let us throw in an IBM-compatible personal computer?"

Sord M-343: Sord, one of Japan's few new companies, makes several interesting microcomputers. (See the comments on the M5 home computer and the M23P portable later in this article.) As photo 9 shows, the M-343's color graphics are impressive. The M-343 is the Sord flagship and is powerful indeed. The pro-

The M-343's color graphics are impressive.

cessors include an 8086, and 8087, and a Z80A. The M-343's large, all-in-one unit can hold up to 1176K bytes of RAM. The video resolution is 640 by 400. There are four serial I/O ports, and the M-343 can serve as the hub of a network of Sord M23 Z80A-based computers. Standard floppy-disk storage is 1.2 megabytes. The keyboard has 20 programmable-function keys, cursor-control keys, a numeric keypad, editing keys, and another 12 keys that I believe are dedicated to communications and system operations. Finally, the M-343

is the only major Japanese 16-bit microcomputer that has three vacant S-100 bus slots.

Sord offers five different operating systems: the Realtime Disk Operating System, the Realtime Multi-job Disk Operating System, MS-DOS, CP/M-86, and the UCSD p-system. Sord has developed an applications system (PIPS) that integrates database, spreadsheet, and graphics functions. Sord achieved this software integration sooner than its American competitors.

Anritsu Packet II Hy Personal Computer: What happened to the 68000 processor chip? The only new 68000-based personal computer that I saw in Japan is the Anritsu Packet II. This powerful machine is an all-in-one computer with two $5\frac{1}{4}$ -inch floppy disks (150K bytes each) horizontally mounted to the right of the video monitor. The keyboard has cursor keys, editing keys, 10 programmable keys, 12 keys dedicated to BASIC commands, and a numeric keypad. A printer is built in and sends 40-column paper scrolling out above the monitor. Standard equipment includes 256K bytes of RAM. You can add memory in 128K and 256K increments. You can also add various kinds of ports and an analog-to-digital (A/D) converter. One of the best features of the Packet II is the way it accommodates added features. The back has six horizontal metal plates that come off and allow you to slide a board in just as you slide a drawer into a chest. Each board has a metal plate on its back that closes the opening in the back of the machine. Each I/O board has appropriate sockets in its back. Anritsu intends the Packet II for technical users, and the software supports engineering graphics.

AI Electronics AI-M16: Another hefty and powerful Japanese microcomputer is the AI-M16 from AI Electronics. Based on the 8086, the M16 also has an 8089 I/O processor and an optional 8087 math coprocessor. The keyboard is detached, but everything else comes in one big package with disk drives mounted vertically to the right of the monitor. Standard equipment includes a calendar clock.

SOFTech

MICROSYSTEMS

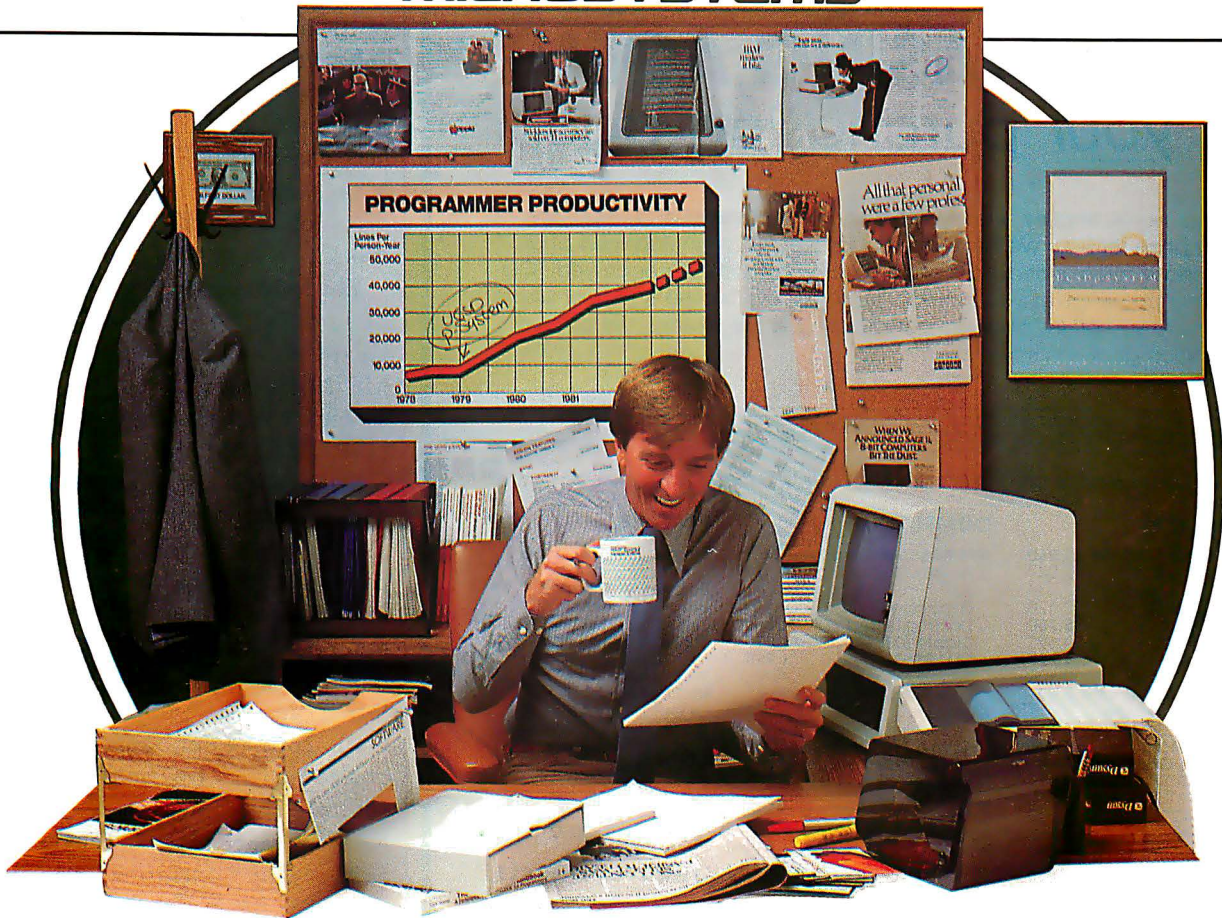

The Universal Operating System.* Finally, all the tools for your trade.

The UCSD p-System* is the first truly universal operating system ever developed. Its capabilities allow you to develop integrated, high quality applications faster and more efficiently with virtually no limit on size. And whether it's an IBM PC or Displaywriter, an Apple, a DEC, an HP, an Osborne, a Philips, a Sage, a Tandy, or a TI, the p-System is portable across virtually any popular micro made anywhere today. Which means you can develop your program, on any micro-computer, then compile to object code, and it's totally transportable.

All the tools you'll need.

The p-System lets you write your programs using any combination of UCSD Pascal,* FORTRAN-77 and BASIC. Each language operating effectively with the others. So you can take advantage of the best features of each—in a single program.

And you also get a completely integrated set of software development tools that work together to make your job even simpler. Including a screen editor,

macro assemblers, a debugger and a print spooler. There are also portable graphics utilities and native code generation—where and when you need it. And the p-System provides for dynamic memory management, as well as automatic linking, multi-tasking, and more.

Truly universal, truly efficient.

When we set out to develop the p-System, we wanted it to be truly universal, truly portable, truly efficient. And we weren't going to be satisfied with anything less. We didn't think you would be, either.

So now you can get all the tools you'll need to develop applications faster. Less expensively. More dependably. For a much larger market.

All at the same time.

All on one micro.

Finally, once is enough.

For product information or information on how to get a copy of the p-System Application Catalog, call or write to us at SofTech Microsystems.

Finally, Once is Enough.

SofTech Microsystems • 16885 West Bernardo Drive • San Diego, Calif. 92127 • (714) 451-1230

*Universal Operating System is a trademark of SofTech Microsystems Inc.. UCSD p-System and UCSD Pascal are trademarks of the Regents of the University of California

THE PURCHASING AGENT is your purchasing agent

As our name implies, we shop the wholesale market and negotiate the best price for you. We have access to over 500 manufacturers and purchase millions of dollars of hardware and software each year. Our buying power gives you more for your money. Our fee is 25% of what we save you off list price. By participating in the savings, we share a common goal—to save you money.

Call us for your price on any product not listed. Prices shown include our fee.

COMPUTERS

Alpha Micro 1000 VW	\$5,960
Alpha Micro 1030	12,047
Alpha Micro 1051	17,634
Alpsa AC1-2/SS	2,320
Altos 8000-10	5,760
Altos 8600-12	9,690
Altos 580-10	4,779
Altos Series 5-15D	2,100
Altos Series 5-5D	3,999
California Computer Systems 300-1A	4,414
Columbia Data	CALL
Compupro Godbout™	CALL
Sys. 816/A*	4,350
Sys. 816/B*	5,560
Sys. 816/C*	7,030
M-Drive-H	1,398
68K	513
CPU-Z 6 mhz	218
Ram 21, 128K	807
Disk II H.D. Contr.	586
Morrow 20 meg. H.D	2,990
Pragmatic 20 meg. HD	2,915
* Assembled and tested	
Cromemco System 1	CALL
Cromemco System 2	CALL
Cromemco 68000 System 1	CALL
DEC Rainbow	3,072
Dynabyte	26% OFF
Eagle II	2,350
Eagle 1600	5,158

SOFTWARE

Call for prices on all your software needs.

COMPUTERS

IBM Personal comp.	CALL
Amdex Color III monitor	429
AST	33% OFF
BabyBlue	530
Davong 5 meg. H.D.	1,569
Diablo 630 API	1,825
NEC 3550	1,920
Seattle boards & all IBM peripherals	CALL
Molecular	CALL
Morrow Micro Decisions	CALL
NEC 16 bit APC system	CALL
Northstar Advantage	2,669
Northstar Adv. H.D. 5	4,395
Onyx 5001 MU-6	7,350
Onyx 8000 MU-10	7,900
Sage	3,200
Sanyo 1000 w/software	1,540
Seattle Gazelle	4,920
Televideo TS-802	2,600
Televideo TS-802H	4,450
Televideo TS-806	5,200
Televideo TS-1602G	3,479
Televideo TS-1602GH	5,409
Vector 4	CALL
Victor	CALL
Zenith ZF-100-21	2,525
Zenith ZF-110-22	3,099
Zenith ZF-120-22	3,176

PRINTERS

Brother, parallel, daisy	910
C. Itoh, F-10, daisy	1,300
Daisywriter 2000 48K	1,150
Diablo 620, daisy, 25 cps	990
Diablo 630, daisy	2,050
IDS Prism 132 all opts.	1,430
NEC 3510	CALL
NEC 7710 R/O	2,325
NEC/Sellum 1, 16K, trc.	2,595
Okidata 92L	510
Qume 9/45 full panel	1,799
Qume 9/55 full panel	2,180
Qume 11/35	1,280
Smith Corona TP-1, daisy	545
Tally 160L w/tractor	790
Texas Instr. TI 810	1,240
Texas Instr. TI 810LQ	1,944

OTHER PERIPHERALS

Amdex Color II monitor	694
Amdex Color IIA (III)	768
Ventel 212 + modem	765
Corvus 10 meg. H.D.	2,995
Houston Instr. DMP-29	1,779
Houston Instr. DMP-40	775
Houston Instr. DMP-41	2,209
Morrow 20 meg. H.D	3,650
Qume QVT 102 terminal	537

BARGAIN CORNER—One of a kind items in stock at wholesale cost (no fee) limited to quantity on hand.

Apple Basic Compiler	256	Spellguard (ISA) 8"	112
IBM Wordstar	240	Supercalc — 8"	237
Hayes Micromoden 100	279	Supercalc — Apple	177

Mastercard, VISA at 3% handling fee. Prices subject to change without notice. Minimum fee \$150.

EXPORT SERVICES AVAILABLE for overseas computer dealers and distributors through AMERICAN BUYING AND EXPORTING SERVICES. **INTERNATIONAL TELEX 470851 or call (415) 376-7600 (export only).**



THE PURCHASING AGENT

1635 School Street
Moraga, CA 94556
Call Toll Free 800-227-2288
In California (415) 376-9020

Standard RAM is 256K bytes expandable to 1 megabyte. The public bus is an IEEE-796 bus. There are two serial ports and provision for a lightpen. A 16K-byte boot ROM and an 8K-byte character-generator ROM are standard, and a 128K-byte kanji (Japanese-character) ROM is optional. Mass storage can be on 8-inch floppy disks or 5¼-inch Winchester hard disks.

The M16 comes with a wide choice of operating systems: Genix, CP/M-86, Concurrent CP/M-86, MP/M-86, MS-DOS, or the UCSD p-System. Languages mentioned include LISP, PL/I, and C.

Seiko 9500 and 8600: The 16-bit Seiko microcomputer shown in Tokyo was the 9500 Super Personal Computer. All the components come in one large package with disk drives mounted horizontally beside the monitor. What makes the 9500 super? It has an 8086 processor, an 8087 math coprocessor, and two 8088s: one to manage I/O and the other to control communications. Standard RAM is 256K bytes, maximum is 512K. The operating system is RMX/86 (from Intel?). The color video is dazzling, with 512 by 480 resolution. But the large package would be awkward in most settings.

While I was in Japan, Seiko introduced the 8600, based on the 8086 microprocessor, intended for the American market, and decidedly smaller and better looking than the 9500.

Slick Consumer Computers

Sharp X1: One eight-bit computer made a big impression at the Electronics Show, the Sharp X1. The X1 has two primary components, the CZ-800D and the CZ-800C. Shown in photo 10, the X1 is a Z80A-based machine but certainly not another Z80A desktop system. Sharp offers the CZ-800D 14-inch color television monitor for 113,00 yen, or about \$425. The CZ-800D has one button that other color televisions don't; it turns the television into a color monitor. For another 155,000 yen (about \$585) you can have the CZ-800C, consisting of an integrated computer and keyboard unit. The computer is

If you stick with timesharing after reading this ad, you haven't read this ad.

Typically, financial planning on a timesharing service runs \$2,000 a month and more. Month after month after month.

And it doesn't take a spreadsheet to figure that as a \$24,000-a-year-after-year expense.

The incredibly cheap alternative.

The Financial Planner™ from Ashton-Tate can stop this cash drain once and for all.

You pay \$700—one time—for the Planner. And handle your financial planning quickly, easily and completely on your microcomputer.

Without having to share your time or your money with anyone.

A forecaster's dream come true.

The Financial Planner has enough depth to solve the most complex business problems you can foresee, yet can be used almost intuitively.

The Planner automatically performs calculations on individual items, rows, columns and entire models. Understands conditional logic. Solves simultaneous equations. Computes Present Value and Internal Rate of Return. Reads and writes dBASE II™ files. And much, much more.

But you use abbreviated names, not mysterious formulas. And you communicate with the computer in the English-like vocabulary of FPL™ (Financial Planning Language), so you can easily set up your budgeting and evaluation models.

Editing and report-writing are an integral part of the package, and you can preview results on the screen, then produce presentation-quality financial reports directly.

And when you have your models and reports just right, you can automate them so even your President can run them.

With the Planner, you produce P & L forecasts and financial consolidations in minutes. Explore



“what if” alternatives. Analyze new business ventures and mergers. Plan real estate acquisition and development. And fine tune operations until you reach the financial objectives you've set.

It's one of the most comprehensive business tools available on any computer. All for a fraction of what you've been spending on timesharing services to do the same things.

For the ardent skeptics.

It may sound too good to be true, but you can check out the Financial Planner with no financial risk.

Run through a hands-on demo at your nearest computer or software store. Then take a package home and use it for 30 days on your IBM PC or CP/M microcomputer. If it's not everything we said it was, just return it and you'll get your money back.

For the name of your nearest dealer, contact Ashton-Tate at 10150 West Jefferson Boulevard, Culver City, CA 90230. Or better yet, call (213) 204-5570 today.

Time's a-wasting.

**The
Financial
Planner™**

ASHTON · TATE 



Photo 10: Sharp X1. The symbol of the Tokyo Data Show is superimposed on the television broadcast.

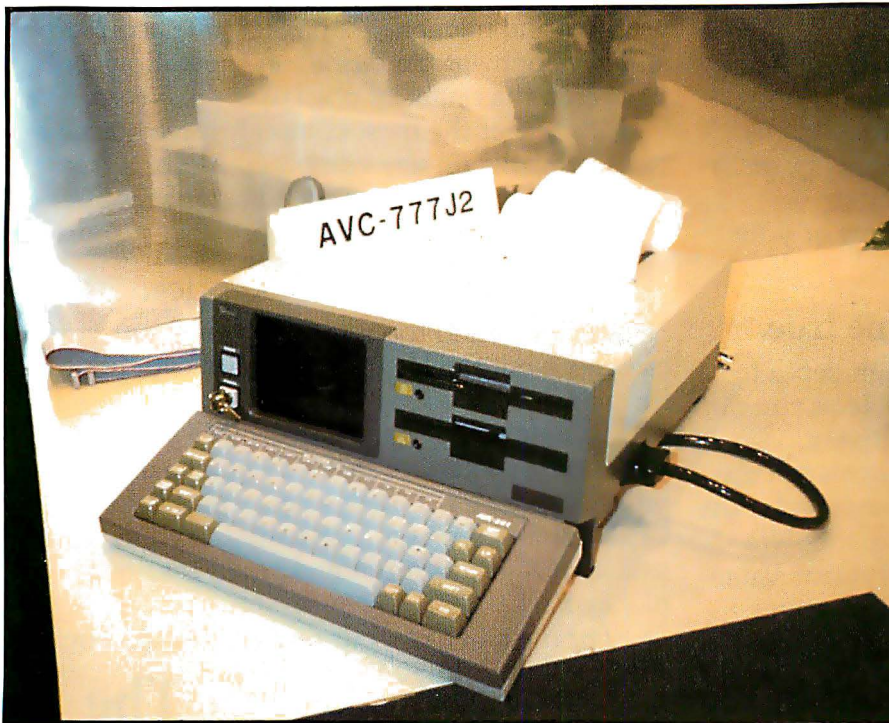

Photo 11: Aval AVC-777J2.

based on a Z80A and has 64K bytes of RAM, 4K bytes of video RAM, and 6K bytes of character RAM. The 80C48 and 80C49 processors supplement the Z80A. You can add another 48K bytes of video RAM as an option.

The computer unit includes a built-in cassette-tape recorder for data

storage. Also standard in the computer unit are a Centronics-type printer interface, an interface for two joysticks, a clock with battery back-up, and sound-synthesis output capacity ranging over eight octaves. When the system is being used as a computer, it can display 25 lines of 80 characters on the monitor. Four addi-

tional I/O ports are optional, as is a unit containing two very thin, 5¼-inch floppy disks.

An optional digital Telopper (the CZ-8DT) lets you connect the computer to a video camera, video-tape recorder, or videodisc. The keyboard has five separate blocks: character keys, number keys, function keys, television-monitor-control keys, and tape-operation keys. A color BASIC interpreter is standard equipment and includes a function that assigns a priority to each character and color in order to achieve the appearance of perspective. You can enlarge, reduce, or move graphics displays under program control. You can change each color variable instantly. You can paint and hatch graphic "phrases" (areas that can be manipulated as units) in eight basic colors and neutral colors to achieve the effect of "tile-painting." You can mix five different character styles in the same display. The calendar clock works with a programmable timer and can turn on the television for a broadcast while you are away.

The Sharp X1 lets you superimpose your computer graphics on video images. You can, in other words, display television signals and computer graphics simultaneously. An RGB (red-green-blue) mix circuit makes the superimpositions possible. Sharp has named the concept *visual integration* and calls the X1 the world's first personal computer/television monitor system. Suggested applications include video editing, art, and games. The most obvious use would be putting titles on home videotapes.

Sony SMC-70: The SMC-70 is another Z80A-based microcomputer and seems destined for integration in a video system too. Sony revealed at the electronics show that the SMC-70's add-on 8086 unit will run MS-DOS. Sony has sold the SMC-70 in the United States only as a business system and has not sold the system in Japan at all. The system differs from the Sharp X1 in several important respects: the SMC-70 has two 3½-inch disk drives as standard equipment, can be upgraded by adding an 8086 microprocessor, has a numeric keypad only as an optional

Now...Supercharged communications software for your high powered 16 bit PC.

The makers of CROSSTALK proudly announce the newest entry into our line of high performance communications software. CROSSTALK XVI — a communications program with the speed and features of a fine racing machine. Shift from status display to incoming communications and back again at full throttle. Drive smoothly through the program with CROSSTALK XVI's integrated help system. Enjoy the full use of function keys. CROSSTALK XVI can be used with most autodial modems, and emulates several of the most used terminals. Test drive CROSSTALK XVI today at your local dealer.

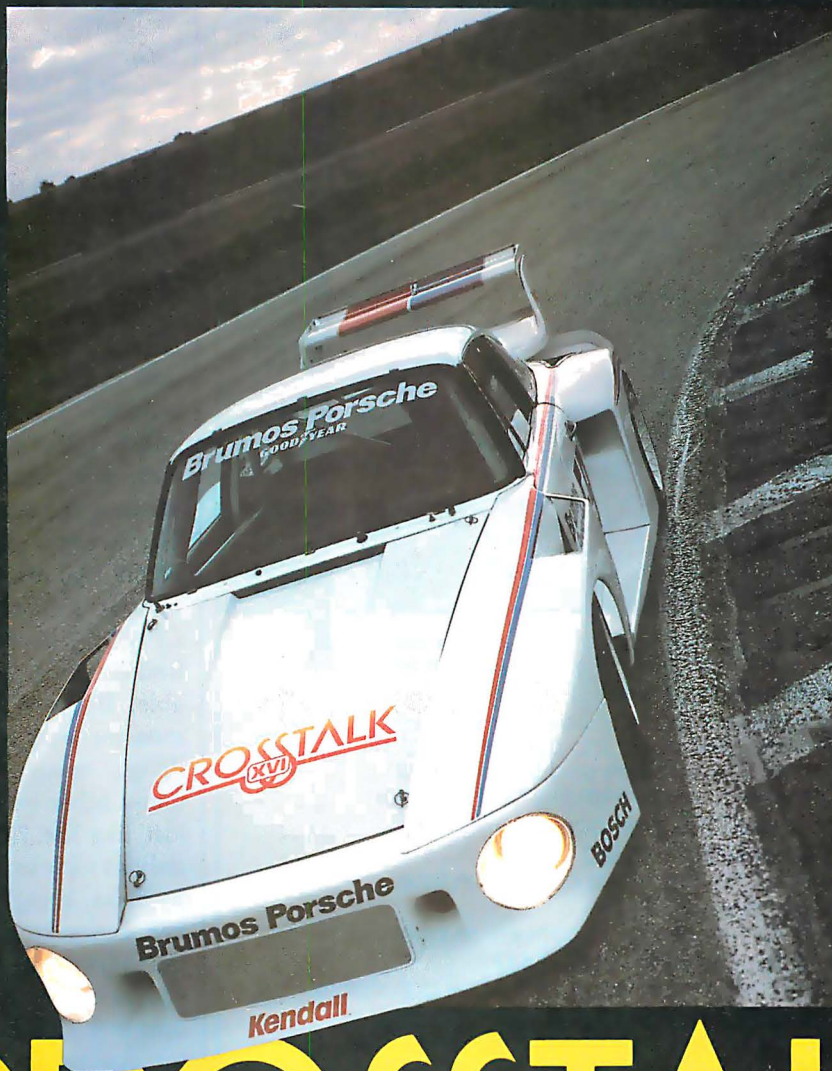

CROSSTALK™

XVI

1845 The Exchange / Suite 140 / Atlanta, Georgia 30339 / (404) 952-0267



CROSSTALK XVI is a trademark of Microstuf, Inc.

**OUR DAISIS
THRIVE WITH
THE NEW
APPLE IIe**

**PICK A
DAISI**

(Data Acquisition and Instrumentation Systems Interface)

To automate your lab—

Exciting new capabilities can blossom in your lab—when you automate it with the DAISI family of data acquisition peripherals for your Apple Computer.

DAISI interfaces, from Interactive Structures, turn your economical Apple into a personal electronic lab assistant. DAISI products are designed to read instruments and sensors, control temperature and pressure . . . with reliability and precision.

Here's a rundown on some DAISI interfaces

AI13, 12-Bit Analog Input System—\$550

■ 16 input channels ■ 20 microseconds conversion time.

AI02, 8-Bit Analog Input System—\$299

■ 16 input channels ■ 70 microseconds conversion time.

AO03, 8-Bit Analog Output System—\$195-\$437

■ up to 8 independent channels ■ range and offset adjustable.

DI09, Digital Interface with Timers—\$330

■ timing and interrupt capability ■ direct connection to BCD digits, switches, relays.

Don't settle for garden variety equipment for your laboratory applications. Get the best—at a great price. Pick a DAISI!



Call us for the DAISI dealer near you.

Interactive Structures Inc.
146 Montgomery Ave.
Bala Cynwyd, PA 19004
(215) 667-1713

All DAISI interfaces come complete with cable, instructional diskette and comprehensive manual.

separate unit (strange for an office computer), and costs much more than the X1. Even though the SMC-70 can control videodiscs, Sony's true consumer computer has yet to appear.

Japanese Portables

I expected to find a lot of new Japanese portable computers at the Tokyo shows but found only four portables of interest, two of them from Aval, one from Sord, and one from Epson.

Aval AVC-777J2: This portable all-in-one computer (see photo 11) running CP/M 2.2 might be thought of as Japan's answer to the Otrona Attache. A Z80A system with 64K bytes of user RAM and 16K bytes of video RAM, The AVC-777J2 has a 5-inch monochrome video monitor, two double-sided thin-line 5¼-inch drives storing 600K bytes each, a built-in 5-inch thermal printer, one parallel port, two RS-232C serial ports, a connector for an 8-inch floppy-disk system, a connector for the system bus, and video output for a larger monitor. The keyboard is detachable and fits into the carrying case along with everything else. The price in Japan is 880,000 yen, or about \$3320. The weight is 12.5 kilograms, or about 27.5 pounds.

Aval AVC-666: This is billed as a CP/M 2.2 development system, but I find it even more appealing as a portable. It doesn't have a printer or a monitor and has the two 5¼-inch drives mounted horizontally. In many other respects, the AVC-666 is just like the 777J2. The AVC-666 is only as wide as the two 5¼-inch floppy disks, brings a video signal out for connection to a monitor, and weighs much less than the 777J2. It costs the equivalent of about \$2500, with an optional 12-inch monochrome monitor costing another \$152. With one monitor at home and the other in the office, the AVC-666 would serve as an adequate portable by today's standards.

Sord M23P: I consider the Sord M23P (see photo 12) a true portable and a good value. The M23P has a Z80A processor, 128K bytes of RAM, and an 8-line by 80-character liquid-crystal display (LCD). That is enough

High Resolution RGB Color Monitor Designed for the IBM Personal Computer

FEATURES

- 80 characters x 25 lines
- 690 dots horizontal resolution
- 16 colors
- .31 mm dot pitch tube
- non-glare, black matrix
- plugs directly to IBM PC, cable supplied
- FCC Class B Approved



Princeton Graphic Systems' new HX-12 high resolution color monitor is designed with an NEC.31 mm dot pitch CRT to give you up to 690 dots horizontal resolution. You need not compromise the display quality of your system with monitors rated at less than the 640 horizontal dots generated by your IBM PC. The PGS HX-12 delivers 16 super colors, 80 characters x 25 lines. It is the best price/performance PC direct drive monitor in the market today. Get the PGS HX-12 and discover for yourself how well it complements your IBM Personal Computer.

phic Systems High Resolution 80 character HX-12 RGB
 phic Systems High Resolution 80 character HX-12 RGB
 phic Systems High Resolution 80 character HX-12 RGB
 phic Systems High Resolution 80 character HX-12 RGB
 phic Systems High Resolution 80 character HX-12 RGB
 phic Systems High Resolution 80 character HX-12 RGB
 phic Systems High Resolution 80 character HX-12 RGB
 phic Systems High Resolution 80 character HX-12 RGB

80 character display

PGS

**Princeton
Graphic Systems**



Photo 12: Sord M23P.



Photo 13: National JR-200 Personal Computer.

of a display to permit work on the road; you can edit text without too much strain on human memory. At home, of course, you'll want the optional 12-inch green monitor or 14-inch color monitor (both 25 lines by 80 characters). The integral keyboard has a numeric pad, four cursor keys, seven programmable-function keys, plus the standard keyboard. Two double-sided Sony microfloppies (running at 600 revolution per minute) provide a total of 580K bytes of high-speed mass storage. With the LCD, the carrying case, and the rechargeable battery pack (the yellow box in photo 12), the M23P weighs 9 kilograms or 19.8 pounds. The M23P runs Sord's PIPS integrated spreadsheet-database-graphics software package and will cost about \$2200 in the United States. The combination of size, price, and performance should make the M23P a real competitor among the portables.

Epson HC-20: This true portable is sold in the United States as the HX-20. It has a tiny display, micro-cassette mass storage, and limited computing power compared to the M23P. The HX-20 costs only about \$800. It is the ideal size for portability (the whole computer is no bigger than full keyboard size) but does have performance limitations. It will be interesting to see how the long-term competition based on size, price, and performance treats the HX-20 and the M23P.

New Home Computers

National JR-200 Personal Computer: The computer shown in photo 13 is one of the three low-cost home computers now produced by Matsushita; the others are the National JR-100 and the Tomy 16-bit Graphics Computer. The JR-200 has a 6802 processor, 16K bytes of ROM, and 32K bytes of RAM. The rubber keyboard has a wonderful touch, a diamond configuration for the cursor keys, plus a full standard keyboard



Photo 14: Sord M5

with shift, insert, and delete keys. It can be used with a variety of monitors, including a television set or an RGB monitor. The JR-2000, which has a list price of about \$300 in Japan, can use tape recorders or disk drives for mass storage, drive a speaker, and handle input from joysticks.

JR-100: The JR-100 has a 6802 pro-

cessor, 8K bytes of ROM, 16K bytes of RAM, a more limited keyboard, and a list price of about \$210. (The Tomy machine was not exhibited at the Electronics Show, but later I saw it for sale in the Akihabara district in Tokyo. The Tomy processor is a TMS9995.)

Sord M5: This computer (photo 14) has a Z80A processor, an 8K-byte ROM containing a monitor, 4K bytes of system RAM, and 16K bytes of graphics RAM. You can get software for the M5 in audio cassettes or ROM cartridges. Cartridges include BASIC, household accounting, bank-loan management, and simple word processing. Most of the ROM packs are 16K bytes. The keyboard is typewriterlike, two joysticks are optional, an audio cassette provides mass storage, and both an AC power unit and a DC power pack are available. The M5 features RF (radio-frequency) output so that you can use a television as a display. Most interesting of all is an animation program that lets you use 32 types of special figures called sprites. The basic M5 costs about \$187 in Japan.

Sanyo PHC-25: The Sanyo PHC-25 is an advanced home computer with a list price of about \$264. The complete computer is slightly larger than a standard keyboard but has four cursor-control keys and four programmable-function keys. A 24K-byte BASIC is in ROM, and there are 22K bytes of RAM. As you

would expect, the PHC-25 uses a television as a video monitor and a cassette recorder for mass storage. The Sanyo PHC-20 is less expensive and less powerful than the PHC-25.

New Hand-Held Computers

Sanyo PHC-8000: This hand-held computer has an NSC-800 CMOS microprocessor, 24K bytes of ROM, and 4K bytes of RAM. To the right of the one-line LCD are five programmable-function keys and the break key. Four cursor-control keys and a home key are in a diamond configuration—a first, I think, for hand-held computers. The QWERTY keyboard is too small for touch-typing, as the description “hand-held” implies. The list price is 69,800 yen or about \$263. An optional I/O unit, the PHC-8010, costs almost twice that amount and permits connection to a video monitor and a microcassette recorder as well as adding 14K bytes of ROM and 22K bytes of RAM. A tiny printer is available, as is an acoustic coupler. Computer, I/O unit, microcassette recorder, acoustic coupler, and

printer all fit in a custom attaché case.

Toshiba Pasopia Mini: The computer in photo 15 has an 8-bit CMOS microprocessor, 4K bytes of RAM, and 20K bytes of ROM, which contain a 16K-byte BASIC. The one-line LCD is above the keyboard. Four cursor-control keys are above the numeric keypad. The base price is about \$210. Another 12K bytes of RAM costs \$113. An I/O expansion unit permits connection of a printer and a cassette recorder and costs another \$170.

NEC PC-2001 Hand-Held Computer: This is the hand-held computer that I liked best. It has an 8-bit CMOS uPD7907 microprocessor running at 4 MHz, 36K bytes of ROM, and 16K bytes of RAM. It also has an RS-232C serial port (up to 2400 bits per second) at the left end, a 2-line by 40-character LCD, four cursor-control keys, two editing keys, five programmable-function keys, a numeric pad, and a typewriterlike keyboard that is, of course, too small for touch-typing. The list price is 59,000 yen, or about \$225.

Company Lines

The trend among electronics companies in Japan is to produce complete lines of microcomputers, everything from hand-held to very powerful desktop systems. Consider NEC, for example. It makes the PC-2001 hand-held computer, the PC-6000 home computer, the PC-8000 Z80-based personal computer, the PC-8800 (an improved Z80-based personal computer), the PC-9800 (an 8086-based personal computer), and the N5200 (or Advanced Personal Computer, another 8086-based personal computer). Toshiba makes the Pasopia Mini hand-held computer, the Pasopia Z80-based personal computer, the T200 8-bit desktop computer with two 5¼-inch floppy disks, the T250 8-bit desktop computer with two built-in 8-inch floppy disks, and the Pasopia 16, an 8088-based personal computer. Both NEC and Toshiba spokesmen said that they will produce keyboard-sized computers similar to the Epson HC-20 before the end of 1983. More powerful portables are likely to appear also.

YOU SPENT \$4,000 ON A PERSONAL COMPUTER. FOR ANOTHER \$12.50, YOU CAN GET YOUR MONEY'S WORTH.

A lot of business people aren't realizing the full potential of their personal computers. Because they haven't realized how much more their computers are capable of.

LIST can help.

LIST is the first publication that puts software first. It contains articles by



some of the most respected names in the computer field. Written to help you get the most out of your personal computer.

What's more, *LIST* contains the *LIST Software Locator*,™ a comprehensive guide to over 3,000 personal computer programs, conveniently indexed by application,

industry, operating system and hardware.

LIST is sold at leading computer stores and bookstores. Or, you can phone our toll-free number, and receive a copy by mail. The price, exclusive of postage and handling, is \$12.50, (VISA and MasterCard accepted).

Which is a pretty small price to pay for something that can maximize a much larger investment.

LIST is published by Redgate Publishing Company, an affiliate of E. F. Hutton.



LIST™

The Software Resource Book For Personal Computer Users

1 800 821-7700

Ext. 1110



Photo 15: Toshiba Pasopia Mini.



Photo 16: These Radicom infrared transceivers are mounted on top of Hitachi BASIC Master 16000 computers. The tapes running from each transceiver to mirrors in the ceiling indicate the path taken by the infrared beams.

What American manufacturer is producing a comparable line of microcomputers? Only Hewlett-Packard. True, Hewlett-Packard makes no home computer like the PC-6000, but HP is making portables, a variety of 8-bit systems, at least two 16-bit systems—one based on the 8086, the other on the 68000—and the incredible new model 9000, which represents the state of the art in microcomputing (a 32-bit system with 128K-byte RAM chips and very fast operation). To some degree, Hewlett-Packard's emphasis on technical users may suggest that the company is not competing for as broad a market as NEC, but Hewlett-Packard cannot be accused of fearing to compete.

The Japanese seem determined to keep making new microcomputers until each segment of the world market says, "That's the computer I've been waiting for." Let's hope that more of the major American electronics manufacturers will broaden their product lines and compete more vigorously.

High-Resolution Displays and Printers

The Japan exhibitions demonstrated once again that the Japanese are pushing ahead in the development of relatively inexpensive high-resolution video monitors, inexpensive high-resolution dot-matrix printers, and color displays and printers. As has often been noted, the Japanese

katakana and kanji character sets force the Japanese to use high-resolution displays and very fine dot-matrix printers. The Japanese had to develop low-cost versions of such displays and printers if the microcomputer market was to expand in Japan as rapidly as elsewhere, and they have now done so. Many companies showed dot-matrix printers that produced characters that could be described fairly as "letter quality." Fujitsu and Matsushita both demonstrated impressive thermal color-transfer printers.

Disappointments

One disappointment—and probably the reason that so few portable computers were introduced—concerned the development of flat-screen displays. The plasma displays and LCD televisions were on view at the shows, but price, product life, or both have prevented their use in affordable portable computers. The Sony flat-screen cathode-ray tube (CRT) was not exhibited. The Victor company showed a very high resolution 5-inch CRT monitor.

Nor was there an abundance of low-cost 5¼-inch Winchester disks. While Matsushita showed an optical storage system, the most interesting such exhibit was from Drexler, an American company (see "Optical-Memory Media" by Edward Rothchild, March 1983 BYTE, page 86).

Optical and Infrared Communications

NEC showed a fiber-optic-based microcomputer network called Netbranch 4800. NEC had four microcomputers connected by NEC optical branch modules at the Electronics Show. The network provides communication at 10 million bps and can extend over 3 kilometers. The Branch 4800 module connects the local network to a larger network.

Is the world ready for an infrared-based local network? Hitachi and a small company called Yagi showed an infrared-based network connecting two Hitachi BASIC Master 16000s. As you can see from photo 16, the usual cables are replaced by infrared transceivers—which look like

EXECUTIVE BENEFITS

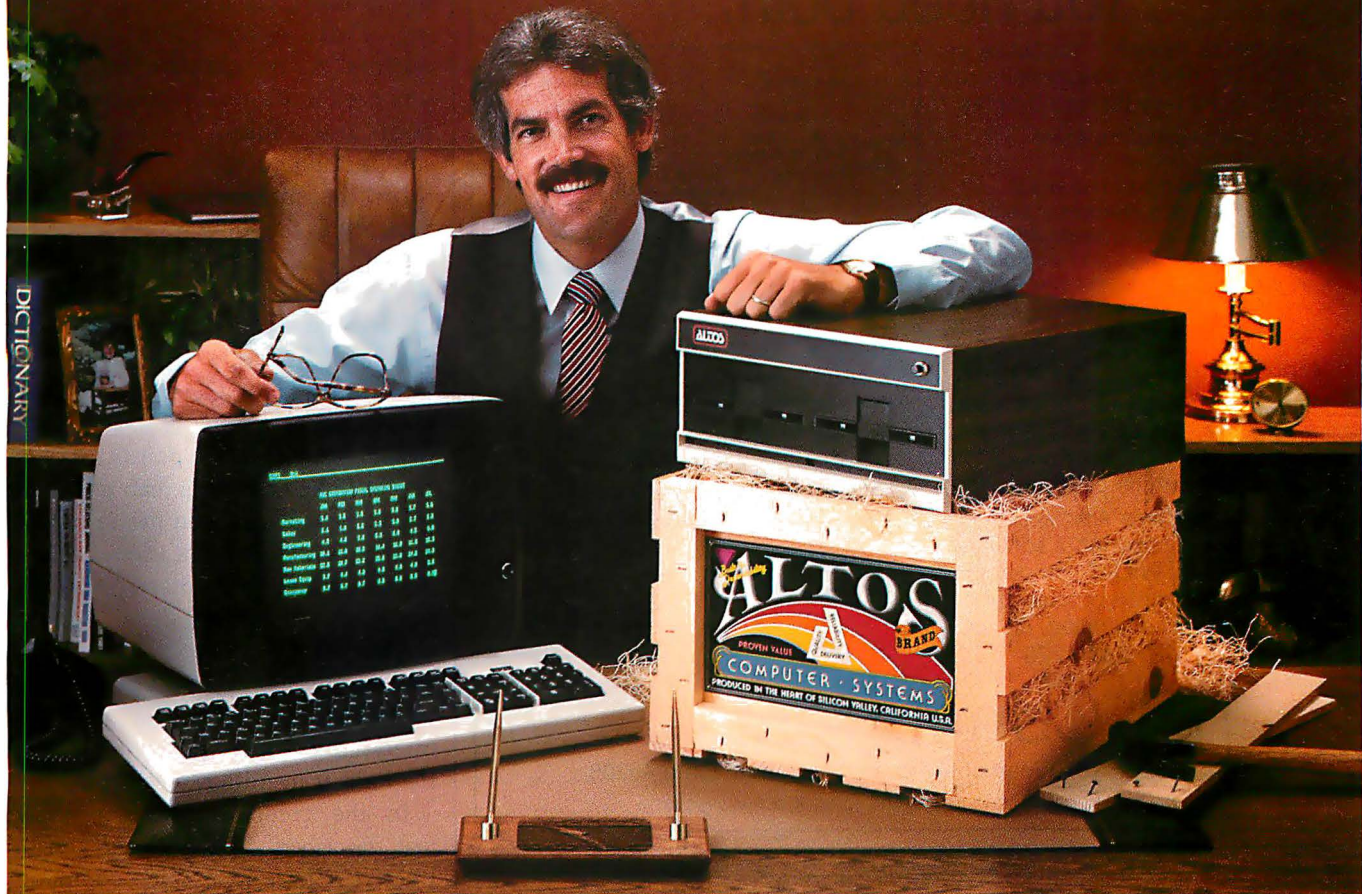

Altos places complete management solutions on your desk for less than \$4,500.*

Finance departments have their number-crunchers. Secretaries have their word processors. But top executives, the leaders and decision-makers of business, are still scratching their ideas, plans and decisions on a note pad. Now you can benefit from increased management productivity with the new ALTOS® EXECUTIVE desktop computer system.

The ALTOS EXECUTIVE is more than just a computer. It's a system designed for management use. Yet it costs less than \$4,500—a small investment that pays big dividends in efficiency.

Managers are planners. The ALTOS EXECUTIVE FINANCIAL PLANNER helps managers consider multiple alternatives, create budgets, and perform "what-if" studies. It's a great planning tool.

Managers aren't typists. The ALTOS EXECUTIVE WORD PROCESSOR makes it easier to input, store and retrieve ideas, plan schedules, and create or modify reports. It even checks your spelling.

What you get. The ALTOS EXECUTIVE includes an Altos microcomputer with advanced MP/M II™ operating system, a smart terminal designed for comfort and ease

of use, data storage for up to 600 document pages, and two applications for executives—word processing and financial planning.

And to make it all easier to use, we've included the ALTOS COMPUTER TUTOR—a self-paced, step-by-step, on-screen tutorial that helps the busiest executive learn to use the computer within minutes.

Room to grow. The ALTOS EXECUTIVE is a business system you can grow with. Add two extra terminals, a Winchester hard disk, other applications (such as our ALTOS ACCOUNTANT, a completely integrated business accounting system), and communication links with other computers. You can also run the ALTOS EXECUTIVE on our new line of eight-user, 16-bit systems.

See the ALTOS EXECUTIVE in action today. And look for more offerings in the ALTOS EXECUTIVE Series to come your way soon. Call our toll-free number for the name of your local Altos sales and service dealer.

Or write: Altos Computer Systems, 2641 Orchard Park Way, San Jose, CA 95134.

Packed with fresh ideas for executives

ALTOS is a registered trademark of Altos Computer Systems. MP/M II is a trademark of Digital Research, Inc. *Price approximate and may vary in your area. System includes an Altos Series 5-15D computer with MP/M II operating system, a smart terminal, and the ALTOS EXECUTIVE WORD PROCESSOR and EXECUTIVE FINANCIAL PLANNER applications with the built-in ALTOS COMPUTER TUTOR. Price does not include printer, cables, installation, taxes, additional training and maintenance. ©1983 Altos Computer Systems

ALTOS
COMPUTER SYSTEMS

800-538-7872
(In Calif., 800-662-6265)

The 68000 needs database. You need both.

Concurrent's integral™ database on the WICAT 68000 boasts features usually found only on "mainframes".

- quick design through graphic techniques
- structures that model real world complexities (see example at right)
- large capacity and expandability
- rapid access to all related records
- automatically maintained structure
- efficient use of disk space
- easy to learn and use

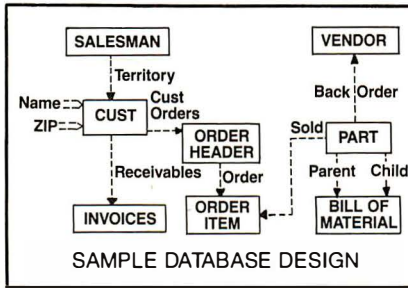

integral™ database and MenuSystem \$2,000
(substantial discount when ordered with computer)

WICAT System 150
Motorola 68000, 256K memory, 10MB Winchester
760KB floppy, terminal, system software, language

Single user \$9,450
Three users \$10,850
Six users (512K)..... \$12,850

MenuSystem™

MenuSystem helps you build "user friendly" systems easily. Screens are "painted" on the terminal and ready to use with no programming.

Application systems are developed quickly using Concurrent's software on the powerful WICAT computers. For more information or to arrange a telephone demonstration, please write or call **(513) 281-1270**



Concurrent™ Corporation

1870 Madison Road Cincinnati, Ohio 45206

HIGH TECHNOLOGY MICROCOMPUTERS FOR SCIENCE AND INDUSTRY

lamps—located atop each BASIC Master 16000. The transceivers, called Radicom, communicate with one another via mirrors on the ceiling. That's right, it's all done with mirrors. As the network gets bigger, you need more mirrors, but you don't need any cables. Would cigarette smoke impair communications? If so, throw the smokers out. The Radicom network at the show was described as a prototype.

Yagi also showed a working infrared-based modem called the Beacom. As you might expect, it looks like a lamp. Described as a free-space optical communication system, Beacom can link two points that cannot be linked by cable, can relay television broadcasts, can perform high-speed data communications, and is said to be free from interference from sunlight and artificial light. Different models communicate at from 1 to 3 million bps and at ranges of from 300 to 1600 meters. Of course, you need interfaces between the computers and the light transmitter/receivers.

In the communications products just described, in the clever and attractive Sharp X1 microcomputer, and in printers and displays, the Japanese have brought something new to the world of microcomputing. More innovations would be welcome, including those innovations that substantially lower the price of equipment already available elsewhere. ■

Exploring the Asian World of Microcomputers

During my travels in Asia, I attended the Korea Electronics Show in Seoul, the Taiwan Electronics Show in Taipei, the Hong Kong Consumer Electronics Show in Kowloon, and China Comm 1982 in Beijing, People's Republic of China, as well as the Japanese shows described in the accompanying article.

A delightful surprise was the discovery of the Akihabara neighborhood in Tokyo, an electronics bazaar that surpasses anything I have ever seen or imagined. I'll discuss this wondrous neighborhood as well as encounters with microcomputers at the other shows in a second article in the May issue of BYTE. . . . P.L.L.

CORVUS SYSTEMS **INTERTEC DATA SYSTEMS**

WE WON THE PRICE WAR

In every battle, we came up the victors. Not only in price, but in service and support as well.

Call to order: **1-800-257-5217**
(in NJ 609-424-4700)



We carry:

Intertec Data Systems
Corvus Concept
Corvus Hard Disk
C. Itoh Printers

TriStar Data Systems
2 Keystone Avenue
Cherry Hill, NJ 08003
609-424-4700
215-629-1289

Send me the remarkable iXO Telecomputing System.

Yes, I'd like to order right now. Send me the iXO Telecomputing System by private courier. I'm enclosing \$299 for each telecomputer I order. (California residents add 6½% sales tax.)

I'm making payment by:

- Check VISA
 Mastercard American Express

Card Number: _____ Expiration: _____

Signature: _____

- Yes, send the FREE software package for...
() IBM I already subscribe to THE SOURCE™
() Apple II Send me the \$50 rebate
() TRS-80 III coupon for another
 teleservice.

NAME: _____

ADDRESS: _____

CITY: _____ STATE: _____ ZIP: _____

I'd also like the following peripherals. Include them with my order.

- iXO 20-Column Printer \$199 iXO Video Interface \$199
 iXO Acoustic Interface \$99 iXO Serial Parallel Interface \$119

Dial (800) 423-3008 Toll Free (In California call collect (213) 877-5384, ext. 10) and use your credit card to charge your iXO Telecomputer by phone.

iXO, Inc.
P.O. Box 3615

Colton City, CA 92320



Send me the remarkable iXO Telecomputing System.

Yes, I'd like to order right now. Send me the iXO Telecomputing System by private courier. I'm enclosing \$299 for each telecomputer I order. (California residents add 6½% sales tax.)

I'm making payment by:

- Check VISA
 Mastercard American Express

Card Number: _____ Expiration: _____

Signature: _____

- Yes, send the FREE software package for...
() IBM I already subscribe to THE SOURCE™
() Apple II Send me the \$50 rebate
() TRS-80 III coupon for another
 teleservice.

NAME: _____

ADDRESS: _____

CITY: _____ STATE: _____ ZIP: _____

I'd also like the following peripherals. Include them with my order.

- iXO 20-Column Printer \$199 iXO Video Interface \$199
 iXO Acoustic Interface \$99 iXO Serial Parallel Interface \$119

Dial (800) 423-3008 Toll Free (In California call collect (213) 877-5384, ext. 10) and use your credit card to charge your iXO Telecomputer by phone.

iXO, Inc.
P.O. Box 3615

Colton City, CA 92320





NO POSTAGE
NECESSARY
IF MAILED
IN THE
UNITED STATES

BUSINESS REPLY CARD

FIRST CLASS POSTAGE PERMIT NO. 315 CULVER CITY, CA

POSTAGE WILL BE PAID BY

iXO, Inc.
P.O. Box 3615
Culver City, CA 90230



NO POSTAGE
NECESSARY
IF MAILED
IN THE
UNITED STATES

BUSINESS REPLY CARD

FIRST CLASS POSTAGE PERMIT NO. 315 CULVER CITY, CA

POSTAGE WILL BE PAID BY

iXO, Inc.
P.O. Box 3615
Culver City, CA 90230



6 GOOD REASONS FOR YOU TO USE THE iXO TELECOMPUTING SYSTEM.

Turn your telephone line into a remarkable information system. Here's how...

The electronic information revolution is here. Your choice is to follow...or to lead with the easy-to-use, low cost, portable iXO Telecomputing System.

HUNDREDS OF WAYS TO USE THE iXO.

1. Receive Instant Information Wherever You Are.

Now have instant access to public information services like THE SOURCE™, CompuServe and Dow Jones Information Service... even New York Times research data. Newson UPI and AP breaks on your iXO "when it happens". The latest stock quotes, commodity prices, interest rates, sports scores and weather bulletins are all available. Plus, subscribe to your favorite newsletter electronically via Newsnet and receive important industry or political updates.

2. Improve Productivity With Electronic Messages.

Avoid telephone tag. Send and receive messages instantly with a personal iXO message center. Communicate quickly, efficiently and accurately with anyone you want to reach, any time of the day, anywhere. The Telecomputing System is fully compatible with major electronic mail services like Dialcom, OnTyme, Telemail, "SourceMail" and Comet...even your company's internal system.

3. Communicate With Your Personal Computer.

Whether you're at work or traveling, you can have remote access to your personal computer. Improve your home energy management, scan your computer address book, check your appointment schedule, or update your stock portfolio wherever you are.

4. Communicate With Your Company's Computer.

Review key operating statistics on sales, production, inventory, order status or cash flow. Even check on mainframe system status from home, office or hotel room easily and effectively.

5. Connect To A Wide Variety of Teleservices.

A wide variety of teleservices bring you electronic shopping, airline schedules, community bulletin boards, local dining and entertainment guides or electronic pen pals. Plus, there are hundreds of other entertainment services... just for fun. Select from strategic games or skill games, such as Blackjack, Football, Dictator, Super Adventure and Blackdragon. They'll keep you enticed for hours.

6. Prepare For The Future.

Soon you can reconcile your checkbook, pay your bills or buy and sell stocks. With your Telecomputing System you'll be one of the first to participate in these new exciting uses from funds transfer to airline reservations all without an operator.

These are just a few of the hundreds of ways to use the iXO Telecomputing System today in your personal and business life. Just call toll free now, and charge it to your credit card. We'll put one in your hands.



The complete personal size Telecomputing System...about the size of a paperback book.

WHAT IS A TELECOMPUTER?

It's a portable computer terminal that transmits and receives information via the telephone line. Simply plug the cord into a modular phone jack, and the whole world of information is at your fingertips. And...it's as simple to use as your telephone.

IT'S EASY TO USE.

This unit was designed to be simple to operate. You may never even read the Owner's Manual. No complicated log on procedures and no computerese are required. Engineers, salespeople, educators, students and professionals delight in the iXO's ease of operation.

HERE'S WHY...

Single Button Access.

Easier to use than using a telephone. When you've decided what service you want to access, the telecomputer will:

- Dial the telephone number
- Log on to the packet switch network, such as Telenet
- Transmit your password to the host computer
- Transmit your service selection to the host computer

"All you did was press the  key!"







Access Center Support

When you register your unit, you electronically enter these things in the iXO Access Center, our central computer...

- How you would like to be greeted when you turn on your unit.
- Whether you require entry of a local password before anyone can use your unit.
- What public information services you want displayed in your menu.
- The protocol for accessing any other computer.
- Whether you want your password automatically transmitted to a remote host computer
- Automatic menu selection to a host computer.

Plain English Command Keys.

In addition to the Phone Key, some of our other easy to use keys are:

<p>Press </p> <p>instead of "Y" and "RETURN"</p>	<p>Press </p> <p>to review the last 80 characters of your message.</p>
<p>Press </p> <p>instead of "N" and "RETURN"</p>	<p>Press </p> <p>to stop the flow of data.</p>
<p>Press </p> <p>OR </p> <p>to easily correct an entry error.</p>	<p>Press </p> <p>instead of "?" and "RETURN"</p>

There are literally hundreds of ways to access and transmit information on the iXO Telecomputing System. You can take them all with you. They're as close as a telephone line.

No Risk Offer.

Use the iXO Telecomputing System for 15 days without obligation. If you decide to return it during this trial period, you'll receive a full refund.

Low Price.

You can afford to put the world at your fingertips now. All that we've described here can be yours at a special introductory price: only \$299 per unit.

Subscription Offer To THE SOURCE.*

The first 1,000 purchasers receive a valuable introductory bargain we simply can't tell you about...it's that good a deal. What we can tell you is that this extra bonus will let you put the iXO Telecomputing System to use immediately.

When you're just beginning, we'll make it easier for you to use THE SOURCE* services. We'll program your telecomputer with automatic menu selection for five popular services: "SourceMail", UPI news and sports, current stock quotations, airline schedules and discount shopping.

(If you already subscribe to THE SOURCE*, we'll send you a \$50 rebate coupon redeemable for usage charges.)

*THE SOURCE and AMERICA'S INFORMATION UTILITY are service marks of Source Telecomputing Corporation, a subsidiary of The Reader's Digest Association, Inc.

Free Software.

You'll also receive a program diskette, instruction sheet and basic program listing for interfacing your iXO Telecomputing System to your Apple II, IBM PC or TRS-80 III.

Unconditional Warranty.

Each telecomputer is backed by our unconditional iXO Service Guarantee which states, "Should any unit require service, we'll ship a replacement no questions asked within 24 hours of receiving notification."

You'll receive the iXO Telecomputing System, a modular cable, a durable carrying case and an Owner's Manual. Plus, we'll provide the software that'll give you remote access to your PC system with the telecomputer.

To order your personal telecomputer today, Just call (800) 423-3008 toll free now (In California call collect (213) 877-5384, ext. 10) and use your credit card to charge your iXO Telecomputing System by phone. Or...complete the reply card below and mail it to us. Your telecomputer is shipped within 24 hours so you'll get speedy delivery.



P.O. Box 3615 Culver City, CA 90230

iXO, Inc., P.O. Box 3615, Culver City, CA 90230

Yes, send me the iXO Telecomputing System fast. I'm enclosing \$299 for each telecomputer I order. (California residents add 6 1/2 % sales tax.)

I'm making payment by: Check Visa Mastercard American Express
Signature: _____
Name: _____
Address: _____
City: _____

Card No: _____ Expiration: _____ State/Zip: _____

Yes, send the FREE software package for: IBM PC Apple II TRS80 III
 I already subscribe to THE SOURCE* Send me the \$50 rebate coupon redeemable for usage charges.

I'd also like the following peripherals. Include them with my order.
 iXO 20-Column Printer \$199 iXO Video Interface \$199
 iXO Acoustic Interface \$99 iXO Serial Parallel Interface \$119

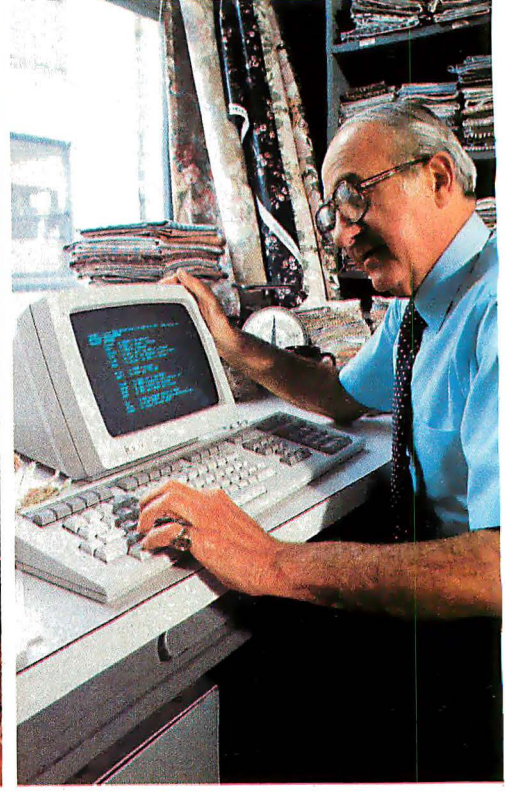
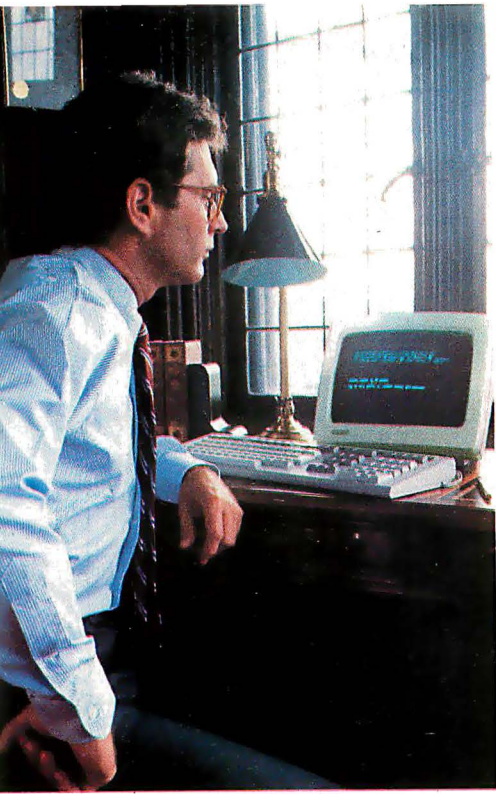

**THREE
NEW PERSONAL
COMPUTERS THAT
MAKE ALL THE
OTHERS MERELY
INTERESTING
HISTORY.**

There was a time in recent history when people could tolerate the inadequacies of personal computers. We believe that era has ended.

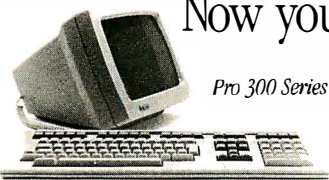

Pro 300 Series

The minicomputer of personal computers.

Now you can own personal computers that are more powerful, easier to use and more fully supported than any to have come before them. They are the new personal computers from Digital Equipment Corporation, the world's second largest computer manufacturer.



DECmate II

The fully supported small business system.

Digital's personal computers give you more information on the screen. More storage. And communications options that let you talk to other, larger computers anywhere in the world.

When it comes to graphics, you no longer have to settle for the "paint-by-numbers" look of yesterday's systems. Digital's optional bit-map graphics give you four times the resolution of even the very best picture tube. And you no longer have to settle for the pale, bland colors of the past. Digital's personal computers give you a wider palette to pick from.

Even more, you no longer have to be content with a narrow choice of personal computers. For Digital gives you three choices: Rainbow, DECmate, and Professional personal computers. Different kinds of personal computers, because there are different kinds of problems to manage.

So if you've been unhappy with the history of personal computing thus far, be glad. A new generation has begun. To find out more, call 800-DIGITAL and we'll send you our free personal computer brochure. Or write: Digital

Equipment Corporation, 200 Baker Avenue, Media Response Manager, CF01-1/M94, Concord, MA 01742.

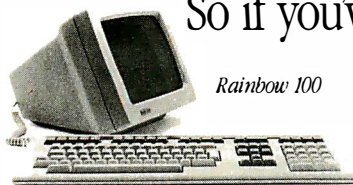

Rainbow 100

The low cost high performance machine.

Intel's 80186

A 16-Bit Computer on a Chip

The 80186 is the first integrated circuit that attacks the cost problem in 16-bit microcomputers.

Tony Zingale
Product Marketing Engineer
Intel Corporation
3065 Bowers Ave.
Santa Clara, CA 95051

Two factors are slowing the rush to 16-bit microcomputers. The 16-bit systems cost more than their 8-bit ancestors, and they have less software available to them than 8-bit systems. Fortunately, time is solving the problem of software availability for 16-bit machines, and very-large-scale integration (VLSI) will soon reduce the cost of 16-bit systems.

The 80186 or iAPX 186 (advanced processor) from Intel is the first integrated circuit that addresses the cost problem in 16-bit microcomputers. The phrase "computer on a chip" is often used to describe microprocessors, but they are really central processing units (CPUs) only. The 80186, on the other hand, incorporates in a single chip all the functions of a CPU board except memory.

The 80186 combines an enhanced 8-MHz 8086-2 CPU with a clock generator, two independent high-speed DMA (direct memory access) channels, and a programmable interrupt controller. It includes three program-

mable 16-bit timer/counters, programmable memory-select and peripheral-select logic, a programmable wait-state generator, and a local bus controller, all on one 68-pin chip (see figure 1). One 80186 chip will replace as many as 20 other chips, reducing the size, weight, power-supply requirements (a single 5-volt supply is all it needs), and the cost of the system while increasing performance (see table 1).

Up until now, the difference in the cost of integrated circuits for 8-bit and 16-bit systems has been significant. A little computation confirms that fact. Building an 8086-based computer system requires the CPU chip (\$19.15 in quantities of 10,000) and additional integrated circuits that cost \$52.35. Building an 8-bit 8085-based system requires a CPU chip that costs only \$2.65 and other chips costing \$27.10, for a total of

\$29.75. The integrated circuits for an 8086-based system, then, cost \$41.75 more than similar parts for an 8085-based system.

The 80186 chip narrows that price differential considerably. While the chip itself costs \$30.00, the additional integrated circuits to complete the system cost only \$5.90. Consequently the integrated circuits for the 80186 cost only \$6.15 more than those for the 8085 system (see table 2).

Equally important to the end user, the 80186 uses the same instruction set as the 8086 and 8088 and is compatible with the large and growing body of software and peripherals available for those systems. The 80186 adds 10 instructions that enable programmers to make more efficient use of the code, and Intel is revising its development software tools to include support for the new instructions.

About the Author

Tony Zingale, product marketing engineer for Intel's 80186 and 80188 microprocessors, has extensive experience in the use of microprocessor technology in a wide variety of applications.

	8085	8086	80186	80286
Performance in MIPS	.07	0.3	0.7	1.5
Cost/performance ratio in IPS/\$	700	1500	10,000	7500

Table 1: Performance comparisons of four microprocessors. MIPS means million instructions per second; IPS/\$ means instructions per second per dollar.

SuperSoft Ada*

The Real Thing

In a world where Ada is becoming a widely accepted standard, it is important that programmers learn this language quickly. SuperSoft Ada provides an excellent means for doing just that. And in contrast to other Ada-like languages, SuperSoft Ada supports standard Ada syntax and only standard Ada syntax. This means you'll learn to write programs in valid Ada code only.

SuperSoft Ada

SuperSoft Ada is a native code, fully recursive, multi-pass compiler which generates ".COM" files. While currently a subset, SuperSoft Ada supports many features of the standard Ada languages such as:

loop	floating point
procedure	printer I/O
strings	case
console I/O	while
arrays	integers
for	disk I/O
characters	integers with exponents

types

- user defined types
- enumeration types (no I/O)
- derived types
- records and selected components

attributes

relational operators for arrays and strings

control structures

- labels
- goto
- exit

in/out mode parameters for subprograms

pragmas

- list
- print
- optimize
- include
- system

Circle 396 on Inquiry card.

The second release of SuperSoft Ada (2.0) includes the most useful features of standard Ada. Anyone purchasing an early release will be promptly notified of all updates and charged only for the small price increase of later releases.

Ada is a state-of-the-art language designed for the demanding, contemporary user/programmer. Because it is required by the Department of Defense, Ada is certain to become a dominant language soon. Begin learning and using Ada now with SuperSoft Ada.

"This compiler is presently an incomplete implementation of the Ada programming language. It is intended that this compiler will be further developed to enable implementation of the complete Ada programming language, and then to be submitted to the Ada Joint Program Office for validation."

(Requires: 48K CP/M®)

Ada Compiler: \$300.00

Manual Only: \$ 40.00

Japanese Distributor: ASR Corporation International, 3-23-8, Nishi-Shimbashi, Minato-Ku, Tokyo 105, Japan, Tel. (03)-4375371 Telex: 0242-2723.

European Agent: Micro Technology Ltd., 51 The Pantiles, Tunbridge Wells, Kent, England TN2 5TH. TEL 0892-45433. Telex: 95441 Micro-G.

*Ada is a trademark of the Department of Defense (Ada Joint Program Office)

CP/M is a registered trademark of Digital Research, Inc.

SuperSoft®

FIRST IN SOFTWARE TECHNOLOGY P.O. Box 1628 Champaign, IL 61820 (217) 359-2112 Telex 270365

(1a)

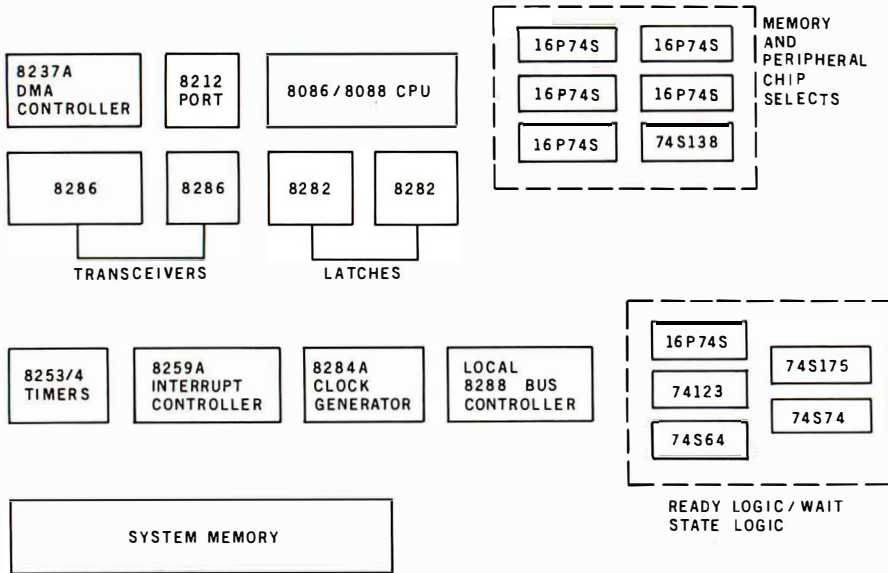

(1b)

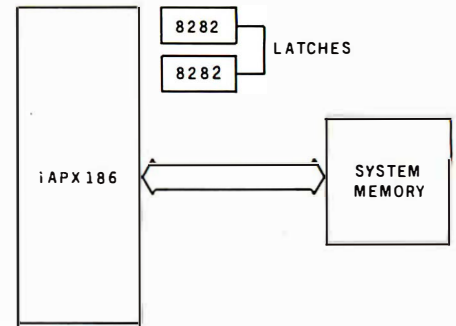

Figure 1: (1a) Chips necessary to make an 8086-based microcomputer system. (1b) Chips necessary to make an 80186-based microcomputer system.

The Intel 8086 family is growing. The 80186 expands on the basic workhorse 8086, and the 80286 (see the text box on page 144) adds multi-user capabilities. The 8088 has the same 16-bit internal architecture as the 8086, but it uses an external 8-bit bus. The same is true for the 80188 or iAPX 188 highly integrated 8-bit microprocessor. (Unless otherwise noted, all references to the 8086 and 80186 apply to the 8088 and 80188.) For detailed information about the architecture of the 8086, see *The 8086 Book* by Russell Rector and George Alexy (Osborne/McGraw Hill, 1980) and *The 8086 Primer* by Stephen P. Morse (Hayden, 1980).

System designers who are familiar with the 8086 will recognize the identical architectural scheme in the 80186. In some cases, hardware has been used to support functions formerly handled in microcode. Though the programmer's instructions are the same, the user will notice the enhanced performance of the 80186 (see table 3).

The instruction set, including the new instructions, is divided into those for data transfer, arithmetic operations, string manipulation, logicals/shifts/rotates, processor control, procedure entry and exit, and program-transfer operations. There are 101 instructions in the 80186 set (see table 4).

The registers within the 80186 are identical to those in the 8086, with the addition of the 16-bit relocation register, which locates the 256-byte peripheral control block in the 80186's 1-megabyte memory or 64K I/O (input/output) space. The control-block registers define the func-

10K Piece Kit		
80186		\$30.00
2 latches (8282)		5.90
	total	\$35.90
Equivalent 16-bit CPU Board		
8086 CPU (5 MHz)		\$19.15
DMA controller (8237A-5 + 8212 port)		15.30
interrupt controller (8259A)		3.75
timers (8253)		3.40
2 latches (8282)		5.90
2 transceivers (8286)		5.90
chip-selects (6 memory/7 peripherals)		3.50
wait-state generator		3.50
local bus controller (8288)		7.95
clock generator (8284A)		3.15
	total	\$71.50
8-bit CPU Board		
8085 CPU (3 MHz)		\$ 2.65
interrupt controller (8259A)		3.75
DMA controller (8237 + 8212 port)		8.80
timers (8253)		3.40
latch (8282)		2.95
transceiver (8286)		2.95
chip-selects (3 memory/3 peripherals)		1.75
wait-state generator		3.50
	total	\$29.75
Note: An 8088-based 8-bit board price following a similar set of options comes to a total of \$58.65.		
Table 2: Price comparisons of chips necessary to make 8- and 16-bit systems based on Intel microprocessors.		

A PICTURE'S WORTH:

U.S. SHIPMENTS (\$ BILLIONS)

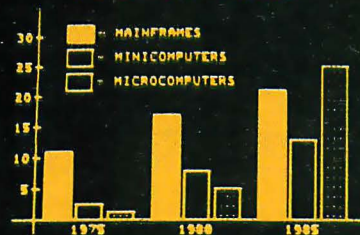

** GRAPHICS CAPABILITIES **

- ◆ High Performance Graphics
- ◆ Tektronix 4010 Compatibility
- ◆ Automatic Scaling (1023x1023) with 250x512 resolution
- ◆ Alpha Mode (35 lines x 73 cols)
- ◆ Optional Joystick
- ◆ Connection to Low Cost Printer for Graphics Hardcopy
- ◆ ASCII and APL character sets
- ◆ Block Fill, Dotted/Dashed Lines

** DISPLAY TERMINAL CAPABILITIES **

- ◆ ANSI Standard Conformance
- ◆ DEC Software Compatibility
- ◆ 80/132 Columns, Windowing
- ◆ 4 Pages of Memory Standard (up to 8)
- ◆ 43 Programmable Functions
- ◆ ASCII and APL models
- ◆ High Resolution Amber Phosphor
- ◆ Setup Mode



\$1895.

Single quantity.

Whether used in video display mode or in its high-performance graphics mode, Human Designed Systems' concept GVT has more to offer at its price for terminal operators, interactive users, and applications developers than any other terminal available today.

Use the concept GVT graphics terminal for all its worth. Call 215-382-5000 or your local HDS sales/service office for a demonstration and free, no-obligation, trial in your office.

HDS human designed systems, inc.

3440 Market Street □ Philadelphia, PA 19104 □ 215-382-5000

Boston — (617) 329-3510; Chicago — (312) 825-2960; Dallas — (214) 696-8031; Delaware — Infocon: (302) 239-2942; Hawaii — Gray Associates: (808) 261-3751; Los Angeles — (213) 410-9454; Northern New Jersey — Infocon: (201) 624-1372; New York City Area — Infocon: (212) 689-8833; New York State — Naco Electronics: Rochester: (716) 223-4490; Syracuse: (315) 699-2651; San Francisco — (415) 692-4184; Washington, DC — International Systems Marketing: (301) 279-5775; Australia — I. O. Peripherals Pty. Limited: (02) 427 3555; Belgium — BELCOMP: 091/25 22 88; Canada — CAIL Systems: Toronto: (416) 362-1063; Denmark — ADCOM Data Aps: 1-19 44 66; Finland — Modulsystem OY: 6926511; France — Walton: (1) 226.06.90; Singapore — DTS Singapore: (65) 33-88-566; Sweden — Allnovo Data AB: 08-37 25 15; Switzerland — Mitek ag: 02/461 22 52; United Kingdom — Shandell Systems Ltd.: 02407-2027; West Germany — COMKO Computersystemges. mbH: 0221-48 30 51.

DISTRIBUTORSHIP INQUIRIES INVITED. Circle 187 on Inquiry card.

CP/M GRAPHICS SOFTWARE

PLOTWARE-Z

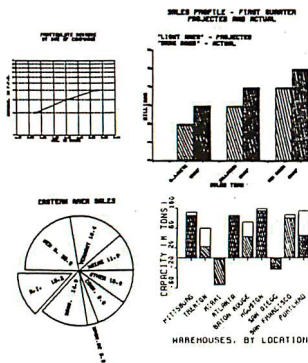

On ALTOS, APPLE, OSBORNE, ZENITH, and most others.

THE MOST COMPLETE:

Use THREE ways:

1. "MENU" GRAPHICS (easy, friendly)
2. "COMMAND FILES" (powerful, flexible)
3. "COMPILER LINKED" (Fortran, etc.)

Use on: most CRT's, dot matrix printers, plotters, word processing printers

THE MOST PROVEN:

2 years in the field

THE MOST IMPLEMENTED:

1. 8 bit and 16 bit machines
2. USER MODIFIABLE
3. many applications programs

\$399 complete

\$35 manual only

VISA, MC, C.O.D., CHECK, M.O.

THE ENERCOMP COMPANY

P.O. Box 28014
Lakewood, Colorado 80228
(303) 988-1648

Also Available Through

WESTICO

The Software Express Service

25 Van Zant Street • Norwalk, Connecticut 06855

(203)853-6880 • Telex 643788

and selected dealers.

Relative 80186 Execution Times
8086 time divided by 80186 time (8-MHz clock rate)

Instruction	8086 (5 MHz)	8086-2 (8 MHz)	8086-1 (10 MHz)
Move Contents of Register to Memory	2.0 to 2.9	1.2 to 1.8	1.0 to 1.4
Add Contents of Memory to Register	2.0 to 2.9	1.2 to 1.8	1.0 to 1.4
Multiply 16-bit Register	> 5.4	> 3.4	> 2.7
Divide 16-bit Register	> 6.1	> 3.8	> 3.0
Multiple (4-bits) Shift/Rotate Memory	3.1 to 3.7	1.95 to 2.3	1.6 to 1.8
Conditional Jump	1.9	1.2	1.0
Block Move (100 bytes)	3.4	2.1	1.7

Table 3: Comparison of execution speeds of 8086 microprocessors to those of the 80186.

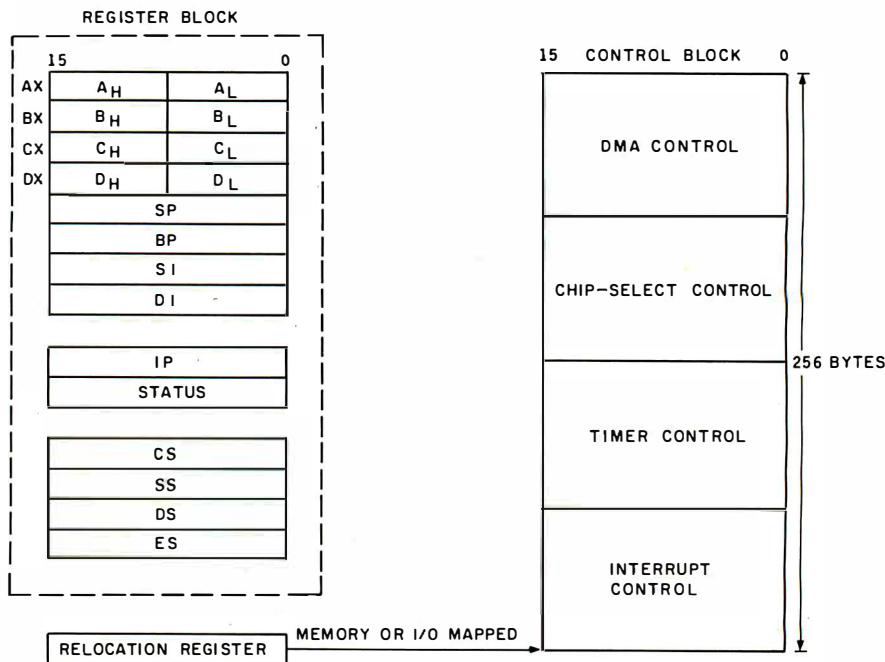

Figure 2: The 80186 register file. Each of the four segment registers—CS, SS, DS and ES—defines a 64K-byte area of memory. There are four general-purpose registers: AX, BX, CX, and DX. The pointer and index registers are stack pointer (SP), base pointer (BP), source index (SI), and destination index (DI). IP is the instruction pointer.

tions of the on-chip timers, DMA support, interrupt controllers, and chip-select logic (see figure 2).

Enhanced CPU

Several enhancements have been made to the 80186's CPU to reduce the number of instructions it needs to carry out a task and to increase the overall processing speed. The multiplier portion has been augmented with additional parallel hardware to

provide a fivefold to sixfold improvement in executing multiplication and division instructions over the standard 5-MHz 8086.

Using its own dedicated hardware adder, the bus-interface unit (BIU) calculates the effective addresses of operands and instructions in parallel with the execution unit (EU). Formerly, this task was done in microcode using the adder that resides in the arithmetic and logic unit (ALU).



Plug 3,000 new applications into your Apple.[®]

THE CP/M Card™ plugs CP/M Plus™ into Apple.
 The CP/M Card gives you the option of running your Apple II with the speed and capability of a professional Z-80 system with CP/M*-compatible software. You plug in the CP/M Card. Then choose CP/M or your standard Apple software at your option.

Plug into a big, new world of software.
 The CP/M Card gives you instant access to the world's largest selection of microcomputer software—more than 3,000 CP/M-compatible applications, languages, and programming utilities. So, you, too can use professional business programs such as WordStar,* SuperCalc,™ Condor,™ and other high-performance software from Day One. Yet, you still have access to your present library of Apple software.

Plug into incredible performance.
 Together, the ultra-fast CP/M Card and CP/M Plus run applications up to

300% faster than your Apple system! The CP/M Card is the only Apple II performance package that offers the speed and efficiency of CP/M Plus.

A plug about quality.

The CP/M Card was designed and built by Digital Research, the creators of CP/M, and Advanced Logic Systems, the most respected manufacturer of Apple performance products. So you know the CP/M Card is the most perfectly integrated Apple performance package you can buy.

Why just keep plugging along? The CP/M Card provides everything you need—including 64K of on-board memory, CP/M Plus, CBASIC,* GSX™-80 and full documentation—for just \$399.

Now available through the CP/M library. See your local microcomputer dealer today. Or contact Advanced Logic Systems, 1195 East Arques Ave., Sunnyvale, CA 94086 (800) 538-8177. (In California (408) 730-0306.)



Advanced Logic Systems
The CP/M Card for your Apple II.

CP/M, CP/M Plus, the CP/M Card and CBASIC are either trademarks or registered trademarks of Digital Research Inc. Z-80 is a registered trademark of Zilog, Inc. WordStar is a registered trademark of MicroPro International Corporation. SuperCalc is a trademark of Sorcim Corporation. Condor is a trademark of Condor Computer Corporation. GSX-80 is a trademark of Graphics Software System. Apple is a registered trademark of Apple Computer, Inc. ©1982 Digital Research Inc.

Data-Transfer Instructions	
GENERAL PURPOSE	
MOV	Move byte or word
PUSH	Push word onto stack
POP	Pop word off stack
PUSH(X)	Push user-specified value
PUSHA	Push all registers on stack
POPA	Pop all registers from stack
XCHG	Exchange byte or word
XLAT	Translate byte
INPUT/OUTPUT	
IN	Input byte or word
OUT	Output byte or word
ADDRESS OBJECT	
LEA	Load effective address
LDS	Load pointer using DS
LES	Load pointer using ES
FLAG TRANSFER	
LAHF	Load AH register from flags
SAHF	Store AH register in flags
PUSHF	Push flags onto stack
POPF	Pop flags off stack

String Instructions	
MOVS	Move byte or word string
INS	Input bytes or word string
OUTS	Output bytes or word string
CMPS	Compare byte or word string
SCAS	Scan byte or word string
LODS	Load byte or word string
STOS	Store byte or word string
REP	Repeat
REPE/PREZ	Repeat while equal/zero
REPNE/REPNZ	Repeat while not equal/not zero

Arithmetic Instructions	
ADDITION	
ADD	Add byte or word
ADC	Add byte or word with carry
INC	Increment byte or word by 1
AAA	ASCII adjust for addition
DAA	Decimal adjust for addition
SUBTRACTION	
SUB	Subtract byte or word
SBB	Subtract byte or word with borrow
DEC	Decrement byte or word by 1
NEG	Negate byte or word
CMP	Compare byte or word
AAS	ASCII adjust for subtraction
DAS	Decimal adjust for subtraction
MULTIPLICATION	
MUL	Multiply byte or word unsigned
IMUL	Integer multiply byte or word
AAM	ASCII adjust for multiply
DIVISION	
DIV	Divide byte or word unsigned
IDIV	Integer divide byte or word
AAD	ASCII adjust for division
CBW	Convert byte to word
CWD	Convert word to doubleword

Processor Control Instructions	
FLAG OPERATIONS	
STC	Set carry flag
CLC	Clear carry flag
CMC	Complement carry flag
STD	Set direction flag
CLD	Clear direction flag
STI	Set interrupt enable flag
CLI	Clear interrupt enable flag
EXTERNAL SYNCHRONIZATION	
HLT	Halt until interrupt or reset
WAIT	Wait for TEST pin active
ESC	Escape to extension processor
LOCK	Lock bus during next instruction
NO OPERATION	
NOP	No operation

Table 4: The 80186 instruction set. The 80186 instructions not found in the 8086 instruction set are highlighted. Table 4 continues on page 139.

Shift/Rotate/Logical Instructions	
LOGICALS	
NOT	"Not" byte or word
AND	"And" byte or word
OR	"Inclusive or" byte or word
XOR	"Exclusive or" byte or word
TEST	"Test" byte or word
SHIFTS	
SHL/SAL	Shift logical/arithmetic left byte or word
SHR	Shift logical right byte or word
SAR	Shift arithmetic right byte or word
ROTATES	
ROL	Rotate left byte or word
ROR	Rotate right byte or word
RCL	Rotate through carry left byte or word
RCR	Rotate through carry right byte or word
High-Level Instructions	
ENTER	Format stack for procedure entry
LEAVE	Restore stack for procedure text
BOUND	Detect values outside prescribed range

Additional hardware offers the programmer streamlined string-manipulation operations. Previously, the Repeat Prefix to Move instruction on the 8086 caused a delay for each byte that was moved because a microcoded subroutine had to be executed to decrement the CX register and check the status flags for "end of move." The extra hardware on the 80186 eliminates this overhead by performing these operations in parallel. As a result, string-move operations occur at nearly bus bandwidth (2 megabytes per second).

Bit-manipulation instructions such as Shift and Rotate have also been enhanced by means of additional hardware. Now both operate at a rate of 1 bit per clock.

Superset of Instructions

The 80186 adds additional instructions to those of the 8086. The Block I/O Move instruction is similar to the existing 8086 string instructions but allows the source or destination to be in the I/O space rather than in memory. If Block I/O Move is used with the repeat prefix, the number of words or bytes specified by the CX register is moved. The result is a very high transfer rate (4 megabytes per

Program-Transfer Instructions			
CONDITIONAL TRANSFERS		UNCONDITIONAL TRANSFERS	
JAJNBE	Jump if above not below nor equal	CALL	Call procedure
JA/JNB	Jump if above or equal not below	RET	Return from procedure
JB/JNAE	Jump if below not above nor equal	JMP	Jump
JBE/JNA	Jump if below or equal not above		
JC	Jump if carry	ITERATION CONTROLS	
JE/JZ	Jump if equal/zero		
JG/JNLE	Jump if greater/not less nor equal	LOOP	Loop
JGE/JNL	Jump if greater or equal/not less	LOOPE/LOOPZ	Loop if equal/zero
		LOOPNE/LOOPNZ	Loop if not equal/not zero
JLE/JNG	Jump if less or equal/not greater	JCXZ	Jump if register CX = 0
JNC	Jump if not carry		
JNE/JNZ	Jump if not equal/not zero	INTERRUPTS	
JNO	Jump if not overflow		
JNP/JPO	Jump if not parity/parity odd	INT	Interrupt
JNS	Jump if not sign	INTO	Interrupt if overflow
JO	Jump if overflow	IRET	Interrupt return
JP/JPE	Jump if parity/parity even		
JS	Jump if sign		

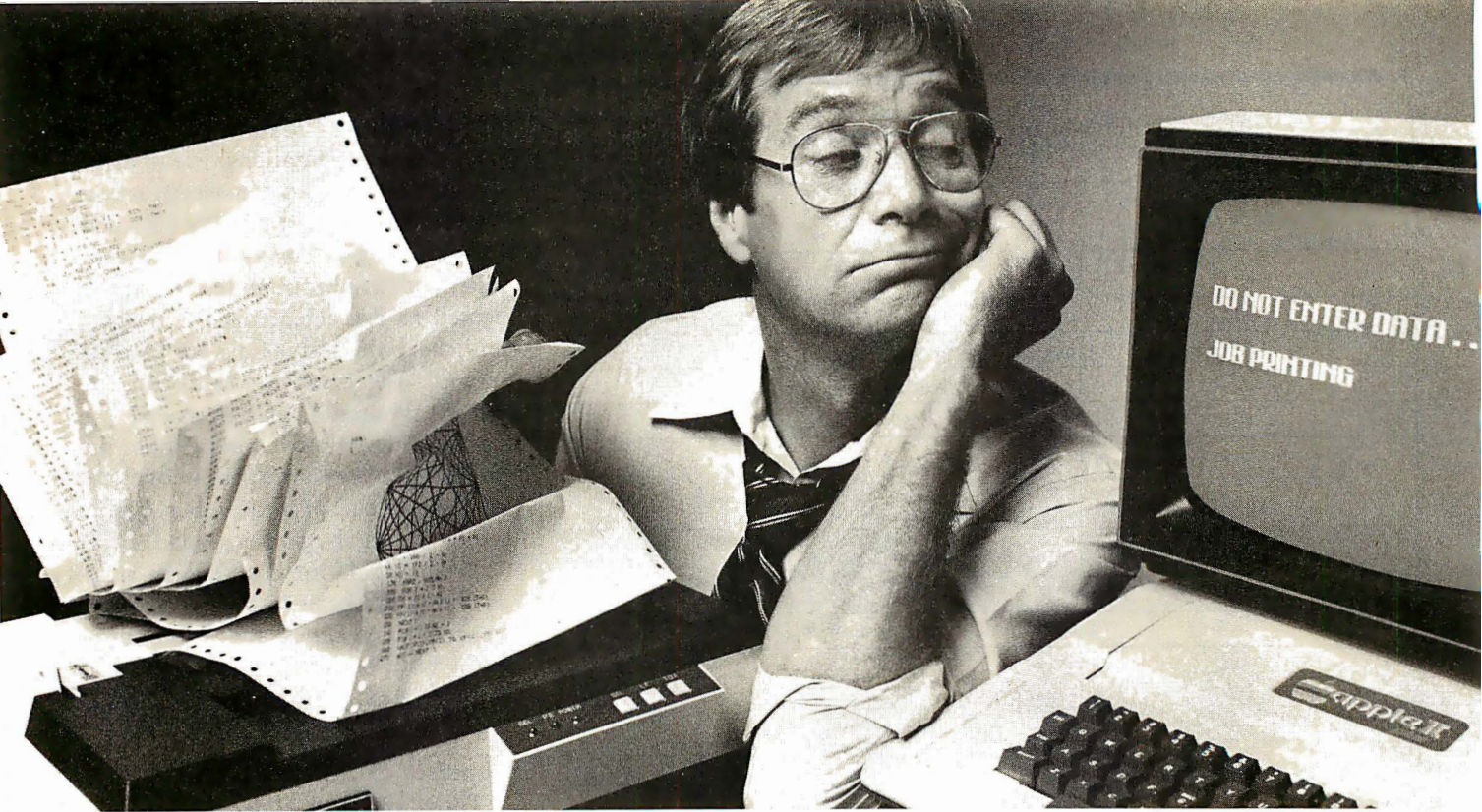

If your printer uses your Apple[®] more than you do, you need The Bufferboard.[™]

If your Apple is locked into the "PRINT" mode so much that you've taken up solitaire to kill the boredom, you need a buffer. And if your computer is the Apple II or III, the only buffer for you is The Bufferboard. Expandable to 64K of storage, The Bufferboard stores an instantaneous **bucketful** of print data from your computer. Then it feeds the data to your printer at its own printing rate. Your Apple is set free from driving your printer and is ready for more data from you.

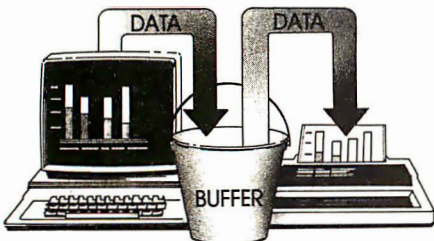

Take your existing interface— and buffer it!

Only The Bufferboard has a simple Interface-Docking System. No bulky boxes

or expensive power supplies are needed because The Bufferboard fits right into your Apple—and docks onto your existing printer interface. The result is convenient

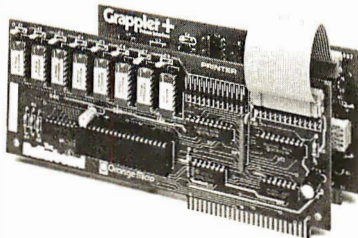

and economical buffering of most popular printer interfaces, including the Grappler +[™] interface, Epson interface, and Apple printer interface. Thirty seconds and a single hook-up are all you need to end the printer waiting game forever.

Up to 20 letter-size pages stored at a time.

The Bufferboard comes standard with 16K, and is expandable to 32K or 64K of buffering capacity with the addition of

memory chips. This "bucket" will hold up to 20 pages of a print job, allowing you freedom to use your Apple.

The Bufferboard—designed exclusively for the Apple Computer.

Specifications:

- Versions for Grappler + interface, Epson interface, Apple interface, and other popular printer interfaces
- 16K buffer standard
- Upgradeable to 32K or 64K
- Automatic memory configuration
- Automatic self test
- Includes interface docking cable.

The Bufferboard is made by Orange Micro, Inc., the same people who brought you the popular Grappler + printer interface. Both the Grappler + and The Bufferboard are now available at your local Apple dealer.

Apple is a registered trademark of Apple, Inc. Epson is a registered trademark of Epson America, Inc.

Orange Micro inc.

1400 N. Lakeview, Anaheim, CA 92807
U.S.A. (714) 779-2772
TELEX: TX 183511 CSMA

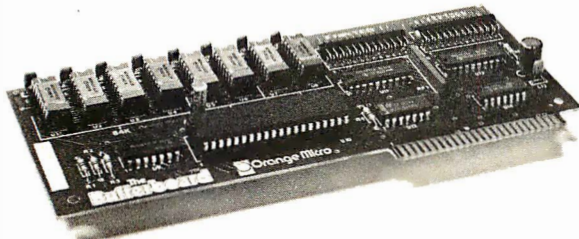

The Bufferboard[™]
For Apples and Printers

Circle 310 on inquiry card.

© Orange Micro, Inc. 1982

IMAGINE IT...

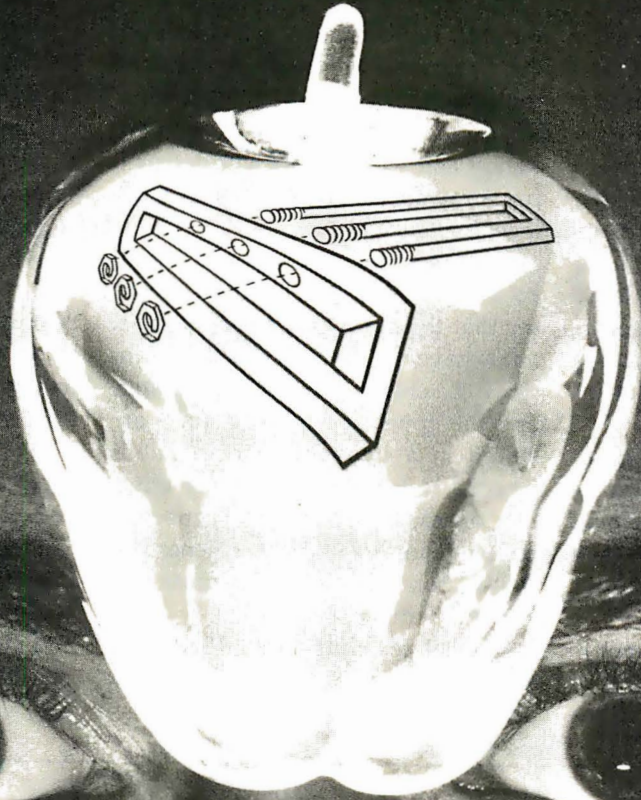

CAPTURE IT.

COMPLETELY REDESIGNED.
NOW, THE GRAPPLER +.

The original Grappler was the first graphics interface to give you hi-res screen dumps from your keyboard. The new Grappler+ with *Dual Hi-Res Graphics* adds flexibility with a side-by-side graphics printout of page 1 and page 2.

The Grappler+ can now be used with the Apple® Dot Matrix, the Okidata 84, and is Apple III compatible.* In addition, the IDS Grappler+ is currently available with color capability, including color graphics screen dumps.

UP TO 64K BUFFER OPTION
An optional Bufferboard can now be added to all existing Grappler and Grappler+ interfaces. See your Apple Dealer for details.

* Requires additional software driver.
** Requires graphics upgrade.

© Orange Micro, Inc. 1982
Circle 311 on Inquiry card.

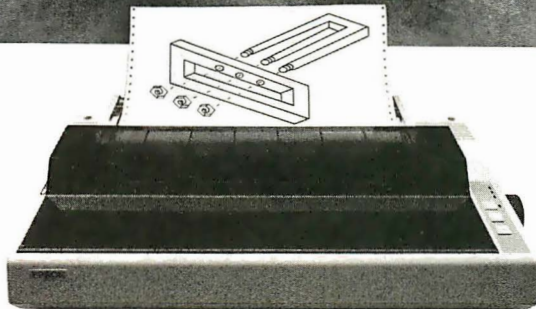

ACTUAL APPLE II PRINTOUT USING GRAPPLER+ AND EPSON MX100

With The
Grappler+
Printer Interface

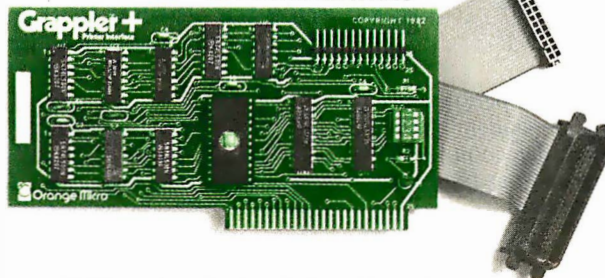

CP/M is a registered trademark of Digital Research, Inc.
Apple is a registered trademark of Apple Computer, Inc.

THE GRAPPLER+ FEATURES:

- Dual Hi-Res Graphics • Printer Selector Dip Switch • Apple III Compatible* • Graphics Screen Dump • Inverse Graphics • Emphasized Graphics • Double Size Picture • 90° Rotation • Center Graphics • Chart Recorder Mode • Block Graphics • Bell Control • Skip-over-perf • Left and Right Margins • Variable Line Length • Text Screen Dumps • also works with Pascal and CP/M®

THE GRAPPLER+ INTERFACES WITH THE FOLLOWING PRINTERS:

- Anadex • Apple Dot Matrix • Centronics 122 • C. Itoh ProWriter • DMP-85 • Epson Series** • IDS 460, 560, Prism 80 and 132, Microprism • NEC 8023 • Okidata Series** • Star Micronics Series • and many other printers

 **Orange Micro**
inc.

1400 N. Lakeview Ave.,
Anaheim, CA 92807 U.S.A.
(714) 779-2772 Telex: 183511 CSMA
Foreign Dealer Inquiries Welcome

second) because no op codes are fetched during the operation.

To support block-structured, high-level-language programs, Enter Procedure and Leave Procedure instructions are included. The Enter instruction performs the calling sequence for a high-level language, flushes the register set, and sets up the segment pointer registers as well as performs the other necessary "housekeeping" tasks. The Leave instruction, on the other hand, restores the 80186 to its state prior to entering the procedure. Normally, such operations would be done using assembly-language subroutines. In that case, the operations are performed with microcode for increased throughput.

Instead of using an internal register to temporarily store constants during a routine, the new Push Immediate instruction lets the user put a signed 8- or 16-bit value directly on top of the stack.

Numeric calculations are faster with "immediate" instructions, too. The two Multiply Fast instructions

(one for signed 16-bit, the other for extended 8-bit values) work with immediate values. These instructions take one operand from the immediate field of the instruction itself and the other from either a memory or a register. In both cases, the values are "latched" by the new streamlined multiplier array for fast processing. These new instructions are very handy and were specifically designed for array index calculations in high-level languages.

Array handling is further enhanced by a Bound instruction that checks to see that the bounds of an array index value have not been exceeded. The index to be checked is kept in a register, and the upper and lower bounds are stored in a two-word block that is pointed to by the instruction's effective operand address. If the index is out of bounds, a "trap" is generated that vectors instruction execution to a known memory location.

Immediate Shift and Rotate instructions speed bit manipulations. In addition to the 3-bit field for deter-

mining left or right movement, an additional byte specifies the number of bits to be shifted or rotated; this eliminates the need to use a loop to perform that same function.

Finally, the contents of the AX, BX, CX, SP, BP, SI, and DI registers can be pushed onto the stack with a single Push All instruction. Similarly, they can be popped off with the Pop All instruction. Again, this instruction eliminates the use of slow assembly-language subroutines when you're servicing interrupts and subroutine calls. Another enhancement in the 80186 is its ability to generate an error interrupt when the 80186 attempts to execute an illegal instruction op code.

Interrupt Controller

The on-chip interrupt controller can handle eight prioritized, vectored interrupt sources. Internal interrupt sources are the counter/timer unit and the two DMA channels, which can be selectively disabled via bits in

Text continued on page 148

INTERSTELLAR DRIVE™

A SOLID STATE DISK EMULATOR



Save valuable time!
5 to 50 times faster
performance than floppy disks
and Winchester drives

PION'S INTERSTELLAR DRIVE is designed for use with a family of interfaces and software packages. Currently available are interfaces for IBM, S100, TRS80, Apple, SS50, and most Z80 uP, and software for most popular operating systems. Additional interfaces are continually being developed for the most popular computers.

SAVE MONEY!
Increase your
computer's productivity

The INTERSTELLAR DRIVE is a high performance data storage subsystem with independent power supply, battery backup, and error detection. It has 256KB to 1 Megabyte of solid state memory integrated to perform with your operating system.

Basic Price for 256KB unit [Includes Interface and software]
\$1095. plus tax (where applicable) and shipping
Visa and Master Card accepted.



PION, INC. Tel. (617) 923-8009
101R Walnut St., Watertown, MA 02172

TRS80 trademark of Tandy Corp. Apple trademark of Apple Computers
Interstellar Drive trademark of PION, Inc.

PKASO™

Printer Interface Family

Welcomes the
New Apple IIe...
We work together.



PKASO Interfaces come complete with Cable, Instructional Diskette and Comprehensive Manual.

The PKASO family makes you and your Apple Computer a master of text and graphics.

PKASO makes it easy to use the features of your printer—select character sizes, vary line spacing, even print in colors. Simple PKASO commands make these features usable from the keyboard or a program.

PKASO also adds features to your system. Press a few keys and get a snapshot "dump" of the image you see on the screen—text or graphics. Add new characters and symbols that you couldn't print before, using our SuperFont™ system. Add our new Pipeline™ printing buffer and your printer can take its time while you and your Apple move on to the next task. The Pipeline is a modular add-on to the standard PKASO board.

The PKASO interface is designed for Apple II and Apple III in all the popular configurations. It prints in full color on the IDS Prism Printer, and in striking black on C. Itoh, Centronics, Epson, IDS, NEC, and Okidata matrix printers.

NEW!

The IS Pipeline™ Printing Buffer with Random Access Printing stores paragraphs or pictures for printing in any order—any number of times!

- Universal—works with any parallel (Centronics style) computer/printer combinations.
- 8K to 128K Bytes of memory with data compression for efficient use of memory space.



Interactive Structures Inc.
146 Montgomery Avenue
Bala Cynwyd, PA 19004
Telephone: (215) 667-1713

56 page FREE catalog

Business Forms and Supplies for MICRO Computers

Save money. Your firm name and address printed on standardized, continuous checks, invoices, statements, letterheads and labels.

Designed to work with programs from over 200 software sources . . . or program to our attractive forms yourself with guides provided. Full color catalog also has stock tab paper, envelopes, diskettes, many other supplies and accessories.

- Quality products at low prices
- No "handling charges" or hidden extras
- Available in small quantities
- Money-Back Guarantee

Fast service . . . buy direct by mail or

PHONE TOLL FREE
1 + 800-225-9550

(Mass. residents 1 + 800-922-8560)
8:00 A.M. to 5:00 P.M., ET

NAME _____ PHONE _____

COMPANY _____

STREET _____

CITY, STATE and ZIP _____

Required to help us send you correct information:

SOFTWARE BRAND _____ PACKAGE# _____ Do own programming.

COMPUTER MAKE _____ MODEL# _____ Have not purchased yet.

YOUR LINE OF BUSINESS _____ Number of employees. _____

11104

Neb's Computer Forms



12 South Street, Townsend, Massachusetts 01469
A division of New England Business Service, Inc.

The 80286

Today's microcomputer systems are capable of serving many users and simultaneously running a variety of programs. These multiuser, multitasking systems require high-performance processing, a large memory space, efficient addressing, and an effective means to protect system software from inadvertent user mishandling. In addition, each user's programs and data must be protected so that another user's program cannot "write" over them. Isolating both system software and user software requires effective hardware-supported protection.

Multiuser and multitasking systems are not new concepts; minicomputers have offered both of these features for years. But the demand for such microcomputer systems is a relatively recent development. To date, no microprocessor exists that has built-in memory management and protection or the ability to efficiently address a gigabyte (2³⁰) of virtual memory. In that regard alone, the 80286 or iAPX 286 sets a precedent. The capabilities of the 80286 along with its high performance make for a rare combination indeed.

Moreover, the 80286 lets users take advantage of a large base of existing software. Underlying several new instructions aimed at streamlining high-level-language coding and operating system execution (see table 1) is the familiar instruction set of Intel's popular iAPX 86/88 (8086/8088) family. The 80286 is compatible with the software that exists for these other processors. As a result, users can now achieve an immediate increase in a system's performance simply by making design changes in the new 80286 hardware and using the existing software or the growing base of third-party software written for the 8086. Later, programs may be moved to run in a memory management and protection environment. Further system enhancements or completely new products can be produced with no hardware changes.

Many logic elements, and therefore many active devices such as transistors, are required to handle all the functions that the 80286 includes. The 8086 microprocessor contains approximately 29,000 transistors; the 80286, in comparison, contains 130,000.

Organized in Four Pipelined, Functional Units

In most microprocessors, a complete sequence of instruction fetching, decoding, and execution must take place before the next instruction can be fetched. In the 80286, these operations are carried out in parallel, resulting in an overall increase in performance without the use of faster memory chips, which would be needed if performance were enhanced simply by speeding up the clock rate.

Pipelined architecture permits the CPU to detect invalid op codes well in advance of their execution, another advantage. The 80286, for example, has time to perform the memory-protection functions without degrading the processing performance or restricting memory access.

Pipelining in the 80286 is separated into four logical units: bus, address, instruction, and execution.

The bus unit provides a demultiplexed bus interface between the processor, system memory, and external I/O subsystems. It monitors bus-cycle requests from other processors or the chip's own address unit, and when there is a pause, the bus unit's "prefetcher" grabs the next instruction and places it in a "code queue." Here, instructions are available for immediate access by the chip's instruction unit.

Text box continued on page 146

The VISUAL 100 video display terminal is 100% compatible with the DEC VT 100 terminal from identical software right down to the layout of the keys and the sculpturing of the keyboard.

But when it comes to ergonomics, the VISUAL 100 is something else! For example, the VISUAL 100 is designed in lightweight plastic that can easily be swiveled and tilted for maximum operator comfort. A detached, low profile keyboard, and 12" or 14" non-glare screen are just a few of the other human engineering advantages of the VISUAL 100.

The Advanced Video package and current loop interface that are optional with the DEC terminal are standard with the VISUAL 100. Plus we've added an optional Buffered Printer Interface with independent baud rate, independent parity and printer busy via "XON-XOFF" protocol. And although the VISUAL 100 is a step up from the DEC VT 100, it is priced a step below. Only \$1,345. Call or write for full details.

Service available in principal cities through Sorbus Service, Division of Management Assistance, Inc.

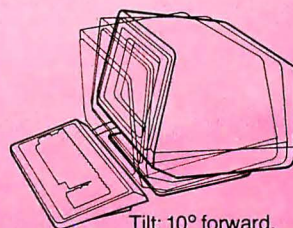

Tilt: 10° forward, 15° backward

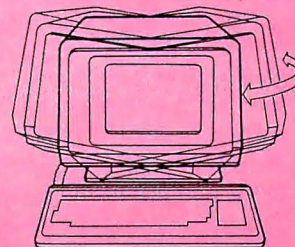

Swivel: 270°

VISUAL 100.

Combines VISUAL'S ergonomic excellence with DEC VT 100[®] performance.



\$1,345

VISUAL See for yourself

Visual Technology Incorporated
 540 Main Street, Tewksbury, MA 01876
 Telephone (617) 851-5000. Telex 951-539
 Circle 431 on Inquiry card.

Text box continued:

The instruction unit receives data at a rate of 1 byte per clock cycle, decodes and formats complete instructions, and places them in its "instruction queue" to await action by the execution unit.

The execution unit contains the CPU registers, the arithmetic and logic unit (ALU), and the microcode firmware for the CPU in read-only memory (ROM). Instructions are executed under the control of the ROM's internal micro-instruction sequence. When it nears completion of the sequence, the ROM signals the execution unit to take the next instruction out of the instruction queue. This treadmill-like process keeps the execution unit operating very efficiently.

Finally, the address unit performs the memory-management and protection function by translating virtual addresses to physical addresses and checking protection rights, all simultaneously. This unit maintains its own explicit cache containing all address mapping and protection information (base address, boundary limit, and the access rights) for the virtual-memory segments currently selected by the executing task. By storing this information in its own on-chip cache, the address unit does not need to retrieve it from memory-based address-translation tables. Therefore it can perform all functions in a single clock cycle.

By operating in parallel, these units enable the 80286 to manage virtual memory and protect the memory without degrading system throughput.

Memory and User Protection Via Tight Access Control

The 80286's memory-management and protection mechanism is an integral part of the architecture. It is physically integrated on the same silicon die as the rest of the CPU, so the protection of system and user code and data does not require extensive system software or add-on memory-management units (MMU). Such an approach has many advantages. It is more reliable, easier to implement, and faster. It also reduces software overhead.

The 80286 protects users from one another and the system software from its users. Each user has up to one gigabyte of virtual address space that may be split between shared and private use. Common data, files, and library routines are typically stored in shared space. Each user's private space is accessible only to him.

Each user's large virtual address space contains his "view" of the operating system. Because all users share the operating system, it is usually stored in the shared address space. Putting the operating system within the direct-address space of each user means that access to operating system routines is simpler and faster. Within each user's virtual-memory space are up to four hierarchical protection levels, so that even within his own space a user's application-program tasks can be guarded from improper access to the operating system.

The 80286's hardware supports this four-level protection hierarchy. Should a task attempt to access an address without right of access, the CPU will prevent it and then signal that a fault has occurred. In addition to providing more protection than usual, this architecture is more flexible and efficient than the typical two-level schemes minicomputers and other microprocessors use. It offers the user more flexibility, configurability, and reliability for the system software. These features are especially important for reprogrammable business and office systems applications, which will typically have many concurrent users.

Software Compatibility

Like the 80186, the 80286's instruction set is a superset of the 8086/8088 set, and its software is compatible with them. This provides a real upgrade path from the 8086 and 8088 to the 80286, and users can take advantage of the wealth of existing 8086/8088 software to get a jump on the development process. Current 8086 users will be able to enhance system performance immediately simply by changing the CPU subsystem hardware for the 80286. They can also modify their software to take advantage of the 80286's new instructions for further performance enhancements.

BTA MODEL 953B EPROM PROGRAMMER - \$359

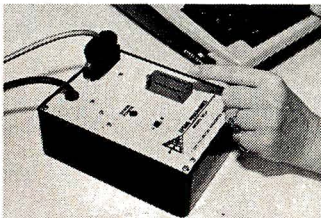

BAY TECHNICAL ASSOCIATES, Inc.

HWY. 603, P.O. BOX 387
BAY ST. LOUIS, MISSISSIPPI 39520
(601) 467-8231

- Programs 2508, 2758, 2516, 2716, 27C16, 2532, 2732, 2732A, 27C32, 2564, 2764, 27C64, MCM68766, 27128.
- RS-232, 3 line serial interface, Xon/Xoff format, DB-25 I/O connector.
- No personality modules - software control EPROM selection.
- Extended diagnostics.
- LED warning indicates power applied to EPROM socket.
- Supports Intel, Motorola, and Intel 8086 data formats as well as HEX data dump.
- Automatic baud rate selection.
- Textool zero insertion force socket.
- Available CP/M software.

- Model 953A, programs most 24 pin EPROMS.

Price - \$269.00

BHART

Computers for: Business, Home Applications, Resource Management, Technology & Science
 NEW: 15-Day Exchange Privilege (See "TERMS" for details)

Displayed and sold at our Showroom, 12210 Michigan Ave., Grand Terrace, CA:

MICRO-DECISION by Morrow Designs



Perfect desk-top computer:

- Z-80, 1 Floppy standard, 2nd optional, Optional terminal, or use your own.
- CP/M with user friendly "shell."
- WordStar, SpellChecker, SpreadSheet, Microsoft Basic-80 & BASIC. List \$1195 to \$1790, Limited Quantity CALL For Availability.

NEW: Now with double-sided double-density Floppies (800 KB storage), and with Data Base Management Software. CALL For Availability!

NEC APC



Extremely sophisticated graphics and color display (1024x1024 pixel) 16-bit (8086i), 128K standard, expandable to 256K. 1-2 8" Floppies 1 MEG each (run any CP/M program available on 8"). Detachable keyboard. Integral monitor (monochrome/color). Extensive software.

- H01 Monochrome, 1 Floppy List \$3298
- H02 Monochrome, 2 Floppies List \$3998
- H03 Color monitor, 2 Floppies List \$4998

CALL for appointment

3 GRAPHICS SYSTEMS:

NEC P-8800



Personal Computer System: Just Arrived:

All the flexibility one could ask for, in highest performance system! Z-80 standard, 8086 16-bit processor optional, ROM Basic (8/16 bit), Graphic RAM, 64 K user RAM standard, supports up to 256K. Both 5 1/4 and 8" floppies. Most sophisticated graphics include 3 individually-controlled windows; 640x200 pixel resolution, overall text & graphics, RGB or composite display, serial & parallel ports, cassette interface. LIMITED SUPPLY \$CALL!

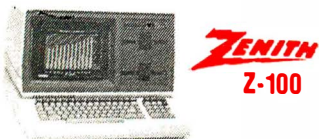

ZENITH Z-100

Advanced color graphics under Z-BASIC, 16 bit (8088) & 8-bit (8085) 128K RAM, expandable to 768K (Expand to 192K for only \$180). Runs most IBM-PC software and CP/M.

- ZF-100 128K RAM 8/16 bit, 1 floppy monochrome graphics LIST \$3,249 \$CALL
- ZF-110 Similar to above, but COLOR GRAPHICS, 2 floppies LIST \$3,999 \$CALL
- ZF-120 128K RAM, 8/16 bit, 2 floppies, monochrome graphics, integral display LIST \$4,099 \$CALL
- ZENITH Hard Disk \$CALL



TeleVideo 803

New, all the features of 802, PLUS: • Larger Screen: Nearly double the standard 12" video displays. Adjustable positioning standard! • High-resolution graphics under CP/M, (640 x 240 pixels) standard! • 16 programmable function keys standard! • And the best of all: Priced at \$1000 under the 802! With all these features, the new TeleVideo computer is an outstanding buy!!! List \$2495 \$ CALL For Availability!!!

IBM/APPLE PRODUCTS:

HARD DISKS & MICRODISKS: Your backup worries are 4.

- QCS Hard disk 6 MEG removable + 6 MEG fixed. List \$3,499. ONLY \$2,795
- CORONA Hard disk 5 MEG, mounts internally ONLY \$1,536
- 10 MEG ONLY \$1,919
- AMDEK 3" Micro-Floppy System, w/controller, 1 MEG total. List \$899 \$CALL

MEMORY & I/O BOARDS:

- QUADBOARD: clock, serial & parallel ports, 128K \$599
- QUADS12 + 64K + serial port \$369
- QUADS12 + 256K + serial port \$699
- QUADSCREEN Super-Monitor (166 col. x66 line) \$CALL
- QUADCOLOR for better color graphics \$CALL

MONITORS & PLOTTERS:



SMD Monitor: New, intermediate resolution, 8 colors, composite input, audio input and speaker built in superb display quality at price close to a comparable monochrome monitor! List \$449. ONLY \$339

- AMDEK 12" Amber \$159
- AMDEK COLOR II RGB, hi-resolution, 13" \$699
- AMDEK COLOR III RGB \$382
- ZENITH RGB high-resolution RGB \$524
- PRINCETON high-resolution 12" RGB \$CALL
- NEC 12" RGB high resolution \$CALL
- TYMAC printer-adapter f/APPLE \$89
- GRAPPLER \$129



SYSCOM-2:

Apple-Compatible Computer

Runs most software written for the 6502 (Apple II and the Franklin Ace). Many improvements engineered into this fine machine. Digital analog board is part of CPU rather than a separate component. High and low resolution graphics, both black and white and color, with video memory and sound, are all part of the computer. 48K, 52 keys, 16 colors. List \$869 \$CALL

SPECIALS OF THE MONTH!



SMITH-CORONA

TP-1:

AT OUR PRICE,
NO COMPUTER
SHOULD BE
WITHOUT ONE!

Daisy-wheel, letter-quality, interfaces all computers. Serial & parallel models at same low price. No less than 18 print-wheels—only \$6.95 each. List \$849 ONLY \$545!
SPECIAL, ONLY this month . . . \$527
 NEW: Tractor for TP-1,
 easy retro-fit. \$159

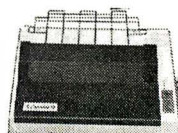

GEMINI-10 from Star-Micronics

All the features of EPSON-FT, plus backspace, continuous underline. List \$499 ONLY \$CALL!!!

**Special: New prices
TOO LOW TO ADVERTISE!**

GEMINI-15 similar but 15" carriage. Even better buy: List \$649 ONLY \$CALL!!!

Mannesmann-Tally MT-160I

No other printer can match all these features: serial AND parallel inputs **standard**, 160 cps **standard**, dot graphics **standard**, front-panel programming **standard**, heavy-duty construction. **TRACTOR INCLUDED** \$654
MT 160 L: all features of MT-160I plus LETTER-QUALITY printing at 50 cps.
Exceptional buy ONLY \$744



3-user Decision-1 computer by Morrow Designs:

MORROW DESIGNS

Z-80 based system allocates each user his own 64 K RAM partition (other multi-user systems support only 48 K partition/user). UNIX-derived operating system also emulates CP/M for broad software compatibility. Included with system: MICRONIX Operating System, CP/M, WordStar, Spell-Checker, LogiCalc, MicroSoft BASIC-80, BAZIC, Personal Pearl Data Base. Supports up to 15 users! System w/ 256K RAM, 16 MByte Hard Disk, 1 5 1/4 Floppy (8" optional), Clock, Interrupt Controller & Centronix port. Accounting, Inventory, Data Base Management software optional. List \$7395 \$CALL

COMPLETE TELEVIDEO MULTI-USER SYSTEM:

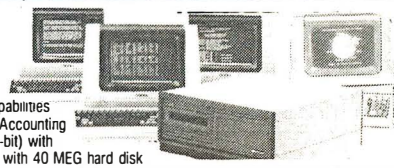

Multiple workstations with independent capabilities and tasks: 3 inventory control stations, 2 Accounting Office Stations, 1 Management station (16-bit) with graphics capability, TeleVideo TS-816 CPU with 40 MEG hard disk and tape backup. Complete accounting, inventory control, financial management and business graphics programs, operating under Turbo-Dos w/file & record lockout for uninterrupted multi-user service. 1 high-speed dot-matrix printer and 1 letter-quality printer, receive/auto-dial modem. Complete integration included.

List \$29,395 CALL FOR INFORMATION

COLUMBIA

IBM-COMPATIBLE COMPUTER:



COLUMBIA 1600 16-bit 8088, accepts all IBM boards, reads & runs all IBM software, but has also additional Z-80 processor to run 8-bit CP/M. So compatible it can even use IBM keyboard! 128K, 1 parallel & serial ports standard, 8 expansion slots! COLUMBIA 1600 package: computer as above + keyboard + CRT controller. List \$3,635 \$CALL

INTERFACES & MODEMS, ETC.

- Hayes Modems:
- SmartModem 300 \$214
- SmartModem 1200 \$523
- MicroModem II \$269
- MicroModem 100(S-100) \$289
- VENTEL RS-232 Modem \$763
- MICROFAZER printer buffer \$139
- INTERFAZER f/multi-users, up to 8 terminals & 2 printers! \$239

DOT-MATRIX PRINTERS:

- NEC-8023A (parallel) \$459
- AXIOM 80 col. 30cps, graph. p. \$289
- Okidata 82A (ser/parallel) \$CALL
- Okidata 83A 132 col. (s/p) \$649
- Okidata 84-P 200 cps, & 50 cps. \$994
- correspondence mode \$1099
- Okidata 84-S same, but serial \$1099
- Okidata 92, just released \$CALL
- IDS Microprint: serial and parallel inputs, two printing speeds and printing grades: Draft/Correspondence \$529

Letter-quality printers:

- NEC 3510 33cps serial \$1449
- NEC 3530 same, parallel \$1599
- NEC 7710/30 55cps, s/p \$2194
- DIABLO 620 25cps, ser \$1094
- BROTHER HR-1 \$794
- DAISY WRITER, 16K Buffer \$999
- QUME NEWSPRINT II 40 cps LIST \$1681 \$CALL

NEW: COD 15-Day Exchange Privilege (subject to terms below)

ORDERS & INFORMATION:

Member, Better Business Bureau

Mo.-Fri. 9:00 AM-5:30 PM PST, Sat. 12:00 AM-5:00 PM PST

1-(800) 845-5555 CA, AK, HI call (714) 783-1363 TELEX: 472-0127 ATTN: EMD

BANK REFERENCE: BARCLAYS BANK OF CALIFORNIA (213) 892-7244



AMERICAN EXPRESS, VISA, MASTERCARD
 APO, FPO, INTERNATIONAL ORDERS ACCEPTED



INC. P.O. Box 3791, Riverside, CA 92519

TERMS: Prices in this ad apply to prepaid orders only, reflect 5% cash discount off our regular sale prices. Personal checks allow 2 weeks to clear. Fortune-1000 companies, Universities and Government only: 30-day net, based on our regular (non-cash) prices. COD based on non-cash prices and requires payment in full by Cashier's Check or Certified Check upon delivery. California residents add 6% tax. This ad supersedes all prior offers. Prices subject to change and offers may be withdrawn without prior notice. All merchandise new in original factory cartons, carry full manufacturer's warranty, and are covered by full insurance during shipping. Absolutely no return on used or damaged items. Software returnable ONLY in UNOPENED original wrapping. We now offer 15-DAY EXCHANGE PRIVILEGE, subject to 10% restocking charge on returned merchandise, and excluding special order items. Add 3% for Handling, Shipping & Insurance (\$3.95 minimum).

CP/M is a registered trademark of Digital Research. Microsoft MultiPlan are trademarks of Microsoft Corp. CYMA is trademark of CYMA Corp., TurboDOS is trademark of Software 2000. Z80A is registered trademark of Zilog Inc. WordStar, SpellStar, CalcStar DataStar, MailMerge are trademarks of MicroPro Company. APPLE is trademark of Apple Computer Inc.

GET FULL VALUE FROM YOUR VICTOR 9000™

with the UCSD p-SYSTEM™ IV.1

Get the most from your VICTOR 9000 as well as from your software development efforts. The power and portability of the UCSD p-System is available for the VICTOR 9000 from TDI.

The Standard Development System Includes:

- Full Screen Editor, Filer, Assembler and other Utilities
- The UCSD Pascal Compiler
- Native Code Generator
- Ram Disk Support Above 128K
- Turtlegraphics—full use of VICTOR screen (800 x 400)
- Complete documentation

Options:

- Fortran 77 and Basic compilers
- Hard disk support



TDI SYSTEMS, INC
620 HUNGERFORD DR.
ROCKVILLE, MD 20850
(301) 340-8700

TDI LIMITED
29 ALMA VALE RD.
BRISTOL, U.K. BS8 2HL
0272 742 796

VICTOR 9000 is a trademark of VICTOR TECHNOLOGIES, INC.
UCSD p-SYSTEM and UCSD PASCAL are trademarks of the Regents of the University of California



**NEW
HARD
DISK
SUPPORT**

Text continued:

the interrupt control register. The controller resolves simultaneous requests based on predefined priorities. The higher-priority interrupt will cause servicing to cease on a lower one. Interrupt control can be expanded externally by cascading 8259A programmable interrupt control chips or 80130s to the 80186 via dual-function interrupt pins provided for that configuration. Five external interrupt input pins—four plus non-maskable interrupt (NMI) input—can be programmed to respond to either levels or edges.

Chip-Select and Ready Functions

All CPU subsystems must interface with an array of memory and peripheral chips. In other typical microcomputer systems, external random logic or VLSI components must be used to translate microprocessor output states into appropriate memory or peripheral chip-select signals. Because the 80186 has built-in chip-select generation circuitry, in many cases no additional external logic is needed to interface with memory I/O subsystems.

Users can program in a selection of wait states (0 to 3 states) to accommodate memory or peripheral chips with a variety of access-time characteristics. Where the 80186's internal wait-state selections are not sufficiently long, external wait-state generators can be ORed to the internal "read" circuitry.

Memory can be divided into three separate sections—upper, middle, and lower. The upper- and lower-memory sections are selected by a single select line. The middle-memory section is selected by four select lines, so it can be further divided into four equally sized subsections. Memory-block sizes may be programmed for 2K, 4K, 8K, 16K, 64K, or 128K bytes. The upper and lower sections can be programmed for those sizes as well as for 1K and 256K bytes. Thus if sixteen 64K by 1-bit chips are used in the upper segment, that select line would be programmed for 128K bytes.

Peripherals are selected by as many as 7 signal lines. Each line is active for

The Serious Game Design Tool For The Serious Designer At The Price Of A Toy For The Hobbyist

The Game Cartridge Development System for the Atari® 2600 Video Computer System™ Optional: Atari 5200 Supersystem Adapter Package.

Features Include:
Real-time development
No machine modification
Apple II® 48K/ one disk drive required.

Now Only \$495
Call today to order
408-429-1551
All major credit cards accepted.

For high profit rewards, purchase the tool that can do the job at an unbeatable price.



The FROB-26™

frobo

A Division of Tri-comp Polytechnical, Inc.
P.O. Box 8378, Santa Cruz, CA 95061
408-429-1551
The Miracle of Creation Can Be Yours™

Atari and Apple are registered trademarks of Atari, Inc. and Apple Computer, Inc., respectively. Video Computer System is a trademark of Atari, Inc.



a 128-byte memory segment (the peripheral block). As many as 7 of these segments can be grouped contiguously, and the entire 996-byte set of blocks may be located on any 1K-byte boundary. Two control registers, the base address register (PACS) and the mode register (MPCS), govern the function of the peripheral select lines.

Users can select 5 or 7 lines. The 5-line mode is convenient for 8-bit peripherals because the remaining 2 lines can be used as latches for the A₁ and A₂ address lines. That way, the 80186 can treat the address lines as if they were 16-bit peripherals located on even-address boundaries. Then no external logic or compensatory software routines are necessary.

Direct Memory Access Support

When blocks of data are to be moved from one memory location to another, or from memory to an I/O device, or even from one I/O device to another, it is inefficient for the CPU to handle this data 1 byte or word at a time. DMA makes these kinds of transfers much more efficient by limiting the CPU's involvement. The 80186 supports two such DMA channels, each capable of transferring data at a rate of 2 megabytes per second.

Each DMA channel maintains two 20-bit source and destination hardware pointers that can be incremented or decremented after each data transfer. Each transfer typically consumes only two bus cycles, one to fetch the data and the other to store it in its new location.

Each channel is associated with a control register that specifies word or byte transfers and states whether an interrupt must be generated upon completion. The control register also specifies automatic incrementing (or decrementing) of source or destination registers, the channel priority, and the starting and stopping of the transfer itself.

Programmable Counter/Timers

Many microcomputer applications depend on timing or counting external events, generating nonrepetitive waveforms, and combinations of

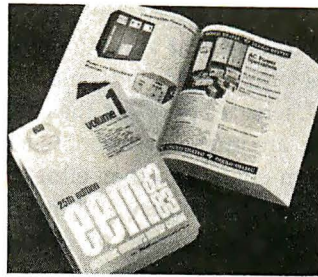

EEM. A MUST FOR EVERY COMPUTER LIBRARY.

The 1982-83 EEM/Electronic Engineers Master is the world's largest electronics catalog. Over 4,500 pages. Two giant volumes filled with detailed technical data and specifications on products from almost 1000 manufacturers. Components. Connectors. Capacitors. Power Supplies. Whatever you need you'll find in EEM. A complete sales directory and handy selection guide make ordering products fast and easy. Over 100,000 copies of EEM are distributed worldwide. To get yours, fill out the order form below. And, for a limited time, save over 50% off the regular price.

If you're not totally satisfied, return EEM within 30 days for a full refund.

Yes! I want the 1982-83 EEM at over 50% off the regular price.

A check/money order for \$29.95 is enclosed. EEM will pay all sales tax and shipping charges (U.S. only).

Charge \$29.95 to my: MasterCard Visa

Name _____

Address _____

City _____ State _____ Zip _____

Credit Card No. _____ Exp. Date. _____

Signature _____

Mail to: EEM (Hearst/UTP), 645 Stewart Avenue, Garden City, NY 11530

Please allow 30 days for delivery.

BY43

JANUS Ada

!!Thank You!!

We have received an overwhelming response to our introductory demo package offer and would like to say thanks to all our satisfied customers.

Take a sample ride with our hottest product before you make your choice. Our demo package allows you to experience the power of JANUS/Ada.

JANUS/Ada is a subset implementation of Ada that includes many features not found in any other micro-processor programming language. These include true modular programming, full error messages in English, error walk-backs, and re-entrant initialized variables. These and more features are described in greater detail in our informative brochure.

Take up to 30 days to experience the power of JANUS/Ada. Make sure it does what you want. Then if you find it isn't right for you, send it back and we'll return your money, no questions asked. But we're sure you'll want the complete package after experiencing part of the power of JANUS/Ada. Best of all, you still can buy our demo package for \$50.00.

Information

Call, write or circle our reader service number to receive our informative brochure.

Ordering

Please specify your microcomputer, CPU, disk format and operating system.

JANUS/Ada Demo Disk and Manual

Contains evaluation compiler, linker and example programs.

Available on 8" MS-DOS, 8" CP/M[®], Apple softcard and IBM-PC \$50.00
\$50.00 can be applied to full JANUS/Ada package.

JANUS/Ada Package

Contains complete compiler, linker, assembler, example programs, manual and more

Prices from \$300
Available on most disk formats. Call for your system price.

The language that is based on the past but looks to the uses of the future.

RR SOFTWARE

CP/M, CP/M-86, MP/M-86 are trademarks of Digital Research, Inc. MS-DOS is a trademark of Microsoft. Apple Softcard is a trademark of Microsoft, Inc. ADA is a trademark of the U.S. Department of Defense. ©Copyright 1983 RR Software

specialists in state of the art programming

P.O. BOX 1512 MADISON, WISCONSIN 53701

(608) 244-6436

counting and timing. To meet these needs, CPU subsystems commonly have one or more timer/counters implemented with external circuitry. The 80186's three timer/counters eliminate the need for the external circuits.

Two of the 80186's 16-bit timer/counters are designed to interface to external circuits, and the third is for internal operations. All three have several programmable options that are selected by a set of three 16-bit control registers. In addition, each timer has its own maximum-count register (timers 0 and 1 have two).

Each timer/counter can be programmed to halt or continue when it reaches the specified maximum count. Users can program the counter to issue an interrupt upon reaching maximum count and then either continue or reset and then continue. The various functions are programmed via the mode-control register.

On-Chip System Clock

An on-chip system clock is implemented by a crystal oscillator and divide-by-two logic. By connecting a 16-MHz crystal to the external pins, an 8-MHz system clock signal is pro-

duced. This signal is used internally to control the synchronous execution of instructions and operations. One of the 80186 pins provides an external clock signal and can be used to synchronize external circuits to the internal clock.

Interface with Support Chips

The 80186 interfaces with Intel's full line of peripheral control components. Like the 8086, the 80186 communicates with and controls those components via the system bus. The 80186 emits the same local bus handshake signals as the 8086.

Memory control, data communication, and display control components as well as VLSI controllers are available for the graphics display, disk drive, and keyboard interface. Controllers for the serial and parallel, asynchronous and synchronous data-communications protocols are also available.

Systems integrators can choose from several operating systems, among them iRMX-86, CP/M-86, and MS-DOS. Compatible operating system software for the above is available from Intel for the 8086, 8088, and 80186.

Many applications programs have been written for 8086- and 8088-based systems. The list is growing significantly as a result of IBM's introduction of the 8088-based Personal Computer.

For users who already have developed software for their 8086- or 8088-based machines, the 80186 offers an additional advantage: programs written for the 8086 and 8088 will run on the 80186 without modification. The 10 new instructions can replace longer subroutines, making programs more compact.

Conclusion

The 80186 replaces as many as 20 chips in an 8/16-bit microcomputer at about half the cost of the 8086/8088 kit of parts. It also has twice the capability of the standard 8086/8088 running at the standard 5-MHz clock rate. The 80186 will pave the way for the next generation of microcomputers to be both less expensive and more powerful. ■



EXPOTEK

2723 W. Windrose Suite 3
Phoenix, Arizona 85029

1-800-528-8960

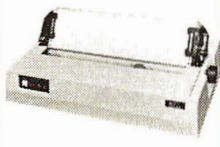

All Prices Subject To Change

COMPUTERS	PRINTERS
<p style="text-align: center; margin: 0;">ATARI</p> <p>1200 — \$645 800-48K — \$499 410 — \$77 810 — \$429 830 — \$155 850 — \$159</p> <p style="text-align: center; margin: 0;">ALTOS</p> <p>5-15D — \$2120 5-5D — \$4100</p> <p style="text-align: center; margin: 0;">NORTHSTAR</p> <p>Advantage—\$2600 Horizon 64QD—\$2600</p> <p style="text-align: center; margin: 0;">TELEVIDEO</p> <p>802 — \$2599 802H — \$4450 806 — \$4950 800A — \$1250</p> <p style="text-align: center; margin: 0;">APPLE-LOOK-A-LIKE CALL</p>	<p style="text-align: center; margin: 0;">OKIDATA</p> <p>M80 — \$305 M83A — \$639 M82A — \$399 w/Tractor & Grap. \$479 M84P — \$978 M84S — \$CALL</p> <p style="text-align: center; margin: 0;">ANADEX</p> <p>9500A — \$1290 9501A — \$1290</p> <p style="text-align: center; margin: 0;">CITOH</p> <p>F-10P — \$1370 F-10S — \$1375 1550P — \$659 Prowriter 1550CD — \$709 8510AP — \$459 8510ACD — \$550</p> <p style="text-align: center; margin: 0;">DATASOUTH</p> <p>DS120 — \$595 DS180 — \$1175</p> <p style="text-align: center; margin: 0;">DIABLO</p> <p>630RO — \$1945 620 — \$900</p> <p style="text-align: center; margin: 0;">NEC</p> <p>8023 — \$450 7710 — \$2099 3510 — \$1499 3550 — \$1925</p> <p style="text-align: center; margin: 0;">TI</p> <p>810 — \$1240 820 — \$1795</p>
APPLE CARDS	TERMINALS
<p>16K RAM — \$78 Z80 CARD — \$245 Videx Card — \$227 Smart Term — \$279 Microsoft Prem. Pk — \$489</p>	<p style="text-align: center; margin: 0;">ADDS</p> <p>A1 — \$485 Viewpoint A3 — \$510</p> <p style="text-align: center; margin: 0;">HAZELTINE</p> <p>1500 — \$995 ESPRIT — \$498</p> <p style="text-align: center; margin: 0;">TELEVIDEO</p> <p>910 — \$569 925 — \$718 920 — \$735 950 — \$899</p> <p style="text-align: center; margin: 0;">ZENITH</p> <p>Z19 — \$689 Z89 — \$2129</p>
SOFTWARE	MONITORS
<p>Apple All Major Brands — \$CALL Wordstar — \$299 Datastar — \$180 Calcstar — \$100 Spellstar — \$165</p>	<p>Amdek 300 — \$140 Color I — \$300 Amdek Color II — \$645 Color III — \$385 BMC Green — \$85 USI Amber — \$159</p>
DISK DRIVE	COMPUTER IC'S COMPLETE LINE
<p>Microsci Apple Dr. — \$300 Rana Elite I — \$300 IRana Elite II — \$450 Rana Elite III — \$550</p>	<p>SPECIAL 4164 (150ns) \$9.50ea.</p>
MODEMS	DISKETTES/BOXES
<p>HAYS — MICROMODEM — \$285 HAYS — SMARTMODEM — \$210 HAYS — 1200 Baud — \$530</p>	<p>Elephant — \$20 Scotch — \$25 Dysan — \$35</p>
GUARANTEED LOW PRICES	Customer Service 602-863-0759

"Where can I get a full-featured printer that's fast and letter-perfect every time? I didn't think I could until I got Daisy Systems' M45."

"I needed quality printers for my company's IBM systems. Until I found Daisy's M45, I thought we'd spend a fortune."

"All of the different computers in our offices run with Daisy's M45. Where else could we get that kind of versatility?"

"My department is responsible for generating output for five separate divisions. When they need it, I can count on Daisy."

"I'm a microcomputer dealer and when I found that Daisy Systems had an inexpensive printer for my personal computer, my customers began asking for it."



ONE FOR ALL.™

The World's Most Versatile Daisywheel Printer.

There's never been a printer to match the versatility, low-cost, speed and reliability of our new Daisy M45. Its got innovative features that most printer makers talk about but few produce.

Take its simple-to-change interface unit that allows the M45 to be easily plugged into literally any computer system.

Or its "Long Life" hammer that not only improves print quality but guarantees it for hundreds of million strikes.

With 35% fewer parts than conventional printers, Daisy's solid, proven durability gives you unmatched reliability.

Talk to a Daisy owner — better yet see one at your local dealer. We think you'll be duly impressed with Daisy's good looks. And you'll find it surprisingly practical to own.

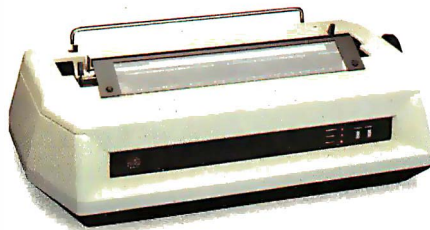

Dealer inquiries welcome.

A Trademark of Daisy Systems Holland BV

Introductory Offer

- I am interested in top value letter-quality printers, send info now.
- I am interested in a Daisy dealership, send info now.

Name _____

Company _____

Address _____

City/State/Zip _____

Phone _____

Daisy Systems Holland BV
Nieuweweg 279, P.O. Box 125
6600 AC Wijchen, The Netherlands
Phone 011-31-(8894)-18170, Telex 48281

An **AES** Company Manufactured in Holland

See us at Comdex/Spring booths 3226-3228.

Circle 463 on inquiry card.

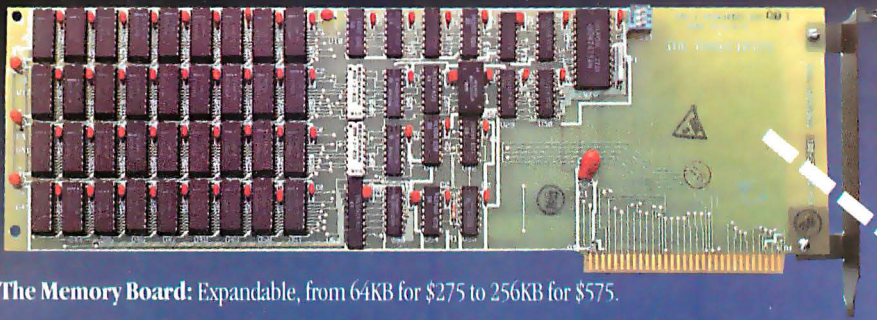

The Memory Board: Expandable, from 64KB for \$275 to 256KB for \$575.

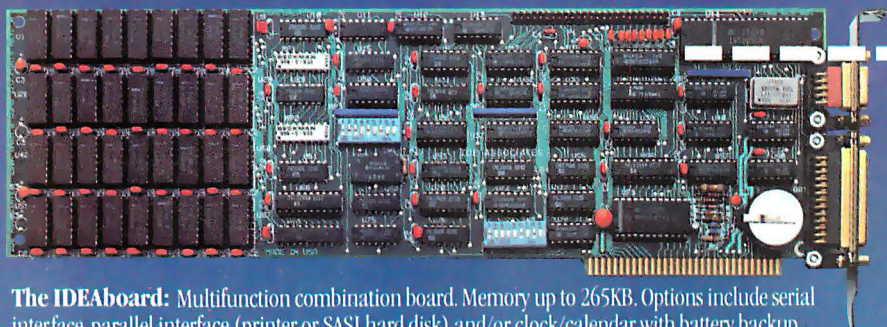

The IDEBoard: Multifunction combination board. Memory up to 265KB. Options include serial interface, parallel interface (printer or SASI hard disk) and/or clock/calendar with battery backup. Prices range from \$350 for 64KB with 1 option to \$725 for 256KB with 3 options.

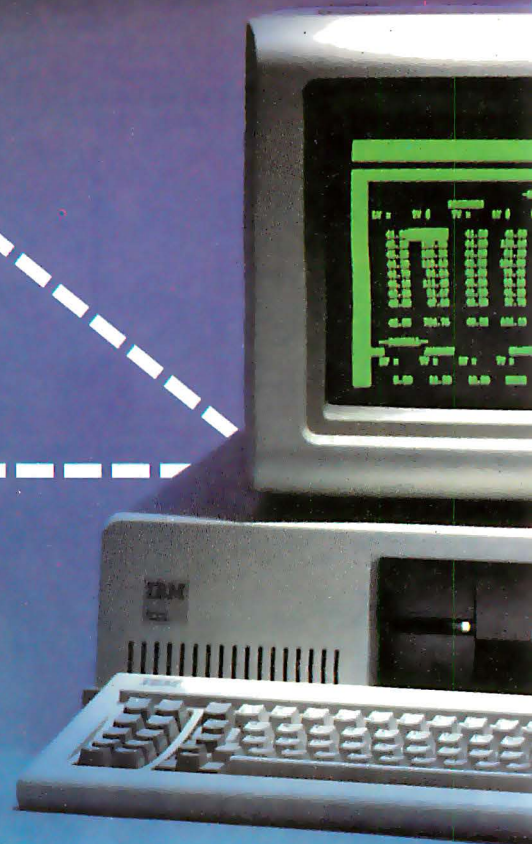

Five better ideas from IDE for expanding your IBM PC.

We think the IBM Personal Computer is the best on the market. That's why we've concentrated our efforts on making add-ons strictly for the IBM PC.

We have ideas that can make your IBM PC even better. And more affordable.

Granted, those are ambitious goals. Goals that take quite a bit of imagination – and nerve – to reach.

And at IDE, we think we have the ideas it takes.

Better Idea No. 1: Innovative products.

We're leaders, not followers. IDE was first with a Combination

Board for the IBM PC that includes a Winchester disk drive interface. On the board itself.

We were the first to let you cable both serial *and* parallel interfaces from the back of the board. Without any troublesome jury rigging, without wasting expansion slots, and with the unit's protective cover in place.

And the innovations don't stop there. Removable Winchester disk drives. Expandable memory boards. Printer spooler software. Disk emulation software. A broad array of products...with still more to come.

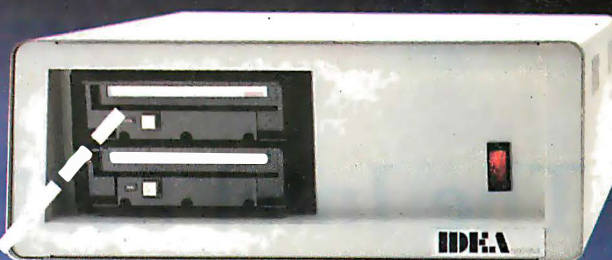

The IDEAdisk: Winchester disk drives, in-chassis or self-contained external mount, fixed or removable cartridge. From \$1450 to \$1700. Special offer: 10MB (5+5) external mount from \$2700 to \$2800.

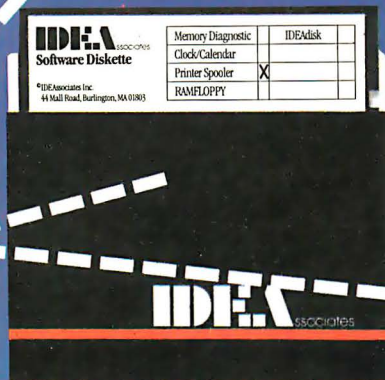

IDEAware: Printer Spooler software \$60.

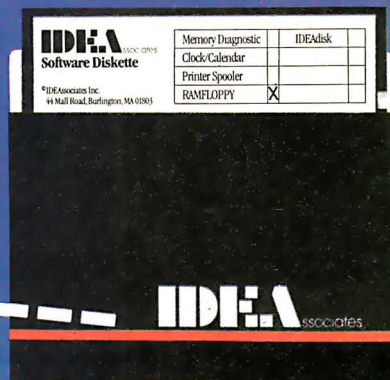

RAMFLOPPY disk emulation software \$60.

Better Idea No. 2: One year warranty.

We believe in the quality of our products. We buy only burnt-in components; we do extensive burn-in ourselves; and we customize final testing to match customers' configurations.

That's why we offer a full year warranty with all IDE products. 365 days. Not 90.

And we back it up with full software support and diagnostics, including software updates as necessary.

Better Idea No. 3: Unique upgrade policy.

When you buy any IDE product, you buy only the options you want. So you never have to pay for something you don't need.

Then you can add extras as you need them.

Take our boards, for example. For one year, you can trade up a board for one with more memory and/or options for the price differential plus \$25. In fact, you can trade up any IDE product for anything else in our product line the same way.

And that's unique.

Better Idea No. 4: Service that really delivers.

Our products are available through IDE dealers and representatives around the country. And our network is growing quickly.

We offer free installation in the metropolitan areas listed below, and our retailers will install any of our products for you right in the store.

If you'd rather do it yourself, we provide every IDE product

with all the documentation you need to perform the installation yourself. In minutes.

Better Idea No. 5: High value; low price.

Since our products are made strictly for the IBM PC, we can concentrate our efforts. Run our company more efficiently. And keep costs down.

But keeping costs down isn't enough for us. We pursue an aggressive pricing policy, too. Because we believe that by selling more add-ons at lower prices, we will become a leader in the industry. Our ideas will see to that.

You'll find all of IDE's better ideas on display at the fine retailers shown below.

If you don't see one for your area, call us toll-free. The list is growing all the time, and we'll give you the name of a dealer near you. Or take your order directly by phone.

And remember: when you think of expanding your IBM PC, think of IDE first. We have five great ideas for you.

1-800-257-5027

(In Massachusetts call 617 272-7360)

IDEAssociates

Better ideas for personal computers.

44 Mall Road, Burlington, MA 01803

Circle 194 on inquiry card.

IDE Dealers: Florida: Suncoast Forms & Systems, Sarasota □ Iowa: ComputerLand, Des Moines □ Kansas: CompuType, Manhattan □ Massachusetts: Arby Corporation, Cambridge □ Michigan: BCS Inc., Canton; The Computer Workshop, Houghton; MCS Inc., Okemos □ Minnesota: Computer Depot/Daytons Computer Centers, Minneapolis, St. Paul, Burnsville Center, Ridgedale, Rosedale, Southdale □ Nebraska: ComputerLand, Lincoln; ComputerLand, Omaha □ New Jersey: Peripheral Engineering Co., Marlton □ Oklahoma: Micro-Com Systems, Tonkawa □ Tennessee: Campus Computer Corp., Nashville □ Wisconsin: LaCrosse Computer Systems, LaCrosse □ **IDE Representatives** in: Boston, New York, Philadelphia, Washington, D.C., Atlanta, Houston, Chicago, Los Angeles.

The Intel 8087 Numerics Processor Extension

This chip lets you perform mathematical operations with 18-decimal digits of accuracy.

R. B. Simington
Intel Corporation
27 Industrial Ave.
Chelmsford, MA 01824

So you have a shiny new 8086/8088-based microcomputer and you want to write some accounting software that will meet the requirements of the fussiest CPA. Or perhaps you want to write some code to control your latest robotics experiment and you need to do some critical number-crunching with very accurate results. Let me introduce you to the Intel 8087 Numerics Processor Extension (NPX).

The 8087 NPX is a chip that will give you, regardless of your mathematical skill, the ability to write code that will perform mathematical operations with guaranteed accuracy of 18-decimal digits. To make things even easier, the NPX, known as a coprocessor, is easy to interface to a host processor (8086 or 8088). When you add an NPX to one of its host processors, you have a Numeric Data Processor (NDP).

Registers

The 8087, due to its special status as a coprocessor, combines with the

About the Author

Bob Simington is a curriculum developer for Intel's customer training department. He is responsible for the development of all microprocessor training curricula. His most recent assignment was to develop a course based on 16-bit personal computers.

architecture of the host processor to produce a processor that contains all the capabilities of an 8086 or 8088 plus a register stack of eight 80-bit registers, as shown in figure 1. The NDP also brings the ability to execute a set of 68 new floating-point-arithmetic instructions in addition to the extensive instruction set of the host alone. These 80-bit registers hold all the operands for the floating-point operations in a format called Tem-

porary Real, which is capable of representing any whole number up to 2^{64} exactly. This 80-bit format is accurate enough to guarantee 18-decimal-digit accuracy.

You can think of the eight registers of the 8087 as a standard register set or use them as a classical stack. This arrangement allows you a great amount of flexibility in using these storage areas. You can use the registers as a stack, for example, to

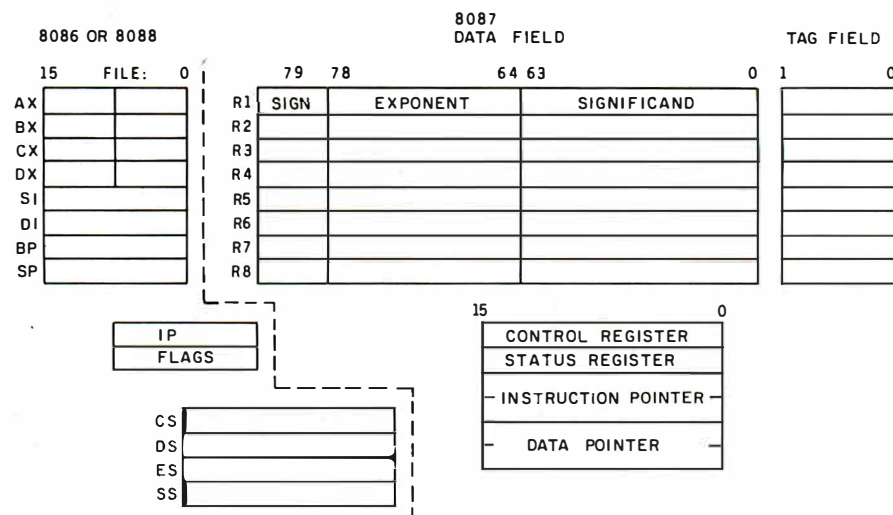

Figure 1: The NDP register set of eight 80-bit registers.

Interested in the Computational Power of the amazing National Semiconductor 16032?

LMC is. That's why we've been developing a new family of "mega-microcomputers" built around this remarkable state-of-the-art processor. The 16032 internally is a 32-bit microprocessor providing unrivalled performance. Systems using the 16032 outperform the previous generation of microcomputers and many minicomputers as well. In addition to the larger word size, the NS 16000 family includes a floating-point unit (a standard feature on LMC's soon-to-be-available 16032-based systems) that performs 64-bit hardware multiply/divide. With a floating-point chip, the NS 16032 does 161,000 64-bit (double precision) floating point multiplications per second. But, most importantly, the 16032 is the first microprocessor to incorporate hardware virtual memory. Virtual memory allows less-expensive off-board memory to appear as fast on-board memory - as a result, each user has a vast amount of fast memory available (at low cost) and very large programs can be handled with ease (including many that previously could not run economically on microcomputers). For example, a virtual system allows each user to compute as if he had 16 megabytes of program space and 16 megabytes of data space even if the hardware configuration has very little "true" RAM.

We regard the 16032 as the most important technological advance in microcomputing since 16-bit processors first became available over three years ago. Because this advertisement goes to press early in February and (as we have explained) because it is a corporate policy of LMC never to claim that a new product has "arrived" or is "available" until we have completely debugged it, fully tested it and have it available for immediate delivery, we cannot announce full production and current availability of our 16032 systems. We have, however, tested our first 16032 systems and by the time you read this advertisement, we believe we will have systems available for demonstration and perhaps even for delivery. And, because National made cross-compilers available to systems software developers over a year ago, many languages already have been developed for the 16032 processor. For example, UNIX (with Berkeley 4.2 enhancements to take advantage of the 16032's demand-paged virtual memory), C, FORTRAN and PL/1 already are available.

Of course, our high-performance 16-bit microcomputers (built around the Motorola 68000 and Zilog Z-8000 microprocessors) are available immediately and are ideal for many applications.

If you are interested in state-of-the-art microcomputers (16 or 32-bit), call or write us for information.



**The Logical
Alternative**

The Logical MicroComputer Company

140 South Dearborn, Chicago, Illinois 60603 USA, 312.580.0250, Telex: Lexecomp

All of LMC's equipment is protected by a limited one-year warranty. Service contracts are available as is factory service at an hourly rate. In fact, if a customer purchases our special-service feature, we will ship a replacement system anywhere in the free

world within 24 hours of a hardware failure (at our expense). This means that for most customers we can guarantee delivery of a replacement system within one day. Call or write us for detailed information.

HIGH RESOLUTION GRAPHICS

FOR SUPERBRAIN, COMPUSTAR, Z-89 & TRS-80 MODEL II.

XCEL™ HARDWARE: A retrofit package for graphics display with 512 x 240 resolution. TRS-80 Mod. II, \$595. All others, \$895.

XCEL™ SOFTWARE: Operates under CPM™ and is compatible with Basic, Fortran, Cobol, PLI and Pascal.



SYMBOL GENERATOR- \$175

Alternate character sets with bold face, 90° rotation, circles, quadrants, vectors, rectangles and area fills.



GRAPH PLOTTER- \$175

Line, graph, histogram, bar graph and scatter plot with automatic annotation of axes scaling.

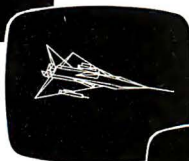

3-D GENERATOR- \$345

Creating, editing and viewing "wireframe" objects from any angle with scaling zoom and graphics editor.

GRAPHICS TERMINAL- \$395

Configures computer as a low cost graphics terminal.

"NEW" SCREEN PRINTER-\$65

Allows hard copy printout on most dot matrix printers.



SURFACE PLOTTER- \$395

True perspective view, with hidden line removal.

SAVE UP TO \$950 ON PACKAGE PRICE OFFERS!

FOR MORE INFORMATION CALL (213) 320-6604



MAXTEK, INC. 2908 Oregon Court, Torrance, CA 90503

Available in Europe from Micronex Ltd., Chew Magna, England 3042 (STD 027-589 3042)

TRS-80 registered trademark Tandy Corp. Superbrain trademark Interlec Data Systems
TextiOnix registered trademark TextiOnix inc CPM registered trademark Digital Research

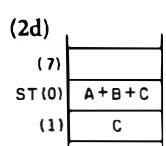
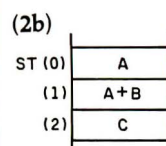
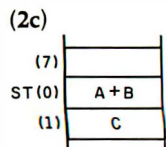
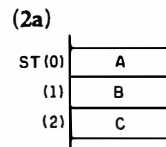

Figure 2: The effects of instructions on the register stack.

pass operands to a floating-point subroutine that expects to find its parameters in the 8087 register stack. The instruction set of the 8087 exploits this capability by allowing assembly-language instructions that use the stack top as one of the operands implicitly.

You can also treat these registers as a standard register set; the instruction set supports this use of the registers by allowing both operands to be specified explicitly for an operation. Look at the example in figure 2.

Your NPX stack contains the values A, B, and C, as shown in figure 2a. You can cause the value in the stack top to be added to the value in the next stack element (ST(1)), as shown in figure 2b, and then have the stack popped, so that the sum is the new stack top, as shown in figure 2c, with the one instruction FADD. This is the classical stack operation where none of the operands are specified. The same instruction could have been specified explicitly with the instruction FADD ST(1),ST.

As another example, you could add the value that is in ST(1) to the value in the stack top and retain both values, as shown in figure 2d, with the instruction FADD ST,ST(1). All registers are addressed with respect to the current stack top. The Status Word of the 8087 contains a field that identifies the current stack-top status at all times.

Status Word

The Status Word, as its name implies, reflects the status of the NDP at

ATTENTION!
• PROFESSIONALS
• SMALL BUSINESS
• MANAGERS

FAST FILE

PERSONAL COMPUTER APPLICATIONS

On Your  PC

FAST FILE is a unique system for use on your IBM PC. **FAST FILE** meets a variety of user requirements through the application "generator" concept. A simple interactive dialog is used to define data dictionaries for each new application system you require. Using the dictionary **FAST FILE** automatically generates a completely integrated system of application programs providing:

- Full Screen Menus
- Indexed File Inquiry
- Report Writer
- File Maintenance
- Password Protection
- Easy to Use Documentation

FAST FILE runs on the IBM PC with a minimum of two single sided Floppy Disks and at least 128K of memory running DOS.

With **FAST FILE** you can create applications for:

- Inventory and Distribution
- Financial Planning
- Information Tracking
- List Maintenance
- Data Communication
- Calendar Management
- Sales Analysis

DHD, INC.
(703) 556-0950
1945 GALLOWES ROAD
VIENNA, VA 22180

A product of International Computer Consulting Services
IBM PC and the IBM logo are trademarks of International Business Machines Corp.

OCTOPUS

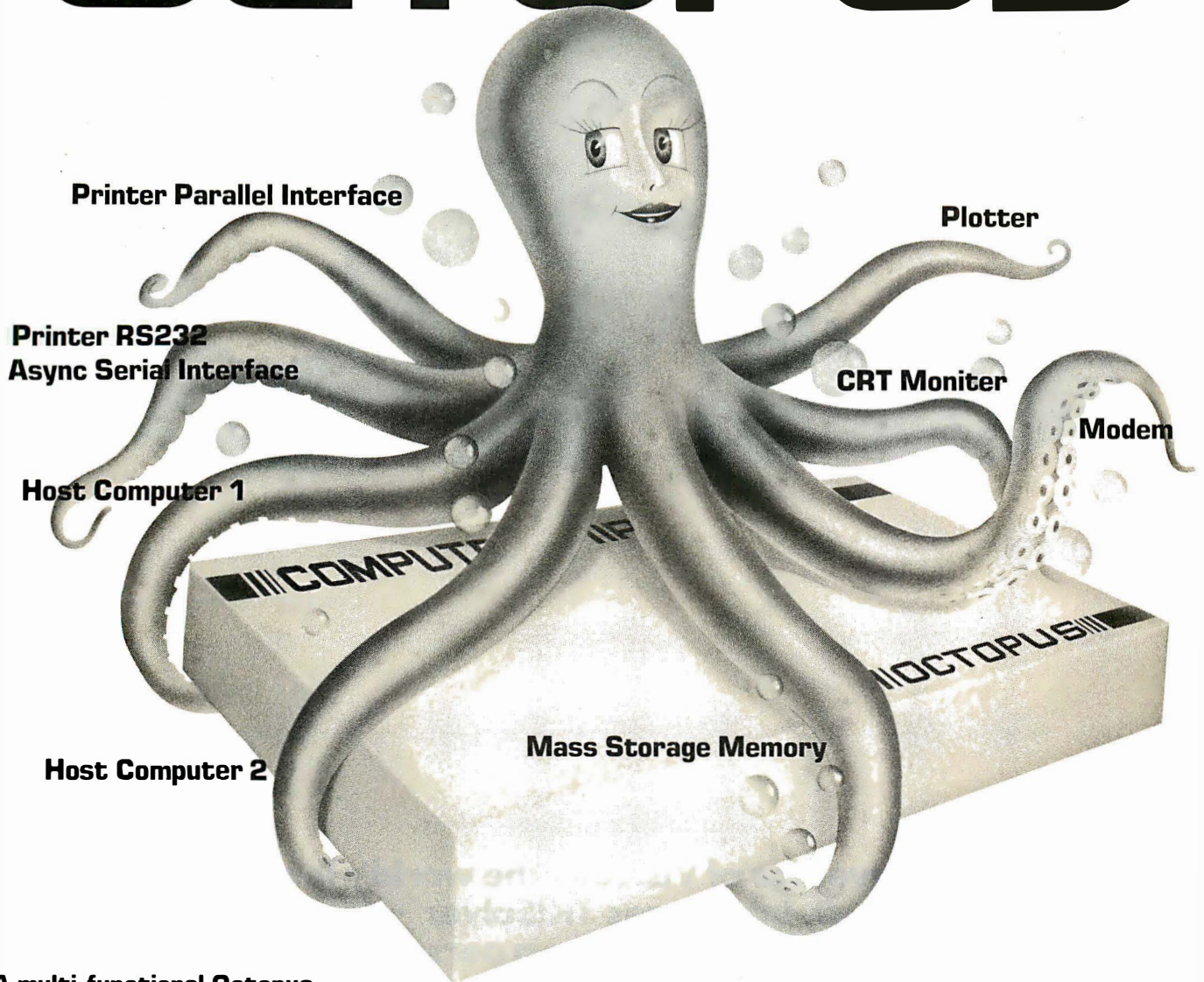

A multi-functional Octopus

It's a printer buffer, a printer spooler, frees computer time and enables copying capability.

A data protocol translator:

parallel to parallel parallel to serial
serial to parallel serial to serial

A multitask data channel controller:

- enables host computer to communicate to multiple peripherals simultaneously.
- enables multiple computers to communicate with multiple peripherals simultaneously.
- compatible to most interface protocols.

All in one for only \$197.50.

Standard product includes: Z80 CPU

One parallel input port (centronic printer and IBM PC compatible), one parallel output port (centronic printer and IBM PC compatible), two Serial RS232 Asynchronous ports, 8KB resident memory.

Options include:

- Up to 256KB upgradable memory
- Graphic enhancements.
- Modem with Auto Dial capability.
- Two additional parallel ports
- Two additional Serial RS232 Asynchronous ports.
- Customized software enhancements.

computer peripherals

1117 Venice Boulevard Los Angeles CA 90015 Call Collect (213) 298-1297 Telex: 194561 LSA

CRUI

The inventor of VisiCalc®, the world's leading software product, introduces TK!Solver™ —the revolutionary way to crunch problems on a personal computer.

With VisiCalc, Software Arts™ created an entirely new application for personal computers — the electronic spreadsheet.

Now Software Arts has developed TK!Solver, another entirely new and different application for personal computers — the problem solver. Business and financial problems. Scientific and engineering problems. Architectural and building design problems. Any kind of problem you can dream up, in any area.

What's so revolutionary about that?

Simply this: the power of the TK!Solver program comes from the ease with which you can set up problems, vary assumptions, find solutions, and display results. All the facilities needed to solve the problems — simple or complex — are built-in, and need not be developed. Once you have stated your problem, simply enter the known values, then solve the problem with a single keystroke.

For even easier problem solving use a TK!SolverPack™ in which models for

NCH!

solving common problems in such areas as finance, engineering and education have already been formulated by professionals in these fields.

There is no software product in existence that solves problems as quickly, flexibly, and easily as TK!Solver—The Problem Cruncher.™ In fact, no

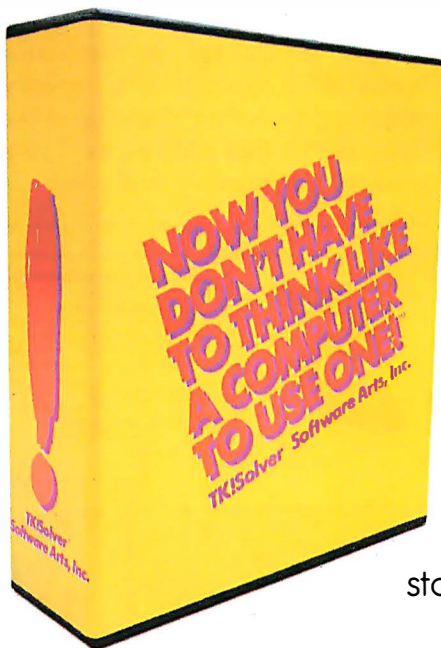

other software product even works the way TK!Solver does. It is a necessity for personal computer owners.

See for yourself. Visit your nearest computer store for a demonstration and find out how much you can do with a personal computer when it thinks as flexibly as you do.

Software Arts™

27 Mica Lane, Wellesley, MA 02181

TK!Solver, TK!SolverPack and TK!Solver—The Problem Cruncher, are trademarks of Software Arts, Inc. Software Arts is a trademark of Software Arts, Inc. and Software Arts Products Corp. VisiCalc is a trademark of VisiCorp. Copyright © 1983. Software Arts, Inc. All rights reserved.

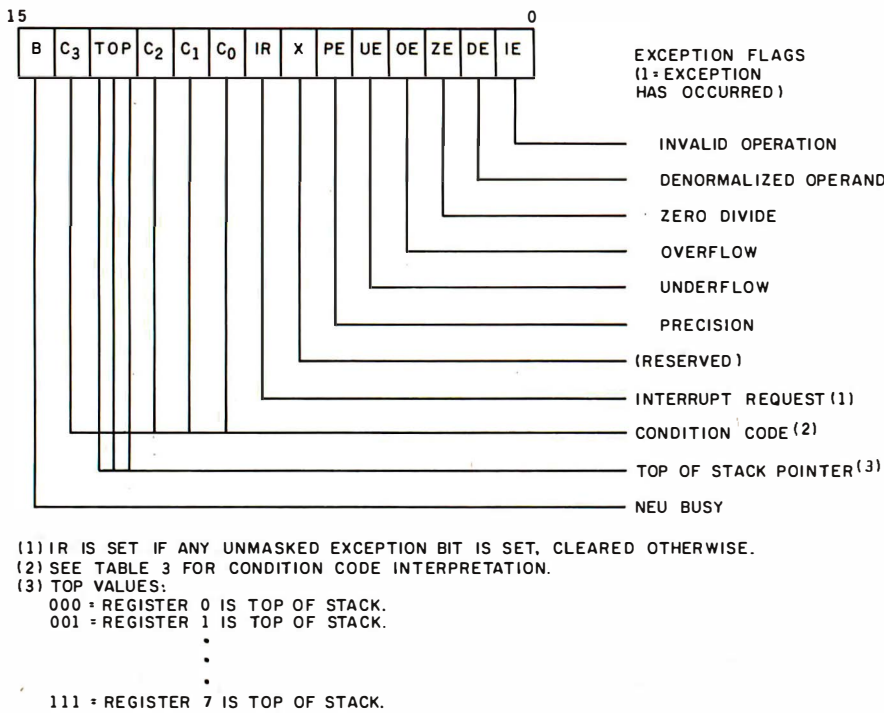

Figure 3: The various fields of the Status Word.

all times. The various fields of the Status Word are shown in figure 3.

The Busy bit indicates whether the 8087 is in the process of performing an operation at any given time. The 4 condition bits (C3 through C0) denote the result of a previous operation, and the host processor can examine them to determine if a branch should take place in the program.

This is accomplished by storing the 8087's Status Word in memory and then causing the host processor to fetch and examine the condition codes.

Three of the bits of the Status Word, ST2 through ST0, specify which register is the current top of the stack. Notice that if the ST field contains 000, for example, and a value is

pushed onto the NDP's stack, the ST field would decrement to 111. By the same token, if the ST field contains 000 and a value is popped from the stack, the ST field would increment to 001.

As it turns out, you really don't need to know which register is the current stack top, but this gives you some idea of what the bits mean. You *do* need to know the relative position of your various data elements on the stack, however, and keeping track of them is one of the jobs of the programmer.

All the remaining bits in the Status Word apply to exceptions (errors) and the way to handle them. Bits 0 through 5 signify whether the NDP detects an exception condition. Table 1 indicates the significance of these exceptions. Bit 7 is set to indicate whether the 8087 requests the host central processing unit to execute an interrupt-service routine in response to one of the exception conditions. It is possible for an exception condition to take place without an interrupt request if the programmer masks a particular exception (or group of exceptions). Generally, however, the NDP uses a collection of built-in default routines to handle most exceptions.

If you really want to avoid the messy error-condition-handling business, you can leave those problems to the nice people who wrote the

Super 5

Super 5 has the following advantages compared to the normal floppy disk drive:

Characteristics	Super 5	Normal Type
Servo motor/Spindle connection	Direct shaft drive	Belt drive
Head positioning mechanism	Metal band positioner	Plastic CAM positioner
Track to track time	Approx. 3-6 msec.	Approx. 40 msec.
Write-protected sensor	Photo coupler	Mechanical switch
No. of tracks	40 tracks	35 tracks

Super 5-T40 single side, Super 5-T80 (super 5w) double side,

The Finest Quality Disk Drive for Apple®

The *Super 5* stands alone in fine quality and workmanship. The above facts are self evident . . .

EI-EN ENT, JAPAN TLX: J23325
LOS ANGELES BRANCH

Mitsuba Corporation

642 S. Second Ave., Covina, CA 91723 • (213) 331-8434.
CANADIAN INFOCOM SERVICES Tel.: (604) 738-1285
DEALERS INVITED

® Apple is a registered trademark of Apple Computer, Inc.

Working with the wrong software is like eating a taco with chopsticks.

Frustrating.

But now there's DigiSoft. We help you choose the micro-software that's right for you.

You can't go wrong with DigiSoft. We've taken all the surprises out of buying software. No guesswork. No regrets. We give you all the information you need to make the right choice. But we don't stop there. You get plenty of professional support after the sale. And we guarantee your full satisfaction.

Call Toll-Free 800/328-2777

You'll get lots of help from our well-trained software consultants. They'll answer your questions, offer solutions and present several alternatives.

DigiSoft has a comprehensive software inventory, tested and evaluated for top quality and performance. We've labeled our programs I, II and III, so you can select the features best-suited to your needs and budget.

Limited Introductory Offer*:
20% Off Asset III™

Asset III is a complete, easy-to-learn series of accounting systems, consisting

of Accounts Receivable and Payable, General Ledger and Inventory Control. Each program can function on its own or interface with others in the series. Asset III systems also interface with DMS, DigiSoft's relational database management Series, and DCalc, our financial planning system, giving you almost unlimited possibilities for management information. If you're interested in Asset III or any of its programs, be sure to take advantage of this special DigiSoft price.

30-Day Money-Back Guarantee

Try our software in your own office, on your own computer for thirty days. If you're not completely satisfied, you're welcome to return it. You have nothing at all to lose.

To order, or request more information, call or send in the coupon today. Visa and Master Card accepted.

*Offer expires 5/15/83.

DigiSoft™
Professional Software Center

Please rush Asset III™ @ \$1320 (reg. \$1650)
 Check enclosed.
Charge to VISA MASTER CARD

_____ Exp. Date _____

Signature _____

Send more information about these DigiSoft programs: DMS I DMS II DMS III
 Asset III GL III A/P III A/R III
 I/C III DCalc II DCalc III Medical III
 Optimizer I, II, III Other: _____

Name _____

Title _____ Company _____

Computer Type _____

Address _____

City _____ State _____ Zip _____

Mail to: DigiSoft,
10901 Red Circle Drive,
Mpls., MN 55343
Call 800/328-2777
612/933-7671

C



SUPERBRAIN II

**PRICE
BREAKTHROUGH**

Intertec Data Systems' new SuperBrain II has all the features of the former SuperBrain, plus:

- Below-the-line descenders and reverse video
- Faster, enhanced disk operating system
- Battery operated real-time clock
- Microsoft Basic at no extra charge

- SUPERBRAIN II Jr.**\$1,849
350 K Disk—64 K RAM
- SUPERBRAIN II QD**\$2,209
700 K Disk—64 K RAM
- SUPERBRAIN II SD**.....\$2,619
1.5 MB Disk—64 K RAM
- 10MB HARD DISK**.....\$2,880
(Includes Interface)

NEW

IBM PC



Includes
FREE \$650
Dot Matrix
100 CPS Printer
or PC Software

COMPLETE SYSTEMS AVAILABLE
System includes: keyboard, monochrome display, dual SD/DD (1 megabyte), disk drives, 64K RAM, parallel printer adapter and DOS 1.2 & manual.

Call for Price and Availability

SANYO

- SANYO MBC 1000**\$1,399
64 K RAM—320 K Disk
- SANYO MBC 2000**\$2,345
64 K RAM—(2) 320 K Disk
- Printers —
- Anadex DP-9501A (150 cps).....\$1,359
- Anadex DP-9620A (200 cps).....1,459
- Anadex WP-6000 (180/330 cps).....2,759
- Comrex CR-1-C (17 cps Daisy).....772
- Comrex CR-1-S (17 cps Daisy).....799
- Daisywriter—16 (17 cps Daisy).....1,237
- Epson MX80 FT x/Graftrax.....555
- Epson MX100 FT w/Graftrax.....725
- NEC 8023 A Matrix (100 cps).....499
- NEC 3510 (RS232) (35 cps).....1,480
- NEC 3550 (35cps) IBM PC.....1,949
- NEC 7710 (RS232) (55 cps).....2,367
- NEC Trimliner—300 Lpm.....4,585
- Okidata ML80 (80 cps).....325
- Okidata ML82A (120 cps).....470
- Okidata ML83A (120 cps).....719
- Okidata ML84 (200 cps).....1,175
- Smith-Corona TP-1 (12 cps Daisy).....625
- Gemini 10 (100 cps · 10").....368
- Gemini 15 (100 cps · 15").....485
- TI 810-Full Package.....1,535

— Free hardware-software catalog —
Call or Write
(214) 931-9069

WESTSTAR MICRO
16990 Dallas Parkway • Suite 151
Dallas, Texas 75248

Ordering Information: Money Orders, cashier checks or bank wires welcome. Personal or company checks, allow 15 days to clear. Surface freight standard F.O.B. origin. Include your telephone number. No COD's please. Prices are subject to change without notice. Hours are 9 to 5 CST.

90 Day Money Back Guarantee*
120 Day Extended Warranty**
72 Hour Burn In Available

SuperBrain is a Registered Trademark of Intertec Data Systems. *Returns are Prioritized. **Extended Warranty offered by WestStar.

Invalid Operation
Attempt to load a register that is not empty
Attempt to pop an operand from a register
Operand is a NAN (not a number)
Operands cause operation to be indeterminate (% , $\sqrt{\quad}$ - number)

Denormalized Operand
Attempt to use an operand that is not normalized

Zerodivide
Attempt to divide by 0

Overflow
Result too large for destination format

Underflow
Result too small for destination format

Precision
Result not exactly representable in destination format
8087 rounds result

Note: Exception bits are "sticky" and can be cleared only by the FCLEX (clear exceptions) instruction.

Table 1: The significance of the exceptions.

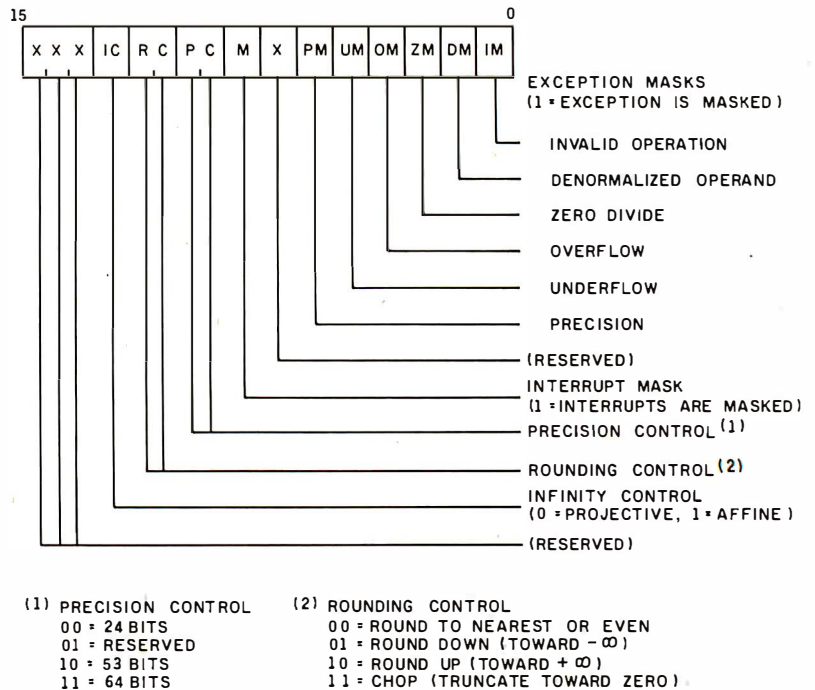

Figure 4: The Control Word.

IEEE standard that specifies the NDP default routines. (See the text box on pages 174-175.) In other words, you can take responsibility for handling an exception condition or you can let the chip do it. To inform the NDP which exceptions it will handle and which ones you will handle, you use the Control Word.

Tag Word

Before we move to the Control Word, let's look at one other thing.

How would the NDP know if we had tried to pop something from an empty register so that it could set the invalid operation flag? For that matter, how would it know if one of the operands was not a number? Well, the NDP stores a Tag Word that contains a 2-bit field for each of the eight registers, and which keeps track of the contents of each register and marks the contents as being Valid, Zero, Special (not a number, infinity, etc.), or Empty.

DBPlus™

SORT, COMPRESS, and TRANSFORM ***dBASE II™ DATA FILES***

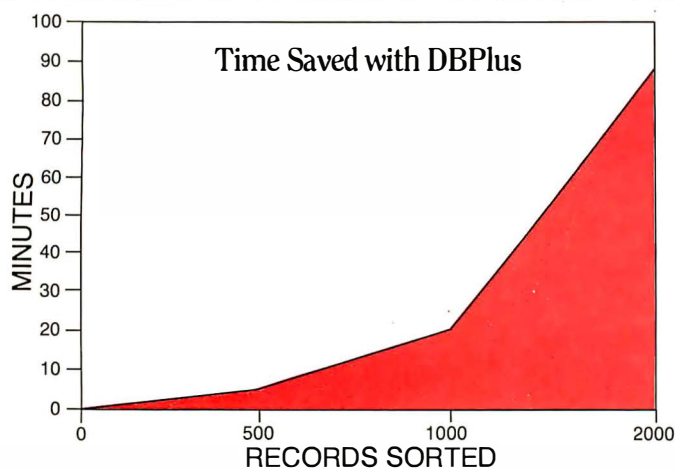

If you are serious about dBASE II™ you need DBPlus. This program runs outside of dBASE II™ and performs the following important functions on dBASE II™ data files:

- **Sort**
- **Compress/Decompress**
- **Transform**

DBPlus™ is designed to free you from the chore of typing or memorizing a new language. In most cases all you have to do is move the cursor to the next menu item and press return!

SORT

DBPlus™ can sort a data file up to 15 times faster than dBASE II™ on a single field; 32 fields may be sorted in a single pass and each additional field requires 1% more sorting time.

COMPRESS/DECOMPRESS

A copy of any dBASE II™ data file can be produced which is only 30% to 40% of the original size.

The compressed file will save you transmission time and phone costs when you send a data file over a modem.

Making backup copies of large data files can use up many floppy disks. Compressed files will save you space in archival storage.

TRANSFORM

You can now modify the structure of any data file by adding, deleting, and modifying fields without any programming knowledge.

DBPlus™ can also create a new file which is compatible with WordStar/MailMerge™.

Now retailing for \$125.

Manual and demo disk may be purchased separately.

Dealer and distributor inquiries invited!

HumanSoft

661 Massachusetts Avenue
Arlington, Mass. 02174
(617) 641-1880

dBASE II is a registered trademark of AshtonTate, Inc.
WordStar/MailMerge is a registered trademark of MicroPro, Inc.
DBPlus is a registered trademark of HumanSoft

Circle 188 on Inquiry card.

FLOPPY DISK DRIVES - 8"**PRICE QTY. ONE****QUME**

242 - Half height DSDD 48TPI	450.00
842 - Full size DSDD 48TPI	465.00

TANDON

TM-848-2 - Half height DSDD 48TPI	465.00
-----------------------------------	--------

MITSUBISHI

M-2894-63 - Half height DSDD 48TPI	465.00
------------------------------------	--------

FLOPPY DISK DRIVES - 5 1/4"**QUME**

142 - Half height DSDD 48TPI	195.00
542 - Full size DSDD 48TPI	260.00
592 - Full size DSDD 96TPI	335.00

TANDON

TM-100-2 - Full size DSDD 48TPI	255.00
TM-100-4 - Full size DSDD 96TPI	365.00

(For the IBM PC)

MITSUBISHI

M-4853 - Half height DSDD 96TPI 1MB	335.00
M-4854 - Half height DSDD 96TPI 1.6MB	395.00

WINCHESTER HARD DISKS**AMPEX**

Pyxis 7-5/8" 7MB capacity	650.00
Pyxis 13-5/8" 13MB capacity	795.00
Pyxis 27-5/8" 27MB capacity	1225.00

*** 1 year warranty ***

WINCHESTER SUBSYSTEMS**MEDIA DISTRIBUTING**

MD-10 - 11MB Capacity	2695.00
MD-20 - 22MB Capacity	3595.00

For Z-80, CP/M Systems

TERMINALS**ADDS**

VIEWPOINT - Green phosphor	479.00
-----------------------------------	---------------

AMPEX

D-80 - Green phosphor	595.00
D-81 - Green phosphor	625.00

Amber phosphor optional \$20.00

QUME

QVT-102 - Green phosphor	595.00
QVT-103 - Green phosphor	750.00
QVT-108 - Green phosphor	750.00

PRINTERS**QUME**

Sprint 11 - 40 CPS Daisy wheel	1395.00
--------------------------------	---------

MPI

Printmate 150 A-1 - Serial. 4K buffer	999.00
---------------------------------------	--------

**(408) 438-5454****SUPPLIES AND ACCESSORIES ALSO AVAILABLE****DEALER INQUIRIES INVITED****TERMS: COD, CASH WITH ORDER, MASTERCARD, VISA****FREIGHT CHARGES WILL BE ADDED TO ALL ORDERS**

Circle 257 on inquiry card.

Control Word

The Control Word is shown in figure 4. The least significant portion of the Control Word coincides with the least significant portion of the Status Word in that you set or clear these bits to mask or unmask (respectively) the exception conditions and to disable or enable the ability of the 8087 to interrupt the host processor. The Control Word also has bits that allow you to set the precision of the NDP to various levels. You should realize that there is no advantage to lowering the precision of the NDP in terms of execution speed. This capability exists only to allow the 8087 to more accurately emulate previous floating-point products that might be replaced by the 8087.

The next 2 bits in the Control Word set the rounding convention that the NPX uses. You can set the NPX to round up, round down, round to the nearest or even number, or to round toward zero.

Lastly, a bit in the Control Word selects the model of infinity for the NPX. Just think, philosophers argue whether infinity even exists and you get to define it in one of two different ways!

Simply put, the first method, known as the Affine closure mode, considers that there are numbers that are positively infinite and numbers that are negatively infinite. While this may seem reasonable, it can cause unexpected problems in calculations. For example, if we divide a number by the number X, and X is very, very small and positive, the result could be positive infinity. If X is very, very small but negative, the result could be negative infinity. In other words, you have two very different results.

The Projective closure mode uses only one infinity. Although it is very large, it has no sign. This mode is the easiest to use and therefore is recommended.

Exception Pointers

If an exception does take place, and you have unmasked that particular exception flag, it would be nice to know a few things before you jump in and try to recover from your error. You would probably like to know

Thoughtware™ tames your CP/M™ system for just \$49.95

CLIP™, our Command Line Interpretive Program, makes your system more efficient than ever before. CLIP replaces the interactive portion of CP/M with a user friendly "shell". CLIP is sophisticated enough to satisfy the entire spectrum of needs from the novice to the most expert programmer.



Command Files

Command sequences that you use often can be placed in a command file. From then on you'll never type the commands again, since typing the name of the file will execute the commands as if you typed them by hand. These files can ask questions and perform different tasks depending on the answers received. In addition, a special command file can begin working whenever your computer is turned on.

All input text can be edited.

Once CLIP is in control, entry of text into ANY program can be edited as if you were using a word processor. The single keystrokes that you use to edit the text can be defined to be similar to your existing word processor. CLIP also remembers your previously entered line, and it can be retrieved with only one keystroke.

Built-in file editor

Clip contains a simple editor for editing command files, programs, or data files. English-like commands simplify any editing task.

Automatic file searching

With file searching you can keep files that are frequently accessed in a common place. CLIP will find them when requested by a program or command file, no matter which disk or user number you are currently at. This can save precious disk and directory space.

Help Files

Extensive on-line help is available for each of the 50+ commands in CLIP. You can also add your own help files to customize your working environment.

Built in calculator.

CLIP has a built in 16-bit calculator with the functions: +, -, *, /, remainder, AND, OR, XOR, and NOT. The calculator has 10 memory registers and works in any base from 2 to 16.

Circle 411 on inquiry card.

A Unix™ like environment with I/O redirection and pipes.

With CLIP you can direct screen output from any program to a file for later viewing or printing. CLIP can also take any program's input from a file instead of the keyboard. "Pipes" force the output from one program into the input of another automatically.

Sophisticated command language with over 50 commands.

CLIP is a state-of-the-art command language that includes:

- Conditional command execution with IF, THEN, ELSE, and ELSEIF and ENDIF commands up to 64 nested levels.
- Command files (or macros) with looping capabilities and conditional termination. Macros can use other macros. Extensive argument extraction capabilities can extract values and switch options off of a command line.
- The ability to trace command file execution.
- Commands that can OPEN, CLOSE, READ and WRITE files.
- Ten alphanumeric registers that can store command lines, filenames, file input, or anything you desire.
- Multiple commands per line.
- A copy command that can copy files between disks and user numbers.

Buy CLIP and get 50% off our software tools. Just \$25.00!

We have a collection of 10 software tools that make difficult tasks easy.

- BC - Binary file comparison
- SC - Source file comparison
- SR - Search for a pattern in a file
- SRT - Simple in memory sorter
- DMP - Hex file dumper with ASCII
- BFE - Binary file editor
- XC - Extract columns from a file
- XW - Extract words from a file
- WC - Counts words, lines, and bytes
- HC - Horizontal file concatenate

Also get 50% off our file encryption program. Just \$25.00.

If you have more than one person accessing your computer, then you need our file encryption program. This program won't stop the KGB, but it will stop others from seeing sensitive data. A twelve-character password gives you all the protection you need. For just \$25.00, you can't afford to be without it.

ORDERING INFORMATION:

**Order HOT LINE: 8-5 MST
1-800-821-6010 / (AZ 327-4305)**

CLIP	\$49.95
Tools	\$49.95 (\$25.00 with CLIP)
Encryption	\$49.95 (\$25.00 with CLIP)

CLIP user's manual can be purchased separately for \$25.00

CLIP, the tools, and the file encryption program have been designed for the Z80™ microprocessor, running CP/M version 2.2. Distribution is on standard 8-inch SS/SD floppies.

Visa and Mastercard accepted.
No COD's, please.

Send check or money order to:

Thoughtware, Inc.
P.O. Box 41436
Tucson, AZ 85717

Please add \$3.50 shipping for all orders.
AZ residents please add 6% sales tax.
Prices are subject to change.

CP/M - TM Digital Research, Unix - TM Bell Labs, Z80 - TM Zilog Inc. Thoughtware and CLIP - TM of Thoughtware Inc.



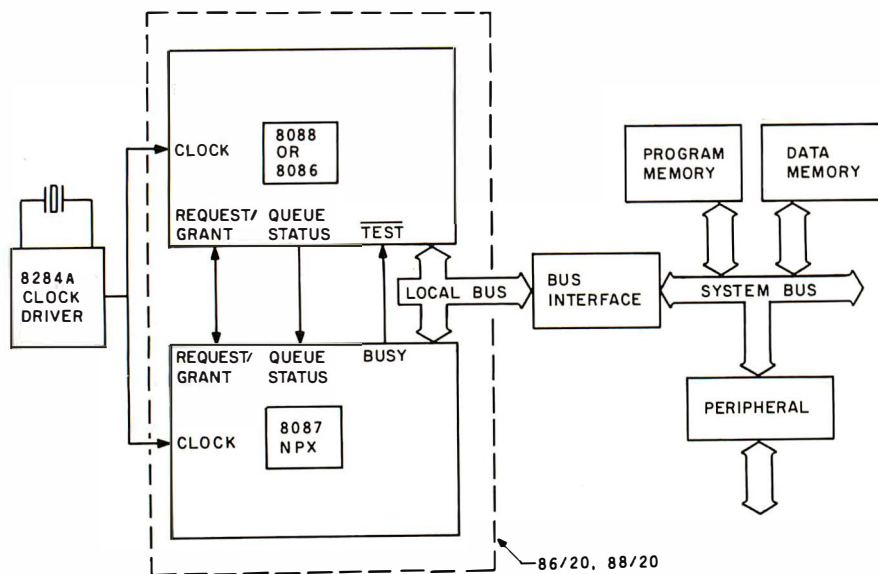

Figure 5: The interface and communication lines.

which instruction or op code caused your problem. It would also be nice if you could determine this instruction's address so that you might resume at that point when you have eliminated the cause of the problem. Also, if the instruction operated on data in memory, you might want to know where this data came from. The 8087 contains all this information in three registers that are collectively called the Exception Pointers. The operational details of these registers are beyond the scope of this article, but can be found in Intel technical documents.

Synchronization

The 8087 works in close harmony with its host. In order for this to take place, there must be some communication and synchronization between the two devices. The interface and communication lines are shown in figure 5.

When you add an 8087 to a host microprocessor, the host retains the responsibility of fetching the instructions from system memory. As the host fetches these instructions, the 8087 also captures them and puts them in a queue—just as the host processor does. The answer to how the 8087 knows whether to emulate the 6-byte queue of the 8086 or the 4-byte queue of the 8088 is quite simple.

Whenever the processor is reset,

the host processor goes to absolute address 0FFFF0 hexadecimal to begin fetching instructions. The 8088 always fetches a byte from this location because the 8088's data bus is a byte wide. The 8086, however, can fetch its instructions one word at a time. So when it goes to address 0FFFF0 to fetch its first instruction, it

**In order for the
8087 to work in close
harmony with its host,
there must be some
synchronization
between
the two devices.**

fetches a word instead of a byte. To accomplish this, the 8086 issues a signal called Byte High Enable (BHE/). The 8087 simply looks to see if its host generates a BHE/ signal when it performs its first op-code fetch after a reset. The presence or absence of the signal determines if it is connected to an 8088 or an 8086, and it then emulates the correct queue.

All 8087 instructions have a unique 5-bit prefix called the Escape prefix (11011). When the host fetches an op code with this prefix, it is placed in the queue as any other instruction would be. The 8087 captures the same op code as it is fetched by the host

and places the op code in its own queue. As this op code moves through the queue of the host processor, its movement must be emulated by the NPX queue as well. The mechanism that is set up to do this is the first of the three types of synchronization signals that are shared by the host and the NPX. The host has two lines called the Queue Status lines (QS0 and QS1). They allow an external device such as a coprocessor to emulate its queue. When this floating-point instruction finally makes its way through the queue, the host determines that it is an instruction for the NPX rather than for itself.

Once the host has determined that the instruction is an NPX instruction, it looks at the instruction to see if the NPX will need to access memory in the execution of the instruction either to fetch (read) an operand from memory or to store (write) an operand to memory. If it sees that this is the case, the host will calculate the address of the operand and perform a *dummy read*. By performing this dummy-read operation, the host can supply the NPX with the address of the memory operand. The host generates the address and even issues the strobe signals, but it ignores the data that is read from the addressed location.

The NPX, on the other hand, captures the address that the host generates. Then, depending on whether the NPX needs the data that is read or whether it needs the address so that it can write a result in memory after it finishes its instruction, the NPX captures the data or ignores it. Even if the data were required by the NPX to execute the instruction at hand, the dummy read will result in only one byte or one word of data. Typically, the NPX will be working with data types that are 4, 8, or even 10 bytes in length. This means that the 8087 will have to perform additional memory-read cycles in order to access the remainder of its operand. Because the 8087 shares the host processor's buses, it must have a way of informing the host that it wishes to use them.

The mechanism to do this is the

Text continued on page 170

You can't reach the top using just your woods.



Arnold Palmer

© 1982 Lanier Business Products, Inc.

To succeed in business, you can't let good ideas slip through your grasp. Or forget to write those quick, but important notes.

When a thought strikes, you have to capture it immediately. Often, a pencil and pad just aren't up to the task.

Now you can get rid of that handicap. With a Pocket Caddy™ Thought Processor from Lanier. The Pocket Caddy goes where you go. And can be operated with just a thumb and a finger.

So even in a car, where a pencil is useless, you can record all the ideas that will help you get ahead faster.

The choice? Scratch out a living. Or get the Pocket Caddy. And move ahead at the speed of sound.



APR. '83 BYTE 1 76 6 C3

I'd like more information on the Pocket Caddy.

Name _____

Title _____

Company _____ Phone _____

Business Address _____

City _____

County _____ State _____ Zip _____

Mail to Lanier Business Products, Inc.
1700 Chantilly Drive N.E., Atlanta, GA 30324

Ask your office manager about Thought Processors.
Or call (800) 241-1706. In Georgia, (404) 321-1244 collect.

LANIER

MOVE AHEAD AT THE SPEED OF SOUND **LANIER THOUGHT PROCESSING™**

For a no obligation demonstration of the Pocket Caddy™, the Lanier Thought Processor™ that can help you reach the top faster, circle. 228



DAILY SALES REVENUE

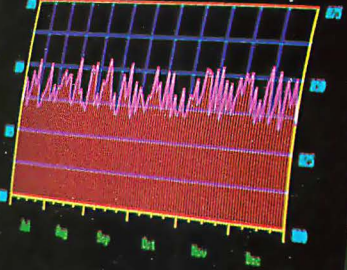

The new TI Professional Computer. It makes you the one with the answers.



Today's business executive is faced with a world of questions. Questions about productivity. Cost control. And the bottom line.

To help you come up with the answers and alternatives, we introduce the new Texas Instruments Professional Computer. The one with the power, the expandability, the easiest-to-use keyboard, extremely high resolution graphics, and a broad array of software.

All the leading operating systems and programming languages are available. You can use many popular application programs from the best software suppliers to help you create spreadsheets, do word processing, construct graphics, communicate with other data bases or create your own. All of which lets you control assets, manage your time, and make projections for tomorrow's performance — today.

And for a clear "hard copy" print-out of information, you can rely on the new 850 Series printers, made by Texas Instruments especially for the new TI Professional Computer.

In short, the TI Professional Computer helps you make better business decisions based on better information. With the performance and reliability you expect from TI.

If you're on your way up, the new Texas Instruments Professional Computer can help. Because it makes you the one with the answers.

For full information and a demonstration, visit your local computer dealer, or write: Texas Instruments, Dept. 1A, P.O. Box 402430, Dallas, Texas 75240. Or call toll-free: 1-800-527-3500.

Creating useful products and services for you.



TEXAS INSTRUMENTS

SPECIFICATIONS

System Unit

16-bit, 8088 microprocessor
64K byte RAM, expandable to 256K bytes
4K byte graphics display memory
5-slot expansion bus

Keyboard

Specially designed low profile
Popular typewriter layout
97 keys, including 12 function keys
Separate numeric keypad and cursor control clusters

Tactile response, for quick positive entry
Upper- and lower-case letters

Display Units

12-inch monochrome (green phosphor) or
13-inch full-color, 25 lines x 80 columns
High resolution, 720 x 300 pixels

Mass Storage

Built-in 320K byte diskette standard
Additional internal storage of 320K byte diskette, or 5 or 10 Mbyte Winchester disks optional

Communications Options

300 BPS or 300/1200 BPS internal modem
TTY, 3780
3270 SNA stand-alone (Summer 1983)
3270 BSC and SNA cluster (Fall 1983)

Operating Systems

MS™-DOS, Digital Research™ CP/M-86®, and
Concurrent CP/M-86™, UCSD p-System™

Languages

BASIC, COBOL, FORTRAN, Pascal
Applications Software

Over 100 programs available from the most popular software vendors such as Microsoft, Ashton-Tate, Micro-Pro, IUS, Sorcim, Peachtree, BPI, Lifeboat and others.

Printers (Available Spring 1983)

150-cps TI 850 Series for most applications

FOOTNOTES: MS-DOS is a trademark of Microsoft Corporation. CP/M-86 and Concurrent CP/M-86 are trademarks of Digital Research, Inc. UCSD p-System is a trademark of the Regents of the University of California.

same used by any potential bus master to borrow bus cycles from the host. This line is the Request/Grant line (RQ/GT), and it is the method that the host uses to implement the HOLD and HLDA (hold and hold acknowledge) functions. When the NPX wants to use the buses, it toggles the RQ/GT line low. The host latches this request and, when it is done with the buses, three-states its buses and signifies to the requesting device that it can have them by toggling the same line low itself.

The NPX takes over the buses at this point and generates all the signals (address and control) to access the operand. It signifies when it is finished by once again toggling the RQ/GT line low. In the case where the NPX needs the address generated during the dummy read to store a result, it simply executes its instruction, saving the address until it has completed the execution and then re-

quests the bus so that it can perform the memory-write cycles required to put the result in the proper memory location.

In some cases, the host can continue to fetch and execute instructions (with the NPX emulating its queue) while the 8087 is busily crunching numbers. There may be a situation, however, when this cannot take place. For example, we have two instructions in a program, the first of which causes the NPX to operate on a variable and to store the result in memory. If the second instruction causes the host to use this result, we must not allow the host to execute the second instruction and to access the variable until the 8087 has written the proper value in the variable location.

To accomplish this, we precede the instruction intended for the host with a WAIT instruction. The WAIT instruction causes the host to look at its TEST pin. The TEST pin, as you can

see in figure 5, ties to the BUSY line of the NPX. Whenever the NPX is busy, the BUSY line is high and the TEST pin on the host is high. When the host executes the WAIT instruction, it cannot go on to the next instruction until its TEST pin goes low.

Another case where you would not want the host to go off blindly is when you have more than one floating-point instruction back to back. In this situation, the host would like to be more than obliging by performing all the dummy reads in the world just so that it can get to an instruction that it can execute. The problem is that the 8087 queue has to be in sync with the host, and if the host just gobbles its way through a series of floating-point instructions, ignoring them as it is designed to, the devices will never be able to regain sync. You can solve this problem simply by adding a WAIT instruction in front of all floating-point instructions.

Listing 1: An application of the 8087 using an Intellec Series III Microcomputer Development System and Intel's 8087 software emulator.

```

SERIES-III 8086/8087/8088 MACRO ASSEMBLER V1.0 ASSEMBLY OF MODULE PYTHAGORUS
OBJECT MODULE PLACED IN :F1:EUCLID.OBJ
NO INVOCATION LINE CONTROLS

LOC  OBJ                LINE    SOURCE
      . 1 +1 $SYMBOLS DEBUG
      2
      3             NAME PYTHAGORUS
      4
      5             EXTRN  INIT87:FAR
      6
----   7 TRIANGLE      STRUC
0000   8             BASE  DD      ?      ; The DD memory allocation allows
0004   9             ALT   DD      ?      ; enough space for the variables
0008  10             HYP   DD      ?      ; to be defined in the SHORT REAL
000C  11             AREA  DD      ?      ; format.
----  12 TRIANGLE      ENDS
      13
----  14 DATA      SEGMENT PUBLIC 'DATA'
      15
0000  16 RIGHT     TRIANGLE    <>      ;We will assume that these
0004  ?????????
0008  ?????????
000C  ?????????

      17                                     ;variables are initialized by
      18                                     ;another program.
0010 3E03      19 CONTROL_87    DW      033EH
      20
      21 ; This is the default control word which masks all exception except
      22 ; INVALID OP, leaves the INTERRUPTS UNMASKED, ROUNDS TO NEAREST OR EVEN,
      23 ; and sets the INFINITY CONTROL to PROJECTIVE.
      24
----  25
      26 DATA      ENDS
      27
----  28
      29 STACK     SEGMENT STACK  'STACK'
      30
0000 (100      31             DW      100 DUP(?)
      ????)
      )

```

Application

The following application of the 8087 uses an Intellec Series III Microcomputer Development System and Intel's 8087 software emulator (see listing 1). The program takes the base and altitude of a right triangle, which are stored in memory as two fields of a structure called TRIANGLE, and uses this data to calculate the area of the triangle and the length of its hypotenuse. Notice that I define the fields of the structure as double words (DD). This allows me to define the variables in the Short Real format. I will discuss the program using both the listing and a chart in figure 6 that tracks the status of the NPX's stack as references. When I refer to the chart, I use lower-case letters in parentheses.

The procedure INIT87, which I reference on line 42, is in the 8087 emulator and prepares the environment. The FLDCW instruction on line

46 causes the Control Word, which is stored in memory at a location symbolically called CONTROL-87, to be loaded into the 8087. The function of the Control Word is explained beginning with line 21.

Notice that all the floating-point instructions are preceded by a hexadecimal 9B op code. This is the WAIT op code that is inserted automatically by the assembler. The first thing that I must do is set up the stack so that I can perform my calculations. The instructions on lines 50 through 53 perform this. FLD1 puts the number 1.0 on the top of my stack (figure 6a). FADD ST,ST(0) causes the value at ST(0), which is my stack top, to be added to the stack top.

The result of this instruction is to multiply the stack top by 2 (figure 6b). The FLD instructions cause the 8087 to load the contents of the specified memory locations, which are considered to be in the Real for-

mat, on the stack (figure 6c). In the process of loading these values, they are transformed into the Temporary Real format. Notice that because the host processor calculates all the operand addresses, I can use any of the addressing modes of the host. The 8086 and 8088 processors are capable of 24 powerful addressing modes. In this case, I am accessing a field of a structure.

Next, I calculate the area of the triangle. The instructions that do this are on lines 57 through 60. The FLD ST(1) instruction causes the contents of the current ST(1) register to be duplicated on the top of my stack (figure 6d), and the FMUL ST,ST(1) instruction puts the BASE X ALT in the stack top (figure 6e). FDIV ST,ST(3) divides the stack top by the 2.0 that I have saved on the stack (figure 6f), and the FSTP causes the result, which is equal to the area of the triangle, to be popped into the ap-

Listing 1 continued:

```

00C8          32      T_O_S LABEL WORD
              33
----         34      STACK ENDS
              35
              36 +1  $EJECT
----         37      CODE SEGMENT PUBLIC 'CODE'
              38          ASSUME CS:CODE,DS:DATA,SS:STACK
              39
              40          ; INITIALIZE 8087
              41
0000 9A0000---- E    42      INIT: CALL INIT87          ; This routine is in a library.
              43                          ; It sets up the environment
              44                          ; for the 8087.
              45
0005 9BD92E1000 R    46          FLDCW CONTROL_87      ; Load control word from memory.
              47
              48          ; SET UP 8086 REGS AND CONSTANT STACK IN 8087
              49
000A 9BD9E8     50      SETUP: FLD1          ; PUT 1.0 IN STACK TOP (ST)
000D 9BDCC0     51          FADD ST,ST(0)      ; ST=ST X 2
0010 9BD9060000 R    52          FLD RIGHT.BASE      ; ST <-- BASE
0015 9BD9060400 R    53          FLD RIGHT.ALT       ; ST <-- ALT
              54
              55          ; CALCULATE AREA=(BASE X ALT)/2 AND STORE IN MEMORY
              56          ;
001A 9BD9C1     57      CALC: FLD ST(1)          ; Duplicate BASE in ST
001D 9BD8C9     58          FMUL ST,ST(1)      ; ST <-- BASE X ALT
0020 9BD8F3     59          FDIV ST,ST(3)      ; ST <-- ST/2
0023 9BD91E0C00 R    60          FSTP RIGHT.AREA    ; Store ST in AREA and discard
              61
              62          ; CALCULATE HYPOTENUSE = ((BASE**2)+(ALT**2))** 1/2
              63          ;
0028 9BDCC8     64          FMUL ST,ST(0)      ; Square ALT
002B 9BD9C9     65          FXCH ST(1)         ; Exchange ALT**2 and BASE
002E 9BDCC8     66          FMUL ST,ST(0)      ; Square BASE
0031 9BDEC1     67          FADD ST,ST(0)      ; ST <-- BASE**2 + ALT**2
0034 9BD9FA     68          FSQRT              ; ST <-- ST** 1/2
0037 9BD91E0800 R    69          FSTP RIGHT.HYP    ; Store ST in HYP and discard
              70
003C F4         71      HALT: HLT
              72
              73
              74
----         75      CODE ENDS
              76          END INIT,DS:DATA,SS:STACK:T_O_S

```

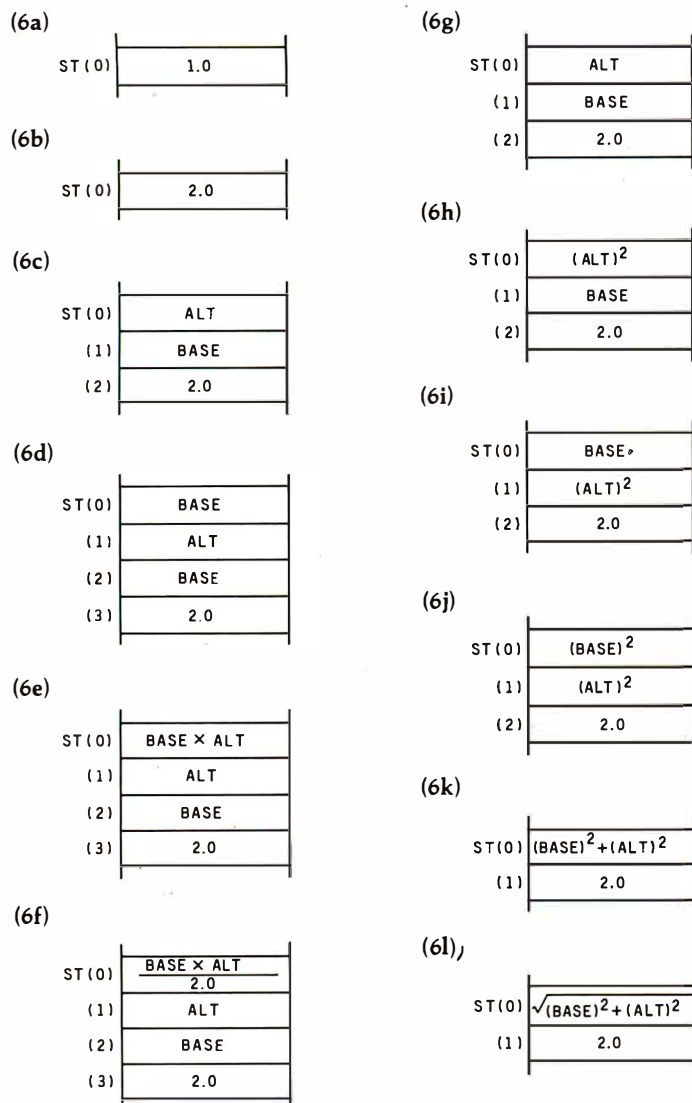



Figure 6: The status of the NPX stack during operation of the program in listing 1.

appropriate memory location in the Short Real format (figure 6g).

My next task is to calculate the length of the hypotenuse of the triangle. The instructions to do this are on lines 64 through 69. First, I multiply the element on the top of the stack by itself (figure 6h). Next, I exchange this element with the element below it (figure 6i), and once again I square the stack top by multiplying it by itself (figure 6j). All that remains is to add the stack top to the register below it, pop the old stack top (figure 6k), and find the square root of the stack top (figure 6l). The value in the stack top now equals the length of the hypotenuse. I next pop this value into the appropriate location in memory and I am finished.

This concludes the example. I have just performed calculations that involve transcendental functions and that use operands that are very accurate with no concern for either the complexity of the algorithm or the accuracy of the result. If I had attempted to perform the same calculation in software, I would have had to write some very complicated algorithms and the code necessary to trap any errors that may have occurred. Instead, I let the 8087 and the standard to which it complies worry about such things. It puts the world of accurate, high-level mathematics in the realm of every assembly-language programmer. ■

ENHANCE YOUR COLOR COMPUTER WITH THESE GREAT PRODUCTS!

MACRO-80c DISK BASED EDITOR/ASSEMBLER

This is a powerful macro assembler, screen oriented editor and machine language monitor. It features local labels, conditional assembly, printer formatting and cross reference listings. Assemble multiple files. Program comes on Radio Shack compatible disk with extensive documentation. Price: \$99.95

MICROTEXT COMMUNICATIONS

Make your computer an intelligent printing terminal with off-line storage! Use Microtext for timesharing interactions, printing what is received as it is received and saving text to cassette, and more! Price: \$59.95

PIB8C PARALLEL PRINTER INTERFACE

Use a parallel printer with your Color Computer! Serial-Parallel converter plugs into the serial port and allows use of Centronics-compatible printers. You supply the printer cable. Price: \$69.95

THE MICRO WORKS COLOR FORTH

Color Forth is easier to learn than assembly language, executes in less time than Basic and is faster to program in than Basic. Rompack comes with 112-page manual containing glossary of system-specific words, full standard FIG glossary and complete source. A fascinating language designed for the Color Computer! Price: \$109.95

SDS-80C SOFTWARE DEVELOPMENT SYSTEM

SDS-80C is a Rompack containing a complete editor, assembler and monitor. It allows the user to write, assemble and debug assembly language programs with no reloading, object patching or other hassles. Supports full 6809 instruction set. Price: \$89.95

80C DISASSEMBLER

Runs on the Color Computer and generates your own source listing of the Basic interpreter ROM. Documentation includes useful ROM entry points, complete memory map, I/O hardware details and more. Cassette requires 16K system. Price: \$49.95

GAMES: Star Blaster ★ Pac Attack ★ Berserk ★ Cave Hunter ★ Starfire ★ Astro Blast ★ Starship Chameleon ★
Adventure: Black Sanctum ★ Adventure: Calixto Island ★

THE MICRO WORKS

Also Available: Machine Language Monitor Books Memory Upgrade Kits
Parts and Services . . . Call or write for more information

California Residents add 6% Tax
Master Charge/Visa and
COD Accepted

P.O. BOX 1110 DEL MAR, CA 92014 619-942-2400

SUPER BARGAINS

ACE 1000 COLOR

COMPUTER! List \$1545
SHARP COMPUTER 249

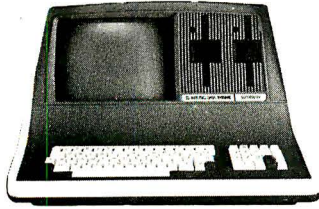

SUPERBRAIN II

Double Density 1894
Quad Density 2274
Super Density SD 2649
COMPUSTARS
TO DEALERS CALL & SAVE

Advanced Micro Digital S-100 Super-Quad Single Board Computer. Z80 64K RAM, Disk Controller, RS-232 Only 699

ALDOS — single and multi-user
ACS-8000-15D List 5990
Only 4699

ATARI 400 289
800 655

PRINTERS

OKIDATA 82A 489
CENTRONICS 739-1 499
IDS PRISM 80 743

EPSON MX-80 FT 547
MX-80 459
MX-100 749

ANADEX 9501A 1345
Silent Scribe 1623
NEC #3510 Letter Quality 1399
C. ITOH F10 Letter Quality 595
Smith Corona TP-1

TRAXX 5 1/4" Add-on Drives 249

Memory Merchant 16K static 159
Central Data RAM S-100 64K 299
Systems Group
RAM S-100 64K 449
Microangelo Video Graphics 715

AMERICAN SQUARE COMPUTERS is organizing a World Wide Association of Computer Dealers. Open a Store or Start Work Out of Your Home! We Charge NO FRANCHISE FEE! (Our Competitors charge a FRANCHISE FEE of from \$15,000.00 to \$45,000.00.) Be a Winner! Let US help YOU get started MAKING MONEY by HELPING PEOPLE to put COMPUTERS to WORK. Write or Phone today.

Which Computers are Best? ... Free
Insured Shipping at Low Rates.

We Repair Computers

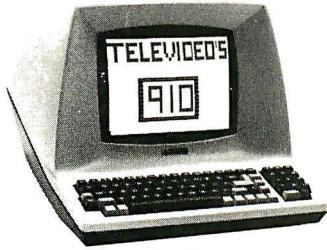

TELEVIDEO

Televideo 910+ 518
Televideo 925 718
Televideo 950 899
Televideo Computers Call

ADDS VIEWPOINT A-1B 469
ZENITH Z-19 Terminal 649
Z-89 48K Computer 2119
Z-90 64K DD 2399
ZVM-121 ZENITH
Green Screen monitor 125

INTERTUBE III
or EMULATOR \$710
AMDEK Color Monitor \$329

GODBOUT COMPUPRO
Super Sixteen 8085/8088. The fastest 8-16 bit computer! Runs 8 and 16 bit code! 128K Static RAM, 6MHz CPU's LIST 3440 SPECIAL 2569

New: Systems 816/A, B, and C with enclosure and drives.
816/A List 5495 Only 4395

SEATTLE pure 16 bit computer is the fastest microcomputer by actual test! S-100, 128K Static RAM, 8 MHz 8086, 22 slot Mainframe
Model #2 List 3785 Only \$3028
#1 as above
but 64K List 2990 Only \$2392

IBM PC memory made by SEATTLE.
Now with "Flash Disk" ... 192K = 697
64K = 427

CALIFORNIA COMPUTER 2210A
List \$1995 Only \$1595
Z80, 64K, I/O, Disk controller + CPM.
California main frame 484

SYSTEMS GROUP computers run FRIENDLY OASIS Call SAVE

QUAY COMPUTER
Two drives + CPM \$1745
Four user MPM 208K +
Hard Disk \$5945

TARBELL'S
Empire I & II have two 8" disk drives. The I is single sided, the II is double sided.

FREE Business Software
Empire I List 4888 Only 3495

Corvus Hard Disk SAVE
SSM Video BRD VB3 kit 361
Spectrum Color ASM 223

One hour free troubleshooting on business systems.

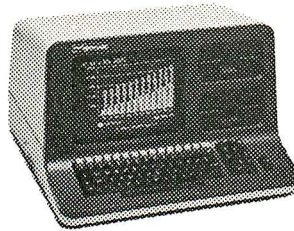

NORTH STAR

ADVANTAGE 64K Green Phosphor. The Best Business Graphics. 2 Disks. Serial Port. Options CPM — Business programs \$2894

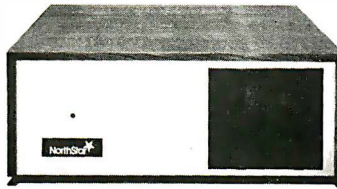

NORTH STAR Horizon
Powerful North Star BASIC Free
Superb for Business & Science
Free Secretary Word Processor

Horizon Standard is now HRZ-2-64K Quad

Factory Assembled & Tested Only
Horizon-2-64K-Quad \$2894
Horizon-1-64K-QHD 5 3999
Horizon RAM 64K 594
Big Sale on Multi-User

Time-Sharing SAVE
North Star Hard Disk 18Mb 4295
English to Basic Translator 75
Zbasic 2 to 5 times faster! 325

Secretary Word Processor 69
Wordstar Word Processor 278
Floating Point Board 699
Oasis 699

CPM for N*-Extra features 147
Micro Mike Software CALL
MICROSTAT \$355
Pascal-80 539

Extra Precision BASIC 49
Northword 179
Infomanager 329
General Ledger 399

Accounts Receivable 399
Accounts Payable 399
Inventory 399
Order Entry 399

PROPAC 1299
DOS + BASIC 5.2 28

INTEGRAND main frames S-100. Many models to choose from

Only 200 & UP

MODEMS

DC HAYES — S-100 \$329
POTOMAC MICRO MAGIC 369
SIGNALMAN 97
CAT NOVIATION 159
AUTOCAT 215

Full Time Graduate Technician on Duty.

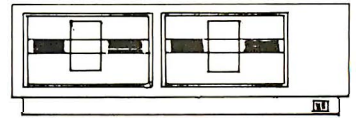

MICRO DECISION

"A DEAL YOU CAN'T REFUSE"

64K RAM, Z80, 4MHz, 2 Serial Ports, Disk Controller. FREE SOFTWARE: CPM — Microsoft BASIC — BaZic — Wordstar — Logicalc — Correct-It.

List Only
with 1 5 1/4" Disk .. \$949 ... \$1049
with 2 5 1/4" Disks .. 1545 ... 1400



DECISION I

"The IBM-360 on the Z-80 & S-100 BUS!"

Sixteen Programs running simultaneously! Free CPM, Microsoft BASIC, and WORDSTAR with complete system!

DECISION I + 65K Static + 8" Disks DMA 3403
DECISION I + 65K Static + 2 5 1/4" Disks 2795

DECISION I + 65K Static + 5" Disk + 5 Mb Hard Disk 4235
DECISION I-2user 256K Static + 5" Disk + 5 Mb Hard Disk +

MICRONIX 5830
DECISION I — Z-80 + I/O + 65K 1915
DECISION I — Rackmount + 20 Mb

HD - 8" DRV Reg. 6235
Inventory Sale 5415

MORROW Hard Disks up to 26 MEGABYTES

HDC-M26 \$3333
HDC-M20 3333
HDC-M10 2955

DMA-M5 Reg. 1775
Inventory Sale 1400

DMA-M10 2235
DMA-M16 2795

MORROW 8" Disk

Discus 2D + CPM 600K ... Only \$834
Discus 2 + 2 + CPM 1.2 Mb ... 1068
Add Drives 2D = 599 2 + 2 = 1795

Discus 2D dual + CPM ... Only 1384
Free Microsoft BASIC from MORROW with Discus system or hard disk.

FAST FIGURE — Most powerful spread sheet. 5 1/4" or 8" 99

Wordstar
All MicroPro Software for IBM, Apple, North Star, Morrow, etc. SAVE! CALL

Call for latest prices & availability

Factory Guarantees

We Beat Prices

AMERICAN



COMPUTERS

919-889-4577

4167 Kivett Dr.

Jamestown N.C. 27282

919-883-1105

Guaranteed Standard Results with the 8087

In an attempt to standardize both the data types and algorithms used in floating-point-arithmetic problems, the IEEE formed a committee in 1979 to produce a standard to which all floating-point-arithmetic processors and software would comply. This standard not only established standard data formats, but also set rules for rounding and precision control and required that all machines (and software packages) complying with the standard be capable of performing the same algorithms with the same predictable results. The concept of exception handling was expanded and standardized so that all machines (and software) that complied with the standard would monitor their own activity and be capable of signifying when the result of their calculations was suspected of being in error. The 8087 implements this standard fully.

Data Formats

One of the most important aspects of the IEEE standard was the definition and standardization of the seven data formats that would be used in floating-point calculations. These formats belong to three basic types: Integer, Decimal, and Real.

The Integer type should be familiar because it is a standard data type used quite generally. The Integer formats are capable of representing signed whole numbers. The most significant bit denotes the sign (where a 0 indicates a positive number and a 1 indicates a negative number that is represented in standard two's-complement notation). The three Integer formats differ in length. The shortest format, Word Integer, is 16 bits in length and identical to the Integer format used by the host processor in its own instruction set (IMUL, IDIV). The Short Integer is 32 bits in length. Most 8086 assemblers allow you to allocate space for this type of variable using the Define Doubleword (DD) operator. Appropriately, the longest format is the Long Integer, which is 64 bits in length. Most assemblers allow you to allocate space for this type of variable with the Define Quadword (DQ) operator.

The Packed Decimal format, 80 bits long, is similar to the Integer format in that the most significant bit is a sign bit.

The similarity ends there, however, because the data is stored in Packed Decimal format where the 18 least significant nybbles (bits 0 through 72) each represent a decimal digit. This means that each group of 4 bits must be equal to a value between 0 (0000) and 9 (1001). If this looks like a lot of data, remember that this processor is capable of delivering results that use all 18 nybbles of this format with no round-off error! You can use the Define Ten-byte (DT) operator to allocate space for this variable.

Up until now I have described only data formats that represent whole numbers. While it would be nice if everything always worked out neat and clean without any fractions, in the real world we have to deal with all types of numbers. The next data type, Real, was created to handle these types of numbers.

The Real data type contains three formats. They are very similar to the scientific notation that represents large decimal numbers. A number represented in scientific notation has three components—sign, mantissa, and exponent. In scientific notation, I would represent the decimal number $-547,390$ as -5.4739×10^5 . In other words, I denote the sign of the number in the normal manner. Then I display its value or mantissa as a value between 0 and 10. I do this by moving the decimal point to either the right or the left. Whenever I move the decimal point to the left to normalize the number (make it equal to a value between 0 and 10), the exponent increases. When I move the decimal point to the right to normalize the number, the exponent decreases. For example, 0.0075 becomes 7.5×10^{-3} . The Real formats also have a sign, mantissa or significand, and an exponent, but they are binary values that are calculated a little differently.

As an example, I'll convert the decimal number 66 to the Short Real format. The Short Real format uses the 23 least significant bits to denote the mantissa of the number, the next 8 most significant bits to denote the exponent, and the most significant bit to denote the sign of the number. The first thing I must do is to convert the

number to binary: decimal 66 = binary 1000010. Because this is a whole number, I have no fractional part to worry about. Now I must normalize the number by moving the decimal point over so that the value has a "1" in the most significant digit. As in scientific notation, I increase the exponent whenever I move the decimal point to the left and decrease the exponent whenever I move the decimal point to the right. In this case, because I move the decimal point to the left, the exponent is positive: $1000010 = 1.000010 \text{ E } 110$.

Now I am just about to finish the conversion, but you must know two things. In the Short and Long Real formats I save a bit by dropping the leading "1" bit of the significand. This allows me to denote 24 or 53 digits in the space required for 23 or 52 in the Short or Long formats, respectively. For some reason, this is not done in the Temporary Real format. The second thing is that the standard format requires that a bias be added to the exponent so that negative exponents appear as positive values. The bias is different for each format and is shown in figure 7. The bias for the Short format is 7F hexadecimal (01111111). This means that the exponent becomes $110 + 01111111 = 10000101$. Putting it all together, I get

sign	biased exponent
0	10000101
	significand
	000010000000000000000000

or

0100 0010 1000 0100 0000 0000 0000 0000

With a number with a fractional part, the conversion looks like that shown in table 2. Table 3 is useful in understanding the power of the various data types.

Guaranteed Accuracy

The key to the 8087's ability to produce results with such a high degree of accuracy lies in the fact that the 8087 performs all its calculations in the Temporary Real data format. Regardless of the format in which an operand is stored in memory, any piece of data

that is loaded into the 8087 is transformed into this highly accurate, 80-bit-long format. The benefit derived by using this format for all internal calculations can be best illustrated by the following analogy.

I have a calculator with a range of 3 decimal digits and I want to use it to solve the equation $F = A \times B / C$. I got a calculator with 3-digit accuracy because I determined that A, B, and C would never be greater than 3 digits in length. If $A=100$, $B=10$, and $C=10$, you can see that I will have trouble

solving this problem using my calculator because $A \times B$ is outside of its range. Even though the final result may be well within the range of my calculator, I may have trouble with the intermediate results.

Although changing the order of operations may help in this particular situation, it should be obvious that this solution will not resolve the problem in all cases, for instance, if $A=100$, $B=10$, and $C=0.1$. In this case, I would have a problem if I were to calculate A/C .

Now, if I got a new calculator that had a range of 4 or 5 digits, even though I expected all my results to be 3 digits or less, I could solve my problem. Regardless of the order in which I did my calculations, the intermediate results would probably not overflow the range of the new calculator.

This is precisely how the 8087 can guarantee such accurate results. By using the Temporary Real format for all its calculations, it avoids errors that may appear in the calculation of its intermediate results. The Temporary Real format, as you can see from table 3, has a range so large that we would probably never overflow it in our calculations. Also, because it uses 64 bits for the mantissa, it can provide results that are accurate to 18 significant digits with no round-off errors.

Ease of Use

Another way in which the 8087 can guarantee accurate and standard results is by providing default exception handlers that ensure results even though an error may have occurred during one of the intermediate calculations. For example, if for some reason during the operation of one of my calculations I somehow manage to attempt to divide a number by 0, the 8087, rather than aborting the operation, executes a default response to the zerodivide exception and replaces the quotient with the most reasonable value—infinity. In this manner, the 8087 provides standard results.

```

-178.125D = -10110010.001B
10110010.001 = 1.0110010001 E 111
111 + 01111111 = 10000110
sign    biased exponent    significand
1       10000110          011001000100000000000000
1100 0011 0011 0010 0010 0000 0000 0000

```

Table 2: The conversion of a number with a fractional part.

Data Type	Bits	Significant Digits	Approximate Range
Word Integer	16	4-5	$-32768 < x < 32767$
Short Integer	32	9	$-2E9 < x < 2E9$
Long Integer	64	18	$-9E18 < x < 9E18$
Packed Decimal	80	18	$-99...9 < x < 99...9$ (18 digits)
Short Real	32	6-7	$0, 1.2E-38 < x < 3.4E38$
Long Real	64	15-16	$0, 2.3E-308 < x < 1.7E308$
Temporary Real	80	19-20	$0, 3.4E-4932 < x < 1.1E4932$

Table 3: The various data types.

DATA FORMATS	RANGE	PRECISION	MOST SIGNIFICANT BYTE									
			7	07	07	07	07	07	07	07	07	07
BYTE INTEGER	10^2	8 BITS	₇ ₀ TWO'S COMPLEMENT									
WORD INTEGER	10^4	16 BITS	₁₅ ₀ TWO'S COMPLEMENT									
SHORT INTEGER	10^9	32 BITS	₃₁ ₀ TWO'S COMPLEMENT									
LONG INTEGER	10^{18}	64 BITS	₆₃ ₀ TWO'S COMPLEMENT									
PACKED BCD	10^{18}	18 DIGITS	S — _{D17} _{D16} _{D1} _{D0}									
SHORT REAL	$10^{\pm 38}$	24 BITS	S _{E7} _{E0} _{F1} _{F23} _{F0} IMPLICIT									
LONG REAL	$10^{\pm 308}$	53 BITS	S _{E10} _{E0} _{F1} _{F52} _{F0} IMPLICIT									
TEMPORARY REAL	$10^{\pm 4932}$	64 BITS	S _{E14} _{E0} _{F0} _{F63}									
INTEGER: I PACKED BCD: $(-1)^S (D_{17}...D_0)$			REAL: $(-1)^S (2^{E-BIAS})_1 (F_0...F_{1...})$ BIAS = 127 FOR SHORT REAL 1023 FOR LONG REAL 16383 FOR TEMPORARY REAL									

Figure 7: The seven data formats contained in the three basic types.

Super Graphics Hardware from NEC

The NEC 7220 GDC is a new item of sophisticated graphics hardware for microcomputers.

Graphics capability is rapidly becoming a common feature of personal computers, partially because of consumer demand. The latest item of sophisticated graphics hardware for personal computers is the NEC (Nippon Electric Company) 7220 GDC (graphics-display controller), already found in the NEC Advanced Personal Computer, Epson's QX-10, and the Corvus Concept.

Before explaining what this controller does, I'll make a distinction between video displays and graphics. A video controller generally deals with displaying alphanumeric information such as ASCII (American National Standard Code for Information Interchange) characters. Primarily, it converts ASCII data into a dot pattern that a video monitor displays. You can read a good basic discussion of this subject in *The TV Typewriter Cookbook* by Don Lancaster (Howard W. Sams, 1976).

By contrast, a graphics-display controller converts graphics-image

About the Author

Steve Levine is currently programming computer-graphics simulations and voice I/O for the U.S. Navy. He is employed by Information Network Systems in Warminster, Pennsylvania. Steve is also one of the cochairmen of The Personal Computer Arts Group, which is responsible for five annual Symposia on Small Computers in the Arts held in Philadelphia. He is also involved in the research of a new digital music synthesizer.

Steve Levine
c/o Personal Computer Arts Group
POB 1954
Philadelphia, PA 19105

data into pixel (picture-element) data, and then stores them into or fetches them from display memory. The pixel data represents some arbitrary number of different shades or colors (including white or black) for each element of the picture. A graphics controller shares the display memory with a host computer. This arrangement permits both the host and the controller to read from or write to the display memory. In many cases, this arrangement uses a dual-port memory or interlaced DMA (direct memory access). Thus, data written into display memory can be manipulated by the GDC while the processor is off doing something else.

The most time-consuming part of getting a computer to draw a shape is calculating the next display-memory address to access. In fact, you must repeat this part of the process to change any dot on the screen. If you use the host processor to perform the calculations, the display often exhibits flicker and jerkiness because of the calculation time required. Despite this drawback, however, most small-computer manufacturers leave graphics control to the microprocessor, trading quality for lower cost. Pres-

ently, special graphics computers use external hardware dedicated to vector generation, as well as shape functions (such as rectangles, squares, and circles) prestored in ROM (read-only memory). With these systems cost is usually secondary, as performance is of most importance to the user.

Parts of the 7220 GDC

The 7220 GDC has several parts. The *microprocessor-interface module* serves as an 8-bit bidirectional interface to the host processor. Data transfers into and out of the device are done by monitoring status-register bit flags, which reflect the state of a FIFO (first-in/first-out) buffer. These transfers do not interfere with internal ongoing operations, and the FIFO buffer can store up to nine 16-bit words. The *command processor* decodes commands, interprets the contents of the FIFO buffer, and passes parameters to the proper blocks within the GDC.

The *DMA control* gives you an easy interface to Intel's 8257 and 8237 DMA controller devices. You can also interface other DMA controllers. Display data can be directly loaded into or out of the GDC display memory over the host microprocessor's bus. Sixteen bytes of internal *parameter RAM* (random-access read/write memory) hold the display parameters used by the GDC when drawing. The programmable *video-sync generator*

Microsoft languages connect your software to more 16-bit systems.

The largest market for 16-bit software. Over 95% of all 16-bit microcomputers run Microsoft® operating systems, languages, or both. That means your programs written in Microsoft languages find their market in the largest installed base of 16-bit systems. The IBM® PC, and systems from Wang, Zenith, DEC, Victor, Altos, Texas Instruments and Radio Shack, to name just a few. And, if you're working with Microsoft operating systems and languages, you'll find that it's far easier to transport software between systems.

A full range of languages. The versatile MS-BASIC interpreter and the fast MS-BASIC compiler, Microsoft Business BASIC and MS-COBOL for business use. MS-FORTRAN for scientific and engineering applications. Microsoft C, a complete C, that provides a productive alternative to assembly language. And MS-Pascal, a high-level language compiler specifically designed for microprocessor system software implementation. All these languages are compatible with ANSI or ISO standards.

A total programming environment. Compatible languages. Operating systems. Utilities. Plus complete support. All the tools you need to write software that sells.

Leadership in micros.

Microsoft wrote the first BASIC for the

first production microcomputer. Since then, we've added a full range of 8-bit and 16-bit languages, plus the MS™-DOS and XENIX™ operating systems. What's more, we are constantly enhancing both languages and operating systems. And we make those enhancements available to our customers. That means Microsoft programming languages are state-of-the-art programming tools. Tools that allow your applications programs to reach more systems. More effectively.

More information? See your Microsoft dealer for complete information on Microsoft's 16-bit languages and operating systems. Or, write for our booklet, "The MS-DOS Language Family." A family of tools that give your programs access to the largest installed base of 16-bit systems.

BETTER TOOLS FOR MICROCOMPUTERS

MICROSOFT™

MICROSOFT CORPORATION
10700 NORTHUP WAY
BELLEVUE, WASHINGTON 98004



Microsoft is a registered trademark, and MS, XENIX and the Microsoft logo are trademarks of Microsoft Corporation.

takes its time reference from the master clock and provides synchronization signals for interlaced video raster. It also accepts external slave synchronization when used in conjunction with multiple 7220s. The *memory-timing generator* provides two clock-cycle refresh signals and four clock-cycle read/modify/write signals for the display memory.

The *zoom and pan controller* module allows you to program a zoom factor (or magnification factor) in integers between 1 and 16. Pan (or side-to-side) control is effected by programming different display-

window starting addresses. The *drawing controller* calculates the pixel addresses for lines, figures, and characters. You set the drawing parameters and a starting point, and the controller proceeds to draw the desired figure, without assistance, from that point on. The *display-memory controller* handles all memory multiplexing, modification, refresh counting (for dynamic memories), and partitions the video-field time between different types of cycles. Finally, the *light-pen de-glitcher* looks for two rising edges occurring at the same point in two suc-

cessive video fields. When this occurs, its signals change a status bit to show that the address contained in the light-pen register is valid.

Display Modes

You can select three basic display modes with the 7220: graphics, character, or mixed.

The graphics mode lets you use bit-mapped graphics at the pixel level. This mode allows a display to be up to 4096 pixels square (allowing 1 bit per pixel for intensity information) or 1024 pixels square (allowing 4 bits for color or intensity-level information). Other combinations can be set up as well—the circuit used in this article produces a 512- by 240-pixel window, 1 bit deep, on a 1024-pixel-square, 1-bit-deep world.

Character mode allows up to 8K bytes of display memory for character codes and attributes.

The mixed character and graphics mode allows 64K bytes of display memory.

Displaying Memory

A basic read/modify/write cycle takes place in less than 800 nanoseconds (ns). This interval is the minimum for writing totally new pixels into memory, one at a time. The GDC provides the memory control, refresh, and handshake with DMA controllers. The benefits are obvious. The hardware designer does not have to design circuitry to produce refresh signals, because the 7220 generates them. Additionally, because the 7220 controls the data-modification and video-display functions, you get a clean display without visi-burps. You control several display parameters, including the horizontal width, vertical size, and the world size (total amount of display memory). You can also select zoom factors and interlaced or noninterlaced synchronization.

To display a complete frame of video information, an image must be kept in display memory. Because memory organization is a linear-address space, an image of a single horizontal line is actually stored as a number of widely separated dots. If you divide the number of dots per

DECADES OF SERVICE

Washington Computer Services

97 Spring Street
New York, New York 10012

TO ORDER: CALL OUR TOLL-FREE NUMBER: (800)221-5416

In N.Y. State and for technical information: (212) 226-2121

HOURS: 9:30 AM—5:30 PM (EST) Monday-Friday

an affiliate of **WASHINGTON ELECTRIC COMPANY** est. 1912

CUSTOM COMPUTER ROOM WIRING SINCE 1960

TELEX: 12-5606 CABLE: WASHCOMP NYK

FULLY CONFIGURED BUSINESS SYSTEMS

The following are some examples of the fully assembled and tested business and scientific computer systems which we offer

IMS The Premier Multi-User Computer System CALL FOR CONFIGURATION
8000 SX, multi-processor, turbo BUS
INTERNATIONAL CPM 2.2 FULL 2 YEAR WARRANTY!
5000 IS, S-100 desk top mainframe
8000 S up to 16 user
3270 Software Available
On-Site Service Contracts Available

NEC APC-8086, 16 bit, 128K, 8" DRIVES, Optional 1024 x 1024 Color Graphic, 32 bit FP Proc., MS DOS, CP/M 86 from \$3295
PC-8800 Personal Computer
The Professional's Work Station
NEC on N.Y.S. Contract #P-07220

IBM 68000 16 bit multi-user, S-100, UNIX V. 7 SCALL

A SEATTLE COMPUTER 8086 16 bit, 128K RAM, S-100, Gazelle

Systems Group **XEROX** **MORROW DESIGNS**
California Computer Systems **GOABOUT** **ALTOS**
Under Systems **NorthStar** 8 & 16 BIT BOARDS & SYSTEMS

SCION MicroAngelo Hi Res Graphics Systems SCALL
Similar savings on SSM, DELTA, DYNABYTE, TELEVIDEO, DIGIAC, ADDS, DEC, DATA GEN., ATARI, TECHMAR, EPSON, ZENITH, MORROW, AND MANY OTHERS

PRINTERS

Teletype 40, 300 LPM, typewriter quality, RS-232 interface. This quality printer is available in many configurations including forms access, queued case, etc. from Only \$3200

Teletype 43 from \$995

ANADEX	DIABLO	MANNESMANN TALLY
CENTRONICS	EPSON	NEC AMERICA
C. ITOH	FACIT	QUME
DATA PRODUCTS	OKIDATA	TOSHIBA
DIGITAL EQUIP. CORP.	OLIVETTI	TELETYPE
INTERGRAL DATA SYS.	QANTEX	TEXAS INSTRUMENTS

Where Do You Turn To Solve Your Computer Puzzle?

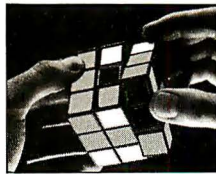

TURN TO US!

We'll show you the easiest way to put the pieces together.

Matched. Compatible. Proven—Use Someone Else's Engineering to Supplement Yours.

SOFTWARE

Over 2000 business scientific, professional applications & educational packages are available. Call with your requirements for our advice or a quotation. We feature DBase II & Fox & Geller.

8" DISK DRIVE SALE

NOW!

8" SHUGART SAB01R \$385 8" SHUGART SA 851R \$540 2 for \$1025
QUME DATATRACK 8 or MITSUBISHI \$550 2 for \$1050
Enclosure, power supply for 2 8" drives A & T \$350
MORROW DISCUS 20 + CP/M* MICROSOFT BASIC, CONT. \$950
VISTA SCALL

TERMINALS

PMMI MODEM	\$359
TELETYPE	ADDS
TELEVIDEO	ANN ARBOR
LEAR SIEGLER	VISUAL
	IBM 3101
	DIGITAL EQUIP. CORP.
	HAZELTINE

AMPEX Dialogue 175™

18 Emulations
• Full cursor control
• Full editing keys
• Full visual attributes
• 2 pages (4 page optional)
• Printer port

• Black & White, Green, or Amber screen
\$795



NEW!
QUME QVT 102
\$669

FIRST OF A NEW GENERATION

PLEASE! Do not confuse us with mail order dealers. We are a full service distributor serving the data processing & installation needs of business & industry from micros to mainframes. System houses, educational institutions & governmental agencies given special consideration. Leasing available.

N. Y. State agencies, municipalities, and schools — call us for information on our O.G.S. term contracts on hardware & software.

DEALER and INTERNATIONAL INQUIRIES WELCOME

For fast delivery, send certified check, money order or call to arrange direct bank wire transfer. Personal or company checks require two to three weeks to clear. Prices subject to change without notice; call for latest prices. Prices include 3% cash discount. N.Y. residents add sales tax. Qantex is a trademark of North Atlantic Industries, Inc. CP/M* is a trademark of Digital Research. All sales subject to our standard sale conditions (available on request). Call for shipping charges. Above prices do not include customization or installation. DBase II is a trademark of Ashton Tate. P.O.'s accepted upon our credit approval; call for prices and terms.

See other ad on page 483.

(a) Pitch (P)
 $P = (XMAX + 1) / 16$

(b) Line-Base Address (LBA)
 $LBA = P \cdot Y$

(c) Execute Address (EAD)
 $EAD = LBA + INT(X/16)$

(d) DAD (dot address)
 $DAD = \text{remainder (from EAD calculation)} \cdot 16$

Figure 1: Four equations to locate an individual dot address.

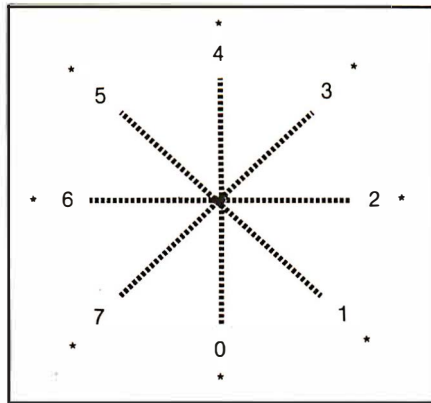

Figure 2: A direction map for controlling pixel-drawing direction.

A0	Read	Write
0	S/R	Parameters into FIFO
1	FIFO	Command into FIFO

Figure 3: GDC addressing.

Data Ready	FIFO Full	FIFO Empty	DWG in Progress	DMA Execute	V-sync Active	H-blank Active	L-pen Detect
B7	B6	B5	B4	B3	B2	B1	B0

Figure 4: The status register.

line by 16 you get a value called pitch, or the number of 16-bit memory words per line. To move the cursor down one dot on the screen, you add the pitch to the 18-bit value in the word address and use a 4-bit dot address to access the individual pixel within that word. To move the cursor forward or backward on a line, all you need are simple increments and decrements. You obtain diagonal movement with some combination of these two methods.

When a new pixel is to be written into display memory, its position within a 16-bit word is loaded into the mask register. Then you specify the absolute cursor position, the modification pattern, and the type of modification (replacement, complement, set, or reset). The GDC automatically changes only the bit you want to update. The host processor continues to do other things while the display processor performs this legwork. You will notice the real power of this approach when you try to create complex shapes made up of many fundamental shapes and scale, and then move or redraw them.

Pixel Addressing

There can be up to 2^{22} pixels organized as 2^{18} sixteen-bit words, and you need a two-part address to select an individual pixel. First, the

EAD (execute address) selects a particular 16-bit word out of the 256K bytes; then the DAD (dot address) selects which bit or pixel from the 16 to operate on.

Consider an x - y vector-list scheme where we would like to find the individual dot address (see figure 1). You simply derive the P or pitch from equation a, find the line-base address (LBA) using equation b, and get the EAD from equation c. Next you obtain the dot address from equation d, and you now point to the exact pixel in the x,y matrix. We structure the memory as a power of 2 in order to avoid real arithmetic for these calculations. We send these numbers to the GDC (in binary) to set the cursor position.

An important parameter in deriving consecutive pixel addresses is the DIR, which controls pixel-drawing direction. This is best illustrated by the direction map in figure 2. Drawing direction is divided into eight movements about the center. By specifying a direction, you get a resulting dot movement according to the figure.

Talking to the 7220

The GDC appears as two consecutive addresses to the host, which selects between the two by using address bit 0 (see figure 3). The first ad-

dress is status register on read and parameter into FIFO buffer on write. The second address serves as read/write FIFO buffer, with write pertaining only to command into FIFO buffer. In order to get commands and data into the FIFO buffer, you handshake with a FIFO ready bit in the status register. You first send a command byte followed by several parameter bytes that make up the command. After initial loading, an internal command processor decodes the commands, sets the appropriate registers to the passed values, and starts the specified process.

A simple software or hardware handshake is necessary when loading data into the GDC FIFO buffer. The status register has FIFO FULL, EMPTY as well as other flags of interest to the programmer (see figure 4).

Summary of Commands

The FIFO buffer holds both commands and parameters. By writing data to the second, or command, address, you apply a special tag to the data that identifies it as a command when it is put into the FIFO buffer. This tag helps the command processor to tell the difference between parameters and commands. When the command processor receives a new command byte, it terminates previous commands. Commands for the GDC are shown in table 1.

Figure Drawing

The *digital differential analyzer* (DDA) forms the workhorse section of the figure-drawing logic. It per-

\$1590



Full size smart terminal with detachable keyboard

4Mhz Z80A CPU
64K RAM Main Memory
200Kbyte 5 1/4" floppy disk
(Osborn, Xerox, IBM, CP/M-86 formats)
Two serial ports

Complete software package includes:

- WordStar word processing
- Correct-It spelling checker
- LogiCalc electronic spreadsheet
- Microsoft BASIC
- NorthStar compatible BAZIC
- CP/M 2.2 Operating System



At \$1790, this computer was selling like hotcakes. So we dropped the price.

Crazy? No, not really. You see in order to meet the demand for the Micro Decision™ we increased our production. When we did that, our costs dropped. We're passing our savings on to you, because that's our philosophy.

More for less.

So now it only takes \$1590 to buy a Micro Decision with 64K of memory, a 200K double density floppy drive and a full-size Morrow smart terminal with detachable keyboard. Not bad. But there's more.

The Micro Decision also includes a package of business and professional software worth well over \$2000. The WordStar® word processor. A 36,000 word spelling checker. The LogiCalc™ electronic spreadsheet. And both Microsoft BASIC-80® and NorthStar-compatible BAZIC®. Plus, the CP/M® 2.2 Operating System that gives you access to thousands of other software programs. And, we take the mystery out of CP/M with plain English commands and single-key operation.

If you have your own terminal, you can buy the complete

computer and software package for \$995. That's the Micro Decision MD1™. The MD2™ includes another double-density disk drive, plus Personal PEARL™ the relational data base manager. Price? Only \$1395.

More memory? No problem. The Micro Decision MD3™ gives you two double-sided, double-density disk drives with 768K of storage and Personal PEARL for only \$2290. Without the terminal, \$1695.

Come in for a complete demonstration at your nearest Morrow Designs dealer. If you don't know who that is, call us toll-free at (800) 521-3793. In California, call (415) 430-1970. At \$1790, the Micro Decision sold like hotcakes. At \$1590, we've just sweetened the deal.

More computer, for less.

MORROW DESIGNS

MORROW DESIGNS
600 McCormick Street □ San Leandro, CA 94577
(800) 521-3793 □ (415) 430-1970 In California



Circle 290 on Inquiry card.



Micro Decision, MD1, MD2, and MD3 are trademarks of Morrow Designs
WordStar is a registered trademark of MicroPro, Inc.
LogiCalc is a trademark of Software Products International
BASIC-80 is a registered trademark of Microsoft Corporation
BAZIC is a registered trademark of Micro Mikes, Inc.
Personal PEARL is a trademark of Relational Systems, Inc.
CP/M is a registered trademark of Digital Research, Inc.

Video Control		
A	RESET:	Set 7220 to idle, set video-display format
B	SYNC:	Set video-display format
C	VSYNC:	Master or slave video-sync mode
D	CCHAR:	Cursor and character row heights
Display Control		
A	START:	Begin scanning
B	ZOOM:	Specify zoom factors
C	CURS:	Specify cursor position in display memory
D	PRAM:	Set display area's start and length. Also set 8 bytes for the graphics character
E	PITCH:	Display-memory X-dimension width
Drawing Control		
A	WDAT:	Write data into display memory
B	MASK:	Specify mask-register contents
C	FIGS:	Figure specify of drawing parameters
D	FIGD:	Draw the above specified figure
E	GCHRD:	Graphics character draw
Data Read		
A	RDAT:	Read data from display memory
B	CURD:	Read cursor position
C	LPRD:	Light-pen address read
DMA Control		
A	DMAR:	Request a DMA read transfer
B	DMAW:	Request a DMA write transfer

Table 1: The GDC command summary.

16-bit integer used as a slope term. These four parameters are derived from equations that represent initial and ending vectors of a line, arc, or rectangle. In addition to specifying values for these four parameters, you must load the EAD of the beginning pixel, the DAD, and the DIR values before you issue the FIGD (figure draw) command.

With a minimum of instructions, you can make the GDC draw fundamental shapes. The DDA, which is on-chip hardware, does the time-consuming calculation to produce the next pixel address for the shape. This circuit and the memory-modification hardware (read/modify/write) combine to produce a rapid update of new pixels.

When you want to begin figure drawing, you load a figure type, drawing direction, drawing parameters, cursor starting address, and the pattern into the FIFO buffer. Then you issue a FIGD command. A FIGS (figure specify) command alerts the GDC to the necessary drawing parameters, which are either computed by the host processor or stored in a table (see figure 5).

A Line-Drawing Example

The GDC drawing technique uses independent and dependent axes. The host processor determines which axis is independent and which is dependent for the particular drawing direction or octant of that vector. To draw a line from XY Start to XY End, you first move the cursor to XY Start with the CURS command, then calculate the Deltas ($\Delta X = X_{End} - X_{Start}$, $\Delta Y = Y_{End} - Y_{Start}$, and find the direction by locating the quadrant and the octant (see table 2). If $ABS \Delta X = ABS \Delta Y$, the vector is on octant boundary within that quadrant and you choose the higher-numbered odd octant.

You then determine the independent and dependent axes with the following equation:

$$\begin{aligned} &\text{If } \Delta X > \Delta Y \\ &\quad \text{Then } I = X, D = Y \\ &\text{If } \Delta X \leq \Delta Y \\ &\quad \text{Then } I = Y, D = X \end{aligned}$$

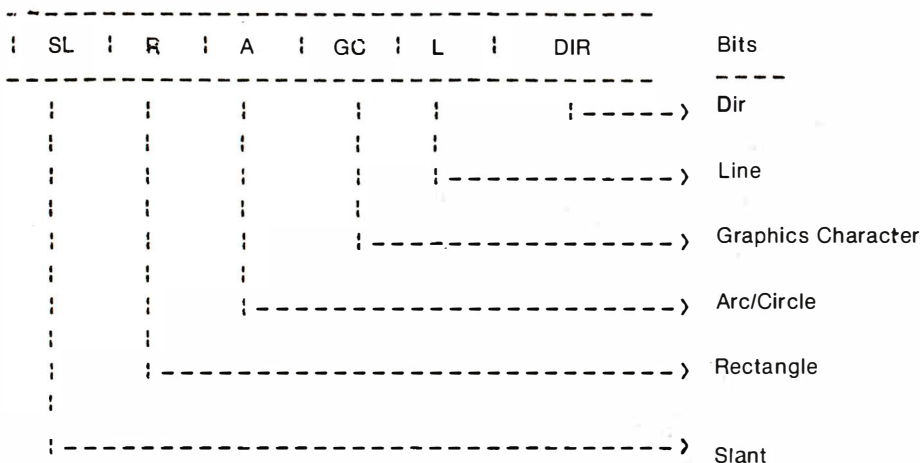

Figure 5: The layout of the FIGS (figure specify) command.

forms the necessary adds, shifts, and counts that allow you to draw a 100-pixel figure in only 80 microseconds (μs), using differential equations to specify the delta x, y information. (See *Principles of Interactive Computer Graphics* by William M. Newman and Robert F. Sproul [McGraw-Hill, 1979, pp. 22-28].)

To perform the differential opera-

tions on vectors, you specify values for the DDA parameters. The four DDA parameters for vector operations are DC (dot count), an unsigned integer from 0 to 16,383 calculated by the host to be the total number of pixels to move; D1, the same type of number, but used for slope-encoding terms; D, a 16-bit integer, also used as a slope term; and D2, another



IF MetaCard DOESN'T IMPROVE YOUR WORKING CONDITIONS WE'LL GIVE YOU YOUR MONEY BACK.

It's almost three in the morning. You knew just one more line of code and your program would be finished. That was seven hours ago. It's hard work developing good software. Writing it on the Apple II is no exception. Although we can't promise to get you to bed by eleven o'clock, we can make your job a lot easier.

When we developed MetaCard, a co-processor system for the Apple II, we designed in 128K bytes of on-board memory with parity. Enough memory to run the most powerful development tools available. We included memory expansion capabilities beyond 128K.

And we made sure it could run all three operating systems for the IBM PC. MetaCard does more than make your job easier, it opens up new development areas. If you want to create or run more powerful applications software for the Apple, or for the IBM PC or other 8086/88-based systems, you should have a MetaCard in your Apple. MetaCard supports the most popular development languages available for MS-DOS, CP/M-86 and UCSD p-System Version IV. Languages like Pascal, C, COBOL,

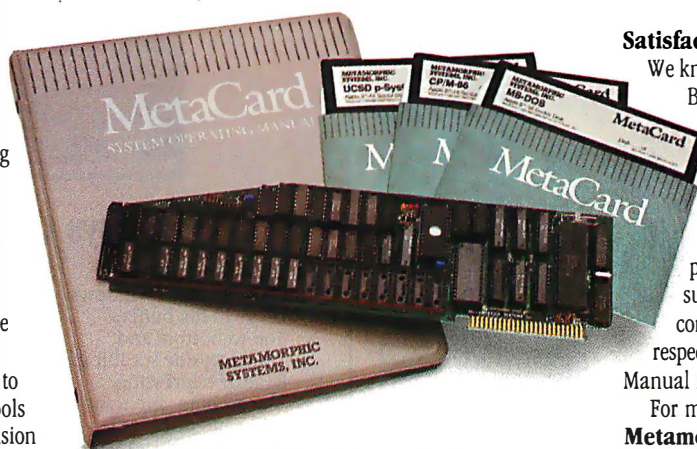

FORTRAN, BASIC and almost all others operate at peak performance. MetaCard enables you to continue to use most of the popular peripherals for your Apple II, plus all of your existing software. And with many best selling applications for the IBM PC available soon, you can use your Apple in new and developing areas.

MetaCard uses the Intel 8088 processor and operates at a full 5 Mhz. And MetaCard's real-time clock, external power supply, parity checking RAM, and power-up ROM diagnostics give you the features and reliability you demand.

Satisfaction Guaranteed

We know you'll still work through the night.

But if MetaCard doesn't improve your working conditions, return it within 30 days, and we'll send your money back. No questions asked.

MetaCard, complete with documentation, MS-DOS and UCSD p-System (CP/M-86 optional) and power supply, is available in both 64 and 128K configurations, priced at \$980 and \$1,150 respectively. The MetaCard System Operating Manual is available for only \$25.

For more information write us today, **Metamorphic Systems, Inc.**, 8950 Villa La Jolla Drive, Suite 1200, La Jolla, CA 92037.

Or call us today to order yours at

800/228-8088

In California call 619/457-3870.

MetaCard is a trademark of Metamorphic Systems, Inc., Apple — Apple Computer Inc., Intel 8088 — Intel Corporation, CP/M-86 — Digital Research Corporation, MS-DOS — Microsoft, UCSD p-System — University of California, IBM PC — IBM.

Circle 464 on inquiry card.

MetaCard

Quadrant		
Delta__X sign	Delta__Y sign	Quadrant
+	-	1
-	-	2
-	+	3
+	+	4

Octant		
ABS Delta__X	>	ABS Delta__Y
If Quadrant	Then	Octant
1		2
2		5
3		6
4		1

Octant		
ABS Delta__X	<	ABS Delta__Y
If Quadrant	Then	Octant
1		3
2		4
3		7
4		0

Table 2: Information for locating the quadrant and octant for line drawing.

Now you compute the line-drawing DDA parameters:

$$DC = ABS (Delta_I)$$

$$D = [2 * ABS (Delta_D)] - ABS (Delta_I)$$

$$D2 = 2 * [ABS (Delta_D) - ABS (Delta_I)]$$

$$D1 = 2 * ABS (Delta_D)$$

You can make these operations fairly efficient by using a table for octant and axis determination.

Once these parameters are calculated, you load them into the GDC FIFO buffer with a FIGS command. Then you load a pattern into parameter RAM with a PRAM command. The pattern corresponds to the type of line—broken, dashed, or solid. A WDAT (write data) command with bit modifier and a FIGD command complete the figure-drawing process (see photos 1 through 4).

Drawing a circle of arbitrary radius at a specified point on the display requires that you prepare most of the parameters discussed above with the

Edix™ + Wordix™ has word processing features that our competitors are still dreaming about . . .

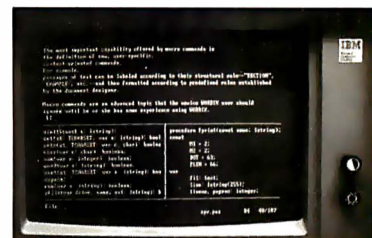

\$390 buys the whole dream.

Edix Editing Features

- Up to 4 screen windows
- Up to 12 file buffers
- Top-to-bottom and side-to-side scrolling.
- Regular expression searching and translating
- Intra- and inter-buffer moving and copying
- Online help
- Online tutorial

Wordix Formatting Features

- Auto footnotes
- Auto table of contents
- Auto hyphenation
- Multi-line headers and footers
- Multi-column layout
- Powerful macros
- Data file access
- Requires 128K IBM PC
- Edix alone: \$195

EMERGING
TECHNOLOGY

2031 Broadway Boulder, Colorado 80302 303 447-9495

For more information, or to place an order, call toll-free 800-782-4896.

TM Trademark of Emerging Technology Consultants, Inc.



TEAR AND COMPARE TO 5251s OUT

THE PCI 51, AN ASCII SOLUTION THAT'S KEYSTROKE FOR KEYSTROKE 5251-11 KEYBOARD COMPATIBLE. SYSTEM 34/38 5251 EMULATION WITH PCI'S 1051.

Name _____

Company Name _____

Address _____

City _____ State _____ Zip _____

Phone _____

- Send me more information on the PCI 51 and PCI 1051.
- Send me information on all PCI products.

PCI PROTOCOL
COMPUTERS, INC.
(800) 423-5904
(213) 716-5500 (In California)



6150 Canoga Ave., Suite 100, Woodland Hills, CA 91367-3773



Dear Ma:

Racal-Vadic has the Ultimate 212A. It's like getting a Porsche at Volkswagen prices!



**The Auto-Dial VA212...
For Those Who Want Everything**

Racal-Vadic has the ultimate 212A-compatible modem. It operates at 1200 and 0 to 300 bps and has a built-in automatic dialer with a non-volatile memory that can store as many as 15 phone numbers, up to 31 digits each. Non-volatile means the memory is retained even if you lose power.

This remarkable modem "talks" to the terminal operator using English words and phrases to indicate call progress, option status, and telephone numbers in memory. Calls can be originated or answered from the terminal keyboard or the modem front panel.

The front panel is really something, Ma. It has a 16-key tactile-touch keyboard and an eight character liquid crystal display. Twenty-six user programmable options are stored in the modem's memory, and can be keyed in from the front panel... eliminating the need to open the modem to change options.

The VA212LC... For The Economy Minded

For those who don't want auto-dial, Racal-Vadic has the perfect modem. It's called the VA212LC. LC means low cost... just \$550 in single quantity.

This is not a stripped down model. The VA212LC is a full-featured 212A-compatible modem with manual originate and automatic answer. It operates at 1200 and 0 to 300 bps full-duplex.

The VA212LC's extensive diagnostics include remote digital loopback and self test. Remote loopback allows end-to-end testing over the telephone from any of Racal-Vadic's regional diagnostic centers. The carrier indicator shows when you've established connection.



Now there is a real choice in the 212A market... A Porsche at a Volkswagen price... or the Volks itself at an even lower price.

Phone or write Racal-Vadic today!
Your Independent Thinking Son,

Alexander Graham Jr.

PHONE: 800-543-3000, Operator 507

Circle 363 on Inquiry card.

Racal-Vadic Member IDCMA

222 Caspian Drive, Sunnyvale, CA 94086
Tel: (408) 744-0810 • TWX: 910-339-9297

RACAL

"See us at NCC Booth W6248"

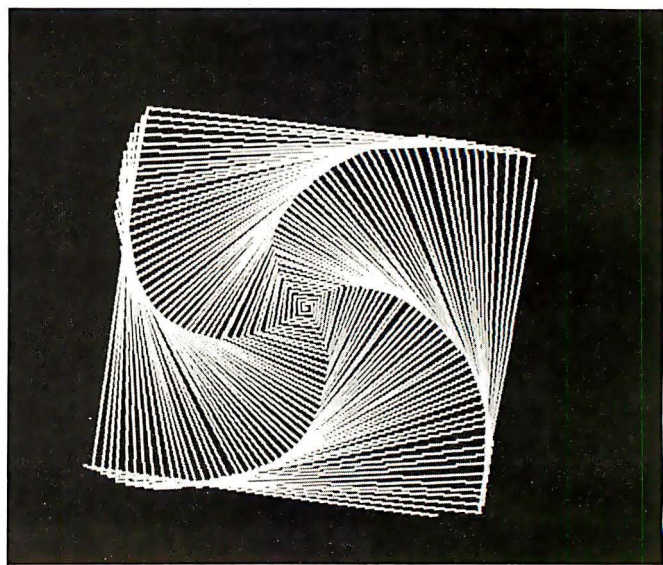
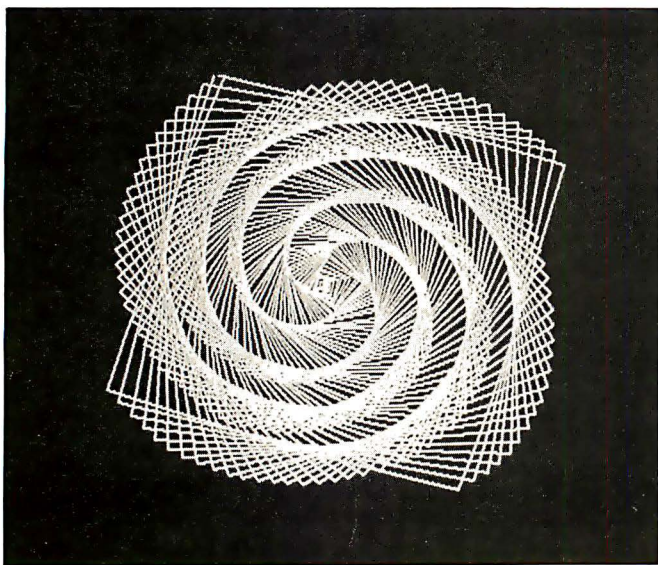
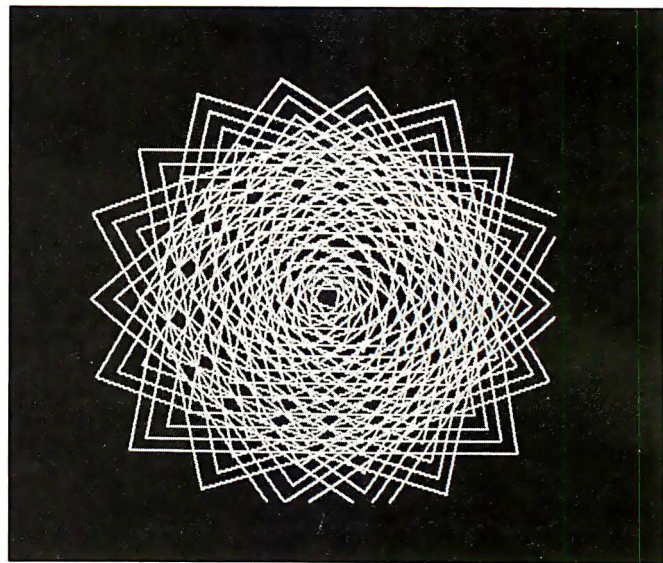
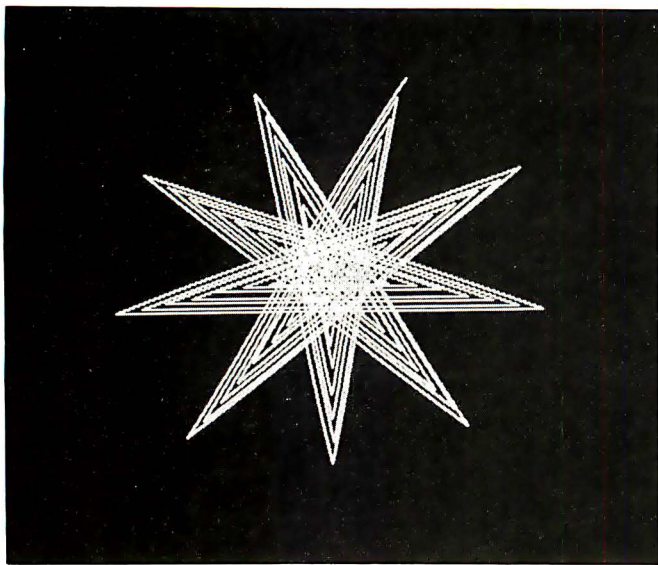

Photos 1-4: Examples of the GDC figure-drawing process.

exception of the DDA drawing parameters. The following information draws a circle as eight arcs, with two per quadrant:

$$\begin{aligned} DC &= \text{Radius} * \text{Sin}(\text{Theta}) \\ D &= \text{Radius} - 1 \\ D2 &= 2 * (\text{Radius} - 1) \\ D1 &= -1 \\ DM &= \text{Radius} * \text{Sin}(\text{Phi}) \end{aligned}$$

The starting points might be

$$\begin{aligned} &\text{radius}, 0 \\ &0, \text{radius} \\ &-\text{radius}, 0 \\ &0, -\text{radius} \end{aligned}$$

Rectangle drawing is similar, but simpler:

$$\begin{aligned} DC &= 3 \text{ (fixed for circles or arcs)} \\ D &= (\text{Total number of pixels in} \\ &\quad \text{initially specified direction}) \\ &\quad -1 \\ D2 &= (\text{Total number of pixels in} \\ &\quad \text{perpendicular direction}) -1 \\ D1 &= -1 \\ DM &= \text{Same as } D \end{aligned}$$

Applications

The 7220 GDC is not a simple device. While many of you have probably written a BIOS (basic input/output system) or CRTC (cathode-ray tube controller) handler, developing a decent assembly-language driver for this chip is non-trivial. The driver I am currently using was written by Frank Caparello

under the auspices of Roger Amidon and others, the developers of the new Epson QX-10. The S-100 board I used to draw the demonstration screens was also developed by them. The Epson QX-10 uses a 7220 as a display chip but has operating-system calls to do all the fancy stuff.

The GDC design manual that NEC provides is very well written and offers you a basic tutorial on computer graphics. It includes numerous examples of parameter derivation as well as hardware-interface information. I highly recommend it.

I believe the 7220 GDC will be a standard for microcomputer displays for the next few years. If the price falls, you may even find it in arcade games and low-end terminals. ■

FREE
with software purchase—
One CPM Handbook

DISCOUNT SOFTWARE

✓ = New items

ASHTON-TATE
dBASE II... call for price (\$477)

CP/M®

ARTIFICIAL INTELLIGENCE®

Medical(PAS-3)... \$849
Dental (PAS-3)... \$849

ASYST DESIGN®/FRONTIER

Prof Time Accounting... \$549
General Subroutine... \$269
Application Utilities... \$439

DIGITAL RESEARCH®

CP/M 2.2®
NorthStar... \$149
TRS-80 Model II (P+T)... \$159
Micropolis... \$175
CP/M-Intel MDS... \$135
PL/1-80... \$449
BT-80... \$179
MAC... \$ 85
RMAC... \$179
Sid... \$ 65
Z-Sid... \$ 90
Tex... \$ 90
DeSpool... \$ 49
CB-80... \$459
CBasic-2... \$ 98
Link-80... \$ 90

FOX & GELLER

Quickscreen... \$135
Quickcode... \$265
dutil... \$ 65

MICRO-AP®

S-Basic... \$269
Selector IV... \$295
Selector V... \$495

MICRO DATA BASE SYSTEMS®

HDBS... \$269
MDBS... \$795
DRS or ORS or RTL... \$269
MDBS PKG... \$1999

MICROPRO®

WordStar... \$279
Customization Notes... \$449
Mail-Merge... \$ 99
WordStar/Mail-Merge... \$369
DataStar... \$249
WordMaster... \$119
SuperSort I... \$199
Spell Star... \$139
CalcStar... \$259

MICROSOFT®

Basic-80... \$199
Basic Compiler... \$329
Fortran-80... \$349
Cobol-80... \$589
M-Sort... \$175
Macro-80... \$144
Edit-80... \$ 84
MuSimp/MuMath... \$224
MuLisp-80... \$174
FPL: Bus. Planner... \$595

ORGANIC SOFTWARE®

TextWriter III... \$111
DateBook II... \$269
Milestone... \$269

OSBORNE® (McGraw/Hill)

General Ledger... \$ 59

SAVE \$255 ON PRODUCTIVITY PAC #3!

Everything you need: a wordprocessor, spreadsheet and database. And a phenomenally low, low price!

	Retail	Regular Discount
Final Word	\$300	\$270
Plannercalc	\$ 99	\$ 50
Condor I	\$295	\$275
	\$694	\$595

SPECIAL COMBINATION PRICE: \$439

Offer good to the end of the month of publication of this magazine. Call for our other PAC prices.

Acct Rec/Acct Pay... \$ 59
Payroll w/Cost... \$ 59
All 3... \$129
All 3 + CBasic-2... \$199
Enhanced Osborne (vandatta) (Includes CBasic)... \$269

PEACHTREE®

General Ledger... \$399
Acct Receivable... \$399
Acct Payable... \$399
Payroll... \$399
Inventory... \$399
Surveyor... \$399
Property Mgt... \$799
CPA Client Write-up... \$799
P8 Version... Add \$234
MagiCalc... \$269
Other... less 10%

STAR COMPUTER SYSTEMS

G/L, A/R, A/P Pay... \$ 349
All 4... \$1129
Legal Time Billing... \$ 849
Property Mngmt... \$ 849

STRUCTURED SYSTEMS®

Business Packages, Call for Price
SORCIM®
SuperCalc... \$249
Trans 86... \$115
Act... \$157

SUPERSOFT®

Ada... \$270
Diagnostic I... \$ 49
Diagnostic II... \$ 84
Disk Doctor... \$ 89
Forth (8080 or Z80)... \$149
Fortran... \$219
Fortran w/Ratfor... \$289
C Compiler... \$189
Star Edit... \$266
Scratch Pad... \$174
Analyze II... \$ 45
Dataview... \$174
Disk Edit... \$ 89
Encode/Decode II... \$ 84
Optimizer... \$174
Super M List... 68
Term II... \$179
Zap Z-8000... \$450
Utilities I... \$ 54
Utilities II... \$ 54

ACCOUNTING PLUS

1 Module... \$385

4 Modules... \$1255
All 8... \$4500

UNICORN®

Mince... \$149
Scribble... \$149
Both... \$249
The Final Word... \$270

WHITESMITHS®

'C' Compiler... \$600
Pascal (incl 'C')... \$850

"PASCAL"

✓ Pascal/MT+ Pkg... \$429
Compiler... \$315
Sp Prog... \$175
Pascal/Z... \$349
Pascal/UCSD 4.0... \$670
Pascal/M... \$355
Tiny Pascal... \$ 76

"DATA BASE"

FMS-80... \$894
dBASE II... \$595
✓ Condor I... \$275
Condor II... \$535
FMS-81... \$445

"WORD PROCESSING"

WordSearch... \$179
SpellGuard... \$199
Peachtext... \$289
Magic Spell... \$269
Spell Binder... \$349
Select... \$495
The Word... \$ 65
The Word Plus... \$145
Palantier-I (WP)... \$385

"COMMUNICATIONS"

Ascom... \$149
BSTAM... \$149
BSTMS... \$149
Crosstalk... \$139
Move-It... \$ 89

"OTHER GOODIES"

Micro Plan... \$419
Plan 80... \$269
Target (Integerchange)... \$125
Target (Planner)... \$189
Target (Task)... \$299
Plannercalc... \$ 50
Encode/Decode II... \$ 89
Tiny 'C' Compiler... \$229
Nevada Cobol... \$179
MicroStar... \$224
Vedit... \$130
MiniModel... \$449
StatPak... \$449
Micro B+... \$229
Raid... \$224

String/80... \$ 84
String/80 (source)... \$279
ISIS CP/M Utility... \$199
Lynx... \$199
Supervyz... \$ 95
ATI Power... \$ 75
Mathe Magic... \$ 95
CIS COBOL... \$765
ZIP MBASIC, CBasic... \$129
Real Estate Analysis... \$116

APPLE II®

BRODERBUND
G/L (with A/P)... \$444
Payroll... \$355

INFO UNLIMITED®

EasyWriter (Prof)... \$155
Datadex... \$129
EasyMailer (Prof)... \$134
Other... less 15%

MICROSOFT®

✓ Softcard (Z-80 CP/M)... \$239
Fortran... \$179
Cobol... \$499
Tasc... \$139
✓ Premium Package... \$549
✓ RAM Card... \$129

MICROPRO®

✓ Wordstar... \$199
MailMerge... \$ 99
Wordstar/MailMerge... \$349
SuperSort I... \$159
Spellstar... \$129
CalcStar... \$175
DataStar... \$265

VISICORP®

✓ Visicalc 3.3... \$189
Desktop/Plan II... \$219
Visitem... \$ 90
Visidex... \$219
Visiplot... \$180
Visitrend/Visiplot... \$259
Visifile... \$219
Visischedule... \$259

PEACHTREE®

G/L, A/R, A/P Pay or Inventory (each)... \$224
Peach Pack P40... \$795

SOFTWARE DIMENSIONS, INC.

Accounting Plus II, G/L, A/R, A/P or Inventory (each)... \$385
(Needs G/L to run)

"OTHER GOODIES"

Super-Text II... \$127

Data Factory... \$134
DB Master... \$184
Versaform VS1... \$350
VH1... \$445

16-BIT SOFTWARE

WORD PROCESSING

IBM PC
✓ Wordstar... \$279
✓ Spellstar... \$175
Mailmerge... \$109
Easywriter... \$314
Easyspeller... \$159
Select/Superspell... \$535
Write On... \$116
Spellguard (also available for 8" 8086 systems)... \$229
SP Law (for Spellguard)... \$115
Textwriter III... \$189
Spellbinder... \$349
Final Word... \$270

LANGUAGE UTILITIES

IBM PC
Crosstalk... \$174
BSTAM... \$149
BSTMS... \$149

8" 16-BIT SYSTEMS

✓ Pascal MT+ /86, SSP... \$679
CBasic 86... \$294
Pascal M/86... \$445
Act 86... \$157
Trans 86... \$115
XLT 86... \$135

16-BIT 8" AND DISPLAYWRITER

CP/M 86... \$294
MP/M 86... \$585

OTHERS

IBM PC
SuperCalc... \$269
VisiCalc... \$219
Easycalc... \$359
Mathematic... \$ 89
CP/M Power... \$ 65
Condor 21... \$265
Condor 22... \$535
Condor 23... \$895
Condor 20Q... \$175
Condor 20R... \$265
Statpak... \$449
Optimizer... \$174
Desktop Plan II... \$219
Desktop Plan III... \$259
Visidex... \$219
Visitrend... \$259
Many others available for use with the "Baby Blue Board®"

8" 16-BIT SOFTWARE

SuperCalc... \$269
CP/M Power... \$ 65

FORMATS AVAILABLE:

8" single density
8" OS/2
Superbrain
Micropolis/Vector Graphic
NorthStar Horizon
NorthStar Advantage
Osborne
Health/Zenith
Cromemco
Televideo
Xerox 820
Dynabyte
Hewlett-Packard 125
NEC
Eagle
Apple II/III
Otrona
TRS-80 Model I/II/III
DEC VT-180
Altos
CP/M-86
IBM PC

LOWER PRICES, COME HELL OR HIGH WATER.

ORDERS ONLY • CALL TOLL FREE • VISA • MASTERCHARGE
U.S. 1-800-421-4003 • CALIF. 1-800-252-4092

Outside Continental U.S.—add \$10 plus Air Parcel Post • Add \$3.50 postage and handling per each item • California residents add 6 1/2% sales tax • Allow 2 weeks on checks. C.O.D. \$3.00 extra • Prices subject to change without notice. All items subject to availability • ®—Mfgs. Trademark. Blue Label \$3.00 additional per item.

CP/M is a registered trademark of DIGITAL RESEARCH, INC.

THE DISCOUNT SOFTWARE GROUP

6520 Selma Ave. Suite 309 • Los Angeles, Ca. 90028 • (213) 837-5141

Int'l TELEX 499-0446 DISCOSOFT LSA • USA TELEX 194-634 (Attn: 499-0446)
TWX 910-321-3597 (Attn: 499-0446)

Circle 146 on inquiry card.



OUR PRICES, SELECTION AND SAME-DAY SHIPPING MAKE US COMPETITIVE.

Red Baron. Home of the Nation's

NEC 8023 TEC M-8510/DMP-85 Outstanding Graphics, Print Quality & Performance



144 x 160 dots/inch • Proportional spacing
• Lower case descenders • N x 9 dot matrix
• 8 character sizes • 5 unique alphabets • Greek
character set • Graphic symbols • 100 CPS print
speed • Bi-directional, logic-seeking • Adjustable
tractors • Single-sheet friction feed • Vertical &
horizontal tabbing

\$Call

IDS Prism 80/132 Affordable Color, Speed



200 CPS • Bi-directional, logic-seeking • 24 x 9 dot
matrix • Lowercase descenders • 8 character sizes
• 80-132 columns • Proportional spacing
• Text justification • Optional color and dot resolu-
tion graphics

Prism 80 Base List \$1,299 **\$Call**
Prism 132 Base List \$1,499

The Epson Series High-Quality Printers at a Low Price.

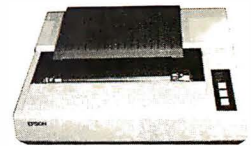

160 CPS • Dot graphics • Proportional spacing •
Downloadable character sets • 10 and 12 CPI •
Super/subscripting • Underlining • Reverse line
feed

Epson FX series **\$Call**

Full Line of Epson Accessories

Smith-Corona TP-1 Daisy Wheel Printer For Under \$900

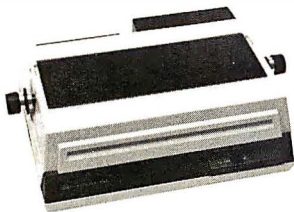

Letter quality • Standard serial or parallel data
interface • Drop-in ribbon • 144 WPM • Various
fonts available • Loadpaper like typewriter
• Handles single sheets for forms

Smith-Corona TP-1 List \$895 **\$Call**

Brothers HR-1 Daisy Wheel Perfect for quality, quiet word processing.

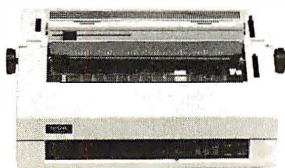

• 16 CPS • Prints up to 6 copies • Bi-directional
• Cloth or carbon quick-change cassette ribbon
• Quiet, efficient operation for word processing

Brothers HR-1
Parallel List \$1,100 **\$Call**
Serial List \$1,200

Star Micronics Gemini 10/15

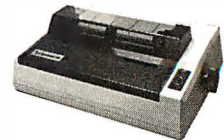

120 x 144 dot graphics • 100 CPS • 2.3K buffer
• 2K User programmable ROM •
Underlining • Super/subscripts
• Friction feed and adjustable
tractors

Gemini 10
Gemini 15

**Lowest
Priced
Dot
Matrix**

Anadex Silent Scribe The Quiet Serial Matrix Impact Printer



Up to 500 CPS • Dot addressable graphics
• Parallel and serial interfaces standard • Switch
selectable protocol • Cartridge ribbon • Foreign
character sets • Underlining • 1.5k to 12k buffer
• Correspondence quality print

	List	Discount
Anadex DP-9501A	\$1,725	\$1,325
Anadex DP-9620A	\$1,845	\$1,475
Anadex WP-6000	\$3,250	\$2,800

Televideo CRT's Price, Performance & Reliability



	List	Discount
910	\$ 699	\$575
925	\$ 995	\$730
950	\$1195	\$945
970	\$1495	\$Call

Monitors Crisp, Clear, Compatible



Amdex
Video 300, green List \$249 **\$Call**
Color I List \$499 **for low prices**

OUR PEOPLE MAKE US EXPERTS.

Largest Computer Printer Inventory.

The Grappler+™ Apple® Graphics Interface

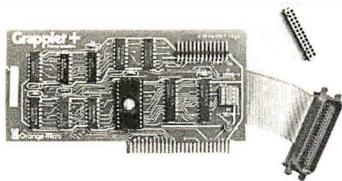

- Graphic and text screen dumps • Dual Hi-Res Graphics • Printer selector dip switch • Apple III compatible • Inverse graphics • Emphasized graphics • Double size picture • 90° Rotation • Center graphics • Works with Pascal and CPM® • Optional bufferboard available

Grappler + **\$175**

* Requires software driver
Apple is a registered Trademark of Apple, Inc.

The Bufferboard™ For Apples and Printers

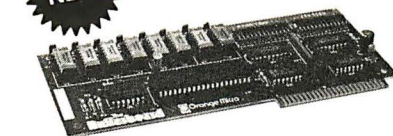

Take your existing printer interface—and buffer it!

- Versions for Grappler+, Apple interface, Epson interface, and others • Comes standard with 16K buffer • Expandable to 32K and 64K • Includes interface docking cable

The Bufferboard..... **\$175**

IDS Microprism 480 Prints like a daisy, priced like a matrix!



- Correspondence quality in a single pass • Dual speed 75, 110CPS • Proportional spacing • Bi-directional, logic-seeking • Platen Pin or pressure feed • 24 x 9 dot matrix • 10, 12, 16, 8 characters per inch • Double width characters

IDS Microprism 480List \$799 **\$Call**



Customer Benefit Package

1. Free Expert Consultation.
2. Technical Staff. Even your most involved questions get quick, helpful answers from our staff of printer technicians.
3. Free Catalog. Get your informative catalog with printer comparison chart and print samples today.
4. Warranty. The manufacturer's warranty where applicable.
5. Same-Day Shipping.
6. Free MasterCard and Visa.
7. We Stock What We Sell. We make every effort to keep a large stock of our advertised products.
8. APO/FPO Orders Welcome.

NEW! The Okidata Series Microline 92 & 93



- 160/200CPS • Correspondence quality • Proportional spacing • Enhanced, emphasized and expanded characters • 10, 12 and 17 pitch • Super/subscripts • Underlining • Okigraph dot graphics • Alternate downline loadable character set

Okidata 92List \$ 699
Okidata 93 (w/ Tractor) List \$1249
Okidata 84 (Parallel) . .List \$1395 **\$Call**

Other Quality Printers at Red Baron

NEC Spinwriter RO
Serial Parallel 7710 \$3055 **\$2425**
Serial 3510 \$1895 **\$1600**

Interface Equipment Complete Stock of Options, Cables and Accessories

CCS APPLE SERIAL Interface & Cable . . \$150
SIGNALMAN MODEM \$Call
HAYES MICROMODEM II \$300
COMPLETE STOCK OF EPSON
ACCESSORIES \$Call
CUSTOM PRINTER CABLES FOR
Apple, Atari, IBM, TRS-80 (all models) \$Call
PRINTER STANDS: Large \$ 99
Small \$ 25
PRINTER RIBBONS—Most Types \$Call

Here's How To Order:

Phone orders are welcome; same-day shipment on orders placed before 11:00 a.m. Free use of MasterCard and Visa. COD's accepted. Personal checks require 2 weeks clearance. Manufacturer's warranty included on all equipment. Prices subject to revision.

Call For Free Catalog:

(800) 854-8275
CA, AK, HI (714) 779-2779



Circle 312 on Inquiry card.

4501 E. Eisenhower Circle, Anaheim, CA 92807

NAPLPS: A New Standard for Text and Graphics

Part 3: Advanced Features

NAPLPS can draw irregular lines, compress repeated code segments, define new text characters, and divide the display screen into separate fields.

Jim Fleming
Unir Corporation
Suite 106
5987 East 71st St.
Indianapolis, IN 46220

The North American Presentation-Level-Protocol Syntax (NAPLPS) is a communications standard that can encode both text *and* graphics. The goal of this standard is to facilitate the exchange of information from one machine to another without regard to differences in the individual graphics-handling capabilities of each machine. In fact, in some ways NAPLPS can be viewed as an extension of the American National Standard Code for Information Interchange (ASCII).

Part 1 of this series presented an overview of NAPLPS. In part 2 I described the basic features of NAPLPS with an emphasis on the actual coding. In this part I will concentrate on the more advanced features of NAPLPS, specifically, Incremental Lines, Macros, Dynamically Redefinable Characters, and Fields. This article will present merely an overview of these advanced features. In order to

get a complete description of them, you should obtain a copy of the actual NAPLPS document from the Computer and Business Equipment Manufacturers Association (CBEMA), whose address is listed at the end of this article.

Incremental Lines

As we saw in part 2, line drawings and objects can be encoded by specifying the endpoints of each line using a terminal-independent coordinate system. In general, it takes about 3 bytes to encode each line in a drawing. For objects with only a few sides or a regular shape (i.e., rectangle, arc, etc.), this efficient approach makes it easy to encode lines. But if an object has an irregular shape, the normal encoding method becomes very inefficient.

NAPLPS supports a method of *chain-encoding* irregular edges of shapes. An assumption is made that the irregular edge is composed of a large number of small line segments. Each segment can be encoded using just 2 bits of information—a substantial reduction over the 3 bytes needed using the normal method.

The method for chain-encoding line segments with 2 bits is shown in table 1. The first step is to establish a pair of relative coordinates (symbolized as dx , dy) that determines the length of the line segments. Multiple 2-bit values are then specified that indicate directions in which to draw the line segments. As shown in table 1, a line segment can be drawn horizontally, vertically, or diagonally.

If a horizontal segment is specified, it is drawn in the direction initially set by the value dx . If dx is positive, the horizontal segment will be drawn to the right; if dx is negative, the segment will be drawn to the left.

If you are following closely, you may be asking how we could get lines drawn to the left if we initially specify dx as positive. As shown in table 2, an Escape sequence is provided to reverse the direction of the drawing. Any time a 2-bit value is 00, the next 2 bits are interpreted as an instruction to change direction. The sequence 00 01 indicates that the horizontal direction should be reversed, the sequence 00 10 changes the vertical direction, and the sequence 00 11 reverses both directions.

About the Author

Jim Fleming is a member of the ANSI X3L2 Committee on Character Sets and Coding. He is an independent consultant specializing in interactive computing systems.

More Apple II owners choose Hayes Micromodem II than any other modem in the world. Compare these features before you buy. You should. It's your money. Thousands of other Apple II owners have already compared, considered, and are now communicating — all over the U.S.A. — with Micromodem II. The best modem for the Apple II. The most modem for your money.

A complete data communication system. Micromodem II is not "base priced" plus necessary "options." It's a complete, high-performance data communication system. The printed circuit board fits — quickly and easily — into your Apple II, eliminating the need for a serial interface card. And the Microcoupler™ (included) connects the Apple II directly to a standard modular telephone jack. Auto-dial and -answer features are built in. Operation can be full or half duplex,

with a transmission rate of 300 bps. And it's Bell 103 compatible and FCC approved.

Now there's Hayes Terminal Program, too! Developed by Hayes specifically for Micromodem II, this new

Terminal Program allows you to access all the great features of your modem in a matter of seconds.

With it, you can use your CP/M®, DOS

3.3 or Pascal formatted disks to create, send, receive, list and delete files. Hayes Terminal

Program is a complete, stand-alone disk.

And because it's menu driven, you can choose from

a wide variety of options to set your communication parameters — as well as change hardware configuration — directly from the keyboard. It even allows you to generate ASCII characters that are normally not available from Apple

keyboards, further extending your capabilities. Incoming data can be printed (on serial or parallel printers) as it's displayed on your screen.

Micromodem II is available with or without the Terminal Program. Buy your modem by itself, or optionally packaged with the Terminal Program disk and user manual at extra cost. The software is also sold separately, for those who already own a Micromodem II.

If you're ready to communicate with other computers, to access information utilities, time-sharing systems, or use bulletin boards, then you're ready for Micromodem II. Come on. Compare. Consider. Then buy.

Micromodem II is already the best-selling modem for the Apple II. And Hayes' new Terminal Program

makes it better than ever. Available at computer stores nationwide.



Hayes

Hayes Microcomputer Products, Inc.
5835 Peachtree Corners East
Norcross, Georgia 30092 (404) 449-8791

Your Apple II
just isn't the same without
Hayes Micromodem II.™

NEW!
Terminal Program
from Hayes!

Everybody's Logic Analyzer

12 Channels
16 Words



\$379

A logic probe and oscilloscope are no longer adequate for analysis in today's digital world. For testing or debugging microcomputer or other digital logic circuits you need a real logic analyzer.

The LA-12 captures, stores and displays TTL and LSTTL digital data so that the instantaneous meaning of the data stream (e.g. data value, ASCII code, address) can be understood and analyzed long after the actual events have passed.

- Easy to Use ■ 10 MHz ■ Clock Qualifier ■ Trigger input ■ 3 Trigger Qualifiers ■ Built-in LED Display — No oscilloscope needed ■ Compact ■ Expandable ■ Low Cost

30 day trial

Purchase an LA-12, use it, and if you are not completely satisfied, return it within 30 days and receive a full refund.

Free Offer

If you order within 45 days, and mention this magazine, you will receive a \$49.95 input cable free with each LA-12 ordered.

Save \$28.95

In addition, if you enclose payment with your order you can deduct 5% and we will pay shipping charges.

All prices are in US dollars for 120VAC. To order in the Continental US call

TOLL FREE
1-(800)-228-6505

Connecticut microComputer, Inc.
36 Del Mar Drive, Brookfield, CT 06804
(203) 775-4595 TWX: 710-456-0052

Q	Description	Price	Total
	Logic Analyzer	\$379.00	
	Input Cable	49.95	
	20 Color-coded microclips	44.95	
Connecticut residents add 7½% sales tax			
	Shipping & Handling	\$10.00	
Total			

Company purchase order enclosed (Rated Firms only)
 Check VISA MasterCard
 Acct. No. _____
 Signature _____ Exp. Date _____
 Name (Print) _____
 Address _____

 City _____
 State _____ Zip _____

Dealer inquiries invited

Two-Bit Incremental Line Instructions

Symbolic Code	Two-Bit Encoding	Result
-	00	Change dx or dy values (see table 2)
X	01	
Y	10	
D	11	

Table 1: With the Incremental-Line features of NAPLPS, some line segments can be specified with just 2 bits of information. The values dx and dy signify relative coordinates. If dx is negative, the line will be drawn to the left; if dy is negative, the line will be drawn downward. Other lines can be drawn by using the 4-bit direction changing codes shown in table 2.

Incremental Line Escape Sequences

Symbolic Code	Four-Bit Encoding	Result
- -	00 00	If pen is down, then lift it up. If pen is up, then put it down.
- X	00 01	dx = -dx
- Y	00 10	dy = -dy
- D	00 11	dx = -dx, dy = -dy

Table 2: Four-bit codes are used to change the direction of the drawing and control the pen position.

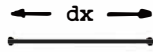
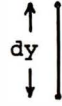
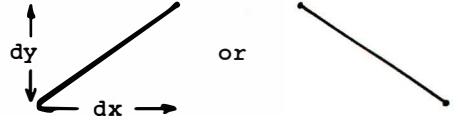
If you are still with me, you may ask what happens when 00 is followed by 00. That sequence indicates that the state of the pen should be reversed. If the pen is currently down, it will be raised; if the pen is up, it will be lowered.

The 2-bit values are encoded in a series of bytes, 6 bits per byte (from left to right in table 3). The pen is

assumed to be down at the beginning of a command. The last byte can be padded with a pen reversal if the number of line segments is not even.

Figure 1 shows a chain-encoded outline of the state of Indiana that is composed of 217 short line segments. These 217 segments require 87 bytes of coding in NAPLPS. If I had encoded this drawing using the normal



This Programming professional deserves a lot more from his personal computer.

He's earned it. As a seasoned professional, he's learned to master some of the world's most advanced programming tools. Tools specially designed to meet the everyday demands of programming experts.

But as the owner of a personal computer, he's come to expect less. Less performance. Less sophistication. And less flexibility.

Why should programming a personal computer be any different?

Prior to the announcement of micro/SPF™ development software, experienced programmers felt programming a personal computer was a lot like playing with a toy. You couldn't take it seriously.

But today, there's micro/SPF™ a solution to elementary program editing tools now offered with most micro-computers.

With micro/SPF™ you get the same procedures and commands experienced programmers are accustomed to using at work. By mimicking features found in

standard SPF software, micro/SPF™ provides all the sophisticated utilities programming professionals expect.

Programming experts can take advantage of skills they've spent years perfecting.

Now, for the first time, mainframe software is available for personal computers. SPF screens are fully reproduced in logical sequence and each screen is formatted identical to those found in the SPF system.

In addition, micro/SPF™ comes equipped with the same primary and line commands, tutorial messages and program editor (with program function keys) experienced programmers are used to.

Programming professionals who've spent years perfecting the art of writing sophisticated code deserve to work with state-of-the-art tools, not toys. Find out how micro/SPF™ can help you do work-compatible programming on your personal computer today!

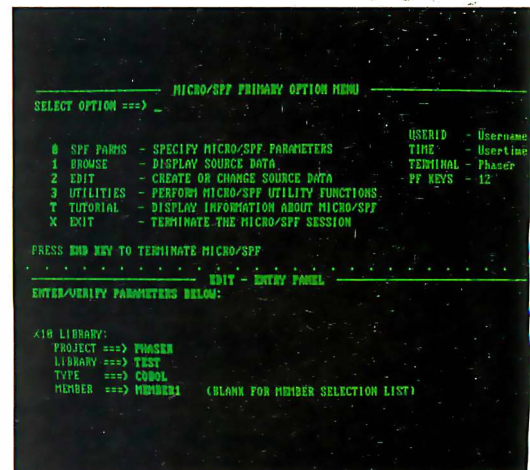

PHASER

PHASER SYSTEMS, INC 50 WEST BROKAW ROAD
SAN JOSE, CA 95110



Figure 1: An example of an incremental-line drawing. The size can be changed simply by changing the values of the relative coordinates dx and dy . This drawing was done on a Diablo 630.

method, 651 (217×3) bytes would have been needed. (Although these calculations ignore the fact that the northeast corner of the state could be efficiently drawn with normal straight lines, a large amount of memory would be required nonetheless.)

A symbolic representation of part of the chain encoding for figure 1 appears in table 3. It is the coding for part of the southwestern border of Indiana. The corresponding binary and octal values of the encoding are also included. The two outlines were produced from the same encoded data.

The scaling effect achieved in figure 1 was accomplished by changing the size of the dx and dy values. As shown in figure 2, the Incremental-Line op code (3A hexadecimal or 3/10 using a 16 by 16 column/row representation) and a relative coordinate pair (dx , dy) precede the encoded data. This (dx , dy) value can be changed to create some interesting effects. For example, it can be scaled so that the resulting drawing is larger or smaller, even though the *same* en-

coded data is used. Also, the values of dx and/or dy can be negative, resulting in mirror-image drawings from the same encoded data. The values of dx and dy can be very different, resulting in a stretching effect in one of the dimensions.

Besides chain-encoded outlined drawings, NAPLPS also supports chain-encoded filled polygons. These solid figures are subject to the same attributes of objects such as rectangles and arcs. These attributes can be used to draw the state of Indiana with a textured interior to help distinguish it from other objects on the screen or page.

Incremental encoding is a powerful technique for compactly representing irregular objects. The efficiency obtained by incremental encoding pays off in data-transmission time and disk storage. Another feature of NAPLPS that improves coding efficiency is the Macro capability.

Macros

Macros provide a means of storing an arbitrary string of NAPLPS codes

Sample of Incremental Line Encoding

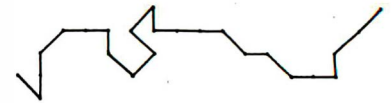

Symbolic Code	Binary Code	Octal Code
- Y D	X1 00 10 11	113
- Y Y	X1 00 10 10	112
Y D X	X1 10 11 01	155
X - Y	X1 01 00 10	122
Y D -	X1 10 11 00	154
Y D -	X1 10 11 00	154
X D -	X1 01 11 00	134
X D -	X1 01 11 00	134
Y Y X	X1 10 10 01	151
X X D	X1 01 01 11	127
X D X	X1 01 11 01	135
X - Y	X1 01 00 10	122
Y D D	X1 10 11 11	157

Table 3: An example of incremental-line coding. This is part of the coding used to produce the drawing of Indiana in figure 1.

under one of 96 names. The string can be recalled using the 1-byte name associated with the string.

Macros are useful when a common string of NAPLPS codes is used for a particular application. For example, in a home-banking application the words Balance, Amount, and Payment will appear many times during a session. NAPLPS lets us store these words as macros and recall them by transmitting just 1 byte.

Macros can be used to store both text and graphics. Entire screens of in-

INTRODUCING THE BIG WORD IN UNINTERRUPTIBLE POWER SYSTEMS: SMALL.

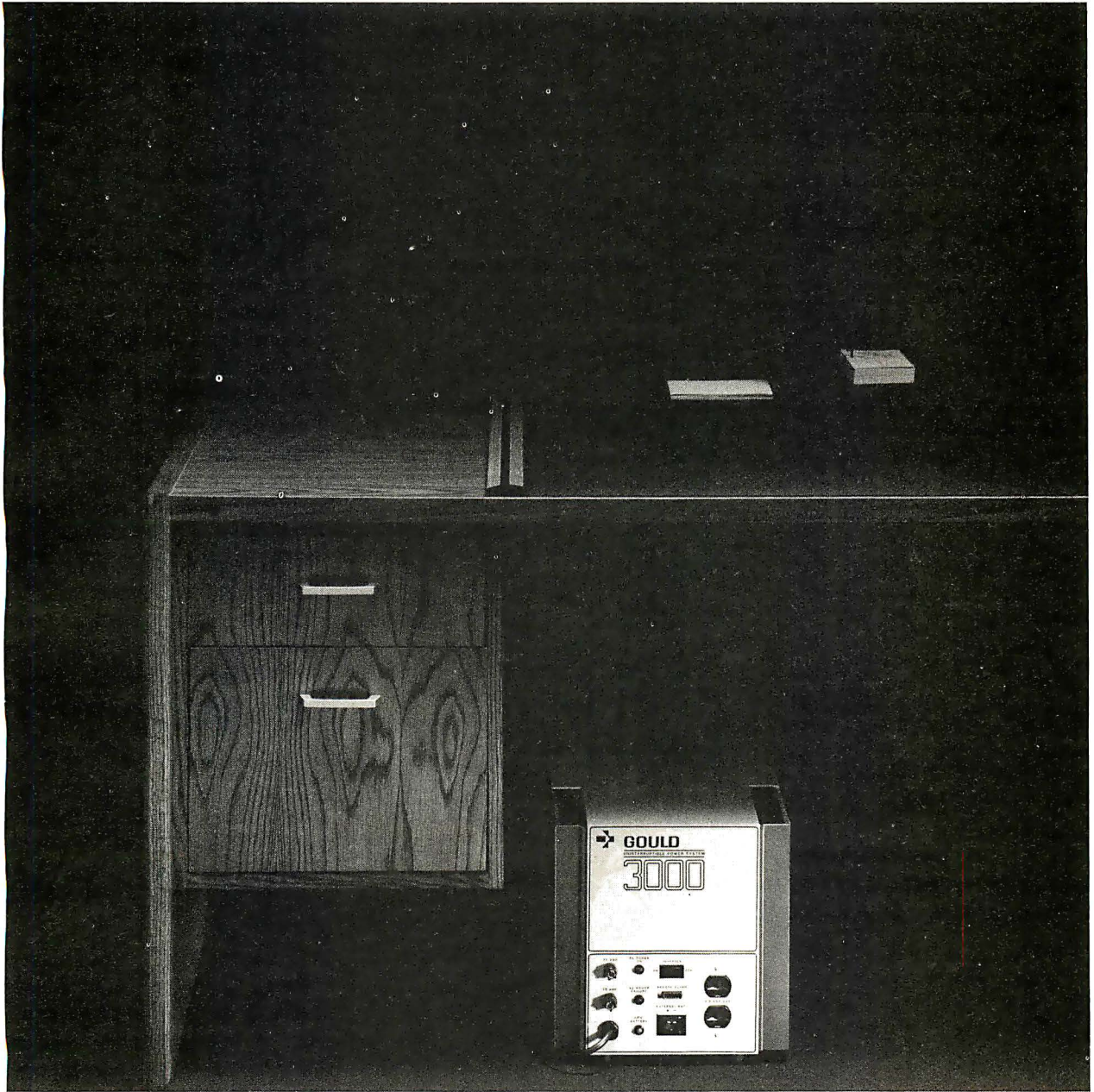

The Gould 3000 UPS. A small \$1300.

Gould's new micro UPS is a big breakthrough for the small systems user. In price. And performance.

Because you no longer have to buy a line conditioner and battery backup. The Gould 3000 both conditions your line and keeps you in power. With an efficient, silent operation.

And as with all Gould products, we use the fewest number of conservatively rated parts possible. We keep our design simple to keep your power up. And your costs down.

Gould's new 3000 Series uninterruptible power systems are currently available in 50 or 60Hz versions at ratings of 500VA and 1000VA.

So now that the word is out, put

Gould's new micro UPS into action. And discover the power of simplicity.

Gould Inc., Electronic Power Conversion Division, 2727 Kurtz Street, San Diego, CA 92110. Phone (800) 854-2658. In California (619) 291-4211. TWX (910) 335-1241.

COMDEX/SPRING '83
April 26 to 29, 1983 • Georgia World Congress Center • Atlanta, Georgia

 **GOULD**
Electronics & Electrical Products

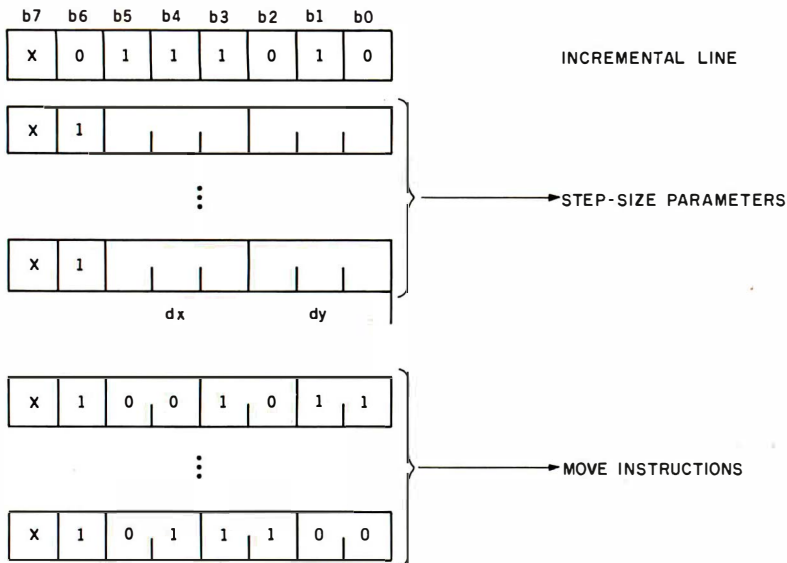

Figure 2: Structure of the Incremental-Line instructions. The first byte indicates that a series of Incremental-Line instructions will follow. The next series of bytes indicates the size of the relative coordinates dx and dy to whatever resolution is desired. The last series of bytes is composed of the actual 2- and 4-bit drawing instructions.

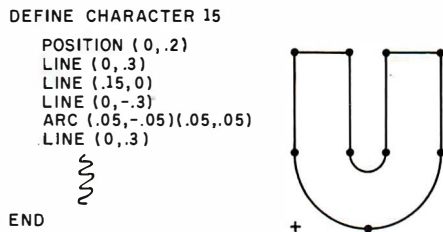

Figure 3: Using the Dynamically Redefinable Character Set (DRCS) capability of NAPLPS, we can define our own characters.

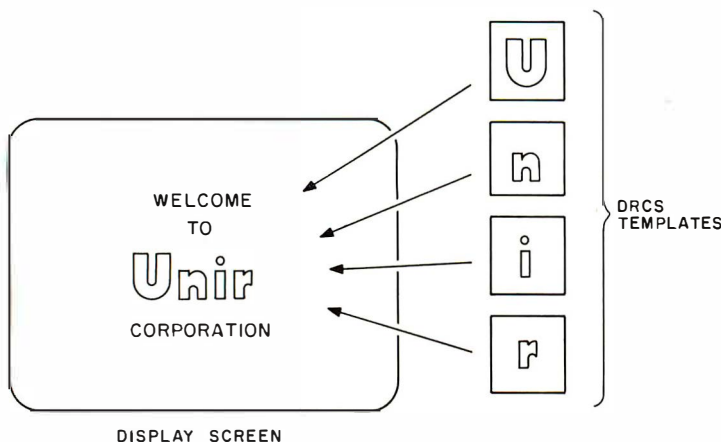

Figure 4: Once a DRCS set has been defined, its characters can be mapped just like text characters onto the display screen.

formation can be stored as one macro. In addition, other text and graphics can be intermixed with macros.

In applications like adventure games, each time a new room is entered, a macro can be defined with the picture of the room. If the room is reentered later in the game, the long graphics-and-text description does not have to be retransmitted. The host computer simply has to refer to the macro name and the entire room is drawn.

If the host computer is really smart, it can send down macros for all the rooms that are near the current room you are in. This can be done while you are deciding your next move. The screen will not be changed as these macros are defined. When you finally move to a new room, the host refers to the proper macro that was previously defined, and the user sees an almost instant response.

Macros can also be applied in conjunction with the Incremental-Line op code described earlier. Nothing prevents you from storing just the encoded data as a macro. If this is done, an Incremental-Line op code (3/10) can be sent followed by a (dx, dy) coordinate value followed by the macro reference. In the previous example (Indiana), the 87 bytes of encoded data would be retrieved and processed as if they had been sent after the (dx, dy) value. Thus, the size of the shape could be changed almost instantaneously.

Part 1 of this series includes an example of macro definition and reference. A NAPLPS code segment for that example is shown in listing 1. As you may recall, a macro (Macro 26) was defined that cleared the screen to blue and put the string "READY:" on the screen in white. Whenever Macro 26 is later referenced, the screen will be cleared and "READY:" will appear.

The amount of storage allocated to macros has been left open as a terminal- and application-dependent parameter. With 96 macro names and the ability to store long variable-length strings, the macro storage required could exceed the internal memory capacity of most personal

ScratchPad

The Ultimate Spreadsheet for CP/M-86[®], IBM PC DOS[®], and CP/M[®]

The Ultimate Spreadsheet? YOU BET!

Packed with more important features and performance than any other spreadsheet, ScratchPad is perfect for "what if" analyses and financial modeling of all kinds.

The features tell the story:

Flexible Spreadsheet

A ScratchPad innovation. Now you can design the spreadsheet to fit your application, rather than redesigning your application to fit the spreadsheet. For example, if you need a worksheet that is extremely wide but not very deep, ScratchPad can do it. The matrix dimensions are up to you.

Virtual Memory

Another ScratchPad innovation. When your computer runs out of memory in RAM, your disk drives act as a backup memory for additional spreadsheet data. (This is something other spreadsheet people don't talk about in their ads. They can still run out of memory!)

ScratchPad with a hard disk on the IBM PC, for example, allows in excess of 20,000 entries! NEVER see those disastrous OUT of MEMORY messages again.

Consolidation

This lets you combine several spreadsheets, adding or averaging the numeric data. It is especially useful to businesses that want to combine data from several departments, or add or average spreadsheets from different months of the years. Just another reason why ScratchPad is the ultimate spreadsheet.

These features and many others make ScratchPad the most powerful spreadsheet available! So, find out why we call ScratchPad the Ultimate Spreadsheet.

Write: ScratchPad Information, SuperSoft, Box 1628, Champaign, IL 61820.

This is what others are saying:

Small Business Computers, July/August '82

"In our opinion ScratchPad is an excellent business-oriented spreadsheet program, easy to learn, easy to use, and well documented."

InfoWorld, Sept. 6, '82

"ScratchPad . . . [is designed] for users who want entry simplicity and fast answers."

Business Computer Systems, Sept. '82

" . . . a new memory innovation from SuperSoft . . . ScratchPad[s] virtual memory can accommodate an essentially unlimited number of entries by tapping the disk drive for secondary memory."

Available for IBM PC DOS, CP/M-86[®] and CP/M[®].

ScratchPad: \$295.00

(Requires 96K* with PC or MS DOS, 64K* with CP/M-86[®], and 56K with CP/M[®])

Now available for OASIS: call 802-658-5600.

Japanese Distributor: ASR Corporation International, 3-23-8, Nishi-Shimbashi, Minato-Ku, Tokyo 105, Japan. Tel. (03)-4375371 Telex: 0242-2723.

European Distributor: Micro Technology Ltd., 51 The Pantiles, Tunbridge Wells, Kent, England TN2 5TH. TEL. 0892-45433. Telex: 95441 Micro-G.

*Additional memory recommended for optimal performance of all features.

CP/M and CP/M-86 are registered trademarks of Digital Research.

Circle 397 on Inquiry card.

SuperSoft[®]

FIRST IN SOFTWARE TECHNOLOGY P.O. Box 1628 Champaign, IL 61820 (217) 359-2112 Telex 270365

Listing 1: A short segment of NAPLPS code (in octal form) showing how a macro can be defined and referenced. The contents of Macro 26 will be bytes 4 to 21 inclusive.

BYTE #	OCTAL FORM	SYMBOLIC FORM	DESCRIPTION
.	.	.	.
.	*****	Define Macro 26	*****
.	.	.	.
1	033	ESC	Define Macro 26
2	100	DFM	
3	072	M26	
.	.	.	.
.	.	.	.
4	016	SO	Select G1 (Graphics)
.	.	.	.
.	.	.	.
5	074	SET	Set color to Blue
6	111	BLU	
.	.	.	.
.	.	.	.
7	040	RES	Clear Screen to in-use color
8	120		
.	.	.	.
.	.	.	.
9	074	SET	Set color to white
10	177		
.	.	.	.
.	.	.	.
11	044	SPA	Set Point Absolute
12	101	}	}
13	110	}	- (x,y) = (.05078125,.25) => (13,64)
14	150	}	}
.	.	.	.
.	.	.	.
15	017	SI	Select G0 (Text)
.	.	.	.
.	.	.	.
16	122	R	
17	105	E	
18	101	A	
19	104	D	
20	131	Y	
21	072	:	
.	.	.	.
.	.	.	.
22	033	ESC	End Macro Definition
23	105	END	
.	.	.	.
.	.	.	.
.	*****	Referencing the Macro	*****
.	.	.	.
.	.	.	.
??	035	SS3	Assume 7 Bit Mode with Macros in G3
??	072	M26	Macro 26
.	.	.	.

computers. There is absolutely no reason why disk storage cannot be used to store macros. When disks are used, a crude form of file transfer begins to emerge.

Macros thus provide a powerful capability of code reduction when using NAPLPS. The important thing to remember about macros is that a simple string replacement is performed. The resulting stream of code (after the macro expansion) is processed as if it had been sent from the host. No special scaling, rotation, or attributes are applied to the macro part of the resulting stream. In fact, in most systems, once the macro is expanded all knowledge is lost that a macro was used.

Dynamically Redefinable Character Sets

The Dynamically Redefinable Character Set (DRCS) capability in NAPLPS is similar to the Macro feature. The DRCS facility allows arbitrary streams of NAPLPS code to be associated with one of 96 names. The 96 DRCS names, however, are completely different from the macro names.

The primary difference between macros and DRCS characters is that when the DRCS image is referenced, it is scaled, rotated, and mapped to the current character field, just like a text character. In other words, a simple code replacement is not performed. Instead, the current environment of attributes and character-field size is used when the DRCS character is requested. Figures 3 and 4 show an application of the DRCS capability.

One of the primary functions of the DRCS is to define new text characters, because all TEXT command attributes (scaling, rotation, spacing, etc.) are applied when the DRCS is requested. Because of this text-character orientation, only two colors can be used when the DRCS is drawn. In other words, the drawing of the DRCS is done with a "spray-paint" technique, as with other characters. The DRCS thus acts only as a stencil.

The DRCS can also be viewed as a simplified form of the computer-graphics idea of a *window* and a *viewport*. When using a DRCS, the

Text continued on page 202

Your guide to the world of microprocessors.

The Micro-Professor™ -A low cost tool for learning, teaching and prototyping.

Here in one attractive package and at a price of only \$149.00 is a Z80* based microcomputer to lead you step by step to a thorough knowledge of the world of microprocessors.

The Micro-Professor is a complete hardware and software system whose extensive teaching manual gives you detailed schematics and examples of program code. A superb learning tool for students, hobbyists and microprocessor enthusiasts, as well as an excellent teaching aid for instructors of electrical engineering and computer science courses.

But the Micro-Professor is much more than a teaching device. With it you can do bread-boarding and prototyping, designing your own custom hardware and software applications with Z80, 8080 and 8085 compatible code.

The standard 2K bytes of RAM is expandable to 4K, and the standard 2K bytes of ROM can be increased to 8K.

All this plus a built-in speaker, a cassette interface, and

sockets to accept optional CTC/PIO. Bus is extendable.

As well as being an exciting learning tool, the Micro-Professor is a great low-cost board for OEM's. Call for details

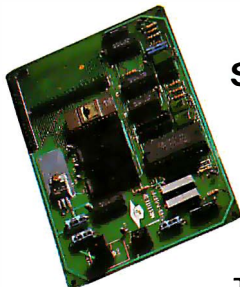

**SSB-MPF
Speech
Synthesizer
Board \$129**

A vocabulary of up to 400 words based on the TMS 5200 chip.

**EPB-MPF
EPROM
Programming
Board \$169**

For all +5V 1KB/2KB/4KB EPROMs. Read/Copy/List/Verify Capability.

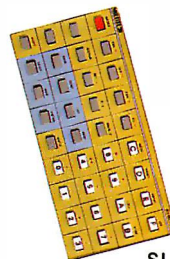
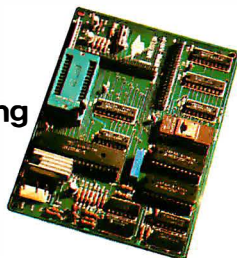

**BASIC-MPF
Tiny Basic \$19**

2KB BASIC interpreter with hardware control capability. Machine-code subroutine accessible.

**PRT-MPF
Printer
\$99**

A thermal printer with built-in alphanumeric character patterns and Z80 disassembler. 20 characters per line, 0.8 line per second.

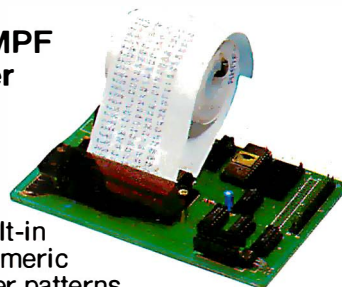

* Z80 is a trademark of Zilog Inc.



Multitech Electronics Inc.

30 day trial period with full refund. 90 day warranty.

Circle 294 on Inquiry card.

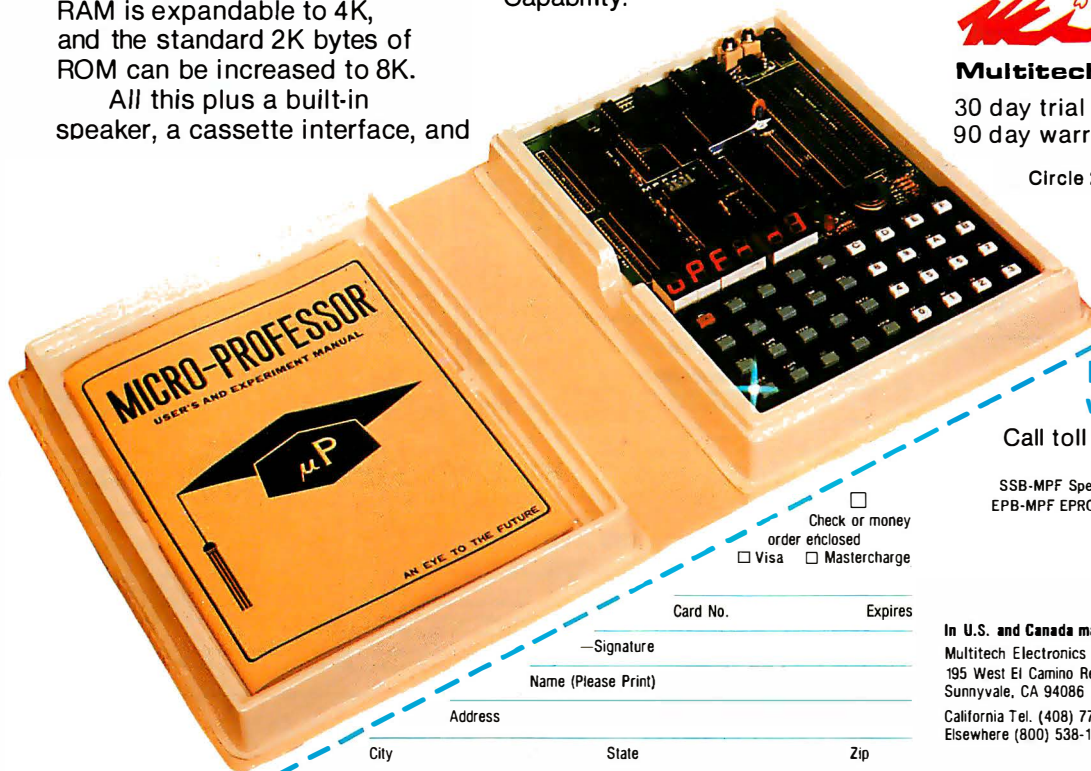

I'm ready to enter the world of microprocessing

Call toll free to order.

	Price	Qty.	Amount
MPF-I Micro-Professor	\$149.00		
SSB-MPF Speech Synthesizer Board	\$129.00		
EPB-MPF EPROM Programming Board	\$169.00		
PRT-MPF Printer	\$ 99.00		
BASIC-MPF	\$ 19.00		
Shipping and Handling	\$ 4.95		4.95
California residents add sales tax.			
TOTAL			

In U.S. and Canada mail to:
Multitech Electronics Inc.
195 West El Camino Real
Sunnyvale, CA 94086
California Tel. (408) 773-8400
Elsewhere (800) 538-1542

Outside of North America mail to:
Multitech Industrial Corporation
977 Min Shen E Road 105
Taipei, Taiwan, ROC
Tel. 02-769-1225
TWX 19162 MULTIC.
23756 MULTIC

Check or money order enclosed
 Visa Mastercharge

Card No. Expires

—Signature

Name (Please Print)

Address

City

State

Zip

The Choice of

DEALERS
WE BUY
EXCESS
INVENTORIES

Computer Exchange — The Supply Center for the IBM-PC

SOFTWARE for the IBM-PC

BUSINESS

	LIST PRICE	OUR PRICE
*ASHTON-TATE, dBase II with User's Guide by Software Banc	\$ 730	\$439
dBase II, requires CP/M-86 & 128K	\$ 700	\$449
dBase II, requires PC-DOS & 128K	\$ 389	\$265
APPLIED SOFTWARE TECHNOLOGY, Versalorm	NEW!	\$ 130
DATAMOST, Real Estate Investment Program	NEW!	\$ 130
Write-On		\$ 89
EAGLE SOFTWARE, Money Decisions	NEW!	\$ 150
HOWARDSON, Real Estate Analyzer II		\$189
INFORMATION UNLIMITED, Easywriter II (a WPS)		\$350
EasySpeller (188K Words)		\$175
Easylyler (a DBMS)		\$400
INNOVATIVE SOFTWARE, I I M III (a DBMS)		\$495
INSOFT, Data Design (a powerful easy to use DBMS)	NEW!	\$225
ISM, MatheMag		\$ 90
LOTUS, 1 2 3		\$495
*MICROCRAFT, Requires CP/M-86		\$395
Legal Billing & Time Keeping — Verdict		\$750
Professional Billing & Time Keeping — Billkeeper		\$750
*MICRO LAB, The Tax Manager		\$189
*MICROPRO, WordStar plus free WordStar Training Manual		\$495
MailMerge 1™		\$250
SpellStar 1™		\$250
3 Pak, Word & Mail & Spell, above 3		\$845
InloStar	NEW!	\$495
ReportStar	NEW!	\$350
MICROSOFT, Flight Simulator (By Sub-Logic)	NEW!	\$ 50
NORTH AMERICAN BUS. SYSTEM, The Answer		\$250
PBL CORPORATION, Personal Investor	NEW!	\$145
*PEACHTREE, Peach Pak 4 (GL, AR & AP)		\$595
PERFECT SOFTWARE, Perfect Writer 1™		\$389
Perfect Speller 1™		\$189
SELECT INFO, Select (a WPS)		\$595
SORCIM/ISA, SuperCalc		\$295
SuperWriter		\$395
Spellguard		\$195
STC, The Creator	NEW!	\$300
SYNERGISTIC, Data Reporter	NEW!	\$250
*VISICORP, VisiCalc®/256K		\$250
VisiDex or VisiSchedule, each		\$250
VisiTrend/Plot		\$219
VisiFile or Desktop Plan I, each		\$300

UTILITY

1983 CE SOFTWARE AWARD:

"Copy II PC by Central Point Software is the best CE software buy of 1983. It will copy more copy protected software and faster than any other backup system. Unlike other copiers it makes an exact duplicate of your original and it does 100% verification of copy. Documentation is excellent."

CENTRAL POINT, Copy II PC, Backup and Utility	NEW!	\$ 40	\$ 35
*ComX, Fasttrak, RAM/Disk emulator program, Works on any PC DOS version or RAM Card. Menu driven.		\$ 100	\$ 49
DIGITAL RESEARCH, Concurrent CCP/M-86		\$350	\$235
CBASIC 86		\$200	\$225
NORELL DATA, System Backup		\$ 50	\$ 39
NORTON, Norton Utilities, 14 powerful programs, 3 disks		\$ 80	\$ 65

HOME & EDUCATIONAL

AUTOMATED SIMULATIONS, Temple of Apsah		\$ 40	\$ 29
Oil Barons	NEW!	\$ 100	\$ 75
BRODERBUND, Apple Panic		\$ 30	\$ 22
*CONTINENTAL, The Home Accountant Plus		\$150	\$112
DATAMOST, Pkg Pen or Space Strike, each		\$ 30	\$ 22
DAVIDSON, The Speed Reader		\$ 75	\$ 55
INFOCOM, Deadline		\$ 50	\$ 39
Zork I or Zork II or Zork III, each		\$ 40	\$ 29
*INSOFT, WordTrix	NEW!	\$ 35	\$ 29
Quotrix	NEW!	\$ 35	\$ 29
ON-LINE, Golf Challenge	NEW!	\$ 25	\$ 19
Ulysses & The Golden Fleece		\$ 35	\$ 25
PBL CORP., Personal Investor		\$145	\$ 99
SENTIENT, Cyborg	NEW!	\$ 35	\$ 25
SIRIUS, Conquest or Call to Arms, each		\$ 30	\$ 23
SPINNAKER, Snooper Troops, #1 or #2, each		\$ 45	\$ 35
Story Machine or Face Maker, each		\$ 35	\$ 25
STRATEGIC, The Warp Factor		\$ 40	\$ 30

DISKETTES

Control Data Corporation 12 for 10 Special. Limited Time!

CDC, 120 each, 5 1/4", with ring, SS, SD (Apple, IBM, etc.)	\$ 450	\$195
12 each, 5 1/4", with ring, SS, SD (Apple, IBM, etc.)	\$ 40	\$ 22
12 each, 5 1/4", with ring, SS, DD, (IBM, H/P, etc.)	\$ 35	\$ 25
12 each, 8", SS, SD	\$ 45	\$ 24
10 each, 5 1/4", with ring, DS, DD, (IBM)	\$ 50	\$ 39
IBM, 10 each, 5 1/4", SS, SD (Apple, IBM, etc.)	\$ 60	\$ 45
10 each, 5 1/4", SS, DD (H/P, IBM, etc.)	\$ 65	\$ 49
VERBATIM, 10 each, 5 1/4", with ring, SS, SD or SS, DD	\$ 50	\$ 28
MAXELL, 10 each, 5 1/4", SS, DD or SS, SD	\$ 55	\$ 35
DYSAN, 10 each, 5 1/4", SS, SD	\$ 55	\$ 39
10 each, 5, DS, DD	\$ 65	\$ 49

* Means a BEST buy.

Ad #963



64K IBM-PC \$2850

IBM is a trademark of IBM Corporation.

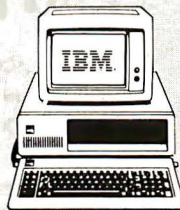

System Includes
Two 320K Disk Drives
12" Green Amdek Monitor

90 Day Warranty
Call For Details And
Other Configurations

HARDWARE for the IBM-PC

	LIST PRICE	OUR PRICE
MEMORY CHIP KITS, 64Kaddon toy memory cards, 9 chips		
200NS, tested and burned-in, 90 day warranty	\$ 150	\$ 99
AST RESEARCH Combo Plus, 64K with async. port	\$ 495	\$359
Combo Plus, 64K with parallel port	\$ 495	\$359
Combo Plus, 64K w/async. & para	\$ 555	\$395
Combo Plus, 64K w/async. para & clock/cal	\$ 595	\$429
For above Combo Plus of 128K add \$85, for 192K add \$192, for 256K add \$256		
CURTIS, PC Pedestal™ for Display on PC	\$ 80	\$ 65
9 Foot Cable for IBM Keyboard (extends 3' to 9')	\$ 50	\$ 35
Mono. Extension Cables, Power and Signal	\$ 55	\$ 45
DAVONG DS1-501 Hard Disk, 5 Meg	\$1995	\$1495
DS1-501, 6 MB Hard Disk	\$1995	\$1495
DS1-512, 12 MB Hard Disk	\$2495	\$1895
DS1-519, 19 MB Hard Disk	\$2995	\$2295
MAYNARD, Floppy Drive Control Board, for up to 4 drives	\$ 195	\$165
With Serial Port add \$40 For Parallel Port add \$70.		
MICROSOFT 64K RAM Card w/Parity	\$ 350	\$259
128K RAM Card w/Parity	\$ 525	\$395
256K RAM Card w/Parity	\$ 875	\$659
QCS Big Blue, Z80 CPU plus five functions	\$ 595	\$449

QUADRAM CORPORATION

Quadboard, 64K, expandable to 256K, 4 function board	\$ 595	\$435
Quadboard, 128K, expandable to 256K, 4 function board	\$ 775	\$565
Quadboard, 192K, expandable to 256K, 4 function board	\$ 895	\$635
*Quadboard, 256K, four function board	\$ 995	\$670
Microclizer, w/Copy, Par/Par, 8K, #MP8	\$ 159	\$119
Microclizer, w/Copy, Par/Par, 64K, #MP64	\$ 299	\$235
Microclizer, w/Copy, Par/Par, 128K, #MP128	\$ 445	\$345
Microclizer, Snap-on, 8K, Par/Par, Epson, #ME8, w/PSI	\$ 159	\$145
Microclizer, Snap-on, 64K, Par/Par, Epson, #ME64, w/PSI	\$ 299	\$235
All Microclizers are expandable (w/copy to 512K) (Snap-on to 64K).		
TG PRODUCTS, Joystick	\$ 65	\$ 49

Control Data or Tandon

DISK DRIVES, Double Sided 320K Same as now supplied with IBM-PC Tested, burned-in and with installation instructions 90 day warranty by us

1 each	\$ 650	\$249
2 or more	\$ 650	\$239

PRINTERS AND ACCESSORIES

EPSON PRINTERS	CALL	CALL
NEC, Dot Matrix, 8023 Printer F/T	\$ 695	\$525
STAR MICRONICS, 9x9 Dot Matrix, 100cps, 2.3K, Gemini 10"	\$ 499	\$385
9x9 Dot Matrix, 100cps, 2.3K, Gemini 15"	\$ 649	\$495
ANADEX, DP8000 Dot Matrix, 120cps, Serial & Cent. Para. I/F	\$ 995	\$495
IBM-PC to Epson or Star Micronics Cable	\$ 60	\$ 45
Apple Interface and Cable for Epson or Gemini	\$ 95	\$ 59
Grapple™ w/Orange Micro, specify printer	\$ 165	\$119
Apple Graphics Dump Program	\$ 15	\$ 9
MICRO TEK, Apple Dumping GX, Graphics Printer Interface with Cable	\$ 249	\$169
Apple Dumping 64, Buffered 64K Spooler with Cable	\$ 349	\$239
LETTER QUALITY — DAISY WHEEL PRINTERS:		
OLYMPIA, ES-100, Printer/Typewriter, complete with serial interfacing to the Apple II or IBM-PC	\$1735	\$1295
*COMREX, Comriter CR-1, RS232 Serial I/F, 200 wpm	\$1199	\$845
Comriter Tractor Feed for CR-1	\$ 118	\$ 99
SMITH-CORONA, TPI Printer/Typewriter, specify serial or parallel	\$ 899	\$579
TPI Tractor Feed	\$ 149	\$129
SUPPLIES: Tractor Feed Paper, Ribbons, Heads, Qume Daisy Wheels & Ribbons.		

8" CP/M-80

BUSINESS & SYSTEM SOFTWARE

	LIST PRICE	OUR PRICE
*ASHTON-TATE, dBase II with User's Guide by Software Banc	\$ 730	\$439
COMSHARE TARGET, Target PlannerCalc	\$ 99	\$ 39
INFOCOM, Deadline	\$ 60	\$ 45
Zork I or Zork II or Zork III or Slarcross, each	\$ 50	\$ 39
ISM, MatheMagic	\$ 100	\$ 75
MICROCRAFT, Legal Billing & Time Keeping	\$ 750	\$395
Prof. Billing & Time Keeping — Billkeeper	\$ 750	\$395
*MICROPRO, WordStar™ plus free WordStar Training Manual	\$ 495	\$249
MailMerge 1™	\$ 250	\$159
SpellStar 1™	\$ 250	Call
3 Pak, Word & Mail & Spell, 3 above	\$ 845	Call
InfoStar	NEW!	\$495
ReportStar	NEW!	\$350
MICROSOFT Multiplan	\$ 275	\$199
Series 4 GL, AR, AP, Inv or Pay, 80	\$ 500	\$325
BASIC Compiler	\$ 395	\$295
COBOL 80	\$ 750	\$545
BASIC 80	\$ 350	\$275
mulisp/muStar 80	\$ 200	\$145
M-Sort 80	\$ 195	\$145
Edit 80	\$ 120	\$ 80
Macro 80	\$ 200	\$145
OASIS, The Word Plus (45,000 word verification)	\$ 150	Call
PEACHTREE, Magic Wand	\$ 500	\$395
Series 4 GL, AR, AP or Inventory, each	\$ 600	\$395
Series 8 GL, AR, AP, Inv or Pay, each	\$ 750	\$495
Series 9 Peach Tree	\$ 500	\$330
Series 9 Spelling Proofreader	\$ 300	\$195
Series 9 Calc, Mail List or Telecom, each	\$ 375	\$247

MICROSOFT

MONITORS

NEC, 12" Green, Model J81201M	\$ 249	\$159
12" Color, Composite, Model J121212M	\$ 450	\$349
TAXAN, RGB vision	\$ 399	\$339
SANYO, 9" B&W, Model YM4509	\$ 190	\$149
9" Green, Model DM5109	\$ 200	\$139
12" Green, Model DM8112CX	\$ 260	\$199
13" Color, Composite, Model DM0513	\$ 470	\$349
ZENITH, 12" Green, Model ZVM121	\$ 150	\$119
AMDEK, 12" Green #300	\$ 200	\$159
13" Color I, Composite	\$ 449	\$359
13" Color II, RGB, Hi Res (Ap. II, III & IBM PC)	\$ 899	\$799
13" Color III, RGB, Commercial, (Ap. II, III)	\$ 569	\$469
DVM, Color II or III to Apple II Interface	\$ 199	\$175
Note: Color II and III come with cable for IBM PC.		

MODEMS AND TELE COMMUNICATIONS TERMINAL

HAYES, Micromodem II (for the Apple II)	\$ 379	\$275
Apple Terminal Program for Micromodem II	\$ 99	\$ 69
MICROCOM, Micro Courier for Apple II	\$ 250	\$125
Micro Telegram for Apple II	\$ 250	\$125
SSM, Transcend I for Apple II Data Comm.	\$ 89	\$ 69
NOVATION, Applenet II Modem	\$ 389	\$269
212 Apple Cal	\$ 725	\$599
HAYES, Stock Chronograph (RS-232)	\$ 249	\$189
Stock Smartmodem (RS-232)	\$ 289	\$225
Smartmodem 1200 (RS-232)	\$ 699	\$535
Micromodem 100 (IS-100 bus)	\$ 399	\$275
SIGNALMAN, Modem MK1 (RS-232)	\$ 99	\$ 79
IBM PC to Modem Cable	\$ 39	\$ 29
AXLON, Datalink 1000 Hand Held Communications Terminal	\$ 399	\$325

CORVUS SYSTEMS

* 6 Meg Hard Disk, w/o interface	\$2395	\$1895
* 11 Meg Hard Disk, w/o interface	\$3195	\$2695
* 20 Meg Hard Disk, w/o interface	\$4195	\$3495
IBM PC Interface (IBM DDS), Manual & Cable 5	\$ 300	\$239
Mirror built in for easy backup	\$ 790	\$595
Apple Interface, Manual & Cable 5	\$ 300	\$239
Omni Disk Server for Apple II (Special)	\$ 990	\$495
Omni Transporter, Card Apple II (Special)	\$ 495	\$275
Omni Junction Box Set (Special)	\$ 39	\$ 25
Other Interfaces, Omni-Net, Constellation, Mirror, All in Stock		
H/P 75C Portable Computer, 48K, load to 168K	\$ 995	\$795
Call for H/P 75 Portable Computer Software & Peripherals		
H/P 7470A Graphics Plotter	\$1550	\$1195
H/P 41C Calculator	\$ 195	\$149
H/P 41CV Calculator with 2.2K Memory	\$ 275	\$219
Full 41 accessory and software in stock. Call		

Portland, OR Cash & Carry Outlet, 11507-D SW Pacific Hwy., Terrace Shopping Center, Portland, OR. Over-the-counter sales only. On 99W between Rte. 217 and Interstate 5. Open Mon.-Sat. 10-6. Call 245-1020.

ORDERING INFORMATION AND TERMS: All Mail P.O. Box #23068, Portland, OR 97005. All items usually in stock. We immediately honor Cashiers Checks, Money Orders, Future 1000 Checks and Government Checks. Personal or Company Checks allow 20 days to clear. No C.O.D. Add 3% for VISA or MC. Include telephone number. Add 3% for shipping insurance and handling (S&H) with \$5 minimum. UPS ground is standard so add 3% more for UPS Blue with \$10 minimum. Add 12% total for S&H for USPS, APD or FPO with \$15 minimum. For Hawaii, Alaska and Canada, UPS is in some areas only, all others are Postal so write, or specify PD. Foreign orders except Canada for S&H add 18% or \$25 minimum except for monitors add 30% or \$50 minimum. Prices subject to change and typo errors, so call to verify. All goods are new, include factory warranty and are guaranteed to work. Due to our low prices, all sales are final. Call before returning goods for repair or replacement. Orders received with insufficient S&H charges will be refunded. ORDER DESK HOURS 8 to 6 PST M-F and 10 to 4 Sat. 1 PM here is 4 PM in NY.

We have been a computer dealer since 1978 and in mail order since 1980. Banks: First Interstate Bank (503) 776-5620 and Jefferson State Bank (503) 773-5333. We belong to the Chamber of Commerce (503) 772-6293, call Dan & Bradstreet if you are a subscriber. Computer Exchange is a division of O'Tech Group, Inc.

Professionals T.M.

LOW PRICES TO PROFESSIONALS WHO KNOW WHAT THEY WANT AND KNOW HOW TO USE IT.

DEALERS
WE BUY
EXCESS
INVENTORIES

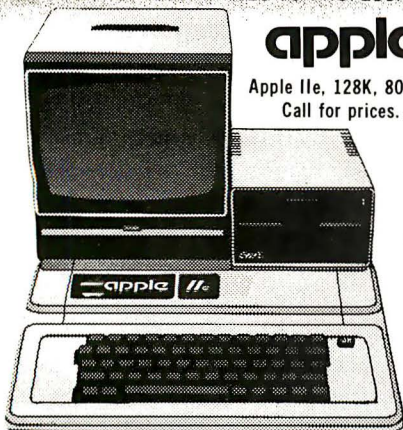

apple II+/IIe supply center

Apple IIe, 128K, 80 col.
Call for prices.

DISK DRIVES for APPLE II+/IIe			
U-SCI	A2, 5 1/4", 143K Disk Drive	\$ 479	\$299
MICRO-SCI	Controller Card for A2 Drive	\$ 100	\$ 79
	A40, 5 1/4", 160K Disk Drive	\$ 449	\$339
	A70, 5 1/4", 286K Disk Drive	\$ 599	\$459
	Controller for A40 or A70	\$ 100	\$ 79
	Filter, Disk Utility Software	\$ 20	\$ 15
VISTA	Solo, 5", 143K Disk Drive, Std. Height	\$ 300	\$249
	Half Height	\$ 420	\$329
	Duet, 5", Double Sided, 320K, Half Height	\$ 420	\$329
	Quartet, 5", 2 Duet's Side by Side or Standard Cabinet	\$ 715	\$575
	Controller Card for above, Fully Apple Compatible	\$ 89	\$ 75
	V1000 Dual 8", Std. Format w/Controller, Complete	\$2195	\$1495
	V1200, 5", 6MB Disk Pack System	\$1549	\$1199
TEAC	Super-5, 143K Disk Drive, Half Height	Call	Call
	Super-5, Controller Card, Fully Apple Compatible	\$ 89	\$ 75

HARDWARE

for Apple II

RAM EXPANSION

	LIST PRICE	OUR PRICE
* ComX RAM Card	\$ 179	\$ 49
* ALS, ADDRAM	\$ 149	\$ 79
* Microsoft, RAMCard	\$ 100	\$ 89
* Saturn Systems, RAM Card 32K	\$ 249	\$169
* Axlon, RAM Card 128K	\$ 475	\$375
* RAM Disk System 320K	\$1395	\$995

80 COLUMN VIDEO CARDS

ALS, Smarter II	\$ 179	\$139
Dirt Cheap Video	\$ 89	\$ 69
Videx, Videoterm	\$ 345	\$229
Vista, Vision 80	\$ 395	\$199

MISCELLANEOUS

* ALS, The CP/M Card	\$ 399	\$299
* 2 Card	\$ 169	\$129
* 16K ADDRAM Special	\$ 149	\$ 79
* Synergizer w/S'calc + Condor	\$ 749	\$529
* Color II	\$ 179	\$139
* Axlon, 320K RAM Disk System	\$1395	\$995
* ASTAR, RF Modulator	\$ 35	\$ 25
* CCS, Serial Interface 7710A	\$ 150	\$129
* Other CCS Cards in stock	Call	Call
* Dan Paymar, Lower Case Chops	\$ 50	\$ 39
* Don't Ask, DAO-003 S.A. Mouth	\$ 125	\$ 85
* Eastside, Wild Card, copier	\$ 130	\$ 99
* Kensington, System Saver	\$ 90	\$ 69
* Kraft, Jystick	\$ 65	\$ 49
* Paddle	\$ 50	\$ 39
* M&R, Sup R Ian	\$ 50	\$ 39
* Microsoft, 280 Softcard	\$ 345	\$245
* Softcard Premium Pack	\$ 695	\$495
* 280 Softcard Plus	\$ 645	\$459
* 16K RAMCard	\$ 100	\$ 89
* Micro Tek, Dumping GX, Graphics Printer I/F	\$ 249	\$169
* Dumping 64, Buffered 64K Spooler	\$ 349	\$239
* Mountain, CPS Multifunction Card	\$ 239	\$199
* Orange Micro, Grappier Plus	\$ 165	\$119
* Practical Peripherals, MBS 3K, Serial (Epson)	\$ 159	\$129
* MBP 16K Para (Epson)	\$ 159	\$129
* Microbuffer II 16K, (specify)	\$ 259	\$209
* Microbuffer II 32K, (specify)	\$ 299	\$229
* PCPI, Appli-Card, 14 features, 6 Mhz	\$ 595	\$435
* RH Electronics, Super Fan II	\$ 75	\$ 59
* SSM, A10 11, Serial/Para Interface	\$ 225	\$169
* TG Products, Game Paddles	\$ 40	\$ 29
* Jystick	\$ 60	\$ 45
* Select-A-Port	\$ 60	\$ 45
* Trak Ball	\$ 65	\$ 44
* Videx, Videoterm 80 col	\$ 345	\$229
* SoftVideo Switch	\$ 35	\$ 25
* Enhancer II	\$ 149	\$ 99
* Function Strip	\$ 79	\$ 59
* PSIO, Para/Ser Interface	\$ 229	\$169
* Full Videx Line, Call Up to 35% off.		
* WICO, Trackball	\$ 80	\$ 55

SOFTWARE

on disk for Apple II/II+/IIe

BUSINESS

	LIST PRICE	OUR PRICE
Apple Computer, Inc. The Controller GL, AR, AP	\$ 625	\$299
Apple Fortran	\$ 200	\$159
How to (Educational)	\$ 50	\$ 25
Apple Logo	\$ 175	\$149
50% off other Apple Inc. software	Call	Call
Applied Soft Tech., VersaForm	\$ 389	\$265
Artsci, MagicWindow II New!	\$ 150	\$ 99
Ashton-Tate, dBase II (CP/M) with User's Guide by Software Banc	\$ 730	\$439
Continental, GL, AR, AP or PR ea	\$ 250	\$169
1st Class Mail	\$ 75	\$ 49
Home Accountant	\$ 75	\$ 49
Hayden, Pie Writer (Specify brd)	\$ 170	\$ 99
* High Tech., Job Cost System	\$ 750	\$350
Info Master	\$ 189	\$119
Howard Soft., Real Estate Analyzer II	\$ 195	\$129
Tax Preparer	\$ 150	\$ 99
Info, Unim., Easywriter (PRO)	\$ 175	\$119
LJK, Letter Perfect w/MailMerge	\$ 150	\$ 99
Micro Craft, (CP/M)		
* Professional Billkeeper	\$ 750	\$395
Legal Billing & Timekeeping	\$ 750	\$395
* Verdict, (Legal Billing)	\$ 750	\$395
Micro Lab, Tax Manager	Call	Call
Micro Pro, (all CP/M)		
InfoStar	\$ 495	\$329
ReportStar	\$ 350	\$229
WordStar [®] + Training Manual	\$ 495	\$199
MailMerge [™]	\$ 250	Call
SpellStar [™]	\$ 250	Call
SPECIAL! All 3 above	\$ 895	Call
Data Star [™]	\$ 295	Call
Microsoft, Multi-Plan (CP/M)	\$ 275	\$175
Multi-Plan (DOS 3.3) New!	\$ 275	\$175
Muse, Super Text 40/80	\$ 175	\$129
Super Text 40/55/70 New!	\$ 125	\$ 95
* On-Line, ScreenWriter	\$ 130	\$ 89
The Dictionary New!	\$ 100	\$ 69
General Manager II New!	\$ 230	\$155
Osborne/C.P. Soft. (Disk and Book)		
* Some Common Basic Programs, 75 Business, Statistics and Math programs for the Apple II	\$ 100	\$ 49
* Practical Basic Programs, 40 more very valuable programs beyond "Some Com BasicProg"	\$ 100	\$ 49
Peachtree, Requires CP/M and MBASIC, Specify Videoterm or 40 columns		
Series 40 GL & AR & AP, all 3	\$ 595	\$395
Series 40 Inv or Pay, ea	\$ 400	\$275
Series 91 text & Spell & Mail, all 3	\$ 595	\$395
Series 80 GL & AR & AP, Videx	\$ 595	\$395

	LIST PRICE	OUR PRICE
Perfect, Perfect Writer	\$ 389	\$259
Perfect Speller	\$ 189	\$139
Perfect Filter	\$ 289	\$179
Quality, GBS w/3 gen. (a DBMS)	\$ 650	\$475
Sensible, Sens. Speller, specify	\$ 125	\$ 85
* Silicon Valley, Word Handler	\$ 250	\$139
Soft/Sys., Executive Secretary	\$ 250	\$169
Executive Speller	\$ 75	\$ 55
* Solidus, Stockpile	\$ 600	\$350
Software Dimensions/System Plus, Acclg. Plus, General Ledger	\$ 425	\$295
Acclg. Plus, GL, AP and A/R	\$ 995	\$595
Acclg. Plus, above + Inventory	\$1395	\$775
Software Publishing, PFS II	\$ 125	\$ 85
Report	\$ 95	\$ 65
Graph	\$ 125	\$ 85
Southeastern Data Capture, call to specify.		
STC, The Creator NEW!	\$ 200	\$139
Stoneware, DB Master	\$ 229	\$155
DB Utility I or II	\$ 99	\$ 69
Videx, Applewriter II preboot disk	\$ 20	\$ 15
Videx to 64K, preboot disk	\$ 50	\$ 39
Videx to 176K, preboot disk	\$ 90	\$ 69
* VisiCorp/Personal Software, Visicalc 3.3	\$ 250	\$179
VisiDex	\$ 250	\$150
VisiFile	\$ 250	\$179

UTILITY & DEVELOPMENT

Beagle, Utility City	\$ 30	\$ 22
DOS Boss	\$ 24	\$ 18
Apple Mechanic New!	\$ 30	\$ 22
* Central Point Software, Filter, DOS Utility	\$ 20	\$ 15
* Copy II Plus (bit copier)	\$ 40	\$ 35
Epson, Graphics Dump	\$ 15	\$ 9
Insolt, GrafORTH by Paul Lutus	\$ 75	\$ 59
TransORTH II by Paul Lutus	\$ 125	\$ 99
Microsoft, A.I.D.S.	\$ 125	\$ 75
BASIC Compiler	\$ 395	\$299
Cobol 80	\$ 750	\$599
Fortran 80	\$ 195	\$149
TASC Compiler	\$ 175	\$159
* Omega, Locksmith (bit copier)	\$ 100	\$ 75
Penguin, Comp. Graphics Sys New!	\$ 70	\$ 53
Graphics Magician New!	\$ 60	\$ 41
Phoenix, Zoom Grafix	\$ 40	\$ 29
Quality, Bag of Tricks New!	\$ 40	\$ 29
Saturn Systems, VC Expand	\$ 100	\$ 49
VC Expand 80	\$ 125	\$ 69
Sensible, Back It Up, (bit copier)	\$ 60	\$ 49

WHILE THEY LAST OVERSTOCK SPECIALS FOR APPLE II/II-

ComX 16K RAM Card, 2 Yr. Warranty	\$ 179	\$ 49
Microsoft 16K RAMCard	\$ 195	\$ 89
Saturn Systems, 32K RAM Card	\$ 249	\$169
Axlon, 128K RAM Card w/preboot	\$ 475	\$375
Videx Videoterm, 80 column card	\$ 345	\$229
CCS, Serial Interface 7710A	\$ 150	\$129
Centronics Interface 7728	\$ 110	\$ 85
Calendar Clock 7424A	\$ 120	\$ 95
Centronics Interface 7720B	\$ 120	\$ 95
Micro-Sci, A40, 5 1/4", 160K Disk Drive	\$ 449	\$339
A70, 5 1/4", 286K	\$ 599	\$459
Disk Drive Controller Card for A40 or A70	\$ 100	\$ 79
Micro Pro, WordStar [®] (CP/M)	\$ 495	\$199
Below for ALS Smarterm CP/M, Includes 5"x8" manuals:		
Condor, Condor Jr. for ALS Smarterm (CP/M)	\$ 195	\$ 59
Sorcim, Supercalc for ALS Smarterm (CP/M)	\$ 295	\$ 99

This Month 50% OFF While They Last

VIC 20 Hardware and Software
ATARI, 400 and 800 Peripherals and Software
NEC, 8001 Hardware and Software
XEROX 820 Computer System, with Drives Monitor and CP/M, was \$3,695, now \$1,495
ANADEX, DP8000, Dot Matrix Printer, \$495

HOME & EDUCATION

	LIST PRICE	OUR PRICE
Broderbund, Apple Panic	\$ 30	\$ 21
Arcade Machine	\$ 45	\$ 40
Choplifter New!	\$ 35	\$ 26
Many others	Call	Call
Budgetco, Raster Blaster	\$ 29	\$ 22
Continental, Home Accountant	\$ 75	\$ 49
Datamost, Snack Attack	\$ 30	\$ 24
Datassoft, Canyon Climber New!	\$ 30	\$ 23
Edu-Ware, Several in stock	Call	Call
Auto, Simulations, Introductory 3-Pack	\$ 50	\$ 35
Hayden, Sargon II (Chess)	\$ 35	\$ 29
Infocom, Deadline	\$ 50	\$ 38
Insolt, Electric Duet by Lutus	\$ 30	\$ 25
Zargs New!	\$ 35	\$ 27
Spider Raid New!	\$ 30	\$ 24
Lightning, MasterType	\$ 40	\$ 29
Microsoft, Olympic Decathlon	\$ 30	\$ 24
Typing Tutor II	\$ 25	\$ 15
Muse, Robot War	\$ 40	\$ 29
Castle Wolfenstein	\$ 30	\$ 23
On-Line, Frogger New!	\$ 35	\$ 25
Ultima II	\$ 55	\$ 40
Soltipon (X Rated)	\$ 30	\$ 22
Piccadilly, Warp Destroyer	\$ 30	\$ 23
Sirius, Gorgon	\$ 40	\$ 29
Sir-Tec, Wizardry	\$ 50	\$ 39
Knight of Diamonds New!	\$ 35	\$ 26
Sub Logic, Flight Simulator	\$ 34	\$ 25
Pimball	\$ 30	\$ 23
Strategic, Southern Command	\$ 60	\$ 45
OTHER BRANDS IN STOCK. CALL.		

★ Means a BEST buy.

AXLON The Leader in Atari Add-on's
Rampower 128K System (for the Atari 800) \$ 475 \$350
Rampower 48K Module (for 400) \$ 185 \$135
ATARI Rampower 32K (for the Atari 400 or 800) \$ 120 \$ 89
Free with above 3: Ramscan, Diagnostic Oskette.

Ad #963 THE WORLD'S LARGEST COMPUTER MAIL ORDER FIRM

Computer Exchange T.M.

ALL MAIL: P.O. Box 23068, Portland, OR 97005

SHOWROOM AT 11507D SW PACIFIC HWY., PORTLAND, OR. OPEN M-F 10-6

Circle 96 for IBM Peripherals, Circle 97 for Apple, Circle 98 for all others

NATIONAL ORDER DESK TOLL FREE
(800) 547-1289

All Other Orders Including Oregon: 245-6200

Hot Lines For Information
On Your Order
(503) 245-1030 or 245-7404

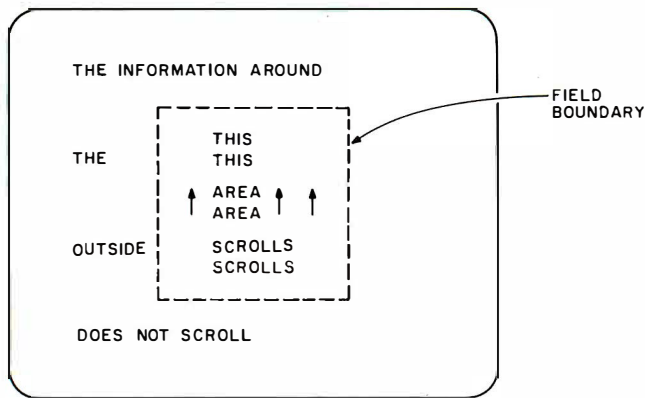

Figure 5: In NAPLPS, some fields of the display screen can be scrolled; others remain stationary.

window is completely mapped to the viewport, which is mapped to the character field on the screen. Figure 4 illustrates this mapping. Because the character field can cover an area from one pixel (picture element) to the entire screen, a scaling effect is achieved.

The DRCS capability is another method for reducing the transmission time of data sent from the host. In applications that require many special symbols, the symbols can be defined, given a name, and referenced with only 1 byte—even for a symbol that may require hundreds of bytes of definition. By replacing the hundreds of bytes with a single one, the transmission is compressed to the point that the users think they are connected to the host by a high-speed link.

Two popular methods of handling DRCS in terminals are available. The first method cuts the template as soon as the DRCS is defined. When the DRCS is requested, the previously cut template is retrieved and handled like any other character-definition template. The templates are usually stored on 8 by 8 or 16 by 16 grids internally in the terminal.

The second method for handling DRCS is to store the graphics commands themselves. No template is cut. When a DRCS is requested, the template is cut in a size appropriate for the current character field. The template may be 32 by 32, or even 256 by 256 for full-screen DRCS.

Once this template is cut, it is mapped to the display screen using the spray-paint concept.

The primary difference between these two methods appears in the areas of speed and resolution. The first method is good when DRCS characters must be displayed very fast and with minimum resolution. If the DRCS is scaled to a much larger size, however, a crude image results from the pre-cut template. The crude image results from the fact that some of the information may be lost when the cutting is performed, especially if the template is very small.

The second method preserves all the information by maintaining the DRCS definition in its original form. If a large DRCS is requested (i.e., the character field is large), all the original information can be used to draw the character. The disadvantage of this method is that the original definition has to be decoded each time the DRCS is requested. This can be quite time consuming for a DRCS that contains several hundred bytes of definition.

These two methods are not the only ways of handling DRCS. As with most features of NAPLPS, no restriction is placed on the method of implementation. The cleverness of the implementation will determine how much of the original information is transferred to the user. The appropriate time, space, and cost trade-offs have to be made in choosing implementation strategies. These decisions,

of course, will help differentiate various companies' products. It would be an extremely boring world if NAPLPS were so restrictive that every terminal looked and performed *exactly* the same.

Fields

The last advanced feature to be discussed here is Fields. Fields are logical rectangular areas defined on the unit screen by the Field command (3/8). These areas are not visible to the user. Only one active field exists although, as will be seen, multiple fields can be defined as long as they do not overlap. Fields are used in a variety of ways in NAPLPS.

A common use of the Field capability is for setting margins. The Field command is used to establish the current active field, which is normally the entire screen. Each time a text character is placed on the screen, an internal cursor position is updated. If the boundaries of the field are exceeded, the cursor is moved to the other edge of the field in a manner compatible with most data terminals. If the cursor moves beyond the top or bottom of the field, a feature called partial screen scrolling comes into play. If scrolling is enabled, only the information inside the field is scrolled. The information around the field is not changed. Figure 5 attempts to show this concept.

Fields are also used to establish an area for high-resolution image display. The Incremental-Point command (3/9) can be used to specify the color information for each point inside a given field. In applications like real-estate listings, these features can be used to combine a photographic-like picture of a house with textual information concerning the same. Figure 6 illustrates a result that can be obtained.

But the most important use of the Field capability is for user input in systems such as videotex. As described in part 1, users are given one or more blank "sheets of paper" on their screen. The Field command is used to define where these sheets are placed.

When these so-called unprotected fields are placed on the screen, the

ROCKY MTN. MICRO, INC.

HIGH TECHNOLOGY PRODUCTS & SERVICE FROM THE HIGH COUNTRY

IBM-PC HARDWARE

PRINCETON GRAPHICS SYSTEM

PGS HX12 RGR Color Monitor
THE High Resolution Monitor for your IBM-PC.
100% IBM Compatible. includes cable
690 Dots Horizontal Resolution CALL

QUADRAM CORPORATION

Quadboard Multifunction Board
Full expandability from 64K to 256K
Parallel Printer Port
Asynchronous RS232 Serial Modem Port
Programmable clock/calendar
Ram Disk Drive (software)
64K starts at \$429.00

Microfazer Printer Spooler
Print Buffering from 8K to 64K
One Model goes to 512K!
Any printer/computer combo
Why wait on your printer?
(All prices include power supply)

8K Epson Snap-On \$139.00
8K par to par w/copy \$149.00
8K ser to par w/copy \$169.00
8K ser to ser w/copy \$179.00
8K par to ser w/copy \$169.00

DAVONG SYSTEMS

Hard Disk Drive / Can be internal
Complete package includes:
Drive, controller, power supply,
software and documentation.
5, 10, or 15 meg
5 meg \$1594.00

THE XEDEX FAMILY

Baby Blue™ CPU Plus
Get CP/M + 64K of main memory CALL

TANDON TM100-2

Industry Standard 320K Drive
Fully IBM Compatible ONLY \$259.00

MAYNARD ELECTRONICS

Floppy Disk Controller Card
Parallel or Serial Port
w/parallel \$229.00
w/serial \$259.00

CORONA DATA SYSTEMS

Hard Disk — 5 or 10 meg
Seagate Technology w/Data Guard
Comes Initialized!
ROS networking available.
16 operating systems in dynamic partitions.
Includes CP/M and Pascal extensions
5 meg \$1539.00 10 meg \$1969.00

COLUMBIA DATA SYSTEMS

IBM compatibility in a Multi-User 16 bit
computer. 128K, two serial ports, parallel port
and 8 exp slots. Runs MS-DOS. CP/M 86 or
MP/M 86. OASIS 16 CALL

IBM-PC SOFTWARE

BUSINESS & PERSONAL

Applied Software Tech., Versaform \$319.00
Aashton Tale, D BASE II,
Requires PC-DOS & 128K \$469.00
Continental, Home Accountant Plus \$109.00
Denver Software, EASY™ \$549.00
Eagle Software, Money Decisions \$145.00
Howard SOFT, FED. TAX Preparer \$120.00
Info. Unlimited, Easy Writer II \$245.00
Easy Planner \$143.00
Easy Speller \$128.00
Easy Filer \$295.00
Micro Lab, The Tax Manager \$189.00
Micro Pro, Wordstar CALL
Peachtree, GL, AR, AP \$372.00
Sorcim, Supercalc \$220.00
Superwriter \$294.00
Visicorp, Visicalc 256K \$199.00
Visidex \$199.00
Visitrend/Visiplot \$232.00
Visifiles \$232.00

GAME SOFTWARE/HARDWARE

Auto. Simulations, Oil Barons \$74.00
Temple of Apsah \$29.00
Curse of Ra \$15.00
Avalon Hill, Galaxy \$19.00
Midway Campaign \$16.00
Fantastic, Snack Attack II \$29.00
Infocorn, Deadline \$37.00
Starcross \$29.00
Zork I, II, III, each \$29.00
Innovative Designs, Pool 1.5 \$25.00
Microsoft, Flight Simulator \$39.00
Sierra-On Line, Ulysses \$29.00
Crossfire \$22.00
Sirius, Gorgon \$29.00
Spinnaker, Snooper Troops, 1 or 2 ea \$35.00
Story Machine or Face Maker \$25.00
M&R Enterprises, Super Mod \$55.00
T&G, Joysticks \$45.00
Trak Ball \$47.00
Tech, Adam & Eve Paddles \$29.00

★★★★ MILE-HIGH SAVER ★★★★★

TEAC HALF-HEIGHT 320K DISK DRIVE

IBM COMPATIBLE 5 1/4" FD55B DS/DD
PUT TWO IN ONE SLOT! HIGH RELIABILITY ONLY LOW POWER DRAIN QUIET
★★★★★★★★ \$279.00 ★★★★★★★★★★

HIGH TECH OF THE MONTH

STB SYSTEMS, INC. "Super-RIO"™ Card

THE TRULY ULTIMATE IBM PERIPHERAL

EIGHT+ FUNCTIONS ON ONE BOARD

- 64-256K
 - Add 64-512K w/ "Super RIO Piggyback"
 - (Optional — Fits on Super RIO — Up to 768K)
 - Two RS232 ports • One parallel port
 - Game port (Apple or IBM joysticks)
 - Up to 64K printer spooler
 - RAM disk drive • clock/calendar
- TRULY A WINNER!**
Call for Price
Simply The Best!

APPLE/FRANKLIN HARDWARE

★★★★ FOURTH DIMENSION SYSTEMS ★★★★★

DISK-DRIVE PRICE BREAKTHROUGH

SUPER DRIVE — Plug-In Apple Compatible Add-On
PLUS one box of Elephant Diskettes SS/DD

\$269.00

WITH CONTROLLER. ADD \$55.00. WITH CONTROLLER, DOS & MANUAL. ADD \$90.00

RANA SYSTEMS

Elite Series
300% faster than Disc II
Advanced write-protect features
Exclusive centering cone-gentler.
more accurate
Elite I (up to 163K) \$289.00
Elite II (326K) \$469.00
Elite III (652K) \$609.00
Four Drive Controller \$99.00

MICROSCI:

A2 — 100% Apple Compatible
Proven performance
Add-On Drive CALL
Drive w/controller CALL
VISTA COMPUTER CO., INC.
PRESENTS THE V1200:
Removable mass storage for your Apple!
6 meg (formatted) per cartridge
Comes complete w/disk, cable, controller,
software and one 6 meg Vistapak cartridge.
All for only \$1195.00

FRANKLIN ACE — THE APPLE II+/IIe ALTERNATIVE

ACE 1000

Upper and Lower Case
Automatic Repeat
Numeric Keypad
Larger power supply with fan
64K on mother board
CALL for Special package price.

ACE 1200

Moveover IIe
128K RAM on Board
80 columns
Z80 Chip for CP/M
Built-in drive, built-in color
Serial and parallel interface
CALL for price w/monitor!

CALL FOR LOW APPLE SOFTWARE PRICES

PRINTERS

DOT MATRIX

C. ITOH
Prowriter I - par CALL
Prowriter II - par \$699.00

EPSON
FX 80 CALL
IDS, Prism & Microprism CALL

OKIDATA
82A \$419.00
83A \$689.00
84 par \$1055.00
92 par CALL
93 par CALL

STAR MICRONICS
Gemini 10 CALL
Quantex 7030 \$1695.00

LETTER QUALITY
BROTHER HR-I \$884.00
BYTEWRITER \$599.00

C.ITOH
Starwriter F-10 par \$1389.00

NEC
7710/7730 \$2291.00
3550 IBM plug-in \$1899.00

MONITORS

AMDEK, 300 Amber \$159.00
300 Green \$155.00
310 A. G IBM including cable \$179.00
Color I composite \$344.00
Color II RGB (IBM compatible) \$744.00

BMC, Green \$88.00

NEC, 1201 Hi-Res. Green \$169.00
1201 Color composite \$329.00
1202 RGB (IBM compatible) \$759.00

TAXAN, Amber \$129.00
Green \$119.00
RGB III (IBM compatible) \$560.00

USI, Pt 3, Amber \$155.00

ZENITH, Green Med-Res \$118.00

DISKETTES & STORAGE

ELEPHANT, 10 each 5 1/4" SS/DD \$23.95
10 each 5 1/4" DS/DD \$34.95

VERBATIM, 10 each 5 1/4" SS/DD \$26.95
10 each 5 1/4" DS/DD \$39.95

LIBRARY CASE, 5 1/4" \$2.50

DISK BANK, 5 1/4" Interlocking swivel \$5.50

DISK FILE, 5 1/4" Elephant "The Trunk" \$21.95

APPLE EXTRAS

16K RAM EXPANSION
Microsoft \$75.00
Microtek \$72.00

80 COLUMN CARDS
Videx \$249.00
Visla \$225.00
Wesper Wizard 80 \$169.00

PRINTER INTERFACES
Microtek, RV611C par \$63.00
Dumpling GX w/graphics \$105.00
Dumpling w/16K Buffer \$160.00
Grappler + \$119.00

MODEMS

HAYES
Smartmodem 300 \$211.00
Smartmodem 1200 \$535.00
Micromodem II \$275.00

NOVATION
CAT (Acoustic) \$153.00
D-CAT \$168.00
Auto Cat \$219.00
Apple Cat II \$273.00
212 module (1200 baud for Apple Cat II) \$354.00
212 Apple Cat II \$626.00

Rocky Mountain Micro, Inc.

MAIL ORDERS: 10890 E. 47th Ave.
Denver, Colorado 80239

TERMS AND CONDITIONS:

- Personal checks (allow 10 days to clear), VISA, MasterCard, wire transfers, include telephone number.
- COD orders accepted — \$300 maximum — \$10 surcharge • All products factory sealed with manufacturer's warranty.
- PO's accepted from qualified customers. • Approval needed on all returns. • 10% restocking charge unless defective, plus shipping • All Colorado residents add 3 1/2% sales tax. City and County of Denver residents additional 3% sales tax.
- Shipping Costs: 2% UPS Ground; UPS Blue Label — rate quoted at time of order. • No foreign orders.
- All prices subject to change without notice. • Lease/financing available.
- Telephone Order Desk Hours: 8 AM to 6 PM, Monday through Friday; 10 AM to 4 PM, Saturday, Mountain Standard Time. CIRCLE 368 ON INQUIRY CARD FOR COMPLETE "LINE CARD"

NATIONAL
ORDER
DESK:

1-800-862-7819

IN COLORADO CALL: 303-371-2430

**YOUR SATISFACTION IS OUR
BEST ADVERTISING
WE SERVICE WHAT WE SELL**

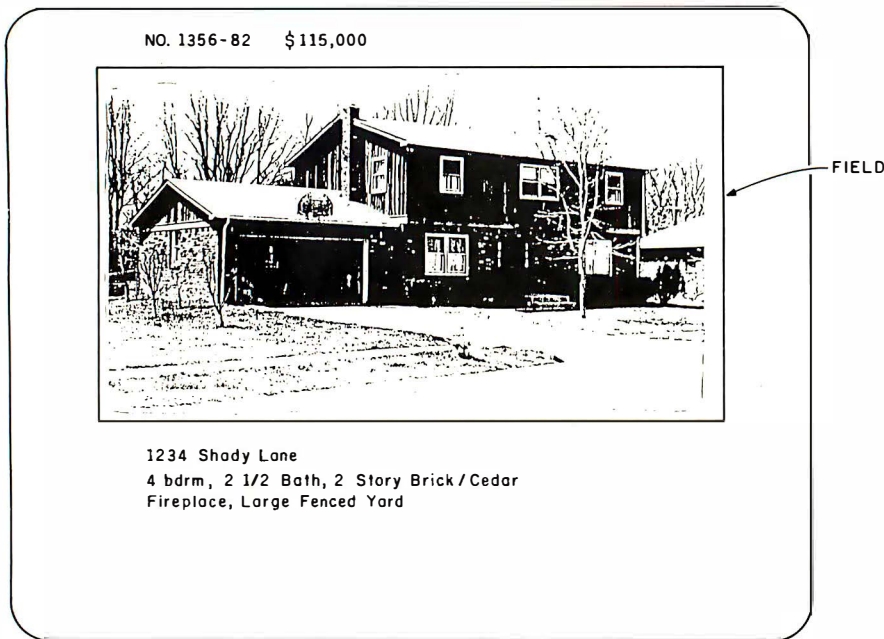

Figure 6: The Incremental-Point command can be used to specify the color information for each point inside a field. In an application such as real-estate listings, a photographic-quality picture of a house can be included with textual information.

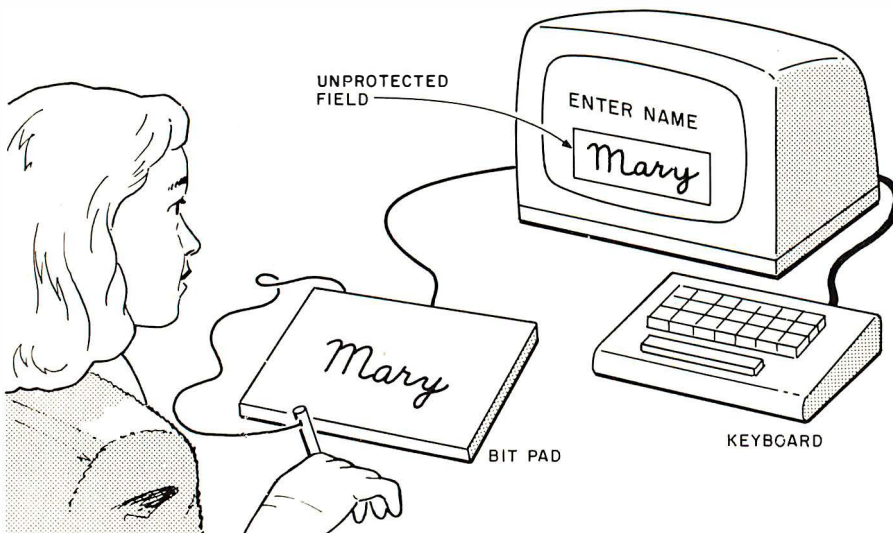

Figure 7: Input from a bit pad can be translated into a series of Incremental-Line instructions and placed into an unprotected (user) field.

user is allowed to enter information. The user can also edit the information with any local capabilities provided by the terminal. Once the information is entered, the user sends the contents of the field to the host.

Any legal NAPLPS stream can be placed in a field. In the example shown in figure 7, a person has used a bit pad to put a signature in the field. When the field is eventually sent to the host, the contents of the field would be an Incremental-Line command followed by a stream of data for the signature.

If, on the other hand, the user had typed information into the field, the information would be sent to the host as characters from the Primary Character Set.

The information that is sent to the host is identified with the location and dimensions of the field. If multiple fields are set up, the host is sent data only from the fields that are modified by the user.

The Field capability provided in NAPLPS is extremely versatile. In comparing this capability with the fields commonly found on data-processing terminals, you should note two items. First, the fields described here are true two-dimensional areas on the screen. This is quite different from the typical one-and-one-half-dimensional fields found on most terminals. Figure 8 illustrates this difference.

The other item of note is that NAPLPS places no restrictions on the user in regard to what type of information can be placed into a field. The

DATA TRANSFER PROBLEMS?

Your Simple Solution is **REFORMATTER®** Diskette Conversion Software

- Avoids serial communication protocols.
- Needs only one system to transfer data.
- Converts source code and data files.
- Allows 2-way transfer.
- Quick, reliable, and inexpensive.

VERSIONS	
Runs On	Reads/Writes
CP/M	↔ IBM 3740
CP/M	↔ DEC RT-11
CP/M-86*	↔ NEW IBM 3740
TRSDOS II	↔ CP/M
TRSDOS II	↔ DEC RT-11
DEC RT-11*	↔ CP/M
CROMIX	↔ DEC RT-11
PRICE:	\$249 *\$350

Requires B" floppy drive.

(415) 324-9114 TWX: 910-370-7457
467 Hamilton Avenue, Suite 2, Palo Alto, Calif. 94301

CP/M[®]
IBM[®]
APPLE[®]

PRICE WAR!

WordStar[®] \$269	dBASE II[™] \$489	SuperCalc[™] \$189	Multiplan[™] \$199	Perfect Writer[™] \$289
WordStar[®] MailMerge[™] \$369	WordStar[®] dBASE II[™] \$749	VisiCalc[®] \$189	SuperWriter[™] \$249	InfoStar[™] \$299

A.L.S. [™] Z-80 Card \$129 CP/M Card \$359	FOX AND GELLER [™] Quickcode \$229 dUtil \$ 69 dGraph \$229	Wordstar/MailMerge \$369 Wordstar/MailMerge/SpellStar \$509 Wordstar/InfoStar \$549 InfoStar \$299 CalcStar \$ 89 DataStar \$179 SuperSort \$149 SpellStar \$149 ReportStar \$229 DataStar Update CALL	OASIS [™] The Word Plus \$129 Punctuation and Style \$109	SORCIM [™] SuperCalc \$189 SuperWriter \$249 SpellGuard \$129
ASPEN SOFTWARE [™] Grammatik \$ 60 Random House Proofreader \$ 39 Random House Thesaurus \$119	HOWARDSOFT [™] Tax Preparer (Apple) \$179 Tax Preparer (IBM) \$189	MicroSOFT [™] Softcard \$259 Ram Card \$ 89 Videterm (Videx [™]) \$269 All Three Above \$509 Multiplan \$199 Enhancer II (Videx [™]) \$119 BASIC 80 \$275 BASIC Compiler \$295 COBOL Compiler \$549 FORTRAN 80 \$349 Flight Simulator \$ 45	ORGANIC [™] Milestone \$269	TCS ACCOUNTING [™] Accounting Package (4 Modules) \$289 GL, AR, AP, PR or Inv. Mgmt \$ 99 ea.
ASHTON-TATE [™] dBase II \$489	IUS [™] Easywriter II \$239 Easyspeller II \$139 Easylier \$269 Financial Management Series CALL	MICROSOFT [™] Softcard \$259 Ram Card \$ 89 Videterm (Videx [™]) \$269 All Three Above \$509 Multiplan \$199 Enhancer II (Videx [™]) \$119 BASIC 80 \$275 BASIC Compiler \$295 COBOL Compiler \$549 FORTRAN 80 \$349 Flight Simulator \$ 45	PEACHTREE [™] Series 4 PeachPak (GL, AR & AP) \$369	VISICORP [™] VisiCalc \$189 VisiTerm \$ 85 VisiDex \$189 VisiFile \$249 VisiSchedule \$249 VisiTrend/Plot \$249 Business Forecaster \$100 Desktop Planner \$249
COMPUTING [™] Power \$119	LEXISOFT [™] Spellbinder \$259	MICROSOFT [™] Softcard \$259 Ram Card \$ 89 Videterm (Videx [™]) \$269 All Three Above \$509 Multiplan \$199 Enhancer II (Videx [™]) \$119 BASIC 80 \$275 BASIC Compiler \$295 COBOL Compiler \$549 FORTRAN 80 \$349 Flight Simulator \$ 45	PERFECT SOFTWARE [™] Perfect Writer \$289 Perfect Speller \$169 Perfect Writer/Speller \$389 Perfect Calc \$169 Perfect Filer \$279 All Four Perfect Products \$749	FLOPPY DISKETTES (Boxes of Ten) 8" \$ 25 5" (SS) \$ 25 5" (DS) \$ 35
CONTINENTAL SOFTWARE [™] Home Accountant CALL	LIFETREE SYSTEMS [™] Volkswriter \$145	MICROSOFT [™] Softcard \$259 Ram Card \$ 89 Videterm (Videx [™]) \$269 All Three Above \$509 Multiplan \$199 Enhancer II (Videx [™]) \$119 BASIC 80 \$275 BASIC Compiler \$295 COBOL Compiler \$549 FORTRAN 80 \$349 Flight Simulator \$ 45	PICKLES AND TROUT [™] CP/M for TRS Model II \$169 CP/M for TRS Model 16 \$189 Hard Disk CALL	
DIGITAL RESEARCH [™] CBASIC \$109 CB-80 Compiler \$379 PASCAL/MT+ \$259 Access Manager \$225 CBASIC 86 \$149 PASCAL/MT+ 86 \$299 Concurrent CP/M 86 \$259	METASOFT [™] Benchmark \$379	MICROSOFT [™] Softcard \$259 Ram Card \$ 89 Videterm (Videx [™]) \$269 All Three Above \$509 Multiplan \$199 Enhancer II (Videx [™]) \$119 BASIC 80 \$275 BASIC Compiler \$295 COBOL Compiler \$549 FORTRAN 80 \$349 Flight Simulator \$ 45	SILICON VALLEY SYSTEMS [™] Word Handler \$149 List Handler \$129	

NOW, PAY LESS, AND GET GREAT SERVICE, TOO!

If you're looking for rock-bottom prices *and* fast, personal service, take a close look at 800-SOFTWARE.

Because we buy in volume, we're able to sell the products you want at prices that finally make some sense. But don't take our word for it. Compare prices and see for yourself!

OUR SERVICE CAN'T BE BEAT.

We take care of you like our business depends on it. Because it does.

When you call 800-SOFTWARE, you get the fastest delivery available anywhere. Which means that every order is filled the day we get it. And that our unique

Order Tracking System[™] is on the job, keeping tabs on your order, every step of the way.

Our giant inventory -- one of the largest in the United States -- also assures you of the fastest possible service. Everything's in stock so you don't have to wait.

Technical support? Business software expertise? We've got it -- and it's the best you'll find *anywhere*.

But, put us to the test. Let us prove what we've proven to satisfied customers around the world.

That our prices *are* lower. That our service *is* better. That there really and truly *is* a difference.

We look forward to your call.

TO ORDER, CALL TOLL-FREE:

800-227-4587

In California, 800-622-0678
or 415-644-3611

CA residents add sales tax.

OR WRITE:

800-SOFTWARE, INC.

3120 Telegraph Avenue,
Berkeley, CA 94705



- Purchase orders accepted.
- Prompt UPS 3 day Blue Label.
- Call for shipping charges, *free catalog*, and other low software prices.
- Now open Mon. Sat.
- International and national dealer requests welcome.
- Quantity discounts available.
- Prices may change.

© Copyright 800-Software 1983

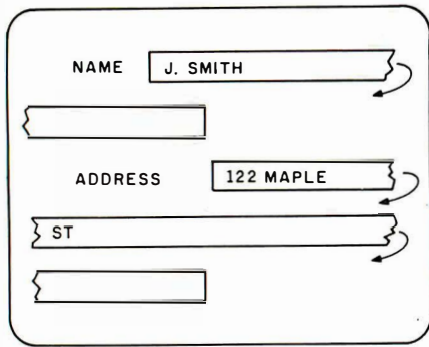

1 1/2 DIMENSIONAL FIELDS

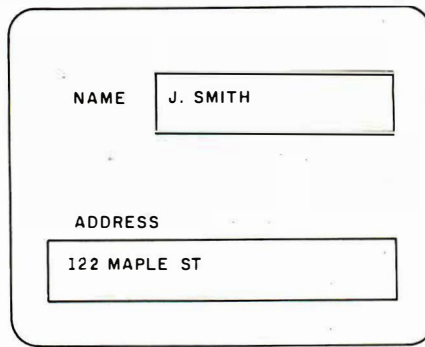

2 DIMENSIONAL FIELDS

Figure 8: An example of the one-and-one-half-dimensional fields found in most terminal systems and the true two-dimensional fields possible with NAPLPS.

NAPLPS has many other powerful features. It is impossible to cover all the features in the context of this series of articles. As I have indicated in the past, anyone who wants more information about NAPLPS, or who is interested in doing serious work with NAPLPS, should obtain a copy of the specification. Copies are available for \$18 from

X3 Secretariat
CBEMA
311 First St., NW
Washington, DC 20001
(202) 737-8888

options available to the user for entering information into fields become merely terminal-dependent features. Terminal manufacturers are thus able to provide unique input and editing facilities to distinguish their products.

No facilities are available in NAPLPS to specify the type of data that can be entered into a field. Many data-processing terminals now forbid

you to enter, for example, alphabetic information into a numeric field. In contrast, the spirit of NAPLPS is to allow free-form user input.

Someday host computers may become smart enough to know that "100," "One hundred," and "1 hundred" all mean the same thing. NAPLPS will be ready to accommodate this capability when it becomes available.

Next Month

NAPLPS offers us a powerful new communications medium, one that should have a significant impact on the amount and the *type* of information we can exchange among ourselves. Next month, I will describe some of the advanced color capabilities and speculate on the ways in which NAPLPS will affect the personal-computer user. ■

<p>12" B&W MONITOR</p>  <p>Contrast Power/Bright V-Hold H-Hold</p> <p>VIDEO 100 by AMDEK FULL FACTORY WARRANTY</p> <p>\$79⁹⁵</p>	<p>5 1/4" Floppy DISKETTES</p> <p>All Certified—100% Guaranteed</p> <p>BOX of 100... \$149⁰⁰ Above with Hub Rings..... \$169.00</p>	<p>COEX 80-FT DOT MATRIX PRINTER</p> <ul style="list-style-type: none"> • Interface with Apple™, Centronics RS-232, IEEE-488 • 9x7 Dot Matrix, 80 CPS, Bi-Directional Printing • 2K Buffered Memory • 80, 96, 132 Columns, Graphics and Block Printing • Selectable Char Pitch, Line Spacing and Feed  <p>\$299⁹⁵</p> <p>COEX Interface Card to APPLE \$49.95</p>	
<p>for APPLE</p> <p>16K RAM CARD Language Transparent COEX FACTORY WARRANTY</p> <p>\$69⁹⁵</p>	<p>FLOPPY DISK DRIVE From <i>Fourth Dimension Systems</i> with • Track Zero Micro Switch • DOS 3.2.1 & DOS 3.3 • CP/M and PASCAL</p> <p>DESIGNED FOR YOUR APPLE™..... \$287⁹⁵ Controller Card for above..... \$99.00</p>	<p>VISION-80® \$249⁰⁰ 80x24 Video Display Card</p> <p>Vista Computer Company's new Vision-80 board is a sophisticated yet easy to use video display card for the Apple™ computer.</p>	
<p>PARALLEL INTERFACE EPSON TO APPLE</p> <p>New From COEX \$49⁹⁵ CABLE INCLUDED</p>	<p>PROTOTYPING CARDS</p> <p>for APPLE.... \$19.95 for I.B.M..... \$49.95</p>	<p>EXTENDER CARDS</p> <p>for APPLE... \$16.95 for I.B.M.... \$19.95</p>	
<p>"Have You Kissed Your Computer Lately?"</p> <p>Components Express, Inc.</p> <p>1380 E. Edinger • Santa Ana, Calif. 92705 • 714/558-3972</p> <p>Terms of Sale: Cash, Checks, Credit Cards, M.O., C.O.D. Calif. residents add 6% sales tax.</p>  			

All you dBASE II™ hotshots are about to get what you deserve.

You've written all those slick dBASE II programs.

Business and personal programs. Scientific and educational applications. Packages for just about every conceivable information handling need.

And everybody who sees them loves them because they're so powerful, friendly and easy to use.

But that's just not good enough.

Uh-uh.

Because now you can get the gold and the glory that you really deserve.

Here's how.

We've just released our dBASE II RunTime™ application development module.

And it can turn you into an instant software publisher.

The RunTime module condenses and encodes your source files, protecting your special insights and techniques, so you can sell your code without giving the show away.

RunTime also protects your margins and improves your price position in the marketplace. If your client has dBASE II, all he needs is your encoded application. If not, all you need to install your application is the much less expensive RunTime module.

We'll tell the world.

With your license for the dBASE II RunTime module, we provide labels that identify your program as a dBASE II application, and you get the benefit of all the dBASE II marketing efforts.

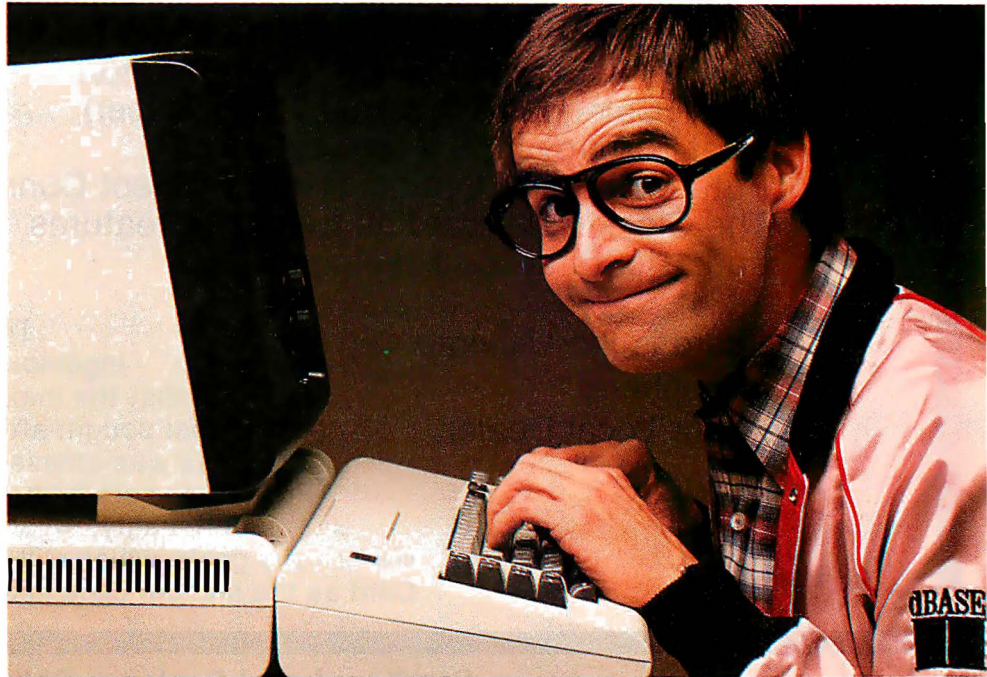

We'll also provide additional "how to" information to get you off and running as a software publisher sooner.

And we'll make your products part of our Marketing Referral Service. Besides putting you on our referral hotline, we'll publish your program descriptions and contact information in *dBASE II Applied*, a directory now in computer stores world-wide.

Go for it.

But we can't do any of this until we hear from you.

For details, write RunTime Applications Development, Ashton-Tate, 10150 West Jefferson Boulevard, Culver City, CA 90230.

Or better yet, just call (213) 204-5570. And get what you deserve today.



ASHTON · TATE

Circle 485 on inquiry card.

©Ashton-Tate 1983.

Monte Carlo Card

THE DISTINGUISHABLE CARD FOR THE DISCERNING USER.
FIVE FUNCTIONS ON A SINGLE BOARD

- ★ 64K to 1 Megabyte RAM Memory
- ★ ONE IBM Compatible Centronics Parallel Port
- ★ ONE IBM Compatible RS-232 Serial Port
- ★ Clock/Calendar (Perpetual Time Keeper)
- ★ Dual-Port Joystick Interface
- Future Upgrade Option: Plug-On Direct Connect Modem
- The Clock/Calendar has full alarm features and 1/100th second timing.

This card is the Ultimate
IBM Peripheral.
See Your Local Dealer.

Available
NOW

The Monte Carlo Card was ingeniously engineered to ensure that the maximum possible variety of the most sought-after features demanded by PC users was amassed upon a solitary board. Providing users with the best value for money, functionality, reliability, and flexibility, were our primary goals, which will enshrine the Monte Carlo Card as the premier expansion board for any PC user.

See Your Local Dealer or Call

I-C Magic +

GRAPHICS

- Full Color or B/W Tones
- HIRES and Medium Res.
- 4-Dot Sizes for Blow-ups
- Reproduce Graphics from Screen to Dot Matrix Printer, Full Screen or Sub-Section
- Rotation, Color Hue Selection
- Shift PrtSc Graphic Dumps
- Color on Prism 132/80
- Operates on EPSON/NEC/C-ITOH PRISM/OKIDATA

SPOOLING

- Selectable buffer 1K to 64K
- Serial or Parallel
- True Background spooling at your fingertips
- Save processor time
- **SAVE MONEY**
- Buffers all text and graphics

TERMINAL

- RS-232 Direct or Modem connection
- Full terminal capability on a chip! Printer Hardcopy/Echo
- Full input/output buffering
- Background terminal features
- Easy for user customization

FOR YOUR IBM PC

IBM is a registered trademark of International Business Machines, Corp. MBI and I-C-Magic are trademarks of Microcomputer Business Industries, Corp

**MICROCOMPUTER
BUSINESS
INDUSTRIES
CORPORATION**



ADMINISTRATIVE OFFICES: 1019 8TH STREET, GOLDEN, COLORADO 80401 (U.S.A.)
TELEPHONE: (303) 279-8438

Circle 280 on inquiry card.

TWX: 910-934-0191

Monte Carlo Card

The distinguishable card for the discerning user

The only true FIVE-function card
for the IBM Personal Computer

- 64K to 1 Megabyte of Memory
- ONE IBM Compatible Centronics Parallel Port
- ONE IBM Compatible Asynchronous Communications Port
- Clock/Calendar (Battery Backed) with Alarm Features
- Dual-Port Joystick Interface
- **Future Upgrade Option:**
Direct Connect Plug-On Modem

Monte Carlo

**MICROCOMPUTER
BUSINESS
INDUSTRIES
CORPORATION**

ADMINISTRATIVE OFFICES: 1019 8TH STREET
TELEPHONE: (303) 279-8438

GOLDEN, COLORADO 80401 (U.S.A.)
TWX: 910-934-0191

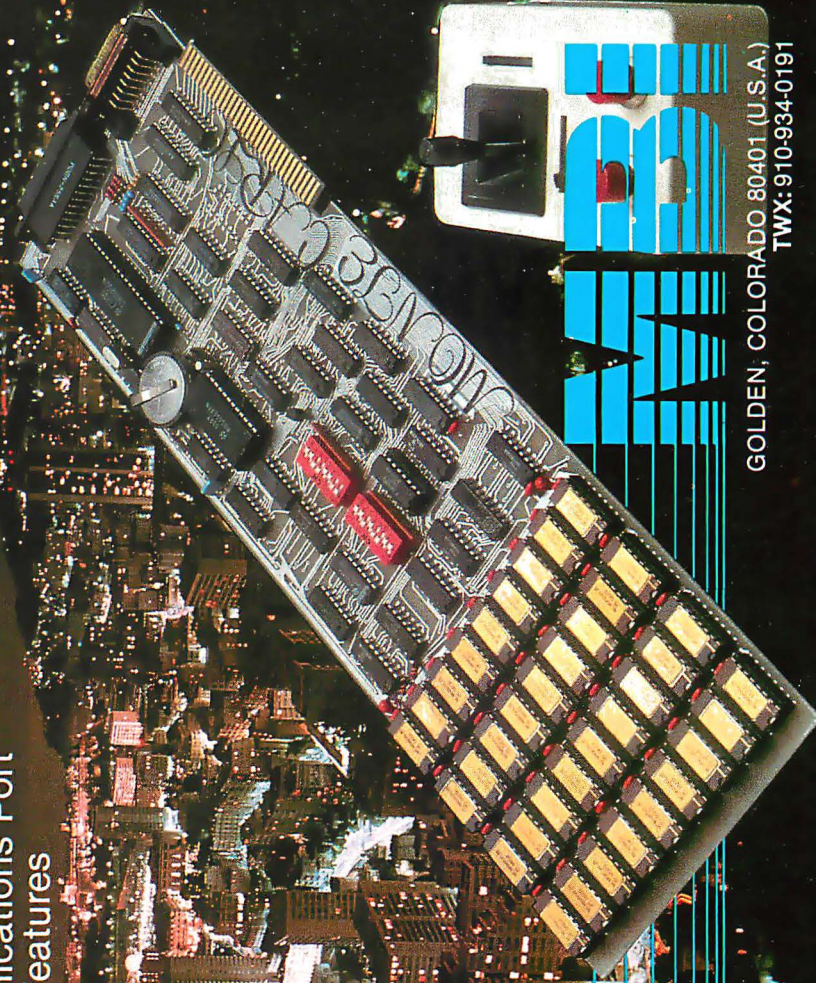

Virtual Memory for Microcomputers

Four New Memory-Management Chips Pave the Way

Stephen Schmitt
2890 Sandhill Rd.
Mason, MI 48854

Not too long ago, a microcomputer system with 32K bytes of memory was considered a luxury. Because memory was very expensive, you took great pains to squeeze, pack, and cram programs into the small amount of memory that you could afford. Today, however, you can buy 256K bytes for less than \$500. And new 16- and 32-bit microcomputers feature directly addressable storage spaces that are 100 to 10,000 times larger than those found in 8-bit architectures. Like the pauper who just became rich, how do you handle this vast wealth?

Another drastic change in the microcomputer world deals with software. Multitasking operating systems, high-level languages, and flexible business software have become popular. The problem is now more complex: How do we take advantage of both the increased hardware power and the new complex software?

Virtual-memory techniques offer

About the Author

Stephen Schmitt has worked for Hewlett-Packard and also taught at Michigan Technological University. He is now doing a review of a version of the Ada programming language for microcomputers.

one answer. Virtual memory is an automatic system for controlling very big memories. But special hardware functions are essential for building such a system. And now, single-chip memory-management units (MMUs) have been developed to provide these capabilities for microcomputers.

In the first part of this article, I will introduce some of the basic concepts

Virtual memory is a powerful concept. It allows you to consider main memory to be very large—much larger than its actual physical size.

of virtual memory. Next, I'll compare and evaluate four MMU chips that have recently become available: Intel's iAPX 286, Motorola's MC68451, and Zilog's Z8010 and Z8015. [This survey does not include the National Semiconductor NS16082 MMU for the NS16032 microprocessor. Because of its fairly recent introduction, the part was not evaluated for the review. The

NS16082 is another interesting MMU that merits analysis.] Finally, I will discuss some implications and applications of virtual memory in microcomputer systems.

Program Folding

Almost every computer system has several types of memory devices that differ in speed and storage capacity. A fundamental tenet of computer technology states that memory price is directly related to its speed. Storage hierarchies thus usually represent an effective compromise between a large, slow, inexpensive memory and a small, expensive one with high access speed. Familiar examples of this are systems with relatively small amounts of fast RAM (random-access read/write memory) and larger, slower, and cheaper disk-storage devices.

Although the cost benefit of such a configuration is substantial, the efficient management of this structure presents a challenge. The movement of data between these two hierarchy levels should be minimal; otherwise, the access time for the slow memory will predominate over the speed of the fast memory. In a typical two-level system, main memory (MM) is

NATIONAL COMPUTER PRODUCTS

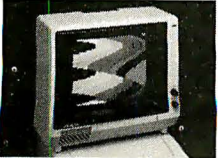

Video Monitors
 AMDEK Video 300 12" hi-res grn 145*
 AMDEK Color II 13" w/audio out 299*
 AMDEK Color II hi-res RGB 339*
 AMDEK Color III med-res RGB 339*
 BMC 12AU 12" hi-res green 99*
 NEC 1201 M 12" hi-res green 169*
 NEC 1212M 12" composite color 329*
 NEC 1203H 12" RGB for IBM PC 699*
 TAXAN Vision 1 12" med-res RGB 329*
 TAXAN Vision 3 12" hi-res RGB 499*
 USI 12" Amber display 169*
 ZENITH 12" hi-res green 119*

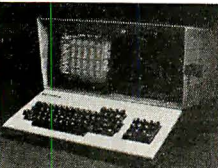

Kaypro
 The anytime-anywhere computer. Includes CP/M, CBASIC, a spreadsheet and wordprocessing software.
 PLEASE CALL FOR MORE DETAILS.

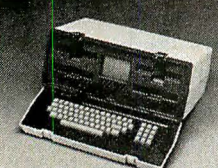

OSBORNE I
 New! Includes double-density drives, and software; CP/M, WordStar, MailMerge, SuperCalc, CBASIC & MBASIC.
 PLEASE CALL FOR OUR PRICE.



Diskettes
 Buy 100 3M Scotch 5 1/4 SS/DD for only \$219.95
 3M Scotch 5 1/4 SS/DD 25*
 3M Scotch 5 1/4 SS/DD Box of 10 35*
 Verbatim 5 1/4 SS/DD Box of 10 29*
 Head Cleaning Diskette 5 1/4 27*

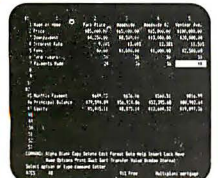

Commodore 64
 Special Price **\$429.95**
 COMMODORE 1541 Disk Drive 289**
 Datasette program recorder 65**
 DATA 20 Z-80 & 80 column pac. 229**
 CARDCO Centronics interface 79**
 Tolt. Text Processor 35**
 Sprintmaster 35**
 MicroSystem RS-232 interface 59**
 We carry a complete line of accessories and software for the Commodore. Please call.

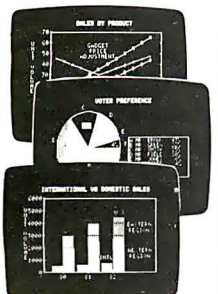

Atari 1200XL
 Only **\$679.95**
 ATARI 800 with 48K 519**
 ATARI 810 DISK DRIVE 429**
 ATARI LIGHT PEN by Symtec 129**
 Alien Voice Box 129**
 File Manager Plus data base 79**
 We carry much more for Atari... Call



VisiCorp
VisiCalc
 Only **\$179.95**
 VisiFile IBM: 219** Apple: 189**
 VisiTextPlot 229**
 VisiSchedule 229**
 VisiWord (for IBM with 128K) 299**
 Please specify Apple II or IBM PC

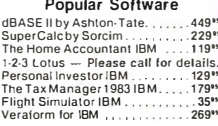

MicroPro
 WordStar 359**
 Random House Thesaurus 129**
 MailMerge 119**
 SuperSort 119**
 SpellStar 119**
 Only **\$179.95** ea.
 Specify Apple, IBM, or 8" CP/M format.
Popular Software
 dBASE II by Ashton-Tate 449**
 SuperCalc by Sorcim 229**
 The Home Accountant IBM 119**
 1-2-3 Lotus - Please call for details.
 Personal Investor IBM 129**
 The Tax Manager 1983 IBM 179**
 Flight Simulator IBM 35**
 Veriform for IBM 269**



EPSON FX-80
 160 cps, 10" carriage, 2K buffer
 EPSON MX-100 699**
 GEMINI 10 650**
 GEMINI 15 650**
 C. ITOH 8510 650**
 C. ITOH 1550 650**
 Please call for prices



OKIDATA ML92
 160 cps, 10 inch carriage, 80 columns
 Only **\$499.95**
 Tractor for ML92 59**
 OKIDATA A93 869**
 OKIDATA 82A with tractor 459**
 OKIDATA 84A par w/tractor 999**



TRANSTAR 315 Color Printer
 Prints 7 colors plus more than 30 shades, all in a single pass of the print head. And it's built by Seiko.
 Only **\$549.95**



COLECOVISION
 State-of-the-Art video game
 Only **\$187.50**
 Donkey Kong game included



Hayes
 MicroModem I by Hayes 269**
 MicroModem II by Hayes 119**
MICROSOFT
 MICROSOFT PREMIUM SYSTEM
 Includes: Z-80 SoftCard, 16K RamCard, Videx Videoterm, Softswitch, & CP/M User Guide by Adam Osborne. List 755.00
 Only **\$459.95**
 Z-80 SoftCard by MicroSoft 239**
 16K RamCard by MicroSoft 69**



NEC 3550 Spinwriter for IBM PC
 Only **\$1995.00**

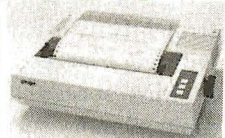

Apple IIe
 Please call for prices on Apple IIe system packages and other accessories.
Call for Lowest Price.



Apple Disk Drives
 Special buy! **Franklin Ace 100 drive w/contoller only \$359.95**
 Forth Dimension 265**
 MicroSci A2 299**
 MicroSci A2 with controller 369**
 Rana Elite I 289**
 Rana Elite I w/contoller 389**
 Corona 5 megabyte hard disk 1895**

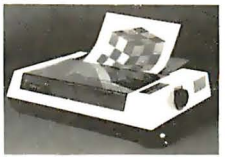

FRANKLIN ACE 1000 & 1200
 Apple II compatible computer - 64K, upper/lower case, and more!
PLEASE CALL FOR DETAILS
 System packages at special prices.



Apple II Accessories
 ALF 9 voice music card 159**
 CCS 7710 Serial card 139**
 16K Ram Card 59**
 Grappler Plus 129**
 PKASO interface 135**
 Wizard 80 column card 189**

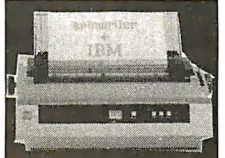

Hayes
 MicroModem I by Hayes 269**
 MicroModem II by Hayes 119**
Videx
 Videx 80 column card 239**
 Enhancer II 119**



MICROSOFT
 MICROSOFT PREMIUM SYSTEM
 Includes: Z-80 SoftCard, 16K RamCard, Videx Videoterm, Softswitch, & CP/M User Guide by Adam Osborne. List 755.00
 Only **\$459.95**
 Z-80 SoftCard by MicroSoft 239**
 16K RamCard by MicroSoft 69**



IBM Personal Computer
 Includes 64K, 2 DD/DS 320K drives, keyboard, color video card, & MS-DOS.
PLEASE CALL FOR SYSTEM PRICES.



Columbia MPC
IBM PC compatible system
 Includes 128K, 2 DS/DD 320K drives keyboard, video card, MS-DOS & CP/M 86 software. Monitor not included.
COMPLETE SYSTEM
 Only **\$3199.00**



corona.
IBM PC COMPATIBLE DESKTOP COMPUTER
 128K 320K disk drives, 9" display, serial & parallel ports, and MS-DOS.
Under \$2400
 Please call for more details.



corona.
IBM PC COMPATIBLE PORTABLE
 128K, 320K disk drives, 9" display, serial & parallel ports, and MS-DOS.
Under \$2300
 Please call for more details



IBM PC Accessories
 QUADRAM 64K 399** 128K 499**
 QuadBoard 192K 599** 256K 699**
 MICROSOFT 64K RamCard 249**
 New! MICROSOFT ComboCard CALL DAVONG 5MB plug-in hard disk 1595**
 AST ComboPlus with 64K 469**
 Joystick for IBM PC 59**

SATISFACTION GUARANTEED
 We will accept the return of most items within 15 days of your receipt of the merchandise. At your request we will repair, exchange, or issue a prompt refund. Understandably, software is not returnable. Please call for more details.



It's Here!
TOLL FREE ORDERING 800-854-6654

National Computers Spring 1983 collection of State-of-the-Art computer merchandise is available now. You'll find hundreds of products, including computers, printers, video monitors, modems, and accessories for the Apple II, IBM PC, and CP/M systems, all at the great prices you expect from us. It includes dozens of illustrations and some very informative comparison charts. For your copy send \$1.00, which we will credit to your next order.
 Circle 118 on Inquiry card.

To order please send money order or cashier's check. Personal checks 3 weeks to clear. Prices reflect 2% cash discount. We accept VISA, MasterCard, American Express, Diners Club and Carte Blanche. Shipping, handling & insurance charges; add 3% of merchandise total (min. \$5.00). California residents add 6% sales tax. Foreign countries please call or write. Prices and availability subject to change without notice. All equipment is new and warranted by the manufacturer.

1000 to 5000 times faster than the magnetic disks used for secondary storage. Thus, disk accesses should be as infrequent as possible if we are to take advantage of the high speed of the main memory.

Another problem is that the relatively small size of the main memory in most systems limits program size. An excessively large program must be broken into parts; each piece is loaded into main memory prior to its processing turn and returned to disk after execution. This technique is called *folding* or *overlaying*, and the task of folding programs is usually a job for the programmer. The problem is that the mechanics of defining separate program parts and adding code to control data transfer between main and secondary memory are usually cumbersome tasks. Also, the additional folding code clouds program logic. Compilers and linkers can simplify the task, but you must still design the overlay framework.

Despite these difficulties, however, folding operations are common. In fact, the word processor I'm using to write this article applies the concept twice. First, the program is too big to fit completely into memory and is divided into three overlays. Second, only a portion of my large text file resides in memory at a given time—the rest is stored on disk.

As you can imagine, manual folding consumes considerable time and effort (as much as 25 to 40 percent of programming costs). But there is a way we can take advantage of the benefits of large, sophisticated programs without spending a tremendous amount of time manually folding them to fit into small memory spaces.

Virtual Memory: Definition

Computer facilities that automatically fold programs and data between two or more memory levels are called virtual-memory systems. Virtual memory is a powerful concept. With it, you can consider main memory to be very large, much larger than its actual physical size. Intermediate files, overlays, and many file-access procedures are no longer necessary. Pro-

gram logic is simpler and is focused on problem solutions, not critical resource management.

The objective of virtual memory is straightforward: to permit programs with very large address spaces to run at MM speeds. In virtual systems, main memory serves as a window (or group of windows) onto the entire address space held in secondary memory. If the window is big enough, and if it accurately reflects the active part of total memory, the technique works extremely well.

The reason for this is that programs tend to access small portions of memory over fairly long periods of computer time. This is called *clustering* or *locality of reference*. Code loops and manipulations of a data structure are examples of clusters or programs with good locality. A virtual system must detect and maintain in main memory only the *working set* of a program,

Address space in a typical virtual system ranges from 16 megabytes to 64 gigabytes, enough to handle very ambitious programming projects.

that is, those locations with high activity. As activity gradually shifts to other memory regions, these areas of secondary storage are automatically accessed and brought into main memory. As you might imagine, a high rate of secondary-storage access will severely degrade performance. This is known as *thrashing*.

Benefits

Let's examine the benefits of virtual-memory management. Foremost, it removes the limit on program size imposed by main-memory size. Address space in a typical virtual system ranges from 16 megabytes to 64 gigabytes—large enough, I dare say, to handle even the most ambitious programming project! And virtual systems offer other advantages:

- Main memory is allocated automatically according to the demands made

by a program. The user does not have to estimate memory allocation prior to execution.

- Manual folding is eliminated and replaced, in part, by high-speed hardware. Thus, programming costs tend to be lower.

- Programs execute correctly regardless of actual main-memory size. But note that the execution speed may be affected if the fast store is too small to meet average memory requirements.

- Relocation and task switching are enhanced indirectly.

- Multiprogramming environments have greater flexibility. The problem of deciding the optimal placement of programs in a fixed-size memory is reduced. More programs can execute concurrently because only the active portion of each occupies main memory. While this may induce less efficient use of the total addressable space, more effective use of the main memory is achieved.

Having outlined the motivation for virtual storage, we are ready to explore basic components of system design. The memory-control process must be transparent to normal operation and relatively efficient. On face value, you might doubt if reasonable performance is possible, but research into virtual-memory behavior clearly demonstrates the concept's potential (see reference 2). I hope to show that some practical systems can also have a remarkably simple design.

Virtual-Memory Design: Basic Concepts

Virtual storage systems require a mixture of specialized hardware- and software-control policies. I will focus on architectural features that influence virtual-memory operation. An understanding of intended applications should aid our analysis of MMU products later.

A computer's *address space* (AS) is the legal range of addresses that can be generated by its instruction set. The maximum size of this is determined by the number of bits in the processor's address register. A *logical address* is a memory specification used by the central processor. *Physical addresses*, on the other hand,

WILD HARE REPROGRAMS THE TORTOISE

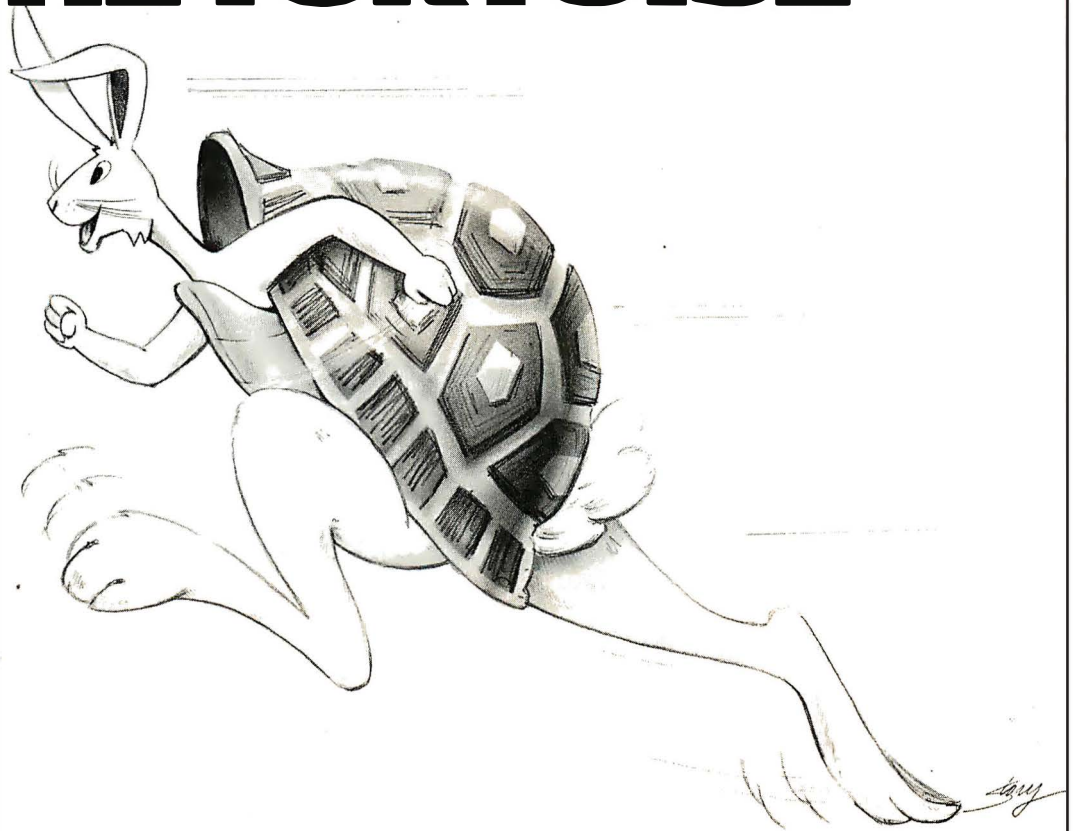

MORE GREAT NEWS FOR DATA GENERAL USERS!

Speedy Hardware puts you out front. Our Enhancer Hardware series is designed to dramatically improve the overall response and throughput of your Data General systems. Designed to look like an incredibly fast disk drive to your operating system, it accesses its 1 MB of data in 2.5 microseconds and transfers it at 2 megabytes/second. Make ICOS (CS/COBOL), RDOS and INFOS streak with a 30-day trial run. AOS/Enhancer available soon!

Productive Software wins the race! In the race for productivity, Wild Hare gives you that extra edge by multiplying the capabilities of your Data General system. Wild Hare's TSS operating system enhancements give Data General NOVA and ECLIPSE users the most from their system. TSS allows you to transform RDOS, ICOS (CS/COBOL) and INFOS into true multilingual, multi-user Time Sharing Systems.

This state-of-the-art system accommodates up to 26 users. Each user can independently edit, compile and execute programs using the language of his choice, like FORTRAN, ALGOL, BASIC, COBOL, Pascal, Assembler and more.

TSS combines RDOS, INFOS and ICOS compatibilities with AOS capabilities at a mere fraction of the cost. Try a 30-day trial run and get an even greater run for your money.

Wild Hare wins the marathon. Wild Hare has a new hardware/software scheme. It allows you to take advantage of the latest hardware and software technology, yet lets you preserve your valuable Data General user software investment. Our new "Hare Brain Scheme" is on the starting line, so watch for the latest solutions from Wild Hare. Our good ideas keep multiplying.



wild hare
COMPUTER SYSTEMS INC.

COM-STAR F/T

Tractor Friction Printer

only **\$299**

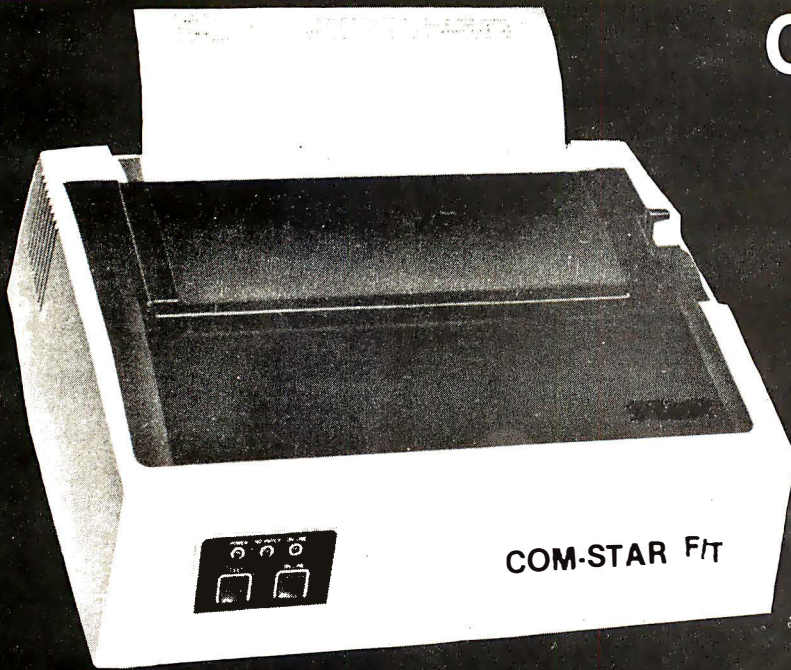

- Lowest price quality tractor friction printer in the U.S.A. • Fast 80 characters per second
- 40, 46, 66, 80, 96, or 132 characters per line spacing • Prints labels, letters, graphs, and tables
- List your programs • Print out data from modem services

Deluxe COMSTAR F/T PRINTER — \$299.00

The Comstar is an excellent addition to any micro-computer system. (Interfaces are available for Apple, VIC-20, Commodore-64, Pet, Atari 400 and 800, and Hewlett Packard) At only \$299, the Comstar gives you print quality and features found only on printers costing twice as much. Compare these features.

• **BI-DIRECTIONAL PRINTING** with a LOGIC SEEKING CARRIAGE CONTROL for higher through-put in actual text printing. 80 characters per second.

• **PRINTING VERSATILITY:** standard 96 ASCII character set plus block graphics and international scripts. An EPROM character generator includes up to 224 characters.

• **INTERFACE FLEXIBILITY:** Centronics is standard. Options include EIA RS232C, 20mA Current Loop. (Add \$20.00 for RS232)

• **LONG LIFE PRINT HEAD;** 100 million character life expectancy.

• **THREE SELECTABLE CHARACTER PITCHES:** • 10, 12 or 16.5 characters per inch. 132 columns maximum. Double-width font also is standard for each character pitch.

• **THREE SELECTABLE LINE SPACINGS:** 6, 8 or 12 lines per inch.

• **PROGRAMMABLE LINE FEED:** programmable length from 1/144 to 255/144 inches.

• **VERTICAL FORMAT CONTROL:** programmable form length up to 127 lines, useful for short or over-sized preprinted forms.

• **FRICION AND TRACTOR FEED:** will accept single sheet paper.

• **224 TOTAL CHARACTERS**

• **USES STANDARD SIZE PAPER**

If you want more try —

Premium Quality COMSTAR F/T SUPER-10" PRINTER — \$389.00

For \$389.00 you get all of the features of the Comstar plus 10" carriage, 100 cps, 9 x 9 dot matrix with double strike capability for 18 x 18 dotmatrix. High resolution bit image (120 x 144 dot matrix), underlining, backspacing, 2.3K buffer, left and right margin settings, true lower descenders, with super and subscripts, and prints standard, Italic, Block Graphics, special characters, plus 2K of user definable characters. For the ultimate in price performance the Comstar F/T Super 10" leads the pack!

WE HAVE THE LOWEST PRICES

We sell to customers and you save the profit margin normally made by computer stores, department stores and distributors, we are willing to take a smaller margin to develop volume. WE LOVE OUR CUSTOMERS — OUR PRICES PROVE IT!

IMMEDIATE REPLACEMENT WARRANTY

If your printer falls because of warranty defect within 180 days from the date of purchase you simply send your printer to us via United Parcel Service prepaid. We will "immediately" send you a replacement printer at no charge via United Parcel Service prepaid. This warranty applies to all products we sell because WE LOVE OUR CUSTOMERS!

15 DAY FREE TRIAL

OTHER OPTIONS

Extra Ribbons \$ 5.95
Roll Paper Holder 32.95
Roll Paper 4.95
5000 Labels 19.95
1100 Sheets Fan Fold Paper..... 13.95

Add \$20.00 shipping, handling and insurance. Illinois residents please add 6% tax. Add \$40.00 for CANADA, PUERTO RICO, HAWAII, ALASKA orders. WE DO NOT EXPORT TO OTHER COUNTRIES. Enclose cashiers check, money order or personal check. Allow 14 days for delivery, 2 to 7 days for phone orders, 1 day express mail available!! Canada orders must be in U.S. dollars.

PROTECTO
ENTERPRIZES (FACTORY-DIRECT)
BOX 550, BARRINGTON, ILLINOIS 60010
Phone 312/382-5244 to order

COMSTAR F/T

ABCDEFGHIJKLMN O PQRSTUVWXYZ abcdefghijklmn
opqrstuvwxyz 1234567890
ABCDEFGHIJKLMN O PQRSTUVWXYZ abcdefghijklmn opqrstuvwxyz 1234567890

SUPER-10"

ABCDEFGHIJKLMN O PQRSTUVWXYZ
ABCDEFGHIJKLMN O PQRSTUVWXYZ 1234567890

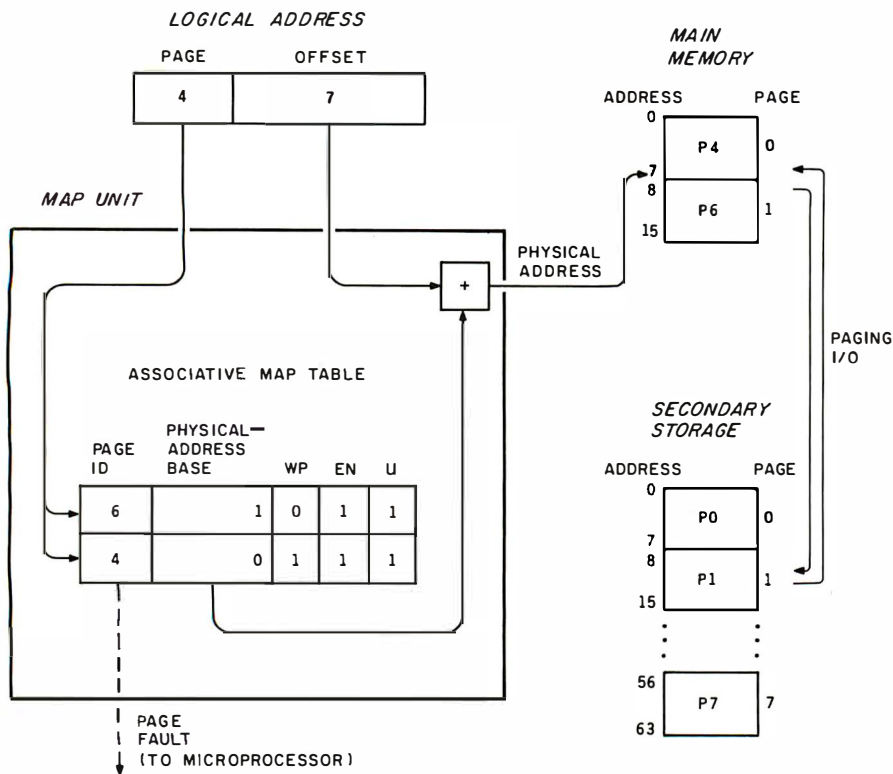

Figure 1: The associative mapping scheme for virtual-memory systems. The central processing unit specifies a memory location with a two-part logical address that includes a page field and an offset field. The page field provides the value used for searching the map table. All cells in the table are searched in parallel. If a match is found, the selected cell's physical-address-base field is added to the offset field. A page fault occurs when there is no match. In this simple diagram, the second cell matches and translates the logical address. The attribute fields in the above map table are WP (write-protected), EN (valid main-memory page; EN = 0 only when main memory is not full), and U (used; recent page access has occurred).

describe actual locations in the main memory. In most systems, logical and physical addresses are one and the same (as, for example, in 8-bit microcomputers). With a virtual system, however, the size of the AS can be significantly larger than main memory. The AS may be thought of as occupying a contiguous area in secondary storage; and logical addresses no longer correspond exactly to actual physical RAM locations.

In a virtual system, main memory contains changing portions of AS. At various times, an instruction may address a part of the AS that is not contained in main memory. This is known as a *page fault*. A virtual-memory system must be able to detect a page fault and move the desired part of the AS into main memory. Then, when that part is subsequently addressed by an instruc-

tion, the system must be able to translate that part's logical address into its present physical address in main memory. This is known as the *mapping process*. Both these processes, page-fault detection and mapping, are fundamental to every instruction step. They must therefore be performed by high-speed hardware.

A page fault stops execution of the current activity that the central processor is performing (e.g., fetching an instruction or processing operand data) until the absent memory is brought into MM. A page fault is similar to an interrupt except that it may occur partway through instruction processing. Thus, special processing logic is needed to handle partially executed instructions (consider the problems associated with restarting a MOVE BLOCK instruction).

In a virtual system, memory can be



Get the total picture.

Improve your present computer system with a high-resolution color monitor from NEC.

NEC's JC-1203 gives you the highest resolution you can get in a color monitor. And it can reproduce as many different colors and shades as the best microcomputers can generate. Compatible with a wide variety of computers, including IBM,* Zenith,* H-P,* and others, including NEC's own PC-8000 and PC-8800.

Compare these specs with your present monitor:

12-inch diagonal screen

RGB input signal with TTL level

Switchable Pos/Neg display characters

80-character, 25-line display

690 (H) x 230 (V) resolution

8x8 dots, 8MHz video bandwidth

*Special interface required

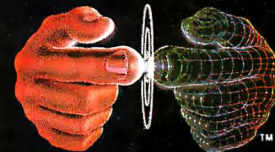

Productivity at your fingertips

NEC

NEC Home Electronics (U.S.A.), Inc.
Personal Computer Division

1401 Estes Avenue
Elk Grove Village, IL 60007
(312) 228-5900

Nippon Electric Co., Ltd., Tokyo, Japan

TCS Heart of TEXAS COMPUTER SYSTEMS

LEADER in MAIL ORDER DISCOUNTS!

800 433-5184

Texas 817/274-5625

IBM Personal Computer

INTERNAL DISKS FOR IBM
Tandon Internal Disk-160K SCALL
Tandon Internal Disk-320K SCALL

HARD DISKS FOR IBM
Complete 5 Meg. Systems from ... \$1550
Multi-computer Network Systems.

QUADBOARD FOR IBM
Includes 64K to 256K additional memory
Serial & Parallel Port and Calendar Clock

PRINTERS FOR IBM
STAR and EPSON SCALL
NEC 3550 Spinwriter SCALL

MONITORS
Med Hi Res-Green Comrex \$89
High Res-Green BMC from \$89
High Res-Color PGS SCALL
Matches IBM PC
Low Res-Color-Taxon Vision 1 ... SCALL
High Res-Color-Taxon Vision 1 ... SCALL
High Res-Green-Taxon SCALL

APPLE

First DISK DRIVE includes controller, DOS 3.3, cables and manual SCALL
Second DISK DRIVE with cable SCALL

APPLE to EPSON card and cable
APPLE TO GEMINI card and cable
Z 80 CARD SCALL
RAM CARD SCALL
Printer Interface Cards SCALL
Graphic Printer Interface Card SCALL
Graphic Spooler Interface Card available with 16K to 64K



FOR IBM, APPLE II AND APPLE III

SPECIFY INTERNAL/EXTERNAL
5 megabyte hard drive SCALL
12 megabyte hard drive SCALL

TCS MODEL III 48K 2 DISK

Systems come with 180 day warranty.

\$1444

With standard 40 track double density drives
Over 340,000 bytes
includes TDOS

\$1644

With 2 dual headed 40 track dbl. density drives
Over 730,000 bytes
Includes DOSPLUS 3.4 (\$150 value)

Fully assembled and tested systems that are software compatible and functionally identical to Radio Shack units sold at computer stores for Shundreds more.

- ▷CONTROLLER BOARDS are high quality double sided epoxy boards with gold plated contacts
- ▷POWER SUPPLY is the finest switching type available.
- ▷MOUNTING HARDWARE includes power and data cables.
- ▷DISK DRIVES are Tandon, the same ones used by Radio Shack...40 track, double density, with a 5 millisecond stepping rate.

TCS MODEL III DISK EXPANSION KITS

- 1 Controller, Power Supply, Mounting Hardware & Instruction \$279
- 2 Controller, Power Supply, Mounting Hardware & one 40 track Tandon Drive \$478
- 3 Controller, Power Supply, Mounting Hardware & two 40 track Tandon Drive \$677
- 3A Kit 3 but with two 80 track drives (dual 40's) \$879
- 3B Kit 3 but with two 160 track drives (dual 80's) \$1099

TCS Model III and Color Computer

Ask about the Green or Amber CRT for your customized-Model III

TRS-80

Model III and Color Computer

With Original 90 day Manufacturer's Limited Warranty
Call for current pricing information on the

Model II...Model 16...Model 12...Model 4

All Radio Shack Equipment shipped from our store in Brady, Texas.

Tandon

TCS DRIVE CABINET is industrial grade heavy gauge metal, safely fused, and comes with gold plated external connector with extender cable

1 DRIVE in Cabinet

40 track single sided \$249
80 track (dual sided 40 track) \$329
160 track (dual sided 80 track) \$449

1 DRIVE/Double Cabinet

40 track single sided \$289
80 track (dual sided 40 track) \$389
160 track (dual sided 80 track) \$499

2 DRIVES/Double Cabinet

40 track single sided \$489
80 track (dual sided 40 track) \$639
160 track (dual sided 80 track) \$849

Drives in cabinets come assembled/tested with power supply. Order cable separately

BARE DRIVES ONLY

40 track single sided SCALL
80 track (dual sided 40 track) SCALL
160 track (dual sided 80 track) SCALL
8 inch Slimline sgl/dbl sided SCALL
Winchester Hard Drives 5-30 Meg SCALL

Smith-Corona® TP-I

Parallel/Serial \$535

TEXAS COMPUTER SYSTEMS

P.O. Box 1327 Arlington, Texas 76004-1327

TECHNICAL ASSISTANCE 817/274-9221

ORDER STATUS 817/277-1913

TELEX/TWX/Easylink ELN 62100790

★ **800 433-5184**

No tax out of state. Texans add 5%. Prices subject to change at any time.

CORVUS

HARD DISKS from \$1889

5 Megabyte Hard Drive SCALL
10 Megabyte Hard Drive SCALL
20 Megabyte Hard Drive SCALL

Add 5, 10 or 20 Megabytes of storage to your TRS-80 Model 1, Model II, Model III, Model 12, IBM, Apple, Atari, Heath, Zenith, Intertec, S100, Osborne, Eagle, Commodore 64, Xerox, Superbrain, Z89/90, DEC LSI-11, NEC PC-8001, and more.

One or several computers can share A HARD DISK

Ask about **OMNINET** for your Apple or IBM PC.



Dedicated
To Being No. 1!

FEATURES

- 100 CPS
- 9X9 Dot Matrix
- True Decoders
- Super Script-Subscript-Underlining
- Friction and Tractor
- Programable Line Spacing
- 99% Compatible with software written for No. 1 Printer.
- High Res. Bit Image Block Graphics
- Backspacing-Doublestrike-And More
- 5, 6, 8 1/2, 10, 12 and 17 Pitch
- Free 2.3K Buffer

Extended Six (6) Months Factory Warranty--FREE!

Gemini 10 (9 inch Carriage) Friction and Tractor SCALL
Gemini 15 (15 inch Carriage) Friction and Tractor SCALL
Serial Interface SCALL
Apple Card and Cable SCALL
Commodore Interface SCALL

Call and ask about the new **High Speed** Printers By Star Micronics

COMMODORE 64

VIC 20--DISK DRIVES--MONITORS
DATASETTES--SOFTWARE
ACCESSORIES

Call For Current Pricing Information.

PRINTERS

TCS has the **LOWEST PRICES** on IN-STOCK PRINTERS

LETTER QUALITY PRINTERS

C ITOH F-10 (40 CPS)
DAISY WHEEL II (RS)
NEC 3510-3550
NEC 7710 7730
BROTHER/COMREX

MATRIX PRINTERS

EPSON-MX & FX MODELS
C.I.TOH 8510/TEC/PMC
DMP 100
DMP 200
DMP 400
DMP 500
DMP 2100
ANADIX 9501-A
CENTRONICS 352/353
OKIDATA PRINTERS

PRINTER CABLES AND INTERFACES AVAILABLE.
CALL FOR CURRENT PRICING INFORMATION.

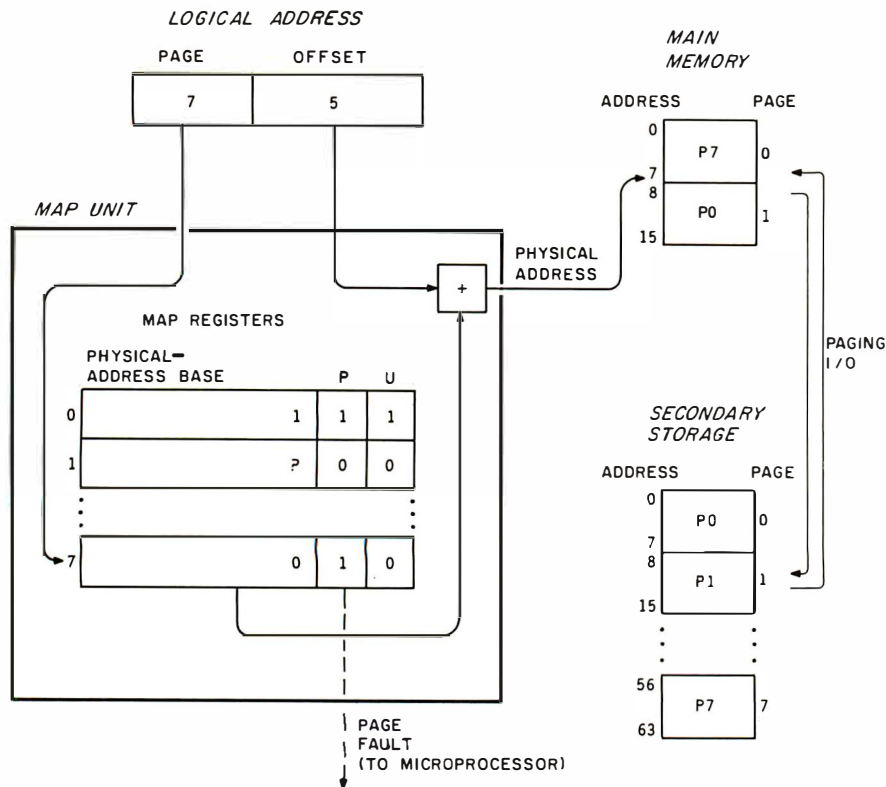

Figure 2: The mapping-by-address (or mapping-by-register, MBR) scheme for virtual-memory systems. This is similar to associative mapping except that each map cell is a register that refers to a page in secondary storage. In this simple example, the page field in the logical address refers to register 7, which in turn refers to page 0 in main memory. If register 1 had been accessed instead, a page fault would have occurred ($P = 0$). Page 1 would then be placed into main memory, probably in the space now occupied by page 7, because page 7 has not been accessed recently ($U = 0$).

divided into either *pages* or *segments*. A paged policy divides memory (both AS and MM) into equal-size blocks. The rationale for pages relates to the clustering principle. Memory activity occurs in scattered parts or clusters of the AS. By organizing storage into pages, you can "break out" the busy sections and place them in main memory. Paging, like disk blocking, also implies a smaller number of data transfers between disk and main memory.

Segments are merely pages of variable size. Segments can closely model program units because code modules and data structures vary in size (as do clusters). Trade-offs exist between page and segment organizations. I'll discuss these later. For now, you can ignore the distinction and call both pages.

Several mapping schemes exist for virtual systems. Figures 1 through 3 illustrate three common techniques.

In the examples, logical-address fields are composed of two parts: a page field and an offset field. The logical page number is translated into a physical location by the map unit. Adding the offset field to this location forms the complete physical address. A simplistic memory model will be used to show the basic operations of each technique.

Associative mapping is shown in figure 1. The logical-address page field is compared, in parallel, to all page entries in the map table. If an entry matches, its corresponding physical-page address is combined with the offset value to form the complete physical address. A page-fault condition is raised when no match occurs. The problem with associative maps is that they are expensive. High-speed register memory with integrated comparative logic is needed; translation has to be fast and transparent. The associated map has to be as large as



Read the fine print.

Improve the output of your present system with a dot-matrix printer from NEC.

For good-looking copy in a hurry, it's hard to beat NEC's hard-working PC-8023A. This is a bi-directional 100 CPS, 80-column printer that can operate in a compressed-print mode to yield 132 columns. Special 2K buffer holds a page of data, so the unit can print while you're typing in something else. Compatible with a wide range of computers, from Apple* to Zenith**.

Compare these features with your present printer:

Tractor and friction feed

Complete ASCII characters plus Greek, math, and graphic characters

Elite, pica, compressed print, proportional spacing, subscript and superscript

Standard parallel Centronics interface, serial optional

Prints clear original and up to three copies simultaneously

*Special cables may be necessary. Contact your local NEC Home Electronics dealer

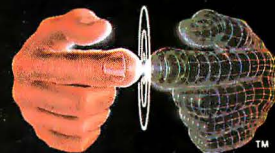

Productivity at your fingertips

NEC

NEC Home Electronics (U.S.A.), Inc. Personal Computer Division
1401 Estes Avenue
Elk Grove Village, IL 60007
(312) 228-5900

Nippon Electric Co., Ltd., Tokyo, Japan

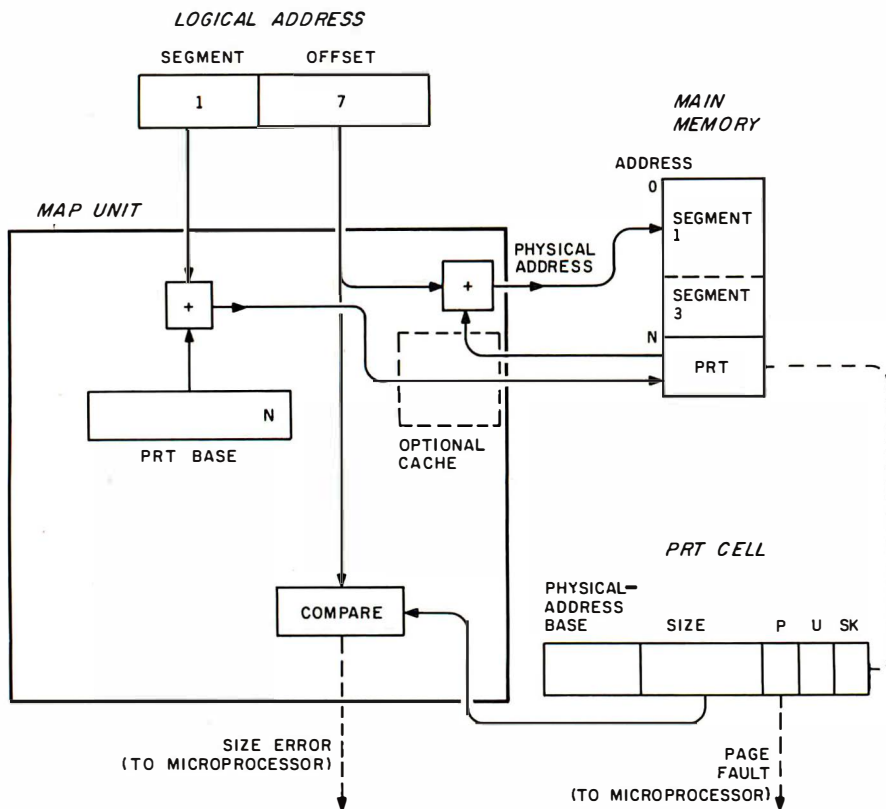

Figure 3: The segment map table scheme for segmented virtual-memory systems. In this mapping scheme, information on each segment of a program in secondary storage is kept in a program reference table (PRT) in main memory. The location of the PRT is stored in a PRT Base register. In this simple example, the segment field in the logical address is added to the contents of the PRT Base register (N). This refers to a map cell at location $N + 1$. In this map cell is a physical-address base that is added to the offset to obtain the desired address in main memory. Note that bounds-checking can easily be done by comparing the offset with the size field. Also, note that things can be speeded up by placing the most active map cells in a small associative cache memory. The attribute field SK indicates a stack segment (i.e., the offset orientation is reversed).

the number of MM page frames. If you change the size of main memory, you have to change the map size accordingly. Associative mapping works best for systems with a large number of AS pages and a moderate-sized, fixed main store.

Figure 2 illustrates *mapping by address* or mapping by register (MBR). In this technique, the logical-address page field refers to an array of high-speed registers. These registers hold status and physical-address information. Mapping by address is analogous to indirect memory addressing except that the registers permit very high processing speeds. Page faults are detected when the addressed register's "present" bit is clear. The problem is that every page in the AS requires a corresponding map register. Fortunately, the economy of conventional registers offsets the mapping array size. Note that the mapping hardware is unaffected by changes in MM size. For relatively small address spaces, mapping by address is quite attractive.

The last technique I'll present applies to segmented systems. Figure 3 design is based on the Burroughs Corporation B5500 mainframe. This approach gives you more flexibility, but is slightly more complex and necessitates additional hardware (for the

Johnny's Function Keys Can't Read

Or write. Or move a paragraph. Johnny is not a programmer, so his function keys are nonfunctional.

For Johnny, and everyone else who wants the convenience of function keys, help is here. **Keychanger™** replaces cumbersome multi-stroke control characters with individual function keys, thus saving keystrokes and time. No more "control P-S" -- simply press the assigned function key. You may choose from four ready-made sets of functions, or create custom function keys with the aid of on-screen guidance. You can change instantly from one set of functions to another.

Keychanger™ is CP/M compatible and presently supports Wordstar®, dBase II™, and BASIC (other selected programs are coming soon). To start your function keys working, send **\$29.95** to **Computer Publishing Co.**, 1945 N. Fine #101, Fresno, CA 93727. For VISA/Mastercard orders, call 209-453-0777. Wordstar is a registered trademark of MicroPro; dBase II is a trademark of Ashton-Tate.

Supplied in many popular diskette formats. Compatible with virtually all terminals having function keys. California residents add sales tax.

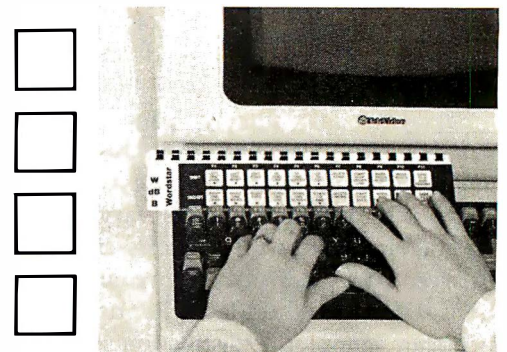

KeyCHANGER™

COMPUTER SPECIALTIES

Circle 104 on inquiry card.

FRANKLIN ACE1000



We Have An Ace Up Our Sleeve For You!
Call For Sale Price Now!



NEW!

The Ace 1200

- 6502 & Z-80 Processors
 - Built-in Drive • 128K RAM
 - 80 Columns
- On Sale Now!

CALL BASIS 108
THE ALTERNATIVE

CORONA

IBM® P/C Compatible.

- Desktop with one 320K Drive
- 128K Ram, Ser. & Par. Ports,
- Hi-Res Monitor, MS DOS,
- Basic and Multiplan ... \$2550
- Portable same components as the "Desktop" but portable ... \$1995

Commodore

Dataset	64
Disk Drive	469
Graphic Printer	319
16K Mem. Expander	79
24K Mem. Expander	139
IEEE-488 Card	69
6 Slot Expand.	99
Afron Chassis	198
40/80 Col. w/16K	229
40/80 Col. w/64K	319
Wico Joystick Delux	37
Wico Trackball	59
Modem	95
Centronics Cable	69



SALE

Software

Choplifter (cart)	34
Trashman (cart)	33
Hesmon (cart)	36
Vic Fourth (cart)	49
Personal Jour. (tape)	26
Vic-Journal (tape)	29

SYSCOM SYSTEMS



New Apple Compatible System **CALL!**

ACCESSORIES

Fourth Drive	279	Hayes 1200 Baud	539
Fourth Controller	89	Sooper Spooler (16K)	299
Rana Elite One	299	Z-80 by Microsoft	229
Rana Controller	89	Videoterm (80 col)	244
Micro Sci A-2	349	EPS Keyboard	319
Micro Sci A-40	349	The GrapplerPlus	119
Trackball By T.G.	49	RGB by Electrohome	219
3" Drives by Amdek	749	Parallel Card (8' cable)	69
New Vista Products...Call	169	Z-Card by ALS	139
Video Card	169	The C/P/M Card by ALS	329
16K Ram (2yr WNTY)	59	Synergizer by ALS	529
Softcard Plus by MS	449	Joystick by TG	46
Softcard Prem. System	449	In Line Buffer	229
J-Cat By Nov	124	Disk Emulator (294K)	689
CPS Multi-Func by Mtn	169	Appli-Card 6M2	429
Micro Modem II	278	Expan Chassis by Mtn	539
Smart Modem	219	Winchester Hard Disk	CALL

COLUMBIA

The Columbia MPC is IBM® P/C Hardware & Software Compatible.
The Price? Non-Comparable!
Save Hundreds and Call

FREE* SHIPPING

SALE KEYCOMP II

By Non-Linear Systems

The totally portable, powerful and profitable computer for your home or office.

- Z-80 • 64K Ram • two 5 1/4" floppy-disc drives (double density) • 9" video display (80 col.)
- RS-232C • Parallel Printer • Interface

SOFTWARE INCLUDED!

- CP/M® 2.2 • S/Basic • Profit Plan
- Perfect Writer/ W/P • Perfect Calc.
- Perfect Filter • Perfect Speller

Commodore 64

On Sale \$399

Complete Catalog Hardware/Software FREE!
NEW SX 100 PORTABLE

with 5" Color and 1 Drive or with 5" Monochrome and 2 Drives

C-64 Accessories

Video Pak Z-80	259
Video Pak 80	159
IEEE Adapt. by MS	89
Viac (adapt any cass)	45

C-64 Software

Hesmon 64 (cart)	129
Heswriter 64 (cart)	34
Home Journal (tape)	39
DataCalc (tape)	39

Apple IIe



SOFTWARE

Screen Writer II	103
Magic Window	69
SuperText II by Muse	118
BPI SOFTWARE	CALL
Exec Secretary by S. S.	189
Pro. Easy Writer by IUS	129
LetterPRFT w/mailmerge	109
WORD HANDLER	147
General Manager	109
Visicalc by Visicorp	183
PFS by Soft Pub. Corp	69
Visifile by Visicorp	184
Visitr/Visipilt by Visicorp	196
PFS: Report	69
DB Master	164

PFS: Graph	89
Desktop Plan	184
Wall Streeter by M.L.	219

CP/M® SOFTWARE

Basic Interpreter™	CALL
Basic Compiler by MS289	
Cobol-80 by Microsoft	539
Fortran-80 by Microsoft	416
Word Star	229
Mail Merge	159
Spell Star	159
Data Star	189
Calc Star	99
Supercalc	212
dBase II by Ashton-tate	494
G/L by Peachtree	CALL
A/R by Peachtree	CALL
Peachcalc	CALL
Quickcode	239
Tax Preparer '82	109
Real Estate Analyzer	139
Bag of Tricks	29
Zoom Graphix	27
Special Effects	27

CALL FOR CATALOG!
*CP/M is a Registered Trademark

IBM-IBM-IBM-IBM-IBM-IBM

AST		QUADRAM	
Combo Plus 64K (S/P)	349	Quadboard II 64K	429
Combo Plus 256K (S/P)	639	Quadboard II 256K	669
MegaPlus 64K (S/P)	459	Quad 512 + 64K	389
MegaPlus 256K (S/P)	749	Quad 512 + 512 K	1049
QUALITY COMP.		TECMAR	
Big Blue	449	Complete Line	CALL
DAVONG		MBI	
5 MB Hard	1489	Monte Carlo 64K	399
10 MB Hard	1899	Monte Carlo 256K	649
15 MB Hard	2249	XEDEX	
Slave 5 MB	1290	Baby Blue (64K & Z-80)	447
		Baby Blue Ramplus	659
SOFTWARE			
Visicalc (256K)	185	Vedit-86 by Cmpview	199
Word Star	249	The Programmer	369
Mail Merge	88	CP/M-86 by Digital	279
Peachtree Pkgs	CALL	Basic-80 by MSoft	297
Volks Writer	129	Fortran-80 by MSoft	419
Super Calc	217	M/Sort by MSoft	159
Easy Writer II	239	Easy by Denver	543
Home Acct. Plus	109	Mathemagic by IBM	69
CP/M-86 by Cmpview	299	Logon by Ferox	129
Vedit by Cmpview	129	Fastscreen by Cu	73

CALL FOR CATALOG!

ZENITH

Free Brochure

Z-100 All In One (Z-120-22)	Call
Z-100 Low Profile (Z-110-22)	Call
Color Upgrade Kit (Z-219-1)	139
192 K Upgrade Kit (Z-205-1)	155
RGB Color Monitor 13" (ZVM-134)	589
Auto-Dial Terminal (ZT-1-A)	589
System Software Pack #1 (Z55-100-1)	449
System Software Pack #2 (Z55-100-2)	299

EAGLE

The Price/Performance Leader!

Eagle II	2495
Eagle III	3199
Eagle IV	4699
File 10	2450

New! Eagle 1600 (8086 Microprocessor) Call!
Free Brochure

ATARI 1200XL On Sale!

800 w/48K 529
400 w/16K 229

410 Recorder	74	The Bookkeeper	194
810 Disk Drive	439	The Entertainer	89
825 Printer	639	The Educator	124
830 Modem	159	The Programmer	56
850 Interface	159	The Communicator	334
Full-View 80	279	PacMan	33
Joystick (Pair)	18	Mouse/Joystick	26
48K by Intek	189	Choplifter	27
32K by Microtek	99	Frogger	37
1010 Recorder	79	Golf	33
Epson Cable	34	Microsoft Basic	69

CALL FOR CATALOG!

TERMINALS TELEVIDEO

TVI 910	578
TVI 910 Plus	589
TVI 970	1150

MONITORS TAXON

RGB Vision I	
RGB Vision III	
12" Amber	

PRINTERS OKIDATA

319 Microline 92	549
539 Pacemark 2410P	2350
129 Microline 82A	419

ADDS

Viewpoint A-2	579
Viewpoint A-3	499
Viewpoint 60	719

AMDEK

Video 300	149
Color I	309
Color II	729

CALL FOR COMPLETE CATALOG

C. ITOH

8510 Prowriter (Par)	399
1550 Prowriter (Par)	659
F-10 Printmaster (Par)	1599

IT'S FREE! NEC 8020 449

ORDER TOLL-FREE!! 1-800-854-2833

TO ORDER: Phone orders invited using Visa, Mastercard American Express, or bank wire transfers. Visa, MC, and American Express service charge of 2%. Mail orders may send charge card number (include expiration date), cashiers check, money order, or personal check (allow 10 business days for personal or company checks to clear). Please add 3% (\$5.00 minimum) for UPS shipping, handling, and insurance. COD's minimum \$250.00 with \$25.00 deposit. All equipment is in factory cartons with manufacturer warranty. Opened products not returnable. Restocking

fee for returned merchandise. Equipment subject to price change and availability. Retail prices differ from mail order prices.
\$40.00 min. purchase. *With prepaid cash orders.
*Exclude certain printers & monitors & foreign orders.
Calif. residents add 6% State Tax.
For APO and FPO - add 10% (\$25.00 min. for postage). Calif. residents add 6% Sales Tax. Include phone number. Credit cards not accepted.
Foreign Orders - include 3% handling, shipped air freight collect. Credit cards not accepted.



COMPUTER SPECIALTIES
(619) 579-0330
MAIL TO: 1251 BROADWAY
EL CAJON, CA. 92021

segment-size field and the *program reference table* or PRT). A segment field replaces the logical-address page field. You can have any number of system segments; MM and AS sizes do not constrain the choice. Translation is similar to mapping by address. The program reference table contains the size and location for each segment. It resides in main memory for two reasons: (1) to allow a large number of segments, and (2) to avoid the high cost of registers that would be wide enough to hold extra mapping data. The table acts like mapping registers, with the segment field—not the page field—providing the index address. At first glance, it looks as if the scheme is twice as slow as the others because every reference needs two memory accesses (one for the PRT and one for the actual data). But this problem can be handled by putting a small buffer-register set in the MMU. Keeping copies of the most active PRT entries in this high-speed buffer greatly increases mapping speed.

Besides translating addresses, mapping units also provide other functions. They hold information to aid memory management and data protection. Table 1 is a list of information found in various mapping systems. Each virtual system uses a subset of these items, determined by the particular mapping scheme used and the memory-control functions.

Up to now, attention has centered on the hardware aspects of virtual systems. Now, let's consider the memory-management and software requirements for virtual systems.

Paging Policies

As mentioned previously, a minimal amount of secondary-storage access is central to a virtual system's viability. Figure 4 shows a graph of disk activity versus main-memory size allocated to a program. From the graph, we see that given enough main memory, disk access approaches zero. However, a primary aim of virtual memory is to provide a huge address space while minimizing expensive main memory. To satisfy both conditions, you must operate at a point just below the "knee" of the

Field	Abbreviation	Description	Field Size (bits)	Memory Structure (Segment vs Page)
Present	P	Indicates if page is present in main memory	1	Both
Used	U	Indicates if page has been recently accessed	1	Both
Dirty	D	Indicates if page has been modified	1	Fixed-page
Type		Various page properties	1-4	
	RP	Read-protected		Both
	WP	Write-protected		Both
	EX	Executable code		Both
	SH	Shared		Segment
	SK	Stack memory		Segment
	OW	Overflow warning		Both
Size	SZ	Size of segment	16-32	Segment
Priority or mode	PR	Indicates task priority or system context to permit access	1-8	Both
Virtual time	LREF	Time of last access to page	12-32	Both
Task ID	TID	Identifies task(s) that owns the segment	8-16	Segment
Fix	F	Indicates that page is not to be replaced	1	Both
I/O access	IO	Protect or hold page for input/output	1	Both
Enable	EN	Indicates valid pages for access (when main memory is not full)	1	Both

Table 1: A summary of the control and status information-used by virtual-memory mapping units. Most mapping schemes use a subset of these different attribute fields.

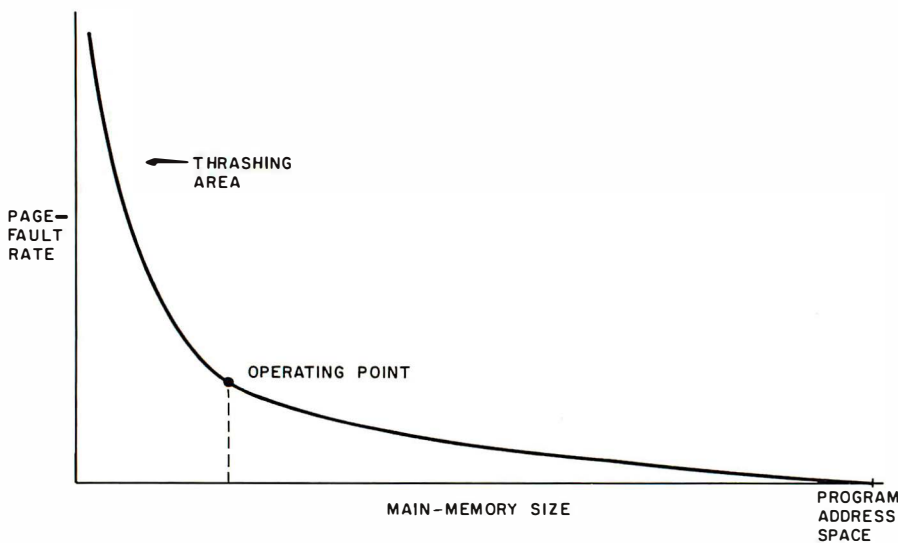

Figure 4: A graph showing how the page-fault rate (i.e., the rate of accesses to pages not present in main memory) is related to the size of main memory. The operating point is the memory size sufficient to hold a program's most frequently accessed routines—its working set. Adding memory past this point has little effect on the page-fault rate. Of course, as the needs of a program change, the operating point will shift.

Keep your bottom line on the up and up and up.

The future never comes with any guarantees.

But there is a way to improve tomorrow's business performance today.

It's a microcomputer program called the Bottom Line Strategist.™

The future is now.

With the Strategist and your microcomputer, you can explore *alternative* business decisions and get answers to the questions common to any business focused on growth:

How much money are we risking? Will the business be profitable? When? Is that soon enough? Can we improve this by changing the price? What's the

impact of our assumptions on net worth, cash flow, market penetration and growth?

The Strategist uses seven sophisticated econometric models originally developed for companies on the Fortune 500 list.

But it's pre-programmed, so all you do is enter your current business assumptions, then sit back and watch the dynamics of your future unfold graphically.

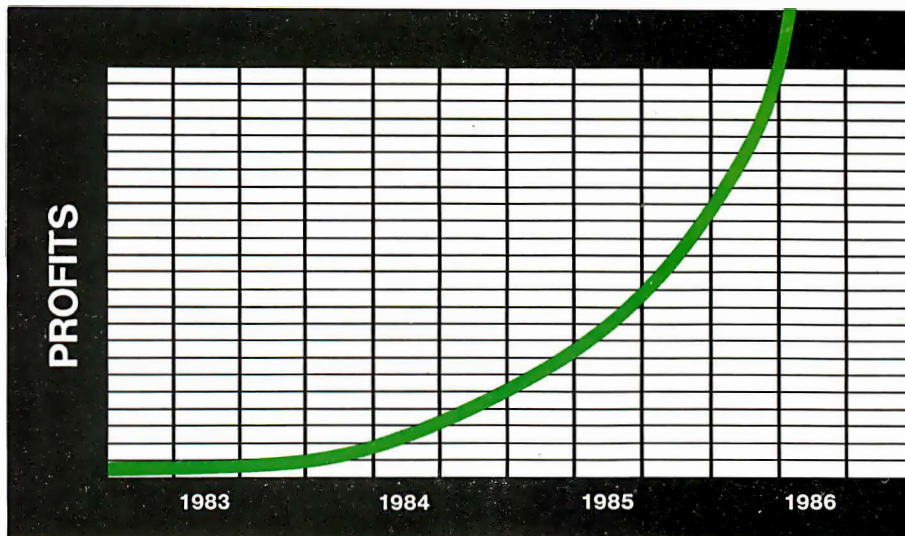

The Strategist plots (and tabulates) your marketing and sales projections; anticipated cash flows; break-even point; Net Present Value; and more—a total of 11 production, financial and marketing forecasts.

If any area looks interesting, the unique "zoom" takes you in for a closer look at the picture. And if you don't like what you see, do it all over again.

Instantly.

Without any programming.

And do it as often as you need to get the results that you want.

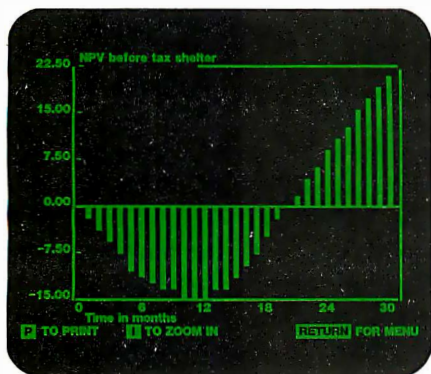

Tomorrow's answers today.

The Strategist is a unique short-cut to experience, without the hard knocks.

You can refine your pricing policies. Optimize your cash flows. And maximize your profits while minimizing your risks.

In today's business climate, how much is that worth? The Bottom Line Strategist is \$400.

Our no risk offer.

You can check out the Bottom Line Strategist with no financial risk.

Drop by a dealer showroom and run through a hands-on demonstration. Then take home a package and use it for 30 days. It runs on 8-bit and 16-bit microcomputers (IBM PC, Apple II, CP/M, etc.) If you don't like it, return it and you'll get your money back.

For the name of your nearest dealer, contact Ashton-Tate at 10150 West Jefferson Boulevard, Culver City, CA 90230.

Better yet, call (213) 204-5570 today. Because if time is money, the Bottom Line Strategist is money in the bank.

The Bottom Line Strategist™

ASHTON-TATE ■

Circle 35 on inquiry card.

P&T CP/M[®] 2 is GROWING

TRS-80 MODEL II
\$185

Still the best CP/M for the Mod II with features like 596 Kb per diskette, type ahead, full serial port support, and more.

TRS-80 MODEL 16
\$220

Includes full support for thinline drives; gives 1.2 Mb per diskette for the Mod 16 (Z-80 mode) and Mod II's with double sided drives.

RADIO SHACK HARD DISK
\$250

Includes all the features of P&T CP/M 2 plus 8.7 Mb per hard disk drive.

CAMEO HARD DISK

Support for the standard Cameo hard disk system (\$250) or the multiplexer (for multiple computers) system \$400.

CORVUS HARD DISK
\$250

Support for a 5, 10, or 20 Mb Corvus hard disk system.

Start with a Model II floppy system and grow into a hard disk. Since all P&T CP/M 2 systems are fully compatible, you will have no conversion worries.

Special note: P&T hard disk systems allow you the user to configure logical drive assignments to your specifications. Write for more details.

Prepaid VISA, M/C, or COD orders accepted. All prices FOB Goleta and subject to change.

CP/M is a registered trademark of Digital Research. TRS-80 is a trademark of Tandy Corp.

PICKLES & TROUT
P.O. BOX 1206
GOLETA, CA 93116
(805) 685-4641



curve (labeled operating point). The locality principle states that the amount of MM needed at any given time is but a small portion of AS. Hence, if you keep the active cluster or working set in memory, thrashing and main-memory needs are minimized.

Sounds simple, doesn't it? Alas, a few minor problems "gum up" matters. For openers, measuring a system's working set is a dynamic process. The size and contents of a working set change rapidly. Keeping track of working sets involves considerable time, resources, and problems. Just how is this working set determined? At what times do we change the working set to reflect locality movement? What happens when several programs are running or there is program I/O? All these problems are handled by a *paging policy*.

Basically, a paging policy does three things:

- Fetching—decides when to transfer pages from secondary storage to main memory
- Placement—determines which MM page frame should hold the fetched page
- Replacement—when main memory is full, chooses which MM page frame should be replaced by the fetched page

In regard to fetching, research has found that demand paging is generally best. When a page fault takes place, you fetch the desired page from secondary storage. The placement decision is resolved automatically by mapping hardware. The last issue, however, choosing which page to replace, is the hard part. The replacement policy affects how well we address the other concerns mentioned above.

Page-replacement techniques, which determine the set of main-memory pages, are all approximation algorithms. This is so because you can't calculate the best page to remove without some future knowledge of which page will be required. The optimal algorithm (OPT), or Belady's algorithm, replaces the ac-

tive page that is next referenced the furthest into the future. Even though totally impractical, it is a benchmark for comparing other techniques.

Page-Replacement Algorithms

Virtual-system performance is very much dependent on the page-replacement technique that is used. Because the process selects departing pages, it indirectly determines the pages remaining in main memory. If the algorithm closely models a system's actual working-set memory demand, few page swaps will result. Algorithms usually base removal choices on prior reference activity, because the locality principle implies that past behavior approximates future needs (at least over short time periods).

Here I will discuss four specific page-replacement algorithms: Least recently used (LRU), Clock, Generalized working set (WS), and WS-Clock.

The LRU Algorithm

This page-replacement policy is conceptually related to the optimal algorithm. Instead of selecting the page with the furthest time until next access, you pick the page whose last reference occurred longest ago. If not used for a long time, the probability that the page will soon be referenced is small. When a page fault happens, you scan the map cell for each page and replace the page having the smallest (oldest) virtual time.

To implement LRU, the memory-management hardware must support two features: a virtual time register in the map unit and the ability to update the page access time during address translation. The time register should be wide enough to ensure sufficient resolution. In addition, the necessity of associating a time stamp with every memory reference dictates high-speed logic and added map complexity.

The LRU algorithm works well. Its performance is much better than that of an arbitrary replacement policy or many other paging policies. But because LRU is a *global policy*, it can exhibit anomalies in multitasking systems. For example, global LRU tends to save pages of the task last executed

The ultimate under \$1000 printing machine.



The one machine solution to every application.

For word processing, plotting and just plain printing.

Save the expense of a costly daisy wheel. Eliminate the limited capability of cheap matrix printers. And get plotting in the process!! Get the all new, advanced MT 160 multifunctional micro printer. You'll be amazed that such a small printer can house so much horsepower.

Capability? You name it, this printer's got it. A resident Report Package puts you in the Word Processing world... letter quality characters, proportional spacing, margin justification, auto centering. A resident Graphics Package

lets you plot whatever your micro wants to portray. The standard print mode lets you generate reports fast—speeds up to 200 lines per minute. Also, print eight different resident character widths.

There's more. Clip-on paper handling attachments let you use fan-fold forms, letterhead, cut sheets or continuous roll paper. The control panel has a "menu select" for machine configuration. When you look under the hood, you'll see what is meant by "solid construction." And the MT 160 is

plug compatible to your micro.

In short, the MT 160 is the epitome of engineering excellence. And it should be. After all, Mannesmann Tally is the technology leader in matrix printing.

MANNESMANN TALLY

8301 South 180th St.
Kent, Washington 98032
Phone (206) 251-5524

IN DISTRIBUTION NOW!

WEST
Anacomp
(206) 881-1113
Byte Industries
(415) 783-8272
Paragon Sales
(408) 263-9510

PGI Distribution
(602) 967-1421
Waybern
(714) 554-4520
Western Micro Technology
(408) 725-1660
Acorn Data Products
(303) 779-6644

CENTRAL
Information Systems
(312) 228-5480
D. L. MacNeil, Inc.
(312) 952-8300
Sysprint
(214) 669-3666
Tek-Aids
(312) 870-7400

EAST
Computermaxx
(904) 878-4121
Digital Solutions
(404) 955-4488
Micro Distributors
(301) 468-6450
Hansen & Hughes
(201) 652-7055

Tech Data
(813) 577-2794
US Plus
(203) 234-0444
Mannesmann Tally Canada
(416) 661-9783
Nation-wide
Hall-Mark Electronics
(214) 343-5000
Kierulff Electronics
(213) 725-0325

**SEE US AT
COMDEX
BOOTH 2046**

Circle 246 on inquiry card.

and favors jobs with smaller locality; low-priority tasks and large programs may experience reduced throughput.

Computer systems using LRU include the CDC Star-100 and the Multics drum-to-disk control. Micro-computer MMU parts lack the hardware mechanisms needed for a "pure" LRU policy.

The Clock Algorithm

This algorithm is a variation of the LRU algorithm. Main-memory pages are logically ordered in a circular list. You can envision each page as a unit marking of a clock face. A pointer or hand always points to the last page replaced. On a page fault, you advance the pointer clockwise to the succeeding page. Then you check and clear that page's *used* bit. If the bit was set (i.e., the page was used recently), scanning continues; otherwise, the frame is not recently used and replaceable. If the replaceable page has been changed (or *dirty*), you must schedule it for transfer back to secondary memory. Scanning stops

when a clean, not recently used page is found, and the pointer is left at the chosen page. A replaceable page is not processed if accessed before the disk transfer.

Studies indicate that the Clock algorithm closely simulates LRU replacement, and the hardware needed is inexpensive. As implied above, only 2 flag bits per cell are required (changed and used). Software complexity and overhead are small. Calculations are trivial and the average number of scans per page fault is a fraction of total map size. Many successful mainframe systems, including the IBM 370 and Multics, use Clock algorithms. However, you should note that deficiencies of LRU apply equally to Clock. The technique offers a simple mechanism and good efficiency; but, as you shall see, other paging algorithms exhibit even better performance characteristics.

The WS Algorithm

This page-replacement algorithm represents the most practical policy

according to empirical studies. WS is so named because it approximates the working-set locality model. In WS, any page referenced within a specified time (designated as Θ) is regarded as a member of the working set. Real working sets of course have variable durations, but if the WS time-control value (Θ) is properly chosen, a real working-set model can be closely approximated.

I will briefly highlight WS operation (see reference 1 for details). The WS policy defines a working set (W) to be those pages of the AS that have been referenced within the previous Θ time units. In order to determine when a page (p) in main memory is no longer in W , and thus is replaceable, we need two things: (1) a procedure to calculate a time value (L) equal to the owning task's current execution time (ET) minus the last reference time for every AS page, $LREF(p)$, and (2) a scan mechanism to check for values of L greater than or equal to Θ . Calculating L can be done with page-frame counter registers. When the page is accessed, its counter register is cleared. Then, at fixed intervals, a global broadcast pulse increments all the counters. The scan operation can run at various times (e.g., at fixed intervals or when a page fault occurs). Pages marked as replaceable become part of the available pool (AP). The page-replacement algorithm merely selects some page from the AP and replaces it. If the AP is empty, the system must suspend a task to free pages.

Although WS accurately models dynamic-memory demands, the computational overhead and extra hardware support it requires diminish the algorithm's viability. Space for the $LREF(p)$ field can effectively double page-table size. Moreover, the counter mechanism is relatively expensive. Scanning requires inspection of each map cell at regular intervals, and AP maintenance adds more control functions. On the plus side, the local scope of WS enforces more consistent multitasking management. And pure WS simulations perform better than other policies. Research systems have implemented practical WS schemes and observed substantial

WE WROTE THE BOOK ON TWO-WAY RADIO. AND IT'S FREE.

Read all about it. How Two-Way Radio can help just about any business lower costs and increase profits via more efficient use of people and vehicles. Plus, how to choose the right radio from Johnson's complete line of mobile communications equipment. All American made by the two-way pioneer not only challenging but pacing the industry. All backed by a full year's 100% warranty on all parts and labor.

Phone toll-free 800-328-5727 Ext. 122.

(In Minnesota, 800-742-5685 Ext. 122.) Or write Johnson Radio Products Division, Waseca, MN 56093, for your free copy.



THE CHALLENGER

Fully Integrated Hardware and Software Systems For Apple II

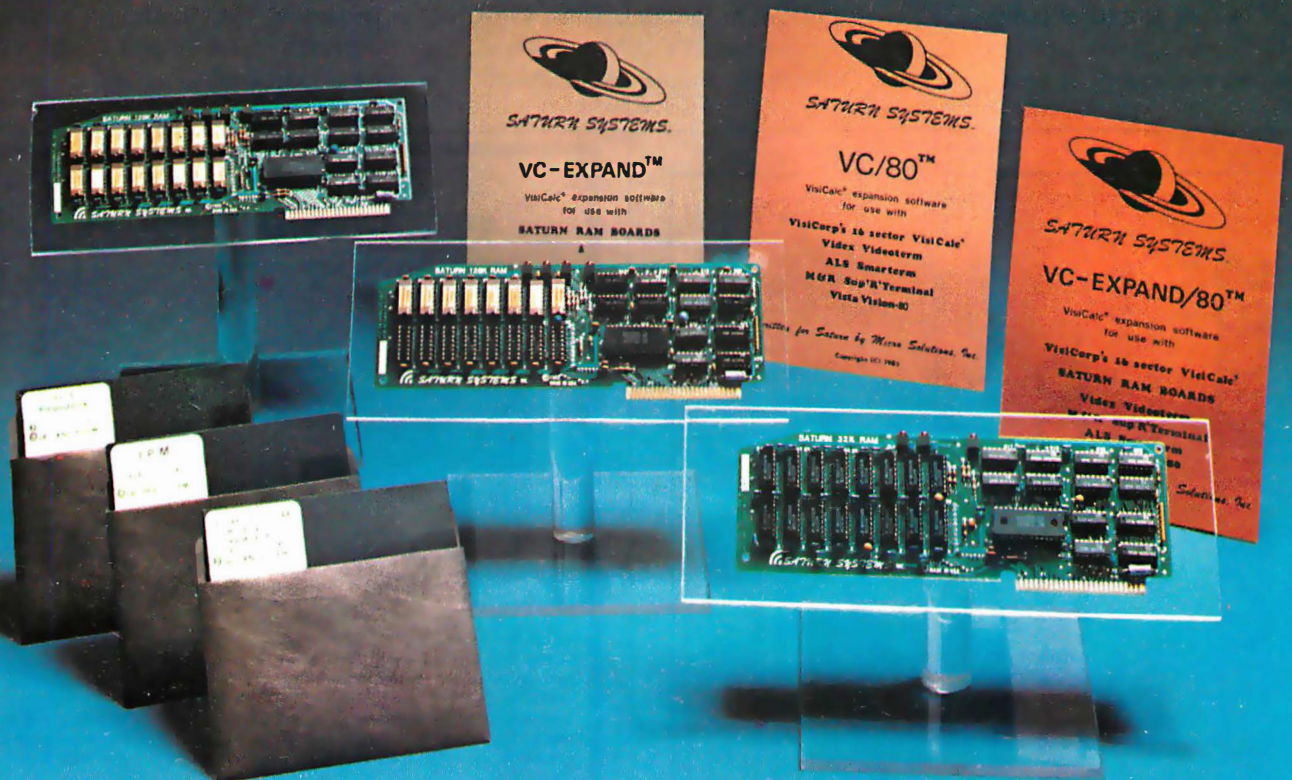

THE SATURN FAMILY OF APPLE PRODUCTS

SATURN 
SYSTEMS INC.
P.O. Box 8050
Ann Arbor, MI 48107
(313) 973-8422

In Europe, Contact:
Pete & Pam Computers
New Hall Hey Road
Rossendale Lancashire UK
BB4 6JG

Circle 376 on inquiry card.

improvements over Clock techniques. The parameter Θ allows you to "tune" a virtual system for different applications. Also, investigations have found that use of the constant value Θ deviates less than 10 percent from an optimal WS.

WS is technically appealing, but design difficulties detract from its advantages. Like LRU, classical WS is impractical for microcomputer application. But the next technique surveyed approaches WS performance and is feasible for microcomputers.

The WS-Clock Algorithm

WS-Clock combines the best properties of Clock and WS. Additionally, the new strengths offset some problems of the separate procedures:

- the extra scanning required by WS is replaced by a simple Clock mechanism
- WS-Clock is a local policy
- LREF(p) registers are needed only for main-memory pages, not for

every AS page

- the available pool (AP) is eliminated

This algorithm organizes page frames in a circular list like Clock. The clock pointer identifies the page replaced during the last scan. When a page fault occurs, the scan advances clockwise to the next page. The used bit is checked and cleared. If the bit was set, you reset the page's LREF(p) to the owning task's accumulated execution time (ET). Otherwise, if the used bit is clear and if $L = ET - LREF(p) > = \Theta$, you remove the page from W. If dirty, a replaceable page is scheduled for disk transfer and not replaced. Scanning halts when you encounter a clean, replaceable page.

WS-Clock approximates WS replacement, and W for the two policies becomes equivalent when the task executes for Θ units of time. Performance differences appear negligible and can be ignored. Thus, WS-Clock approaches WS behavior with a significantly simpler mechanism. The

average number of frames examined per page fault compares favorably with WS. And to implement WS-Clock, you need minimal map hardware: a used bit, a dirty bit, an LREF field, and a task ID descriptor.

Multitasking and Load Control

In a multitasking system, virtual-memory management must coincide with general resource-sharing policies. The problem is that in a dynamic multiprocessing environment, wide variations in programming level and memory demand occur. Every active task consumes a portion of total memory (in both MM and AS). At some point, adding another task will push MM demand past the ideal operating point in figure 4 and trigger the onset of thrashing. Left unchecked, throughput diminishes rapidly. Accordingly, you must either prevent the "overcommitment" of memory or recognize the condition and make corrective adjustments. This is done by a load-control policy.

NO NONSENSE PRICES.

Find the best advertised price in this magazine on software, hardware, and peripherals then call TOLL FREE

1-800-922-9200*

and we will beat it.

We carry all lines of software and hardware for APPLE, IBM, CP/M and other major brands.

Mason Computers

Suite 1, 977 S. Santa Fe Ave. Vista, CA 92083

HOURS 9AM - 8PM PST

*Outside CA - Order line only (Technical assistance) (CA orders subtract \$2.00 on orders over \$200.00) 1-619-726-7784 (Telephone No. & telephone no.), VISA, MASTER CHARGE. Call us for TERMS: Cash, check (please include Drivers License No. & telephone no.), UPS shipping charge. ALL PRICES ARE MAIL ORDER ONLY. SHOWROOM PRICES DIFFER. CA residents add 6% sales tax. All prices and availability subject to change.

NEW! M-68000 SINGLE BOARD COMPUTER

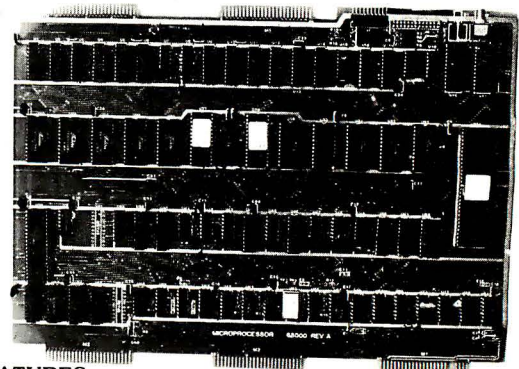

FEATURES:

16 bit Motorola 68000 CPU operating at 5 MHz or 10 MHz, 20K of on board fast static RAM, 16K bytes of on board EPROM space, 7 autovectorred interrupts, 3 memory/device expansion buses, 2 serial communication ports (RS-232 C), 16 bit bidirectional parallel port, 5-16 bit counter/timers with vectored interrupt and time of the day clock. On board monitor allows to download and debug programs generated on APPLE II, TRS-80 and CP/M using our M68000 Cross Assembler.

PRICE:

M68K Bareboard with documentation.....	\$ 99.95
M68MON monitor & mapping PROM's.....	\$135.00
M68000-6 CPU.....	\$ 95.00
M68K Parts Kit.....	\$249.00
M68000 Cross Assembler.....	\$125.00
M68K Documentation only.....	\$ 15.00
Shipping & handling (Domestic).....	\$ 3.50
(foreign).....	\$ 15.00

CALIFORNIA RESIDENTS ADD 6% TAX

EMS

Educational
Microcomputer
Systems

P.O. BOX 16115. IRVINE, CA 92713-6115
(714) 553-0133

For ZX81 or TS1000 software savings, rip off this ad.

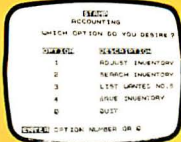

THE STAMP COLLECTOR (#31) Inventory and store up to 600 SCOTT numbers in a single session showing quantity on hand, by major classification, and provide full want list support.



STATES AND CAPITOLS (#32) Test yourself on the fifty states and their capitols. Three options of review are available. (1) States, you provide capitols. (2) Capitols, provide states. (3) A mix of states and capitols.



PINBALL (#35) Plays like real pinball complete with flippers, bumpers, "nudge," bonus points and more. Uses fast, efficient machine code to choose its moves.



VU-CALC (#11) This program constructs, generates, and calculates large tables for financial analysis, budget sheets, and projections. An immensely powerful analysis chart.



THE FLIGHT SIMULATOR (#6) Take control of highly maneuverable light aircraft. With full controls, instrumentation and navigational aids to avoid hazards in landing.



STOCK MARKET GAME (#27) Bull or bear? This realistic simulation lets you analyze information, buy and sell stocks, take out and pay off loans... and win, if you can accumulate \$50,000 in "The Market."

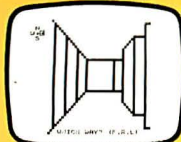

SUPERMAZE (#34) Navigate your way through a three-dimensional maze, with trapdoors, gold bars, marker stones, and compass. Ten separate mazes. Three-dimensional graphics.



CHESS AND CHESS CLOCK (#7) Six levels. All the legal moves including castling and enpassant. Keeps a separate record of plays made for easy reference. Play another opponent or match wits with the computer.



FORTRESS OF ZORLAC (#36) A super fast game in which you are the commander of a fleet of spaceships. Your mission is to rid the galaxy of the dreaded alien, ZORLAC.



PERSONAL FINANCE PLANNER (#28) Perform calculations, finance a house, a car, keep savings accounts, repay loans and calculate an amortization schedule which can be generated for any of the financial programs.

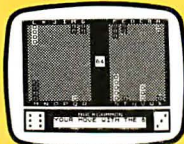

BACKGAMMON AND DICE (#8) A perfect blend of chance and skill. Uses machine code to choose its moves. Full game including graphics board, rolling dice, and double cube. Play the computer or another opponent.



ATOR THE ABC GATOR (#33) Designed to teach recognition and sequence of the alphabet. Combines computer instruction, music and video games.



SUPER MATH (#14) Drill yourself on addition, subtraction, multiplication, and division with five levels of difficulty. Each problem graphically depicted.



THE CUBE GAME (#9) The cube can be displayed in three views: (1) Solid; (2) Two-Dimensional (unfolded); and (3) See-thru cube (3-D). You start with the cube solved, set it up any way you like, or pick up from a previous session.



SPACE RAIDERS, BOMBER (#5) Timex/Sinclair version of the popular arcade games full of bombs and rockets and collisions with skyscrapers.



THE HOME IMPROVEMENT PLANNER (#29) Store up to 20 room measurements (length, width, height), computetotal area in each (wall, floor), estimate costs of painting, wall papering and carpets and draw house blueprints.



REAL ESTATE INVESTMENT ANALYSIS (#30) Two different investment strategies. The first selection allows the user to choose between renting or buying. The second selection consists of a detailed analysis of the rental investment property.



FROGGER (#37) Plays like the arcade game. Hop the frog over traffic, snakes, crocodiles, and treacherous diving turtles before time runs out.

Sinclair*, the company that invented the world's most affordable computer, has invented a way for you to order the most affordable software—right from your home!

You've never had this wide a selection before. You can play games that challenge you, instead of bore you. You can learn new household applications and business programs that reduce work dramatically.

Only Sinclair offers this special software savings. Only ZX81 or Timex TS1000 owners are eligible.

The more you buy, the more you save. A serious Sinclair software offer.

The first cassette you buy, you buy at normal cost: \$15.00. But every cassette thereafter, you get at a savings.

The list below explains how much you save, based on how much you buy. It couldn't be easier.

You were smart to buy the ZX81 or the TS1000. You'll be even smarter to take us up on this software offer. All cassettes listed at left work on both the ZX81 and the TS1000. All cassettes are 16K, which means you need the 16K Memory Module. (If you want more information on this component, please write Sinclair at the address listed below.)

But don't delay. This is a limited time software offer while supplies last.

How to order today!

Just call our toll-free number and use your MasterCard or VISA. Or send this ad with a check or money order. It's as easy as that.

Call toll-free: 800-543-3000. Ask for operator 509. In Canada call 513-729-4300, operator 509. Have your MasterCard or VISA ready when calling. Phones open 24 hours a day, 7 days a week. These numbers are for orders only.

If you simply want information, please don't call, write Sinclair Research, Ltd., 2 Sinclair Plaza, Nashua, NH 03061.

(Sorry, no refunds on software. Defective cassettes will be replaced.)

Call toll free

800-543-3000

(operator 509)

Ad. code: B4BY Mail to: Sinclair Research, Ltd.
One Sinclair Plaza, Nashua, NH 03061

Check the boxes of all cassettes you want at left. Check or money order enclosed.

Fill in the space beside total for your total payment
 1 cassette: \$15.00
 2 cassettes: \$25.00 Plus Shipping/Handling \$5.00
 3 cassettes: \$35.00 (save \$5.00)
 4 cassettes: \$45.00 (save \$10.00)
 5 cassettes: \$50.00 (save \$15.00)
 6 cassettes or more: \$10.00 each \$

Total:

U.S. Dollars

Name

Street

City

State Zip

sinclair

*Sinclair technology is the heart of both the ZX81 and the Timex/Sinclair 1000.

Function or Characteristic	Memory Structure	
	Segments	Fixed Pages
Flexibility	+ Can model pages, has more design options, promotes protection, data sharing, and so on	- Lessens "tuning" options, trade-off exists between efficient I/O blocking and memory waste
Hardware requirements	- Cost and complexity fairly high	+ Lower cost, simpler hardware
VS(1) systems	+ Better security	+ Simpler design
VS(n) systems	+ Segments are mandatory for VS(n) designs	0 Not applicable
Mapping unit		
Map-register size	- More space needed for size fields	+ Minimal
Table size	+ Fewer frames needed if segments are large	0 Larger pages result in memory waste
Memory management overhead	- Extra logic needed to close "holes" and to manage extra attributes	+ Placement simple
Allocation policy	+ Make segments the desired size	0 More complex, but no main-memory waste
Protection	+ Superior—facilitated by extra attribute fields	- Pages do not correspond to program "objects"
Sharing	+ Direct support	- Much harder
I/O efficiency	0 Depends on segment size	+ Facilitated by relating page size to disk block size
Memory usage		
Internal fragmentation	+ None	- Some main memory wasted
External fragmentation	0 Can reclaim with "garbage collection"	+ None
Page-fault rate	+ Lower rate	0 Depends on page size

Table 2: A comparison of the relative strengths and weaknesses of segmented and fixed-page memory organizations. The +/- column indicates approximate merit: (+) good; (-) poor; (0) okay or does not apply.

Load control is sensitive to page-replacement strategy. Local strategies estimate each task's independent memory needs and allocate sufficient main storage to hold the locality set. Global page-replacement strategies discriminate in favor of the most recent task's memory set and can lead to thrashing.

System Design: Issues and Options

Virtual memory reflects a composite of hardware, resource management, and programming processes. We now turn our attention to alternatives that can affect overall micro-computer system design.

VS(1)

A fundamental system decision is whether you treat the large virtual

address space as a shared resource divided among the several active jobs or whether each process is provided a separate AS. The first class, termed VS(1), extends the idea of a conventional operating system where supervisor, system resources, and user tasks occupy one large address space. Software compatibility with non-virtual systems is a major benefit of this system. System complexity is minimized and a single mapping table can define AS structure.

VS(n)

VS(n) systems give each executing task a unique AS. To support this feature, every job has its own mapping table. Typically, a mapping-table origin register (MTOR) points to the mapping table of a running task. When switching tasks, you change

the MTOR and reload the mapping hardware. A VS(n) system gives you, in effect, several virtual machines, each using the same physical resources, running concurrently. VS(n) systems also give you improved system integrity and data protection.

Page Size

An important design consideration is block memory structure. If you select a fixed-page structure, you must determine the number and size of page frames. Secondary storage transfers data in fixed-size units. Hence, for efficient paging memory frames should be an integer multiple of a disk block. Big pages reduce disk overhead and map hardware. On the other side of the coin, however, a large number of small pages lowers page-fault rates and increases the number of locality sets. Some compromise is in order. My research indicates that 1K- to 4K-byte pages are considered optimal.

A segmented address space reflects programming features such as scope rules, data encapsulation, modularity, and so on. Pages, being constant in size, usually waste some memory, a condition termed *internal fragmentation* (e.g., a 5K-byte program takes two pages in a system with 4K-byte pages—3K bytes are unused). Although segments avoid this problem, they are prey to a form of waste called *external fragmentation*. Because variable-size units are allocated, program termination leaves holes of unused space. You must close up these areas periodically to provide sufficient space for large segments. Consequently, the procedures to reclaim these holes add to operating overhead. In general, segmented schemes offer more flexible designs while page organizations make for easier memory management. Table 2 summarizes trade-offs between page and segment organizations.

Many other topics related to virtual memory have not been covered: operating-system interaction, I/O considerations, page locking for non-swappable memory, disk-access properties, and more—the subject is rather deep. However, the topics

The Sanyo MBC 1000 is basically an excellent performer, operating both fast and reliably.
Infoworld - 11/29/82

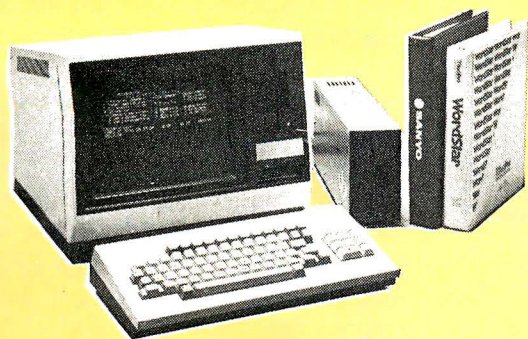

SANYO PLUS

A \$2000 computer, with \$2000 of software, for \$1995.

The Sanyo Plus consists of a Sanyo MBC-1000 computer with a built-in 12" high-res. green phosphor 25x80 display. The detached keyboard features 5 special function keys and a 10-key pad. The Sanyo Plus comes complete with a parallel printer port, a serial communications port and room for three additional cards.

Plus you receive a second drive for a total formatted disk capacity of 624K.

Plus we now include over \$2000 worth of software including CP/M® 2.2, Sanyo Basic, WordStar 3.0 with training guide, Mailmerge, SpellStar CalcStar, InfoStar and a games disk. We thoroughly integrate and test each system, and generate work copies of your software.

Plus you get a 300 baud direct connect modem, with cable free modem software and a one-month subscription to The Source™

Extended warranty available. Five module business software pack: \$99.
Sanyo Minus: One drive system \$1649, 10 MB. Drive system \$3695.

\$1995

TELEVIDEO



Now backed locally by T.R.W. Built-in CRT, detachable keyboard, dual floppies w/750K formatted capacity, 64K, CP/M and more. Special: Telesolutions — Wordstar TM and CalcStar TM w/system \$279.

- 802 w/CP/M® \$2669
- 803 w/CP/M® \$1898
- 806 (20 Mb) \$5149
- TS 1602G \$3495
- 816 (23 Mb) \$6298
- 800A's \$1299

ALTOS

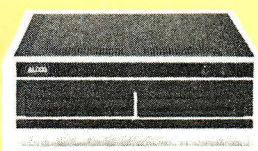

Our tech's favorite systems. From the lowest priced 3-user systems with either 2 or 6 MG. storage, to 40MG, 8-user 16 bit systems.

Add terminals, printers, and software and we can fully test and configure your system or low prices. Back nationwide by Moore Systems Service.

- Series 5-15D \$2195
 - Series 5-5D \$3995
 - 8000-10 \$5575
 - 8600-12 \$9465
- Series 5, 8000, systems include MP/M

DIGITAL

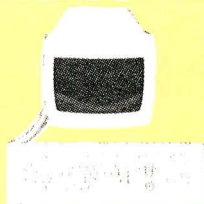

New from DEC - microcomputer designed for the professional. Nationwide DEC service and reliability are standard. Free spreadsheet software with each system. Bridge the 8 bit/16 bit gulf with a system which runs both.

- Rainbow 100 system call
- Professional call
- 325 system call
- Professional call
- 350 system call

NORTHSTAR



FREE SPREADSHEET

Prices now include free burn and test. We warranty each unit for 90 days from the day you receive it (not 90 days from the day we receive it). Call for prices on compatible software and hardware.

- Advantage 64K Quad \$2769
- Horizon 64K Quad \$2695
- Advantage w/5 Mb. \$3795

TERMINALS



- Wyse 100 \$699
- ADDS Viewpoint 3A+ \$479
- Televideo 910 \$579
- Televideo 925 \$735
- Televideo 950 \$927
- Televideo 970 \$1044
- Zenith Z-19 \$689
- Zenith ZT-1 \$459
- Hazeltine Espirit \$499
- Hazeltine Espirit II \$549
- Hazeltine Espirit III \$750
- Qume call

HOUSTON INSTRUMENTS

- DMP-29 \$1796
- DMP-40 \$745
- DT-11 \$677

Zenith, Morrow Micro Decisions call



Scottsdale Systems Ltd.

617 N. Scottsdale Road, Suite B, Scottsdale, Arizona 85257

VISA (602) 941-5856 MasterCard

Call 8-5 Mon.-Fri.

PRINTERS

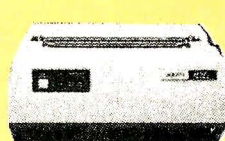

- Okidata 82A \$389
- Okidata 83A \$635
- Okidata 84 \$969
- Okidata 92 \$489
- Okidata 93 \$835
- Tally 160L \$739
- Microprism 480 \$525
- Epson, FX, 100 call

HIGH SPEED

- Prism 80 "Loaded" \$1369
- Prism 132 "Loaded" \$1469
- Anadex 9501A \$1369
- DaraSouth DS-180 \$1249
- TI-810 Basic \$1285

LETTER QUALITY

- Diablo 620 call
- NEC 3510 \$1495
- NEC 7710 \$2149

SERVICE / ORDERING

INTEGRATION: Prices listed are for new equipment in factory sealed boxes with manufacturer's warranty. We will pretest your equipment, integrate your system, configure your software, provide special cables, etc., for an additional charge. Call for prices.

ORDERING: MAIL ORDER ONLY. Prices listed are for cash. No C.O.D.'s. We sell on a net 20 basis to Fortune 500 companies and Universities. Charge cards add 2%. Prices subject to change, product subject to availability. AZ. residents add 5%. Pen. and checks take 3 weeks to clear. 0-20% restocking fee for returned merchandise. Shipping extra - products are F.O.B. point of shipment. CP/M and MP/M are registered trademarks of Digital Research.

SOFTWARE: We sell all popular CP/M® programs at discount. Software sold only with systems not warranted for suitability.

GEMINI



The new best selling dot matrix printers. 100 c.p.s., friction, tractor and roll feed. Graphics, 180 day warranty, 2.3K std. buffer and much more.

- Gemini 15 \$460
- Gemini 10 \$354

DAISYWRITER 2000

The best price/thruput in letter quality printers. 48k buffer, 8 protocols, graphics mode, 4 interfaces std., Sub and superscript. Proportional Spacing, and much more. Uses std. ribbons.

\$1014

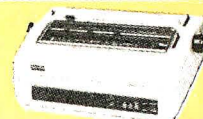

FUNCTIONAL CHARACTERISTICS	MEMORY-MANAGEMENT UNITS			
	Intel iAPX 286	Motorola MC68451	Zilog Z8010	Zilog Z8015/PMMU
Address-translation delay (10 MHz)	0-1.5 μ s	100 ns	60 ns	70 ns
Supports multiple MMUs?	No	Yes	Yes	Yes
No. of MMUs needed to map address space	1	1	2	Depends on MM size
No. of unique address spaces possible (no. of users)	Unlimited	256	8	8
VS(n) support?	Yes	Partial	No	No
Priority levels	4	0	0	0
User/supervisor modes available?	No, uses priority levels	Yes	Yes	Yes
Data sharing?	Yes	Yes	Limited	No
MMU control method	Special instructions	I/O program	I/O program	I/O program
Fault restart data	None	Limited	Moderate	Extensive
Control and status attribute names (dash indicates not supported)				
Present	P	—	CPU1	—
Used	A	U	Ref	Ref
Dirty	—	M	Chg	Chg
Write-protected	W	WP	RD	RD
Read-protected	R	—	—	—
Executable code	E	—	Exc	Exc
Shared	—	AST	—	—
Stacked memory	ED	—	DIRW	DIRW
I/O access	—	—	—	DMAI
Overflow warning	—	—	DIRW	DIRW
Virtual time	LREF	—	—	—
Task ID	(Yes)	(Yes)	(Yes)	(Yes)
Fix	F	—	—	—
Enable	—	E	—	Valid

Table 3: A comparison of the functional characteristics of the four surveyed memory-management units.

covered should give you the perspective to analyze the capabilities of the new memory-management units for microcomputer virtual-memory systems.

Memory Management

The need for a memory-management unit (MMU) derives from two concerns: efficient control of large memories and support for multiprocessing environments. We can summarize the major goals of memory management as follows:

- **Memory allocation**—Allocation policies determine what portions of memory are committed to particular tasks. Address translation allows you to treat physically separate blocks as logically contiguous. Dynamic allocation, which adds memory during execution, is a valuable feature. A

virtual system's large address space makes allocation less of a concern.

- **Program relocation**—Relocation hardware permits a program to load anywhere in physical memory without changing the logical addresses. Systems that swap tasks to disk may need to relocate a program when it's reloaded.

- **Protection**—This prevents inadvertent or unauthorized destruction of data. Also, one task cannot interfere with another's operation.

- **Data sharing**—Controlled access to common data or code.

- **Multitasking**—Several tasks can logically occupy main memory during a given time frame.

Virtual memory is just one of several approaches to memory management. Another approach is *dynamic mapping*, a technique used

to extend the address space of limited-address machines (e.g., the HP-1000 or DEC PDP-11 minicomputers).

A Survey of MMU Chips

The main thing we'll look for when examining these MMU products is how well they implement virtual-memory concepts. We'll review four products: Zilog's Z8010 and Z8015, the Motorola MC68451, and Intel's iAPX 286 processor/MMU. The Zilog chips are to be used primarily with the Z8003 16-bit microprocessor for virtual storage. The MC68451 MMU is designed to work with the soon-to-be-released MC68010 processor. Finally, the iAPX 286 represents a combination of both an 8086-compatible processor and an integral memory-management unit.

The Z8010, MC68451, and iAPX 286 feature segmented-memory architectures. The Z8015, however, is designed specifically for a fixed-page virtual-memory system. All four units support a 16-megabyte physical-address space. Logical-address spaces range from 8 megabytes for the Zilog chips to a whopping 1 gigabyte in the iAPX 286. Tables 3 and 4 compare the basic properties of these chips on a point-by-point basis. As the tables show, there's quite a bit of diversity. For each MMU, I'll point out its unique characteristics, operation, and programming details. Later I'll describe some applications for virtual memory.

The Zilog Z8010

The Z8010 was one of the first single-chip MMU devices on the market. As a consequence, it has a few flaws that have been corrected on newer products. In fact, virtual memory appears to have been an afterthought for this chip because you will need extra hardware to handle the Z8000 microprocessor's page-fault procedure. Still, the product does have good protection features, and it directly supports a supervisor mode for operating-system functions. Another virtue is its fast translation time.

The Z8000 architecture defines logical addresses for 128 segments,

Text continued on page 234

LET THE "ANGEL"™ DO THE WAITING.....

- Two RS-232C Connectors for serial input and output
- 6 Leds to indicate power, transmission and reception status, buffer activities, page number, etc.
- SKIP and REPRINT provide independent page controls to reprint portions of documentation.
- 40 Pin Expansion Bus available for future expansion
- COPY provides convenient one key operation for single copy or multi-copy of text
- 3 externally accessible Dip Switches for baudrate, device type, and parallel and serial selections. Selections can be made without losing buffer

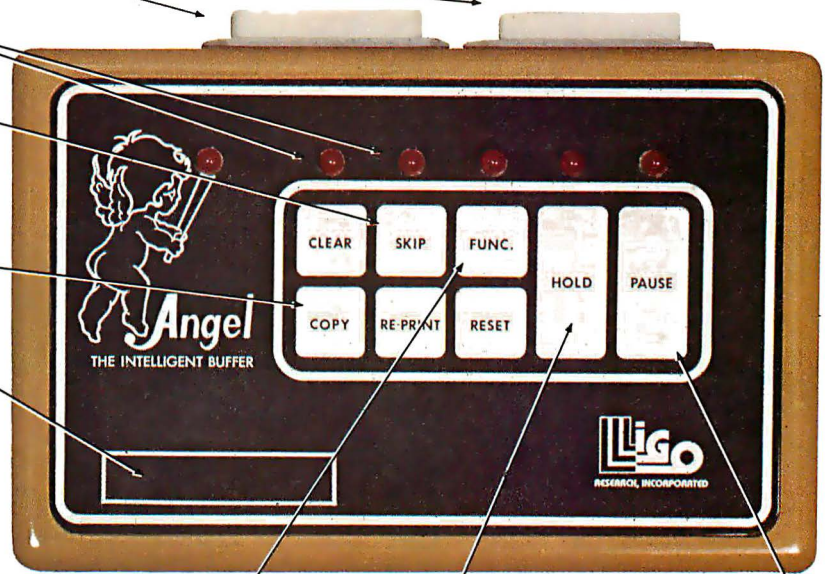

Connect an "ANGEL" between your computer and your printer, and let the "ANGEL" do the waiting

Your valuable computer spends 95% of its time waiting for the printer to catch up...and while the computer waits, the payroll continues.

The computer sends data to the "ANGEL" at speeds up to 19.2K baud. The "ANGEL" stores data and sends it to the printer at a speed the printer can handle, and your computer is free to continue working without interruption.

A USER WRITES:

"I tried the "ANGEL" with my Altos system connected to an Epson MX-100, both set at 9600 baud. Without the "ANGEL" it takes 30 minutes to print 210 doctors' requisition forms. With the "ANGEL" installed, my computer is free after 90 seconds."

With "ANGEL'S" self diagnostics and memory test, the entire system thoroughly checks itself every time you power up.

PAGE REPRINT is another unique feature. EXAMPLE: You are printing a 32 page report, and the paper jams at page 11. Reset the printer to the top of the form, press PAGE REPRINT, and resume printing at the top of page 11. Want to restart two pages back? Press PAGE REPRINT twice, and you resume at page 10.

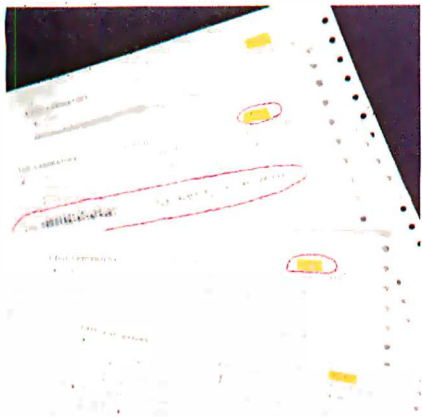

PAGE REPRINT

Function keys extend the useful commands to more than 10, including: hex-dump, memory test, remote loading, etc.

Independent PAUSE and HOLD controls to suspend transmission and reception.

8 easy-to-operate membrane key switches.

Two 20 Pin Edge Connectors for parallel input and output

"ANGEL" is compatible with almost all Micro-Computers, including IBM, Apple, TRS-80, Vector Graphic, NorthStar, Altos, Xerox, Heath, Zenith, NEC, DEC, etc., with RS-232 serial, Hardware Handshaking, or Centronics compatible parallel interface. The manufacturer reserves the right to change the product specification.

...And think of these other possibilities: HEX DUMP. Display or printout every bit of data your computer sends out to the printer in an easy-to-read Hexidecimal and ASCII format. A must for your programmer. Pause and Hold for real time programs. Page skip for selective printing. What a waste to print the entire documentation if you only need part of it.

Simple external switch settings, let the "ANGEL" accept either RS-232 serial or Centronics parallel data and can output either/or in any combination, (S-S,S-P,P-S,P-P). The "ANGEL" is compatible with almost all Micro-Computers, and can be installed by anyone in minutes. Switches are clearly marked for ease of operation, and a concise, USER FRIENDLY operator reference card is included with each unit.

The "ANGEL" has a full one year limited warranty.

THE "ANGEL" WILL NEVER KEEP YOU WAITING!

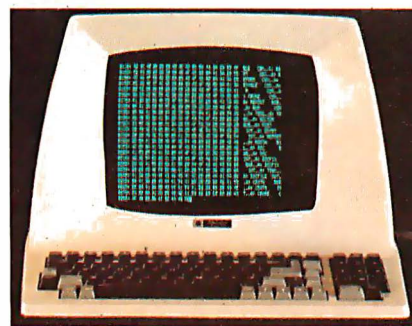

HEX DUMP

The chart shown here illustrates the features of the "ANGEL" compared to other buffer devices. When compared with the "ANGEL", the others just don't measure up. Sorry guys.

Feature	ANGEL	MICRO FAZER **	SPOOLER+	MICRO BUFFER IN-LINE	SOOPER SPOOLER SERIAL **
Price	295.00	330.00	319.00 w/o serial	349.00	603.00
Memory Size	64K	64K	64K	64K	62K
Max Baud Rate	19.2K	?	N/A	19.2K	?
Serial-Parallel	Yes	*	No	*	*
Parallel-Serial	Yes	*	No	*	*
Parallel-Parallel	Yes	*	Yes	*	*
Serial-Serial	Yes	Yes	No	Yes	Yes
Copy	Yes	Yes	No	Yes	No
Reset/Clear	Yes	Yes	No	Yes	Yes
Pause/Hold	Yes	No	No	Yes	No
Page Skip	Yes	No	No	No	No
Page Reprint	Yes	No	No	No	No
Continuous Copy	Yes	?	No	?	No
Self-Diagnostics	Yes	?	?	?	?
Hex-Dump	Yes	No	No	No	No

* Can only be configured for one of the four Modes:

** Information based on available specifications from manufacturer's advertisement as of December, 1982

Micro-Fazer TM of Quadram Corp.

Sooper Spooler TM of Compulink Corp.

TO ORDER:

CALL TOLL FREE 1-800-323-3304
OR SEND CHECK OR MONEY
ORDER TO LIGO RESEARCH

Please rush me () "ANGEL(S)" @
\$295.00 each

Sub total _____

ILLINOIS ONLY Add 6% U.S. sales tax _____

Delivery charge \$4.00 _____

TOTAL _____

Charge my () VISA () MASTERCARD
MY ACCT. # IS _____

EXPIRATION DATE _____

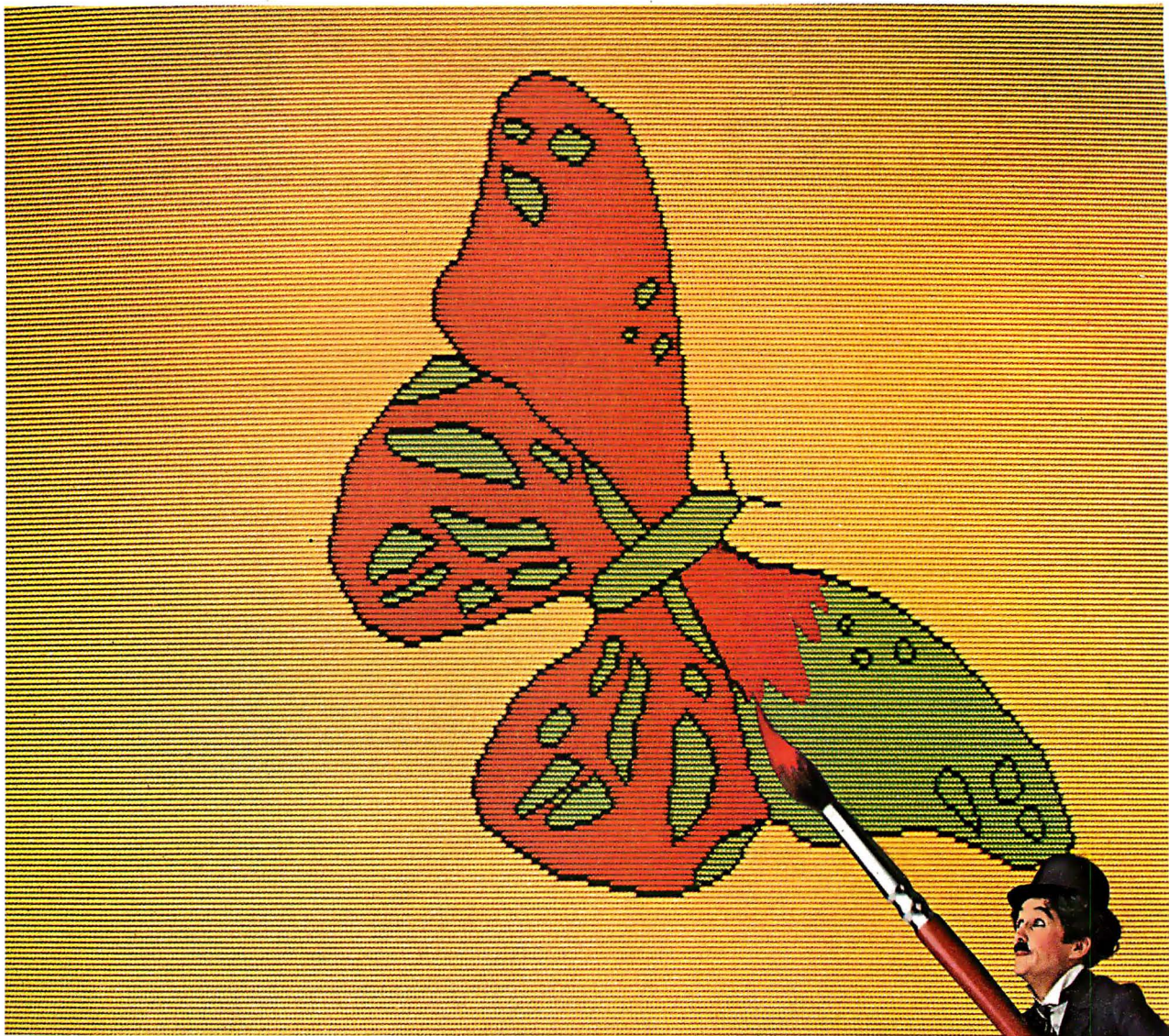

Draw attention to yourself.

(Write a program for the IBM Personal Computer.)

Let your imagination take wing.

Think charts. Graphs. Shapes. Images.

Use originality, creativity and color in programs that entertain. Educate. Organize. Analyze. And programs that get down to business.

Maybe you've written software like that. Or perhaps you're thinking about it.

If so, consider this.

You could draw attention to yourself by writing programs *for* the IBM Personal Computer *on* the IBM Personal Computer. Because all our advanced features (see the box at right) make it faster and easier to do so.

Enhanced BASIC already in ROM, for example, has graphics commands already built in.

And if you write a program using our Advanced BASIC, you'll find the DRAW command particularly appealing. It's virtually a separate graphics language *within* a larger language.

Put your visual together with any of the 128 characters and symbols in ROM for a simultaneous, text-and-graphics mix.

Have musical accompaniment as well.

It's easy, because BASIC controls the built-in speaker with a single command.

Utilize the ten, programmable function keys. Try F3 to paint. F4 for lines. F5 for circles. Or F6 for boxes.



IBM PERSONAL COMPUTER SPECIFICATIONS

User Memory

64K-640K bytes*

Microprocessor

16-bit, 8088*

Auxiliary Memory

2 optional internal diskette drives, 5¼" 160K bytes or 320K bytes per diskette

Keyboard

83 keys, 6 ft. cord attaches to system unit*
10 function keys*
10-key numeric pad
Tactile feedback*

Diagnostics

Power-on self testing*
Parity checking*

Display Screens

Color or monochrome
High-resolution*
80 characters x 25 lines
Upper and lower case

Operating Systems

DOS, UCSD p-System, CP/M-86†

Languages

BASIC, Pascal, FORTRAN, MACRO Assembler, COBOL

Printer

All-points-addressable graphics capability
Bidirectional*
80 characters/second
18 character styles
9 x 9 character matrix*

Permanent Memory

(ROM) 40K bytes*

Color/Graphics

Text mode:

16 colors*

256 characters and symbols in ROM*

Graphics mode:

4-color resolution:

320h x 200v*

Black & white resolution:

640h x 200v*

Simultaneous graphics & text capability*

Communications

RS-232-C interface

SDLC, Asynchronous,

Bisynchronous protocols

Up to 9600 bits per second

*ADVANCED FEATURES FOR PERSONAL COMPUTERS

Remember that these function keys make your program more "friendly" to the user and, therefore, more appealing to us.

In fact, if you're interested in licensing your software, we could be interested in publishing it.

We could also be interested even if it runs on *another* computer. If we select your software, we'll ask you to adapt it to our system.

So if you think your software is close to picture perfect, consider sending it in.

For information on how to submit your completed program, write:

IBM Personal Computer,
External Submissions, Dept. 765 PC,
Armonk, New York 10504.

The IBM Personal Computer A tool for modern times

For more information on where to buy the IBM Personal Computer, call 800-447-4700. In Alaska or Hawaii, 800-447-0890.

†UCSD p-System is a trademark of the Regents of the University of California. CP/M-86 is a trademark of Digital Research, Inc.

PHYSICAL CHARACTERISTICS	MEMORY-MANAGEMENT UNITS			
	Intel iAPX 286	Motorola MC68451	Zilog Z8010	Zilog Z8015/PMMU
No. of pins	68	64	48	48
Integrated processor?	Yes (8086)	No	No	No
Dimensions (mm)	24 by 24	22 by 81	15 by 51	15 by 51
IC process	HMOS	HMOS	NMOS	NMOS
Power (W)	3	1	1.5	1.5
Compatible processors				
Model	Integral	MC68010	Z8001/3	Z8003/4
Clock rates (MHz)	8, 10	4, 6, 8, 10	4, 6, 10	4, 6, 10
Cost per unit (10 MHz)	\$237	\$111	\$383	\$137
Logical addresses				
Virtual size	1 gigabyte	16 megabytes	8 megabytes	8 megabytes
Address width (bits)	32	24	23	23
Memory structure				
Segment or page?	Segment	Segment	Segment	Page
Size field (bits)	16 limit	16 mask	8 limit	NA
Size range	1 byte – 64K bytes	256 bytes – 16 megabytes	256 bytes – 64K bytes	2K bytes
Resolution	1 byte	Power of 2	256 blocks	Adjustable
Page boundary	1 byte	256 bytes	256 bytes	2K bytes
Map organization (mapping scheme)	Segment map table	Associative lookup	Mapped by address	Associative lookup
Maximum no. of pages or segments per MMU	16,384	32	64	64
Map cell width (bits)	64	72	32	32
Physical-address base				
field width (bits)	24	16	16	13
Attribute field (bits)	8	8	8	7
No. of high-speed registers	4	32	64	64
MMU address-generation unit	24-bit adder	16-bit logical	16-bit adder	13-bit concatenation
Global control-register set	1 byte (7 bits)	4 bytes	3 bytes	3 bytes
Global status-register set	0 (status pushed on stack for faults)	18 bytes	6 bytes	9 bytes

Table 4: A comparison of the physical characteristics of the four surveyed memory-management units. All four have the same physical-memory limit: 16 megabytes.

and the Z8010 has 64 map registers. If you use the mapping-by-address technique, you will need two MMUs to map AS. The user/supervisor flag can be used as an extra addressing bit to increase memory size to the full 16 megabytes. With this type of organization, four MMU chips are necessary (i.e., 128 segments in two separate address spaces).

You can assign four protection attributes: read-only, data/code, system reserved, and I/O enable. If you do sophisticated I/O processing, you'll appreciate the I/O flag. Another feature, the direction and warning (DIRW) attribute, indicates the orientation for a stack segment. When set, offsets can be negative. DIRW also provides a warning if you are accessing the last 256 bytes of the segment. The warning allows the sys-

tem to dynamically extend segments during execution, making allocation procedures easier to implement.

Programming the MMU is accomplished through 22 special I/O instructions. By placing the MMU into command mode, you can manipulate map cells and global status registers in a manner similar to programming DMA or peripheral controllers. Z8000 instructions permit you to send a block of commands and data to speed up the process.

Provisions for virtual memory are marginal at best. Only three attribute flags aid paging policies: present, accessed, and changed. Up to eight separate users are possible, but this requires additional MMUs and external hardware. The Z8010's limited number of segments has two major drawbacks. First, it discourages small

segment size. The segment-size resolution may not reflect program modularity (studies indicate that median module size is about 50 words). More important, the number of pages it can handle may be insufficient for working-set purposes. Although you can share data, utility is minimal. Many of the benefits of a segmented design are not fully realized.

The Clock page-replacement policy would probably work well with the Z8010. Without an LREF field and strong multiuser support, WS-Clock is likely to be inefficient. Poor sharing and task switching make a VS(n) design impractical. Time required for MMU programming and the page-fault recovery procedure is partially offset by translation speed. I can't see the Z8010 finding much use outside of systems with few users or nonvirtual environments.

The Zilog Z8015

The Z8015 is most notable for its paged-memory strategy. Although markedly different in mapping and logical block structure, most of its features borrow heavily from the Z8010 design. Protection, programming, and multiprocessing components are virtually identical. This MMU's main selling point is the simplified allocation and storage mechanism inherent in a paged system. Also, several mistakes found in the Z8010 are corrected in the Z8015.

The Z8015 employs an associative lookup mapping scheme. Each Z8015 MMU chip can map 64 pages, each 2K bytes in length. Thus, each unit directly maps 128K bytes. Up to 64 units can be grouped together, giving you a total of 4096 page frames (8 megabytes)—ample room for system expansion.

If you don't like 2K-byte pages, simple wiring alterations allow different size options. Page attributes are the same as a Z8010's except that I/O enable is omitted—too bad, it's a handy feature. Translation time is about 15 percent slower.

As with the Z8010, you should stick to the Clock replacement algorithm and a VS(1) design. The MMU supplies all the information necessary

to recover from a page fault; extra hardware is not required. The increased number of page frames is noteworthy: you can achieve a higher degree of multitasking, and it is easier to expand storage. But with the Z8015's fixed-page policy, you sacrifice some degree of flexibility. Adequate support for virtual memory and system security yield the components of a virtual microcomputer. On top of all this, you can use the Z8015 to implement dynamic mapping for the Z8004, the 16-bit-address version of the Z8000 processor.

triguing methods to build the functions that constitute a virtual-memory scheme.

Like the Z8015, the MC68451 relies on associative mapping. Address translation takes place in two stages consisting of an address range and user-space comparison. A clever technique accomplishes both lookup and segment bounds-checking in one fell

several logical-address page values can map to a single cell entry.

Each map cell contains a user-space number and associated mask. A valid memory reference must match the active processor user number. The masking function allows a range of user numbers (or just one) to use the same segment; sharing among users becomes almost a trivial task.

One worrisome point is the map-table size. You get merely 32 map cells per MMU, and physical limitations restrict you to a total of eight MMU devices (or 256 cells). You need more than that. Also, the MMU design is complex; it has too many internal registers and multiple MMU coordination is complicated. You have your work cut out for you programming this hardware.

Status registers contain used and changed bits to aid virtual paging routines. But there's no provision for an LREF attribute. Curiously, some bits cause an interrupt to be generated whenever reference is made to the segment. The purpose of this feature eludes me—maybe it's for debugging.

Motorola's excellent MC68451 furnishes the horsepower to construct a serious virtual computer system.

swoop. Normally, logical page numbers and each map cell's page number are compared bit-wise for a match. Instead, the MC68451 employs a mask field that selects which address bits to check against a map cell's page number. The mask effectively turns some of these bits into "don't cares." The end result is that

The Motorola MC68451

Motorola has come up with an excellent memory-control product. The MC68451 furnishes the horsepower to construct a serious virtual computer system. In combination with the MC68000, which I think is the best 16-bit microprocessor around, the MC68451 is quite impressive. Before getting too worked up, however, I should mention that I do have a few reservations about the device. Despite this, the MMU uses some in-

FLIP FLOP™

Stop Wasting Half Your MEMORY/MONEY

5 1/4" ONE-STEP 5 1/4" TWO-STEP

FLIP FLOP A Daring, Quick, & Precise way to allow you to use both sides of your single-sided diskettes. **Flip Flops** are not temperamental. The **TWO-STEP** will work with any sectoring and density required by your 5 1/4" or 8" single-sided disk drives. Covering of **Just One Box** of diskettes will pay back your investment. **LIVE the legend: use both sides of your single-sided diskettes.**

SAVE TIME, SAVE SPACE, SAVE MONEY

The technology for making a write-enable/protect cutout in one step along with a prealigned, accurate, and safe way to make the new index-hole cutouts next to hub-ring of diskettes for 2nd step.

5 1/4" ONE-STEP: For Apple, Atari, CBM 4040, Victor, Franklin **only \$19.95**

5 1/4" TWO-STEP: For IBM PC, Osborne, TRS-80 (I & III), Kaypro, Lanier, OSI, TI, Zenith, Archives & all 5 1/4" single-sided drives **only \$29.95**

8" TWO-STEP: For Altos, TRS-80 II, Wang, IBM, Zenith, Xerox, Control Data, DEC, HP, Data General, TI & other 8" single-sided drives **only \$34.95**

Add \$2.50 for shp & hdlg (AK, HI, add \$5. Foreign country add \$10). MA, residents add 5% sales tax. Send check or money order to:

FLIP FLOP P.O. BOX 201 • NEWTON HLDS, MA 02161 Tel: (617) 964-2126
Dealer Inquiries Invited. Copyright 1983 DI/Punch Corp.

QUALITY COMPUTER FORMS AT PRICES YOU CAN AFFORD

Checks To-Go Supports These Software Packages:

- Peachtree • Accounting Plus • BPI • Great Plains • Continental • MBSI • Radio Shack • TCS • Gold • State of the Art • Open Systems • Fedder • Vector Graphic • Libra
- And Many More!

24 Hour Shipping on Blank Stock.
Now you can run your new system without having to wait. Call toll free to place your order for Statements, Invoices, or other available forms.

See Us At **COMDEX/SRING '83**
April 26-29 1983
Georgia World Congress Center and
The Atlanta Apparel Mart
Atlanta, Georgia
Booth 847

Checks To-Go

CALL TOLL FREE NOW: (800) 854-2750 IN CA (800) 552-8817
(619) 460-4975

8384 Hercules St. • P.O. Box 425 • La Mesa, CA 92041

Your Assurance of Value and Service.

Specials of the Month

- Atari 400 with 32K . . . **\$239**
- Atari 1200XL Computer with 64K **\$695**
- 32K RAM Board for Atari 400/800 **\$50**
- TSI Marketing Combo Special #1 Includes Commodore 64 Computer and 1530 Datassette Recorder **\$515**
- TSI Marketing Combo Special #2 Includes Commodore 64 Computer and 1541 Disk Drive . . . **\$759**

Atari 800 Computer with 48K Dnm	\$489
Atari 810 Disk Drive	\$409
Atari 400 with 16K	\$210
Atari Visi Calc DX5049	\$140
Commodore VIC20	\$155
Commodore 64	\$459
Commodore Datassette Recorder	\$69
Commodore 1541 Disk Drive	\$349

CALL FOR OTHER LOW PRICES ON ADDITIONAL ITEMS NOT LISTED

Remarkable Microcomputer Printouts with Real Character.
SMITH-CORONA® TP-1™
Daisy Wheel Printer

OUR PRICE \$595 SAVE \$300

Okidata 82A Dot Matrix Printer	\$420
Gemini 100 GPS Dot Matrix Printer	\$375
Amdec Color I Monitor with Sound	\$320
NEC C122024 Color Monitor with Sound	\$315
NEC J81201 Monochrome Monitor with Sound	\$169

DISPLAYPHONE "A Telephone & Computer Terminal in One"

OUR PRICE \$1395
Sold Nationally for \$1995

TSI Marketing
1560 TEANECK RD.
TEANECK, NEW JERSEY 07666
(201) 837-0032

TERMS OF SALE Cash, Check, Money Order, Mastercard, and Visa. Add 4% for Credit Card. Orders NJ Residents Add 6% Sales Tax. SHIPPING AND HANDLING: Add \$3.00 for First 31 lbs. Plus \$40 for Each Additional Pound Excess. Shipping Charges will Be Refunded.

Protection and data typing are practically nonexistent. You can only write-inhibit segments. Any distinction between code and data or user and supervisor happens at the processor level—this makes security less effective.

The MC68451's multiuser facilities and fast context switching make WS-Clock a possible paging strategy. But you must build an extra data structure to hold reference times to support this approach. Though the MC68451 is short on facilities to fully protect data resources, you are compensated by more features for virtual memory. Also, its architecture delivers functions conducive to VS(n) designs.

The Intel iAPX 286

The Intel iAPX 286 constitutes a complete virtual-memory processor that I believe supplies the best features available in the microcomputer world today. What I consider most amazing is the fact that the memory-control unit is practically identical to a Burroughs B5500 mainframe system—a highly touted segmented architecture. Benefits are numerous and problems sparse. To summarize, I'll list the principal advantages:

- it has an integrated processor/MMU design using the 8086 microprocessor, one of the most popular 16-bit processors, making it compatible with existing software
- it has a gigantic (1-gigabyte) address space
- memory segments can be sized with a resolution of 1 byte, making it ideal for program modules
- it features advanced data-protection measures: four priority levels and several data attributes
- it can completely support WS-Clock and VS(n) designs

The iAPX 286's local data table (LDT) register points to a map table residing in MM. There's also a global equivalent of this (GDT) for shared segments. You can define up to 16,384 active segments per user. The number of users is almost boundless. Four fast internal processor registers hold the most recently accessed seg-

ment descriptors (called a cache). If you reference a map cell held in one of these registers, there's no translation-time penalty.

Because the iAPX 286, like the 8086, uses segment registers, your program must load these registers prior to memory access. Only branching instructions allow you to specify a full 32-bit virtual address. Segment-register management has two negative aspects: segment-control code clutters a program and net translation time grows. Compilers normally solve the first problem. The time problem is more of a nuisance.

The iAPX 286 features excellent virtual-memory support. Map cells have 16 undefined bits that you can use for several purposes. For instance, 12 to 14 bits would be sufficient for an LREF field. You could also allocate a fix bit to lock special pages into MM (e.g., a supervisor kernel program or an LDT table). Used and segment present bits are supplied, but a changed bit is noticeably absent.

The Intel product represents a superb tool for building virtual memory. Drawbacks are minor: small cache size, the need for segment-register management, and no changed bit. And the device is easy to program. Instead of an I/O program to operate a separate MMU, you do simple loads and stores of memory. The iAPX 286's integrated approach, its numerous features, and its regular design comprise an impressive computing engine.

Evaluation

Which MMU should you choose? The answer depends on various factors. Above all else, the companion microprocessor sways this decision. Get a system with a processor you like—it influences your software and operating-system selections. Performance requirements and intended applications are important. Is the multitasking level a factor? Do you want the flexibility of segmentation or the simplicity of paging? What software policies or peripheral components fit your needs? Table 5 compares the MMU products. The evaluation offers a yardstick for

Fox & Geller asks dBASE II™ users: Which would you prefer?

Annual Report, 1982
Unit Sales and Dollar Volume

PRODUCT A, Quarterly Unit Sales, \$39.95/unit net:

	1981	1982	
1st	821	1037	
2nd	510	600	
3rd	385	530	
4th	1020	1298	
	2736	3465	TOTAL UNITS
	\$ 109,303.20	\$ 138,426.75	TOTAL SALES

OR

PRODUCT B, Quarterly Unit Sales, \$24.95/unit net:

	1981	1982	
1st	1196	1240	
2nd	624	803	
3rd	590	752	
4th	1365	1810	
	3775	4605	TOTAL UNITS
	\$ 94,186.25	\$ 114,894.75	TOTAL SALES

PRODUCT C, Quarterly Unit Sales, \$49.95/unit net:

	1981	1982	
1st	745	697	
2nd	485	401	
3rd	380	365	
4th	851	812	
	2461	2275	TOTAL UNITS
	\$ 122,803.90	\$ 113,636.25	

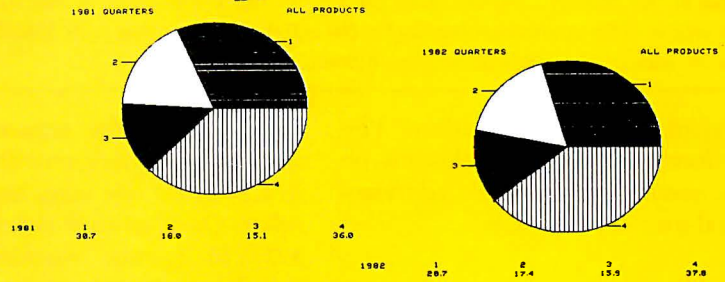
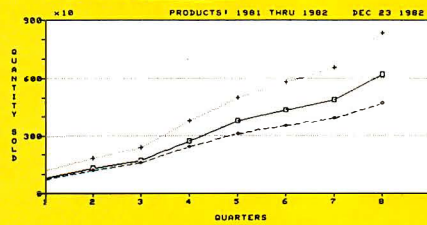
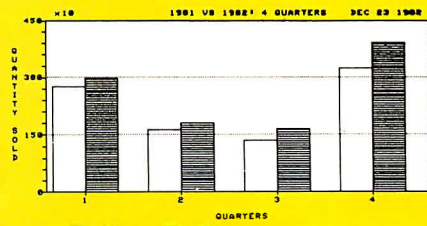

On the left, you have numbers which are important, but can be a bore to read. And it's easy to miss important trends embedded in those numbers.

On the right are graphic aspects of the same numbers. Graphics that are quickly understandable, visually dynamic, and all available from one package, **dGRAPH™** by **Fox & Geller**.

That's right. **dGRAPH** gives you the flexibility to produce bar charts, pie charts, line graphs, and combination piebar charts. All of them are **easy to do**, as easy as naming the kind of graph you want and what kind of data you want to graph. That's it. **dGRAPH's** unique **AUTOGRAPH™** feature takes care of the rest in seconds. That includes loading data, computing scales, drawing grid lines, shading, overlay graphs (if any), and labelling. And the results are transferable to EPSON, OKIDATA, and a growing list of other popular printers so as to enhance your meetings and reports. You get all of the above capabilities plus powerful data manipulation features so you can graph various fields—all this for just \$295.00.

So, dBASE II users, which would you prefer? We think **dGRAPH** is the obvious answer. Don't you?

Ask for **dGRAPH** by name at your local computer dealer. And while you're there, see **Fox & Geller's** full line of quality software. Software that's practical, reliable, and reasonably priced. Software that's created by Jeff Fox and Jacob Geller, individuals who stand behind every product that bears their names.

Use the Reader Service Card for more information. Or contact:

dGRAPH is also available for non-dBASE II users!

dBASE II is a trademark of Ashton-Tate. dGRAPH and AUTOGRAPH are trademarks of Fox & Geller.



Fox & Geller, Inc.

604 Market Street
Elmwood Park, NJ 07407
(201) 794-8883

OVERALL RATINGS	MEMORY-MANAGEMENT UNITS			
	Intel iAPX 286	Motorola MC68451	Zilog Z8010	Zilog Z8015/PMMU
Virtual-memory features	Excellent	Good	Poor	Average
Support for the Clock page-replacement algorithm	Excellent	Excellent	Good	Excellent
Support for the WS-Clock algorithm	Excellent	Good	Poor	Poor
VS(n) architecture	Excellent	Good	Poor	NA
Device features and performance				
Translation speed	Excellent	Poor	Good	Average
Address space	Excellent	Good	Poor	Average
Block resolution	Excellent	Good	Average	NA
Mapping strategy	Good	Excellent	Average	Excellent
Companion processor				
Popularity	Excellent	Good	Average	Average
Architectural design	Average	Excellent	Good	Good
Multiuser capability	Excellent	Excellent	Average	Average
Design flexibility	Good	Good	Average	Poor
Expansion potential	NA	Good	Average	Good
Protection features	Excellent	Average	Good	Good
Ease of programming	Excellent	Average	Good	Good
Hardware requirements	Excellent	Good	Poor	Good
Complexity (board level)	Excellent	Good	Poor	Average
Page-fault overhead	Good	Excellent	Poor	Poor

Table 5: An overall comparison of the four memory-management units surveyed in this article. This evaluation highlights the differences between each MMU and gives you an idea of the application possibilities.

analyzing potential applications. You can draw your own conclusions on how well each device addresses virtual-memory concepts.

New Horizons

Virtual memory opens up a whole new world for microcomputer systems. The expanded address space accommodates traditional large-scale software applications: database-management systems, sophisticated operating systems, and complex high-level-language translators. Moreover, some unique applications of virtual memory exist for microcomputer systems.

Virtual storage streamlines database operations. For example, you don't have to use complex file-access techniques to locate data. A 1-giga-byte address space defines an enormous amount of information. Applications can be much bigger and retrieval time much faster.

A VS(n) design has very exciting implications for microcomputers. You may have observed the trend among microcomputer vendors to offer a choice of several of the leading operating systems with their hardware. With a VS(n) organization, several different operating systems

could run in the separate logical-address spaces concurrently. Think of it, CP/M for one user, Xenix for another, Oasis-16 over there. The IBM 370/VM (virtual machine) applies this approach with good success.

Virtual microcomputers give you many other unique software avenues. Consider the memory needs of a 1K-by 1K-byte color graphics system. With various shades and colors, you will quickly consume 1 megabyte of memory. And how about the trend toward integrated business environments? Word processing, report generation, spreadsheet analysis, electronic filing, etc., collectively take a sizable amount of storage.

When will virtual microcomputers be available? They are right now. Altos Computer Systems, Integrated Business Computers (IBC), and Plexus all feature virtual systems designed around the Motorola MC68000 processor. IBM has been looking at the iAPX 286 with some interest, and its future microcomputer systems should prove interesting. The trend is just beginning.

Conclusion

Virtual memory will play a vital role in the evolution of microproces-

sor-based computer systems. The memory-management units I've reviewed here lay the foundation by supplying the essential hardware components.

Some people claim that virtual memory fails to provide good performance. I disagree. A carefully designed unit, properly tuned (e.g., with the proper Θ parameter for the WS-Clock algorithm), should actually improve a system's operation. MMUs, sophisticated microprocessors, and simple management policies collectively supply the elements that make virtual systems viable and inevitable. A wider range of advanced applications becomes feasible.

Which MMU is the best is not totally clear. Obviously, the iAPX 286 offers some outstanding features. However, your intended applications and software considerations should figure prominently when you make your determination.

A big memory space presents a new software frontier. With these new MMU devices, it will soon be possible to have the processing power of a mainframe in the size of a desktop. ■

References

1. Carr, R. and J. Hennessy. "WSCLOCK—A Simple and Effective Algorithm for Virtual Memory Management." *Proceedings of the 8th Symposium on Operating Systems Principles*, ACM, Vol. 15, No. 5, December 1981, pp. 87-95.
2. Denning, P. "Working Sets Past and Present." *IEEE Transactions on Software Engineering*, Vol. SE-6, No. 1, January 1980, pp. 64-84.
3. Easton, M. and P. Franaszek. "Use Bit Scanning in Replacement Decisions." *IEEE Transactions on Software Engineering*, Vol. C-28, No. 2, February 1979, pp. 133-141.
4. Hellerman, H. and T. Conroy. *Computer System Performance*. New York: McGraw-Hill, 1975.
5. *Intel iAPX 286 Preliminary Users Manual*. Santa Clara, CA: Intel Corporation, 1981.
6. *Motorola MC68451, Advance Information*. Austin, TX: Motorola Inc., 1981.
7. *Z8015 Paged Memory Management Unit, Product Specification*. Campbell, CA: Zilog Inc., 1981.
8. *Zilog 1982/83 Data Book*. Campbell, CA: Zilog Inc., 1982.

CompuPro's Latest... the Industry's Finest.



System 816/68K™

If you're excited about FORTH, you couldn't find a better companion than this 68000-based system. **System 816/68K** includes CompuPro's indomitable new CPU 68K, 256K bytes of 16-bit memory, 1.5 megabytes of M-Drive/H™, System Support 1, Interfacer 4, Disk 1 controller, Desktop Enclosure 2, disk enclosure with two Qume drives for 2.4 megabytes of storage, all cables, and software: CP/M-68K™, mapFORTH and C languages. \$8,995.



CompuPro, a Godbout Company, Box 2355, Oakland Airport, CA. 94614

Call (415) 562-0636 for the location of the **Full Service CompuPro System Center** nearest you. CompuPro products are backed by a one-year limited warranty (two years for boards qualified under the **Certified System Component** high-reliability program).

**Send for our catalog for
complete product information.**

Circle 91 on inquiry card.

We've wired **CompuPro** savvy into three of the industry's most potent new processor chips. The results: more performance, more quality, more reliability, and higher speed for greater throughput than ever before.

CPU 286 and **CPU 16032** can upgrade present systems to state-of-the-art operation, or serve as powerful foundations for new systems. **CPU 68K**, aside from being a superb CPU board, is also the core of our **System 816/68K**.

As always, **CompuPro** kept one eye on the future in designing these CPU's. With a **CompuPro**, you don't shudder at fast-changing technology — you welcome it.

We give you brawn and brains in one box, and that's beautiful.

CPU 286

No more fighting to get on the bus, multi-users. **CPU 286** is based on Intel's ultra-high performance 16-bit iAPX 286/10; it includes sockets for both the 80287 math co-processor and up to 16K bytes of on-board EPROM. To protect your existing investment, **CPU 286** accepts 8-bit as well as 16-bit memory, is downward compatible with the vast library of 8086 and 8088 software, and works with all DMA devices meeting IEEE 696/S-100 standards. Operates at 10 MHz clock speeds.

CPU 16032

Power? This one crunches catalogs for breakfast. **CPU 16032** is based on National Semiconductor's NS16032 16-bit microprocessor, with provisions for on-board memory management unit, floating point arithmetic unit, and up to 32K bytes of ROM. Although its internal architecture is 32-bit all the way, **CPU 16032** accepts 8-and/or 16-bit memories and peripherals meeting IEEE 696/S-100 standards.

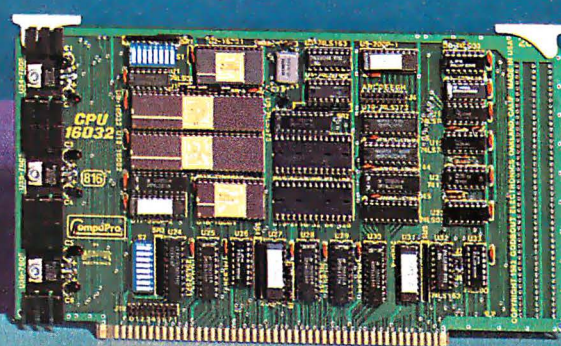
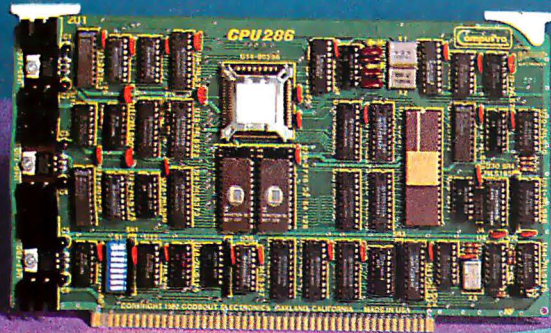

the Rest of CompuPro's Family:

SYSTEMS*

Single user (expandable to multi-user): **System 816/A™** and **816/B™**, **System 86/87™**.

Multi-user: **System 816/C™**, **816/OASIS-8™**, **816/OASIS-16™**.

OPERATING SYSTEMS

CP/M-80™, CP/M-86®, MP/M-816™, FORTH, CP/M-68K™, GP/M-816™, OASIS-8™ and OASIS-16™.

MEMORY BOARDS

RAM 16, RAM 17-48, RAM 17-64, RAM 21, RAM 22 and 512K M-Drive/H™.

DISK CONTROLLERS and SUBSYSTEMS

DISK 1, 2, 3 controllers, Dual Floppy Disk Subsystem, Add-On Hard Disk Drives.

INTERFACERS

Interfacer 1, 2, 3-5, 3-8 and 4.

CPUs

CPUz, CPU 8085/88, CPU 86/87 and CPU 85/88.

MOTHERBOARDS and ENCLOSURES

6-, 12- or 20-slot motherboards, Enclosure 2 (desktop or rack mount).

STD BUS BOARDS

CPU Z, RAM-16, MB-8, MB-16, RAM 32, and RAM 64.

*Software bonus! All CompuPro 816 systems include the following prepackaged software: Sorcim's powerful SuperCalc-86 for business and financial planning, Ashton-Tate's dBase II for data base management, and now, Lorand Andahazy's Field Companion (\$295 value) for increased administrative productivity.

Optional high-speed math processor chip or co-processor board available through **CompuPro.

These high-technology products require skilled installation. They are intended for OEMs, system integrators and experimental researchers only.

CP/M-86 is a registered trademark of Digital Research; M-Drive/H is a trademark of CompuPro; OASIS is a trademark of Phase 1.

Circle 91 on Inquiry card.

Hard Choices for Software Houses

Phil Lemmons
West Coast Editor

The memory-addressing range of the 16-bit microprocessors presents a grand vista to programmers, but an empty one, like the Grand Canyon. The addressing range of these processors extends from 1 to 16 megabytes and up—far enough to hold an applications programmer's grandest dreams: to increase speed of execution, to integrate functions previously done by separate applications programs, to make software easier to use, to design whole new software architectures that revolutionize the way people use computers.

But the actual memory in most of today's 16-bit microcomputers is usually 64K bytes, or sometimes 128K bytes. The present contrast between addressing range and actual memory places software houses in a dilemma. Not to use more than 64K bytes of memory is to waste the greatest asset that the 16-bit microprocessors offer. But if software houses do decide to use more than 64K bytes, how much memory should they require? Answering this question is not a simple matter of surveying the installed base of 16-bit systems to determine the average amount of memory owned. Software houses can

use additional memory to make software more attractive. If the software is attractive enough, people will order the amount of memory necessary to run it at acceptable speed. In other words, software can not only exploit memory but also sell it.

Nevertheless, there is a limit to the amount of memory that most microcomputer users can afford to buy. Software houses must somehow divine that limit to determine how much memory they will have to work with. Whether the amount of memory is 128K bytes, 192K, 256K, or even 512K, software houses will still have to set priorities for its use. How much memory should they devote to increasing speed, how much to integrating functions, and how much to increasing ease of use? Has the time yet come for software that revolutionizes the "user interface" at affordable prices?

Increasing the speed of execution is the easiest and most obvious way to use additional memory, and it is also an important way. In systems with 64K bytes of memory—the most that an 8-bit processor can address—complex programs had to be divided into modules kept on disk. As the user called for specific functions,

the program would go to the disk and bring the necessary module of code into RAM (random-access read/write memory), overwriting another module. Users of the program had to wait for these modules, called "overlays," to be read in. In most cases, 128K bytes of RAM is enough to hold an entire applications program at one time and to eliminate the delays caused by overlays. In addition to eliminating overlays, memory in excess of 64K bytes will also provide room for more of the user's data. Text-editing programs will therefore be able to edit more text more quickly, databases to sort more data more quickly, and so on.

Depending on their priorities, software designers may continue to use overlays, choosing to integrate functions rather than increase speed. Using virtual memory is another strategy for integrating more functions than system memory can hold at one time. In this case, the operating system rather than the applications program swaps modules of software from disk to semiconductor memory and back again. While techniques exist to minimize the delays caused by the use of virtual memory (see "Virtual Memory for an Object-Oriented



Rose™

You've Got TOTAL ACCESS™

TO YOUR COMPUTER HARDWARE & SOFTWARE NEEDS. CALL ROSE TODAY!

*** DISK DRIVES**

- Total Access 40 Track..... \$239
 - Aerocomp 40T Flippy..... \$319
 - Aerocomp 80T..... \$399
 - Aerocomp 80T Flippy..... \$409
 - Aerocomp 40T Dual Head..... \$409
 - Aerocomp 80T Dual Head..... \$399
- For TRS80 Mod I, Mod III & DMPC External & TI99/4A Incl. power supply & enclosure.

- NEW!**
- Apple Compatible Drive..... \$279
 - Apple Comp. Disk Controller Board..... \$89

*** BARE DRIVES**

- Total Access 40T..... \$199
- Aerocomp 40T Flippy..... \$269
- Aerocomp 80T..... \$329
- Aerocomp 80T Flippy..... \$359
- Aerocomp 40T Dual Head..... \$329
- Aerocomp 80T Dual Head..... \$469

*** DRIVE CABLES**

- 2 drive..... \$24
- 4 drive..... \$34
- Extender cable..... \$13

*** OPERATING SYSTEMS**

- TRSDOS 2.3 Disk & Manual..... \$20
- LDOS (1 or II)..... \$119
- DOSPLUS 3.4..... \$129
- NEWDOS/80 (1 or II)..... \$129

*** DISK CONTROLLERS/SEPARATORS**

- Aerocomp "DDC" double dens. disk controller for Mod. I..... \$139
- w/DOSPLUS 3.3D..... \$179
- w/LDOS..... \$189
- Aerocomp "DDS" double dens. data sep. for Percom or LN Doubler..... \$49
- Aerocomp "SDS" single dens. data sep. for Mod. I..... \$29

MODEL III DRIVES

- Complete kits including 40 track disk drives (1 or 2), disk controller board, power supply and all hardware and cables.

- NEW!**
- One Drive System Kit..... \$479
 - Two Drive System Kit..... \$689

*** ODD STUFF**

- Single drive power supply..... \$44
- Drive enclosure (silver)..... \$24
- Diskettes (box of 10)..... \$24
- MX80 ribbon..... \$9

120 day warranty on drives. Add \$5 per drive shipping in Cont. US UPS. COD charge \$1.50. There is a 15 day FREE TRIAL ON DRIVES. If not complete, justified ill refund your money (less shipping). No take exception to improper use or mishandling.

*** TRS-80 SPECIAL EQUIPMENT**

- 4/5 Mhz Speedup mod for Mod I/III..... \$89
- 48K CP/M for Mod III includes all hardware and CP/M 2.2..... \$275
- 64K CP/M for Mod III with 80 x 24 video and CP/M 2.2..... \$399
- Alcor PASCAL, Model I or III..... \$169
- 16K Memory, 200nsec, Guor 1 yr..... \$12
- 64K Memory, 200nsec, Guor 1 yr..... \$12
- 12" Green Phosphor Monitor..... \$99

* TRS80 & Radio Shock are trademarks of Tandy Corp. Copyright 1982 TOTAL ACCESS

KAYPRO II

Portable Computer

64K CP/M, Centronics and Serial Ports
Perfect Writer & Speller
Perfect Calc & Filer
9" Green Video 80 x 24
2 DblDen(200K) Drives

Your
Choice

\$1699

Micro

MICRO DECISION

64K CP/M, 2 serial Ports, MBASIC, WordStar, Logicalc, Correct-IT, BoZic
12" Green Video 80 x 25
DoubleDen(200K) Drive

FRANKLIN ACE1000

Uses APPLE Software
Extra Features

\$999

brother

HR 1 Daisy Wheel Printer
EM 1 Electronic Typewriter
Either One

\$799

COEX 80 F/T

80cps Friction Tractor
EM 1 Electronic Typewriter
6, 8, 12 lpi
2K Buffer

\$299

NOTICE

Mod II, Mod III, Mod IV, Mod 12, Mod 16.....
Color Computer, Pocket Computer...
Please call us TOLL FREE for up-to-date prices on the above computers. Many are now SALE PRICED at HUGE SAVINGS.

***SOFTWARE**

- All Radio Shock Software****20%****off
 - Super Utility Plus 3.0 by Kim Warr..... \$65
 - P&T CP/M for the Mod II..... \$159
 - P&T CP/M for the Mod 16..... \$189
 - P&T CP/M for the Hard Disk..... \$199
 - All SNAPPWARE..... **40%****off
- I have lots of other software. Call me now for your needs. All or discount.

***MEDIA & SUPPLIES**

- 8" disks 55 DblDen, Guor. Forever..... \$29
- 8" disks DS DblDen, Same Guarantee..... \$39
- 5" Flipsort, holds 50 disks..... \$23
- 8" Flipsort, some deal..... \$29
- 5" Library boxes..... \$2.50
- 8" Library boxes..... \$3.50
- 5" or 8" Head cleaning kit..... \$9
- Tractor paper, letter size 2900 sheets..... \$25

***LNW COMPUTERS**

- 128K LNW-80 Mod II, NTSC/RGB, RS232, CP/M 2.2 and 5/8 controller, FREE 12" Green Screen Monitor and Cable..... \$1995

***PRINTERS & OTHER ACCESSORIES**

- 26-1158 Daisy Wheel II, 43 cps..... \$1599
- 26-1447 RS Tractor Assembly..... \$208
- 26-1448 RS. Sheer Feeder..... \$999
- 26-1455 Acoustic Cover..... \$339
- 26-1250 DWP-410, 25 cps..... \$1275
- 26-1459 RS Tractor Assembly..... \$199
- 26-1251 DMP-400, 140 cps..... \$969
- 26-1252 DMP-500, 220 cps..... \$1499
- 26-1253 DMP-100, 50 cps..... \$309
- 26-1254 DMP-200, 120 cps..... \$599
- 26-1256 DMP-2100, 184 cps..... \$1649
- 26-1441 RS Tractor Assembly..... \$139
- 26-1192 CGP-115 Color Printer..... \$199
- 26-1193 Florbed Plotter..... \$769
- 26-1196 GT-116 "X-PAD"..... \$295
- 26-1195 Digitizer with software..... \$395
- ANADEx DP-9620A, 200 cps..... \$1449
- ANADEx WP-6000, 284 cps, NLQ..... \$2695
- PROWRITER, 120 cps, 10" Fric/Troc..... \$449

- PROWRITER 2, 120 cps, 15" Fric/Troc..... \$669
- STARWRITER F-10, 40 cps, Daisy Wheel..... \$1399
- PRINTMASTER F-10, 55 cps, Daisy..... \$1599

***PERIPHERALS - Models I/II/III, 16, CC**

- 32K LNW Expansion Interface w/RS232..... \$349
- LN Doubler 5/8 with DOSPLUS..... \$169
- 26-1145 Mod I RS232 firs RS. E/I..... \$85
- Mod III RS232..... \$79
- 26-1172 DC Modem I..... \$125
- 26-1173 DC Modem II..... \$199
- 26-1208 CCR-81 Recorder..... \$51
- 26-1130 Hard Disk 5Mb, primary..... \$1899
- 26-1131 Hard Disk 5Mb, secondary..... \$1499
- 26-1162 Mill 1sr Drive Kit, Pure RS..... \$599
- 26-3022 CC 1sr Drive w/controller..... \$399
- 26-3023 CC 2nd Disk Drive..... \$259
- 26-4152 Hard Disk 12Mb, primary..... \$2795
- 26-4153 Hard Disk 12Mb, secondary..... \$1999
- 26-4167 Thinline odd-on drive..... \$305

ORDER NOW! TOLL FREE 800-527-3582

Write or call. Toll free lines are for orders only. Texas residents call 214/458-1966 and deduct \$2.00 from your order. If you need technical information or service use the Texas number. Prices are subject to change without notice and are mail order only. I accept VISA or MASTERCARD, you can send a check or money order (allow a couple of weeks for personal or company checks to clear) or order COD (cash, certified check or money order only). Shipping is not included unless otherwise indicated. Please add \$5 handling charge to all orders under \$24. Texas orders add 5% tax. No tax added on shipments outside Texas. Order up - I need the money!

TOTAL ACCESS™
P.O. BOX 3002
RICHARDSON, TX 75080
214-458-1966

NEXT DAY SHIPMENT on all in stock Merchandise.

GET THE BULL FREE WHEN YOU BUY FROM BISON!!!

PERIPHERALS

Here are some of the products BISON carries for Apple Computers.

If you don't see what you want here, give us a call.

Microtek 16K RAM Card for Apple II \$65.00
Microsoft Premium Pack 479.50
BISON Add-on Disk Drive 260.00
<i>(100% Apple Compatible)</i>	
Apple Joystick 49.50
Parallel Printer Card with Cable 71.00
Kensington System Saver 75.00
D.C. Hayes Micromodem II 270.00
Microtek Apple Dumping GX 118.00
<i>(also available with buffer)</i>	
Microtek Magnum 80 249.00
Microsoft Z80 Softcard with CP/M 239.00
Videx Enhancer 119.00
Videx Function Strip 59.00
Practical Peripherals	
Microbuffer II, 16K, Parallel 209.00
Microbuffer II, 32K, Parallel 239.00
Microbuffer II, 16K, Serial 209.00
Microbuffer II, 32K, Serial 259.00
Microbuffer 8K, Serial 125.00
Microbuffer 16K, Parallel 125.00

Atari Joysticks & Software in stock!

For more information, circle reader service 55

PRINTERS

BISON carries all of the major brands of printers. If you need help choosing the proper printer for your needs, call and talk to one of our support technicians.

NEC PC-8023A Fric. & Trac. w/Graph.	... \$485.00
Okidata Microline 82A 80 Col. w/Trac.	... 439.00
Okidata Microline 83A w/Trac., 132 Col.	... 639.00
Okidata Microline 84P, Parallel	... 925.00
Okidata Microline 84S, 200 cps/S	... 999.00
Okidata Microline 92	... 599.00
Okidata Microline 93	... 839.00
Star Micronics Gemini 10 Printer	... 399.00
Star Micronics Gemini 15 Printer	... 575.00
C. Itoh Prowriter I, Parallel	... 485.00
C. Itoh Prowriter II, Parallel	... 625.00
C. Itoh Prowriter II, Parallel/Serial	... 685.00
C. Itoh F-10 Starwriter, P. or S., 40 cps	... 1225.00
C. Itoh F-10 Printmaster, P./S., 55 cps	... 1495.00

Comrex Daisy Wheel Printer, Parallel 735.00
Comrex Daisy Wheel Printer, Serial 785.00
Comrex Tractor Feed 235.00
Toshiba P1350 Printer 1695.00
Toshiba Tractor Feed 235.00
Diablo 630 Daisy Wheel Printer 1675.00

For more information, circle reader service 56

MONITORS

SANYO

12" Green Monitor Model DM2112 89.00
DMC 6013 13" Color Monitor 375.00
VMC 7013 13" RGB Color Monitor 375.00

AMDEK Monitors

AMDEK Video 300	
12" Green Phosphor Non-Glare 145.00
AMDEK Color II	
13" Color Monitor RGB IBM/NEC/Apple	... 685.00
AMDEK Color I	
12" Color Monitor 299.00

NEC

12" Green Monitor 159.00
13" Color Monitor 325.00
13" RGB Color Monitor 755.00

COMREX

6500 13" Color Monitor 289.00
------------------------	--------------

For more information, circle reader service 57

TELEVIDEO PRODUCTS

TeleVideo computer terminals and desktop computer system — high price features at low prices.

TeleVideo TS-802 Computer System

64K, 4 Mhz Z-80A, CP/M™	
Dual Floppies, 720K Total	
Same CRT and Keyboard as Televideo 950 Terminal	
Network Expansion Capabilities	
TeleVideo TS-802 2695.00
TeleVideo TVI-925 Terminal 695.00
TeleVideo TVI-950 Term.— Top-of-Line	... 875.00

For more information, circle reader service 58

MICROPRO SOFTWARE

Call for tremendous savings on MicroPro Software.

S-100 PRODUCTS

Sierra Data Sciences

S-100 Master/Slave Single Board Computers	
Master — 4 Mhz, Z80A 690.00
Slave — 4 Mhz, Z80A 625.00

Sierra Data CP/M™ w/Sierra Data BIOS	... 225.00
Sierra Manual 25.00
Sierra Data-Winchester Adaptor 159.00
Sierra Data Turbo DOS 750.00

QT Products

QT 6-Slot, Dual 8" Drives 530.00
QT 8-Slot, Dual 8" Drives 560.00
QT I2-Slot, Dual 8" Drives 620.00

DISK DRIVES

Qume #842 (Replaces Data-Trak 8) 490.00
Tandon Thin 8" Sngl-Side, Dbl-Density	... 345.00
Tandon Thin 8" Dbl-Side, Dbl-Density	... 475.00
Mitsubishi Dbl-Side, Dbl-Density 399.00

For more information, circle reader service 59

SPECIAL ON FLOPPY DISKETTES WABASH

*Single-Sided, Single-Density
Box of 10, 8" or 5 1/4"*

\$19.00

SPECIAL OFFER:

Buy a Case of
Wabash 5 1/4" Diskettes
(100 diskettes to a case)
and you pay only

\$170.00

(Save \$2.00 a box)

TDK

5 1/4" Single-Sided, Single-Density 20.00
8" Single-Sided, Single-Density 30.00
5 1/4" Double-Sided, Double Density 25.00
8" Double-Sided, Double-Density 35.00

Head Cleaning Kit

5 1/4"	19.95
--------------	-------

THE BULL DISKETTE AND INFORMATION HOLDER

FREE

*with \$100 purchase.
(Normally retails for \$9.95)*



"we accept Cash, Certified Checks, VISA and MasterCard"

ADD 3% FOR CREDIT CARD PURCHASES

All merchandise new in factory cartons with manufacturer's warranty
Corporate and School District P.O.'s accepted subject to credit approval
Enclose financial statement with order

California residents add Sales Tax. Shipping charges added to all orders.

"No refunds without prior approval" — Bison credit only on returned merchandise

QUANTITIES LIMITED ON SOME ITEMS — PRICES SUBJECT TO CHANGE WITHOUT NOTICE

Send Mail Orders To: P.O. Box 9078-184 • Van Nuys, California 91409

For Questions or Phone Orders Call: (213) 994-2533

THE ULTIMATE IEEE/S-100 MEMORY WOULD...

- **BE NONVOLATILE**, holding data for up to eight years with the power off.
- **RUN AT 6MHZ** without wait states.
- **HAVE EXTENDED 24-BIT ADDRESSING** and bank select.
- **HAVE DYNAMICALLY MOVABLE WRITE PROTECT AREAS** to prevent accidental erasure of programs and critical data.
- **GENERATE POWER-FAIL** interrupts for orderly system shutdown & power failure recovery.

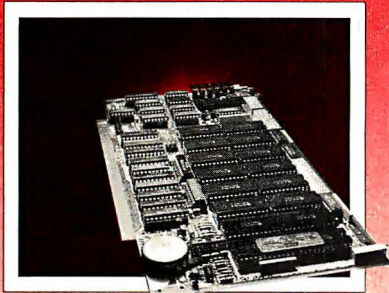

CMEM

AVAILABLE NOW FROM DUAL SYSTEMS, the CMEM memory boards combine high-speed CMOS memories with a new 5-8 year lithium battery. The CMEM offers the nonvolatility of an EPROM board while retaining the instant writability of a high-speed read/write RAM. These industrial grade boards are subjected to a 168-hour burn-in and a 1000-cycle power interruption test to insure data retention and the highest degree of reliability possible.

CMEM-32K, 32K Bytes \$695
 CMEM-16K, 16K Bytes \$595
 CMEM- 8K, 8K Bytes \$495

PRICES SLASHED!

DUAL

DUAL SYSTEMS CORPORATION

2530 San Pablo Avenue • Berkeley
 CA 94702 • (415) 549-3854 • 172029 SPX

few of these software houses have targeted their software for the same amount of memory, and even those who agree about the amount of memory available disagree on how to use it.

To date, the software houses that have placed the greatest emphasis on enhancing the user interface have been understandably slower in bringing their products to market. They seem to be centering their new user interfaces on the object/verb "desktop manager" approach developed at Xerox PARC (Palo Alto Research Center). The screen becomes a metaphor for a desktop, and users select first what they want to work on (the object) and then the action that is to be performed on the object (the verb). (For a fuller description of a desktop manager, see "The Smalltalk Environment" by Larry Tesler, August 1981 *BYTE*, page 90, and "The Lisa Computer System" by Gregg Williams, February 1982 *BYTE*, page 33). To select both object and verb, you usually point at them with a mouse or a similar device.

Software houses are responding to the issues of integration and ease of use in several different ways. Three general approaches prevail: the all-in-one approach, which combines all major applications in a single program; the separate-but-compatible approach, which provides fully functional independent programs with some mechanism for data interchange among them; and the desktop-manager approach described above, which gives the user access to all applications, entirely hiding from him the problem of data interchange.

The products described in the pages that follow are among the most important ones under development now.

All-in-One

Context Management's MBA: If the question is "Which integrated program currently incorporates the most functions?" the answer can only be MBA. Written in Pascal for easy portability to different processors, MBA is a full-featured spreadsheet, a business graphics program that lets you choose one of nine different

kinds of graphs for a set of data, a database that permits sorting data on as many as eight keys, a word processor that takes advantage of function keys to implement its 13 commands, and a communications program that takes data from big computers and automatically loads it into an MBA spreadsheet. The database is relational and lets you add, delete, and rearrange fields at any time. Moreover, you can query the database by typing an example of the sort of thing you want to search for. It can also support databases as large as 16 megabytes, if disk capacity permits.

Although the early version of MBA ran rather slowly on the IBM Personal Computer, it was faster than loading and unloading several different programs to get a job done. The more recent version of MBA shown at last November's Comdex in Las Vegas ran much faster on the IBM PC and faster still on the new Hewlett-Packard Series 200 Model 16, a 68000-based system.

Aside from integrating the user interface for its constituent programs, MBA is not especially innovative. Most commands are invoked by typing a mnemonic preceded by the "/" that Visicalc uses. The program provides online help. MBA organizes data as "folders" containing up to 28 files each—somewhat like the desktop-manager file concept. MBA uses virtual memory to permit documents to refer to data in other documents. When it's in the spreadsheet "context," MBA will divide the display into as many as four windows, any of which may be text, data, a model, or graphics. MBA automatically redraws graphics after changes in data.

Jim Peterson, director of development at Context Management, says that integrating functions was the highest priority in creating MBA partly because integration itself is the main issue in achieving both ease of use and speed. "You have to look at overall speed including telecommunications and the time required to complete an overall task such as producing a report," he notes. Peterson adds that Context has made MBA run faster by reducing the number of

overlays and keeping some memory free for user workspace.

Peterson distinguishes MBA from Lotus Development's 1-2-3 (see below) by saying that "having graphics and numbers and text all on the screen at the same time is important. 1-2-3 doesn't do that. MBA uses more function keys and works in a window while other things are on the screen. The time required to go into and out of a word processor is another drawback for 1-2-3." As for Visicorp's forthcoming Visi On, Peterson expects that its use of a desktop manager will significantly slow execution speeds. He also observes that, while mice are useful when you are just looking at data, you still have to use the keyboard when you're entering data. Mice are expensive, too, he adds.

Lotus Development's 1-2-3: Gregg Williams has already fully described this program (see December 1982 BYTE, page 182), so I will cover it only briefly here. Lotus Development's 1-2-3 runs in 128K bytes and runs fast because it is written entirely in assembly language. The program incorporates three general functions: spreadsheet, graphics, and database management, but the database is quite limited. Lotus plans to add a word processor later. For the most part, the user interface of 1-2-3 is a good implementation of the command-line-plus-online-help strategy familiar from the 8-bit world, but highlighting and selection by cursor do simplify some aspects of the program. The program has some delays

while it goes to disk for help text, which also takes up a lot of disk space. As a result, you can't run 1-2-3 on single-sided drives in the IBM PC. For the present, 1-2-3 is best classified as an enhanced spreadsheet.

Separate but Compatible

Micropro's Star Series: Micropro International Corp. introduced Infostar, a relational database manager, at Comdex. Infostar is now available only for 8-bit systems. Seymour Rubinstein, Micropro's president, is proud of the company's achievement in producing a series of compatible programs that let users program applications without knowing a programming language. Users must understand what they want to do but need to know nothing about the grammar, syntax, or command structures that overwhelm many computer users.

The user interface of all the Micropro application programs seems to be based on the enormously successful Wordstar word processor. All versions of Wordstar to date use the same control-code-based user interface Wordstar first introduced some years ago. The most common control codes are shown in on-screen help menus that can be suppressed once the user learns the codes. Like other programs that require the user to enter control codes to execute commands, Wordstar is difficult to learn. Once learned, however, it is powerful. Micropro's strategy for integrating software seems to be to make data movable between applica-

tions but to keep each application program independent. This seems to result in a powerful set of programs. Curiously, the 16-bit version of Wordstar uses as many overlays as the 8-bit version regardless of how much memory is present in the 16-bit machine.

The current 16-bit version of Wordstar runs in 64K bytes, but Seymour Rubinstein believes that 256K bytes of RAM will become standard because "the standard memory size [of a system] has always been determined by the size of the standard memory chip." Most recently, the standard chip has been 64K bits (8 chips make 64K bytes of memory). Next year the standard chip will be 256K bits. "Memory has two big applications," Rubinstein says. "Graphics and networking."

Rubinstein also anticipates continual improvements in the user interface. To the extent that these improvements use graphics, they will demand memory. Rubinstein adds, "There will be breakthroughs in input beyond the keyboard." Whether Micropro is preparing such a breakthrough remains mysterious, but Rubinstein does point out that Micropro owns a Xerox Star, the first commercial computer system with a mouse-driven desktop manager. Furthermore, rumors abound that Micropro will make major announcements at the National Computer Conference in May. When the 16-bit version of Infostar becomes available, however, using the Micropro programs under Concurrent CP/M-86

XEROX SPECIAL • 8088 CO-PROCESSOR \$699

FOR 820/820II (64K RAM INCLUDED - UPGRADABLE TO 256K)

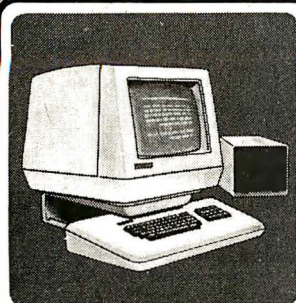

820-II FEATURES: 4MHz, 280A, CP/M BASED, 64K RAM, 12" HI RES SCREEN (24 x 80), DD DISK CONTROLLER, THIN LINE GRAPHICS, ENHANCED SCREEN FEATURES (H/L INTENSITY, REVERSE VIDEO, FLASHING CHARACTERS), TONE GENERATOR, 2 RS-232 PORTS, ONE PARALLEL PORT, ALSO BOOTS AS INTELLIGENT TERMINAL.

820/820 II OPTION PKG. I Save \$46!

- 280C CPU SPEEDUP - 10.5MHz for 820 \$149
- 280C CPU SPEEDUP - 10.8MHz for 820II \$189
- DISPLAY RISER - Elevates 5" Steel Construction \$ 29
- ACRYLIC GREEN SCREEN - Mated to fit CRT \$ 19
- ANTI-GLARE SCREEN - Nylon, stretches over CRT. \$ 19
- SYSTEM DUST COVERS - (3) (8" slightly higher) \$ 29

OPTION PACKAGE II Save \$79!

- INCLUDES ALL THE OPT. PKG. I PLUS -- \$ 25
- 10 Diskettes (DS & 8" slightly higher) \$ 25
- Surge-Protected Multiple Outlet Strip \$ 29
- Enter/Key for Numeric Keypad \$ 19
- Cooling Fan - Fits in display/processor. \$ 35
- Disk Drive Head Cleaning Kit - 5" or 8" \$ 25

8088 Co-Processor/64k	\$ 699	820 Double Density Kit	\$ 249	5MB Hard Disk - exp. to 20 MB	\$ 1995
128k Version	\$ 799	820II Extended DD (670k/side)	\$ 99	32k Printer Buffer	\$ 250
256k Version	\$ 1050	Amber or Green CRT replacement	\$ 89	Hayes Smart/modem	\$ 239
256k Version + CP/M-86	\$ 1250	Parallel Printer Cable	\$ 49	Anti-Static Floor Mat	\$ 25

Xerox 25 cps Daisy	\$ 1195	VISA Account	\$ 99	C.I.T.O.H. Prowriter	\$ 479
Xerox 40 cps Daisy	\$ 2095	Benchmark	\$ 349	Prowriter 2	\$ 659
Qume Sprint 11 +/40	\$ 1395	CP+	\$ 119	F-10 Daisy	\$ 1369

DEALER INQUIRIES WELCOME!

XEROX 820 II SYSTEMS

	LIST	SALE
5 1/4" SS/DD	\$3295	\$1995*
5 1/4" DS/DD	\$3695	\$2295*
8" SS/DD	\$4095	\$2695*
8" DS/DD	\$4895	\$2995*
10 MB/Floppy	\$7695	\$4995

*with Tandem drives

microNEST

Box 545, 1700 Front Street
Fort Benton, MT 59442
CALL COLLECT TO ORDER:
(406) 622-5651 9-5 MST, M-F

VISA, MC, DC, MD, DDD. Add 3% for VISA or MC. Add 3% for Ship/Handling Ins. Via UPS. Minimum \$2.50

XEROX 820/820 II are trademarks of XEROX Corp. CP/M is trademark of the Digital Research Corp.

might result in the highest degree of integration of the Micropro product line.

Sorcim's Superware: Sorcim's Supercalc is an excellent electronic spreadsheet that provides good textual online help on demand. Sorcim has recently expanded its product line (called Superware) by introducing Superwriter, a word processor; Superdata-File Manager, a database management system; Superchart, a business graphics program; and Superdata Interchange, a program that permits data interchange among the Sorcim programs. Superdata In-

terchange converts Superware files into either a common BASIC file format or a Superware format. Supercalc can manipulate data stored by Superdata, Superwriter can include Supercalc data in a text file, and Superchart can generate graphics from Supercalc data.

Each of the Superware programs uses conditional overlays. If memory is scarce, overlays are read in from disk when needed; if memory is abundant, overlays reside in memory rather than on disk. This approach takes advantage of the additional memory that 16-bit machines may

have but does not require it.

Each Sorcim application program is powerful. Superwriter, for example, incorporates an excellent spelling checker and a mailing-list feature for producing form letters. Superdata File Manager can sort on 16 fields at once and can manage files of up to 32,000 records each and 1023 bytes per record. In addition, Superdata permits the linking of files to form larger files and the creation of new file formats from old ones. All the Superware programs have user interfaces much like Supercalc's. The Superware series will run under Concurrent CP/M-86, which means that you can have multiple Superware programs running simultaneously and switch at will among them.

Richard Frank of Sorcim sees three main problems in achieving the next step toward greater ease of use and integration: creating an underlying data structure, providing sufficiently powerful applications programs, and writing good drivers for I/O (input/output). He says that Sorcim is now at work in all three of these areas, and he argues that neither CP/M-86 nor Unix will support the solution of all three problems.

Because Visi On works atop MS-DOS and CP/M-86, Frank believes that the new Visicorp software cannot properly address the problem of the underlying data structure; it deals only with the I/O process. Sorcim will be developing its future software for machines running MS-DOS but will create its own data structure. It will be interesting to see how much of Sorcim's "data structure" resembles traditional operating systems.

If the I/O drivers are done well, Frank says, they will handle keyboards, mice, touch panels, and other types of I/O devices. Frank believes that the design of the software should not require a mouse. "The hardware people are trying to make the machines' 'footprints' [the amount of desk space an object occupies] smaller," Frank observes, "while software people are trying to make footprints bigger by requiring space for a mouse to roam." He notes that people have enough trouble just managing the keyboard, and adding a mouse

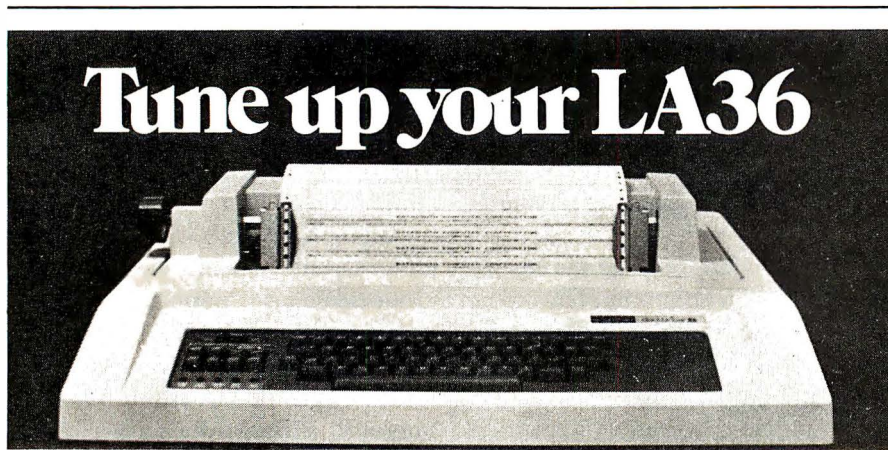

The DS120 Terminal Controller makes your LA36 perform like a DECwriter® III.

The Datasouth DS120 gives your DECwriter® II the high speed printing and versatile performance features of the DECwriter® III at only a fraction of the cost. The DS120 is a plug compatible replacement for your LA36 logic board which can be installed in minutes. Standard features include:

- 165 cps bidirectional printing
- Horizontal & Vertical Tabs
- Page Length Selection
- 110-4800 baud operation
- 1000 character print buffer
- X-on, X-off protocol
- Self Test
- RS232 interface
- 20 mA Current Loop interface
- Top of Form
- Adjustable Margins
- Double wide characters
- Parity selection
- Optional APL character set

Over 5,000 DS120 units are now being used by customers ranging from the Fortune 500 to personal computing enthusiasts. In numerous installations, entire networks of terminals have been upgraded to take advantage of today's higher speed data communications services. LSI microprocessor electronics and strict quality control ensure dependable performance for years to come. When service is required, we will respond promptly and effectively. Best of all, we can deliver immediately through our nationwide network of distributors. Just give us a call for all the details.

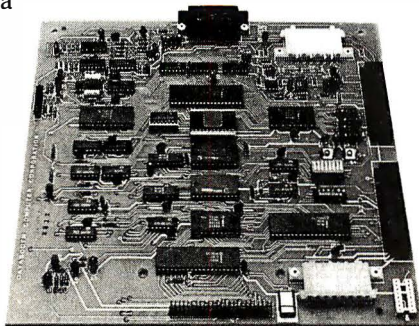

datasouth computer corporation

4216 Stuart Andrew Blvd. • Charlotte, North Carolina 28210 • 704/523-8500

IS THIS LEVEL OF RELIABILITY REALLY NECESSARY?

ACCUTRACK



If you've ever lost data due to a faulty disk, you know how important reliability can be.

That's why Accutrack disks are critically certified at 2-3 times the error threshold of your system. Why they're precision fabricated for higher signal quality, longer life and less head wear. And why we take such extra steps as testing single-density mini disks at double-density levels. So you don't have to worry about the reliability of your media.

Accutrack disks. OEMs have specified them for years. You can trust them for your data. Call toll-free (800) 225-8715 for your nearest dealer.



ACCUTRACK
Dennison KYBE Corporation

82 Calvary Street, Waltham, Mass. 02254
Tel. (617) 899-0012; Telex 94-0179
Outside Mass. call toll free (800) 225-8715
Offices & representatives worldwide

Dealers: Give your customers a choice—Accutrack's OEM performance as well as your heavily advertised brand. We have the industry's only complete line of disks, cassettes and mag cards, including virtually all special formats. If you want a quality line, small minimums, the ability to mix and match, private labeling, fast delivery and great price, call today. Find out how responsive a media supplier can be.

Circle 136 on Inquiry card.

TWA.

Our First is foremost.



Only TWA has First Class Sleeper-SeatsSM on every widebody. For First Class comfort.

First and foremost, there are our First Class Sleeper-Seats.

They are available on every 747, every L-1011, and every 767, everywhere we fly in the U.S., Europe and the Middle East. So you can rest easy every time you fly TWA.

Just settle into a Sleeper-Seat, and you'll be impressed with its incredible comfort and legroom. Then settle back—the seat stretches out with you.

Royal AmbassadorSM Service. **First Class service in a class by itself.**

TWA's Royal Ambassador Service is available on every transatlantic and transcontinental route we fly, as well as selected shorter domestic flights.

We offer a gourmet menu with a choice of entrees like Chateaubriand. Vintage wines from California and France. A selection of fine liqueurs and cognac. All cordially offered to you in a warm, personal manner.

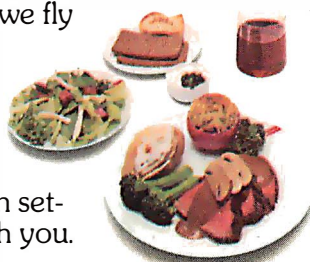

We even cater to your needs before you take off. In major airports, you'll find a special First Class desk to speed you through check-in. And a special lounge for transatlantic passengers to relax in before flight time.

So call your travel agent, corporate travel department, or TWA.

Because for First Class service that's second to none, there's only one choice. TWA.

You're going to like us



with its own buttons won't make matters easier.

As for concurrency, Frank argues—as does Microsoft's Bill Gates—that simultaneously running more than one application program on a single microprocessor is neither necessary nor desirable. What he believes users really need is *interruptability*—the ability to switch quickly from one application to the next. Frank also discounts the usefulness of splitting the screen among four applications. There is no need, he says, to run a spreadsheet while running a word processor; the real need is to run one after the other in rapid succession. That is the end toward which Sorcim is working.

Concurrency for Separate-but-Compatible Programs

Digital Research: Digital Research's Concurrent CP/M-86 provides a mechanism that can help integrate separate application programs. Under Concurrent CP/M-86, you can run several independent application programs (or other kinds of software) at one time. Instead of having windows on each application, Concurrent CP/M-86 permits easy switching from one "virtual terminal" to another. Each virtual terminal is the whole-screen display of one of the application programs that is running. You can get information from one program while running another by switching briefly from one virtual terminal to the next. More direct integration of data from one program into another depends on their data structures. By choosing application programs from a single vendor who has created a common data structure and a common user interface for all the programs, you should be able to achieve a high degree of integration under Concurrent CP/M-86.

Digital Research has often expressed a commitment to making computers accessible to more people, and president Gary Kildall suggests visual aids as one means to that end. There is a lot of speculation about Digital Research's plans for making computers easy to use, but the company has not announced any plans that extend beyond creating tools to

increase the productivity of programmers working for independent software vendors.

Desktop Managers

Microsoft's Multi-Tools Series: Microsoft chairman Bill Gates says, "You can do a lot in 192K." While he offers few details about the company's forthcoming Multi-Tools series of integrated applications programs, Gates notes that Charles Simonyi, formerly of Xerox PARC, is Microsoft's manager of end-user software. Simonyi and Larry Tesler, who was instrumental in the development of Apple's Lisa applications software, spent some time together at Xerox PARC disputing the number of buttons that a mouse should have. Tesler said one, and Lisa has a one-button mouse. Look for Microsoft to use a two-button mouse.

The Multi-Tools series will be available in two versions: one will run on all machines, and one will run on advanced hardware. The Multiplan that runs now on the IBM Per-

sonal Computer probably shows what the run-on-anything series will be like. Even without a mouse, the program lets users select functions by cursor movement. For those who prefer words to formulas, Multiplan's ability to let users refer to cells by English labels rather than alphanumeric coordinates (i.e., "Sales*Unit-price" instead of "C15*C16") is an important convenience.

The advanced-hardware version of the Multi-Tools series requires a non-keyboard input device (such as a mouse), high-resolution graphics, and a 16-bit processor. This version will provide a desktop manager and windows on more than one application at a time. Each application will have a separate window and its own verbs (as opposed to all applications sharing the same window and verbs).

Gates remarks that software shown to date has "ignored the metaphor of how you see data. In a spreadsheet, remembering formulas in cells is a problem. Popping graphs out of windows is also unsatisfactory. You need

Petro-Lewis

PETRO LEWIS

Oil and Natural Gas Income Program XIII

A series of limited partnerships formed to acquire producing oil and natural gas properties—

including two major specified acquisitions that generate immediate distributions.

No exploratory or development drilling

Minimum subscription—\$2,500 (\$2,000 for Qualified IRA Plans)

This announcement is not an offer to sell or a solicitation of an offer to buy any of these securities. The offering is made only by the Prospectus, copies of which may be obtained in any State only from dealers or brokers who may lawfully offer these securities in such State.

Please see that I receive the latest information on this offering including a current Prospectus.

Mail To:
Kay Grover
Petro-Lewis Securities Corporation
P.O. Box 2250, Dept. H
Denver, CO 80201

Name _____ Telephone Number _____
Firm _____
Street Address _____
City _____ State _____ Zip _____

CALL "THE COMPUTER-LINE" In Colorado.

"Committed to bringing computers within the reach of all Americans"TM

The Computer-Line believes that it is important to be competitive by offering low prices; however, we regard service as the most important aspect of a mail-order organization. All our lines are available so that you, the customer, are able to talk to fully qualified computer specialists trained to answer all your questions pertaining to our line of microcomputers. We are renowned for our excellent after-sales support and our promptness for delivery. Peace of mind and excellence in service is our pledge to all our customers.

PRODUCTS for the IBM® PERSONAL COMPUTER

The Ultimate IBM® Peripheral MONTE CARLO™ CARD

Five Functions — Memory/Serial/Parallel/Clock/Joystick

- Up to 1 Megabyte Expandable Memory
- One IBM Compatible Centronics Parallel Port
- One IBM Compatible Asynchronous Communication Port
- Clock/Calendar (Battery-backed) with Alarm
- Dual Port Joystick Interface
- Future Upgrade Options: Direct Connect Modem

..... \$CALL

And The Sensational I-C — MAGIC

Prom Chip

Programmable Graphics Screen Dump

Print Spooling up to 64K

Terminal Emulation..... \$CALL

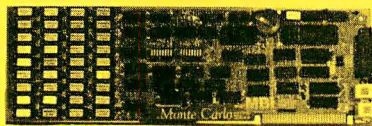

Hard Disk System for the IBM® Personal Computer

The Davong System's Hard Disk Drive fits conveniently inside or outside of the second floppy disk drive location of the IBM® Personal Computer chassis, providing more than 30 times the capacity of a floppy diskette, plus greater speed & reliability.

Available for internal or external installation. Please specify.



SOFTWARE

Ashton-Tate:

D. Base II..... \$475.00

Continental:

Home Accountant Plus \$99.00

Denver Software:

Easy Effective Accounting..... \$595.00

Rose Data Base..... \$259.00

Service Manager..... \$1395.00

MicroPro

Wordstar..... \$329.00

Mailmerge..... \$159.00

Sorcim Software:

Supercalc..... \$199.00

Superwriter..... \$299.00

Spellguard..... \$149.00

Lifefree Systems:

Volkswriter..... \$149.00

Visicorp:

256K Visicalc..... \$185.00

Visidex..... \$185.00

Peachtree

Peachpak..... \$CALL

QUADRAM CORPORATION

Quadboard: The memory board for the IBM featuring:

- Fully Expandable from 64K - 256K
- Parallel Port
- Asynchronous (RS232) Serial Port
- Clock/Calendar
- RAM Disk Drive..... \$CALL

Microfazer:

- Buffering from 8K - 64K (4 - 32 pages of text)
- Printer & Computer Independent
- Parallel/Parallel; Parallel/Serial; Serial/Serial available
- Compute while you print!..... \$CALL

Peripherals for all Computers

PRINTERS

TEC / C-ITOH Printers

Prowriter I Parallel..... \$379⁰⁰

Prowriter I Parallel/Serial..... \$499⁰⁰

Prowriter II Parallel..... \$649⁰⁰

Prowriter II Parallel/Serial..... \$699⁰⁰

F10 Printmaster 55 CPS..... \$CALL

Okidata

Microline 92: 160 CPS bidirectional with 40 CPS correspondence. 80 column..... \$575⁰⁰

Microline 93: 160 CPS bidirectional with 40 CPS correspondence. 132 column..... \$995⁰⁰

Pacemark 2350: 350 CPS bidirectional/2 color printing/136 column..... \$2195⁰⁰

Parallel..... \$2195⁰⁰

Serial..... \$2295⁰⁰

Pacemark 2410: 350 CPS bidirectional/2 color printing/85 CPS correspondence..... \$2495⁰⁰

Parallel..... \$2495⁰⁰

Serial..... \$2595⁰⁰

ICALL FOR PRICES ON ALL OKIDATA PRINTERS!

Star Micronics

Gemini 10 & 15..... Price is Too Low To Publish!

IDS Prism

132 Color..... \$1495⁰⁰

Smith Corona

TP-I Parallel or Serial..... \$569⁰⁰

Call for prices on Epson's New FX Series

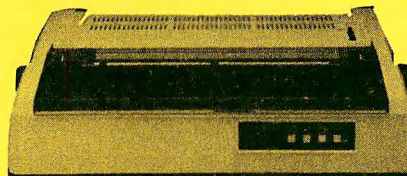

F10 Starwriter Letter Quality

40 CPS Printer, Diablo Standard Daisywheel

..... \$1195⁰⁰

DISKETTES

**Kangaroo:

The disks with the 'jump' on the competition. Outstanding value with library case and a ten year warranty.

5 1/4" SS/DD (Box of 10)..... \$19⁹⁵

5 1/4" DS/DD (Box of 10)..... \$28⁹⁵

Verbatim Diskettes

5 1/4" SS/DD (Box of 10)..... \$23⁹⁵

5 1/4" DS/DD (Box of 10)..... \$43⁹⁵

8" SS/DD (Box of 10)..... \$39⁹⁵

8" DS/DD (Box of 10)..... \$44⁹⁵

Elephant Diskettes

5 1/4" SS/DD (Box of 10)..... \$22⁹⁵

5 1/4" DS/DD (Box of 10)..... \$29⁹⁵

Monitors

Amdek Color I..... \$299⁰⁰

Color II..... \$699⁰⁰

300G Green..... \$154⁰⁰

300A Amber..... \$159⁰⁰

310G Green..... \$179⁰⁰

310A Amber..... \$179⁰⁰

BMC 15MHZ Green..... \$ 85⁰⁰

20MHZ Green..... \$149⁰⁰

NEC 1201 Green..... \$159⁰⁰

1212 Color Composite..... \$299⁰⁰

1203 RGB Hi-Res Color..... \$679⁰⁰

Zenith ZVM-121 15MHZ..... \$109⁰⁰

Taxan Amber..... \$145⁰⁰

MODEMS

D.C. Hayes:

Micromodem II (Apple) w/ Terminal Program..... \$289⁰⁰

Micromodem II (Apple) w/o Terminal Program..... \$259⁰⁰

Smartmodem 300 Baud..... \$209⁰⁰

Smartmodem 1200 Baud..... \$525⁰⁰

Novation:

J-Cat RS232 Direct Connect..... \$119⁰⁰

Cat..... \$149⁰⁰

Smart Cat 1200 Baud..... \$455⁰⁰

Applecatt II (Apple)..... \$289⁰⁰

Apple IIe®

Provides these standard features:

- Typewriter-style, full ASCII keyboard, upper and lower case, and auto-repeat feature
- 6502A microprocessor (8-bit CPU)
- 64K bytes RAM memory
- 16K bytes ROM, which includes built-in Apple-soft BASIC language
- color graphics and sound capabilities
- seven I/O expansion slots
- back panel designed for quick connect/disconnect, using D-style connectors

.....SCALL



Special PRINCETON GRAPHICS SYSTEMS

- 690 Dots Hor.
- 16 Colors
- Non-Glare Screen
- Color at Its Finest

***** SCALL

RAM SPECIAL

4164 Dynamic Ram

200NS...\$5.00 ea.

U.S. made by Texas Instruments. We can supply the quantity & price Dealers & Manf need. Call or write for volume pricing

TANDON DRIVE Special

Double Side/Double Density

320K Bytes of Storage.

TM-100-2

\$245⁰⁰



Basis 108 Summarized:

- Single-board computer
- Serial RS-232C interface
- Parallel printer interface

- 6502 and Z80 microprocessors built in
- 64K RAM, expandable to 128K (4164 dynamic RAM, 200 ns)
- 2K system Monitor ROM
- 10K address space for ROM or EPROM (type 2716)
- 6 system expansion slots
- Detachable ANSI standard keyboard with numeric keypad, 15 programmable function keys, and cursor control block
- 2 page text display; 40/80 characters, 24 lines
- Five character sets
- 3 graphics modes with up to 16 colors; 40 x 48 blocks, 80 X blocks, and 280 x 192 dots

.....SCALL

IBM® Personal Computer



Features:

- 64K Memory
- 2 Tandon TM-100-2 320K Byte Drives
- 1 floppy disk controller
- 1 color graphics card

SlimLine drives and hard disk drives configurations are available upon request.

Call for pricing on all IBM® Systems.

WORD PROCESSING SPECIALS

On Line Screenwriter **\$85** Pro **\$149**

Silicon Valley Word Handler **\$119**

NEC's APC™

Offers:

- 128K or 256K bytes of user memory
- monochrome and color displays
- two-million bytes of floppy disk storage
- 5 1/4" hard disk
- hi-res symbol and line drawing graphics
- user-definable character set
- user-definable function keys
- CP/M -86™ operating system

.....SCALL

Franklin Ace 1000

Offers:

- 64K Memory
- 40 column upper/lower case display
- Apple IIe compatibility
- more space between expansion slots and internal fan aid cooling

.....SCALL

Call for prices on Franklin Ace 1200!

PRODUCTS for the APPLE COMPUTER

We are smashing the prices on Apple Compatible Disk Drives!



FOURTH DIMENSION Drives

Plus a box of Kangaroo Diskettes\$289⁰⁰

FOURTH DIMENSION Drive with Controller Plus a box of Kangaroo Diskettes\$379⁰⁰

We also carry:

- | | |
|-------------|--------------|
| Microsci A2 | Rana Elite I |
| A35 | Elite II |
| A 40 | Elite III |
| Generic |SCALL |

COMPUTER-LINE is Now Open 7 DAYS A WEEK!

Product Information & Ordering Lines
Mon. - Fri. 7 a.m. to 8 p.m.
Sat. & Sun. 8 a.m. to 6 p.m.
(Mountain Standard Time)

MBI APPTIME CARD

Works with DB Master and Visidex Mountain Computer mode.

Basic and pascal operation complete with datebook software \$ 89⁰⁰

MBI VIP CARD (Half Height Drives)

Dual Port Parallel/Serial Graphics Card.....\$129⁰⁰

Use ASCII Express The Professional 4.0 to simultaneously transfer data from modem to printer using the VIP Card.

ASCII EXPRESS (The Professional)..... \$99⁰⁰

APPLE SOFTWARE

Continental:	
The Home Accountant	\$ 54 ⁰⁰
Silicon Valley Systems:	
Word Handler	\$119 ⁰⁰
List Handler	\$ 59 ⁰⁰
Stoneware:	
DB Master	\$159 ⁰⁰
DB Utility 1, 2, 3	\$69 ⁰⁰ ea.
Visicorp:	
Visicalc 33	\$185 ⁰⁰
Visifiles	\$185 ⁰⁰
Visidex	\$185 ⁰⁰
Visitrend/Plot	\$229 ⁰⁰
Denver Software:	
Financial Partner.....	\$149 ⁰⁰
Pascal Tutor	\$ 89 ⁰⁰
Pascal Programmer.....	\$199 ⁰⁰

RAM CARDS

Microsoft 16K \$79⁰⁰

CP/M FOR APPLE

Microsoft Z80 Card\$269⁰⁰

Advanced LogicSCALL

Kensington System Saver \$69⁰⁰

T & G:

Joysticks \$44⁰⁰

Select A Port..... \$44⁰⁰

Game Paddles..... \$29⁰⁰

Kraft:

Joysticks \$49⁰⁰

Game Paddles..... \$33⁰⁰

80 Column Cards

Videx with Softswitch.....\$279⁰⁰

Circle 105 on Inquiry card.

Write or Call for Our Comprehensive Catalog.

Call "THE COMPUTER-LINE"

Product Information & Order Lines: (303) 279-2848 or (800) 525-7877

Customer Service & Order Inquiry Line: (303) 278-8321

ORDER DEPARTMENT: COMPUTER-LINE, Inc. • 1019 8th Street • Golden, CO 80401
COMPUTER-LINE of Denver • 1136 So. Colorado Blvd. • Denver, CO 80222

TERMS: All prices reflect a 2.9% cash discount. All goods acknowledged faulty on receipt by the customer, will be repaired or replaced at our discretion. Customers must call for a RMA number before returning any goods. This facilitates our quick attendance to faulty goods. We reserve the right to repair or return to the manufacturer for repair all goods becoming faulty within the specified warranty period. Any goods (hardware or software) returned for restocking are subject to a 15% restocking fee at our discretion. The charge for cancellation of orders is 10%. No returns on software. We accept no responsibility for any false claims made by manufacturers. Prices quoted for stock on hand and subject to change without notice. Specialists in APO and international deliveries. Please add 2% (minimum \$3.00) for shipping APO and add to all prices 5% for shipping (minimum \$5.00). Please allow 10 working days plus mail time (if an order is mailed) in for receipt of all UPS delivered goods. All goods (other than APO or international) delivered UPS ground.

ALL BRANDS ARE REGISTERED TRADEMARKS

We have leasing terms available on all our equipment.

Look for our "Computer-Line" Stores opening throughout the U.S. Write for our Franchise Package.

Main/Frames

Main/Frames

from
\$200

- 30 Models of Enclosures
- Assembled and tested
- Quasi-Coax Motherboards
- Power Supply
- Card cage and guides
- Fan, line, cord, fuse, power & reset switches

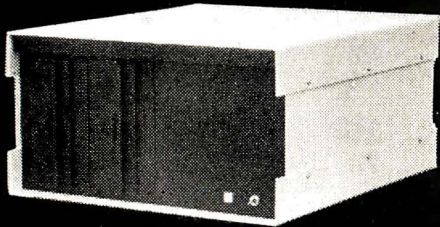

8" Floppy Main/Frame
\$482

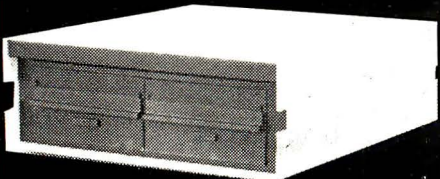

8" Disc Enclosure
\$250

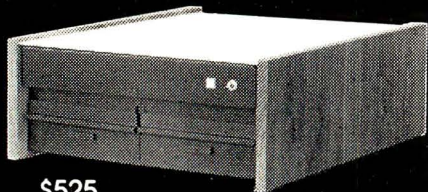

\$525
Phase/80 8" Floppy Mainframe



\$900

Phase/80 Desk + Mainframe

Write or call for our brochure which includes our application note: "Building Computers — A Recipe"

INTEGRAND

8620 Roosevelt Ave. • Visalia, CA 93291
209/651-1203

We accept BankAmericard/Visa and MasterCharge

a more substantial metaphor." His comments suggest that Microsoft conceives of the window on each application not just as a means of gaining access to data but also as a way to provide user aids uniquely suited to the particular application. The idea is to integrate the user interface as much as possible for different applications without sacrificing coherence or intuitive appeal.

Gates also argues that true concurrency is not really desirable. Instead of needing to run more than one application program on the same microprocessor at the same time, Gates says, users need to be able to switch rapidly from one application to the next. "You need interruptability," Gates says, "but not simultaneity." The argument is that timesharing a single microprocessor is less efficient than having the microprocessor run only one application program at a time and switch from one to the next quickly as the user requests. [In many cases, users would have trouble perceiving any difference between interruptability and simultaneity (concurrency).] Nevertheless, Microsoft's MS-DOS will support true concurrency in a future release.

Visi On from Visicorp: When Dave Clough, project manager at Visicorp, was asked how much memory a system would need to resolve the conflict between ease of use and added functionality, he said, "That conflict will never go away." Clough also said that when forced to choose between ease of use and additional functions, Visicorp would choose ease of use.

The prototype of Visi On shown at Comdex was a desktop manager that appeared to integrate substantial functionality and great ease of use. While the Visi On desktop manager lacks the Lisa's pictorial detail, it still allows the user to choose from items shown on the desktop by using a mouse to point at one item. The mouse used with Visi On has two buttons.

Visi On's windows let the user view different applications in progress simultaneously. Nine verbs will be common to all applications under Visi On, and other verbs are specific to each application.

The word processor shown with Visi On, presumably a relative of Visi Word, resembles Multiplan in that it enables the user to select a function by pointing at an item in a list. Visicorp has a whole new series of applications, not yet shown or described, that will run under Visi On.

Visi On will permit users to install applications modules as needed. If you need a database and a word processor but not a spreadsheet, you can buy only what you want. If your needs change, you can install an additional module yourself.

Visi On, described as an "operating environment," occupies an interesting territory between conventional operating systems and application programs. It runs on top of either CP/M-86 or MS-DOS and provides concurrency independently of the underlying operating system. Because Visicorp will make technical details about Visi On available to applications programmers, software written outside Visicorp should be available to run in the Visi On environment. Visi On will be portable to different machines, and different application programs can be written to be portable under Visi On.

Apple Computer's Lisa: It's easy to see that a company like Apple Computer Inc., which produces both its new Lisa computer and the Large-scale Integrated Software Architecture to run on it, has an advantage over software houses in producing new-generation software. (For full descriptions of Apple's Lisa and its software, see the February 1982 BYTE.) Apple can change the software and the hardware to suit each other. Knowing that Lisa will have a megabyte of memory has enabled Apple to succeed in a remarkably ambitious project. For combined integration of function and ease of use, Lisa is the leader by far. Lisa's drawback is its high price—not high in relation to function or value, but in absolute terms. While a toolkit will permit programmers to write application programs that run on the Lisa, the Lisa's software cannot be transferred to MS-DOS and CP/M-86 systems. Apple has plans to implement fuller database functions on the Lisa but ad-

The MultiMode Printer with The Magnificent Fonts



MultiMode Printer Offers Flexibility

. . . At a Sensible Price

"Flexibility" means instantaneous call up of any of this trend-setting machine's many features whether for *word processing*, *data processing*, *graphics* or *forms generation*. Using either of the two built in interfaces, an external keyboard or downloading from your computer, you can program the Qantex Model 7030 to do more.

The "Beautiful" Font

Compare the "Beauty" of our printed letters for the word processing fonts which include Cubic, Trend, Spokesman, Courier, Italics, Script, OCR-A, APL, Scientific plus *downloaded* fonts from your computer. Draft copy modes include 8 resident fonts — U.S., U.K., German, French, Spanish, Swedish, Finnish, Norwegian and Danish.

Other features include high resolution graphics — 144 x 144, single pass and double pass word processing, and 180 cps data processing modes and user defined formats.

Operator initiated, the MultiMode printer provides a complete printed status report of operating parameters and diagnostics.

For more information, or a demo, call us about the new Qantex Model 7030 MultiMode Printer.

 **north atlantic**
Qantex

60 Plant Avenue, Hauppauge, NY 11788
(516) 582-6060 (800) 645-5292

Circle 354 on Inquiry card.

D.E.C. LA120 ESCAP
A) PRINTER CHARACTER
B) ACTIVE POSITION
C) LINE FEED/NEW
D) HORIZONTAL
E) FORMS I.F.
F) VERT

mits that the present database manager is somewhat limited. For ease of use, however, Lisa's database manager is unrivaled.

Summing Up

Most of today's software falls far short of our hypothetical Be-All and End-All package. Such a large and friendly software package is likely to remain hypothetical for some time. But inexpensive memory and 16-bit processors may make many of today's hypotheses real surprisingly soon. For those who have spent years struggling to coordinate unrelated application programs in the past, any of the approaches to integrating software represents real progress and welcome relief.

As for deciding what software to buy now, the choice is difficult. The revolutionary graphics-based software has great appeal as long as it doesn't sacrifice one of the specific functions that you happen to need, decrease the operating speed of the program beyond your tolerance, or

increase the price of a system beyond your means. When specific products meet your needs, you will buy one of the new software packages whether it has been announced today or not.

If none of the revolutionary products meets your specific requirements in function, speed, and cost, you must choose between the separate-but-compatible approach to application software (as in Sorcim's Superware) and the all-in-one approach (as in Context Management's MBA). In making this choice, the most important factor will probably be whether the all-in-one program offers all the features and all the power that you happen to need. If you do buy separate application programs, the best course is probably to buy from one software house and hope for increased integration in subsequent releases. If an all-in-one program has almost but not quite everything you need, you might ask its publisher whether future versions will include what you need.

Advances in hardware technology

may hasten the triumph of the revolutionary software by reducing the price of very fast mass storage and thus reducing the penalty paid for using overlays and virtual memory. But no revolution is perfect or final or above criticism. A small skeptical voice inside me keeps raising three questions:

•Should all software be written so that it's easy for a novice to learn, or so that it is most useful and productive in the long term?

•Will the metaphor of the desktop remain a good one? It seems appropriate for the transition from paper work to computer work, but once we grow accustomed to working with computers, why should we want our computers to emulate desks?

•Can the mouse compete with the efficiency of programmed function keys in all fundamental operations like deleting characters? To delete characters with the Delete key, you just put the cursor on the characters to be deleted and press the key. Auto repeat makes swift deletion of more words and sentences easy: you just hold the Delete key and watch the cursor swallow the characters to its right. To delete characters with the mouse-driven systems that I have seen, you put the mouse's pointer on the character you want, press a button on the mouse to select the character, and press a button on the mouse to choose the verb Delete. That seems to add a step. Selecting larger blocks of text may require you to press more buttons (or the same button more times) on the mouse.

To date, ingenious software designers have debated these and the other issues of integrated and friendly software. All their conclusions remain as hypothetical as Be-All and End-All. Only the marketplace can say which hypotheses are true. The decision of the marketplace is uncertain because the people who will constitute most of the market have never touched a computer. Technology will determine how these people will first touch computers, but from then on they as new users will decide everything on non-technical grounds. ■

How to make dBase II™ work magic. It's a snap with Autocode™.

Finally, the first practical application of artificial intelligence in personal computer software. Autocode 1 is a powerful program generator for dBASE II. No prior knowledge of programming required.

AUTOCODE 1

- Automatic menus & sub menus
- Automatic data entry screens
- Automatic data entry routines
- String, numeric, date & calculated fields
- Automatic multiple reports
- Automatic programs in dBASE II code with interactive screens
- No prior knowledge of dBASE II required
- CP/M & MS DOS operating systems
- Handy pocket size manual
- Average learning time only 4 hours

ONLY \$200

STEMMOS LTD.

666 Howard Street, San Francisco, CA 94105

Just send the following to address above today.

- Your diskette format & hardware
- Your name & complete address
- How many Autocodes you want at \$200 each.
- A check or money order.

ORDER TOLL FREE 800-227-1617 (Ext. 417) IN CA CALL 800-772-3545 (Ext. 417)

Credit card buyers may substitute their card number and expiration date for the check. Or call us toll free and save the trip to the mail box



U.S. Address: 666 Howard St. San Francisco CA 94105 / U.K. Address: 344 Kensington High Street, London W14
Tel: (415) 777-3800 Dealer Inquiries invite Tel: 01 602 6242

dBASE II™ Ashton Tate

*In California add 6% sales tax.

Autocode 1™ Stemmoss Ltd.

INTRODUCING WORK SPACE



The new TEAC half height disk drive gives you everything you expect from a top quality disk drive, and one more thing, space. Now you can have up to 3.2 megabytes of floppy storage for the IBM PC without adding an expansion cabinet. Choose four 40 track double sided drives and get 1.2 Mb. Or four 80's for 3.2 Mb. Mix two 40's and two 80's for 2.2 Mb. The TEAC drives operate under PC DOS 1.1 (80 track drives come with JFORMAT, providing electronic disk, print spooling and ten sector formats). Now you can have both increased storage and space. The TEAC double sided 40 track and 80 track drives are priced at just \$299 and \$365 respectively.

Save on our line of other IBM compatible products.

DRIVES

- Single and Double sided 40 track drives. Fully supported by PC DOS version 1.1. Drives are easily installed in minutes. Tandon single sided (160K) — \$225, Double sided (320K) — \$299.
- Double sided 80 track (650K) Tandon drive. Available with JFORMAT for PC DOS 1.1 — \$435.
- 5 megabyte Winchester internal or external disk drive — \$1695.

BOARDS

- RAM Card — uses 64K dynamic RAM chips, with parity. 64K card — \$149, additional 64K increments (expandable up to 256K) available for \$79.
- Combo Card. Adds parallel printer, RS 232 async comm and clock calendar

functions. Uses only one slot — \$199. RS 232 Cable — \$24.95. Parallel Printer Cable — \$29.95.

- Clock Calendar Card. Features seconds, minutes, hours, day of week, date, month and year. Battery backup maintains time and date even when system is turned off — \$99.
- Prom Blaster. Programs most 4K to 64K bit 24 PIN EPROMs. Complete with personality modules and read/write software — \$129.
- Prototype Card. 3.5 by 8 inch wire-wrap area holds over 85-14 pin dips — \$29.95.
- 48K Additional Ram. 27 chips plug easily into master PC board — \$75.

HARDWARE

- 64K Byte Hardware Print Spoolers. Internal spooler comes with parallel printer adapter. External version connects easily between computer and printer. Both buffer 32 pages of print output and are user programmable — \$319.

SOFTWARE

- Home Finance. Easy to use checkbook

& budget manager — \$34.95.

- Apparat Game Diskette. Includes blackjack, othello, matches and spiralgraph — \$24.95.

MONITORS

- Your choice of high quality and reliable Amdek 12" green or amber screens. Choose the V300 G/A for the color graphics card priced at just \$170, or the V310 G for the monochrome card at just \$199. Both monitors are 18 Mhz BW and are anti-glare.
- Princeton graphics HX-12 RGB color monitor \$695. Other Amdek and NEC monitors also available at big savings. Call for prices.

PRINTERS

- A variety of the newest Epson, C. Itoh, Okidata and NEC printers available. Call for prices.

To order any of the above products, write Apparat, Inc., 4401 S. Tamarac Parkway, Denver, Colorado 80257, 303/741-1778. Or to speed up your order, call us toll free at

800/525-7674. 

 **Apparat, Inc.**

50 and 100 Years Ago in **BYTE**

Edited by Rich Malloy

As staff members of one of the world's oldest microcomputer magazines, we sometimes enjoy looking back at the interesting articles we've published in the past. For example, here are some items that appeared in our pages 50 and 100 years ago this month.

BYTE

APRIL, 1933: The International Business Machines Company of Elmira, New York, announced last month that, although it will continue to manufacture typewriters and adding machines, most of its resources will be devoted to the development and sale of fire alarm systems.

"We figure that the most important device in a business office is the fire alarm," said Thomas Watson, the president of the company. "After all, if there's a fire, who cares whether you have a typewriter or not. In fact, in future years, when you think of International Business Machines, the first thing that'll come to your mind will be fire alarms."

In a related item, film star Charlie Chaplin turned down a request by International Business Machines to appear in its promotional literature. "It's a great company," said the mustachioed comic, "but frankly the idea of having me promote business machines is one of the most ridiculous things I've ever heard."

* * *

Things continue to heat up in the adding-machine market. Following the introduction last year of the mini-adding machine, rumors have reached us that the Japanese are ready to market a "micro-adding machine." This new invention, said to employ VLSS (very large-scale smallness) technology, has an incredibly light weight of only 47 pounds. To combat the threat of this new small machine, American adding-machine manufacturers are said to be at work incorporating deluxe features into their new models. One rumor has it that work is almost complete on a machine that can multiply.

* * *

The Acme Calculating Company of Piscataway, New Jersey, has just announced a machine which it calls a "Disk Storage Device." The machine consists of a disk-drive mechanism called a "turntable" and a series of interchangeable data disks, or "records." The disk is read by placing it on a rotating platform located on top of the disk drive. A pin, called a stylus, is inserted into one of dozens of grooves etched on the disk. Under proper conditions, a voice-like sound can be heard. This voice can be used to encode all types of data and can even be used to portray music-like sounds.

The Acme Calculating Company will market the Disk Storage Device as part of an "Office System," which will include a typewriter, an adding machine, a typist, and someone to crank up the turntable. Also included will be software by Al Jolson and Rudy Vallee and His Connecticut Yankees.



APRIL, 1883: Professor Eaton Zweiback of Slippery Rock University recently announced the discovery of a new number system called the "Binary System." This system uses only two numerals, 0 and 1, as opposed to the decimal system which uses ten. Professor Zweiback claims that the binary system will have absolutely no practical value and will be used mostly as a mathematical novelty.

* * *

Harvard anthropologists have discovered the remains of an ancient Arabian city just 75 miles north of where ancient Babylon once stood. Little is known about the inhabitants of this city except for the fact that for some unknown reason they wrote the numeral zero with a slash through it. The anthropologists are completely puzzled as to why these people used such a strange symbol.

* * *

Agricultural experts have abandoned efforts to develop farm land in the valley south of San Francisco, California. The experts claim that is difficult to grow crops in the soil because there is too much silicon. There is so much silicon present that some residents of the valley have started gathering it together and melting it into "chips," which they then plan to dump somewhere near Boston, Massachusetts.

* * *

Missionaries near Peking have discovered a very small abacus, which the Chinese call "Mei Kro." This extremely small device, about the size of a postage stamp, is said to be extremely fast for computations. One of its drawbacks, however, is that the operator must use a pair of tweezers to manipulate the beads.

The UniFLEX™ Operating System extracts



every last drop

from the 8 bit 6809 microprocessor allowing it to outperform many 16 bit systems

With the UniFLEX™ Operating System, the 8 bit 6809 microprocessor can perform as well as larger CPUs in a multi-user, multi-tasking environment.

Independently developed from the ground up, UniFLEX™ closely models the features found in the UNIX™ Operating System. And in two years of use, UniFLEX™ has proven the abilities of the 6809 to perform large system functions when incorporated into a properly designed mainframe.

Some of the features supported include:

- full multi-user, multi-tasking capabilities
- hierarchical file systems
- device independent I/O
- four Gigabyte disk capacities
- full file protection
- inter-task communication via pipes
- I/O redirection
- task swapping for efficient memory usage
- full random-access files
- comprehensive shell command language
- foreground-background jobs
- electronic mail and printer spooling
- system accounting facilities

The support software currently available for use under UniFLEX™ is extensive.

A sampling of the programs available includes:

- native C compiler (full implementation)
- native Pascal compiler
- FORTRAN 77 ANSI Subset compiler
- COBOL compiler with ISAM files, Report Writer & Sort/Merge
- Extended BASIC interpreter
- Extended BASIC precompiler
- text editing and processing software
- enhanced printer spooler
- variety of absolute and relocatable assemblers
- debug and diagnostic packages

Technical Systems Consultants, Inc. also offers a line of single user FLEX™ software products for 6800 and 6809 processors. For those having an absolute need for a 16 bit processor, UniFLEX™ will be available through OEM licensing arrangements for the 68000 microprocessor. Please call or write for additional information on individual products or OEM licensing arrangements.

UNIX™ is a trademark of Bell Laboratories.
FLEX™ and UniFLEX™ are trademarks of Technical Systems Consultants, Inc.

 technical systems
consultants, inc.

111 Providence Road
Chapel Hill, North Carolina 27514
(919) 493-1451

The Enhanced VIC-20

Part 3: Interfacing an MX-80 Printer

Joel Swank
12550 SW Colony #3
Beaverton, OR 97005

To do any serious programming with the Commodore VIC-20, you need a printer. Commodore markets two that plug directly into the VIC serial port: the VIC-1515 and the VIC-1525 graphics printers. Both form characters with a 6 by 7 dot matrix and operate at 30 characters per second.

For most uses these printers are satisfactory. But if you look closely at a VIC character on the screen, you can see that it is composed of an 8 by 8 matrix of dots. Neither Commodore printer can print true VIC characters or graphics. And because the VIC has only a serial printer port that uses a DIN (Deutsche Industrie Norm) connector, you can't interface printers that have standard Centronics-style parallel ports with the VIC.

This article will show you how to select an alternative printer for use with the VIC and how to interface it with the computer to get true VIC characters and graphics.

Selecting a Printer

The first consideration is which printer to buy. A large number of low-cost dot-matrix printers offering a wide range of features and capabilities are now available. Two features in particular are necessary to adapt the printer to the VIC. First, the printer must have graphics capability so that the VIC character patterns can be formed in memory and then sent to the printer. Second, the printer

must have 8 or more wires in its print head if it is to print the VIC's 8 by 8 characters efficiently.

Many printers use a 7-wire print head and normally print a character that is only 7 dots high. These printers can print only 7 dots vertically on each pass of the print head across the paper. Because the VIC character is 8 dots high, the print head would have to make two complete passes to print the entire VIC character, slowing the effective printing speed by one-half. Making two passes can also distort the VIC character because horizontal alignment is not always perfect on some printers.

The Epson MX-80 is one of the more popular printers. It has a 9-wire print head, and with the Graftrax option, it can do graphics. The MX-80 also offers italics, several print sizes, and proportionally spaced characters. To give you an idea of some of its features, I have included a summary of its escape sequences and control codes in table 1. These are the commands that the computer uses to tell the printer the desired print format. The MX-80 meets the requirements for use with the VIC and is moderately priced.

Interfacing the Printer

The next consideration is how to connect the printer to the VIC. The most obvious way is through the user I/O (input/output) port, which is the opening at the left rear of the VIC case. The logic assignments of each pin on this port are given in table 2 (see figure 1 on page 288 for user port I/O connections). Some of the pins are already assigned to other uses, but a full 8-bit parallel I/O port that is capable of driving a printer does exist. This is actually the B port of a 6522 VIA (versatile interface

Editor's Note: *The VIC-20 is one of the new breed of low-cost computers that offer a surprising amount of computing power for the money. But its low cost also means that it lacks some of the features we've come to take for granted. In this series of articles, author Joel Swank will "enhance" the VIC-20 and in so doing increase the utility of this very interesting computer. . . S. J. W.*

Lycy Computer Marketing & Consultants

TO ORDER
CALL US

TOLL FREE 800-233-8760
In PA 1-717-398-4079

FREE

DUST COVER
with Purchase of

ATARI 800 48K \$489.00

ATARI 400 64K \$349.00

810 DISK DRIVE.....\$419.00

ATARI 1200 64K RAM... \$CALL \$

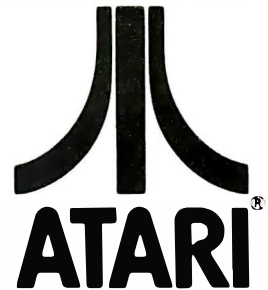

A Warner Communications Company

ATARI HARDWARE

810 DISK DRIVE.....\$419.00
410 RECORDER\$75.00
1010 RECORDER.....\$75.00
850 INTERFACE.....\$164.00

PACKAGES

CX482 EDUCATOR\$119.00
CX 483 PROGRAMMER.....\$54.00
CX488 COMMUNICATOR\$219.00
CX419 BOOKEEPER\$189.00
KX7104 ENTERTAINER\$69.00

NEW RELEASES

400 KEYBOARD.....\$99.00
MINER 2049er.....\$32.75
FROGGER.....\$25.75
PREPIE\$19.75
SEA DRAGON\$24.75
STRATOS\$24.75
DISKY\$39.95
MONKEY WRENCH 2.....\$52.75

MONITORS

NEC JB1260\$125.00
NEC JB1201\$155.00
NEC TC1201\$315.00
AMDEK 300G\$159.00
AMDEK COLOR I.....\$329.00

MODEMS

ANCHOR MARK I\$79.00
ANCHOR MARK II.....\$79.00
HAYES SMART\$239.00
HAYES MICRO II\$309.00
CAT\$144.00
J-CAT\$CALL \$

PERCOM DISK DRIVES

SINGLE DRIVE AT88.....\$389.00
ADD ON.....\$289.00
SINGLE DRIVE 40S1\$529.00
ADD ON.....\$329.00
DUAL DRIVE 40S2\$845.00
DUAL HEAD SINGLE DRIVE 44S1 ...\$649.00
DUAL HEAD DUAL DRIVE 44S2\$789.00

SAVE on these in-stock PRINTERS

PROWRITER.....\$375.00

NEC 8023A.....\$439.00

SMITH CORONA TP1 ...\$569.00

STARWRITER.....\$1475.00
PRINTMASTER.....\$1675.00

OKIDATA B2A\$419.00
OKIDATA B3A\$639.00
OKIDATA B4\$1029.00
OKIDATA TRACTOR.....\$63.00

PRINTER CABLES for Atari

CITOH\$35.00
EPSON\$35.00
NEC\$35.00
OKIDATA\$35.00
SMITH CORONA\$35.00

DISKETTES : In Stock

BASF\$19.00
ELEPHANT.....\$21.00
MAXELL MDI.....\$34.00
MAXELL MDII.....\$44.00

BUSINESS SOFTWARE

VISICALC\$159.75
LETTER PERFECT.....\$115.75
LETTER PERFECT ...ROM ...\$159.75
DATA PERFECT.....\$75.75
TEXT WIZZARD.....\$79.75
SPELL WIZZARD\$64.75
FILE MANAGER 800\$69.75
ATARI WORD PRO.....\$109.75



POLICY
DURING APRIL



In-Stock items shipped within 24 hours of order. Personal checks require four weeks clearance before shipping. No deposit for COD orders. PA residents add sales tax. All products subject to availability and price change. Advertised prices show 4% discount offered for cash. Add 4% for Mastercard and Visa.

TO ORDER
CALL TOLL FREE
800-233-8760
In PA 1-717-398-4079
or send order to
Lycy Computer
P.O. Box 5088
Jersey Shore, PA 17740

Plot your next meeting yourself.

Read how 2 pens can become your best presentation tools.

Introducing the New Personal Computer Plotter from Hewlett-Packard.

Now you can use your personal computer to generate your own presentation charts, graphs, and pie charts. How? Simply add on the new high quality, low cost HP 7470A Personal Computer Plotter.

The 7470A helps you save time and save money, and lets you communicate quickly, accurately and *effectively*.

Quicker understanding.

Data, when visualized graphically, becomes information fast. Charts and bar graphs can make any presentation clearer and more readily understood. But asking your staff to produce the graphics manually for your next presentation doesn't ensure accuracy or artistic talent. And going to outside graphics suppliers can be costly. Combined with your personal computer, the new HP 7470A plotter does the communicating for you. Quickly. Logically. And with off-the-shelf software available from most HP dealers.

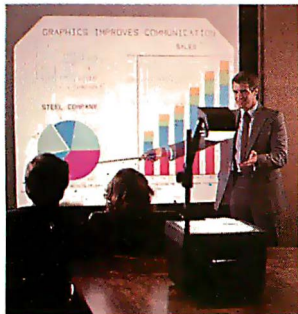

Fast and pretty.

The 7470A gives you high plotting speed with excellent line quality...faster than any competitive small plotter. On top of all that, it comes in an attractive design package that looks nice on your desk. And it does it for only \$1,575. (U.S.A. domestic suggested retail price.)

Count on it.

The 7470A is built the Hewlett-Packard way. To last. Designed and engineered with only a few parts, none of which require adjustment. And with customized integrated circuits that ensure reliability.

Pen pals.

The HP 7470A has two single-pen stables. Simple pen changes give you multi-color plots in your choice of ten coordinated colors. Pens are automatically capped and stored.

An option you'll want, too.

For only \$95, you can also get a 17057 Overhead Transparency Kit that turns your plots into transparencies for overhead projectors. For "I need it tomorrow at 9:00 A.M.!" meetings, it's a necessity.

Start plotting your next presentation today. Clip and mail the coupon below. Now.

Mail the coupon below and we'll send you—absolutely free—a sample plot, a more detailed brochure, and a sample overhead transparency.

Then...stop in at your nearest Hewlett-Packard Dealer. See the HP 7470A in action. Once you see it demonstrated you'll find a hundred ways to make your own applause-winning presentations.

When performance must be measured by results



Seeing is believing. Send me a sample plot, an overhead transparency, and more detailed information.

Name _____ Title _____

Company _____

Address _____

City, State & Zip _____

Phone Number () _____

Send to: Hewlett-Packard, 16399 W. Bernardo Drive, San Diego, CA 92127 — Attn: Nancy Carter

11203 BT4

VIC to Epson Connections

VIC Via Pin #	VIC User Port	Signal	Epson 36-Pin Connector
	A	GND	19
CB1	B	Acknowledge	10
PB0	C	D0	2
PB1	D	D1	3
PB2	E	D2	4
PB3	F	D3	5
PB4	H	D4	6
PB5	J	D5	7
PB6	K	D6	8
PB7	L	D7	9
CB2	M	Data Strobe	1

Table 3: VIC-20 to Epson MX-80 connections. This illustrates the output pins from the VIC versatile interface adapter (VIA) chip, the connections from the VIC user port, the signals involved, and the corresponding pins on the MX-80.

6522 VIA. Table 3 shows the physical connections you need to connect the MX-80 to the VIC via the user port. Eleven wires must go from the VIC to the printer; one to ground it, 8 for the 8 bits of data, and 2 for handshaking. Handshaking lines are used to keep the printer and the VIC synchronized. The VIC uses the DATA STROBE line to tell the printer when a character is ready. The printer uses the ACKNOWLEDGE line to tell the VIC when it has accepted the character. The 6522 VIA, when used in the handshake output mode, takes care of these signals.

The least expensive way to connect the VIC and the MX-80 is with a ribbon cable. To do so, keep the length of the wire as short as possible. I have used an 8-foot cable with no problems. The VIC end of the cable must be a 24-pin card-edge connector that has contacts on 0.156-inch centers. The MX-80 end must be a 36-pin Centronics-style male printer connector. I have a standard printer cable with a male connector on each end. To use this cable, I wired a short ribbon cable from the VIC connector to a female 36-pin connector. My VIC can now be connected to the standard printer cable. These connectors are available at many electronics stores and from mail-order companies.

The interface as shown in table 3 does not take full advantage of all of the features of the MX-80. Seven other signals on its connector are not used. These provide, among other things, an out-of-paper signal and a busy

adapter) chip, a very powerful I/O device that is used on many computers that have the 6502 microprocessor. The VIC programmer's reference manual gives a complete description of it starting on page 229.

Most printers, including the MX-80, come equipped with an "industry-standard parallel interface." This interface is not actually a standard, but all versions are similar, and all of those I've seen can be driven with a

General Software

Mailing Address:
1454 S. 25th St.
Terre Haute, IN 47803
WE HONOR
VISA and MASTERCHARGE

TOLL FREE - Outside Indiana
ORDER DESKS ONLY
1-800-457-0517
For Information or Questions
(812) 234-9421
Not to be confused
with Software General

Outside US add \$10 plus Air Parcel Postage. Add \$3.50 postage and handling per each item. Indiana residents add 5% sales tax. Allow 2 weeks on checks. COD add \$3.00 per item. Prices subject to change without notice. All items subject to availability.

Disk with Manual	Manual Only
ARTIFICIAL INTELLIGENCE	
Dental (PAS-3)	\$775
Medical (PAS-3)	\$849/40
Programmable	\$875
ASHTON-TATE	
*dBASEII	\$525
BALCONES	
The BossFin. Acc. System	\$1750
BYROM SOFTWARE	
*BSTAM	\$149
*BSTMS	\$149
CAXTON	
Carbox	\$225
COMPUTER CONTROL	
*Fabs (B-Tree)	\$140/35
Ultrasoft	\$140/35

CONDOR COMPUTER	
Condor I	\$255/50
Condor II	\$515/55
Condor III	\$795/55
DIGITAL RESEARCH	
CP/M	
2.2 Intel MDS-800	\$149
Northstar (Horizon)	\$149
Micropolis	\$169
TRS Model II	\$159
CB-80	\$429/45
PL-1-80	\$429/50
CBasic2	\$ 98
BT-80	\$190
8" only	
RMAC, Linkib, XREF	\$190
Display Manager	\$350
Access Manager	\$279
DJR ASSOCIATES, IWC	
FMS80	\$775
FMS 80-1	\$400
FMS 80-2	\$400
ECOSOFT	
Microstat	\$275
EPIC COMPUTER	
*Super vyz	\$115/25
FAIRCUM	
*Micro B+	
(Specify language)	\$229/30
FINANCIAL PLANNING	
*Mini Model	\$429/50
FOX & GELLER ASSOCIATES, INC.	
Quickscreen	\$140
Quickcode	\$225
FRONTIER SOFTWARE	
Professional	
Time Accounting	\$499/50
General Subroutine	\$269/50
Application Utilities	\$439/50
FYI, INC.	
Superfile	\$155
PASCAL LANGUAGE	
Pascal Z	\$349/40
Pascal MT + V.5.5	\$429/40
Compiler	\$316/25
SPP Only	\$165/15
KEY BITS	
Wordsearch	\$179/50
String 80	\$ 84
String 80 (Source)	\$279
LEXISOFT	
*Spellbinder	\$349/55
MARK OF THE UNICORN	

Final Word	\$255
MICRO AP	
Selector IV	\$249
Selector V	\$449/50
MICRO TAX	
*Level I	\$195
*Level II	\$995
*Level III	\$995
Microsoft 5.3	49
Run time module	
MICROSOFT	
Basic-80	\$279
Basic Compiler	\$319
Fortran-80	\$379
Cobol-80	\$579
M-Sort	\$180
Macro-80	\$154
MuSimp/muMath	\$224
MuLisp-80	\$174
Multiplan	\$245
NORTHWEST ANALYTICAL	
*Statpak	\$409/45
OASIS	
*"The Word"	\$ 75
The Word Plus	\$140
PEACHTREE® SOFTWARE	
General Ledger	\$399
Accounts Receivable	\$399
Accounts Payable	\$399
Inventory	399
Mailing Address	\$399
for PB Version	add \$119
Series 6-Peachtree	
CPA	\$799
Passive Payroll	\$449
Series 7-Peachtree	
Sales Tracker	\$3049
AR-SalesAnalysis	\$1299
Inventory	\$799
Order Entry	\$699
REDDING GROUP	
*Lynx	\$199
RYAN-McFARLAND CO.	
RM/Cobol	\$650
SORCIM	
*Pascal/M Z80	\$349/40
Pascal/M 86/88	\$449/40
*Act 65, 68, 69, 86, 88	\$149
*Trans 86	\$119/25

*Supercalc	\$229
SOUTHERN COMPUTERS	
Call for our unbeatably low prices.	
STRUCTURED SYSTEMS GROUP	
GL, AR, AP, PR, OE	\$849/50
SUPERSOFT	
*Diagnostic II	\$ 84/20
*Forth	\$149/30
*SSS Fortran	\$219/30
*Fortran w/RATFOR	\$289/35
*C Compiler	\$175/20
*Tiny Pascal	\$ 80/25
*Disk Doctor	\$ 84/20
*Term I	\$129/25
Term II	\$169/25
Scratch Pad	\$210
Dataview	\$165
Stats Graph	\$165
Combination of above 3	\$495
Z8000 Kassemler	\$449/35
WHITESMITHS	
C Compiler	\$700/40
Pascal (incl C)	\$900/45
IBM PERSONAL COMPUTER	
Wordstar 3.2	\$295/60
Mailmerge	\$150/25
Supercalc	\$229/NA
Visicalc (256K)	\$229/NA
Optimizer	\$200/NA
Supersoft C - CP/M86	\$500/NA
Peachtree 3 Pak GL, AP, AR	\$595
Final Word	\$265
Condor I, II, III	CALL
Statpak	\$439
BSTAM	\$149
Move-It	\$129
Easy Writer II	\$315
Easy Speller	\$155
Easy Filer (dBase mgr.)	\$335
Spellbinder	\$355/49
Concurrent CPM 86	\$335
Pascal MT & 86	\$360
SPP 86	\$180
AM Cobol	\$800
APPLE II DOS	
Word Handler II	\$155
Listhandler	\$ 85
Broderbund Software	
General Ledger (w/ A/P)	\$435
Payroll	\$325
Professional Easywriter	\$155

* Available for Apple with Softcard

\$3,995

You can't buy an S-100 hard disk system for less.

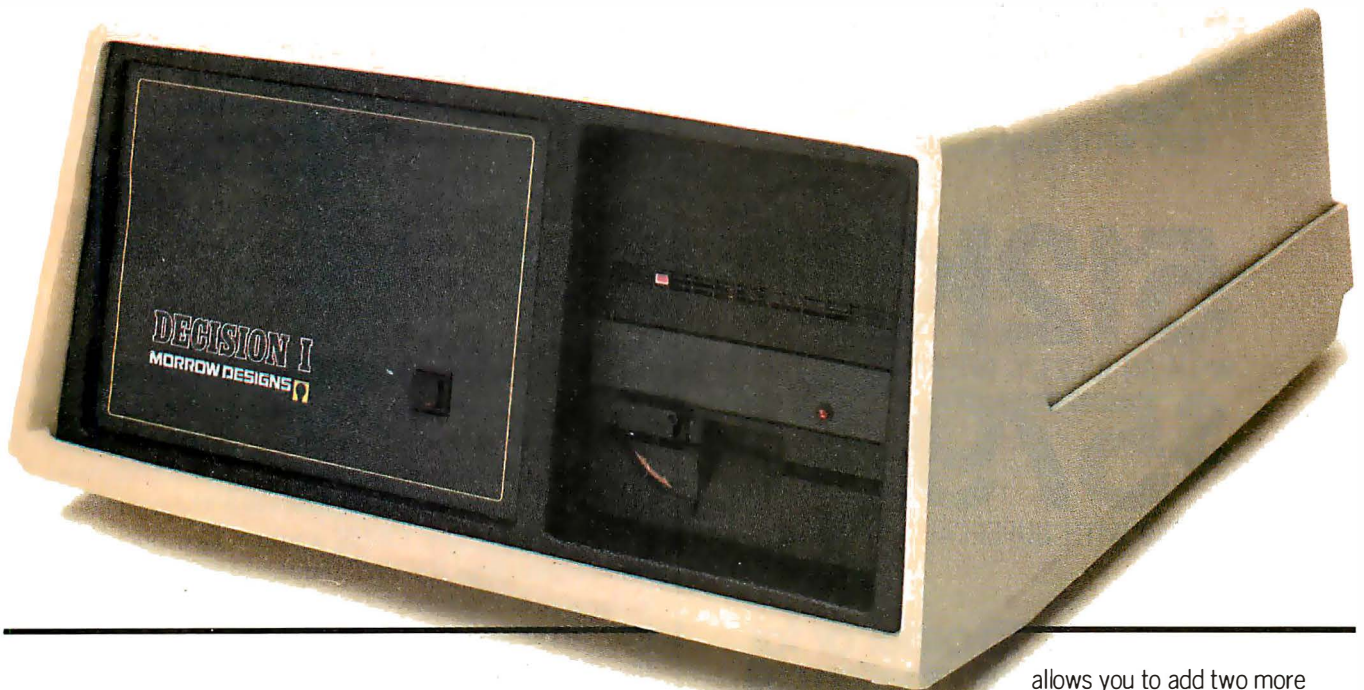

5 MEGABYTES.

\$3,995

That's the full price for the complete Decision I™ computer. Including an S-100, (IEEE-696) 14-slot motherboard, 64K of RAM, DMA floppy and hard disk controllers, a 5 Megabyte hard disk, a 200K floppy disk drive, one parallel and three serial ports. Plus, CP/M® 2.2 and Microsoft® BASIC-80.

5 MEGABYTES, PLUS.

\$4,400

For another \$405, you double your floppy capacity to 400K. And, you get over \$1,200 worth of applications software: WordStar®, Correct-It™ spelling checker, the LogiCalc™ spreadsheet, and the Personal PEARL™ relational data base manager.

NOW, MULTI-USER. For an additional \$1,995, you get a package that

allows you to add two more users to your system. Which makes the Decision I the lowest priced multi-user, multi-tasking system you can buy. The package adds an additional 192K of RAM, plus Micronix™, Morrow's UNIX™-like operating system. The OS includes a CP/M emulator which allows you to use CP/M software in a multi-user environment.

BUY IT YOUR WAY. Single-user or multi-user/multi-tasking. Or, buy a single user system now and expand it later. No matter how you buy it, you can't buy more performance for less.

MORROW DESIGNS

MORROW DESIGNS □ 600 McCormick St. □ San Leandro, CA 94577 □ (415) 430-1970

WordStar is a registered trademark of MicroPro, Inc., CP/M is a registered trademark of Digital Research, Inc. Decision I, Micronix, and Correct-It, are trademarks of Morrow Designs

Personal PEARL is a trademark of Relational Systems, Inc. UNIX is a trademark of Bell Laboratories, Inc. LogiCalc is a trademark of Software Products International Microsoft is a registered trademark of Microsoft Corporation

You'll never have a better reason
to begin shopping by mail:

IBM RAM BOARDS

256K
WITH AN RS-232C INTERFACE
\$349
\$529 WITH SUPERCALC

512K
WITH AN RS-232C INTERFACE
\$579
\$749 WITH SUPERCALC

Our fully-populated memory boards include parity checking and a standard RS-232C interface. They are compatible with all IBM software.

This is a rare opportunity to save a great deal of money without sacrificing quality. These boards meet the highest standards of design, materials and manufacturing available — at any price. They are completely guaranteed for two years.

**Alpha
Byte**
COMPUTER
PRODUCTS

31245 LA BAYA DRIVE
WESTLAKE VILLAGE, CA 91362

**To order or for
information call**

In New York:
(212) 509-1923

In Los Angeles:
(213) 706-0333

In Dallas:
(214) 744-4251

By Modem:
(213) 991-1604

CALL OUR MODEM LINE
FOR WEEKLY SPECIALS.

VICEPS Commands and Open Options

SYS(7168)	OPEN printer for graphic output of VIC characters. Select the following options before calling:
POKE 780,1	Select 8 lines per inch (LPI).
POKE 780,2	Select graphic LPI (no space between lines).
POKE 780, (anything else)	Select 6 LPI.
POKE 781,1	Select double horizontal density. Uses 960 graphics mode. Slows printer 1/16 ASCII mode. Good for work to be photocopied.
POKE 781, (anything else)	Select single density. Uses 480 mode graphics. Slows printer 1/4 over ASCII mode.
SYS(7188)	OPEN printer for ASCII output. All printer escape sequences and control codes are under user control. Some standard VIC characters are also Epson control codes.
SYS(7202)	CLOSE the printer and restore the output vector. If in graphics mode the end of the last line must be sent to the printer.

Table 4: VICEPS program commands. The SYS commands open and close the VIC user port for output to the printer. The POKE commands select various printer options.

signal. You don't need to use these signals to get the MX-80 to work. Because the VIC has no more user I/O pins available, the extra signals are ignored.

Software Interface

Listing 1 is the VICEPS program, which allows the VIC to communicate with the MX-80. Written in 6502 assembly language, it occupies about 400 bytes of memory. It is accessed with a BASIC SYS command. To use the program, you must first enter the command SYS (7168) to start the OPEN routine (see line 36). This routine initializes the VIA and the printer and inserts the address of the printer output routine into the VIC's display vector as well. The display vector is the pointer to the VIC's program to display a character on the screen. All screen output comes through this vector. It was provided by the designers of the VIC for just such an application as this. After the initialization routine has been started, all characters that are displayed on the screen will also be sent to the printer.

Before entering the SYS command you can also give some information to the OPEN routine. This information is passed via the SYS register area at memory locations 780 and 781. Table 4 lists a summary of the VICEPS program options. Location 780 is used to select the vertical print density—how much space is left between lines of print. Entering 1 into location 780 produces a vertical density of 8 lines per inch (LPI). This leaves one blank row of dots between lines. Entering a 2 into location 780 results in graphic density. This leaves no space between lines so that graphic characters will connect, as they do on the VIC screen. Entering any other number into location 780 produces the default print density of 6 LPI, which makes for the most readable program listings and text.

Text continued on page 280

We accept VISA, MasterCard or C.O.D. (add \$3 for C.O.D.). Add a \$3 shipping charge to prepaid orders; actual shipping charges will be added to non-prepays. California residents, add appropriate sales tax.

Circle 20 on Inquiry card.



Oryx systems

QUALITY DISCOUNTS

for a complete selection of microcomputer hardware, software and accessories.

Apple/Franklin

Hayes Smartmodem, Serial Card, Dow Jones Analyzer — or — Micromodem & Dow Jones Analyzer
Reg. 779 NOW \$ 619

BRODERBUND

ApplePanic \$ 25
Chopflifter 26
Serpentine 26

CONTINENTAL SOFTWARE

Home Accountant . . . \$ 58

CHARLES MANN

Basic Teacher \$ 30
Teacher Plus 32
Medical II 879

CDEX

*Visicalc Training . . . \$ 45

DENVER SOFTWARE

*Easy (Exec. Att'g) . . . \$ 535
Financial Partner . . . 188
Pascal Tutor 97
Pascal Programmer . . 220

HOWARD SOFTWARE

Real Estate Analyzer . . \$ 145
Tax Preparer '83 175
Tax Preparer state:
CA, NY, NJ, IL . . . \$Call

KRELL CO. Logo \$ 75

LINK SYSTEMS

Datafax \$ 159
DataLink 79

MICROPRO

Wordstar (Reg. CP/M) . . \$ 295
Mailmerge 149
CalcStar 99
SpellStar 149
SuperSort 149
Data Pak (Special) . . . 480

MICROSOFT

Basic Compiler \$ 295
Cobol-80 550
Fortran-80 155
Time Manager 125
TASC Compiler 135
A.L.D.S. 99
Multiplan (DOS) 215

OMEGA

Locksmith \$ 79
Inspector 47
Watson 44

PEACHTREE

Peackpak 40 G/L + A/R + A/P (Special) . . . \$ 359
Series 40
G/L, A/R, A/P ea. . . . 225
Inventory 225
Series 9

Peachcalc 279
Telecommunications . . 279

PENGUIN SOFTWARE

Complete Graphics . . \$ 57
Graphics Magician . . . 48

TERRAPIN Logo \$ 135

VISICORP

Visicalc \$ 185
Visischedule 219

GAMES

HaydenSargon II \$ 25
Infocom Zork I, II or III . 35
Infocom Deadline . . . 42
L & S Crossword Magic . 38
Sirtech Wizardry 39
Sirtech Night of Diamonds 29
Ultima II 47

MISC.

ISM Mathemagic \$ 80
ISA Spellguard 199
LJK Edit 6502 82
On-Line Screen Writer II . 95
PFS: Filing, Report or Graph 112

CP/M

ASHTON-TATE

*dBase II \$ 450

COMPUVIEW

V-Edit 8080Z80, IBM PC \$130
V-Edit CP/M86, MS DOS 165

DIGITAL RESEARCH

Pascal Mt + W/SSP . . . \$ 389
MAC 85
SID (8080 Debugger) . . . 65
ZSID (Z80 Debugger) . . . 90
CP/M 2.2 - DD 170
C Basic 2 97
PU1-80 439

FOX AND GELLER

Quick Screen \$ 125
Quick Code 237
D-Util 89

MARK OF UNICORN

*Final Word \$ 245

MICROPRO

*WordStar (Special) . . . \$ 250
*MailMerge 149
*CalcStar 99
*SpellStar 149
*SuperSort I 99
*InfoStar 250
3-Pack 399
Wordstar/Mailmerge . . 299

MICROSOFT

Basic 80 \$ 275
Basic Compiler 289
Fortran 80 345

Cobol 80 550
Macro80 150
MuMath/MuSimp 199
Multiplan 215

OASIS

*The Word Plus \$ 120
*Punctuation and Style . 99

PEACHTREE

*Peackpak 4 (G/L, A/R, AP) (Special) \$ 359
General Ledger Series 4 . 399
Accounts Receivable Series 4 399
Accounts Payable Series 4 399
Inventory Series 4 399
CPA Client Write-up . . . 799
Series 8 Modules each . 485
Peachtext 350

PROTEM SOFTWARE

*Footnote \$ 105

SORCIM

Supercalc \$ 225
Trans 86 115
Act 155

STAR COMPUTER SYSTEM

G/L, A/R, A/P or Pay . . \$ 350
Legal Time, Billing . . . 845
Property Management . . 845

SUPERSOFT

Diagnostic II \$ 83
Disk Doctor 78
Fortran 4 299
Basic-8086 225
Lisp 120
Z8000 Assembler 400
C Cross Assembler . . . 400
Fortran 8086 340
*ScratchPad 219

GAMES

Infocom Zork I, II or III . \$ 35
Deadline 42
Supersoft Nemesis . . . 37
Dungeon Master 34
Analyze II 39

IBM PC

*Please see CP/M listing for products with a "****". All programs with a "*" will run on PC DOS.

Peackpak 4 \$ 359
IUS EasiWriter II 299
IUS EasiSpeller 149
IUS Accounting Module . 460
Alpha DataBase Manager 190
Alpha Mailing List 85
Data Most Write-on . . . 110

Woolf Move It 125
ISA Spellguard 247
Lifetree Volkswriter . . . 145
Special Peackpak (GL, AR & AP) 359
Ecosoft Microstat 257
Northwest Statpak 397
Howard Software Tax Preparer '83 195
Organic Software Milestone 269
Datebook II 269
*Microstuf Crosstalk . . 139
Copy II Plus 32

GAMES

Temple of Apshai 33
Galaxy 22
Midway Campaign 20
Frogger 30

Accessories/Hardware

BOARDS

APPLE/FRANKLIN

CoProcessors 88 card . \$ 795
Softcard (Z80 CP/M) . . . 245
Applescope (your Apple as an Oscilloscope) . . 595
Videx 80 Col. Board . . . 247
Microsoft Premium Pak . 599
Videx Enhancer I 149
K & D Enhancer 115
ALS Smarterm 379
ALS Z-card 269
Versacard 160
Bit 3 Dual Comm-plus . . 209
16K RAM WIZARD 79
Microsoft 16K RAM . . . 89
Echo II Speech Synthesizer 159

IBM PC

BYAD DS-1 (64K, Z80, CP/M) . . \$ 599
Datamac 64K 399
Zedex Baby Blue 495
Quadram Quad Board . . 445
Quadram 128K Ram . . . 495
AST Combo + 64K w/Par. Port 350
Hercules Graphics Board 555
Orchid Monochrome Graphic Adptr 432
QuCeS Big Blue 499
Vista Maxicard 64K . . . 325

MISCELLANEOUS

Percom Doubler II . . . \$ 167
Symtec Light Pen (IBM PC) 140
Symtec Light Pen (AP II/III) 200

Microfazer BK Printer Buffer 135
Maynard Floppy Drive Controller w/Par. Port (ICMPC) 229

PROMETHEUS

Apple Surance \$ 120

COMPUTERS

Franklin/Televideo Nec/Xerox — Call for Price Information

MONITORS & TERMINALS

Amdek Video 300 \$ 160
Amdek RGB Color 699
NEC 12" Hires Green . . 159
Sanyo 12" Hires Green . 199
USI Hi-RLS 12" Amber . 199
Zenith ZVM 12" Green . 115
PGS RGB Color 599

MODEMS

Novation Apple-Cat II . \$ 269
Novation 212 Auto Cat . 585
Hayes Smartmodem . . . 225
Hayes Smart Modem 1200 520
Micromodem II 319
Hayes Chronograph . . 189
US Robotics: Auto-Dial (Full Auto300/1200) 459
Auto-Line (Auto Answer300/1000) . . . 399

PRINTERS

Epson FX-80 \$ 650
C. Itoh Starwriter 1450
C. Itoh Prowriter 485
Generic Prowriter 425
NEC 3530 1850
NEC 8123A 489
Okidata Microline 82A . 460
Okidata Microline 83A . 685
Prism 80 (w/4 options) color 1399
Prism 132 (w/4 options) 1547
Smith-Corona TP-1 . . . 625

DISK DRIVES

Rana Elite I (AP II) (Special) \$ 299
Rana Elite II 420
Rana Elite III 550
Rana Controller (AP II) . 90
Micro Sci A35 (AP II) . . 399
Tandon 100-2 280

... and many more!

ORDER TOLL FREE - Outside WI - 1-800-826-1589

Please: • Wisconsin residents — add 5% for sales tax.
• Add \$3.50 for shipping per software and small items. Call regarding others.
• Foreign — add 15% handling & shipping for small items & software.
• Prices subject to change

We welcome: • Visa, Mastercharge — (Add 4%)
• Checks (Allow 1-2 weeks for clearing)
• COD (Add \$1.50 per shipment)

Working Hours: Mon.-Th. 8:30 - 5:30 • Fri. 8:30 - 6:30 • Sat. 10:00 - 2:00
For technical information & in Wisconsin: 715-848-2322
Store prices differ from mail order.

Oryx Software • 205 Scott St. • P.O. Box 1961 • Wausau, WI 54401



Listing 1: The VICEPS program is a software interface between the VIC-20 and the MX-80. It controls output to the printer.

```

LINE#  LOC   CODE   LINE
0001  0000      :   VICEPS : VIC-20 INTERFACE TO THE EPSON MX-80 PRINTER
0002  0000      :           VIA THE VIC PARALLEL USER PORT
0003  0000      :           THE EPSON MUST HAVE GRAFTRAX
0004  0000      :   ZERO PAGE LOACTIONS
0005  0000      RUSMOD =#C7      : REVERSE MODE FLAG
0006  0000      QUOTMO =#D4      : QUOTE MODE FLAG
0007  0000      VICPAT =#FB      : TEMPORARY ZERO PAGE POINTER
0008  0000      :   VIC PIA LOCATIONS
0009  0000      IORB1  =#9110    : I/O REG B
0010  0000      DORB1  =#9112    : DATA DIRECTION REG B
0011  0000      PCR1   =#911C    : PERIPHERAL CONTROL REG
0012  0000      IFR1   =#911D    : INTERRUPT FLAG REG
0013  0000      IER1   =#911E    : INTERRUPT ENABLE REG
0014  0000      :   TV CONTROLLER LOCATIONS
0015  0000      TVCTL5 =#9005    : CHARACTER SET/SCREEN BUFFER PORT
0016  0000      :   VIC SUBROUTINES
0017  0000      VICOUT =#F27A    : ROUTINE TO SEND CHAR TO SCREEN
0018  0000      :   VIC RAM
0019  0000      SYSA   =#30C     : A REG STORAGE FOR SYS COMMAND
0020  0000      SYSX   =#30C     : X REG STORAGE FOR SYS COMMAND
0021  0000      DISVEC =#32E     : VECTOR TO SCREEN DISPLAY ROUTINE
0022  0000      :   EQUATES
0023  0000      CR     =#0D     : RETURN CHAR
0024  0000      INSDel =#14     : INSERT-DELETE CHARACTER
0025  0000      ESC    =#1B     : ESCAPE CHARACTER
0026  0000      LF     =#A     : LINE FEED CHARACTER
0027  0000      LINLIM =#60     : MAX CHARACTERS PER LINE
0028  0000      LPIGRF =#8      : PRINTER GRAFIC DENSITY CODE
0029  0000      LPI8   =#9      : 8 LINES PER INCH CODE
0030  0000      LPI6   =#12     : 6 LINES PER INCH CODE
0031  0000      *      =#1C00
0032  1C00      ;**
0033  1C00      ;***   OPENS : ENTRY POINT TO TURN ON ROUTINE TO
0034  1C00      ;**   ECHO CHARACTERS TO THE PRINTER IN
0035  1C00      :       IN FULL VIC GRAPHICS
0036  1C00  20 26 1D  OPENS JSR INITOT      : INIT THE PIA FOR OUTPUT
0037  1C03  A9 30      LDA #<GRFOUT      : MOVE OUTPUT ROUTINE ADDRESS
0038  1C05  8D 26 03  STA DISVEC
0039  1C08  A9 1C      LDA #>GRFOUT
0040  1C0A  8D 27 03  STA DISVEC+1
0041  1C0D  20 6A 1D  JSR INITPR       : INITIALIZE THE PRINTER
0042  1C10  20 40 1D  JSR INILIN      : INITIALIZE FOR FIRST LINE
0043  1C13  60      RTS
0044  1C14      ;**
0045  1C14      ;***   OPENA : ENTRY TO TURN ON ROUTINE TO ECHO
0046  1C14      ;**   CHARACTERS TO PRINTER IN ASCII
0047  1C14  20 26 1D  OPENA JSR INITOT      : INIT PIA FOR OUTPUT
0048  1C17  A9 16      LDA #<ASCOUT      : MOVE ADDRESS OF ASCII DISPLAY
0049  1C19  8D 26 03  STA DISVEC      : ROUTINE TO DISPLAY VECTOR

```

Listing 1 continued on page 270

Will this year's bells and whistles be next year's hoots and howls?

NOT IF IT'S A GIFFORD.

Freedom from obsolescence now costs less than \$10,000 for 3 users. Because Gifford Multi-User Computer Systems, based on industry standard IEEE 696/S-100 with 20 bus slots, allow ample expandability and upgradability as new processors and peripherals are introduced. For example, up to four additional users can be added for only \$600 each, plus terminal costs. All while protecting your investment.

That's why Gifford computer systems, with their dual processor CompuPro CPUs, have proven themselves to be THE

SYSTEM for business and technical professionals requiring obsolescence-proof, hard-disk computers.

GIFFORD GIVES YOU THE BEST OF TWO SOFTWARE WORLDS.

We were the first company to develop a system that runs any combination of 8 and 16 bit CP/M™ programs simultaneously. So, if you go with Gifford, you'll *know* you can use the thousands of 8 bit CP/M programs available, PLUS any of the more powerful 16 bit programs ... at the same time.

And, in addition to compatibility with all the CP/M software that's out there, you also get SuperCalc-86™, dBase II™ and MP/M-86™ FREE.

PRICELESS INFORMATION FOR THE PRICE OF A STAMP.

We invite you to cut out the coupon and mail it to us today. We'll send you a free brochure with detailed information regarding all the other advantages of going with Gifford. Such as, our exclusive networking and multi-tasking telecommunications packages, our two year warranty, complete service and support, system integration and custom application software. Plus all the benefits of selecting an IEEE 696/S-100 bus-based system.

MP/M 8-16 is a proprietary implementation of MP/M-86 and was configured for CompuPro by Gifford Computer Systems. CP/M and MP/M are registered trademarks of Digital Research. SuperCalc is a trademark of Sorcim. dBase II is a trademark of Ashton-Tate. CompuPro is a trademark of Godbout Electronics. Prices and specifications subject to change.

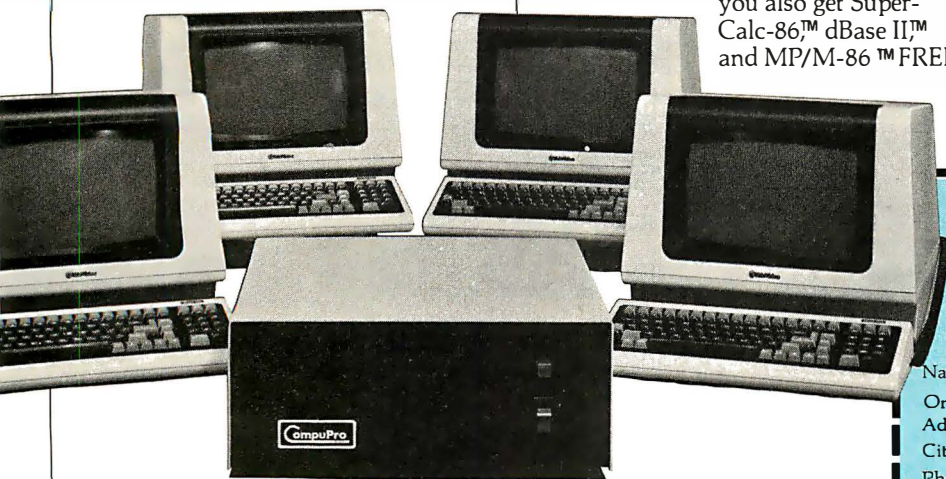

GIFFORD COMPUTER SYSTEMS

1922 Republic Avenue, San Leandro, CA 94577
(415) 895-0798 A division of G&G Engineering
I'D LIKE THE WHOLE STORY.
Please send me your brochure.

Name _____ Title _____
Organization _____ M/S _____
Address _____
City _____ State _____ Zip _____
Phone _____
 Please have a representative call me.

Other centers opening soon nationwide.

GIFFORD COMPUTER SYSTEMS CENTERS SAN LEANDRO, CA 94577 (415) 895-0798 SAN FRANCISCO, CA 94104 (415) 391-4570
 LOS ANGELES, CA 90064 (213) 477-3921 OKLAHOMA CITY, OK 73112 (405) 840-1175 HOUSTON, TX 77046 (713) 877-1212

```

0050 1C1C A9 1D          LDA #>ASCOUT
0051 1C1E 8D 27 03      STA DISVEC+1
0052 1C21 60              RTS

0053 1C22                ;**
0054 1C22                ;*** CLOSE ; ENTRY TO TURN OFF EITHER ECHO ROUTINE
0055 1C22                ;**

0056 1C22 A9 7A          CLOSE LDA #>VICOUT ;RESTORE VECTOR TO SCREEN
0057 1C24 8D 26 03      STA DISVEC ;DISPLAY ROUTINE
0058 1C27 A9 F2          LDA #>VICOUT
0059 1C29 8D 27 03      STA DISVEC+1
0060 1C2C 20 A9 1C      JSR FILLIN ;FINISH CURRENT LINE
0061 1C2F 60              RTS

0062 1C30                ;*** GRFOUT ; ROUTINE TO GENERATE VIC GRAPHICS
0063 1C30                ; ON THE PRINTER

0064 1C30 8D 9D 1D      GRFOUT STA ASAVE ;SAVE CHARACTER
0065 1C33 48            PHA
0066 1C34 9A            TXA ;SAVE ALL REGS
0067 1C35 48            PHA ;ON STACK
0068 1C36 98            TYA
0069 1C37 48            PHA
0070 1C38 AD 9D 1D      LDA ASAVE ;GET CHAR BACK
0071 1C3B 20 7A F2      JSR VICOUT ;SEND TO VICS SCREEN

0072 1C3E                ; NOW CONVERT THE ASCII CHARACTER INTO A VIC
0073 1C3E                ;POKE CODE, KEY ON OR TO END LINE,
0074 1C3E AA            TAX
0075 1C3F 10 1C        BPL BITOFF ;HI BIT ON?
0076 1C41 29 7F        AND #7F ;NO
0077 1C43 C9 7F        CMP #7F ;YES, TURN IT OFF
0078 1C45 D0 02        BNE NOT7F ;CONVERT 7F TO 5E
0079 1C47 A9 5E        LDA #5E
0080 1C49 C9 20        NOT7F CMP #20 ;CONTROL CHAR?
0081 1C4B 8D 0C        SCS NOTCTL ;NO
0082 1C4D C9 0D        CMP #CR ;RETURN?
0083 1C4F F0 4B        BEQ FINLIN ;YES
0084 1C51 A2 D4        LDX #QUOTMO ;IN QUOTE MODE?
0085 1C53 F0 4D        BEQ GRFBAK ;NO, THEN IGNORE IT
0086 1C55 09 C0        ORA #C0 ;ON 2 HI BITS
0087 1C57 D0 26        BNE SAUPOK ;TO MAKE POKE CODE
0088 1C59 09 40        NOTCTL ORA #40 ;TURN ON BIT 6
0089 1C5B D0 1C        BNE CKRUS ;AND GO CHECK REVERSE

0090 1C5D C9 0D        BITOFF CMP #CR ;RETURN CHAR?
0091 1C5F F0 38        BEQ FINLIN ;YES, END OF LINE
0092 1C61 C9 20        CMP #20 ;CONTROL CHARACTER?
0093 1C63 8D 0A        SCS NOCTL ;NOPE
0094 1C65 C9 14        CMP #INSDL ;YES, IS IT DELETE?
0095 1C67 F0 39        BEQ GRFBAK ;YES, IGNORE IT
0096 1C69 A6 04        LDX QUOTMO ;NO, IS QUOTE MODE ON?
0097 1C6B D0 10        BNE HIBIT ;YES, THEN PRINT IT
0098 1C6D F0 33        BEQ GRFBAK ;NO, IGNORE IT
0099 1C6F C9 60        NOCTL CMP #60 ;OVER #60?
0100 1C71 9D 04        BCC LOWER ;NO
0101 1C73 29 DF        AND #DF ;YES, OFF BIT 5
0102 1C75 D0 02        BNE CKRUS
0103 1C77 29 3F        LOWER AND #3F ;TURN OFF BITS 6 & 7
0104 1C79 A6 C7        CKRUS LDX RUSMOD ;REVERSE MODE ON?
0105 1C7B F0 02        BEQ SAUPOK ;NO
0106 1C7D 09 80        HIBIT ORA #80 ;ON BIT 7 TO REVERSE CHARACTER
0107 1C7F 8D 9D 1D      SAUPOK STA ASAVE ;SAVE POKE CODE

0108 1C82                ; CHECK FOR FULL LINE
0109 1C82 AD 9E 1D      LDA LCOUNT ;CHECK CHARACTER COUNT
0110 1C85 C9 3C        CMP #LINLIM ;AT LIMIT?
0111 1C87 D0 08        BNE NOTFUL ;NO, SKIP
0112 1C89 A9 0A        LDA #LF ;SEND LINE FEED TO PRINTER
0113 1C8B 20 19 1D      JSR FUTCHR

```

HARD DISK PACKAGE DEAL: \$980. \$1280.

8 MEGABYTES WITH CONTROLLER

16 MEGABYTES WITH CONTROLLER



THE PACKAGE: THE DEAL:

XCOMP, a worldwide leader in the Hard Disk business for six years is now offering a "Package Deal" to OEMs second to none! Take your choice: The 8MB or the 16MB. Both are Hard Disk specials that indeed offer more. More **Storage**. More **Value**. More **Support** and More **Speed**.

With the 8MB or the 16MB "Package Deal" you get a formatted drive and controller. Choose from 2 models: **1)** The ST/S for S100 Computers and the **2)** The ST/R General Purpose Controller with simple 8-bit micro interface for single board computers. There is an optional Z-80 Adapter for the GP Computer that allows you to just "plug 'er in". Nothing to build!

PICK A COMPUTER.

You pick the micro computer and XCOMP will probably be able to provide a "Package Deal", or a Turnkey Subsystem to fulfill your needs.



"Turnkey" Subsystems are available for OEMs. Ask for details. The Subsystem pictured above shows the available enclosure.

The 8MB "Package Deal" is \$980. The 16MB "Package Deal" is only \$1280. You get a 2-Board Controller and an 8 or 16MB **Mini-scribe Drive**. Optional equipment includes Software, Cable set, Adapter and Desk Top Enclosure (pictured).

No sense in shopping around. You won't find a "Package Deal" like this anywhere. Next Step? Call us.

XCOMP's super Hard Disk 8MB or 16MB "Package Deal" both have a complete one-year warranty on parts and workmanship!

"The Deal".

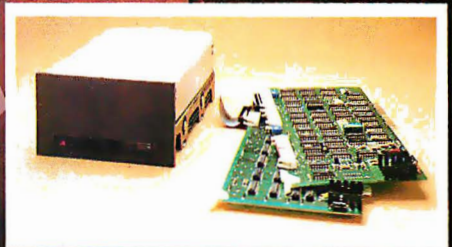

7566 Trade Street/San Diego, CA 92121
Phone (619) 271-8730/TLX 182786

XCOMP

Fast becoming the leader.

YES! I'm interested in your 8MB "Package Deal". Your 16MB "Package Deal".
I have a (type of computer) _____

I am also interested in: "Turnkey" Hard Disk Subsystems. S100 Hard Disk Subsystem.
 General Purpose Subsystem. SG/R Controller for SA1000 Interface. SM/R General Purpose
Controller for Storage Module Drives. AN/R Controller for ANSI Interface Disk and Tape.
 SG/S, SM/S and AN/S same as others for the S100 bus.

Name _____
Company Name _____
Title _____ Phone _____
Address _____
City _____ State _____ Zip _____

CPM is a registered trademark of Digital Research.

Circle 451 on inquiry card.

WE'RE MAKING LIFE EASIER FOR OEMs. CALL NOW, (619) 271-8730.

End users can take advantage of XCOMP quality and low prices by contacting their local dealers.

QUADBOARD™

THE FIRST AND ONLY BOARD YOUR IBM PC MAY EVER NEED.

Your IBM personal computer is a very versatile piece of equipment. Perhaps more versatile than you realize. New applications and functions are being developed every day. Now with Quadboard

by Quadram you can keep your options open for tomorrow's technology. Following in the tradition of Quadram Quality, four of Quadram's best selling IBM boards have been combined into one board. Your remaining slots will be left free and available to accommodate future expansion needs and uses which you may not even be able to contemplate today.

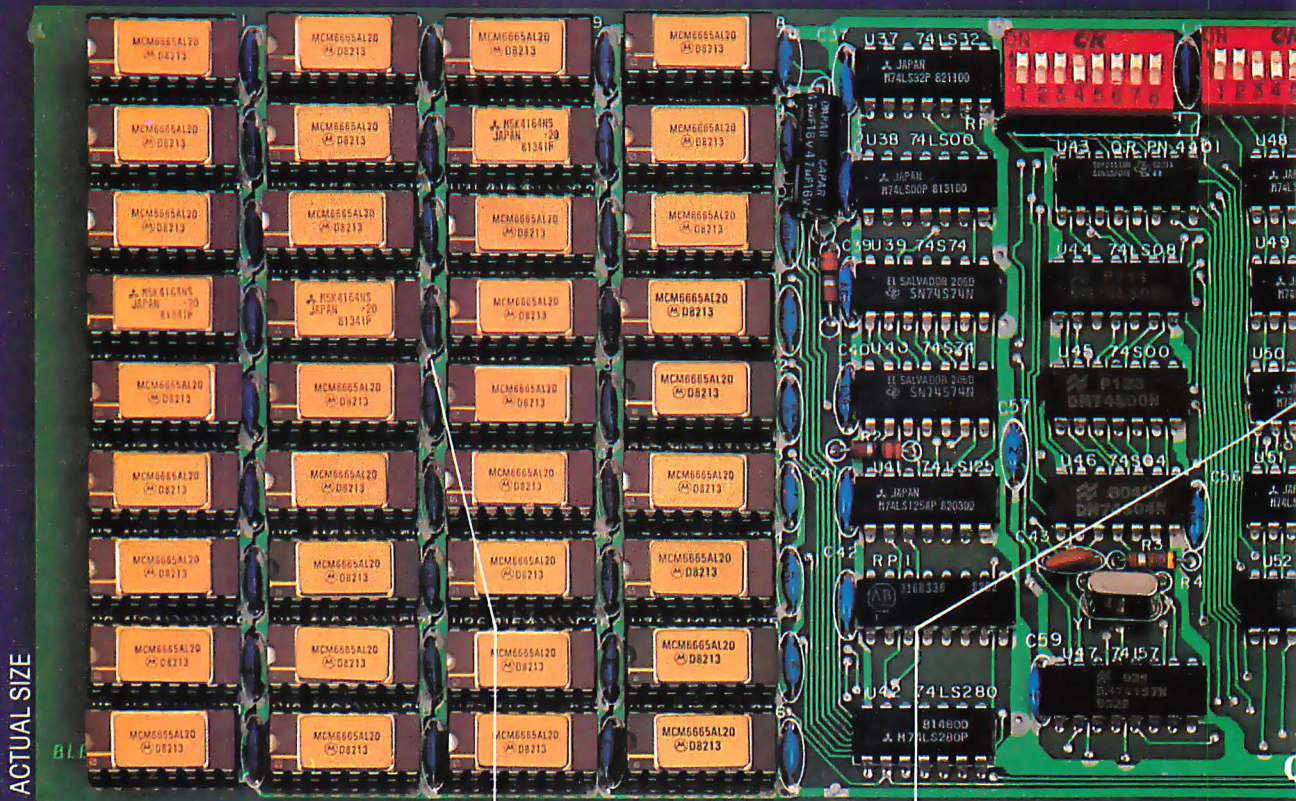

PROVEN DESIGN.

Quadram has been shipping IBM boards with each of the Quadboard functions on separate boards since December, 1981. They are still available as separates (including a Dual Port Async Board) for those who desire a quality board but do not need to keep slots open for future expansion. And they all come with a one year warranty from the leader in technology applications.

256K MEMORY EXPANSION.

Socketed and expandable in 64K increments to 256K, full parity generation and checking are standard. A Quadboard exclusive feature allows parity to be switch disabled to avoid lock-up upon error detection. The dip switches also allow it to be addressed starting on any 64K block so that it takes up only as much as it has memory installed. Memory access and cycle time naturally meet all IBM specifications.

CLOCK/CALENDAR.

Quadboard eliminates the hassle of manually inputting the date on system boot-up by providing for the clock and all software routines necessary for inserting the appropriate programs on your diskettes. The internal computer clock is automatically set for compatibility with most software routines which utilize clock functions. On-board battery keeps the clock running when the computer is off.

BY QUADRAM

ALL ON ONE BOARD

Now you can utilize all the PC's capacity with Quadram's extremely flexible configurations. And it's totally compatible with IBM hardware, operating systems, and high level languages. It's a full-size board that can be inserted into any free system slot and it even includes a card edge guide for securely mounting the card in place.

SOFTWARE TOO!

With Quadboard you receive not only hardware but extensive software at no extra cost. Diagnostics, utilities, and Quad-RAM drive software for simulating a floppy drive in memory (a super-fast SOLID STATE DISK!) are all part of the Quadboard package.

\$595

with 64K
Installed



PARALLEL PRINTER I/O.

A 16 pin header on Quadboard is used for inserting a short cable containing a standard DB25 connector. The connector is then mounted in the knock-out hole located in the center of the PC back-plane. The parallel port can be switch disabled or addressed as Printer 1 or 2. No conflict exists with the standard parallel port on the Monochrome board. The internal cable, connector and hardware are all included.

ASYNCHRONOUS (RS232) COMMUNICATION ADAPTER.

Using the same chip as that on the IBM ASYNC board, the device is software programmable for baud rate, character, stop, and parity bits. A male DB25 connector located on the back connector is identical to that on the IBM Async Adapter. The adapter is used for connecting modems, printers (many letter quality printers require RS232), and other serial devices. Switches allow the port to be configured as COM1 or COM2 and the board fully supports IBM Communications Software.

INCREDIBLE PRICE!

Priced at \$595 with 64K installed, \$775 with 128K, \$895 with 192K and \$995 with 256K.

ASK YOUR DEALER.

All products are sold through local personal computer dealers. If yours does not stock Quadram, please ask him to call us at (404) 923-6666.

QUADRAM
CORPORATION

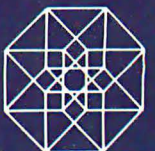

4357 Park Drive/Norcross, Ga. 30093

Circle 357 on inquiry card.

Listing 1 continued:

```

0114 1C8E 20 40 1D      JSR INILIN      ;SETUP FOR NEW LINE
0115 1C91 AD 9C 1D      NOTFUL LDA ASAVE ;RETRIEVE POKE CODE
0116 1C94 20 EF 1C      JSR SEND       ;SEND CHAR TO PRINTER
0117 1C97 EE 9E 1D      INC LCOUNT    ;COUNT IT
0118 1C9A D0 0E          BNE GRFBK     ;SKIP TO END

0119 1C9C          ;FINISH LINE
0120 1C9C 20 A9 1C      FINLIN JSR FILLIN ;FILL LINE WITH BLANKS
0121 1C9F 20 40 1D      JSR INILIN    ;INITIALIZE NEW LINE

0122 1CA2 68          GRFBK PLA      ;RESTORE ALL REGS
0123 1CA3 A8          TAY
0124 1CA4 68          PLA
0125 1CA5 AA          TAX
0126 1CA6 68          PLA
0127 1CA7 18          CLC
0128 1CA8 60          RTS          ;AND RETURN

0129 1CA9          ;*** FILLIN : FILL REMAINDER OF LINE WITH BLANKS
0130 1CA9 AE 9E 1D      FILLIN LDX LCOUNT ;GET CHAR COUNT
0131 1CAC E0 3C 1D      CPX #LINLIN   ;AT LIMIT?
0132 1CAE B0 0A          BCS NXTLIN    ;YES, QUIT
0133 1CB0 A9 20          LDA #32       ;NO, SEND A BLANK
0134 1CB2 20 BF 1C      JSR SEND
0135 1CB5 EE 9E 1D      INC LCOUNT   ;COUNT IT
0136 1CB8 D0 EF          BNE FILLIN    ;REPEAT
0137 1CBA A9 0A 1D      NXTLIN LDA #LF ;SEND LINE FEED TO PRINTER
0138 1CBC 4C 19 1D      JMP PUTCHR

0139 1CBF          ;*** SEND : ROUTINE TO USE VIC POKE CODE TO FIND
0140 1CBF          ; THE CHARACTER PATTERN, CONVERT IT TO
0141 1CBF          ; THE PRINTERS FORMAT AND SEND TO PRINTER

0142 1CBF          ; FIRST CALC THE ADDRESS OF THE CHARACTER
0143 1CBF 85 FB          SEND STA VICPAT ;SAVE POKE CODE
0144 1CC1 A9 00          LDA #0        ;IN PATTERN POINTER
0145 1CC3 85 FC          STA VICPAT+1
0146 1CC5 A0 02          LDY #2        ;LOOP TO MULTIPLY THE POKE CODE
0147 1CC7 18          MULTS CLC        ;BY 8 TO GET OFFSET INTO CURRENT
0148 1CC8 26 FB          ROL VICPAT   ;CHARACTER SET
0149 1CCA 26 FC          ROL VICPAT+1
0150 1CCC 88          DEY
0151 1CCD 10 F8          BPL MULTS    ;THREE TIMES THRU
0152 1CCF A2 80          LDX #80
0153 1CD1 AD 05 90      LDA TUCTL5   ;USE DATA FROM TV CHIP TO
0154 1CD4 29 0C 90      AND #8C     ;DETERMINE LOCATION OF
0155 1CD6 F0 02          BEQ NOALT   ;OF CURRENT CHARACTER SET
0156 1CD8 A2 10          LDX #10
0157 1CDA 8A          NOALT TXA    ;ADD IN HI NYBBLE
0158 1CDB 18          CLC        ;OF CHARACTER SET ADDRESS
0159 1CDC 65 FC          ADC VICPAT+1
0160 1CDE 85 FC          STA VICPAT+1
0161 1CE0 AD 05 90      LDA TUCTL5   ;CALC SECOND NYBBLE VALUE
0162 1CE3 29 03          AND #3
0163 1CE5 18          CLC
0164 1CE6 0A          ASL A
0165 1CE7 0A          ASL A
0166 1CE8 65 FC          ADC VICPAT+1 ;AND ADD IT IN
0167 1CEA 85 FC          STA VICPAT+1

0168 1CEC          ; CONVERT VIC PATTERN TO PRINTER PATTERN
0169 1CEC A0 07          LDY #7
0170 1CEE B1 FB          BYTLUP LDA (VICPAT),Y ;GET A VIC PATTERN ROW
0171 1CF0 A2 00          LDX #0
0172 1CF2 0A          BITLUP ASL A ;SHIFT EACH BIT INTO A
0173 1CF3 7E 95 1D      ROR PRTPAT,X ;COLUMN OF THE PRINTER PATTERN
0174 1CF6 E8          INX
0175 1CF7 E0 08          CPX #8       ;GOT ALL 8?
0176 1CF9 90 F7          BCC BITLUP   ;NO, DO ANOTHER
0177 1CFB 88          DEY        ;YES BUMP Y TO NEXT ROW OF VIC PATTERN
0178 1CFC 10 F0          BPL BYTLUP   ;DO ALL 8

0179 1CFE          ; SEND CONVERTED PATTERN TO PRINTER:

```

DATA STORAGE FROM 1 TO

33.2

MEGA-BYTES

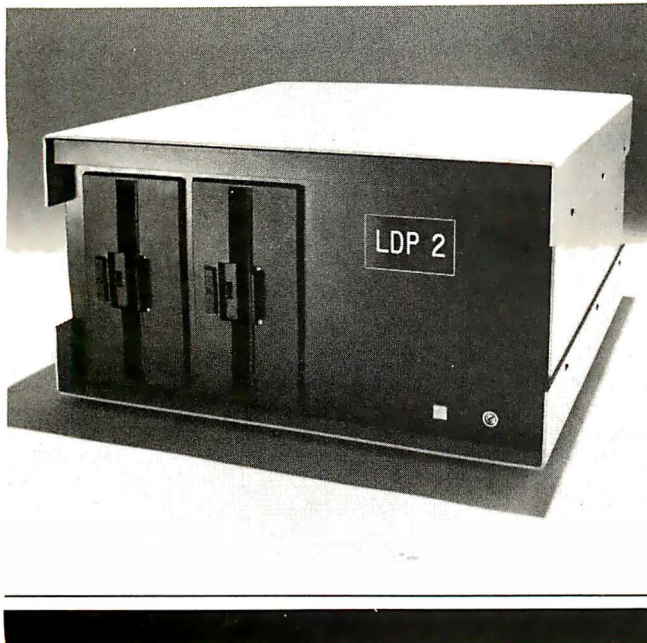

LDP S100 Bus Systems: Designed for high reliability, flexibility and upgradeability.

Lomas Data Products offers a variety of pre-packaged computer systems, and options, allowing a user to quickly configure a system for his individual requirements. With disk storage from 1 to 33.2 MegaBytes of formatted data, LDP systems are ideal for any business or scientific application.

LDP systems offer the following advanced features:

- 10 MHz 8086 CPU
- IEEE 696 (S100) standard expansion
- Up to 1 MegaByte of main memory
- Battery backed up clock calendar
- Supports CP/M-86*, MP/M-86*, CONCURRENT* CP/M* and MS-DOS**
- Supports up to 8 users under MP/M-86
- Runs CP/M programs under either software simulation or on our slave Z80 processor board
- Floppy disk or streaming tape backup of Winchester drives

Call LDP for a full line of quality S100 bus products . . . systems, software and "no-nonsense" boards.

Dealer and OEM inquiries invited.

LDP

LOMAS DATA PRODUCTS, INC. □ 66 Hopkinton Road, Westboro, Mass. 01581 □ Tel: (617) 366-6434

* Trademark of Digital Research ** Trademark of Microsoft

Listing 1 continued:

```

0180 1CFE A2 00          LDX #0
0181 1D00 BD 95 1D    OUTLUP LDA PRTPAT,X      ;GET A DOT COLUMN
0182 1D03 20 19 1D    JSR PUTCHR         ;SEND TO PRINTER
0183 1D06 AC 9F 1D    LDY DOTFLG        ;DOUBLE DOT MODE?
0184 1D09 C0 01          CPY #1
0185 1D0B D0 03          BNE NOZDOT        ;NO, SKIP
0186 1D0D 20 19 1D    JSR PUTCHR         ;YES, SEND IT AGAIN
0187 1D10 E8          NOZDOT INX
0188 1D11 E0 08          CPX #8            ;DONE ALL?
0189 1D13 90 EB          BCC OUTLUP        ;NO, REPEAT
0190 1D15 60          RTS

0191 1D16          ;*** ASCOUT ; ROUTINE TO SEND ASCII CHARACTER TO PRINTER

0192 1D16 20 7A F2    ASCOUT JSR VICOUT      ;SEND TO SCREEN

0193 1D19          ; SEND BYTE TO PRINTER
0194 1D19 48          PUTCHR PHA          ;SAVE CHARACTER
0195 1D1A A9 10          LDA ##10          ;TEST INTERRUPT BIT
0196 1D1C 2C 1D 91    WAITO BIT IFR1     ;IN FLAG REG
0197 1D1F F0 FE          BEQ WAITO         ;WAIT UNTIL IT TURNS ON
0198 1D21 68          PLA
0199 1D22 8D 10 91    STA IORB1        ;THEN SEND CHARACTER
0200 1D25 60          RTS

0201 1D26          ;*** INITOT ; INITIALIZE PIA FOR OUTPUT

0202 1D26 AD 1C 91    INITOT LDA PCR1        ;GET PCR
0203 1D29 29 0F          AND ##0F         ;CLEAR B PORT BITS
0204 1D2B 09 A0          ORA ##A0         ;SET IT TO AUTO PULSE MODE
0205 1D2D 8D 1C 91    STA PCR1        ;AND STORE IN PCR
0206 1D30 A9 10          LDA ##10         ;DISABLE INTERRUPT
0207 1D32 8D 1E 91    STA IER1
0208 1D35 A9 FF          LDA ##FF         ;SET ALL BITS TO OUTPUT
0209 1D37 8D 12 91    STA DORB1
0210 1D3A A9 00          LDA #0           ;START WITH A NULL
0211 1D3C 8D 10 91    STA IORB1
0212 1D3F 60          RTS

0213 1D40          ;*** INILIN ; PREPARE FOR SENDING A LINE

0214 1D40 A9 00          INILIN LDA #0           ;CLEAR LCOUNT
0215 1D42 8D 9E 1D    STA LCOUNT
0216 1D45 A9 1B          LDA #ESC         ;START ESCAPE SEQ
0217 1D47 20 19 1D    JSR PUTCHR
0218 1D4A AC 9F 1D    LDA DOTFLG      ;DOUBLE DOT MODE REQUESTED?
0219 1D4D C9 01          CMP #1
0220 1D4F D0 08          BNE ONEDOT      ;NOPE
0221 1D51 A9 4C          LDA #'L'        ;YES, 960 MODE
0222 1D53 A0 C0          LDY #<960       ;LOAD 960 INTO X AND Y
0223 1D55 A2 03          LDX #>960
0224 1D57 D0 06          BNE PUTREG      ;GO SEND
0225 1D59 A9 4B          ONEDOT LDA #'K'      ;480 MODE
0226 1D5B A0 E0          LDY #<480       ;480 INTO X & Y
0227 1D5D A2 01          LDX #>480
0228 1D5F 20 19 1D    PUTREG JSR PUTCHR ;SEND CODE
0229 1D62 98          TYA
0230 1D63 20 19 1D    JSR PUTCHR      ;AND THEN COUNT
0231 1D66 8A          TXA
0232 1D67 4C 19 1D    JMP PUTCHR

0233 1D6A          ;*** INITPR ; STARTUP INITIALIZATION FOR PRINTER

0234 1D6A A2 00          INITPR LDX #0
0235 1D6C BD 92 1D    IPRLUP LDA PRTAB,X      ;GET A BYTE
0236 1D6F F0 06          BEQ IPDUN       ;QUIT IF 0
0237 1D71 20 19 1D    JSR PUTCHR      ;SEND IT
0238 1D74 E8          INX
0239 1D75 D0 F5          BNE IPRLUP
0240 1D77 AE 0C 03    IPDUN LDX SYSA        ;GET A REG
0241 1D7A A9 09          LDA #LPI        ;GET S LPI CODE
0242 1D7C E0 01          CPX #1          ;1=SLPI
0243 1D7E F0 08          BEQ PUTDEN     ;YES, SLPI
0244 1D80 A9 08          LDA #LPIGRF    ;LOAD GRAPHIC DENSITY CODE
0245 1D82 E0 02          CPX #2          ;2=GRAPHIC DENSITY

```

Listing 1 continued on page 278

WESTICO — The Software Express Service that really delivers:

SOFTWARE FOR PROFESSIONALS

Designed for 8 bit and 16 bit personal computers.

Westico — for the best and most current software. Your order is shipped at once, and expert technicians are always on hand to provide assistance and advice. When you need the finest software available, call Westico. Among the 300 quality programs in stock:

MicroGANTT — Sophisticated project planning system which uses Critical Path Method analysis. Interactively defines tasks which comprise a project and displays a Gantt chart of the resulting plan. Budget costs and work hours are also calculated and displayed automatically. An entire project can be included in a more global project as a single task. All data is easy to modify and can be displayed or printed. \$395/\$25.

T/MAKER III — Powerful yet easy to use data processing tool with integrated full-feature word processor. Can be used to maintain and process data for complex financial projections. Allows user to define equations to automatically process data in tables. Sorts data, tallies frequency distributions, executes cross-tabulations. Repositions columns of data, prepares tables for printing in reports, and makes bar charts. Advanced visually oriented word processing feature does multi-line headers and footers and footnotes. \$275/\$70.

STATPAK — Statistics software library in Microsoft BASIC. Performs probability calculations, one independent variable statistics, discrete distribution functions, continuous distribution functions, regression analysis, means testing, survey data/contingency tables, non-parametric statistics and analysis of variance. Includes plotting and file management modules. \$500/\$40.

PRIORITIES — Easy to learn system for efficient time management. Schedules and prioritizes daily and recurring tasks and appointments for individuals or entire staff. Tasks not accomplished on schedule automatically appear on the next day's agenda, which can be updated and printed at any time. Saves valuable time because necessary data such as names and phone numbers are included on the agenda. \$195/\$35.

WONDERCALC — Spreadsheet that collects data and prepares financial reports and projections. Handles up to 99 columns and 998 rows of data. Can consolidate multiple spreadsheets into an overall report (3D calculation). Produces graphic reports. Includes sort program for data manipulation. \$395/ — . Inhibited version for use by branch offices or secretaries. \$195/ — .

PROPERTY MANAGEMENT — Manages real estate accounting from single family homes to office complexes. Reports include operating statements, G/L accounts, A/P accounts, late rents, tenant/vendor lists, etc. \$695/\$35.

MINIMODEL™ — Financial planning tool. Does big financial planning jobs at micro prices for cash flow projections, financial forecasting, venture analysis, project planning and risk analysis. Models limited only by disk space. Report content and format totally under user control. \$495/\$50.

GRAFTALK — Easily mastered graphics business tool capable of producing bar, pie, line and symbol charts. Compatible with numerous graphic CRTs and plotters. Can use letter-quality and dot matrix printers for high resolution graphics. \$450/\$40.

VERDICT — For law offices with up to 25 attorneys and a total of 35 timekeepers (including paralegals, secretaries, etc.). All time and expenses are distributed to client accounts or other designated overhead accounts. Produces monthly client review sheets and ready-to-mail itemized bills. \$995/\$50.

BILLKEEPER — For professional offices — architects, accountants, engineers, consultants, ad agencies. All the features of VERDICT including analysis of each professional's billings, aging of receivables, analysis of the work effort of each timekeeper. \$995/\$50.

The Westico 24-Hour Computer Hotline for 300 or 1200 baud modems (203)853-0816 for detailed information and quick access ordering.

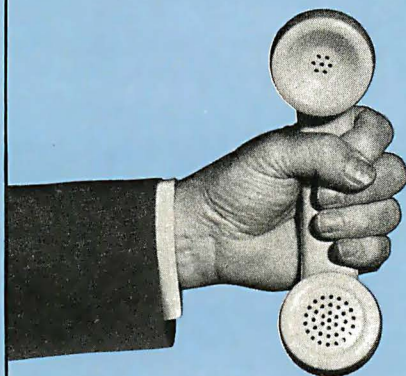

• Westico has more than 300 programs that work on a wide variety of microcomputers including ADDS Multivision, Altos, Apple, Canon, CPT, Cromemco, DEC, Dynabyte, Eagle, Exxon, Facit, Hewlett-Packard, IBM, Intersystems, Intertec, Kaypro, Monroe, NEC, North Star, Northern Telecom, Ohio Scientific, Otrona Attache, Radio Shack, Rainbow 100, Syntrex, Televideo, Vector Graphic, Victor, Xerox, Zenith. We're working hard to be your software company.

Send for FREE 1983 catalog

4 Ways to order

- Write Westico, Inc., 25 Van Zant Street, Norwalk, CT 06855.
- Call (203) 853-6880.
- Telex 64-3788.
- Dial-up our 24-hour computer (300 or 1200 baud) (203) 853-0816.

COD, MasterCard and VISA accepted.

Prices do not include shipping and are subject to change. In CT add 7 1/2% sales tax. All sales final.

Manual price may be credited toward purchase of software.

Dealer inquiries invited.

Copyright © 1983 Westico, Inc. **WES-59**

WESTICO
The Software Express Service

25 Van Zant Street • Norwalk, Connecticut 06855
(203) 853-6880 • Telex 64-3788

Listing 1 continued:

```

0246 1D84 F0 02          BEQ PUTDEN          :YES
0247 1D86 A9 0C          LDA #LPI6          :ELSE DEFAULT TO 6 LPI
0248 1D88 20 19 1D      PUTDEN JSR PUTCHR
0249 1D8E AD 0D 03      LDA SYSX          :SAVE DOT MODE FLAG
0250 1D8E 8D 9F 1D      STA DOTFLG
0251 1D91 60            RTS

0252 1D92              : PRINTER PARM TABLES

0253 1D92 1B          PRTAB ,BYT ESC,'A',0
0254 1D93 41
0255 1D94 00

0256 1D95              : DATA AREAS

0257 1D95          PRTPAT *==+8          :PRINTER: PATTERN AREA
0258 1D9D          ASAVE *==+1          :CHARACTER TEMPORARY
0259 1D9E          LCOUNT *==+1        :CHARACTER IN LINE COUNTER
0260 1D9F          DOTFLG *==+1        :DOT MODE FLAG

0261 1DA0          LAST ,END
0262 1DA0          ERRORS= 0000

```

SYMBOL CROSS REF FOR UIC TO EPSON MX-80 INTERFACE PAGE 05

SYMBOL DEFINED REFERENCES

A	0000	0172	0165	0164			
ASAVE	0258	0115	0107	0070	0064		
ASCOUT	0192	0050	0048				
BITLUP	0172	0176					
BITOFF	0090	0075					
BYTLUP	0170	0178					
CKRUS	0104	0102	0089				
CLOSE	0056						
CR	0023	0090	0082				
DDRB1	0010	0209					
DISVEC	0021	0059	0057	0051	0049	0040	0038
DOTFLG	0260	0250	0218	0183			
ESC	0025	0253	0216				
FILLIN	0130	0136	0120	0060			
FINLIN	0120	0091	0083				
GRFBK	0122	0118	0098	0095	0085		
GRFOUT	0064	0039	0037				
HIBIT	0106	0097					
IER1	0013	0207					
IFR1	0012	0196					
INILIN	0214	0121	0114	0042			
INITOT	0202	0047	0036				
INITPR	0234	0041					
INDEL	0024	0094					
IORB1	0009	0211	0199				
IPDUN	0240	0236					
IPRLUP	0235	0239					
LAST	0261						
LCOUNT	0259	0215	0135	0130	0117	0109	
LF	0026	0137	0112				
LINLIN	0027	0131	0110				
LOWER	0103	0100					
LPI6	0030	0247					
LPI8	0029	0241					
LPIGRF	0028	0244					
MULT8	0147	0151					
NOALT	0157	0155					
NOCTL	0099	0093					
NOT7F	0080	0078					
NOTCTL	0088	0081					
NOTFUL	0115	0111					
NOZDOT	0187	0185					
NXTLIN	0137	0132					
ONEDOT	0225	0220					
OPENA	0047						
OPENG	0036						
OUTLUP	0181	0189					
PCR1	0011	0205	0202				
PRTAB	0253	0235					

Listing 1 continued on page 280

Expand your possibilities with Concurrent CP/M.™

If you have to wait impatiently for your personal computer to finish a job before moving on to another task, you need Concurrent CP/M. This new software technology from Digital Research increases the productivity of your IBM PC by allowing you to do more with it.

Using Concurrent CP/M, you can run several programs simultaneously, switching instantly from one program to another. For the first time you can write a letter while you do your financial planning. For the first time

you can write text while printing other documents. For the first time you can edit programs while your program compiles. Concurrent CP/M is the best investment you can make in microcomputing because it multiplies the value of your hardware and lets you use all the CP/M compatible programs. And if you're developing software, it ensures that you're on the crest of the hottest new wave in the business.

So quadruple the effectiveness of your IBM Personal Computer with Concurrent CP/M. See your local microcomputer dealer.

Circle 144 on Inquiry card.

Now your IBM® PC can do more than one thing at a time.

The image shows a person from behind, sitting at a desk with an IBM PC. Four monitors are arranged around the PC, each displaying a different application. The top-left monitor shows an email, the top-right shows a calendar, the bottom-left shows a journal, and the bottom-right shows a bar chart. The person's hands are on the keyboard.

TO: Frank Bellister
FROM: Kevin North
RE: Staff Meeting

Frank,
This memo is to remind you of our staff meeting, which will be held this Friday at 10:00 a.m. in the boardroom. The major objective of this meeting will be to review the sales figures for the past fiscal year, and to project what level of business we can realistically expect to achieve next year.

I think we all recognize how important this meeting will be. The marketing manager will be in attendance to help us target key accounts for our sales force. Hopefully, by the end of the meeting we will have a well defined strategy to help us meet our objectives.

Regards,
Kevin

Console-2 Dynamic Printer-0 W010 14:27:25 Wep

Friday

9:00 - 9:30 Weekly project status

10:00 - 12:00 Staff Meeting
Note: Marketing Manager will attend

12:00 - 1:30 Lunch with Jenny

2:00 - 3:00 Interview J.S. for Marketing Rep Position

4:30 - 5:00 Kevin's Daily Mail

7:00 - Bill and Jenny coming for Marketing Rep Dinner

Console-2 Dynamic Printer-0 CALNDAR 14:30:00 Wep

January Journal for David Aubley

Number	Account	Date	Amount	Description
1000	103	10/1/82	12.00	Gas Bill
1001	210	10/2/82	30.00	Cash
1002	107	10/4/82	42.25	Electric bill
1003	205	10/5/82	121.00	Car repair
1004	103	10/9/82	51.50	Food
1005	342	10/11/82	5.25	Tips
1006	109	10/13/82	75.42	Phone Bill
1007	142	10/15/82	45.21	Records
1008	110	10/19/82	200.00	Buson repair
1009	101	10/21/82	22.50	Dinner
1010	117	10/22/82	23.20	Cable TV
1011	100	10/24/82	0.00	VOID
1012	302	10/25/82	242.05	Airplane ticket
1013	132	10/27/82	62.50	New chair
1014	200	10/29/82	42.10	Theater tickets

Console-2 Dynamic Printer-0 BILL 14:29:07 Wep

Projected units shipped in 1983

Console-2 Dynamic Printer-3 BILL 13:06:00 Wep

The logo, tagline and names of DRI products are either trademarks or registered trademarks of Digital Research Inc. IBM is a registered trademark of International Business Machines, Corp. © Copyright 1982 by Digital Research Inc.

**DIGITAL
RESEARCH**[™]
The creators of CP/M[™]

Listing 1 continued:

```

PRTPAT 0257 0181 0173
PUTCHR 0194 0248 0237 0232 0230 0228 0217 0186 0182 0138 0113
PUTDEN 0248 0246 0243
PUTREG 0228 0224
QUOTMO 0006 0096 0084
RUSMOD 0005 0104
SAVPOK 0107 0105 0087
SEND 0143 0134 0116
SYSR 0019 0240
SYSX 0020 0249
TVCTL5 0015 0161 0153
VICOUT 0017 0192 0071 0058 0056
VICPAT 0007 0170 0167 0166 0160 0159 0149 0148 0145 0143
WAITO 0196 0197
X 0000 0235 0181 0173
Y 0000 0170

```

Text continued from page 266:

Location 781 passes the horizontal density to the OPEN routine. The MX-80 offers two horizontal densities in graphic mode: 480 dots per line (DPL) and 960 DPL. Entering a 1 into location 781 produces the 960 DPL mode, and entering anything else in 781 produces the 480 DPL mode. In both modes 60 VIC characters are printed on a line. In 960 DPL mode, each dot of a VIC character is printed twice, resulting in a very black, dense printout. In 480 DPL mode each dot is printed only once, resulting in lighter print.

Printing in graphics mode slows the speed of the MX-80 considerably. It cannot print bidirectionally in

graphics mode, thus halving the normal printer speed. It takes two passes to print a line in 480 DPL mode, slowing printer speed to one-fourth the normal rate. In 960 DPL mode the printing speed is reduced by one-half and it takes four passes to print each line, resulting in one-sixteenth of normal printing speed.

Once the OPEN routine has been executed, any character that is displayed on the screen will also go to the printer. Characters that are entered directly into the screen buffer with a POKE command will not be printed. When you have finished printing, you can turn off the printer by entering the command SYS (7202) to execute the CLOSE routine, which restores the display vector. No

PROGRAMMERS FLIGHT SIMULATOR Apple II Plus DOS 3.3 48K



This total IFR System disk features gobs of menu selectable flight programs each with breath taking realistic picture graphics, moving scenery, airport approaches, holding patterns and much much more.

\$50.00 At your Computer Store or direct from
Visa Mastercard

Programmers Software
2110 N. 2nd Street
Cabot, Arkansas 72023
(501) 843-2988

5-INCH HARD DISK SUBSYSTEMS WITH LOW COST PER MEGABYTE.

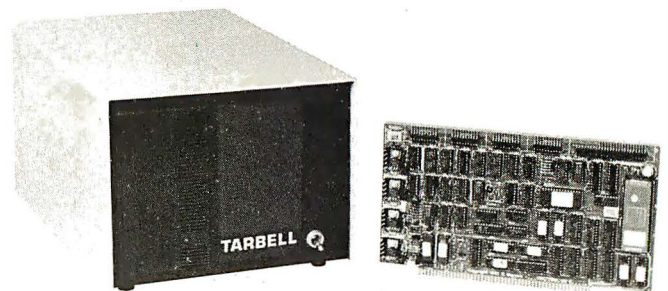

Tarbell 5-inch hard disk subsystems with amazingly low cost per megabyte are available in 5, 10 or 16 megabyte formatted configurations.

Subsystem includes 5-inch hard disk drive, 8-inch metal frame with 5-volt and 12-volt regulators or optional cabinet with power supply, hard disk controller and cable, CP/M 2.2 for Tarbell floppy and hard disk, and documentation.

Data transfer rate is 5 megabits per second and average seek time 120 milliseconds.

LESS COST PER MBYTE

5 Mbyte	\$2095
10 Mbyte	\$2265
16 Mbyte	\$2375
Cabinet with power supply	\$200

Tarbell
Electronics

950 Dovlen Place, Suite B
Carson, California 90746
(213) 538-4251

CP/M is a trademark of Digital Research

EXTRA**EXTRA**

S-100 World News

MACROTECH International Corporation

22133 Cohasset Street, Canoga Park, California 91303 • 213-887-5737

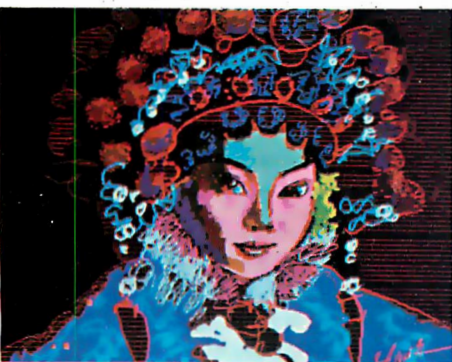

Image achieved by DGS' CAT 1600 Series color video graphic workstation. Picture courtesy of Digital Graphic Systems, Inc. See story below.

GRAPHICS: NOW MAX-IMIZED

CANOGA PARK—March 30, 1983—The decreasing costs and increasing density of memory made possible the present boom in digital graphics. Graphic systems designers are now able to take another major step with the introduction of MAX-M, a one megabyte memory board for S1983. As large size system memory and multi-megabyte Virtual Disk, MAX-M opens up major new low cost implementations.



Wayne Maw, Director of R&D for RGB Dynamics, Salt Lake City, Utah, reports, "My application is dependent on speed. With the Macrotech dynamic board, I have the needed speed." The RGB system is a Z80-based, high resolution color directory system for shopping malls, due for April release.

Empirical Research Group of Kent, Washington, creates a state-of-the-art high resolution color video graphics system by integrating their fast 68000 computer, Macrotech system memory, and the color video image processor from Digital Graphic Systems, Inc., Palo Alto, California. Radcliffe Goddard of Digital Graphics states, "High speed image processing requires large system memory to provide instantaneous display frame paging."

The demand for MAX-M by the graphics industry was nearly instantaneous following the initial Macrotech announcement. ■

MAX—256K to 1M S-100 Memory

CANOGA PARK—March 30, 1983—Mike Pelkey, Macrotech International president, today released details of the revolutionary MAX line of S-100 memory boards. Pelkey stated: "IEEE-696 now has a new standard for dynamic memory. The MAX product line offers 256K to 1M, at a price that ranges down to less than \$0.00023 per bit." Pelkey continued, "The MI product line now includes our ultra fast (70 ns) 128K static memory, with battery backup capability, plus the 150 ns dynamic memories—in every 128K step from 256K through 1M (1024K) bytes, and add-on kits to permit field upgrade of sizes."

The extreme density of the MAX family is made possible through the use of proprietary PALs (programmable array logic). Also stated as available for add-on to any size MAX is

Macrotech's popular M³ memory mapping architecture. M³ permits the 16-bit address space of an 8-bit processor to be dynamically mapped in 4K pages into as much as 16 megabytes of physical memory.

Parity error detection and 8/16 bit data transfer capabilities are provided as standard on the MAX series memory board. ■

Software for M³ Available

BURBANK—March 30, 1983—"M³ bank switching for 8-bit processors is much more useful with the new creative systems programs," states Dan West of Westcom Systems Inc. MP/M II* disk intensive applications are greatly improved with the new Virtual Disk routines now available through Macrotech OEM's and dealers for their M³ memory boards.



Westcom Systems, as the software consulting firm for Macrotech, has also provided subroutine listings to easily incorporate M³ mapping into the new CP/M 3.0* (CP/M Plus*) Biosmodule. The advantages of CP/M 3.0* with disk buffering, hashed directories, and user program expansion go hand in hand with Macrotech's flexible "bank switched" memory capabilities.

All Macrotech software and manuals are available through Dan West's Comuserve account #70250,102. Leave comments/questions as E-Mail.

These new techniques can combine the above features with custom needs of the future, such as printer buffering, multi-page display and memory-intensive graphics displays.

The software listings are included in the Macrotech memory board manuals and are optionally available on 8" diskettes. ■

PRICE INDEX

	SIZE	P/N	PRICE
Static Memory	128K	128-ST	\$1232
Dynamic Memory	256K	MAX-256	\$1108
24-bit	384K	MAX-384	1292
Addressing	512K	MAX-512	1647
	768K	MAX-768	1815
	896K	MAX-896	1899
	1M	MAX-M	1983

With 16-bit M³ Addressing option, add \$91

	FROM/TO	P/N	PRICE
Upgrade Kits	256K/384K	MKT-2/3	\$ 192
	256K/512K	MKT-2/5	692
	256K/768K	MKT-2/7	876
	256K/896K	MKT-2/8	967
	256K/1M	MKT-2/M	1060
	384K/512K	MKT-3/5	600
	384K/768K	MKT-3/7	784
	384K/896K	MKT-3/8	876
	384K/1M	MKT-3/M	968
	512K/768K	MKT-5/7	284
	512K/896K	MKT-5/8	376
	512K/1M	MKT-5/M	468
	768K/896K	MKT-7/8	192
	768K/1M	MKT-7/M	284
	896K/1M	MKT-8/M	192
M³ option		MKT-M3	121

Software (provided on 8" disk)

Virtual Disk for MP/M II* and CP/M 2.2,
CP/M 3.0* Bios modules,
CP/M memory tests \$ 25

Manuals (sold separately)

128/ST \$ 15
MAX Technical Manual 15



MuSYS gives S-100 the best in networks. . .

with TurboDOS*

With CP/M® compatible TurboDOS and MuSYS network slave boards you can turn any Z80-based, S-100 system into a superior multi-processor, multi-user network.

TurboDOS is faster than CP/M® for system functions. TurboDOS supports larger files (134 MB) and disks (1048 MB) and, unlike CP/NET*, it's compatible with nearly all 2.2 applications software. Many features which are optional, extra cost or not available at all in CP/M® are standard with TurboDOS. Add a MuSYS NET/82* and you've got a complete, hardware isolated network slave including Z80A CPU, two serial ports and many other advanced features. For special applications an additional bank of 64K memory is available.

Expand your S-100 system economically with MuSYS now! Ask for all the facts on TurboDOS and our expanding line of network slave boards. (Generous quantity/dealer discounts available.)

*TurboDOS is a trademark of Software 2000, Inc. CP/M and CP/NET are trademarks of Digital Research, Inc. NET/82 is a trademark of MuSYS Corp.

MuSYS
CORP
Specialists in Multi-user Microsystems

1752 B Langley
Irvine, CA 92714
(714) 662-7387
TWX: 910-595-1967
CABLE: MUSYSIRIN

more characters will be printed until the OPEN routine is executed again.

A second OPEN routine, called by the command SYS (7188), is provided to allow the VIC to communicate with the MX-80 directly in ASCII (American National Standard Code for Information Interchange) instead of VIC character patterns. This enables the VIC to take complete control of all of the MX-80's features. If you want complete control, remember to initialize the printer as necessary for your application. Notice that some of the VIC control characters for color change and cursor movement are also command codes to the printer (see table 1). If you aren't careful, you could get some strange results.

Listing 2 is the CHARACTER SET program that prints the entire VIC character set in the various modes. A sample of its output follows the program listing. The entire listing was printed with an MX-80 by the VIC.

The main routine in the VICEPS program is a subroutine called GRFOUT (see line 64). It is executed each time a character is sent to the VIC screen. It must convert the ASCII code into a VIC screen POKE code so that it can find the VIC character pattern in memory. A routine in the VIC KERNAL ROM at location E756 hexadecimal converts ASCII to VIC screen codes. Unfortunately, this routine is part of the display routine and cannot be called externally. GRFOUT is based on the logic in this routine. After converting ASCII to screen code, GRFOUT calls the subroutine SEND to convert the screen code to a graphic image and send it to the printer. SEND finds the character pattern the same way that the VIC TV controller chip finds the pattern; as a result, any character that can be displayed on the screen can be printed. If you've designed your own characters for the VIC, this routine will find them and print them.

After the appropriate character pattern is found, it must be converted into printer format. The VIC stores its character patterns in memory as rows of dots. Each of the 8 bytes of the pattern represents one row of dots of the character. The printer requires that the character be sent a column at a time. Row patterns must be converted into column patterns. Next, each column must be sent to the printer, which requires sending 8 bytes in the 480 DPL mode and sending 16 bytes in the 960 DPL mode.

VICEPS should be fairly easy to convert for use with another printer whose print head has 8 or more wires. Any changes required will be in the subroutines INILIN and INITPR (see lines 214 and 234). These routines send to the printer the commands to set the LPI and initialize the graphics mode. These commands will be different for another printer.

Some printers may represent a column of dots differently from the MX-80. The MX-80 uses the high-order bit of the byte to represent the top dot in the column and the low-order bit to represent the bottom dot. Other printers might do the reverse, which would make all characters come out upside-down. You can correct the situation by reversing the direction of the Y register-loop index in the pattern-conversion routine in the subroutine SEND. It currently starts Y at 7 and decrements through

Text continued on page 286

Okidata **MICROLINE 92**



\$524.88 UPS DELIVERED

- 160 characters per second, bi-directional, logic-seeking printhead action with 80 & 40 cps hi-res correspondence print modes
- 9 x 9 matrix produces correspondence, 10, & 17 cpi with true descenders: double width & download option for character sets standard
- Subscripts, superscripts, underlining, backspace, & forms control
- Friction & pin feed paper handling takes up to 3-part forms (8.5")
- Centronics parallel or RS-232C interfacing (specify)

Microline 93 (136 columns).....\$884.88

C. Itoh **F-10 Starwriter**

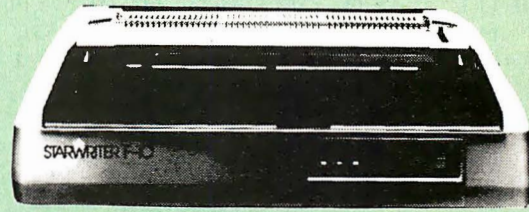

\$1379.88 UPS DELIVERED

- 40 characters per second, bi-directional, logic-seeking printhead action
- 136 column, friction fed, takes 15" paper & 3-part forms
- 96 character set, fully-formed letters on Diablo-compatible daisywheels for optimum print quality
- Subscripts, superscripts, underlining, backspace, & forms control
- Centronics parallel or RS-232C interfacing (specify)

F-10 Printmaster (55 cps).....**\$1679.88**
F-10 Tractor (Starwriter/Printmaster).....**\$289.88**

PRINTERS

Anadex

Anadex WP-6000A (P&S) ... **\$3099.88**
Anadex DP-9501 A (P&S) ... **\$1499.88**
Anadex DP-9620A (P&S) ... **\$1499.88**

Centronics

Centronics 122 (P)..... **\$829.88**
Centronics 122 (R)..... **\$949.88**
Centronics 352 (P&S)..... **\$1684.88**
Centronics 353 (P&S)..... **\$2329.88**

C. Itoh



C. Itoh Prowriter..... **\$399.88**
w/RS-232C..... **\$609.88**
C. Itoh Prowriter 2..... **\$734.88**
w/RS-232C..... **\$789.88**

Daisywriter



Daisywriter 2000 48K buffer (P&S)
sold only w/cable..... **\$1139.88**
Tractor..... **\$149.88**
Sheetfeeder..... **\$739.88**

Diablo

Diablo 620 (S)..... **\$1029.88**
Diablo 630 (S)..... **\$1969.88**
Diablo 630 KSR (S)..... **\$2694.88**
630/630KSR Tractor..... **\$289.88**

Star Micronics



Gemini 10 (P)..... **\$399.88**
Gemini 10 (P&S)..... **\$479.88**
Gemini 15 (P)..... **\$499.88**
Gemini 15 (P&S)..... **\$579.88**

PRINTERS

IDS



IDS Prism 80 (P&S)..... **\$1104.88**
above w/graphics..... **\$1189.88**
above w/sheetfeed..... **\$1294.88**
above w/4-color..... **\$1539.88**
IDS Prism 132 (P&S)..... **\$1269.88**
above w/graphics..... **\$1339.88**
above w/sheetfeed..... **\$1459.88**
above w/4-color..... **\$1699.88**
IDS Microprism (P&S)..... **\$579.88**

Okidata

Microline 80 (P)..... **\$339.88**
Microline 82A (P&S)..... **\$419.88**



82A Okigraph ROM..... **\$49.88**
80/82A Tractor..... **\$59.88**

PRINTERS

Okidata

82A Roll Paper Holder..... **\$49.88**
Microline 83A (P&S)..... **\$679.88**
83A Okigraph ROM..... **\$49.88**
Microline 84 w/graphics & tractor

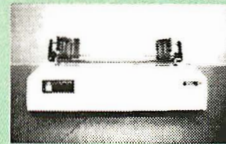

Parallel, 200 cps..... **\$1024.88**
RS-232C, 200 cps..... **\$1139.88**

NEC



NEC 3510 (S)..... **\$1929.88**
NEC 3530 (P)..... **\$1759.88**
NEC 3550 (P)..... **\$2199.88**
3500 Tractor..... **\$239.88**
NEC 7710 (S)..... **\$2399.88**
NEC 7720 KSR (S)..... **\$2799.88**
NEC 7730 (P)..... **\$299.88**

PRINTERS

NEC



NEC PC-8023A (P)..... **\$499.88**

Qume

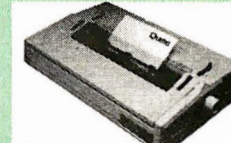

Qume Sprint 11 + Parallel or RS-232C,
includes cables..... **\$1449.88**

Smith-Corona

Smith Corona TP-1..... **\$579.88**
Specify either 10 or 12 cpi,
& parallel or RS-232C interface

Transtar

Transtar 130..... **\$759.88**

CALL FOR PRICES on Cannon, Data-south, Epson, Mannesmann Tally, Panasonic, Ricoh, Silver Reed, & others

Interfaces

PKASO card/cable..... **\$139.88**
IDS P ASO card/cable..... **\$159.88**
Parallel Card w/cable..... **\$89.88**
Grapplet+ w/cable..... **\$149.88**
CBM/PET w/cable..... **\$119.88**
TRS-80 Color RS-232C to
Parallel, w/cable..... **\$99.88**
VIC/Commodore 64 Serial Inter-
face w/cable..... **\$149.88**

Parallel Cables

IBM-PC..... **\$39.88**
TRS-80 Model I/III..... **\$29.88**
TRS-80 Model II/16..... **\$29.88**
Atari 800..... **\$39.88**
Osborne-1 (IEEE488)..... **\$39.88**
Prism 80/132/MicroPrism Centronics
cable adapter..... **\$20.00**
Centronics male/male..... **\$39.88**
Centronics male/female..... **\$39.88**

RS-232C Cables

DB-25 male/male..... **\$29.88**
DB-25 male/female..... **\$29.88**

Information & Orders
(603)-881-9855

Orders Only: (800)-343-0726

No Hidden Charges

FREE UPS shipping on all orders—No extra charge to use credit cards—All equipment shipped factory fresh with manufacturer's warranty—COD orders accepted (\$10 fee added)—No purchase orders accepted—No foreign or APO orders accepted—Minimum \$50 per order—This ad prepared in February; prices are subject to change.



HIGH TECHNOLOGY AT AFFORDABLE PRICES
THE BOTTOM LINE

MILFORD, NH 03055-0423 □ TELEPHONE (603) 881-9855

FACTORY DIRECT!!

IBM PERSONAL COMPUTER MEMORY

\$295.00

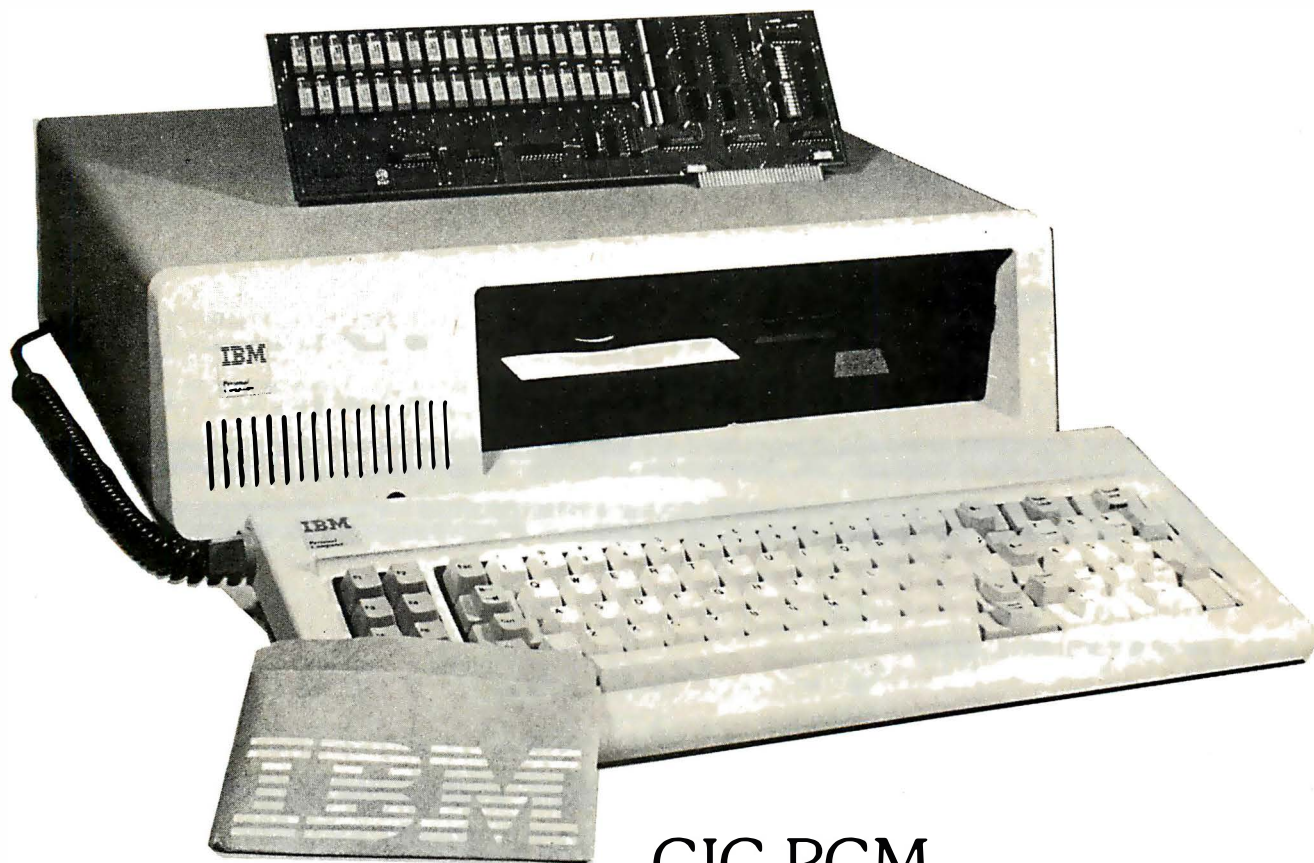

CIC-PCM

Designed Specifically for IBM's PERSONAL COMPUTER

FEATURES:

- 256K BYTE MEMORY WITH PARITY.
- ALL PARTS INDUSTRIAL GRADE.
- 1 YEAR PARTS AND LABOR WARRANTY.
- BUY FACTORY DIRECT AND SAVE!!

\$295.00

- PRICE INCLUDES: ELECTRONIC DISK AND DIAGNOSTIC SOFTWARE.
FREIGHT CHARGES ANYWHERE IN CONTINENTAL U.S.



Chrislin Industries Caribe, Inc.

P.O. Box FF, Canovanas, Puerto Rico 00629
(809) 725-2100 • (809) 876-6160

DISCOVER THE DYSAN DIFFERENCE

Dysan Software Duplication:

It's your name on the package label. And your company's reputation on the line. Whether your program retails for \$40.00 or \$400.00, or is for company internal distribution, the cost of duplicating it on diskettes is just a fraction of the value of your product. Doesn't it make sense to protect the time, money and talent invested in your software with the finest and most complete software duplication services available?

Quality Software Deserves the Quality Media.

Dysan's software duplication services are unsurpassed for fidelity of reproduction. Not only is your program copied unerringly onto the finest media made—the Dysan diskette—but it's also copied on proprietary equipment manufactured by Dysan, exclusively for Dysan. Plus Dysan offers you the widest variety of support services available—from software protection to serialization and packaging.

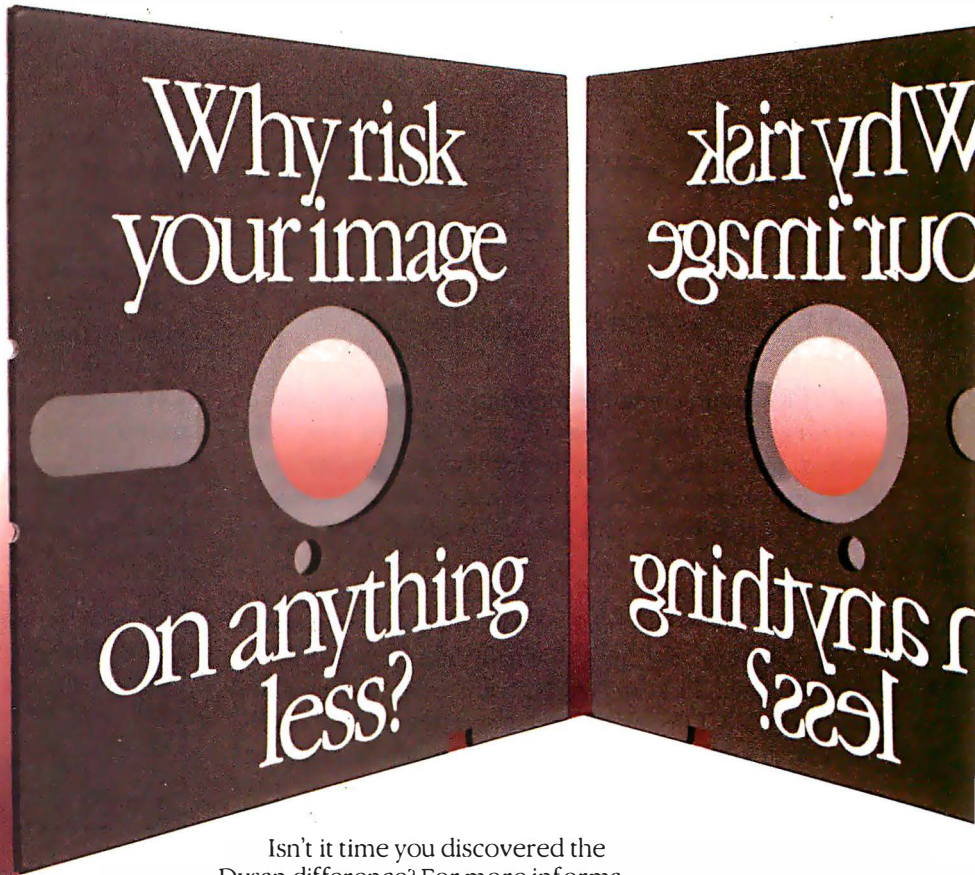

Isn't it time you discovered the Dysan difference? For more information on Dysan software duplication, fill out and return this coupon today, or call (800) 551-9000.



Circle 151 on inquiry card.



Dysan Software Duplication Division
5201 Patrick Henry Drive
Santa Clara, CA 95050
(800) 551-9000
(408) 988-3472

Please send me more details on
Dysan's Software Duplication Services.

Name: _____

Company: _____

Address: _____

City: _____ State: _____ Zip: _____

Phone: (____) _____

Listing 3: An alternate version of the SEND subroutine for the VICEPS program. This enables you to use the program with other printers that use the reverse of the MX-80's representation of dots in a column.

```

0168 1CEC          : CONVERT VIC PATTERN TO PRINTER PATTERN
0169 1CEC A0 00   LDY #0
0170 1CEE B1 FB   BYTLUP LDA (VICPAT),Y :GET A VIC PATTERN ROW
0171 1CF0 A2 00   LDY #0
0172 1CF2 0A     BITLUP ASL A :SHIFT EACH BIT INTO A
0173 1CF3 7E 97 1D ROR PRTPAT,X :COLUMN OF THE PRINTER PATTERN
0174 1CF6 E8     INX
0175 1CF7 E0 03   CPX #8 :GOT ALL 8?
0176 1CF9 90 F7   BCC BITLUP :NO, DO ANOTHER
0177 1CFB C8     INY :YES BUMP Y TO NEXT ROW OF VIC PATTERN
0178 1CFC C0 03   CPY #8 :DONE THEM ALL?
0179 1CFE 90 EE   BCC BYTLUP :NO, CONTINUE

```

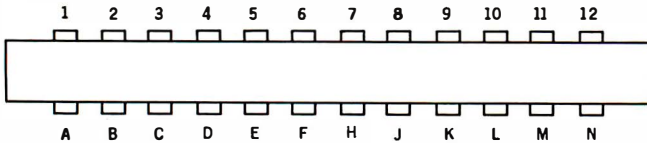

Figure 1: VIC-20 user port I/O connections.

would be incomplete but recognizable. The descenders on lowercase and special characters would be lost. This method might be acceptable for many applications. I have implemented both of the above solutions using my Base 2 7-wire printer. This method could also be used on the VIC-1515 printer.

VICEPS as shown in listing 1 resides in VIC memory at location 1C00 hexadecimal. It uses the top two pages of BASIC memory, the area normally used by BASIC for string storage. To keep BASIC from using this area and destroying VICEPS, you must move the end of BASIC memory down by using a POKE command to enter a 28 into locations 52 and 56. On an expanded VIC with more than 8K bytes of memory, 1C00 would not be a very

good place to locate VICEPS because it would be right in the middle of BASIC memory. Assembling VICEPS at a higher address would be better.

Conclusion

By interfacing a full-featured printer to the VIC-20, you can make lighter work of developing programs. And by breaking the VIC out of the benevolent grasp of Commodore-manufactured peripherals, you can further unleash the power of this talented computer. ■

The VICEPS program has been incorporated into a full-featured printer driver program for the Epson and other printers. The program supports VIC graphics and all Epson functions via standard BASIC OPEN, CLOSE, and PRINT# statements (no SYS calls). It also has a special mode that formats BASIC program statements for readability. It will communicate to the printer via either the parallel method described above or via an RS-232C interface at up to 9600 bits per second with handshaking. For more information contact United Microware Industries Inc., 3503C Temple Ave., Pomona, CA 91768.

SCOTCH DISKETTES at 50% off!

ALL 3-M MEDIA AVAILABLE at 50% or MORE OFF LIST PRICE

<p>Why settle for inferior substitutes when you can now get the very best media at unprecedented savings. Be it 8" or 5 1/4", hard- or soft-sectored: We are an Authorized 3-M Distributor and can ship it immediately.</p>	<table border="0" style="width: 100%;"> <tr> <th style="text-align: left;">Part #</th> <th style="text-align: left;">Examples:</th> <th style="text-align: left;">List</th> <th style="text-align: left;">OUR PRICE</th> <th style="text-align: left;">(per diskette. In box of 10, individual envelopes)</th> </tr> <tr> <td>744D</td> <td>5 1/4" SSDD (hard/soft sector)</td> <td>4.20</td> <td>\$1.96</td> <td></td> </tr> <tr> <td>745D</td> <td>5 1/4" DSDD (hard/soft sector)</td> <td>6.00</td> <td>2.84</td> <td></td> </tr> <tr> <td>741D</td> <td>8" SSDD (hard/soft sector)</td> <td>5.55</td> <td>2.84</td> <td></td> </tr> <tr> <td>743D</td> <td>8" DSDD (hard/soft sector)</td> <td>7.10</td> <td>3.29</td> <td></td> </tr> </table> <p><i>(even greater savings on diskettes in bulk pack—call for information)</i> Minimum order: 10 boxes. For orders of 1000 or more deduct 2%, for 5000 or more deduct 5%, for 10,000 or more deduct 7.5%. Call for savings or larger orders.</p>	Part #	Examples:	List	OUR PRICE	(per diskette. In box of 10, individual envelopes)	744D	5 1/4" SSDD (hard/soft sector)	4.20	\$1.96		745D	5 1/4" DSDD (hard/soft sector)	6.00	2.84		741D	8" SSDD (hard/soft sector)	5.55	2.84		743D	8" DSDD (hard/soft sector)	7.10	3.29	
Part #	Examples:	List	OUR PRICE	(per diskette. In box of 10, individual envelopes)																						
744D	5 1/4" SSDD (hard/soft sector)	4.20	\$1.96																							
745D	5 1/4" DSDD (hard/soft sector)	6.00	2.84																							
741D	8" SSDD (hard/soft sector)	5.55	2.84																							
743D	8" DSDD (hard/soft sector)	7.10	3.29																							

BHART

TELEX: 472-0127 ATTN: EMD

ORDERS & INFORMATION:
 Mo.-Fri. 9:00 AM-5:30 PM PST, Sat. 12:00 AM-5:00 PM PST
 1-(800) 845-5555 CA, AK, HI call (714) 783-1363

BANK REFERENCE: BARCLAYS BANK OF CALIFORNIA (213) 892-7244
 AMERICAN EXPRESS, VISA, MASTERCARD
 APO, FPO, INTERNATIONAL ORDERS ACCEPTED
 INC. P.O. Box 3791, Riverside, CA 92519

3M Authorized Distributor

Terms: Cashier's check, Visa, MasterCard, American Express (add 4% for credit cards). Purchase orders from approved organizations on 30 day net at 25% surcharge. COD at 10% surcharge. Shipping charges extra.

BYTE BOOK CLUB

Membership Order Card

Please enroll me as a member and send me the three choices I have listed below. Bill me only \$3.00, plus local tax, postage and handling. I agree to purchase a minimum of three additional books during my first year as outlined under the Club plan described in this ad. Membership in the club is cancellable by me any time after the three book purchase requirement has been fulfilled. A shipping and handling charge is added to all shipments.

Indicate below by number the books you want. A few expensive books (noted in the descriptions) count as more than one choice.

<input type="text"/>	<input type="text"/>	<input type="text"/>
----------------------	----------------------	----------------------

Name _____

Address/Apt. # _____

City, State, Zip _____

Corporate Affiliation _____

This order subject to acceptance by McGraw-Hill. All prices subject to change without notice. Offer good only to new members. Orders from outside the U.S. cannot be accepted.

BYTE BOOK CLUB

Membership Order Card

Please enroll me as a member and send me the three choices I have listed below. Bill me only \$3.00, plus local tax, postage and handling. I agree to purchase a minimum of three additional books during my first year as outlined under the Club plan described in this ad. Membership in the club is cancellable by me any time after the three book purchase requirement has been fulfilled. A shipping and handling charge is added to all shipments.

Indicate below by number the books you want. A few expensive books (noted in the descriptions) count as more than one choice.

<input type="text"/>	<input type="text"/>	<input type="text"/>
----------------------	----------------------	----------------------

Name _____

Address/Apt. # _____

City, State, Zip _____

Corporate Affiliation _____

This order subject to acceptance by McGraw-Hill. All prices subject to change without notice. Offer good only to new members. Orders from outside the U.S. cannot be accepted.



NO POSTAGE
NECESSARY
IF MAILED
IN THE
UNITED STATES

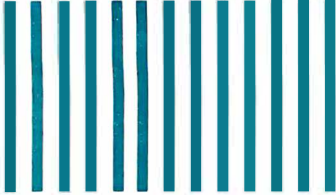

BUSINESS REPLY CARD

FIRST CLASS PERMIT NO. 42 HIGHTSTOWN, N.J. 08520

POSTAGE WILL BE PAID BY ADDRESSEE

BYTE BOOK CLUB

P.O. Box 582
Hightstown, New Jersey 08520



NO POSTAGE
NECESSARY
IF MAILED
IN THE
UNITED STATES

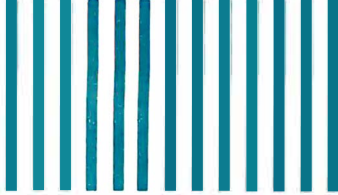

BUSINESS REPLY CARD

FIRST CLASS PERMIT NO. 42 HIGHTSTOWN, N.J. 08520

POSTAGE WILL BE PAID BY ADDRESSEE

BYTE BOOK CLUB

P.O. Box 582
Hightstown, New Jersey 08520

Introducing...the Byte Book Club

FORMERLY COMPUTER PROFESSIONALS' BOOK CLUB

POWERFUL TOOLS! POWERFUL SAVINGS!

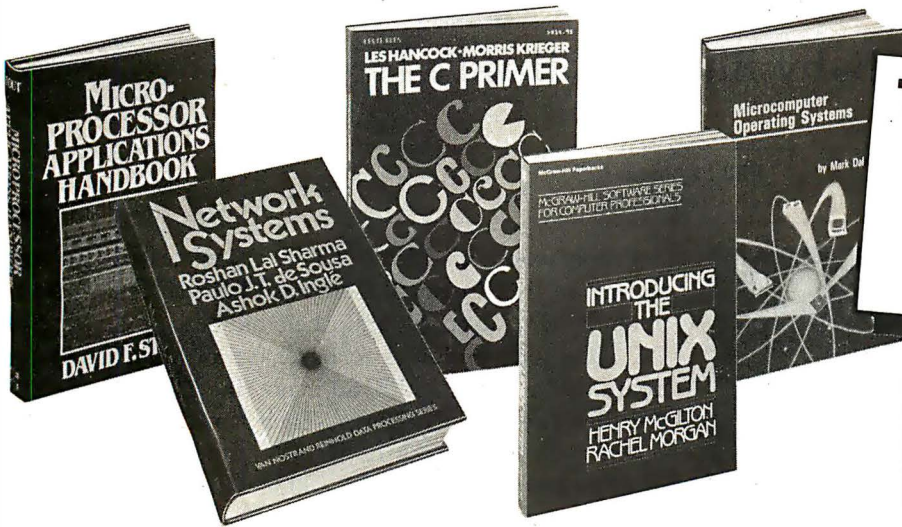

Take any 3 books
for \$1.00
only each
(Values up to \$63.00)

If you join now for a trial period and agree to purchase three more books—at handsome discounts—during your first year of membership. (Publishers' prices shown)

MICROPROCESSOR APPLICATIONS HANDBOOK By D. R. Stout
617/988B \$35.00
(Counts as 2 of your 3 books)

NETWORK SYSTEMS By R. Sharma, P. J. T. deSousa, A. D. Ingle
582557-0B \$29.95
(Counts as 2 of your 3 books)

SOFTWARE ENGINEERING: A Practitioner's Approach By R. S. Pressman
507/813B \$32.95
(Counts as 2 of your 3 books)

CIARCIA'S CIRCUIT CELLAR, Volume 2 By S. Ciarcia
109/63X \$14.75

COMPILER CONSTRUCTION: Theory and Practice By W. Barrett, and J. D. Couch
788/499B \$25.93
(Counts as 2 of your 3 books)

AN INTRODUCTION TO VISICALC® MATRIXING FOR APPLE® AND IBM® By H. Anbarlian
016/054 \$22.95

BUILD YOUR OWN Z-80 COMPUTER—and 280 USERS MANUAL. By S. Ciarcia & J. Carr
582337-3B \$29.90
(Counts as 2 of your 3 books)

MICROCOMPUTER OPERATING SYSTEMS By M. Dahmke
150/710 \$15.95

MINICOMPUTER AND MICROPROCESSOR INTERFACING By J. C. Cluley
582585-6B \$27.50
(Counts as 2 of your 3 books)

WORD PROCESSING BUYER'S GUIDE By A. Naiman
458/693 \$15.95

APPLE PASCAL By P. Luehmann
491/712 \$16.95

MICROCOMPUTER GRAPHICS AND PROGRAMMING TECHNIQUES By H. Katzan, Jr.
582576-7 \$18.95

BASIC: GETTING STARTED By W. S. Davis
582355-1 \$5.95

INTERFACE PROJECTS FOR THE TRS-80 By R. C. Hallgren
582466-3 \$18.95

PRINCIPLES OF INTERACTIVE COMPUTER GRAPHICS, 2/e By W. M. Newman & R. F. Sproull
463/387B \$32.50
(Counts as 2 of your 3 books)

THE SMALL COMPUTER CONNECTION By N. L. Shapiro
564/124 \$16.95

INVITATION TO FORTH By H. Katzan, Jr.
582284-9 \$17.50

TRS-80 GRAPHICS FOR THE MODEL I AND MODEL III By D. Kater & S. Thomas
333/033 \$12.95

DATABASE DESIGN 2/E By G. Wiederhold
701/326B \$32.00
(Counts as 2 of your 3 books)

CONVERSION OF COMPUTER SOFTWARE By J. R. Wolberg
582588-0 \$19.95

THE C PRIMER By L. Hancock & M. Krieger
259/81X \$14.95

INTRODUCING THE UNIX SYSTEM By H. McGilton & R. Morgan
450/013 \$18.95

PROGRAMMING WITH ADA: An Introduction by Means of Graduated Examples By P. Wegner
789/24X \$17.95

Why YOU should join the Byte Book Club now!

- **Best and newest books from ALL publishers!** Books are selected from a wide range of publishers by expert editors and consultants to give you continuing access to the best and latest books in your field.
- **Big savings!** Build your library and save money too! Savings range up to 30% or more off publishers' list prices—usually 20% to 25%.
- **Bonus books!** You will immediately begin to participate in our Bonus Book Plan that allows you savings up to 80% off the publishers' prices of many professional and general interest books!
- **Convenience!** 14-16 times a year (about once every 3-4 weeks) you receive the Club Bulletin FREE. It fully describes the Main Selection

and alternate selections. A dated Reply Card is included. If you want the Main Selection, you simply do nothing—it will be shipped automatically. If you want an alternate selection—or no book at all—you simply indicate it on the Reply Card and return it by the date specified. You will have at least 10 days to decide. If, because of late delivery of the Bulletin you receive a Main Selection you do not want, you may return it for credit at the Club's expense.

As a Club member you agree only to the purchase of three additional books during your first year of membership. Membership may be discontinued by either you or the Club at any time after you have purchased the three additional books. Orders from outside the U.S. cannot be accepted.



Fill out the card and mail today! If the card is missing, write to:

BYTE BOOK CLUB, P.O. Box 582, Hightstown, New Jersey 08520

Two Ways to Use CP/M-80 on the IBM PC

Xedex's Baby Blue and Byad's DS1

Phil Lemmons
West Coast Editor



Photo 1: The Baby Blue CPU Plus from Xedex converts your CP/M-80 files into PC-DOS format and attaches a header to the file to identify it. You don't have to keep track of two different file formats.

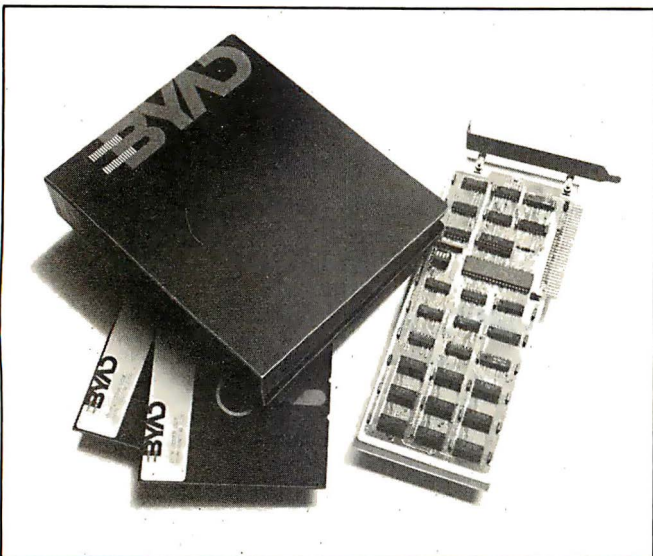

Photo 2: The DS1 from Byad uses a technically more elegant approach to integrating the Z80B system into the IBM PC. When the Z80B is in control, the 8088 uses its system memory for disk and print buffering.

People who own a lot of CP/M-80 software but want to buy an IBM Personal Computer have several choices about how to keep running their old software with the PC. One such option is to purchase an 8-bit processor board. Both Xedex and Byad make fine Z80B boards for the IBM Personal Computer. Each has a printed-circuit board with 64K bytes of RAM (random-access read/write memory) as well as the Z80B microprocessor. What distinguishes these boards is the software sold with each and the way they integrate with the IBM PC. Choosing between the boards is largely a matter of determining your software needs.

Xedex and Byad provide utility programs for converting some 5¼-inch CP/M-80 disk file formats to the format used by each of the new boards. Both companies found the problem of conversion much more complex than initially thought. (See the text box, "Reading CP/M-80 Disk Formats with the IBM PC," on page 298.) If you need to convert a lot of disk files (whether data or programs) for use with Xedex's Baby Blue or Byad's DS1, be sure that software is available from Xedex or Byad to handle conversion of your old disk format. If neither company has software to read your old disk format, you may still be able to send your old data to the IBM PC on a serial communications line. Both companies supply the necessary software for receiving data on the IBM PC as part of the standard DS1 package.

Xedex's Baby Blue CPU Plus

Xedex's software for the Baby Blue includes programs called Header, Bind, and Convert. Header must be added to the beginning of each CP/M-80 program in order for the program to run on Baby Blue under PC-DOS, IBM PC's operating system. (You don't actually get CP/M-80 with Baby Blue; it emulates CP/M.) Bind attaches Header to the beginning of CP/M-80 files. Convert takes CP/M-80 programs in any of four different disk formats—NEC PC-8001, IMS 5000, DEC VT-180, Heath/Zenith (48 tracks per inch)—converts them to PC-DOS format, and then attaches Header to the beginning of the

THE PRICE SLASHER!

APRIL SPECIAL: GEMINI 10 BY STAR MICRONICS \$335

**ACE 1000
1200**
..... CALL

The Professional Personal Computer



FRANKLIN
COMPUTER CORPORATION

- TEXAS INSTRUMENTS CALL
- ALTOS CALL
- ATARI CALL
- COMMODORE CALL

DISK DRIVES

HARD DISKS AVAILABLE CALL

APPLE COMPATIBLE

- Single w/Power Supp & Shugart Dr. \$299.
- Double w/Power Supp & Shugart Dr. 599.
- Controller card. 85.

MICRO SCI

- A35 w/Controller 399.
- A40 w/Controller 466.
- A70 w/Controller 593.

PRINTERS

OKIDATA

- Microline 80A. \$399.
- Microline 82A. 459.
- Microline 83A. 720.
- Microline 84(PAR). 1149.
- Microline 2410P 2599.
- Microline 92 599.
- Microline 93 CALL

BROTHER

- HR-1 Daisy Wheel - Parallel 889.
- HR-1 Daisy Wheel - Serial 969.
- Forms Tractor 149.

STAR MICRONICS

- GEMINI 10 399.
- GEMINI 15 559.

DIABLO

- 630, RS-232, Daisy Wheel 1995.
- 630 API-Apple, IBM TRS 80 1795.
- 620 1324.

MANNESMANN TALLY PRINTERS

- MT 160 L 879

MONITORS & TERMINALS

- USI
- 12" Hi Res Green \$149.
- 12" Amber 159.

SANYO

- 12" Black & White 123.
- 12" Green Screen 135.
- 13" Color 420.
- 13" Color Hi-Res 885.

HAZELTINE

- Espirit 585.
- Espirit II 649.

AMDEK

- 12" Green 169.
- 13" Color I 358.
- Color I Hi-Res 849.
- Color III RGB Color 475.

TELEVIDEO

- 910 639.
- 912 745.
- 925 825.
- 950 989.

NEC

- JB 1260 12" Econo Green
- Hi-Res 120.
- JB 1201 12" Green Screen
- Hi-Res w/Sound 169.
- JC 1201 12" Color 349.
- JC 1203 12" Hi-Res Color
- for IBM PC 799.
- Cable for IBM PC 19.

ACCESSORIES

SORRENTO VALLEY ASSOCIATES

- App-L-cache 256K Memory \$995.

SSM

- AS10 Apple Serial I/O Card 129.
- AP10 Apple Parallel I/O Card 75.
- AIO-II 164.

TG PRODUCTS

- Game Paddles 32.
- Joy Stick 44.

ORANGE MICRO

- GRAPPLER PLUS 139.

KRAFT SYSTEMS

- JOYSTICK 49.

MPC PERIPHERALS

- Bubble Memory NEW 679.
- 16K Memory Board for Apple II 62.
- 32K Memory Board for Apple II 139.
- Parallel Printer Card for Apple II 72.
- Upper and Lower Case ROM PROM-IT: Eprom for the Apple II 99.
- Serial Input/Output Card for Apple II 119.
- 16/32K Expansion Memory Board 125.

M&R ENTERPRISES

- SUP R TERMINAL 80 Column Video Board 269.

PRACTICAL PERIPHERALS

- Microbuffer II 16K for Apple II 239.
- Microbuffer II 32K for Apple II 279.
- 8K Serial Buffer for Epson Printer 129.
- 16K Parallel Interface for Epson Printer 129.

MICROSOFT

- Z-80 Softcard for Apple 249.

MOUNTAIN COMPUTER

- CPS Multifunction for Apple 165.
- The Clock for Apple 235.
- Romplus 119.
- Ramplus 16K for Apple 135.
- Ramplus 32K for Apple 152.
- Music System for Apple 319.
- Rom Writer for Apple 139.

SEATTLE COMPUTER

- 64K RAM + for the IBM PC 385.
- 128K RAM + for the IBM PC 529.
- 256K RAM + for the IBM PC 789.

CALIFORNIA COMPUTER SYSTEMS

- Asynchronous Serial Interface 145.

VIDEX, INC.

- Videoterm 269.
- Softvideo Switch 29.
- Inverse Chip 24.
- Enhancer II 119.

SOFTWARE FOR CP/M

- Crosstalk. MICROSTUF \$162.
- Supercalc SORCIM 205.
- The Word Plus OASIS 119.
- Spellbinder. LEXISOFT 279.
- T/Maker II LIFEBOAT 219.
- Supervyze EPIC SOFTWARE115.
- Condor III CONDOR 799.

ASHTON-TATE

- dBase II 499.

MICROPRO

- Wordstar CALL
- Mailmerge CALL
- Calcstar CALL
- Datastar CALL
- Supersort CALL
- Spellstar CALL
- Infostar CALL
- Reportstar CALL

MICROSOFT

- Fortran 80 369.
- Macro 80 189.
- Basic Compiler 319.
- mu/MATH/mu/SIMP 80 219.
- Cobol 80 595.
- Basic 80 299.
- Edit 80 96.
- mu/LISP/mu/STAR 80 175.
- Multi Plan *Also Available For Apple 205.

SOFTWARE DIMENSIONS, INC.

- Accounting Plus CALL

SOFTWARE FOR IBM

- Write On DATAMOST \$99.
- Condor II CONDOR 449.
- Crosstalk MICROSTUF 165.
- MathMagic ISM 75.
- The Tax Manager MICROLAB 195.
- dBase II ASHTON-TATE 499.

SORCIM

- Supercalc 205.
- SuperWriter 295.
- Spellguard 229.

SELECT INFORMATION SYSTEMS

- Select Word Processor w/Superspell 369.

VISICORP

- Visicalc 256K Version 185.
- Visitrend/Visipilot 235.
- Visidex 185.
- Visifile 235.
- Desktop Plan I 249.

MICROPRO

- Wordstar CALL
- Mailmerge CALL
- Spellstar CALL

I.U.S.

- Easyspeller 139.
- Easyfiler 289.
- Easywriter II 269.

SOFTWARE DIMENSIONS, INC.

- Accounting Plus CALL

CONTINENTAL SOFTWARE

- The Home Accountant Plus 119.

SOFTWARE FOR APPLE

- BRODERBUND
- Serpentine \$29.
- Choplifter 29.

MICROSOFT

- Typing Tutor II 18.
- Adventure 25.
- *Fortran 80 165.
- A.L.D.S. 100.
- *Basic Compiler 315.
- mu/MATH/mu/SIMP 80 200.
- Olympic Decathlon 25.
- *Cobol 80 595.
- M/Sort 156.
- Softcard Premium System 599.
- Time Manager 119.

VISICORP

- Visicalc 209.
- Visiterm 85.
- Visiplot 169.
- Visidex 209.
- Visitrend/Visiplot 249.
- Visifile 209.
- Visischedule 249.
- Desktop Plan II 209.

MICROPRO

- *Calcstar CALL
- *Datastar CALL
- *Supersort CALL
- *Wordstar CALL
- *Mailmerge CALL
- *Spellstar CALL
- Infostar CALL
- Reportstar CALL

SORCIM

- Spellguard 229.

SOUTHEASTERN SOFTWARE

- Data Capture 4.0 58.

EDU-WARE

- Step by Step. PROG. DESIGN 59.
- Datafax LINK SYSTEMS 149.
- dBase II ASHTON-TATE 499.

CALL FOR MORE APPLE SOFTWARE!!

Note: Apple is a registered trademark of Apple Computer, Inc. C/PM is a registered trademark of Digital Research

MODEMS

HAYES MICROCOMPUTER PRODUCTS

- Smartmodem \$229.
- Smartmodem 1200 599.
- Micromodem II w/Term. Pgm. 310.
- Micromodem 100 325.
- Chronograph 199.

NOVATION

- Cat. 169.
- D-Cat. 185.
- Auto Cat. 293.
- Apple Cat II 309.
- Apple Cat II - 212 CALL
- J-Cat 135.
- 103/212 Smart Cat. 499.

WE ACCEPT • MONEY ORDER • C.O.D. • CASHIERS or CERTIFIED CHECK
• PERSONAL CHECK (allow 10 days to clear) • BANK WIRE TRANSFERS
• VISA MASTERCARD (add 2%)

Add 3% for shipping, handling & insurance (\$5 min.) Calif. residents add 6% tax. All equipment is new, comes with manufacturers guarantees. PLUS we guarantee it for 30 days and pay shipping charges on any returns. All equipment subject to price change & availability without notice. Check quantity discounts.



9434 Chesapeake Drive • San Diego, CA 92123

ORDERS ONLY: 800-752-1341
CALIFORNIA ORDERS: 619-277-8002
INFORMATION: 619-277-8006

At a Glance

Name

Baby Blue CPU Plus

Type

Z80B card for running CP/M-80 programs on the IBM Personal Computer

Manufacturer

Xedex Corporation
Box 222, Route 59
Suffern, NY 10901
(914) 368-0353

Price

\$600

Hardware

A printed-circuit board with a Z80B microprocessor and 64K bytes of dynamic RAM with parity

Software

Header, a prefix for CP/M-80 programs that enables them to run under PC-DOS in the IBM Personal Computer; Bind, a program that attaches Header to the beginning of CP/M-80 files; Convert, a program that converts four 5¼-inch CP/M-80 disk formats—NEC PC-8001, IMS 5000, DEC VT-18, Heath/Zenith (48 tracks per inch)—and the CP/M-86 format for the IBM Personal Computer into IBM PC-DOS disk format

Documentation

Forty-page typeset manual with index

Audience

Any IBM PC owner who needs to run CP/M-80 software

DOS finds the Xedex Header on a file, the operating system sends the program to Baby Blue's Z80B for execution. While the Z80B executes the CP/M-80 program, the Header sends CP/M-system calls to the IBM PC's 8088 microprocessor. Then the 8088 manages input/output for the CP/M program. Software with the Baby Blue also includes a program for moving files through the PC's serial port.

Baby Blue is easy to install and use, performs as advertised, and has a superb user's guide. One of Baby Blue's beauties is that after converting your 8-bit programs to PC-DOS format, you no longer have to worry about managing two different file formats on one computer. You don't have to keep track of which disks are CP/M-80 disks and which are PC-DOS disks. Most important of all, any CP/M-80 program or PC-DOS program can access and process any of your data files, because they are all in PC-DOS format. Well, perhaps not any program. The Baby Blue user's guide says (pages 21 and 22), "We have never promised anyone perfect compatibility with CP/M-80. . . . What's of interest to us and to the majority of users is compatibility with plain-vanilla, no-tricks, maximally portable, hardware-independent CP/M-80 programs." The only software that the Baby Blue definitely won't run is CBASIC. The Baby Blue console interface emulates the Televideo 950 terminal to support screen handling (cursor placement, etc.) of CP/M-80 programs.

Baby Blue is easy to install because the procedure is straightforward and the user's guide is written and illustrated well. Photographs orient the user at different stages of installation. The instructions for resetting the IBM and Baby Blue switches to configure both the PC and the Z80B board for different amounts of memory leave nothing to chance. Side-by-side illustrations of the correct positions of all eight switches for the PC and Baby

converted file. In other words, Convert does the same work as Bind but also converts the file to PC-DOS format. After the Header is added, whether by Bind or by Convert, the user can invoke the CP/M-80 program just as if it were a program written for the IBM PC. When PC-

WHY YOU SHOULD MAKE A CORPORATE CONTRIBUTION TO THE AD COUNCIL

The Advertising Council is the biggest advertiser in the world. Last year, with the cooperation of all media, the Council placed almost six hundred million dollars of public service advertising. Yet its total operating expense budget was only \$1,147,000 which makes its advertising programs one of America's greatest bargains . . . for every \$1 cash outlay the Council is generating over \$600 of advertising.

U.S. business and associated groups contributed the dollars the Ad Council needs to create and manage this remarkable program. Advertisers, advertising agencies, and the media contributed the space and time.

Your company can play a role. If you believe in supporting public service efforts to help meet the challenges which face our nation today, then your company can do as many hundreds of

others—large and small—have done. You can make a tax-deductible contribution to the Advertising Council.

At the very least you can, quite easily, find out more about how the Council works and what it does. Simply write to: Robert P. Keim, President, The Advertising Council, Inc., 825 Third Avenue, New York, New York 10022.



A Public Service of This Magazine & The Advertising Council.

The cost of preparation of this advertisement was paid for by the American Business Press, the association of specialized business publications. This space was donated by this magazine.

Blue cover every possibility in 32K-byte increments all the way from 128K bytes (including Baby Blue's own 64K bytes) to 544K bytes. Steve Walton, the author of the Baby Blue user's guide, could do the microcomputer world a great service by teaching courses in how to write clear and pertinent documentation.

If you already own 8-bit versions of your favorite applications programs, you will probably want to convert them and run them on Baby Blue. It is worth noting, however, that Xedex sells versions of Wordstar and Mailmerge for Baby Blue. In fact, Xedex has done a better job of adapting Wordstar to run on Baby Blue than Micropro has done of converting Wordstar to run on the IBM PC's 8088. Xedex's version of Wordstar makes better use of the IBM PC's function keys by both using more keys and making better choices of which control codes are sent by the keys. Xedex sells Baby Blue, Wordstar, and Mailmerge as a package for a total of \$980. In effect, you get the 8-bit versions of both Mailmerge and Wordstar for \$380. Xedex also offers Personal Pearl and the Baby Blue for \$650.

Note that Baby Blue's software does not include the CP/M-80 operating system and its utilities. You do not receive a license to CP/M-80 when you buy Baby Blue. Header and Bind just enable Baby Blue to execute machine-language command (.COM) files that will execute under CP/M-80. The usual procedure when selling one machine and buying another is to write the publisher of each program and pay a small fee to transfer your license from the old processor to the new one. Presumably you should do that before using Header and Bind to make your old CP/M-80 programs run on Baby Blue.

Byad's DS1

When you buy Byad's DS1, you buy both a Z80B board and a license to CP/M-80, including all its utilities. Obviously this implies complete compatibility with CP/M-80 (although some versions of CP/M-80 may differ in disk formats and hardware-specific features). Byad now sells CP/M-80 version 2.2 with DS1 but will also offer CP/M-Plus, the greatly enhanced new version of the venerable 8-bit operating system. For those IBM PC owners who have chosen CP/M-86 or Concurrent CP/M-86, the Byad DS1 (or its cousin, the DS2, which has its own RS-232C serial port that can also drive RS-422A lines) is the logical choice as a CP/M-80 card. The DS1 and DS2 use the same disk format on the IBM PC as CP/M-86.

The DS1's software includes programs called Transfer, Filex, and Setup as well as the usual CP/M-80 utilities (STAT, PIP, ED, etc.). Transfer enables you to capture data coming through the IBM PC's serial port. Filex lets you read certain 5¼-inch disk formats (including NEC PC-8001, Televideo, Cromemco, Heath/Zenith, Intertec Superbrain, and others) into the DS1 format. Setup is necessary for configuring the system after installing the DS1 board. Among other things, Setup lets you enhance CP/M by setting aside some of the PC's memory to serve as disk buffers, a print buffer, a serial-in buffer, and a

Thunder Tector
UNINTERRUPTIBLE POWER SUPPLY

TM



DON'T BE LEFT IN THE DARK!
For \$295, you can protect **YOUR**
Data, Time and Computer.

Protect your computer operation from loss of data files, lost keyboard input, and questionable integrity of stored information due to power failure. Operation is completely automatic, just attach your own 12V battery, or purchase below.

Available for:

Apple, Radio Shack, IBM, Olivetta,
and most other personal and business computers.
Specify equipment to be attached when ordering.

If not completely delighted, return in original condition within 30 days for refund. Ten percent restocking fee will be charged. Ninety-day factory warranty.

Gel battery pack available with cables: 1-amp. computers - \$65; 2-amp. computers - \$111.

For fastest delivery, send certified check or money order payable to "Thunderhawk." Send 10% with C.O.D. orders. Sent FOB, Texas. Price subject to change without notice. Texas residents add 5% sales tax. Broad selection of power ranges available for larger computers — call for prices.

DEALER INQUIRIES INVITED — send on letterhead.

Thunderhawk Manufacturing (214) 586-6256
A Division of Thunderhawk Corporation
P.O. Box 573
Jacksonville, TX 75766

© 1983 Thunderhawk Corporation

Dogged attempt to learn a second language.



CP/M is a registered trademark of Digital Research Corp. Apple is a registered trademark of Apple Computer, Inc. IBM is a registered trademark of International Business Machines Corp.

For the name of the dealer nearest you, phone (800) 227-2400, ext. 948; in California, (800) 772-2666, ext. 948. For more information,

And now, InfoStar.™

The first DBMS you can use without speaking programmerese.

So put away your GO TOs and DO WHILEs.

InfoStar is one microcomputer data base system that doesn't ask you to write in code. Or learn a programming language. Instead you make selections from an on-screen menu written in one easy language. English.

Which means you don't have to be a programmer or computer jock to use it. But, in case you are, there's something in it for you, too.

With InfoStar, you can generate a custom application four times faster than with other DBMS software.

Reason being it has a lot of the features that made WordStar® the standard in the industry. For instance, select-as-you-go menus prompt you through all procedures. And to format a data entry form or report, you simply draw it on the screen.

We've said it before: what you see is what you get.

But, of course, that's not all you get. Fact is, InfoStar has more informative (and self-documenting)

capabilities than you've come to expect from any microcomputer DBMS.

Starting with report writing. A custom report feature — complete with transactional updating and exception processing abilities — lets you format, manipulate and merge countless different ways. And a quick report feature lets you finish faster than you can count them — usually in 60 seconds or less.

Not that you have to slow down to sort things out either. Because InfoStar can sort five to six times faster than any other DBMS in its class.

And for data entry, there are high-end minicomputer features. Like batch editing. And 200 editing mask combinations, to name a few.

All that's required of you is that you have an IBM PC, Apple II or CP/M-based computer. And that you take a trip over to your local computer store to ask about InfoStar.

They don't speak programmerese.

But they're happy to talk business.



MicroPro
The Microcomputer Software Company

At a Glance

Name

DS1

Type

Z80B card and CP/M-80 operating system for the IBM Personal Computer

Manufacturer

Byad Inc.
5345 North Kedzie Ave.
Chicago, IL 60625
(312) 539-4922

Price

\$660

Hardware

A printed-circuit board with a Z80B microprocessor and 64K bytes of dynamic RAM with parity

Software

CP/M-80 and all its utilities; Setup configures the DS1 for different hardware and terminal emulation; Format formats disks; Filex converts files from certain CP/M-80 5¼-inch disk formats (including NEC PC-8001, Televideo, Cromemco, Heath/Zenith, and Intertec Superbrain) to Byad format; and Transfer enables the DS1 to receive files from another CP/M-80 computer

Documentation

Preliminary at time of review

Audience

Any IBM PC owner who needs to run CP/M-80 software

serial-out buffer. You can also choose to have the DS1 emulate one of three different terminals: the DEC VT-52, the Lear Siegler ADM 31, or the Heath H-19.

Installation of the DS1, following the **instructions** in the *preliminary* version of the manual, was somewhat awkward. The manual was about average; the only serious lack that I noted was instructions for setting the PC's switches to accommodate different amounts of memory. The blame for the awkwardness of installation, however, goes more to the procedure itself than to the manual. You must remove any other memory expansion boards from the IBM PC while installing the DS1. You must then set the PC system board switches for either 48K or 64K bytes of RAM. After putting in the DS1 board, you close up the system to see whether it will still run PC-DOS. Having done this, you remove the PC-DOS disk and boot the Byad CP/M-80 system and run some CP/M utilities (such as STAT, the disk status command) to confirm that CP/M works. No problem. But then you have to configure the system to use any memory not on the PC's system board or the Byad board.

Configuration takes two steps: first, edit the Byad file called SETUP.CMD; second, run SETUP.CMD. It sounds easy, but you have to use the CP/M editor ED to edit SETUP.CMD. ED is a primitive editor, and most people who use CP/M-80 use another editor. I had to reread the old Digital Research instructions for using ED in order to install the DS1.

Having relearned ED, I was all set to reconfigure the system for my expansion memory, which required entering the correct segment addresses. The DS1 instructions gave only four possibilities, so I was off to the IBM PC manuals. Having decided at last on the segment addresses, I went on editing SETUP.CMD in order to configure some of the DS1's buffers. I wanted to try using 64K bytes of RAM as a print buffer, but because I hadn't yet put back my own 256K-byte memory board or reset the system board switches, Setup informed me there was not enough memory for the desired buffer. I should have realized that. But I still faced a problem: I couldn't configure the system for my hardware until my own memory board was installed and the switches were adjusted, but the instructions told me that I also couldn't use the configuration procedure until after removing my memory board—sort of a "catch-22" installation procedure. The solution was to go through the setup procedure for one set of parameters, reinstall my memory board, and then repeat the configuration procedure. At length, after re-reading the Byad preliminary documentation and re-examining the ED documentation, I succeeded in installing the DS1. Of course, although the setup procedure is awkward and time-consuming, installation is usually a one-time event, and the DS1 documentation was preliminary.

To use CP/M-80 with the Byad board, you just boot the IBM PC with the Byad system disk in drive A. After doing so, I had no difficulty in running a variety of CP/M-80 applications programs on the DS1. Performance seemed excellent.



TEAR OUT AND COMPARE TO 3278s

THE PCI 78, AN ASCII SOLUTION THAT'S KEYSTROKE FOR KEYSTROKE 3270 KEYBOARD COMPATIBLE. SNA/SDLC 3270 EMULATION WITH PCI'S 1076.

Name _____
Company Name _____
Address _____
City _____ State _____ Zip _____
Phone _____

Send me more information on the PCI 78 and PCI 1076.
 Send me information on all PCI products.

PCI PROTOCOL COMPUTERS, INC.
(800) 423-5904
(213) 716-5500 (In California)

6150 Canoga Ave. Suite 100, Woodland Hills, CA 91367-3773

Before you bet your software business on an OS, look who's betting on MS-DOS and XENIX.

A waiting market. If you write and sell 16-bit software, MS-DOS and XENIX give you the largest installed base. In fact, over fifty 16-bit manufacturers offer their microcomputers with MS-DOS or XENIX. IBM, Victor, Altos, Wang, Radio Shack, Zenith and Intel, to name just a few. And the list is growing. That means there's a ready and expanding market for your 16-bit applications software.

The UNIX™ connection. XENIX is the multi-user, multi-tasking, UNIX-derived operating system for 16-bit microcomputers. MS-DOS 2.0 is Microsoft's single-user OS. MS-DOS and XENIX share hierarchical file structure and I/O redirection, including simple piping. MS-DOS 2.0 also provides XENIX-compatible system calls. That means there's a migration path for programs written to run under MS-DOS and XENIX. What's more, both MS-DOS and XENIX are supported by Microsoft® languages. Which means you can look to a single supplier for total support.

Comprehensive support. Microsoft offers you a full product support program. Excellent documentation. Plus continual enhancements to both languages and operating systems. Your applications programs can even be listed in Microsoft's growing Source Directory of 16-bit applications packages. Contact us for current software offerings and vendors.

Leadership. Microsoft led the world into the 8-bit micro-computer marketplace with

the first BASIC for microcomputers. Now, we're leading it into the 16-bit market with single and multi-user operating systems. Fully supported by Microsoft.

Bet the winner. If you're writing and marketing software in the 16-bit marketplace, MS-DOS and XENIX are setting the standard. In fact, they're the standard operating systems for the world's largest selling 16-bit microcomputer systems. Which means your market is already there... and growing. Contact us for complete information. Before you bet your software on an operating system, look where your market is betting.

BETTER TOOLS FOR MICROCOMPUTERS

MICROSOFT™

MICROSOFT CORPORATION
10700 NORTHUP WAY
BELLEVUE, WASHINGTON 98004

Microsoft is a registered trademark, and MS, XENIX and the Microsoft logo are trademarks of Microsoft Corporation. UNIX is a trademark of Bell Laboratories.



The Best In Price, Selection and Delivery

Professional Quality

Call Now TOLL FREE
800-368-3404

(In VA, Call Collect 703-237-8695)

AMPEX • INTERTEC • TEXAS INSTRUMENTS • GENERAL DATA
COMM. • ANDERSON JACOBSON • C. ITOH • QUME • BEEHIVE •
DATASOUTH • DIABLO • CENTRONICS • NEC • PRENTICE

MICROS

INTERTEC SUPERBRAIN II

64K DD* ONLY \$1895
64K DD* ONLY \$2295
64K SD* (96TPI) ONLY \$2695

*(includes M/Soft BASIC)

DDS-10 Meg
(Hard Disk) ONLY \$3195

DYNABYTE
PRINTERS Call

NEC

7710 Ser. \$2149
7715 \$2196
7730 Par. \$2149
7720 \$2449
7725 \$2496
Std. Tractor 77 xx \$ 199
3510 \$1390
3510EX Call for Special Price
3515 \$1395

DATASOUTH

DIABLO
620-SPI \$1144
630-R102/147 \$1949
630-ECS Call
630-R155 \$1745
*(for IBM P.C., Apple II, TRS-80)
630-K104 (KSR) \$2385

QUME

Sprint 9/45 FP \$1794
Sprint 9/55 FP \$2119
Sprint 9/55 FP/XMEM \$2186
Sprint 9/55 LP/XMEM \$2094
Sprint 11/40-PLUS Call
Bi-Dir. Forms Tractor \$ 199

CENTRONICS: 34/38

Call

TERMINALS

AMPEX
D80 \$ 699

BEEHIVE (SMART DISPLAY)
DM5 Call
DM5A Call
DM310 (3101 Emulator) Call
DM 3270 (3270 Emulator) Call
Protocol Converter Call

QUME
QVT-102 \$ 594
QVT-103 \$ 739

C. ITOH
CIT 101 \$1350
CIT 161 (Color) Call

TEXAS INSTRUMENTS
745 Standard \$1390
745 Std. (Reconditioned) Call

In addition, we can make EIA RS 232 or RS 449 cables to your order, and supply you with ribbons, printer stands, print wheels, thimbles for all printers listed. And many, many more items. CALL NOW.

All items shipped freight collect either motor freight or UPS unless otherwise specified. All prices already include 3% cash discount. Purchase with credit card does not include discount. Virginia residents, add 4% Sales Tax. For fastest delivery send certified check, money order or bank-wire transfer. Sorry, no C.O.D. orders. All equipment is in factory cartons with manufacturers warranty (honored at our depot). Prices subject to change without notice. Most items in stock.

**TERMINALS
TERRIFIC**



Terminals Terrific, Inc., P.O. Box 216, Merrifield, VA 22116
Phone: 800-368-3404 (In VA, Call Collect 703-237-8695)

[Late notes: Scott Bartky of Byad informs me that the installation procedure has been simplified since I used the system. The instructions now require using ED to edit only a single line of text and show exactly what the user must type to edit that one line. In addition, the instructions list the segment address that must be entered for any amount of memory that may be in the machine.]

At Comdex in November, Byad and Digital Research announced an agreement under which Byad will produce a new Z80B card to be called the CP/M Card. The new card will be equipped with 256K bytes of RAM, a Z80B, and a serial port. Digital Research acquired all rights to the CP/M Card, including the marketing rights. The availability of the CP/M Card with CP/M-86 for the IBM PC will enable CP/M users to run 8- and 16-bit software without worrying about maintaining two different disk file formats. Using the CP/M Card along with Concurrent CP/M-86 will make possible running a CP/M-80 program as one task while the 16-bit operating system is in control. Byad itself will also be bringing out a Z80B board with up to 256K bytes of memory and is making its boards compatible with PC-DOS, no longer requiring the user to keep separate disks for PC-DOS and CP/M-80.

Conclusion

If you just want to run your old 8-bit machine-language programs on your IBM PC, then Xedex's Baby Blue CPU Plus probably suits your needs. If you want to continue doing work with the CP/M-80 utilities or to keep revising your old 8-bit assembly-language programs, then the Byad DS1 is the better choice (though you can use CP/M development tools, languages, linkers, etc., with Baby Blue). Another major factor in deciding on one of these two boards is your choice of 16-bit operating systems for the IBM PC. If you are using PC-DOS (Microsoft's MS-DOS) exclusively, you will want Baby Blue CPU Plus. If you are using Digital Research's CP/M-86 or Concurrent CP/M-86, you will want the DS1. ■

Reading CP/M-80 Disk Formats with the IBM PC

W. Scott Bartky
Byad Inc.
5345 North Kedzie Ave.
Chicago, IL 60625

In designing a Z80B board to let users run CP/M-80 on the IBM Personal Computer, we encountered several obstacles that made it difficult to read CP/M-formatted 5¼-inch soft-sectored disks on that machine. Although the disks were supposedly physically compatible with the PC, a combination of three factors determined whether or not a successful read operation could take place.

**We speak
your language
and translate
your software needs
into efficient and
Quality Services...**

DMA products operate
on the full range of 8080-8088
processors, including the IBM-PC

Here's what you can do!

Data Base Management
The FORMULA.

The Application Generator™

This unique software package lets you create sophisticated business application software without programming. The FORMULA builds files, reports, updates, sorts, and menus and links them all according to the user's specifications. It incorporates features of a data base manager, a word processor, and a compiler into the first "system language" for microcomputers.

Communications

ASCOM™

ASCOM™ is the most versatile asynchronous communication package for microcomputers on the market. It features interactive, menu-driven, and batch operations; supports auto-answer and auto-dial modems; includes most popular protocols; provides network simulation; and many other options. Xerox Corporation, NCR, Monroe Systems for Business, and the big 8 accounting firms use ASCOM.

Utilities

EM80/86™

This software emulator lets you use eight bit software on sixteen bit microcomputers without hardware modifications.

UT-86™

This package of user-friendly utilities for the IBM Personal Computer and similar systems includes copying, directory sorting, patching, and a general purpose file print utility.

Coming Soon

DMA."C"™ — A "C" language compiler which will generate either Z80 or 8086 assembly language code. Due to a unique optimization routine which is based upon a functional "P-code" model, the efficiency of DMA."C" will far exceed that of existing compilers.

SYNC/COM™ — A bisynchronous communication package that will be configurable for a variety of systems and include a flexible interface to the operating system.

The 8086 O. S. Converter™ — A program which will permit programs written for Digital Research's CP/M-86™ to execute under IBM's PC DOS.



WE SPEAK YOUR LANGUAGE WE SPEAK YOUR LANGUAGE WE SPEAK YOUR LANGUAGE

DYNAMIC MICROPROCESSOR ASSOCIATES, INC.

545 FIFTH AVENUE, NY, NY 10017

Dealer Inquiries only • (212) 687-7115

One factor was a problem in the disk-controller hardware. The IBM PC uses a disk-controller chip manufactured by Nippon Electric Company, the NEC 765 or 765a. Either chip has a built-in reset tied to the detection of the disk's index hole. If you try to read a disk that has been formatted with the first sector too close to the index hole, the chip doesn't have enough time to reset itself and read the disk.

The solution is simple: cover the disk's index hole. Most popular soft-sectored formats identify each sector by the sector's header block. The controller does not need to use the index hole for locating a given sector. Fortunately, the 765 does not require the index hole to either read or write data. In fact, the index hole is important only when formatting the disk.

To use this solution, you should start all disk records at the same point on each track so that track-to-track seeks can take place quickly and efficiently. Once the disk is formatted, the hole can be covered, and the controller will still be able to read and write data. The only possible complication is that the operating system may never wait the maximum time needed to read a disk if your machine uses the index hole for this purpose. The IBM PC uses an independent time-out schema, and the covering of the hole won't produce a change in performance.

With the hardware problem solved, we soon found another obstacle to reading disks formatted on other systems. Some systems format their disks in ways that violate common rules of good engineering practice. For example, Intertec's implementation of ten 512-byte sectors per track exceeds the sensible track-length specification by some 70 bytes. This design reduces the size of the interrecord gap, the

space between the first and last sectors on a track.

When we find a format in which this interrecord gap is too small, we use either of two possible solutions. One is to set up a formatting function on the IBM PC to format disks for the nonstandard machine. Then we take the disk formatted by the IBM PC, use it with the other machine and transfer all the files to that disk. A second solution is to slow the speed of the nonstandard machine's drive slightly (about 1 percent) to produce a longer interrecord gap when it formats a disk. Neither solution may work all of the time because multiple writing and reading may cause "creeping" of the records, and the gap will shorten once more.

The third problem affects even well-designed disks such as Cromemco's. IBM uses a phase-locked loop (PLL) in its data separator. Unlike the simpler one-shot multivibrator designs, used in some older systems, that synchronize to the data stream in two pulses, the PLL requires several clock pulses to lock in. (Although it requires the additional pulses, the PLL is a better design than its simpler counterpart because it is less susceptible to noise and rapid fluctuations.) If you attempt to read disks from an older system and are unsuccessful, it is highly probable that your problem is in the data separator design. There is no permanent cure for this incompatibility without altering the IBM card—a complicated operation. All you can do is try again or transfer the data through some other means.

As a result of our efforts to overcome these obstacles, the Byad DS1 is now successfully reading and writing a large number of nonstandard formats on the IBM PC.

The History of Computing

To document landmark efforts in computing, Digital Press offers this series of books on key projects, personalities, and issues in the evolution of computers and the computer industry.

Herman Hollerith: Forgotten Giant of Information Processing *Geoffrey Austrian* Herman Hollerith's punched card tabulating machines lead eventually to the modern computer. His business, after merger with several others, eventually became IBM. (Columbia University Press) 1982, hardbound, 418 pages, \$25

The Computer from Pascal to von Neuman *Herman H. Goldstine* The author focuses on the research and development at the University of Pennsylvania's Moore School and later at the Institute for Advanced Study. (Published by Princeton University Press) 1972, hardbound, 378 pages, \$25

Charles Babbage: Pioneer of the Computer *Anthony Hyman* Babbage's Difference and Analytical Engines were the forerunners of the modern computer. This biography clarifies Babbage's position in the history of science. (Published by Princeton University Press) 1982, hardbound, 287 pages, \$25

Computer Engineering: A DEC View of Hardware System Design *C. Gordon Bell, J. Craig Mudge, and John E. McNamara* Shows how such real-world constraints as evolving technologies, marketplace eco-

nomics, and manufacturing costs influenced computer engineering at Digital Equipment Corporation. 1978, hardbound, 585 pages, \$28.

Early British Computers: The Story of Vintage Computers and the People Who Built Them *Simon Lavington* This book examines such landmark projects as the world's first working stored-program computer, the first commercially available computer, and the first transistorized computer. (Available outside the U.S. and Canada from Manchester University Press) 1980, paperback, 140 pages, \$9

Project Whirlwind, The History of a Pioneer Computer *Kent C. Redmond and Thomas M. Smith* Whirlwind was the first computer with synchronous parallel logic and the first to use a random-access, magnetic core memory. 1980, hardbound, 280 pages, \$25

From ENIAC to UNIVAC: An Appraisal of the Eckert-Mauchly Computers *Nancy Stern* This book examines the social, economic, and political factors that influenced development of the ENIAC, the EDVAC, the BINAC and the UNIVAC. 1981, hardbound, 286 pages, \$25

Data Processing Technology and Economics, Second Edition *Montgomery Phister, Jr.* A thorough history of the computer industry from its inception, this book includes complete coverage of data processing operating costs, programming costs, system performance and reliability, time sharing economics, software performance, and much more. (Co-published with Santa Monica Publishing Company) 1979, 720 pages, \$45. (hardbound); \$30. (paperbound)

ORDERING INFORMATION: Postage and handling free when order is prepaid. Ten percent discount when ordering two or more books. Make check payable to **Digital Equipment Corporation**. Check or charge card required on all orders under \$50. TOLL-FREE ORDER NUMBER: To order books by Mastercard or VISA, call the Digital Press toll-free number 1-800-343-8322 or 8321 (in Massachusetts call (617) 663-4124) from 8:00 a.m. to 4:00 p.m., Eastern time. Please check to make sure your order is signed and includes the following information: name, company/school, address, city, state, and zip. If paying by card: charge card number, expiration date, and telephone. Return to: Digital Press Order Processing, Digital Equipment Corporation, 12A Esquire Road, Billerica, MA 01862. *All prices quoted are U.S. only. For prices outside the U.S., contact your nearest office of Digital Equipment Corporation, Educational Services. Prices are subject to change without notice.

digital

Our Prices Will Get Your Attention. Our Service Will Keep It.

ORDER NO. DESCRIPTION LIST A/E PRICE ORDER NO. DESCRIPTION LIST A/E PRICE ORDER NO. DESCRIPTION LIST A/E PRICE

FRANKLIN

Franklin ACE 1000 1330 Call

TELEVIDEO SYSTEMS

TS-802 Integrated Single User Computer 3295 2632
 TS-802H Integrated Hard Disk Computer 5995 Call
 TS-1602G 16 Bit 802 Type Computer 4495 Call
 TS-1602GH 16 Bit 802H Type Computer 6995 Call
 TS-806-20 Multi-User Computer 7195 Call
 TS-816 Multi User Computer 8995 Call
 TV-910-P Televideo 910 Plus 699 573
 TV-910 Televideo 910 699 573
 TV-912 Televideo 912C 925 685
 TV-920 Televideo 920C 995 737
 TV-925 Televideo 925 995 745
 TV-950 Televideo 950 1195 921
 TV-9010 Second Page Option 912/920 80 50
 TV-9050 One Additional Page for 925/950 95 62
 TV-9051 Three Additional Pages for 950 120 95
 TV-MM For Any Televideo Terminal 60 53
 TS-24-001 TeleSolutions WordStar CalcStar 790 Call
 TS-806H/20 20 MB Expansion for TS-806 3600 2948
 TS-TW Teletwriter - NEC 3500 2195 1629

NORTHSTAR

NS-94404 Adv-2Q-64K Computer ... 3599 Call
 NS-97404 Adv-1Q-64K-HD-5 Computer 4999 Call
 NS-94401 Hrz-2Q-64K Horizon 3599 Call
 NS-97401 Hrz-1Q-64K-HD-5MB 4999 Call
 PLUS OTHER NORTHSTAR PRODUCTS

ZENTH

ZVM-121 Green Screen Monitor ... 160 99
 Z-19-CN Z-19 Terminal 895 672
 ZT-1-A Auto-Dial Terminal 699 526
 Z-25-AA Z-25 Dot Matrix Printer ... 1495 1198
 Z-89-81 Z-89 Computer System 1995 Call
 Z-90-82 Z-90 Computer System 2799 2176
 Z-89-X Z-89 w/o Integral Drive ... 2495 1749
 Z-90-80 Z-90 w/o Integral Drive ... 2895 1950
 Z-37 Z-37 Dual 5" Disk Drives ... 1995 1593
 Z-87-89 Z-87 Dual 5" Disk Drives ... 999 898
 Z-87-90 Same Disk add 400K to Z-90 999 898
 ZS-67 Z-67 Winchester Floppy Drive 5995 4747
 Z-47-DA Z47 Dual 8" Disk Drives ... 3695 Call

NEC PRINTERS

NE-3510-1 NEC 3510 Spinwriter R/O Serial 35 CPS 1895 Call
 NE-3515-1 NEC 3515 Spinwriter R/O Serial Diablo Compatible 1925 Call
 NE-3530-1 NEC 3530 Spinwriter 1995 Call
 NE-3550-1 NEC 3550 Spinwriter R/O Parallel IBM Compatible 2350 Call
 NE-35-TRAC Bi-directional Tractor 265 Call
 NE-7710-1 NEC 7710 Spinwriter R/O Serial 55 CPS 2795 Call
 NE-7715-1 NEC 7715 Spinwriter R/O Serial Diablo Comp 2825 Call
 NE-7720-1 NEC 7720 Spinwriter KSR Serial 55 CPS 3610 Call
 NE-7725-1 NEC 7725 Spinwriter KSR Serial Diablo Comp 3710 Call
 NE-7730-1 NEC 7730 Spinwriter 2795 Call
 NE-PC-8023 Parallel 695 Call
 PLUS OTHER ACCESSORIES

STAR MICRONICS

DP-8480-TP 80 Column Dot Matrix Printer - Parallel 449 Call
 DP-8480-TS 80 Column Dot Matrix Printer - Serial 464 Call
 Gemini-10 10" Carriage - Parallel ... 499 Call
 Gemini-15 15" Carriage - Parallel ... 649 Call
 Serial Interface Card 85 Call
 DP-8240 40 Column Dot Matrix - Parallel or Serial 250 Call

OKIDATA

OK-82A Okidata Microline 82A with Tractor Feed 719 486
 OK-83A Okidata Microline 83A ... 1195 713
 OK-84A-P Okidata Microline 84A - Parallel 1395 Call
 OK-84A-S Okidata Microline 84A - Serial 1495 Call
 OK-G-82 Okigraph I for 82A 99 45
 OK-G-83 Okigraph I for 83A 99 45
 OK-2K 2K Buffer/Serial BD all Models 140 119

MANNESMANN TALLY

MT1605 Serial 200 CPS 1695 1441
 MT1602 Parallel 200 CPS 1695 1441
 MT1805 Serial - 200 CPS or 50 CPS 1995 Call
 MT1802 Parallel - 200 CPS or 50 CPS 1995 Call
 S or P - 160 CPS 990 809

PLUS: MORROW • ALTOS • EAGLE • NEC PERSONAL • ANADEX • C-ITOH • TI • DIABLO • COMREX • TOSHIBA

ALSO AVAILABLE: MODEMS • DISKETTE STORAGE BOXES • DISKETTES • CLIP/SIRIF • RIBBONS

SYSTEM SOFTWARE AVAILABLE

Altos CP/M 5 1/4"
 Apple CP/M 5 1/4"
 Apple DOS - Cassette
 Apple DOS - Diskette
 Atari 400/800 Diskette
 Atari Cartridge
 Atari Cassette
 Basic 4 CP/M 5 1/4"
 CP/M-86 Display Writer
 Cromemco CP/M 5 1/4"
 DEC VT-180 CP/M 5 1/4"
 Eagle CP/M 5 1/4"
 Heath Z-90 CP/M 5 1/4"
 Heath Zenith CP/M 5 1/4"
 Hewlett Packard 125 CP/M 5 1/4"
 Hewlett Packard 87 CP/M 5 1/4"
 IBM PC CP/M 86
 IBM PC DOS
 NEC CP/M 5 1/4"
 Northstar Advantage CP/M 5 1/4"
 Northstar Horizon CP/M 5 1/4"
 Ohio Scientific C-3 CP/M 5 1/4"
 Osborne CP/M 5 1/4"
 Otrona CP/M 5 1/4"
 QD-Micropolis Mod II/Vector Graphic
 Sanyo 1000 CP/M 5 1/4"
 Sirius Victor 5 1/4"
 Software for 8086 Computers
 Standard CP/M 5 1/4"
 Superbrain 5 1/4"
 Timex/Sinclair ZX81
 TRS-80 Cassette Models I & III
 TRS-80 Diskette Models I & III
 TRS-80 Model II CP/M
 Televideo CP/M 5 1/4"
 Vic 20
 Wang CP/M 5 1/4" 8"
 Xerox 820 CP/M 5 1/4"

CALL FOR CURRENT PRICING

NEW ITEMS
 Pantier Word Processor 450 Call
 For use with Apple II (64K) CPM 350 Call

APRIL SPECIAL

TELEVIDEO™ 925 TERMINAL

- Function Keys
- Detached Keyboard

only **\$704.00** save \$291.00 off list

These prices effective 2/83



Prices change daily — call for current pricing and shipping charges.



CALL TOLL FREE:

800-854-7635

IN CALIFORNIA CALL:

(619) 562-7571

AUTOMATED EQUIPMENT, INC.

8775 Olive Lane, Suites I & J · Santee, CA 92071



GUARANTEE

- PROVEN PRODUCTS
 - SYSTEM DESIGN HELP
 - BENCH TESTING AND CONFIGURING
 - TECHNICAL SUPPORT STAFF
 - SERVICE AFTER SALE:
- (800) 854-7635 TECHNICAL SERVICE SUPPORT**
 We will pay the freight — both ways — for repair on verified returns within 30 days of sale.

TERMS AND CONDITIONS

Prices change daily. Call for current pricing and availability. Prices based on prepaid cash orders. We accept: cashiers checks, money orders, bank wires, or personal checks (10 days to order). C.O.D. — standard charges plus 2% handling for orders outside California. MasterCard & Visa — 5% handling. California residents add state and local sales tax.

In the beginning, there was the printer.

And right on its heels came the first printer breakdown.

Unfortunately, the first printer service call didn't happen nearly so quickly, thus creating downtime – a problem that still plagues users today.

What's the answer? Non-Stop-Printing from Trilog.

Two heads are better than one.

Most dot-matrix line printers use only a single print head. That's fine – unless something goes wrong with the head. Then you're out of business until a service representative shows up.

On the other hand, the Trilog TIP-300 uses an exclusive two-headed system. Both 150 lpm print heads run simultaneously. Giving

you a total output of 300 lpm.

Should one print head temporarily fail, the user simply flips a switch and the remaining head continues printing at 150 lpm.

Now that's Non-Stop-Printing!

Dual heads offer another advantage, too. Instead of being pushed to capacity like most single heads, each Trilog head runs at a 50% duty cycle. This makes them much

Non-Stop-Printing.TM advance since the p



more reliable than conventional print heads.

Advanced innovation isn't just in our heads.

That's why we also gave Trilog printers dual tractors. They not only stabilize the paper and minimize friction, but allow the paper to move forward and backward. This gives you plotting capability and lets you generate forms. You can also print

bar codes. Plus business and engineering graphics.

Five printers for the price of one.

Besides graphics, the TIP-300 gives you four other types of printing: standard data processing characters. Letter quality characters that approach the sharpness of fully formed characters. And two versions of compressed characters for paper

savings and special formats.

For more information contact: Trilog, Inc., 17391 Murphy Ave., Irvine, CA 92714. Or call (714) 549-4079. TWX (910) 595-2798.

You'll see that compared to Trilog, other printers are still in the Dark Ages.

Non-Stop-Printing starts with



The single greatest printer was invented.



Building a Hard-Disk Interface for an S-100 Bus System

Part 2: The Hardware

Andrew C. Cruce and Scott A. Alexander
ASC Associates Inc.
209 Spring Valley Dr.
Lexington Park, MD 20653

In last month's article we described Winchester disk-drive technology and generally how drives of this type are integrated into microcomputer systems. This month we will be more specific and describe how a particular set of hardware can be assembled to provide Winchester disk capability for an S-100-bus microcomputer. After reading this article, you should understand the concepts involved in the design, fabrication, and integration of the hardware needed for a 10-megabyte S-100-based Winchester disk system.

The block diagram presented in figure 1 shows the various components of the Winchester disk subsystem. The functions of the host computer adapter (HCA), the disk controller, and the disk drive were described in last month's article. The only remaining component in the diagram is the power supply, which provides the disk drive and controller with power.

About the Authors

Andrew Cruce has a Ph.D. in Aeronautical Engineering and has recently received an S.M. degree in management as a Sloan Fellow at MIT. Scott Alexander has an M.S. in Electrical Engineering. Both have extensive design and implementation experience with small computers and are full partners in the firm of ASC Associates, which markets the hardware described in this series of articles.

This diagram suggests an approach to designing the disk system. The first step is to establish the data path; that is, you must determine how the HCA, the disk controller, and the disk drive are connected. Before you can do this you need to settle on the particular disk and controller to be used in the system as well as the functions that are to be included in the HCA. Once you complete this process, you'll have enough information available to specify power requirements for the system and to identify power supplies that could be used in the system. Finally, when the data interface is complete and you've chosen a power supply, you can consider how to package the system.

We'll now proceed through this design sequence, first discussing the availability of disk drives and controller cards and which ones we ultimately adopted. Next we'll cover the requirements for the HCA and go into the detailed logic design of this component. Finally, we will examine some of the options in choosing a power supply for the system and show the steps required to construct an attractive and reliable package for the system.

Disk Selection

The first decision we made in selecting a disk was on its size and stor-

age capacity. As we stated last month, we chose the 5¼-inch disks because they offered what we consider to be more than sufficient storage capacity for most applications at a reasonable price. When we started this project, a number of manufacturers, including Seagate Technology, Shugart, Memorex, and Miniscribe, offered 5¼-inch Winchester drives. We needed a drive with a disk-to-controller interface equivalent to that of the ST-506 disk drive manufactured by Seagate Technology. This interface has become the de facto standard in the industry and provides the freedom to select from a number of potential controllers that are compatible with this interface.

In considering the storage capacities available on the 5¼-inch-drive systems, we found that 10-megabyte systems were becoming available at prices only marginally higher than the smaller 5-megabyte systems. Based on the attractive cost per bit of storage capacity of the 10-megabyte drives, we opted for the higher-capacity disk systems.

With these criteria in mind, and taking into account the price/performance ratios of the available units, we chose the 10-megabyte disk drive manufactured by the Miniscribe Corporation. Our initial choice could change because we made it at a time

NEC passes your toughest screen test.



If you're getting into "pictures," you can't do better than NEC's new PC-8800 personal computer system. It gives you the highest resolution (640 x 400) of any standard system you can buy.

And no other system can give you the PC-8800's high-powered graphics hardware. With R/G/B output and more than 60 distinct colors, it's the perfect system for people who like to paint by numbers.

But it's more than just a pretty face. The PC-8800 is powerful, too, with 8-bit and optional 16-bit capability and up to 256K of RAM. It offers parallel and serial interface, and gives you both color and monochrome capability standard. Either 5¼" or 8" disk drives can be used.

The modular design is attractive and convenient, making the PC-8800 pleasing to your eye in more ways than one.

And a whole range of software is available for the CPM™-based* PC-8800.** You can use it when you're getting down to business or just having fun.

The PC-8800 computer system. Audition it at your local NEC Home Electronics dealer.

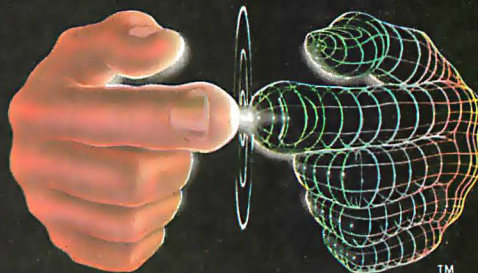

Productivity at your fingertips

NEC

**NEC Home Electronics (U.S.A.), Inc.
Personal Computer Division**

1401 Estes Avenue,
Elk Grove Village, IL 60007

Nippon Electric Co., Ltd., Tokyo, Japan

*TM Digital Research

**MS-DOS (TM Microsoft) and CPM-86 operating systems will also be available soon.

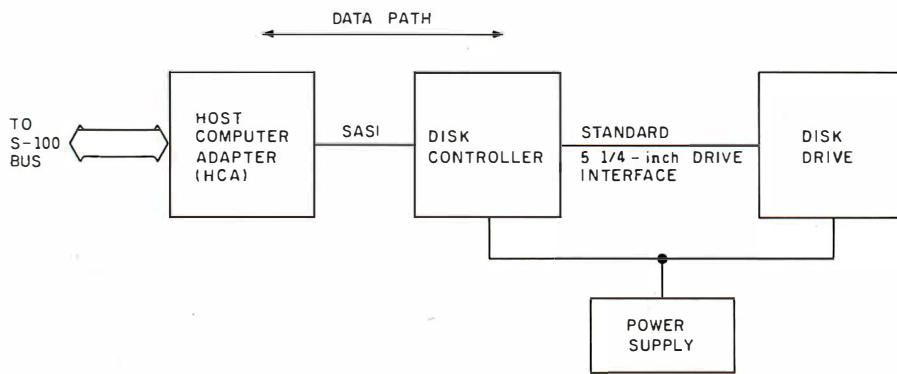

Figure 1: Winchester disk-drive subsystem block diagram.

when many disk-drive manufacturers had not yet commenced delivery of .10-megabyte hardware. However, now that the Seagate Technology interface has become the industry standard, virtually any new 5¼-inch drive currently being manufactured could be immediately plugged into whatever controller we selected. This also means that, for the purposes of this article, you could substitute any other 5¼-inch Winchester disk drive as long as it uses the Seagate Technology standard interface.

Controller Selection

Our decision on which controller to use in the system was somewhat more complicated. The first and most important requirement was that the controller be compatible with the Seagate Technology ST-506 interface (so as to be compatible also with any of the disk drives we were considering).

The second requirement was that the controller implement the Shugart Associates Systems Interface (SASI) to the HCA so that we could interface not only to S-100 systems, but also to a variety of other microcomputers such as the Apple, the Osborne, and the TRS-80. This criterion eliminated some of the available controllers, including those made by Morrow, which interfaced directly with the S-100 bus. A few of these devices would also have been eliminated because any system they are used in must conform to the IEEE standard for the S-100 bus. The problem here is that many of the older S-100 systems do not conform completely to this standard (for example, a number of

systems do not implement the extended 24-bit addressing of the IEEE S-100-bus specification) and thus would not operate properly with the "S-100-compatible" controllers.

Working within these constraints, we considered the cost, performance, size, and power consumption characteristics of a number of commercially available Winchester disk-drive controller boards. At the time we made the selection, the Xebec S1410 controller appeared to offer the best performance per dollar expended. Again, for purposes of this article, the choice of the particular controller board does not largely influence the rest of the design. If you have a controller board that uses the SASI to connect to the HCA and a Seagate-Technology-compatible interface to connect to the Winchester drive, then the hardware and software designs covered in this series should work with little or no modification.

After we verified that the controller and disk were indeed compatible, all we needed to complete this interface was to fabricate a 34-conductor and a 20-conductor ribbon cable to connect the disk and the controller. The next step was to decide on the requirements for the HCA and to design the hardware accordingly.

HCA Interface Requirements

Several preliminary choices had to be made before we designed the host computer adapter for the Winchester disk system. The first was whether the disk subsystem should have DMA (direct memory access) capability. The alternative was to design the HCA to allow the host computer to

perform data transfers between the disk and computer memory. Based on our assessment of most microprocessor system requirements, we considered that the additional speed gained by providing DMA capability in the HCA was not worth the additional complexity and expense that this capability would require. Thus we initially decided that the HCA would not perform DMA data transfers from the disk to memory.

The second decision concerning the design of the HCA was whether or not this device should contain a PROM (programmable read-only memory) chip and a new system-bootstrap program. Assuming that the system to which the Winchester disk is to be connected is operable, it should already have a bootstrap program. However, this program is designed to work with the original disk peripherals. It is possible to interface a Winchester disk with such a system and then use a separate "Winchester Boot" program to bring the Winchester disk BIOS (basic input/output system) routines into the system. However, this means that a hardware bootstrap will always go to the original disk system and that the Winchester Boot program must always be run to bring the Winchester drive into the system. We considered this to be a fairly cumbersome procedure and decided that we should provide the capability for a new bootstrap for the system that would bring up the Winchester disk and all the previously existing peripherals in the system.

Host Computer Adapter Design

Based on these requirements, the design of the HCA can be divided into three essential elements: a connection to the SASI on the disk controller board, a PROM subsystem on the HCA board to store a new bootstrap program, and an interface to the S-100 bus that provides all the signals required to support the first two elements. The combination of these elements results in the initial top-level HCA block diagram presented in figure 2.

The SASI interface on the disk controller is a 2-byte parallel interface.

HOME · PERSONAL · BUSINESS COMPUTERS & EQUIPMENT DISCOUNT PRICES

BUY BY DIRECT-MAIL

1-800-841-0860

CONVENIENT ORDER ENTRY

MICRO MANAGEMENT SYSTEMS INC.

<p>TRS-80 COLOR COMPUTER</p>  <p>DISCOUNT PRICED FROM CALL</p> <p>BUY DIRECT 26-3004</p>	<p>SMITH CORONA TP-1 DAISY WHEEL PRINTER</p>  <p>DISCOUNT PRICED FROM \$559</p> <p>BUY DIRECT</p>	<p> commodore</p> <p>VIC 20 COMPUTER... \$CALL VIC 1530 RECORDER... \$CALL VIC 1541 DISK DRIVE... \$CALL VIC 1525 PRINTER... \$CALL</p>	<p> commodore</p> <p>COMMODORE 64 COMPUTER C-64... \$CALL COMMODORE 64 SOFTWARE... \$CALL</p>
<p>TRS-80 MODEL 16 COMPUTER</p>  <p>DISCOUNT PRICED FROM \$4098</p> <p>BUY DIRECT 26-6001</p>	<p>TRS-80 PRINTERS MFG BY RADIO SHACK</p> <p>DWP-410 \$1287.00 DMP-100..... \$339.00 DMP-200..... \$679.00 DMP-400..... \$1015.00 DMP-500..... \$1525.00</p>	<p>OKIDATA PRINTERS</p> <p>ML 80..... \$CALL ML 82A..... \$CALL ML 92P..... \$CALL ML 93P..... \$CALL</p>	<p>EPSON PRINTERS</p> <p>MX 80..... \$CALL MX 100..... \$CALL FX 80..... \$CALL</p>
<p>TRS-80 MODEL III COMPUTER</p>  <p>DISCOUNT PRICES FROM \$588</p> <p>BUY DIRECT 26-1061</p>	<p>NEW TRS-80 PRODUCTS \$CALL</p>	<p> ATARI HOME COMPUTERS DISCOUNT PRICED FROM \$548 ATARI 800</p>	<p>FRANKLIN ACE 1000 & 1200 COMPUTER DISCOUNT PRICED FROM CALL</p>
<p>TRS-80 MODEL 12 COMPUTER</p>  <p>DISCOUNT PRICED FROM CALL</p> <p>BUY DIRECT</p>	<p>ALL TRS-80'S ARE PURE RADIO SHACK EQUIPMENT AND COVERED BY THE MANUFACTURERS WARRANTY</p>	<p>CALL US BEFORE YOU BUY! We continue to offer NEW PRODUCTS. Check us on any products not listed.</p>	<p>WE OFFER YOU</p> <ul style="list-style-type: none"> • Fast Delivery • Low Prices • Large Inventory • Toll Free Phones • Brand New Products
<p>FREE</p> <ul style="list-style-type: none"> • Discount Price List • MFG's Copy of Warranty <p>CALL 912-377-7120</p>	<p>MICRO MANAGEMENT SYSTEMS INC.</p> <p>Parcel Division Dept. 1 2803 Thomasville Rd. • Cairo, Ga. 31728 Ga & Info 912-377-7120</p>	<p>SAVE MONEY</p> <p>Prices and products subject to change without notice. Orders subject to acceptance and verification.</p>	

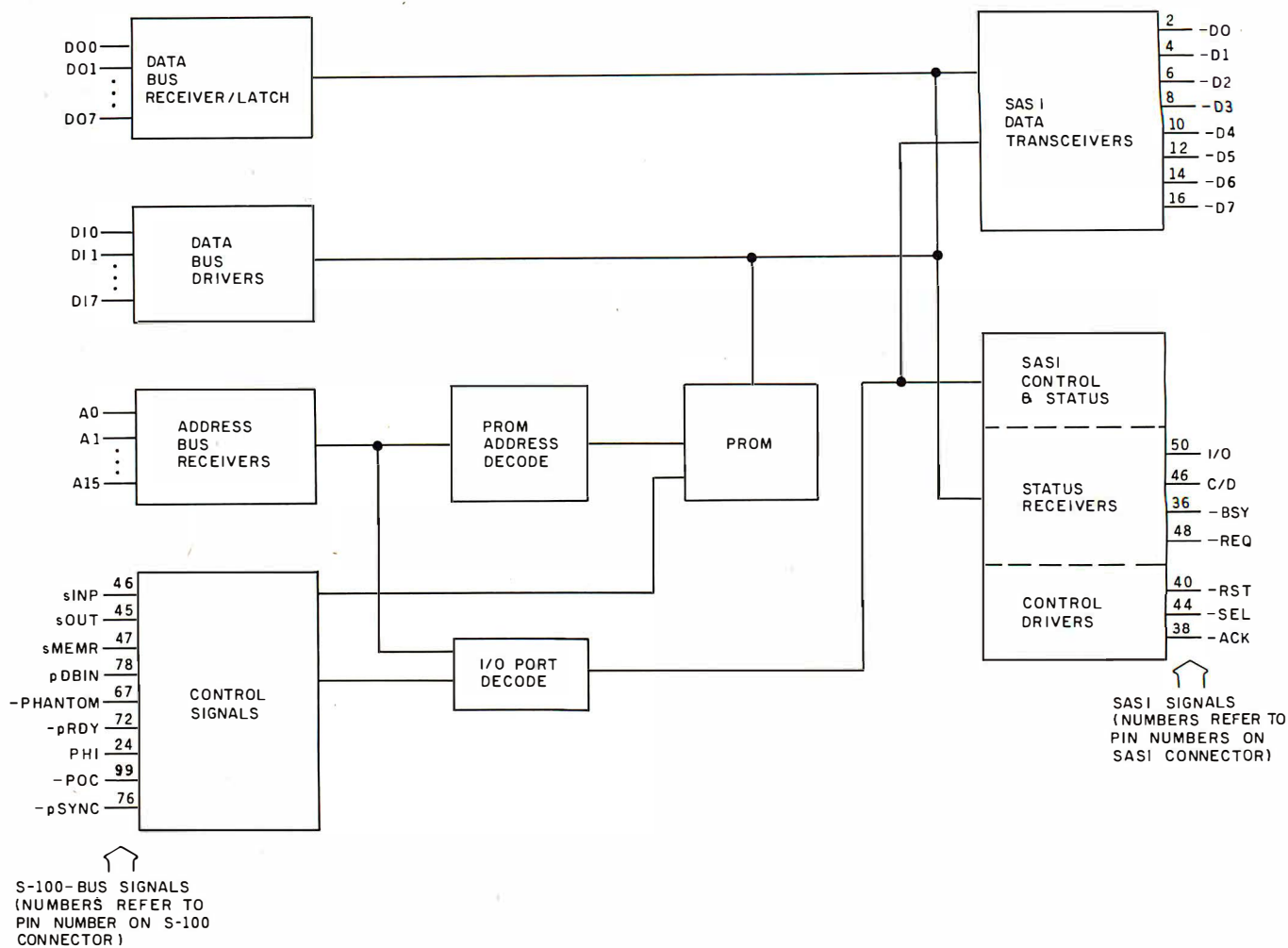

Figure 2: Block diagram of the host computer adapter (HCA) for the Winchester disk drive.

The first byte contains 8 bits of data being sent to or received by the controller. The second byte consists of control and status signals that are used by the host processor to determine the status of and provide control to the disk controller board. The controller board receives these signals on a standard 50-conductor ribbon cable. The signal names, descriptions, and pin numbers are presented in table 1. The portion of the HCA that communicates with the disk controller must send these signals to the controller, preferably via a 50-conductor cable.

The PROM portion of the HCA board is relatively simple in concept. Basically, it provides 2K bytes of nonvolatile memory to store a bootstrap loader. However, in considering the actual design, a number of questions arise. The first is whether to provide a wait state for access to the

PROM. Depending on the speed of the processor being used, it may be necessary to make the processor wait during memory-access operations to allow the PROM time to access the requested data. Another question is whether to provide compatibility with memory systems that support phantom memory. In these systems the bootstrap PROM can be located in memory locations that overlay normal RAM (random-access read/write memory). During the bootstrap operation, the PROM system must assert a PHANTOM signal, which causes the RAM in the computer not to respond as long as the signal is asserted. Thus the PROM is accessed during the bootstrap, and then after the bootstrap is finished the PROM is disabled and conventional RAM memory replaces the PROM in memory. As we will show, neither of these two options is particularly difficult to

implement, so we decided to design both a wait-state enable and phantom-memory support into the HCA. Again, figure 2 shows basically how these two capabilities fit into the system.

With the SASI interface and the PROM memory established, it is now possible to determine what signals from the S-100 bus must be used to communicate with these two elements. Accessing the PROM is like accessing normal memory. All that is required is some address-decode logic and some combinational logic using the S-100 bus signals sMEMR and pDBIN to gate the PROM data onto the S-100 bus. Several other signals are needed to support the memory wait state and the phantom-memory capability. These are the -pRDY signal going back to the processor (which keeps the processor in a wait state), the -PHANTOM signal back

Signal Name	Pin Number	Description
I/O	50	Input/Output: open collector output from controller to HCA. Low level indicates a controller-to-HCA data transfer. This signal is qualified by -REQ.
C/D	46	Command/Data: open collector output from controller to HCA indicating command or data on the data bus. Low level means command bytes. This signal is qualified by -REQ.
-BSY	36	Busy: open collector output from controller to HCA indicating a controller is ready to receive data or command information from the HCA. High level means controller is ready for data.
-MSG	42	Message: open collector output from controller to HCA indicating that the current command is complete. (This signal is not used in our design.)
-REQ	48	Request: open collector output from controller to HCA to initiate controller-host handshaking sequence.
-ACK	38	Acknowledge: host-generated signal that is asserted active low in response to controller -REQ when the host is ready to receive or transmit data. In order to complete the handshake, the host adapter must send -ACK in response to each -REQ from the controller.
-RES	40	Reset: host-generated signal, active low, that resets the controllers. This signal must remain low for at least 100 nanoseconds.
-SEL	44	Select: host-generated signal, active low to initiate a command transaction to a controller.
-DB0	2	Data Bus 0 through 7: tristate input/output bus to send data/command information from the host to the controller or for the host to receive data from the controller.
-DB1	4	
-DB2	6	
-DB3	8	
-DB4	10	
-DB5	12	
-DB6	14	
-DB7	16	

Table 1: Signals and pin locations for the Shugart Associates Systems Interface (SASI) between the disk controller and the host computer adapter (HCA).

to RAM (causing it not to respond), one phase of the system clock (PHI), and the Power On Clear signal (-POC or -RESET).

In addition to supporting the PROM, it is also necessary to provide for data communication between the S-100 bus and the SASI ports on the HCA. There are two ways of doing this. One is to make the SASI ports appear as memory to the processor and use memory-mapped I/O to communicate with these ports. However, this uses up memory space, and a better approach is to use the I/O ports that are accessed by the 8080 IN and OUT instructions. This again

calls for some address-decode logic to determine which port is selected and some combinational logic on the S-100-bus signals sINP and sOUT. These signals indicate whether data is to be written to or read from the particular port selected; figure 2 shows generally how they are used in the HCA design. They are standard S-100 signals, and a detailed description of their use and required characteristics can be found in any complete description of the S-100 bus.

In the logic design process, the block diagram shown in figure 2 is expanded to include the digital logic necessary to perform the functions in-



Peripherals a Generation Ahead
**Voice Coil Actuated
 Dual 8" Floppy Disk Drive**

- FAST
- Apparent performance of a Hard Disc
- Equivalent of two standard drives

Model 299B (DS DD/SD)
 Model 270/277 (SS DD/SD)

PERSci, INC.



12210 Nebraska Ave.
 Los Angeles, CA 90025
 (213) 820-7613
 TELEX 687444

Circle 480 on inquiry card.

Full Size Keyboard Conversion



For Your ZX81/TS1000
 SUN KD-81
\$69.95

Easy To Install
 No Soldering - No Modifications

41 Keys with Full Size Space Bar • Allows Touch Typing
 Same Key Layouts as Sinclair • Two Color Keytops
 Keyboard Case Holds Both Keyboard and Computer
 Commands and Graphics Spelled Out on Keytops

16K Piggyback RAM Module ... P/N MX-16 \$49.95

SUNTRONICS CO., INC.
 In Calif Call 213-644-1149
 Outside Calif Call 1-800-421-5775
 Or send Check or M.O. to:
 P.O. Box 1957 Hawthorne CA 90250
 California residents add 6 1/2% sales tax.
 Add \$4.00 ship/handling. VISA/Mastercard include expiration date.

Circle 478 on inquiry card.

Exclusively

UNIX* and C Information

That's **UNIQUE**, the oldest and largest independent journal covering the UNIX* and C marketplace.

- product reviews/listings/prices
- applications/tutorials/indexes
- industry inside information

Full year, \$54 (\$66 Foreign) - write, call or circle reader service number for full brochure and FREE sample copy.

InfoPro Systems
 Dept. B • Box 33 • E. Hanover NJ 07936
 (201) 625-2925
 *UNIX is a trademark of Bell Laboratories
 Formerly The UNIX Software List

Circle 479 on inquiry card.

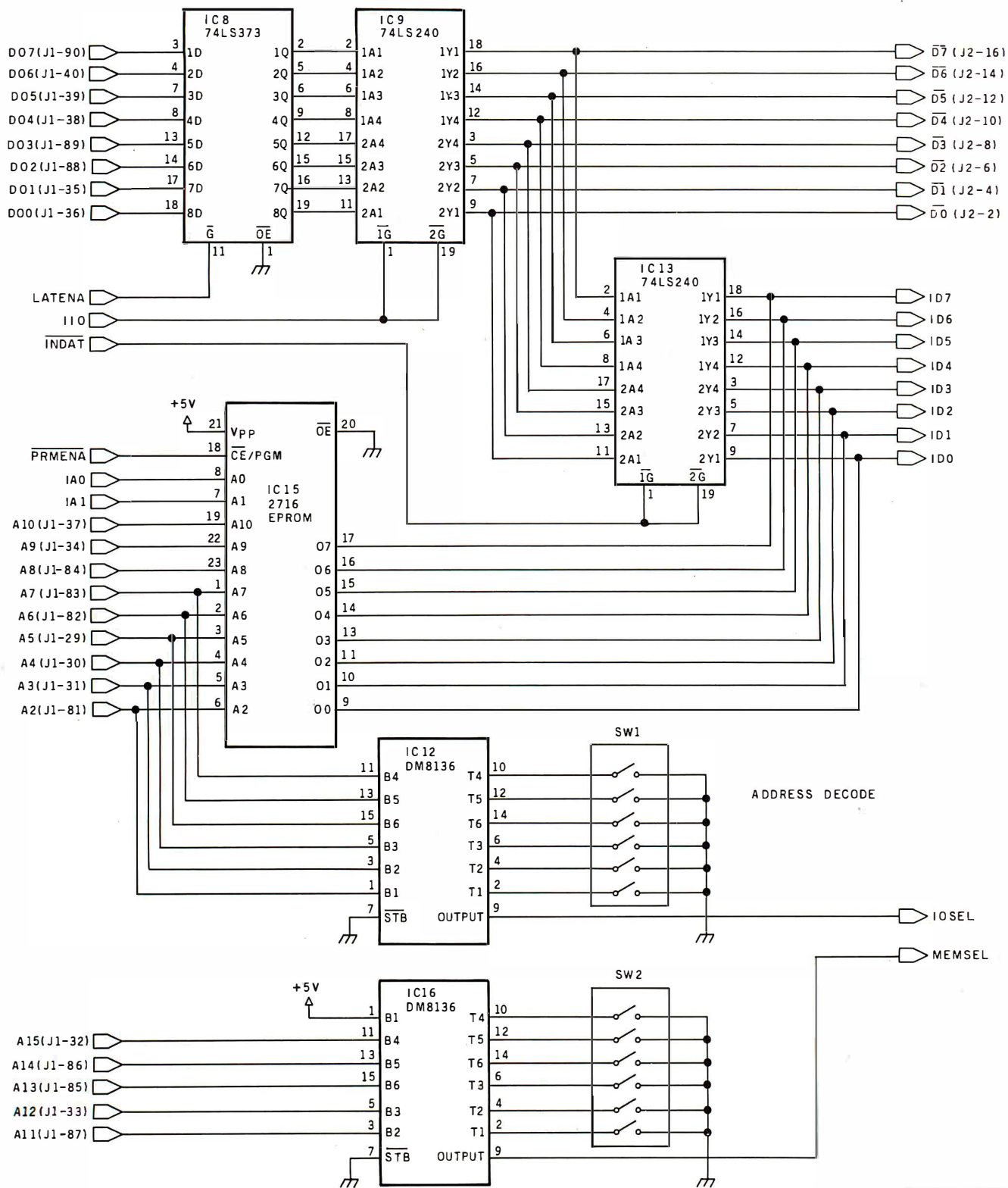
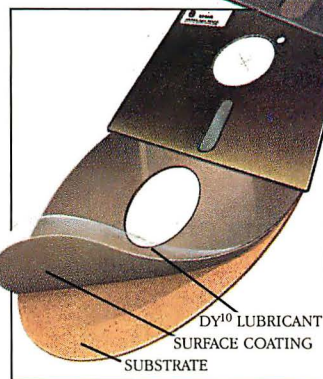
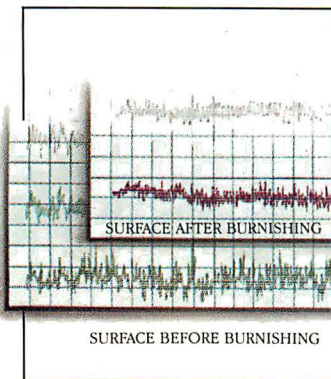

Figure 3: Diagram of the address-decode logic of the HCA.

Power table applies to figures 4 and 5, as well.

Number	Type	+5 V	GND	Number	Type	+5 V	GND
IC1	74LS10	14	7	IC10	74LS74	14	7
IC2	74LS139	16	8	IC11	74LS74	14	7
IC3	74LS244	20	10	IC12	DM8136	16	8
IC4	74LS00	14	7	IC13	74LS240	20	10
IC5	74LS04	14	7	IC14	74LS04	14	7
IC6	7438	14	7	IC15	2716	24	12
IC7	74LS240	20	10	IC16	DM8136	16	8
IC8	74LS373	20	10	IC17	74LS244	20	10
IC9	74LS240	20	10	IC18	74LS00	14	7

Four Reasons Why The Dysan Difference is Worth Paying For



1. 100% Surface Tested

Only Dysan provides fully usable diskette surfaces that are truly 100% error-free across the entire face of the diskette. An exclusive on-and-between the track testing procedure guarantees error-free performance regardless of temperature and humidity distortions or slight head misalignments.

2. Advanced Burnishing Techniques

Dysan's advanced polishing methods create a smoother, more uniform diskette surface. This results in better signal quality on each track, less wear on drive heads and reliable access to data after millions of head passes.

3. DY¹⁰™ Lubricant

Dysan's proprietary DY¹⁰ lubricant complements the advanced burnishing process. Both maximize error-free performance while minimizing headwear. Optimal signal presence is maintained between the head and diskette surface during millions of write/read interfaces.

DY¹⁰ is a trademark of Dysan Corporation

4. Auto-Load Certification

Dysan's unique quality control methods reflect technological leadership in designing, producing and testing precision magnetic media. Each diskette is unerringly certified by Dysan-built, automated and microprocessor controlled certifiers. Your system and data base will benefit from Dysan's diskette reliability and unsurpassed quality.

Select from a complete line of premium 8" and 5¼" diskettes, in single or double densities, certified on one or both sides.

Circle 152 on inquiry card.



Corporate Headquarters:
5201 Patrick Henry Drive
Santa Clara, CA 95050
(800) 551-9000

How to get your fir

You're not alone, you know.

We've all been through that same excruciating moment when we realized that we were going to have to learn a lot more than we wanted to know about programming, in self-defense.

But most of us survived.

Many of us with a little bit of help called dBASE II, the relational database management system (DBMS) for micros.

The best defense is a strong offense.

Don't get seduced by BASIC, because basically BASIC is weak. And to make it do anything useful can take 10 times as much programming (and time) as with dBASE II.

dBASE II is much easier because it's a relational DBMS, and you control your information with powerful, English-like commands.

With a word or two, you CREATE databases, APPEND new data, UPDATE, MODIFY and REPLACE fields, records and entire databases. DISPLAY some or all of your data for any conditions you want to apply. Organize months worth of data in minutes with REPORT.

You can prepare your forms and formats precisely the way you want them. Do calculations on fields, records and entire databases with 10-place accuracy.

And do even more with dozens of other commands.

Here's the catch.

With any language, you'll need to understand relational operators ("less than," "greater than," "equals") and a bit of logic ("or," "and," "not").

With dBASE II, you'll also get an easy way to make choices (IF..THEN..ELSE) and a powerful way to perform repetitive tasks (DO WHILE..).



With these tools, you're ready to tackle your accounting and time billing, project management, and any other data handling and record keeping. You can work interactively and get your answers right now. Or save your instructions and repeat everything with two words: DO Manhours, DO ProjectX, DO whatever has to be done.

Use dBASE II to help make your choice.

If you've got a 48k CP/M micro with a disk drive (96k IBM PC), send us \$700 (\$400 for a 56k Apple). We'll send you a copy of dBASE II to use free for 30 days.

the best of st micro.



Instead of just poring over a manual, run it and make certain that dBASE II does what you need done.

Then if you find it isn't right for you, send it back and we'll return your money, no questions asked.

But we know that you'll probably keep it.

Because having dBASE II is like having a black belt in micros.

Call (213) 204-5570 today or drop by your local computer store for the rest of the story.

Ashton-Tate, 9929 Jefferson Blvd., Culver City, CA 90230.

Ashton-Tate

©1982 Ashton-Tate
CP/M is a trademark of Digital Research

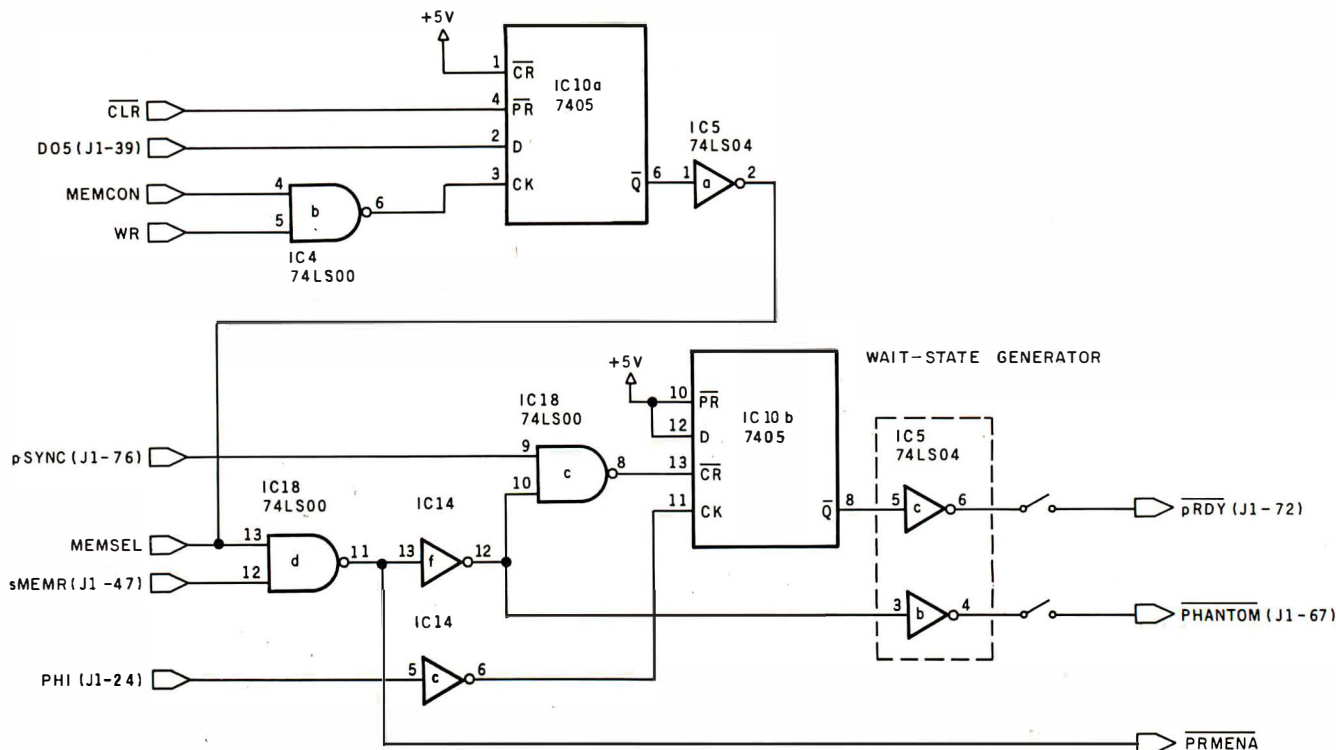

Figure 4: Diagram showing how the PHANTOM signal and the memory wait state are generated in the HCA.

Port Number	Action	Function
0	READ	reads SASI data onto S-100 data lines
	WRITE	writes S-100 data to SASI data port
1	READ	returns four status bits on S-100 data lines
	WRITE	generates SASI SELECT signal
2	READ	no action
	WRITE	with data bit 5 set turns PROM on
3	READ	no action
	WRITE	generates SASI RESET signal

Table 2: I/O port read/write functions of the host computer adapter (HCA), relaying information between the S-100 bus and the disk controller.

indicated in the diagram. Figures 3 through 5 show the result of this expansion. Figure 3 shows the address-decode logic and the S-100/SASI data bus buffering. Figure 4 shows how the PHANTOM signal and the memory wait state are generated, and figure 5 shows the port-decode logic and the remainder of the system.

The memory and port-address logic are set up so that the address of the PROM and the I/O ports are selectable using a set of switches on the HCA board. For the PROM, the upper five address bits are compared with a switch setting on the board and used to generate the MEMSEL

signal, which is used by the logic in figure 4 to generate -PRMENA to enable the PROM. Similarly, bits 2 through 7 of the address are compared with switch settings on the HCA to determine if an I/O port on the HCA has been selected. If a match is found, IOSEL is asserted and bits 0 and 1 are used to determine which of four possible I/O ports has actually been selected. At this point there are eight possible operations because each possible I/O port may be either read or written depending on the status of the sINP and sOUT signals on the S-100 bus. Table 2 shows the results of each of these possibili-

ties. If ports 0 or 1 (of the block of four selected I/O ports) are read, signals are generated that cause either SASI status or SASI data to be placed on the S-100 data bus. Reading ports 2 or 3 does not cause anything to happen. A write to port 1 generates a select signal at the SASI, and a write to port 0 writes 8 bits of data from the S-100 bus to the SASI data port. A write to port 3 generates a -RST signal at the SASI. Finally, a write to port 2 with data bit 5 set or reset enables or disables the PROM on the HCA.

Figure 4 shows how the wait-state and the phantom-memory options are handled. When the memory is selected, the output of the flip-flop U10 is set low and remains low until the next transition of the PHI clock signal raises it. This sequence generates the -pRDY signal, which is qualified by a switch setting. If the switch setting allows this signal to get to the S-100 bus, the result is a single wait state each time the PROM is selected. This allows use of PROM memory that would be too slow to respond to the high-speed Z80 processor boards on some S-100 systems. The upper portion of the figure also

shows the combinational logic used to generate the PHANTOM signal.

The PHANTOM signal is generated whenever the PROM is selected, depending on the state of flip-flop (U10). This flip-flop enables generation of the PHANTOM signal on receipt of the Power On Clear (-POC) signal and disables generation of PHANTOM when the host writes to port 2 of the four selected output ports with data bit 5 set. This whole operation is qualified by the switch on the board that either allows or disables PROM operation. For systems that support phantom memory, the intended mode of operation is to have the Power On Clear signal (which is the hardware boot signal) enable the PROM and the generation of the PHANTOM signal. The bootstrap in the PROM would then run and load a loader program into RAM. The loader program would then load the CP/M operating system, and (as a final instruction before transferring control to the operating system) the loader program would write data to

port 2 with data bit 5 reset to disable the PROM from memory.

Figure 5 shows how this all comes together to perform the required HCA functions. For a PROM access, the upper five bits of the address, qualified as shown in figure 4, form the -PRMENA signal that enables the PROM. The lower eleven bits of the address are sent directly to the PROM to select the byte of data from the PROM that is to be read. This data is then placed on the S-100 data bus using the tristate bus driver (U17).

The way data and control information are transferred to and from the SASI depends on the particular portion of the SASI being addressed. The -RST and -SEL signals are generated by writing to ports 3 and 0, respectively. The -ACK signal is automatically generated if -REQ is asserted any time data is read from or written to the SASI. The control information from the disk controller to the host computer is read by sending an IN instruction to port 1. This places four bits of control information on the

S-100 data bus. The data portion of the SASI is addressed by reads and writes to port 0. A data write to port 0 latches the data off the S-100 bus (U8) and passes this data through the data bus driver (U9) to the SASI if it is enabled by the SASI I/O control line. Data is received from the SASI data bus by U13. When the HCA is driving the data bus, the latched data from the S-100 bus will be turned around through U9 and U13 and will be available if a read is directed to port 0. This state exists whenever a controller is not active on the SASI bus and is useful for verifying the HCA data paths.

The next step in the design process is to take the logic diagrams shown in figures 3 through 5 and reduce them to a printed-circuit card that can be inserted in a standard S-100 bus 100-pin socket. Because the S-100 bus is fixed, the only choice in this operation is to decide how the HCA card will be physically connected to the disk controller card. For our controller card, this is done using a

Text continued on page 319

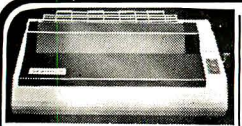

Star Gemini-110 100 CPS, 9x9 hi res. graphic, friction/tractor feed, 80 column, Parallel interface...SCALL Gemini 15 15" carriage... SCALL

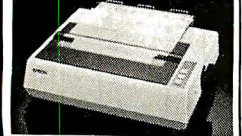

The new Epson FX-80 in stock now! Has all the features of the famous MX-80 plus the speed of 160 CPS. Epson MX100 III - New! In price. Call C. Itoh ProWriter 8510AP, 120 CPS, 80 col., Graphics, Parallel...\$459 C. Itoh ProWriter-II 1550, 120 CPS, 136 col., 2K buffer, parallel...\$699



NEC SPINWRITER 3550
NEC's new letter-quality printer especially designed for the IBM PC. 203 columns, auto proportional space, justification, bi-directional, 350 words per min. Serial...\$1,995



BROTHER HR-1
Letter quality daisywheel printer 15 CPS, bi-directional, friction feed, parallel interface. Super value...\$759 Serial interface...\$829 Tractor...\$119

AST Multi-Function Enhancement Cards for IBM PC

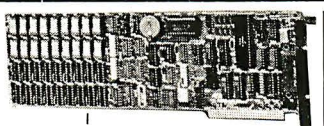

ComboPlus Cards
ComboPlus cards offer a maximum of 6 features. User expandable parity memory from 64K to 256K and optional features can be added at a later date. Disk emulator (SuperDrive) and print spooler (SuperPrint) software programs are included with each card.

Amount of memory installed on card	64K	128K	192K	256K
with one option (serial or parallel port or clock)	\$335	\$447	\$558	\$669
with two options (SP or SC, or PC)	\$375	\$487	\$598	\$709
with all options (serial, parallel ports & clock)	\$405	\$517	\$628	\$739

MegaPlus Cards
MegaPlus cards offer a maximum of 8 features. User expandable parity memory from 64K to 512K. Serial port No. 1 and clock/calendar included with each card. Disk emulator & Print spooler programs are also included.

Amount of memory installed on card	64K	128K	192K	256K
w/ standard features indicated above	\$395	\$506	\$617	\$728
w/ either parallel or additional serial port No. 2	\$435	\$546	\$657	\$768
w/ both parallel and additional serial port No. 2	\$465	\$576	\$687	\$798
MegaPak option for 512K expansion				\$399

I/O Plus Cards
I/O cards come w/serial port No. 1 and clock/calendar as standard features standard card with one serial port No. 1 & clock/calendar...\$145 w/ either parallel port or additional serial port No. 2...\$185 w/ both parallel and additional serial port No. 2...\$225

MONITOR SALE

***** GREEN SCREEN *****
Dynax GM-120, 12" green, 600 line, 20 MHz. Very sharp looking. List \$200.00...\$129.00
Taxan KG-12N, 12" green 800-dot, List \$199.00...\$149.99
Zenith ZVM121, 12" green, 15MHz List \$139.00...\$119.00

***** AMBER SCREEN *****
Dynax AM121, 12" amber, 600-dot 20 MHz. Excellent! List \$250.00...\$149.00
Taxan KA12N, 12" amber, 800-dot, List \$205.00...\$150.00



IBM Personal Computers

A. 64K system unit & keyboard, two 320K drives & controller, color/graphic card. \$2,850

B. 64K system unit & keyboard, two 320K drives & controller, IBM monochrome display & display/printer adapter. \$3,225

Other configurations available

COMREX CR-1-C
17 CPS daisywheel printer, bi-directional, Parallel...\$799 CR-1-S Above but serial...\$799 Tractor...\$119

Kaisei
Autorange
Digital Multimeter
3.5-digit LCD w/ auto unit & sign indication. Full auto ranging on Volt & Ohm w/ 10Amp AC/DC range. Model SK-6440 Special \$89.50
Above features plus keypad for continuity tests, overload warning. Zero adj. cancels resistance value of test leads for more accurate measurements. Model SK-6330 Special \$129.50

C. Itoh F-10 StarWriter
40 CPS daisywheel (parallel) SCALL
55 CPS daisywheel (parallel) \$1,675

THE BUSINESS MANAGER™
The most complete and affordable business package on the market... with all the software and storage you ever wanted... just plug into your IBM PC and run your business!

- * Fully Integrated Accounting System
- * GENERAL LEDGER
- * ACCOUNTS RECEIVABLE
- * BILLING
- * INVENTORY CONTROL
- * ACCOUNTS PAYABLE
- * PAYROLL
- * Word Processor - Perfect Writer™
- * Spelling Checker - Perfect Speller™
- * File Management - Perfect Filer™
- * Elec. Spreadsheet - Perfect Calc™

All programs self-programming and menu-driven. All software pre-installed on hard disk and ready to use. No more diskettes and tedious paper work. High speed operation. All software and hardware fully guaranteed and supported.

5MB HARD DISK PLUS \$2,995
above listed software... (Requires 128K and power supply) Power Supply (required)...\$195

***** RGB COLOR *****
Electrohome 13", Hi res., 580 dot, 16 colors, IBM PC direct drive. List \$975.00...\$795.00
NEC JC1203 RGB Color. Ideal for IBM PC. 690 dots hi res. 2,000 char. (8x8 dots). List \$895.00...\$749.00
Cable: NEC to IBM PC...\$19.00
Princeton HX-12, 12" RGB color, designed with an NEC .31mm dot pitch color tube. Hi. res. 690 dots. 80 char x 25 lines. Identical IBM cabinet. Most pleasing & best price performance monitor for your IBM PC. List \$795... Bestbuy SCALL
Taxan RGBVision I, 12", 380-dot, 18 MHz, 2,000 char (5x7 dots). List \$399.00...\$365.00
Taxan RGBVision II, 12", 510-dot, 18 MHz, 2,000 char (5x7 dots). List \$599.00...\$549.00
Taxan RGBVision III, 12", 630-dot, 18 MHz, 16 colors. List \$699.00...\$640.00
Cable: Taxan to IBM or Apple II/1S/19

SOFTWARE FOR IBM PC

NEW! TKISolver - by the inventor of VisiCalc. A fantastic software that is so easy to use that requires no programming knowledge. It can also produce table & graphs...\$249

VisiCalc...\$250 \$179
Desktop Plan...\$300 \$229
VisiDex...\$250 \$189
VisiFile...\$360 \$235
VisiSchedule...\$360 \$229
VisiTrend/Plot...\$360 \$229
SuperCalc...\$199
Basic Compiler...\$340
DOS 1.1...\$40
Cobol Compiler...\$799 \$650
Fortran Compiler DOS...\$350 \$320

5% TANDON DRIVES
The newest IBM PC compatible. Installation instruction included. TM100-1A, SSD0 160K...\$175
TM100-2A, DSD0 320K...\$259

EASTERN ENTERPRISES, INC.
2937 S. VAIL AVE., LOS ANGELES, CALIF. 90040
TOLL-FREE Order Desk (800)392-7081 Calif., Alaska, Hawaii (213)725-3080
TELEX 664477

MasterCard VISA

To order, please send money order or cashier's check. Personal or company checks require 2-3 weeks to clear. Prices reflect 3% cash discount. Visa/Mastercard accepted. Shipping, insurance & handling charges are 3% of total order value by UPS Surface, 5% by UPS Air or Parcel Post. COD's requires 20% deposit. California residents add sales tax. No sales tax on out-of-state orders. Prices & availability subject to change without notice. We are not responsible for typesetting errors. Send for catalog.

Circle 230 on inquiry card.

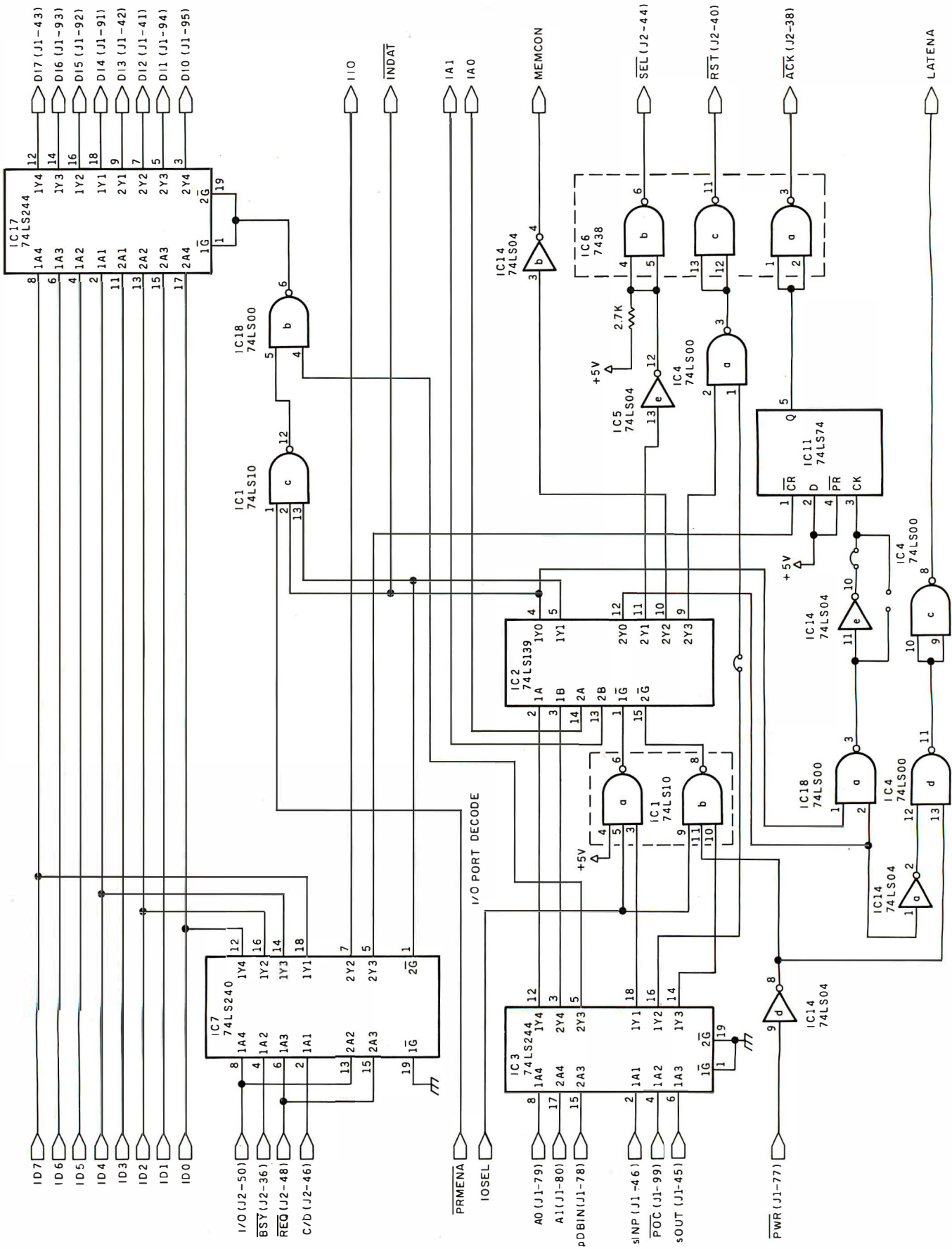

Figure 5: Diagram of the port-decode and HCA-interface logic.

It's True — We Did It!

We have met or have beaten most advertised prices.

Don't be foolish. Buy Direct!



NORTHSTAR

ADVANTAGE

- 64K, Z80A Operating System
- 2 Quad Capacity Floppy Drives
- Business Graphics Software
- 12" Green Phosphorus Screen
- Bit Mapped Graphics
- 6 I/O Business Slots

HORIZON

- Multi User System
 - Z80A Operating System
 - S-100 Bus
 - 5Mb-18Mb Hard Disc Available
- Super Super Super **\$2,495.00**

Super Super Super **\$2,619.00**



IDS

- Proportional Spacing
 - 200 CPS Bi Directional
 - Sheet Feed
 - 8 Character Styles
 - Color Optional
 - Graphics
- Prism 80 W/Sprint **\$899.00**
 Prism 80 Loaded W/Color **\$1,239.00**
 Prism 132 W/Sprint **\$1,039.00**
 Prism 132 Loaded W/Color **\$1,395.00**

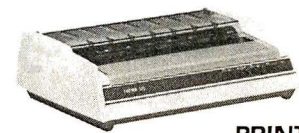

PRINTEK

- Dot Graphics 144x144
 - Correspondence Quality
 - 8 Character Pitches
 - 1 Year Warranty
 - 8 Foreign Character Sets
 - Serial Interface Standard
- Model 910 200 Cps **\$1,329.00**
 Model 920 **340 Cps \$1,889.00**



ALTOS
ZENITH
TELEVIDEO
SANYO

FRANKLIN
HAYES
NOVATION
UDS

OMNITEC
VENTEL
AMDEK
BMC

TAXAN
DIABLO
NEC
EPSON

OKIDATA
OSBORNE
COMREX
DAISYWRITER

GTC
ADDS
DEC
MANY OTHERS

For FREE Information and Price Quotes Call:

1-800-328-8905

In Arizona Call:
602-941-3191

411 South Madison
Tempe, Arizona 85256
(Mail Order Only)

LIBERTY COMPUTER SALES



Circle 231 on inquiry card.

Everything in
computer related
products:

- Computers
- Modems
- Printers
- Software
- Monitors
- Terminals
- Accessories
- Paper
- Ribbons
- Diskettes
- Office Furniture

Prices listed reflect a cash discount and are subject to change without notice. We welcome Certified and Cashiers Checks, Bank Wires and Money Orders. Allow 2 to 3 weeks for personal checks to clear. No C.O.D.s. Product is subject to availability. Equipment is in factory sealed boxes with manufacturer's warranty. There will be a restocking charge for returned merchandise. Call first for an RMA number. Software not warranted for suitability. No return of Software which has been opened. Add 2% for shipping charges (minimum \$2.50). Z80A is a registered trademark of Zilog, Inc.

Rutishauser

The Feeder World of Quality

Portrait and landscape forms – Models for most letter quality printers – With or without interfaces – Electronically or mechanically controlled – No operator adjustments required – No reverse platen motion required – High precision registration – UL-recognitions – Multi-part forms – No paper cassettes – Field proven – Envelope attachment – Any paper size up to 12" x 15" – Clip-on mounting – Complete control of paper and its pathway to print-mechanism! – Lightweight – The Single Bin Cut Sheet Feeder most in use – Swiss-made quality

RT 200
Bi-directional Forms-Tractor.
For precise continuous form feeding.



RT 200

RS 700
Mechanical Sheet Feeder.
Automatic feeder with mechanical control mechanism. No electronics required. Driven forward by printer platen.

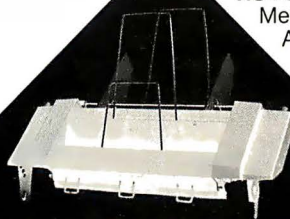

RS 700

RS 800
Demand Sheet Feeder.
Feeds sheets on command from an external interface. Compatible with RS 950.

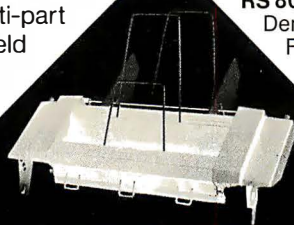

RS 800

RS 900
Single Bin Sheet Feeder.
Self-controlled automatic feeder with internal electronics for universal application. The most widely used single bin feeder in the world.

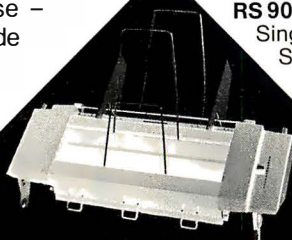

RS 900

FGH. 83.1

Rutishauser Products are available for a wide variety of popular types of Letter Quality Printers.

AES · Anadex · Binder · Brother · Centronics · Daisy Systems ·

RS 950 Single Bin Sheet Feeder.
Feeds sheets from either of two supply bins upon command from an external interface. Direct control by printer electronics. OEM supplied interface or custom interface available for selected printers.

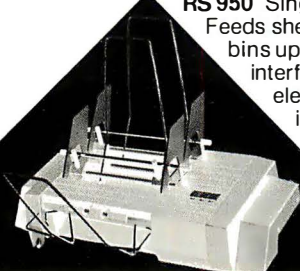

RS 950

Diablo · Data-Royal · Dataproducts · Facit · Fujitsu · HPI · IBM-System 6 · Mannesmann Tally · NEC · Olympia · Qume · Ricoh · T.A. · Santec · SCM · TEC/C. Itoh · Toshiba · Walther · Wang · Xerox

Maybe you didn't know we offer such a large Family of Devices!

RS 1000
Programmable Double Bin Sheet Feeder. Independent self-controlled feeding from two supply bins, with or without external electronic commands. Several modes of operation including user programmable sheet selection and programmed platen motion sheet selection.

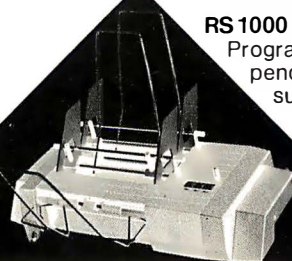

RS 1000

RF 400 Front Feed Device.
Programmed insertion of single or multipart forms for precisely registered applications – pre-printed forms, ledger cards, etc.

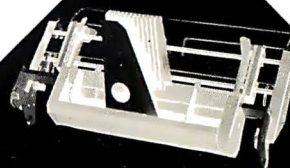

RF 400

Rutishauser

Circle 486 on inquiry card.

Rutishauser Data AG, Rhynerstrasse 9, 8712 Stäfa, Switzerland
Tel. (01) 926 43 00, Tx. 875171 ruti ch
Rutishauser of America, Inc., 9677 Wendell Road, Dallas, TX 75243, U.S.A.,
Tel. (214) 3439154, Tx. 730609 ruti dal – a subsidiary of Rutishauser Data AG

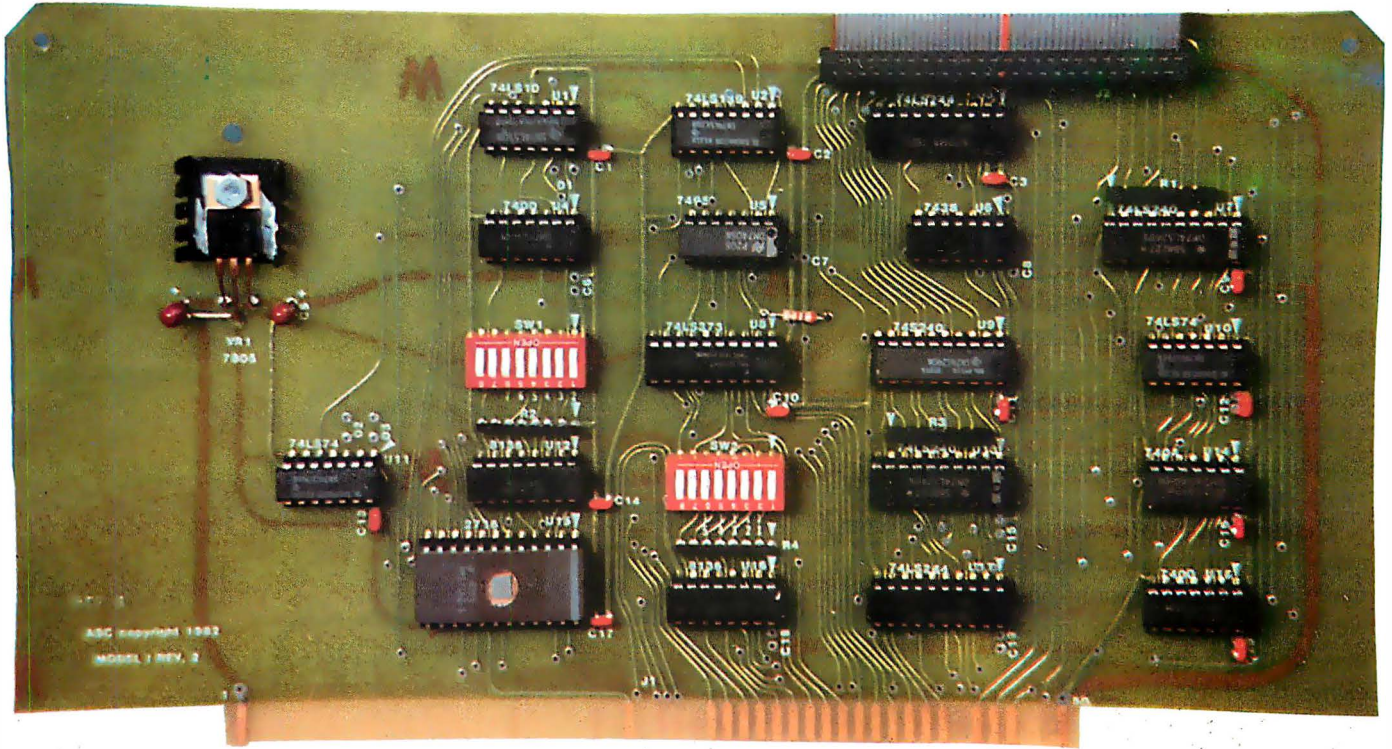

Photo 1: The host computer adapter (HCA) printed-circuit card.

50-conductor ribbon cable, which is the SASI standard. Photo 1 shows the printed-circuit card that results. For anyone interested in building only one of these devices, the HCA could also be implemented on a wire-wrap card instead of a printed-circuit card.

Power-Supply Characteristics

The HCA board obtains its power

from the S-100 bus so the only elements of the Winchester disk subsystem that require external power are the disk drive and the controller card. Both these devices require +5 and +12 volts (V) DC. Adding up the power requirements for both devices at both voltages results in total power requirements of about 1.5 amps at +12 V and about 3.0 amps at +5 V.

Several options were available for providing this power. These included designing and constructing a power supply, buying a commercially available linear supply, or finding a commercially available switching supply. Fortunately we were able to find a commercially available switching supply that provided 2.0 amps at +12 V and 3.0 amps at +5 V. This exactly fit our power requirements. Because it was a switching supply it was small enough physically that we could include it in a small enclosure with the disk drive and controller card, and the supply was relatively efficient so that power dissipation and cooling problems in the disk enclosure would be minimized.

System Packaging

Choosing the power supply completed the overall design of the Winchester disk subsystem. The only remaining step was to devise a way to package the system. This was particularly important due to the characteristics of the Winchester disk drive. Photo 2 shows the Miniscribe disk as it is delivered from the manufacturer. From this view it is apparent that the disk drive, as is true of all Winchester disk drives, is intended to be mounted

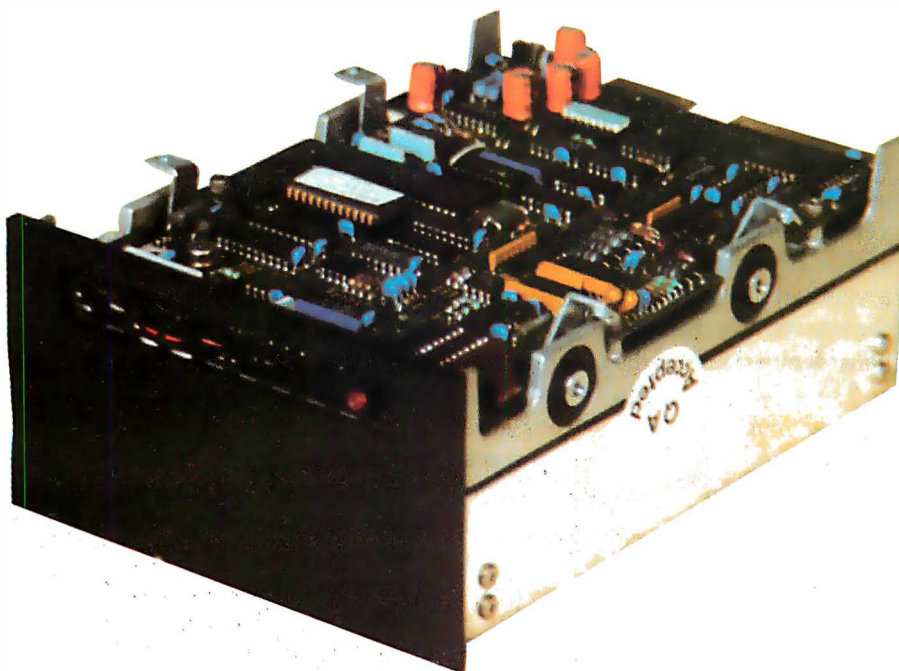

Photo 2: The Miniscribe 5 1/4-inch Winchester disk assembly.

in some type of enclosure. In fact it is even more important to install this disk in an enclosure than the photo would indicate. The disk is meant to be installed using the isolation points shown in the photo to isolate the disk mechanically from the rest of the system. These isolation points absorb high-frequency shocks occurring during handling that could result in damage to the very sensitive read/write head of the drive. Thus it is imperative to install the disk in an enclosure as soon as possible and to exercise extreme care in handling the disk prior to its installation.

The controller card and the power supply we chose had dimensions that made it feasible to mount both these elements in the same enclosure as the disk drive. Photo 3 shows all these elements before assembly. We chose to mount this equipment in a box 7 inches wide, 12 inches deep, and 7¼ inches tall. In our opinion, a box this size approached the median between having a small, compact system and still providing enough free space in the enclosure for adequate ventilation.

The enclosure selected had a removable top, and photo 4 shows how these various components were mounted in the box. The disk drive was bolted to channels attached to the box. The controller card was attached to the bottom of the box using angle brackets, and the power supply was bolted directly to the bottom of the box. We constructed a cable harness to route electrical power from the power switch to the power supply and on to the disk drive and controller. Also we fabricated three ribbon cables. One of these was used to connect the HCA to the controller board and the other two were used to connect the controller board to the disk drive. Photo 4 shows the installation with all the cables in place. As the photo shows, the installation is still rather compact but has sufficient room for ventilation.

One of the last but, from a reliability standpoint, one of the most important design considerations was to allow sufficient ventilation of the assembled product to prevent excessive heat buildup. Photo 5 shows

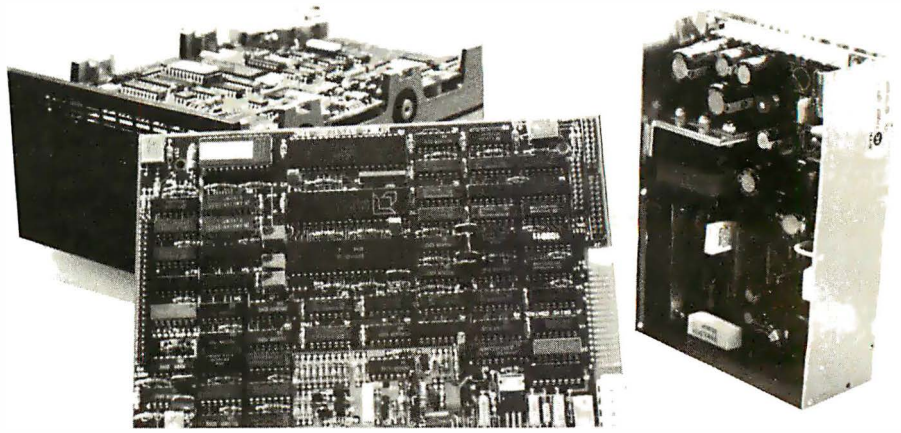

Photo 3: The Winchester disk-drive subsystem components before assembly.

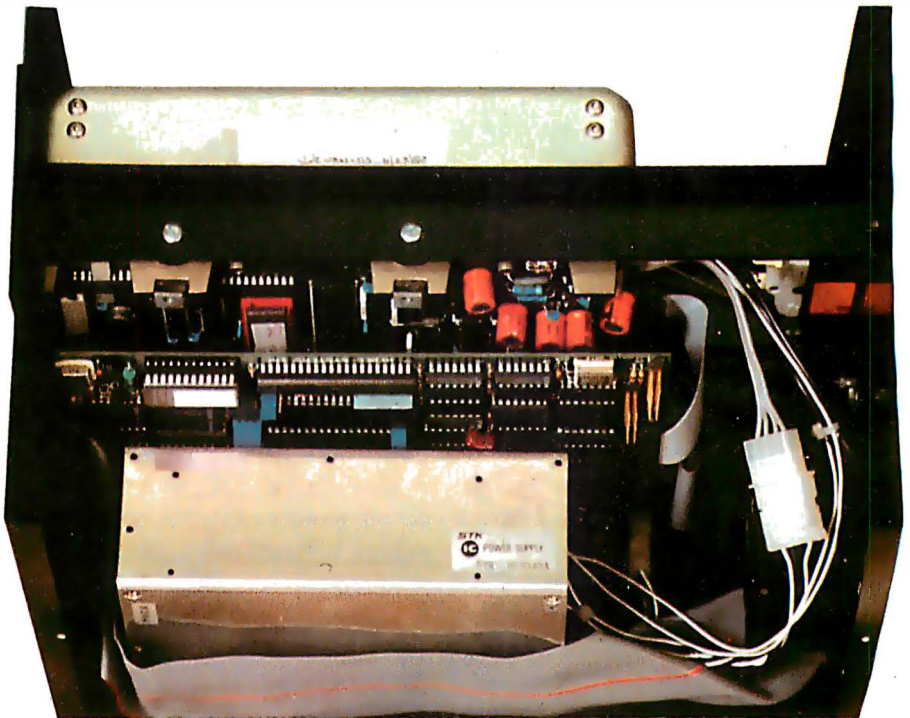

Photo 4: The completed disk-drive assembly.

both the front and back of the assembled enclosure. We punched ventilation holes on the front of the enclosure and on the rear we included a ventilation fan to force air through the system. We then measured the exhaust temperature of the air at the fan and measured the temperature inside the box during operation to assure ourselves that there were no hot spots in the box. The fact that we found no hot spots was not surprising because all the equipment in the enclosure is designed to be convectively cooled, and the fan we chose had a volume flow rate that replaced the air in the enclosure about 40 times every minute. The end result of the entire

design operation was the set of hardware shown in photo 6, a forced-air enclosure containing the disk drive, controller, and power supply; an HCA card that plugs into an S-100 backplane; and a 50-conductor ribbon cable to connect these two elements.

Summary

In this article we have described the design and construction of the hardware necessary to interface a Winchester technology disk drive with an S-100 computer system. You should now have a detailed understanding of what is required to perform this type of integration, and with sufficient

Q.

What group of gifted folk has experienced a 304% population explosion over the past 6 years?

A.

BYTE subscribers.
Here's how to join them:

1. Complete this post-paid reply card and mail.
2. Within 6 to 8 weeks, your subscription will be processed.
3. Prior to receiving your first issue, you will receive our invoice. After examining BYTE, honor the invoice if you're satisfied. If not, just write "cancel" on the invoice and return it to us. You will not be charged for that issue.



4H43

Name Please print

Address

City State/Province/Country Code

United States

One year \$21 (12 issues) 2 years \$38 3 years \$55

Canada or Mexico

One year \$23 (12 issues) 2 years \$42 3 years \$61

Foreign Rates (to expedite service, remit in U.S. funds drawn on a U.S. bank)

- Europe, one year, air delivered, \$53
- All other countries, one year, surface delivered, \$37
Air delivery available upon request
- Check enclosed (entitles me to 13 issues for price of 12, North America only)
- Bill VISA Bill Master Charge Bill me (North America only)

Card Number

Expires

Signature

Q.

What group of gifted folk has experienced a 304% population explosion over the past 6 years?

A.

BYTE subscribers.
Here's how to join them:

1. Complete this post-paid reply card and mail.
2. Within 6 to 8 weeks, your subscription will be processed.
3. Prior to receiving your first issue, you will receive our invoice. After examining BYTE, honor the invoice if you're satisfied. If not, just write "cancel" on the invoice and return it to us. You will not be charged for that issue.



4H43

Name Please print

Address

City State/Province/Country Code

United States

One year \$21 (12 issues) 2 years \$38 3 years \$55

Canada or Mexico

One year \$23 (12 issues) 2 years \$42 3 years \$61

Foreign Rates (to expedite service, remit in U.S. funds drawn on a U.S. bank)

- Europe, one year, air delivered, \$53
- All other countries, one year, surface delivered, \$37
Air delivery available upon request
- Check enclosed (entitles me to 13 issues for price of 12, North America only)
- Bill VISA Bill Master Charge Bill me (North America only)

Card Number

Expires

Signature



NO POSTAGE
NECESSARY
IF MAILED
IN THE
UNITED STATES

BUSINESS REPLY CARD

FIRSTCLASS PERMIT NO.39 MARTINSVILLE, NJ

POSTAGE WILL BE PAID BY ADDRESSEE

BYTE

Subscription Dept.
P.O. Box 590
Martinsville, NJ 08836



NO POSTAGE
NECESSARY
IF MAILED
IN THE
UNITED STATES

BUSINESS REPLY CARD

FIRSTCLASS PERMIT NO.39 MARTINSVILLE, NJ

POSTAGE WILL BE PAID BY ADDRESSEE

BYTE

Subscription Dept.
P.O. Box 590
Martinsville, NJ 08836

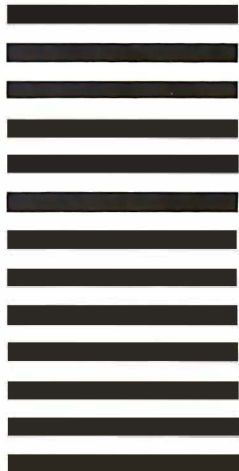

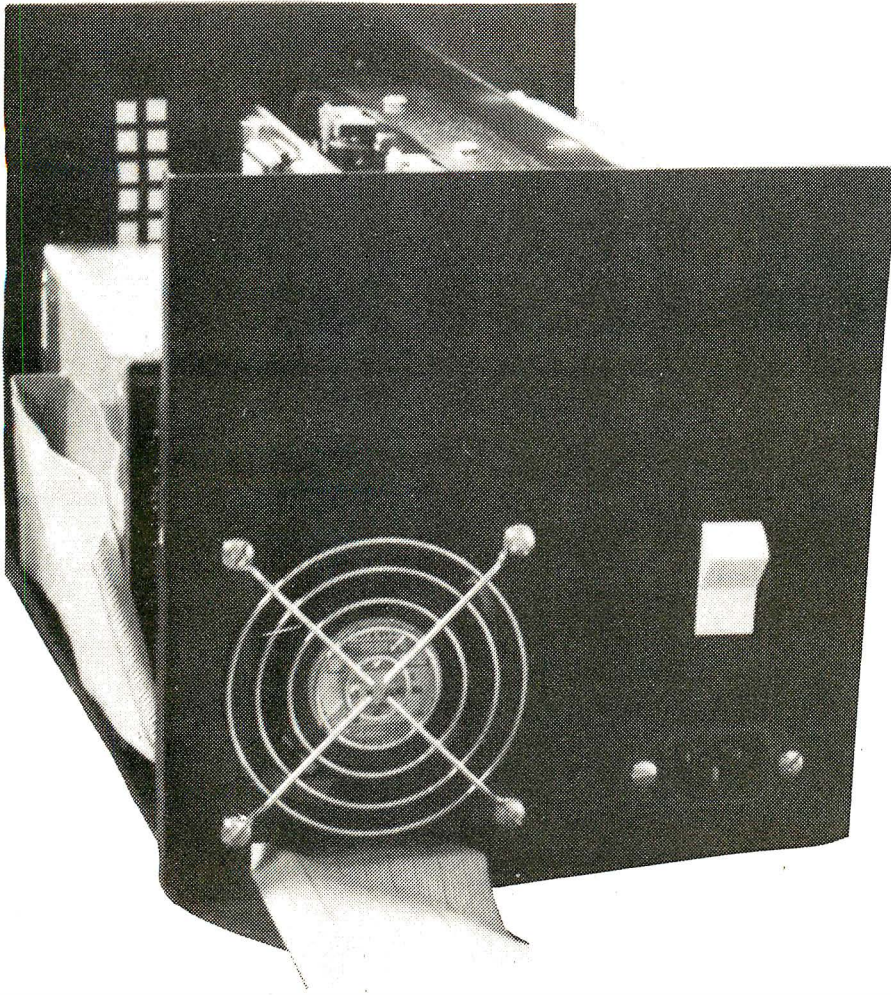

Photo 5: Ventilation details of the disk-drive assembly.

perseverance you should be able to design and construct one of these systems. Next month we will finish this series by describing the various software components that must be developed to interface the hardware with the system. Specifically, we will cover how to write a BIOS that combines the BIOS for the existing peripherals on the system with a set of BIOS routines to handle the hard disk. We will also discuss how to write a relocatable bootstrap loader for the HCA PROM and discuss some of the methodology involved in testing and debugging the various hardware interfaces in the system. ■

The Winchester disk-drive subsystem described in this series of articles is available as a completely assembled unit from ASC Associates of Lexington Park, Maryland. In addition to the S-100 version discussed, versions are also available for TRS-80 and Apple computers. The disk-drive systems for these computers use the same drive and controller hardware as the S-100 version but use a different host computer adapter and interface software. Until a nationwide dealer distribution network is established, these systems will be available by mail order for \$1995. To order or obtain further information, write to ASC Associates Inc., POB 615, Lexington Park, MD 20653, or phone (301) 863-6784.

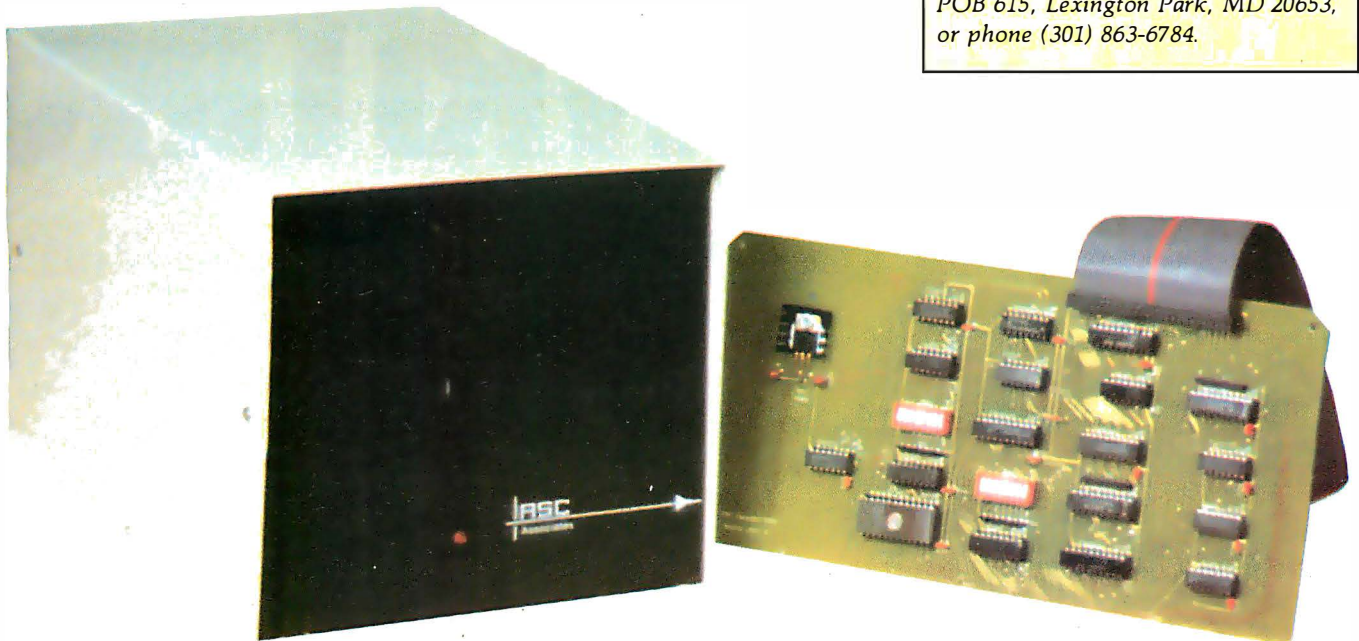
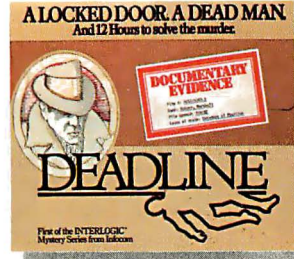
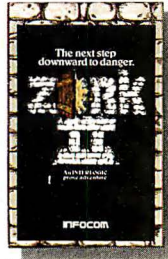
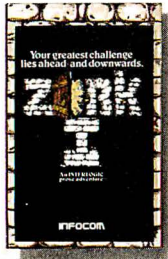

Photo 6: The completed disk subsystem showing the drive assembly and the HCA printed-circuit card.



WE'RE WRITING

THEM AS FAST AS WE CAN!

At the rate we're going, we'll have these pages filled by 2083. And by 2084, people will be clamoring for the next Infocom creation.

We hate to disappoint our public. So we keep you waiting. Because while the software factories are cranking out arcade game after arcade game, pulpy adventure after trite fantasy, we're writing and rewriting, honing and perfecting. Before a single person enters one of Infocom's worlds, it must be crafted into a living, riveting, definitive experience.

Judging from the public's reaction, it's worth the wait. For instance, *Creative Computing* welcomed DEADLINE™ as "thoroughly engrossing and realistic," while a *Softalk* readers' poll recently voted ZORK™ I and ZORK II the most popular adventures of 1981.

And now, for the moment, your wait is over. ZORK III, your final

step in the underground trilogy, and STARCROSS™, an exploration of a new dimension in science fiction, are ready for you.

Look at them up there, the little worlds of Infocom. As our universe expands, companions will come to help fill that vast expanse of white space. Till then, they'll continue to stand alone as the best of all possible worlds.

INFOCOM™
55 Wheeler Street, Cambridge, MA 02138

Infocom's worlds are available for Apple®, Atari®, IBM, TRS-80®, Commodore, NEC, Osborne, CP/M®, and DEC.™

Apple is a registered trademark of Apple Computer, Inc. Atari is a registered trademark of Atari, Inc. TRS-80 is a registered trademark of Tandy Corporation. CP/M is a registered trademark of Digital Research, Inc. DEC is a trademark of Digital Equipment Corporation.

Terminal Solutions, Manual Madness, BASIC Bits, and Info Helpers

Terminal concerns for Wordstar users, BASIC comments, and a bunch of useful utilities are reviewed at Chaos Manor.

Jerry Pournelle
c/o BYTE Publications
POB 372
Hancock, NH 03449

My Televideo (TVI) 950 terminal holds an ambiguous position here at Chaos Manor. I rather like it in some ways. However, I haven't got around to writing a program that will make use of all its reprogrammable keys, and it has all these extra (and nonreprogrammable) "feature" keys that seemed so useful when I bought it, but which turn out to be worse than useless now that I have it. For example, not one text-editor program I know of can make use of the arrow keys. Worse, there's Back Tab.

I find I'm not alone in my distaste for the Back Tab key on the Televideo 950 terminal. It does nothing useful at all. I and many others keep hitting it instead of the Control key. For those not familiar with TVI terminals, Back Tab is just below Control and outboard of Shift, optimally placed for being hit when it shouldn't be. It produces the sequence Escape I, which, depending on what you're doing at the time, can range from annoying to disastrous.

Thus, sometimes I think I'll keep the 950, and other times I'm tempted to sell it.

My friend and sometime associate Tony Pietsch has found a way for his WRITE text editor to distinguish between an Escape sequence done by a human operator and one sent by a programmable key. I'm not sure how he does it. One way would be to use a timing test: Escape followed by some character is interpreted one way if the character comes almost immediately, as it will if it's part of a sequence sent by the terminal, and another way if there's an appreciable lag between the Escape and the following character.

However Tony does it, his installation of WRITE on the TVI converts the Back Tab key to something harmless. That's certainly one possible solution, and somewhat less drastic than what I was tempted to do, which involved removing the key entirely. Of course, it works only when using the text editor, although I suppose I could use the same sort of trick in my

CBIOS (customized basic input/output system) to intercept Back Tab's Escape I and turn it into, say, a null . . .

Good News for Wordstar/TVI Addicts

Wordstar users now have available a very elegant way to get around Back Tab, while making use of all those lovely extra feature keys that made the TVI 950 so attractive when I thought of buying it, and which turned out to be so useless once I brought it home. Wordtech Systems TV2000 Conversion will turn the TVI 950 into an excellent Wordstar terminal.

The Wordtech system consists of a new PROM (programmable read-only memory) that replaces the one that comes with the 950, a new set of key tops, and a label strip. It's easy enough to install, although getting the old PROM out and putting the new one in does involve opening up the terminal, and you'll want to be

NO COMPROMISE ON P3*

I/O TECHNOLOGY S-100/IEEE-696 PLUG-INS

DUAL GPIB-488 INTERFACE BOARD

The Dual GPIB-488, is a Stand-Alone, independently controlled Dual Channel IEEE-488, 1978 Interface Controller. Interface Activity Modes such as Controller In-charge, Controller Assigned or Terminal Bus Slave and all Interface Functions, their Sub-Functions including Extended Functions, are handled by an On-Board 5MHz Processor and DMA Controller. 500K Byte Data rates are easily achieved with minimum host processor overhead.

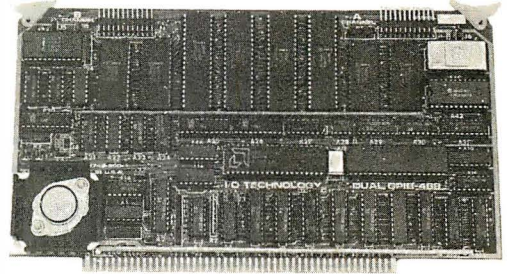

Assembled and tested, P/N 52748-800-100 \$650.00

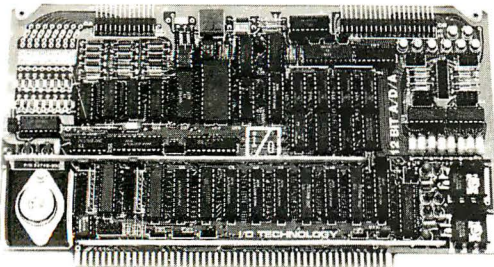

12-BIT A-D-A CONVERTER BOARD

8 Channel A-D: 12 microsec. Conv. time, Programmable gain & Offset Voltage control, Diff./Single Voltage or Current Input.

8 Channel D-A: 2 microsec. Settling time, Bipolar V / Unipolar I Output, Programmable Reference levels, DUAL-PORTED Refresh RAM. 16 or 8-bit Data Transfers via Program I/O or Memory Mapped I/O, Extended Addressing and much more.

Assembled and tested, P/N 52748-900-100 \$430.00

128K x 8 / 64K x 16 CMOS STATIC RAM MODULE

TOP BOARD SUPPORT
LOGIC AND
32K x 8 / 16 x 16 RAM

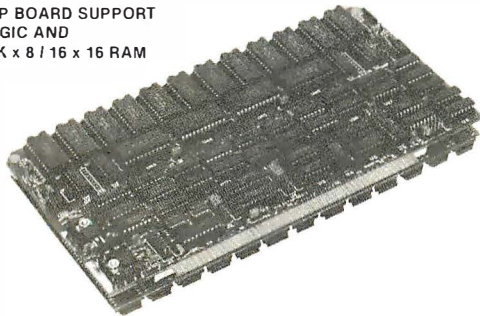

BOTTOM BOARD
96K x 8 / 48K x 16 RAM

150 nsec. Access, 2716 compatible RAM devices, Extended Addressing, Programmable wait cycles, Write protect and Bank select. Battery back-up capability. No wait cycles with fast 16-Bit Processors. The module's "Piggy-back" arrangement provides high density @ low input power yielding an improved MTBF and space utilization.

Assembled and tested, P/N 52748-650-128 \$825.00

MULTI-FUNCTION I/O BOARD

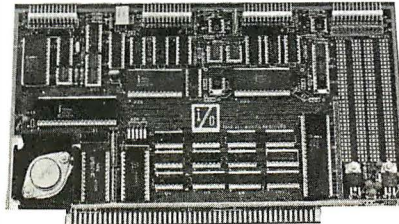

Assembled and tested,
P/N 52748-100-101 \$325.00

Two Serial SYNC/ASYNCRS-232, TTL or Current Loop with XTAL controlled Dual Baud Rate Generator, Four Parallel Ports (Input, Output or Bi.), Three 16-Bit timers, 8-level Interrupt Controller and large Proto area with +5V, ±12V for custom applications.

PROTOTYPING BOARD KIT

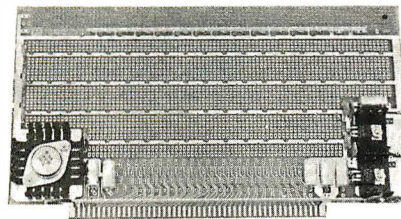

Can be used for wire-wrap or solder prototyping projects. Comes complete with +5, ±12V Regulators, Heat sinks, 2 Bus Bars, Filter Capacitors and Manual.

Kit P/N 52748-400 \$59.95

* PERFORMANCE, POWER, PRICE

New additions to our line of fine products are always on the drawing board. Please watch for the introduction of these new items as they become available.

POST OFFICE BOX 2119
CANYON COUNTRY, CA 91351
(805) 252-7666



CANYON COUNTRY
CALIFORNIA



Calif. residents add 6 1/2 % sales tax.
U.S. Domestic Price, F.O.B. Factory.
Prices and Specifications subject to change without notice.

Circle 192 on inquiry card.

careful in handling the chips. Once that's done, you pull off the old key tops and put in the new according to a chart provided by Wordtech.

The Wordtech changes will be invisible, and your TVI terminal won't seem to be changed until you enable it through an Escape sequence. Once that's done, all the new key tops will apply. Back Tab, for example, becomes Block Menu or Control-K. All the other keys become useful also. The Wordtech rearrangement of the keyboard is not the one I would have designed, but then I'm not a Wordstar user, and thus might easily be

mistaken. One thing's for sure, the Wordtech arrangement is about a zillion times more convenient than the way the TVI keyboard comes.

You can go back to regular TVI mode any time with a different Escape sequence. The key tops have the old function names as well as the new.

The Wordtech scheme is an excellent one, and I recommend it for all Wordstar users who have the TVI 950 terminal.

I've been talking to the people at Wordtech, and they claim they can make me a new PROM for the TVI

that will optimize it for WRITE and Wordmaster, which are the editors I use. I think I'll love that.

Status Line Removal

Several letters inform me that there's a simple way to get rid of the TVI 950's status line: just go Escape g Escape f Space Space Space Carriage Return. (The case is important: that is, use lowercase g and f.)

This certainly works, although I wasn't able to figure it out from the manual. I thank those who told me about it.

Manual Trades, Part One

There's good news and bad news on the document front. The good news comes from Paul Brest of Pro/Tem Software who says, "In a review of Cardfile several months ago, you quite justly criticized the documentation. The review persuaded me to rewrite the manual from scratch." He enclosed a copy of the new manual.

Cardfile is marketed by Digital Marketing, an organization whose distinctive logo shows up in a lot of places. In its own words, "Cardfile automatically stores, retrieves, and displays the sort of information typically kept in index card files—summaries of books and articles, notes, recipes, menus, catalogs of phonograph records, etc." It does this in a complex way that's made reasonably transparent to the user. In my previous review I said I was favorably impressed by the program, but quite unhappy with the manual.

That's fixed now. The new manual is very good. It tells what the program does and how to make it do that. There are plenty of examples, and it's clearly written. My only complaint is relatively trivial: unlike the previous manual, this one is not punched for storage in a 3-ring binder, and it's a little too thick for my punch, while too thin to have its name on the spine so it can be shelved by itself.

Manual Trades, Part Two

I really do like Digital Research and much of what it publishes, honest I do. That doesn't stop me from trying

FRANCHISE OPPORTUNITIES.



IT'S NEVER BEEN A BETTER TIME!

The computer industry is experiencing a spectacular growth, by 1990 it will become a 20 billion dollar industry. Computer retailing was one of the few industries not seriously effected by the recent economic crisis.

Now... is a good time to consider

a franchise opportunity with MicroAge, a leader in computer retailing. MicroAge has a proven "track record" with over thirty franchised stores throughout the United States and Canada. In an industry where experience is crucial, MicroAge has it, with six years computer retail experience and three years in franchising. It's just good sense to go with a leader.

If you're committed to success in computer retailing, it's essential you evaluate the MICROAGE COMPUTER STORES Franchise opportunity. Investment: \$130,000-\$200,000.

For detailed information about MicroAge "Franchise Opportunities," call (602) 968-3168 or write to:

MicroAge Computer Stores Inc.
1425 W. 12th Place
Tempe, AZ 85281

MicroAge
COMPUTER STORE
"The Solution Store"™

to change its documentation habits, which aren't very good.

Example. The other day I decided to put random-access files into my Minimum Data Base (MDB), which is written in CBASIC and CB-80. CBASIC pseudocompiles to an intermediate code that is then interpreted a line at a time; CB-80 compiles to true 8080 machine code. They aren't the same language, but they don't differ by much. If you're careful, programs will compile in both. CBASIC will run under CP/M 1.4; CB-80 needs 2.2 or later. MDB is a little do-all program that I use for Christmas cards, menus, and all kinds of odd jobs.

I haven't done much CB-80 file-management programming for a while, so I thought I'd read the manual as a refresher. After all, the CBASIC manual had taught me enough about random-access files to allow me to write the accounting program I use, and what I had in mind for the MDB wasn't anywhere near that complicated. Because I was going

to work primarily in CB-80, I took out that manual and turned to the index.

No entry for "random access." None for "sequential" either.

I began to splutter. "Now wait a minute!" I yelled, causing my assistant, two of the boys, and the dog to come running in to see what was wrong. There *had* to be random-access files in CB-80. I *know* there are, because the POST program that takes my journals and posts them into ledgers, although written originally in CBASIC, compiles and runs fine under CB-80; and each of those ledger pages is a random-access file.

Nothing for it but to scan the table of contents, which I did. Nothing on file types at all. Best to read the whole chapter, then. In the opening paragraphs on "File Description" there is a brief discussion of "fixed" and "stream" files. It is terse to the point of uselessness.

The remaining 13 pages on files are much the same: if you can understand what's said there, you already know

at least that much about the subject. If you don't know what's going on, you won't learn it from that stupid manual. Perhaps that's an overstatement, but not by much.

The old CBASIC manual, published before Digital Research bought out Gordon Eubanks and his Compiler Systems company, had more than 20 pages on files, including an excellent section called "Programming with Files" that explicitly discussed the differences between "sequential" and "random-access" files, and explained precisely how "random access" worked. Example:

Randomly accessed records must use the fixed [record length] organization. CBASIC locates each record on a randomly accessed file by taking the relative record number specified in the program, subtracting one from the number, and multiplying it by the length of a record. The result is the byte displacement of the record measured from the beginning of the file. If the records were of varying length, the displacement could not be calculated in this manner.

DEVELOPMENT HARDWARE/SOFTWARE GTEK MODEL 7128 EPROM PROGRAMMER

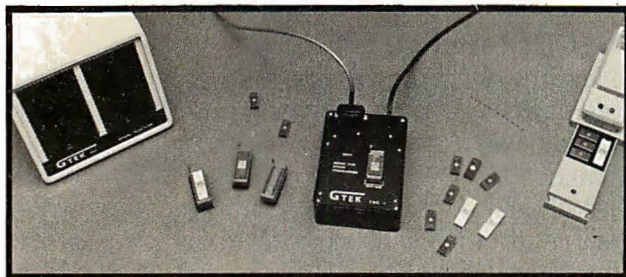

- Microprocessor based intelligence for ease of use and interface. You send the data, the 7128 takes care of the rest.
- RS-232 interface and ASCII data formats make the 7128 compatible with virtually any computer with an RS-232 serial interface port.
- Auto-select baud rate.
- Use with or without handshaking. Bidirectional Xon/Xoff supported. CTS/DTR supported.
- Devices supported as of DEC 82.

MMOS	NMOS	CMOS	EEPROM	MPU'S
2758	2508	27C16	5213	8748
2716	2516	27C32	X2816	8749
2732	2532	C6716	48016	8741
2732A	2564	27C64		8742
2764	68766			8751
27128	8755			8755

- Read pin compatible ROMs also.
- Automatic use of proper program voltage based on type selected.
- Menu driven eprom type selection, no personality modules required. (40 pin devices require adapter)
- INTEL, Motorola and MCS-86, Hex formats. Split facility for 16 bit data-paths. Read, program, and formatted list commands also.
- Interrupt driven type ahead, program and verify real time while sending data.
- Program single byte, block, or whole eprom.
- Intelligent diagnostics discern between eprom which is bad and one which merely needs erasing.

- Verify erasure and compare commands.
- Busy light indicates when power is being applied to program socket.
- Complete with TEXTOL zero insertion force socket and integral 120 VAC power supply. (240 VAC/50HZ available also)
- High Performance/Cost ratio.
 - Model 7128 PRICE \$389.00 •••

MODEL 7128 SOCKET ADAPTERS
MODEL 481 allows programming of 8748, 8749, 8741, 8742 single chip processors.
Price \$98.00

MODEL 511 allows programming the 8751, Intel's high powered single chip processor.
Price \$174.00

MODEL 755 allows programming the 8755 EPROM/IO chip
Price \$135.00

MODEL 7128/24 - budget version of the 7128. Supports 24 pin parts thru 32K only. Upgradable to full 7128 capacity.
Price \$289.00

Non-expandable, very low cost models available for specific devices.
MODEL 7128-L1 for 2716 only \$149.00
MODEL 7128-L2 for 2732 only \$179.00

Also available from stock:
Eprom Erasers UVP model DE-4 . . . \$78.00
Avocet Systems Cross Assemblers \$200.00
RS-232 Cable Assemblies \$25.00
Programmable Devices call
Complete development systems . . . \$3240.00

Post Office Box 289
Waveland, Mississippi 39576
(601) 467-8048

GTEK INC.

Radio Shack TRS-80's Full Line

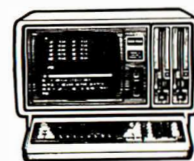
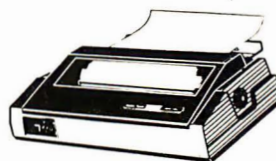

YOU CAN SAVE money when you buy Radio Shack TRS-80 Computers from **Pan American Electronics**. Pan American Electronics went into business in 1976 and led the way in bringing consumers original Radio Shack TRS-80 Computers at reduced prices. **NO** other company has done it longer. **NO** other company has done it better and **NO** other company sells them for less.

Pan American Electronics

TOLL FREE NUMBER 800/531-7466

1117 Conway Avenue • Department B
Mission, Texas 78572
Phone: 512/581-2766
Telex Number 767339

TM — Trademark of Tandy Corporation

Unsurpassed luxury in the Middle East... that's the Sheraton styleSM

The Sheraton style is providing today's traveller with the utmost in luxury throughout the Middle East. From state of the art business facilities and luxurious rooms, to exquisite cuisine and a tradition of fine service and hospitality. So on your next trip, come experience Sheraton's style in the Middle East.



Cairo Sheraton—Sheraton is your business and pleasure headquarters in the city of Cairo. Enjoy outstanding service, a variety of oriental and Middle Eastern cuisine, outdoor pool and top of the line business facilities.

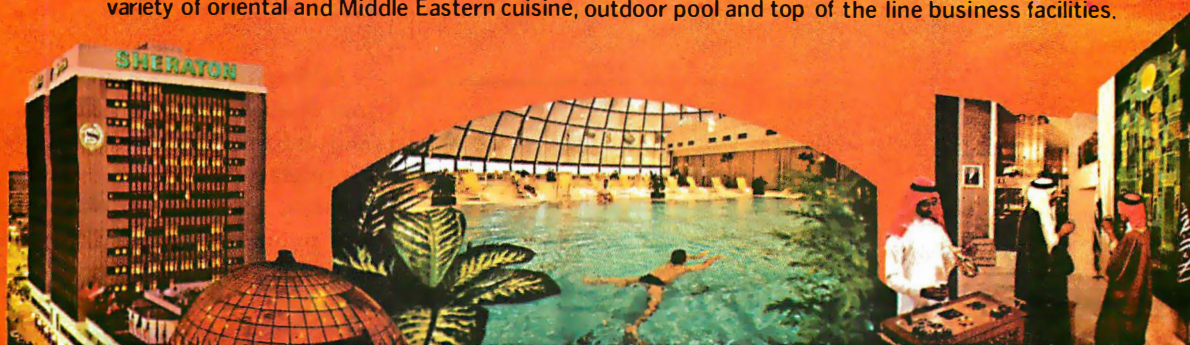

Al-Badr Jeddah Sheraton—Luxury styled to today's businessman. Centrally located to diplomatic and commercial centers. Enjoy our glass domed pool, health club and the ambiance of our elegant restaurants.



Montazah Sheraton-Alexandria—The newest hotel in Montazah, situated on the clear blue waters of the Mediterranean. Sheraton's luxury offers excellent meeting facilities and an outstanding choice of international cuisine.



Heliopolis Sheraton—In Cairo's most fashionable suburb, convenient to downtown, airport and historical sites. Experience the atmosphere in our variety of international restaurants, exciting lobby lounge and excellent business facilities.

Sheraton
HOTELS & INNS, WORLDWIDE

800-325-3535
OR CALL YOUR TRAVEL AGENT

Circle 467 on inquiry card.

INVESTMENT ANALYSIS FROM CENTENNIAL

CENTENNIAL SOFTWARE / 410 17TH ST. SUITE 1375 / DENVER, CO 80202 / (303) 595-9193

STOCK-FOCUS

Find out how low is low and how high is high. Using capital structure and performance data, Stock-focus objectively calculates the underlying value of a stock. The system was first developed by the management science department of a major money center bank, and is now in use by investment advisors, trust companies and brokerage houses. On your screen, Stock-focus will plot an estimate of lowest value, highest value and the current price. You then decide what to buy, sell or hold.

REAL-FOCUS

Exhaustively analyze potential real estate investments using the Wharton School's approach to real estate analysis. In minutes you can project profit, costs, and IRR for any project over a 10 year period. Real-focus accounts for amortization, debt, income, operating expenses, taxes, depreciation, and cash flows for both after-tax holding and the results of sale. With Real-focus you can analyze any potential investment from a single building project to a complex time-phased planned unit development.

THE FOCUS TECHNIQUE

FOCUS is CENTENNIAL SOFTWARE's new approach to Program Architecture, providing a natural interaction between microcomputers and users. It provides worksheet style input screens, free access to all program segments, and the ability to com-



bine individual results files for portfolio analysis. You also receive a usable reference manual, menu helps, a program glossary, multiple report formats and spooling. With our FOCUS technique even the most complex programs are versatile and easy to use.

COMPUTER	MEMORY-K	REAL-FOCUS	STOCK-FOCUS
IBM PC	64	\$179.00	\$189.00
Apple (plus) II	48	149.00	159.00
TRS-80 I	48	149.00	159.00
TRS-80 II	64	179.00	189.00
TRS-80 III	48	149.00	159.00

ALL PROGRAMS IN DISK BASIC

IBM is a trademark of IBM, Apple is a trademark of Apple Computer Corp., TRS-80 is a trademark of Tandy Corporation.

ORDER NOW! FILL IN OR CALL 800-525-2003 (Toll Free)

PROGRAM NAME _____ COMPUTER _____ MEMORY _____
 NAME _____ PHONE # _____
 ADDRESS _____  
 ACCOUNT # _____ EXP. DATE _____

And so forth. That's informative. The result was that way back when I began playing with small computers, I was able to create a pretty sophisticated accounting program, because the CBASIC manual told me something about the language, and said it in comprehensible terms.

None of that is in the CB-80 manual. Now true: the CB-80 manual calls itself a "Reference Manual," meaning, I suppose, that it's the user's responsibility to get his or her own primer. This is not, in my judgment, a sane marketing strategy. Whatever the relative merits of CB-80 and Pascal—and I am prepared to defend CB-80 as a real candidate for the beginner's microcomputer language of the future—there's no contest if you can't *learn* one of the languages.

Adding insult to it all, at the bottom of every page is the silly phrase, "All Information Presented Here is Proprietary to Digital Research." The constant repetition of this meaningless pomposity would be irritating enough if the information were more comprehensible, but given what you actually get it's doubly so.

I'd strongly advise Digital Research to generate a good beginner's manual for CB-80. The language, with features like true local variables, parameter passing, functions that can serve as true "procedures" and can be called by name, etc., is far too good to be restricted to experts. Flash: there have been reforms at Digital. More next month.

Free BASIC and PBASIC

My October 1982 column generated a lot of mail, some angry and some thoughtful, by quoting computer expert Edsger Dijkstra:

It is practically impossible to teach good programming to students that have had a prior exposure to BASIC; as potential programmers they are mentally mutilated beyond hope of regeneration.

Now I don't believe that; not only can people whose first computer experience was BASIC programming

HARDWARE/SOFTWARE - WHOLESALE!

Purchase your Hardware and Software directly from an OEM/ Systems Integrator. Take advantage of our buying power! We stock a full line of Board Level Components, Software, and Peripherals. Call for your needs. We'll give you the Lowest Prices, and the Technical Support and Know-How we are quickly becoming well-known for. Satisfied Customers Nationwide! The Nation's Custom Systems House for Business, Education, Science.

SOME OF OUR CURRENT SUPER-SPECIALS

IMMEDIATE DELIVERY! MORROW MICRO DECISION ALL COT TESTED!
1 DRIVE - \$819 2 DRIVE - \$1149 2 DS DRIVE - \$1299 MORROW TERMINAL - \$499
 MICROSOFT MBASIC - 8" CP/M - \$199 • ASHTON-TATE dBASE II \$459
 MICROPRO WORDSTAR - 8" CP/M - \$259 • WYSE 100 TERMINAL - \$769
 MITSUBISHI DSDD 8" DRIVES - FULL OR HALF HEIGHT - \$449 (THE BEST)
 SIEMENS SSDD 8" DRIVES - \$239 • OKIDATA 82 - \$419 / 83 - \$679 / 84 - \$1029

BOARDS/SYSTEMS COMPUPRO CUSTOM BUILT BUSINESS SYSTEMS

LIMITED SPECIAL: SYSTEM 816A - \$4395 816B - \$5595 816C - \$7195

M-DRIVE CP/M - 128K - \$959 • DISK 1W/CP/M - \$489 • M-DRIVE H - \$1395
 8085/88 - \$319 • 8086/87 - \$519 • CPU-Z - \$229 • DISK 1 - \$369 DISK 2 - \$599
 INTERFACER 1 OR 2 - \$199 • INTERFACER 3-5 - \$449/3-8 - \$519 • INTERFACER 4 - \$279
 RAM 17 (12 MHZ) - \$359 • RAM 16 (12 MHZ) - \$399 • SYSTEM SUPPORT 1 - \$309
 ENCLOSE 2 - DESK - \$659/RACK - \$699 • RAM 21 - \$849 • CPU 68K - \$519
 CP/M - \$149 • CP/M 86 - \$259 • MP/M 8-16 - \$769 • HARD DISKS, CABLES, ETC. - CALL US!

SIEMENS DUAL 8" SSDD SUBSYSTEM - \$699 MITSUBISHI DUAL 8" DSDD SUBSYSTEM - \$1099 w/All Cabling!
 20 MEG FUJITSU HARD DISK SUBSYSTEM W/ DISK 2, BIOS, & ALL CABLING - \$3199

WE ARE THE LARGEST IN THE CUSTOM CONFIGURATION OF COMPLETE STATE-OF-THE-ART S-100 SYSTEMS, AT PACKAGE PRICING, WITH INTEGRATION, BURN-IN & PROGRAMMING. WE CUSTOM BUILD COMPUPRO SYSTEMS/HARD DISK SYSTEMS FOR BUSINESS APPLICATIONS.

WE NOW FEATURE A SPECIAL LEASE/OPTION AND FINANCING ON BUSINESS SYSTEMS - CALL!

WOW! \$\$ SPECIALS \$\$ GOOD THROUGH MONTH END. As supplies last. Rainchecks may be given if possible. Cash Sales Only!

CUSTOM COMPUTER TECHNOLOGY

1 CRAFTSMAN COURT, BOX 4160, SEDONA, ARIZONA, 86340 (602) 282-6299

PRICES & AVAILABILITY SUBJECT TO CHANGE. ALL PRODUCTS NEW. AND CARRY FULL MANUFACTURER'S WARRANTIES. CALL FOR CATALOG. FREE TECHNICAL HELP TO ANYONE. WE CAN CONFIGURE BOARDS & SOFTWARE FOR YOUR SYSTEM. PLUG-IN & GO. AZ RESIDENTS ADD APPLICABLE SALES TAX. CP/M® DIGITAL RESEARCH

learn to write good code in other languages, but some good programs are written in BASIC itself. By a "good" program, I mean one that does something useful, is easily used, and can be updated and maintained; and I contend that Minimum Data Base and my Accounting Package both meet those criteria. (I don't say there aren't *better* programs; only that for me these are *good enough*.)

However, Dijkstra, whose paper "GOTO Seen Harmful" was one of the primary works that began the structured-code movement, has a valid point. BASIC, especially its early versions, encouraged "spaghetti" code, and many older BASIC programs expire in an impenetrable fog of GOTO statements. No one, including the original programmer, has any idea of what's going on, or why, and it's very easy to write that sort of horror in BASIC.

Several possible solutions to this problem are available. One is to give up BASIC; an idea that has many advocates among my readers. Unfortunately, there's no agreement on what to put in its place. Pascal, Logo, various assemblers, FORTRAN and RATFOR, C, PL/I, FORTH, and LISP all have their (very vocal) advocates. Moreover, a lot of people out there have BASIC and don't want it to go to waste.

Another possibility is to change BASICs. CBASIC was a start. Its compiled successor CB-80 is a more obvious candidate; indeed, CB-80 has nearly all the structured features of Pascal. However, CB-80 is expensive, and, as I noted above, the introductory manuals leave something to be desired; while CBASIC is slow. For files programming these versions have another disadvantage: not only are they slower than Microsoft's MBASIC, but their files take up considerably more disk space. That used to be more important than it is now in these days of megabyte floppies, but it can still be significant if you have a machine with limited disk capacity such as an Osborne.

Furthermore, there are a lot of advantages to using an *interpreted* language like Microsoft MBASIC. Interpreted languages make programming

BABY BLUE™ THE "PLUG IN" SOLUTION TO SOFTWARE FOR THE IBM PERSONAL COMPUTER (AND SOME PC COMPATIBLES)

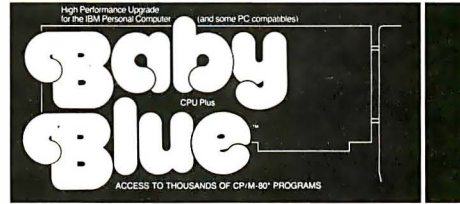

SOFTWARE SELECTION: BABY BLUE™ upgrades your IBM Personal Computer and allows you to run nearly 3000 popular CP/M® software programs.
SOFTWARE VERSATILITY: The BABY BLUE™ package includes three special "utility" software programs at no additional cost, making your computer very versatile.
SOFTWARE SAVINGS: BABY BLUE™ is now available bundled with WordStar™, MailMerge™, Personal Pearl™ and WonderCalc™ for only \$995. That's four applications programs plus BABY BLUE™ for only \$995.
ADDITIONAL MEMORY: BABY BLUE™ gives your computer 64K of additional main memory.

If you are looking for software BABY BLUE™ is the solution!

Buy BABY BLUE™ at your microcomputer dealer.



Xedex Corporation
222 Route 59, Suffern, NY 10901
(914) 368-0353
West Coast Sales Office
7700 Edgewater Drive Suite 360
Oakland, CA 94621 (415) 569-3100

Xedex is a subsidiary of
Terminals Unlimited International, Inc.
Dallas, TX (NASDAQ: TUII)

BABY BLUE™ is a trademark of Xedex Corporation
WordStar and MailMerge are trademarks of MicroPro International Corporation
Personal Pearl is a trademark of Realtime Systems International Corporation
CP/M is a registered trademark of Digital Research Incorporated

© 1982 Xedex Corporation

“Clearly one of the most powerful and versatile word processing programs available”
PC Magazine, January 1983

“You’ll wonder how you ever got along without it”
Software Retailing, February 1983

Write or call Mark of the Unicorn P.O. Box 423, Arlington, MA 02174, (617) 489-1387

- Display and edit multiple files simultaneously on a split screen
- Program-generated indexes, footnotes and table of contents
- Supports all printers . . . does true proportional spacing
- Total user customization
- Available for IBM PC and CP/M systems

simpler; you can check out your code a little at a time and trace the program operation. It's especially nice if you can then compile it to increase program operation speed, as you can with Microsoft's BASCOM. A lot of people have MBASIC; perhaps there's a way to structure programs while still using it?

Which brings us to the third possibility, given in Richard Mateosian's excellent book *Inside Basic Games*. Far from just a book on games (although it is that, and quite good, too), this book is a darned good lesson in programming technique.

Early in the book, Mateosian introduces what he calls "Free BASIC." This isn't really a language; it is what my mad friend used to call a *meta-language description* of a program. Free BASIC uses an exact syntax and includes most of the constructs required for structured programming: IF. . THEN. . ELSE, DO. . WHILE, DO. . UNTIL, and CASE. The programs Mateosian uses as illustrations are all "top-down" structured, and in

his discussions of how to program he emphasizes the techniques of top-down programming, introducing concepts such as "stubs" (dummy subroutines for checking program logic). If all BASIC programs were first written in Free BASIC before translation to regular BASIC, there would be a great deal less criticism of the BASIC language.

Alas, though, there is no such thing as Free BASIC; that is, unlike RATOR, for which there is an actual preprocessor that translates top-down structured code into standard FORTRAN, there is no Free BASIC program; the "language" exists only in concept, and once you've written your program in Free BASIC you must hand-translate it into actual code. I agree with Mateosian that using Free BASIC is an excellent idea and to be recommended; but I am also certain that, like many good ideas, it's not likely to be adopted. That shouldn't stop beginning programmers from reading his book, though.

Another possibility is PBASIC. This is an actual preprocessor that takes structured code and turns it into Microsoft MBASIC.

PBASIC allows unlimited comments, "pretty printing" with indentation to increase readability, alphabetic labels for subroutines, code without line numbers, local variables and parameter passing, and the like. It also makes "chaining" programs easier: that is, programs can call other programs as subroutines. Finally, PBASIC has simplified methods for creating and maintaining a library of subroutines and including them in new programs as needed.

Bruce Tonkin, PBASIC's creator, is convinced that PBASIC is much better than both CBASIC and CB-80. He may well be right about CBASIC. PBASIC is a compiler rather than an interpreter, of course, and thus has some inherent problems; but it compiles into interpretive MBASIC, which is usually easier to debug.

I don't think I agree about CB-80,

DISCOUNT PRINTER RIBBONS

Brand New, Top Quality, Exact Replacement Ribbons & Cartridges. These Ribbons Produce Super Jet Black Impressions and Ultra Reliable Print Life. They Are Delivered to Your Door Promptly for Much Less Than Most Retail Stores

★SPECIAL! BUY 10 and GET ONE FREE!

YOUR PRINTER	PACK SIZE	RETAIL LIST**	YOUR WHOLESALE PRICE	SIZE	COMMENTS	CAT. ORDER#
ANADIX 9000 Series	1 pk	14.00 ea	14.00	500	Nylon Jet Blk	C-777
CENTRONICS 700-703, 737, 779	3/pk	18.95/3 pk	11.95/3 pk	563" x 45"	Nylon Jet Blk	C-700
CENTRONICS 100, 101A, 102, 103, 300, 301, 306, 308, 330, 358, 398, 500, 501, 503, 508, 588, 620, 820	3/pk	26.33/3 pk	17.55/3 pk	1" x 108"	Nylon Jet Blk	C-100
CENTRONICS 704-705	1/pk	16.95 ea	13.95/Giant Cart	5'16" x 210'	Giant Cart	C-7045
DEC 1/2 x 40YO	3/pk	17.77/3 pk	12.95/3 pk	1'2" x 120'	Double Spools	R-600
DEC 1/2 x 60YO	3/pk	20.12/3 pk	14.25/3 pk	1'2" x 180'	Double Spools	R-644
DIABLO HYTYPE II (M/S BLK) HI YIELD. FITS 70 PRINTERS!	1/pk	9.31 ea	6.87 ea	5'16" x 'High Yield'	300,000 plus imp	C-511
EPSON MX70, 80	1/pk	16.00 ea	16.00 ea	500'x60'	Nylon Jet Blk	C-522
IBM --"SILVER DOLLAR" Sys. 34, Sys. 32 MOLA, Series IMOL4974, 5256, 3287, 3770, 3771-3774, 4974, 5100, 5103, 5110, 5228, 5256, 5320MOLA IBM - HARMONICA 1/2" SERIES I, MOD 4973/II, 3200, 3289, MOD 2.	5/pk	5.80 ea	14.90/5 pk	9'16" x 30'	Nylon Jet Blk	R-300
NEC SPINWRITER DUME (FITS 80 PRINTER M00S)	4/pk	23.40/3 cart	23.60/4 pk rli reload	1'2" x 51'	Nylon/Ex Lng Life	R-400
RADIO SHACK DAISY WHEEL II	3/pk	18.00/3 pk	13.95/3 pk	1'4" x 310'	Multistrike Film	C-525
RADIO SHACK LP III, LPV	1 pk	24.95/3pk	8.25	250'	Mylar Multistrike	C-789
RADIO SHACK LP III, LP IV	one/pk	13.95/cart	8.95/Reload rib" only	500" x 45"	Nylon Incl Instr	R-73
TELETYPE M00 33, 28, 35, 37, 38, 88.	3/pk	18.95/3 pk	11.95/3 pk	563" x 45"	Nylon Jet Blk	C-700
WANG M/S 5541W, WC 5581, WD, 6581W, 2281W	10/pk	2.40 ea	13.90/10 pk	1'2" x 36'	Nylon Jet Blk	R-450
	1/pk	6.85 ea	5.95 ea	5'16" x 393'	Multistrike Film	C-550

40% OFF!! OR MORE!

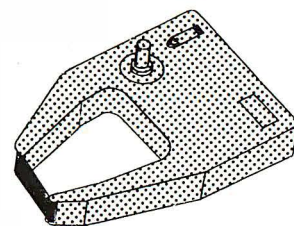

TERMS:

MINIMUM PURCHASE - \$20
PAYMENT BY: C.O.D. (UPS), CHECK, MASTER CARD, OR VISA CHARGE CARD.

VOLUME DISCOUNTS:
20 - 50 PACKS 10%
51 - 100 PACKS 15%

*UNDER \$20, ADD \$5 HANDLING.
**APPROX. RETAIL. PRICE VARIES.

ANCIE LABORATORIES

5200-J Philadelphia Way 301-345-6000 (Wash. D.C. Local)
Lanham, Maryland 20706 301-792-2060 (Balto. MD Local)
800-638-0987 (National)

NAME _____
ADDRESS _____
CITY _____ STATE _____ ZIP _____

ANCIE Laboratories 301-345-6000 (Wash. D.C. Local)
5200-J Philadelphia Way 301-792-2060 (Balto. MD Local)
Lanham, Maryland 20706 800-638-0987 (National)

QTY	CAT.#	AMT.
_____	_____	_____
_____	_____	_____
_____	_____	_____
TOTAL	_____	_____

Check Enclosed
 C.O.D.
 VISA
 MASTER CHARGE
ACCT. # _____
EXP. DATE _____
MIN. ORDER \$20
PRICES SUBJECT TO CHANGE

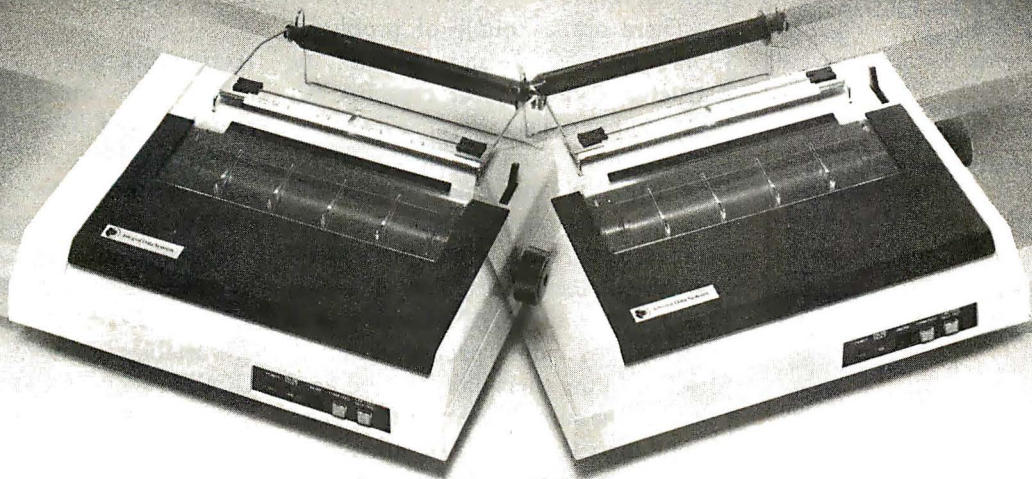

PRINTS LIKE A DAISY... COSTS LIKE A MATRIX.

Integral Data Systems introduces the only low-cost dot matrix printer on the market that features Maisey™ printing. Maisey printing is a technique that allows you to produce correspondence-quality text approaching that of more expensive daisy-wheel printers, but at much faster speeds.

How fast? With Microprism Printer's™ dual speed capability, you can output at 75cps in correspondence-quality and 110cps in high-speed data mode. And it also features sharp, high-density graphics in an 84 x 84 dpi format.

You'll get cleaner, crisper output than you ever thought possible in a single pass.

Other standard features of the Microprism include proportional

spacing, text justification and, of course, software compatibility with our more expensive Prism Printer™ line.

The Microprism Printer is the perfect system mate that can handle all of your printing requirements . . . it's the best of both worlds. So if you've been waiting for the price of daisy-wheel printers to come down, or the quality of dot matrix to go up, now is the time to check out the exciting new Microprism Printer from Integral Data Systems.

Stop in at your local dealer today and ask for a demonstration. If you need the name of the dealer nearest you, call us toll-free at (800)258-1386.

Or write Integral Data Systems, Milford, NH 03055.



Integral Data Systems, Inc.

Microprism Printer, Prism Printer and Maisey are registered trademarks of Integral Data Systems, Milford, NH.

Circle 206 on inquiry card.



**SAVE AT ELEK-TEK
HEWLETT-PACKARD**

**It's
Here**

**HP-75C
16K PORTABLE COMPUTER**

\$745⁰⁰ Mfr Sugg
995

The battery powered portable computer which includes a built-in HP-IL interface, card reader, and time and appointment modes. Typewriter keyboard.

HP-IL Products also available:

	Mfr Sugg	Elek-Tek
Digital Cassette Drive	450	\$349
Thermal Printer/Plotter	450	349
Video Interface	225	175
Solution Books	35	29

CALCULATOR SAVINGS

	Mfr Sugg	Elek-Tek
HP-41C	195	\$149
HP-41CV	275	209
Optical Wand	125	95
Card Reader	195	149
Printer	385	283
Quad R.A.M.(for HP41C)	75	60
Ext. Memory Module	75	60
Ext. Function Module	75	60
Time Module	75	60

**HEWLETT-PACKARD
SLIMLINE Programmable
LCD CALCULATORS**

HP-10C Scientific	\$54
HP-11C Scientific	70
HP-15C Scientific	92
HP-12C Financial	92
HP-16C Programmer	92

LIMITED TIME OFFER!

**HP-11C, 12C, 15C
Solution Books 8.50**
purchased with calculator.

**Special! 50% off mfr. suggested
retail price (\$150.00 ea)**

HP-34C Scientific	75
HP-38C Financial	75



**CALL TOLL FREE 800-621-1269
EXCEPT Illinois, Alaska, Hawaii**

Access. discounted too. Corporate Accts. Invited. Mastercard or Visa by mail or phone. Mail Cashier's Check. Money Ord. Pers. Check (2 wks to circ.) Add \$4.00 1st item. (AK, HI, P.R., Canada add \$8.00 first item) \$1.00 ea. add'l shog. & handl. Shipments to IL address add 6% tax. Prices subj. to change. **WRITE for free catalog. ALL ELEK-TEK MERCHANDISE IS BRAND NEW, FIRST QUALITY AND COMPLETE.**

ELEK-TEK, inc.
4557 N. Lincoln Ave., Chicago IL 60645
(800) 621-1269 (312) 677-7660

which has excellent structured features. No matter. Anyone who has Microsoft BASIC Version 5.2 or later should get PBASIC, whether or not they intend to get CB-80 or CBASIC. PBASIC isn't perfect, but it's more than worth its price to anyone who intends writing Microsoft BASIC programs.

PBASIC comes with a very good library of callable subroutines, such as "CALLPROG" that will actually chain to another program, a set of alphabetic and numeric conversions, uppercase and lowercase converters, and so forth.

There are a couple of problems. First, PBASIC doesn't have all the structured concepts of Free BASIC. It's another dialect. Because it's a pre-processor, it can't get inside Microsoft MBASIC and make fundamental changes; the result is that there are some costs. For example, there aren't any *real* local variables; PBASIC keeps track of variables internal to subroutines and procedures and doesn't allow their names to be used outside the subroutine, but it can't do more than that. They're still global variables, and you can have problems with nested subroutines if you're not careful.

Finally, the documentation isn't all that clear. You'd want to be pretty familiar with BASIC before tackling the PBASIC manual. It does have a good index, and there are examples; it's not *that* formidable.

PBASIC is mostly compatible with BASCOM, the Microsoft BASIC compiler. You can write PBASIC programs with any text editor that uses Carriage Return-Linefeed pairs as newline characters and doesn't set the eighth bit. (Wordstar in nondocument mode is fine; so is Wordmaster. WRITE and Electric Pencil will require a simple conversion program; a suitable converter is available along with a lot of other useful stuff on CP/M Utility Disk One from Workman and Associates.)

If you do much programming in Microsoft BASIC, I recommend that you get PBASIC. If you're just learning, I recommend that you get Mateosian's *Inside Basic Games* and read about Free BASIC, then get PBASIC.

PBASIC is available in standard 8-inch CP/M format directly from the author; it can also be obtained in Osborne, Otrona, KayComp II, and (possibly) other formats from Workman and Associates. Osborne users, with their limited disk space, should find PBASIC especially valuable, because Microsoft MBASIC packs random-access disk files into about 60 percent of the space required by CBASIC. Do understand that PBASIC is not a stand-alone language; you must have Microsoft BASIC 5.2 or later to make any use of it.

Active Trace

Another extremely useful program for Microsoft BASIC users is Active Trace, by an outfit known as The Data Works. Active Trace is distributed by Digital Marketing.

Three major programs are included in Active Trace: VREF, which makes an alphabetized cross-reference table of variables in an MBASIC program; GOREF, which makes a map of every line called by GOTO or GOSUB; and SCOPE, which runs with the program much like TRON (the built-in trace utility within MBASIC), but which outputs not only line numbers but variable values as the program runs.

These programs were written in Microsoft BASIC, but the source code is not provided. They have been compiled with Microsoft's BASCOM, and both the linked (.COM) versions and the BRUN versions (which require that you have Microsoft's BRUN run-time package, not provided with Active Trace) are included on the disk.

The documentation is good, if a bit disorganized. It contains examples, a tutorial, and a rambling essay on structured programming and program philosophy. I had no problems understanding it, but some of the students here required help. They didn't need *much* help, but the documents would be improved by testing with high school or undergraduate beginning programmers. I've got a class of Boy Scouts working on the Computer Merit Badge meeting here in a couple of weeks, and I'll try to note down

Text continued on page 338

DISC-LESS™

The **DISC-LESS** approach to S-100 architecture increases system performance so well that we guarantee satisfaction.

BENCHMARK

	2.2	3.0	DISC-LESS
Write 100 files to disc	3.26 min.	2.22 min.	25 sec.
General sort functions	5.25 min.	4.17 min.	15 sec.
Search and replace	2.30 min.	1.45 min.	3 sec.
Document recall	45 sec.	30 sec.	2 sec.

Upgrade your existing S-100 system to DISC-LESS

- "Ram-Disc 256"
- "Rom-Disc" with CP/M 2.2 in ROM
- All software included

\$1295.00

Complete single-user DISC-LESS Board Set with CP/M 2.2 in ROM

- Z-80A CPU (SBC-200)
- 256K bank select RAM (XRAM III)
- Single board controller handles four 5 1/4" or 8" drives, any mix (Versafloppy II)
- "Ram-Disc 256"
- "Rom-Disc" with CP/M 2.2 in ROM

\$2750.00

Now, add the DISC-LESS network controller to existing S-100 systems and convert to network operation quickly and easily.

- Base band coax
- Broad band coax

- 2 megabit/sec.
- CSMA
- Guaranteed message service
- CP/M compatible
- Turbodos compatible
- S-100 single board design

\$950.00

Under DISC-LESS operation networks use the "Ram-Disc" as local on-line cache storage for non-stop computing.

CP/M 3.0 Single-User Board Set

- SBC-200
- Bank select XRAM III 64K or 256K*
- Versafloppy II
- CP/M 3.0 bank select with documentation

\$925.00

*Systems with 256K RAM.
\$1295.00

Turbodos Single-User Board Set

- SBC-200
- Bank select XRAM III 64K
- Versafloppy II
- Turbodos with documentation

\$1295.00

Versafloppy II Disc Controller

- CP/M 3.0 bank select **FREE**

Complete S-100 DISC-LESS System

- Low profile system design
- CPU, 64K RAM, floppy controller
- "Ram-Disc 256"
- "Rom-Disc" with CP/M 2.2 in ROM
- Qume Model 102 video terminal
- Single 5 1/4" or 8" floppy drive

\$4950.00

Complete DISC-LESS Word Processing System

- Full DISC-LESS system
- "Wordstar" in ROM
- Letter-quality printer, 25cps.

\$6999.00



SONICS

MICRO SYSTEMS INC

1500 N.W. 62 STREET
FORT LAUDERDALE, FL 33309

1-800-327-5567

IN FLORIDA CALL: 305-776-7177

at Sonics "We are Technology"

VISICALC*



INTERACTIVE ELECTRONIC WORKSHEET

YES



ON-LINE REFERENCE GUIDE

NO



"NAMING" OF CELLS OR AREAS

NO



PLAIN ENGLISH PROMPTS

NO



INDIVIDUAL COLUMN WIDTHS

NO



EXTENSIVE FORMATTING CAPABILITIES

NO



PROTECTED CELLS

NO



MULTIPLE, LINKED WORKSHEETS

NO



SORTING CAPABILITY

NO

VisiCalc[®] was a swell idea for then.

The next generation. First generation electronic worksheets were a good idea. They were early software management tools that could eliminate a lot of hours with a spreadsheet, calculator, pencil and eraser. Enter Multiplan, the next generation electronic worksheet that's as easy to use as it is useful.

Make comparisons. Compare Multiplan to any of the earlier electronic worksheets. We've given you some "prompts" above.

Compare learning time. Multiplan's tutorial book brings you up to speed. Fast. But Multiplan doesn't stop there. Multiplan's On-line Reference Guide gives you instant help if you have questions. It knows where you are in Multiplan and offers information related to your problem, right on the screen.

Compare ease of use. All Multiplan prompts are full length words or phrases. And Multiplan provides "naming," the ability to assign a plain English name to any

cell or area. "Gross Profit = Sales—Cost" rather than "AA44=AZ23—BK154." Which means you can work more intuitively. And faster.

Compare utility. Multiplan lets you link related worksheets so that information is transferred between them automatically. For instance, you can keep regional sales forecasts on separate sheets but link them with your overall company forecast. Then, just change the forecast for any region, and the company forecast sheet is updated automatically. Something you can't do with first generation worksheets.

Compare reports. Not just the work you can do, but the way you can present it. Multiplan's flexible formatting options allow you to produce presentation-quality reports. And its sorting capability lets you sort by either alphabetic or numeric order. So a sales manager who normally lists sales regions alphabetically could sort by amount sold and conveniently rank by sales performance. The

*Based on features in releases VC-202B0-AP2 and VC-156Y0-IBM of VisiCalc on the Apple II and IBM-PC respectively.

MULTIPLAN

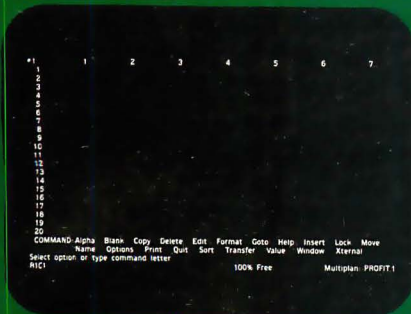

INTERACTIVE ELECTRONIC WORKSHEET

YES

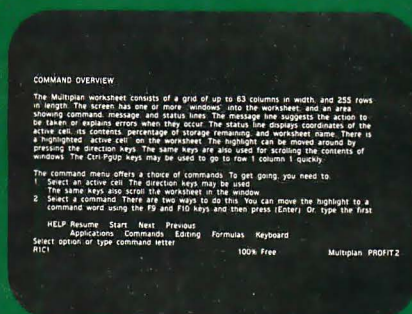

ON-LINE REFERENCE GUIDE

YES

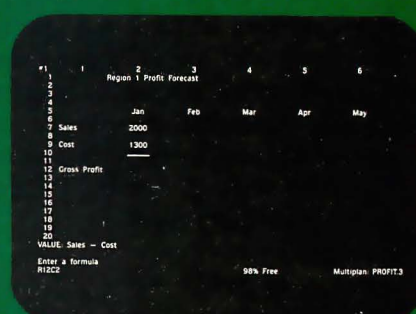

"NAMING" OF CELLS OR AREAS

YES

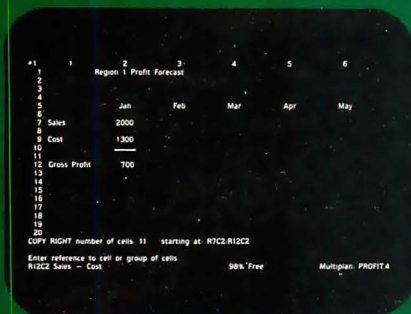

PLAIN ENGLISH PROMPTS

YES

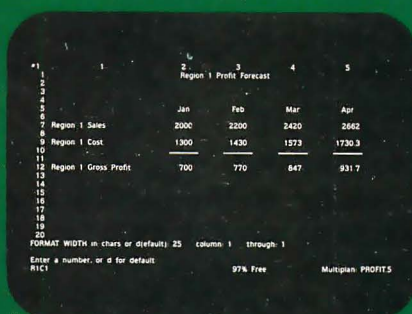

INDIVIDUAL COLUMN WIDTHS

YES

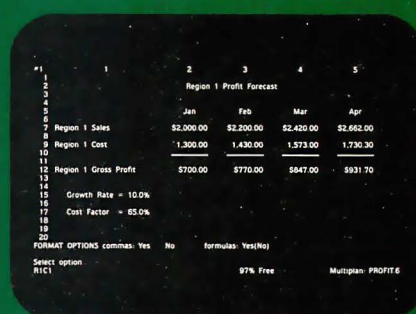

EXTENSIVE FORMATTING CAPABILITIES

YES

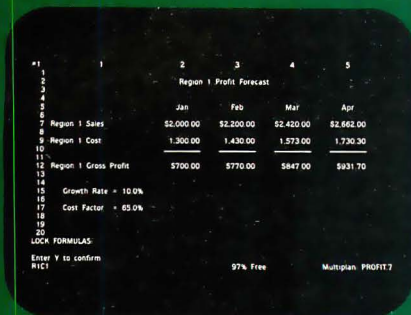

PROTECTED CELLS

YES

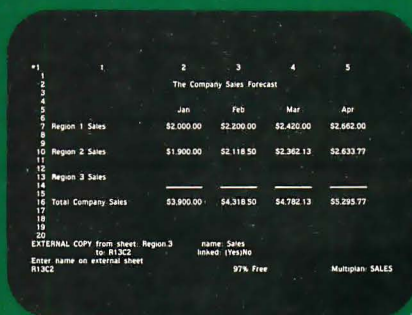

MULTIPLE, LINKED WORKSHEETS

YES

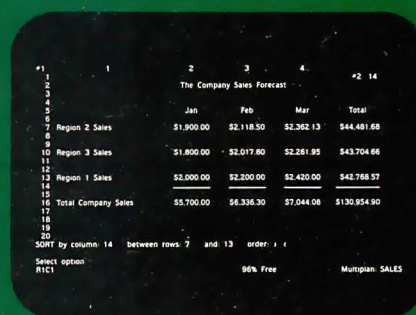

SORTING CAPABILITY

YES

Multiplan™ is a great idea for now.

result is a more meaningful and useful presentation of data.

Compare availability. With Multiplan, you're not limited to a single range of computers. Multiplan is available for Apple® and for microcomputers that run MS™, DOS, XENIX™, or CP/M-80® operating systems. Multiplan supports both 40- and 80- columns on the Apple II.

Compare the source. Microsoft was the world's first microcomputer software company. Today, Microsoft software is running in well over a million installations, worldwide. Languages. Utilities. Business programs. All, maintained at the state-of-the-art.

Compare for yourself. Drop into your computer store. Compare Multiplan's powerful, user-oriented features to any electronic worksheet on the market. If you've been using VisiCalc, Multiplan's ability to directly utilize your VisiCalc files lets you easily upgrade to Multiplan. And that's just another of the many features designed

to make Multiplan the electronic worksheet for now. And years from now.

BETTER TOOLS FOR MICROCOMPUTERS

MICROSOFT®

Microsoft is a registered trademark, and Multiplan, XENIX, and MS are trademarks of Microsoft Corporation

VisiCalc is a registered trademark of VisiCorp

CP/M-80 is a registered trademark of Digital Research, Inc.

Apple is a registered trademark of Apple Computer, Inc.



their questions to feed back to The Data Works. However, I don't want to overstress the document problem; this was better than most I see.

Anyone doing much programming in Microsoft BASIC should appreciate Active Trace a lot.

Osborne Expands

Two weeks ago I packed up my Osborne and sent it off to Osborne in Hayward. It was returned today. Along with it came new system disks in double density.

What should I say? It works, and instead of 92K bytes on each disk there's now 184K bytes for data storage; not quite as much as my first computer's single-density 8-inch disks with their 242K bytes, but enough for most purposes.

A manual update explains what double density is, and it tells you that you've not only bought double density, but also the ability to read disks created by a variety of machines: Osborne 1 single density, Xerox 820 single density, Cromemco single den-

sity, and the IBM PC double density providing that it used CP/M-86 (all in 5¼-inch disks, of course). They don't mention it, but the new Osborne will also read disks created by Compupro.

There's no universal standard in 5¼-inch disks, but Osborne is doing his best to get around that. I applaud his efforts.

The manual is quite good; although comprehensible at the elementary level, it is quite complete. Everything works beautifully, and I can't imagine anyone who has an Osborne will want to be without the double-density conversion.

The New Math

Actually, not new math, but a new way to do math: the 8087. The 8087 "math chip" can do 16-bit mathematical operations like lightning; matrix-operation programs that took 10 to 20 minutes to run with the 8088 can now run in less than a minute.

There aren't many implementations of the 8087, and not much software for it; but I expect both those

situations to change.

I have two boards that can make use of the 8087. One comes from Compupro and is an 8086/87 board for the S-100 bus. I don't have that running yet because I'd have to disable the 8085, and I need that dual processor.

The other 8087 comes from Jim Hudson of Hudson and Associates. Hudson sells a small "piggyback" board that plugs into my Compupro CPU-816 dual processor CPU (central processing unit) board, fitting in where the 8088 chip normally goes; the 8088 is then put into Hudson's board. (One wants to take due care not to allow static charges while messing with chips; like all complex chips, the 8087 is sensitive to static. Ground yourself and don't work on a carpet; having high humidity in the room helps, too. In my case we keep tropical fish, which humidifies things nicely . . .)

The 8087, alas, runs only at 5 MHz, meaning that if you're going to use it you have to slow the processor down somewhat; but if you have many math operations to do, the result is *well* worthwhile: on my benchmark matrix-multiplication program, using Pascal/MT+86 with the 8087 "reals" linked in, the 20 by 20 case ran at 7.8 seconds. For a 50 by 50, it ran in 1:41.2; both these times are faster than the Sage II using UCSD Pascal.

As I write this, I have seen only two software sources that support the 8087: Pascal/MT+86 from Digital Research and the C86 C compiler from Computer Innovations. I know nothing of the C compiler, but I use Pascal/MT+ routinely now. We're just getting CPM-86 running; when I do, I'll use MT+86 with the Speed Programming Package even more. Its only rival is the Sage II (which continues to operate beautifully).

I've only started using the Hudson 8087 board, and as I write this I hear from Bill Godbout that Compupro is going to be marketing Hudson's board (with a few Compupro modifications); but since Hudson's system works nicely now, and Godbout's people have a prodigious reputation for improving anything they get their



IN STORE ITEM*
INCREDIBLE
NEW LOW PRICE

800-368-3417



Complete and Customized Software Available

**PRINTERS & PORTABLES & PERIPHERALS & PEOPLE
MAKE OUR PACKAGE!**

PRINTERS DIABLO 630 ... 1784 NEC 3510 ... 1389 COMREX ... 895 STARWRITERS ... CALL	PORTABLES ZORBA* (400K/DRIVE) (19 PROGRAMMABLE KEYS) ... 1995	PERIPHERALS INTERFACES MODEMS CABLES MONITORS SOFTWARE	PEOPLE YOU & THE TREE
DOT MATRIX EPSON ... CALL OKIDATA ... CALL COEX80FT ... 359 PROWRITER ... CALL	KAYPROII* (NOW WITH MICROSOFT BASIC) ... CALL EPSON HX-20	FOURTH DRIVES QUENTIN DRIVES PERCOM DRIVES CALL FOR NEW LOW PRICES	IN STORE ONLY 256K EPSON QX-10 VALDOCS HX-20

THE **Computer Learning Tree**

Government Sales
Call 703-750-2632



7023 Little River Tnpk
Annandale, VA 22003

338 April 1983 © BYTE Publications Inc

Circle 460 on Inquiry card.

INTEX-TALKER™

TEXT TO SPEECH SYNTHESIZER

Sets a new price/performance standard

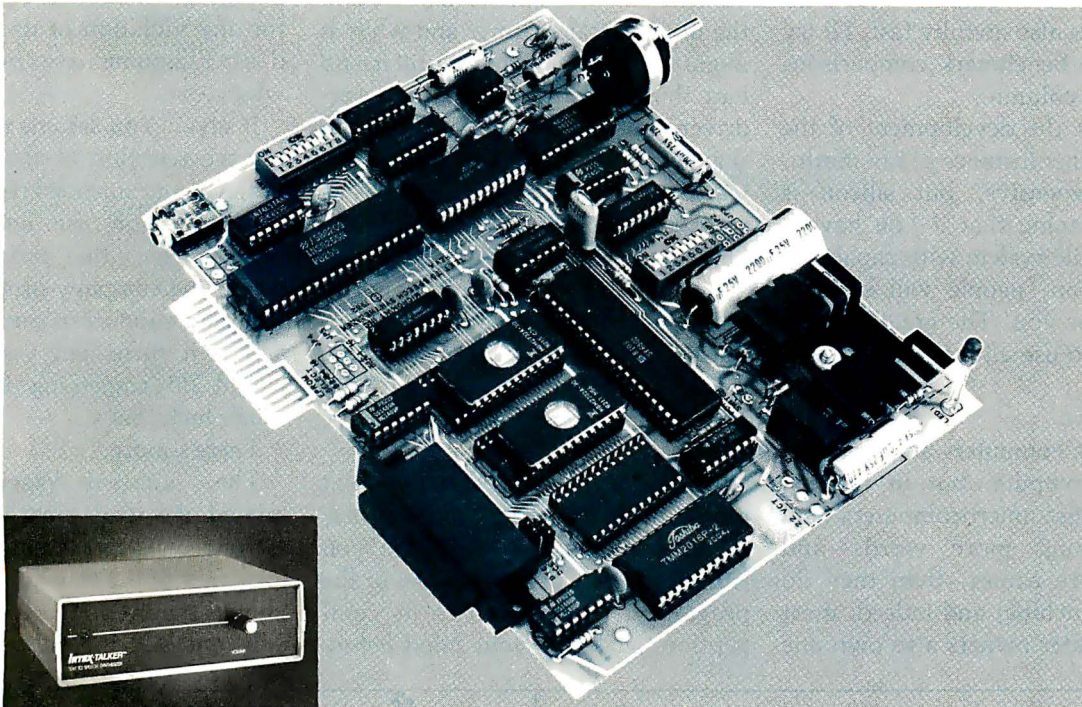

INTEX-TALKER, the new second generation text-to-speech synthesizer with unlimited vocabulary, an advanced text-to-speech algorithm and 64 levels of inflection provides a new high level of speech intelligibility.

INTEX's built-in text-to-speech algorithm is a marvel of efficiency, pronouncing the 1,000 most commonly used words with an accuracy of greater than 96 percent.* It will even set an inflection profile for a phrase or sentence.

INTEX-TALKER can announce any ASCII text; emergency messages, warnings, prompts, instructions.

Available at the board level or with case, INTEX-TALKER offers a cost-effective modular design easily customized for your OEM application. Field upgradable - nothing is potted.

Have It Your Way

Configure INTEX-TALKER to your requirements. Add additional memory if your application requires it (up to 4K bytes of RAM and 16K bytes of EPROM available in existing sockets - more with minimal changes.

Use the INTEX-TALKER's 6502 micro to run your operating system and perform external tasks. When speech output is required hand control back to the INTEX-TALKER with a simple command.

*based on frequency weighted average

An optional self configuring buffer is also available - up to 2.7K characters.

INTEX will be pleased to work with you in meeting your special requirements.

At only \$295.00 compare these features:

- Unlimited vocabulary speech synthesizer chip
- 6K text-to-speech algorithm with automatic inflection control
- 64 crystal controlled programmable inflection levels
- 6502 microprocessor
- Full ASCII character set recognition and echo
- 750 character buffer standard (2.7 character option)
- User expandable memory option
- Adjustable baud rate (75-9600)
- RS232C and parallel connectors
- X-On/X-Off handshaking
- Phoneme access mode
- Spelling output mode
- 7 octave music and sound effects capabilities
- Onboard amplifier and power supply +12V, +5V

For More Information

Call us at the number below to order or request more information. Charge to your credit card (Master Charge or Visa) or send a check for \$295.00 plus \$4.00 delivery. Individuals add 4% sales tax in Michigan.

INTEX™

Intex Micro Systems Corporation

755 West Big Beaver Road - Suite 1717
Troy, Michigan 48084
Telephone: 313/362-4280

hands on, I have no difficulty in predicting that the Compupro edition will work very well.

If you have a need for fast number-crunching—and that includes financial stuff as well as scientific—the 8087 may be what you need. I don't want to be too dogmatic about that: the Sage II is also awfully fast. I'll try to get some benchmark comparisons for another column.

Note that the development of the 8087 is another instance of my motto, "Iron is expensive, but silicon is cheap"; meaning that if you have a good versatile system with capability for expansion, people will develop upgrades for you. The great thing is to be able to use all this new stuff.

Mathemagic

One thing computers are supposed to do is compute, but in my experience most microcomputers end up processing more words—and playing more games—than they do number-crunching; and indeed, most microcomputer owners also own one

or more sophisticated calculators, which they use in preference to their computers when they want to do math.

Comes now Mathemagic to change all that.

Mathemagic advertises that it "transforms your microcomputer into the ultimate calculator," and while it might not go so far as *that*, still it's no bad thing. Mathemagic is a menu-driven way to put your head back in shape if you had nauseating math teaching. It's not as versatile as spreadsheet programs like Sorcim's Supercalc, but it will handle longer and more complex formulas, and it's fairly easy to use. I can think of applications in which Mathemagic would be much more useful than Supercalc (although I'd rather have Supercalc myself).

Whatever you do, though, *don't* buy Mathemagic from the publisher; go to a reputable dealer, one you trust, and get a demonstration of the program in comparison to its competition. Make up your mind *before*

you put out any money. If this sounds like harsh advice, it's merited: International Software Marketing, which publishes Mathemagic, has reached new levels in "user-threatening" licensing agreements.

Not only does this company explicitly say it's going to prosecute you for any violation of its terms, but it doesn't assume *any* responsibilities whatsoever.

It says, "You assume responsibility for the selection of the program to achieve your intended results, and for the installation, use, and results obtained from the program." This means the company promises to provide *zero* support in getting it to run, and if it turns out you thought it would do something it won't do, tough luck, baby.

There's more.

The "Limited Warranty" isn't limited, it's nonexistent. It says, "The entire risk as to the quality and performance of the program is with you. Should the program prove defective, you (and not ISM or an authorized

Can a Software Package Change the World?



Spread Sheets First... QUESTEXT™ Next!

- A Revolutionary New Microcomputer Concept for Systems Developers and End Users Alike
- Buy One General Purpose Package and save buying dozens of Specialized Programs
- ULTRA FRIENDLY • 100% Menu Driven
- LEARNABLE in one session • No Programming
- ALLOWS INSTANTANEOUS INNOVATION • Not a DBMS

QUESTEXT III is a mature general purpose system for organizing and communicating textual information. It organizes text into tree-like menu structures. It is the first electronic WordSheet, a generalized information handler.

Unlimited uses: Dealer Demo; On line help and documentation; Computer aided instructions; On job training; Top-down software documentation; Writer's outlines; Electronic filebox; Speech teleprompting; Classroom blackboarding; Address; phonebook; Public access question answering; Calendar; datebook; Scheduling; planning; Archiving; Library and File cabinet indexing; Observation logging; Personnel aids (locator service, job description, line of command); Customer New Product support and training; Technical information management; Diagnosis support; Quality control; Price; Product data; Electronic Publishing; Bulletin boarding; Tutorials

and quizzes for textbooks; Personal computing times; sage-reminder and note comment management; disk file inventory annotation; system protocols, procedures, etc.); Home Computing (insurance inventory, Records management, etc.); Surveys and experiment control; Much more. Unprecedented potential for contract consultants and systems developers.

FEATURES: Easy updating; Cursor editing; Error trapping; English prompting; No syntax; Fast machine executable code; Simple commands (Help, Show, Add, Delete, Insert, Move, Edit, Print, Next, Up, Top, Garbage recycling, Easy file control (Create, Delete, Backup, Mkdir, etc.); REQUIRES IBM PC or 2. x 56K CP/M, ASCII CRT. WHO CAN USE QUESTEXT? ANYONE CAN! Systems Developers, Business People, Educators, Consultants, Scientists, Programmers and Nonprogrammers alike.

SEE BELOW FOR ADVANTAGES OF EARLY ORDER MONEY BACK OFFER ON MINI VERSION. PHONE ORDERS 617-369-5719 • OEM AND DEALER INQUIRIES WELCOME. Available from



Mail to: iRr, 1538 Main Street, Concord, MA 01742

PLEASE SEND ME QUESTEXT III

INFORMATION REDUCTION RESEARCH

- | | |
|--|--------------------|
| <input type="checkbox"/> Mini Version (6 lines menu, up to 40 screens, 300 records) (Returnable for 14 days if Mini Version is returned in good condition) | \$ 2995 |
| <input type="checkbox"/> Full System (99 lines menu, up to 6,000 screens, 32,700 records) (Wholesale to May 31, 1983) (Atk. + May 30, 1983, Retail) | \$17995 |
| <input type="checkbox"/> Manual Only | \$ 2995 |
| <input type="checkbox"/> Selfteaching disk w/ 5 applications | \$ 2995 |
| ADD \$3.00 Postage and Handling | TOTAL COST \$ 2995 |

*Features/Prices/Availability subject to change without notice. © 1983 iRr

SD Osborne IBMPC (Others from dealer)

Payment enclosed VISA MASTERCARD Card No. _____ Expiration Date _____

Signature _____ Telephone _____

Print Name _____ Address _____

City _____ St. _____ Zip _____

Epson, OKI, IDS, NEC, Diablo, Qume

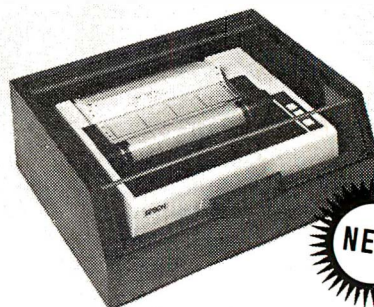

ACOUSTIC ENCLOSURES

- Reduces Noise Up to 90%
- Heavy Duty Acrylic Cover
- Bottom Feed Capability
- Woodgrain Finish

Micro Printercenter™

Dealer & Ordering Info
800-343-4311

Master Charge and Visa Accepted
Shipping & Handling Charges Additional

CAB-TEK, Inc.

Riverside St. Nashua, NH 03062
CIVILIZING COMPUTERS

- | | |
|---|------------------------------|
| MPC I \$99 (MX 80) | MPC II \$129 (OKI82) |
| MPC III \$179 (83A, MX100) | MCP IV \$199 (Daisy Printer) |
| Power Control & Ventilation \$80 | |
| Paper Rack \$30 Bottom Feed Brackets \$30 | |
| MPC I SHOWN | |



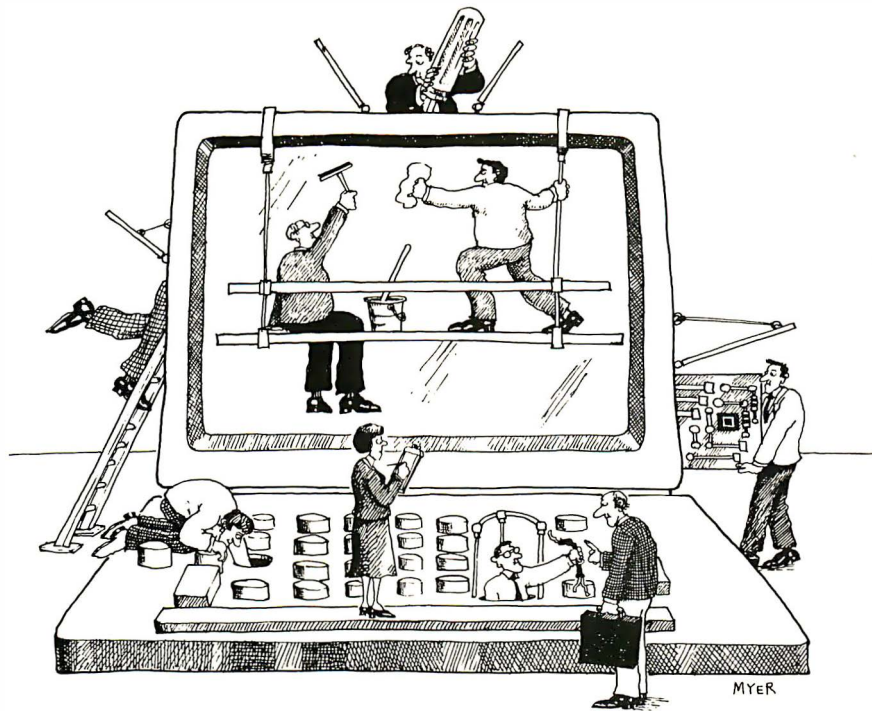

UPTIME IN NO TIME. SORBUS FIXES COMPUTERS. FAST.

If you have a computer, there's a good chance Sorbus can fix it. Faster than the maker can.

MAI/Sorbus is the nation's largest independent computer maintenance service company, and we fix all kinds of computers in all kinds of places:

BIG COMPUTERS. TINY COMPUTERS.

Big computer owners have voted us #1 in dozens of big-computer magazine surveys.

We're still big in big. But now that small is big, we're also big in micros.

We're making easy-to-use computers even easier for their owners, with innovative services. Like a phone-order data processing supplies catalog. And retail centers where small computers are usually fixed overnight.

COMPUTERS IN NEW YORK. COMPUTERS IN NEW MEXICO.

Sorbus has built its reputation fixing computers anywhere in the country, from the urbs, to the suburbs, to the sub-suburbs.

And now, if your computer is small enough—like the IBM Personal Computer—and close enough, you can carry it in for 24-hour service or, we'll pick it up.

If it's not, we still have the tools, the experience, and will travel. Anywhere. Anytime.

Just call us.

YOUR COMPUTER.

Whether you manage a mammoth operations center, or just a desktop micro, Sorbus can bring you back up when you're down.

Faster. Better. Almost always for less.

Of course, even we don't specialize in every computer ever made. But if you call us with a problem, we promise to do what we can.

Try Sorbus® service next time your memory gets foggy, or your printer suffers from terminal illness.

Where there's Sorbus, there's a way.

For more information, call (215) 296-6000, or fill out and mail coupon to:

MAI Sorbus
Service®

Sorbus Service Division of Management Assistance, Inc.
50 E. Swedesford Road
Frazer, PA 19355

Please send me more information on Sorbus service for my _____

Please have a representative contact me.

Please send me the *Sorbus® Supplies Catalog*. 64-pages of quality printwheels, ribbons, diskettes, and other computer supplies.

Or, call toll-free: 800-523-0552.

In PA: 215-296-6200.

NAME _____

TITLE _____

COMPANY _____

ADDRESS _____

CITY _____ STATE _____ ZIP _____

PHONE _____

"A MAJOR STEP FORWARD INTO THE EXPLORATION OF THE WAYS WE ARE ALL GOING TO LIVE WITH MICRO CHIPS."

—Daniel Dennett, Co-author of *The Mind's I*

Musician and sociologist David Sudnow has written the first book to define the essence of video skill—not how to master; but what mastery is. "In this worthy sequel to [*Ways of the Hand*,] his tract on mastery of music-craft, Sudnow once again explores a lot of worlds at once—the real one, the one in the machine, and all the myriad ones inside the self. It may not show us how to coax the children home, but this book gives us good ideas of where they go" (Marvin Minsky, Department of Artificial Intelligence, MIT).

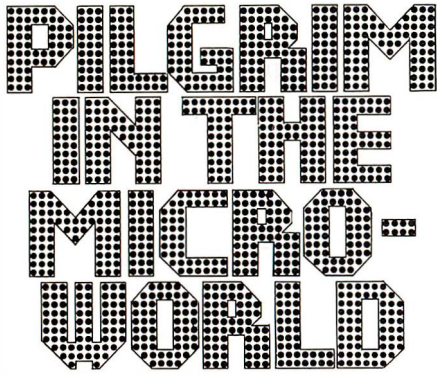

EYE, MIND, AND THE ESSENCE OF VIDEO SKILL

"An intriguing account of the breakthroughs and breakdowns of the adult mind as it plunges into the advancing microworld. Sudnow shows us an exciting way to relate to approaching computer technology."

—Tim Gallwey, Author of *The Inner Game of Tennis*

"Sudnow has made a breakthrough in assessing the two-dimensional 'world' of the computer and the sort of body and mind it creates in us."

—Hubert Dreyfus, Author of *What Computers Can't Do*



WARNER BOOKS

Now at Bookstores

To order, send \$16.50 (includes postage and handling) to: Dept. PAA (BT) 0-446-51261-3, Warner Books, 666 Fifth Avenue, New York, NY 10103. Check or money order only. Allow four to six weeks for delivery.

dealer) assume the entire cost of all necessary servicing, repair, or correction." Later it says, "ISM does not warrant that the functions contained in the program will meet your requirements or that the operation of the program will be uninterrupted or error free."

Translation: if it don't work, tough luck, baby. We may fix it, but you get to pay.

So. As I said, get a demonstration from a dealer you trust.

Footnote

I don't use Wordstar to *create* text, but it's awfully handy to have around. It's not so much Wordstar itself as the tons of support programs like Footnote that make it useful. I have no doubt that when WRITE becomes more generally available, comparable programs will be developed for that, too, but meanwhile most of the really nifty word-mashing utilities need Wordstar.

Footnote comes from Pro/Tem and is marketed by the ubiquitous Digital Marketing. Like all Digital Marketing products, it's way above average, with very complete documentation and well-tested programs. The marketing agreement is rational, too.

As you'd suspect, Footnote handles footnotes in Wordstar text files. It does what everyone wants it to, putting the notes at the bottom of the page or, alternatively, into a separate file that can be appended to the end of a document. The format is standard thesis style, suitable for term papers, dissertations, or submissions to academic journals.

Footnote is easy to use. You don't need to remember the numbers; all notes get the symbol @ when created, ↑R indicates the beginning of a block of notes, @ delimits each note within the block, and .pa ends the block. Notes can be put in anywhere you please, near the place referenced or before or after it; it makes no difference, as long as ↑R precedes the block and .pa ends it.

The program then goes through and numbers the notes, both in the text and within blocks of notes; after that it extracts the notes, reformats the text, and moves everything

around so that it will print out properly. (Naturally you must give the program your text-printout format: margins, line width, line spacing and lines per page, etc.)

It does it all painlessly and simply.

Some programs are so well done that there's not much to say about them. Footnote is one of those; it's hard to think of improvements.

My copy of Footnote came bundled with a program called "Pair," which matches the underline and boldface characters for Wordstar so that you don't end up with page after page of unwanted underlined material. WRITE doesn't require that kind of checkup, but Wordstar users ought to appreciate it.

If you do scholarly writing and you use Wordstar, you'll want Footnote.

Wedged . . .

Everywhere you look there's a new spreadsheet program for sale. Spreadsheets are programs that let you enter a matrix of numbers and formulas, and recalculate the whole matrix if you change the value of any one entry. The first of these was called Visicalc, which was a really great idea, and one of the most useful programs ever developed for microcomputers.

Visicalc is one of the great success stories of the computer world, and I truly wish I'd thought of it. (I did, actually, as a sort of "I wish I had a program that would . . .", but I didn't do anything about the wish, so that counts as not thinking of it.)

Visicalc was designed for the Apple, and I'm told it was responsible for a lot of Apple sales. Naturally there was a rush to get versions running for the CP/M 8080/Z80 family of machines. One of the earliest, and best, Visicalc "workalikes" was Sorcim's Supercalc, which I've mentioned here often enough, and which I recommend.

Predictably, there's a rash of others. It's very hard to compare them feature by feature, and in general they all do the same thing anyway, so how do you tell them apart (other than by price)? One possible marketing strategy is to make distinctive product packages.

Text continued on page 346

UNSINKABLE PRICES

One Hull of a Deal

SYSKOM II

Faithful to the Core
\$725



COMPUTERS

Apple—New models, New prices	SCALL
Atari 800 48K	\$535
Chameleon, Compac, Columbia (PC emulators)	SCALL
Franklin ACE 1000	\$955
IBM PC—MANY SYSTEM CONFIGURATIONS	SCALL
Kaypro—portable, 9" CRT, 2 drives, software	\$1695
Osborne Double Density	\$1725
Slimline S-100: Z-80, CP/M, 64K, 2 MByte drives	Under \$2000
Syscom II—Apple II Plus emulator	\$725
Syscom II PKG: 48K, Drive w/Controller, 12" Hi-res Green CRT, Z-80 Card, 80 Column Video Card, 16K RAM Card	\$1650

FOR APPLE & FRANKLIN

ALS Z-Card	\$215
Corvus all Items	\$816 DISCOUNT
dBase II (requires CP/M)	\$395
Z-80 Card—Applied engineering	
1-9 pcs	\$175
10+ pcs	\$155
Universities, clubs, and dealers welcome.	
Fourth-D—parallel interface, cable	\$49
Grappier + (parallel, cable, graphics)	\$135
Hayes Micromodem II	\$275
Microtek Dumping D—graphics, 0 to 64K buffer	\$135
Extra RAM-16K sets	\$20
Hayes Micromodem II	\$275
Rana Elite I	\$285
Rana Elite II—double	\$455
Rana Elite III—quad	\$585
2MByte Floppy System	\$1695
Omnivision 80 column, with software	\$165
Prometheus Expand-a-Ram, up to 128K	\$195
Videx Videoterm 80 column	\$245
Visicalc 3.3	\$179
Vista Quartet (2 drives, thin, 640K, controller)	\$655
Vision-80	\$219
V-1200, 6MB removable cartridge	\$1325
6MB extra cartridge	\$75
VR Data 5MB Hard Disk with error correction	\$1575

FOR IBM PC

There is no market more competitive than IBM-PC compatible cards. AST RESEARCH rightfully sells the most IRONSIDES COMPUTER, recognizing functionality and design regardless of price, endorses AST RESEARCH products as BEST. Beyond all doubt.

AST RESEARCH CARDS NOW INCLUDE SPOOLER AND DISK EMULATOR SOFTWARE NO EXTRA CHARGE

AST ComboPlus 64K with Parallel, Serial, Clock \$375

AST MegaPlus 64K, expandable to 512K, SPC \$435

Corona 5MB Hard Disk \$1495

Parallel cable \$35

Serial cable \$32

RAM sets, 64k with parity \$85

Tandon TM 100-2 drive—with installation notes \$237

TANDON DRIVES

TM-100-2—5-1/4" DOUBLE SIDED	\$237
TM-50-2—5-1/4" THIN DOUBLE SIDED (STACKS IN PC)	SCALL
TM-848-2—8" DOUBLE SIDED/DOUBLE DENSITY	\$435

Chameleon "The Compatible Computer"

- Runs IBM PC & Z-80 software • 128K RAM, expandable to 700K
- Dual 320K drives • PC style keyboard • 9" green display, 80 x 25 with graphics • Software: DOS, Perfect Writer, Perfect Calc, Basic • PORTABLE!!!

You must register your order now to receive the introductory price of
\$1995



JCS RGB-III

VIDEO MONITORS

- Industrial steel case • 13" CRT • 16 colors on IBM PC • Cable for IBM PC • 630 lines horizontal resolution • Made in Japan with industrial Hitachi CRT • High brightness phosphors • 1 year parts warranty
- CUSTOMERS: GET A \$50 REBATE FOR BUYING AFTER ARRANGING A DEMO AT YOUR LOCAL COMPUTER STORE.**

DEALERS: CALL FOR DETAILS ON DEMO PLAN. Suggested List \$595

Amdek 300G 12" green	\$145
Amdek 300A amber	\$160
Amdek 310G for IBM	\$170
Amdek 310A amber	\$180
Amdek Color I	\$325
Amdek Color II	\$685
8MC 12" Green	\$89
Dynax 12" green, 20MHz	\$129
Dynax 12" amber, 20MHz	\$145
JCS RGB-III (630 lines, 16 colors, PC cable)	\$0 DEMO REBATE
Taxan/JCS 12" green	\$135
Taxan/JCS RGB-1	\$345

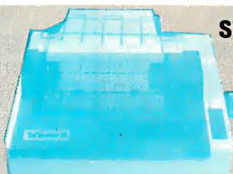

STAR MICRONICS GEMINI 10 \$365

PRINTERS

Epson MX-80FT—w/Graphtrax Plus	\$485
Epson MX-100—w/Graphtrax Plus	\$645
Brother/Comrex—17 cps Daisy	\$745
F-10 Starwriter—emulates Diablo	\$1190
IDS Microprism 110cps, 80 column, graphics	\$529
IDS Prism 80	\$850
IDS Prism 132	\$1025
NEC 7710-1	\$2065
NEC 7730-1 for IBM PC	\$2095
Okidata uses standard spool type ribbons	
u82A—80 column, 120cps	\$395
u83A—132 column, 120cps	\$660
u84AP—200cps, 132 column, parallel	\$935
u92A—160cps, 80 column	\$525
Prowriter/PMC—80 column, 120cps, proportional	\$435
Prowriter II—132 column, 120cps	\$655
STAR MICRONICS Runs Epson software, 100cps, 1/1, graphics. Uses spool ribbons—a likely savings of \$100.	
Gemini 10—80 column, 2k expandable buffer	\$385
Gemini 15—132 column	\$475

ATARI

Atari 800 48K	\$535
Microtek 32k RAM (AT 400/800)—list \$139	\$105
Percom RFD40-S1 (176K)—list \$699	\$545
"RFD44-S1 (352K)—list \$845	\$685
810 Disk	\$450
830 Modem	\$159
850 Printer Interface	\$185
Printer cable	\$35
Serial cable	\$35



S-100 THINLINE MAINFRAME

+ 6 slot motherboard, cage + Power for S-100 and 2 thinline 8" drives + Fan, EMI filter, connector cutouts + 12" wide x 19" deep x 9.8" high

1-4 pcs... \$475 5-9 pcs... \$450
10+... \$425

CABLES

Kaypro cable, printer—5ft	\$35
Osborne printer, parallel—5ft	\$35
Osborne serial, modem—5ft	\$35
8" floppy, 6 ft, 50 conductor, for 2 drives	\$35

Also see Apple, IBM, and Atari

SIERRA DATA SCIENCES

- S-100 cards for single and multi-user systems • Multi-user systems need one master, one additional slave per user and TurboDOS software • Complete systems with drives and CRT terminal are available.

Z-80 4MHz Master (64K/2 serial/floppy controller/hard disk port)—SBC-100	\$655
Z-80 4MHz Slave (2 serial/2 parallel/64K/EPROM programmer)—SBC-100S	\$565
4-Port serial communication board—ZSIO/4	\$235
RS-232 Multiplexor board—SOS-MUX	\$235
Hard disk interface for Micropolis—SOS-HDI-M	\$129
CP/M I/O Master with BIOS—CPM/BIOS	\$150
Turbo-Dos for Master with Slaves—TURBO-DOS	\$645

MODEMS

Anchor Automation—FREE SOURCE

subscription	WORTH \$100
Mark I, 300 baud	\$95
Mark II, 300 baud, Atari	\$95
Mark III, 300 baud, TI	\$115
Mark V, 300 baud, Osborne	\$115
Mark VI, 300 baud, IBM PC	\$235
Mark VII, 300 baud, auto answer/dial	\$135
Mark VIII, 1200/300 baud, auto answer/dial	\$435
9 Volt DC Adapter	\$10
Hayes Smartmodem 300	\$215
Smartmodem 1200	\$515
Novation Apple-cat II	\$269
212 Apple-cat	\$595
D-cat	\$179
Auto-cat	\$125
212 Auto-cat	\$585

ALPHA SOFTWARE

Software for IBM PC and Apple II. We recommend this software. The documentation is excellent, and the prices are comparatively very low.

DATA BASE MANAGER—PC	\$229
MAILING LIST—PC	\$85
TYPE FACES—PC	\$105
TYPE FACES—APPLE	\$105
APPLE-IBM CONNECTION—transfers files between	\$175

QUME DRIVES

DT242, 8" thin, dsdd	\$485
OT842, 8" std, dsdd	\$495
DT542, 5 1/4", dsdd, 48 tpi	\$295
DT592, 5 1/4", dsdd, 96 tpi	\$385

S-100 THINLINE COMPUTER SYSTEM

- Z-80 4MHz, 84K, CP/M • 2 Thinline drives, 8" 2MByte • Mainframe • Add any standard video terminal and printer
- NOT \$3500 NOT \$2500 JUST \$1895

ADD-ON DRIVES FOR ZENITH Z-100 COMPUTERS

- 2 Thinline 8" drives, double sided, 2MByte
 - Thinline cabinet, vertical, power supply, fan, cable
- Just plug it in... \$1175

COMPUPRO (Godbout)

Co-Processor 8086/8087 8 MHz	\$615
Dual Processor 8085/8088 6MHz	\$385
Disk I, Floppy Controller	\$490
RAM 17, 64K CMOS, 12MHz	\$515
RAM 21, 128K Static, 12MHz	\$1155
M-Drive, 128K	\$1150
S-100 Mainframe, 20 slot, rack	\$795
S-100 Mainframe, 20 slot, desk	\$735
System Support I, I/O	\$335
Interfaces 3, 8 serial	\$615

WABASH DISKETTES

5 1/4" Single Sided, Double Density with Hub Ring	
5 boxes	\$17.50/box

EPSON RIBBONS

MX-80 black	\$25/3pcs.
MX-10 black	\$39/3pcs.

TELEVIDEO TERMINALS

Extra Memory Pages (kit) INCLUDED—No Charge

TV1925—w/2nd page	\$745
TV1950—w/2nd, 3rd, 4th page	\$945

MEMORY IC's

4164 64K Dynamic 200ns	\$7.25
4164 64K Dynamic 150ns	\$7.95
4116 16K Dynamic 200ns	\$2.00
2716 Eprom	\$4.00
2732 Eprom	\$6.50
6116 2Kx8 Static RAM, 200ns	\$5.00
6116", 150ns	\$5.50

Verify prices by phone. Add 2% for Visa or Mastercard. Add 6 1/2% tax on California orders. Shipping is extra except within the Continental US on prepaid orders. \$3 surcharge on orders under \$25.

IRONSIDES COMPUTER CORP

(213) 344-3563

(800) 528-9537

18546 Sherman Way,

Suite #110,

Reseda, CA 91335

Circle 218 on inquiry card.

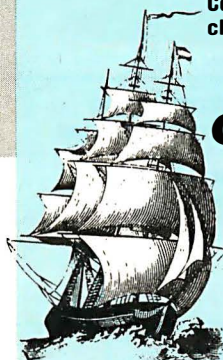

BASIC

VERSUS

A NO-HOLDS-BARRED

1 EASE-OF-USE

While Basic is easily learned, for just a little extra effort invested, Pascal pays much bigger dividends. Many universities use only Pascal to teach programming; *it's the more modern language, incorporating advanced programming techniques*. Example: by dividing programs into modules, JRT Pascal makes very complex programs—of nearly any size—a breeze to manage.

Pascal code is *self-documenting*; program sections are identified by meaningful names, not line numbers. And error messages are verbal, not number codes. JRT offers more (and more powerful) *data types: 12*—to Basic's 2 or 3. Use regular or hex numbers; JRT gives you the choice.

Total it all up, and the result is a language that's very easy to use.

2 POWER

For power—the ability to write better, clearer programs, faster—Pascal is the run-away winner. The CASE statement is just one good example:

Basic	JRT Pascal
IF X = 5 OR X = 10 THEN\ X = 73\ GOTO 99	CASE X OF 5,10 : X := 73; Z-4 : WRITE (X); ELSE : WRITE ('X NOT VALID'); END ;
IF X = Z - 4 THEN\ PRINT X\ GOTO 99	
PRINT "X NOT VALID" 99 REM	

JRT simplifies programming by accomplishing complicated operations (for Basic) with one command:

Basic	JRT Pascal
IF A\$ = "V" OR A\$ = "W" OR A\$ = "X" OR A\$ = "Y" OR A\$ = "Z" THEN...	IF A IN ['V'..'Z'] THEN...

Convinced?

Here's the real shocker!

Features	Basic	JRT Pascal
Structured programs	No	Yes
Separate compiled modules	"Chaining"	Structured procedures with auto-loading & purging
Arithmetic precision	Usually 6 or 7 digits	14 digits
Indexed files	No	Yes
Maximum string size	255 characters	64,000 characters
Loop statements	1	3
Data types	Usually 2 or 3	12
CASE statement	No	Yes
Introduced	1965	1980
Price	???	\$29.95!

3 FLEXIBILITY

JRT Pascal's wide variety of data types reduces programming restrictions; *the language works for you, not against you*. And Pascal data types are not all fixed in size. Add *JRT's 3 looping statements* (Basic has one), and you get programming better tailored to your specific needs. That's flexibility.

You gain flexibility, too, because programs aren't limited to one diskette. With JRT Pascal, even very large programs can be created and run, because program modules can be spread over many disks. Common modules can be used for several programs, avoiding time-consuming, expensive duplication.

Basic generally limits text strings to 255 bytes; *JRT strings go up to 64K*. You process entire documents, not just single lines.

Flexibility—it could be JRT's middle name.

4 EFFICIENCY

Whereas Basic relies on a static, inefficient memory map to allocate storage, JRT's *dynamic storage* fills every available main storage area; there's no waste.

With Basic, sub-routine modules *must* be linked together; with JRT, they can be linked—but don't have to be. Another storage efficiency.

JRT programming hours are more productive, because our more powerful commands run faster. Typically, you'll *write Pascal programs 3 to 10 times faster* than in Basic. And the programs are more reliable, easier to read, easier to use.

Exclusive: JRT lets you directly access the CP/M* operating system for better total system control. That's the last word in efficiency.

5 NOW...

Look over JRT's complete feature list. Consider our copy policy. (If you want to make copies, it's OK with us—so long as they're not for re-sale.) Check our astounding price: **\$29.95!**—for the complete

JRT PASCAL:

COMPARISON.

JRT Pascal system on diskettes (two 5¼" or one SSSD 8"), a 175-page user manual with handsome 3-ring protective plastic binder, a handy Reference Card, all postage paid. *And satisfaction is guaranteed!—or your money back.*

Now compare: Basic versus JRT Pascal. Which comes out on top? Right! The coupon below is for your convenience. Or call. Today.



175-page user manual with 3-ring protective plastic binder & 5¼" or 8" diskettes

Handy JRT Pascal reference card

Full support for indexed files

CRT screen formatting & full cursor control

Facilities for formatting printed reports

File variables & GET/PUT

Dynamic arrays

SEARCH procedures for fast table look-up

Extended CASE statements

Graphing procedures

Statistic procedures

Random files to 8 megabytes with variable length records

64K dynamic strings

Activity analyzer prints program use histogram

14 digit BCD FLOATING POINT arithmetic

True dynamic storage

Advanced assembly interface

Fast one-step compiler; no link needed

Efficient compiler needs only 85K diskette space

Maximum program size: more than 200,000 lines

More than 200 verbal error messages

Separate compilation of auto-loading external procedures

No limits on procedure size, nesting or recursion

THE COMPLETE PASCAL FOR CP/M.

JRT/PASCAL 3.0

\$29.95!

Send to **JRT SYSTEMS** or phone **415/388-0530**
45 Camino Alto/A2
Mill Valley, CA 94941

Name _____
 Address _____
 City _____ State _____ Zip _____

Check C.O.D. MasterCard VISA
(CA residents add sales tax. Add \$6 for shipping outside North America.)

Card # _____ Exp. _____

Signature _____
*CP/M is a Digital Research TM. A 56K CP/M system is required.

Here's my \$29.95; please send me JRT Pascal. I understand that if I'm not completely satisfied, I can return it within 30 days—with the sealed diskettes unopened—for a full refund. (Allow 4-6 weeks for shipping.)

I need the 5-1/4" diskettes for Apple CP/M; Heath, Hard Sector; Heath, Soft Sector; Northstar; Osborne; Superbrain; Televideo; Xerox 820. I need 8" SSSD diskettes.

The Wedge, by Access Software Inc. of Palo Alto and marketed by Systems Plus Inc., does just that. It comes in a handsome cardboard 8-inch disk box rather than in a loose-leaf binder or something similar as most do. All the documents have slick, glossy covers. I find the name unfortunate, but the package is attractive enough.

I haven't had time to do a lot with The Wedge, but it seems to work all right, and it was easy enough to install. There's a set of 8-inch flash cards, that is, slick paper sheets, each of which has a tutorial lesson on getting the spreadsheet running, setting up spreadsheets, saving them, printing them, etc. As far as the program itself goes, I didn't notice any special features not present on other spreadsheets, and the documents don't seem to claim any. It will handle numbers up to 999,999,999.99 (just shy of a billion), and as small as 0.001, and that's a greater range than many such programs have, although not outstandingly so.

The Wedge's competitive edge, then, must be the documents; and if Access Software had stayed with the style of its typeset tutorials, there'd have been a real contest, and I'd have had a lot more work to do. Alas, it was not to be. I *suspect* the manuals, 20 pages in the Installation Guide and 80 pages with index in the Applications Manual, are well written and fairly complete; but I could confirm my suspicions only at the risk of my already failing eyesight, and I'm just not willing to do that.

The outside pages, including the Table of Contents, are typeset and readable; but the body of both documents is two-column printout, probably from a Diablo. It is not right justified. It was printed with either a bad ribbon or a misaligned print head (or most likely both), then photoreduced. In a strong light I can read them, though not easily, and as I said, I think they're well written. However, I'm never going to find out, and everyone else here declines to do so, so I guess we just won't have a test

of The Wedge against Supercalc.

I can't imagine why, having spent what Access Software did on the rest of the package, it didn't get a good dark typescript to work from; after all, amateur science-fiction magazines ("fanzines") manage it. This company didn't, though, and thus wedged itself out of my being able to give it a fair evaluation. Those with much patience and stronger eyesight than mine might find this product interesting.

Superfile

I swear it: something has *got* to be done about silly licensing agreements before we all become a complete nation of scofflaw computer users.

Let's look at the good part first.

Authors have problems: we have to keep track of characters. For short stories that's not so difficult, but with epic-sized books like *Lucifer's Hammer* or our new *Footfall* things can get messy. We may think we're done with a character in chapter one—say the aged uncle of the waitress in the restaurant where the main characters meet—and then later discover he's just ideal for a walk-on in chapter nine; except that we don't remember precisely where he appeared, or what we named him, and we sure don't want to stop and look it up.

Consequently, for some time I've had in my "Do It" book a note to make up a table of characters for *Footfall*, our novel in progress. I haven't got around to it, though, mostly due to sloth. I expected to do it in my own Minimum Data Base that allows search by keywords and is easy to set up; easy or not, however, it involves work. I'd have to have a paper copy of the book to read while entering the names and data, or else have two machines going side by side, one displaying text, the other taking data entries.

Then, suddenly, there was Superfile, which appeared out of the blue courtesy of UPS. (Turns out Alex had spoken with the company while I was in Italy.)

Superfile has some very nice features. It requires no fixed length for fields, you can mix entry lengths, and you use your own text editor to create

DUCES TECUM LAWMATE™

Bring Justice To Your Documents, Briefs, Pleadings and Contracts.

LAWMATE Features:

- Creates Table of Authorities Cited
- Multiple Document Indexes
- Word Use and Consistency Analysis
- Concordance Generation
- Document Line Numbering
- Wordstar* Compatible

Legal Aid at an (Almost) Unlawfully Low Price.

Try **LAWMATE** at Your Local Osborne Computer Dealer, or Call Us for the Name of the Nearest Authorized ORTHOCODE Textware Dealer.

ORTHOCODE
The Textware Company

THE ORTHOCODE CORPORATION
P.O. Box 6191
Albany, CA 94706
(415) 753-3222

™ LAWMATE is a Trademark of ORTHOCODE CORPORATION
*Wordstar is a Trademark of MicroPro International

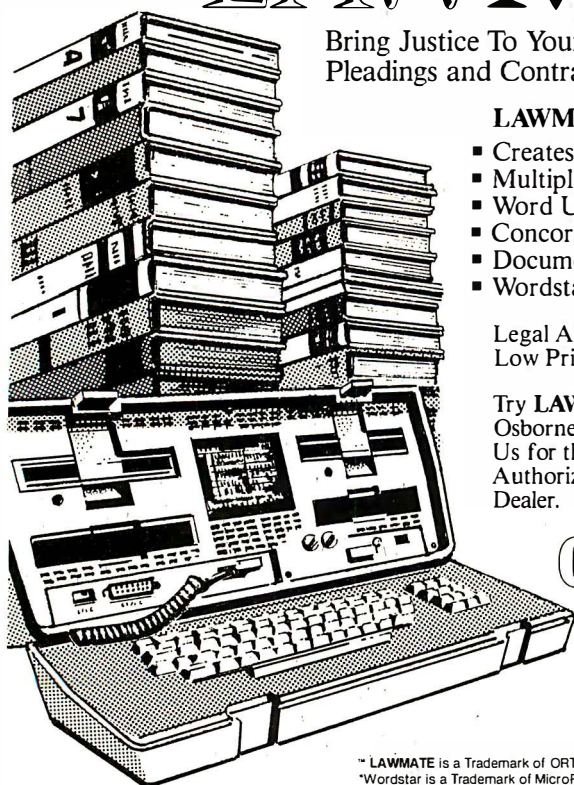

How to dress up your IBM.

Fred Molinari, President

Low cost data acquisition and control for the IBM Personal Computer.™

Data Translation is fashioning a new look in the personal computer market.

Our new single board plug-in brings complete analog and digital I/O capability to your IBM Personal Computer.

The complete DT2801 I/O system fits on just one board. It includes A/D, D/A, digital I/O, and a programmable clock and has direct memory access capabilities.

With power and performance to match that of the IBM PC, the DT2801 provides 12-bits of resolution with over 14kHz throughput rates.

And whether your application is in laboratory data acquisition or in industrial process control, you will find the DT2801 highly reliable at a very low cost... under \$1,200.

The DT2801 is easy to use. Just plug it in to one of the IBM Personal Computer's expansion slots. No need for separate housing or cables. An optional terminal panel is available for connecting analog and digital input signals.

And it's easy to program. More than 30 I/O functions are accessed with just 3 commands from the IBM Personal Computer's BASIC. Programming instructions and sample routines are detailed in the comprehensive User Manual.

Plus, as with all Data Translation products, the DT2801 is fully backed by our service and support team.

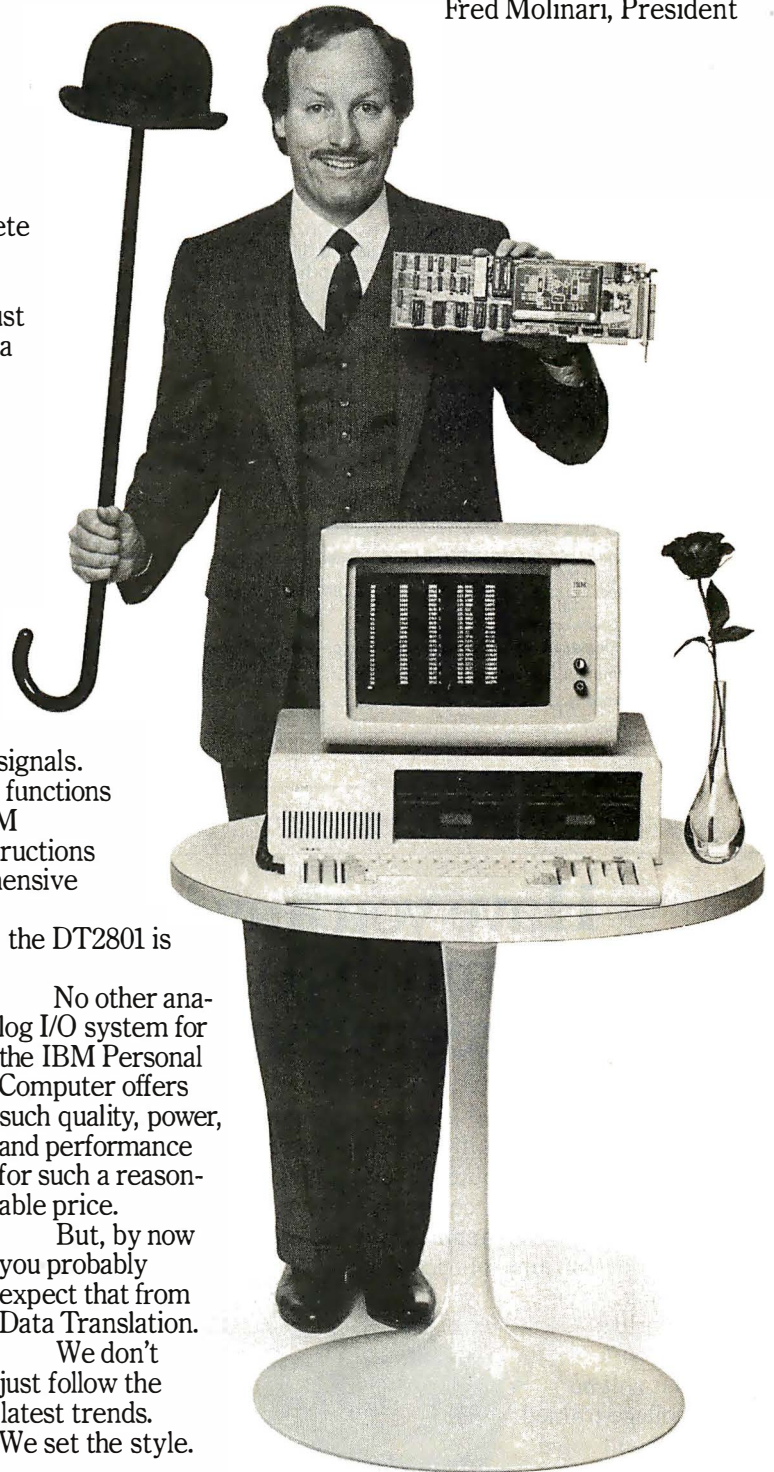

No other analog I/O system for the IBM Personal Computer offers such quality, power, and performance for such a reasonable price.

But, by now you probably expect that from Data Translation.

We don't just follow the latest trends. We set the style.

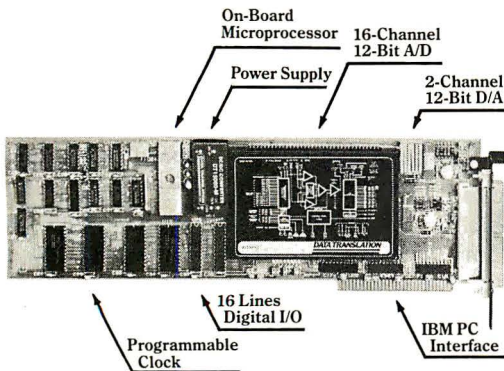

The DT 2801 from Data Translation is a complete single board data acquisition system for the IBM Personal Computer.

DATA TRANSLATION

World Headquarters: Data Translation, Inc., 100 Locke Dr., Marlboro, MA 01752 (617) 481-3700 Tlx 951-646.

European Headquarters: Data Translation, Ltd., 430 Bath Rd., Slough, Berkshire SL1 6BB England (06286) 3412 Tlx 849-862.

IBM Personal Computer is a registered trademark of IBM.

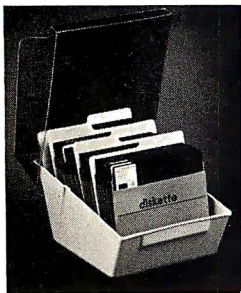

Protect your Diskettes!

This sharp looking Diskette Tray with hinged lid keeps diskettes handy and free from hazards that can create data dropout. Complete with plastic dividers and foam cushion bottom, it provides easy, warp-free storage. And, as with all Pryor products, if you aren't completely satisfied, return the merchandise within 30 days and we'll return your money.

PRYOR Computer Supplies Catalog

— PHONE TOLL FREE 800-558-6866, or send coupon —

Pryor Catalog Sales Corporation
8785 North Port Washington Road
P.O. Box 17829, Milwaukee, Wisconsin 53217

BT 483

Send _____ 5 1/4" Mini-Diskette Trays, Order No. 527-206 at \$29.95 ea. Total \$ _____
(Qty)

Send _____ 8" Diskette Trays, Order No. 527-209 at \$35.95 ea. Total \$ _____
(Qty)

Check enclosed Bill me

Please send a Free copy of the Pryor Computer and Word Processing Supplies Catalog

Name _____

Company _____

Address _____

City _____ State _____ Zip _____

Phone _____ Signature _____

Have you any idea how much America's colleges mean to you?

It was college-based research and college-trained minds that gave us electronic computers, television, spacecraft. That conquered polio, smallpox, diphtheria. That developed new strains of rice and wheat to help feed the world's hungry.

And it will be today's college-trained minds that will solve

tomorrow's problems: Energy. Transportation. Health. City planning. International relations.

But only if you help. America's colleges are in deep financial trouble.

They cannot train minds for tomorrow unless you make it possible now. So give them a hand. The help you give today will make tomorrow's world a better one.

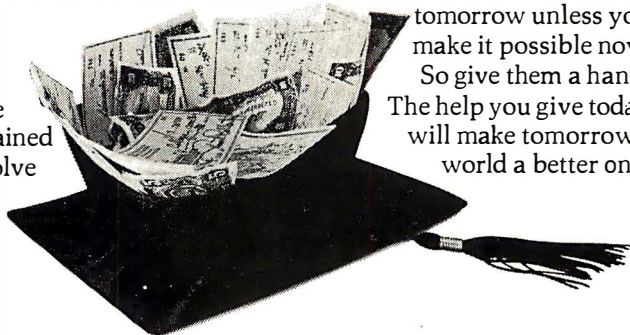

Make America smarter. Give to the college of your choice.

Council for Financial Aid to Education, Inc.
680 Fifth Avenue, New York, N.Y. 10019



A Public Service of This Magazine & The Advertising Council

index files. When it's all done, it makes a "dictionary" of keywords used, and you can search using up to 64 keywords combined with AND, OR, and NOT.

The search algorithm used has some problems: although it uppercases both keyword and search entry (there is an override if you really want to differentiate between uppercase and lowercase), it doesn't use an "include" comparison; the result is that BYTES won't be found if you search for BYTE. I think this is unfortunate, but you can live with it.

There are problems with the Sort feature, too. Superfile thinks all numbers are strings; at least that's my guess as to what's going on. What's certain is that "numbers used for sorting must all be the same length and format. If you use numbers 1 through 999, for example, all one- and two-digit numbers must have leading zero's (0) as 'pads,' like this: 001, 002 . . ."

Problems always exist with any "free-form" data-retrieval system; because the data is not in any fixed format, it's hard for a Sort routine to find the "field" on which you want to sort. The advantage, of course, is that you don't have to enter data in fixed format and in response to prompts.

My intention with Superfile is to go through and, using my normal text editor, "mark up" a copy of *Footfall*. Superfile thinks that *C begins a data entry, *K begins the keyword field for that entry, / separates keywords, and *E ends the entry. Thus, I should be able to create a characters database right from the marked copy of the text. This isn't an indexing program, so it won't know what page it found the entry on, but that isn't fatal; the great thing is that it ought to pull all that stuff out. If I make the character name the first entry after the *C, according to the documents Superfile will be able to sort the newly created database, giving me an alphabetic list of my characters along with whatever comments I decide to include between the character name and the *K; plus a bunch of keywords, such as the names of people they're associated with, so that I can find them again.

PORTASYS™ - A Low Cost, Versatile Expandable Development System

OEM Dedicated Controller

General Purpose Controller

PROTOSYS MAINFRAME

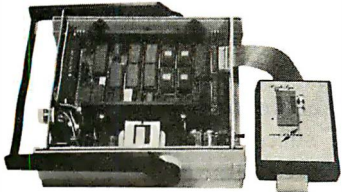

EPROM ZAPPER

MAINFRAME

- *3 Cards Capacity
- *AC power or Battery power (Battery not included)
- *Comparator senses power dropout and switches to battery
- *Output voltages: 5V, ±12V
- *Battery Voltage: 8V to 12V

Mainframe.... PR-1001.... \$149.00

EPROM ZAPPER (Programmer)

- *Programs 2716 or 2732 Eprom (not the A series, i.e. 2732A)
- *Firmware included in an Eprom
- *Connects to the Main CPU card parallel I/O ports

Eprom Zapper... PR-1002... \$ 79.00
Zero Insertion Socket ... 10.00

16K/32K CMOS RAM BOARD W/BATTERY BACK UP

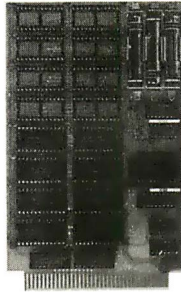

4.5 in. x 7.0 in.

16K/32K BATTERY BACKED CMOS RAM/EPROM BOARD

- *16 Sockets for 6116 Low Power CMOS and/or 2716 Eprom - Total board capacity of 32K bytes
- *On board battery holder for 3 AAA NiCad Batteries - trickle charged by the regular supply
- *Very low power consumption for Data Retention - Can store program when power is turned off
- *Bank selectable
- *Other memory can occupy empty socket space location
- *Gold plated edge finger for reliable contact

16K CMOS Ram Card..... \$195.00
PR-1005..... \$195.00
(Batteries not included above)

Z8/8741A CPU BOARD



4.5 in. x 7.2 in.

Z8671/8741A

- *Z8671 CPU with built in TINYBASIC INTERPRETER
- *12K on board capacity CMOS Ram interchangeable with 2716 Eprom
- *Data retention Battery backup capability
- *Memory expandable to 60K - Bank selectable to greater than 480K
- *All Buss Interface lines buffered and Tristatable for multiple CPU operation
- *24 Fully programmable parallel I/O lines - uses 8255A IC
- *14 additional I/O lines buffered and available at Main connector
- *6 Interrupts
- *RS232 Serial I/O switch selectable from 110 to 9600 Baud
- *Optional Fully Programmable Real Time Clock - uses MM58167 IC with its own crystal controlled oscillator
- *Optional 8741A Universal Peripheral Interface CPU or 8748 single chip processor, each with 1K of on board Eprom - Digital Cassette Interface software for the 8741A UPI available soon
- *Fully Gold Plated edge fingers for reliable contact
- *High quality Printed Circuit Boards

CPU Card with 4K Ram..... \$195.00
PR-1000CM..... \$195.00
8741A UPI IC..... 29.00
PR-8741A..... 29.00
MM58167 Real Time Clock..... 19.00
PR-58167..... 19.00

12 BIT AD/DA AMP BOARD

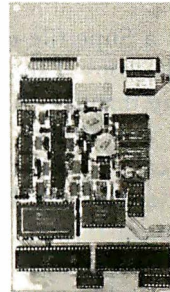

4.5 in. x 7.0 in.
4.5 in. x 8.5 in. w/ Kluge Area

12 BIT AD/DA AMP - CONTROL BOARD

- A to D Section**
- *12 Bit Analog to Digital Converter - uses ADADC80 IC - 25 microsecond conversion time
 - *Input Voltage ranges: 10V, 5V, ±2.5V, ±5V, ±10V
 - *16 Lines Multiplexer single ended or 8 lines differential - differential pin out for twisted pair flat cable
 - *Data latched and controlled by 8255A ICs
 - *2 LM310 Buffers with balance control for differential nulling
 - *2 LM318 inverted amplifiers with adjustable gain control
 - *1 LM318 Differential to single ended converter
 - *2 LM733 Video amplifiers with adjustable gain control

- D to A Section**
- *12 Bit D to A converter - uses AD DAC80 IC - 3 microsecond conversion speed
 - *Voltage ranges: 10V, 5V, ±2.5V, ±5V, ±10V
 - *8 Analog switches for multiplexing output (or other applications)
 - *DAC and Analog switches fully controlled by 8255A ICs

- GENERAL Section**
- *3 optional double pole double throw relays
 - *2 optional HI SPEED current amplifiers buffers - uses LH0033 - 1500 V/microsecond slew rate ±100 ma drive current - current limited - Very high input impedance - perfect for high speed peak detector, sample hold, etc.
 - *6 additional parallel I/O lines
 - *Kluge area available

12 Bit AD/DA Amp Control..... \$299.00
PR-1020..... \$299.00

8 Bit AD/DA-Other Circuits Same as Above..... PR-1021..... \$195.00

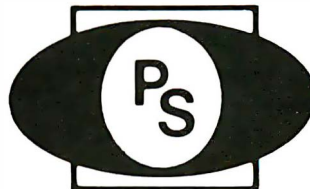
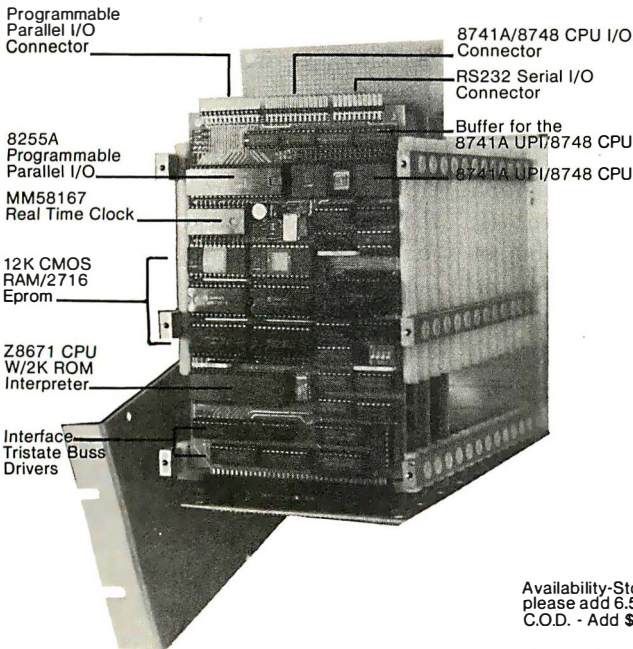

Availability-Stock to 2 weeks, California Residents- please add 6.5% Sales Tax. Shipping and Handling Charges: UPS - \$5.00 UPS Blue Label - \$8.00 C.O.D. - Add \$5.00 in addition to above

Send for detail information:



ProtoSys

830-4 Jury Court • San Jose, CA 95112 • (408) 998-4477
P.O. Box 23698 • San Jose, CA 95123 • (408) 998-4478



Superfile runs only on a Z80 (I tried it with the 8085/8088 Compupro dual-processor system, and it won't run on that), but I have Zeke II running fine, so that's no difficulty.

There is a problem. The program documents give no examples at all. They write instructions in what's very nearly baby talk, but they don't show what's going on. Let me give an example.

There's a Superfile utility that will open a file, copy it to a new file, and on the way through change any characters to any others. This kind of utility is called a filter, and it's very useful for doing such things as changing the print-format commands so that text files created by one editor can be printed by another.

Superfile is all menu driven. To run this utility, you specify the "change characters" option in the utilities program. I now give you Superfile's instructions exactly as they appear in the book:

```
Enter the present characters first, then
the replacement characters
present      >
```

```
change to   >
```

```
At this point you simply list the
characters that you want changed,
and then what you want them
changed to.
```

That's it. No more instructions. One problem: how does it know when you're finished listing characters you want changed, and ready to accept the ones you want them changed to? On trying it, I find that you simply list what you want it to look for, end the list with a Carriage Return, and begin a new list; the program lines them up for you, old above new, so it's relatively easy to do; but it sure would have been a lot simpler to figure out if they'd given an example.

Please. Any of you out there writing programs and contemplating sales: Do not assume that your deathless prose is so sparkingly clear that you can dispense with examples. Paper isn't that expensive.

Incidentally, the Superfile utility will let you enter characters by ASCII

(American National Standard Code for Information Interchange) number, so that you can change all the Control-Qs to Control-As or any such. Alas, there doesn't seem to be a way to create or remove eighth-bit-set characters (which appear as reverse video on my system) as created by Wordstar. For reasons I don't understand, Superfile will accept numbers greater than 128 (the ASCII representation of a character with the eighth bit set), but what it does with them is simply not predictable.

Still in all, let's try it. I'll go do that now.

* * *

The asterisks indicate passage of time. They also indicate mild gnashing of teeth. Superfile has its good

Superfile has its good points, but there are some infuriating aspects to it as well.

points, but there are some infuriating aspects to it as well.

First, like many programs nowadays, Superfile wants your text editor to mark the ends of lines with not only Carriage Return, but Linefeed. This is annoying. To save space on files, WRITE (like Electric Pencil before it) marks paragraph ends with a Carriage Return. (It doesn't mark line ends at all, but of course when you're using something like Superfile you'll make each line a separate paragraph; no problem.) Thus, I have to run my stuff through a filter before Superfile will deal with it—and Superfile's "change characters" utility will *not* deal with that problem, because it won't substitute two characters for one. Grrr.

Second, Superfile doesn't extract stuff from your old document; what it does is make a mess of pointers to where in your document each entry can be found. Then it renames it. Thus, I started with a chapter called DISCOVERY.TXT and went through marking it up: whenever I found a

character, I put a *C at the beginning of a line, then the character name, then notes that were often just pulled from the text itself; then *K and a bunch of keywords, then *E to show that entry was done. It wasn't onerous. I didn't bother to eliminate the text between entries.

To be safe, I saved that as DISCHAR.TXT, put it into the B drive, and invoked Superfile. After some frustration with the instructions—they *will* not give examples and just assume that all is very clear—we succeeded in "creating a database" called FOOTCHARS (meaning characters in *Footfall*, the title of the novel).

Examining the disk shows there are new files: FOOTCHARS.NDX and FOOTCHARS.DIC, as well as a file called DISCHAR.D00, which is nothing more than DISCHAR.TXT with a new extension name. Four entries were crammed in among one whole lot of useless text. No extraction had been done at all. I'd obviously had the wrong idea about what Superfile does—yet I'd spent some time reading the documents.

Close rereading discloses that if I want to add anything to my "database," it will append the new files on to the old one; it still won't extract.

This means that my scheme of marking up existing stuff and extracting it into a Superfile isn't going to work; I'll have to eliminate the extraneous matter. It will be simple enough to write a small filter program that does that, and while it's at that job it can put Carriage Return-Linefeed pairs wherever it sees a Carriage Return; whether that's easier than using my Minimum Data Base (which *will* find included strings and thus would find BYTES if you searched for BYTE) is another matter.

Thus, after a couple of hours' work I was able to figure out what Superfile is and does. Understand, it's not all that hard to *use* the program, because it's all menu driven and the documents are pretty good at walking you through a lot of it; but I, at least, had my problems figuring out what it was going to do until it did it.

Superfile lets you make a whole mess of entries in any format you

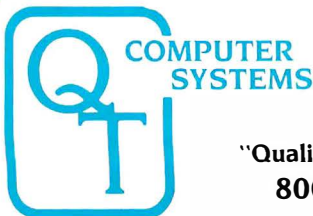

COMPUTER SYSTEMS

"Quality Throughout"
800-238-3100

Q.T. Products Division
COMPATIBLE COMPUTER CORP.
3330 South Third St. West
Salt Lake City, UT 84115
☎ 1801| 974-0999

Q.T. Systems Division
GOLDEN WEST COMPUTERS
60 North 300 West
Provo, UT 84601
☎ 1801| 373-1467

NOTICE: CP/M is a trademark of Digital Research. Turbodos of Software2000 and INFOWARE of Compatible Computer Corporation. The Q.T. products and systems above are produced and sold under license by Compatible Computer Corporation and Golden West Computers, Inc. The Q.T. trademark and product designs remain the property of the licensor, Q.T. Computer Systems, Inc. of Hawthorne, Calif.

NEW IMPROVED 1983 MODELS

The entire Q.T. product line has been redesigned and improved using computer controlled manufacturing techniques to insure the highest quality. Many new features have been added to every item. The Q.T. 1983 models are among the best S-100 products available on the market today. They are fully compatible with the latest 16/32 bit cpu's.

Call (800) 238-3100 today for the location of your nearest dealer and/or to obtain the 1983 Q.T. catalog. Substantial dealer/OEM discount offered.

Stocking dealers with retail showrooms and mail order facilities include:

- Priority One, Chatsworth, CA ☎ 800-423-5922
- Bison Products, Los Angeles, CA ☎ 213-994-2533
- Compatible Computer, New York City ☎ 212-221-7900

TERMS: Cash prepayment @ 2% discount. COD or net 30 days with prior credit approval. Initial dealer/OEM orders must be COD or prepaid (MC/Visa credit card OK). Purchase orders accepted from D&B rated firms. Shipping and handling charges estimated at \$0.50/lb UPS ground and \$1.00/lb UPS Blue Label or airfreight. Minimum \$3.00. Utah residents add sales tax. Export orders welcomed—telex 426382 ITR UI.

Q.T. DISCOUNT MICRO-SYSTEMS PACKAGES



Q.T. MAXI-SYSTEM PACKAGE—Model 800P

\$6,395.00

List \$7,995.00—Save \$1,600.00

- Q.T. 8" Mainframe with 8 slot Motherboard
- Televideo 925 Full Featured CRT
- Choice of printer: C. Itoh F-10 daisy wheel or Oki data M84P high speed dot matrix (200 cps.)

The Q.T. Maxi-System is an industry standard S-100 expandable microcomputer which is ideal for general business computing, word processing and data base management applications. CP/M operating system is standard. MP/M or Turbodos optional. Unique Infoware[®] utilities simplify operation and user training.

- Electronics on Two Cards
 - 64K RAM Standard
 - Universal Disk Controller
 - 2 Megabytes on line
 - 4Mz Z80A CPU
 - Parallel Printer Port
 - 10-40 MB Hard Disk Option
 - Expandable to 256K RAM
 - Filtered Fan
 - Two A.C. Outlets
 - Key Lock Switch
 - Two Serial Ports
- Package Price Includes Cables, Documentation & Utility Programs. Model 800 alone \$4,995

Q.T. MINI-SYSTEM PACKAGE—Model 500P

\$3,995.00

List \$4,995.00—Save \$1,000.00

- Q.T. 5 1/4" MINI-FRAME w/6 slot MB
- Televideo 910 Green CRT
- Dot Matrix printer (M82A)

- CP/M standard. Turbodos optional.
 - Reliable Single Card Electronics
 - Z80 CPU/Universal DMA controller
 - Dual Double Sided/Density Drives
 - Memory: 64K RAM & 320K Disk Drive
 - Cables, manuals, Infoware[®] Utilities
- Model 500 alone \$3,495.00

Q.T. INDUSTRY STANDARD S-100 MAINFRAMES

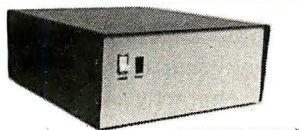

Q.T. MICRO-FRAME[™]

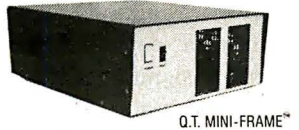

Q.T. MINI-FRAME[™]



Q.T. MAXI-FRAME[™]

Q.T. MICRO-FRAME[®]—Series 600

Desk Top—Plain Front Panel

- 6 to 22 slot Motherboard
- Full I/O Cutout Array
- Fused EMI/RFI Filter
- Heavy Duty Power Supply (+8V@16A ±16V@3A)

QTC-MF+1	No MB	\$499
QTC-MF+6	6 slot MB	\$599
QTC-MF+8	8 slot MB	\$649
QTC-MF+12	12 slot MB	...	\$699
QTC-MF+18	18 slot MB	...	\$799
QTC-MF+22	22 slot MB	...	\$899

Q.T. PRO-FRAME[®]—Series 700

Rack Mount—Constant Voltage

QTC-RM+12	12 slot MB	...	\$799
QTC-RM+18	18 slot MB	...	\$899
QTC-RM+22	22 slot MB	...	\$999

Q.T. MINI-FRAME[®]—Series 500

Desk Top—Dual Mini Drives

- Holds two 5 1/4" Drives
- Full Cutout Array
- 6, 8, or 12 slot MB.
- Fused EMI/RFI Filter
- Hard Disk Power Supply (+8V@16A, ±16V@3A, ±12V@5A, +5V@5A)

QTC-MF+MD	(No MB)	..	\$699
QTC-MF+MD6	6 slot MB	..	\$799
QTC-MF+MD8	8 slot MB	..	\$849
QTC-MF+MD12	12 slot MB	..	\$899

Q.T. MAXI-FRAME[®]—Series 800

Desk Top for Dual 8" Drives

- 6, 8, 12 slot Motherboard
- Universal Drive mounts
- Key lock Power Switch
- Heavy Duty Power supply (+8V@16A, ±16V@3A, +5V@5A, -5V@1A, +24V@5A)

QTC-MF+DD1	No MB	\$799
QTC-MF+DD6	w/6 s. MB	..	\$899
QTC-MF+DD8	w/8 s. MB	..	\$949
QTC-MF+DD12	w/12 s. MB	..	\$999

Standard features & Options: All Q.T. mainframes are built on a strong steel chassis with sturdy heavy gauge aluminum covers. Heavy duty power supplies have individually fused outputs and are shielded by an EMI/RFI filter & line surge protector. Standard I/O cutouts include provision for 16 DB 25's, 1 DC 37, 2 DA 15's, centronics parallel, 134 pin and 250 pin IDC ribbon cable connectors. Filtered positive pressure cooling fan. Twin AC outlets provide convenient connection for and control over printer and terminal. Standard colors are charcoal/light grey to match Televideo terminals. Optional colors include brown/tan and federal spec. ivory at extra charge. Constant voltage power available on most models—add \$100.00. EIA rack mount rails available on some units—add \$95.00. Complete OEM customization available on orders of 10 or more units. Contact factory for details and pricing.

Q.T. DISK DRIVE CABINETS AND SUBSYSTEMS

Q.T.'s All in One[™]

Universal Disk Drive Cabinet

- Expandable
- Accepts all 8" drives

Q.T.'s unique new disk drive cabinet has been designed to accept virtually any 8" drive on the market today from Tandon Thinlines to 40 megabyte Quantums. Features include interchangeable face plates (Qume, Shugart, Tandon, etc.) and "electronics in a drawer" construction to simplify installation and maintenance. Heavy duty power supply will carry any combination of up to four Thinline, two standard, or one hard disk drive with floppy backup. +5V@5A, -5V@1A, +24V@5A.

QTC-DDC8	8V-XX w/one faceplate	\$399.00
Replacement Faceplates (Specify type & number of drives)		 \$25.00
Tandon 4-drive power cable		 \$15.00
Data Cables available		 \$20-50.00



Front—Tandon Panel

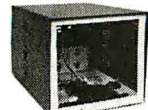

Front—no panel



Rear view

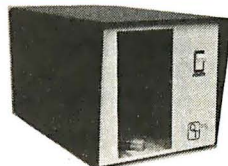

SINGLE 8" VERTICAL CABINET

Size: 11"H 11"W 18"D
Perfect add-on disk drive for any system. Accepts most brands.
QTC-DDC8V \$299



DUAL 8" HORIZONTAL DRIVE CABINET

Dimensions: 5"H 17"W 20"D

Designed to provide basic disk storage capacity for S-100 and other computers. Low profile permits table top stacking.
QTC-DDC+88H \$349

Q.T. "ALL IN ONE" EXPANDABLE DISK DRIVE SUBSYSTEM SPECIALS

QTC-DDS+0	with two single sided Siemens Drive (0.5MB)	\$695
QTC-DDS+1	with one double sided Mitsubishi Drive (1MB)	\$895
QTC-DDS+2	with two DSDD Mitsubishi Drives (2MB)	\$1,495

Will This Happen to You?

NOT IF YOU BUY YOUR PRINTER FROM...

THE Printer

STORE

SERVICE, COMPUTER AND SOFTWARE COMPATIBILITY, and LOW PRICE, are among the many factors to consider when purchasing a printer. At the **PRINTER STORE** we specialize in printers, so our trained professional staff can help you choose the right printer for your personal and business needs. When you buy a printer from us you can be assured that your purchase will also include:

- ★ FULL FACTORY AUTHORIZED SERVICE
- ★ FREE TECHNICAL CONSULTATION
- ★ FULL AFTER SALE SUPPORT

DOT MATRIX PRINTERS

EPSON SERIES

FX 80 \$ CALL
MX 100 \$ CALL

OKIDATA SERIES

82 A \$380
83 A \$685
92 A \$ CALL
93 A \$ CALL
84 (parallel) \$ CALL

C. ITOH SERIES

8510 Prowriter \$395
Prowriter II \$ CALL

IDS SERIES

Microprism 480 \$ CALL
Prism 80 \$ CALL
Prism 132 \$ CALL

GEMINI SERIES

Gemini 10 \$339
Gemini 15 \$ CALL

NEC 8023

NEC 8023 \$ CALL

Toshiba P 1350

Toshiba P 1350 \$1750

LETTER QUALITY PRINTERS

BROTHER SERIES

HR-1 (parallel) \$815
HR-1 (serial) \$ CALL

COMREX SERIES

CR-1 (parallel) \$ CALL
CR-1 (serial) \$ CALL

Transtar 130

Transtar 130 \$785

Daisywriter

Daisywriter \$ CALL

NEC SERIES

3510 \$1575
3515 \$2000
3530 \$1850
3550 \$ CALL
7710 \$2425
7720 \$2900
7725 \$3000
7730 \$2400

SCM-TPI

SCM-TPI \$585

Micro Buffer

Micro Buffer \$ CALL

Grappler+

Grappler+ \$ CALL

Apple Dumping

Apple Dumping \$ CALL

We carry a full line of Cables and Accessories

Call (213) 470-1888 and ask us about...

PHONE REBATE

We are so confident of our LOW PRICES and SUPPORT that we are going to ask you to make the initial investment by calling us. In return, when you buy your printer from us, we will rebate the cost of your call and deduct it from your invoice.

- 1) LOW PRICES
- 2) FREE INTERFACING BOOKLET
- 3) FREE TECHNICAL SUPPORT
- 4) FULL SERVICE OPTION

HOW TO ORDER: Our phone lines are open from 8 a.m. to 6 p.m. PST Monday-Friday. We accept VISA, MASTERCARD (at no extra charge), personal checks take two weeks to clear. COD's accepted. Same-day shipment on orders placed before 1 p.m. Manufacturer's warranty applicable on all equipment. Prices subject to change.

THE Printer

STORE 2357 Westwood Blvd., L.A., CA 90064

The Printer Store, 1983

like. You begin each entry with a *C. If you want to make mailing labels, you can make the first entry a name, last name first for sorting. This still isn't clear to me because there's no entry for "mailing labels" in the index, and the various references to making labels didn't tell me much; I presume that if I read the whole document I'd find out.

You can put anything you like, in any format you like, in the entry. This free format severely limits the ways Superfile can sort your data; the simplest is by the first words after the *C. There appear to be ways to do "numeric" sorting as an alternative, but that isn't clear, and the sort algorithm insists that the numbers be padded with leading 0s.

Lines in the entries must be separated by Carriage Return-Line-feed pairs; anything else will prohibit you from displaying any filed data, making the whole exercise futile. Superfile will *not* add Linefeeds, although it does have some limited filter capabilities.

At the end of the data part of the entry you put a *K, followed by keywords. Keywords must be separated by the "/" character; since there can be spaces in keywords (i.e., Superfile can use keyword *phrases*), this is reasonable, but of course that means that spaces are significant characters; BYTE NOW and BYTE NOW are different. Furthermore, Superfile looks for the *exact* keyword, and there is no provision for searching for *inclusions*.

Superfile takes the whole text file you've just created, renames it, and makes up an index; it also makes a sorted dictionary of keywords. This is done automatically and painlessly and is one of the best features of the program. The text file you've created becomes your "database." You can mark up existing files and add them to the database; however, extraneous matter not part of any entry will remain in the database, taking up space and presumably adding to the access-time requirements. I don't know what happens if you try to sort a database containing extraneous matter.

Superfile is quick and easy to use, and FYI Inc., which markets it, is so

Now NRI takes you inside the TRS-80 Model III microcomputer with disk drive to train you at home as the new breed of computer specialist!

NRI teams up with Radio Shack advanced technology to teach you how to use, program and service state-of-the art microcomputers . . .

It's no longer enough to be just a programmer or a technician. With microcomputers moving into the fabric of our lives (over 250,000 of the TRS-80™ alone have been sold), interdisciplinary skills are demanded. And NRI can prepare you with the first course of its kind, covering the complete world of the microcomputer.



Learn At Home In Your Spare Time

With NRI training, the programmer gains practical knowledge of hardware, enabling him to design simpler, more effective programs. And, with advanced programming skills, the technician can test and debug systems quickly and easily.



Now training includes either the TRS-80 Model III Microcomputer with Disk Drive or TRS-80 Color Computer with Computer Access Card; professional LCD multimeter; the NRI Discovery Lab; and hundreds of demonstrations and experiments.

(TRS-80 is a trademark of the Radio Shack division of Tandy Corp.)

Only NRI gives you both kinds of training with the convenience of learning at home. No classroom pressures, no night school, no gasoline wasted. You learn at your convenience, at your own pace. Yet you're always backed by the NRI staff and your instructor, answering questions and giving you guidance.

TRS-80 Model III Plus Disk Drive to Learn On and Keep

NRI training is hands-on training with practical experiments and demonstrations. You not only learn to program your computer, you learn all about it . . . how circuits interact . . . interface with other systems . . . gain a real insight into its nature. Under NRI's carefully planned training, you even install a disk drive, verifying at each step its operation.

You also work with a professional 4-function, 3½ digit digital multimeter and the NRI Discovery Lab®, performing over 60 separate experiments. Both microcomputer and equipment come as part of your training for you to use and keep.

Same Training Available With Color Computer

NRI offers you the opportunity to train with the TRS-80 Color Computer as an alternative to the Model III. The same technique for getting inside is enhanced by using the new NRI-developed Computer Access Card. Only NRI offers you a choice to fit your specific training needs.

Send for Free Catalog

Get all the details on this exciting course in NRI's free, 104 page catalog. It shows all equipment, lesson outlines, and facts on other electronics courses such as Electronic Design, Industrial Electronics, Video/Audio Servicing . . . 12 different career opportunities in all. Keep up with the latest technology as you learn on the latest model of the world's most popular computer. If card has been used, write to:



NRI Schools
McGraw-Hill Continuing
Education Center
3939 Wisconsin Avenue
Washington, D.C. 20016

We'll give you tomorrow.

!!!!FANTASTIC PRICES!!!! FROM DIGITAL DIMENSIONS

OKIDATA

ML-80..80 COL., 80 CPS	\$339
ML-82A..80 COL., 120 CPS	\$415
*ML-83A..136 COL., 120 CPS	\$675
*ML-84..PARALLEL, 136 COL., 200 CPS ..	\$975
*ML-84..SERIAL, 136 COL., 200 CPS ..	\$1,095
**ML-92..80 COL., 160 CPS	\$509
*ML-93..136 COL., 160 CPS	\$869
PACEMARK 2410..350 CPS	CALL
PACEMARK 2350..SERIAL, 350 CPS ..	CALL
*Includes TRACTOR FEED	
**Inc., OKIGRAPH™ DOT ADDRESSABLE GRAPHICS	

SCM-TP I	\$649
120 word/min Daisy Wheel, 10 or 12 pitch, serial or parallel interface	

DAISYWRITER 2000	\$1,015
Bidirectional 40 CPS Average Throughput, 48K Buffer, Centronics, 488, RS232 & C. Loop Included.	

DAISYWRITER 1500 S	\$955
4K Buffer Serial Only	
DAISYWRITER 1500 P	\$925
4K Buffer Parallel Only	

IDS

PRISM 80	\$1,046
Includes 3.4K Buffer and 200 Sprint.	
PRISM 80	\$1,245
Includes 3.4K Buffer, sheet feed, Sprint 200 CPS and graphics.	
PRISM 80	\$1,445
Includes 3.4K Buffer, sheet feed, Sprint 200 CPS, graphics and color.	
PRISM 132	\$1,606
Includes all of above.	

C. ITOH

Prowriter (Parallel)	\$489
Prowriter (Serial)	\$629
Prowriter 2 (Parallel)	\$719
Prowriter 2 (Serial)	\$769
Starwriter F-10	\$1,449
Printmaster F-10	\$1,699

DISK DRIVES

Rana Elite I	\$305
Micro-Sci	\$289

MODEMS

Hayes 300 Baud Smart Modem	\$219
Hayes 1200 Baud Smart Modem	\$515

E-Z COLOR board	\$199
For the Apple II or Apple II Plus. 16-Color, 256 x 192 resolution. Requires 3.3 DOS. Includes demo software and E-Z COLOR Editor.	

E-Z COLOR board for S100 Systems	\$279
E-Z COLOR board for TRS-80	\$239

INTEX TALKER text-to-speech synthesizer. Serial and parallel interface included	\$280
--	-------

AMDEK 13" COLOR-1	\$335
AMDEK 13" COLOR II	\$719
NEC JB1201 GREEN Monitor	\$159

FOR THE IBM P.C.

Quadram Quadboard w/64k	\$469
Quadram Quadboard w/128K	\$519
Quadram Quadboard w/192k	\$609
Quadram Quadboard w/256k	\$699

DIGITAL DIMENSIONS

190 Chapel Rd., Manchester, CT 06040
Info & Orders Call 203-649-3611
Orders Only 1800-243-5222

C.O.D. Welcome. Allow 2-3 Weeks For Checks. MC/VISA OK.
All Prices Include UPS Ground Freight In U.S.
CT Residents Add 7 1/2% Sales Tax.
Prices Subject To Change Without Notice.

confident that you'll like it that it will let you have it for a 30-day trial; if at the end of the time you don't want it, you can return all the materials plus a certificate swearing that you've kept no copies, and FYI will refund your money.

Superfile seems to work, and I expect it's easy enough to learn. The cascade menu system is nearly fool-proof—I deliberately tried to crash the system by typing Control-C at various places and I couldn't do it—and the various prompts and error messages make sense, or at least do so with increasing experience. There are some annoying aspects, but on the whole this is a pretty good program. It's a lot faster than dBASE II, but of course it's also a lot less versatile.

I'd recommend it, especially with that money-back guarantee and trial period—except that FYI has devised another user-threatening agreement. This thing is in tiny print; I need a strong light and the glass from my transistorized *Oxford English Dictionary* to read it, and even then I have trouble.

The agreement is in legalese. It begins with the word *Whereas*, goes on to *witnesseth*, and ends with a signature block so damned small that I couldn't get my real name in there if I were foolish enough to sign the silly thing. If you're planning to sign as J. Doe you can just about do it, and maybe that's no bad plan unless your name really is J. Doe.

I don't know what FYI warrants; the print's too small to read. I see in the last line it disclaims any responsibility for letting you assume this product was useful or merchantable or fit for any particular purpose.

In another place there's a provision to be sure the lawyers are paid no

matter what else happens. I wonder why that doesn't surprise me?

In theory you can't get Superfile without signing this thing, which is actually in the form of an application; the last line says "Upon receipt of two (2) properly completed and signed copies of this Agreement, along with the appropriate Order Form(s) and Fee payment, FYI or its authorized Dealer will return one copy of this Agreement to End User [I think that means customer] along with the appropriate FYI product materials."

Now that I look at it, I've apparently locked myself out of ever being able to be an authorized user: that is, I sure haven't signed this stupid agreement; but one of its provisions is that any use of FYI products without having signed this is unlawful and subjects me to all kinds of horrible penalties, liability for which I acknowledge by signing the agreement . . .

If you can put up with a company that lets its lawyers run wild like that, and you're willing to sign a licensing agreement that you can't read and hasn't room for a signature anyway, you might like Superfile, although I suggest you examine Cardfile first to see if it would do; Superfile has a number of features Cardfile lacks, but it costs a lot more, too.

I may yet use it, if I get around to writing the filter programs it would need before it could solve my problems. ■

Jerry Pournelle welcomes readers' comments and opinions. Send a self-addressed stamped envelope to Jerry Pournelle, c/o BYTE Publications Inc., POB 372, Hancock, NH 03449. Please put your address on the letter as well as on the envelope. Due to the high volume of letters, Jerry cannot guarantee a personal reply.

Items Reviewed

Active Trace	\$125
Cardfile	\$89
Footnote	\$125
Digital Marketing	
2670 Cherry Lane	
Walnut Creek, CA 94536	
(415) 938-2880	

Text box continued on page 356



Real-Time Multitasking Executive

for
8080, Z80, 6809
and **8086**

Gives your application a head start

Save time and money in the development of your product or system by using AMX, the software executive with proven, fault-free operation.

SIMPLE OPERATION

You divide complex control programs into a number of separate, more manageable programs, called tasks, each designed to do one job. This allows tasks to be written and tested separately and then combined to form a reliable, finished system.

AMX supervises the orderly execution of these tasks, assuring that the most important jobs always get done first. Tasks appear to be executing simultaneously. It's almost like having a separate CPU for each task!

HARDWARE INDEPENDENCE

AMX does not require a particular hardware configuration. You control your environment. You pick the I/O method. You decide the preferred interrupt service technique for your system. AMX will support you on the microprocessor of your choice.

AMX is fast, compact, and ROMable. The AMX nucleus, less than 1400 bytes in size, features multiple task priorities, intertask message passing with priority queuing, external event synchronization, and interval timing.

Support modules provide extended memory management, buffer control and resource allocation. Fast, re-entrant integer and floating point math libraries are also available.

AMX interfaces support programs written in C, PASCAL, PL/M, FORTRAN and assembler.

Access to CP/M® disk files in real time is possible using the AMX I/O Supervisor:

COMPLETE DOCUMENTATION

We deliver AMX source on diskette to permit AMX to be moved to the software development system of your choice. Our liberal license agreement permits binary (object) distribution without royalties.

HOW TO ORDER

A specification sheet and price list are available, free. Your check or money order for \$75 will purchase the AMX Reference Manual for immediate evaluation (specify 8080, Z80, 8086 or 6809 processor). Add \$25 for postage and handling outside USA and Canada. The standard 8080/Z80 AMX Multitasking Executive package, including source code, is **\$800**. Support modules and interfaces are available separately.

AMX is the choice of professionals the world over. Make it yours, today.

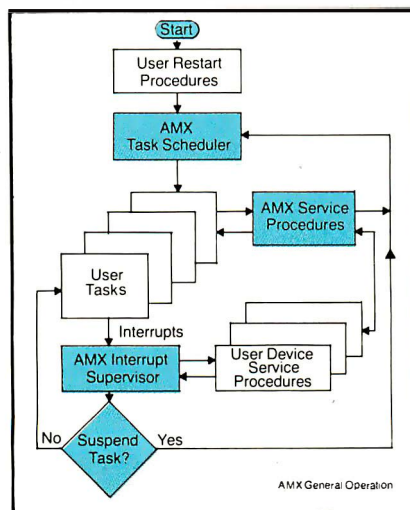

AMX is a trademark of KADAK Products Ltd.
CP/M is a trademark of Digital Research Corp.
Z80 is a trademark of Zilog Corp.



KADAK Products Ltd.



206-1847 W. Broadway Ave., Vancouver, B.C., Canada V6J 1Y5/Phone: (604) 734-2796 Telex: 04-55670

MODEM \$129⁹⁵

No other acoustic modem gives you all these features at this low price.



The MFJ-1232 Acoustic Modem gives you a combination of features, quality and performance that others can't match at this price.

0-300 Baud, Bell 103 compatible. Originate/Answer. Half/full duplex. RS-232, TTL, CMOS level compatible. Use any computer. Cassette tape recorder ports save data for reloading or retransmission. 6 pole active filter handles weak signals. Carrier detect LED indicates adequate signal strength for data recognition. Quality "muffs" gives good acoustic coupling, isolates external noise for reliable data transfer. Crystal controlled. "ON" LED. Aluminum cabinet. 110 VAC or 9 volt batteries. 9x1 1/2x4 in.

Apple II, II Plus: software and cable for modem, MFJ-1231, \$39.95. Plugs into game port. No serial board needed.



It's like having an extra port **\$79⁹⁵**

MFJ-1240 RS-232 TRANSFER SWITCH. Switches computer between 2 peripherals (printer, terminal, modem, etc.). Like having extra port. Push button switches 10 lines (pins 2,3,4,5,6,8, 11,15,17,20). Change plug or cable to substitute other lines. Push button reverses transmit-receive lines. LEDs monitor pins 2,3,4,5,6,8,20. PC board eliminates wiring, crosstalk, line interference. 3 RS-232 25 pin connectors. 7x2x6 in.

\$99⁹⁵ MFJ-1108 AC POWER CENTER.

Adds convenience, prevents data loss, head bounce, equipment damage. Relay latches power off during power transients. Multi-filters isolate equipment, eliminate interaction, noise, hash. Varistors suppress spikes. 3 isolated, switched socket pairs. One unswitched for clock, etc. Lighted power, reset switch. Pop-out fuse. 3 wire, 6 ft. cord. 15A, 125V, 1875 watts. Aluminum case. Black. 18x2 3/4x2 in. **MFJ-1107, \$79.95.** Like 1108 less relay. 8 sockets, 2 unswitched. Other models available, write for free specification sheet.

Order from MFJ and try it. If not delighted, return within 30 days for refund (less shipping). One year unconditional guarantee.

Order yours today. Call toll free 800-647-1800. Charge VISA, MC. Or mail check, money order. Add \$4.00 each for shipping and handling.

CALL TOLL FREE ... 800-647-1800

Call 601-323-5869 in MS, outside continental USA

MFJ ENTERPRISES, INCORPORATED

921 Louisville Road, Starkville, MS 39759

Text box continued:

CB-80 \$500
CBASIC \$150
Pascal/MT+ \$350
Pascal/MT+86 \$600
 Digital Research
 POB 579
 Pacific Grove, CA 93950
 (408) 649-3896

Mathemagic Apple \$89.95
 International Software Marketing Ltd. Others \$99.95
 Suite 421 University Bldg.
 120 East Washington St.
 Syracuse, NY 13202
 (315) 474-3400

Osborne 1 Double-Density Option \$250 plus installation
 Osborne Computer Corporation
 26500 Corporate Ave.
 Hayward, CA 94545
 (800) 772-3545, ext. 905 (California)
 (800) 227-1617, ext. 905 (outside California)

PBASIC (8-inch CP/M) Not available
 Bruce W. Tonkin
 34069 Hainesville Rd.
 Round Lake, IL 60075
 (312) 223-0832

Superfile \$195
 FYI Inc.
 4202 Spicewood Springs Rd. #114
 Austin, TX 78759
 (512) 346-0133

TV2000 Conversion Kit \$220
 Wordtech Systems
 Suite 114
 953 Mountain View Dr.
 Lafayette, CA 94549
 (415) 254-7747

The Wedge \$199
 Systems Plus Inc.
 1120 San Antonio Rd.
 Palo Alto, CA 94303
 (415) 969-7047

8087 Add-on Board \$495
 Hudson and Associates
 POB 2957
 Santa Clara, CA 95055
 (408) 554-1316

8087 Board \$300
 Compupro Systems
 Oakland Airport, CA 94614-0355
 (415) 562-0636

Book Reviewed

Inside Basic Games \$14.95
 Richard Mateosian. Berkeley, CA: Sybex, 1981, 352 pages. \$1.50 postage and handling

STATPRO

The most comprehensive and sophisticated statistics and graphics database program ever developed for the personal computer.

Years of research, development, and field testing have resulted in the most extensive statistics and graphics database program specifically designed for the personal computing environment. STATPRO™ provides the data analysis capabilities and flexibility previously available only on a large computer. Researchers, business professionals, and other data analysts will welcome the breadth yet simplicity of this program! STATPRO requires no previous computer experience, no special command language. Single keystrokes access all of the data manipulation, statistics, and graphics power of STATPRO.

STATPRO allows easy access to its extensive numerical data capabilities.

The strength of STATPRO is found in the functions of its user friendly, menu-driven database. You can easily learn to enter and edit, manipulate, transform, and print out data. STATPRO's searching

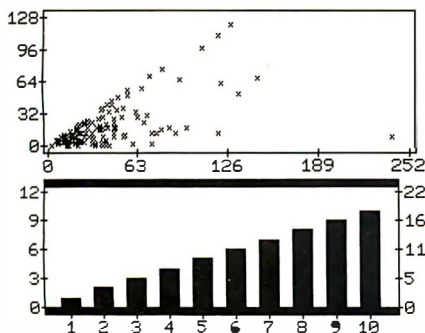

capabilities allow these functions to be performed on all your data or a user defined subset of your data. Over 600 transformations and conversions are available. You can place the results of these transformations into the same field or any other field in STATPRO's database.

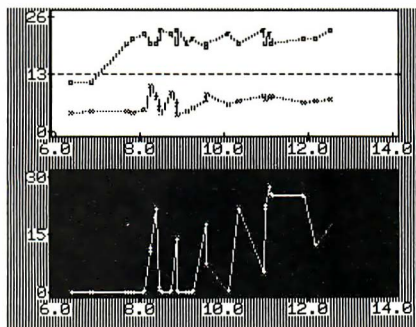

STATPRO offers a comprehensive collection of statistical procedures.

The statistics component of STATPRO contains a multitude of procedures, grouped into the following modules:

Descriptive: Contingency analysis, cross tabulation, normality tests; descriptive, comparative, range and non-parametric statistics.

Regression: Linear, non-linear, stepwise, and multiple regressions; residual analysis and statistical matrices.

Analysis of Variance: Single and nested classifications, two and three way equal and unequal sample size and non-parametric ANOVA.

Time Series: Moving averages, multi-stage least squares, fitted polynomials and trig functions, additive and multiple forecasting.

Multivariate: Principal components factor, orthogonal factor, oblique factor, pair-weighted cluster, discriminant function, multiple contingency, and canonical correlation analysis; positive definite inverse and determinant.

STATPRO provides graphic representation of your data in minutes.

STATPRO graphics plot *all* the results of your STATPRO statistical

analyses including scatter, triangle, regression, and box plots; piecharts, histograms, and dendograms. Further, with STATPRO you can custom edit with keyboard, paddles or graphics tablet. You can create characters and shapes and place them anywhere on a graph. Mix text with data fields. Place multiple plots on each screen. Define your axis limits.

You can save your graphics on a disk for a multiple color "slide show" presentation, or print them out through a variety of compatible printers.

STATPRO documentation wraps up the package.

Although STATPRO software is essentially self-documenting, complete print documentation is provided. This includes walk-through tutorials, easy to understand pocket reference guides and comprehensive user's guides.

STATPRO currently runs on the Apple® II and Apple III personal computers. It will soon be available for the IBM® PC.

Find out more about STATPRO: The Statistics and Graphics Database Program.

Contact your local dealer, or call us toll-free at

800-322-2208

You can also call us toll-free for information on corporate purchase through our National Account Program.



WADSWORTH
Electronic
Publishing
Company,
20 Park Plaza,
Boston, MA 02116.

COMPU SHACK



IBM PC- COMPLETE LINE

IBM

PC System: includes 64K IBM-PC with 2 Floppy Disk Drives, Floppy Drive Controller, Color Graphics Card. All for only **\$2999.00**

LOTUS 1-2-3 SOFTWARE ... CALL

TAVA CORP. PRODUCTS



TRUMPCARD

A unique memory card with 256K Ram Game I/O and Serial I/O. ... **\$499.00**

TRUMP CARD II

Serial I/O and 512K fully populated memory card ... **\$699.00**



TRUMP CARD V

Features Parallel and Serial I/O, Game I/O and a Clock/Calendar with battery back-up. A fully populated 256K memory board ... **\$599.00**

QUADRAM

Quad Board - 256K, Parallel Port, Serial I/O, Clock Calendar with battery backup ... **\$599.00**

512K Ram with Serial I/O. ... **\$799.00**

AST RESEARCH

Combo Plus- 256K, Parallel & Serial Port, Clock Calendar W/Bat. back-up, Superdrive, Superspool ... **\$599.00**

Mega Plus- 512K, Parallel & Serial Port, Clock Calendar W/Bat. back-up ... **\$1199.00**

MAYNARD ELECTRONICS

Floppy Disk Controller. ... **\$179.00**

Floppy Disk Controller w/Parallel Port ... **\$229.00**

Floppy Disk Controller w/Serial Port ... **\$239.00**

HERCULES GRAPHICS CARD

This card gives you 720 x 350 graphics ... **\$499.00**

*CP/M86 is a registered trademark of Digital Research, Inc.
*CP/M is a registered trademark of Digital Research, Inc.

BIG BLUE

Dual I/O ports, dual processing, Serial port, Parallel port, 5 MHZ, Z80 B, 64K, Hard disk interface, Clock/Calendar, let's you run existing CP/M® software. List **\$589** ... Ours **\$479**

OTHER PRODUCTS FOR IBM

MODULE CONVERSIONS FOR YOUR IBM-PC



Z-80 Card-Will put PC in touch with 20,000 existing programs **CALL**

8086-Lets your IBM run 3 to 4 times faster ... **CALL**

68000-Converts PC to 32 bit Architecture and UNIX III. It transforms PC to a powerful cost effective Commercial Engineering work station ... **CALL**

80286-A multi-user expansion provides cost effective benefits ... **CALL**

16032-This micro-card offers VAX like functionality and architecture to PC ... **CALL**

UNIX/XENIX™-XENIX on IBM-PC ... **CALL**

PC Versa Card-512K Memory Card provides user flexibility to run on time tested Software available on any of the chosen processors ... **CALL**

FLOPPY DISK DRIVES

TANDON

TM-100-1 SS/DD ... **\$189.00**

TM-100-2 DS/DD. ... **\$249.00**

TM-100-4 DS/DD. ... **\$359.00**

TM-848-1 SS/DD ... **\$425.00**

TM-848-2 DS/DD. ... **\$499.00**

SHUGART

SA400 SS/SD. ... **\$169.00**

SA450 DS/DD. ... **\$239.00**

SA800/801 SS/SD. ... **\$365.00**
SA850/851 DS/DD. ... **\$459.00**

SIEMENS

FDD 100-5 ... **\$159.00**

FDD 200-5 ... **\$199.00**

QUME

DT-5 DS/DD. ... **\$269.00**

DT-8 DS/DD. ... **\$469.00**

HARD DISK SYSTEMS FOR IBM AND APPLE

DATAMAC

6MB ... **\$1595.00**

12MB ... **\$1995.00**

18MB. ... **\$2695.00**

Complete subsystem with software, cables and power supply.

CORVUS

5MB Special ... **\$1999.00**

10MB Special ... **\$2999.00**



PRINTERS

EPSON

MX-80 W/graftrax plus ... **\$439.00**

MX-80 FT W/graftrax plus ... **\$499.00**

MX-100 W/graftrax plus ... **\$659.00**

STAR MICRONICS

Gemini 10 ... **CALL**

Gemini 14 ... **CALL**



BROTHER

HR-1 A parallel ... **\$769.00**

HR-1 A serial. ... **\$869.00**

Tractor feed option. ... **\$135.00**



NEC

SPINWRITER

7710-1 **\$1995.00** | 3510 **\$1495.00**

7715-1 **\$1995.00** | 3515 **\$1595.00**

7730-1 **\$1995.00** | 3520 **\$1995.00**

7720-1 **\$2395.00** | 3525 **\$1995.00**

7725-1 **\$1995.00** | 3530 **\$1595.00**

3550 ... **\$1995.00**

PC8023A ... **\$ 479.00**

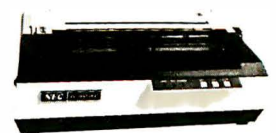

*DATA DRIVE, APPLETT 1, APPLETT 2, and TRUMP CARD are registered trademarks of TAVA Corporation, respectively.

**WE'VE MOVED
TO BIGGER FACILITIES
TO SERVE YOU BETTER
PLEASE NOTE OUR NEW PHONE NUMBER**

(714) 261-1000

Sales and Service: Business & Home Computers

PRICES MAY VARY AT DIFFERENT LOCATIONS

SMITH CORONA 
TP-1 parallel **\$579.00**
TP-1 serial **\$579.00**

OKIDATA
82A **\$429.00**
83A **\$699.00**
84AP parallel **\$999.00**
84AS serial **\$1099.00**

MONITORS

AMDEK MONITORS
AVAILABLE (All Models) **CALL**

PRINSTON GRAPHICS SYSTEMS
High Res. Color **CALL**

NEC
JB-1201M 12" green
screen **\$169.00**
JC-1212M 12" color (Lo-Res) ... **\$335.00**
JC-1203DH (A) 12" (Hi-Res) ... **\$752.00**

ELECTROHOME
13" RGB monitor (Med-Res) ... **\$299.00**
13" RGB monitor (Hi-Res) **\$549.00**

SINCLAIR/TIMEX PRODUCTS
MEMOTECH PRODUCTS

16K Memopack **\$ 59.00**
32K Memopack **\$ 99.00**
64K Memopack **\$169.00**
Memopack High Res. Graphics ... **\$139.00**
Memopack Centronics Parallel inter-
face **\$139.00**

EPSON QX-10
Z-80 CPU, w/64K Ram Video Graphics
Processor, 12" monitor and many more
features **CALL**

HX-20
Notebook Computer **CALL**



APPLE IIe 64K System, 80 Column
card, one disk drive w/controller, mon-
itor, plus 20 diskettes **\$1995.00**

16861 ARMSTRONG, IRVINE, CA. 92714
HEADQUARTERS/TELEX: 181667 — ANSWER BACK: COMPDShAK TSTN



Apple II+ Computer System with 48K
of memory, 2 "data Drive" disk drives,
controller card, 12" green screen hi-
contrast monitor. All cables and manuals
are included for a CompuShack price
of **\$1699.00**

For the same system listed above with a
16K card, Z80 card and an 80 Column
card add **\$351**

OTHER PRODUCTS FOR APPLE

Special of the Month!



**TAVA CORP.
DATA DRIVE®**

\$299.00

100%
Compatible
disk drive
w/controller
for Apple II +

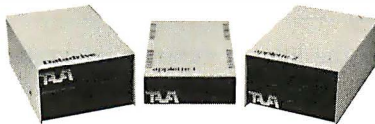

SUGGESTED RETAIL PRICE ... **\$429.00**

APPLETTE 1
Slimline drive **\$339.00**
APPLETTE 2 **\$659.00**

TAVA CORP. PRODUCTS

e plus 101
Interface for parallel printer **\$89.00**

e plus 102
Parallel output buffer board ... **\$169.00**

e plus 103
8K Epson buffered interface ... **\$149.00**

e plus 104
16K Serial output buffer card ... **\$199.00**

Z80 card CP/M® included... **\$159.00**
80 column card **\$179.00**

Disk drive controller card W/
diagnostics software **\$99.00**

Disk drive controller **\$79.00**

**HAYES MICROCOMPUTER
PRODUCTS**

Micromodem II **\$299.95**
Smartmodem 1200 baud full
duplex **\$529.95**

KAYPRO II COMPUTER SYSTEM

64K-Ram, Perfect Writer, Perfect Filer,
Perfect Speller, Perfect Calc, S-Basic,
CP/M® version 2.2, two disk drives, 9"
(green) monitor, RS232 interface, Parallel
Printer interface, and Weatherproof
carrying case, plus 20
diskettes **\$1795.00**

DEC Rainbow 100

Keyboard, CPU, Z-80/8088, 64K, Serial
RS232 Port, 2 X-400KB disk (x-400)
drives, Monitor, CP/M86®/80 Software
..... **Visit our stores for Price!**

DECMATE II

Complete System, Keyboard, CPU, 64K
Words Ram, two 400 KB disk drives,
monochrome monitor, operating sys-
tem. **List \$4500.00**

DEC PROFESSIONAL 300

Complete System, Keyboard, CPU, 256
KB Ram, two 400 KB disk drives, mono-
chrome monitor, operating system
..... **Under \$5000.00**

**WE'RE OPENING RETAIL
STORES THROUGHOUT
THE U.S.A. SOON!**

CompuShack

**CALL YOUR LOCAL
COMPUShACK DEALERS:**

California	Anaheim	*
	Concord	(415) 828-4752
	Glendale	(213) 340-7000
	La Mirada	(213) 947-9505
	Newport Beach	*
	San Fernando Valley	(213) 906-7000
	San Jose	(408) 973-1444
	Tustin	(714) 261-1000
	Walnut Creek	(415) 945-8011
	West L.A.	(213) 906-7306
	Woodland Hills	(213) 888-0030
Colorado	Denver	(303) 422-4545
	Twin Falls	*
Illinois	Chicago	(312) 964-4612
Montana	Great Falls	*
	Missoula	(406) 721-1811
New York	Albany	*
	Rochester	*
	Rome	(315) 336-0266
Texas	Austin	(512) 258-1062
Washington	Richland	*
	Spokane	*
	Verona	(608) 845-7110
Canada	Toronto	(416) 593-8974
U.K.	London	01-935-0480

*Call For Phone Number

ALL FLOPPIES REPAIRED QUICKLY AT LOW COST

Build this Memory, Part 2

Constructing the Memory Card

Cameron Spitzer
175 Calvert Dr., R105
Cupertino, CA 95014

This month I will continue development of the 64K-byte memory board (see part 1 in the March 1983 BYTE, page 310) by describing the construction procedure I followed (skipping the errors I made). You should follow the "test-as-you-go" procedure to reduce the bug hunt to a small portion of the board at a time.

You can build this memory board if you can solder cleanly and wire-wrap consistently. As I mentioned last month, careful construction of the circuit will result in a dependable, versatile memory that you can fill with software and enjoy for years. If you rush the job or buy untested parts, you could have a stimulating puzzle to tinker with or worse. Wiring problems (errors, poor wrapping, loose metal floating around, cold solder joints) have been known to

blow the lids off ceramic integrated-circuit (IC) packages. Building this memory card should not be attempted as a first project.

The parts are all widely available, except for the crystal. The circuit

**For a happy ending,
don't rush the job
and don't buy untested
parts.**

seems to work with any clock from 4 to 15 MHz, but wait states are necessary below 14 MHz when using a 4-MHz Z80 microprocessor. The crystal is not critical, but I advise you to stay between 13 and 14.5 MHz, especially if you can't measure the frequency it runs at. Crystals love to run at impossible harmonics. The prototype board seemed to have trouble holding data until I forced its 10.17-MHz crystal to stop oscillating at 20.34 MHz.

Incidentally, if you can't get a 74S65, use a 7422 and a 7403 with all their outputs tied together. You may substitute regular TTL (transistor-transistor logic) for the S-type

Schottky TTL (labeled 74SXX), but you may get a wait state in some opcode fetches. If you buy a spare set of ICs, a wiring disaster can't cost too much time (table 4 is a parts list). The heat sinks I used were made from 3/4-inch aluminum angle stock: a 1-inch length for the -5-volt (V) regulator, and a 3-inch length for both positive regulators. (The -5-V regulator barely gets warm; the others get hot, but not dangerously so.)

Mark locations and edge-pin numbers before installing anything. Use the layout in figure 6 to minimize bus-line length. Leave one row of holes between the memory ICs and two or three holes between rows of TTL: this leaves space for later additions.

Build the power supply first. Wire the regulators so that you can change them for debugging or for future 5-V-only memory devices. The supply fits in a 1- by 5-inch strip at the end of the board, out of the way. Test the supplies with a pair of number 47 pilot lights and a voltmeter. Two bulbs in series, across +12 V and ground, glow white, and in parallel each 5-V regulator can light both

All caption numbers are continued in sequence from part 1, March 1983 BYTE, page 310.

About the Author

Cameron Spitzer designs I/O channels for Four-Phase Systems, a Motorola subsidiary.

FROM THE CREATORS OF THE DATA DRIVE® COMES APPLETTTE 1® AND APPLETTTE 2® SLIMLINE DRIVES

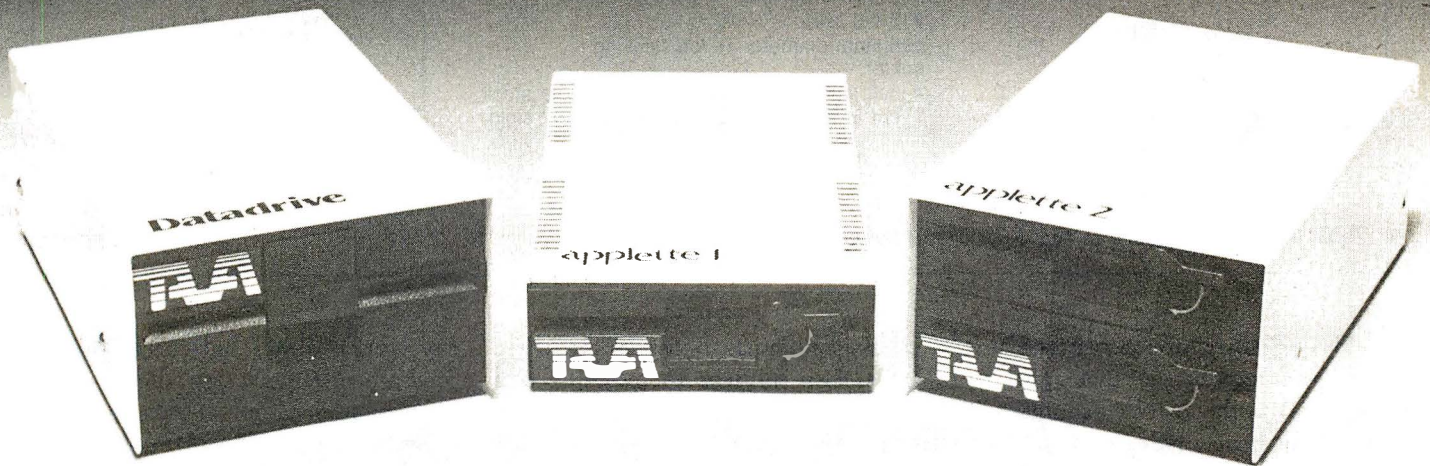

Available At CompuShack Stores

Applette 1® and Applette 2® are 100% Apple II compatible. Halftracking, DOS, PASCAL, and CP/M®. 300% faster track to track speed with 15% greater storage capacity on a 40 track mode with enhancer diskette. TEAC® mechanism and read/write electronics. Direct shaft drive, metal band positioner, photo coupler write-protected sensor. 10,000 lifetime hours, and more. **One year warranty on all parts and labor.**

Headquarters Telex: 18-3511

TAVA  **CORP.**

Answer Back CSMA

(714) 730-6772

*DATA DRIVE, APPLETTTE 1, APPLETTTE 2, and TRUMP CARD are registered trademarks of TAVA Corporation, respectively.

*TEAC is a registered trademark of TEAC Corp.

*CP/M is a registered trademark of Digital Research, Inc.

Circle 341 on Inquiry card.

Item	Designation	Quantity	Description	You May Substitute
1	Board	1	Vector 8801-1 bare S-100 plugboard	10- by 5-inch perforated board (See table 1, March BYTE, page 311)
2	RAMS	32	MK 4116-3 16K-bit dynamic RAM	4 to 14.5 MHz (see text)
3	XTAL	1	14.5-MHz quartz crystal	LM340T-5.0
4	7805	1	5-V, 1-A positive voltage regulator (TO-220)	LM320T-5.0, 79M05, 79L05
5	7905	1	5-V, 1-A negative voltage regulator	LM340T-12
6	7812	1	12-V, 1-A positive voltage regulator	4.7 μ F tantalum
7		2	22- μ F, 25-V electrolytic capacitor	22 μ F tantalum
8		1	47- μ F, 25-V electrolytic capacitor	
9	Caps	40	0.1- μ F, 15-V ceramic capacitor	
10		1	150-pF ceramic capacitor	
11		2	33-pF ceramic capacitor	
12	Diodes	5	1N4001 50-V, 1-A silicon diode	1N4002, etc. Do not use 1N914
13	U9,U12	2	74S00 quad NAND gate	74LS00
14	U2	1	74LS00	7400
15	U15	1	74S04 hex inverter	*
16	U1	1	74S10 triple NAND gate	*
17	U36	1	74LS30 NAND gate	Any 74LSxx (see text)
18	U21	1	74S65 AND-OR-INVERT	7465, 7403, and 7422 (see text)
19	U3,U10	2	74S74 dual D-type flip-flop	74LS74
20	U13,U27	2	74LS74 dual D-type flip-flop	7474A
21	U20	1	74LS139 dual 1-to-4 decoder	*
22	U33	1	74LS151 1 of 8 multiplexers	74151
23	U4	1	74S175 4-bit D-type flip-flop with clear	*
24	U26	1	74LS240 octal line receiver	*
25	U19,U24	2	74LS373 octal D-type latch	25LS373 (74LS240, U19 only)
26	U17,U18,U25	3	74LS374 octal edge-triggered flip-flop	25LS374
27	U6,U11	2	74LS393 dual 4-bit counter	4x 74LS293, etc. Binary only
28	RP1	1	1 k Ω \times 13 14-pin resistor DIP	
29	RP2	1	4.7 k Ω \times 13 14-pin resistor DIP	
30		1	2 k Ω	
31		3	470 Ω	
32		14	33 Ω	} 1/4-watt 5-percent resistors
33		1	1 k Ω	
34		6	20-pin	
35		37	16-pin	} wire-wrap sockets
36		17	14-pin	
37		75	loose wire-wrap pins	
38			#30 wire-wrap wire	
39			#18 bell wire	
40			#18 inner-diameter Teflon sleeving	
41			solder	
42		2	4-inch length of 3/4-inch aluminum angle stock cut into 1- and 3-inch pieces (for heat sink)	

32	RAMs	\$55
60	sockets	30
	board	20
	ICs	20
	spare ICs	20
	crystal	5
	odds and ends	5
		<u>\$155</u>

* Indicates "do not substitute"

Table 4: Parts necessary to build the 4116-type memory.

bulbs yellow. Do not proceed until the power supplies are just right. You may bolt both positive regulators to the same heat sink, but be sure to isolate the case of the 7905, because it is at -5 V.

Next, mount the memory sockets, as shown in figure 6, by soldering AWG18 wire to all pins 16 (ground) in a grid. I formed the wire into a zigzag and slid bits of Teflon tubing down it. Then I could solder in a whole row at one time. Each pin 16 is connected to the next, horizontally and vertically, to form a low-impedance ground plane. Repeat the grid process on pins 1 and 8 separately. Use a buzzer or ohmmeter to

check for shorts between the three grids. Use sunlight to look for bad (rough, dull) solder joints. Remove bad solder, don't just reheat it.

The TTL-supply wiring is less critical. I supplied power to the TTL sockets by wiring a few wrap posts up with AWG18 copper wire, then connecting these to the sockets with AWG30 wire-wrap wire. The +5-V supply is wired as an address line, using a grid pattern. Again, check for shorts.

Copy the schematic diagram twice. Wire the address and data lines among the memory devices as shown in figure 4 (see part 1 in March 1983 BYTE, page 320). Notice how the ar-

ray works: almost all corresponding pins are just tied in parallel (i.e., all the pins 15 are hooked together). The exceptions are $\overline{RAS0}$ through $\overline{RAS3}$, and the data pins 2, 4, and 14. Each \overline{RAS} line runs across a bank of eight devices. Each data line (16 of them, in all) ties four pins together vertically. Do not tie together any pins with different numbers. On the first schematic copy, color each line you complete. Wire the TTL and resistors point to point, minimizing each line length (neat bundles of wire-wrap wire will just cause noise trouble). Do not connect the circuit to its regulators yet.

The clock is wired by soldering the

TAVA CORP. INTRODUCES THE TRUMP CARD[®], IBM[®] COMPATIBLE, FULLY POPULATED 256K RAM + SERIAL I/O + GAME I/O. \$499

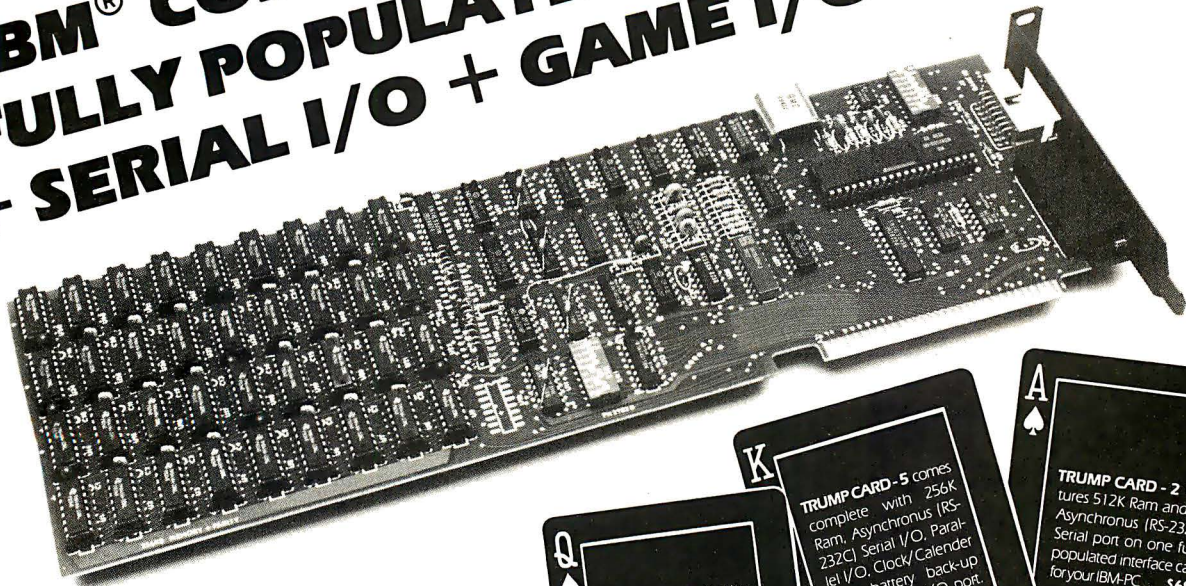

256K RAM

A 64K to 256K parity checking RAM is fully socketed for easy memory expansion. The memory address is switch selectable, using up only the required memory space.

GAME I/O

Interface consisting of two joy-sticks and four switch inputs are IBM BASIC compatible. A standard GAME I/O DB 15 connector provides connection to the rear plate of the IBM computer.

GOLD IBM INTERFACE

Gold connectors as well as glass epoxy PCB will provide years of reliable service, with all hardware interface meeting the IBM specification.

ASYNCHRONOUS COMMUNICATION

A RS232 and 20Ma (TTY) interface supports software programmable baud rates, parity, stop bits, and character. Modem and serial printer are fully supported by the IBM communication software. A standard DB25 connector allows for the easy connection to serial devices.



**Available At
CompuShack Stores
OUTSTANDING
QUALITY
AT AFFORDABLE
PRICES!**

For Further Information Contact:

Tava Corp.

2630 Walnut Ave., Suite G

Tustin, CA 92680

(714) 730-6772

Headquarters Telex: 18-3511

Answer Back CSMA

*TRUMP CARD is a registered trademark of TAVA Corporation

*IBM is a registered trademark of IBM Corporation

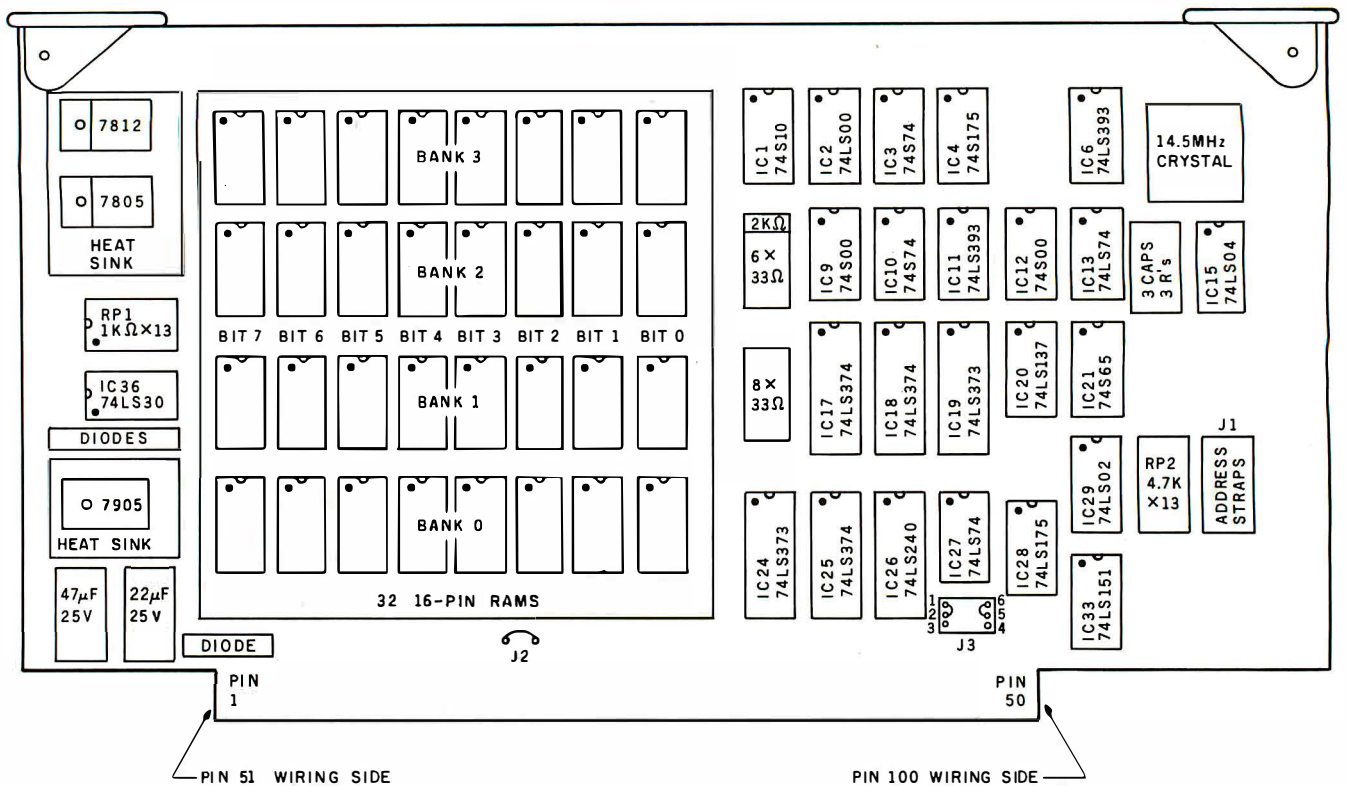

Figure 6: Layout of ICs on wire-wrap circuit card. Note that, in some places, resistors and capacitors are shown in IC-like blocks.

resistors and capacitors directly to the pins of the 74S04 socket, keeping leads short and using insulating sleeving. All the other resistors and all ICs but the regulators are in wire-wrap sockets. I made the jumper pads (J2 and J3) by splitting a gold socket with a razor saw.

Once you think you've wired the whole memory, inspect the colored copy carefully for missing color. Then, use an ohmmeter and the second copy to verify that all the connections are there. Inspect that copy, too, for missing color and then compare the two copies. Spot check the longer lines for shorts to other lines. All this checking pays off if you find one wiring error! Finally, inspect the whole job very carefully, in sunlight.

Now, connect the regulators to the circuit and use a meter to verify the supply voltages at each socket. You should check each bank of memories for extra voltages. After that, mount the 32 decoupling capacitors (0.1-microfarad [μf] ceramic) by soldering them to the pins of the memory sockets. Use a checkerboard arrangement, with a capacitor at

every other memory socket between pins 8 and 16. Then mount the second half of the capacitors on the sockets you skipped before, between pins 1 and 16. Then test the supplies again.

All the checking pays off if you find one wiring error.

Distribute the remaining 6 or 8 capacitors around the TTL power lines. Remember the TTL power pin assignment: highest numbered pin is +5 V, the pin with half that number is ground.

Debugging

Plug in all the TTL parts and resistors. Apply power to the board and watch it carefully, feeling all the parts for excessive heat. No LS (low-power Schottky) TTL parts should get noticeably warm, and nothing is supposed to get burning hot. If a regulator gets hot enough to burn you, you have a short or a part installed backwards. You can find a

bad TTL part by applying power to the board several times, adding one part each time, until you find the one drawing too much current. (TTL is reliable, but when one part dies, it usually shorts.) When all the regulators and the TTL seem right, turn off the board for a while and plug in a row of memory devices. Pick an address bank that is free in your machine's memory space. Don't install a jumper at J1 (8K block enables) yet. Apply power again and quickly measure the voltage at each pin of one memory device. They should run cool to the touch. When all seems well, your new memory has passed its "smoke test."

Install a jumper at J1 to enable half the addresses in the bank of memory. Using your computer's front panel, or machine-language monitor, try to read from and write to the new memory. There are three possibilities now: it looks good, it looks bad because the memory is not working, or it looks bad because the bus is incompatible. If it looks good, load your system software and run your toughest memory test program (see

IBM, APPLE and ATARI USERS

CompuShack announces



SOFTWARE FOR YOUR IBM PC

Continental - The Home Accountant	\$99.95
Datamost - Write On / Word Processor	\$109.95
Denver Software -	
Easy Effective Accounting System	\$599.00
ISM	
Mathmagic	\$79.00
Graphmagic	\$79.00
Infocom	
Zork I	\$29.95
Zork II	\$29.95
Deadline	\$39.95

Information Unlimited

Easy Filer	\$299.00
Easy Planner	\$159.00
Easy Speller	\$139.00
Easy Writer II	\$259.00

Micro Lab - Tax Manager

.....	\$199.00
-------	----------

Micro Pro

Wordstar	\$299.00
Mailmerge	\$99.00

Peechtree

General Ledger	\$499.00
Accounts Receivable	\$499.00
Accounts Payable	\$499.00

Sir Tech - Galactic Attack

.....	\$29.95
-------	---------

VisiCorp

256K Visicalc	\$199.00
Visitrend/Visiplot	\$259.00
Visidex	\$199.00
Visifiles	\$259.00

SOFTWARE FOR YOUR ATARI 400/800 PERSONAL COMPUTER

Asteroids	\$27.95
Centipede	\$35.95
Pac-Man	\$35.95
Blackjack	\$15.95
Caverns of Mars	\$32.95

APEX CASSETTES

Avalanche	\$19.95
Outlaw/Howitzer	\$19.95
747 Landing Simulator	\$19.95
Eastern Front	\$23.95
Dog Daze	\$19.95
Reversi II	\$19.95
Blockbuster	\$15.95
7-Card Stud	\$15.95
Downhill	\$19.95
Video Math Flash Cards	\$15.95
Letterman	\$19.95
Wordmaker	\$19.95
Cubbyholes	\$19.95

DISKETTES

Data Management System	\$19.95
Family Cash Flow	\$19.95
Family Budget	\$19.95
Advanced Music System	\$25.95
Eastern Front	\$25.95
Supersort	\$19.95
Insomnia	\$19.95

SOFTWARE FOR YOUR APPLE II + ART-SCI INC.

Magic Window	\$79.00
Magic Mailer	\$49.00
Magic Words	\$49.00
Magic Pak - Includes All Three	\$157.00
Magic Window II	\$119.00

ASHTON-TATE

Dbase II (Apple)	\$499.00
Dbase II (Apple 48K)	\$299.00

We Are The Systems Specialist

CONTINENTAL SOFTWARE

First Class Mail	\$59.95
CPA I General Ledger	\$199.00
CPA II Accounts Receivable	\$199.00
CPA III Accounts Payable	\$199.00
CPA IV Payroll	\$199.00
CPA V Property Management	\$399.00
The Home Accountant	\$59.95
The Home Accountant Plus	\$119.00

DAKIN 5 CORPORATION

Depreciation Planner	\$299.00
Budget Planner	\$119.00
Business Bookkeeping System	\$299.00

HAYDEN

Applesoft Compiler	\$159.00
--------------------------	----------

IMS

Graph Magic	\$69.95
Math Magic	\$69.95

LIGHTNING SOFTWARE

Master Type (Hi-Res)	\$29.95
----------------------------	---------

MICRO PRO

Word Star Customization Notes	\$299.00
Wordstar	\$199.00
Super Sort	\$129.00
Mail Merge	\$89.00
Data Star	\$199.00
Spell Star	\$129.00
Calc Star	\$129.00
Word Star Training Guide	\$19.95
Word Star Update	\$69.00

MICROSOFT

Time Manager	\$129.00
Fortran	\$159.00
A.L.D.S.	\$99.00
Basic Compiler	\$299.00
muMath/muSimp	\$185.00
COBOL	\$499.00
M/SORT	\$149.00
TASC	\$149.00
Multiplan (Native Apple)	\$199.00
Multiplan	\$199.00

SOFTWARE FOR YOUR APPLE II + ON-LINE SYSTEMS

Screen Writer II	\$99.00
The General Manager	\$119.00
The Dictionary	\$79.00
Speed-ASM	\$29.95
Expediter II	\$79.00
Memory Management II	\$39.00
Lisa 2.5	\$59.00
Lisa Educational System	\$79.00

PEECHTREE SOFTWARE

General Ledger	\$299.00
Accounts Receivable	\$299.00
Accounts Payable	\$299.00
Inventory	\$299.00
Payroll	\$299.00

Peachcalc Electronic Spreadsheet	\$289.00
--	----------

Telecommunications	\$289.00
Spelling Proof Reader	\$250.00
Mailing List Manager	\$289.00
Peachtext	\$350.00

SENSIBLE SOFTWARE

Back It Up	\$49.95
Disk Recovery	\$19.95
Disk Organizer II	\$19.95
Multidisk Catalog	\$17.95
Super Disk Copy	\$25.95
Sensible Speller	\$89.95
Sensible Speller Supertext	\$89.95

SOFTWARE PUBLISHING COMPANY

Personal Filing System	\$89.00
Personal Report System	\$65.00
Graph	\$79.00

SORCIM CORPORATION

Supercalc	\$215.00
-----------------	----------

STONEWARE

Stat Pac	\$69.00
D B Master	\$145.00
D B Utility Pack	\$69.00
D B Utility Pack II	\$69.00
Graphic Processing System Standard	\$49.00
Graphic Processing System Professional	\$69.00

SYSTEMS PLUS

General Ledger	\$249.00
GL/AR/AP	\$599.00
GL/AP/AR/Inventory	\$699.00

VISI CORP

Visifiles	\$189.00
Desktop Plan	\$189.00
Visiplot	\$149.00
Visidex	\$189.00
Visicalc 3.3	\$189.00
Visischedule	\$219.00
Business Forecasting Model	\$75.00
Visilink	\$189.00

COMPUShack

Business Home Computers

2630-H Walnut Avenue, Tustin, CA 92680
(714) 730-7207 Telex 18-3511 Ans Bck ESMA

Listing 2: *These loops exercise parts of the board for observation by oscilloscope. (See also photo 4a.) Remember to disable the chain not being tested.*

```

0000 21 06 00    LD HL,!      ; Reading test.
0003 11 80 7F    LD DE,RAM    ; Row=0s, col=1s
0006 1A        ! LD A,(DE)    ; Observe
0007 E9         JP (HL)

0006 12         LD (DE),A    ; Write test (same loop)
                        END

7F7D 21 80 7F    LD HL,7F80
7F80 E9         JP (HL)    ; Observe an op-code fetch
                        END ; Used for photo 4a

```

listing 1, on page 372). Run the test overnight. When you see no errors, celebrate and continue with the next section.

Alas, a swarm of potential bugs could plague your new card. Using the divide-and-conquer method, you can sort them into *bus* and *on-card* categories and chase them all down.

First, eliminate the most obvious bus problems. Dig out the schematics of your other cards to see if any of them are using pin 67 for anything but PHANTOM. If one is, remove the jumper at J2. Check the processor-board schematic to find out how it derives the status signals. The most common processor board will be a Z80 driving a few gates (probably 74LS02). For this board, connect by jumper pins 1 and 2 on J3, as well as pins 5 and 6. If your system is an 8080A, using an 8228 to derive sMEMR, place the read-status jumper on pins 2 and 3 of J3. If your system is an 8080 with no 8228 or a Z80 inside a spiderweb of gates and one-shots (monostable multivibrators), try moving the other jumper also.

In the worst case, you may have to figure out what the status lines from your particular processor really do and use them to set the three request flags via some special circuit. (I will be glad to help readers who send all the details of their problems, along with a self-addressed, stamped envelope.) Most non-8080 processors have a lot of trouble generating pSYNC, so you might look there first. Some processors generate the S-100 clocks with one-shots, also suspects.

If you have the Z80 version and the card doesn't work, the bug is probably on the card. I debugged the prototype with only a computer, a 5-MHz oscilloscope, and a logic probe. Starting with a valid schematic means you can probably find your manufacturing problem with just a probe.

As you can see in figure 3 (March BYTE, page 318), all activity on the card propagates down two chains: *refresh* and *memory*. The chains share the cycle generator, its clock, power, and the memory devices themselves. Because the refresh chain runs (when all is well) by itself, it's easiest to check first. If your probe can't detect a 25-nanosecond (ns) pulse, hook up a Schottky one-shot on a breadboard for these tests. Check the refresh chain with no other cards plugged into the S-100 bus.

Check to see if the clock is running. If it's not, try a 74LS04 in the socket. The clock ripples through the timer and sets the refresh-request flag (IC13, pin 5). Check whether the flag is stuck and whether the pulse gets to IC4, pin 4 (ANY REQ). IC4 should cycle, clearing the flag again. This logic is self-clearing for any initial state, so any stuck flag reveals a defect. IC4 will cycle every 10 microseconds (μ s). Refresh cycles make pulses on IC3, pins 2 through 6, that reach IC20 (address selector) and IC19. IC11 counts, producing long square waves (down to 1 kHz). If any of this isn't happening, the break in the chain pinpoints the trouble.

Because the TTL is static logic, you can run it very slowly. (I first ran the

board at 1 Hz to check the gross logic design.) CK5 will still be 20 ns to 40 ns long, however. You can therefore root out a total failure using LEDs (light-emitting diodes). Some devices (the "untested" or "hobby-grade" ones), though, fail only their AC timing tests, and they'll seem to work at low speeds.

The memory-cycle chain is more complex, but its shared parts have been tested already. The easiest part to check is the read-buffer latch (IC24) and its interface. Unplug the memories. Stick a 470-ohm resistor in each of eight memory sockets between pin 14 and either pin 16 (logic 0) or pin 9 (logic 1), and try to read the test pattern formed by using your monitor. If you can't read the proper pattern, lift pin 11 of IC12 and try again. This test checks the path through J1, MADDR, TALK, and the output latch. If lifting pin 11 of IC12 makes it work, you have trouble around the CAS gate.

To check the write logic, probe memory pin 3 as you write with your monitor. There should be one pulse per write. (Be sure J1 is properly connected by jumper for this test.) The chain from MWRT to pin 3 is simple. The write-request flag must be free to change state.

If you have an oscilloscope, it's easy to follow pulses through both chains. You can check the signal at various points by lifting one of the request-flag pins and exercising the board with a tight software loop as you observe the other chain (see listing 2). Remember that extra activity is as bad as no activity. CAS should stay high during refresh cycles. WR (write) should stay high during reads. CK5 should never be low for more than 50 ns; it may be hard to see, but it can trigger a 74LS74 clock.

Before giving up, have a friend double-check the board for you. Some people can check the same error a dozen times and never see it. Perhaps the information in listing 1 and photos 4a and 4b on page 370 can be used to some advantage.

Think Big

In part 1 of this article, I mentioned

XEROX

Okay. Tell me how I can replace my impact printer with the Xerox 2700 and get speedy printing, too.

Name/Title _____

Company _____

Street _____

City _____ State _____

Zip _____ Tel. (____) _____

Mail to: Keith Davidson, Xerox Printing Systems Group, 880 Apollo Street, El Segundo, CA 90245. Or call (213) 615-6329.

Okay. Tell me how I can replace my line printer with the Xerox 2700 and get letter-quality printing, too.

Name/Title _____

Company _____

Street _____

City _____ State _____

Zip _____ Tel. (____) _____

Mail to: Keith Davidson, Xerox Printing Systems Group, 880 Apollo Street, El Segundo, CA 90245. Or call (213) 615-6329.

There are two ways to look at the Xerox 2700.

The first is as a letter-quality printer. The second is as a speed printer.

That's because the Xerox 2700 distributed electronic printer actually functions as both.

But in a very creative way. You see, it doesn't limit you to typical word processor and data processor type styles.

It lets you choose from a wide variety of font sizes, designs, styles and weights. And it lets you change them, even within a single line, if you want.

It also lets you print logos and signatures, actually format a page with headings and subheadings, and create simple forms or bar charts.

So your documents end up with a customized, print-shop look.

And the people you send them to end up getting them at a handy 12 pages per minute.

But what's nicer is, the Xerox 2700 is very small. And very quiet. So you can place it exactly where it's most convenient for the people who need it.

Terrific, you may be thinking, but what does this amazingly flexible, high-quality electronic printer cost?

Not at all what you'd expect.

To find out, just mail in one of our coupons.

Either one will bring you a very pleasant surprise.



Introducing GENIE™

5-10-15-20

Megabyte 5.25" GENIE Winchester Drives

I.B.M. • APPLE II PLUS • RADIO SHACK

5 MEGABYTES
\$ **2295**⁰⁰

10 MEGABYTES
\$ **2595**⁰⁰

15 MEGABYTES
\$ **2895**⁰⁰

20 MEGABYTES
\$ **3195**⁰⁰



Talk about user friendly...

Comprehensive system utilities package.

Allows eight-character names to be assigned to virtual volumes.

User can back-up to either our 5 + 5™ removable Cartridge Drive or to diskettes.

Mix & match different system file types on the same disk.

System status screen messages.

Up to 16 volumes on-line at a time.

Excellence in Engineering

Genie Drives were built with the user in mind. A design backed by many years of experience, the Genie Drive is everything a user ever wanted in a hard disk. We offer the **ultimate** in hard disk mass storage systems that money can buy.

FEATURES

- Precision Manganese-zinc heads
- Average access time 77 ms.
- File sizes 5-20 megabytes
- Power-on self test
- Built-in error detection and correction
- System expandable to eight drives
- Comes complete with all necessary software and hardware
- No preventative maintenance required
- Built-in fan
- Operates 110/220 VAC 50-60 Hz
- One year warranty

IBM	APPLE II PLUS	RADIO SHACK
<ul style="list-style-type: none"> • Supports IBM-DOS, CP/M-86, PASCAL 	<ul style="list-style-type: none"> • Supports DOS 3.3, CP/M, and PASCAL 	<p><i>available soon</i></p>
<ul style="list-style-type: none"> • Ultra High Speed DMA data transfers • Only uses one slot in your IBM-PC • Allows you to run with up to four floppy disk drives 	<ul style="list-style-type: none"> • Boot from Hard Disk • Can assign Hard Disk volume to any slot or drive number in the system 	<p>S-100</p> <p><i>available soon</i></p>

*Manufacturer's suggested retail price. Includes all required components. IBM DOS Personal Computer is a registered trademark of IBM Corporation. Apple is a registered trademark of Apple Computer, Inc. Radio Shack is a registered trademark of Tandy Corporation. CP/M and CP/M-86 are registered trademarks of Digital Research.

Available at your local computer dealer

GENIE COMPUTER CORPORATION

31125 Via Colinas #908 • Westlake Village, CA 91362 • (213) 991-6210

Introducing

GENIE™

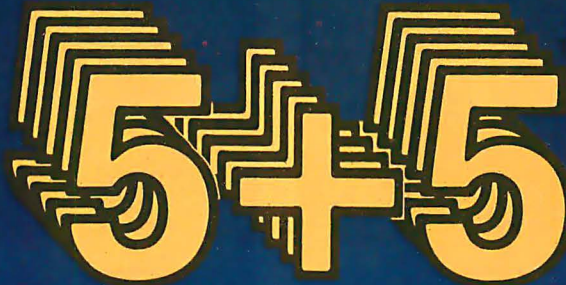

5.25" Removable GENIE Winchester Cartridge Drive IBM • APPLE II PLUS • RADIO SHACK • S-100

The **Genie Cartridge Drive** is a revolutionary new 10 Megabyte Hard Disk Drive that includes a 5 Megabyte removable Winchester cartridge. The cartridge Drive system simply plugs into your computer, and includes all necessary software and hardware. Genie Drives are compatible with most popular software, and each cartridge replaces over 30 double-density floppy disks.



FEATURES

- 10 Megabytes of on-line storage.
- File sizes to 5 Megabytes.
- Power-on self-test.
- Easy back-ups in minutes.
- System expandable to eight drives.
- Built-in error detection and correction.
- No preventative maintenance required.
- Comes complete with all necessary software and hardware.
- MTBF 8000 Hours.
- Built-in fan.
- Operates 110/220 VAC 50-60 Hz.
- One year limited warranty.

Only **\$3995⁰⁰***

GENIE COMPUTER CORPORATION

31125 Via Colinas #908 • Westlake Village, CA 91362 • (213) 991-6210

Circle 177 on inquiry card.

Removable Cartridge. Imagine, 5 Megabytes in the palm of your hand. These small Winchester cartridges are only .75 inches thick and 5.50 inches square. The disk itself is completely sealed from the outside and all its hazards by a sliding door that opens only once the cartridge is firmly seated inside the drive. Long term availability of this cartridge is assured by its adoption by several well known manufacturers including Dysan and Memorex, the world leaders in computer mass storage media.

Talk about user friendly •••

Comprehensive system utilities package. Allows eight-character names to be assigned to virtual volumes. User Can back-up to any Genie REMOVABLE Cartridge Drive, or to diskettes. Mix & Match different system file types on the same disk. System status screen messages. Up to 16 volumes on-line at a time.

Available at your local computer dealer

Manufacturer's suggested retail price. Includes all required components. Concurrent CP/M-86 is a registered trade mark of Digital Research. IBM Personal Computer is a registered trademark of IBM Corporation. Apple is a registered trademark of Apple Computer, Inc. Radio Shack is a registered trademark of Tandy Corporation. Dysan is a registered trademark of Dysan Corp.

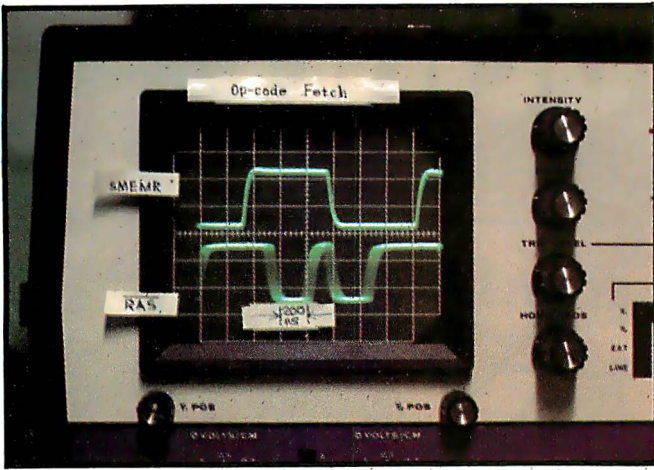

Photo 4a: The Z80 clock runs at 3.58 MHz, and the memory clock at 14.5 MHz. An op-code fetch (a short Read with M1 high) sets two request flags. The first \overline{RAS} pulse is the actual op code being fetched, and the one on its heels is a "hidden refresh." The time elapsed for each vertical line on the scope face is 200 ns. The horizontal smear on \overline{RAS} is the 69-ns latency time of the cycle generator.

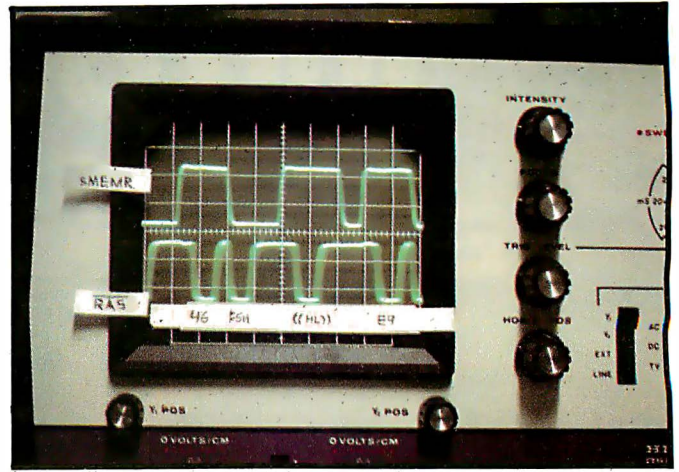

Photo 4b: This is a "scope loop," like those in listing 2. The first sMEMR (high-going pulse) fetches an indirect-read instruction (B-(HL)). The next sMEMR carries out the instruction. Because HL points to the instructions location, we have two kinds of read from the same location. The single \overline{RAS} in the middle is the data read. Finally, an E9 hexadecimal (jump to (HL)) is fetched, restarting the loop.

that this card may be expanded to cover a larger address space and to support write protection and overlaid-page selection (sometimes called *paging* or *multiuser*). I have described in detail a 64K-byte memory, but for simplicity's sake the schematic (see figure 4 in part 1 in the March 1983 BYTE, page 320) doesn't show any upgrade options. The fancy addressing additions will fit on the card if you pack the circuit as tightly as I did, but each user's requirements will be different.

On the other hand, the upgrade to denser memory devices is easy. The 4164 is a 64K-by 1-bit dynamic memory device whose pins are almost the same as the 4116's. There is one more address pin (9), and there's only a +5-V supply. Here's how to use the 4164s:

1. Get the board working with 4116s first!
2. Remove the 4116s, the 7812, and the 7905 and its diodes. Replace the 7812 with another 7805. Mount a 1k-ohm resistor between pin 8 and pin 1 of any memory device.
3. Remove any capacitors from pin 9 of the memory grid that used to be the +5-V supply. Connect the pin-9 grid to the two dangling resistors marked by a star on figure 4). Make sure the +5

voltage is no longer present on any pin 9.

4. Move the two wires now on S-100-bus pins 32 and 86 to pins 16 and 17, respectively. Each 8K-byte jumper now represents one 32K-byte block (for a total of 256K bytes).
5. Install the 4164s. Run your toughest memory test. The early version of the 4164 sometimes suffered a high error rate due to internal radioactivity, but this problem has been solved.

As for the other upgrades, you can easily change the 2-bit bank-select latch (IC2) into an output port and control it via software. Be sure to install only two jumpers on J1, or the same 16K-byte block will appear all over your address space.

To build a PC board that will provide write protection for 8K-byte blocks, change the input of the write-request flag (IC13, pin 12) from MADDR to the output of another multiplexer, controlled by a port instead of jumper straps. The port will then control the write enable to each 8K-byte block. It should be cleared by a power-up reset.

Large-Scale Integration

The 4116 contains more than

20,000 transistors. Why, then, can't we find an equally complex IC to replace all that TTL? The manufacturers offer some dynamic RAM (random-access read/write memory) controllers and other support parts now (error-correction devices, line drivers, etc.), but most are still unavailable on the hobby market. The older ones, Motorola 3242 and Intel 8202, provide only a 7-bit address path with no latches in it. These parts do not support the 4164, which is now the preferred device for new designs. Some new parts, now in volume production, are National's DP8409, TI's TMS4500A, Intel's 8203 and 8207, and AMD's Am2964B. These devices support the 4164.

During the time this article was in production, my associates at Video Concepts of Maryland (4401 East-West Highway, Suite 408, Chevy Chase, MD 20014) have developed my hobby project into a commercial-quality printed-circuit board. They have added addressing accessories that support most of the de facto standard operating systems used in S-100 machines. The card easily accommodates 4116s, 4164s, or the newly available 41256s (you guessed it: 256K bits in one 16-pin package!), and it uses the Am2964B to save about half the small TTL devices shown in this article. ■

MICRO

BUSINESS WORLD INC.
Information Line (213) 996-2252
TOLL FREE MAIL ORDER LINES
(800) 423-5886 Outside Calif.



IBM SPECIAL OF THE MONTH IBM

DISK DRIVES FOR THE PC
DOUBLE SIDED/DOUBLE DENSITY 320K

MSL
\$650.00

OUR ONE YEAR WARRANTY
PRICE **\$239.00**

APPLE II PLUS

PLUG-COMPATIBLE DRIVES
RANA ELITE I

W/CONTROLLER	MSL	OUR PRICE	W/OUT CONTROLLER	MSL	OUR PRICE
	549.00	399.00		449.00	329.00

IBM PERSONAL COMPUTER

INCLUDES:
2 Drives DS/DD
Color Graphic Board
64K Memory
12" BMC GRN PHS

MSL **3550.00** OUR PRICE **\$2,995.00** Save **555.00**

*Subject to availability

NEW! APPLE IIE*

CALL FOR PRICE

*Subject to availability

SYSCOM — THE APPLE II

APPLE II **1430.00** OUR PRICE **849.00**

WORK ALIKE W64 K AND COLOR SYSCOM II

THE APPLE COMPATIBLE ALTERNATIVE FRANKLIN BUSINESS SYSTEM

Franklin Ace 1000 system • 64K • Disk Drive with controller card • green phs. video monitor.
Available In Store Only

\$1395.00

SAVE \$1000 COMPARED TO APPLE SYSTEM

ALTOS 8 BIT SYSTEMS

Z80-BASED MULTIUSER WINCHESTER HARD DISK AND FLOPPY SYSTEMS INCLUDES MP/M II OPERATING SYSTEM

Model No.	No. of Floppy Disks	Floppy Disk Storage	Suggested List Price	Our Price
Series 5-15D	2	2 Mb	\$2,990	\$2,449.00
Series 5-5D	1	1 Mb	\$5,490	\$4,288.00
580-10	1	1 Mb	\$6,490	\$5,422.00

Base Price:	ALTOS 5-150	APPLE III
	\$2990	\$2995
Disk Drives:	2	1; add 1 @ \$450
Capacity:	2M bytes	320K bytes (for both)
Video:	User Opt. CRT	Monitor included
Terminal Cost:	\$800 average	Monitor included
Operating Syst.:	MPM included	Apple POS
CP/M MP/M:	MPM included	CP/M @ \$465
Oasis DOS:	available	not available

I/O Port	RAM	Processor:	Computer	Grade:	Dot Matrix	Printer	TOTAL
3 ser., 1 parallel	192 K	Z80A	Industrial	User Opt.	@ \$600	@ \$600	\$4390*
1 ser., 1 par.	128K	6502A	Standard	User Opt.	@ \$600	@ \$600	\$4675*

RADIO SHACK TRS 80 MOD III

w/48K 2 DRIVE RS232

OUR PRICE \$1733.00

OSBORNE PERSONAL COMPUTER

DOUBLE DENSITY INCLUDES SOFTWARE

- CPM
- MAIL MERGE
- WORDSTAR
- CB BASIC
- SUPERCALC
- M BASIC

OUR PRICE 1795.00

APPLE PERSONAL COMPUTER PERIPHERALS AND SOFTWARE

HARDWARE	MSL	Our Price
Videx Combo Package	375.00	259.00
Videx Videoterm Card	345.00	239.00
Videx Keyboard Enhancer II	149.00	115.00
Microsoft Softcard with CP/M	345.00	235.00
Microsoft Premium Pak	695.00	499.00
Microsoft 16K Card	99.95	72.50
PCP Appl I - Card (4 MHz version)	445.00	339.00
PCP Appl I - Card (6 MHz version)	595.00	449.00
Corvus Winchester 5MB	2,495.00	1,949.00
Corvus Winchester 10MB	3,495.00	2,449.00
Corvus Winchester 20MB	4,495.00	3,399.00
Saturn Systems 32K	249.00	165.00
Saturn Systems 64K	425.00	312.00
Saturn Systems 128K	599.00	452.00
Hays Micromodem II	379.00	285.00
Hays Smartmodem	279.00	225.00
Kensington System Saver	90.00	68.00
M & R RF Modulator	30.00	22.00
M & R Super Fan	50.00	37.00
Grappler +	175.00	135.00
Practical Peripherals Microbuffer II 16K	259.00	225.00
Practical Peripherals Microbuffer II 32K	299.00	239.00
Prometheus Versa Card	199.00	149.00
SVA Disk 2 + 2 Controller DSSD	395.00	335.00
SVA Disk 2 + 2 Controller DSSD	595.00	489.00
SVA App-L Cache 256 K Memory	1,200.00	1,049.00
TG Joystick	59.95	42.00
TG Select-A-Port	59.95	42.00
Wesper Micro Wizard 80	249.00	179.00
Wesper Micro BPO 15K	219.00	139.00
Wesper Micro SOB 32K	249.00	159.00
Wesper Micro SOB 16K	219.00	149.00
Wesper Micro SOB 32K	219.00	149.00
BMC 1401 w/RGB Interface	595.00	319.00
ALS Z Card w/CPM for Apple II	349.00	209.00

IBM PERSONAL COMPUTER PERIPHERALS & SOFTWARE

HARDWARE	MSL	Our Price
QUADRAM Quadboard, 4 function brd with 64 K	595.00	489.00
with 256 K	995.00	699.00
Quad Color II With 640x240 Resolution	575.00	459.00
Quad Color III With 640x400 Resolution	850.00	669.00
Printer Card w/cable(parallel)	159.00	109.00
Printer Card w/cable(serial)	179.00	139.00
Davong Hard Disks		CALL

IBM SOFTWARE

Software	MSL	Our Price
Zork I by Infocom	39.95	28.50
Zork II by Infocom	39.95	28.50
Zork III by Infocom	39.95	28.50
Snooper Troops #1 by Spinnaker	44.95	33.50
Snooper Troops #2 by Spinnaker	44.95	33.50
Deadline by Infocom	49.95	37.50
Flight Simulator by Microsoft	49.95	37.50
Starcross by Infocom	39.95	28.50
Story Machine by Spinnaker	34.95	26.50
The Home Accountant by Continental	150.00	111.00
VisiCalc by VisiCorp	250.00	189.00
Wordstar by Micropro	415.00	369.00
The Tax Manager by Microlab	250.00	189.00
VisiFile by VisiCorp	300.00	229.00
Supercalc by Sorcim	295.00	229.00
dBase II by Ashton Tate	700.00	489.00
Personal Investor by PBL	145.00	119.00

hp HEWLETT PACKARD

HANDHELD CALCULATORS AND COMPUTERS*

Model	MSL	Our Price
HP-10C Slim-Line Prog Scientific	80.00	64.00
HP-11C Slim-Line Adv Prog Sci	100.00	79.00
HP-12C Slim-Line Adv Finan Prog	150.00	129.00
HP-15C Slim-Line Advanced Programmable Scientific w/Matrices	135.00	119.00
HP-15C Slim-Line Prog for Digital Electronics and Comput Science	150.00	129.00
HP-41CV Handheld Comp with 5K Memory	275.00	209.00
HP-97 Desktop Fully Prog Print Card Reader for 41CV/C	750.00	599.00
Printer for 41CV/C	215.00	162.00
Printer for 41CVC	385.00	289.00
Optical Wand for 41 CVC	125.00	97.00
Quad Ram Equals 4 Mem. Mods	95.00	81.00

PRINTERS

Printer	MSL	Our Price
EPSON Epson MX 80 T Type III*	645.00	CALL
Epson MX-80F/T Type III*	745.00	CALL
Epson MX-100 Type III*	995.00	CALL
*w/graphics		
OKI/Ota Okidata 82A w/tractor 80 col	549.00	409.00
Okidata 83A W/tractor 132 col	899.00	709.00
Okidata 84P 132 col. serial	1395.00	1019.00
Okidata 84S 132 col. parallel	1495.00	1177.00
C. Itoh C. Itoh F 1040 cps (parallel)	1795.00	1377.00
C. Itoh F 10 40 cps (serial)	1895.00	1439.00
C. Itoh Prowriter (parallel)	695.00	519.00
C. Itoh Prowriter (serial)	749.00	565.00
SMITH CORONA TP-1 Letter Quality Tractors	895.00	599.00
STAR MICRONIC Gemini 10	150.00	139.00
	495.00	379.00

S-100 PRODUCTS
ALL BOARDS ASSEMBLED & TESTED!

Product	MSL	Our Price
CALIFORNIA COMPUTER SYSTEMS Z 80 CPU	325.00	259.00
Disk Controller/CPM 2.2	425.00	339.00
64K Static RAM (200 ns)	750.00	549.00
Mainframe 110/60 HZ or 220V/50HZ	575.00	475.00
2 Serial Port+2 Parallel	360.00	289.00
CP/M 2.2	150.00	119.00

SOFTWARE

Software	MSL	Our Price
CHDFLIFTER by Broderband	34.95	26.20
Frogger by Sierra On-Line	34.95	26.20
Canyon Climber by Datasoft	29.95	22.50
Wizardry by Sir-Tech	49.95	37.50
Zork by Infocom	39.95	29.95
Snooper Troops #1 by Spinnaker	44.95	33.75
Deadline by Infocom	49.95	37.50
Apple Panie by Broderband	29.95	22.50
Master Type by Lightning	39.95	29.95
Typing Tutor II by Microsoft	24.95	18.75
Story Machine by Spinnaker	34.95	29.95
The Home Accountant by Continental	74.95	56.50
PFS: File by Software Publishing	175.00	131.25
VisiCalc by VisiCorp	250.00	189.00
PFS: Report by Software Publishing	95.00	71.25
Screenwriter II by Sierra On-Line	129.95	97.50

MONITORS

Model	List Price	Our Price
BMC 12" Grn. Phs KQ 12 EU	249.00	179.00
12" Grn. Phs EO 1200SU	219.00	149.00
NC		
JB 12" Green	249.00	175.00
JC 12" Color	495.00	345.00
USI		
PI-2 12" Green	249.00	155.00
PI-3 12" Amber	289.00	185.00
AMDEK		
300 12" Green	195.00	145.00
Color I	395.00	325.00
Color II RGB Highres	895.00	695.00
ELECTRONHE		
ECM 1302 113" RGB Hires	595.00	395.00
ECM 1302 213" RGB Hires	895.00	595.00
Color Board for Apple II	249.00	195.00

MICRO BUSINESS WORLD MAIL ORDER WAREHOUSE
18720 Oxnard, #108 Tarzana, CA 91356

W. reserve the right to correct typographical errors. This ad supersedes all previous ads. Prices subject to change without notice.

*California residents add 6 1/2% sales tax.
**Add 3% Shipping & Handling — Add 3% surcharge for credit cards. Order cannot be shipped unless accompanied by payment, including shipping, handling and tax where applicable.

TOTAL ORDER \$
TAX IF APPLICABLE*
SHIPPING & HANDLING**
TOTAL ENCLOSED \$

Name (Please print): _____
Address: _____
City: _____ State: _____ Zip: _____

Qty	Make	Model	Description	Price	Total

Certified Check or M.O. Allow 2 weeks clearance for personal check
Bank Wire Transfer

CREDIT CARD # _____ Exp Date _____ Signature _____

VISA **MasterCard**

BMC • CENTRONIC • NEC • HAZELTINE • AMPLEX • VERBATIM • HITACHI • HAYDEN • CANON • NOVATION • D.C. HAYS MICROCOMPUTERS • PAPER TIGER • PERSONAL SOFTWARE • GTE

HP • D.C. HAYS MICROCOMPUTERS • PAPER TIGER • GTE • DIABLO • BMC • CENTRONIC • NEC • HAZELTINE • MEMOREX • AMPLEX • PERSONAL SOFTWARE • ADDS • XEROX • DIABLO

Listing 1: Use this program to convince yourself the card is really working. The program writes a test pattern, waits 5 seconds (to test refresh), checks the pattern, and inverts the pattern. After two passes, the main loop has tested each cell with a 0 and a 1. The program calls monitor routines for I/O, as described in the equates at the top. You will have to fill in the addresses for your monitor. It prompts for the limits of memory in order to test and for a character in order to flag continuous or once-through operations.

A counter is maintained for each 4116. The low byte counts errors, and the high byte records the error pattern. The counter dump forms a map of the board (front view), so that you can see a bad device easily. A dump of all 0s says all is well.

The column buffer register isn't exercised by the test. To check it, use your monitor to write at 1000 hexadecimal. Check that the byte you wrote doesn't appear at addresses 1080, 1100, 1200, . . . , 3000 hexadecimal. An open or stuck bit would cause the same byte to appear at two locations.

```

;          CONFIDENCE          by Cam Spitzer
;                               and Phil Perucci
;
; This program will count errors in an expanse of RAM.
; It requires external I/O routines for 16 bit numbers, and for ASCII.
; A single pass will count ALL errors, and once there are no hard
; errors, the continuous mode will accumulate soft errors.
;
; Stuck RAM address lines will appear as large chunks of errors.
; The column address buffer register, and address lines A7-A15 are not
; tested.
;
; Fill in the locations of your monitor routines:
;
F2E4      SP16IN EQU    0F2E4H  Type a space, then get a number into HL.
F317      OUT16 EQU    0F317H  Type out value in HL.
F355      ASCOUT EQU    0F355H  Type A out as ASCII.
F361      ASCI  EQU    0F361H  Get an ASCII character into A.
F015      CRLF  EQU    0F015H  Type carriage return, line feed.
F081      YERMON EQU    0F081H  Graceful monitor re-entry point.
;
0093      TIX   EQU    93H     Data retention time constant (about 5 sec.)
;
; The test resides in 1K of known good RAM, beginning at SAFE.
;
0000      SAFE EQU    0000
;
0000      ORG   SAFE
;
0000 00   TIMES DB    0       Single or running test.
0001      ERRS DS    64       Bit error count, (32 words)
;                               low byte counts errors. High byte records
;                               error bit pattern. (ERRS) refers to Bank 0,
;                               bit 0. (ERRS+63) refers to Bank 3, bit 7.
;
0041 00 00 WASTE DW    0
0043 00 00 STRMUD DW    0       Start of MUD. (Memory Under Debug.)
0045 00 00 ENDMUD DW    0
;
03FD      STAK EQU    SAFE+3FDH
;
0047 31 FD 03 BEGIN LD    SP,STAK
004A 3E 40      LD    A,"a"
004C CD 6E 00   CALL  ASCO      Prompt for lower test limit.
004F CD E4 F2   CALL  SP16IN
0052 22 43 00   LD    (STRMUD),HL  Save lower limit.
0055 3E 3B      LD    A,";"
0057 CD 6E 00   CALL  ASCO      Prompt for end of supposed RAM.
005A CD E4 F2   CALL  SP16IN
005D 22 45 00   LD    (ENDMUD),HL  Upper limit.
0060 3E 5B      LD    A,"x"
0062 CD 6E 00   CALL  ASCO
0065 CD 61 F3   CALL  ASCI
0068 32 00 00   LD    (TIMES),A    Continuous test?
;
006B C3 78 00   JP    GENTP
;
006E C3 55 F3   ASCO  JP    ASCOUT  Eases relocation for you.
;
007A      ORG   78H
;
; Loop to write a test pattern:
;
0078 ED 5B 43 00 GENTP LD    DE,(STRMUD)
007C 0E 00      LD    C,00H      Positive mask. (Neg. = FFH)
007E 78        ONETP LD    A,E
007F A9        XOR   C
0080 12        LD    (DE),A    The positive test pattern is simply
;                               the low byte of the address.
;
0081 CD CD 00   CALL  CPDEHL
0084 2B 03      JR    Z,TPISIN

```

Listing 1 continued on page 376

Powerful CP/M Software.

For Apple, Osborne, Xerox, Kaypro, North Star, SuperBrain, Heath/Zenith, and others.

Now only **\$29.95** each!

NEVADA

COBOL

was \$199.95 now only **\$29.95.**

When we introduced Nevada COBOL in 1979, it was loaded with innovations. Today's Edition 2 is even better!

- Extremely Compact. You can compile and execute up to 2500 statements in 32K RAM, 4000 statements in 48K, etc.
- It's based upon the ANSI-74 standards with level 2 features such as compound conditionals and full CALL CANCEL.
- You can distribute your object programs royalty FREE!
- You get a diskette, 153-page manual with lots of examples and 16 complete COBOL source code programs.

Also available: COBOL Application Packages, Book 1 \$9.95

NEVADA

PILOT

was \$149.95 now only **\$29.95.**

- Perfect for industrial training, office training, drill and testing, virtually all programmed instruction, word puzzle games, and data entry facilitated by prompts.
- John Starkweather, Ph.D., the inventor of the PILOT language, has added many new features to Nevada PILOT. There are commands to drive optional equipment such as Video Tape Recorders. There's a built-in full-screen text editor, and much more.
- Meets all PILOT-73 standards for full compatibility with older versions.
- You get a diskette, 114-page manual and ten useful sample programs.
- See Review in *Microcomputing*, January 1983, page 158.

NEVADA

FORTRAN

was \$199.95 now only **\$29.95.**

- Based on ANSI-66 standards with some 1977 level features.
- IF . . THEN . . ELSE constructs.
- A very nice TRACE style debugging.
- 150 English language error messages.
- You get a diskette, 174 pages of Documentation and five sample programs. Requires 48K RAM.

NEVADA

EDIT

was \$119.95 now only **\$29.95.**

- High quality text editing for micros!
- A character-oriented full-screen video display text editor designed specifically to create COBOL, BASIC and FORTRAN programs.
- Completely customizable tab stops, default file type, keyboard control key layout and CRT by menu selection.
- The diskette comes with an easy to read manual.

To make our software available to even more micro users, we've slashed our prices. What's more, we're offering a money back guarantee. If for any reason you're not completely satisfied, just return the package—in good condition with the sealed diskette unopened—within 30 days and we'll refund your money completely.

This is a limited time offer, so order yours today!

Shipping/handling fees. Add \$4.00 for first package and \$2.00 each additional package. OVERSEAS Add \$15.00 for first package and \$5.00 each additional package. Checks must be in U.S. funds and drawn on a U.S. bank!

Trademarks: CP/M, Digital Research; TRS-80, Tandy Corp.; TeleVideo, TeleVideo Systems, Inc.; Apple II, Apple Computer Inc.; Osborne 1, Osborne Computer Corp.; Xerox 820, Xerox Corp.; Kaypro, Non-Linear Sys.; Heath/Zenith, Heath Co.; IBM, International Business Machine, Corp. © 1983 Ellis Computing.

MAIL TODAY! To: Ellis Computing
3917 Noriega St.
San Francisco, CA 94122
(415) 753-0186



ELLIS COMPUTING

The CP/M-80 Operating Systems and 32K RAM are required.

Indicate diskette format:

- 8" SSSD (Standard IBM 3740 format)
- 5¼" Apple CP/M Osborne
- North Star DD North Star SD
- TRS-80 Mod I (4200 hex) TRS-80 Mod I/Mapper
- Heath, Hard Sector Heath, Soft Sector
- Micropolis Mod II Superbrain DD DOS 3.X (512 byte sectors)
- Xerox 820 (Kaypro) TeleVideo

Indicate software packages: COBOL PILOT
 FORTRAN EDIT

Send my order for _____ packages @ \$29.95 each Total _____
COBOL Applications Package @ \$9.95 each Total _____

Check enclosed In CA add sales tax _____
 MasterCard VISA Shipping/handling _____
_____ Exp. Date _____
TOTAL _____

Signature _____
Ship to: _____
Name _____
Street _____
City/St/Zip _____
Country _____

Dial A Deal with Palomar!



Call us toll-free and discover big, big savings! Depend on Palomar for great backup, too. (1) Expert technical advice. (2) Fast response on orders. (3) In-house service repairs. (4) Guaranteed satisfaction.



APPLE SYSTEMS SPECIAL

Apple-Compatible 48K Computer with Super 5 Disk Drive and Controller, BMC 12" Green Screen Monitor ... **NOW—\$1,255⁰⁰**

Same system with a 64K Franklin Ace 1000 \$1525.00
Same system with a 48K Apple II e \$1595.00

IBM

HARDWARE

IBM PC	CALL	Corona 10MB Winchester	CALL
Amdek Color II RGB Monitor	799.00	M & R SuperMod/5	59.00
Amdek 3" Dual Disk Drive	785.00	Micro Buffer In Line, (32K)	259.00
BMC 12" Green Monitor	149.00	MPI 320K Drive	299.00
BMC Color Composite Monitor		PGS Hi-Res RGB 12" Monitor	759.00
with Sound	399.00	PMC Disk Drive	199.00
BMC Hi-Res RGB Monitor	759.00	Ram Plus Quad Board	449.00
Computer Peripherals 64K Ram	199.00	Tandon TM 100-1 Disk Drive	219.00
Computer Peripherals 128K Ram	375.00	Tandon TM 100-2 Disk Drive	299.00
Computer Peripherals I/O Printer Interface (4 Ports)	159.00	TG Joysticks	49.00
Computer Peripherals 64 I/O Memory Card	299.00	TG Trak Ball	55.00
Computer Peripherals Octopus Printer Buffer	165.00	Tech Adam & Eve Paddles	29.00
Corona 5MB Winchester	CALL	64K RAM Card	199.00
		128K RAM Card	375.00
		192K RAM Card	499.00
		256K RAM Card	635.00
		64K Kit (9 64K x 1 Chips)	119.00

Palomar features a complete selection of Apple and IBM Software. Call for details.

APPLE

HARDWARE

ALS Z Card	159.00	Mountain Computer Ramplus (32K)	179.00
ALS CP/M Card	379.00	MPC Serial Printer Card	89.00
ALS CP/M Card with SuperCalc	595.00	M & R Super Fan	40.00
Apple II Plus	CALL	Nikrom Master Diagnostics	45.00
CCS IEEE Card	175.00	Novation Apple Cat	299.00
CCS Analog/Digital Card	105.00	Novation Expansion Module	35.00
Comrex Clock Card	69.00	Novation J-Cat	139.00
CPS Multifunction Card	179.00	Novation Handset	27.00
Echo II Speech Synthesizer	125.00	Numeric Key Pad	150.00
EDP AC Surge Protector	49.00	Pyamar Lower Case Adapters:	
EDP EMI-RFI Filter	39.00	Old (Rev. 1-6)	29.00
Expandport-6 Ports With Speaker	55.00	New (Rev. 7)	19.00
Hayes Micromodem II	299.00	PCPI Appli-card, Multifunction	
Microbuffer II 16K	219.00	Z 80 Card	395.00
Microbuffer II 32K	245.00	PCPI 88 Card—16K CPU	659.00
Microsoft Z80 Softcard with CR/M	265.00	Softworks R.O.S.	559.00
Microtek 16K Ram Card	79.00	STB 64K Expansion Card	239.00
Microtek Parallel Printer Card	69.00	STB 128K Memory Card	399.00
Microtek Graphics Card	109.00	System Saver-Fan/Outlets/Switch	79.00
Microtek Graphics Card—16K	185.00	TG Game Paddles	29.00
Microtek Graphics Card—(32K)	235.00	TG Joy Sticks	45.00
Microtek Graphics Card—(64K)	305.00	TG Select-A-Port	45.00
Microtek Q Disk (128K)	399.00	Videx 80 Column Card	279.00
Microtek Magnum 80—Column Card	209.00	Videx Enhancer II (Rev. 7)	119.00
Mountain Computer Rom writer	145.00	Videx Function Strip	65.00
		Viewmax 80	199.00

Many items are not listed. Please call our 800 number if you don't see what you're looking for.

PERSONAL COMPUTERS

ALTOS

ACS 8000-2	3199.00
ACS 8000-15	4399.00

APPLE

Apple II Plus	CALL
Disk II D.O.S. 3	CALL
Disk II	CALL

BASIS

108-0003 (64K)	CALL
108-0004 (128K)	CALL

CHAMELEON

IBM-Compatible	1995.00
----------------	---------

FRANKLIN

ACE 1000 (64K)	CALL
ACE 10, Disk Drive	CALL

IBM

IBM PC	CALL
--------	------

MORROW

Micro Decision with Terminal & 1 Drive	CALL
Micro Decision with Terminal & 2 Drives	CALL

OSBORNE

Osborne I Portable, Includes \$200 Extras	1795.00
With Double Density Drives	1995.00

TELEVIDEO

TS 802	3119.00
TS 806	5735.00
TS 816	10365.00

VICTOR

9000 (SS) 2 Single-sided Drives	CALL
9000 (DS) 2 Double-sided Drives	CALL
9000 (HD) 1 Double-sided Drive, 10 Mb Hard Disk	CALL

DISK DRIVES

Corona 5MB Winchester	CALL
Corona 10MB Winchester	CALL
Disk II With Controller Card	CALL
Media Distributing 11 Mb Winchester Subsystem	2595.00
Media Distributing 22 Mb Winchester Subsystem	3495.00
Media Distributing 44 Mb Winchester Subsystem	4270.00
Microsci A35 With Controller Card	375.00

Microsci Controller Card	99.00
Rana Disk Drive	319.00
Rana Controller	109.00
TEAC Super 5 Disc Drive	299.00
TEAC Super 5 Controller Card	89.00
TEAC Super 5 Double-sided Disk Drive	429.00
TEAC Super 5 Controller Card for Double-sided Disk Drive	109.00

MONITORS

BMC

BM-12AU 12" Green	89.00
BM 12AU 12" Amber	99.00
BM-12 EUN 12" Green	149.00
BM-1401 RGB with Card and/or Cable	399.00
BM-AU919U Color, Composite Sound	399.00
BM-AU919U RGB for IBM-PC	759.00

COMREX

CR 5500-12" Green	155.00
CR 6500-13" Composite	315.00
CR 6600-13" RGB	429.00

ELECTROHOME

13" RGB	339.00
13" Hi Res. RGB	589.00
Apple II Interface	199.00
IBM 16 Color Cable	35

TAXAN

KG 12N-12" Green	CALL
KA 12N-12" Amber	CALL
RGB Vision I-12" RGB	CALL
RGB Vision III-12" RGB	CALL
RGB Apple II Card	CALL
RGB II Apple II Card with Text Color	CALL

ZENITH

12" Green	119.00
-----------	--------

NEC

PC-8041A-12" Green	159.00
--------------------	--------

AMDEK

Video 300-12" Green	165.00
Color I -13" Color Composite	349.00
Color II -Hi Res. RGB	749.00
Color III -Lo Res. RGB	439.00
RGB Apple II Card	165.00

SANYO

9" Hi Res. Green	159.00
12" Green Screen	135.00
12" Hi Res. Green	209.00
13" Color	419.00
13" Hi Res. Color	899.00

U.S.I.

9" Green Screen	119.00
9" Amber Screen	155.00
12" Green Screen	155.00
12" Amber Screen	175.00

P.G.S.

12" Hi-Res RGB for IBM	759.00
------------------------	--------

MODEMS

HAYES

Micromodem II (Apple II)	289.00
Micromodem II With Terminal Program	315.00
Micromodem 100 (S-100)	339.00

UDS

103 LP Direct	175.00
103 JLP Auto Answer	209.00
202 SLP 1200 BAUD	255.00
212 LP	469.00

PRINTERS

COMREX

Comriter CR-1C	CALL
Tractor Feed	89.00

EPSON

ASAP 2K Serial	59.00
Comrex 4K Serial Buffer	139.00
Microbuffer-16K Parallel	139.00
Microbuffer-8K Serial	139.00

FACIT

4510	635.00
------	--------

SMITH CORONA

TP-1	599.00
------	--------

NOVELL

Image 800	999.00
-----------	--------

NEC

3510 RO Serial	1515.00
3520 KSR Serial	2100.00
3530 RO Parallel	1695.00
3550 RO IBM	1880.00
7710 RO Serial	2325.00
7730 RO Parallel	2395.00
8023-A Dot Matrix	489.00
Bi-Directional Tractor (3500)	230.00
Cut Sheet Guide (3500)	90.00
Envelope Handler (3500)	270.00
Horizontal Tractor (7700)	150.00
Bi-Directional Tractor (7700)	345.00
Friction Attachment (7700)	35.00



OKIDATA

Microline 82-A	489.00
Microline 83-A	689.00
Microline 84-S	1199.00
Microline 84-P	1059.00
2K Parallel Interface	129.00
Forms Tractor (82-A)	55.00

OLYMPIA

COMPACT Serial Interface	849.00
ES 100 KRO	949.00
ES 100	699.00
Serial/Parallel Interface	250.00
CCS Apple Serial Card	135.00

SILVER REED

EXP 550 Serial/Parallel Interface	695.00
-----------------------------------	--------

STAR MICRONICS

Gemini 10	CALL
Gemini 15	CALL

TEC

PMC 8510 Parallel	465.00
PMC 8510 Serial	585.00
ITOH 8510-A Parallel	469.00
ITOH 8510-A Serial	619.00
ITOH 1550 Parallel	750.00
ITOH 1550 Serial	789.00
ITOH F-10-40	1395.00
ITOH F-10-55	1795.00



Palomar makes buying easy ...



ORDER TOLL-FREE! Call 800-237-3333

In California call 800-338-5555

Telex 697120-150

TERMS OF SALE: Cash, Check, money order, bank wire transfer, credit card, or purchase orders from qualified firms and institutions. Please include telephone number with order and expiration date on credit card orders. California residents add 6% sales tax. Advertised prices are for prepaid orders F.O.B. shipping point. Add 3% or \$3.00 minimum for shipping in the U.S. Pricing and availability subject to change without notice. Address written orders to:

910-105 W. San Marcos Blvd., San Marcos, CA 92069
Telephone (619) 744-7314

PALOMAR

COMPUTER PRODUCTS

Circle 326 on Inquiry card.

Listing 1 continued:

```

0086 13          INC    DE
0087 18 F5      JR     ONETP
;
;      Setup the test.
;
0089 AF          TPISIN  XUR    A          Zero.
008A 06 40      LD     B,64
008C 11 01 00   LD     DE,ERRS
008F 12          CLRERR  LD     (DE),A      Initialize error counters.
0090 13          INC    DE
0091 10 FC      DJNZ  CLRERR
0093 06 02      LD     B,2          Loop count for single test.
;
0095 00 00 00 00 00 PAD1  DW    0,0,0,0,0,0,0,0
;
;      Main loop.
;
00A5 CD 6A 01   TEST  CALL  LAPSE
00A8 CD DB 00   CALL  BYTES  Check pattern
00AB CD 04 01   CALL  COMPL  Flip it
00AF CD 28 01   CALL  DUMP   Dump error count.
00B1 3A 00 00   LD     A,(TIMFS)
00B4 FE 31      CP     '1'  Once?
00B6 20 ED      JR     NZ,TEST
00B8 10 EB      DJNZ  TEST
00BA C3 81 F0   JP     YCRMON Done.
;
00BD          PAD2  DS    16
;
;      Compare DE, HL
;
00CD A7          CPDEHL  OR     A          Clr carry.
00CE E5          PUSH  HL
00CF ED 52      SBC  HL,DE
00D1 E1          POP   HL
00D2 C9          RET          Zero if =, Minus if DE>HL.
;
00D3          PAD3  DS    8
;
;      Verify expected pattern
;
00DB ED 5B 43 00 BYTES  LD     DE,(STRMUD)
00DF 2A 45 00   LD     HL,(ENDMUD)
00E2 1A          ONETST  LD     A,(DE)
00E3 AB          XOR    E
00E4 A9          XOR    C
00E5 28 06      JR     Z,OKBYTE
00E7 CD 91 01   CALL  BYFAIL  Count the erroneous RAMs.
00EA 7B          LD     A,E
00EB A9          XOR    C          Recompute the expected pattern.
00EC 12          LD     (DE),A      Remind the flaky RAM.
;                                     This way, soft errs count just once.
00ED CD CD 00   OKBYTE  CALL  CPDEHL
00F0 C8          RET     Z
00F1 13          INC    DE
00F2 18 FE      JR     ONETST
;
00F4          PAD4  DS    16
;
;      Complement mask and test Pattern
;      After two passes, main loop has tried 0's and 1's
;      in each bit of MUD.
;
0104 79          COMPL  LD     A,C
0105 2F          CPL     Mask
0106 4F          LD     C,A
0107 ED 5B 43 00 LD     DE,(STRMUD)
0108 2A 45 00   LD     HL,(ENDMUD)
010E 1A          ONEFLP  LD     A,(DE)
010F 2F          CPL     RAM contents
0110 12          LD     (DE),A
0111 CD CD 00   CALL  CPDEHL
0114 C8          RET     Z
0115 13          INC    DE
0116 18 F6      JR     ONEFLP
;
0118          PAD5  DS    16
;
;      Dump out the 32 error counters
;
0128 C5          DUMP  PUSH  BC
0129 E5          PUSH  HL
012A DD 21 3F 00 LD     IX,ERRS+62  Dump in descending order.
012E 06 04      LD     B,4          4 Banks.
0130 CD 15 F0   DBANK  CALL  CRLF
0133 C5          PUSH  BC
0134 06 08      LD     B,8          8 Bits.

```

Listing 1 continued on page 378

A calculated way to cut your electricity costs.

Saving on electricity costs is as easy as switching light bulbs. This *free* slide rule calculator from Westinghouse shows you where to begin.

Use your Westinghouse Energy-Saving Calculator to take a hard nosed look at the lamps you are using now. Your calculator will help you select the most efficient type of lamps for offices, plants, show rooms and display areas.

If you have fluorescents, substituting Westinghouse Econ-o-watt® lamps for standard lamps will have an immediate effect of up to six watts per socket, with no appreciable change in light level.

Or save up to 80% in energy by replacing incandescent lighting with high pressure sodium lamps. They save energy while producing an equivalent

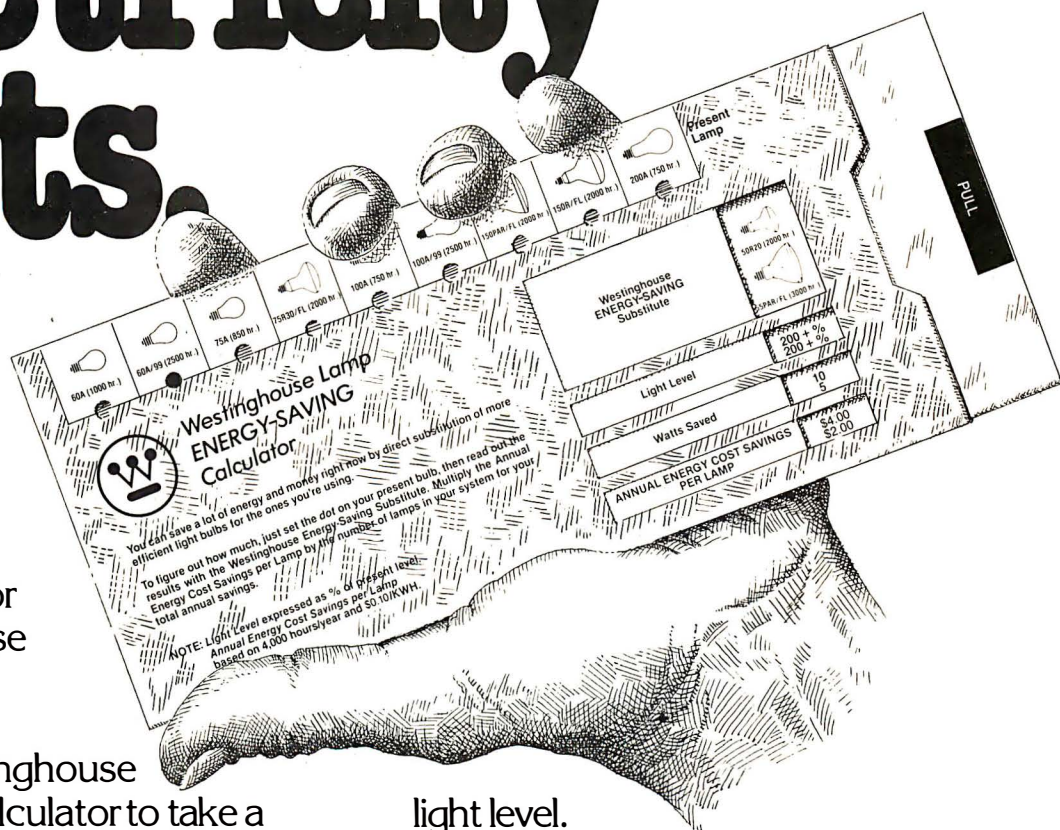

light level.

Westinghouse lamp products and programs are calculated to help save you from rising electricity costs. Our free calculator will show you how.

Get your free energy-saving calculator now! Call toll-free 800-631-1259.



Westinghouse

Lamp Divisions
Bloomfield, New Jersey 07003

Listing 1 continued:

```

0136 3E 20          DBIT      LD      A,' '
0138 CD 6E 00      CALL    ASCO
013B DD 66 01      LD      H,(IX+1)
013E DD 6E 00      LD      L,(IX+0)
0141 CD 17 F3      CALL    OUT16
0144 DD 2B         DEC     IX
0146 DD 2B         DEC     IX
0149 10 EC         DJNZ   DBIT
014A C1           POP     BC
014B 10 E3         DJNZ   OBANK
014D E1           POP     HL
014E C1           POP     BC
014F C3 15 F0      JP      CRLF
                                Blank line upon completion.
0152          ;
                                PAD6 DS 24
                                ;
                                ; Delay (to test data retention while no MCYR0's)
                                ;
                                ;
                                LAPSE PUSH BC
016A C5          LD      B,TIX Time is roughly proportional to TIX cubed.
016B 06 93          LD      B,TIX
016D C5          L1     PUSH BC
016E C5          L2     PUSH BC (For TIX=FFH, at 4MHz Z-80 clock,
016F 10 FE          L3     DJNZ L3 LAPSE takes about 20 seconds.)
0171 C1          POP     BC
0172 10 FA          DJNZ   L2
0174 C1          POP     BC
0175 10 F6          DJNZ   L1
0177 C1          POP     BC
0178 C9          RET
                                ;
0179          ;
                                PAD7 DS 24
                                ;
                                ; Bad data was read, so count each 4116 in error.
                                ; Entry: (DE) => bad byte
                                ; (A) => set bits flag error positions.
                                ;
                                ; Exit: All appropriate error counters have been bumped.
                                ; No regs A=L altered
                                ; (IX) => counter of highest bad bit.
                                ;
0191 E5          BYFAIL PUSH HL

```

Listing 1 continued on page 380

Co-owner Jack Abbott says, "I hope you've been reading my review series in Byte magazine on Database Management Systems. Please call me at (602) 842-1133 if I can be of help in solving your software requirements."

WAREHOUSE SOFTWARE

CALL TOLL FREE FOR ORDERS
1-800-421-3135

MOST DISK FORMATS AVAILABLE:

Program names prefaced with "#" available also for IBM PC

CP/M DATA BASE MANAGEMENT SYSTEMS:

#Ashton-Tate DBase II **Call**
 #Condor III **Call**
 #T.I.M. **\$365**

CP/M UTILITIES

Package Price, Wordstar, Mailmerge, Spell Checker, for CP/M 80 and for IBM PC **\$445**
 Above package with Spell Star ... **\$495**
 #Wordstar **\$285**
 #Mailmerge **\$125**
 #Wordstar & Mailmerge **\$395**

#Infostar **Call**
 #Spellstar **\$165**
 Calcstar **\$135**
 #Aspen 50K Spell Checker **\$70**
 C-Basic **\$100**
 CB-80 **\$415**
 Datastar **\$215**
 Supersort **\$175**
 #Supercalc **\$195**
 CP/M Power **\$135**
 #T.C.S. AR, PAY, AP, GL customized with operating function keys for IBM PC **\$400 or \$125** each module
 Target Systems Planner Calc. **\$85**
 #MOVE-IT (Micro to Micro COM & MODEM) **\$105**
 Peachtree Magic Wand, Spell Checker, Mail List **\$350**

Microsoft Basic 80 **\$265**
 Microsoft Basic Compiler **\$295**
 Accounting Plus Modules ... **\$485** ea
 Visicalc for IBM PC **\$195**
 Fox Geller Quickscreen **\$135**
 Peachtree Peach Pak, AR, AP, GL... **\$375**
 Graphics CP/M for Advantage... **\$150**
 Graphics NS DOS for Advantage, Inc. N.S. Basic. **\$150**

IBM PERIPHERALS

IBM Disc Controller Adapter w/par. or serial port **\$249**
 Seven Function Board—64K expandable to 256K, par. port, async port, realtime clock w/battery, game paddle port, print spool software, ramdisk software, 1 year warranty **\$395**
 4 Function Board, same as 7 function board without the RAM or the software. . **\$250**
 64K RAM expandable to 256 w/Async port **\$295**
 Tandon 100-2 D/S D/D Drives 320K for IBM PC **\$245**
 5MEG Winchester w/removable cartridge **Call**

WAREHOUSE SOFTWARE

Orders—Call 1-800-421-3135
 Technical Information—
 (602) 842-1133

4935 W. Glendale Ave.
 Glendale, Arizona 85301

SPECIAL OF THE MONTH

Lotus 1, 2, 3 Spread Sheet Graph Package for the IBM PC Only. \$375

ALL PROGRAMS GUARANTEED LATEST VERSION— FULL DOCUMENTATION

Prices reflect 3% cash discount. Please add \$5.00 per order for shipping. Price & availability subject to change without notice.

COMPUTER WAREHOUSE

CALL TOLL FREE **1-800-528-1054**

ATARI

Special 800 System	
800 w/48K, recorder, Pac Man or Star Raiders, joysticks	\$640
800 (48K) w/Basic	\$525
400	\$225
810 Disk Drive	\$440
850 Interface	\$170
410 Recorder	\$75
830 Modem	\$155

COMMODORE

64	\$395
--------------	--------------

AXLON

Rampower 48 for Atari	\$140
Rampower 128 for Atari	\$355
Ramdisk 128 for Apple	\$355
Ramdisk 320 for Apple	\$1035
Data Link	\$300

PRINTERS

Anadex	
9620	\$1445
C-Itch	
F-10-Parallel	\$1170
F-10-Serial	\$1170
55 CPS-Series	Call
8510 Parallel (Prowriter)	Call
Computer International	
Daisywriter 2000 w/16K	\$975
Daisywriter 2000 w/48K	\$1000
Comrex	
CR-1-S	\$800
CR-1-P	\$775
Datasouth	
DS 180	\$1170
Diablo	
620 RO wo/Tractors	\$915
630 RO wo/Tractors	\$1750
IDS	
Microprism 480	\$525
Epson	
All models	Call
NEC	
PC-8023A	\$450
3510	\$1375
3550	\$1835
7710	\$2050
7720	\$2425
Okidata	
All models	Call
Smith-Corona	
TP-1	\$650
Star Micronics	
Gemini-10	Call
Gemini-15	Call
Tally	
1805/1802	\$1455
MT 160I w/Tractors	Call
MT 160L w/Tractors	Call
MT 180	Call
Texas Instruments	
810 Basic	\$1260
Toshiba	
P1350	\$1760

SPECIAL OF THE MONTH

Diablo 620 w/Ribbon, Thimble & Cable . . . \$915

DISK DRIVES

Percom	
Atari S/S S/D 1st Drive	\$400
Atari S/S S/D 2nd Drive	\$300
Atari S/S D/D 1st Drive	\$525
Atari S/S D/D 2nd Drive	\$330
Rana (Drives for Apple)	
Elite 1	\$275
Elite 2	\$460
Elite 3	\$585
Controller (w/Drive only)	\$75

MONITORS

Zenith	
12" Green Screen	\$115
Amdek	
Video 300	\$145
Color I	\$300
Color II	\$645
Color III	\$390
BMC	
12" Green	\$85
13" Color	\$265
Comrex	
13" Color Composite	\$290
13" RGB	\$455
NEC	
JB 1201	\$155
JB 1260	\$115
Taxan	
12" Amber	\$125
USI	
9" Amber	\$130
12" Amber	\$150

MODEMS

Hayes Smartmodem	\$210
Novation	
CAT	\$140
D-CAT	\$155
J-CAT	Call

VIDEO TERMINALS

Qume	
QVT 102	\$550
Televideo	
910	\$570
910 Plus	\$570
920	\$735
925	\$730
950	\$915
970	\$1100
Zenith	
Z-19	\$670
ZT-1 Keyboard Only	\$350

COMPUTERS

Altos	
ACS 8000-15	\$3550
Series 15D	\$2125
Series 5-5D	\$3900
5-80-10	\$4699
Eagle II	\$2330
NEC	
8001	\$730
8012	\$470
8031	\$730
APC	Call
Northstar	
Advantage	\$2800
Advantage w/5MB	\$3600
Horizon II 64K QD	\$2625
Sanyo	
MBC-1000 w/WordStar, CalcStar, S-Basic, CPM®	Call
Above w/2 Drives	Call
Televideo Systems	
TS-802	\$2599
TS-802H	\$4450
Zenith	
Z-120	\$3100
Z-110	\$3025

DISKETTES

Maxell	
MD-1 (Qty. 100)	\$250
Scotch	
744-0 (Qty. 100)	\$225



2222 E. Indian School Rd.
Phoenix, Arizona 85016

Order Line: 1-800-528-1054 Other Information: 602-954-6109
Order Line Hours: Mon.-Fri. 10-5 MST Saturday 9-1 MST

Prices reflect 3% to 5% cash discount. Product shipped in factory cartons with manufacturer's warranty. Please add \$8.00 per order for shipping. Prices & availability subject to change without notice. Send cashier's check or money order...all other checks will delay shipping two weeks.

Listing 1 continued:

```

0192 D5          PUSH    DE
0193 C5          PUSH    BC
0194 F5          PUSH    AF
0195 DD 21 01 00 LD      IX,ERRS      Point to base of error counters.
0199 7A          LD      A,D
019A CB 0F       RRC     A
019C CB 0F       RRC     A
019E E6 30       AND    00110000B
01A0 5F          LD      E,A          E => which bank has failure in it, (Bits 5,4)
01A1 16 00       LD      D,0
01A3 DD 19       ADD    IX,DE          Point to 8 counters.
01A5 F1          POP    AF            Restore bad bits to A.
01A6 F5          PUSH   AF
01A7 06 08       LD      B,8          Load 8 times.
01A9 CB 0F       RRC     A
01AB 4F          LD      C,A
01AC E6 80       AND    10000000B
01AE 79          LD      A,C
01AF 2A 03       JR     Z,OKBIT
;
01B1 DD 34 00       ;      INC    (IX+0)      Here he is!
;                          ;      Count the little jerk.
;
01B4 DD 23          OKBIT  INC    IX
01B6 DD 71 00       LD      (IX+0),C      Store the error pattern.
01B9 DD 23          INC    IX            Ready next counter.
01BA 10 EC         DJNZ  BITCHK
01BD F1          POP    AF
01BE C1          POP    BC
01BF D1          POP    DE
01C0 E1          POP    HL
01C1 C9          RET
;
;      Special thanks to Litton Amecom's Electronic Warfare Product
;      Development Department, for the after-hours use of their Zenith Z-89
;      microcomputer, on which this program was assembled. Also the Real-
;      Time Software Department for the use of their line printer, and
;      Mike Cunningham (EW Product Dev.) for software and systems support.
;      I am proud to have been associated with this organization.
;
END      BEGIN

```

SNA X.25

Systems Strategies/Communications Division
Specialists in Data Communications Software

225 West 34th Street
New York, New York 10001
(212) 279-8400

- Custom software to allow your product to interface networks and emulate other vendors equipment
- SNA, X.25, BSC software to communications compatible product developers for a more timely and cost effective entry into the marketplace
- Software that is utilized by computer and terminal manufacturers. Target processors have included Zilog Z-80, Z-8000, Intel 8086
- Close contact with your engineers to adapt our software to your hardware
- Software in 'C', Pascal and Assembler
- Microcomputer systems development

THE COMPETITIVE EDGE CAN BE YOURS

WHEN YOU DEAL WITH SLUDER



RACK OR DESK?
10 or 20 SLOT
C.V.T. or NO
C.V.T, Floppy
& HARD DISK ?
DUAL FLOPPYS?
SINGLE USER?
MULTI - USER?
GODBOUT ?
LOMAS ?
SEATTLE ?
OR TELETEK ?

IT'S YOUR CHOICE, WHAT IS BEST FOR YOU
THE CUSTOMER IS THE IMPORTANT QUESTION
SAMPLES OF READY TO BOOT & RUN SYSTEMS

4MHz Z80 Teletex, 2.4 MegaByte	\$2495
6MHz Godbout CPU Z,64K 2.4MB	2895
6/8MHz 85/88 Godbout,64K,2.4MB	2995
10MHz Godbout 8086,128K, 2.4 MB	3695
10MHz Godbout 68000,128K 2.4 MB	3695
10MHz Lomas 8086,128K, 2.4 MB	3595

(714) 895-1746
BOX 951 WESTMINSTER CA 92683-0951

"Training? Call a computer school."

"More documentation? Go to a book store."

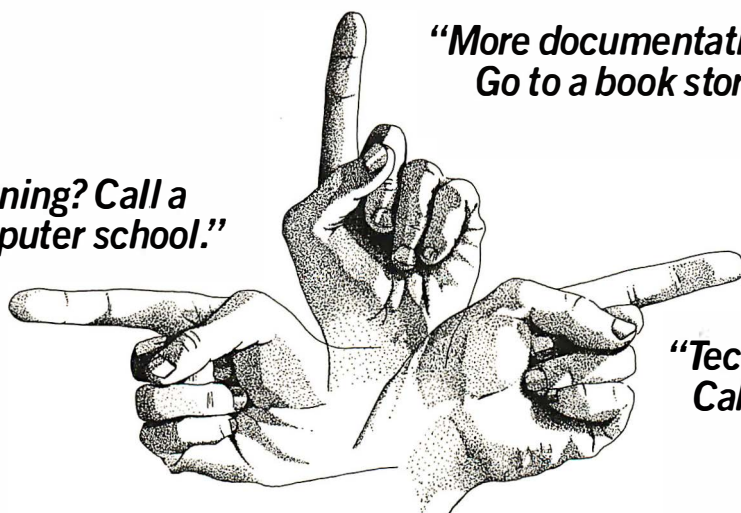

"Technical support? Call the publisher."

Interested in dBASE II™ or 1-2-3™? Beware The Dreaded Finger Pointers!

Sound familiar? After buying software you often find that your dealer turns into a "finger pointer" when you need help.

At SoftwareBanc we offer a complete system that doesn't stop when the software is delivered.

Careful Product Selection

We only sell the best programs on the market. After a thorough evaluation we chose dBASE II™ for data processing, and 1-2-3™ for financial management.

We are constantly selecting the best add-on programs so that you can continue to get the most from your software.

Do you get bewildered by the endless lists of software you find in most ads? Let us be your quality control department.

Expert Technical Support

When you buy software from us, you can be assured that help is only a phone call away. Just call us at (617) 641-1235 for all the free support you need.

Free dBASE II™ User's Guide

We don't send you somewhere else to learn more about a product we sell. Order dBASE II™ from us, and you'll receive a free copy of our dBASE II™ User's Guide. You can also buy the User's Guide first for only \$29, and then receive a full credit when you buy dBASE II.™

With over 140 pages of examples and sample programs, the User's Guide has become the standard text on dBASE II.™

National dBASE II™ Classes

Want more in-depth information about dBASE II™? Attend one of our introductory or advanced classes in a city near you. Each session runs from 9 to 5, and costs \$100.

Atlanta
APR. 23, 24

Boston
MAR. 4, 5, 7

Chicago
MAR. 18, 19, 20

Houston
FEB. 4, 5, 6

New York
FEB. 25, 26, 28

San Francisco
APR. 8, 9, 11

Prices You Can Afford

1-2-3™	Call for price*
dBASE II™	\$495
ABSTAT	\$379
dBASE II™ User's Guide	\$29
DBPlus™	\$95
dGRAPH	\$229
dUTIL	\$69
QUICKCODE	\$229

*Only available for IBM PC with MS-DOS.

Free Catalog

If you want information about SoftwareBanc, call or write for our free product catalog.

SoftwareBanc

661 Massachusetts Avenue
Arlington, Mass. 02174

To order call: (800) 451-2502
(617) 641-1241 in Mass.

For technical support call:
(617) 641-1235

1-2-3 is a registered trademark of Lotus Development Corporation/dBASE II is a registered trademark of Ashton-Tate, Inc.

Payment may be made by: MasterCard, Visa, check, money order. Mass. residents please add 5% sales tax. Add \$5.00 for shipping and handling.



EAGLE

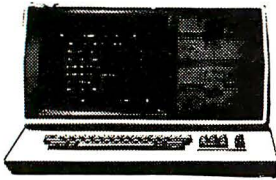

Call on Eagle 8 Bit & 16 Bit Computers and Software

TeleVideo TERMINALS

910.....	\$579.00
912C.....	\$699.00
920C.....	\$749.00
925C.....	\$749.00
950.....	\$950.00
WYSE WY100.....	\$749.00

COMPUTERS

800A.....	\$1299.00
802.....	\$2649.00
802H.....	\$4695.00
806.....	\$4999.00
816.....	\$8999.00
803.....	CALL
1602/1603.....	CALL

PANASONIC

JR200U 32K Pers. Computer...\$309.00

MONITORS

TR-120, 12" Hires Green.....	\$159.00
CT-160, 10" Dual Mode Color.....	\$299.00
DT-D1000, 10" RGB.....	\$349.00
DT-D1300, 13" RGB/Composite.....	\$429.00

SANYO

MB 1000 Computer.....	\$1599.00
MB 160 Add on Drive.....	\$539.00
5500 Letter Quality Printer.....	\$699.00



SHARP PC-1500
POCKET COMPUTER
\$169.

PC 1250...\$89.00

CE 150 Printer, Plotter and Cass. Interface Unit.....	\$172.00
CE 152 Cass. Recorder.....	\$62.00
CE 155 8K Ram Expansion Module.....	\$94.00
CE 125 Printer/Micro Cassette.....	\$129.00

MONITORS

AMDEK

300G.....	\$159.00
300A.....	\$169.00
310G.....	\$179.00
310A.....	\$169.00
Color I.....	\$299.00
Color II.....	\$599.00
Color II A.....	\$799.00
Color III.....	\$349.00

BMC

12AU 12" Green.....	\$79.99
140i 13" Color (Mid Res.).....	\$369.00
9191U 13" Composite.....	\$329.00

TAXAN

Color Composite.....	CALL
RGB 1.....	\$329.00

ZENITH

ZVM 121.....	\$99.00
ZT-1 Terminal.....	\$369.00

SHARP

13" Color TV.....	\$269.00
19" Color TV.....	\$339.00

Commodore

VIC 20

\$149

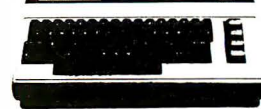

VIC 64

\$399.

Motor Mouse.....	\$23.00
Centipede.....	\$23.00
Frogge (VIC).....	\$23.00
Frogge (64).....	\$23.00
VIC 20 Dust Cover.....	\$9.99
VIC 1530 Datasette.....	\$69.00
VIC 1541 (64K Disk Drive).....	\$339.00
VIC 1525 Graphic Printer.....	\$339.00
VIC 1210 3K Mem. Exp.....	\$32.00
VIC 1110 8K Mem. Exp.....	\$53.00
VIC 1111 16K Mem. Exp.....	\$94.00
VIC 1011 RS232C Term. Interface.....	\$43.00
VIC 1112 IEEE-488 Interface.....	\$86.00
VIC 1211 Super Expander.....	\$53.00
VIC Mother Board.....	\$99.00

HFS, UMI, EPYX & Creative Software
for VIC. Now In Stock!!

PROFESSIONAL SOFTWARE
Word Processing for VIC 64.....\$79.95

8032.....	\$1039.00
4032.....	\$749.00
8096 Upgrade Kit.....	\$369.00
Super Pet.....	\$1499.00
2031.....	\$469.00
8250 Dbl.Sided Disk Drive.....	\$1699.00
D9060 5 Meg. Hard Disk.....	\$2399.00
D9060 7.5 Meg. Hard Disk.....	\$2699.00
8050.....	\$1299.00
4040.....	\$969.00
8300 (Letter Quality).....	\$1549.00
8023.....	\$599.00
4022.....	\$399.00
New Z-Ram, Adds CP/M® & 64K.....	\$549.00
The Manager.....	\$209.00
Magis.....	CALL
Word Pro 5 Plus.....	\$319.00
Word Pro 4 Plus.....	\$299.00
Word Pro 3 Plus.....	\$199.00
The Administrator.....	\$379.00
Info Pro Plus.....	\$219.00
Power.....	\$79.00

NEC

COMPUTERS

6000.....	CALL
8001A.....	\$719.00
8031.....	\$719.00
8012.....	\$549.00

PRINTERS

8023.....	\$469.00
7710/7730.....	\$2299.00
3510/3530.....	\$1549.00

MONITORS

JB-1260.....	\$119.00
JB-1201.....	\$149.00
JC-1212.....	\$299.00
JC-12-202.....	\$299.00
JC-1203.....	\$599.00

PRINTERS

SMITH CORONA

TP 1.....	\$599.00
Tractor Feed.....	\$129.00

C. ITOH (TEC)

Starwriter(F10-40CPS).....	\$1299.00
Printmaster(F10-55CPS).....	\$1649.00
Prowriter 8510 P.....	\$399.00
Prowriter 8510 S.....	\$599.00
Prowriter 1550 P.....	\$769.00
Prowriter 1550 S.....	\$799.00

OKIDATA

82A.....	\$429.00
83A.....	\$659.00
84 (Parallel).....	\$1049.00
84 (Serial).....	\$1149.00
92.....	\$599.00
93.....	\$999.00

IDB

MicroPrism.....	\$649.00
132 (Fully Configured).....	\$1599.00
#0 (Fully Configured).....	\$1399.00

Call for other configurations.

STAR

Gemini 10.....	\$379.00
Gemini 15.....	\$489.00

DAISYWRITER

Letter Quality.....	\$1049.00
---------------------	-----------

DIABLO

620.....	\$999.00
630.....	\$1769.00

HEWLETT PACKARD



41CV
\$209

HP75 \$799.



HP 41C(free memory module).....	\$149.00
HP 10C.....	\$59.00
HP 11C.....	\$72.00
HP 12C.....	\$99.00
HP 15C.....	\$99.00
HP 16C.....	\$99.00

MODEMS

HAYES

Smart.....	\$219.00
Smart 1200 (1200 Baud).....	\$549.00
Chronograph.....	\$199.00
Micromodem 100.....	\$309.00
Micromodem II.....	\$279.00
Micromodem II (with Term).....	\$299.00

NOVATION

J-Cat.....	\$119.00
Cat.....	\$144.00
D-Cat.....	\$159.00
103 Smart Cat.....	\$189.00
Apple Cat II.....	\$279.00
103/212 Smart Cat.....	\$439.00
212 Apple Cat II.....	\$609.00
Apple Cat II 212 Upgrade.....	\$309.00

ANCHOR

Mark I (RS-232).....	\$79.00
Mark II (Atari).....	\$79.00
Mark III (TI-99).....	\$109.00
Mark IV (CBM/PET).....	\$125.00
Mark V (OSBORNE).....	\$95.00
Mark VI (IBM-PC).....	\$179.00
Mark VII (Auto Answer Call).....	\$119.00
TRS-80 Color Computer.....	\$99.00
9 Volt Power Supply.....	\$9.00

TIMEX SINCLAIR

1000 \$85.

16K Memory Module.....	\$44.95
Vu-Calc.....	\$17.95
Check Book Manager.....	\$13.95
The Organizer.....	\$14.95
The Budgeter.....	\$13.95
Stock Option.....	\$14.95
Loan & Mortgage Amortizer.....	\$12.95
Mindware Printer.....	\$109.00
Orbit Software.....	CALL

IBM®

NEC
3550 PRINTER...\$1999

PERCOM/TANDOM

DRIVES

5¼" 160K Disk Drive.....	\$249.00
5¼" 320K Disk Drive.....	\$299.00

AMDEK

310A Amber Monitor.....	\$169.00
310G.....	\$179.00
Amdisk (3¼" Drive).....	\$679.00
XY Plotter.....	\$649.00
Color II.....	\$599.00

SOFTWARE

I.U.S. Easywriter II.....	\$249.00
I.U.S. Easyspeller.....	\$129.00
Peach Package (GL/AP/AR).....	\$419.00

PROFESSIONAL

SOFTWARE

IBM/PC Word Processing.....	\$319.00
-----------------------------	----------

CONTINENTAL

SOFTWARE

The Home Accountant Plus.....	\$119.00
1st Class Mail/Form Letter.....	\$99.00

BYNAPSE

File Manager.....	\$119.00
-------------------	----------

Dept.
401

computer mail order east

800-233-8950

IN PA. CALL (717)327-9575, 477 E. THIRO ST., WILLIAMSPORT, PA. 17701

Not a deposit on C.O.D. orders. Pre-paid orders receive free shipping within the UPS Continental United States Delivery Zone with no waiting period for certified checks or money orders. Add 3% (minimum \$3.00) shipping and handling on all C.O.D. and credit card orders. Larger shipments may require additional charges. NV and PA residents add sales tax. All items subject to availability and price change. **NOTE:** We stock manufacturer's and third party software for most all computers on the market. Call today for our new catalog.



Call on FRANKLIN Computers, Disk Drives, Software and System Specials.

MICRO-SCI
DISK DRIVES FOR
APPLE & FRANKLIN

- A2.....\$299.00
- A40.....\$349.00
- A70.....\$459.00
- C2 Controller.....\$79.00
- C47 Controller.....\$89.00

VISICORP

- for Apple, IBM & Franklin
- Visidex.....\$189.00
 - Visifile.....\$189.00
 - Visiplot.....\$159.00
 - Visiterm.....\$89.00
 - Visitrend/Plot.....\$229.00
 - VisiSchedule.....\$229.00
 - Desktop Plan.....\$189.00
 - Veicak(Apple/IBM).....\$179.00
- Visicorp prices for IBM may vary slightly.

CONTINENTAL

- Home Accnt. (Apple/Atari).....\$59.00
- The Tax Advantage(Apple/Atari).....\$45.00
- 1st Class Mail/Form Letter(Apple).....\$79.00
- The Book of Apple.....\$14.95
- The Book of Atari.....\$14.95
- The Book of Apple Graphics.....\$14.95

SIRIUS

- Free Fall.....\$24.00
- Beer Run.....\$24.00
- Snake Byte.....\$24.00
- Space Eggs.....\$24.00
- Sneakers.....\$24.00
- Bandits.....\$28.00

BRODERBUND

- Apple Panic.....\$23.00
- David's Magic.....\$27.00
- Star Blazer.....\$25.00
- Arcade Machine.....\$34.00
- Choplifter.....\$27.00
- Serpentine.....\$27.00

INFOCOM

- Deadline(Atari,Apple,IBM).....\$35.00
- Star Cross.....\$29.00
- Zork I. II. or III.....\$29.00

MPC

- Bubdisk (128K Ram).....\$719.00

AXLON

- Apple/Franklin 128K Ram.....\$399.00
- Apple/Franklin Ram Disk.....\$999.00

KRAFT

- Apple Joystick.....\$44.00



- 1010 Recorder.....\$74.00
- 1020 Printer.....\$269.00
- 1025 Printer.....\$589.00
- 830 Modem.....\$159.00
- 820 Printer.....\$259.00
- 850 Interface.....\$169.00
- CX40 Joy Sticks (pair).....\$18.00
- CX414 Bookkeeper Program.....\$119.00
- CX419 Bookkeeper Kit.....\$195.00
- CX481 Entertainer Package.....\$69.00
- CX482 Educator Package.....\$130.00
- CX483 Programmer Package.....\$54.00
- CX484 Communicator Package.....\$344.00
- Full Stroke Replacement Keyboard... for Atari 400.....\$119.00

ALIEN

- Atari Voice Box.....\$119.00
- Apple Voice Box.....\$149.00

MEMORY

- Axlon 32K Ram.....\$89.00
- Axlon 48K Ram.....\$139.00
- Axlon 128K Ram.....\$399.00
- Intec 32K Board.....\$74.00
- Intec 48K Board.....\$99.00
- Intec 64K Board(400 Only).....\$149.00

WICO

- Joystick.....\$24.95
- Famous Red Ball.....\$26.95
- Apple Trackball.....\$59.00
- Atari/VIC Trackball.....\$55.00
- Apple Adapter.....\$16.00



DISK DRIVES FOR ATARI

- AT 88-S1.....\$399.00
- AT 88-A1.....\$299.00
- RFD 40-S1.....\$549.00
- RFD 40-A1.....\$349.00
- RFD 40-S2.....\$889.00
- RFD 44-S1.....\$679.00
- RFD 44-S2.....\$1029.00

RANA DISK DRIVES

Call for price and availability on the new Rana Disk Drives for The Apple and Franklin Computer Systems.

FLOPPY DISKS

MAXELL

- MD I (Box of 10).....\$32.00
- MD II (Box of 10).....\$44.00
- FD I (8").....\$40.00
- FD II (8" DD).....\$50.00

VERBATUM

- 5 1/4" SS SD.....\$26.00
- 5 1/4" DS DD.....\$36.00

ELEPHANT

- 5 1/4" SS SD.....\$19.99

48K
800
\$499

ATARI 400

- 16K.....\$199
 - 32K.....\$274*
 - 48K.....\$299*
 - 64K.....\$359*
- *Non-Atari Ram
- One Year Extended Warranty.....\$70.00

ATARI

- Pac-Man.....\$33.00
- Centipede.....\$33.00
- Caverns of Mars.....\$32.00
- Asteroids.....\$29.00
- Missile Command.....\$29.00
- Star Raiders.....\$35.00
- Galaxian.....\$33.00
- Defender.....\$33.00
- Atari Visicalc.....\$159.00

ON-LINE

- Jawbreaker.....\$27.00
- Softporn.....\$27.00
- Wizard and the Princess.....\$29.00
- The Next Step.....\$34.00
- Mission Asteroid.....\$22.00
- Mouskattack.....\$31.00
- Frogger.....\$31.00
- Cross Fire (ROM).....\$36.00

SYNAPSE

- File Manager 800#.....\$69.00
- Chicken(Rom).....\$34.00
- Picnic Paranoia(Rom).....\$34.00
- Claim Jumper (Rom).....\$34.00
- Slime (Rom).....\$34.00
- Shamus(Rom).....\$34.00
- Protector (Rom).....\$34.00
- Dodge Racer (C/D).....\$26.00
- Nautilus (C/D).....\$26.00
- Shadow World (C/D).....\$26.00
- Survivor (C/D).....\$26.00
- Drelbs (C/D).....\$26.00
- Necromancer (C/D).....\$26.00
- Pharaohs Curse (C/D).....\$26.00
- Fort Apocolypse (C/D).....\$26.00
- Page 6.....\$19.00
- Assembler.....\$30.00
- Disk Manager.....\$24.00

DATABOFT

- Pacific Coast Highway.....\$25.00
- Canyon Climber.....\$25.00
- Tumble Bugs.....\$25.00
- Shooting Arcade.....\$25.00
- Clowns and Balloons.....\$25.00
- Graphic Master.....\$30.00
- Graphic Generator.....\$13.00
- Micro Painter.....\$25.00
- Text Wizard.....\$79.00
- Spell Wizard.....\$64.00
- Bishop's Square.....\$25.00
- Sands of Egypt.....\$25.00
- Moon Shuttle.....\$25.00
- Zaxon.....\$29.00



810 Disk Drive.....\$429.00

Call for Price and Availability of the **NEW 64K ATARI 1200**

APX

- Text Formatter.....\$18.50
- Family Budgeter.....\$18.50
- Eastern Front.....\$24.00
- Family Cash.....\$18.50
- Jukebox.....\$13.50
- Downhill.....\$18.50
- Outlaw.....\$18.50
- Holy Grail.....\$24.00
- Player Piano.....\$18.50
- Keyboard Organ.....\$18.50
- Number Blast.....\$13.50
- Frogmaster.....\$18.50
- 747 Land Simulator.....\$18.50
- Bumper Pool.....\$13.50

CBS

- K-razy Shoot Out.....\$32.00
- K-razy Kritters.....\$32.00
- K-razy Antics.....\$32.00
- K-star Patrol.....\$32.00
- Stick Stand.....\$5.99

EPYX

- Crush, Crumble & Chomp.....\$24.00
- Crypt of the Undead.....\$24.00
- Curse of Ra.....\$16.00
- Datestones & Ryn.....\$16.00
- Invasion Orion.....\$19.00
- King Arthur's Heir.....\$24.00
- Morloc's Tower.....\$16.00
- Rescue at Rigel.....\$24.00
- Ricochet.....\$16.00
- Star Warrior.....\$29.00
- Temple of Asphai.....\$29.00
- Upper Reaches of Apsal.....\$16.00

SPINNAKER

- Snooper Troops #1.....\$34.00
- Snooper Troops #2.....\$34.00
- Face Maker.....\$24.00
- Story Machine.....\$24.00
- Delta Drawing.....\$45.00
- Rhymes and Riddles.....\$21.00
- Kinder Comp.....\$21.00

ROKLAN

- Wizard of War (Rom).....\$34.00
- Deluxe Invader (Rom).....\$29.00
- Gorf (Rom).....\$34.00

FIRST STAR

- Astro Chase.....\$25.00

BIG 5

- Miner 49er.....\$35.00

GAMESTAR

- Baja Buggles.....\$24.95
- Football.....\$24.95

computer mail order west
800-648-3311

Dept.
401

IN NV. CALL (702)588-5654, P.O. BOX 6689, STATELINE, NV. 89449

INTERNATIONAL ORDERS: All shipments outside continental United States must be pre-paid by certified check only! Include 3%(minimum \$3.00) shipping and handling
EDUCATIONAL DISCOUNTS: Additional discounts are available from both Computer Mail Order locations to qualified Educational Institutions.

APD & FPD: Add minimum \$5.00 shipping on all orders.

CP/M is a registered trademark of Digital Research, Inc.



The Micromint MPX-16 Microcomputer System.

As featured on the cover of "BYTE" magazine, November 1982.
Also featured in Ciarcia's Circuit Cellar, November, December 1982 & January 1983.

These are all the tools you'll need to build the world's most powerful single board microcomputer.

The Micromint MPX-16. Put one together tonight.

Once assembled, the most useful tool will be your own imagination. The possibilities are limitless. Micromint will help you tailor the MPX-16 system to your particular needs and budget. Purchase the MPX-16 as a bare pc board, as a semi-kit with all the IC sockets, I/O connectors and discreet components wave soldered to the pc board, or as an assembled and tested unit.

- Directly boots CP/M-86 or MS-DOS.*
- Runs all CP/M-86 or MS-DOS* applications programs.

On board features.

- IBM PC bus compatible with 9 expansion slots.
- Intel 8088 16-bit microprocessor.
- Optional Intel 8087 math coprocessor.
- 256K bytes on board memory.
- Up to one megabyte of system memory.
- Up to 64K bytes of system ROM/EPROM.
- Two RS-232C serial I/O ports.
- Three parallel I/O ports.
- Floppy disk controller for 5 1/4" or 8" single or double density disk drives.
- Four independent DMA channels.
- Sixteen levels of vectored interrupts.

* Available Soon.

Circle 271 on inquiry card.

Micromint MPX-16
The System with the Winning Combination.

To get the MPX-16 up and running only requires one disk drive, power supply and serial terminal.

- MPX-16 single board computer assembled, tested and burned in with 64K bytes of RAM, CP/M-86 or MS-DOS operating system * \$1,895.00
 - MPX-16 with 256K bytes of RAM \$2,135.00
 - MPX-16 Semi-Kit (wave soldered pc board) less IC's \$595.00
 - Complete kit of IC's burned in and tested with 64K bytes of RAM \$595.00
 - With 256K bytes of RAM \$800.00
 - MPX-16 Unpopulated (bare) pc board, silk screened and solder masked \$300.00
 - CP/M-86 Operating System on 5 1/4" or 8" diskette. . . \$200.00
 - MPX-16 Switching Power Supply including power supply harness \$300.00
 - MPX-16 Technical Reference and User's Manual \$50.00
- Call for current pricing on serial terminals, floppy disk drives, metal enclosures, hard disk systems, etc.

To Order: Call Toll Free
1-800-645-3479
In N. Y. 1-516-374-6793

MICROMINT INC.
561 Willow Avenue
Cedarhurst, NY 11516



Modula-2

A Worthy Successor to Pascal

Niklaus Wirth, creator of Pascal, now brings us a general-purpose systems-implementation language based on modules.

Joel McCormack
Richard Gleaves
Volition Systems
POB 1236
Del Mar, CA 92014

In 1969, no appropriate programming language existed to clearly display the problem-solving techniques known as *structured programming*. Niklaus Wirth wanted to teach the principles of structured programming unencumbered by the irregularities and deficiencies of existing languages. To accomplish his task, he designed a new and elegant language: Pascal. Then, after nine years of researching Pascal's prob-

lems, Wirth created a language to replace it; that language is Modula-2.

Despite its lack of support from either the government or the computer industry, Pascal's remarkable ability to clearly express algorithms and data structures soon vaulted it out of academia and into the commercial world. In 1977, Welsh, Sneeringer, and Hoare (see reference 3) stated that "Pascal is at the present time the best language in the public domain for purposes of system programming and software implementation." Pascal's popularity soared phenomenally through the 1970s, and today it is one of the most popular microcomputer languages.

And yet, Brian Kernighan, a proponent of the C language, describes Pascal in its pure form as "suitable only for small, self-contained programs that have only trivial interactions with their environment and that make no use of any software written by anyone else" (see reference 1). In his blunt but accurate analysis of Pascal, Kernighan identifies eight major areas where Pascal lacks capabili-

ties necessary for serious programming. He concludes that "Pascal is a toy language, suitable for teaching but not for real programming."

How can Pascal be the best system-programming language available while being completely unsuitable for anything but teaching?

Extended Pascal

In his famous Turing Award lecture (see *Communications of the ACM*, February 1981; reprinted in September 1981 *BYTE*, page 414), Tony Hoare offered advice on language design that helps to resolve these two points of view: "You include only those features which you know to be needed for every single application of the language and which you know to be appropriate for every single hardware configuration on which the language is implemented. . . . That is the great strength of Pascal, that there are so few unnecessary features and almost no need for subsets. That is why the language is strong enough to support specialized extensions. . . ."

Editor's Note: Portions of this article were presented at the Mini-Micro '82 Computer Conference and Exhibition, September 14-16, Anaheim, California.

About the Authors

Joel McCormack is a software and hardware engineer at Volition Systems. As a UCSD graduate student, he coauthored the UCSD Pascal Z80 interpreter. McCormack is coauthor of Volition's Modula-2 compiler.

Richard Gleaves is a software engineer and technical writer at Volition Systems. Formerly a member of the UCSD Pascal project, Gleaves is coauthor of the original Apple Pascal interpreter and Softech Microsystem UCSD Pascal compiler.

Computer manufacturers, software houses, and universities have repeatedly shied away from computer languages nominally designed for "real programming." Recognizing the truth in both Kernighan's and Hoare's comments, they have instead chosen (or created) extended versions of Pascal. These computer users have no desire to sacrifice Pascal's unique abilities to:

- clearly describe data structures and algorithms
- detect programming errors as syntax errors (rather than quietly rearrange the meaning of the program)
- protect against improper mixing of different types
- prohibit assigning illegal values to variables

While C and FORTH proponents often dismiss these advantages as trivial, the worldwide proliferation of Pascal dialects testifies to the number of programmers who disagree.

Oregon Software and Digital Equipment Corporation have extended Pascal for real-time work; the University of California, San Diego, and Microsoft included features oriented to programming operating systems; Texas Instruments, Hewlett-Packard, Burroughs, National Semiconductor, and IBM have all added capabilities beyond the basic language. Even Tony Addyman, the driving force behind the ISO (International Organization for Standardization) Pascal Standard, admits to using a "kludged version of Pascal" in his hardware laboratory. How much do these various Pascals have in common? How well designed are their extensions?

The answers, sadly enough, are "not much" and "not very."

For example, UCSD Pascal (and derivative systems such as Apple Pascal and Pascal/M) includes predefined procedures for manipulating character arrays. Called Scan, MoveLeft, MoveRight and FillChar, these procedures blithely accept arguments of incorrect types, perform no checking of array bounds, and, unless used with the utmost care, can "wear out their welcome

with random precision." Microsoft Pascal has a similar but different set of procedures called ScanEq, ScanNe, MoveL, MoveR, and FillC.

Critical analysis of existing extensions drives home two points: (1) most programmers (though they may be very good programmers) are poor language designers; and (2) any given deficiency of Pascal has been "solved" in at least a dozen different ways.

Standard Extended Pascal

The alarming growth in extended Pascal dialects naturally led to the idea of defining a standard set of Pascal extensions. The first such effort was organized (with Wirth's approval) in January 1978 by Dr. Jorgen Steensgard-Madsen. Nine major implementers of Pascal (all but one from universities) attempted to reach agreement on a small number of extensions. This effort resulted only in the OTHERWISE clause for the CASE statement and some suggestions on the ISO Pascal standardization effort regarding conformant array parameters (see reference 2).

A second group—this time mostly commercial implementers—was assembled by Ken Bowles in July 1978, but this effort fared no better than the first. Though many language extenders were in attendance, few were experienced language designers. Group members tended to be loyal to extensions already implemented in their own compilers, so in the limited amount of time allotted for the conference only a small number of extensions—all trivial—was approved. A large number of items was passed on to the Steensgard-Madsen group, which at the time still appeared to be a viable committee. The remaining hodgepodge of conflicting proposals was tossed together under the label "experimental." (This meeting is documented in "Proceedings of the UCSD Workshop on Systems Programming Extensions to the Pascal Language," Institute for Information Systems, UCSD, 1979.)

Today, a third attempt is being made to standardize Pascal language extensions, this time under the auspices of the American National Standards Institute (ANSI). Con-

sidering the outcome of the first two groups (in which one of the authors participated) and the slow and tortuous path taken just to define an ISO Pascal standard, we have doubts that the ANSI effort will prove any more effective than its predecessors. The time for agreement on Pascal extensions quietly passed years ago; even if ANSI could issue a standard tomorrow, the prospects are bleak for conformance by major Pascal vendors. Popular systems such as Apple Pascal and UCSD Pascal fail to conform to even the base language standard. With their large (and growing) user base, such vendors may find it difficult to offer a new set of standardized extensions while maintaining compatibility with their plethora of existing proprietary extensions.

Meanwhile, Modula

Niklaus Wirth's direct involvement in the Pascal extension efforts was conspicuously small. Indeed, years of debate might have been avoided had he stepped in with his own extension proposals. However, Wirth's comments reflect a motivation by ideals rather than by politics: "If a language proves to be only marginally suitable for some application that was obviously not envisaged by its originator, we should muster the courage to build a new, truly adequate tool, instead of just grafting a fix onto the existing one" (see page 83 of reference 4).

After designing Pascal, Wirth chose to investigate the programming problems posed by multiprocessing and I/O devices. He designed the special-purpose language Modula to gain firsthand experience with programming small real-time control systems:

The primary benefit of the use of a suitable high-level language lies in the possibility of defining abstract machines in a precise manner that is reasonably independent of characteristics of particular hardware. Assembly code is still used virtually exclusively in those applications whose predominant purpose is not to design a new system based on abstract specifica-

tions, but to operate an existing machine with all its particular devices. . . . A major aim of the research on Modula is to conquer that stronghold of assembly coding, or at least to attack it vigorously [reference 4, page 3].

Modula consisted of a minimal subset of Pascal, to which was added the module structure, an improved syntax, and facilities for multiprocessing and low-level machine access. Unlike Pascal, Modula was not intended as a general-purpose language: among other things, it lacked Pascal's files, sets, and pointers. Modula's most significant feature was the module structure. While programming was awkward without Pascal's data-structuring facilities, modules proved an invaluable asset—as far a step beyond Pascal's block structure as the block structure had been beyond the FORTRAN subroutine call.

Though Modula is still in use today at some universities, Wirth discontinued his own research with the language after spending a sabbatical year at the Xerox Palo Alto Research Center (PARC). Modula had served its purpose as a programming tool designed for a specific task.

Finally, Modula-2

At Xerox PARC, Wirth had the opportunity to use the Alto personal computer and the Mesa programming language. Upon returning to Switzerland, he embarked on a project to design a similar but simpler computer system—including both hardware and software. Wirth states:

This system (later to be called Lilith) was to be programmed in a single high-level language, which therefore had to satisfy requirements of high-level system design as well as those of programming of parts that closely interact with the given hardware. Modula-2 emerged from careful design deliberations as a language that includes all aspects of Pascal and extends them with the important module concept and . . . multiprogramming [see page 3 of reference 5].

Modula-2 is a general-purpose systems-implementation language that includes the best elements of its predecessors. Modula-2's statement structures and data types are a superset of Pascal's; the systematic syntax, module concept, machine access, and multiprocessing are improved versions of those features found in Modula-1. In addition, the design of Modula-2 systematically addresses Pascal's problems (see "Solving Pascal's Problems" on page 389).

Modules

The key difference between Modula-2 and Pascal is in the way they are extended. Pascal extensions are built into the language, so Pascal programmers cannot change them or add new extensions. Modula-2 is extensible—it allows Modula-2 programmers to create their own extensions. The key to this ability is the module structure.

A module is a collection of declarations that work together to perform a given task. A simple example of a

Listing 1: *The module RandomNumbers serves as a wall around the random function and its seed variable. The export statement allows the random function to be called outside of the module, but the seed variable remains hidden inside the module and can be accessed only by the random function. The outer block of the module is automatically executed when the program begins; it assigns an initial value to Seed by assigning it the value of the identifier SystemTime. SystemTime is declared outside of the module but can be accessed inside because it has been imported.*

Note how the module contains all the details concerning the operation of the random-number generator; only the identifier Random is visible outside the module. It is their ability to collect together and hide all the unnecessary details of a mechanism that makes modules such powerful constructs for organizing large programs.

```
MODULE MainProgram;

  VAR i: INTEGER;
  ...

MODULE RandomNumbers;

  IMPORT SystemTime;
  EXPORT Random;

  VAR Seed: INTEGER;

  PROCEDURE Random(): INTEGER;
  CONST Modulus = 7415;
        Inc     = 25543;
  BEGIN
    Seed := (Seed + Inc) MOD Modulus;
    RETURN Seed;
  END Random;

BEGIN
  Seed := SystemTime;
END RandomNumbers;

...

BEGIN
  i := Random();
  ...

END MainProgram.
```

Listing 2: This program uses three separately compiled modules: the library module *SimpleFiles*; the definition module, which exports the type *FILE* and file operations; and the implementation module.

```

DEFINITION MODULE SimpleFiles;

  EXPORT QUALIFIED
    FILE, Open, Close, Read, Write, Error;

  TYPE FILE;      (* Opaque type... structure unknown outside *)

  PROCEDURE Open (VAR f: FILE; name: ARRAY OF CHAR);
  PROCEDURE Close (VAR f: FILE);
  PROCEDURE Read (f: FILE; VAR ch: CHAR);
  PROCEDURE Write (f: FILE; ch: CHAR);

  PROCEDURE Error (f: FILE): BOOLEAN; (* TRUE if I/O error *)

END SimpleFiles.

IMPLEMENTATION MODULE SimpleFiles;

FROM SYSTEM IMPORT ADDRESS, ADR;

CONST FileNameLength = 20;

TYPE blockrange = [0..511];

TYPE FILE = POINTER TO RECORD      (* Details hidden inside *)
  FileName: ARRAY [0 .. FileNameLength-1] OF CHAR;
  CASE diskfile: BOOLEAN OF
    TRUE: diskblock: CARDINAL;
        byteinblock: blockrange;
        buffer: ARRAY blockrange OF CHAR;
    | FALSE: IOUnit: CARDINAL;
  END (* case *)
END (* FILE *);

PROCEDURE Open (VAR f: FILE; name: ARRAY OF CHAR);
  (* body of Open *)
END Open;
...
PROCEDURE DiskIO (unit: CARDINAL; buf: ADDRESS);
  (* low-level procedure hidden in module *)
END DiskIO;

BEGIN
  ...
END SimpleFiles.

MODULE MyProgram;

  FROM SimpleFiles IMPORT
    FILE, Open, Close, Read, Error;

  VAR f1, f2: FILE;
      ch: CHAR;

BEGIN
  Open(f1, "myfile.data");
  ...
  Read(f1, ch)
  IF Error(f1) THEN HALT END;
  ...
  Close(f1);
END MyProgram.

```

module is a random-number generator consisting of a random function and its seed variable (see listing 1). A module forms a wall around its objects; except for explicitly *imported* and *exported* identifiers, the module's contents are isolated from the surrounding program. In the random-number generator, the procedure `Random()` can be called from outside the module because it is exported; the variable `Seed`, however, remains hidden inside the module and is accessible only by the random function.

It is their ability to encapsulate related declarations that makes modules such a powerful concept—they are the software equivalent of a “black box.” Modules partition large programs into logically related pieces with well-defined interfaces (i.e., the imported and exported identifiers); as a result, Modula-2 programs are easier to read, easier to understand, and less prone to erroneous side effects than Pascal's block-structured programs. (Anyone who has ever read a large Pascal program knows how they are structured: an army of procedures interconnected by pages of global declarations.)

The ability of modules to divide programs into semi-independent parts provides the foundation for separate compilation in Modula-2. Library modules are divided into two separately compiled parts: a *definition module* and its corresponding *implementation module*. The definition module contains declarations made available to other modules (called *client modules*). The implementation module contains the actual code and data that implement the operations defined by the definition module.

Listing 2 shows three separately compiled modules. The library module *SimpleFiles* provides a simple file I/O system, the definition module exports the type *FILE* and file operations, while the implementation module contains the code implementing the file system.

The type *FILE* is called an *opaque* type—its record fields are fully accessible within the implementation

module, but only the type name is visible outside the module. Opaque types are a form of the programming concept known as *abstract data types*. Abstract data types are objects whose only operations are defined by a set of procedures. Pascal's FILE type is an example of an abstract type; however, Pascal does not allow programmer-defined abstract types.

This example introduces the concept of *qualified* export. When an export list includes the symbol QUALIFIED, client modules must prefix all references to the exported identifiers with the name of their module; for instance, the identifier Open would have to be referenced as SimpleFiles.Open. Qualified export allows library modules to avoid clashes with identifiers already declared in client modules. Client modules in turn can "unqualify" identifiers by preceding their import lists with the symbol FROM and the library module name.

The module MyProgram imports SimpleFiles to perform its file I/O. MyProgram is an executable program; however, it can also be called by other modules as a subprogram. (Subprogram calls are performed with the procedure Call exported by the library module Program.) Programs and subprograms share information by importing the same library module.

Separate Compilation

The separate compilation facilities in most programming languages are more aptly termed "independent compilation" facilities; no type checking is performed between separately compiled parts. This has traditionally been a great source of problems, especially when parts of a large software system are developed by different people. In fact, data-processing professionals invented a special term to describe this sometimes harrowing task: they call it "system integration."

Modula-2 is specifically designed to maintain type checking across module boundaries. The compiled form of a definition module contains type information that is accessed when compiling both the corresponding implementation module and all

Solving Pascal's Problems

In a paper entitled "Why Pascal Is Not My Favorite Programming Language," the noted C language proponent Brian Kernighan identifies eight major problems with Pascal. R.T. Summer and R.E. Gleaves have shown how Modula-2 addresses each of these problems ("Modula-2—A Solution to Pascal's Problems," ACM SIGPLAN Notices, September 1982):

Pascal arrays are fixed in size, making string handling difficult and general-purpose math libraries impossible.

Modula-2 includes "open" array parameters, which accept arrays of varying length. Also, character strings are assignable to array variables of different lengths.

Pascal's lack of "own" variables forces programmers to use global variables, which have a larger scope than they ought to.

The module structure offers a superior method for hiding variables from most of a program.

Pascal's lack of separate compilation hinders the development of large programs and makes the use of libraries impossible.

Modula-2 offers separately compiled library modules and subprogram modules. Library modules are collections of procedures and data that are accessible by other modules. Subprogram modules are separately compiled modules that can be called by other modules. Unlike many languages, Modula-2 offers full type checking across separately compiled modules.

Pascal's required declaration order prevents related declarations from be-

ing grouped together.

Modula-2 allows constants, types, variables, procedures, and modules to be declared in any order. Modules provide an even better way to group related declarations.

Pascal's Boolean expressions are not conditionally evaluated, resulting in convoluted expressions and extraneous state variables.

Modula-2 explicitly defines the evaluation order of logical expressions as conditional "short-circuit" evaluation, allowing statements like "WHILE ($p < > NIL$) AND ($p \neq \text{data} < 0$) DO . . .".

Pascal's CASE statement is hampered by its lack of an OTHERWISE clause.

Modula-2 CASE statements have an optional ELSE part for catching unspecified case values. Also, subranges can be used in case constant lists, eliminating the need to explicitly declare all case constant values.

Pascal's I/O facilities are extremely limited; they cannot deal with real-world files or program arguments.

The Modula-2 language includes no I/O facilities. I/O is provided by standard library modules, but these can be supplemented (or replaced) by defining different I/O modules.

Pascal's strict enforcement of type checking prohibits low-level programming.

Modula-2's low-level programming facilities provide machine-level operations: type conversion, pointer arithmetic, bit manipulation, and direct access to memory. Unlike many languages, Modula-2 provides controlled low-level access, preventing erroneous high-level programs from merely becoming low-level programs.

client modules. The separation of definition and implementation enables you to change implementation modules without forcing recompilation of all client modules. Because the definition module remains unchanged, type consistency is preserved. This saves a lot of unnecessary system-generating (sysgen) time when maintaining large software systems.

Changing both definition and implementation, however, invalidates all client modules because the inter-

face between the module and its clients has now changed. Executing an out-of-date client module might crash the system.

Wirth solved this problem in Modula-2 by maintaining a system-wide module-version control scheme. When a definition module is compiled, the compiler assigns a unique value to the module. This value is known as a *module key*. When the corresponding implementation module is compiled, it inherits the module key of its definition. When a

client module imports the library module, a copy of the imported module's key is recorded in the resulting code file.

When a program is executed, the program loader checks that the module keys recorded in the program match those found in the compiled code of the imported implementation modules. As implementation modules receive their keys from the corresponding definition module, implementations can be optimized, modified, or entirely replaced without affecting any client modules. But if a definition module (and, subsequently, its implementation) is recompiled—perhaps to change a parameter list or add a variable to the module's interface—a new module key is assigned. Attempts to execute client modules compiled with the old library module result in a version error, indicating that the client module must be recompiled.

The implications for multiperson project management are revolutionary: system integration no longer needs to be plagued by mismatches between the agreed-upon interfaces and the actual code.

If a software system is sufficiently well understood to be fully defined beforehand, the system's definition modules can be distributed in compiled form to the programming team members, who can then write and modify implementation modules without forcing everybody else on the project to recompile when a change is made. Individual team members cannot alter a module interface, as the compiler enforces conformance between the procedure headings declared in the definition module and the corresponding headings in the team member's implementation module.

If team members are granted access to the source text of definition modules (to make small changes to the specification), several versions of the "same" definition module may proliferate; however, the version-control system prevents the execution of mismatched modules, allowing system testing to proceed only after all modules adhere to the same set of interfaces.

Libraries

Pascal requires an underlying operating system for its I/O and storage management. Modula-1 requires a small run-time system for scheduling processes. Modula-2 requires neither: because such operations are programmed as library modules, the language itself requires virtually no support above the hardware level.

A Modula-2 library typically contains modules for the following operations:

- Console I/O and keyboard polling
- Format conversion between text and binary representations
- File I/O operations—read, write, and seek
- File directory operations—create, delete, and rename
- Storage management—new and dispose
- Program execution
- Process scheduling
- Mathematical functions
- Dynamic string manipulation

It is no coincidence that these operations are normally the domain of an operating system; however, there is a crucial difference between module libraries and operating systems. Operating systems are traditionally written by elite bands of systems programmers who, in their attempts to deliver monolithic systems suitable for all applications, often create systems with so much overhead that they are unusable. Modula-2 lets you select the system facilities you need without having to pay for those you don't need. The module library constitutes a flexible and extensible operating system.

The library contains not only the usual system facilities, but also every library module and program module in the system. Any library module in the system can be imported by any other module; any program module in the system can be called as a subprogram by any other module. This encourages a building-block approach to the development of software systems: high-level library modules are built from collections of

low-level modules; large programs are built from collections of smaller programs.

Modula-2's library concept offers the potential for writing portable software systems that can be moved with little or no change across different operating systems. A set of standard definition modules can provide client modules with an operating environment that is independent of any operating system. Moving software to a new operating system merely requires a set of implementation modules that use the host system's facilities to implement the standard definition modules. (This approach is equally suited for using large systems to develop software targeted for small stand-alone systems.)

Modula-2 also has a remarkable ability to incorporate existing software into the Modula-2 environment. Programs written in other languages can be called as subprograms, thus becoming part of a Modula-2 program. Specially defined modules can access non-Modula library routines, host-operating-system calls, and even machine instructions. Yet, because all these facilities are accessed via definition modules, they are uniformly referenced as Modula-2 library modules.

As Wirth so succinctly states, library modules are "an essential part of a Modula-2 implementation" (see reference 5).

Run-Time Binding

The modular nature of Modula-2-based systems requires a different environment from that of most software development systems. In particular, the compiler, program loader, and library form an integrated system, with module binding performed automatically at run time. Adding a module to the library (or updating an existing module) requires only that the module be compiled; the compiler writes the code file to the library, so when the module (or one of its clients) is executed, the loader can find it by searching the library.

Run-time module binding eliminates linking and the resulting problems associated with large linked object files containing multiple copies

of the same module code. Instead, a single copy of a module-code file can be shared by a number of programs. Because run-time binding is slower than executing prelinked object files, facilities are also provided for optionally linking collections of modules together to form a single object file. This yields faster program loading at the expense of extra effort to update any of the modules in the program.

Procedure Variables

The module structure encourages the development of reusable software components. (The philosophy of software components is simple: it is easier to use an existing program than it is to write one from scratch!) A common problem with software components is that they are often difficult to tailor to the needs of client modules. For instance, one client may want a library module to perform its own error handling, while another client of the same module may want to substitute different error-handling routines.

Modula-2 addresses this problem by introducing the concept of *procedure variables*, a generalization of Pascal's procedure parameters. Procedure variables are variables that are assigned procedures as values. Calling a procedure variable invokes the procedure assigned to it.

Procedure variables allow client modules to "plug" their own procedures into a library module. For instance, a client can plug an error-handling procedure into a library module; when the library module detects an error condition, it calls an internal procedure variable, in turn invoking the client's own error-handling procedure.

Another use of procedure variables is the definition of automatic initialization and termination sections for library modules. This enables a library module to start up and shut down its own resources independently of any client modules.

For example, a network-handler module might define an initialization procedure that performs the hardware operations necessary to hook itself up to a network; similarly, it would define a termination procedure

to unhook the network connection. The network-handler module passes these procedures to the program loader, indicating that they are to be called when the module is first loaded into memory and when it is about to be released. Client modules are unaware of these actions; all they know is that the module gives them access to an open network connection.

Listing 3 shows how procedure

variables can be used to implement error handling and initialization/termination sections in a network-handler module.

Machine Access

Because low-level system facilities are written as library modules, Modula-2 provides facilities for machine-level programming. Such facilities are by nature machine-dependent, so they may vary across

Listing 3: *In this example of procedure variables, the library module Network manages a network connection. Initialization and termination procedures are established by calling the procedure SetEnvelope imported from the loader (a module named Program). The initialization procedure is called when Network is first loaded; the termination procedure is called when it is about to be released from memory.*

The procedure SetHandler allows error handlers to be attached to open network nodes. (The type PROC is a predefined type denoting a parameterless procedure.) The client module NetWriter declares its own error-handling procedure and attaches it to the node variable by calling SetHandler. Note that Netwriter does not require error-checking code after every network operation, because the network module will automatically call NetWriter's error-handling procedure if a network error occurs.

```
DEFINITION MODULE Network;

  EXPORT QUALIFIED
    NODE, Open, Close, Send, Receive, SetHandler;

  TYPE NODE;

  PROCEDURE Open    (VAR n: NODE; device: CARDINAL);
  PROCEDURE Close  (VAR n: NODE);
  PROCEDURE Send   (n: NODE; ch: CHAR);
  PROCEDURE Receive (n: NODE; VAR ch: CHAR);

  PROCEDURE SetHandler (VAR n: NODE; handler: PROC);

END Network.
```

```
IMPLEMENTATION MODULE Network;

  FROM Program IMPORT SetEnvelope;

  ...

  TYPE NODE = POINTER TO RECORD
    HandleProc: PROC; (* error handler procedure *)
    AccessMode: NetAccess;
    Buffer: ARRAY bufrange OF CHAR;
    ...
  END;

  PROCEDURE Send (n: NODE; ch: CHAR);
  BEGIN
    ...
    IF LostConnection THEN n^.HandleProc() END;
  END Send;

  ...
```

Listing 3 continued on page 392

Listing 3 continued:

```
PROCEDURE SetHandler (VAR n: NODE; handler: PROC);
BEGIN
  n^.HandleProc := handler;
END SetHandler;

PROCEDURE Startup;
BEGIN
  (* open network connection *)
END Startup;

PROCEDURE Shutdown;
BEGIN
  (* disconnect from network *)
END Shutdown;

BEGIN
  SetEnvelope(Startup, Shutdown);
END Network.
```

```
MODULE NetWriter;

  IMPORT Terminal;

  FROM Network IMPORT
    NODE, Open, Close, Send, SetHandler;

  PROCEDURE handler;
  BEGIN
    Terminal.WriteString("Network error!");
    HALT;
  END handler;

  VAR n1: NODE;
      ch: CHAR;

  CONST Copier = 121;

  BEGIN
    Open(n1, Copier);
    SetHandler(n1, handler);
    ...
    Send(n1, ch)
    ...
    Close(n1);
  END NetWriter.
```

Modula-2 implementations and should be avoided in programs designed for portability. Machine-level programming is usually isolated in a small number of modules to separate machine-specific from portable software.

The predefined type BITSET is defined as a set that fits in one machine word. Bitsets allow efficient bitwise manipulation of word quantities.

The predefined module SYSTEM exports the system-dependent identifiers WORD, ADDRESS, SIZE, TSIZE, and ADR. When the type WORD is used as a parameter type, it is compatible with any object occupying one word. When WORD is used as the base type of an unbounded array parameter (ARRAY OF WORD), the parameter is compatible with variables of any size or type, including records and sets. The type WORD

allows for writing general-purpose routines that operate on variables of any type.

The type ADDRESS is compatible with the type CARDINAL (unsigned integer) and all pointer types. Arithmetic operators can be applied to variables of type ADDRESS, allowing pointer and address arithmetic. This is important for writing storage managers, especially since Modula-2 translates the standard procedures NEW and DISPOSE into calls to the low-level procedures ALLOCATE and DEALLOCATE. These procedures are usually imported from a standard storage-management module, but they can also be defined in other ways to allow different styles of storage management.

The functions SIZE(x) and TSIZE(t) return the size of variables and types. The function ADR(x) returns the memory address of variables.

Variables can be declared to reside at fixed memory addresses. This is useful for accessing memory-mapped device registers.

Type checking can be circumvented by using a type identifier as a *type-transfer function*, which converts the type of its parameter argument to the type of the function identifier. Type conversion is restricted to objects that occupy the same number of words.

Code procedures enable Modula-2 programs to directly access facilities provided by the underlying hardware or host operating system. A code procedure consists of a procedure heading followed by the reserved word CODE and a series of machine instructions; these instructions are substituted inline for each procedure call. The use of code procedures is generally restricted to low-level modules.

Listing 4 shows Modula-2's machine-level programming facilities in action.

Multiprocessing

Most modern systems-programming languages include multiprocessing facilities as part of the language. For instance, Modula-1 offers processes and semaphores, Ada includes tasks and rendezvous, and

Concurrent Pascal contains monitors. Modula-2 forgoes these higher-level multiprocessing models in favor of the simpler and lower-level *coroutine* concept.

Coroutines are procedures that execute independently but not concurrently. In a group of coroutines, only one coroutine executes at a time—the rest are inactive. Coroutines communicate by calling each other; in a coroutine call, the calling coroutine becomes inactive, and the called coroutine resumes execution.

Coroutine facilities exported by the module SYSTEM include the procedures NEWPROCESS, TRANSFER, and IOTRANSFER, and the type PROCESS.

The procedure NEWPROCESS (Procedure, Adr, Size, Coroutine) creates a new coroutine. The parameter Procedure specifies the procedure to be executed by the coroutine. The parameters Adr and Size specify an area of memory for the coroutine to execute in. The newly created coroutine is returned in the parameter Coroutine, which is a variable of type PROCESS.

Coroutine calls are performed with the procedure TRANSFER (with process variables Old and New). TRANSFER suspends the current coroutine, assigns it to the process variable Old, and then resumes execution of the coroutine previously assigned to the process variable New.

The procedure IOTRANSFER (with process variables Old and New, and integer value IntVect) allows coroutines to be used as interrupt handlers. IOTRANSFER initiates a coroutine call from Old to New; however, when the peripheral device specified by IntVect causes an interrupt, control is automatically transferred back to the interrupt-handling coroutine. Listing 5 shows how coroutines work as interrupt handlers.

Coroutines are appropriate for many common multiprocessing applications; however, when higher-level forms of process scheduling are needed (e.g., semaphores or message passing), they can be constructed in terms of coroutines and stored in library modules. Modula-2 thus has

Listing 4: This program demonstrates Modula-2's machine-level programming facilities. The module MyStorage provides a very simple storage allocator: starting at memory address 0, it assigns successive memory words to dynamically allocated variables. Note that ALLOCATE accepts arguments of any pointer type and that any calls to NEW in this program are handled by the storage module.

The variable Console is declared to reside at hexadecimal memory address FFE8. The variable Sneaky uses a type-transfer function to gain bitwise access to a 32-bit real number. The code procedure LoadByte provides direct access to the Apple Pascal p-code instruction LDB: it loads a byte from memory onto the P-machine evaluation stack. The procedure PrintHex accepts variables of any type as arguments. Inside PrintHex, the parameter is viewed as an array of words in the range 0 to HIGH(mem). HIGH is a standard function that returns the upper index of array parameters.

```

MODULE LowLevel;

  FROM InOut IMPORT WriteHex;

  MODULE MyStorage;
    EXPORT ALLOCATE;

    VAR HeapTop: ADDRESS;

    PROCEDURE ALLOCATE (VAR ptr : ADDRESS; size: CARDINAL);
    BEGIN
      ptr := HeapTop;
      HeapTop := HeapTop + size;
    END ALLOCATE;

  BEGIN
    HeapTop := 0
  END MyStorage;

  VAR Console [OFFE8H]: BITSET;

  PROCEDURE LoadByte (base: ADDRESS; offset: CARDINAL): CARDINAL;
  CODE
    190; (* LDB p-code: gets base & offset off stack *)
  END LoadByte;

  PROCEDURE PrintHex (mem: ARRAY OF WORD);
  VAR i: CARDINAL;
  BEGIN
    FOR i := 0 TO HIGH(mem) DO WriteHex(mem[i], 0) END;
  END PrintHex;

  VAR ch: CHAR;
      r: RECORD
        x,y,z: REAL;
      END;
      a: ARRAY [0..50] OF CARDINAL;

  TYPE SetReal = SET OF [0 .. 31];

  VAR Sneaky: SetReal;

  BEGIN
    Sneaky := SetReal (1.OE-13);
    a[0] := LoadByte(3FFFH, 3);
    PrintHex(ch);
    PrintHex(r);
    PrintHex(c);
  END LowLevel.

```

Listing 5: This program, which illustrates coroutines and interrupts, writes a continuous stream of "hos" to the screen, but an occasional "hi" pops up among the "hos."

The main program creates the coroutines Hi and Ho, then transfers to Hi (suspending itself permanently). The first thing Hi does is execute IOTRANSFER, transferring control to Ho. Ho runs in a loop, continually writing "ho" out to the screen; however, when an interrupt occurs through interrupt vector 4, control is automatically transferred back to Hi. Hi writes out "hi," transfers back to Ho, and waits for the next interrupt. In this example, interrupt vector 4 might be triggered by typing a key on the keyboard. Interrupt-vector assignment varies on different systems.

```

MODULE HiHo;

FROM SYSTEM IMPORT
  WORD, ADR, SIZE, PROCESS, NEWPROCESS, TRANSFER;

FROM Terminal IMPORT WriteString, Writeln;

CONST maxHiHo = 17;

VAR i: CARDINAL;
    Hi, Ho, Main: PROCESS;
    A, B: ARRAY [1..200] OF WORD;

PROCEDURE WriteHi;
BEGIN
  LOOP IOTRANSFER(Hi, Ho, 4); (* intpt. vector = 4 *)
    WriteString("hi");
  END;
END WriteHi;

PROCEDURE WriteHo;
BEGIN
  LOOP WriteString("ho");
    INC(i);
    IF i > maxHiHo THEN
      Writeln; i := 0;
    END;
  END;
END WriteHo;

BEGIN i := 0;
  NEWPROCESS(WriteHi, ADR(A), SIZE(A), Hi);
  NEWPROCESS(WriteHo, ADR(B), SIZE(B), Ho);
  TRANSFER(Main, Hi);
END HiHo.

```

the advantage of being able to provide most any kind of process scheduling (including none at all).

Miscellaneous Improvements

Modula-2 is more than just Pascal extended with modules, machine access, and multiprocessing. It also introduces the following changes to Pascal that simplify programming and improve program readability and efficiency, as shown in listing 6:

- Each structured statement has an explicit terminating symbol: UNTIL for the REPEAT statement, and END

for the rest. This eliminates the need for Pascal's compound statement (i.e., BEGIN . . . END).

- Everywhere Pascal allows constants, Modula-2 allows constant expressions; for instance, TYPE a = ARRAY [0..n-1] OF CHAR.

- CASE statements can have subranges in their case constant lists (eliminating the need to specify each constant value); also, CASE statements have an (optional) ELSE part.

- Variant records use the same syntax as CASE statements.

- Functions can return any type, including records and arrays.

- Procedures can declare unbounded ("open") array parameters, which accept arrays of varying length.

- The symbols # and & are defined as synonyms for the often-used symbols < > and AND.

- The AND and OR Boolean operators skip the second operand if the expression value can be determined from the first operand. Conditional-expression evaluation simplifies the programming of many situations.

- The LOOP/EXIT statement allows for clear and efficient expression of loop-and-a-half constructs.

- The FOR statement has an optional BY part for specifying step values other than 1.

All characters in a Modula-2 identifier are significant, not just the first eight, allowing you to use long identifiers without having to worry about accidental aliasing. The capitalized reserved words stand out in larger programs, improving readability. Modula-2 enforces case sensitivity of identifiers to prevent identifier aliasing (e.g., MYIDENT being the same as myIdent).

Conclusion

Pascal is ill-suited for implementing systems software, yet its basic structure is sound enough that many have chosen to extend the language rather than abandon it. This has resulted in an irremediable Tower-of-Babel syndrome from which the only escape is a new and better language.

Other languages vie for this honor, notably C and Ada, but none can be demonstrated to be superior to extended Pascal. C has proven itself as a practical language, but it suffers from unreadability, lack of type checking, and inadequate separate compilation facilities. Ada is a jungle of intertwined features; one suspects it was designed as a challenge to compiler writers, not as a tool for software engineers.

With Modula-2, Niklaus Wirth has created the language that will replace Pascal. Modula-2 can express everything from device drivers and system software to libraries and ap-

Listing 6: Modula-2 is more efficient and more readable than Pascal. The example shows a piece of Pascal code and its Modula-2 equivalent. The Modula-2 code is two lines shorter and has one less variable reference and two fewer statements. Modula-2's conditional-expression evaluation eliminates the need for the second Pascal "if" statement. The standard procedure INC shortens the expression (and produces more efficient object code) by eliminating the second reference to the variable accountbalance.

(* PASCAL *)

```
if p <> NIL then
  if p^.update then
    begin
      p^.accountbalance := p^.accountbalance + receipts * 2;
      p^.update := false;
    end;
```

(* MODULA-2 *)

```
IF (p # NIL) & p^.update THEN
  INC(p^.accountbalance, receipts * 2);
  p^.update := FALSE;
END;
```

plication programs. Modula-2's module concept and improved syntax make it more readable than Pascal. Modula-2 is as simple as Pascal and is small enough to allow efficient program development on 8-bit microcomputers. Modula-2 has enough in common with Pascal that Pascal programmers are able to write Modula-2 programs in a matter of hours.

In short, Modula-2 contributes to the design of software systems what Pascal has contributed to the design of programs. It is indeed a worthy successor to Pascal. ■

References

1. Kernighan, B. "Why Pascal Is Not My Favorite Programming Language," *Computing Science Technical Report No. 100*, Bell Laboratories (July 18, 1981).
2. Sale, A. "Consensus Position on Case Defaults," *Pascal News #13*, page 84.
3. Welsh, J., W. J. Sneeringer, and C. A. R. Hoare. "Ambiguities and Insecurities in Pascal," *Software Practice and Experience* 7 (1977), pages 685-696.
4. Wirth, N. "Modula: a Language for Modular Multiprogramming" and "Design and Implementation of Modula," *Software Practice and Experience* 7 (1977), pages 3-35, 67-84.
5. Wirth, N. *Programming in Modula-2*. New York: Springer-Verlag, 1982.

Where to Get Modula-2

The following organizations distribute Modula-2:

Institut für Informatik
ETH
CH-8092 Zurich
Switzerland



ETH Zurich is the university where Modula-2 was conceived. ETH distributes Modula-2 compilers for the PDP-11, 68000, 6809, and Lilith. Lilith is a high-speed personal computer with superior graphics, a mouse, and a bit-slice processor designed to execute M-code.

Modula Research Institute
950 North University
Provo, Utah 84604

MRI is a nonprofit research organization that builds Lilith computers and sells them to large organizations for about \$15,000 apiece. Liliths include Modula-2 software developed at ETH.

Volition Systems
POB 1236
Del Mar, CA 92014

Volition Systems released the first commercial implementation of Modula-2. Volition's current Modula-2 system runs under the UCSD Pascal system; it is available for the Apple II, Apple III, Sage II, Scenic One, NCR ALP-2, TI 9900, and 8080/Z80-based systems. Modula-2 compilers for other processors and operating systems will be available in the near future.

<p>BASIS Authorized Sales & Service U.S. #1 Dealer for Basis</p> <p>BASIS 108 Computer w/64K or 128K completely assembled, tested, configured Fourth Dimension, Rana Elite or Hard Disk 5, 10, 15 MB built-in, Basis Diagnostic Controller Card BAS RAM 256K Card Call</p> <p>COMPUTER SYSTEMS Basis 108 Computers NEC PC8000 Computers Call Eagle Computers } Best Epson Computers } Prices Sanyo Computers }</p> <p>DISK SYSTEMS Inquire about our complete line of 5 1/4", 8" & Hard Disk Drives</p> <p>COMMUNICATIONS Hayes Micromodem II \$275 Hayes Modem 1200 Call</p>	<div style="text-align: center;">  <p>COMMUNI-CAL INC.</p> <p>1400 GRANT AVE. / NOVATO, CALIFORNIA 94947 ORDER TOLL FREE 1-800-421-6594 IN CALIFORNIA CALL COLLECT 415-892-7139 TECH SUPPORT 415-897-1414</p> </div> <p>BUY COMPUTERS FROM PEOPLE WHO KNOW HOW TO USE THEM. SERVICES AVAILABLE: SOFTWARE APPLICATIONS • HARDWARE PERIPHERALS COMPUTER SECURITY • TELECOMMUNICATIONS • BUSINESS • SCHOOLS CORPORATIONS • CONSULTATION SERVICES • 24-HOUR AIR EXPRESS AVAILABLE Ask about our clients. All equipment tested prior to shipment. If you don't see it, please ask us.</p> <table border="0"> <tr> <td>MONITORS</td> <td></td> <td>MICROSOFT PREMIUM SYSTEM</td> <td></td> </tr> <tr> <td>NEC Hi-Res 12" Green</td> <td>\$129</td> <td>Upgrade your Apple!</td> <td>\$599</td> </tr> <tr> <td>NEC RGB 12" Color</td> <td>Call</td> <td></td> <td></td> </tr> <tr> <td>USI P13 12" Amber</td> <td>\$169</td> <td></td> <td></td> </tr> <tr> <td>Sanyo</td> <td>Call</td> <td>* DISKETTE SPECIAL *</td> <td></td> </tr> <tr> <td>Amdek</td> <td>for</td> <td>Maxell MD-1 (Box of 10)</td> <td>\$32</td> </tr> <tr> <td>Electrohome</td> <td>} Best</td> <td>MISC</td> <td></td> </tr> <tr> <td>Televideo Terminals</td> <td>Prices</td> <td>Atari Software</td> <td></td> </tr> </table>	MONITORS		MICROSOFT PREMIUM SYSTEM		NEC Hi-Res 12" Green	\$129	Upgrade your Apple!	\$599	NEC RGB 12" Color	Call			USI P13 12" Amber	\$169			Sanyo	Call	* DISKETTE SPECIAL *		Amdek	for	Maxell MD-1 (Box of 10)	\$32	Electrohome	} Best	MISC		Televideo Terminals	Prices	Atari Software		<div style="text-align: center;">  </div> <p>Minimum order \$100. Cashiers checks and money orders accepted. Add 3% for VISA or MC. Add 3% for shipping/insurance/handling. UPS. No COD. Prices subject to change. Call weekly. Order hours 9-6 PST. Mon-Fri. Personal checks allow 20 days to clear. All products with full manufacturer's warranty. Factory sealed. Call. Residents add 6% sales tax. Bank wires & P.O.'s accepted. Retail prices may vary. Apple is a registered trademark of Apple Computer, Inc. All brand names are registered trademarks.</p> <table border="0"> <tr> <td>IBM Software & Peripherals</td> <td>Call</td> </tr> <tr> <td>PERIPHERALS</td> <td></td> </tr> <tr> <td>Thunderclock</td> <td>\$125</td> </tr> <tr> <td>Mountain Computer Products</td> <td></td> </tr> <tr> <td>Videx Products</td> <td></td> </tr> <tr> <td>MicroSoft Products</td> <td></td> </tr> <tr> <td>TG Joysticks, Paddles</td> <td>Call</td> </tr> <tr> <td>System Saver Fans</td> <td>for</td> </tr> <tr> <td>Saturn Systems</td> <td>Best</td> </tr> <tr> <td>Axon Products</td> <td>Prices</td> </tr> <tr> <td>SVA Products</td> <td></td> </tr> <tr> <td>16 Bit Apple Card</td> <td></td> </tr> <tr> <td>Passport Designs Music System</td> <td></td> </tr> </table>	IBM Software & Peripherals	Call	PERIPHERALS		Thunderclock	\$125	Mountain Computer Products		Videx Products		MicroSoft Products		TG Joysticks, Paddles	Call	System Saver Fans	for	Saturn Systems	Best	Axon Products	Prices	SVA Products		16 Bit Apple Card		Passport Designs Music System		<p>PRINTERS AND INTERFACES NEC PC 8023A NEC Spinwriter Series Epson w/Graftrax Plus Okidata Microline } Call IDS MicroPrism } for Anadex Products } Best CCS Interface Cards } Prices Micro Buffer II Grappler Techmar Products Synetix 294K Card</p> <p>MICRO PRO WordStar InfoStar SpellStar CalcStar MailMerge SuperSort</p> <p>BUSINESS SOFTWARE Accounting Plus Series BPI Accounting Software dBase II FMS-80, 81, 82 } Call The Last One } for MicroSoft MultiPlan } Best Peachtree Software } Prices SuperCalc CP/M Versaform VisiCorp Software</p>
MONITORS		MICROSOFT PREMIUM SYSTEM																																																											
NEC Hi-Res 12" Green	\$129	Upgrade your Apple!	\$599																																																										
NEC RGB 12" Color	Call																																																												
USI P13 12" Amber	\$169																																																												
Sanyo	Call	* DISKETTE SPECIAL *																																																											
Amdek	for	Maxell MD-1 (Box of 10)	\$32																																																										
Electrohome	} Best	MISC																																																											
Televideo Terminals	Prices	Atari Software																																																											
IBM Software & Peripherals	Call																																																												
PERIPHERALS																																																													
Thunderclock	\$125																																																												
Mountain Computer Products																																																													
Videx Products																																																													
MicroSoft Products																																																													
TG Joysticks, Paddles	Call																																																												
System Saver Fans	for																																																												
Saturn Systems	Best																																																												
Axon Products	Prices																																																												
SVA Products																																																													
16 Bit Apple Card																																																													
Passport Designs Music System																																																													

INTRODUCING 1-2-3.[™]
IT'LL HAVE YOUR
IBM/PC
JUMPING THROUGH
HOOPS.

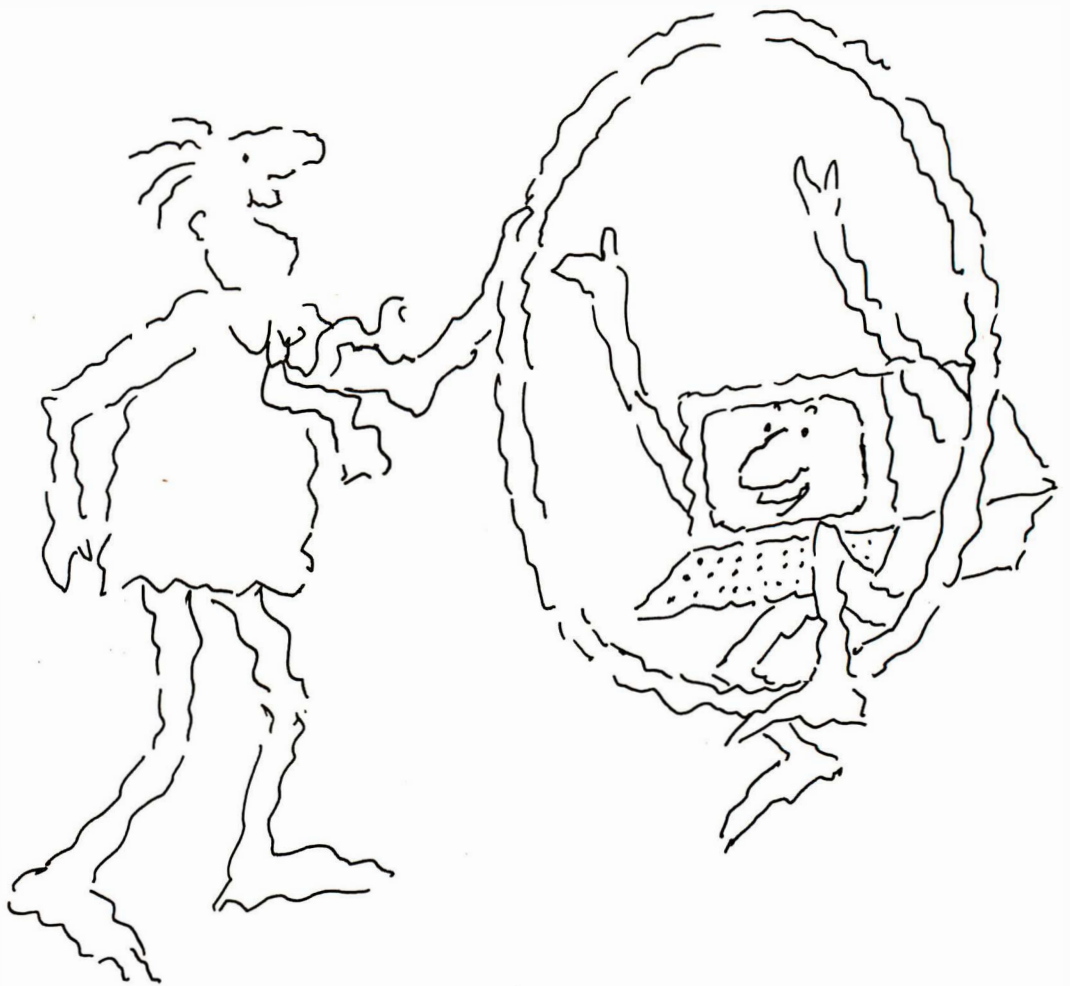

Meet 1-2-3 – the remarkable new software package that puts more raw power at your fingertips than anything yet created for the IBM PC. 1-2-3 actually combines information management, spreadsheet, and graphing in one program that can perform all three functions interchangeably and instantly at the touch of a key. That's power.

To explain: since 1-2-3's information management, spreadsheet and graphing functions reside in memory simultaneously, you can go from retrieval to spreadsheet calculation to

graphing instantly, just by pressing a few keys. So now you can experiment and recalculate and look at data in an endless variety of ways. As fast as your mind can think up new possibilities. There's no lag between you and the computer. And that's a new kind of power – power that's greater than the sum of its programs.

The spreadsheet function.

If 1-2-3 were just a spreadsheet, you'd want it because it has the largest workspace on the market (2048 rows by 256 columns). To give you a quick idea of 1-2-3's spreadsheet capabilities: VisiCalc's spreadsheet for the IBM PC offers 15 arithmetic, logical and relational operators, 28 functions and 32 spreadsheet-related commands. 1-2-3 has 15 operators, 41 functions and 66 commands. And if you include data base and graphing commands, it actually has 110!

In addition, 1-2-3 is up to 50 times as fast as established spreadsheets. With all the features you've ever seen on spreadsheets. 1-2-3 also gives you the capability to develop customized applications (with 26 macro keys) and lets you perform repetitive tasks automatically with one keystroke. If 1-2-3 were just a spreadsheet, it would be a very powerful tool. But it's much, much more.

The information management function.

Add to 1-2-3's spreadsheet a selective information management function, and the power curve rises at an awesome rate. Particularly since 1-2-3's information management capability reads files from other programs such as WordStar, VisiCalc and dBase II. So you can accumulate information

on a limitless variety of topics and extract all or pieces of it for instant spreadsheet analysis. Unheard of before. Specific 1-2-3 information management features include sorting with primary and secondary keys. Retrieval using up to 32 criteria. 1-2-3 performs statistical functions such as mean, count, standard deviation and variance. It can produce histograms on part or all of the data base. 1-2-3 also allows for the maintenance of multiple data bases and multiple criteria.

The graphing function.

1-2-3's sophisticated graphing commands enable you to create graphs of up to six variables using information already on the spreadsheet. And have it on screen in less than two seconds! Once you've made a graph, three keystrokes will display it in a different form. If data on the spreadsheet changes, you can display a revised graph with one keystroke. This instant relationship of one format to another opens up a whole new application area. For the first time graphics can be used as a "what if" thinking tool!

To fully understand just how much power 1-2-3 adds to the personal computer you'll want to go to your nearby 1-2-3 dealer for a full demonstration. For his name and address (and more information if you want it) call 1-800-343-5414.

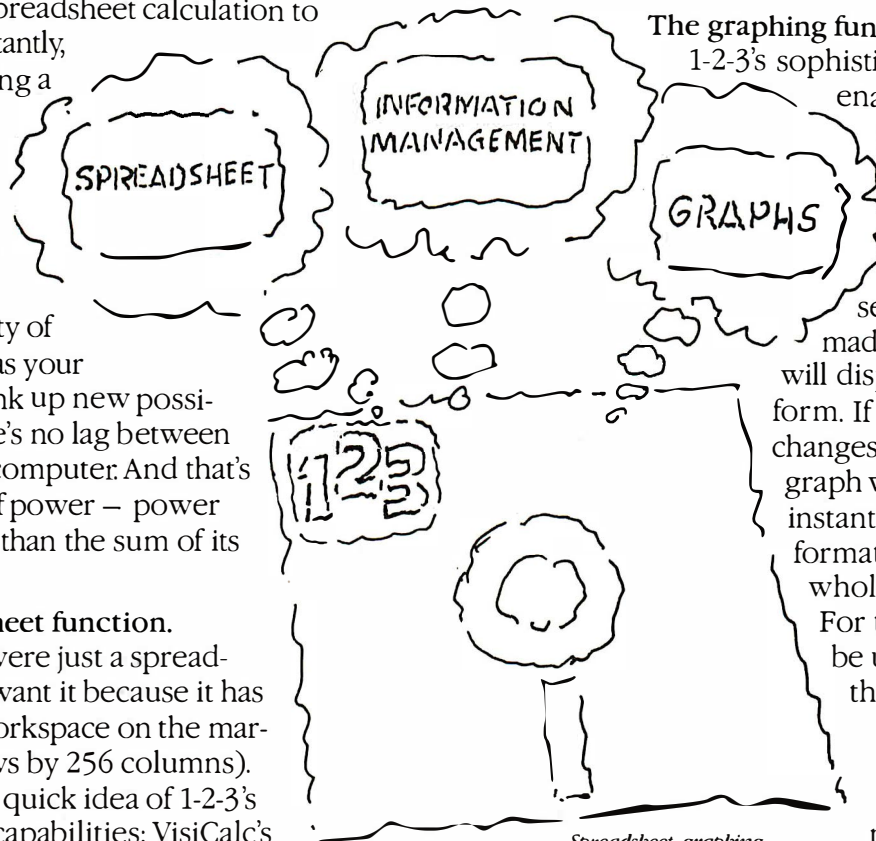

Spreadsheet, graphing, information management all-in-one.



© Lotus Development Corporation;
Cambridge, MA 02138, (617) 492-7171.
All rights reserved.

WordStar is a registered trademark of MicroPro Inc.
VisiCalc is a registered trademark of VisiCorp.
dBase II is a registered trademark of Ashton-Tate.
1-2-3 and Lotus are trademarks of Lotus
Development Corporation.

Circle 488 on inquiry card.

The Design of an Advanced Logic Simulator

Macrocircuits and time-saving features make this new version easy to use.

Robert M. McDermott
33 Dora Circle
Bridgeport, CT 06604

In a previous article ("Simulation of Simple Digital Logic through a Computer-aided Design System," January 1983 BYTE, page 396), I described the design of a primitive logic simulator to replace hardware breadboarding in learning to design basic digital circuits. I also outlined enhancements that could give the program functions comparable to professional-level simulators available on large mainframe computers. After finding how easy it was to write a logic simulator for Radio Shack's TRS-80, I endeavored to write a professional-level program. This article includes the program and describes in detail the operation of the enhancements. While the description is oriented toward the logic simulator, the basic concepts employed could be used in other ap-

plications as well, particularly the processing of macroinstructions and the use of selective trace for event-driven phenomena.

Background

As described in the previous article, a logic simulator accepts the description of a proposed design in

and the process is repeated. This operation implies that every logic element produces the same delay. This fixed delay allows for the modeling of sequential devices because feedback loops work properly.

The propagation of signals among the various logic elements is controlled by a description of the logic network, consisting of a list of each element's logic type and the nodes to which the element's input and output are connected. The appearance of one node as the output of one element and the input to another element implies that the output and input are electrically connected. Node numbers serve as an index to an array that contains the logic values (old and new) for each signal.

The primitive version of this program was a direct implementation of this concept that merely filled the appropriate arrays directly from the input provided and proceeded to simulate the design in a single-step manner. The logic primitives supported were the standard logic operators: AND, NAND, OR, NOR, and XOR. This basic approach, while simple to implement, left much to be

A macrocircuit is a black box with specified input and output signals.

terms of logic-element interconnections and external stimuli. It applies the external stimulus to the simulated logic network and displays the resultant output.

The simulator operates by keeping track of the states of all connection nodes. An *old* (before stimulus) state is used as the input to each simulated logic device, and results are stored as *new* state; once all devices have been stimulated using the old values as inputs, the new values replace the old

About the Author

Robert M. McDermott is the manager of CAD (computer-aided design) software engineering at International Telephone and Telegraph's Large-Scale Integration Technology Center. The recipient of both BEE and MS degrees, he also teaches computer science at Bridgeport Engineering Institute.

Is 42 seconds worth \$10000?



The new Transtar 130 daisy wheel printer generates a full-page letter in 78 seconds. The least expensive 40 cps printer does it in 36. Only 42 seconds difference...for twice the price.

At only \$895, the Transtar 130 letter-quality printer makes speed its only compromise. Shannon-text rated at 16 cps, the Transtar 130 gives you better printing quality than any 40 cps printer. It allows you the full range of word-processing functions such as proportional spacing, superscript, subscript, under-scoring and a true boldface. The 130 is "plug and go" compatible with the best-

selling word processing packages. It's quiet: only 65dB. It's durable. It boasts a unique new autoload feature that automatically loads paper to one of four pre-selected positions with the touch of a button. And, as if that weren't enough, its end-user warranty runs a full six months—twice that of most of its competitors.

Affordable and loaded with all the features of printers costing twice as much, the Transtar 130 letter-quality printer retails for less than \$900. But it's up to you: Is 42 seconds really worth \$1000?

Transtar

Box C-96975, Bellevue, Washington 98009

THANKS FOR HELPING TO KEEP UNITED WAY IN BUSINESS.

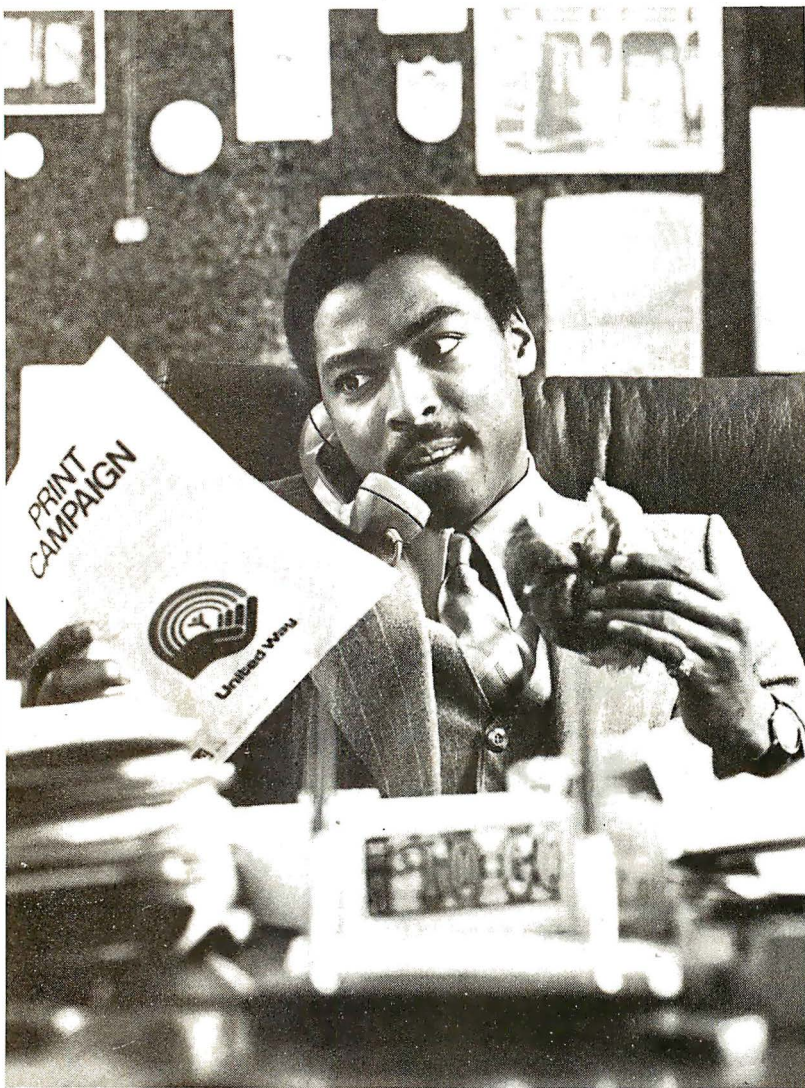

Every year, United Way successfully continues to support local human service agencies in communities all across the United States.

A lot of the credit for this success goes to the dedicated efforts of people in business — to top corporate leaders who volunteer their organizational skills and financial expertise, to middle-management people who work lunch-hours and evenings to help organize local campaigns and collect money, to the newest mailroom clerk who swallows his shyness and asks his fellow workers for a last-minute contribution.

And by operating like any other modern, well-run business enterprise, United Way succeeds in delivering the maximum in human services for the dollars that are collected.

Thanks again for *your* help.



Thanks to you, it works. For all of us. **United Way**

Ad
Council A Public Service of This Magazine & The Advertising Council

desired in terms of ease of use, error checking, and models of commonly used higher-level logic elements (flip-flops, counters, etc.).

A more professional system is shown in listing 1 (see page 428) and diagramed in figures 1 and 2; it supports named nodes rather than numbers, a "macro" capability for repetitiously used blocks of circuitry, an expanded library of logic primitives (see figures 3 and 4), procedures for rapid simulation, and a flexible output-display feature.

Named Nodes

Most nodes in a proposed design have functional names associated with them (e.g., Clock, Reset, etc.). For ease of use and a more meaningful input description, a well-designed program must support the use of named nodes. It is much easier to debug a design described by lines such as

```
AND DATA LOAD DATA-IN
```

rather than

```
AND 3 7 33
```

The advanced version of this program uses a free-field input format. Spaces are used as string delimiters when a line is read and parsed into distinct names by the subroutine at line 10000. A table look-up assigns unique numbers to each signal name. The subroutine at line 11500 looks up each name, while the routine at line 11600 adds to the list names not already there. Note that unused entries have the name "0," and this is the only reserved signal name; any other combination of symbols can be used as a valid signal name (e.g., LOAD— could be used to signify a load-not signal). Additionally, some devices subsequently described contain numeric parameters, such as an N-bit shift register, and these numbers are distinguished from signal names by using # (the number sign) as the first character in the name.

Macro-circuit Capability

To support structured design, and to make entering input data easy,

Complete Integrated Accounting System

Just plug it into your IBM® and run your business!

INTEGRATED ACCOUNTING SYSTEM

GENERAL LEDGER

ACCOUNTS RECEIVABLE

BILLING

INVENTORY

ACCOUNTS PAYABLE

PAYROLL

WORD PROCESSOR - Perfect Writer™

SPELLING CHECKER - Perfect Speller™

File Management System - Perfect Filer™

Electronic Spreadsheet - Perfect Calc™

The best business program package on the market . . . providing all the software and storage you ever wanted.

- All programs self-prompting & menu driven
- Completely integrated accounting system
- General Ledger includes a chart of accounts developed by a CPA
- Has been in use for four years
- High speed operation
- All software pre-installed on hard disk and ready to run. No more diskettes & tedious paper work
- Self-explanatory . . . easy to use
- All software & hardware fully guaranteed & supported

5 MB WINCHESTER DISK
plus ABOVE LISTED SOFTWARE
in ONE INTEGRATED PACKAGE

\$2,995⁰⁰*

*Auxiliary Power Booster Required \$195.

10 MB Model
also available

Dealer
Inquiries
Invited

The Business Manager™

1420 E. Edinger Ave., Suite 115, Santa Ana, CA 92705

(714)836-3569

Circle 62 on inquiry card.

(1a)

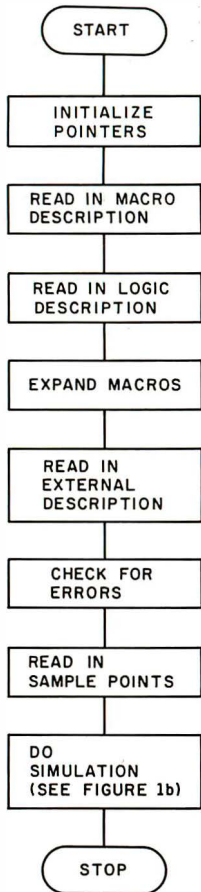

(1b)

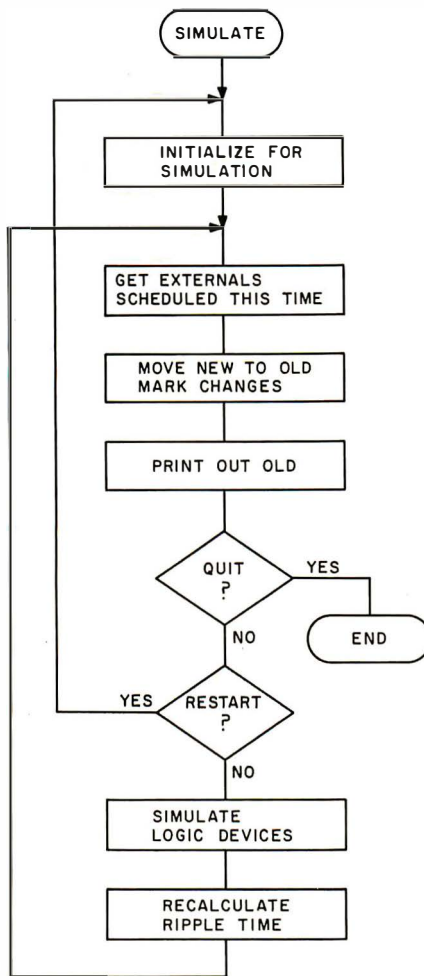

Figure 1: Flowchart of the fundamental procedures used in the simulator. Figure 1a shows the arrangement of the functional blocks; figure 1b describes in more detail the actual simulation process.

capability should be included to allow predefined blocks of circuitry—macrocircuits—to be installed simply. A macrocircuit is a black box with specified input and output signals; the description of the macrocircuit includes the logic devices required to generate the output from the inputs, using internal

A macrocircuit is similar to a function call in BASIC or a subroutine call in FORTRAN or Pascal.

signals as required. Handling a single-level macrocircuit involves the replication of a block of logic devices, with the appropriate translation of the signal names used within the macrocircuit to those used within the circuit.

A macrocircuit is similar to a FUNCTION call in BASIC (or more appropriately, a subroutine call in languages such as FORTRAN or Pascal). The definition of the macrocircuit is like BASIC's DEFFN definition in that the variables used in the definition are dummy variables. When the macrocircuit is called in the logic-description input, the dummy

Text continued on page 412

Give and Take.

Give a little today.
Take a lot tomorrow.
That's what makes
United States Savings
Bonds a great way to
secure your future.
And why over nine
million people like you
have already joined the
Payroll Savings Plan.

You see, once you
sign up, a small part of
each paycheck is set
aside to buy Bonds.
Saving is so automatic,
you'll soon forget
about it.

So buy United
States Savings Bonds.

Automatically,
through the Payroll
Savings Plan.
You won't even feel
like you're giving, until
all those Bonds are
yours for the taking.

Take
stock
in America.



Ad Council A public service of this publication
and The Advertising Council.

Introducing a sensible solution to the problems of dBASE II.™

	dBASE II	The Sensible Solution
Records Per File	65,535	999,999
Maximum Record Size	1,024 bytes	1,536 bytes
Fields Per Record	32	384
Key Fields Per File	7	10
Number of Files Simultaneously Accessible	2	10
Number of Screens Per Program	Limited by system memory	Limited only by system storage
Data Dictionary	No	Yes

We don't mean to debase dBASE II, but if you're looking for a data base manager that's long on features, dBASE II can come up a little short.

For instance, a single dBASE II record can only contain 32 fields. And when you need to share information between one file and another, you can only access two at a time.

So, as good as dBASE II is, its limitations can quickly paint you into an electronic corner.

And that's why we created *The Sensible Solution*.

Finally A sensational relational.

Along with all the usual things you expect from a data base manager, *The Sensible Solution* lets you handle the kind of tough assignments that dBASE II can't.

You can design data files with more than 300 variables. You can create reports using 10 different files at once. You can even set up file locking for multi-user computers.

Ready to get down to business.

A data base manager without ready-to-run application programs is hardly worth the disk it's copied on.

So, along with *The Sensible Solution*, you can also add *The Sensible Solution Bookkeeper*™ or *Sensible Management*™, our complete one-entry accounting and management system.

They're both affordable. Business-tested. And supplied with source code so you can make your own modifications.

A sensible trial offer.

When you purchase *The Sensible Solution*, we'll send along a special trial disk that lets you create forms and enter a limited number of records. If, after 30 days, you're not satisfied, just return the unopened master system disk for a full refund.

So why not take us up on our trial offer? You've got nothing to lose.

Except the problems of dBASE II.

The Sensible Solution™

To order, write or call: O'Hanlon Computer Systems, 11058 Main Street, Bellevue, WA 98004 USA, Phone (206) 454-2261. Prices: *The Sensible Solution*—\$695, *Sensible Solution Bookkeeper*—\$495, *Sensible Management*—\$895. In Washington, add 6.5% state tax. VISA, Mastercard and dealer inquiries welcome.

dBASE II is a registered trademark of Ashton-Tate. Sensible Solution, Sensible Solution Bookkeeper and Sensible Solution Management are trademarks of O'Hanlon Computer Systems, Inc.

**CP/M
USERS**

**GET RID
OF YOUR
TYPEWRITERS!**

KWIC-KEY / K

**WORKS LIKE MAGIC TO
TURN YOUR \$7000 WORD
PROCESSOR INTO A \$500
ELECTRIC TYPEWRITER.**

- Envelopes
- Preprinted forms
- Quick notes, index cards, etc.
- All those typed documents your word processor can't handle

**Connects your CRT
keyboard directly to
your printer and
makes full use of
specialty printer
features.**

\$60⁰⁰

**MASTER CARD
VISA C.O.D.**

**ONE KEY WORD PROCESSING
on your TELEVIDEO™
with WORDSTAR™ and . . .**

**OVER
500 SOLD!**



\$99⁹⁵

Mastercard
Visa

- **Nu Key™** Automates the 36 most commonly used word processing functions
- Reduces learning time while increasing operator speed
- For beginners and Wordstar experts
- Comes complete with 14 new matching keycaps

For your TELEVIDEO™ 950, TS-800, TS-800A, and TS-802
PLEASE SEND WORDSTAR SERIAL NUMBER TO:

**Business Solutions, Inc.
91 W. Long Lake Rd., Suite 9
Bloomfield Hills, MI 48013
(313) 540-3360**

CP/M™ OF DIGITAL RESEARCH/TELEVIDEO & TELESOLUTIONS™
OF TELEVIDEO/ WORDSTAR™ OF MICROPRO INTERNATIONAL/
NuKey & KWIC-KEY™ OF BUSINESS SOLUTIONS, INC.

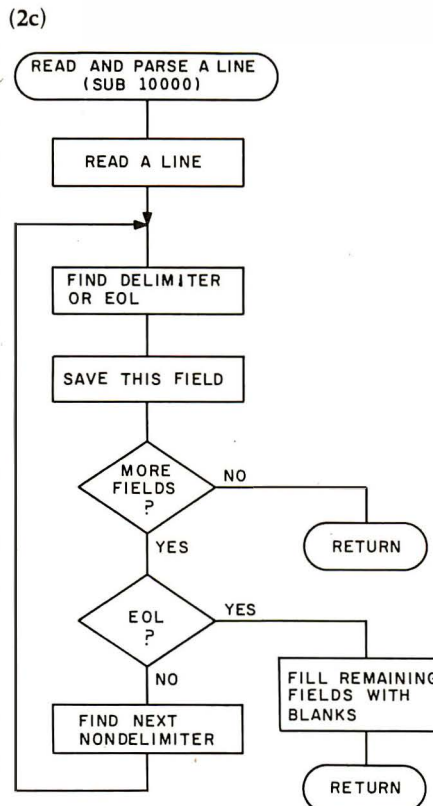
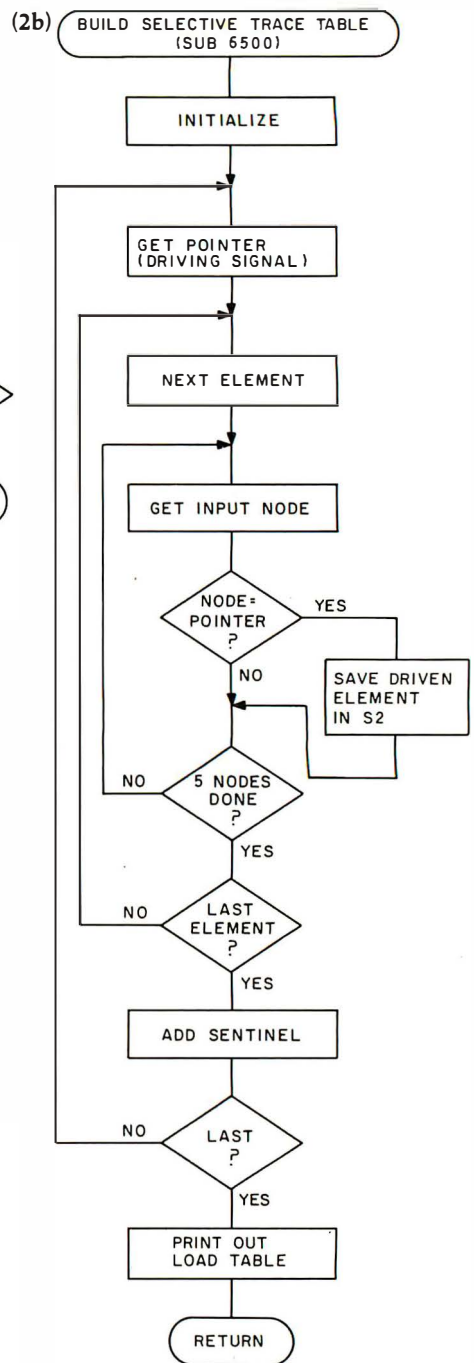
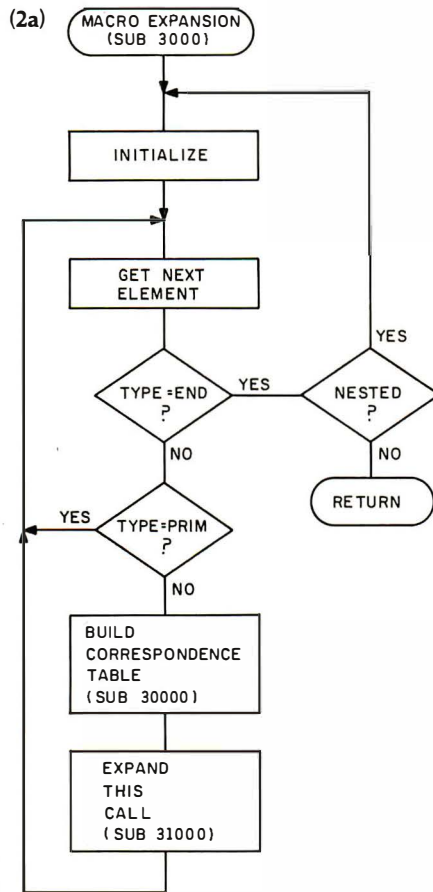
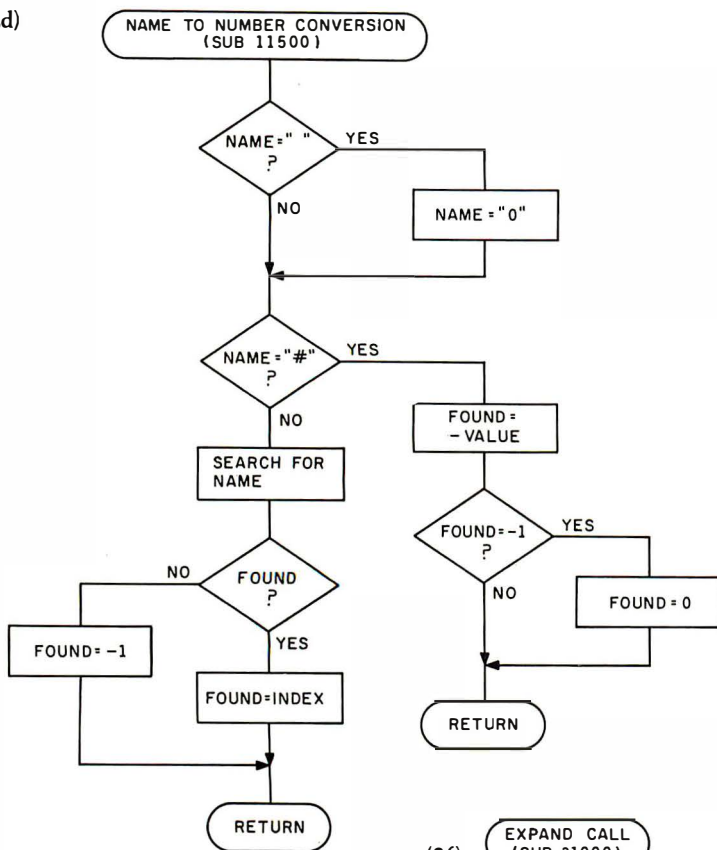
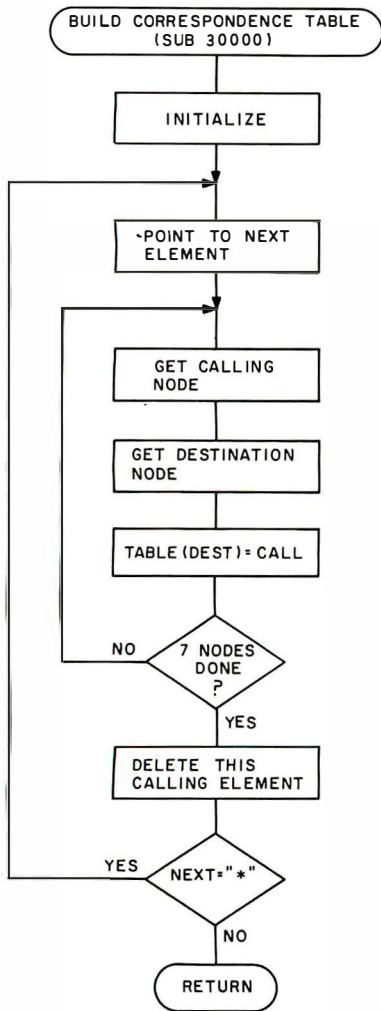

Figure 2: Flowcharts for the functions added to the advanced version of the simulator; note the line-number references to listing 1 at the top of each flowchart.

(2d)



(2e)



(2f)

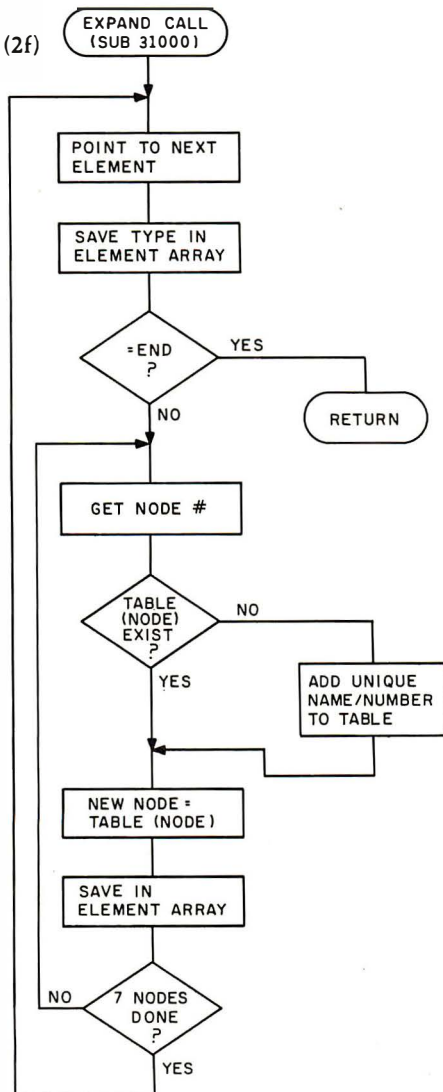

S100

Div. of 696 Corp



Est. 1977

COMPUTERS:

COMPUPRO 8/16 Systems	CALL
COLUMBIA (LIKE IBM-PC)	
12BK RAM/2 Drives	\$2546.00
EAGLE II w/software	2339.00
MICROECISION w/2 Drives	
& 8 S.W. Pkgs	1185.00
SO SYSTEMS	
DISK-LESS COMPUTER	CALL

BOARDS:

ADV. DIGITAL	
Superquad & Slave	CALL
CALIF COMP SYSTEMS	
Z80 CPU	259.00
COMPUPRO 64K	
STATIC RAM	374.00
CROMEMCO DPU	
68000/Z80	839.00
SCION'S Microangelo Graphics	
MA520	986.00
SD SYSTEMS 3 8D SET	
w/1 yr warranty:	
SBC 200 W/MONITOR PROM	
VERSAFLOPPY II w/CP/M 3.0 & BIOS	
256 K EXPANDORAM III	1295.00
SEATTLE IBM-PC 64K	
RAM + w/serial	359.00
SSM (2 para/2 serial) I/D 4	232.00
TARBELL DO FD Controller	396.00

MONITORS/TERMINALS:

ADDS VIEWPOINT A3	475.00
LIBERTY FREEDOM 100	
(emulates Tele. 925)	535.00
TELEVIDEO 950	915.00

PERIPHERALS - ETC.

EPSON'S NEW FX80	CALL
CROMEMCO Z2X Box w/o	
ZPU 8DS	845.00
HARD DISK SUBSYSTEMS	CALL
HAYES Smartmodem 1200	519.00
INTEGRAND 800 DB/2F	
w/options	497.00
MORROW Floppy Subsystems	CALL
OPEN SYSTEMS S/W	500.00 ea.
PARA DYNAMICS	
2018R Mainframe	675.00
NEW PRONTO	1225.00
TECMAR 5 MEG Cartridge for	
IBM-PC	1525.00
VOTRAX Speech Synth.	275.00
TANDON 100-2 DS/DD Drives	
for IBM-PC	245.00
QUME 8" Drives D.S./DD	
Thinline 242	445.00
Standard 842	445.00

FULL DEALER SUPPORT

VISIT OUR SHOWROOM

Hrs. 9:00 A.M.-5:30 P.M. M-F
 Subject to Available Quantities
 Prices Quoted Include Cash Discounts
 Shipping & Insurance Extra

S-100

14425 North 79th Street, Suite B
 Scottsdale, Arizona 85280
 SALES 800-528-3138
 TECHNICAL 802-891-7870
 TELEX 185025

STOP LOSING MONEY ON TIMESHARE SERVICES!

LOGICSIM



CP/M based professional logic simulator

- * For engineering work stations
- * For gate-array, custom and all other IC designers
- * For digital system engineers

Nine logic states, ability to simulate TTL/NMOS/CMOS/PMOS logic, ROM's and RAM's, three-state and transfer gates, wired-or'ed nodes, propagation delays, spike and race analysis, expandable pin-number based TTL macro library plus numerous other features make LOGICSIM comparable to industry standard simulators.

Try it now. Send us a \$30 check for LOGICSIM demo copy and User's Manual.

Please specify 8" IBM 3740/ 5" APPLE II (13/16 sector), CP/M based 56K to 64K systems (APPLE's with CP/M card, Introductory price \$276.

For more information, call (408) 578-8096. Or write:
E/Z ASSOCIATES, 5589 Starcrest Dr., San Jose, CA 95123

APPLE, CP/M, LOGICSIM are trademarks of Apple Computer, Digital Research and E/Z ASSOCIATES

Circle 153 on inquiry card.

Verbatim® Diskettes



Top-quality Verbatim® Diskettes from **Tech•Data**, your complete word and data processing supply center. Dealer inquiries invited.

Call Toll Free
1-800-237-8931.
In Florida, call
813-577-2794.

Tech•Data Corporation
3251 Tech Drive North
St. Petersburg, FL 33702

Circle 404 on inquiry card.

Scotch® Diskettes

Rely on Scotch® diskettes to keep your valuable data safe. Dependable Scotch diskettes are tested and guaranteed error-free. The low abrasivity saves your read/write heads. They're compatible with most diskette drives.



(800)235-4137



PACIFIC EXCHANGES
1001 Foothill Blvd
San Luis Obispo, CA
93401 In Cal call
(805)592-5945 ext
(805)543-1147

Dealer Inquiries Invited

Circle 319 on inquiry card.

Figure 3: The fundamental logic elements predefined within the logic simulator.

(3a)

LOGIC TYPE: AND GATE

LOGIC EQUATION: $Q = A \cdot (B) \cdot (C) \cdot (D) \cdot (E)$

LOGIC SYMBOL:

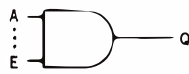

TRUTH TABLE:

A	B	Q
0	0	0
0	1	0
1	0	0
1	1	1

ELEMENT CODING: AND A (B) (C) (D) (E) Q (Q)

NOTES: () DENOTES OPTIONAL FIELDS, "0" IF NOT USED.

(3b)

LOGIC TYPE: NAND GATE

LOGIC EQUATION: $Q = \overline{A \cdot (B) \cdot (C) \cdot (D) \cdot (E)}$

LOGIC SYMBOL:

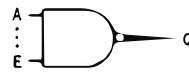

TRUTH TABLE:

A	B	Q
0	0	1
0	1	1
1	0	1
1	1	0

ELEMENT CODING: NAND A (B) (C) (D) (E) Q (Q)

NOTES: () DENOTES OPTIONAL FIELDS, "0" IF NOT USED.

(3c)

LOGIC TYPE: OR GATE

LOGIC EQUATION: $Q = A + (B) + (C) + (D) + (E)$

LOGIC SYMBOL:

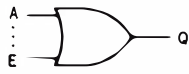

TRUTH TABLE:

A	B	Q
0	0	0
0	1	1
1	0	1
1	1	1

ELEMENT CODING: OR A (B) (C) (D) (E) Q (Q)

NOTES: () DENOTES OPTIONAL FIELDS, "0" IF NOT USED.

(3d)

LOGIC TYPE: NOR GATE

LOGIC EQUATION: $Q = \overline{A + (B) + (C) + (D) + (E)}$

LOGIC SYMBOL:



TRUTH TABLE:

A	B	Q
0	0	1
0	1	0
1	0	0
1	1	0

ELEMENT CODING: NOR A (B) (C) (D) (E) Q (Q)

NOTES: () DENOTES OPTIONAL FIELDS, "0" IF NOT USED.

(3e)

LOGIC TYPE: EXCLUSIVE OR GATE

LOGIC EQUATION: $Q = A \oplus B$

LOGIC SYMBOL:

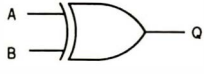

TRUTH TABLE:

A	B	Q
0	0	0
0	1	1
1	0	1
1	1	0

ELEMENT CODING: XOR A B 0 0 0 Q (Q)

(3f)

LOGIC TYPE: EXCLUSIVE NOR GATE

LOGIC EQUATION: $Q = \overline{A \oplus B}$

LOGIC SYMBOL:

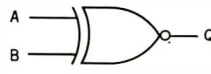

TRUTH TABLE:

A	B	Q
0	0	1
0	1	0
1	0	0
1	1	1

ELEMENT CODING: XNOR A B 0 0 0 Q (Q)

Nobody offers you a wider variety of computer printers and printer experience than Facit/Dataroyal... all the way from low cost (\$695 list) matrix printers, to sophisticated graphics and color matrix printers, to models that print variable size characters and bar codes, to "daisy wheels" and a multimode near letter-quality printer. Industry standard parallel and RS232C serial interfaces are available in all printers.

Our products are built to perform day after day in the most rugged

environments. We achieve that kind of reliability by incorporating modern, trouble-free LSI circuitry, and fewer moving mechanical parts along with a high level of quality control.

Hundreds of computer systems manufacturers choose Facit/Dataroyal products with confidence, as do a great number of Fortune 500 companies who use Facit/Dataroyal peripherals with their systems.

If you want a trouble-free printer, contact your local computer

printer dealer or Facit/Dataroyal, 235 Main Dunstable Road, P.O. Box 828, Nashua, NH 03061, (603) 883-4157.



**FACIT
DATAROYAL**

Circle 170 on inquiry card.

Printers, printers, and more printers.

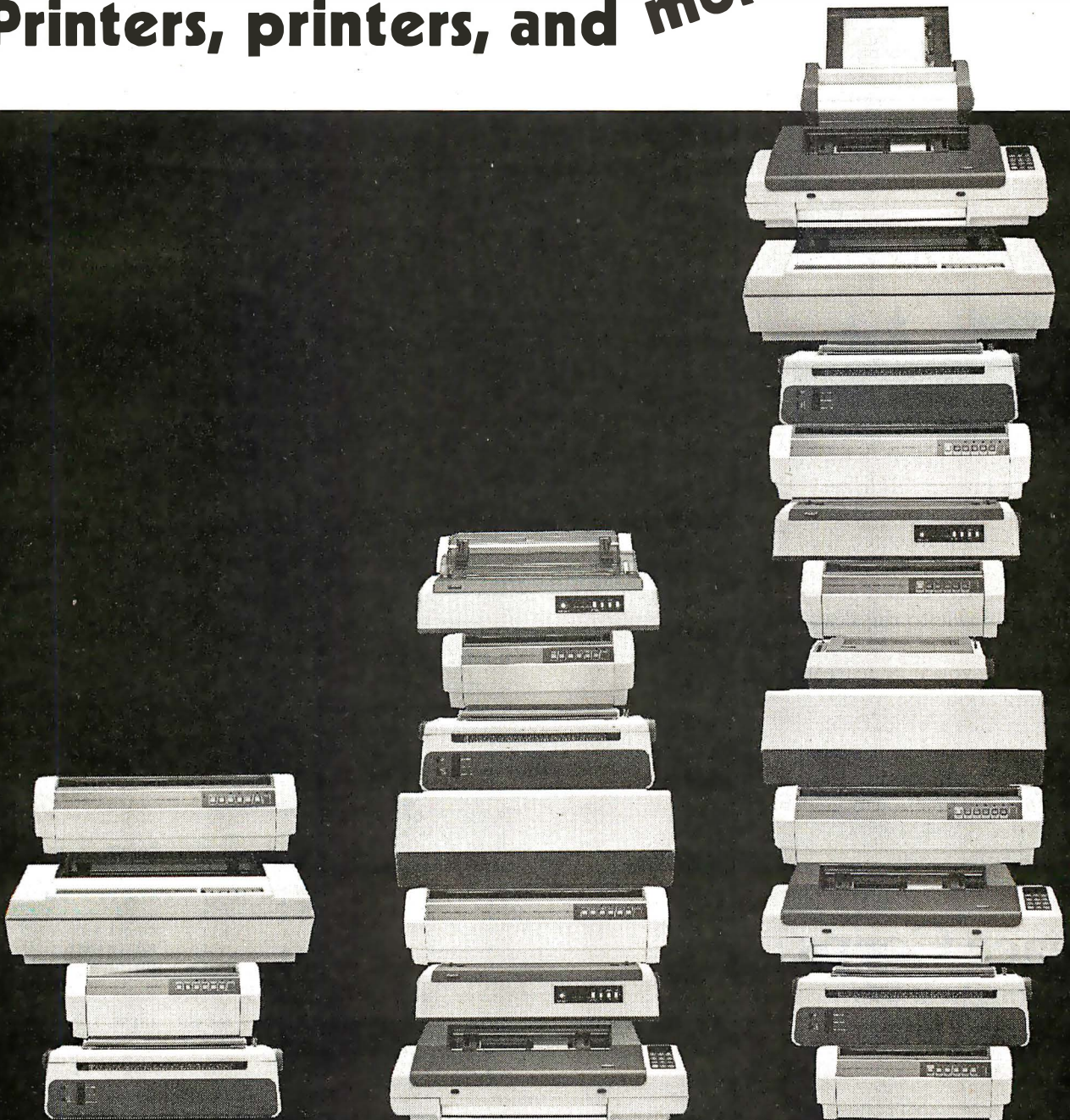

What makes a streetwise kid from New York want to help rice farmers in the tropics?

Meet Mike Harvey. He's not out to change the world, just to understand it a little better. And because he thinks that underneath all the differences people are basically alike, he feels he can help.

It's what today's Peace Corps is all about. Americans from every kind of background, of all ages, making a commitment to live and work with people around the world to meet basic human needs.



You won't be asked to move mountains but you'll understand what volunteers like Mike Harvey mean when they talk of small miracles. Why they want to work hard at a challenge unique to the Peace Corps.

Above all, you'll be learning something about the world, making friends with people you can help. And that's what life should be all about.

For further information, call toll free 800-424-8580. Or write Peace Corps, Washington, D.C. 20525.

Peace Corps

The toughest job you'll ever love.

Ad Council A Public Service of This Magazine & The Advertising Council

Figure 4: Additional logic elements predefined within the advanced version of the logic simulator.

(4a)

LOGIC TYPE: D-TYPE FLIP-FLOP

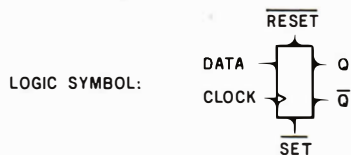

TRUTH TABLE:

DATA	CLOCK	RESET	SET	Q	Q̄
X	X	0	0	0	1
X	X	1	0	1	0
X	X	0	1	0	1
0	⌋	1	1	0	1
1	⌋	1	1	1	0
X	⌋	1	1	Q	Q̄

ELEMENT CODING: OFF DATA 0 CLOCK (RESET) (SET) Q (Q̄)

NOTES: X= DON'T CARE.
SET AND RESET ARE ACTIVE LOW; IF UNUSED "0", THEY DEFAULT TO LOGIC 1.

(4b)

LOGIC TYPE: JK FLIP-FLOP

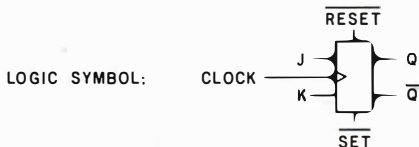

TRUTH TABLE:

J	K	SET	RESET	Q	Q̄	CLOCK	NEXT Q	NEXT Q̄
1	X	1	1	0	1	⌋	1	0
X	0	1	1	1	0	⌋	1	0
0	X	1	1	0	1	⌋	0	1
X	1	1	1	1	0	⌋	0	1
X	X	1	1	X	X	⌋	NO CHANGE	
X	X	0	1	X	X	X	1	0
X	X	1	0	X	X	X	0	1
X	X	0	0	X	X	X	0	1

ELEMENT CODING: JKFF J K CLOCK (RESET) (SET) Q (Q̄)

NOTES: X= DON'T CARE.
SET AND RESET ARE ACTIVE LOW; IF UNUSED "0", THEY DEFAULT TO LOGIC 1.

(4c)

LOGIC TYPE: N-BIT COUNTER

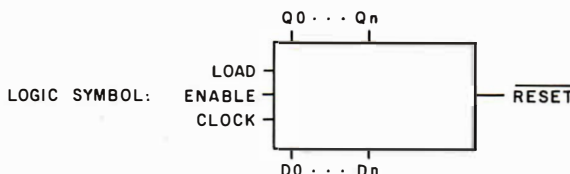

TRUTH TABLE:

DATA	LOAD	ENABLE	RESET	CLOCK	COUNT (Q0...Qn)
0	1	X	1	⌋	0
1	1	X	1	⌋	1
X	0	X	0	X	0
X	0	1	1	⌋	COUNT + 1
X	0	1	1	⌋	NO CHANGE
X	0	0	1	⌋	NO CHANGE

ELEMENT CODING: CNTR (D0) ENABLE CLOCK (LOAD) (RESET) Q0 (Q̄0)
* (D1) 0 0 0 0 Q1 (Q̄1)
* . 0 0 0 0 Qn (Q̄n)
* Dn Qn (Q̄n)

NOTES: X = DON'T CARE. LOAD AND ENABLE ARE ACTIVE HIGH AND LOAD OVERRIDES ENABLE.

stair[★]war

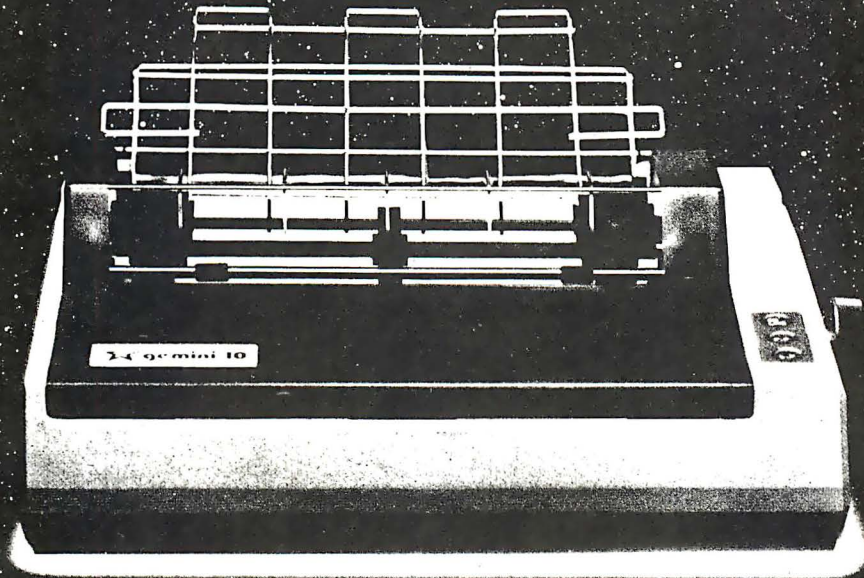

AN ASTRONOMICAL VALUE AND
THE LOWEST PRICES
IN THE GALAXY ON

stair[★]
PRINTERS

CALL: (303) 279-2848 or (800) 525-7877



THE COMPUTER LINE, INC.
GOLDEN, COLORADO
Offer void outside the Milky Way

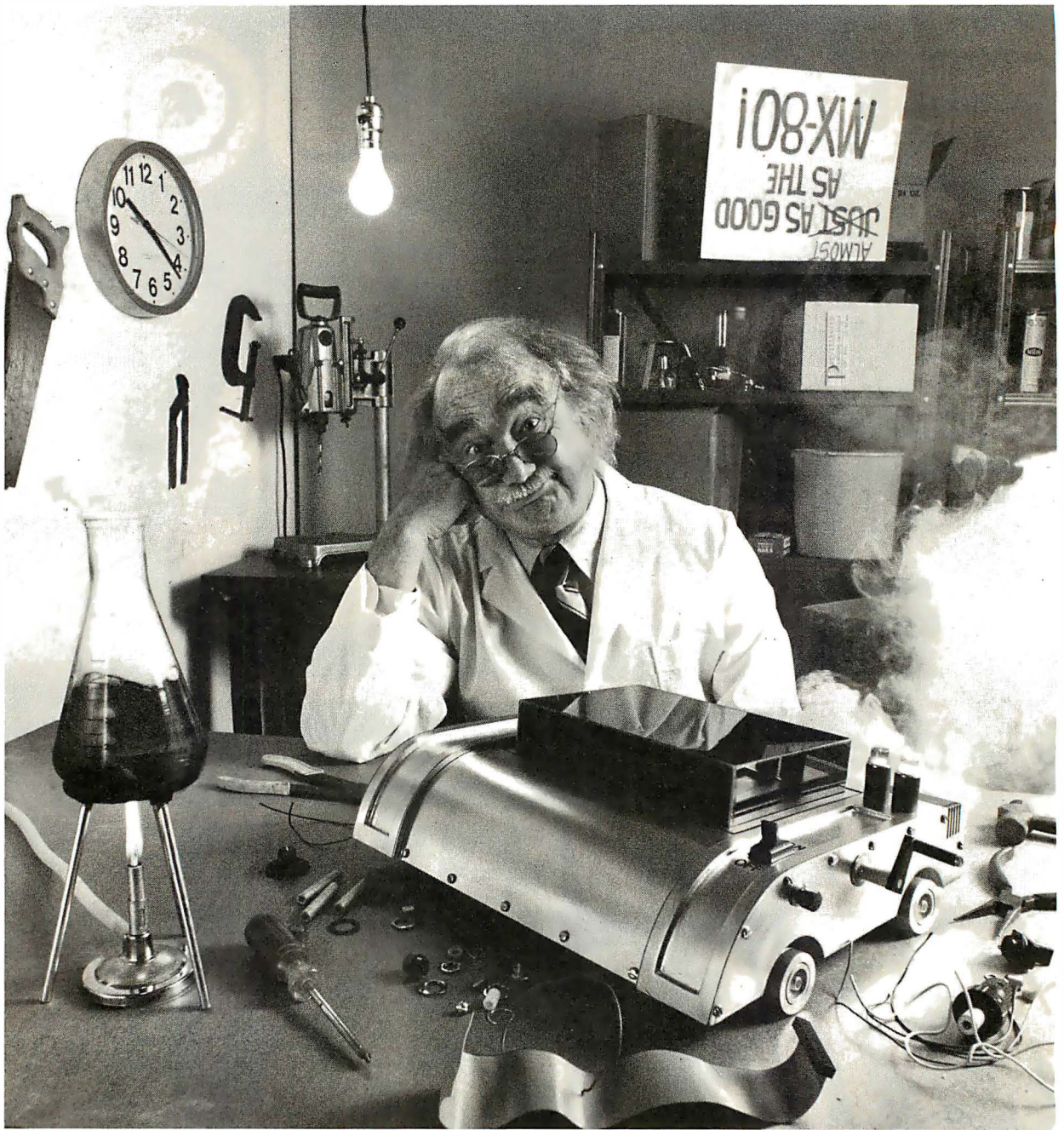

For everyone who's tried
to top the MX-80, bad news.
We just did.

Epson.

The Epson MX-80 is the best-selling dot matrix impact printer in the world. It has been since its introduction. And despite the host of imitators it spawned, no one has been able to top it. Until now.

FX-80: Son of a legend.

The new Epson FX-80 is far more than just doo-dads added on to last year's model. It's the most astonishing collection of features ever assembled in a personal printer.

For starters, it's fast: 160 CPS. And clean. All the print quality Epson is famous for in a tack-sharp 9x9 matrix.

But that hardly scratches the surface.

Create your own alphabet.

With the new FX-80, you aren't limited to ASCII characters. You can create your own. Any character or symbol that can be defined in a 9x11 matrix can be added to the FX-80's already impressive library of type styles and stored in its integral 2K RAM.

So you can create "Sally's Gothic" or "Tom's Roman" just by downloading and modifying standard characters. Or you can create a custom set from scratch. Either way, you can store up to 256 new characters. And if you don't need a new alphabet, the RAM functions as a 2K data input buffer.

Who knows graphics better than Epson?

Nobody, that's who. And if you don't believe it, witness the FX-80.

With a 12K ROM capacity, the FX-80 gives you a few things the others don't. For example, not one, not two, but *seven* different dot addressable graphic modes are program

selectable. And can be mixed in the same print line. Everything from 72 DPI (dots-per-inch) Plotter Graphics to the 640 dots per line resolution designed to match the remarkable monitor clarity of the Epson QX-10 personal computer.

And *that* is in addition to an astonishing array of 136 different user-selectable type styles including Proportional, Elite and Italic as well as the more conventional faces you get on other printers.

Hard-to-beat hardware.

The FX-80 has all the hardware features you've come to know and love on the MX Series: logic seeking, bidirectional printing, the by-now-famous disposable printhead, and more.

The FX-80 features an adjustable pin platen or optional friction/tractor feed, so you can use fanfold, roll or sheet paper ... backwards or forwards. The FX-80 even gives you reverse paper feed.

And if you're printing forms, the FX-80 has a feature you're gonna love: a function that allows you to tear off the paper within one inch of the last print position.

Be the first on your block.

We'd be willing to bet that the FX-80 — like the MX-80 — will have its share of imitators. Don't be fooled. To make sure you get the genuine article, rush down to your local computer store right now and let them show you everything the FX-80 can do.

And while you're there ... ask them to show you how it works with our computers.

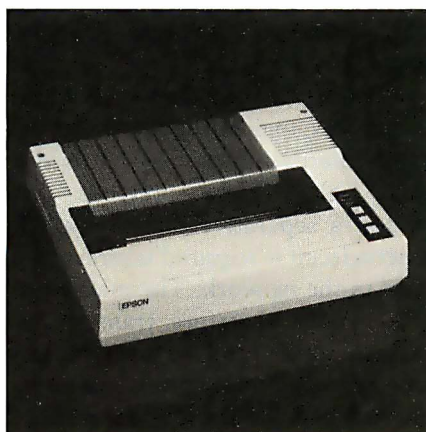

EPSON
EPSON AMERICA, INC.
COMPUTER PRODUCTS DIVISION

3415 Kashiwa Street
Torrance, California 90505
(213) 539-9140.
Outside California, phone
(800) 421-5426 for the
Epson dealer nearest you.

Circle 166 on Inquiry card.

Serial ← ■■■■■■■■ → **Parallel**

NEW! PRINTERS! PLOTTERS! PUNCHES! ROBOTS!



Convert What You Have To What You Want!

- RS232 Serial
- 8 Baud Rates
- Latched Outputs
- Centronics Parallel
- Handshake Signals
- Compact 3 1/2 x 4 x 1 1/2

No longer will your peripheral choices be limited by the type of port you have available! Our new High Performance 700 Series Converters provide the missing link. Based on the latest in CMOS technology, these units feature full baud rate selection to 19.2K, with handshake signals to maximize transfer efficiency. Detailed documentation allows simplified installation. Order the Model 770 (Ser/Par) or Model 775 (Par/Ser) Today!

only **\$89.95**

Buffer Products
Coming Soon!

Engineering Specialist
1501 B Pine Street
Post Office Box 2233
Oxnard, California 93030

Connector Option \$10.00
CA Residents 6% tax
UPS Shipping \$3.00

CALL (805) 487-1665 or 487-1666
For FAST Delivery

Circle 164 on Inquiry card.

maxell®

Floppy Discs

CALL NOW - TOLL FREE
1-800-328-DISC

Dealer inquiries invited. C.O.D.'s and charge cards accepted.

All orders shipped from stock, within 24 hours. Call toll FREE.



North Hills Corporation
3564 Rolling View Dr.
White Bear Lake, MN 55110
1-800-328-DISC
MN Call Collect 1-612-770-0485

Circle 305 on Inquiry card.

HERE'S SOMETHING NEW
IN

BUSINESS ACCOUNTING SOFTWARE

MODERN SOFTWARE SYSTEMS
GENERAL LEDGER ACCOUNTING SYSTEM
RADIO SHACK MODEL II 12 and 16

Multi-Client and/or Multi-Company
Batch Processing
Consolidated Financial Statements
Comparative Balance Sheet
3 Yr. Comparative Income Statements
12 Mo. Comparative Income Statement
Source & Application of Funds
Working Capital Statement
Changes in Financial Position
Unlimited Group Totals on Statements
Unlimited Sub-Totals on Statements

RATED FOUR STAR BY RADIO SHACK
DEMO SYSTEM AND MANUAL \$195.00
DEALER INQUIRIES INVITED

MODERN SOFTWARE SYSTEMS
P.O. BOX 363, ELDON, MISSOURI 65026
314-392-5876

Circle 370 on Inquiry card.

(4d)

LOGIC TYPE:

N-BIT SHIFT REGISTER

LOGIC SYMBOL:

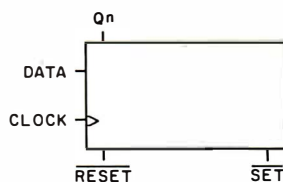

TRUTH TABLE:

DATA	RESET	SET	CLOCK	Q1	Qn
0	1	1	┌	0	Qn-1
1	1	1	┐	1	Qn-1
X	1	1	└	Q1	Qn NO CHANGE
X	0	1	X	0	0
X	1	0	X	1	1

ELEMENT CODING:

SREG DATA #BITS CLOCK (RESET) (SET) Qn (Qn)

NOTES: #BITS IS THE TOTAL NUMBER OF SHIFT BITS REQUIRED, IF "0", THEN DEFAULTS TO 1.
X = DON'T CARE.

(4e)

LOGIC TYPE:

PARALLEL LOAD SHIFT REGISTER

LOGIC SYMBOL:

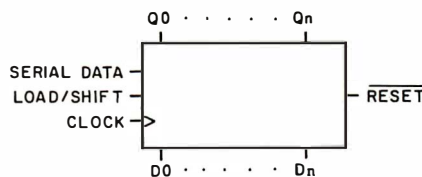

TRUTH TABLE:

D0	DSER	LOAD	RESET	CLOCK	Q0	Qn
X	X	X	0	X	0	0
1	X	1	1	X	1	1
0	X	1	1	X	0	0
X	0	0	1	┌	0	Qn-1
X	1	0	1	┐	1	Qn-1

ELEMENT CODING:

PLSR D0 DSER CLOCK LOAD (RESET) Q0 (Q0)
* D1 0 0 0 0 Q1 (Q1)
* Qn 0 0 0 0 Qn (Qn)

NOTES: X = DON'T CARE
LOAD/SHIFT- LOAD ON HIGH, SHIFT ON LOW.

Text continued from page 402:

signal names are replaced by the signal names used in the actual network description.

A macrocircuit typically performs a complex logical function. Because some internal nodes may be used to hold values from previous time cycles, a separate replication of the macrocircuit is required wherever it is used in the network. The macro processor must therefore translate the defined inputs and outputs of each macrocircuit and generate unique signal numbers for the internal nodes.

A macrocircuit can be considered as a subcircuit; typically, a complex but common logical function is designed and simulated as a single cir-

cuit to verify its proper operation. Once this design is characterized with regard to the input and output pins, it can be used as a building block for other designs. This approach is comparable to structured programming, where a functional block is completely characterized by the arguments passed to and returned from it.

Because a macrocircuit is conceptually a subcircuit, the same routine used to read the logic circuit (at line 2000) is used to process the macrocircuit. Pointers are maintained to keep track of where in the logic-description array each macrocircuit starts. The NAME\$ array is reused because the names used in each macrocircuit are

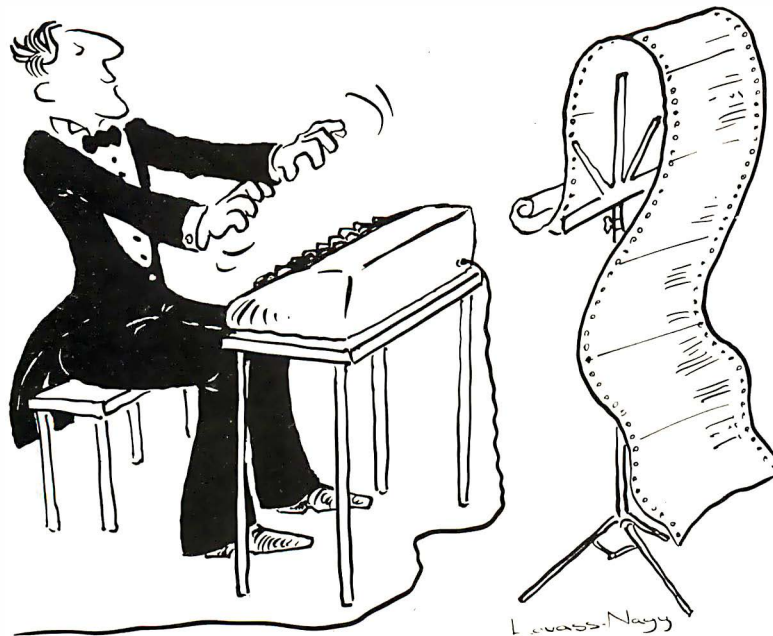

The Well-Tempered Cross-Assembler

Before Johann Sebastian Bach developed a new method of tuning, you had to change instruments practically every time you wanted to change keys. Very difficult.

Before Avocet introduced its family of cross-assemblers, developing micro-processor software was much the same. You needed a separate development system for practically every type of processor. Very difficult and very expensive.

But with Avocet's cross-assemblers, a single computer can develop software for virtually any microprocessor! Does that put us in a league with Bach? You decide.

Development Tools That Work

Avocet cross-assemblers are fast, reliable and user-proven in over 3 years of actual use. Ask NASA, IBM, XEROX or the hundreds of other organizations that use them. Every time you see a new microprocessor-based product, there's a good chance it was developed with Avocet cross-assemblers.

Avocet cross-assemblers are easy to use. They run on any computer with CP/M* and process assembly language for the most popular microprocessor families.

XASMO5	6805	
XASMO9	6809	
XASM18	1802	
XASM48	8048/8041	
XASM51	8051	
XASM65	6502	\$200
XASM68	6800/01	each
XASMF8	F8/3870	
XASM28	Z8	
XASM400....	COP400	
XASM75	NEC 7500	\$500
(Coming soon: XASM68K 68000)		

Turn Your Computer Into A Complete Development System

Of course, there's more. Avocet has the tools you need from start to finish to enter, assemble and test your software and finally cast it in EPROM:

Text Editor VEDIT -- full-screen text editor by CompuView. Makes source code entry a snap. Full-screen text editing, plus TECO-like macro facility for repetitive tasks. Pre-configured for over 40 terminals and personal computers as well as in user-configurable form.

CP/M-80 version \$150
 CP/M-86 or MDOS version \$195
 (when ordered with any Avocet product)

ROM Simulator -- ROMSIM by Inner Access eliminates need to erase and reprogram EPROM. Installed in an S-100 host, ROMSIM substitutes RAM for EPROM in external target system. 16K memory can be configured to simulate the 2708, 2758, 2716, 2516, 2732, 2532, 2764, 2564 in either byte or word organization. Avocet's configurable driver makes loading of HEX or COM files fast and easy.

From \$495 depending on cabling and RAM installed.

EPROM Programmer -- Model 7128 EPROM Programmer by GTek programs most EPROMS without the need for personal utility modules. Self-contained power supply ... accepts ASCII commands and data from any computer through RS 232 serial interface. Cross-assembler hex object files can be down-loaded directly. Commands include verify and read, as well as partial programming.

PROM types supported: 2508, 2758, 2516, 2716, 2532, 2732, 2732A, 27C32, MCM8766, 2564, 2764, 27C64, 27128, 8748, 8741, 8749, 8742, 8751, 8755, plus Seeq and Xicor EEPROMS.

(Upgrade kits will be available for new PROM types as they are introduced.)

Programmer \$389
 Options include:
 Software Driver Package \$ 30
 RS 232 Cable \$ 30
 8748 family socket adaptor \$ 98
 8751 family socket adaptor \$174

Call Us

If you're thinking about development systems, call us for some straight talk. If we don't have what you need, we'll help you find out who does. If you like, we'll even talk about Bach.

VISA and Mastercard accepted. All popular disc formats now available -- please specify. Prices do not include shipping and handling -- call for exact quotes. OEM INQUIRIES INVITED.

*Trademark of Digital Research.



**AVOCET
SYSTEMS INC.**
 DEPT. 483B
 804 SOUTH STATE STREET
 DOVER, DELAWARE 19901
 302-734-0151 TLX 467210

RS-232

DATA ACQUISITION

Control & Measurement

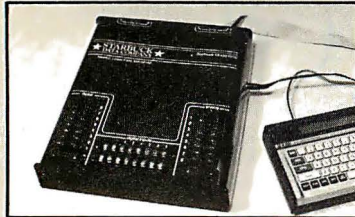

Starbuck Model 8232

A general purpose real-world interface: connects to ANY computer or terminal via RS-232

TYPICAL APPLICATIONS:

- Use with printing terminal: create low-cost data logger
- Use with modem and phone for remote acquisition & control
- Capture data bursts for subsequent analysis/plotting
- Monitor experiments; transfer data daily to main computer

FEATURES:

- 8 analog inputs, 0-5 VDC
- 8 digital input channels
- 8 opto-isolated outputs
- All inputs and outputs fully protected to withstand abuse
- 8 bit (0.4%) analog accuracy
- On-board 2000 point buffer
- Up to 5000 analog readings/s
- Triggered acquisition
- Units may be chained for extra channels
- Controlled by ASCII strings
- Application manual details interfaces for common sensors
- Applications engineer on call
- THRIFTY PRICE: \$540. complete! Applications manual only: \$5. TRS-80 version also available



PO Box 24, Newton, MA 02162
(617) 237-7695

Dealer and OEM inquiries welcome

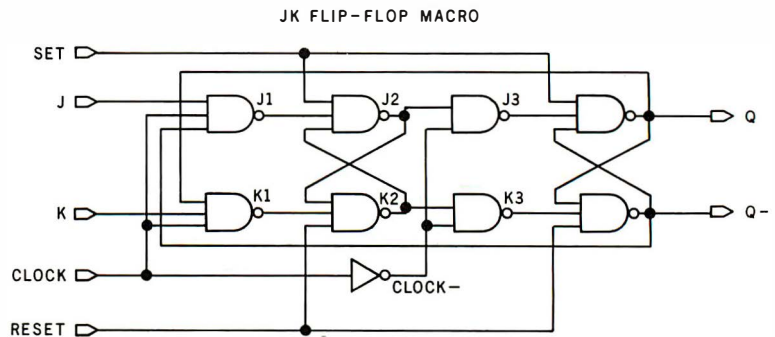

***** READING IN MACRO: JK

```

JK J K CLOCK RSET SET Q Q-
NAND J CLOCK Q- 0 0 J1 0
NAND K CLOCK Q 0 0 K1 0
NAND SET J1 K2 0 0 J2 0
NAND RSET K1 J2 0 0 K2 0
NAND J2 CLOCK- 0 0 0 J3 0
NAND K2 CLOCK- 0 0 0 K3 0
NAND J3 Q- 0 0 0 Q 0
NAND K3 Q 0 0 0 Q- 0
NAND CLOCK 0 0 0 0 CLOCK- 0
END 0 0 0 0 0 0
    
```

***** EXPANDED LOGIC DESCRIPTION *****

TYPE	INPUTS					OUTPUTS	
	1	2	3	4	5	Q	Q-
NAND	J1	CLOCK1	Q0-			88	
NAND	K1	CLOCK1	Q0			89	
NAND	SET	88	810			811	
NAND	RESET	89	811			810	
NAND	811	812				813	
NAND	810	812				814	
NAND	813	Q0-				Q0	
NAND	814	Q0				Q0-	
NAND	CLOCK1					812	
END							

Figure 5: Defining a macrocircuit. Using predefined logic elements, the JK flip-flop shown here can be described to the logic simulator once, then that description can be used wherever a flip-flop is needed; the user is not required to define the device every time it is used. (Multilevel or nested macros are also allowed.)

dummy names and need not be retained after the macrocircuit's description is stored.

The use of a macrocircuit is demonstrated in figure 5. The logic coding for a JK flip-flop was described in the January article; once its proper operation is verified, it can be used as a macrocircuit. Using the black-box approach, the user need provide only the J, K, Clock, Reset, and Set inputs and name the Q and Q- outputs. The macro processor, however, must assign unique signal numbers to the internal nodes wherever this JK flip-flop is used.

Nested macrocircuits (a macrocircuit used within a macrocircuit) add a further level of complexity in this signal-translation and node-generation procedure. One approach typically taken is to maintain a list of the defined signals on a stack and push and pop the signal names as macrocircuits are called and expanded. This pro-

cedure is efficient in that macrocircuits can be expanded as they are encountered, but typically requires either large memory for the stack or a limit to the nesting depth.

A procedure that allows for unlimited nesting depth requires multiple passes through the logic-description array: one pass to expand each level of macrocircuit. This procedure is not processor-time efficient, but the signal names need be stored only once for cross-referencing to a single macro call at any one time. One example of a nested macro would be when a 4-bit ripple counter is defined as a macrocircuit containing the JK flip-flop macrocircuit.

The macro expander (at line 3000) must perform two tasks: maintaining correspondence to the simulated circuit's signal names and generating unique signal names for other internal nodes. This process is performed by maintaining a macro-to-logic corre-

Now your computer can say anything and say it well. Introducing the Votrax Personal Speech System.

Quite articulate.

The unlimited vocabulary Votrax Personal Speech System is the most sophisticated, low cost voice synthesizer available today. Its highly articulate text-to-speech translator lets your computer properly pronounce conversational words at least 95% of the time.

For all those unusual words and proper names, you can define an exception word table and store your own translations. And remember, the entirely self-contained Votrax PS System gets your computer talking without using any valuable computer memory.

Built-in versatility.

Much more than just a voice output device, the Votrax PS System lets you mix either speech and sound effects or speech and music. A programmable master clock and 350 programmable frequencies give you unmatched control of speech and sound effects.

The Votrax PS System offers user expandable ROM for custom applications, user downloadable software and sound effects subroutines for easy user programming. Its programmable speech rate provides more natural rhythm, while 64 programmable amplitude levels give you greater control of word emphasis.

Actual size: 12.2" x 4.5" x 2.6"

Friendly to humans.

Designed to look like a printer to your computer, the Votrax PS System is extremely easy to use. It can be used in tandem with your printer without an additional interface card. Both serial and parallel ports come standard, allowing you to connect the Votrax PS System to virtually any computer. Speech, music and sound effects are only a PRINT statement away.

What to say after "Hello".

Businesses will appreciate spoken data transmission, narration of graphic displays and unmanned, oral product demonstrations. Spoken verification of data input will make computers much easier for the blind to use. School children can receive comprehensive

computer instruction with voice textbooks as well as spoken drills and testing. And then, late at night, you can make those adventure games explode.

A quick list.

- Highly articulate Votrax text-to-speech translator.
- 350 programmable frequencies for speech/sound effects.
- 64 amplitude levels.
- Simultaneous speech and sound effects or speech and music.
- 8 octave, 3 note music synthesis.
- Serial and parallel interface standard.
- User programmable master clock.
- User defined exception word table.
- User programmable speech rate, amplitude and inflection.
- User expandable ROM for custom applications.
- User downloadable software.
- 3,500 character input buffer: sub-divisible for a printer buffer.
- Internal speaker and external speaker jack.
- Real time clock and 8 user defined alarms.
- Oral power up and error prompting.
- X-on/X-off and RTS-CTS handshaking.
- Programmable Baud settings (75-9600).
- Interrupt driven Z-80 microprocessor.
- Parallel/Serial interconnect modes.
- Proper number string translation: the number "154" is pronounced "one hundred fifty four".

To order, see your local computer retailer or call toll-free

1-800-521-1350

Michigan residents, please call (313) 588-0341. MasterCard, VISA or personal check accepted. The price is \$395 plus \$4 for delivery. Educational discount available. Add sales tax in Michigan and California.

© VOTRAX 1982

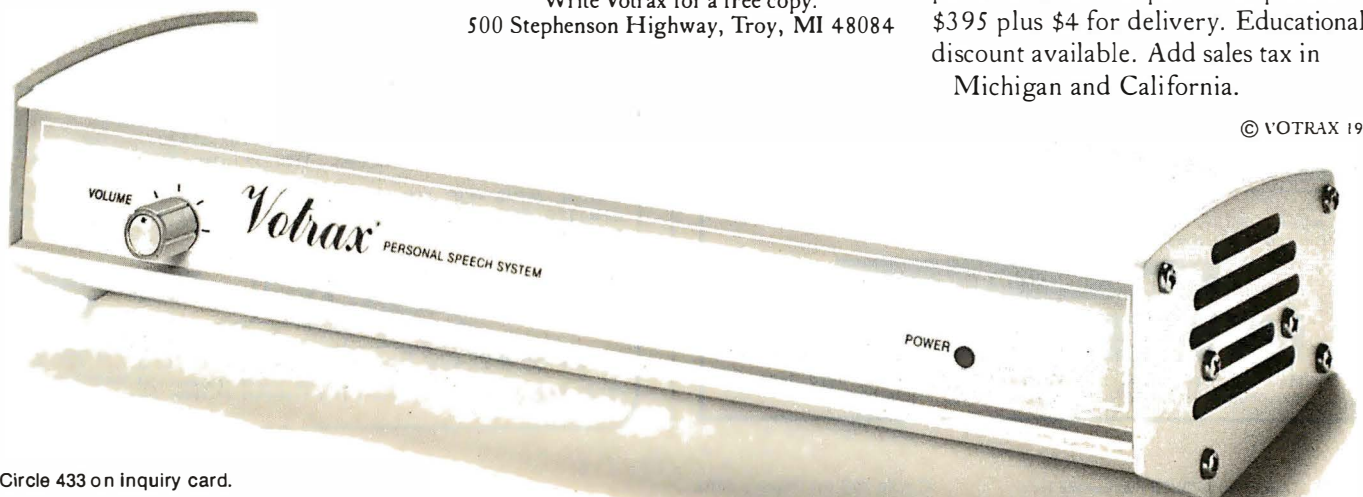

spondence array; because the array used to store old logic values is not needed at this point, this array is used to maintain this correspondence, thus conserving memory.

The subroutine at line 30000 builds this correspondence by placing the calling signal number in the array position pointed to by the macrocircuit signal number; all other entries are set to a -1 to indicate that no correspondence has yet been made. This correspondence is location-dependent, i.e., the location of a calling signal within the calling description corresponds to a signal in the same location in the macrocircuit's definition line (the first input in the call corresponds to the first input to the macrocircuit definition, etc.).

The subroutine at line 31000 is called to expand the called macrocircuit and add it to the end of the logic-description array. If a macrocircuit name has no correspondence to a calling name, a unique number is assigned, as well as a reference name. As each macrocircuit is expanded, the

calling entry in the logic-description array is deleted by moving the array up to overwrite the calling entry. The logic-description array is repeatedly scanned for macrocircuit calls, and the above process continues until no macrocircuit calls are found.

Error Checking

The basic error checking that should be performed consists of checking that a name is not used as the output of two or more logic elements and that each named input signal is defined as either an external stimulus or the output of a logic element. These checks are applicable for macrocircuit blocks, as well as for the total expanded logic description; although an error in a macrocircuit block will be found when the total network is checked, it is easier to debug an error if its location can be easily isolated. Each macrocircuit expansion involves a separate error check (at line 1500), and the total circuit is checked after expansion (at line 5000).

The check for multiple definitions of an output is performed by scanning the element-description array for the same signal number on two or more outputs. Rather than compare each output with every other output (requiring $N \times (N-1)/2$ comparisons), a single pass through the logic-description array can identify multiple uses of the same signal. The OL array (see line 12200) is used to mark the occurrence of a signal number as an output of a logic device or as an external stimulus; if a signal is already marked, it is flagged as an error.

This same marked array is then used to check for defined inputs (at line 12300); the logic array is scanned and each input is checked for a 0 in the OL array as being undefined. Additionally, for defined signals, this entry is incremented for each occurrence of the signal as an input, providing for an indication of the load on each signal. This count is also used to determine the array requirements for selective trace, as described in the

New for APPLEII®

*APPLE II is a registered trademark of APPLE Computer, Inc.

Keyboard

NKB-102

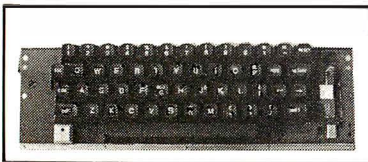

\$104

•N-Key Rollover Function •High Flexibility for Modification or Expansion •Plug-in Compatible with AppleII •Mount Immediately in AppleII Case •Included CP/M-Mode •User Programmable Function •Upper or Lower Case Letters •25 Fixed Function Keys

Floppy Disk

NF-505

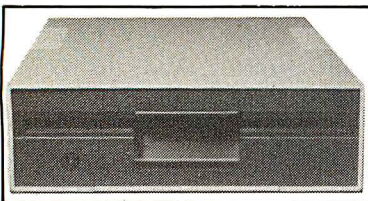

\$249

Fully Compatible with Disk II

•Low Profile High Performance •Fast Head seeking •Stable Circuit using Custame IC •40 Tracks Available

Dealer inquiries invited

NEWTECH Co., Ltd.

Maruzen Bldg, 1-8-6, Kandasurugadai Chiyoda-ku Tokyo Japan
Telephone: 03(295)8577 Telex: JJ33255 NEWTECH

IBM CP/M Apple

IBM-PC SPECIALS:

AST Research Exp. Board 64K—\$279, 128K—\$369, 192K—\$489, 256K—\$569. Combo/Mega Plus available. Quadram 256K port, ser 1/0 clock & calendar—\$589. Porsyst Time Spectrum & Spectrum with Insta Drive. Call. We carry many other brands of memory boards. Compupro—Seattle—STB—Microsoft Wizard. Xedex Baby Blue —\$499. Software: Best Buy Spellblinder—\$249. dBASE II—\$459 Supercalc—\$189 Visicalc—\$189 Peachtree Peach Pack—\$395 Micro Com Terminal—\$79 For more information circle reader service card #252.

CP/M SPECIALS:

Televideo TS 802 64K, 4MHz, 280A, 5 1/4" Dual Floppies—\$2639 Cromemco C-10SP—\$1698 Teletek Systemmaster I—\$674 Sclon Microangelo with Screen Pak II MA 520—\$995. SOFTWARE: Microsoft: Basic 80—\$249 Basic Compiler—\$299, Fortran—\$359 Digital Research: Pascal MT+SPP—\$395, CB 80—\$395 P/L180—\$429 WordStar—\$295 SuperSoft C Compiler—\$189. For more information circle reader service card #253.

APPLE SPECIALS:

Microsoft Prem Pak—\$469 MicroSci Drive—\$289 Controller—\$85 J-Cat Modem—\$119 Advance Logic CP/M Plus—\$299 For more information circle reader service card #254.

Epson MX 100—\$629 C.ltoh Prowriter—\$429 C.ltoh F-10 Parallel or Serial—\$1325 NEC 3550 Printer—\$1969. Ribbons.

SPECIAL DEPARTMENT FOR UNIVERSITIES, ASK FOR ANNE. WE ACCEPT LIMITED P.O.'S. ALL PRICES FOB, EL TORO, CA AND SUBJECT TO CHANGE. PLEASE CALL FIRST.

McNeill

VISA



Suite #186 • 25422 Trabuco Rd. #105 El Toro, CA 92630
(714) 768-8114

CP/M is a registered trademark of Digital Research. Apple is a trademark of Apple Computer.

DAWN OF A NEW GENERATION

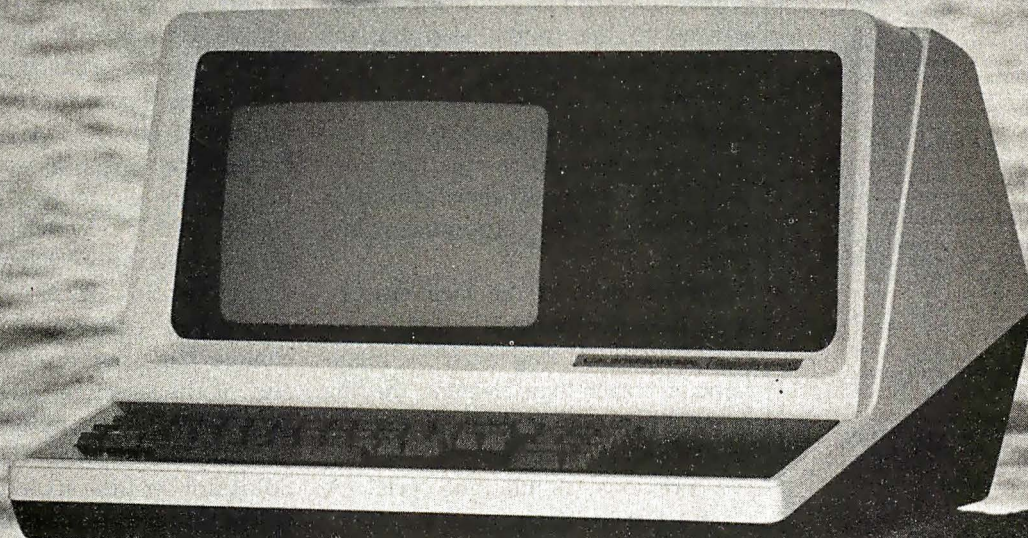

CMC 8/16 SuperSystem

- TurboDOS*, CP/M** and CP/M-86** operating systems
- Floppy and hard disk drives
- SuperNet, local area networking, accommodates up to 16 users with 6 MB to 52 MB storage
- All stand-alone models utilize 750K to 19 MB storage and can be field-upgraded to SuperNet status

RELIABLE EFFICIENT UPGRADABLE

- All 8-bit SuperSystems are easily upgraded to our new 8/16-bit system which features Intel's 80186 Processor and full CP/M-86 compatibility
- "Perfect Writer" word processing standard with all models.
- Generous dealer and OEM discounts
- 6 month warranty
- National on-site service in over 150 cities

CMC INTERNATIONAL

11058 Main Bellevue, WA 98004 (206) 453-9777 Telex: 152556 SEATAC

*TurboDOS is a registered Trademark of Software 2000

**CP/M is a registered Trademark of Digital Research, Inc.

Circle 466 on inquiry card.

BYTE April 1983 417

Call for MTI's lowest prices!

"QED" DISCOUNTS. VISA & MASTERCARD.

VIDEO TERMINALS

ADM-3A Upper case only, direct cursor address.
 ADM-5 Full ASCII, keypad, limited editing, etc.
 MTI personal computing option for above, 800Kb.
 Esprit Full ASCII, num. keypad, limited edit., etc.
 Esprit II Full Esprit feat., Adds, ADM-3 & 5 emu.
 Esprit III Full Esprit feat., Teletideo 950 emu.
 ADM-22 Ergonom. detached key, editing, etc.
 ADM-23 Conversation & block mode, 2 page mem.
 ADM-24 ADM-22 feat., 256 char buffer, graphics.
 ADM-31 Full editing, 2 page buffer, protected fields.
 ADM-32 Ergonom. ADM-31 with bus, graphics, etc.
 ADM-36 DEC System terminal, 80 or 132 col., etc.
 ADM-36 I IBM 3277 keyboard layout, use with p.c.
 VT 100 DECScope, 80 or 132 col., upgradable, etc.
 VT 18X Personal computing option, 360 Kb stor.
 VT 101 Non-upgradable VT100.
 VT102 Non-up. VT100 with adv. video, print. port.
 VT 131 Above with editing and block mode.
 TI 940 80 or 132 col., ergonom., one page buff., etc.

GRAPHICS TERMINALS

VT 125 Full VT100 with DEC ReGIS firmware.
 VT 100/Digital Eng. Retro-Graphics Tektronix comp.
 VT 101/Digital Eng. Retro-Graphics Tektronix comp.
 VT 102/Digital Eng. Retro-Graphics Tektronix comp.
 VT 131/Digital Eng. Retro-Graphics Tektronix comp.
 ADM-3A/Digital Eng. R-Graphics Tektronix comp.
 ADM-5/Digital Eng. Retro-Graphics Tektronix comp.
 Colorscan 10/D,E,R,G, VT 100/52 emu., Tektronix.
 VT100 w/TI 810 plotter, Tektronix compatible.

TELEPRINTERS

LA 34-AA DECwriter IV 30 cps, variable char. widths
 Diablo 620 RO letter quality 512-byte input buffer.
 Diablo 630 RO API letter quality most pers. comps.
 Diablo 630 KSR letter quality, 2688-byte buffer, etc.
 TI 745 portable, thermal, built-in acoustic coupler.
 TI 765 portable, above feat. with bubble memory.
 Epson MX-80 80 cps serial impact printer, 80 CPL.
 Epson MX-100 MX-80 plus 100 characters per line.
 LA 120 RA receive only 180 cps, 132 col. multi. cop.
 LA 120 AA KSR DECwriter III keyboard version.
 LA 100 letterprinter, 240, 80 & 30 cps, graphics.
 LA 50 personal printer, 100 cps, graphics capability.
 LA 12 portable KSR, 150 cps on normal bond paper.
 TI 783 portable, thermal, 120 cps bidirectional, etc.
 TI 785 783 features plus acoustic coupler, etc.
 TI 787 783 features plus internal modem, etc.
 TI 810 RO impact, 150 cps, 132 cpl, multiple copies.
 TI 820 RO 810 feat. plus full ASCII, 1280 char. buff.
 TI 820 RO full features of RO plus full ASCII key.

DATAPRODUCTS LINE PRINTERS

M-200 2400 baud 200 lpm at 72 cpl dot matrix printer.
 B-300 tabletop band printer, 300 lpm, 132 col., etc.
 8-600 pedestal-mounted 600 lpm band printer.
 B-1000 cabinet-enclosed 1000 lpm band printer.
 BP-1500 cabinet-enclosed 1500 lpm band printer.

ACOUSTIC COUPLERS

Omnitec 715 300 baud orig./full duplex.
 Omnitec 710 300 baud orig./half & full duplex.
 Vadic VA 3413 300/1200 orig. only.

MODEMS

VA 103 300 baud modemphone, rotary & tone.
 VA 355 300 baud 103 orig./ans. full duplex.
 VA 212LC low cost 1200 baud 212A orig./ans.
 VA 212PA orig./ans. with auto dial.
 DFO3AA DEC 212A.
 VA 1250 202 dir. con. w/o rev. chan.
 VA 1255 202 dir. con. w/rev. chan.
 VA 3212 212A/103 orig./ans. w & w/o auto dial.
 VA 3451 triple modem w & w/o auto dial.
 Vadic double modems VA & Bell comp.
 VA 2450 Bell 201 comp. w & w/o rev. chan., etc.
 MICOM modems up to 9600 bps.

LINE DRIVERS

MICOM asynch. & synch. line drivers.
 MICOM 4 & 8-channel multiplexing line drivers.

MULTIPLEXORS

MICOM 4, 8 & 16-channel multiplexors.

PERSONAL COMPUTERS

DEC VT 180 64K, 360 Kb 5 1/4" dual floppy stor.
 MTI Rooster 64K, 800 Kb 5 1/4" dual floppy stor.

CP/M APPLICATIONS SOFTWARE

MicroPro, Microsoft, Polygon & Select.



Applications Specialists & Distributors
 Computer Terminals, Peripherals & Systems

New York:
 516/621-6200, 212/767-0677, 518/449-5959
 Outside N.Y.S.: 800/645-6530
 New Jersey: 201/227-5552
 Ohio: 216/464-6688

next section.

As each error is reported, the user is given the option to have the program ignore the error and continue with simulation. This is particularly useful when a signal appears both as the output of a logic element and as an external stimulus for initialization.

Selective Trace

A logic element's output state will not change unless a change appears at its input; this fact can be used to optimize run-time by simulating an element only when such a change occurs. On a global scale, no element need be simulated until an external stimulus is applied.

The global optimization can be easily implemented by maintaining a single *change flag* used to skip the entire simulation process when no changes are noted. Additionally, if the next scheduled stimulus change time is known, the simulator clock (ripple time) can be automatically advanced to that point, skipping the intermediate (inactive) time steps. The variables C9 (change flag), E9 (next scheduled stimulus time), and S9 (next scheduled sample time) are used to determine RI (next scheduled ripple time) in the subroutine at line 7500.

Optimization at the logic-element level (selective trace) is slightly more complicated. A flag must be maintained for each logic element; the flag is set when one or more of the element's inputs changed state during the previous simulation cycle. A cross-reference array must be maintained to identify which logic elements are affected by each output signal; conceptually, an array is required where one dimension represents the logic elements and the other dimension is the number of signal nodes.

This array contains a 1 if the element is driven by the corresponding node; otherwise, it contains a 0. This array would contain primarily 0s, because few nodes would fan out to more than a few logic elements; as such, sparse-matrix techniques are used to minimize the memory requirements for such processing.

The S0, S1, and S2 arrays are used

to perform this sparse-matrix tracing and marking. S0 contains the flag for each logic element; S1 is arranged by signal number and points to entries in S2 (which contains the list of elements driven by each signal number—the drive table). On entry to the routine that builds these arrays, a check is made to see that sufficient memory remains to store these values; because selective trace is not necessary for simulation, if sufficient memory is not available, this process is skipped entirely and the ST (selective-trace flag) is cleared.

The subroutine at line 6500 creates the drive table; this table is, in effect, a form of a linked list. Because the length of the list of elements driven by a particular signal is of variable size, this list is dynamically allocated and uses a delimiter to mark the end of the list for each signal (the next entries in the array are the list of elements driven by the next signal).

During simulation, as the output signals are moved from the NEW to the OLD array, a check is made to see if a change has occurred on a signal (at line 8500); if so, C9, the global-change flag, is set (as are the change flags of the elements driven by this signal if the selective-trace flag is set—see the subroutine at line 8620). The simulation of the logic elements is skipped entirely if the global-change flag is not set (line 40010); and, if the selective-trace flag is set, each element's simulation is skipped if its individual-change flag (in array S0) is not set (line 40030). The global optimization can produce a twofold to fivefold decrease in processing time, and the element-level selective trace another twofold to tenfold decrease, depending upon the relative activity of the logic network.

Sampled Output

The primitive version of this program produced a display of each selected logic signal at each simulation cycle. To get a more global view of the operation of the logic network, however, it is often desirable to display the outputs at periodic intervals rather than at each cycle. This is comparable to the sweep control on an oscilloscope. In the simulation of a

The speed and power of an IBM PC on a \$345 Apple® Card.

ADVANCED 16-BIT PROCESSOR

Technology moves quickly in the computer world. Your Apple's 8-bit processor and 64K memory were state-of-the-art just a few years ago. Today's technology: the 16-bit processor, with the speed and power you need to tackle today's problems.

MEETING THE CHALLENGE

How do you give your Apple the advantages of the latest technology? ALF's \$345 Processor Card is the answer, with its 16-bit 5 MHz 8088 processor. The same processor used in the newest computers available: the IBM PC, the DEC Rainbow 100 and and Professional 350, the Zenith Z-100, the TI Professional Computer, and others.

With ALF's Processor Card, you get the best of both worlds. You can still use all your Apple software. And you can run the latest 16-bit programs. With CP/M™-86 (the 8086/8088 version of the CP/M operating system), you can use the latest high-level programming languages: Digital Research CBASIC-86 and PASCAL/MT+, Computer Innovations C86, and more. Take advantage of sophisticated applications programs like Sorcim SuperCalc, MicroPro Wordstar-86, Ashton-Tate dBASE II-86, and Peachtree accounting programs. Or use your Apple to develop programs for other CP/M-86 compatible computers. CP/M-86 is available for just \$200.

EXPAND YOUR APPLE TO 192K

Of course the Processor Card can use your existing Apple memory to run programs up to 46K long under CP/M-86. If you need to run larger programs, add ALF's Memory Card with 64K or 128K (for programs to 110K or 174K). It's accessed directly by the 8088 processor (not by the Apple's processor) for fast 5 MHz operation. When using DOS 3.3, you can use the 128K Memory Card as a disk emulator for ultra-fast DOS functions. The Memory Card is only \$370 with 64K, or \$445 with 128K and the disk emulator program.

FASTER MATH FUNCTIONS

Today's financial and scientific calculations

rely on floating-point math functions. Programs can be rewritten in the new high-level languages for faster execution, but rewriting isn't always desirable. ALF's Processor Card lets you speed up math functions in *existing* programs, without modification — and without buying new operating systems or languages.

The "FTL" program supplied with the Processor Card speeds up most math functions in Applesoft programs (including programs compiled with most Applesoft compilers). And "FTL87" gives you even faster math functions with the optional 8087 Numeric Data Processor chip. Both programs are incredibly easy to use.

Micro Magic's "Pascal Patch" speeds up math functions in your Apple Pascal programs. Like FTL, the Pascal Patch sends numbers to the Processor Card for faster computation. The Pascal Patch is simple to use, and is priced under \$50.

RELIABLE DESIGN

ALF's years of experience in building Apple accessories and our reputation for quality products stand behind every card. Low-power components help avoid overheating: the fully expanded Processor Card and the Memory Card with 128K each draw less than Apple's ROM card — far less than many of today's complex cards.

The Processor Card can be used in any slot except 0.

The Memory Card can be used in any nearby slot, including slots which cannot usually be used (slot 3 on the Apple IIe or slot 0 on the Franklin Ace 1000).

SEE YOUR COMPUTER DEALER TODAY

See your dealer, or write us for more information. Whether you have an Apple II, an Apple II-Plus, an Apple IIe, a Basis 108, or a Franklin Ace, ALF's Processor Card gives your system the speed and power you need today!

"Apple" is a trademark of Apple Computer. "CP/M-86" is a trademark of Digital Research.

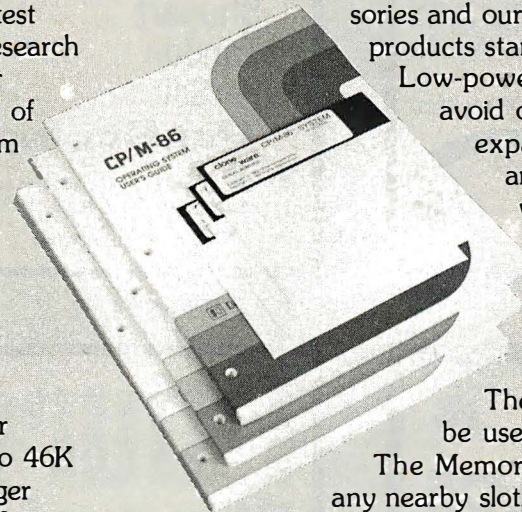
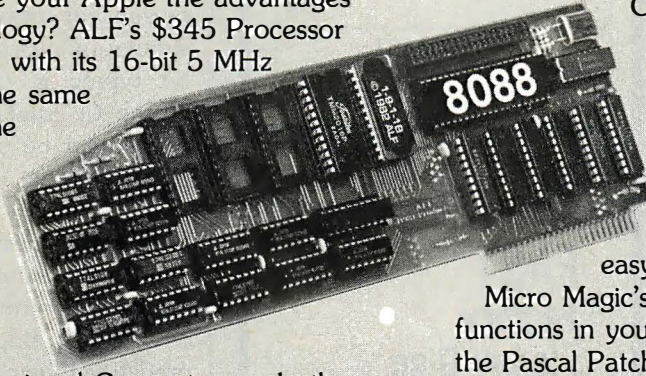

ALF

ALF Products Inc. 1315F Nelson St. Denver, CO 80215

(303) 234-0871 Telex: 4991824

Bill Cosby
says:
"When you
learn CPR,
you're
ready to
save lives—
anywhere."



American
Red Cross

**DAISY WHEEL PRINTERS
SMITH-CORONA TP-1**

\$529



- BROTHER HR-15(2 colors) **SAVE**
- BROTHER HR-1 (16k) **\$749**
- DAISY WRITER 2000(48k) **\$999**
- C-I TOH F-10(40 cps) **\$1295**
- COMMODORE 64 Computer **SAVE**
- OSBORNE Computer **\$1595**
- SANYO MBC-1000(incl swtware) **\$1595**
- KAY-PRO II **SCALL**
- ZORBA **SAVE**
- Wordstar/Spellstar/Mailmerge **\$349**
- Franklin-Ace **\$899**

MICRO MART

5375 Kearny Villa Rd #115, San Diego CA 92123
(619) 268-0169

Circle 269 on Inquiry card.

**Votrax SC-01A
SPEECH SYNTHESIZER**



\$50 Each

Order in Ones or Thousands

The SC-01A Speech Synthesizer is a completely self-contained solid state device. This single chip phonetically synthesizes continuous speech of unlimited vocabulary.

The SC-01A contains 64 different phonemes which are accessed by a 6-bit code. Computer interfaces and text-to-speech algorithms also available for product development.

Votrax is a trademark of Federal Screw Works

Call 1-800-645-3479, in N.Y. 1-516-374-6793

MICROMINT INC.

917 Midway
Woodmere, N.Y. 11598



Call for
quantity pricing.



Circle 484 on Inquiry card.

**FAST
Factory
Floppy Disc
Drive
Repair**

Specialists in the repair of:

**Shugart
Tandon
PerSci**

PERSci, INC.



12210 Nebraska Ave.
Los Angeles, CA 90025
(213) 820-7613
TELEX 687444

Circle 481 on inquiry card.

FLY BOARD
Programable
INTERFACE
for the Apple II



The FLY BOARD is an interfacing system designed for Apple Owners who want to learn computer interfacing. The FLY BOARD is programable through BASIC or Assembly.

Fly Board's Hardware:

- 16 bidirectional I/O lines
 - 4 control lines
 - 2 - 16-bit timers
 - interrupt ability
 - accepts RP# commands
 - Replaceable with an EPROM
 - not used by monitor, BASIC, or DOS
- 6522 VIA
- 2K bytes RAM

2 - 36" DIP Jumper Cables
• connect to your projects

Support Materials Included:

User's Manual expertly written to guide the novice and intrigue the expert

Summary Card details at a glance

Engineer's Notebook 128 page electronic cookbook

6522 Data Sheet explains advanced features

only **129⁹⁵** Ready to use add \$2 for shipping

SHAVE SYSTEMS P.O. Box 927 Niles, IL 60648 (312) 966-4505

Visa, M.C. or check

Circle 482 on Inquiry card.

Future Shock!

age 65
years worked 40
retirement benefits 0

The U.S. Department of Labor has a free booklet that will help you answer these questions and a lot more. Send for it today.

Write: Pensions, Consumer Information Center, Pueblo, Colorado 81009

U.S. Department of Labor

counter, for example, it is often desirable to display the resultant count at each clock cycle rather than at each gate-simulation cycle.

This option is directly implemented by specifying the start time and the sampling interval. For every simulation cycle, the subroutine at line 9000 checks to see if a sample is required (RI=S9), and if so, displays the values. It also increments S9 for the next scheduled time and checks for a full screen. If the screen is full (50 samples displayed), the user is given options for continued processing. The simulation process can be reinitialized by typing R (restart), aborted by typing Q (quit), or the monitored points can be changed by typing C (change).

Sequential-Device Models

A logic simulator for advanced digital design must include sequential devices (flip-flops, counters, etc.) as predefined logic primitives. While sequential devices can be modeled as macrocircuits of the basic logic elements, such modeling is inefficient (requiring, for example, nine combinational devices to model a single JK flip-flop).

The combinational models previously described (AND, OR, XOR gates) each have inputs that are congruent; i.e., for a 2-input AND gate, it doesn't matter which signal is given as the first pin and which as the second. For sequential devices, however, each input has a specific function; i.e., the Clock pin operates differently from the J input pin on a JK flip-flop. To maintain this "pin significance," each sequential model uses a fixed order of signal pins in the input description shown in figure 4; in the JK flip-flop model, for example, the first input signal will be interpreted to be the J input, the second the K, third Clock, fourth Reset, and fifth Set. This assignment is used directly by the sequential models to accurately simulate the operation of these devices; in all cases, the devices are triggered on the *rising edge* of the clock and contain optional asynchronous, active-low Set and Reset pins.

The use of sequential devices as

Figure 6: Models of sequential devices. Figure 6a shows a level-sensitive, edge-triggered latch used in simulation of more complex devices. A parallel-loading counter (similar to a 74LS163) is modeled in figure 6b. Each stage is a combination of some logic elements and a shift register.

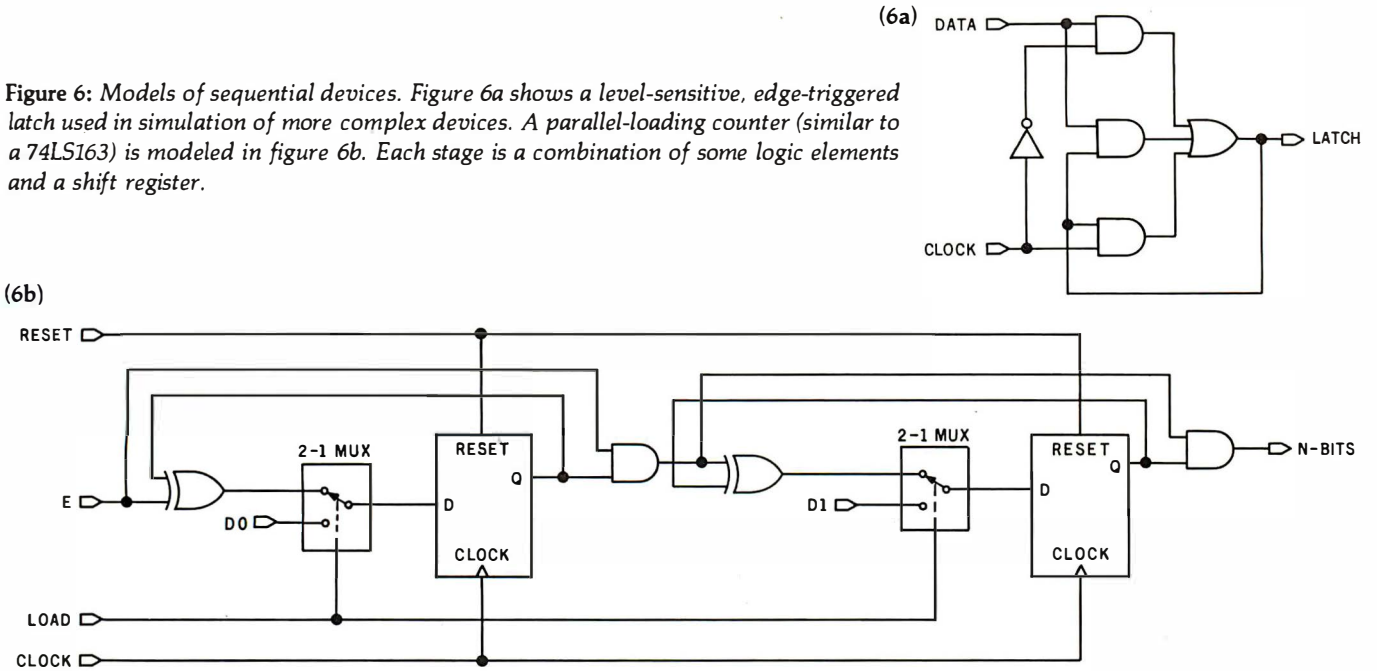

primitives requires that such devices be predefined. Thus, we must address the fact that sequential devices, by definition, contain some memory of their prior state. For example, the operation of a counter is dependent upon its prior count, as well as its immediate inputs. Each logic element in the program includes an array position for maintaining this memory value (or a pointer to another array for maintaining multiple memory values).

Each of the sequential devices described herein is a level-sensitive, edge-triggered device. When the clock goes to a logic 1, the resultant output is latched to the desired state; it cannot change value (except by asynchronous Set or Reset), except on the rising edge. Such a level-sensitive, edge-triggered operation is typically designed by using dual latches on opposing clock values. When the clock is low, the input is latched to its appropriate value while the output retains its prior latched value; when the clock is high, the input latch is disabled from changes on the input and the output is driven by this internal latch value. Figure 6 shows such a latch; this logical model is used for simulation. Because the prior output value is available from the OLD array, the program need retain only the internal latch value for proper se-

quential modeling (this is the eighth entry in the logic-description array).

The subroutine at line 45000 performs the basic latch function (a 2-to-1 multiplexer); the subroutine at line 45100 performs the basic shift register function by two calls to the latch function, returning YL as the internal latch value and Y as the second (Q output) latch value. (The shift register function also calls the routine at line 45200 to process the asynchronous Set and Reset signals, if any.)

The model of a D-type flip-flop is merely a direct call to the shift register function; note that the optional Set and Reset pins are set to a default of logic 1 by presetting the 0 entry of the OLD array to a logic 1. If the signals are unused (signal number 0), this logic 1 is read as the current input (Set and Reset are active-low).

The model of a JK flip-flop is basically some combinational logic followed by a shift register. The internal D input should be the desired Q output upon receipt of an active clock edge; the combinational logic to generate the D input is

$$(J \text{ AND } \overline{Q}) \text{ OR } (\overline{K} \text{ AND } Q)$$

To properly model a possible Q-unknown value, however, a third term (J AND \overline{K}) is included.

A parallel load counter (similar to a 74LS163) is modeled as shown in figure 6b; again, each stage is merely some combinational logic followed by a shift register. Using one line of input coding for each stage of the counter provides for a latch position for each stage; note that the use of "continue" lines for the additional stages provides for an automatic determination of the number of stages used and required, precluding the necessity of predefining the number of stages.

A parallel load shift register is identical in concept to the parallel load counter, the only difference being in the combinational logic feeding each shift register.

The N-bit shift register, however, is implemented differently. For ease of coding, as well as efficient memory use, it is unreasonable to require a separate line of input coding for each of the N stages. The second input signal to the N-bit shift register is actually a numeric value specifying N. This input is treated as a numeric value rather than a signal name by using # (number sign) as a prefix to the numeric value, and having the input processor properly handle this numeric marking. (Note that the number/signal distinction is made during input processing without regard to the logic-element type; this

"What major local area networks will Lanier fit into?"

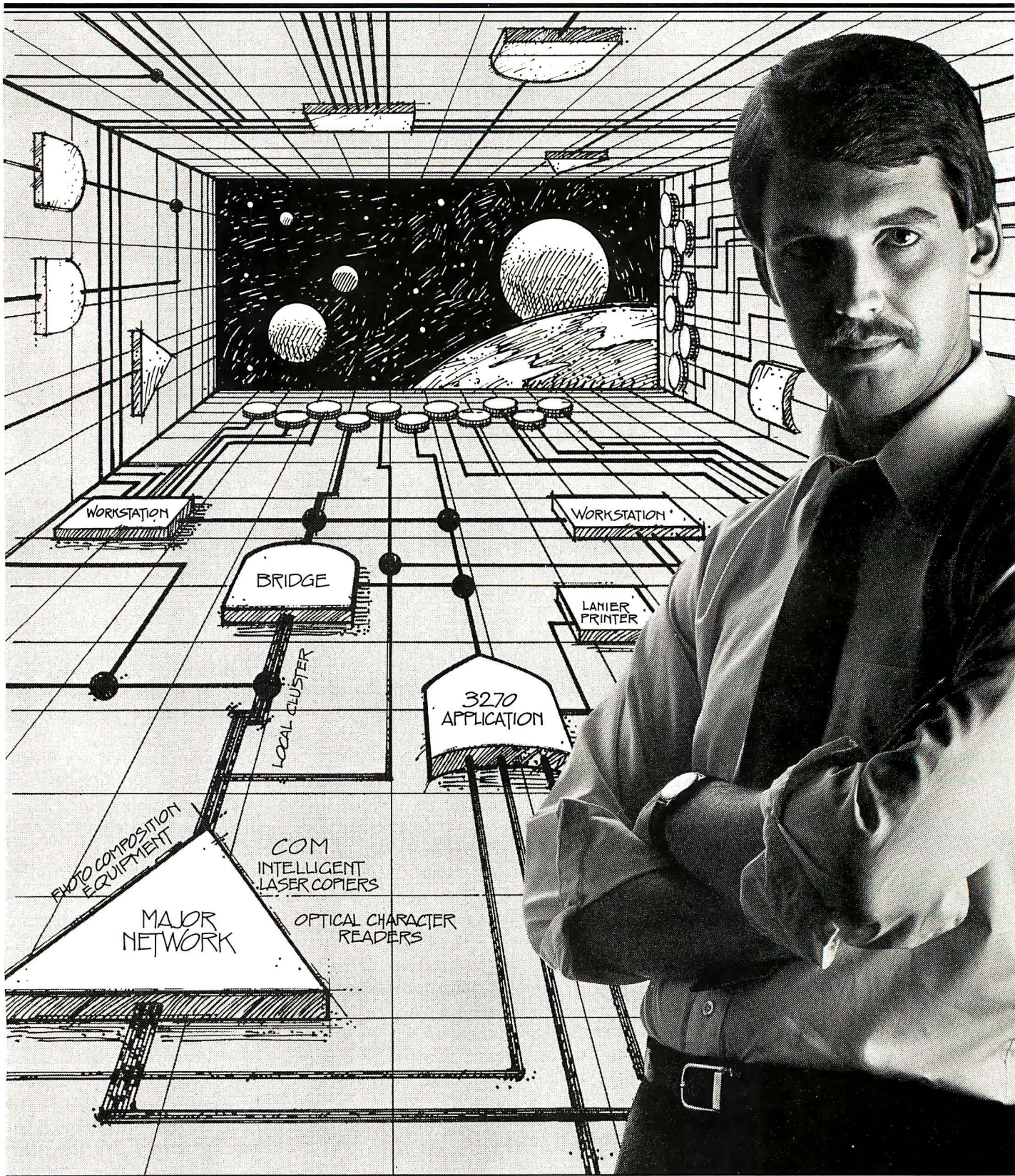

"You name it."

Leo Cortjens, Director, Networking Development,
Electronic Office Systems Division

With all the different networking alternatives available, the last thing anyone needs is one more. So Lanier is proud to announce that we're not introducing another new standard. Instead, we're going to support the industry's major local area network schemes. By doing this, Lanier will give you compatibility.

"That takes care of compatibility. What about cost?"

"It's small. Lanier makes sure your investment is small because our systems connect to each other very inexpensively. You can connect Lanier systems in one department with a simple interface that's a fraction of the typical cost of local area network interfaces and cabling. Then, when you're ready to connect to your mainframe computer, you can use the same protocols you've already implemented for your terminal network."

"Can I connect Lanier equipment to my IBM mainframe?"

"Of course. We support SNA/SDLC, IBM's standard for communications and one of today's most used protocols. By implementing SNA, Lanier makes it easy for you to connect your office automation equipment to your IBM mainframe computers."

"How do Lanier office automation systems communicate with my IBM computers?"

"With special 'bridges.' Lanier system elements such as terminals and printers connect to each other by inexpensive interfaces. Then the entire Lanier system communicates with your IBM computer through a Lanier 'bridge.' The Lanier bridge can talk to SNA systems: your IBM mainframe, another Lanier bridge via a telephone line, or any SNA subsystem you can reach through data lines, all without any compatibility problems."

"But what about other local area networks?"

"Lanier will support the local area networks that become widely used in the marketplace. Implementing other protocols doesn't mean we have to modify our whole system architecture. The network management layer will change to support new protocols."

"How does Lanier fit into my master plan for office automation?"

"We will be able to integrate voice, word and data processing. And Lanier systems easily interface with other devices such as optical character readers, intelligent laser copiers, photocomposition and COM equipment."

Lanier looked into the future. And we found that offices don't need another unique network. That's why all Lanier systems are designed to be compatible with the major local area networks in use now. And with ones that become industry standards in the future. So whatever plans you have for your office automation, you can be sure Lanier will fit into them.

Send us this coupon, or call Jennifer Scott at (800) 241-1706 for more information about Lanier's electronic office systems. Except in Alaska and Hawaii. In Georgia, call collect: (404) 321-1244.

Send to:
Lanier Business Products, Inc.
1700 Chantilly Drive N.E.
Atlanta, GA 30324
Attn: Jennifer Scott

Name _____
Title _____
Phone _____ Best time to call _____
Firm _____
Address _____
County _____
City _____ State _____ Zip _____

Mar. '83 Byte 4 76 B C3

We'll change your mind about the future
Right here and now.

LANIER®

Circle 227 on inquiry card.

ONE



IN



SIX

CAN'T KEEP UP

Exercise builds strong bodies. Strength and coordination help a child to be healthy and happy, but...

in America today, many normally healthy children cannot pass a simple fitness test: one in six cannot do twenty situps or even one pullup.

Lacking the strength and stamina they need, these children can't keep up with their friends.

Don't let this happen. Your school or recreation center should have special programs for boys and girls to improve strength and endurance. See that your child gets help—now.

Send for this free booklet.
Write: Fitness
Washington, D.C.
20201

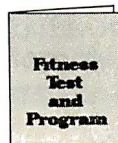

**In the long run,
they'll be the winners.**



The President's Council on Physical Fitness and Sports

approach is more flexible than having a separate processor for an N-bit shift register—logic devices defined later may also need such numeric values.) This number is actually stored as a negative number to distinguish it from signal numbers; the sum of these negative numbers is used to dimension array ME for retaining internal memory values.

The eighth entry in the logic-description array contains a pointer to this array for each N-bit shift register used rather than containing the single latch value. The model itself is simulated by N calls to the shift register function, using and storing values in the ME array.

Enhancements

The only obvious enhancement to the program is to add primitives (such as transmission gates and buses) and dynamic array allocation. The program is structured to support the addition of logic primitives by having no fixed limit on the number of primitives used. The initialization subroutine (line 500) reads a list of primitive logic-element names, ended by pseudotype "LAST"; adding primitive names before this "LAST" entry automatically adds it to the primitive list. The statement

```
ON LT GOSUB ...
```

at line 40130 calls the appropriate subroutine to model each primitive; these subroutines are called with IN(1) through IN(5), containing the input signal numbers, and Q0 and Q1, containing the output signal numbers. The subroutine for the added primitive is expected to store the resultant Q output in variable Y; upon return, this value will be stored in NEW(Q0) and its complement in NEW(Q1).

For proper modeling, particularly for proper handling of logic unknowns, a proposed primitive should first be simulated as a combination of existing primitives to verify its operation. The primitive subroutine should then be coded in terms of logical operations (AND and OR), and use the LN array for logical NOTs.

NUMERO UNO

EN SOFTWARE EN ESPAÑOL

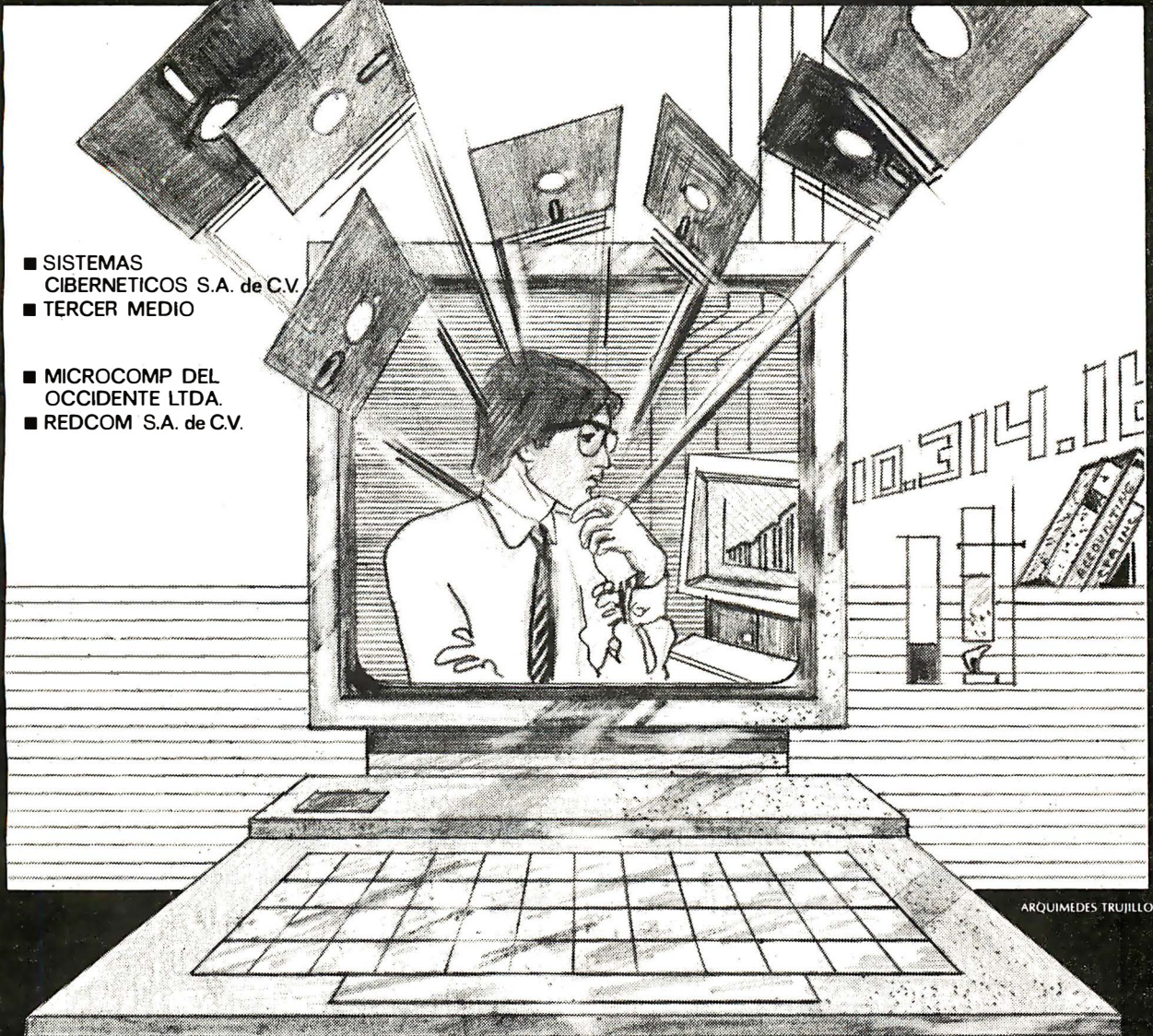

- SISTEMAS CIBERNETICOS S.A. de C.V.
- TERCER MEDIO

- MICROCOMP DEL OCCIDENTE LTDA.
- REDCOM S.A. de C.V.

¡International Micro Systems ha conquistado esta nueva y dinámica frontera! Somos los primeros especialistas en software en español, creados específicamente para satisfacer todas las necesidades de su empresa. . . y para ser utilizados con las computadoras de mayor renombre: APPLE, IBM Personal Computer, TRS - 80, los sistemas CP/M® . . .

Así que, si usted es un hombre de negocios que requiere una computadora que le hable en su propio idioma o un distribuidor que necesite suplir la demanda de sus clientes, nosotros nos encargaremos de poner a su alcance esta serie de programas. Para mayor información, por favor escribanos o llámenos a:

Contabilidad
Cuentas por Cobrar
Control de Costo de Obras
WordStar*
MailMerge*
DataStar*
CalcStar*
PERT/CPM
Procesadores de Palabras

Control de Bancos
Análisis Financieros
Control de Inventario
y Facturación
Análisis de Costos para la
Construcción
Generadores de Reportes
Generadores de Programas
Juegos

* Marcas registradas de MicroPro International Corp.



International Micro Systems, Inc.

9380 Sunset Drive Suite B 210
Miami, Florida 33173
(305) 279-0186 (305) 279-0194

The program in listing 1 is not necessarily memory-efficient under all conditions. The maximum dimension for each array is predefined, independent of the actual number of array locations required by the circuit being simulated; some designs may contain few logic elements and many external stimuli, other designs may have many logic elements but few stimuli, yet the program preallocates a fixed portion of RAM for each array. If it is known, a priori, exactly how many logic elements are required, the dimension could be adjusted accordingly, providing more memory for external stimuli or selective trace; such a predefinition, however, is cumbersome for the user, particularly if macrocircuits are used.

Two approaches are available to optimize memory use. The most straightforward way is to perform a two-pass operation: on the first pass, the required array sizes are calculated; then the data is restored and the arrays are dimensioned to their required sizes for the second pass, which actually performs the storing

of values and the simulation.

A more efficient process is "dynamic allocation," in which a single array is used to contain all numeric data. Such an array is dimensioned to the maximum available memory and as each element or external is read, an index is maintained to point to the start of each subarray, similar to the approach taken in LO (the logic-description array), which contains both the macrocircuit definitions and the actual network logic description. The external stimuli array, for example, would follow the network description in this array with a single variable used to store the start of this array; it would then be followed by the selective-trace arrays, the old and new value arrays, and so on.

Conclusion

The use of a logic simulator can replace the use of a hardware digital breadboarding system, particularly if the higher-level modeling capabilities described in this article are included in the system. The added features

such as named nodes, macro processing, and sampled outputs make such a system easy to use and provide for a hard-copy logic description that is easier to debug than the equivalent breadboarded system.

Logic simulation is used at professional design centers to verify proper logical operation of proposed designs prior to the costly fabrication of printed-circuit boards. I find this system particularly useful for the simulation of designs presented in hobby magazines, before investing in parts to build these sometimes-untested designs.

One of the biggest advantages I find in using a software-based logic simulator is that I never run out of spare parts on a Saturday night when the local supply stores are closed, nor do I ever burn out expensive ICs by improper connections! ■

Listing 1 begins on page 428

The author can supply copies of the advanced logic simulator for the Radio Shack Model III (listing 1) for \$20.

BYTE Back issues for sale

	1976	1977	1978	1979	1980	1981	1982	1983
Jan.		\$2.00		\$2.75	\$3.25	\$3.25	\$3.70	\$3.70
Feb.			\$2.75	\$2.75	\$3.25	\$3.25	\$3.70	\$3.70
March			\$2.75	\$2.75	\$3.25	\$3.25	\$3.70	\$3.70
April			\$2.75	\$2.75	\$3.25	\$3.25	\$3.70	\$3.70
May		\$2.00	\$2.75	\$2.75	\$3.25	\$3.25	\$3.70	
June		\$2.00	\$2.75	\$2.75	\$3.25	\$3.25	\$3.70	

	1976	1977	1978	1979	1980	1981	1982	1983
July	\$2.00	\$2.00	\$2.75	\$2.75	\$3.25	\$3.25	\$3.70	
Aug.	\$2.00	\$2.00	\$2.75	\$2.75	\$3.25	\$3.25	\$3.70	
Sept.		\$2.75	\$2.75	\$2.75	\$3.25	\$3.25	\$3.70	
Oct.			\$2.75	\$2.75	\$3.25	\$3.25		
Nov.	\$2.00	\$2.75		\$3.25	\$3.25	\$3.25	\$3.70	
Dec.	\$2.00	\$2.75	\$2.75	\$3.25	\$3.25	\$3.25	\$3.70	

Circle and send requests with payment to:
BYTE Back Issues
P.O. Box 328
Hancock, NH 03449

Please allow 4 weeks for domestic delivery and 8 weeks for foreign delivery.

name _____
 address _____
 city _____
 state _____ zip _____

The above prices include postage in the US. Please add \$.50 per copy for Canada and Mexico; and \$2.00 per copy to foreign countries.

Check enclosed

Payments from foreign countries must be made in US funds payable at a US bank.

VISA Master Card
 Card # _____ Exp. _____

Signature _____



FORMULA INTERNATIONAL INC.

12603 Crenshaw Blvd., Hawthorne, CA 90250

For information (213) 973-1921 • Orders Only (outside Calif.) (800) 672-8758



pineapple™

The Alternative! The Compatible! The Affordable! 48K Color Computer Kit!

\$645⁰⁰ EACH

(please add 5% shipping and handling)

FEATURES:

- ★ Fully compatible with Apple® II+ ★ Built in 2-watt amplifier for realistic sound effect with volume control
- ★ Singleboard for easy assembly
- ★ Popular 6502 MPU for large amount of software
- ★ Game paddle connector on both sides of case
- ★ 8 on board peripheral connectors for expansion
- ★ 14 key numeric key-pad
- ★ 5-amp switching power supply

Easy to assemble! All components are clearly silk-screened on the high quality double-sided mother board. All integrated circuits, IC sockets, peripheral connectors, keyboard, switching power supply and the professional high impact plastic case are included.

NEW

High Quality 16K RAM Card Kit

(no cable required)

Same feature as the one we've been selling but without the mess of Dip-wire for Apple® & Pineapple™. **\$59.95** per kit

5 1/4" Flexible Disc Sale

Why buy other brands when you can buy WABASH discs for much less and backed by 1-year factory warranty. All discs come with Hub Rings

M13A411X	5 1/4" SSDD Soft Sector	\$2.25	} 10-99
M43A411X	5 1/4" SSDD 10 Hard Sector	\$2.25	
M53A411X	5 1/4" SSDD 16 Hard Sector	\$2.25	
M14A411X	5 1/4" DSDD Soft Sector	\$3.65	
F111111X	8" SSSD IBM compatible	\$2.45	
F131211X	8" SSSD 26 sectors 128 bytes	\$3.05	

16K RAM Card Kit For Your Apple® & Pineapple™ Computer



Kit includes:

- High Quality P.C. Board • 8 ea. 4116 (200ns) • All the IC's & parts • 16-pin Dip wire • Easy to assemble. You can do it in less than 30 minutes!

\$49.95 per kit

5 1/4" Disc Drive 100% Apple® & Pineapple™ Compatible



We did it once, response was great! Now we are doing it again, don't miss it!

\$295.00 ea. w/o controller

\$385.00 ea w/controller

Replacement Keyboard For Your Apple® II Computer

Got a bad Keyboard? Here's the alternative!

- ★ Full ASCII code
- ★ N-key rollover function
- ★ TTL level output
- ★ On-Off indicator
- ★ Low power consumption
- ★ With upper/lower case function



\$99.95 ea.

At last! Here's the computer case everyone has been looking for!

Ideal for your homebrew *AP-II 6502 MPU based computer. Made with high impact plastic. Color and shape are compatible with the standard Apple II computers.



Introductory Offer **\$150.00** ea.

Keyboard not included see our Ad in this page.

MODEL: AP-II

*AP-II model is compatible with Apple II but not manufactured by Apple Computers, Inc. ©Apple or Apple II is a registered trade mark of Apple Computers, Inc.

6502 MPU Based Computer Motherboard! You ask for it, you got it!

- ★ 48K on board memory (4116)
- ★ 12K on board EPROM memory (2716 or 2732)
- ★ 8 expansion slots for peripheral cards
- ★ Composite-video output
- ★ size: 14 1/4" x 8 1/2"



\$99.95 ea.

Switching Power Supply For Apple®, AP-II, and Pineapple Computer

Compact size switching power supply.

Specification:	4006A	4007A
+5V at	3A	5A
-5V at	2A	3A
+12V at	.5A	1A
-12V at	.5A	1A



4006A **\$99.00** ea.

4007A **\$145.00** ea.

Size: Width 3 1/2", Depth 9 3/4", Height 2 1/4"

Size and mounting holes will be same as the one used in Apple II.

* Apple is a registered trademark of APPLE COMPUTERS, INC.

SHIPPING AND HANDLING CHARGES	
Under \$50.00 Purchase	Over \$50.00 Purchase
10%	5%
15%	10%
25%	20%

Minimum Order \$10.00 / Calif. Residents add 6.5% Sales Tax. Phone Orders Accepted on VISA or MC ONLY, NO C.O.D.'s. Prices subject to change without notice.



STORE HOURS
MON-FRI — 10-7
SAT — 10-6

Circle 171 on inquiry card.

Listing 1: The advanced version of the logic-simulation program, written in BASIC for the Radio Shack Model III. The major subroutines are diagramed in figure 1 and figure 2; predefined logic elements are shown in the other figures. The program is very modular and can be expanded to include more predefined logic elements than it now contains. The data statements starting at line 50000 contain a sample set of input coding for a 4-bit counter using nested macros (CNTRM-MUXD-MUX) and as a logic primitive (CNTR).

```

370 PRINT:PRINT" ***** READING IN NODES TO BE SAMPLED *****:GOSUB 6000
'READ SAMPLE POINTS
380 PRINT:PRINT" ***** SETTING UP FOR SIMULATION *****:GOSUB 7000
'DO SIMULATION
390 STOP
400 REM
500 REM ***** INITIALIZE POINTERS *****
510 NL=0:NTYPE=0
520 READ QS
530 IF QS<>"LAST" THEN TYS(NTYPE)=QS:NTYPE=NTYPE+1:GOTO 520
540 DATA "AND","NAND","OR","NOR","XOR","XNOR"
550 DATA "DFF","JKFF","CNTR","PLSR","SREG","*"
560 DATA "LAST"
570 NPRIM=NTYPE:NTYPE=NTYPE+1 'NTYPE=NEXT TYPE PTR.
590 REM LOGIC PRINT VALUES AND INVERSIONS
600 LO=0:L1=3:LX=1 'INTERNAL VALUES FOR LOGIC VALS.
610 DIM LVS(3),LPS(3),LN(3) 'LOGIC INPUT SYMBOL, LOGIC PRINTSYMBOL, LOGIC
INVERSION
620 LVS(LO)="0":LPS(LO)="":LN(LO)=L1:LX=L1
630 LVS(L1)="1":LPS(L1)="1":LN(L1)=L1:LX=L1
640 LVS(LX)="X":LPS(LX)="?":LN(LX)=LX:LX=LX
680 DIM TEXS(1):FOR I=0 TO 1:READ TEXS(I):NEXT I
690 DATA "A","p"
900 RETURN
1000 REM ***** READ IN MACROS *****
1010 GOSUB 10000 'READ AND PARSE LINE
1020 IF LEFT$(L1,3)<>"MAC" THEN RETURN 'SHOULD SAY "MAC TYPE"
1030 XS=LIS(1) 'GET MAC TYPE
1035 PRINT:PRINT " ***** READING IN MACRO: ";XS;" *****"
1040 TPTR=-1
1050 GOSUB 11000 'SEARCH FOR TYPE
1060 IF FOUND=-1 THEN 1100 'CHECK FOR DUPS
1065 IF TPTR=-1 THEN 1100
1070 PRINT "THIS MACRO NAME ALREADY EXISTS, SHOULD IT BE REPLACED WITH THIS
ONE?"
1080 INPUT "ENTER R(eplace) OR N(oreplace)";QS
1090 IF LEFT$(QS,1)="N" THEN 1200 'SKIP TIL NEXT END
1100 TPTR=NLGIC 'POINT TO NEXT LOGIC LOCATION
1110 GOSUB 11100 :MT=FO 'ADD TYPE TO LIST
1150 GOSUB 2000 'READ CKT DESCRIPTION
1160 GOSUB 1500 'CHECK FOR MACRO ERRORS
1170 GOTO 1000 'LOOP FOR NEXT MACRO
1200 REM *** SKIP THIS MACRO ****
1210 GOSUB 10000:IF LIS(0)<>"END" THEN GOTO 1210
1220 GOTO 1000 'GET NEXT MACRO
1500 REM *** CHECK FOR MACRO ERRORS *****
1510 PRINT:PRINT" ***** CHECKING MACRO ";TYS(MT);" FOR ERRORS *****"
1520 X1=TY(MT):GOSUB 12000 'CLEAR ARRAY
1530 FOR I=1 TO 5 'STEP THRU INPUTS
1540 X=LO(X1,I):GOSUB 12100 'MARK EACH SIG #
1550 NEXT I
1560 X1=X1+1
1570 X=LO(X1,0):IF TYS(X)="*" THEN GOTO 1530 'LOOP FOR CONTINUES
1580 ST=X1
1590 GOSUB 12200 'MARK AND CHECK OUTPUTS
1600 GOSUB 12300 'CHECK INPUTS
1610 ER=0 'CLEAR ERROR FLAG, MAC ERRORS DONT COUNT.
1620 RETURN
2000 REM ***** READ IN LOGIC DESCRIPTION *****
2010 SL=NL:NAS(0)="0":NNAM=1 'SIGNAL 0 IS PREDEFINED

```

Listing 1 continued on page 432

```

10 REM AN ENHANCED LOGIC SIMULATION PROGRAM
20 REM ROBERT M. MCDERMOTT
30 REM AUGUST 1981
40 REM
50 REM
60 REM THE FOLLOWING PROGRAM SIMULATES A DIGITAL LOGIC DESIGN
70 REM THE LOGIC DESCRIPTION MAY CONSIST OF LOGIC 'PRIMITIVES',
80 REM (AND,OR,XOR,ETC. GATES; D, JK FLIP FLOPS; N-BIT COUNTER)
90 REM OR 'MACROS' (BLOCKS OF COMMONLY USED PRIMITIVES).
100 REM EACH LOGIC ELEMENT CONTAINS 5 INPUTS AND TWO OUTPUTS,
110 REM UNUSED 'PINS' ARE CODED AS "0".
120 REM THE LOGIC IS DRIVEN BY 'EXTERNAL STIMULI'. THE STIMULI
130 REM ARE DESCRIBED AS PERIODIC OR APERIODIC, THE SIGNAL NAME,
140 REM STARTING LOGIC VALUE, START TIME, AND 5 CHANGE TIMES.
150 REM
160 REM
170 REM THE FOLLOWING PARAMETERS DEFINE THE MAXIMUM ARRAY LIMITS
180 REM THEY CAN BE ADJUSTED TO FIT A DESIGN TO AVAILABLE RAM.
185 CLEAR 1000:DEFINT A-Z
190 MNAMS=200:MLGIC=200:MEXTERN=30:MSAMPLES=14:MTYPES=50
195 PRINT" LOGIC SIMULATOR: ";MN;" NAMES ";ML;" LOGIC DEVICES"
196 PRINT" ";MT;" TYPES ";ME;" EXTERNAL STIMULI"
197 PRINT
198 PRINT
200 DIM MNAMS(MNAMS) 'SIGNAL NAMES
210 DIM LO(MLGIC,8) 'LOGIC DESCRIPTION
' (7 SIGNALS,LATCH)
220 DIM EXTERNALS(MEXTERN,10) 'EXTERNAL STIMULI
230 DIM TYPES(MTYPES) 'LOGIC TYPES (PRIM&MACS)
240 DIM TYPEP(MTYPES) 'POINTERS TO LOGIC DES.
250 DIM OL(MN) 'SAMPLED NODES
260 DIM SA(MS) 'TEMP ARRAYS
270 DIM T(10),LIS(10)
280 DIM ***** START OF PROGRAM *****
290 PRINT:PRINT" ***** INITIALIZING ARRAYS ***** ":GOSUB 500
300 PRINT:PRINT" ***** READING IN ANY MACROS ***** ":GOSUB 1000
310 PRINT:PRINT" ***** READING IN LOGIC NETWORK ***** ":GOSUB 2000
320 PRINT:PRINT" ***** EXPANDING ANY MACROS *****:GOSUB
3300 'EXPAND MACROS
340 GOSUB 3500 'LIST EXPANSION
350 PRINT:PRINT" ***** READING IN EXTERNAL STIMULI *****:GOSUB 4000
360 PRINT:PRINT" ***** CHECKING FOR ERRORS *****:GOSUB 5000
'CHECK FOR ERRORS

```

Micomint will put both a computer development system and an OEM dedicated controller in the palm of your hand for as little as \$127.*

The Z8 Basic Computer/Controller represents a milestone in microcomputer price-performance. The entire computer is 4" by 4 1/2" and includes a tiny BASIC interpreter, 4K bytes of program memory, one RS-232 serial port and two parallel ports plus a variety of other features. The Z8 microcomputer board is completely self-contained and optimized for use as a dedicated controller. Can be battery operated. Comes with over 200 pages of documentation.

Z8 BASIC COMPUTER/CONTROLLER

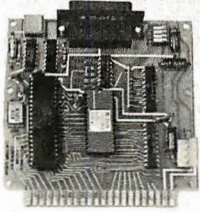

- Uses Zilog Z8671 single chip microcomputer
- On board tiny BASIC interpreter
- 2 parallel ports plus serial I/O port.
- Just connect a CRT terminal and write control programs in BASIC
- 4K bytes of RAM. EPROM pin compatible
- Baud rates 110-9600 BPS
- Data and address buses available for 124K memory and I/O expansion
- Consumes only 1.5 watts at +5, +12 & -12v.

- BCC01 Z8 Basic Computer**
Assembled & Tested . . \$199.00
- BCC02 Z8 Basic Computer**
Kit \$169.00

COMING SOON
A/D Converter 8 Channel 8 Bit
AC I/O Board
• 4 Channel 115Vac inputs
• 4 Channel 115Vac outputs
20 MA ADAPTER

Z8 MEMORY, I/O EXPANSION & CASSETTE INTERFACE

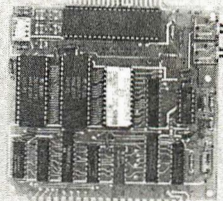

The Z8 Memory, I/O Expansion & Cassette Interface Board (Z8 Expansion Board for short) allows you to add up to 8K of additional memory plus three 8-bit parallel ports to your Z8 Basic Computer/Controller. The memory expansion will support any combination of byte wide RAM memory chips or 2716 or 2732 EPROM. The cassette interface is 300 baud Kansas City Standard (2400Hz/1200Hz).

- BCC03 Z8 Expansion Board**
w/4K memory \$140.00
- BCC04 Z8 Expansion Board**
w/8K memory . . \$170.00

Z8 EPROM PROGRAMMER

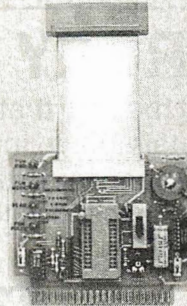

The EPROM Programmer board allows you to transfer application programs in BASIC or Assembly language directly from RAM to either 2716 or 2732 EPROMS. Requires Z8 Basic Expansion Board for operation.

NOTE: We recommend the higher current UPS03 or UPS04 power supply when using the EPROM Programmer.

- BCC07 Z8 EPROM Programmer**
Assembled & Tested . . . \$145.00

Z8 SERIAL EXPANSION BOARD

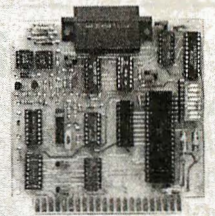

The Serial Expansion Board adds an additional RS-232C serial port to the Z8 system. It runs at 75 to 19,200 baud in all standard protocols. The 20 ma. current loop is opto-isolated for reliability and protection.

- BCC08 Z8 Serial Board**
Assembled & Tested . . . \$180.00

MOTHER-BOARD

- MB02 Z8 Mother Board**
with 5 connectors (Gold)
Assembled & Tested . . . \$81.00

UNIVERSAL POWER SUPPLY

- +5 @ 300 ma. +12 & -12V @ 50 ma.
UPS01 Assembled and
Tested \$ 35.00
- UPS02 Kit** \$ 27.00
- +5 @ 1 amp. +12 & -12V @ 50 ma.
UPS03 Assembled and
Tested \$ 60.00
- UPS04 Kit** \$ 50.00

Z8 CROSS ASSEMBLERS

- FROM ALLEN ASHLEY
XAS01 For TRS-80 Mod I \$ 75.00
XAS02 For TRS-80 Mod III \$ 75.00
XAS03 For CP/M-8" . . . \$150.00
- FROM MICRO RESOURCES
MR01 CP/M-8" Diskette . \$ 75.00
MR02 APPLE II CP/M 5 1/4" \$ 75.00

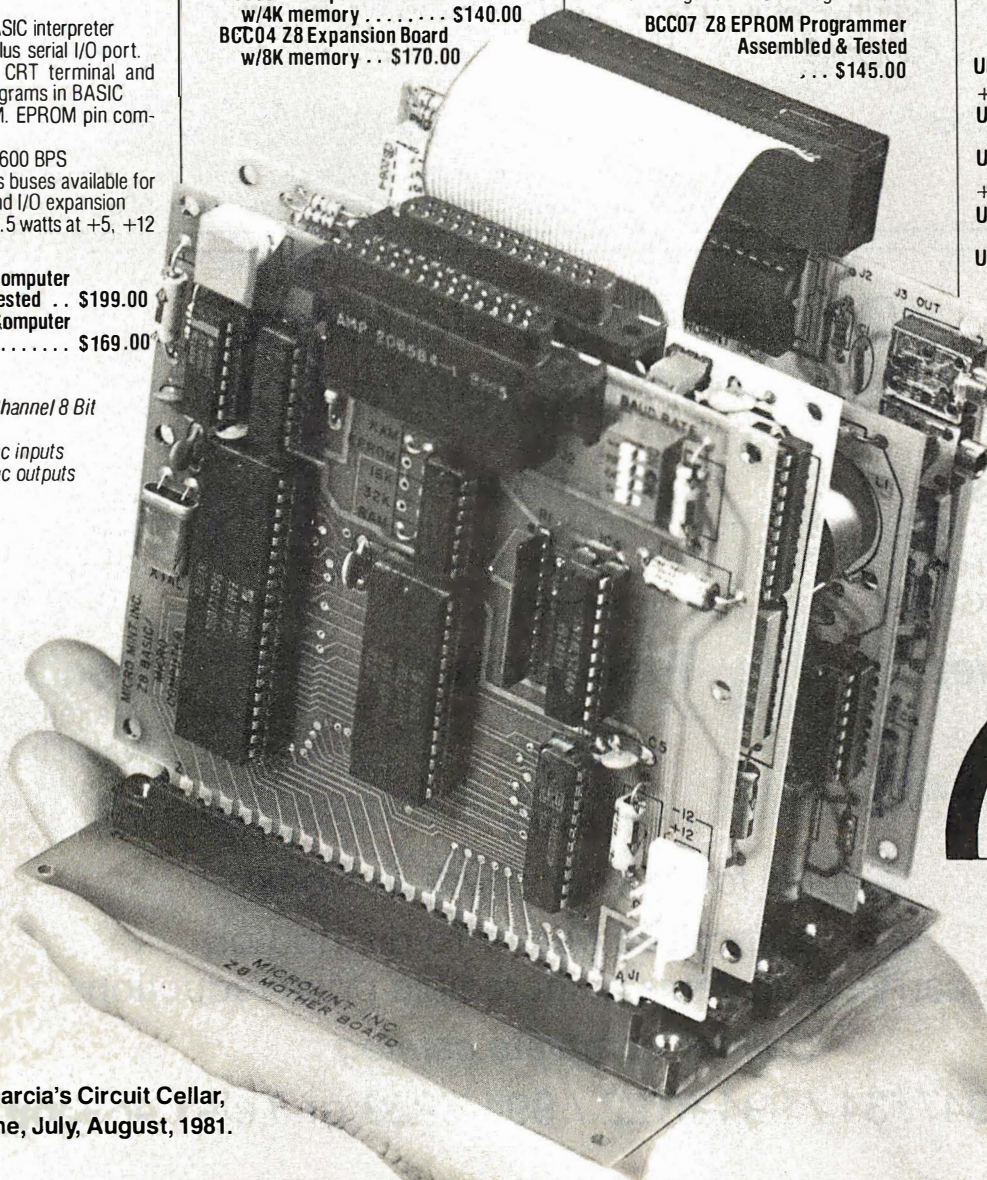

MICROMINT INC.
561 Willow Avenue
Cedarhurst, NY 11516

To Order:
Call Toll Free
1-800-645-3479
For Information Call:
1-516-374-6793

Circle 261 on inquiry card.

*In quantities of 100

Distribution Is A Tradition At
MARCEY, INC.

Distributors of Computers and Computer Products

THE MARCEY COMET MEDIA SAFE

Protect your valuable media in the safe that's passed the most rigorous test in the book. Standards for media protection require maintaining an internal temperature of 125 degrees Fahrenheit or less and a humidity below 85%. On the Japanese Industrial Standard Test (the toughest test in existence for fire-proof safes), the Marcey Comet passed with flying colors, maintaining an internal temperature of 117 degrees Fahrenheit, 66% humidity.

Specifications:

External dimensions: 31½" high; 26¼" wide; 24½" deep.

Internal dimensions: 18½" high; 16" wide; 11½" deep.

Holds approx. 200 8" floppy disks or 300-350 5¼" floppy disks.

(It will also hold 12 sector disk packs and other specialized packages.)

One internal shelf. (Various other internal configurations will be available within 90 days.)

Double door safe.

Combination lock and key lock.

Retail Price:
\$1995

Our Price: \$1495

(Does not include delivery.) (Dealer Inquiries Invited)
Delivery time is approx. 60 days from receipt of order.

*Dealers Shop No More,
Marcey Has The Price You're Looking For!!*

Printers

C. Itoh NEC
Comrex Toshiba
Okidata Gemini

Monitors

Sanyo
NEC
Amdek

Terminals

Televideo
Liberty

Disk Drives

Tandon
Shugart
Axlon RAM Disk 320

Peripherals

Modems
Interfaces
Buffers
Spoolers

Media

Maxell
Wabash
TDK

Cables for all your needs in stock!

As an authorized MicroPro distributor,
We're carrying all items at incredible price reductions.

Call for complete catalog.

(213) 9947734 / 994-6122 / 994-6259 or Telex 469369

What is the definition of
ENCRYPTION

The answer is
(Making secret or disguising information to be understood
only by the persons who have the key to it.)

CYPHERMASTER™

Data Encryption Program For Microcomputers

No need to buy additional hardware — through software, CYPHERMASTER™ emulates hardware devices that encrypt computer data using the National Bureau of Standards (DES).

Your sensitive or proprietary files can be encyphered or superencyphered using a sophisticated encryption algorithm. At the rate of speed at which CYPHERMASTER™ encrypts data, it would take approximately 30 million years to examine all the possible keys to break the code for a single block of data!

Protect Trade Secrets

Prevent Competitors From Obtaining Your Customer Lists

*Prevent Competitors From Obtaining Cost Figures Or Confidential
Bid Prices Prior To Contract Issuance*

Protect Business Plans And Proprietary Designs

Protect Payroll Information

System Requirements

Hardware

Z-80™ Microprocessor CPU
Minimum 24K Computer Memory
Minimum 1 Floppy Disk Drive
80 x 24 CRT

Also Available For
IBM PC, DEC Rainbow, DEC 11-23 or 11-03
& soon to be available for Apple

Software

CP/M™ Operating System or equivalent
multi-user OS such as (MP/M™ or TurboDOS™)
CM.COM (provided with CYPHERMASTER™)
must be present on system

Also Available For
PCDOS, RT-11 or RX-11

Your Business is YOUR business!
Keep it that way with CYPHERMASTER™

CP/M is a registered trademark of Digital Research, Inc.
Z-80 is a registered trademark of Zilog, Inc.

MP/M is a registered trademark of Digital Research, Inc.
TurboDos is a registered trademark of Software 2000, Inc.

MARCEY, INC.

Distribution Division

6700 Valjean Avenue / Van Nuys, CA 91406 / (213) 994-7734 / Telex 469369

Dealer Inquiries Invited

Quantity Pricing Available

For Further information, Please Circle Reader Service # 248 on inquiry card.

```

2020 FOR I=1 TO MN:NAS(I)="" :NEXT I
2040 GOSUB 10000
2050 XS=LI$(O)
2060 GOSUB 11000:IF FO=-1 THEN GOSUB 11100 'ADD IF NOT FOUND
2070 T(O)=FO
2080 FOR I=1 TO 7
2090 XS=LI$(I):GOSUB 11500
2100 IF FO=-1 THEN GOSUB 11600
2110 T(I)=FO:NEXT I
2120 GOSUB 20000
2130 IF T(O) <> 0 THEN GOTO 2040
2140 RETURN
2150 REM ***** EXPAND MACROS *****
3000 REM ***** EXPAND MACROS *****
3010 ST=SLGIC:FM=0 'START AT LOGIC ARRAY, CLEAR MAC FLAG
3020 FOR I=ST TO NLGIC-1
3030 IF LO(I,O) <= NPRIM THEN 3100
3040 GOSUB 30000
3050 GOSUB 31000
3060 FM=1
3100 NEXT I
3110 REM REPEAT PROCEDURE UNLESS NO MACROS WERE FOUND
3120 IF FM <> 0 THEN GOTO 3000
3130 RETURN
3500 REM ***** LIST OF EXPANDED LOGIC DESCRIPTION *****
3510 CLS:PRINT " ***** EXPANDED LOGIC DESCRIPTION *****":PRINT
3511 PRINT "TYPE";TAB(20);"INPUTS";TAB(50);"OUTPUTS"
3512 FOR I=1 TO 5:PRINTTAB(8*I);I;:NEXT I:PRINTTAB(48);"Q";TAB(56);"Q-"
3515 NAS(O)=""
3520 FOR I=SL TO NL-1
3530 PRINT TYS(LO(I,O));
3540 FOR II=1 TO 7
3550 PRINT TAB(8*II);
3552 XX=LO(I,II):IF XX < 0 THEN PRINT "#";-XX;:GOTO 3560
3554 PRINT NAS(XX);
3560 NEXT II:PRINT:NEXT I
3565 NAS(O)=""
3570 RETURN
4000 REM ***** READ IN EXTERNAL DESCRIPTION *****
4010 NEX=0:GOSUB 10000 'IGNORE "EXTERNAL"
4020 GOSUB 10000 'GET EXTERNAL DESCRIPTION
4030 IF LI$(O) < "END" THEN RETURN
4040 FOR I=0 TO 1:IF LI$(O)=TEXT$(I) THEN T(O)=I 'GET TYPE OF EXT
4050 NEXT I
4060 XS=LI$(1):GOSUB 11500 'GET SIGNAL NUMBER FROM NAME
4070 IF FO=-1 THEN GOTO 4020 'IGNORE IF UNDEFINED
4080 T(1)=FO
4090 FOR I=0 TO 3:IF LI$(2)=LV$(I) THEN T(2)=LV(I) 'LOGIC VALUE
4100 NEXT I
4110 FOR I=3 TO 9:T(I)=VAL(LI$(I)):NEXT I 'CHANGE TIMES
4120 GOSUB 21000 'STORE T(O)-T(9) IN EX ARRAY
4130 GOTO 4020 'LOOP TILL "END"
5000 REM ***** CHECK FOR ERRORS *****
5010 GOSUB 12000:MM=0 'CLEAR OLD ARRAY
5020 FOR I=0 TO NEX 'MARK EXTERNALS FIRST
5030 OL(EX(I,1))=1
5040 NEXT I
5050 ST=SL:GOSUB 12200 'MARK AND CHECK OUTPUTS
5060 GOSUB 12300 'CHECK ALL INPUTS
5070 RETURN
6000 REM ***** READ IN SAMPLE POINTS *****
6010 NS=0:ON ERROR GOTO 6200
2020 GOSUB 10000 'READ IN LINE (IF ANY, IF NOT, GOTO 6200
2030 GOSUB 10000 'GET REAL LINE (PRIOR ONE WAS "EXT...")
2040 IF LI$(O) < "END" THEN ON ERROR GOTO 6: RETURN
2050 FOR I=0 TO 10
2060 XS=LI$(I):IF XS="" THEN 6100 'GET NAME, IGNORE BLANKS
2070 GOSUB 11500:IF FO=-1 THEN 6100 'LOOK UP NAME, IGNORE UNDEFINED
2080 IF NS < 14 THEN NS=NS+1:SA(NS)=FO
2100 NEXT I
2110 GOTO 6030 'LOOP TILL "END"
2200 REM ***** ERROR TRAP FOR END OF INPUT *****
6210 LS="END":RESUME NEXT
6500 REM ***** SELECTIVE TRACE TABLE BUILD *****
6510 STP=0 'SEL. TRACE FLAG
6520 AI=(NL+NN+(TL+NN))*2 'REQUIRED RAM (NN FOR 1ST, TL+NN FOR 2ND, NL FOR OTH
6530 AS=MEM-200 'AVAILABLE (ASSUME MAX 200 NEEDED LATER)
6540 IF AS < AI THEN RETURN 'NOT ENOUGH RAM, FORGET IT
6550 PRINT:PRINT " ***** BUILDING SELECTIVE TRACE TABLE *****":PRINT
6560 STP=1:DIM SO(NL),SI(NN),S2(TL+NN)
6570 T1=0 'T1 POINTS TO SECOND ARRAY
6580 FOR I=1 TO NN:SI(I)=T1 'FOR ALL NODES
6590 FOR J=SL TO NL:FOR K=1 TO 5 'SCAN ALL INPUTS TO LOGIC
6600 IF LO(J,K)=I THEN S2(T1)=J:T1=J+1 'ON MATCH, SAVE LOGIC #
6610 NEXT K:NEXT J
6620 S2(T1)=I:T1=J+1 '-1 = "SENTINEL" BETWEEN BLOCKS
6630 NEXT I
6635 GOSUB 6700 'PRINT OUT LOAD TABLE
6640 RETURN
6700 REM ***** PRINT OUT OF LOAD TABLE *****
6710 PRINT " ***** LOAD TABLE *****":PRINT "NODE
ELEMENTS"
6720 FOR II=1 TO NN:PRINT NAS(II);TAB(10);
6730 T1=SI(II)
6740 IF S2(T1)=-1 THEN GOTO 6760
6750 PRINT S2(T1)-SL+1;:T1=T1+1:GOTO 6740
6760 PRINT:NEXT II:RETURN
7000 REM ***** DO SIMULATION *****
7010 DIM NE(NN),ME(MM,1):IF ER <> 0 THEN RETURN 'NO SIMULATION ON ERROR
7020 NN=NN-1:NL=NL-1:NE=NE-1 'POINT TO ENDS, NOT NEXT
7030 GOSUB 6500 'BUILD SELECTIVE TRACE TABLE
7040 GOSUB 7300 'INITIALIZE, GET SAMPLE TIMES
7050 GOSUB 8000 'GET EXTERNALS SCHED FOR THIS TIME
7060 GOSUB 8500 'MOVE NEW TO OLD, MARK CHANGES
7070 GOSUB 9000 'PRINT OUT OLD, GET RESPONSE
7080 IF QS="Q" THEN RETURN
7090 IF QS="R" THEN GOTO 7040 'RESTART
7100 GOSUB 40000 'SIMULATE LOGIC DEVICES
7110 GOSUB 7500 'RECALC RIPPLE TIME
7120 GOTO 7050 'LOOP
7300 REM ***** INITIALIZE FOR SIMULATION *****
7310 FOR I=0 TO NN:NE(I)=LX:NEXT I 'ALL NEWS = LOGIC X
7320 FOR I=SL TO NL:LO(I,8)=LX:NEXT I 'ALL INTERNAL LATCHES =X
7330 PRINT:RI=0:INPUT "ENTER SAMPLE START TIME, INCREMENT TIME";S9,S2
7340 IF S2=0 THEN S2=1 'CANT HAVE 0 INCREMENT.
7350 E9=32767:FOR I=0 TO NEX: E3=EX(I,3):GOSUB 8200:NEXT I 'PUT
EXTERNALS START TIME INTO NEXT SCHEDULED TIME
7360 IF NS=0 THEN GOSUB 9660 'GET NAMES FOR SAMPLING IF NOT READ
7370 IF MM <> 0 THEN GOSUB 7400 'SET ASIDE MEMORY FOR SREGS
7390 QS="":RETURN
7400 REM SET ASIDE MEM FOR SREGS
7410 M1=0 'M1 POINTS TO NEXT AVAIL MEM
7415 FOR I=0 TO MM:ME(I,0)=LX:ME(I,1)=LX:NEXT I

```

The two hottest new fields in high technology:

Pocket Computers and Local-Area Networks

You need to know about them!

**Attend
The Famous Programmers' School
Seminar on
Pocket-Computer Local Networks.**

An exhaustive 14-day seminar developed in direct response to thousands of requests from professionals like you.

Learn about:

- Latest Information & Approaches
- Pocket-Switching Protocols
- Relationships of Network Architectures to Sleeve Length
- Analysis of Button-Through Flap Pockets
- Fault-Tolerant Epaulet Construction

As part of your participation in the FPSSPCLN, you'll receive a handsome vinyl looseleaf binder, in which you can write anything you like. And you can earn 0.05 continuous education credits and a certificate of competence.

Enroll Today.

The size of the seminars will be limited. Clip the handy coupon and send it now.

**Famous Programmers'
School
Dept. APRFOL
P.O. Box 463
Paulsborough, NH
03458-0463**



Our staff of experts, demonstrating a bus network topology. From left to right: **Rod Snobol** (with his gerbil, **Jovial**), **Ignatious "Call Me Blaise" Pascal**, **Nolan Logo**, **Victoria Ether-Dixon**, **C. Kenneth Wirthson**, **Barbara Baseband**, and **Rudolf Forth**.

Coming soon to one of these major cities near you:

Keene, New Hampshire April 1-14	Lake Wobegone, MN. May 19-32
Sanford, North Carolina April 18-31	Lewistown, Montana May 35-48
King of Prussia, PA. May 1-4	Keene, California May 50-63

.....

• **Sign me up!** I want to learn all there is to know about pocket-computer local area networks. I'm shipping my \$10,000 payment under separate cover, in the form of ingots of strategic metals, or I'm enclosing billing instructions.

• **Name** _____

• **Company** _____

• **Address** _____

• **City** _____ **State** _____

• **ZIP or Postal Code** _____

• **Choice of Seminar Location** _____

Dept. APRFOL

Our Slogan: Top down programming for the masses.

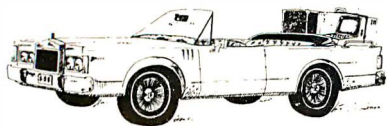

```

7420 FOR I=SL TO NL
7430 IF TYS(LO(I,0))="SREC" THEN LO(I,8)=MI:MI=L1-LO(I,2)
7440 NEXT I:RETURN
7500 REM ***** RECALCULATE RIPPLE TIME *****
7510 IF C9=1 THEN RI=RI+1:RETURN
7520 RI=E9:IF RI>S9 THEN RI=S9 'GET MIN OF E9 (EXT) AND S9 (SAMPLE)
7530 RETURN
8000 REM ***** GET NEXT SCHEDULED EXTERNAL *****
8010 IF RI<>E9 THEN RETURN
8020 E9=32767
8030 FOR I=0 TO NEX
8035 E3=EX(I,10)
8040 IF E3=RI THEN GOSUB 8100 'PROCESS IF SCHED.
8045 GOSUB 8200
8050 NEXT I
8060 RETURN
8100 REM *** FIND NEXT SCHED CHANGE (OR FIRST VAL) ***
8110 EO=EX(I,0):E1=EX(I,1):E2=EX(I,2):E3=EX(I,3)
8120 Y=NE(E1)
8130 IF RI<E3 THEN Y=LN(E2)
8140 NE(E1)=LN(Y)
8150 REM SCHEDULE NEXT CHANGE
8160 IF TEX$(EO)="P" THEN E3=EX(I,10)+EX(I,4): RETURN
8170 J=4:E3=32767
8175 IF J>=9 THEN RETURN
8180 IF EX(I,J)<=RI THEN J=J+1: GOTO 8175
8190 E3=EX(I,J): RETURN
8200 REM STORE NEXT SCHED, KEEP TRACK OF MIN (E9)
8210 EX(I,10)=E3 'LOPH ENTRY IS NEXT SCHED TIME FOR THIS SIGNAL
8220 IF E9>E3 THEN E9=E3 'E9 IS NEXT SCHED TIME FOR ANY SIG.
8230 RETURN
8500 REM *****MOVE NEW TO OLD, MARK CHANGES *****
8510 C9=0:IF STP<>0 THEN GOSUB 8700 'CLEAR CHANGE FLAGS
8520 FOR I=1 TO NN
8530 IF NE(I)<>OL(I) THEN GOSUB 8600 'MARK CHANGES
8540 NEXT I
8560 RETURN
8600 C9=1:OL(I)=NE(I)
8610 IF STP=0 THEN RETURN
8620 I=SI(I)
8630 J=S2(II):IF J=-1 THEN RETURN 'RETURN ON HITTING A SENTINEL
8640 SO(J)=I:II=II+1:GOTO 8630 'MARK IT, GET NEXT LOGIC NUMBER
8700 REM CLEAR SO
8710 FOR II=SL TO NL:SO(II)=0:NEXT II
8720 RETURN
9000 REM ***** DISPLAY LOGIC VALUES
9002 PRINT @57,RI;
9005 IF S9<RI THEN RETURN
9010 IF PC=0 THEN GOSUB 9100 'PUT NAMES ON SCREEN IF START
9020 GOSUB 9500 'PRINT VALUES DOWN SCREEN
9025 S9=S9+S2
9030 PC=PC+1:IF PC>60 THEN GOSUB 9600 'END OF SCREEN, GET INPUT
9040 RETURN
9100 REM ***** SET UP DISPLAY (NAMES AND TICS) *****
9110 PC=11
9120 CLS:GOSUB 9200
9125 PRINT @5,"TIME";:PRINT @10,RI;
9130 X=128
9140 FOR I=1 TO NS:PRINT @X,NAS(SA(I));
9150 X=X+64:NEXT I
9160 RETURN
9200 REM *****PRINT TIC MARKS *****
9210 FOR X=75 TO 124:PRINT @X,CHRS(176);:NEXT X
9220 X=75
9230 FOR I=1 TO 5:PRINT @X,CHRS(191);:PRINT @X+5,CHRS(198);
9240 X=X+10:NEXT I:RETURN
9500 REM *****PRINT VALUES DOWN COLUMN *****
9510 X=PC+128
9520 FOR I=1 TO NS:Y=OL(SA(I)) 'GET LOGIC VALUE
9530 PRINT @X,LP$(Y);:X=X+64:NEXT I
9540 RETURN
9600 REM ***** FULL SCREEN, GET RESPONSE *****
9610 PRINT @15,"(C)change),(R)reset),(Q)uit), OR ANY OTHER KEY";
9620 QS=INKEY$:FORX=0TO100:NEXTX:PRINT @15,STRINGS(41," ");
9625 IF QS="" THEN GOTO 9610
9630 PC=0 'RESET AND QUIT ARE HANDLED ON RETURN
9640 IF QS<>"C" THEN RETURN
9650 REM GET NEW SAMPLE NODE NAMES
9655 CLS
9660 PRINT "AS EACH CURRENT SAMPLE NODE IS DISPLAYED, HIT RETURN FOR NO
CHANGE, NEW NAME FOR CHANGE"
9670 FOR I=1 TO 14
9680 XS="" :PRINT NAS(SA(I));:INPUT XS
9690 IF XS="" THEN GOTO 9720
9700 GOSUB 11500:IF FO=-1 THEN GOTO 9680
9710 SA(I)=FO
9720 IF SA(I)<>0 THEN NS=I
9730 NEXT I:RETURN
10000 REM ***** READ AND PARSE LINE *****
10010 READ LS
10020 I=1:I3=1:LI=0:I2=LEN(LS)
10030 I=I+1:IF I>I2 THEN 10050
10040 IF MIDS(LS,I,1)<>" " THEN GOTO 10030 'FIND BLANK
10050 LIS(LI)=MIDS(LS,I,1)<>" " 'PUT NAME IN LIS
10060 LI=LI+1
10070 IF LI>I2 THEN RETURN
10080 I=I+1:IF I>I2 THEN 10120
10090 IF MIDS(LS,I,1)="" THEN GOTO 10080 'SKIP BLANKS
10100 I3=I:GOTO 10030
10120 FOR I=LI TO I0 'FILL REMAINING LIS$
10130 LIS(I)="" :NEXT I
10140 RETURN
11000 REM ***** LOOK UP TYPE *****
11010 FO=-1
11020 FOR II=0 TO NTYP-1
11030 IF XS=TYPS(II) THEN FO=II:TP=TYPTR(II)
11040 NEXT II
11050 RETURN
11100 REM ***** ADD TYPE *****
11110 IF FO=-1 THEN FO=NTYP:NTYP=NTYP+1
11120 IF FO>NTYP THEN NTYP=FO
11130 TYPS(FO)=XS
11140 TYPE(FO)=TPTR
11150 RETURN
11500 REM ***** LOOK UP SIGNAL NAME *****
11510 FO=-1:IF XS="" THEN XS="0" 'BLANK =NO SIGNAL
11515 IF LEFT$(XS,1)="#" THEN GOTO 11560 'NUMERIC INPUT
11520 FOR II=0 TO NNAM
11530 IF XS=NAMS(II) THEN FO=II
11540 NEXT II
11550 RETURN
11560 REM "NAME" IS A NUMBER, STORE AS NEGATIVE

```

THE FORTH SOURCE™

MVP-FORTH – A Public Domain Product

MVP Forth is fig-FORTH updated to the FORTH-79 Standard Required Word Set. The source is public domain. Included are an editor, FORTH assembler, tools and utilities, making it compatible with the instructional book, *Starting FORTH*. Except for hardware dependencies, all high level FORTH is transportable between all systems. Modifications and extensions can be simplified through the use of MVP-FORTH Programming Aids and Meta and Cross Compilers.

MVP FORTH Books – A Series

- Volume 1**, *All about FORTH* by Haydon. MVP-FORTH glossary with cross references to fig-FORTH, *Starting FORTH* and FORTH-79 Standard. 2nd Ed. \$25
- Volume 2**, *MVP-FORTH Assembly Source Code*. Includes CP/M, IBM-PC®, and APPLE® listing for kernal \$20
- Volume 3**, *MVP-FORTH Math & Floating Point Extensions* by Koopman. \$20

MORE COMING!

MVP-FORTH Software – A Transportable FORTH

- MVP-FORTH Programmer's Kit** including disk, documentation, Volumes 1 & 2 of MVP-FORTH Series (*All About FORTH*, 2nd Ed. & *Assembly Source Code*), and *Starting FORTH*. Specify CP/M, IBM-PC, TRS-80/1® or 3, TRS Color Computer or APPLE. \$150
- MVP-FORTH Cross Compiler** for CP/M Programmer's Kit. Can also generate headerless code for ROM or target CPU \$300

- MVP-FORTH Meta Compiler** for CP/M Programmer's kit. Use for applications on CP/M based computer. Includes public domain source \$150
- MVP-FORTH Fast Floating Point** for APPLE Programmer's Kit. Includes 9511 math chip on board with disk and documentation. \$400
- MVP-FORTH Programming Aids** for CP/M, IBM or APPLE Programmer's Kit. Extremely useful tool for decompiling, callfinding, and translating. \$150
- MVP-FORTH** by ECS Software for IBM-PC or ATARI® 400/800. Standalone with screen editor. License required. Upgradeable \$90
- MVP-FORTH** by ECS Software for IBM-PC or ATARI 400/800. Enhanced with color animation, multitasking, sound, utilities, and unlimited run time license. \$175
- MVP-FORTH Professional Application Development System (PADS)** for CP/M, IBM-PC, or APPLE. A three level integrated system with complete documentation. Complete system for IBM, CP/M, or APPLE \$400
 - MVP-FORTH PADS** enhanced virtual system \$150
 - MVP-FORTH PADS** Programming Aids \$150
 - MVP-FORTH PADS** Meta Compiler \$150

*** MVP-FORTH operates under a variety of CPU's, computers, and operating systems. CP/M® disks can be supplied 8", SS/SD, 3740 format or 5 1/4" for Osborne® Northstar® Micro Decisions® Kaypro® or H89/Z89®. Specify your computer and operating system. ***

FORTH DISKS

FORTH with editor, assembler, and manual.

- | | |
|---|--|
| <input type="checkbox"/> APPLE by M.M. \$100 | <input type="checkbox"/> NOVA by CCI \$100 |
| <input type="checkbox"/> APPLE by Kuntze \$90 | <input type="checkbox"/> TRS-80/1® by N.S. \$90 |
| <input type="checkbox"/> ATARI® valFORTH \$50 | <input type="checkbox"/> Z80 by L.M. \$50 |
| <input type="checkbox"/> CP/M® by M.M. \$100 | <input type="checkbox"/> 8086/88 by L.M. \$100 |
| <input type="checkbox"/> HP-85 by Lange \$90 | <input type="checkbox"/> VIC FORTH by HES, VIC20 cartridge \$60 |
| <input type="checkbox"/> IBM-PC® by L.M. \$100 | |

Enhanced FORTH with: F-Floating Point, G-Graphics, T-Tutorial, S-Stand Alone, M-Math Chip Support, MT-Multi-Tasking, X-Other Extras, 79-FORTH-79.

- | | |
|--|---|
| <input type="checkbox"/> APPLE by M.M., F, G, & 79 \$140 | <input type="checkbox"/> Extensions for L.M. IBM,Z80, and 8086 Software Floating Point \$100 |
| <input type="checkbox"/> ATARI by PNS, F,G, & X \$90 | <input type="checkbox"/> 8087 Support (IBM-PC or 8086) \$100 |
| <input type="checkbox"/> CP/M by M.M., F & 79 \$140 | <input type="checkbox"/> 9511 Support (Z80 or 8086) \$100 |
| <input type="checkbox"/> Apple, GraFORTH by Insoft \$75 | <input type="checkbox"/> Color Graphics (IBM-PC) \$100 |
| <input type="checkbox"/> IBM-PC, PolyFORTH by F.I. F, G, S, M, MT, & X \$300 | <input type="checkbox"/> Data Base Management \$200 |
| <input type="checkbox"/> Multi-Tasking FORTH by S.L., CP/M, X & 79 \$395 | <input type="checkbox"/> Requires LM FORTH disk, specify IBM, Z80, or 8086 |
| <input type="checkbox"/> TRS-80/1 or III by M.M.S. F, X, & 79 \$130 | |
| <input type="checkbox"/> TUTORIAL by L & H, includes <i>Starting FORTH</i> \$95 | |

CROSS COMPILERS Allow extending, modifying and compiling for speed and memory savings, can also produce ROMable code.

•Requires FORTH disk.

- | | |
|---|---|
| <input type="checkbox"/> CP/M \$300 | <input type="checkbox"/> IBM• \$300 |
| <input type="checkbox"/> TRS-80/1 \$300 | <input type="checkbox"/> Z80• \$300 |
| <input type="checkbox"/> Northstar® \$300 | <input type="checkbox"/> Apple II/II+ \$300 |
| <input type="checkbox"/> 8086• \$300 | |

- fig-FORTH Programming Aids** for decompiling, callfinding, and translating. Specify CP/M, IBM-PC, 8086, Z80, or Apple \$150

Key to vendors: M.M. MicroMotion
 F.I. FORTH Inc. M.M.S. Miller Microcomputer Services
 L & H Laxen and Harris N.S. Nauticus Systems
 L.M. Laboratory Microsystems S.L. Shaw Labs

Jupiter Ace Computer – Z80 FORTH micro code – \$150

FORTH MANUALS, GUIOES & DOCUMENTS

- | | |
|--|---|
| <input type="checkbox"/> ALL ABOUT FORTH by Haydon. See above. \$25 | <input type="checkbox"/> 1982 Rochester FORTH Proc. \$15 |
| <input type="checkbox"/> FORTH Encyclopedia by Derick & Baker. A complete programmer's manual to fig-FORTH with FORTH-79 references. Flow charted, 2 nd Ed. \$25 | <input type="checkbox"/> A FORTH Primer \$25 |
| <input type="checkbox"/> FORTH Encyclopedia Pocket Guide \$7 | <input type="checkbox"/> Threaded Interpretive Languages \$21 |
| <input type="checkbox"/> And So FORTH by Huang. A college level text. \$25 | <input type="checkbox"/> AIM FORTH User Man \$12 |
| <input type="checkbox"/> FORTH Programming by Scanlon \$17 | <input type="checkbox"/> APPLE User's Manual MicroMotion \$20 |
| <input type="checkbox"/> FORTH on the ATARI by E. Floegel \$8 | <input type="checkbox"/> METAFORTH by Cassady. Meta compiler in 8080 code \$30 |
| <input type="checkbox"/> Starting FORTH by Brodie. Best instructional manual, available. (soft cover) \$16 | <input type="checkbox"/> Systems Guide to fig-FORTH \$25 |
| <input type="checkbox"/> Starting FORTH (hard cover) \$20 | <input type="checkbox"/> Caltech FORTH Manual \$12 |
| <input type="checkbox"/> 1980 FORML Proc. \$25 | <input type="checkbox"/> Invitation to FORTH \$20 |
| <input type="checkbox"/> 1981 FORML Proc 2 Vol \$40 | <input type="checkbox"/> PDP-11 User Man. \$20 |
| <input type="checkbox"/> 1982 FORML Proc. \$25 | <input type="checkbox"/> CP/M User's Manual , MicroMotion \$20 |
| <input type="checkbox"/> 1981 Rochester FORTH Proc. \$25 | <input type="checkbox"/> FORTH-79 Standard \$15 |
| <input type="checkbox"/> Installation Manual fig-FORTH \$15 | <input type="checkbox"/> FORTH-79 Standard Conversion \$10 |
| | <input type="checkbox"/> Tiny Pascal fig-FORTH \$10 |
| | <input type="checkbox"/> NOVA fig-FORTH CCI \$15 |

Source Listings of fig-FORTH, for specific CPU's and computers. The Installation Manual is required for implementation. Each \$15

- | | | | |
|--------------------------------|----------------------------------|-------------------------------|--|
| <input type="checkbox"/> 1802 | <input type="checkbox"/> 6502 | <input type="checkbox"/> 6800 | <input type="checkbox"/> AlphaMicro |
| <input type="checkbox"/> 8080 | <input type="checkbox"/> 8086/88 | <input type="checkbox"/> 9900 | <input type="checkbox"/> APPLE II |
| <input type="checkbox"/> PACE | <input type="checkbox"/> 6809 | <input type="checkbox"/> NOVA | <input type="checkbox"/> PDP-11/LSI-11 |
| <input type="checkbox"/> 68000 | <input type="checkbox"/> Eclipse | <input type="checkbox"/> VAX | <input type="checkbox"/> Z80 |

Ordering Information: Check, Money Order (payable to MOUNTAIN VIEW PRESS, INC.), VISA, MasterCard or COD's accepted. No billing or unpaid PO's. California residents add sales tax. Shipping costs in US included in price. Foreign orders, pay in US funds on US bank, include for handling and shipping by Air: \$5 for each item under \$25, \$10 for each item between \$25 and \$99 and \$20 for each item over \$100. Minimum order \$10. All prices and products subject to change or withdrawal without notice. Single system and/or single user license agreement required on some products.
DEALER & AUTHOR INQUIRIES INVITED

MOUNTAIN VIEW PRESS, INC.

PO BOX 4656

MOUNTAIN VIEW, CA 94040

(415) 961-4103

```

11570 XXS=RIGHTS(XS,LEN(XS)-1) 'STRIP OFF # SIGN
11580 FO=VAL(XXS):IF FO=-1 THEN FO=0 'IGNORE N-1 (DEFAULT)
11590 RETURN
11600 REM ***** ADD NAME TO LIST *****
11610 IF FO=-1 THEN FO=NNAM:NNAM=NNAM+1
11620 IF FO=NNAM THEN NNAM=FO+1
11630 NAMS(FO)=XS
11640 RETURN
12000 REM ***** CLEAR OLD ARRAY *****
12010 FOR I=0 TO MN:OL(I)=0:NEXT I
12020 TL=0:RETURN
12100 REM ***** MARK (OUTPUTS) AND CHECK FOR DUPES *****
12110 IF X=0 THEN RETURN
12120 IF OL(X)<>0 THEN GOSUB 12150
12130 OL(X)=1:RETURN
12150 PRINT "ERROR, MULTIPLE DEFINITION OF OUTPUT ";NAS(X)
12155 GOSUB 12160:RETURN
12160 INPUT "ENTER I (gnore) TO IGNORE ERROR, ANY OTHER KEY TO PREVENT
SIMULATION";QS
12170 IF LEFT$(QS,1)<>"I" THEN ER=1
12180 RETURN
12200 REM ***** CHECK FOR MULTIPLE OUTPUTS *****
12210 X1=ST
12220 FOR I=X1 TO NL-1
12230 FOR J=6 TO 7
12240 X=LO(I,J):GOSUB 12100 'MARK AND CHECK
12250 NEXT J:NEXT I:RETURN
12300 REM ***** CHECK FOR DEFINED INPUTS *****
12310 X1=ST
12320 FOR I=X1 TO NL-1
12330 FOR J=1 TO 5
12340 X=LO(I,J):GOSUB 12400 'CHECK FOR MARK
12345 IF X<0 THEN MM=MM-X 'KEEP TRACK OF MEM REQUIRED
12350 NEXT J:NEXT I:RETURN
12400 REM ***** CHECK FOR MARK *****
12410 IF X<=0 THEN RETURN
12420 IF OL(X)=0 THEN GOSUB 12450
12430 OL(X)=OL(X)+1:TL=TL+1:RETURN
12450 PRINT "ERROR, UNDEFINED INPUT ";NAS(X)
12460 GOSUB 12160:RETURN
12470 ER=1:RETURN
20000 REM ***** ADD T(0) THRU T(7) TO LOGIC ARRAY *****
20010 FOR II=0 TO 7
20020 LO(NL,II)=T(II)
20030 NEXT II
20040 PRINT:TY$(LO(NL,0));" ";FOR II=1 TO 7
20050 XX=LO(NL,II):IF XX<0 THEN PRINT "#;";-XX;" ";:GOTO 20070
20060 PRINT NAS(XX);" ";
20070 NEXT II:PRINT:NL=NL+1:RETURN
21000 REM ***** ADD T(0) THRU T(9) TO EXTERNAL ARRAY *****
21010 FOR II=0 TO 9
21020 EX(NE,II)=T(II)
21030 NEXT II
21040 PRINT TEX$(EX(NE,0));" ";NAS(EX(NE,1));" ";LVS(EX(NE,2));" ";:FOR II=3 TO
9:PRINT EX(NE,II);:NEXT II:PRINT
21050 NE=NE+1:RETURN
30000 REM ***** BUILD MACRO CORRESPONDENCE ARRAY *****
30010 REM I=EL #, J=MACRO POINTER
30020 LO=I:X=LO(I,0):J=TYPE(X):Y=LO(J,0):M1=J:OL(0)=0
30025 PRINT:PRINT" ***** EXPANDING CALL TO MACRO: ";TV$(X);"
30030 REM USES OLD VALUE ARRAY FOR EXPANSION (SINCE NOT USED YET)

```

1 SUPER WAREHOUSE

PHONE ORDERS FREE
(ONE DOLLAR CREDIT FOR PHONE ORDERS)

203-265-1223

PRINTERS

ANADEX	MFG. LIST
9000/1A	\$1625.
9500/1A	1725.
9620A	1845.
9625A, Dual	1995.
WP6000, Dual	3250.

DATASOUTH	
DS180	\$1595.
DS220, Dual	1995.

DIABLO	
630, Letter	\$2095.
WP Option	300.

FACIT/DATA ROYAL	
4510	\$ 695.
4560, Letter	1295.
4565, Letter	1895.
4570, Dual	3295.
5000c	1595.

MANNESMANN TALLY	
1601	\$ 930.
160L, Dual	1075.
1801	1190.
180L, Dual	1335.
1602	1695.
1605	1695.
1612KSR	2295.
1612RO	1945.
1802, Dual	1995.
1805, Dual	1995.

QANTEX	
7020, Dual	\$1595.
7030, Dual	1995.
7040, Dual	2195.

SMITH CORONA	
TPI, Letter	\$ 850.

VIDEO TERMINALS

LEAR SIEGLER	
ADM3A	\$ 595.
ADM5	645.
ADM21	695.
ADM22	695.
ADM24	1195.
ADM31	1095.
ADM32	1295.
ADM36 (DEC)	1195.
ADM42	2195.
VECTOR GRAPHICS	1050.
MODEMS	925.
PRINTERS 310	2045.
PRINTERS 500	1695.

ANN ARBOR	
GENIE	1195.
GENIE+PLUS	1395.
AMBASSADOR	1595.
META MODE	50.
DEC MODE	100.

DUAL = MATRIX/LETTER QUALITY



**IF YOU REALLY WANT IT
— CALL US —
BEST AND LOWEST PRICES**

- DATA SWITCH BOXES • BUFFER BOXES
- INTERFACE CARDS • GRAPHIC BOARDS
- SHEET FEEDERS • PRINT SPOOLING
- DS120 CONTROLLER CARDS
- ANDERSON JACOBSON MODEMS
- FLOPPY & WINCHESTER DRIVES

In addition, we can make EIA RS 232 cables to your order, and supply you with ribbons, printer stands, print wheels, thimbles for all printers listed. And many, many more items. **CALL NOW.**

All items shipped freight collect either motor freight or UPS unless otherwise specified. All prices already include 5% cash discount. Purchase with credit card does not include discount. Connecticut residents, add 7½% Sales Tax. For fastest delivery send certified check, money order or bank-wire transfer. Sorry, no C.O.D. orders. All equipment is in factory cartons with manufacturers' warranty. Prices subject to change without notice. Most items in stock or shipped as received.

1 **NATIONWIDE SERVICE, MOST PRODUCTS**
SUPER WAREHOUSE

P.O. BOX 373 WALLINGFORD, CONNECTICUT 06492

ORDER LINE
203-265-1223

ORDER HOURS
9:00 AM - 5:00 PM-EST
MONDAY-FRIDAY

PRICES SO LOW—WE CAN'T LIST THEM!

```

40200 REM ***** STORE Q AND Q- *****
40210 NE(Q0)=Y:NE(Q1)=LN(Q1):RETURN
40300 REM *** GET Q INTO XQ *****
40310 OL(O)=LN(OL(Q1)):XQ=OL(Q0):RETURN
41000 X=Q0:Q0=Q1:Q1=X ***** NAND GATE *****
41010 OL(O)=L1:Y=L1 ***** AND GATE *****
41020 FOR I=1 TO 5:Y=Y AND OL(IN(I)):NEXT I
41030 RETURN
41100 X=Q0:Q0=Q1:Q1=X ***** NOR GATE *****
41110 OL(O)=LO:Y=LO ***** OR GATE *****
41120 FOR I=1 TO 5:Y = Y OR OL(IN(I)): NEXT I
41130 RETURN
41200 X=Q0:Q0=Q1:Q1=X ***** XNOR GATE *****
41210 OL(O)=LX ***** XOR GATE *****
41220 YO=OL(IN(1)):Y1=LN(YO):YC=OL(IN(2)) 'DO AS MUX
41230 GOSUB 45000:RETURN
41500 REM ***** D FLIP FLOP *****
41510 GOSUB 40300:OL(O)=LX:XD=OL(IN(1)):XC=OL(IN(3)) 'GET VALUES
41520 XL=LO(L,8):OL(L,8)=L1:XR=OL(IN(4)):XS=OL(IN(5)) 'MORE INPUTS
41530 GOSUB 45100:LO(L,8)=YL 'SR FUNCTION CALL, YL=LATCH
41540 RETURN
41600 REM ***** J-K FLIP FLOP *****
41610 REM SET UP AS A MULTIPLEXED DFF, Q CONTROLS MUX
41620 GOSUB 40300:XM=XQ:OL(O)=LX:XC=OL(IN(3))
41630 DO=OL(IN(1)):D1=LN(OL(IN(2))) 'D=J*Q- OR K-*Q
41640 OL(O)=L1:XR=OL(IN(4)):XS=OL(IN(5)):XL=LO(L,8)
41650 GOSUB 45300:LO(L,8)=YL:RETURN 'DO AS MUX-D
41700 REM ***** PARALLEL LOAD COUNTER *****
41710 OL(O)=LX:YE=OL(IN(2)):XC=OL(IN(3)):OL(O)=LO:XM=OL(IN(4))
41720 OL(O)=L1:XR=OL(IN(5)):XS=L1
41730 GOSUB 40300:XL=LO(L,8) 'GET Q AND LATCH
41740 YC=YE:YO=XQ:Y1=LN(YO) 'COUNT =COUNT- IF ENAB=1, (MUX)
41750 GOSUB 45000:DO=Y:D1=OL(IN(1)):GOSUB 45300 'MUX THEN MUXD
41760 LO(L,8)=YL:IF TY$(LO(L+1,0))<>"*" THEN RETURN
41770 GOSUB 40200:L=L+1:IN(1)=LO(L,1):Q0=LO(L,6):Q1=LO(L,7)
41780 YE=YE AND Y:GOTO 41730 'LOOP AFTER GETTING NEXT CARD
41800 REM ***** PARALLEL LOAD SHIFT REGISTER *****
41810 OL(O)=LX:DO=OL(IN(2)):XC=OL(IN(3)):OL(O)=LO:XM=OL(IN(4))
41820 OL(O)=L1:XR=OL(IN(5)):XS=L1
41830 OL(O)=LX:D1=OL(IN(1)):GOSUB 40300:XL=LO(L,8):GOSUB 45300 'DO MUX-DFF
41840 LO(L,8)=YL:IF TY$(LO(L+1,0))<>"*" THEN RETURN
41850 GOSUB40200:L=L+1:IN(1)=LO(L,1):Q0=LO(L,6):Q1=LO(L,7):DO=Y
41860 GOTO 41830 'LOOP AFTER STORING Q AND GETTING NEXT
41900 REM ***** N BIT SHIFT REGISTER *****
41910 IF IN(2)=0 THEN GOTO 41500 '(1 BIT IS SAME AS DFF)
41920 OL(O)=LX:XD=OL(IN(1)):XC=OL(IN(3)) 'GET D AND CLOCK
41930 OL(O)=L1:XR=OL(IN(4)):XS=OL(IN(5)) 'GET RESET AND SET
41940 M1=LO(L,8) 'LATCH POS. IS USED TO STORE MEMLOC.
41950 FOR I=1 TO -IN(2) 'LOOP THRU FOR EACH STAGE (N IS STORED -)
41960 XL=ME(M1,0):XQ=ME(M1,1) 'GET LATCH AND Q FROM MEM
41970 GOSUB 45100:XD=XQ:ME(M1,0)=YL:ME(M1,1)=Y 'DO SR AND STORE
41980 M1=M1+1:NEXT I
41990 RETURN
45000 REM ***** MUX FUNCTION *****
45010 Y=(YO AND LN(YC)) OR (Y1 AND YC) OR (YO AND Y1)
45020 RETURN
45100 REM ***** SHIFT REGISTER FCN *****
45110 YO=XD:YC=XQ:Y1=XL '1ST MUX, CLOCKS IN XD ON CLOCK LOW
45120 GOSUB 45000 :GOSUB 45200 'MUX FCN AND SET,RESET
45130 YL=Y:YO=XQ: GOSUB 45000:GOSUB 45200 . " " AFTER STORING LATCH
45140 RETURN
45200 REM ***** SET AND RESET FUNCTION *****
45210 Y= (Y OR LN(XS)) AND XR: RETURN
45300 REM ***** MUX AND DFF *****
45310 YO=DO:Y1=D1:YC=XN:GOSUB 45000 'DO MUX
45320 XD=Y:GOSUB 45100 'DO DFF
45330 RETURN
50000 DATA MACRO MUX
50010 DATA MUX AO A1 C 0 0 0 Q
50020 DATA AND AO C- 0 0 0 X1
50030 DATA AND A1 C 0 0 0 X2
50040 DATA AND AO A1 0 0 0 X3
50050 DATA OR X1 X2 X3 0 0 0 Q
50060 DATA NAND C 0 0 0 0 C-
50070 DATA END
50080 DATA MACRO MUXD
50090 DATA MUXD AO A1 C CLK RSET Q
50100 DATA MUX AO A1 C 0 0 D-IN
50110 DATA DFF D-IN 0 CLK RSET 0 Q
50120 DATA END
50130 DATA MACRO CNTRM
50140 DATA CNTRM D1 LOAD CLOCK ENAB RSET Q1
50150 DATA * D2 0 0 0 Q2
50160 DATA * D3 0 0 0 Q3
50170 DATA * D4 0 0 0 Q4
50180 DATA AND ENAB 0 0 0 E1
50190 DATA XOR E1 Q1 0 0 DC1
50200 DATA MUXD DCL D1 LOAD CLOCK RSET Q1
50210 DATA AND ENAB Q1 0 0 E2
50220 DATA XOR E2 Q2 0 0 DC2
50230 DATA MUXD DC2 D2 LOAD CLOCK RSET Q2
50240 DATA AND ENAB Q1 Q2 0 0 E3
50250 DATA XOR E3 Q3 0 0 DC3
50260 DATA MUXD DC3 D3 LOAD CLOCK RSET Q3
50270 DATA AND ENAB Q1 Q2 0 0 E4
50280 DATA XOR E4 Q4 0 0 DC4
50290 DATA MUXD DC4 D4 LOAD CLOCK RSET Q4
50300 DATA END
50500 DATA ELEMENTS
50510 DATA CNTR DATAO ENABE CLOCK LOAD RSET Q0
50520 DATA * DATA1 0 0 0 0 Q1
50530 DATA * DATA2 0 0 0 0 Q2
50540 DATA * DATA3 0 0 0 0 Q3
50550 DATA CNTRM DATAO LOAD CLOCK ENABE RSET Q0M
50560 DATA * DATA1 0 0 0 0 Q1M
50570 DATA * DATA2 0 0 0 0 Q2M
50580 DATA * DATA3 0 0 0 0 Q3M
50590 DATA END
60000 DATA EXTERNALS
60010 DATA P CLOCK 0 5 10
60020 DATA A RSET 0 0 2
60030 DATA A ENABE 1 20 100 150 170 200
60040 DATA A DATA0 0 10 160
60050 DATA A DATA1 0 10 160
60060 DATA A DATA2 0 10 160
60070 DATA A DATA3 1 0 10 160
60080 DATA A LOAD 1 10 20 220 250
60090 DATA END
65000 DATA OUTPUTS
65010 DATA DATA1 DATA2 CLOCK LOAD ENABE RSET
65020 DATA Q0 QOM Q1 Q1M Q2 Q2M Q3 Q3M
65030 DATA END

```

QUALITY
SERVICE



ACTIVE, YOUR
NUMBER ONE
CHOICE

Active Electronic

Active Electronics

Your one stop source for the
widest variety of factory

fresh electronic components

FEATURING
THE 1982 LC MASTER
\$39.95

WHILE QUANTITIES LAST

Extensive Product Offering

Semiconductors, Integrated Circuits, Micro-
computer Boards, Microprocessor and
Support Circuits, Transistors, Diodes,
Capacitors, Resistors, Optoelectronics,
Potentiometers, Relays, Multimeters,
Switches, Knobs, Connectors, Sockets, P.C.
Boards, Enclosures, Data and Reference
Books, Soldering Aids, AND MUCH MORE

Superior Service

Greater choice, Easier, faster ordering and more
reliable deliveries. Active's all NEW comprehensive
Fall/Winter catalog is now available — FREE OF
CHARGE. Circle No. 6 on free information card or
write to: P.O. Box 8000, Westboro, MASS. 01581 U.S.A.

Call Toll Free 800-343-0874

MASS. customers call (617) 366-0500

MICROSTAT® - Release 3.0

MICROSTAT® + baZic® = PERFORMANCE

The best just got better! MICROSTAT has been the leader in the statistics field for microcomputers since 1979, and the new release 3.0 outperforms and is noticeably faster than previous versions. Just a few of the features include:

GREATER ACCURACY

BCD with up to 14 digit precision;

PROGRAM ENHANCEMENTS

Missing data capabilities and many more;

FASTER EXECUTION

Calculation time greatly reduced;

DYNAMIC FILE ALLOCATION

Data can be inserted, added, or deleted;

SPECIAL PRICE:

For a limited time get MICROSTAT plus baZic complete with program disk and documentation for each for \$395.00, save \$50.00!

The MICROSTAT - baZic version requires: a Z80 CPU, CP/M™ and 48K of memory. Available formats: 8" SD disk or 5¼" North Star only. Check with your dealer for other formats. Also available for: Microsoft's Basic-80™, North Star DOS and IBM. For more information, call or write:

ECOSOFT INC.

P.O. Box 68602

Indianapolis, IN 46268-0602

(317) 255-6476



MICROSTAT is a registered trademark of ECOSOFT, INC.
baZic is a registered trademark of MICROMIKES, INC.
CP/M is a registered trademark of DIGITAL RESEARCH
Basic-80 is a registered trademark of MICROSOFT

We are OVERSTOCKED!!!



ADM Systems has a huge quantity of
ONE MEGABYTE CONTROL DATA 5¼"

FLOPPY DISK DRIVES

96 TPI DOUBLE SIDED DOUBLE DENSITY

CALL NOW! THIS OFFER WON'T LAST LONG...

800-531-5104 In Texas call 512-250-9323

ADM • SYSTEMS

AUSTIN DATA MANAGEMENT SYSTEMS COMPANY

13010 Research Blvd., Suite 103

**GD CONTROL DATA
CORPORATION**

Austin, Texas 78750

Say Goodbye to Computer Under-Use!



Say Hello to Condor Database!

**Now you can do hundreds of tasks quickly and easily
without programming experience.**

We know the frustrations. You bought a micro-computer to help manage your business better. Then came the realities of software—canned programs, computer languages, programmers and consultants. Finally, you got something running... but it's not what you wanted. To make matters worse, the computer is sitting idle much of the time. And you expected to be able to do so much more.

Condor to the rescue

Condor has a management system for your micro-computer that helps you accomplish hundreds of tasks . . . quickly and easily . . . **without programming experience.** Called Condor Database, it truly helps you do most of the things that prompted you to buy a computer in the first place. Simple things like reminding you of important dates or setting up zip code sorted mailing lists. Or intermediate tasks like organizing your files, project control and customer tracking. Or more complex applications like analyzing cash-flow and generating extensive management reports. All are accomplished with less time and effort with Condor. Much less!

Easy to use with fast results

Condor Database eliminates complex programming. It uses simple English words to do the things

you want to do. You'll be amazed how quickly Condor helps manage your business, even if you're a first-time user. No wonder many of the largest hardware manufacturers have tested and feature Condor Database with their microcomputers. Companies like Zenith, Hewlett-Packard, DEC, NEC, Sony, Sanyo and Monroe.

\$295 with a money-back guarantee

More good news. Condor Database helps you grow in steps. Start with Condor 1—the file manager for just \$295. As your needs grow, buy Condor 3—the complete database manager for \$650. Both come with an easy-to-use manual and a full 30-day money back guarantee. We'll even discount the Condor 3 price \$245 when you upgrade from Condor 1. For full information, see your local software dealer or contact us. You've got a world of useful applications to gain. And nothing to lose except your frustrations.

P.S. If you're about to buy a microcomputer, buy it with Condor Database to start. You'll avoid frustration in the first place!

NOTE: Compatible with all microcomputers with CP/M, MSDOS, CP/M-86, MP/M, PC DOS or TURBODOS



CONDOR COMPUTER CORPORATION

2051 S. State Street
Ann Arbor, Michigan 48104
(313) 769-3992

Condor Database — it's simply better!

GSA Schedule. Contact 1828 L. Street, N.W., Suite 117, Washington, D.C. 20036 Phone (202) 466-8551

Circle 116 on inquiry card.

Information Hiding

A Brief Example

*Consider this helpful alternative
to structured programming and modular design.*

Gregg Williams
Senior Editor

While writing the display routine for a game-related program, I decided against a possible change in implementation detail because it would require me to rewrite almost the entire program. This is not an unusual situation for programmers to find themselves in. Had it not been for a vague memory that brought two words to mind, I probably would have continued to find myself in the same situation in years to come. The words were *information hiding*, recalled from an article I had read some time ago. They prompted me to do some thinking about program design, and the work I did refining the display routine algorithm became the basis for the material in this article.

The DRAWCUBE Problem

The problem was simple: I had a 3 by 3 cube (the Rubik's Cube puzzle), with each 1 by 1 square on the face of the cube being one of six colors; the task was to display the state of the cube on the video display of the computer I was programming. I quickly settled on the details of the representation: a given cube could be described by 54 consecutive bytes of

memory (the larger problem to be solved—writing a game-related program—dictated that a large number of cube images had to be simultaneously stored in memory); each 1 by 1 square (to be called a *unit* for the rest of this article) was to be stored as a number from 1 to 6 in 1 byte of memory, with the sequence of bytes

being taken as six faces of 9 bytes each and the units of a face being stored in row-major order. Also, the cube was to be displayed as a “cross” of six squares that fold together to make a cube (see figure 1).

With these representation choices already decided, I wrote the program DRAWCUBE1, shown in listing 1. The program is straightforward in design. The subroutine DRAWFACE draws one face as a 3 by 3 square, starting at the current cursor position. The subroutine UPDATEBASE positions the cursor to the upper left-hand corner of the next face to be drawn. Finally, the main program coordinates these two subroutines, thus displaying the cube represented in memory starting at the location BEGINCUBE. What could be simpler?

I found to my dismay that a lot of things could be simpler. The one change I rejected (because of the rewriting it would necessitate) led to another and another until I had a list of what-if suppositions, each of which would require major revisions to the DRAWCUBE program. For example:

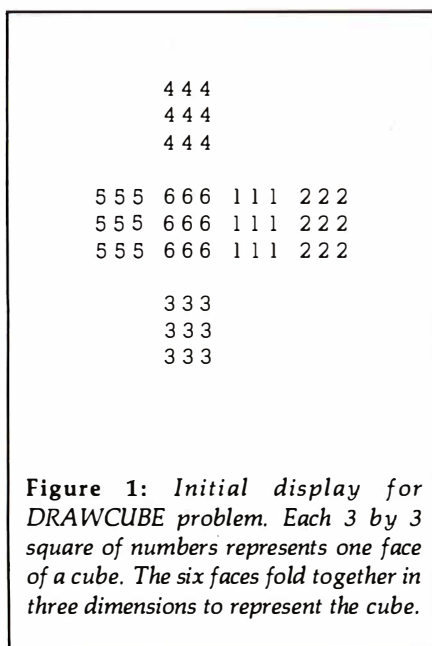

Figure 1: Initial display for DRAWCUBE problem. Each 3 by 3 square of numbers represents one face of a cube. The six faces fold together in three dimensions to represent the cube.

- What if units were packed two to a byte?
- What if I wanted a perspective display that shows only three faces of the cube?
- What if each unit that had not changed since the last display were flagged in the top bit of its representation in memory?

These and other disruptive changes are listed in table 1.

Alternate Solutions

Design by flowcharting: My first attempt at writing the DRAWCUBE program represents a superficial level of design that most of us usually work at; it could easily be called "design by flowcharting" because it draws heavily on the structure of the coded program that the programmer already has in mind.

Even though the program in listing 1 uses structured programming, which is generally considered to be good programming practice, there is something vitally wrong with it. The flaw is invisible until you extrapolate to a program a thousand times the size of this one. It then becomes obvious that the program in question requires detailed knowledge of the implementation decisions made before the program was designed or coded. A well-written program, however, should be as independent of implementation decisions as possible; it should concentrate on the details of the *algorithm*, not the details of the implementation decisions.

Design by decomposition into modules: A somewhat deeper analysis of the problem might result in the design of the program as a series of modules, each of which is as independent of the others as possible. In such a simple example as I am considering here, the modules represent the three basic actions of any program—input, process, and output—as follows: input the cube from memory into a three-dimensional array; do any processing on the array that might be required (in this example, nothing); and display (or output) the cube on the video display screen.

Wasting Money! We Have the World's Most Cost Effective Development System.



- Includes HexKit 1.0, a powerful 100% machine code editor/debugger/utility program that makes coding for 8-bit Micros a snap.
- Program from Commodore VIC-20 keyboard into built-in 4K ROM emulator
- Jumper to target ROM socket
- Test programs in circuit
- Built-in EPROM programmer and power supply
- Burns & runs EPROMs for the Commodore VIC-20, too
- Comprehensive manuals
- Fits EXPANSION PORT

PROMQUEEN CARTRIDGE ONLY \$199

Send for Free Brochure

Distributed in U.S. by Arbutus Total Soft, Inc., 4202 Meridian, Suite 214, Bellingham, WA 98226. Phone 800-426-1253. In Washington 206-733-0404
Distributed in Canada by IBC/Distribution Canada, 4047 Cambie St. Vancouver, BC V5Z2K9. Phone 604-879-7812

VISA AND MASTERCARD ACCEPTED

Commodore approved product

	Prices	U.S.	CAN.
PROMQUEEN 64		\$299.00	\$399.00
8K board with 1 EPROM		\$29.95	\$39.95
16K board with 1 EPROM		\$38.95	\$48.95
8K board with 1 EPROM-C84		\$39.95	\$49.95

Circle 30 on Inquiry card.

POWER PROTECTION FOR YOUR SYSTEM

The Datasaver™ AC Power Backup fits most desktop and portable microcomputer systems. Call **Cuesta Systems, Inc.** at (805) 541-4160 for product information and application literature. VISA/Mastercard orders call (800) 851-6055.

INSTANT POWER

Circle 125 on Inquiry card.

BASF FlexyDisks®

5 1/4"	Specify soft, 10 or 16 sector	Price/10	Price/100
	1 side/double density	\$20.00	\$185.00
	2 sided/double density	34.50	325.00

8"	Specify soft or 32 sector	Price/10	Price/100
	1 side/single density	\$21.00	\$195.00
	1 side/double density	29.50	275.00
	2 sided/double density	34.50	325.00

Certified Check - Money Order - Personal Check
Allow up to 2 weeks for personal checks to clear.
Add \$3.00 to each order for U.P.S. shipping charges.
NJ Residents add 6% NJ Sales Tax

DATA EXCHANGE, INC.
280 Dukes Parkway, P.O. Box 85
Somerville, N.J. 08876 • (201) 725-6680
Dealer Inquiries Invited

Circle 129 on Inquiry card.

CONTROL YOUR HOME OR OFFICE APPLIANCES AND MORE... WITH OUR UNIVERSAL COMPUTER SWITCH!

- * Use your computer's Parallel or Serial Port to control both Industrial and Home Appliances...lights, burglar alarms, even robots... its uses are virtually limitless!

* TTL and RS-232C compatible!

* Available in both kit and assembled formats:

140 volt, 1.5 amp switch: 140 volt, 10 amp switch:
The Kit @ \$34.95 The Kit @ \$54.95
Assembled & Assembled &
Tested @ \$79.95 Tested @ \$99.95

(When ordering the 10 amp. switch... please specify whether you're using RS-232C or TTL output to the switch.)

We accept Checks, Master Card and VISA.
Note: N.Y. and N.J. residents add applicable sales tax.

Include \$3.00 to cover shipping and handling.
For further information contact:

Driver-Harris Systems, Inc.
2460 Lemoine Avenue
Fort Lee, New Jersey 07024
(201) 944-0322 (212) 695-7480

Circle 149 on Inquiry card.

compubag™

—the executive carryall

The Compu-bag, the ideal carrying case for your computer accessories. The forward compartment holds box of 105 1/4" diskettes. Main compartment—an 8 1/2 x 11 looseleaf with up to 3 inches of materials. Made of high quality calfskin, heavy duty zippers and brass findings. Available in: Brown, Black or Burgundy—just \$79.95.

Send your check or money order to:
EMC Distributors
366 Fifth Avenue
New York, N.Y. 10001
Telephone 212-594-6673
dealer inquiries invited

Circle 160 on Inquiry card.

Apple Compatible Drives	\$285.00
Controller	\$89.00
Vista Duet Drives	\$399.00
Vista Quartet	\$989.00
Vista V1100 8" System	\$1795.00
IBM Compatible Drives 5 1/4"	\$228.00
Vista V1100 8" System	\$1795.00
Hard Disks Available	CALL
Tandon TM 100-2 5 1/4"	\$248.00
TM 100-4 5 1/4"	\$318.00
TM 848-2 8"	\$417.00
TM 803E 14.2 Mini	\$895.00
Controller/Interface Available	CALL
Epson FX80	Retail \$745.00	Sale \$598.00
MX100	\$895.00	\$699.00
NEC 8023A	\$795.00	\$540.00
Okidata 92 new	\$899.00	\$580.00
93 new	\$1248.00	\$815.00
Pacemarkip)	\$2895.00	\$2200.00
Morrow Micro Decision 1	\$885.00
MD II	\$1255.00
MD III	\$1525.00
Terminal	\$595.00
Apple 48K (Apple Compatible)	\$599.00
Televideo TS802 Computer	\$2595.00
TS 1602 G Computer	\$3385.00
TS 808/20 Computer	\$4889.00
910 Terminal	\$598.00
925 Terminal	\$745.00
950 Terminal	\$849.00
*Apple IIs, Franklin, Basts, Osborne	CALL
Floppy Diskettes	\$18.95/50 (10)

VISA, Mastercard, wire, checks, quick est. Some COD's accepted.
Prices and specifications subject to change without notice.

WHOLESALE SUPPLIERS

Div. B.O.S.S. Inc.
P.O. Box 22428 Carmel, CA 93922
Call (408) 373-0320

Circle 444 on Inquiry card.

computers wholesale

**No UPS Shipping Charges
On Prepaid Orders!**

—SYSTEMS—

ALTOS List.....	Less 20%
CROMEMCO List.....	Less 20%
INTERTEC SB Jr.....	\$1889
INTERTEC SB QD.....	2269
INTERTEC DSS-10.....	2895
MORROW Micro Decision.....	NEWLOW
MORROW Decision I.....	PRICES
EAGLE II 64K 2/SS.....	Call for Price
EAGLE III 64K 2/DS.....	Call for Price
EAGLE IV 1 floppy, 1 HD.....	Call for Price
NORTHSTAR Advantage.....	2895
NORTHSTAR HR2Q.....	2685

—PRINTERS—

CENTRONICS 730-1 Par.....	299
C.ITOH 8510 Par.....	425
C.ITOH Prowriter II Par.....	689
C.ITOH Prowriter II Ser.....	739
EPSON MX-80 III.....	425
EPSON MX-80FT III.....	510
EPSON MX-100FT III.....	665
OKIDATA 82A.....	395
OKIDATA 83.....	639
OKIDATA 84S.....	1020
OKIDATA 92P.....	539
OKIDATA 93.....	989
IDS Prism 80 Basic.....	750
IDS Prism 132 w/color.....	1465
TI-810 Basic.....	1289
TI-810 Full.....	1549
TI-820 Basic.....	1545
NEC 8023.....	465
NEC 3510.....	1489
NEC 7710.....	2145
QUME 11/40.....	1339
QUME 9/45.....	2095
DIABLO 630 RO.....	2049
ANADEX 9501.....	1290
ANADEX 9620.....	1329
ANADEX WP6000.....	2315

—TERMINALS—

TVI 910.....	515
TVI 925.....	715
TVI 950.....	899
TVI 970.....	Call
SOROC 130.....	589
SOROC 135.....	719
SOROC 140.....	995
HAZELTINE.....	Call
ZENITH Z-19.....	639
WYSE 100.....	795
WYSE 100-2Page.....	839

—MONITORS—

BMC 12" Gr.....	85
AMDEK-100.....	89
AMDEK Color I.....	310
AMDEK Color II.....	649
AMDEK Color III.....	419

—MODEMS—

HAYES Smart Modem-300.....	219
HAYES Smart Modem-1200.....	520
NOVATION D-Cat.....	149
NOVATION 212.....	520
NOVATION J-Cat.....	149
SIGNALMAN MODEMS.....	Call

315-472-3055

Box 91 Brewerton, N.Y. 13029

Advertised prices reflect a cash discount on prepaid orders only. Most items are in stock for immediate delivery in factory sealed cartons w/full factory warranties. N.Y. residents add appropriate sales tax. Shipping is not included (unless otherwise stated). C.O.D.'s require a 25% deposit. All prices and offers may be changed or withdrawn without notice.

This modular approach separates code *temporally*. For example, the cube contents are copied into an array before any processing or display operations take place; because of this, any change in the way a cube is stored can affect code only up to the point at which the cube is copied into the array. This temporal isolation of implementation decisions is a step in the right direction, but it is still somewhat related to the "design-by-flowcharting" philosophy. It is possible to obtain further separation by *functional* isolation of implementation decisions.

Design using information hiding:

The premise of information hiding is to write a series of modules that hide implementation decisions from all other modules. Although this cannot always be carried out fully, the attempt to hide as much implementation information as possible results in programs that are increasingly less sensitive to implementation changes.

These modules are of a different sort from those previously discussed. They are instead groups of functions that provide a certain behavior when viewed from outside the module. In this way, the main program is provided with a set of modules that appear as "black boxes" to each other: the modules (boxes) can operate knowing only *what* functions the other modules provide; ideally, they are totally independent of *how* another module accomplishes its objective.

Nor are these modules necessarily used sequentially; in many cases, the main program uses several modules repeatedly to accomplish a given task. (This is the case with the DRAWCUBE2 example given in listing 2.) This switching among modules is a potential source for a severe decrease in program speed, especially if the program is large enough so that successive modules have to be swapped in and out of memory to be executed. However, this problem can usually be avoided by proper module design.

In the case of the problem given here, program DRAWCUBE2 (see listing 2) is divided into three modules: CREATEARRAY, which creates *the appearance* of an array

CUBE (*facenum, rownum, colnum*) that allows other modules to access any unit of the cube; PROCESS-ARRAY, which manipulates the information to be displayed; and DISPLAYARRAY, which displays the processed information. These are conceptual modules that are implemented by one or several procedures and functions in this Pascal program. Table 2 lists and describes the modules and lists their component procedures and functions.

Comparison of Algorithms

The algorithm of DRAWCUBE2 is distinguished from that of DRAWCUBE1 and the modular approach discussed above in its use of *transactions* to separate the manipulation of the information to be displayed from the actual display of the same information. The subroutine GENERATETRANS generates transactions until it signals the end of the algorithm by setting the SITUATION flag to ALLDONE. A transaction is defined as a quartet of numbers (*facenum, rownum, colnum, colornum*), which is the minimal number that can completely describe an arbitrary unit for display by the DISPLAYARRAY module.

Consider the "normal-array-with-flag" change listed in table 1. The DRAWCUBE1 program would have to be changed in several places to accept the new cube format. The hypothetical modular program (call it DRAWCUBEM, with modules READCUBE and DISPLAYCUBE) would have to change both its modules: the change to READCUBE follows from the fact that the input format has been changed; the change to DISPLAYCUBE results from the necessity of skipping over units that remain unchanged from the last display operation. (I use the word necessity because the only reason for storing the units with flags is to speed up the display process by discarding the transactions of unchanged units.)

The information-hiding DRAWCUBE2 program handles the display operation so that the main program does not have to change when the input is changed to include flagged data. It does this by burdening the

EMPLOYMENT OPPORTUNITIES

SYSTEMS ENGINEERS Immediate Openings

State of the art technology in commercial and military simulation is what Link Flight Simulation Division of the Singer Company is all about. Due to new contract awards, we have an immediate need for experienced design engineers with an EE degree and 2 plus years experience in the following areas:

- Computer Systems Realtime SW
- SW Configuration Control
- Propulsion Design
- Aircraft Accessory Systems
- Tactics Engineers
- Avionics Systems
- Weapon Delivery

Excellent salary and benefit plans. All positions are at our scenic upstate New York headquarters. Send your resume in confidence to or call:



Robert Montgomery
Dept. BY
Link Flight Simulation Div.
Binghamton, NY 13902
(607) 772-3163
E/O Employer M/F

Implementation Change	Details
1. Packed sparse Boolean array	The cube is represented as six strings of 54 bits each, one string for each color as given by a predefined sequence of colors. The 54 bits represent the 54 units (6 faces times 9 units per face) that make up the cube. A 1 bit in the 54-bit substring represents the presence of the associated color on the corresponding unit of the cube, while a 0 represents its absence. This method occupies 324 bits or 40.5 bytes to represent the cube.
2. Cube stored on disk	The 54 bytes of the original 1-byte-per-unit method are stored in one sector of a floppy disk.
3. Packed array	The cube is represented in the original manner except that the color numbers of units are represented as 4-bit numbers and packed two to a byte. This method occupies 28 bytes to represent the cube.
4. Normal array with flag	This method assumes that the cube is already displayed on the video display. The top bit of a byte representing a unit can be 1 to represent the need of updating the unit or 0 otherwise. This scheme might be used to decrease the time needed to display the new representation of the cube.
5. User viewpoint modification	Before the cube is displayed, the user can specify one of several rotations as multiples of a quarter turn around any of the three axes of the cube.
6. Printed output	The cube is to be printed out in the "cross" format instead of being displayed on the video display.
7. Perspective display	The video display shows a perspective view that leaves three faces visible. Each unit may be represented by either its color number or a diamond shape of the appropriate color.

Table 1: A list of possible implementation changes to the DRAWCUBE problem.

Module	Component Functions and Procedures	Purpose of Module
CREATEARRAY	INITARRAY CUBE	Once this module has been executed, calls to CUBE give the impression to the calling module that the contents of the given cube are stored in a three-dimensional array CUBE (<i>facenum, rownum, colnum</i>).
PROCESSARRAY	INITGENERATE GENERATETRANS	This module acts on the "array" CUBE to generate a series of transactions that, together, completely describe the cube to be displayed.
DISPLAYARRAY	INITPUT PUTTRANS FLUSHARRAY	This module contains the necessary subfunctions to ensure that the cube is displayed properly.

Table 2: Modules within program DRAWCUBE2, the Pascal procedures and functions that represent them, and their purposes.

transaction-generating routine (GENERATETRANS) with the task of discarding units that do not need to be redisplayed. Although this change is one of repositioning, not simplifying, a design guided by information-

hiding principles might indeed result in simplifying the process of program conversion if the overall program were big enough. In any case, the main program of DRAWCUBE2 seems much more solid and un-

For only . . .

\$1064

your recruitment ad in this 4" space will reach 300,000 qualified readers just like yourself.

To place your ad call 212-997-2556, or send your copy to the address below.

BYTE

P.O. BOX 900, NY 10020

Change	Implementation Details Changed	Modules Needing to Be Changed (Y = yes, N = no)								
		DRAWCUBE1			DRAWCUBEM			DRAWCUBE2		
		UPDB	DRAW	INIT	READ	DISP	CRTE	PROC	PUT	
1. Packed sparse Boolean array	input	N	N	Y	Y	N	Y	N	N	
2. Cube stored on disk	input	N	N	Y	Y	N	Y	N	N	
3. Packed array	input	N	N	Y	Y	N	Y	N	N	
4. Normal array with flag	input and process	N	Y	Y	Y	Y	Y	Y	N	
5. User-viewpoint modification	process	N	N	Y	N	Y	N	Y	N	
6. Printed output	output	Y	Y	Y	N	Y	N	N	Y	
7. Perspective display	output	Y	Y	Y	N	Y	N	N	Y	
Abbreviations:	INIT = INITIALIZE READ = READCUBE CRTE = CREATEARRAY	UPDB = UPDATEBASE DISP = DISPLAYCUBE PROC = PROCESSARRAY	DRAW = DRAWFACE PUT = PUTARRAY							

Table 3: A table of implementation changes and the modules affected by them.

shakable than the corresponding main programs of DRAWCUBE1 and DRAWCUBEM.

Table 3 further displays the merits of information hiding by listing the modules in the current program version that would have to be altered to accommodate the change specified in the first column. Study of the results for DRAWCUBE1 (and reflection on the duties of each module within) point up the imbalance among the modules: modules INITIALIZE and UPDATEBASE deal only with the

output phase of the task, while module DRAWFACE incorporates aspects of the input, process, and output phases. This results in its being modified for every change listed. It is true that, in all versions of the DRAWCUBE problem, all the changes discussed in this article result in only one or two modules being changed; but in a more complex problem, several modules may share the lack of information hiding displayed here by module DRAWFACE, thus making the pro-

cess of changing an existing program more difficult and unmanageable.

Similar analysis of the two modules of DRAWCUBEM shows a cleaner separation of functions as a result of an emphasis on modularity. Module READCUBE is affected only by changes in the input format, while module DISPLAYCUBE is affected by changes in the process and output phases. The modules of DRAWCUBE2, however, show the greatest separation; modules CREATEARRAY, PROCESSARRAY, and

MIND YOUR OWN BUSINESS.

It's time to take a long, hard look at your business.

Chances are, it's not running as productively as it could be.

And the effects—lowered product quality, limited resources, a tighter profit squeeze—can be staggering. Not just for your business, but for our nation as a whole.

There are no instant cures.

Growth in your business—and in this nation—depends on working more productively than ever. And on getting more out of what you're already putting in.

With careful planning and a sustained effort, you can improve the productivity of your operations, the quality of your product, create better job satisfaction within your work force and outperform your competition.

To learn more, send for the American Productivity Center's free brochure, "A Productivity Program... or Productivity Improvement." It will tell you where to start.

Don't put it off.

Minding your own business is the best way to help the business of America.

A public service of this publication, the Ad Council and the American Productivity Center.



AMERICA. WE'VE GOT A JOB TO DO.

Kathleen Sutton, American Productivity Center,
123 N. Post Oak Lane, Houston, Texas 77024

Yes, I would like to improve my company's productivity. Please send me a free copy of "A Productivity Program... or Productivity Improvement."

NAME _____

ADDRESS _____

CITY _____ STATE _____ ZIP _____

PUTARRAY are affected only by changes in input, process, and output phases, respectively.

Even though the differences between the modular program, DRAWCUBEM, and the information-hiding program, DRAWCUBE2, are minimal, the latter has a noticeable edge in modularity in that all the program changes discussed in tables 1 and 3 could be made without changing the main program routine. This explains the use of empty modules like INITARRAY and FLUSHARRAY; in other versions of this program, these modules might perform some needed function.

One final observation should be made about the difference in size of the program DRAWCUBE1 (which is highly implementation-dependent) when compared to DRAWCUBE2 (which is highly implementation-independent). The compactness of DRAWCUBE1 is specifically due to its ability to take shortcuts because of its knowledge of the specific implementation details. Conversely, DRAWCUBE2 is longer because it

assumes no knowledge of these details and so must work harder to accomplish the same results.

For example, consider the output sections of both programs. DRAWCUBE1 must position the cursor only once every three units because it knows that the cursor will be in position for the next (sequential) unit on the same row. DRAWCUBE2, in assuming that the transactions might come in any order, must reposition the cursor for each unit.

The Case for Information Hiding

The advantages of information hiding include the increased separation among modules and the increased ease of making large implementation-based changes to the program. Its disadvantages include the increased size and execution time of the resulting program. The following paragraphs describe several situations that indicate the use of information hiding techniques:

- You should use information hiding for large programs, especially

those designed in an uncertain environment. Examples of this are software designed before or during the choice of computer hardware and software that will be run on leased equipment, on several computer systems, or on equipment due to change.

- Information hiding is also appropriate for programs that are likely to be maintained over an indefinite period of time, especially programs written for a business environment. For example, it makes more sense to use information hiding if you know that someone will probably be modifying the program five years from now; it makes less sense if the program will be written, used several times, then discarded.

- Information hiding is useful if the amount of data being manipulated by the program might greatly increase in the future. Such an increase indicates the possibility of changing to another form of data storage, and such a change might be feasible only if the existing program has been designed to anticipate it.

GET THE SAME VIDEO TRAINING THE PEOPLE AT SONY GET.

Now you can be trained by Sony even if you aren't employed by Sony.

Because we're making our vast library of training videotapes available to you. The very tapes that teach our own engineering, service and sales personnel.

The tapes cover the products and concepts of video and its related technologies. You can learn the basics of video recording. Color systems. Digital video and electronics. Television production. And more.

Plus you can learn how to service cameras, VTR's, and other video products. As professionally as Sony does.

The tapes are produced entirely by Sony and contain up-to-the-minute information. They communicate clearly and simply. And some of them are even programmed for interactive learning.

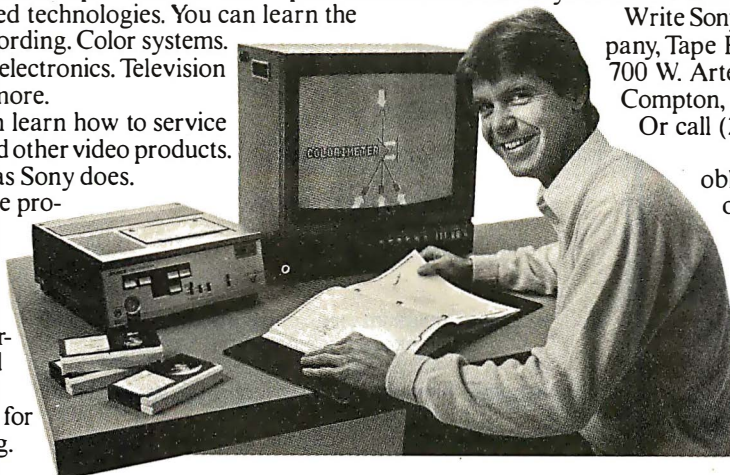

And learning through video can be done at your own pace, in the convenience of your home, shop or school. Reviewing is quick and easy. And the tapes are always available for reference.

Send for your catalog, which lists more than 250 titles. In your choice of 3/4" or 1/2" formats.

Write Sony Video Products Company, Tape Production Services, 700 W. Artesia Boulevard, Compton, California 90220. Or call (213) 537-4300.

Of course, there's no obligation. Except the obligation you have to yourself: to find out about the best training available in one of the country's fastest-growing, most lucrative fields.

SONY
Video Communications
Sony is a reg. trademark of Sony Corp.

S-100 Boards from S. C. Digital

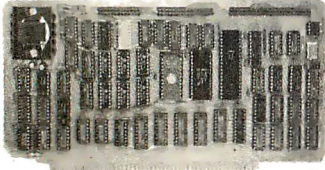

FLOPPY DISK CONTROLLER

Model FDC1
 ● Single or Double density, sides, in any combination of up to four 8" or 5.25" drives. ● Digital phase locked loop.
 ● DMA data transfer with cross 64K boundaries, 24B address, DMA arbitration. ● Monitor/boot EPROM accommodating two different processors. ● CPM Bios programs.
 ● Serial port to 19.2K baud.

Z80B CPU BOARD

Model Z80 CPU
 ● 2, 4 or 6 mhz clock. ● 22 bit Address by Memory Mapping in 16K blocks. ● 2 or 4Kbyte EPROM (not supplied) with Phantom generation. ● Jump on Reset. ● Provision to run two different CPU's on the same bus, such as forthcoming 8086.

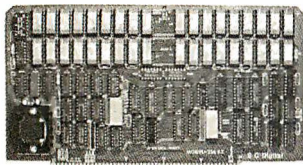

NEW 256K DYNAMIC RAM

Model 256KZ
 ● 8/16B Data, 24B Address. ● Parity bit per Byte ● Transparent refresh ● Unlimited DMA ● 180nsec. Access time ● Will run 8086, 8088, 68000 to 8mhz, Z80, Z8000 to 6mhz without wait states.



NEW 64K STATIC RAM

Model 64KS
 ● 8/16B Data 24B Address ● Disable in 2K increments ● 180nsec Access Time (with 64KB) from address on, runs 8086, 68000 to 10mhz, Z80, Z8000 to 8mhz without wait states ● Battery back up capable.

32K STATIC RAM 'Uniselect: 4'

Model 32KUSM
 ● 8/16 bit data, 16/24 bit address. ● Bank Select by SW selectable port, bit in 32K block. ● Battery backup (battery not supplied) with power-fail detect/automatic Ram disable. ● Complete EPROM (2716) capability with wait states (up to 3), phantom responding or generating.

All boards conform to IEEE696/S100 specifications, fully socketed, screened legends, masks, Gold contacts. Guaranteed One Full Year.

Model	New Price	Effective February 1, 1983
FDC1	\$425	Monitor EPROM
Z80 CPU	\$349	Memory Mapping, 6mhz clock
256KZ	\$795	256KB, Parity
64KS	\$425	64KB, CMOS
32KUSM	\$325	32KB, CMOS
32KUSM-N	\$169	no ram, no power fail
3SPC	\$259	3 serial, 1 parallel, cassette
Z80 monitor	\$95	2K in EPROM, source code

All Boards come assembled and tested. Call for current and package deal prices.

Delivery is within 3 to 5 working days. MC, Visa or COD orders accepted. (Add \$6 for COD orders) Illinois residents add 5 1/4% sales tax.

D.E.M. & DEALER PRICING AVAILABLE

S. C. DIGITAL

P.O. Box 906

1240 N. Highland Ave., Suite # 4

Aurora, Illinois 60507

Phone: (312) 897-7749

Conclusions

Information hiding is a technique of program design that confines implementation-dependent details to as few modules as possible and organizes the modules to present a predefined appearance to all other modules. Because the implementation details are not visible to other modules, the program can be modified by changing only those modules that hide the pertinent details.

Information hiding is most appropriate to large programs that are to be maintained over long periods of time. The advantage of flexibility in the face of unknown future changes is offset by the disadvantages of larger program size and longer execution time, but these disadvantages can be controlled given proper planning.

Due to the necessary limitations in its size for tutorial purposes, the example given here does not correctly show the relative advantages and disadvantages of using information hiding; the advantages are more pronounced in a larger program (where a version of the program not using these techniques might be less recep-

tive to implementation changes and where the increase in program size becomes proportionally smaller as the program size increases).

The disadvantages of increased program size and execution times are minimized by the extremely low cost of computer memory and the increasingly faster computers currently being manufactured. The most significant expense today is the time spent by the programmer in writing and, more important, *maintaining* a program. Any techniques (of which information hiding is only one) that increase a programmer's productivity should be seriously considered. ■

References

1. Parnas, D. L. "On the Criteria to Be Used in Decomposing Systems into Modules." In Edward Nash Yourdon (ed.), *Classics in Software Engineering*. New York: Yourdon Press, 1979.
2. Ross, D. T., J. B. Goodenough, and C. A. Irvine. "Software Engineering: Process, Principles, and Goals." In P. Freeman and A. I. Wasserman (eds.), *Tutorial on Software Design Techniques* (3rd ed.). New York: IEEE Computer Society, 1980.

Listing 1: Program DRAWCUBE1.

```
PROGRAM DRAWCUBE1;

( The purpose of this program is to simulate
  an algorithm that draws onscreen the six
  faces of a 3 by 3 by 3 cube stored in memory.
  In this implementation, each 1 by 1 "unit"
  is represented as a number from 1 through 6,
  and the cube is drawn on the screen as shown
  in figure 1. )

CONST RANK=3;
      MAXFACES=6;

TYPE SCREENCONSTANTS=ARRAY[1..6] OF INTEGER;

      ONE_TO_MAXFACES=1..MAXFACES;

      ONE_TO_RANK=1..RANK;

VAR  BASEROW, BASECOLUMN, CURRENTFACE,
      CUBEBEGIN, MEMPOINTER: INTEGER;

      MEMORY: ARRAY[1..180] OF ONE_TO_MAXFACES;

      FACE_ROW_BEGIN, FACE_COL_BEGIN:
      SCREENCONSTANTS;
```

Listing 1 continued:

```
PROCEDURE SIMULATEMEMORY;

( This procedure is included only for the
purpose of simulating the computer memory
used to store the characteristics of one
or more cubes. Strictly speaking, this
routine is not part of the DRAWCUBE
algorithm. )

VAR I, J, SUBSC: INTEGER;

BEGIN

CUBEBEGIN:=19;
MEMPOINTER:=CUBEBEGIN;

FOR I:=1 TO 20 DO
  FOR J:=1 TO 9 DO
    BEGIN
      SUBSC:=J+9*(I-1);
      MEMORY[SUBSC]:=(I MOD 6)+1
    END;
  END { SIMULATEMEMORY };

PROCEDURE INITIALIZE;

( FACE_ROW_BEGIN[N] and FACE_COL_BEGIN[N]
give the row and column position of the
cursor at the beginning of the Nth face. )

BEGIN
  FACE_ROW_BEGIN[1]:=3; FACE_COL_BEGIN[1]:=13;

  FACE_ROW_BEGIN[2]:=FACE_ROW_BEGIN[1] + 5;
  FACE_ROW_BEGIN[3]:=FACE_ROW_BEGIN[1] + 5;
  FACE_ROW_BEGIN[4]:=FACE_ROW_BEGIN[1] + 5;
  FACE_ROW_BEGIN[5]:=FACE_ROW_BEGIN[1] + 5;
  FACE_ROW_BEGIN[6]:=FACE_ROW_BEGIN[1] + 10;

  FACE_COL_BEGIN[2]:=FACE_COL_BEGIN[1] - 8;
  FACE_COL_BEGIN[3]:=FACE_COL_BEGIN[1];
  FACE_COL_BEGIN[4]:=FACE_COL_BEGIN[1] + 8;
  FACE_COL_BEGIN[5]:=FACE_COL_BEGIN[1] + 16;
  FACE_COL_BEGIN[6]:=FACE_COL_BEGIN[1]

END { INITIALIZE };

PROCEDURE UPDATEBASE;

( This procedure updates variables BASEROW
and BASECOL to the correct values for the
beginning of the next face. )

BEGIN
  BASEROW:=FACEROWBEGIN[CURRENTFACE];
  BASECOLUMN:=FACECOLBEGIN [CURRENTFACE];
END;

PROCEDURE DRAWFACE;

( This procedure draws one face (9 units)
of a cube starting at the current cursor
and BASEROW positions. )

VAR CURRROW, CURRCOL:INTEGER;

BEGIN
  FOR CURRROW:=1 TO 3 DO
    BEGIN
      BASEROW:=BASEROW+1;
      GOTOXY (BASECOLUMN, BASEROW);
```

Listing 1 continued on page 450

Could you pass this Red Cross swimming test?

SWIM:

1. Breaststroke — 100 Yds.
2. Sidestroke — 100 Yds.
3. Crawl stroke — 100 Yds.
4. Back crawl — 50 Yds.
5. On back (legs only) — 50 Yds.
6. Turns (on front, back, side).
7. Surface dive — underwater swim — 20 Ft.
8. Disrobe — float with clothes — 5 mins.
9. Long shallow dive.
10. Running front dive.
11. 10-minute swim.

Anybody who's taken a Red Cross swim course knows how tough it can be. There's a good reason.

We believe drowning is a serious business.

Last year alone, we taught 2,589,203 Americans not to drown—in the seven different swim courses we offer all across the country. (Incidentally, most of the teaching—as with almost everything American Red Cross does—is done by dedicated volunteers.)

A good many of the youngsters not only are learning to keep *themselves* safe. Thousands upon thousands of them are learning to become lifesavers.

And the life they save—may be your own.

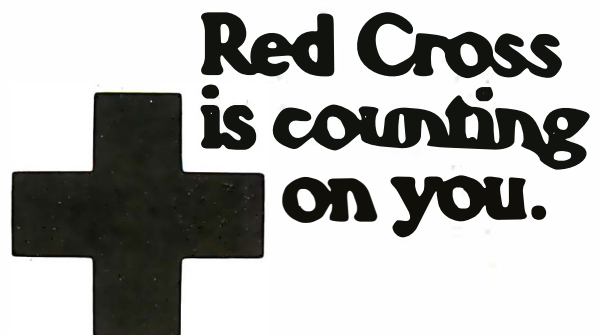

A Public Service of This Magazine & The Advertising Council



Listing 1 continued:

```

FOR CURRCOL:=1 TO 3 DO
  BEGIN

  WRITE (MEMORY [MEMPOINTER]);
  WRITE ( ' ');
  MEMPOINTER:=MEMPOINTER+1;

  END;

WRITELN;

END;

END { DRAWFACE };

BEGIN { MAIN PROGRAM }

SIMULATEMEMORY;
INITIALIZE;

FOR CURRENTFACE:=1 TO 6 DO

  BEGIN
    UPDATEBASE;
    DRAWFACE;
  END;

END { MAIN PROGRAM }.

```

Listing 2: Program DRAWCUBE2.

```

PROGRAM DRAWCUBE2;

{ The purpose of this program is to simulate
an algorithm that draws onscreen the six
faces of a 3 by 3 by 3 cube stored in memory.
In this implementation, each 1 by 1 "unit"
is represented as a number from 1 through 6,
and the cube is drawn on the screen as shown
in figure 1. }

CONST RANK=3;
      MAXFACES=6;

TYPE TYPESITN=(BEGINNING, NEXTCOL, NEXTROW,
NEXTFACE, ALLDONE);

SCREENCONSTANTS=ARRAY[1..6] OF INTEGER;

ONE_TO_MAXFACES=1..MAXFACES;

ONE_TO_RANK=1..RANK;

VAR COLORNUM:ONE_TO_MAXFACES;

    FACENUM :ONE_TO_MAXFACES;

    ROWNUM, COLNUM:ONE_TO_RANK;

    SITUATION:TYPESITN;

    FACE_ROW_BEGIN, FACE_COL_BEGIN:
    SCREENCONSTANTS;

```

Listing 2 continued:

```

CUBEBEGIN:INTEGER;

MEMORY:ARRAY[1..180] OF ONE_TO_MAXFACES;

PROCEDURE SIMULATEMEMORY;

{ This procedure is included only for the
purpose of simulating the computer memory
used to store the characteristics of one
or more cubes. Strictly speaking, this
routine is not part of the DRAWCUBE
algorithm. }

VAR I, J, SUBSC: INTEGER;

BEGIN

  CUBEBEGIN:=19;

  FOR I:=1 TO 20 DO
    FOR J:=1 TO 9 DO
      BEGIN
        SUBSC:=J+9*(I-1);
        MEMORY[SUBSC]:=(I MOD 6)+1
      END;
    END { SIMULATEMEMORY };

{ ----- begin module CREATEARRAY ----- }

PROCEDURE INITARRAY;

BEGIN

  { In this version, INITARRAY
  is empty. }

END { INITARRAY };

FUNCTION CUBE (FACENUM, ROWNUM, COLNUM: INTEGER)
              :INTEGER;

{ This function returns the value of the unit
that is in face FACENUM, row ROWNUM, and
column COLNUM of the current cube as defined
by the pointer CUBEBEGIN. }

VAR UNITS_IN_FACE:INTEGER;
    UNITS_IN_ROW :INTEGER;
    CURRENTUNIT:INTEGER;

BEGIN

  UNITS_IN_FACE:=RANK*RANK;
  UNITS_IN_ROW :=RANK;

  CURRENTUNIT:=CUBEBEGIN
  + (FACENUM-1) * UNITS_IN_FACE
  + (ROWNUM -1) * UNITS_IN_ROW
  + (COLNUM -1);

  CUBE:=MEMORY[CURRENTUNIT]

END { CUBE };

{ ----- begin module PROCESSARRAY ----- }

PROCEDURE INITGENERATE;

{ This procedure must be executed once
before GENERATETRANS is valid. }

BEGIN

```

THE *Smart* GIFT

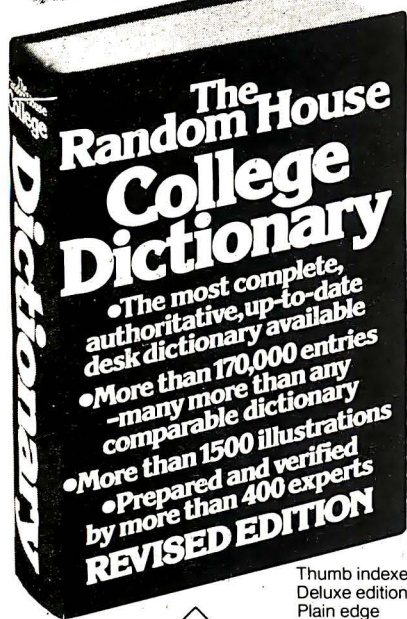

Thumb indexed \$14.95
Deluxe edition \$15.95
Plain edge \$13.95

Now at your bookstore  **RANDOM HOUSE**

Publishers of *The Random House Dictionary of the English Language, Unabridged Edition*

PC-1 Powerline Controller

Puts Bidirectional A.C. carrier communications in your APPLE II

- Operates up to 256 Leviton/BSR remote control devices
- Receives input communications from Leviton/BSR transmitters
- On board real time clock
- Worldwide compatibility (50/60 Hz)
- Easy installation and operation

PC-1 is available for \$285.00
Dealer inquiries invited.

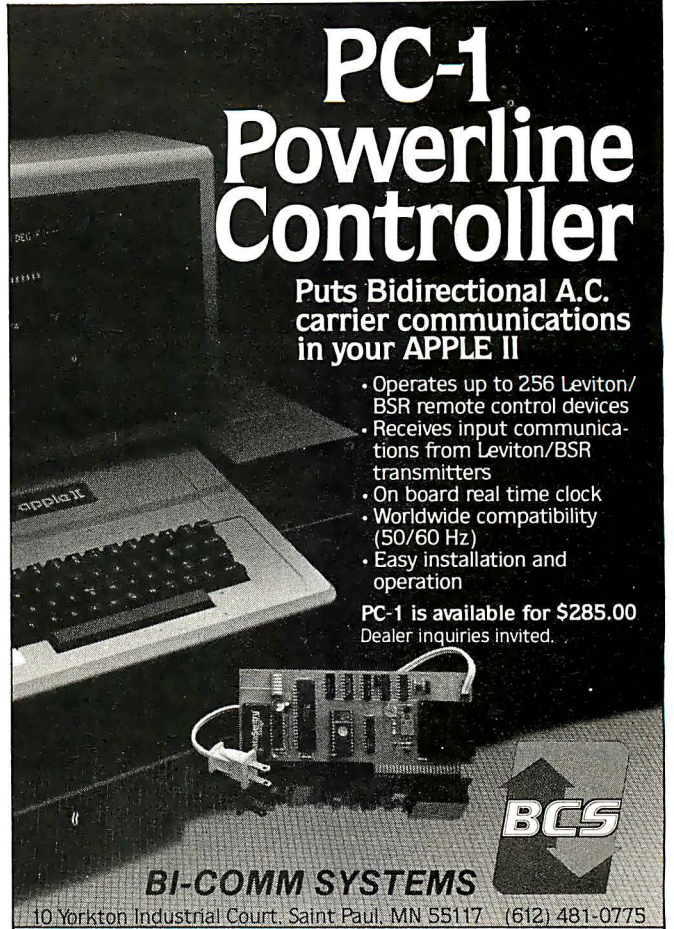

BI-COMM SYSTEMS

10 Yorkton Industrial Court, Saint Paul, MN 55117 (612) 481-0775

Best Price • Good Quality • Swift Delivery • Export

COMPUTER

The Best Graphic Personal Computer
LNW 80 I Z80A, 65K, 480 x 192 999

Multuser Business/Engineer
CROMEMCO Best Price Anywhere
CS1 5 1/4" floppy, Z80 3,196
CS1H W/5 MB hard disk 5,596
CS1D2E 256K RAM, 68000 & Z80
two 5 1/4" floppy 4,396
CS1D2 no error correction 3,996
CS3D5E 512K RAM, 6800 & Z80
two 8" floppy 7,996
C10 64K, 12" monitor
Z80A, keyboard 1,090

Professional/Word Process
ZENITH Z90-80, 64K 2,050
NORTH HORIZON, 1
STAR quad drive, HD5 3,999
ADVANTAGE, 2
quad drives, 64K 2,999
CROMEMCO 64K, 12" monitor, 390K
C10 floppy, letter quality printer,
CP/M type O.S. + word processing
+ spreadsheet 2,750

Zenith 16-Bit
Z-110 dual drives, 128K RAM color board,
225 x640 graphic, IBM PC
compatible 3,099
ZVM-134 superb color monitor 550

16-bit CPU
WICAT S150 WS 1-user 9,100
256K RAM, 10MB hard disk,
960KB floppy CRT, OS+1 language
68000 S150-3 WS 3-users 10,800
same as S150 WS
S150-6 WS 6-users 12,800
512K RAM same as S150 WS
Graphics 300 x 400 900
DUAL 68000, 512K RAM, 20MB hard disk,
IBM floppy, UNIX, S100 14,500

SOFTWARE

dBASE II Ashton-Tate database 499
CONDOR II 450
MICROSOFT BASIC 80 285
Micro Pro WORDSTAR 350
Digital Research CPM 2.2 139
Accounting Plus System Plus 399

PRINTER

Integral Data System
MICROPRISM 75 cps excellent print/110 cps
84 x 84 graphic, RS232/parallel
pin & friction feed 520

PRISM 80 200 cps, 80 col. 945
w/graphics 84 x 84 1,025
PRISM 132 200 cps, 132 col. 1,100
w/graphics 84 x 84 1,180
graphic, color, friction 1,590
TI 810 Super 1,325
OKIDATA MICROLINE 84 parallel 1,025
PRINTTEK 920 340cps, 144 x 144 2,450
EPSON FX new product CALL

Letter Quality

C.ITOH Starwriter F-10 40 cps 1,345
NEC 7710, 7730 2,250
7720 KSR 2,695
3510 1,500
3530 1,650
QUME, DIABLO, BROTHER CALL

TERMINAL

ZENITH Z29 smart terminal 670
ZT-1 w/modem telecom 560
HAZELTINE ESPRIT II 588
III 788
BEEHIVE DM5 A 995
IBM 3101-10 1,295
TELEVIDIO 970 1,119
VISUAL 300 948
550 graphic 2,285

MONITOR

ZENITH 12" green 114
AMDEK COLOR IV 720 x 400 1,050
COLOR II RGB 13" 725
COLOR I 13" 340
300 G 12" green 169
13" RGB 750
SANYO 12" green 170
NEC 1203 RGB 725
Electrohome RGB 580 x 235 599

MODEM

D.C. Hayes Smartmodem 300 baud 230
300/1200 baud 570
Novation CAT 300 baud 180
1200 baud 590
Smart Cat 103/212 CALL

IBM PC

AST full line of cards CALL
AMDEK 310 monitor 189
IDS Microprism 480 525
EPSON FX CALL
NEC 3550 letter quality 1,948
C. ITOH F-10 40 cps 1,345

Microsoft 128K RAM 360
EASY WRITER II IUS 255
CP AIDS Master Tax 1,195
LEGAL TIMEKEEPING STAR 725
Digital Research Pascal MT + 86 310
Concurrent CP/M 86 299
Peachtree GL, AR, AP 330
Structured Systems Accounting 700

DIGITIZER/PLOTTER

HOUSTON INSTRUMENT DMP29 CALL
HI PAD DIGITIZER DT-11 11" x 11" 725
AMDEK AMPLLOT 11" x 14" 780

DISK DRIVE

Tandon TM 100-2 5 1/4" DD, DS 260
MITSUBISHI 8"
DS, DD, Qume & Shugart compatible
M2894-63 bare drive 410
8" subsystem 2 Mitsubishi bare drives,
cabinet w/power supply fan 1,099
assembled subsystem 1,130
manual 25
signal cable 50

CALL (212) 937-6363
free catalogue

Prices subject to change. American Express, Visa/
Mastercard add 3%. F.O.B. point of shipment. 20% re-
stocking fee for returned merchandise. Personal checks
take 3 weeks to clear. COD on certified check only. N.Y.
residents add sales tax. Manufacturers' warranty only.
International customers, please confirm price before
order. Accept P.O. from Fortune 500 & schools.

Computer Channel **TELEX:**
21-55 44th Road **4294 18**
Long Island City, NY 11101 **CSTNY**

Computer Channel

Listing 2 continued:

```
SITUATION:=BEGINNING

END ( INITGENERATE );

PROCEDURE GENERATETRANS;

( This procedure generates one 4-tuple
  (facenum, rownum, colnum, colornum)
  to be processed by PUTTRANS. )

BEGIN

IF (SITUATION <> BEGINNING) THEN
  BEGIN
    IF (COLNUM < RANK) THEN SITUATION:=NEXTCOL;

    IF (COLNUM >= RANK) AND (ROWNUM < RANK) THEN
      SITUATION:=NEXTROW;

    IF (COLNUM >= RANK) AND (ROWNUM >= RANK)
      AND (FACENUM < MAXFACES) THEN
      SITUATION:=NEXTFACE;

    IF (COLNUM >= RANK) AND (ROWNUM >= RANK)
      AND (FACENUM >= MAXFACES) THEN
      SITUATION:=ALLDONE;
  END;

CASE SITUATION OF

  BEGINNING: BEGIN
    FACENUM:=1;
    ROWNUM :=1;
    COLNUM :=1;
    SITUATION:=NEXTCOL;
  END;
```

Listing 2 continued:

```
NEXTCOL : COLNUM:=COLNUM + 1;

NEXTROW : BEGIN
  COLNUM:=1;
  ROWNUM:=ROWNUM + 1
END;

NEXTFACE : BEGIN
  COLNUM:=1;
  ROWNUM:=1;
  FACENUM:=FACENUM + 1
END;

ALLDONE : ( DO NOTHING )

END ( CASE );

COLORNUM:=CUBE(FACENUM, ROWNUM, COLNUM)

END ( GENERATETRANS );

( ----- begin module DISPLAYARRAY ----- )

PROCEDURE INITPUT;

( This module initializes the two arrays
  FACE_ROW_BEGIN and FACE_COL_BEGIN, which
  are used to simplify cursor position
  calculations within PUTTRANS. )

BEGIN

  FACE_ROW_BEGIN[1]:=3; FACE_COL_BEGIN[1]:=13;
```

CompuPro

8 and/or 16 Bits.

A Full Service CompuPro System Center is much more than a computer store: It is the first place to look for business, scientific and industrial computing solutions. When you're ready for professional level, state-of-the-art microcomputing, turn to the professionals listed below... they're ready for you.

ARIZONA

S-100
14425 N. 79th St. #B
Scottsdale, AZ 85260
(602) 991-7870

CALIFORNIA

Computer Center, Inc.
1514 University Ave.
Berkeley, CA 94703
(415) 845-6366

Mentzer Computer Systems
1441 Rollins Rd.
Burlingame, CA 94010
(415) 340-9363

Logic Systems
5830 Jameson Ct.
Carmichael, CA 95608
(916) 971-3133

Priority 1
9161 Deering Ave.
Chatsworth, CA 91311
(213) 709-5464

Byte Shop of Hayward
1122 B St.
Hayward, CA 94541
(415) 886-4732

American Computers & Eng.
2001 S. Barrington Ave. #204
Los Angeles, CA 90025
(213) 477-6751

Gifford Computers
2323 Corinth Ave.
Los Angeles, CA 90064
(213) 477-3921

ACC
833 Steirlin Rd. #B110
Mountain View, CA 94043
(415) 969-4969

Computer Center, Inc.
2100 Broadway St.
Oakland, CA 94612
(415) 839-3230

System Interface Consultants
17440 Revello Dr.
Pacific Palisades, CA 90272
(213) 454-2100

Advanced Information Mgmt.
145 Kentucky St.
Petaluma, CA 94952
(707) 763-7283

Best Computer Stores
5516 Springdale Ave.
Pleasanton, CA 94566
(415) 463-2233

Gifford Computers
230 California St. #207
San Francisco, CA 94104
(415) 391-4570

Gifford Computers
1922 Republic Ave.
San Leandro, CA 94577
(415) 895-0798

Computer House
501 B St.
San Rafael, CA 94901
(415) 453-0865

Data Bank
629 State St.
Santa Barbara, CA 93101
(805) 962-8489

Data Bank
600 S. Broadway
Santa Maria, CA 93456
(805) 922-1333

Matrix Computers
720 Mendocino Ave.
Santa Rosa, CA 95401
(707) 542-0571

Listing 2 continued:

```
FACE_ROW_BEGIN[2]:=FACE_ROW_BEGIN[1] + 5;
FACE_ROW_BEGIN[3]:=FACE_ROW_BEGIN[1] + 5;
FACE_ROW_BEGIN[4]:=FACE_ROW_BEGIN[1] + 5;
FACE_ROW_BEGIN[5]:=FACE_ROW_BEGIN[1] + 5;
FACE_ROW_BEGIN[6]:=FACE_ROW_BEGIN[1] + 10;

FACE_COL_BEGIN[2]:=FACE_COL_BEGIN[1] - 8;
FACE_COL_BEGIN[3]:=FACE_COL_BEGIN[1];
FACE_COL_BEGIN[4]:=FACE_COL_BEGIN[1] + 8;
FACE_COL_BEGIN[5]:=FACE_COL_BEGIN[1] + 16;
FACE_COL_BEGIN[6]:=FACE_COL_BEGIN[1];

END ( INITPUT );

PROCEDURE PUTTRANS(FACENUM, ROWNUM,
                  COLNUM, COLORNUM: INTEGER);

( This procedure puts one transaction to the
  output device. )

VAR   CURR_ROW_LOCATION: INTEGER;
      CURR_COL_LOCATION: INTEGER;

BEGIN

  CURR_ROW_LOCATION:=FACE_ROW_BEGIN[FACENUM]
    + (ROWNUM - 1);

  CURR_COL_LOCATION:=FACE_COL_BEGIN[FACENUM]
    + 2 * (COLNUM - 1);

  GOTOXY(CURR_COL_LOCATION, CURR_ROW_LOCATION);

  WRITELN(COLORNUM)

END ( PUTTRANS );
```

Listing 2 continued:

```
PROCEDURE FLUSHARRAY;

( This routine is used to trigger stored
  results to be output (in versions that
  cannot completely process a transaction
  within PUTTRANS). )

BEGIN
  ( In this version, FLUSHARRAY
    is empty. )
END ( FLUSHARRAY );

( ----- begin main program ----- )

BEGIN ( MAIN PROGRAM )

  SIMULATEMEMORY;

  INITARRAY;
  INITGENERATE;
  INITPUT;

  WHILE SITUATION <> ALLDONE DO

    BEGIN

      GENERATETRANS;
      PUTTRANS (FACENUM, ROWNUM, COLNUM,
                COLORNUM)

      END;

    FLUSHARRAY

  END ( MAIN PROGRAM );
```

Spoken Here...

Pragmatic Designs, Inc.
950 Benicia Ave.
Sunnyvale, CA 94086
(408) 736-8670

FLORIDA

Micro Computer Technology
1549 W. Brandon Blvd.
Brandon, FL 33511
(813) 685-7659

HAWAII

Capacity Plus Computers
250 Alamaha St. N14
Kahului Maui, HI 96732
(808) 877-3496

ILLINOIS

Computers Plus
201 N. Main St.
Athens, IL 62613
(217) 636-8491

MARYLAND

JR Systems
8227 Woodmont Ave. #200
Bethesda, MD 20014
(301) 657-3598

MASSACHUSETTS

New England Electronic Exch.
138 Arlington St.
Boston, MA 02116
(617) 491-3000

Key Micro Systems
822 Boylston St.
Chestnut Hill, MA 02167
(617) 738-7306

NEW YORK

John D. Owens Associates, Inc.
12 Schubert St.
Staten Island, NY 10305
(212) 448-6283

OKLAHOMA

Gifford Computers
6161 N. May #177
Oklahoma City, OK 73112
(405) 840-1175

OREGON

Microwest Computer Products
811 E. Burnside #117
Portland, OR 97214
(503) 238-6274

RHODE ISLAND

Key Micro Systems
1606 Nooseneck
Coventry, RI 02816
(401) 828-7270

WISCONSIN

Byte Shop of Milwaukee
4840 S. 76th St.
Greenfield, WI 53220
(414) 281-7004

CANADA

Dynacomp Business Computers Ltd.
3258 Beta Ave.
Burnaby, British Columbia V5C 4K4
(604) 299-3747

UNITED KINGDOM

Comcen Technology Ltd.
45/46 Wychtree St., Morrision
Swansea SA6 8EX
(0792) 796000

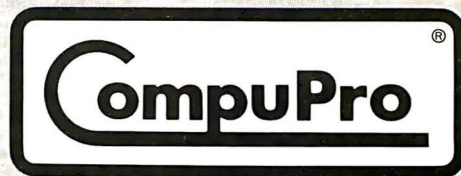

CompuPro, a Godbout Company,
Box 2355, Oakland Airport, CA. 94614.

IF YOU KNOW WHAT YOU WANT . . .

EDIX/WORDIX
\$149 (ea.)

Personal Data Base \$93

SUPERCALC
\$185

CONDOR 3
\$488

• PFS \$99

• PFS Report \$79

WORD HANDLER
\$145

• PFS Graph \$99

VISICALC
\$169

CROSTALK
\$119

EASYWRITER II
\$259

MULTIPLAN
\$179

DB MASTER
\$148

FINAL WORD
\$223

IBM PC®

Advanced Operating Systems	List Now
The Programmer	200 150
American Training International, Inc.	
ATI-Power for PC	
DOS	75 56
Applied Software Technology	
Versaform	389 288
Ashton-Tate	
dBase II	[4] 700 425
Aspen Software	
Grammatik	75 56
Proofreader	50 38
Byrom Software	
BSTAM (Micro to micro comm.)	200 149
BSTMS (Micro to mainframe comm.)	200 149
Comshare	
Master Planner	325 253
Condor Computer Corp.	
Condor 1	195 147
Condor 3	650 488
Continental Software	
Home Accountant	
Plus	150 112
1st Class Mail	125 98
CP Aids	
Master Tax	1695 1371
Standard Tax	595 446
DataMost	
Write On	130 94
Real Estate Investment Program	130 95
Denver Software	
EASy (Executive Acclg. System)	750 562
Dictronics	
Random House Electronic Thesaurus	150 113
Digital Research	
CBASIC 86	200 150
CIS COBOL 86	800 600
Concurrent CP/M-86	350 294
Level 2 COBOL 86	16001200
Pascal MT+86/w SSP	600 468
SID86	150 94
SPP86	200 168
Eagle Software	
Money Decisions	199 149
Emerging Technology	
Edix	195 149
Wordix	195 149
EZ Tax	
EZ Tax	69 55
Howard	
Real Estate Analyzer	
II	250 187
Tax Preparer 1983	250 187
Innovative Software	
T.I.M. III	495 357
Fast Graphs	295 221
Intellect Assoc.	
PC Text	100 73
PC Text	150 113
ISA (see Sorcim)	
ISM	
MatheMagic	100 75
Graphmagic	90 65
Combo Pack	160 120

dBASE Corner

- dBASE II (relational DBMS) ... \$425
- Quickcode (program generator) ... \$195
- dUTIL (programmer's utilities) ... \$59
- ABSTAT (statistics package) ... \$359

IUS	
Easy Speller	125 94
Easy Filer	400 281
Easywriter II	350 259
Easy Planner	250 188
AR/API/GL (ea)	600 450
Financial Management Series	1495 1121
Lexisoft	
Spellbinder	495 281
Lifeboat	
Lattice C Compiler	500 415
Lightree	
Volkswriter	195 147
Master type	50 38
Lotus	
1-2-3	495 371
Mark of the Unicorn	
Mince	175 153
Final Word	300 223
Metasoft	
Benchmark Word Processor*	500 367
Benchmark Mail list	175 154
Microlocus	
CIS COBOL 8086	850 637
Micro Lab	
The Tax Manager	250 188
MicroPro	
Infostar	[5] 495 327
Report Star	350 231
Wordstar	[4] 495 327
Spellstar	250 165
Mailmerge	250 165
Wordstar/ Mailmerge	[4] 426
Microsoft	
Flight Simulator	50 38
North American Business Systems	
The Answer	250 188
Northwest Analytical	
Statpak	495 369
OASIS	
The Word Plus	150 112
Organic Software	
Datebook	395 331
Milestone (128K)	395 331
Textwriter III (Text formatter)	125 97
PBL Corporation	
Personal Investor (128K)	145 105
Peachtree	
Series 4 Peachpak (GL/AR/AP)	[5] 595 359
Ryan-McFarland	
RM/COBOL	
• Full Dev. System	950 713
• Runtime only	250 188
Scrapps Data	
Job Cost Systems	495 371
Select Information Systems	
Select with SuperSpell (Word Proc.)	595 369
Sorcim (see also ISA)	
Spellguard	195 146
Supercalc	295 185
Superwriter	395 296
Southeastern	
Data Capture	120 90
Star	
Legal Timekeeping, Billing, & Accts	950 771

Structured Systems	
GL, AR, AP, Payroll, Inventory, OE (ea.)	1250 790
Analyst	250 188
Letterlight	200 150
NAD	100 75
QSORT	100 75
Supersoft	
Optimizer	200 149
Personal Data Base	125 93
Synergistic	
Data Reporter	250 188
Versa Computing	
Graphics Hardcopy System	25 19
VisiCorp	
VisiCalc (256K)	250 169
Desktop Plan I	300 229
VisiTrend/Plot	300 215
Visidex	250 189
VisiFile	300 229
Visischedule	300 234
Business Forecasting Models	100 78
Woolf Software Systems	
Move It	150 99

IBM PC® HARDWARE

Kraft	List Now
Joystick	70 52
Microsoft	
RAM Card 64K	350 253
RAM Card 128K	525 381
RAM Card 192K	700 508
RAM Card 256K	875 634
QUADRAM	
Quadboard 64K	595 428
• 256K	995 670
Tech Designs	
Adam & Eve Paddles	40 15
TG Products	
Joystick	59 43
Versa Computing	
VersaWriter Graphics Tablet	299 249

CP/M® 8"

Other CP/M formats are generally the same price, but please call to confirm.

Adventure International	
Adventures (#1-12)	129 97
American Training International, Inc.	
ATI-Power for CP/M	75 54
Anderson-Bell	
ABSTAT	359
Artificial Intelligence (Requires CBASIC 2)	
Medical	995 749
Dental	995 749
Ashton Tate	
dBase II	[4] 700 425
Aspen Software	
Grammatik	75 56
Proofreader	50 38
Balcones	
The Boss: Financial Accounting System	24951496
Byrom Software	
BSTAM (Micro to micro comm.)	200 144
BSTMS (Micro to mainframe comm.)	200 144
Caxton	
Cardbox	245 177
Centra Systems	
CP/M Northstar (Horizon only)	179 150
CP/M Micropolis	189 156
Computer Control	
FABS (B-TREE file access)	195 146
Ultrasort II	195 146

Computer Development, Inc.	
Image	495 356
Comshare Target Software	
Plannercalc	50 38
Masterplanner	325 263
Condor Computer Corp.	
Condor 1	195 147
Condor 3	650 488
Data Base Solutions	
dNAMES	129
Designer Software	
Palantir	425 319
Digital Research	
Access Manager	300 225
MAC (macro assembler)	90 75
SID (symbolic debugger for 8080)	75 63
ZSID	100 88
CBASIC (language)	150 94
CB80	500 395
CIS COBOL	800 595
Display Manager	400 295
Pascal Mt+ w/SPP	500 395
DJR Associates	
FMS 80	995 625
FMS 80-1	495 312
FMS 80-2	495 312
Ecosoft	
MicroStat (stat package)	295 248
Epic Computer Corp.	
Supervyz	150 94
Faircom	
MICRO B+ (Keyed file accessing)	
For CBASIC 2	260 211
For MBASIC, COBOL, PL1/80, FORTRAN, Pascal MT+, CB 80	260 211
Fox and Geller	
dGRAPH	295 195
Quickscreen	149 125
Quickcode	295 195
dUTIL	99 59
FYI	
Superfile	195 129
Infocom	
Deadline	60 43
Zork I, II, III (ea.)	50 38
Star Cross	50 38
ISA (See Sorcim)	
ISM	
Mathematic	99 72
Ithaca Intersystems	
Pascal Z	450 375
Pascal BZ (64K)	450 375
Pascal Z and BZ	650 542
Lexisoft	
Spellbinder	495 281
Lifeboat	
T-Maker II	275 215
Mark of the Unicorn	
Mince (text editor)	200 136
Final Word	300 229
Micro Pro	
Infostar	[5] 495 327
Report Star	350 231
Wordstar	[4] 495 327
MailMerge	250 165
Wordstar/MailMerge	426
Spellstar	[4] 250 165
Wordstar/Spellstar	[4] 695 426
Word/Spell/Mail	[4] 845 558
Calcstar	145 96
Datatar	295 195
MicroSoft	
BASIC 80	350 252
BASIC Compiler	395 284
FORTTRAN 80	500 360
COBOL 80	750 540
MACRO 80	200 156
EDIT 80	120 94
µ Math/µ Simp	250 194
µ LISP/µ Star	200 156

M-Sort	195 151
Multiplan	275 179
Microstuf	
Crosstalk	195 119
Northwest Analytical	
Statpak	495 369
OASIS	
The Word Plus	150 112
Organic Software	
Datebook	295 229
Milestone	295 229
Peachtree	
Series 4 Peach Pak (GL,AR,AP)	595 359
Pickles and Trout	
CP/M TRS 80 Mod II	185 169
Quality Software	
GBS-DB Apple Dev. Program	650 505
Relational Systems, Int.	
Personal Pearl	295 184
Select Information Systems	
Select with SuperSpell	595 369
Software Dimensions	
Accounting Plus**	
GL, AR, AP, Inv each	402
All four	1435
Sorcim	
Pascal/M (280 or 8080)	395 284
Pascal/M (8086, 8088)	495 356
ACT 80 (280, 8080, 8085)	175 126
ACT 65 (6502)	175 126
ACT 68 (6800)	175 126
ACT 69 (6809)	175 126
ACT 86/88 (8086, 8088)	175 126
TRANS 86	125 90
Spellguard	195 146
SuperCalc	295 185
Superwriter	395 249
Supersoft	
C Compiler	250 188
Ada Compiler	300 225
Systems Plus (see Software Dim.)	
Woolf Software Systems	
Move it	100 66

WE'LL MATCH ANY ADVERTISED PRICE

HARDWARE

Corona	List Now
5MB Hard Disk	[6] 2495 1895
Daisywriter	
Printer	[10] 1395 1235
Hayes Microcomputer Products	
Datacom Pascal Package	50 36
Hayes Stack Chronograph (RS-232)	[4] 249 199
Hayes Stack Smart-Modem (RS-232)	
300 Baud	[4] 279 209
Hayes Stack Smart-Modem (RS-232)	
1200 Baud	[4] 699 509
NEC	
12" Green Hi-Res CRT	[10] 285 167
7710 Printer	[10] 3085 2295
3530 Printer	[10] 2290 1735
8023 Printer	[10] 795 520
Novation	
J-Cat	[4] 149 119
Smart-Cat 103	[4] 259 207
Smart-Cat 103/312	[4] 595 476

APPLE® BUSINESS

Applied Software Technology	List Now
Versa Form:	
VS-1 Apple II/64K	389 249
VH-1 (Corvus)	495 360
VP-1 Versaform Pascal/Intertace	245 180
ARTSCI (Softape)	
Magic Window II (40/70/80)	150 109
Magic Window	100 75
Magic Mailer	70 49
Magic Words	70 49
Magic Pack Combo (Contains all 3)	225 156
Ashion-Tate	
dBase II †	[4] 700 425
Avant-Garde Creations	
Ultra Plot/D.I.F./Data Graph	99 71
Beagle Brothers	
Alpha Plot	40 28
DOS Boss	24 17
Utility City	30 22
Apple Mechanic	30 22
Broderbund Software	
General Ledger (with A/P)	495 305
Payroll	395 275
Commsoft	
Roots/M †	195 140
Computer Station	
Combined Enhanced Graphics Software	55 40
Station Master	175 136
Comshare Target Software	
Target Planner/Calc †	99 74
Image Maker	175 126
Continental	
Home Accountant	75 52
1st Class Mail	75 54
CPA #1 — GL	250 159
CPA #2 — AR	250 159
CPA #3 — AP	250 159
CPA #4 — PR	250 159
All four	[5] 1000 609
CPA #5 — Property Management	495 352
Crane Software	
Menu Generator	40 29
Creative Curriculum, Inc.	
Speed Reading Courseware	99 75
Dakin 5/Level 10	
Depreciation Planner	395 299
Budget Planner	150 112
Business Bookkeeping System	395 299
Datamost	
Write On II	130 90
Real Estate Analysis Program	130 90
Tax Beater	130 90
Datsoft, Inc.	
Micropainter (48K)	35 25
BASIC Compiler (32K)	100 75
LISP Interpreter	125 94
Decision Support	
The Accountant	129 97
Accountant with DBCalc	149 107
Delta Software	
Bookkeeper Master Program	90 68
Bookkeeper Check Writer	40 29
Denver Software	
Pascal Tutor	125 97
Pascal Programmer	296 223
Financial Partner	250 188

Eduware	
Compu-Read	30 22
Perception	25 19
Statistics	30 22
Spelling Bee with Reading Primer	40 30
Compu-Math/ Fractions	40 30
Compu-Math/ Decimals	40 30
Compu-Math/ Arithmetic Skills	50 37
Algebra 1	40 30
Fractions (New version)	49 37
Decimals (New version)	49 37
Algebra 2	40 30
Counting Bee	30 22
Compu-Spell/System	30 22
Compu-Spell/Data Disk Levels 4 thru 8	20 15
Uni-Solve	25 19
PSAT Word Attack Skills	49 37
SAT Word Attack	49 37
Hayden Software	
Pie Writer/Standard	150 108
Pie Writer/Double Vision	150 108
Pie Writer/Multi 80-col (for Smarterm. Videoterm. & Superterm)	150 108
Howard Software	
Creative Financing 1983	195 149
State Tax Prep. CA 83	225 179
Tax Preparer 1983	225 179
Real Estate Analyzer II	195 146
Information Unlimited Software (IUS)	
Datadex	150 108
Datadex/Hard Disk Professional	300 216
Easywriter Professional	175 126
Easymailer	150 108
Easy Mover	100 75
Tellstar Level I	40 30
Tellstar Level II	80 58
FORTH Development System	140 101
Insoft	
GraFORTH II	75 56
Electric Duet	30 23
TransFORTH II	125 94
ALD System II	75 56
International Software	
Marketing	
Mathemagic (Advanced programmable calculator package)	90 65
Graphmagic	90 65
ISA (See Sorcim)	
Kensington Microware Ltd.	
Format II	250 169
Lightning Software	
Mastertype	40 30
Link Systems	
Datafax	199 149
Datalink	100 75
Link Index	195 149
Link Video	55 41
Link Sampler I	60 45
Link Disk	70 51
LJK Enterprises	
Letter Perfect with Mail Merge	150 112
Data Perfect	100 78
Edit 6502	100 78

Lotus	
Executive Briefing System	199 149
Micro Lab	
The Invoice Factory	200 144
The Merger	50 37
The Learning System	150 108
Painter Power	40 30
US Constitution Tutor	30 22
English SAT #1	30 22
VisiBlend	50 37
VisiFactory	75 54
The Asset Manager	200 144
The Tax Manager	180 129
Data Factory 5.0	300 216
Wall Streeter	300 216
Payroll Manager	300 216
Micropro	
Infostar †	[5] 495 327
Report Star †	350 231
Wordstar †	[4] 495 327
Wordstar Customization Notes	[4] 500 327
MailMerge †	250 165
Wordstar/Mail-merge †	[4] 645 426
SuperSort †	250 165
SpellStar †	250 165
DataStar †	295 195
CalcStar †	145 96
Microsoft	
FORTRAN 80 †	195 151
COBOL 80 †	750 584
BASIC Compiler †	395 295
TASC (Applesoft compiler)	175 119
Typing Tutor II	25 19
Time Manager	150 116
A.L.D.S. †	125 97
Adios μMath-80	125 97
Adios μMath/μSimp	250 194
M-Sort	195 151
μLisp/μStar	200 156
Multiplan	275 179
Multiplan †	275 179
MUSE	
Supertext 40/56/70	125 79
Supertext 40/80	175 126
Form Letter Module 48K	100 72
Address Book Mailing List 48K**	50 36
Data Plot 48K**	60 43
Elementary Math Apple Soft 48K**	40 29
The Voice 48K**	40 29
** Requires Applesoft. ROM or Apple II Plus	
Oasis	
The Word Plus †	150 112
On-Line Systems	
The General Manager	230 168
Screenwriter II	130 85
The Dictionary	100 70
Expeditor II* (Applesoft compiler)	135 94
LISA 2.5	80 56
EPFIV (Extended Programming Facility IV)	80 56
LISA Educational Package	120 83
Optimized Systems Software, Inc.	
Speed Read Plus	60 43
Peachtree	
Series 40 GL, AR, AP. Inventory. Payroll (ea)	400 239
Penguin Software	
Complete Graphics System	70 50
Special Effects	40 30

Graphics Magician	60 45
Additional Fonts and Character Sets	20 15
Complete Graphics System II (Apple Tab Ver.)	120 86
Special Effects (Apple Tab Ver.)	70 50
Program Design, Inc. The New Step-by-Step	80 58
Quality Software	
GBS-DB Apple Dev. Prog.	700 504
Sensible Software	
Super Disk Copy III	30 23
Multi Disk Catalog III	25 19
Disk Recovery ("The Scanner")	30 23
Image Printer-Letter Quality	40 30
Image Printer-Epson	40 30
Image Printer-NEC Dot Matrix	40 30
The Bug	50 37
Build Using	30 23
Edit Soft	30 23
Quadrant 6112	35 26
Sensible Speller	125 94
• for Supertext	125 94
• for Apple CP/M	125 94
• Pascal	125 94
BEST (Applesoft Program Optimizer)	40 30
Select Information Systems	
Select (with Superspell)	595 356
Silicon Valley	
Word Handler	199 145
List Handler	90 68
Dictionary	125 94
Sirius	
Pascal Graphics Editor (48K II/II+)	100 69
Sol/Sys, Inc.	
Executive Secretary	250 169
Executive Speller	75 56
Soltech Microsystems	
UCSD P-System Software Set	[4] 625 450
BASIC Compiler and Runtime Package	225 169
Xenophile	50 39
Softtech	125 90
Software Dimensions	
Accounting Plus**	
GL, AR, AP, Inv ea	395 239
All four	1250 669
Software Publishing	
PFS:File	140 99
PFS:Report	125 79
PFS:Graph	140 99
Sorcim	
Spellguard †	195 146
SuperCalc †	295 189
Southeastern Software	
Data Capture 4.0	65 45
Data Capture 4.0/Videx, Smarterm, Superterm	90 65
Southwestern Data	
Z-Term Professional †	150 99
ASCII Express	80 59
ASCII Express Professional	130 89
STC	
Professional Time and Billing	395 284
Language Reading Development Program	175 126
Apartment Manager	325 234

Stoneware	
DBMaster	229 148
Utility Pak #1	99 65
Utility Pak #2	99 65
DBMaster/Hard Disk	499 359
Stat Pac	99 71
Micro Memo	40 30
Electronic Price Sheet	100 72
Compucube	30 22
Graphics Processing System (Standard)	60 45
Graphics Processing System (Professional)	179 129
Synergetic Software	
The Linguist	40 30
The Directory Manager	25 19
Higher Text II	40 30
Higher Graphics II	35 26
Mailing List Database	50 37
Program Line Editor	40 30
Modifiable DataBase	80 59
The Data Reporter	220 158
Integer BASIC Compiler	150 108
Global Program Line Editor	65 49
Data Reporter—Hard Disk	220 158
Versa Computing	
VersaWriter Expansion Pac-I	40 30
VersaWriter Expansion Pac-II	40 30
AXE (Apple Extended Editor)	70 50
VersaWriter Graphics Tablet (accessory)	299 252
VisiCorp (Personal Software)	
VisiCalc II 3.3	250 169
VisiFile	250 169
VisiLink	250 169
VisiLink	250 194
Desktop Plan II	200 156
VisiPlot	300 234
VisiTrend/Plot	250 194
VisiDex	100 65
VisiTerm	300 234
VisiSchedule	300 234
Business Forecasting Model (req. VisiCalc)	100 78

APPLE® HARDWARE

Hayes	List Now
Modem II	[4] 379 259
• with terminal pgm	409 289
Kensington	
System Saver (Fan)	90 65
Micro-Sci	
A2 35T Disk Drive	[5] 479 329
Microsoft	
RAMcard (memory board)	100 69
Softcard (CP/M board)	345 219
Premium System: Softcard, 16K RAMcard, Videx Videoterm 80 col. Card, Softswitch, Osborne CP/M User Guide	[5] 695 489
Personal Computer	
Appli-Card (6MHz)	595 429
Videx	
Keyboard Enhancer II	149 99
Videoterm w/Soft-Switch	375 239

© = Manufacturer's trademark.

TELEPHONE ORDERS

Outside Calif.: (800) 222-8811
 Inside Calif.: (415) 324-3730
 Inquiries/price quotes (415) 324-0305
 Order status (415) 324-0306
 Technical Support (415) 324-0311

Order lines are manned 8-6 Monday thru Saturday and usually outside business hours as well. Other lines are open 9-5, Monday thru Friday.

PROGRAMMING INTERNATIONAL

505 Hamilton Ave. • Suite 107
 Palo Alto, CA 94301

MORE CP/M®, APPLE®, IBM PC®, UNIX™, UCSD p-System™ software, hardware, etc. send \$2.00 (refundable) for price list or call for quote.

TERMS: All prices subject to change without notice and availability. Cashier's check/MO/bank transfer. Allow time for company or personal checks to clear. Prices reflect cash prepaid discount. VISA/MASTER-CARD/COD/PO's + 3%. CA residents add sales tax. SHIPPING: \$2 per item for UPS surface (\$6 for Blue Label) within continental USA, except where shipping cost is specified in square brackets.

WHY PAY MORE?

HP-16C

Computer Scientist
OWNER'S HANDBOOK



It's got all the bases covered.

HP-16C. YOUR PRODUCTIVITY'S UP. AND THE PRICE IS DOWN. Now software engineers and logic designers can spend less time on bit-manipulation, Boolean and base-conversion functions and more time on more productive tasks. Like expanding your own creative potential.

How? Easy.

The HP-16C programmable calculator is capable of converting across four number bases, not only hexadecimal, octal, and decimal but binary as well. And it has the most powerful combination of bit manipulation, word size, and programming capabilities of any pocket calculator in the marketplace to date.

For the authorized HP dealer or HP sales office nearest you, call TOLL-FREE 800-547-3400 and ask for operator 70 (Oregon, Alaska, Hawaii: 503-758-1010).

Personal computation products for professionals on the move.

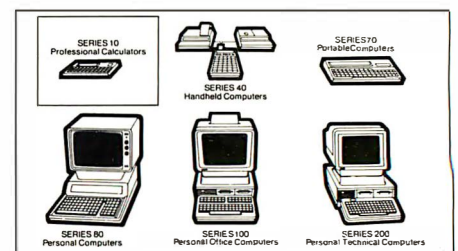

hp HEWLETT
PACKARD

News and Speculation about Personal Computing

Conducted by Sol Libes

Random Rumors:

Microsoft Inc. and Micropro International Corp. are both working on products to compete with the new Visi On system expected from VisiCorp this summer. Visi On is a highly intelligent operating environment for the IBM Personal Computer that allows cursor control using a mouse device. . . . Seagate Technology is expected to introduce shortly two new 5¼-inch Winchester disk drives with capacities of 25 and 33 megabytes. . . . Hitachi Ltd. is reportedly readying an IBM-compatible personal computer for introduction this spring. . . . IBM and TI (Texas Instruments) are said to be jointly working on an IC (integrated circuit) for use in the new IBM LAN (local-area network) system.

It is predicted that at next month's NCC (National Computer Conference) at least 20 companies will introduce 68000-based computer systems running versions of the Unix operating system, at least two firms will demonstrate high-capacity optical disk mass-storage systems, and two or three new portable systems will emerge (probably compatible to some degree with the IBM Personal Computer).

TI is expected to drop the list price of the 99/4A to \$149 soon and to introduce a new 64K-byte memory capacity computer with the hope of selling over 1 million computers this year. . . . It is believed that Commodore will also drop the price of the Commodore 64 when it introduces its P500, a 128K-byte machine, at \$795. Look for

the Commodore 64's price to drop to \$399. . . . The price of the Timex/Sinclair 1000 is expected to drop to around \$85, which means that we may see it discounted to as low as \$60.

Apple Doings: Apple Computer Inc. has committed itself to using the Ethernet LAN system—at least for the coming year. It's rumored that Apple is working on its own LAN system for introduction in 1984. The selection of Ethernet was no doubt based on Apple's attempt to appeal to large corporations, particularly with its Lisa, Mackintosh, and Apple III systems. Apple has entered into a contract with 3Com Corp. to supply the Ethernet hardware, which Apple will then "private label" for resale. The Ethernet interface cards are expected to be available this summer and will sell for between \$900 and \$1000 apiece. Apple will publish its protocols to encourage the development of Ethernet software by independent software houses.

Sales of the Apple III have no doubt been a big disappointment to Apple. An estimated 60,000 units have been sold in the two years it has been on the market. Sales picked up in the second half of 1982 when Apple cut the price significantly and upgraded the product with larger-capacity floppy-disk drives, an IBM-3270 emulator, and an accounting package. In an attempt to further stimulate sales of the Apple III, Apple offered \$100

rebates to floor salesmen on each Apple III they sold.

Analysts and dealers generally agree that the Apple III's lackluster sales are due to a lack of applications software from the independent software industry. They attribute this to the fact that independent software suppliers turned their attention to the IBM Personal Computer and ignored the Apple III. For example, VisiCorp and Lotus Development Corp. both introduced significant new software packages for the IBM Personal Computer but do not plan to introduce versions for the Apple III. Their reasoning is that there are already four times as many IBM Personal Computers in operation as there are Apple IIIs and that the ratio is likely to tip even more in IBM's favor by the end of this year. Certainly the already introduced Lisa and the soon-to-be-introduced Mackintosh will have a further impact on sales of the Apple III.

In January, Apple officially introduced its 68000-based Lisa system. The primary marketing effort for this \$10,000 machine will be directed to the large-corporation marketplace, traditionally dominated by IBM. No doubt IBM will fight hard to keep it that way. IBM, again demonstrating its marketing prowess, introduced a 68000-based machine more than a month before Apple. The IBM system, however, is directed more to the scientific community, while Apple's Lisa, intended for use as a very intelligent workstation, will be spearheading the "office-of-the-future." Apple

appears to have established itself well in the corporate market and is expected to be much more successful with the Lisa than with the Apple III system.

In many ways, the Lisa resembles the Xerox 8010 (the Star), introduced in 1981. The 8010, which sells for \$16,000, is at best only a modest commercial success. To ensure the success of the Lisa, Apple has doubled its sales force (now up to 100 people) selling directly to big national customers. Also, Apple has qualified about 200 dealers to sell the Lisa (a move that has angered some of Apple's other 1400 dealers).

In the meantime, the new Apple IIe, the long-awaited upgrade of the Apple II, is having an impact on suppliers of Apple II memory boards. The Apple IIe includes an enhanced memory that makes many current add-on memory boards obsolete. Two of the seven memory-board manufacturers have already decided to cease production of these boards when the demand lessens: Microsoft and Advanced Logic Systems have announced that they do not plan any new Apple II memory boards.

The Apple IIe has one less I/O expansion slot (slot zero is missing) than its predecessor. This position was previously used for the memory-expansion board. Further, the system contains 64K bytes of memory. Several of the other memory-board manufacturers plan to continue to make memory boards to extend the IIe's memory beyond 64K bytes (e.g., for disk emula-

tion).

Apple also cut costs on the Apple IIe by reducing the number of ICs from 109 to 31; however, the retail price of the Apple IIe is \$45 more than the old Apple II's \$1350. Last year I predicted that the IIe would have an 80-column display (see the October 1982 BYTELINES, page 456); however, Apple has decided to keep the 40-column format but offers the 80-column format as an option. Apple can expect tough competition from IBM, which is expected to introduce two new systems this summer—one lower in price and performance than the current Personal Computer and the other more powerful.

Congress defeated what has been referred to as "the Apple Computer Bill," which would have offered tax breaks to computer manufacturers for donating computers to schools. Opponents argued that the bill would have given Apple a marketing advantage and that the tax benefit would have cost the government \$36 million in lost revenues, transferring the cost burden from corporations to the government. Apple Computer Inc. chairman Steve Jobs, who had promoted the bill, had stated publicly that "Congress would be crazy not to take us up on this." It is expected that the bill will be reintroduced in this year's Congress.

Market Share for the PC: International Data Corp., a market-research firm, estimates that, in its first full year of selling the Personal Computer, IBM sold almost 200,000 systems and that this year sales should rise to 350,000 systems. Thus the firm estimates that the IBM Personal Computer has already gained 17.3% of the market, behind Apple's 26.6% and Tandy's 23.3%.

International Data Corp. also predicts that next year IBM will be the leader in the personal computer market, a market that keeps doubling each year. It has been estimated that 10% of the IBM Personal Computer systems sold have gone to IBM employees, who get discounts and payment plans for the system. The discount policy encourages IBM employees to write software for the system, often for extra pay.

IBM already dominates the medium-performance \$3000-to-\$5000 segment of the personal computer market. Already two dozen IBM-compatible machines have been introduced. The standard memory size for IBM-compatible machines now seems to be 256K bytes. Doubtless IBM's new machine, expected this summer, will have 256K bytes of memory onboard.

Although much lower than IBM in dollar volume, Commodore, TI, and Timex Computer Corp. are the leaders in unit volume. Timex Computer is estimated to have shipped 750,000 units last year, and Commodore and TI about 600,000 computers each. Radio Shack and Atari were not far behind. Thus it appears that close to 3 million personal computers were sold last year. With Timex Computer, Commodore, and TI each expected to sell over 1.5 million computers in 1983, we may see over 6 million computers sold this year.

Total sales for this year are expected to top \$3 billion. Both Apple and Tandy have disclosed that they are shooting for \$1 billion in sales, a 50% increase over last year. Tandy anticipates that its 1983 sales of home systems will top its sales of business systems for the first time. Apple is expected to introduce an under-\$500 computer for the home market.

The Year of the Mouse: 1983 will surely go down as the "year of the mouse." Many of the new personal computers due for introduction at next month's NCC will have them as standard features of the system. Apple's new Lisa has a mouse, and it will no doubt be an option on the soon-to-be-announced Mackintosh. Televideo and several others are expected to show their mouse offerings at NCC.

IBM Buys Into Intel: IBM has bought a 12% stake in Intel Corp. The price was \$250 million. IBM will have an option to increase this to 30% in eight years, and the firm will also get one representative on the Intel board of directors. No doubt this will tighten the association between the two companies. Intel is the primary supplier of add-on memory boards to IBM and a leading supplier of 64K-bit dynamic-memory ICs. Further, the microprocessor and many of the support ICs used in IBM's Personal Computer, Displaywriter, and Datamaster systems are furnished by Intel. IBM has also purchased rights to some manufacturing technologies from Intel. IBM, which has in the past grown by internal expansion, making virtually all of its own ICs, has become increasingly dependent on outside IC suppliers.

Many other IC makers have been acquired or invested in by large customers. For example: General Electric bought Intersil, Schlumberger Ltd. bought Fairchild, United Technologies bought Mostek, and Siemens Corp. owns a 16% interest in Advanced Micro Devices.

Intel, like other IC makers, has been in a slump for the past two years due to the recession and severe price competition from Japan.

While other IC makers resorted to layoffs, Intel increased its staff by 3000 last year, anticipating an upturn that never came. For this year, Intel has cut all salaries by 10% and frozen them for the year. The firm has needed substantial amounts of capital to continue its aggressive research and product development programs. Thus experts speculate that IBM decided to buy a stake in Intel to boost this R & D and thwart a buy-in by a competitor such as AT & T (American Telephone and Telegraph, recently freed from an anti-trust suit and reorganized).

Prices Drop: Commodore has been selling its VIC-20 in the U.S. for close to a year at a list price of \$180; the price is expected to drop soon to \$150 (hence it will be selling for the same price as the Timex Sinclair 2000). The VIC-20 has a better keyboard and better color graphics but less memory. Further, Commodore offers options that include a disk drive. TI is dropping the price of its 99/4A and bringing out a new lower-cost machine, called the 99/2, with a list price of \$100. TI will shortly introduce a high-speed tape-storage unit for both the 99/4 and 99/2 with a list price of \$140.

Sinclair has been talking about a microfloppy-disk drive for its color system that will sell for under \$80. Although the drive will be slow (taking about 4 seconds to load a program), it will store about 100,000 bytes. When this unit becomes available, it should make the Spectrum and its American counterpart, the Timex Sinclair 2000, highly competitive with the VIC-20 and TI units. The machine is expected to be introduced in England this spring and in this country

Clubs and Newsletters

Forum for Sinclair Users

Sinclair Micronews contains programs, tutorials, and user reports on hardware and software for the ZX81 microcomputer and the Timex/Sinclair 1000. The newsletter also provides a forum for users to exchange original ideas and programs. To receive more information and a sample issue, send \$2 to *Sinclair Micronews*, 1280 Paddington Way, San Jose, CA 95127.

VIC-20 Only

The Vic-Nic-News is produced by the Byte House for owners and users of the Commodore VIC-20 home computer. The newsletter features news, programs, and information about the VIC. For a free copy, send a self-addressed stamped envelope to the Byte House, POB 981, Salem, NH 03079.

Update on Electronics

The American Electronics Association (AEA) is a non-profit trade organization that produces a monthly news journal, *Update*, which discusses electronics in relation to the environment and announces relevant seminars in its calendar. For further information, contact Leslie Conley, 2680 Hanover St., Palo Alto, CA 94304, or call (415) 857-9300.

Attention: Software Authors

The Software Author, a special-interest group that meets on the Compuserve Information Service, provides

contacts for freelance programmers, publishers, and software authors. The Software Author includes an electronic bulletin board and databases of market reports. Regular online conferences with guests from the publishing industry allow members to ask questions. The Software Author is open to any Compuserve subscriber; membership is free. Access the Software Author with a "G PCS-117" command from any prompt or select option 13 from the group's menu on PCS-50.

Next: NECS

The New England Computer Society (NECS) produces a monthly newsletter and welcomes exchanges with other clubs. It meets on the first Wednesday of each month at 7 p.m. in Bedford, Massachusetts. Annual dues are \$10. For further details, contact the New England Computer Society, POB 198, Bedford, MA 01730.

Pascal for DEC Owners

USUS (the UCSD Pascal-System User's Society) has formed a special-interest group (SIG) for users of the UCSD p-System on DEC (Digital Equipment Corporation) computers. The DEC SIG will serve as a clearinghouse for information relating to the implementation, optimization, and use of the p-System on DEC computers. Individual membership in USUS is \$20 a year; membership in DEC SIG is free to USUS members. For further information, contact Eli Willner, Datronics Inc., 675 Third Ave., New York, NY 10017.

Microcomputing In British Columbia

The Island Microcomputer Society seeks beginners and experts to join a Canadian microcomputing club. In addition to the monthly newsletter, *The Datafile*, the club offers a library of computer magazines and books, a bulletin board, and an annual computer fair. For further information, call Gil Phillips at (604) 385-4063, or write to the Island Microcomputer Society, Station E, POB 1822, Victoria, British Columbia V8W 2Y3, Canada.

Fast Photo Service

The Photoletter sends newsletters and photos via computer. The twice-monthly market letter pairs buyers with photographers. Subscribers are charged \$24 per hour of access time or a \$15 monthly minimum. For more information, write to Rohn Engh, Pine Lake Farm, Osceola, WI 54020, or call (715) 248-3800.

NEC Group In San Francisco

Users of the NEC (Nippon Electric Company) PC-8001 series of computers have formed the NEC Computer Users group in the San Francisco area, which produces a newsletter containing technical articles on NEC PC-8000 components. Members meet monthly to exchange software and solutions to problems. Dues are \$15 a year in the U.S. For more information, write to NEC Computer Users, POB 500, Benicia, CA 94510.

VIC Club In Chicago

An international clearinghouse in Chicago, Illinois, is devoted to the Commodore VIC-20, 64, and Max computers. The VIC International Computer Knowledge Information Exchange (VICKIE) membership fee is \$20 a year and \$17.50 for students. Sample newsletters are available for \$1. For further information, write to John Rosengarten, VICKIE, 3822 North Bell Ave., Chicago, IL 60618.

Using the Osborne 1

The Os/Tech newsletter is designed to pass along tips that owners of the Osborne 1 have learned as well as to announce new products and software. It is produced six times a year. Subscriptions are \$9 within the U.S. *Os/Tech* will be produced in Spanish if there is enough demand. For more information, contact *Os/Tech*, POB 517, Clearwater, FL 33517, or call (813) 446-7239.

Alternate with the Update

Computer Update is produced every other month by the Boston Computer Society (BCS). Subscription to the magazine is free with BCS membership. BCS contains 19 user/interest groups. Annual membership is \$20, students are \$12, and the international fee is \$40. For further information, write to the Boston Computer Society Inc., Three Center Plaza, Boston, MA 02108, or call (617) 367-8080.

Ask BYTE

Conducted by Steve Clarcia

More on VIC Adapters

Dear Steve,

Your response to Mr. McIlwee's question about VIC-20 cassette adapters bears greater amplification. (See "VIC Cassette Adapter," October 1982 BYTE, page 453.)

For example, the VIC's F-6 pinout must be used to signal the computer that cassette operation is in progress. In addition, I found that the write signal tends to overdrive the recorder and must be attenuated and rolled off in frequency.

Figure 1 is a circuit that I

devised which worked well with a Radio Shack Realistic recorder. The volume control must be set for 6 or above to assure a saturated (square wave) signal to the VIC-20.

When the computer requests "press record and play on tape," the operator reacts accordingly, and the play switch signal (S1) to the computer is closed. At the end of a save, the recorder is stopped and S1 opened. A similar action is taken during a load operation.

I don't know if this circuit will work with all recorders.

Charles A. King
McLean, VA

The VIC-20 is designed for digital input signals and not the normal analog output of the standard recorder. It can be made to work with a standard recorder, but it's very finicky and recorder-dependent.

A standard cassette recorder can be made to work properly with the VIC-20 if a simple interface circuit is used. William R. Hale's article "Add a Cassette Interface to Your VIC-20" (March 1982 BYTE, page 272) gives the necessary information. Note that the Play switch must be grounded during playback or the VIC

will not know that the recorder is running. The volume level is rather touchy for proper operation and can be more easily adjusted if a pair of LEDs (light-emitting diodes) are connected back-to-back across the recorder audio output (i.e., earphone jack or equivalent). Also see Dr. Milan D. Chepko's article "How to Build an Inexpensive Cassette Level Indicator" (September 1981 BYTE, page 435). Adjust the volume control until one of the LEDs begins to flicker steadily and all will work fine. . . . Steve

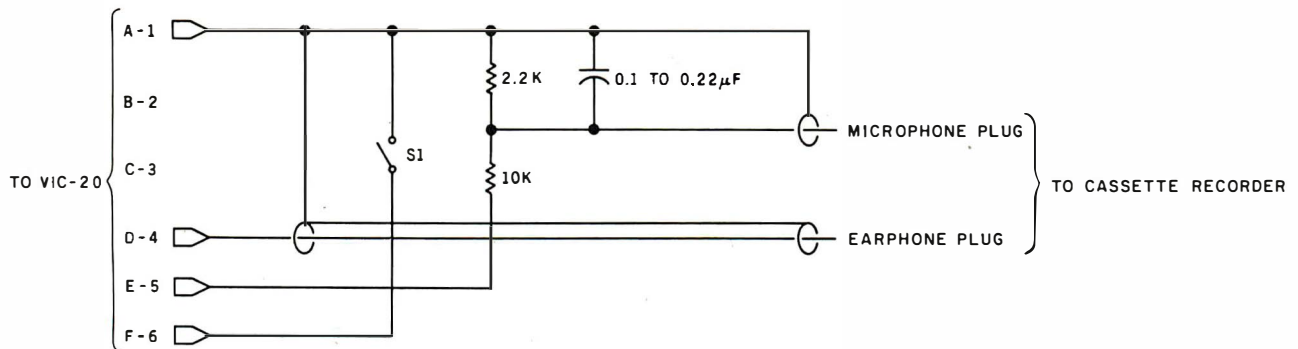

Figure 1: Mr. King's circuit.

Expanding the Z80 Computer

Dear Steve,

I am a graduate student in mathematics at the University of Tennessee. I have supplemented my education with personal and academic study in computer science and electrical engineering. I purchased your book, *Build Your Own Z80 Computer* (available for \$17.95 from BYTE Books/McGraw-Hill, POB 400, Hightstown, NJ 08520). Using it and other sources, I have designed my own version. I have two partners who agree to finance its construction. If could add a disk controller for

some 5¼- or 8-inch floppy-disk drives, it would be a much more useful product to us.

Do you have any information on the design of a floppy-disk controller, or can you point me toward some literature on the subject? I think there may be some BYTE articles on the subject; however, I wouldn't have the issues because my subscription began a little more than a year ago.

Also, in your book, you explain some of the important aspects of a serial interface. However, I would like to purchase a Heath/Zenith or RCA terminal and simply plug it in. Do you have any information

on how to wire standard RS-232C plugs? Is there a source to explain RS-232C protocol?

Finally, in an Ask BYTE column, you mentioned that you can obtain disk access by configuring the computer to an S-100 bus. (See "Build Your Own," March 1982 BYTE, page 444.) That sounds great, but where can I find the specifics for doing that?

Thanks.
Wallace G. Hynds
Knoxville, TN

The June 1980 BYTE contained an article on serial interfaces, "I/O Expansion for the TRS-80, Part 2: Serial Ports" (page 42), that defines

the pertinent RS-232C pinouts and gives theory and construction information on serial ports for a Z80-based system. Also, an excellent book that describes the interfacing of many computer buses to the S-100 is The S-100 & Other Micro Buses, by Elmer C. Poe and James C. Goodwin (available for \$9.95 from Howard W. Sams & Co. Inc., 4300 West 62nd St., POB 7092, Indianapolis, IN 46206).

Here's a list of articles and books on floppy-disk controllers and interfacing the S-100 bus:

"Build the Disk-80: Memory Expansion and Floppy-

Ask BYTE

Disk Control," by Steve Ciarcia, March 1981 BYTE, page 36.

"Interface a Floppy-Disk Drive to an 8080A-Based Computer," by John Hoepfner, May 1980 BYTE, page 72.

Interfacing to S-100/IEEE 696 Microcomputers, Sol Libes and Mark Garetz. Berkeley, CA: Osborne/McGraw-Hill, 1981, \$15.

"Build a Super Simple Floppy-Disk Interface," by James Nicholson and Roger Camp, Part 1: May 1981 BYTE, page 360; Part 2: June 1981 BYTE, page 302. . . . Steve

Multichannel A/D Converters from Single Channels

Dear Steve,

Can I use transistors connected to the address lines of a

computer to make a multichannel A/D (analog-to-digital) converter out of a single-channel A/D?

Joel Chaney
North Kingsville, OH

The answer to your question is yes. However, a simpler method uses a CMOS (complementary metal-oxide semiconductor) 4051-type bilateral switch. This device is

the electronic equivalent of an 8-position rotary switch. When it is enabled, you simply send it a 3-bit address, which allows the voltage level on the corresponding input line to pass through to its single output line.

The 4051, along with its pin assignments, is shown in figure 2. To enable the device, you must ground the inhibit pin. To get it to work with negative-going analog signals, you must connect pin 7 to a -5-volt supply. This pin can be grounded with positive-only voltages.

If you are interested in learning more about CMOS devices, pick up a copy of the CMOS Cookbook, by Don Lancaster. It costs \$13.95 and is published by Howard W. Sams & Company. . . . Steve

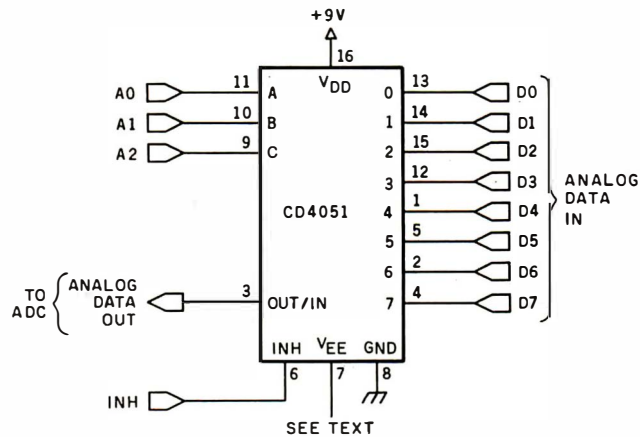

Figure 2: The 4051-type bilateral switch and its pin assignments.

INVENTORY CONTROL LIKE THE BIG GUYS — AT LITTLE GUY PRICES

ARBA SYSTEM: Real time inventory control that starts with the ARBA RS-232 cash register and offers sophisticated Point of Sale and Inventory Control software.



ARBA Register
RS232 interface. . . Utilizes standard ASCII encoding. . . Twin Display Windows. . . Receipt and Detail Tapes. . . Cash, charge, received on account, paid out, void, discount keys. . . 11 key numeric pad. . . Tax, non tax functions. . .

ARBA Register available separately. . . \$1295.00—Suggested Retail

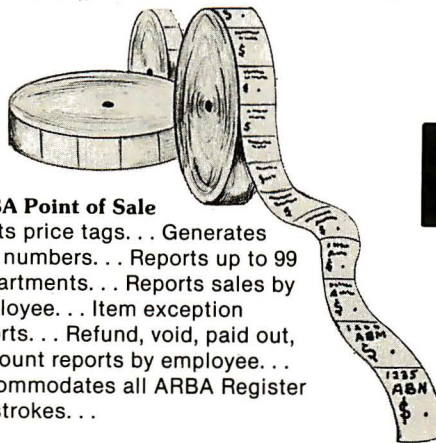

ARBA Point of Sale
Prints price tags. . . Generates part numbers. . . Reports up to 99 Departments. . . Reports sales by employee. . . Item exception reports. . . Refund, void, paid out, discount reports by employee. . . Accommodates all ARBA Register keystrokes. . .



Accounting Plus* Inventory Control
Up to 65,000 items. . . 12 digit alpha/numeric part number. . . Recommended order report. . . Sales analysis by department item or vendor. . . Gross margin analysis. . . Stock status reports. . . Year to date activity. . . Integrates with Accounting Plus. . .
Circle 465 on inquiry card.

Also available - Accounting Plus* General Ledger, Receivables, Payables, Payroll, Purchase Order. . .
Runs under CP/M** and MP/M**

ARBA ARBA Fine Business Computing Corporation
890 East Roosevelt Road
Lombard, Illinois 60148 (312) 620-8566

*TM Software Dimensions Inc., Citrus Heights, California
**TM Digital Research, Pacific Grove, California

DEALER INQUIRIES WELCOME

Homebrewer's Nightmare

Dear Steve,

I have been attempting to interface National Semiconductor's MM58167A real-time clock integrated circuit to an Apple II I/O expansion bus. I have been using your article "Everyone Can Know the Real Time" as a reference (May 1982 BYTE, page 34). I have constructed a circuit (figure 3) on a Vector Plugboard. The MM58167A MOS (metal-oxide semiconductor) is sensitive to static, so it requires special handling procedures. When I installed the clock device, I found that only two of the seven registers could be accessed correctly. Some of the counters and registers were stuck on illegal values (only binary-coded decimal values are allowed), but the thing was apparently keeping time.

I asked the vendor, Jameco, of Belmont, California, to replace the device, which it did. The new chip's registers can be accessed properly, and it, too, seems to keep time. However, it doesn't respond to the GO command, so I can't set it. Finally, the seconds output is stuck on hexadecimal FF.

In both cases, I was careful

to take all the precautions necessary with MOS devices, so I'm sure that I haven't caused the problem. How can I tell if it's the chip or the interface that's the culprit? Also, what is the "test mode" listed in table 1 of your article?

Edward Beighe
Bethlehem, PA

You have just experienced the dilemma of every hardware buff: "is it me or is it the chip?" The best way to test an LSI (large-scale integration) chip is to substitute another. The specification sheets describe the function of the device, and it's usually possible to set up a known condition on the input side and test for a correct output. If some of the outputs are correct and some are not, the chip can usually be suspected.

From the symptoms that you describe, it sounds like you have a defective chip. While you may have taken the proper handling precautions, it's possible that someone before you did not.

Other clock chips use the test mode for production testing. It speeds up certain functions so that the counting rate can be verified. It is not intended to be used in normal operation. . . . Steve

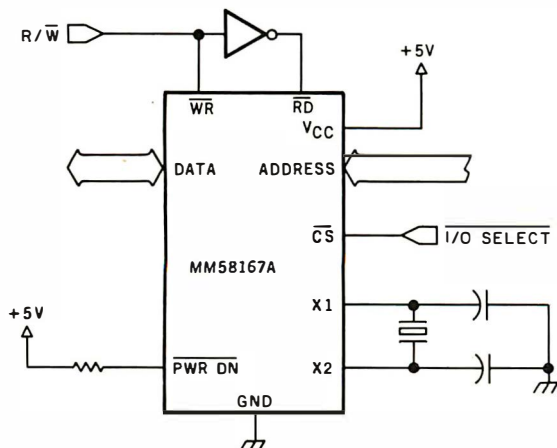

Figure 3: Mr. Beighe's circuit.

Where to Catch the S-100 Bus Standard

Dear Steve,

How can I get a copy of the IEEE S-100 bus standard?

Chip Wiggs
Miami, FL

Order copies of IEEE-696, as the S-100 bus standard is known, from the IEEE Service Center, 445 Hoes Lane, Piscataway, NJ 08854, (201) 981-0060. Write or call for the latest price and shipping details.

Information on this bus and many other buses can be found in the excellent book The S-100 & Other Micro Buses, by Elmer C. Poe and James C. Goodwin. It's published by Howard W. Sams & Company (1981). Also see "The IEEE Standard for the S-100 Bus," by Mark Garetz (February 1983 BYTE, page 272). . . . Steve

In "Ask BYTE," Steve Ciarcia answers questions on any area of microcomputing. The most representative questions received each month will be answered and published. Do you have a nagging problem? Send your inquiry to:

Ask BYTE
c/o Steve Ciarcia
POB 582
Glastonbury CT 06033

If you are a subscriber to The Source, chat with Steve (TCE317) directly. Due to the high volume of inquiries, personal replies cannot be given. Be sure to include "Ask BYTE" in the address.

New Inmac Catalog jam-packed with computer/ wp supplies.



Yours free!

Accurately called "the bible of the industry," it's loaded with great products and ideas for your personal computer, minicomputer or word-processing system. You'll enjoy:

- **One-stop shopping.** Over 2,000 products to choose from.
- **Easy ordering.** Mail, phone, or TWX. Verbal P.O.'s welcome.

- **Fast delivery.** 24-hour shipment. Overnight emergency shipments available.

- **45-day trial.** Full refund if not completely satisfied.
- **Guaranteed quality.** All products field-tested to highest standards.
- **Lower shipping costs.** 7 fully stocked distribution centers serving the U.S.

Send today for your free 100-page Inmac catalog. Or phone (408) 727-1970.

inmac Catalog Dept., 2465 Augustine Drive, Santa Clara, CA 95051
Please be sure to include your phone number.

()
NAME _____ PHONE _____
COMPANY _____
ADDRESS _____
CITY _____ STATE _____ ZIP _____

107120

Event Queue

April 1983

April-May

Courses in C Language and Unix, various sites throughout the U.S. Three 5-day courses are offered by Plum Hall Inc. The "C Programming Workshop," a hands-on course, covers all aspects of the C language for individuals able to program in another language. The "Advanced C Topics Seminar" covers efficiency, portability, readability, debugging, packaging, and interfacing. The "Unix Workshop" is an introductory course that focuses on software development. Each course fee is \$1000. For details, contact Joan Hall, Plum Hall Inc., 1 Spruce Ave., Cardiff, NJ 08232, (609) 927-3770.

April-May

Information Processing Seminars, various sites throughout the U.S. Datapro Research Corporation offers more than 35 seminars about information processing. Among the titles are "Optimizing Source Data Entry: Design Techniques," "User Friendly Information Delivery: Approaches to Online Systems Development," and "Distributed Systems Design: Microcomputers to Mainframes." These courses can be presented on an in-house basis. For a seminar catalog, contact Datapro Research Corp., 1805 Underwood Blvd., Delran, NJ 08075, (800) 257-9406; in New Jersey, (609) 764-0100.

April-June

Computer Literacy for Lawyers, various sites throughout the U.S. This seminar is intended to introduce attorneys to basic computer concepts and their application to the practice of law. Subjects covered include specific ways

that computers can assist in operating legal practices, how computers can help lawyers service clients more effectively, and the uses, costs, and benefits of using computers in legal practice. The fee for each participant is \$550, which includes reference materials. Group discounts are available. For further information, contact Kathryn Mann, Center for Legal Studies, 1926 Arch St., Philadelphia, PA 19103, (215) 732-6999.

April-June

Computer Showcase Expos, various sites throughout the U.S. This popular show will be held in several major cities between April and June. For a schedule, contact The Interface Group, 160 Speen St., POB 927, Framingham, MA 01701, (800) 225-4620; in Massachusetts, (617) 879-4502.

April-June

Courses from Q.E.D. Information Sciences, various sites throughout the U.S. Some of the courses listed are "Systems Analysis Workshop," "Project Management and Control," and "Data Analysis." Address inquiries to Priscilla Goudreault, Q.E.D. Information Sciences Inc., Q.E.D. Plaza, POB 181, Wellesley, MA 02181, (800) 343-4848; in Massachusetts, (617) 237-5656.

April-June

Data Processing Courses, the Hartford Graduate Center, Hartford, CT. Among the courses being offered are "ANS COBOL Programming Workshop 1" and "CICS/VS Command Level Coding Workshop." Hartford Graduate Center data-processing courses are available for on-site presentation. For details, contact Don Florek, The Hartford Graduate Center,

275 Windsor St., Hartford, CT 06120, (203) 549-3600, ext. 252, 253, or 254.

April-June

Fourth Generation Methodologies and Seminars of Excellence, various sites throughout the U.S. The five-day "Fourth Generation Methodologies" seminar explores information engineering, application creation methodologies, and management patterns. James Martin will be the seminar leader. The fee is \$1495.

Some of the areas covered by the "Seminars of Excellence" are local data networks, relational databases, and distributed database systems. Fees range from \$795 to \$950. Details on these seminars are available from the Technology Transfer Institute, 741 10th St., Santa Monica, CA 90402, (213) 394-8305.

April-June

Intel Microcomputer Workshops, various sites throughout the U.S. Among the workshops to be held are "Introduction to Microprocessors" and "iAPX 86, 88, 186 Microprocessors." Intel Customer Training Courses are available for on-site presentation. For details, contact Intel Corp., Mail Stop SV3-1, 3065 Bowers Ave., Santa Clara, CA 95051.

April-June

Intensive Seminars of Interest to Data Processing Professionals, Boston metropolitan area. Among the two- to five-day seminars offered are "Project Management" and "Systems Design." Registration fees range from \$495 to \$975. For a seminar bulletin, contact Ms. Ginny Bazarian, Office of Continuing Education, Higgins House, Worcester Polytechnic Institute, Worcester, MA 01609, (617) 793-5517.

April-June

Management Development Programs, Providence, RI, Boston, MA, and Hartford, CT. The Center for Management Development offers seminars in a variety of areas, including communications, industrial relations, and electronic data processing. Many of the Center's programs can be conducted on location for your organization. For complete information, contact The Center for Management Development, Bryant College, Smithfield, RI 02917, (401) 231-1200, ext. 314.

April-June

Professional Development Seminars, various sites throughout the U.S. Data communications, database management, software and systems, and computer-aided design/manufacturing are some of the areas investigated in seminars offered by the Institute for Advanced Technology. For a detailed catalog, contact the Registrar, Institute for Advanced Technology, Control Data Corp., 6003 Executive Blvd., Rockville, MD 20852, (800) 638-6590; in Maryland, (301) 468-8576.

April-June

Seminars in Simulation, Management, Statistics, and Computer Science, various sites throughout the U.S. "Simulation Modeling for Decision Making," "Database Design," and "Satellite Communications Technology" are some of the topics to be presented. For information, contact the Institute for Professional Education, POB 756, Arlington, VA 22216, (703) 527-8700.

April-July

Courses from Integrated Computer Systems, various sites throughout the U.S. Course titles include "Com-

puter-Aided Design and Manufacturing," "Computer Graphics," "Hands-On Pascal Workshop," "Defining Software Requirements, Specifications, and Tests," and "Computerized Robots." Fees range from \$695 to \$845. For information, contact Ruth Dordick, Integrated Computer Systems, 3304 Pico Blvd., POB 5339, Santa Monica, CA 90405, or call (213) 450-2060.

April-July

Productivity '83, various sites throughout the U.S. and Canada. This is Hewlett-Packard's hands-on showcase of more than 32 computer products and 17 seminars. It's designed to provide data-processing professionals and novices answers to problems confronting the industry. For details, call (800) 453-9500.

April-July

Technical Courses from Zilog, Campbell, CA. A wide variety of such courses as "The Computer: A Survey Course" and "C Programming" are offered. Fees range from \$175 to \$875. For a complete schedule, contact Zilog Inc., Training and Education Department, 1315 Dell Ave., Campbell, CA 95008, (408) 370-8092.

April-October

Courses from the AMA, various sites throughout the U.S. The American Management Associations (AMA) offers an on-going series of seminars in such areas as human resources, information systems, and manufacturing and technology management. In-house development and training seminars can be arranged. For information on AMA membership or seminar particulars, contact the American Management Associations, 135 West 50th St., New York, NY 10020, (212) 586-8100.

April-December

IEEE Conferences and Meetings, various sites around the world. The Institute for Electrical and Electronics Engineers (IEEE) sponsors conferences, meetings, and workshops covering high-technology issues. For details, contact the IEEE Computer Society, Suite 300, 1109 Spring St., Silver Spring, MD 20910, (301) 589-8142.

April 10-13

APL83, Sheraton Washington Hotel, Washington, DC. This conference and exhibition includes hands-on displays and presentations of technical papers. For details, contact D & S Whyte Associates, Conference and Exhibits Manager, Suite 200, 117 King St., Alexandria, VA 22314, (703) 548-2802.

April 10-15

Data Processing Training Managers' Workshop, Dallas, TX. This workshop is intended for individuals with less than 18 months of experience in coordinating data-processing programs. Participants will learn how to establish in-house education programs that meet management's objectives and ensure a high return on their organization's investment in training. The fee is \$1000. Contact Deltak Inc., 1751 West Diehl Rd., Naperville, IL 60566, (312) 369-3000.

April 11-13

Gate Arrays, Boston, MA. For full details, contact the Continuing Education Institute, Oliver's Carriage House, 5410 Leaf Treader Way, Columbia, MD 21044, (301) 596-0111; on the West Coast, call (213) 824-9545.

April 11-13

IBM-MVS Training Seminars, Chicago, IL. Two seminars are offered: "MVS Internals Overview for Data Processing and Operations Man-

agement" and "MVS Internals for Systems Programmers." These courses run for 1½ and 2½ days, respectively. For complete information, contact ACTS Corp., 11910 Gate Way, Austin, TX 78759, (512) 258-7869.

April 11-13

Personal Computers for Scientists and Engineers, Center for Professional Advancement, East Brunswick, NJ. Participants will learn how to use disk-operating systems, electronic spreadsheets, filing systems, and a word processor. Other programs will be demonstrated. Each attendee will work with an Apple II Plus computer. Two session formats are available. The fee is approximately \$750. Contact the Center for Professional Advancement, General Information, POB H, East Brunswick, NJ 08816, (201) 249-1400.

April 11-15

Intergraphics '83, Takanawa Prince Convention Center, Tokyo, Japan. This conference and exhibition will cover a wide range of computer-graphics topics, including business and management graphics, virtual machine languages, and chemical and biochemical applications of computer graphics. Complementing formal programs will be speakers, discussions, and tutorials. For complete details, contact the World Computer Graphics Association, Suite 250, 2033 M St. NW, Washington, DC 20036, (202) 775-9556.

April 12-13

Selecting a Microcomputer for Scientific and Engineering Applications, Golden, CO. This short course reviews hardware and software technology for potential buyers of microcomputers in relation to specific scientific and engineering applications. The

fee is \$195. Contact the Space Office, Colorado School of Mines, Golden, CO 80401, (303) 273-3321.

April 12-13

The Seventh Annual University of Dayton Computer Fair, University of Dayton Arena, OH. This fair is sponsored by the Office for Computing Activities of the University of Dayton. It features terminals, computers, and word processors. Further information can be obtained from Don Schumacher, University of Dayton, 300 College Park Ave., Dayton, OH 45469, (513) 229-3511.

April 12-14

The Ninth Annual Federal Data Processing Expo, Convention Center, Washington, DC. More than 150 companies will display and demonstrate computer and communications products and services. The conference portion of this event will offer 46 sessions on a variety of topics of interest to federal data-processing professionals. For further information, contact The Interface Group, 160 Speen St., POB 927, Framingham, MA 01701, (800) 225-4620; in Massachusetts, (617) 879-4502.

April 12-14

The Sixth Annual Southwest Computer Conference-SWCC, Myriad Convention Center, Oklahoma City, OK. The theme of this conference is "Managing Information Technology in the '80s." Seminars and an exhibition area are planned. For details, contact SWCC, POB 950, Norman, OK 73070, (405) 329-3660.

April 13-15

Local Area Networks: Design and Management, Hyatt Hotel, Los Angeles, CA. This seminar is intended to provide an understanding of the theory and practical implementations of local-area net-

Event Queue

works. Areas of interest include techniques of evaluating proposals for systems, methods in analyzing conflicting information, and probable future developments. The fee is \$595; group discounts are available. This seminar can be presented within your organization. Contact the Center for Advanced Professional Education Inc., 11928 North Earham, Orange, CA 92669, (714) 633-9280.

April 13-20

Hanover Fair '83—Cebit '83, Hanover, West Germany. The Hanover Fair is one of the world's largest industrial trade fairs. Attention will be paid to office equipment and data-processing technology. More than 1200 exhibitors from 30 countries will display their products to a crowd of more than 200,000. Full information is available from the Hanover Fairs Information Center,

Salem Industrial Park, POB 338, Whitehouse, NJ 08888, (800) 526-5978; in New Jersey, (201) 534-9044.

April 14-17

The Second Annual New York Computer Show and Software Exposition, Nassau Coliseum, Uniondale, NY. This show features printers, software, hard disks, modems, memory cards, cartridges, publications, support services, and other peripherals and accessories. Admission is \$5 for adults and \$3 for children. Contact Northeast Expositions, 822 Boylston St., Chestnut Hill, MA 02167, (617) 739-2000.

April 15-16

The Thirteenth Annual Virginia Computer Users Conference—VCUC, Marriott Hotel, Blacksburg, VA. This conference is organized and run by the Virginia Tech Student

Chapter of the Association for Computing Machinery in cooperation with the Virginia Polytechnic Computer Science Department. Topics of interest include Ada, human factors, and computer graphics. For more information, contact Luanne Melown or Paula Brimer, Virginia Polytechnic Institute and State University, 562 McBryde Hall, Blacksburg, VA 24061, (703) 961-6931.

April 15-17

Applefest, Convention Center, Anaheim, CA. This event features conferences, workshops, and panel discussions designed to show users how to effectively use their Apples. Approximately 350 exhibitors will participate. For more information, contact Northeast Expositions, 826 Boylston St., Chestnut Hill, MA 02167, (800) 841-7000; in Massachusetts, (617) 739-2000.

April 15-17

The Use of Computers in Psychology, Hilton, Wilmington, NC. With a focus on microcomputers, the five planned symposia will cover such issues as statistical and therapeutic applications and the use and misuse of microcomputers in psychological assessment. For complete details, write to Steven R. Edelman, Association of Eastern North Carolina Psychologists, 105 Lou Dr., Goldsboro, NC 27530.

April 16

The First Annual Oak Ridge Hamfest/Computerfest, Civic Center, Oak Ridge, TN. Manufacturer displays, trading opportunities, technical talks, demonstrations, and hourly door prizes will highlight this show. For further information, write to the Oak Ridge Amateur Radio Club Inc., POB 291, Oak Ridge, TN 37830.

SuperBrain II™ - CompuStar™ Network Systems

- Excellent dealer & EOM discounts
- CMC's own national on-site service
- Toll-free Ordering & technical assistance
- Module replacement
- Advertising co-op
- After-sale support

CMC ALSO OFFERS

- Six-month warranty
- High resolution graphics
- System support training in our facilities
- Optional green phosphor screen
- Enhanced DOS software with advanced files directory, diagnostics, disk editor, communications software and others

SOFTWARE, PERIPHERALS FOR SUPERBRAIN COMPUTAR

SOFTWARE

Accounting Plus	Microsoft
Wordstar	MBasic
dBase II	Fortran 80
Microplan	Cobol 80
Profitplan	M/T Pascal
Bisynch 80	P/L1 80
CBasic II	Spellguard
	Spellstar

PRINTERS

Datasouth
Epson
C. Itoh
Okidata
NEC
Starwriter
F10

MODEMS

Anderson-Jacobson
CAT Novation

HARD DISKS

CMC Targa
Corvus

MEDIA

Dysan
Verbatim

MISC.

Line Filters
Power Supplies

CompuStar Hard Disk Systems

10mb, 32mb & 96mb

Control Data Corp.
Phoenix Drives
9448-96 CMD
9448-32

**LOWEST PRICES
ANYWHERE!**



CMC INTERNATIONAL

A Division of Computer Marketing Corporation

11058 Main Street, Suite 220
Bellevue, Washington 98004
TELEX: 152556 SEATAC

For Information Call (206)453-9777
To Order, Call Toll-free 1-800-426-2963

DEALER INQUIRIES. GSA. GOVERNMENT. EDUCATIONAL BIDS INVITED

SuperBrain and CompuStar are registered trademarks of Intertec Data Systems Corporation

April 16-17

The Eighth Annual Trenton Computer Festival, Trenton State College, NJ. This festival includes short courses, user group meetings, demonstrations, commercial exhibits, and a flea market. Admission for the two days is \$5. Contact Dr. Allen Katz, Trenton State College, Hillwood Lakes CN 550, Trenton, NJ 08625, (609) 771-2487.

April 18-20

Personal Computers for Scientists and Engineers, East Brunswick, NJ. For details, see April 11-13.

April 18-21

The Thirteenth International Symposium on Industrial Robots and The Robots 7 Conference and Exposition, Conrad Hilton Hotel and McCormick Place, Chicago, IL. The theme for this event, "Robotics: The Emerging Challenge," will be investigated

through more than a dozen conference sessions, four special forums, and three basic sessions. More than 150 companies will exhibit industrial robots and components. This event is cosponsored by Robotics International of the Society of Manufacturing Engineers (RI/SME) and the Robot Institute of America (RIA). Details are available from Ms. Pat Van Doren, SME Technical Activities, One SME Dr., POB 930, Dearborn, MI 48128, (313) 271-1500, ext. 369.

April 18-22

Auditing in the Contemporary Computer Environment, Las Vegas, NV. This course is designed for internal auditors and financial and data-processing professionals. Participants will learn a comprehensive audit approach for computer-based systems, including how to evaluate controls and how to design a pro-

gram of tests using questionnaires, checklists, software tools, and flowcharts. Contact Marge Umlor, EDP Auditors Foundation, 373 South Schmale Rd., Carol Stream, IL 60187, (312) 682-1200.

April 18-22

Auditing Integrity Controls in the Contemporary Computer Environment, Las Vegas, NV. This program is designed to provide an overview of the computer environment, its controls, and its interrelationships. It combines theoretical and practical approaches for electronic data-processing auditing, with an emphasis on integrity controls and related operational concerns. Further details are available from Marge Umlor, EDP Auditors Foundation, 373 South Schmale Rd., Carol Stream, IL 60187, (312) 682-1200.

April 18-22

Digital Communication and

Satellite Systems, University of California, Los Angeles. For details on this short course, contact the UCLA Extension Short Course Program, POB 24901, Los Angeles, CA 90024, (213) 825-1295 or (213) 825-3344.

April 19-20

Workspace 83, Civic Auditorium, San Francisco, CA. This show will feature the latest in electronic office furnishings, systems, and services for corporate, institutional, and commercial offices. Exhibits will include open-plan systems, lighting, fabrics, accessories, and telephone systems. Seminars and workshops relating to automated office space will be held. For details, contact The Charles Co., Suite 500, 44 Montgomery St., San Francisco, CA 94104, (415) 931-8255.

April 19-21

Electro/83—High-Technology

Marymac INDUSTRIES, INC.

**In Texas Orders
Questions & Answers
1-713-392-0747**

**22511 Katy Freeway
Katy (Houston) Texas 77450**

**To Order
1-800-231-3680
800-231-3681**

SAVE BIG DOLLARS ON ALL TRS-80[®] HARDWARE & SOFTWARE

TRS-80[®] BY RADIO SHACK. Brand new in cartons delivered. Save state sales tax. Texas residents add only 5% sales tax. Open Mon.-Fri. 9-6, Sat. 9-1. We pay freight and insurance. Come by and see us. Call us for a reference in or near your city. Ref: Farmers State Bank, Brookshire, Texas.

WE OFFER ON REQUEST

- Federal Express (Overnight Delivery)
- Houston Intercontinental Airport Delivery (Same Day)
- U.P.S. BLUE (Every Day)
- References from people who have bought computers from us probably in your city. We have thousands of satisfied customers. **WE WILL NOT BE UNDERSOLD!**

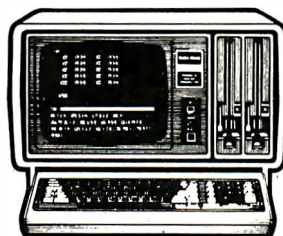

No Tax on Out of Texas Shipments!

**Save
10% 15%
OR MORE**

Telex 77-4132 (Fleks Hou)

* TRS-80 is a Registered Trademark of Tandy Corp

WE ALWAYS OFFER

- We accept Master Card, VISA, and American Express.
- We use Direct Freight Lines. No long waits.
- We always pay the freight and insurance
- Toll free order number
- Our capability to go to the giant TRS-80[®] Computer warehouse 5 hours away, in Ft. Worth, Texas, to keep you in stock.

JOE McMANUS

ED McMANUS



Electronics Exhibition and Convention, Coliseum and Sheraton Centre, New York, NY. This show runs concurrently with the Mini/Micro-Northeast exposition. For information, contact Electronic Conventions Inc., 999 North Sepulveda Blvd., El Segundo, CA 90245, (800) 421-6816; in California, (800) 262-4208 or (213) 772-2965.

April 19-21

Infocom 83, Town and Country Hotel, San Diego, CA. The theme for this second annual joint conference of the IEEE Computer and Communications Societies is "Computers and Communications Integration: Reality and Illusion." Topics of interest include computer network architectures, computer communications standards, and integrated services digital networks. A series of tutorials will be held the day before this conference begins. For further information, contact the IEEE Computer Society, POB 639, Silver Spring, MD 20901, (301) 589-3386.

April 19-22

Applied Time Series Analysis, Columbia Inn, Columbia, MD. For full details, contact the Continuing Education Institute, Oliver's Carriage House, 5410 Leaf Treader Way, Columbia, MD 21044, (301) 596-0111; on the West Coast, call (213) 824-9545.

April 20-22

Local Area Networks: Design and Management, Hilton Inn, Natick, MA. For details, see April 13-15.

April 20-22

Symposium on Computer-Aided Geometry Modeling, Hampton, VA. For information, contact John Shoosmith, Mail Stop 125, NASA Langley Research Center, Hampton, VA 23665, (804) 827-3466.

April 21-22

Broadband Local Networks, Washington, DC. This program is the first of four parts in the Architecture Technology Corporation's 1983 Forum Series. The series will bring together manufacturers and users of local network schemes to exchange views and information in an informal setting. The format includes presentations, panel discussions, and a technological summary. The cost is \$395 per person. For additional information, contact the Architecture Technology Corp., POB 24344, Minneapolis, MN 55424, (612) 935-2035.

April 21-22

Computers in Construction, New York, NY. This seminar is designed to assist construction contractors and construction management firms in acquiring computer systems. The registration fee is \$395. For further information, contact CIP Information Services Inc., 1105-F Spring St., Silver Spring, MD 20910, (301) 589-7933.

April 21-22

Individualized Language Teaching Through Microcomputer-Assisted Instruction, Tampa, FL. This seminar will provide the theoretical background and hands-on experience necessary to enable participants to make practical use of microcomputer-assisted language instruction. For a brochure, contact Ms. Anita Mires, American Language Academy, Suite 200, 11426 Rockville Pike, Rockville, MD 20852, (301) 984-3400.

April 21-24

Virginia/Carolinas Computer Show and Office Equipment Exposition, Pavilion Exhibition Center, Virginia Beach, VA. For details, contact Dee Harris, Computer Expositions

Inc., POB 3315, Annapolis, MD 21403, (800) 368-2066; in Maryland, (301) 263-8044.

April 22

Microcomputers in Physics Instruction, Wilkes College, Wilkes-Barre, PA. This session is sponsored by the Central Pennsylvania Section of the American Association of Physics Teachers. For information, contact F. J. Donahoe, Wilkes College, Box 111, Wilkes-Barre, PA 18766.

April 22-23

The Third Annual Role of the Computer in Education Conference, New Trier High School-West, Northfield, IL. This show is sponsored by Micro-Ideas. The keynote speaker will be Arthur Luehrmann. Further information is available from Richard Nelson, Micro-Ideas, 1335 North Waukegan Rd., Glenview, IL 60026, (312) 998-5065.

April 24-29

Data Processing Training Managers' Workshop, San Francisco, CA. For details, see April 10-15.

April 24-29

The HP 3000 International Users Group Conference, Montreal, Quebec, Canada. The theme for this conference is "Systems Designed with Users in Mind." Technical papers, vendor exhibits, and a lecture by Isaac Asimov will highlight this conference. Full details are available from Ms. Renaye Lee, Conference Manager, HP 3000 IUG, Suite 205, 289 South San Antonio Rd., Los Altos, CA 94022, (415) 941-9960.

April 25-27

The 1983 Symposium on Security and Privacy, Clare-

mont Hotel, Oakland/Berkeley, CA. Papers and panel sessions will explore such topics as security testing and evaluation, application security, and cryptographic protocol. For further details, contact the IEEE Computer Society, POB 639, Silver Spring, MD 20901, (301) 589-3386.

April 25-27

Workshop on Software Engineering Technology Transfer, Konover Hotel, Miami Beach, FL. This workshop will probe some of the problems affecting the use of software engineering tools, techniques, and methodologies, in such areas as marketing, engineering, sales, and customer service. For further information, contact the IEEE Computer Society, POB 639, Silver Spring, MD 20901, (301) 589-3386.

April 25-29

Auditing in the Contemporary Computer Environment, Oklahoma City, OK. For details, see April 18-22.

April 26-28

Exploitation '83—The HP1000 International User Group Conference, Heathrow Penta Hotel, Heathrow, London, England. Papers and commercial exhibits about getting the most from your system will be featured. For full details, contact the HP1000 Conference Centre, Conference Services Ltd., 3 Bute St., London SW7 3EY, England; tel: 01-584 4226; Telex: 916054.

April 26-28

Info/Manufacturing and Hi-Tech 83, McCormick Place, Chicago, IL. These joint conferences and exhibitions cover information systems and advanced manufacturing technologies. The intent is to coordinate efforts and solve common problems confronting manufacturing technology

and information system companies. More than 50 conference sessions are planned. Topics on the agenda include database management and systems integration, office automation, and artificial intelligence expert systems. Conference programs are available from Clapp & Poliak, 708 Third Ave., New York, NY 10017, (212) 370-1100.

April 26-29

Comdex/Spring, Georgia World Congress Center and the Apparel Mart, Atlanta, GA. More than 600 companies will display and demonstrate computers, word-processing systems, peripherals, software, media, supplies, services, and other computer-related items. This third annual conference will offer 56 sessions on business, marketing, and financial subjects of interest to ISOs (independent sales organizations). Contact The Interface Group, 160 Speen St., POB 927, Framingham, MA 01701, (800) 225-4620; in Massachusetts, (617) 879-4502.

April 28-30

Ed Com/Spring '83, Washington, DC. In more than 300 session hours educators will address, evaluate, and analyze the development of computers in education. Demonstrations, seminars, hands-on experience, and panel sessions will display hardware, software, and publications. For more information, contact Carol Houts, Judco Computer Expos Inc., Suite 201, 2629 North Scottsdale Rd., Scottsdale, AZ 85257, (800) 528-2355; in Arizona, (602) 990-1715.

April 28-30

Microcomputers in Education, Cambridge, MA. This hands-on workshop is designed for teachers and administrators at all levels.

Topics include microcomputers in science and mathematics instruction, Logo, Pascal, machine language, and microcomputers and the education of students with special needs. Contact Ms. Sharon Woodruff, Technical Education Research Centers, 8 Eliot St., Cambridge, MA 02138, (617) 547-3890.

April 28-30

Teaching Math with Microcomputers, Chicago, IL. This seminar is designed to inform elementary, intermediate, and secondary school educators how to effectively use the microcomputer as a tool in mathematics teaching. Participants will be divided into workshop groups by academic levels. Guest speakers will explore such areas as computer literacy and awareness, software, programming, and hardware selection. For members of the National Council of Teachers of Mathematics (NCTM), the registration fee is \$145. For nonmembers, the fee is \$245. Address inquiries to NCTM '83 Seminar Series, 1906 Association Dr., Reston, VA 22091, (703) 620-9840.

April 28-May 1

The Third Annual Southwest Computer Show and Software Exposition, Market Hall, Dallas, TX. This show features printers, modems, video displays, plug-in boards, cartridges, software, and support services. Admission is \$5 for adults and \$3 for children. Full details are available from Northeast Expositions, 822 Boylston St., Chestnut Hill, MA 02167, (617) 739-2000.

May 1983

May 1-4

The Thirtieth International Technical Communication

Conference, Sheraton-St. Louis Hotel, St. Louis, MO. This conference is sponsored by the Society for Technical Communication (STC). It will focus on such issues as industrial instruction, consumer education, and safety. For full details, contact the STC, 815 15th St. NW, Washington, DC 20005, (202) 737-0035.

May 2-5

Test and Measurement World Expo, Convention Center, San Jose, CA. More than 50 workshops will explore instruments and techniques critical to performing timely and cost-effective failure analyses of microelectronic circuits and components. Topics to be addressed include X-ray microradiography and surface analysis techniques. Full particulars are available from Meg Bowen, Test and Measurement World Expo, 215 Brighton Ave., Boston, MA 02134, (617) 254-1445.

May 2-6

Auditing Integrity Controls in the Contemporary Computer Environment, Oklahoma City, OK. For details, see April 18-22.

May 2-6

Systematic Software Maintenance in COBOL, Chicago, IL. This seminar incorporates a mixture of structured methodologies, management strategies, solutions for effective testing, criteria development, analysis, and feedback accountability. Contact Edu-teach Inc., Suite 907, 162 North State St., Chicago, IL 60601, (312) 641-1370.

May 4-6

The Sixth Annual Rocky Mountain Data Processing Expo and Conference, Currihan Hall, Denver, CO. Some of the products to be

exhibited include computers, word processors, graphics systems, peripherals, and support services. Complete particulars are available from Industrial Presentations West, Suite 304, 3090 South Jamaica Court, Aurora, CO 80014, (303) 696-6100.

May 5-7

Teaching Math with Microcomputers, New York, NY. For details, see April 28-30.

May 9-13

The Twenty-fourth ADCIS International Conference, Marriott City Center, Denver, CO. The annual conference of the Association for the Development of Computer-based Instructional Systems (ADCIS) features workshops, novice and technical programs, presentations, poster sessions, and exhibits. For more information, contact the ADCIS International Headquarters, Miller Hall 409, Western Washington University, Bellingham, WA 98225, (206) 676-2860.

May 10-11

Selecting a Microcomputer for Scientific and Engineering Applications, Golden, CO. For details, see April 12-13.

May 10-12

Mini/Micro-Northwest, Portland, OR. Running concurrently with Northcon/83, this show addresses such topics as aerospace electronics, laser applications, and signal and image processing. Contact Electronic Conventions Inc., Suite 410, 999 North Sepulveda Blvd., El Segundo, CA 90245, (800) 421-6816; in California, (800) 262-4208 or (213) 772-2965.

May 11-15

Computa '83: The Third International Exhibition on Computer and Information Processing Technology, World Trade Centre, Singa-

pore. Complete information is available from Kallman Associates, 5 Maple Court, Ridgewood, NJ 07450, (201) 652-7070.

May 12-13

The Fourth Annual Computer Law Institute, University of Southern California Law Center, Los Angeles. This year's Institute will present a program on structuring agreements for the distribution of computer products domestically as well as internationally. Other topics include proprietary rights, anti-trust issues, and major systems procurement. An optional session on the basics of computer products and technology will be offered. Contact Ami Silverman, USC Law Center, University Park, Los Angeles, CA 90007, (213) 743-2582.

May 13-15

Applefest, Bayside Exposition Center, Boston, MA. This is the third annual Boston Applefest. More than 400 displays and booths of Apple-compatible products will be featured. Complementing the exposition will be seminars, conferences, workshops, and panel discussions. Call or write Northeast Expositions, 826 Boylston St., Chestnut Hill, MA 02167, (800) 841-7000; in Massachusetts, (617) 739-2000.

May 14-15

Toronto PET User's Group Conference, George Brown College, Casa Loma campus, Toronto, Ontario, Canada. Speakers, workshops, a trader's corner for used equipment, and exhibits of hardware, software, and accessories highlight this event. Contact Chris Bennett, TPUG Corresponding Secretary, 381 Lawrence Ave. W, Toronto, Ontario M5M 1B9, Canada, (416) 782-9252.

May 16-18

Computer Graphics for Engineering/Drafting Practice, University of Texas, Austin. This course will stress developing the ability to prescribe and implement computer graphics equipment for specific engineering applications. A two-day hands-on workshop follows the course. Contact the College of Engineering, University of Texas, Austin, TX 78712, (512) 471-3396.

May 16-18

Mini-Conferences and Professional Growth Seminars, Loews Anatole, Dallas, TX. A special feature of this event will be the introduction of the data-entry certification program. Among the topics to be addressed are motivation, training, and interviewing. Contact Marilyn S. Bodek, Data Entry Management Association, POB 3231, Stamford, CT 06905, (203) 322-1166.

May 16-19

National Computer Conference, Anaheim and Disneyland Hotel Convention Centers, Anaheim, CA. This show features exhibits of computer products and services, technical sessions, seminars, and formal addresses. For complete information, contact the American Federation of Information Processing Societies Inc., 1815 North Lynn St., Arlington, VA 22209, (703) 558-3624.

May 16-19

Patent Your Software for Profit, Anaheim, CA. This seminar, which runs concurrently with the National Computer Conference, will explore software patent examples and offer advice on patenting and licensing software. Patent reference materials will be provided. Full details are available from

Delbert L. Keenon, Automation Inc., 3410 Mona Lee, Houston, TX 77080, (713) 462-4151.

May 16-20

Auditing in the Contemporary Computer Environment, New York, NY. For details, see April 18-22.

May 16-20

Auditing Integrity Controls in the Contemporary Computer Environment, Washington, DC. For details, see April 18-22.

May 17-20

Technology/Invention New Product Expo, Expo Mart, Monroeville, PA. This show will feature everything from diesel fuel-injection systems to spring-loaded fly swatters. Further details can be obtained from Gary F. Brown, Technology/Inpex, Suite 400, 701 Smithfield St., Pittsburgh, PA 15222, (412) 288-1344.

May 18-20

The Fifth National Conference of the Cognitive Science Society, University of Rochester, Rochester, NY. This conference will consist of lectures, panels, commentaries, and papers. Contact the Cognitive Science Conference, Dewey Hall, University of Rochester, Rochester, NY 14627, (716) 275-5402.

May 18-20

Man Machine Interface, Palo Alto, CA. For full details, contact the Continuing Education Institute, Oliver's Carriage House, 5410 Leaf Treader Way, Columbia, MD 21044, (301) 596-0111; on the West Coast, call (213) 824-9545.

May 18-20

Mipro-83: The Sixth Microprocessors/Microcomputers Course/Conference, Con-

gress Center, Hotel Adriatic, Opatija, Yugoslavia. The theme for this conference is "Advanced Microcomputer Application Techniques and New Trends." It is geared toward hardware and software specialists and managers involved with the development, production, and management of microcomputer-based systems. For details, contact Mr. P. Dragojlović, Mipro Secretariat, Trg P. Togliatti 4, 51000 Rijeka, Yugoslavia.

May 19-20

Computers in Construction, Denver, CO. For details, see April 21-22.

May 19-22

Maryland Computer Show and Office Equipment Exposition, Convention Center, Baltimore, MD. Address inquiries to Dee Harris, Computer Expositions Inc., POB 3315, Annapolis, MD 21403, (800) 368-2066; in Maryland, (301) 263-8044.

May 20-22

Computers and Personal Values: Sharing from Experience, Sign of the Dove, Temple, NH. This workshop offers individuals in the computer community the opportunity to examine personal, ethical, or moral questions associated with their work and with the impact of computers on society. The format includes small and large discussion groups and invited speakers. The cost is \$150. For more information, contact Arthur Fink, Prince St., Box 614, Wilton, NH 03086, (603) 654-6518.

May 21

The Sixth Annual Spring Microcomputer Show & Tell Conference, University of Oklahoma, Norman. This conference is designed to let computer enthusiasts share

ideas and information. Six show and tell periods allow speakers to demonstrate their devices and field questions from the audience. Also featured is an on-the-spot programming contest. For additional information, contact Dr. Richard V. Andee, Mathematics Department, University of Oklahoma, Norman, OK 73019, (405) 325-3410.

May 22-25

The Eighteenth Annual Meeting and Exhibit Program of the AAMI, Loews Anatole, Dallas, TX. Topics on the docket include anesthesia instrumentation and technology, computer applications, personnel management, and technology transfer. Roundtable discussions, tutorials, and an exhibit program will be featured. For details, contact the Association for the Advancement of Medical Instrumentation, Suite 602, 1901 North Fort Meyer Dr., Arlington, VA 22209, (703) 525-4890.

May 23-27

Auditing Integrity Controls in the Contemporary Computer Environment, New York, NY. For details, see April 18-22.

May 24-26

Microprocessor Background for Management Personnel, Palo Alto, CA. The fee for this course is \$565, which includes text and program materials. Contact Continuing Education in Engineering, Department 532N, University of California Extension, 2223 Fulton St., Berkeley, CA 94720, (415) 642-4151.

May 31-June 2

The Second Canadian Computer-Aided Design/Computer-Aided Manufacturing and Robotics Exposition and Conference, International Centre of Commerce, Toron-

to, Ontario, Canada. Leading international companies will demonstrate industrial robots, automatic assembly equipment, optical scanners, and numerically controlled machine tools. Technical papers will focus on such topics as robot-vision systems and design analysis. For information, contact Hugh F. Macgregor & Associates, 662 Queen St. W, Toronto, Ontario M6J 1E5, Canada, (416) 363-2201.

May 31-June 4

The Twelfth Annual MUMPS Users' Group Meeting, Hilton Hotel, San Francisco, CA. Introductory and advanced tutorials, workshops, roundtable discussions, site visits, and hardware, software, and systems demonstrations and exhibits will be offered. Registration information is available from Charles White, Professional Associates, 2012 Big Bend Blvd., St. Louis, MO 63117.

June 1983

June

Continuing Engineering Education Courses, George Washington University, Washington, DC. Among the courses available are "Database and File Management for Microcomputers," "Computer Communications Systems and Networks," and "A Phased Approach to Software Conversion." For information, contact Douglas Green, Continuing Engineering Education, George Washington University, Washington, DC 20052, (800) 424-9773; in the District of Columbia, (202) 676-8512.

June 1-4

The First Annual Sunbelt Educational Computing Conference, Texas Tech Univer-



**MACROMEM-3
LET US IMPROVE YOUR MEMORY
WITH
A 64K/128K MACROMEM BOARD
\$499-128K**



- * Operates on Apple II(tm), Apple IIe(tm), Franklin(tm) and other compatible computers
- * Visicalc(tm) expansion capability (40/80 col)
- * Will operate directly with Magicalc(tm)-no preboot required -with 40, 70 and 80 columns for up to 512K.
- * High speed disk emulation (DOS 3.3, Pascal, CP/M (tm)). Store and retrieve files fast.
- * Gives smooth, efficient operation with Wordstar (tm), Spellstar (tm), Pascal Editor, Filer, Compiler and other popular software
- * High speed multiple disk copying with MACROSPEED supplied. Whole disk can be stored and copied at a time.
- * Competitively priced.

For more than 128K of memory or later upgrading select our DISKULATOR (64-512K). Also available are inexpensive 16/32K memory cards, MACROPRINT graphics parallel interface (scaling to 6 times, side-by-side graphics dumps, etc.) and many other products including Saturn, Prometheus, and others.

Contact MACROTECH Computer Products Ltd. for prices and product information. You may order directly from us if you cannot locate a dealer in your area with stock. Payment by VISA, M/O, bank check. Dealer/Distributor inquiries most welcome.

MACROMEM, DISKULATOR, MACROPRINT, MACROSPEED - tm of MACROTECH Computer Products Ltd.
Apple II, Apple IIe - tm of Apple Computer Inc.
Franklin - tm of Franklin Computer Inc.
VisiCalc - tm of VisiCorp.
Magicalc - tm of Artsci Inc.
CP/M - tm Digital Research Inc.
Wordstar, Spellstar - tm of MicroPro

Canada: 1370 Marine Drive, N. Vancouver, B.C. V7P 1T4 (604) 984-9305
USA: 3249 Hackett Ave., Long Beach, C.A. 90808.

MACROTECH Computer Products Ltd.

PUT PRICES IN CHECK

<p>CARTRIDGE RIBBONS FOR NEC 8023A APPLE DMP C. ITOH PROWRITER \$9.⁹⁵ EA. \$107.⁴⁶ DOZ.</p>	<p>CARTRIDGE RIBBONS FOR EPSON MX-80 MX-100 \$7.99 \$12.95 \$89.99 \$139.86 DOZ. DOZ.</p>
<p>MEMOREX DISKETTES 5 1/4" SINGLE SIDE - DUAL DENSITY \$24.99 10 PACK</p>	<p>LABEL SPECIAL \$2.⁹⁹/K (5K/MIN.) 1 ACROSS 3" .115" 16 CONTINUOUS LABELS</p>

COMPLETE LINE OF OTHER RIBBONS AVAILABLE. PLEASE CALL

ALL ABOVE PRICES INCLUDE SHIPPING

Check-Mate™

51 DIAUTO DR. P.O. BOX 103
RANDOLPH, MA 02368

TOLL FREE 800-343-7706 IN MASS 617-963-7694

WE ACCEPT MASTER CARD & VISA
MASS RESIDENTS ADD 5% SALES TAX
PHONES OPEN 9AM-7PM EASTERN TIME

NEW THIS MONTH!!

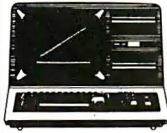
<p>EPSON FX SERIES PRINTERS FX-80 \$599 <i>Now In Stock!!</i></p>	<p>MODEL 12 80K RAM, 2 Drive \$3499 RADIO SHACK 12 Meg. HARD DISK \$3199</p>
<p>IBM P.C. 64K RAM 2 320K Drives AMDEK 300, DOS 1.1 MONOCHROME ADAPTER \$3249.95</p>	<p style="text-align: right;"><i>New</i> <i>Low Prices!</i> MODEL III TRS-80 48K 799 48K, 2 Dr. 1499</p> 
<p>COMPUTERS</p> <p>IBM P.C. \$4399.95 320K RAM Memory, two 320K Disk Drives, DOS 1.1, Color Graphics Card Hi-Res. BMC Green Screen Monitor, Parallel Card, RS-232 Serial Card, Clock, Calendar, Wordstar & Visicalc IBM P.C. \$2699.95 64K Ram Memory, two 320K Disk Drives and Drive Controller</p> <p>PRINTERS</p> <p>Epson MX-80 \$419 MX-80F-T \$499 MX-100 \$630</p> <p>Okidata ML 80 \$350 ML 83A \$425 ML 83A \$699 ML 84 \$1049</p> <p>STAR MICRONICS</p> <p>Gemini 10 \$389 Gemini 15 \$499 Smith-Corona T.P.I. \$599 Serial or Parallel</p>	<p>DISK DRIVES</p> <p>TEAC - Complete with Power Supply & Cabinet 40 Track Single Side \$229 40 Track Dual Side \$340 80 Track Single Side \$340 80 Track Dual Side \$399</p> <p>TANDON - Complete with Power Supply & Cabinet</p> <p>40 Track Single Side \$239 40 Track Dual Side \$319 80 Track Single Side \$319 80 Track Dual Side \$369</p> <p>TEAC - Bare</p> <p>40 Track Single Side \$189 40 Track Dual Side \$289 80 Track Single Side \$289 80 Track Dual Side \$349</p> <p>TANDON - Bare</p> <p>40 Track Single Side \$199 40 Track Dual Side \$269 80 Track Single Side \$269 80 Track Dual Side \$319</p>

THESE ARE OUR CASH DISCOUNTED PRICES. C.O.D. AND CHARGE ORDERS ARE 3% HIGHER. ALL COMPUTERS ARE SHIPPED FREIGHT COLLECT. PRICES, SPECIFICATIONS AND AVAILABILITY ARE SUBJECT TO CHANGE WITHOUT NOTICE. IBM & IBM PERSONAL COMPUTERS ARE TRADEMARKS OF INTERNATIONAL BUSINESS MACHINES, INC. TRS-80 AND RADIO SHACK ARE TRADEMARKS OF TANDY CORPORATION.



918/825-4844 **Small**
AMERICAN **Business**
118 SO. MILL ST **COMPUTERS**
PRYOR, OK 74361

NOW
\$11197
(Frt. Add.)

WAS
159.95



**THE CT709
PROFESSIONAL
COMPUTER
TABLE MODEL**

Incredible savings on the furniture you have wanted designed for your computer.

Ask for FREE color brochure on all models also discounted 30% through June 30, 1983. Also available FREE color full-line supplies catalog.

CALL TOLL FREE
1 (800) 525-8391

AMPERSAND, INC.
1340 WEST BAYAUD
DENVER, COLORADO 80223
1 (303) 698-0797



Event Queue

sity, Lubbock. The theme for this conference is "Practical Applications and Current Issues in Educational Computing." For complete details, write to Dr. Cleborne E. Maddux, College of Education, Texas Tech University, POB 4560, Lubbock, TX 79409.

June 5-8

Consumer Electronics Show (CES), McCormick Place, Chicago, IL. This show is sponsored by the Electronic Industries Association (EIA). For information on this popular event, contact the Consumer Electronics Shows Office, Suite 1607, Two Illinois Center, 233 North Michigan Ave., Chicago, IL 60601, (312) 861-1040.

June 5-8

Mini-Conferences and Professional Growth Seminars, Registry Resort Hotel, Scottsdale, AZ. For details, see May 16-18.

June 5-9

The Twelfth Annual International Software AG Users' Conference, Fairmont and Royal Sonesta Hotels, New Orleans, LA. This conference will feature speakers, presentations, workshops, and tutorials. Contact Paula J. Brooks, Software AG of North America Inc., 11800 Sunrise Valley Dr., Reston, VA 22091, (703) 860-5050.

June 6-8

The Fifth Annual National Educational Computing Conference-NECC 83, Towson State University, Baltimore, MD. This conference provides a broad forum for discussion among individuals at all levels and from all institutions sharing an interest in educational computing. Papers will address such issues as computer education for

teachers, computer education and job opportunities for the handicapped, and accreditation and certification programs. Tutorials will be held, and demonstration and exhibit areas will emphasize computer uses in instruction. For registration forms, contact Doris K. Lidtke, NECC 83, Department of Mathematics and Computer Science, Towson State University, Baltimore, MD 21204.

June 6-8

The Sixth International Conference on Computers and the Humanities-ICCH/83, North Carolina State University, Raleigh, NC. This conference serves as a forum for the exchange of ideas on the use of computers in all areas of the humanities. Features include formal sessions and related activities, discussion groups, tutorials, workshops, and exhibits. For details, write to Dr. Sarah K. Burton, Department of English, POB 5308, North Carolina State University, Raleigh, NC 27650.

June 7-8

International Conference on the Use of Micros in Fluid Engineering, Tara Hotel, London, England. All aspects of the use of microcomputers and microprocessors in fluid engineering will be covered. Subjects of interest include developing software for fluid-engineering design, rapid response controllers, and data-acquisition and analysis on-site. Full details are available from the Organizing Secretary, Micros in Fluid Engineering, BHRA Fluid Engineering, Cranfield, Bedford MK43 0AJ, England; tel: (0234) 750422; Telex: 825059.

June 7-9

International Computer Show, Velodrome, Olympic site, Montreal, Quebec, Canada. This trade show is designed for businesses wish-

ing to identify or compare computers and equipment for automating the office or for industrial activities. The public is invited. Contact Industrial Trade Shows of Canada, 20 Butterick Rd., Toronto, Ontario, M8W 3Z8, Canada, (416) 252-7791.

June 7-9

Maptek Europe 1983: Annual Strategy Conference, Hotel Excelsior, Venice, Italy. This meeting will provide detailed market forecasts and strategic recommendations for computer systems, network information services, communications and teleconferencing, office systems, and departmental integration. Contact Robert B. King, Quantum Science Corp., 1114 Avenue of the Americas, New York, NY 10036, (212) 997-0070. In Europe, contact Constantine E. Adraktas, Quantum Science Corp., 16 Charles II St., London SW1Y 4QU, England; tel: (01) 839-5347.

June 7-11

The Third Rochester FORTH Applications Conference, Laboratory for Laser Energetics, University of Rochester, NY. This conference is sponsored by the Institute for Applied FORTH Research Inc. Guest speakers will cover robotics and FORTH in a special one-day session. For complete details, contact Diane Ranocchia, Institute for Applied FORTH Research Inc., 70 Elmwood Ave., Rochester, NY 14611, (716) 235-0168.

June 8-10

The International Conference on Consumer Electronics-ICCE, Ramada the O'Hare Inn, Des Plaines, IL. Technical papers and panel discussions will address such issues as personal computing, low-cost printers, and computer-aided design/manufacturing techniques. Products will be displayed. This conference is sponsored by the Consumer

Electronics Society of the Institute of Electrical and Electronics Engineers. Contact ICCE, POB 149, Bloomington, IL 60108.

June 9-11

Microcomputers in Education, Watertown, CT. For details, see April 28-30.

June 13-15

Analysis and Design-Oriented Techniques, Los Angeles, CA. For details on this power electronics course, contact Teslaco, Suite 6, 490 South Rosemead Blvd., Pasadena, CA 91107, (213) 795-1699.

June 13-15

Systematic Software Maintenance, Chicago, IL. Topics to be addressed include structured methodologies, solutions for effective testing, resource allocation, and status determination. Full details are available from Eduteach Inc., Suite 907, 162 North State St., Chicago, IL 60601, (312) 641-1370.

June 14-16

Introduction to Microprocessors, University of Texas, Austin. This course will stress basic concepts and hands-on experience. Participants will write and run simple programs on a Z80-based Micro-Professor training system. Contact the College of Engineering, University of Texas, Austin, TX 78712, (512) 471-3396.

June 14-16

Ohmcon/83, High-Technology Electronics Exhibition and Convention, Cobo Hall, Detroit, MI. For information, contact Electronic Conventions Inc., 999 North Sepulveda Blvd., El Segundo, CA 90245, (800) 421-6816; in California, (213) 772-2965.

June 14-18

Tectronica, Earls Court Exhibition Centre, London, England. This exhibition on

laboratory technology, aims to show the latest in instrumentation, equipment, and services for life and physical sciences. For details, contact Good Relations Ltd., 15 Adeline Place, London WC1B 3AJ, England; tel: (01) 636-6561; Telex: 265903.

June 15-17

Basics of Power Electronics, Los Angeles, CA. For information on this course, contact Teslaco, Suite 6, 490 South Rosemead Blvd., Pasadena, CA 91107, (213) 795-1699.

June 15-17

The Twenty-first Annual Meeting of the Association for Computational Linguistics, Massachusetts Institute of Technology, Cambridge, MA. Papers to be presented will address syntax, the representation of knowledge,

machine and machine-aided translation, and other linguistically and computationally significant topics. Information is available from Don Walker, Artificial Intelligence Center, SRI International EJ278, Menlo Park, CA 94025, (415) 859-3071.

June 15-18

1984 Oceania Party Nominating Convention, London. Delegates to this plenipotentiary assembly will discuss the latest developments in viewscreen technology and select candidates for Inner-Party offices and for the office of Big Brother. For information, contact Eric Arthur Blair, Ministry of Truth, Wigan Pier, Craighouse, Jura, UK.

June 16-17

Clinical Laboratory Computers: Symposium 1983,

BREAKTHROUGH

NEW



IMMEDIATE DELIVERY

INCOMM AUTO DIAL 300/1200 (212A) MODEM FOR \$599.00 INTRODUCTORY GET ACQUAINTED PRICE!

(For A Limited Time Only!)

FOR A AUTOMATIC DIALING

300/1200 BAUD MODEM \$495⁰⁰

(Limit Two Per Customer) *Compatible with Hayes

YOU DO NOT NEED A TELEPHONE

"To originate or to receive a call" Simply hook up the modular jack (RJ11C) directly to the phone line, then type the phone number in your terminal or Microcomputer and the INCOMM Auto Dial 212A Modem will automatically dial the number and make the connection. It will then remember the number and will redial by a simple command. The reliability of all INCOMM products is so high that we back our products with a full TWO YEAR WARRANTY!"

DEALER INQUIRIES INVITED!

(Some selected territories are still available)

CALL COLLECT TO ORDER DESK ONLY (312) 459-8874

(Bank Cards Accepted)

INCOMM

115 N. Wolf Road

Wheeling, IL 60090

(312) 459-8881

From Computer Plus to YOU...

PLUS after PLUS after PLUS

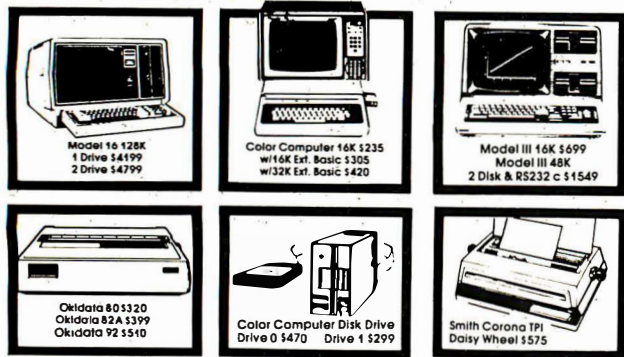

BUY DIRECT Here are just a few of our fine offers... call TOLL FREE for full information.

COMPUTERS		R S Acoustic Coupler AC-3	134	DISK DRIVES	
Model 1264K 1 Drive	\$2699	R S Modem I D C	130	R S Model III 1ST Drive	650
Model 1264K2 Drive	3375	R S Modem II D C	210	Tandon 40 Track Mill	289
Model III 4K LEV I	599	Signalman Modem	89	Color Computer Drive 1	299
MODEL III 16K	699	PRINTERS		Color Computer Drive 0	470
MODEL III 48K	764	Daisy Wheel II	1715	Primary Hard Disk Mill	3099
Model III 48K	1335	DWP-410	1335	Primary Hard Disk Mill	1999
2 Disk & RS232 c	1549	SmithCorona TPI DaisyWheel	575	ETC.	
Color Computer 16k	235	Epson MX80	499	CCR-81 recorder	52
Color Computer 16k		Epson MX80F1	549	C C Joysticks	22
w/extended basic	305	Epson MX100	735	16K RAM N E C 200 N S chips	25
Color Computer 32k-64k		CGP-115	109	64K Ram Chips	75
w/extended basic	420	DMP-100	315	Color Computer Flop D O S	99
Pocket Computer 2	230	DMP-200	599	32k MicroButler Inline	229
Model 161DR 128K	4199	DMP-400	1029	Brand Name Software	
Model 16 2DR 128K	4799	DMP-500	1569	Send for listing	
DT-1 Data Terminal	599	Okidata80	320	R S Software 10% off list	
PI-210 Portable Terminal	779	Okidata82A	399		
MODEMS		Okidata83A	655		
Lynx Direct Connect III/Mill	235	Okidata 84 Parallel	999		
Hayes Smart Modem II	235	Okidata92	510		
Hayes Smart Modem 1200	565	Okidata93	859		
NovationSmartcal 1200	459	P C Plotter Printer	199		

Since 1973 - We have the lowest possible Fully Warranted Prices AND a full complement of Radio Shack Software.

Prices subject to change without notice. Not responsible for typographical errors. RS-80 is a registered trademark of Tandy Corp.



TOLL FREE 1-800-343-8124
computer plus

P.O. Box 1094
480 King Street
Littleton, MA 01460
617-486-3193

Write for your free catalog

Event Queue

Towsley Center for Continuing Medical Education, Ann Arbor, MI. Course credit will be offered. Contact the Office of Continuing Medical Education, Towsley Center Box 057, University of Michigan Medical School, Ann Arbor, MI 48109, (313) 763-1400.

June 17-19
PC '83/West, Brooks Hall/Civic Center Complex, San Francisco, CA. This show will bring together users, developers, distributors, and retailers of products compatible with the IBM Personal Computer. Seminars, workshops, demonstrations, and a conference program will aim to educate users on product features and capabilities. Conference information is available from Northeast Expositions, 826 Boylston St., Chestnut Hill, MA 02167, (800) 841-7000; in Massachusetts, (617) 739-2000.

June 19-23
Conference on Computer Vision and Pattern Recognition-CVPR '83, Crystal City Hyatt, Arlington, VA. This program was formerly known as the Pattern Recognition and Image Processing Conference. Papers on vision, pattern recognition, and image processing will be delivered. For full details, write to CVPR '83, POB 639, Silver Spring, MD 20901.

June 23
The Twenty-second Annual Technical Symposium of the Washington DC Chapter of

the Association for Computing Machinery, National Bureau of Standards, Gaithersburg, MD. The theme for this event is "Microcomputer Systems: Tools or Toys?" Topics of interest include systems software, human factors, and office systems. Contact Howard Weeks Associates, 15201 Shady Grove Rd., Rockville, MD 20850.

June 27-30
The World of CAD/CAM, Marriott Resort, Newport Beach, CA. This seminar consists of four one-day presentations: computer-aided engineering (CAE), computer-aided design (CAD), computer-aided manufacturing (CAM), and computer-integrated manufacturing (CIM). It seeks to give a complete overview of how manufacturing will change in the future as the automated factory becomes a reality. For a brochure, write or call the Center for Manufacturing Technology, 4170 Crossgate Dr., Cincinnati, OH 45236, (513) 791-8801.

June 28-30
National Educational Computer Conference, New York Statler, New York, NY. The theme is "Higher Instructional Techniques in Education." Seminars, exhibits, hands-on demonstrations, and workshops will highlight this event. Further information is available from the National Educational Computer Library, POB 293, New Milford, CT 06776, (203) 354-7760. ■

In order to gain optimal coverage of your organization's computer conferences, seminars, workshops, courses, etc, notice should reach our office at least three months in advance of the date of the event. Entries should be sent to: Event Queue, BYTE Publications, POB 372, Hancock NH 03449. Each month we publish the current contents of the queue for the month of the cover date and the two following calendar months. Thus a given event may appear as many as three times in this section if it is sent to us far enough in advance.

OSBORNE

Games □ Languages □ Utilities

Now 7 arcade action games with full graphics: INVADERS, MUNCHKIN, SPACE PIRATES, SNAKE and the new ARCTURUS TRILOGY. Plus The Original ADVENTURE and MYCHESS championship chess with full graphics.

Word processing programs: Spelling proofreader (50,000 words), file difference detector and more.

Languages for advanced programmers: Top-rated "C" COMPILER (fastest in BYTE benchmark), LISP, RATFOR, 8080, Z80 MACRO ASSEMBLERS. Plus five utilities, and more.

FREE CATALOG

For your free software catalog: (1) see your nearest Osborne dealer (2) call us (3) circle our reader service number or (4) write us.

Osborne I is a registered trademark of Osborne Computer Corp.



The Software Toolworks®

15233 Ventura Blvd, Suite 1118,
Sherman Oaks, CA 91403.
(213) 986-4885

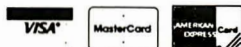

Books Received

Apple II Assembly Language Exercises, Leo J. Scanlon. New York: John Wiley & Sons, 1982; 205 pages, 50 by 66 cm, softcover, ISBN 0-471-86598-2, \$9.95.

BASIC Analysis of Variance Programs for Microcomputers, Allen H. Wolach. Monterey, CA: Brooks/Cole Publishing Co., 1983; 162 pages, 44 by 55 cm, softcover, ISBN 0-534-01423-2, \$8.95.

Basic Mathematics for Electronics, 5th edition, Nelson M. Cooke, Herbert F. R. Adams, and Peter B. Dell. New York: Gregg/McGraw-Hill, 1982; 698 pages, 46 by 58 cm, hardcover, ISBN 0-07-012514-7, \$21.65.

The Computer Tutor, Learning Activities for Homes and Schools, Gary W. Orwig and William S. Hodges. Boston, MA: Little, Brown and Company, 1982; 203 pages, 50.5 by 66 cm, softcover, ISBN 0-87626-147-0, \$10.95.

The Cosmic Mind-Boggling Book, Neil McAleer. New York: Warner Books, 1982; 207 pages, 31.6 by 47.6 cm, softcover, ISBN 0-446-97663-6, \$7.95.

CP/M Simplified, Jeffrey R. Weber. Cleveland, OH: Weber Systems Inc. (8437 Mayfield Rd.), 1982; 316 pages, 32 by 51 cm, softcover, ISBN 0-938862-04-9, \$13.95.

Developing Computer Solutions for Your Business Problems, Henry H. Petersohn. Englewood Cliffs, NJ: Prentice-Hall, 1982; 157 pages, 41 by 56 cm, softcover, ISBN 0-13-204305-X, \$14.95.

The 8086/8088 Primer, 2nd edition, Stephen P. Morse. Rochelle Park, NJ: Hayden Book Co., 1982; 276 pages, 36.6 by 54 cm, softcover, ISBN 0-8104-6255-9, \$10.95.

Engineering a Compiler, VAX-11 Code Generation

and Optimization, Patricia Anklam, David Cutler, Roger Heinen Jr., and M. Donald MacLaren. Bedford, MA: Digital Press, 1982; 269 pages, 39 by 58 cm, hardcover, ISBN 0-932376-19-3, \$24.

Exploring the Worlds of Computers, Donald D. Spencer. Ormond Beach, FL: Camelot Publishing Co., 1982; 102 pages, 37 by 56 cm, hardcover, ISBN 0-89218-055-2, \$10.95.

49 Explosive Games for the ZX81, Tim Hartnell, ed. Reston, VA: Reston Publishing Co., 1981; 140 pages, 36 by 54 cm, softcover, ISBN 0-8359-2086-0, \$10.95.

Fundamentals of Microcomputer Programming, Including Pascal, Daniel R. McGlynn. New York: John Wiley & Sons, 1982; 332 pages, 35 by 54 cm, softcover, ISBN 0-471-08769-6, \$14.95.

How to Write and Publish Engineering Papers and Reports, Herbert B. Michaelson. Philadelphia, PA: ISI Press, 1982; 155 pages, 37 by 55 cm, hardcover, ISBN 0-89495-016-9, \$17.95.

How to Write a TRS-80 Program, Ed Faulk. Chatsworth, CA: Datamost Inc. (9748 Cozycroft Ave.), 1982; 220 pages, 32 by 49.5 cm, softcover, ISBN 0-8359-2992-2, \$14.95.

Introduction to Modern Information Retrieval, Gerard Salton and Michael J. McGill. New York: McGraw-Hill, 1983; 448 pages, 41 by 57.6 cm, hardcover, ISBN 0-07-054484-0, \$32.95.

Invasion of the Space Invaders, Martin Amis. London, England: Hutchison & Co. Ltd. (17-21 Conway St.), 1982; 128 pages, 50 by 70 cm, softcover, ISBN 0-09-047841-3, \$9.95.

Invitation to Ada & Ada Reference Manual, Harry

Katzan Jr. Princeton, NJ: Petrocelli Books, 1982; 429 pages, 43 by 62 cm, hardcover, ISBN 0-89433-132-9, \$29.95.

Language Translators, John Zarella. Suisun City, CA: Microcomputer Applications (POB E), 1982; 200 pages, 36 by 54 cm, softcover, ISBN 0-935230-06-8, \$12.95.

Mastering Machine Code on Your ZX81, Toni Baker. Reston, VA: Reston Publishing Co., 1981; 180 pages, 36 by 54 cm, softcover, ISBN 0-8359-4261-9, \$12.95.

The Microchip: Appropriate or Inappropriate Technology? Alan Burns. New York: Halsted Press, 1981; 180 pages, 36 by 55 cm, hardcover, ISBN 0-470-27206-6, \$39.95.

Micro Cookbook, Volume 1: Fundamentals, Don Lancaster. Indianapolis, IN: Howard W. Sams & Co., 1982; 381 pages, 32 by 51 cm, softcover, ISBN 0-672-21828-3, \$15.95.

Microprocessor Data Book, S. A. Money. New York: McGraw-Hill, 1982; 264 pages, 51 by 66 cm, hardcover, ISBN 0-07-042706-2, \$38.

Microprocessor Operating Systems, volume II, John Zarella, ed. Suisun City, CA: Microcomputer Applications (POB E), 1982; 158 pages, 36 by 54 cm, softcover, ISBN 0-935230-04-1, \$12.95.

101 Pocket Computer Programming Tips & Tricks, Jim Cole. Woodsboro, MD: Arcsoft Publishers, 1981; 128 pages, 33 by 51 cm, soft-

OLIVETTI'S PRAXIS 30 PERSONAL PRINTER

PRAXIS MAKES PERFECT™

AT THE PERFECT PRICE:

\$599*



* add \$10 for shipping

- * PORTABLE DAISY WHEEL PRINTER
- * CENTRONICS AND WORDSTAR COMPATIBLE
- * SERVICE FROM OLIVETTI DEALERS
- * OLIVETTI APPROVED

* VARIABLE PITCH ON PRAXIS 35, ADD \$100

TO ORDER SEE YOUR LOCAL DEALER, OR SEND CHECK OR MONEY ORDER TO:



ARK MICROSYSTEMS
P.O. BOX 4190
ANN ARBOR, MI 48106
(313) 769-7253



Books Received

cover, ISBN 0-86668-004-7, \$7.95.

Osborne CP/M User Guide, 2nd edition, Thom Hogan. Berkeley, CA: Osborne/McGraw-Hill, 1982; 280 pages, 39 by 55 cm, softcover, ISBN 0-931988-82-9, \$15.95.

PATCA, Directory of Consultants, San Jose, CA: PATCA (Professional and Technical Consultants Association, Suite 3, 1190 Lincoln Ave.), 1982; 110 pages, 33 by 51 cm, softcover, ISBN 0-939-840-01-4, \$5.

The PET Index, Michael A. F. Ryan. Aldershot, Hampshire, England: Gower Publishing Ltd. (Gower House, Croft Rd.), 1982; 194 pages, 49.6 by 70 cm, softcover, ISBN 0-566-03426-3, \$12.50.

The Power of Supercalc, Robert E. Williams and Bruce J. Taylor. Englewood Cliffs, NJ: Prentice-Hall, 1982; 110

pages, 50 by 64.6 cm, softcover, ISBN 0-13-687301-4, \$9.95.

The Power of Visicalc, Robert E. Williams and Bruce J. Taylor. Englewood Cliffs, NJ: Prentice-Hall, 1981; 88 pages, 50 by 64.6 cm, softcover, ISBN 0-13-687418-5, \$9.95.

The Power of Visicalc, Real Estate, Patricia J. Hughes and Kaz Ochi. Englewood Cliffs, NJ: Prentice-Hall, 1981; 166 pages, 50.6 by 65 cm, softcover, ISBN 0-13-687350-2, \$14.95.

The Power of Visiplot-Visicalc-Visifile, Patricia J. Hughes and Kaz Ochi. Englewood Cliffs, NJ: Prentice-Hall, 1981; 154 pages, 50.6 by 65 cm, softcover, ISBN 0-13-687368-5, \$14.95.

Programming Concepts with the Ada Language, Roy S. Freedman. Princeton, NJ:

Petrocelli Brooks, 1982; 162 pages, 33 by 49 cm, softcover, ISBN 0-89433-190-6, \$12.

Programming the 6809, Rodney Zaks and William Labiak. Berkeley, CA: Sybex, 1982; 362 pages, 35 by 54 cm, softcover, ISBN 0-89588-078-4, \$14.95.

Programming Microcomputers with Pascal, M. D. Beer. New York: Van Nostrand Reinhold, 1982; 256 pages, 36 by 56 cm, softcover, ISBN 0-442-21368-9, \$13.95.

Software Manual Production Simplified, Richard Zaneski. Princeton, NJ: Petrocelli Books, 1982; 190 pages, 33 by 51 cm, hardcover, ISBN 0-89433-180-9, \$20.

So You Are Thinking About a Small Business Computer, R. G. Canning and N. C. Leeper. Englewood Cliffs, NJ: Prentice-Hall, 1982; 203 pages, 51 by 66 cm, softcover, ISBN 0-13-823617-

8, \$10.95.

SPPC Manual, A Statistical Package for the Pocket Calculator, Walter W. Hudson. Tallahassee, FL: Walmyr Publishing Co. (POB 3554, Leon Station), 1982; 330 pages, 36 by 54 cm, softcover, ISBN 0-942390-01-6, \$14.95.

Using Computers in Mathematics, Gerald H. Elgarten, Alfred S. Posamentier, and Stephen E. Moresch. Reading, MA: Addison-Wesley, 1983; 575 pages, 52 by 57 cm, hardcover, ISBN 0-201-10450-4, \$18.60.

Z8000 Handbook, Martin L. Moore. Englewood Cliffs, NJ: Prentice-Hall, 1982; 398 pages, 41 by 55 cm, softcover, ISBN 0-13-983866-X, \$14.95.

The ZX81 Pocket Book, Trevor Toms. Reston, VA: Reston Publishing Co., 1981; 128 pages, 36 by 54 cm, softcover, ISBN 0-8359-9524-0, \$10.95. ■

a message to our subscribers

From time to time we make the BYTE subscriber list available to other companies who wish to send our subscribers promotional material about their products. We take great care to screen these companies, choosing only those who are reputable, and whose products, services or information we feel would be of interest to you. Direct mail is an efficient medium for presenting the latest personal computer goods and services to our subscribers.

Many BYTE subscribers appreciate this controlled use of our mailing list, and look forward to finding information of interest to them in the mail. Used are our subscribers' names and addresses only (no other information we may have is ever given).

While we believe the distribution of this information is of benefit to our subscribers, we firmly respect the wishes of any subscriber who does not want to receive such promotional literature. Should you wish to restrict the use of your name, simply send your request to the following address.

BYTE Publications Inc
Attn: Circulation Department
70 Main St
Peterborough NH
03458

This is a list of books received at BYTE Publications during this past month. Although the list is not meant to be exhaustive, its purpose is to acquaint BYTE readers with recently published titles in computer science and related fields. We regret that we cannot review or comment on all the books we receive; instead, this list is meant to be a monthly acknowledgment of these books and the publishers who sent them.

BYTE's Bits

Computers Sparkle In Pearl City

A new pearl was added to the Pearl of New Jersey's string of casinos, hotels, and visitor attractions late last month. The grand opening of Ocean One, a three-level shopping, restaurant, entertainment, and exhibition hall resembling a 900-foot oceanliner, was held at the end of March.

The highlight of Ocean One is Computerama 21, a year-

round computer show featuring products from more than 30 computer manufacturers. Printers, software, and accessories will be on display, and a staff of trained technical personnel are on hand to answer questions.

Computerama is open 7 days a week, 14 hours a day. It's located on Arkansas Avenue, near the boardwalk. ■

Software Received

Apple

Accounts Payable, an accounting package. This module will maintain accounts-payable records and link with other State of the Art accounting packages. For the Apple III; floppy disk, \$595. State of the Art, 3183-A Airway Ave., Costa Mesa, CA 92626.

A. E., an arcade-type game. The robots are running amuck, and you must destroy them or force them away from the earth. For the Apple II; floppy disk, \$34.95. Broderbund Software Inc., 1938 Fourth St., San Rafael, CA 94901.

Air Navigation Trainer, a flight-simulation program. Pilots can watch a simulation of their flying techniques using navigation aids and making course corrections. For the Apple II and III; floppy disk, \$40. Space-Time Associates, 20-39 Country Club Dr., Manchester, NH 03102.

Apple II Business Graphics, a utility package that performs data analyses and transforms numerical data into simple illustrations. For the Apple II; floppy disk, \$175. Apple Computer Inc., 20525 Mariani Ave., Cupertino, CA 95014.

Bank Street Writer, a home-oriented word-processing system. This package includes all essential word-processing functions and features an interactive tutorial program on the disk. For the Apple II; floppy disk, \$69.95. Broderbund Software Inc. (see address above).

BASIC Compiler+, a utility program to convert Apple-soft BASIC programs into machine-language files. True integer arithmetic, array vectors, and optimal memory utilization are provided. For the Apple II; floppy disk, \$99.95. Hayden Software Co., 600 Suffolk St., Lowell, MA 01853.

Bellhop, an arcade-type

game. The object of this game is to pick up one piece of luggage at a time and deliver it to the correct suite until all seven pieces are delivered. Your tips depend on speed. For the Apple II; floppy disk, \$34.95. Hayden Software Co. (see address above).

Black Jack Strategy, a program that allows you to test and analyze various strategies of playing blackjack. You set up the bets and the game-playing simulation to develop a winning strategy. For the Apple II; floppy disk, \$69.95. Soft Images, 200 Route 17, Mahwah, NJ 07430.

Black/Kayles, an educational game. Play with a friend or against the computer to fill in the puzzle. The game helps students develop their mathematical strategies. For the Apple II Plus; floppy disk, \$25. Island Software, Department B, POB 300, Lake Grove, NY 11755.

Championship Golf, a golf-simulation game for one to four players. Each hole is displayed from two angles. Players have a choice of 20 clubs. For the Apple II; floppy disk, \$24.95. Hayden Software Co. (see address above).

Crime Stopper, an adventure-type game. You assume the role of a detective who must overcome many obstacles to locate a kidnapped heiress. For the Apple II; floppy disk, \$34.95. Hayden Software Co. (see address above).

Crystal Caverns, an adventure-type game. Without a map, you must hunt for treasure in the caves beneath an old mansion. For the Apple II; floppy disk, \$34.95. Hayden Software Co. (see address above).

Datafax, an unconstructed database-management system that uses keywords to organize non-numeric information. You can categorize and cross-reference information. For the Apple II and III; flop-

py disk, \$199 and \$249, respectively. Link Systems, 1640 19th St., Santa Monica, CA 90404.

Data Plotting Software for Micros, data-analysis tools. This collection of 21 data-plotting programs will help you analyze data and produce a variety of charts. For the Apple II; floppy disk, \$19.95. Kern Publications, 190 Duck Hill Rd., POB 1029, Duxbury, MA 02332.

dBRx, a package of routines to expand the functional capabilities of Ashton-Tate's dBASE II. New functions include sine, cosine, logarithm, exponentiation, and square root. For the Apple II; floppy disk, \$150. Gryphon Micro-products, POB 6543, Silver Spring, MD 20906.

Evolution, an adventure-type game. Work your way up the evolutionary ladder from amoeba to human while avoiding various predators. For the Apple II; floppy disk, \$39.95. Sydney Development Corp., 600-1385 West 8th Ave., Vancouver, British Columbia V6H 3V9, Canada.

Final Conflict, a simulation game. You must program an army of robots to invade and destroy the enemy's central controller. Requires game paddle. For the Apple II; floppy disk, \$34.95. Hayden Software Co. (see address above).

Financial Planning for Multiplan, a set of 17 templates to use with the Multiplan electronic-spreadsheet system. For the Apple II; floppy disk, \$69.95. Howard W. Sams & Co. Inc., 4300 West 62nd St., POB 7092, Indianapolis, IN 46206.

Financial Planning for Visicalc, a set of 17 templates for use with the Visicalc electronic-spreadsheet system. For the Apple II; floppy disk, \$69.95. Howard W. Sams & Co. Inc. (see address above).

Flip Out, an arcade-type strategy game. You are given

10 marbles. You must drop your marbles into the flip-out course in such a way that all your marbles exit before your opponent's. For the Apple II; floppy disk, \$29.95. Sirius Software Inc., 10364 Rockingham Dr., Sacramento, CA 95827.

Foreign Language Series, a French or Spanish vocabulary drill package. Students can respond to quizzes by answering in either English or a foreign language. Special drills can be created. For the Apple II Plus; floppy disk, \$80. Island Software (see address above).

General Ledger, an accounting package. This module will maintain a general ledger with simplified journal entry and audit trails, and will link with other State of the Art accounting packages. For the Apple III; floppy disk, \$595. State of the Art (see address above).

Jigsaw, a set of four picture puzzles to assemble. Each puzzle has 24 pieces that you assemble on the screen. The set increases in difficulty. For the Apple II Plus; floppy disk, \$25. Island Software (see address above).

Know Your Apple, an educational program that uses high-resolution pictures to demonstrate how the Apple computer works. For the Apple II; floppy disk, \$34.95. Muse Software, 347 North Charles St., Baltimore, MD 21201.

Magic Mailer, a mailing-list management system. This program can merge a form-letter file with a data file or keyboard input to create customized form letters. For the Apple II Plus; floppy disk, \$69.95. Artsci Inc., 5547 Satsuma Ave., North Hollywood, CA 91601.

Magic Window Diablo, a printer-driver program for the Diablo series of printers that uses the Magic Window word-processing system. For

Software Received

the Apple II; floppy disk, \$19.95. Artsci Inc. (see address above).

Magic Window NEC, a printer-driver program for the NEC Spinwriter that uses the Magic Window word-processing system. For the Apple II; floppy disk, \$19.95. Artsci Inc. (see address above).

Magic Window II, a word-processing system. This improved version of the Magic Window system features a 70-column uppercase and lowercase display, 160-character line length, and hard-disk support. For the Apple II; floppy disk, \$149.95. Artsci Inc. (see address above).

Magic Words, a spelling-checker system. This program features a 14,000-word dictionary that can be customized. It works with any Apple-compatible word-processing program that uses standard Apple DOS. For the Apple II; floppy disk, \$69.95. Artsci Inc. (see address above).

Microbe: The Anatomical Adventure, an adventure game based on medical facts. You command a miniature submarine through your patient's body, fighting off deadly organisms as you go. For the Apple II; floppy disk, \$44.95. Synergistic Software, Suite 201, 830 North Riverside Dr., Renton, WA 98055.

Micro Mother Goose, a set of games and animated stories. Designed for children aged 3 to 9 years, this package provides three games and nine animated comics with traditional music. For the Apple II; floppy disk, \$39.95. Software Productions Inc., 2357 Southway Dr., POB 21341, Columbus, OH 43221.

Modula-2, a general-purpose programming language designed for systems implementation. Written by Niklaus Wirth, the author of Pascal, Modula-2 is based in part on Pascal and features modules and separate compilation. For the Apple II and III; floppy disk, \$550. Volition

Systems, POB 1236, Del Mar, CA 92014.

Paint Master, a design utility program that allows you to draw or paint high-resolution pictures on the screen, fill in colored sections, and save the drawings on disk. For the Apple II Plus; floppy disk, \$34.95. Avant-Garde Creations, POB 30160, Eugene, OR 97403.

Pandemonium, a challenging word game that contains a built-in dictionary. See how many words you can spell from the letters in a 5 by 5 grid. For one or more players. For the Apple II; floppy disk, \$39.95. Soft Images (see address above).

The Prime Plotter, a statistical-analysis and graphics development package. Using menu-driven commands, you can create a variety of charts and have them printed or drawn by a plotter. For the Apple II Plus; floppy disk, \$239.95. Primesoft Corp., POB 40, Cabin John, MD 20818.

Puss in Boot, an educational program to teach positional concepts to children from preschool through the primary grades. Graphics appear at random to demonstrate In, Out, Left, Right, On, Off, Over, Under, and more. For the Apple II Plus; floppy disk, \$25. Island Software (see address above).

Repton, an arcade-type game. You control the Star Fighter *Armageddon*. Your mission is to save Repton from the Quarriors. You have a laser gun, radar screen, and energy shields. For the Apple II; floppy disk, \$39.95. Sirius Software Inc. (see address above).

Roadsearch, a computerized road atlas. This database of 406 cities and road junctions in the U.S. and Canada allows you to enter a starting point and a destination. You receive a detailed route plan for your next trip by car and save time, money, and gas.

For the Apple II Plus; floppy disk, \$34.95. Columbia Software, POB 2235, Columbia, MD 21045.

Sea Dragon, an arcade-type game. You must navigate the nuclear submarine *Sea Dragon* through a sea filled with deadly obstacles. For the Apple II; floppy disk, \$34.95. Adventure International, POB 3435, Longwood, FL 32750.

Senior Analyst, a modeling program that allows financial planners to analyze and review data. Create models from a common database within the program, or combine many models into one. For the Apple II; floppy disk, \$225. Apple Computer Inc. (see address above).

U.S. Cities, an educational program. Students learn to use a map of the United States. Coordinate locations of major cities are shown on high-resolution displays. For the Apple II Plus; floppy disk, \$25. Island Software (see address above).

Wavy Navy, an arcade-type game. You pilot a PT boat in 30-foot waves while surrounded by enemy planes, helicopters, mines, and missiles. For one to four players. For the Apple II; floppy disk, \$34.95. Sirius Software Inc. (see address above).

Atari

Bulldog Pinball, an arcade-type game. This computer version of a pinball game lets you score points, use flippers, and control ball speed. It features graphics and sound. For the Atari 400/800; cassette, \$29.95. Hayden Software Co., 600 Suffolk St., Lowell, MA 01853.

Castle Wolfenstein, an adventure-type game. You have been captured by Nazis and taken to Castle Wolfenstein for interrogation. You must find the secret war plans and escape. For the Atari 400/800; floppy disk, \$29.95. Muse Software, 347 North Charles

St., Baltimore, MD 21201.

Dragonfire, a video game. Help the prince reclaim the king's treasures. Cross bridges and dodge dragon fire in the quest. For the Atari Video Computer System; cartridge, \$32.95. Imagic, 1875 Dobbin Dr., San Jose, CA 95133.

River Raid, an arcade-type game. You are piloting a B-1 strato-wing assault jet. Your mission is to seek and destroy enemy targets on a dangerous river course. For the Atari Video Computer System; cartridge, \$31.95. Activision Inc., Drawer #7286, Mountain View, CA 94042.

Sea Dragon, an arcade-type game (see description under Apple). For the Atari 400/800; floppy disk, \$34.95. Adventure International, POB 3435, Longwood, FL 32750.

Serpentine, an arcade-type game. You control three blue serpents. Your object is to destroy the hostile orange serpents and create more blue ones. For the Atari 400/800; floppy disk, \$34.95. Broderbund Software Inc., 1938 Fourth St., San Rafael, CA 94901.

Speed Track, a simulation game. Place your bets, watch six horses race toward the finish line, and collect your winnings. For up to eight players. For the Atari 400/800; cassette, \$19.95. Brenner, POB 459, Plainview, NY 11803.

Stratos, an arcade-type game. One or two players can defend a futuristic city from attack by alien spacecraft. For the Atari 400/800; floppy disk, \$34.95. Adventure International (see address above).

Wayout, an arcade-type game. You have a choice of 26 three-dimensional mazes to explore. Look for the fireflies, but beware of the Cleptangle. Wayout glasses and compass included. For the Atari 400/800; floppy disk, \$39.95. Sirius Software, 10364 Rockingham Dr., Sacramento, CA 95827.

Commodore

AC Network Analysis, a program to analyze an AC network with both passive components and transistors. Results are in decibel magnitude, return loss, and phase. For the Commodore 64, PET, and VIC-20; cassette, \$25. R. K. Altenbach, 31 Garner Rd., Stow, MA 01775.

Beginners Assembly Language Programming, a book and software combination that teaches the basics of assembly-language programming. For the Commodore VIC-20; cassette. Price not available. Honeyfold Software Ltd., Standfast House, Bath Place, High St., Barnet, London, England.

Conquer, a medieval strategy game. The object of this game is to conquer as many countries as possible. For 1 to 15 players. For the Commodore VIC-20; floppy disk or cassette, \$16.95. Computer Knowledge, 100 Grove St., Worcester, MA 01605.

The Dungeon, an arcade-type game. Escape an ever-expanding dungeon while meeting monsters, thieves, trap doors, secret keys, coffins, gold, swords, and much more. For the Commodore VIC-20; cassette, \$15. Software III, 1307 Douglas Dr., Sterling, IL 61081.

Vanilla PILOT, an implementation of the PILOT language. This interpreter-based package features turtle graphics and enhanced editing commands. For the Commodore 64 and VIC-20; floppy disk, \$29.95. Tamarack Software, Water St., Darby, MT 59829.

CP/M

Compress, a data-compression program for CP/M files. Storage requirements can be reduced 30 to 40 percent. It is based on a logarithmic relation between relative-letter frequency and bit length. For CP/M-based systems; floppy disk, \$59.95. Digital Marketing Inc., 2670 Cherry Lane,

Walnut Creek, CA 94596.

DES-Crypt Version 1.0, an implementation of the National Bureau of Standards' Data Encryption Standard (DES). This menu-driven package encrypts and decrypts your files. For CP/M-based systems; floppy disk, \$149. Trigram Systems, 3 Bayard Rd. #66, Pittsburgh, PA 15213.

Disk Inspector, a full-screen editor for CP/M-based files. It displays selected sectors in both ASCII and hexadecimal formats. Make changes and rewrite the sector by moving the cursor. For CP/M-based systems; floppy disk, \$29.95. Overbeek Enterprises, POB 726, Elgin, IL 60120.

Peachtext Word Processor, a full-featured word-processing package. It provides menu selection for functions, help display, print formatting, and self-teaching lessons. For CP/M-based systems; floppy disk, \$500. Peachtree Software Inc., Suite 1300, 3445 Peachtree Rd. NE, Atlanta, GA 30326.

Solomon Series Software, an integrated accounting system that includes general ledger, accounts receivable and payable, invoicing, payroll, address and job-cost management. For CP/M-based systems; floppy disk, \$3495. Computech Group Inc., Main Line Industrial Park, Lee Blvd., Frazer, PA 19355.

Spelling Proofreader, a spelling-checker package. Based on the *Random House Dictionary*, this program works with the Peachtext word-processing system to check the spelling of your documents. For CP/M-based systems; floppy disk, \$300. Peachtree Software Inc. (see address above).

Y-Wing II, an arcade-type game. Stormslayer has enslaved all creatures under the sea. Your mission is to fly your Y-Wing fighter through the Stygian Sea and slay the

BYTEK's SECOND GENERATION UNIVERSAL (E)PROM PROGRAMMER—SYSTEM 15

Features:

- Bipolar PROMS.
- Micros - (8748 & 8749)
- I/O - 6 baud rates, 13 formats including Intellec, Textronic and Motorola.
- EPROMs, (2708 - 27128)
- Gang option - programs eight at once.
- Remote control option.

\$645
\$15-P

PROGRAMS
OVER 250
DEVICE TYPES

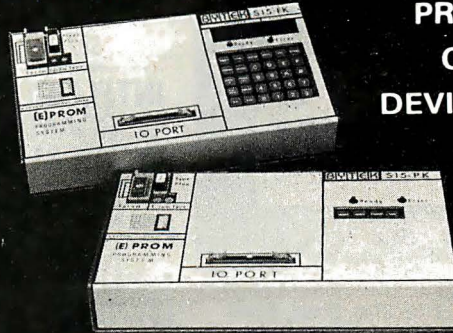

FUNCTIONS:

DISPLAY DEVICE DATA
EDIT RAM DATA
DEVICE PROGRAM
TYPE SELECTION

CRC-RAM
LOAD DATA
COMPARE FIELDS
FILL MEMORY FIELD
BLOCK MOVE
DIAGNOSTICS
and more.



BYTEK

COMPUTER SYSTEMS CORP

2283 S. Federal Hwy.

Delray Beach, FL 33444

(305) 272-2052

VERSATILE DATA REDUCTION, DISPLAY AND PLOTTING SOFTWARE FOR YOUR APPLE* II

STRIPCHARTER — Turns your APPLE and Epson MX series printer into an economical 4-pen chart recorder. Prints and displays continuous 1 to 4-channel strip-charts of any length. Ideal for large data sets. Numerous user-selectable graphics options enhance output quality. Includes 5 demos on disk with 37-page manual \$100

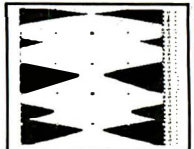

VIDICHART — Proven tool for lab data management. Fast plots of 4 data sets with scrolling in 4 directions, zoom scaling on X and Y axes, 2 types of graphic cursors and on-screen STATUS REPORT, even plots A/D input while sampling. ADD, SUBTRACT, MULTIPLY, DIVIDE, INTEGRATE, DIFFERENTIATE, AVERAGE or NORMALIZE data sets with SIMPLE COMMANDS. Ideal for spectra, chromatograms, rate curves, etc. Includes SAMPLE DATA on disk with 28-page manual \$75

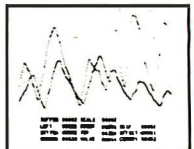

SCIENTIFIC PLOTTER — Draws professional-looking graphs of your data. You choose data format, length and position of axes, 20 symbols, error bars, labels anywhere in 4 orientations. Includes 5 demos on disk plus 30-page manual \$25

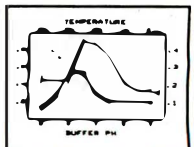

(For DIF file and Houston Instrument or H-P 7470A plotter adaptations, add \$25 for each option selected.)

CURVE FITTER — Select the best curve to fit your data. Scale, transform, average, smooth, interpolate (3 types), LEAST SQUARES fit (3 types). Evaluate unknowns from fitted curve. Includes 5 demos on disk with 33-page manual \$35

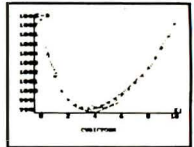

SPECIAL: VIDICHART, SCIENTIFIC PLOTTER, CURVE FITTER on 1 disk \$120

Add \$1.50 shipping on all U.S. orders. VISA or MASTERCARD orders accepted.

*Trademark of Apple Computer, Inc.



INTERACTIVE MICROWARE, INC.
P.O. Box 771, Dept. 3 State College, PA 16801
CALL (814) 238-8294 for IMMEDIATE ACTION

UV EPROM ERASER

- * Erases over 15 EPROMS - 15 minutes erase time
- * Element life 7700 hours
- * Intensity: 12Ws 1/2cm² at 1"
- * Erases all UV EPROMS (2716, 2732, 2516, 2532, etc.).

\$49.95*

* HOBBY MODEL

INDUSTRIAL MODEL

QUV-T8 / 2N

\$68.95

WITH TIMER AND SAFETY SWITCH

QUV-T8 / 2T

\$97.50

INTELLIGENT PROGRAMMER STAND ALONE RS-232

- * RELIABLE
- * EASY COPY (No external equipment needed)
- * USER FRIENDLY

COMPATIBLE: IBM PC, TRS-80, APPLE, CPM, FLEX, TEKTRONICS, MDS

(MCS-48)

PROGRAMMING PRICE INCLUDES PERSONALITY MODULE

\$489.00

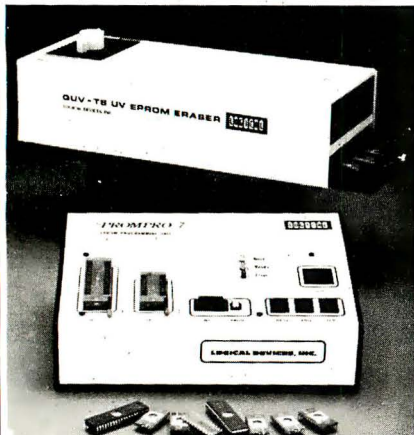

PROGRAMS: 2508, 2516, 2532, 2716, 27C16, 27C32, 2732A, 2758, 8748, 8749H, 8748H

OPTIONAL MODULES: 2564, 2764, 8755A, 8741

- * STAND ALONE, CRT, OR COMPUTER CONTROL
- * UPLOAD/DOWNLOAD IN MOTOROLA OR INTEL HEX FORMAT
- * MICROPROCESSOR BASED * 4 K INTERNAL RAM
- * 90 DAY PARTS & LABOR WARRANTY ON ALL PRODUCTS

SOON TO BE RELEASED:

PROMPRO-8 128K Version \$689.

MONEY BACK GUARANTEE

LOGICAL DEVICES INC.

781 W. OAKLAND PARK BLVD. • FT. LAUDERDALE, FL 33311

Phone Orders (305) 974-0967 • TWX: 510-955-9496

SEE US AT COMDEX SPRING - BOOTH #3019

Software Received

sea giant himself. For CP/M-based systems; floppy disk, \$21.50. Evryware, POB 60802, Sunnyvale, CA 94088.

Heath/Zenith

Empire, a simulated war game. Your army is fighting the computer's army. As the forces move over a grid of unknown territory, your task is to contact and destroy the enemy. For the Heathkit H-11; 8-inch floppy disk, \$40. Northwest Software, 15343 Southeast 43 Place, Bellevue, WA 98006.

Extended Tiny BASIC Compiler, a BASIC compiler program. Convert your BASIC programs into fast machine language. Requires HDOS 1.6. For Heath/Zenith computers; floppy disk, \$31.95. O'Connor Software, 191 Oakridge Dr., Lower Burrell, PA 15068.

Y-Wing II, an arcade-type game (see description under CP/M). For Heath HDOS-based systems; floppy disk, \$21.50. Evryware, POB 60802, Sunnyvale, CA 94088.

IBM Personal Computer

Air Traffic Controller, a simulation game. You must direct air traffic. Several options allow you to tailor the game to your preferences: successfully land planes or cause crashes for a high score. For the IBM Personal Computer; floppy disk, \$29.95. Avant-Garde Creations, POB 30160, Eugene, OR 97403.

Data Plotting Software for Micros, a data-analysis program (see description under Apple). For the IBM Personal Computer; floppy disk, \$19.95. Kern Publications, 190 Duck Hill Rd., POB 1029, Duxbury, MA 02332.

Deadline, an interactive program in which you are a detective who must solve a murder within 12 game hours. The program gives you all the clues you need. For the IBM Personal Computer; 5 1/4- and 8-inch floppy-disk formats,

\$49.95 and \$59.95, respectively. For information, contact Infocom, 55 Wheeler St., Cambridge, MA 02138.

Federation, an arcade-type game. You command a Federation fleet. Your mission is to wipe out invading Drorn Drones. For the IBM Personal Computer; floppy disk, \$29.95. Avant-Garde Creations (see address above).

Financial Planning for Multiplan (see description under Apple). For the IBM Personal Computer; floppy disk, \$79.95. Howard W. Sams & Co. Inc., 4300 West 62nd St., POB 7092, Indianapolis, IN 46206.

Financial Planning for Supercalc, a set of 17 templates for use with the Supercalc electronic-spreadsheet system. For the IBM Personal Computer; floppy disk, \$79.95. Howard W. Sams & Co. Inc. (see address above).

Financial Planning for Visicalc (see description under Apple). For the IBM Personal Computer; floppy disk, \$79.95. Howard W. Sams & Co. Inc. (see address above).

Label Kit PC Disk Organizer, a user-friendly system that prints labels of your alphabetically arranged files. Kit includes a program disk, 300 pin-feed labels, and instructions. For the IBM Personal Computer; floppy disk, \$59.95. PC Goodie Co., Suite 10, 15445 Ventura Blvd., Sherman Oaks, CA 91413.

Lazermaze, an arcade-type game. In the Arena Grid of Justice, your laser will reflect off many obstacles. A keen eye and trigger finger mean victory. For the IBM Personal Computer; floppy disk, \$29.95. Avant-Garde Creations (see address above).

Name & Address List Management System, a simple database-management program designed to maintain lists of names and addresses. You can print listings and mailing labels according to several options. For the IBM

megabytes

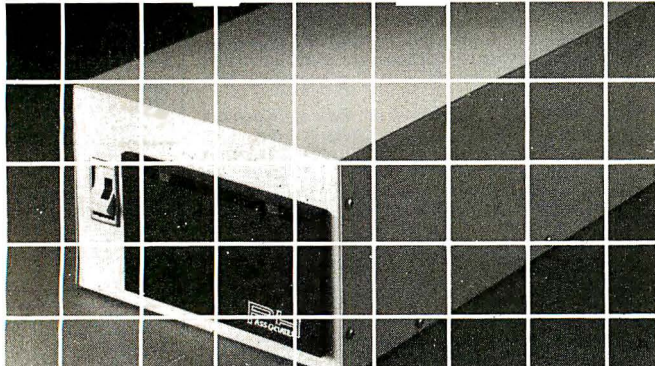

The MARK SERIES WINCHESTER DISK DRIVE SUBSYSTEM

- CAPACITY - 20, 33 and 46 megabytes.
- SIZE - 5 1/4 floppy size (6x4x2).
- SPEED - Twice as fast as the the competition (30 milliseconds).
- COMPATIBILITY - Hardware and Software interfaces for TRS-80[®], Apple II[®], IBM-PC[®], CP/M[®], Turbodos[®], S-100, 8 bit parrallel port, any Z-80[®] computer such as Osborne[®], Xerox[®], Televideo[®], Northstar Advantage[®].
- EXCEPTIONAL WARRANTY - Comprehensive 1 year parts and labor.
- NOTHING ELSE TO BUY - Subsystems include disk, chassis with power supply, controller, cables, hardware adapter and software package.

PH
ASSOCIATES

8720 Old Courthouse Road, Vienna, Virginia 22180
703-281-5762

Personal Computer; floppy disk, \$29.95. M & J Automation, POB 205, Plainsboro, NJ 08536.

Starcross, an adventure-type game. You must explore an alien starship and solve the complex and puzzling alien mysteries. For the IBM Personal Computer; floppy disk, \$39.95. Infocom (see address above).

Terran Jeopardy, an arcade-type game. Pit your strategic skills against the Black Nebula Horde. Terra's fate is in your hands as you defend your base from alien attack. For the IBM Personal Computer; floppy disk, \$29.95. Avant-Garde Creations (see address above).

Zork I: The Great Underground Empire, an adventure-type game. Strive to discover the Twenty Treasures of Zork and escape with them and your life. The game features a Save option for continued play. For the IBM Personal Computer; 5¼- and 8-inch floppy-disk formats, \$39.95 and \$49.95, respectively. Infocom (see address above).

Zork II: The Wizard of Frobozz, an adventure-type game. A continuation in the series, this game takes you deeper into the subterranean realm where you meet the powerful Wizard. For the IBM Personal Computer; 5¼- and 8-inch floppy-disk formats, \$39.95 and \$49.95, respectively. Infocom (see address above).

Zork III: The Dungeon Master, an adventure-type game. This is the final test in the series. You must fight the Dungeon Master himself. For the IBM Personal Computer; 5¼- and 8-inch floppy-disk formats, \$39.95 and \$49.95, respectively. Infocom (see address above).

Texas Instruments

Data Rescue, an arcade-type game. See if you can recover the stolen data-bank models and return them to

earth. For the TI-99/4A; cassette, \$9.95. Kuhl Software, 412 15th Ave. SW, Rochester, MN 55901.

The Dungeon, an arcade-type game (see description under Commodore). For the TI-99/4A; cassette, \$15. Software III, 1307 Douglas Dr., Sterling, IL 61081.

TRS-80

Alphabet Soup, a competitive spelling game with nine skill levels. Once the program generates 5 to 14 letters, you have 200 seconds to spell as many words as you can. For the TRS-80 Color Computer; cassette, \$14.95. Creative Technical Consultants, 16-8 Sangre de Cristo, POB 652, Cedar Crest, NM 87008.

Cyberchess System Program, a chess-tutorial program. This chess-analysis system will play games according to your level of expertise, set up classic games, and rate a player's ability. For the TRS-80 Models I and III; floppy disk, \$29.95. I.J.G. Inc., 1953 West 11th St., Upland, CA 91786.

ZX80/ZX81

Bon Mot, an educational game that teaches vocabulary and spelling skills. Up to 6 players can choose from 11 different anagram games. For the ZX80/ZX81; cassette, \$9.99. Luther A. Gotwald Jr., POB 404, Davidsville, PA 15928.

Musical Scales, a program to convert any series of notes from one musical scale to another. Scales included are Ionian, Dorian, Phrygian, Lydian, Mixolydian, Aeolian, Locrian, and harmonic minor. For the Timex/Sinclair 1000 and ZX81; cassette, \$14.95. Rave Records, 1005 Mechanic St., Decorah, IA 52101.

Schedi-Mort, an amortization-scheduler program. You can compute complete schedules of payments, principal, interest, and remaining

balance on any loans. For the Timex/Sinclair 1000 and ZX81; cassette, \$20. E. Arthur Brown Co., 1702 Oak Knoll Dr., Alexandria, MN 56308.

Other Computers

Dragonfire, a video game (see description under Atari). For the Mattel Intellivision; cartridge, \$39.95. Imagic, 1875 Dobbin Dr., San Jose, CA 95133.

Empire, a simulated war game (see description under

Heath/Zenith). For the Digital Equipment Corporation LSI-11, 8-inch floppy disk, \$40. Northwest Software, 15343 Southeast 43 Place, Bellevue, WA 98006.

Recipe Organizer, a program that stores and retrieves up to 200 recipes on one disk. For the Intertec Superbrain; floppy disk, \$29.95. The Office Partner Inc., 6736 Brookcrest Dr., Charlotte, NC 28210. ■

This is a list of software packages that have been received by BYTE Publications during the past month. The list is correct to the best of our knowledge, but it is not meant to be a full description of the product or the forms in which the product is available. In particular, some packages may be sold for several machines or in both cassette and floppy-disk format; the product listed here is the version received by BYTE Publications.

This is an all-inclusive list that makes no comment on the quality or usefulness of the software listed. We regret that we cannot review every software package we receive. Instead, this list is meant to be a monthly acknowledgment of these packages and the companies that sent them. All software received is considered to be on loan to BYTE and is returned to the manufacturer after a set period of time. Companies sending software packages should be sure to include the list price of the packages and (where appropriate) the alternate forms in which they are available.

DECADES OF SERVICE

Washington Computer Services

97 Spring St., New York, NY 10012 an affiliate of ((WASHINGTON)) est. 1912
ELECTRIC COMPANY

TO ORDER: Call our toll-free number: (800) 221-5416. In N.Y. State and for technical information: (212) 226-2121. Hours: 9 AM-5:30 PM (EST) Monday-Friday TELEX: 12-5606 CABLE: WASHCOMP NYK

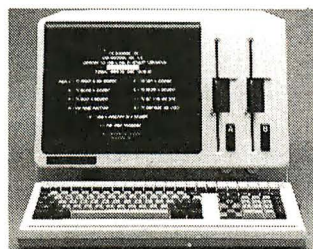

The Professional's Workstation

NEC APC

8086. 16 bit processor; Two 8" DSDS disk drives; 128K RAM (to 640K); green or RGB

PERFECT FOR: color screen.
Word Processing
CAD/CAM graphics
(1024 x 1024 resolution)
DataBase Management
Accounting
Chang Lab's Microplan
IBM emulations
CP/M-86, MSDOS, UCSD P.

This new state-of-the-art work station out-performs all others near its price range.

PRICES START BELOW
\$3300.00
(One disk drive, green)

NEC COMPUTERS AND MONITORS On N.Y.S. Contract #P-07220

PLEASE! Do not confuse us with mail order dealers. We are a full service distributor serving the data processing & installation needs of business & industry from micros to mainframes. System houses, educational institutions & governmental agencies given special consideration. Leasing available. N.Y. State agencies, municipalities, and schools—call us for information on our O.G.S. term contracts on hardware & software.

Please call to make an appointment for demonstration of this extraordinary computer at our showroom. Prices subject to change without notice; call for latest prices. Prices include 3% cash discount. N.Y. residents add sales tax. CP/M[®] is a trademark of Digital Research. All sales subject to our standard sale conditions (available on request). Above prices do not include customization or installation.

See other ad on page 178.

What's New?

NEW CHIPS

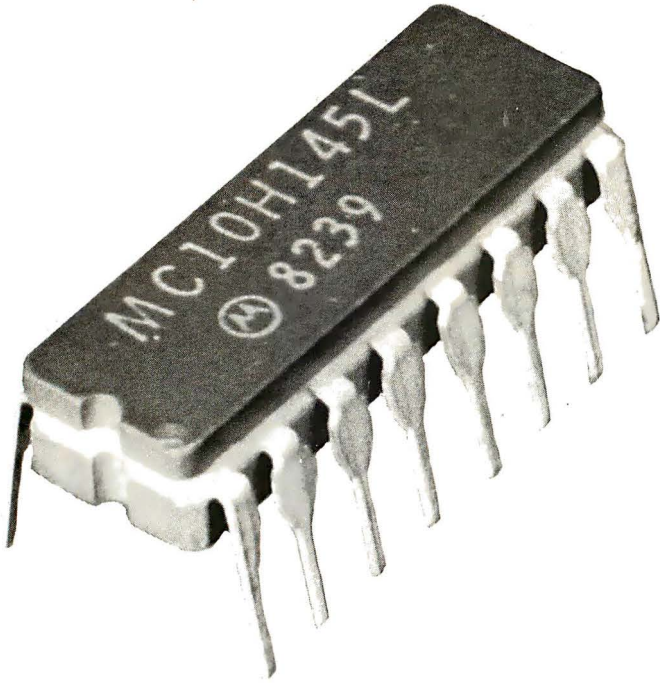

RAM Has 3-Nanosecond Access Time

Motorola's 64-bit MC10H145 bipolar ECL RAM (random-access read/write memory) can be used in any memory storage system requiring high-speed access times. This device, a member of the MECL 10KH family, has a 3-ns (nanosecond) address access time (typical) with 6 ns maximum. It's organized as a 16 by 4 memory array and engineered with Motorola's MOSAIC (Motorola oxide self-aligned implanted circuit) oxide-isolated process, which achieves a purported smaller device geometry, improved bandwidth, and reduced parasitic capacitances. It's completely compatible with the Motorola MECL 10K family and offers an improved noise margin (150 millivolts) and voltage consumption. The memory cell

array features a write and data input buffer, an address buffer and decoder, data output buffers, and a chip select.

Prototype quantities of the MC10H145 are available in ceramic and plastic DIPs (dual-inline packages). In 100-unit lots, these versions cost \$10.65 and \$9.25 each, respectively. Contact Motorola Semiconductor Products Inc., 5005 East MacDowell Rd., Phoenix, AZ 85008, (602) 962-2202.

Circle 550 on inquiry card.

High-Speed Math Chip

Oki Semiconductor's general-purpose 8-bit MSM6203 mathematics circuit is said to be fast enough for radar data cor-

relation and industrial process-control systems. It is built with silicon-gate CMOS (complementary metal-oxide semiconductor) technology and has eight bidirectional I/O pins. It readily connects to such 8-bit microprocessors as Oki's 80C85A. The MSM6203 can perform 8-by-8-bit multiplication or 16-by-8-bit division operations in 3.3 microseconds. Power consumption is 6.5 milliwatts per MHz during arithmetic operation, and the maximum operating frequency is 4 MHz (50% duty cycle). It's housed in an 18-pin plastic DIP (dual-inline package).

The MSM6203 costs \$7.50 each, in 100-piece quantities. Contact Oki Semiconductor Inc., Suite 401, 1333 Lawrence Expressway, Santa Clara, CA 95051, (408) 984-4842.

Circle 551 on inquiry card.

Speedy PROM

The 6353-2 is a 4K-byte nickel chromium PROM (programmable read-only memory) from Monolithic Memories. This chip, organized as 1024 words of 4 bits each, features an address access time of 50 ns (nanoseconds) worst case; 35 ns (typical). Its power consumption is 140 mA (milliamperes), and output leakage current is 40 μ A (microamperes). According to the company, the 6353-2 can be used as a logic element because of its speed. Other applications include program or microcode storage, lookup

tables, and character generators. The 6353-2 PROM is housed in an 18-pin 0.3-inch-wide ceramic package.

In lots ranging from 100 to 999, the 6353-2 costs \$5.25 each. Monolithic Memories Inc., 1165 East Arques Ave., Sunnyvale, CA 94086, (408) 739-3535.

Circle 552 on inquiry card.

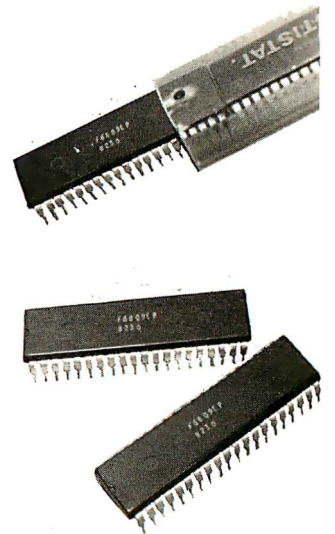

New Member of F6800 Family

Fairchild has added the F6809E to its 8-bit F6800 microprocessor family. This high-performance chip features 16-bit registers, dual 8-bit data paths, 59 basic instructions, the ability to recognize 1464 different variations of instructions and addressing modes, and external clock inputs that permit synchronization with peripherals, systems, or other microprocessors. The F6809E is compatible at the hardware and software levels with the F6800 family.

What's New?

The F6809E microprocessor is available in three speeds: 1, 1.5, and 2 MHz. Quantities can be ordered through local sales offices or franchised distributors. For further details, contact

Product Marketing, Fairchild Microprocessor Division, 3420 Central Expressway, Santa Clara, CA 95051, (408) 773-2102. Circle 553 on inquiry card.

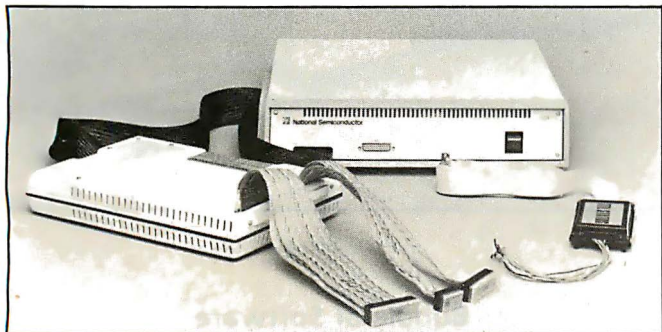

In-System Emulator

The NS-ISE-16 is the vanguard of National Semiconductor's series of In-System Emulators (ISE) for its 16/32-bit NS16000 microprocessor family. A multihost emulator family, the ISE/16 line lets users test and debug both hardware and software on their own 16000-family-based designs. The NS-ISE-16 provides real-time emulation of the NS16032 processor, the NS16201 TCU (timing-control unit), and the NS16082 MMU (memory-management unit). The package has three basic components: an emulation support box, an emulation pod, and a TTL (transistor-transistor logic) status pod. Also provided is the IDBG16 software debugging program, resident on the host computer system. (The IDBG16 is a superset of the NS16000 cross-software debugger, DGB16.)

The NS-ISE-16 currently communicates with a

Digital Equipment Corporation VAX/11 host system. Its two RS-232C ports permit transparent mode communication with the host computer. This means that one port is connected to the VAX while the other connects with the user's terminal, permitting direct communication between the ISE and the VAX for faster response. The user's terminal functions as a command console.

The NS-ISE-16 is supplied with an IEEE-488 GPIB port that will allow it to communicate with future host systems. Other standard features include up to 30K bytes of memory-mapping space, write protect/detect of 2K-byte blocks, and program-flow trace of up to 256 nonsequential fetches. This device is presently specified for operation at speeds of up to 6 MHz, with future upgrades planned to operate at 10 MHz.

The NS-ISE-16 costs \$7500, including the interactive debugger program. Contact National Semiconductor, 2900 Semiconductor Dr., Santa Clara, CA 95051, (408) 721-5000. Circle 554 on inquiry card.

SYSTEMS

Complete Color Graphics System

The Executive Presentation System (EPS) from Intelligent Systems Corporation is said to provide all the hardware and software you need to prepare presentation-quality color graphic visuals. With EPS, you can create overhead projector transparencies, 35 mm slides, and paper prints and plots. EPS software includes CP/M, Microsoft BASIC, and a graphics language that uses such English-statement commands as pie, bar, and line. EPS is device-independent, which lets you use a variety of output peripherals, including color plotters, camera systems, and ink-jet printers. This system is built around the Intecolor 8001R color graphics terminal and the Intecolor 7000 computer.

The Intecolor 8001R features individual dot addressability, 96K bytes of RAM (random-access read/write memory) with red/green/blue readable bit map, a 4K-byte graphics command processor in ROM (read-only memory) with 20 functions, 4K bytes of command software in

ROM to handle routines, and an 8K-byte RAM-based low-resolution memory plane for alphanumeric and graphics, with 96 uppercase and lowercase ASCII characters. Its hardware includes two RS-232C ports, one 8-bit parallel printer port, and a 177-key ASCII keyboard with 28 function keys. The Intecolor 7000 offers 128K bytes of RAM, a scrolling text editor, and dual 8-inch floppy-disk drives with 2.4 megabytes of data space and full-track disk buffer for fast throughput.

An 8-pen color plotter, a color camera system, and a color ink-jet printer are available as options. Prices begin at \$18,000, which includes an output option. For details, contact Intelligent Systems Corp., 225 Technology Park/Atlanta, Norcross, GA 30092, (404) 449-5961. Circle 555 on inquiry card.

Eagles Are IBM PC-Compatible

The Eagle 1600 Series of 16-bit computers is compatible with the IBM Personal Computer. According to the company, this series combines all the features of the PC at up to four times the operating speed. The 1600 computers are fully upgradable and come with networking capabilities and word-processing and financial planning software.

The basic system, the Model 1630, has 128K bytes of RAM (random-access read/write memory), 1

What's New?

megabyte of 5¼-inch floppy-disk storage, 12.5 megabytes of hard-disk storage, a detachable 105-key keyboard with 24 user-definable keys, and a separate monitor and 8086 microprocessor, which operates at 8 MHz. Its internal memory is expandable to 512K bytes, and up to eight PC plug-compatible boards can be added for

peripherals. Additional software available from Eagle includes general accounting, medical and dental practice management, and CPA accounting.

The Model 1630 costs \$6995. Contact Eagle Computer Inc., Building C, 983 University Ave., Los Gatos, CA 95030, (408) 395-5005.

Circle 556 on inquiry card.

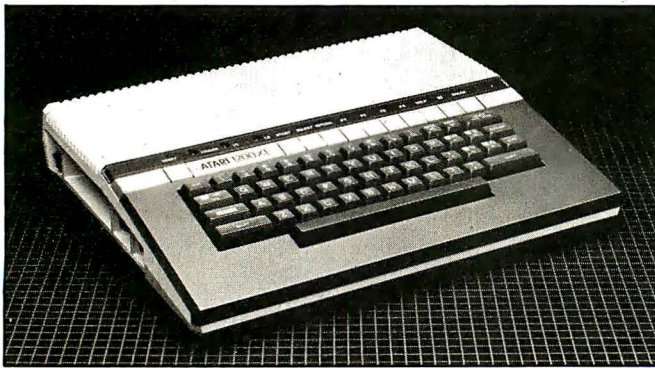
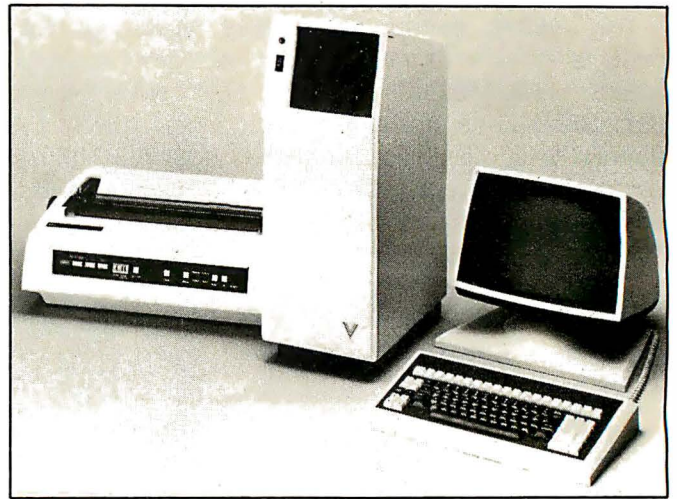

Atari 1200XL

The Atari 1200XL home computer comes with 64K bytes of RAM (random-access read/write memory), 12 user-programmable function keys, and built-in diagnostics. Its keyboard permits shifting into an integral European character set that includes special currency and character symbols. A Help key is standard as are one-touch cursor controls, 256 available colors for a monitor, and a speaker with 4 voices and a 3½-octave range. The 1200XL is compatible with Atari peripherals and software products.

Options for the 1200XL include a cassette memory system, an 80-column printer, and a 40-column printer/plotter. The mem-

ory system, the Model 1010 Program Recorder, uses standard audio cassettes and features two channels for both a program and sound effects. The Model 1025 printer prints dot-matrix characters at 40 cps (characters per second) and accepts single-sheet, fan-fold, and rolled paper. The Model 1020 Color Printer/Plotter produces four-color text, complex charts, and graphs to any set of X,Y coordinates. Prices range from \$99.95 to \$549. The 1200XL costs less than \$1000. Full details are available from Atari Inc., 1265 Borregas Ave., POB 427, Sunnyvale, CA 94086.

Circle 557 on inquiry card.

Bundle of Software Comes with Business System

The Voyager 4000 series of small business computers comes with the CP/M operating system and word processing, spreadsheet with graphics, database management, mailing list, payroll, Telex, and time management software. The basic Voyager has RS-232C and RS-422A ports, dual 5¼-inch double-sided double-density floppy-disk drives (1.2 megabytes of storage), and an 8085 central processor that addresses 64K bytes of RAM (random-access read/write memory). The central processor is upgradable to 8085/8088-based 8- and 16-bit coprocessor operation, addressing 1000K bytes of RAM. Up to 20 megabytes of plug-in hard-disk storage is available. The series also features an adjustable 12-inch non-glare video monitor with dedicated memory and an 8 by 12 matrix on a 10 by 14 grid with a choice of three colors. The computer's detachable key-

board has 100 five-function keys and a 10-key numeric pad.

The Voyager 4000 costs \$4995, including the software. Dealer and OEM (original equipment manufacturer) discounts are available. Contact Voyager Systems Inc., 2192 Anchor Court, Newbury Park, CA 91320, (213) 991-9028.

Circle 558 on inquiry card.

Multuser Telesystem Runs Unix III

A Motorola MC68000-based computer running the Unix III operating system is being marketed by Televideo Systems Inc. The Telesystem II supports up to 16 users and offers interface flexibility by means of 15 serial ports, one RS-422A port, a Centronics-compatible parallel port, and bus expansion capabilities. Standard features include 512K bytes of RAM (random-access read/write memory) and an 8-inch 40-

What's New?

or 80-megabyte Winchester hard-disk drive backed up by a 17.5-megabyte streaming cartridge tape. RAM memory can be expanded to 1 megabyte in 256K-byte increments, and an additional 40- or 80-megabyte drive can be attached for a total storage capacity of 160 megabytes. The operating speed is 8 MHz, and the MC68000 is complemented with an MMU (memory-management unit)

chip. Software available includes COBOL, Pascal, C, and FORTRAN-77.

The Telesystem II costs less than \$14,000, which includes 40 megabytes of disk storage, the backup tape drive, Unix III, and two Televideo displays. Further details are available from Televideo Systems Inc., 1170 Morse Ave., Sunnyvale, CA 94086, (408) 745-7760.

Circle 559 on inquiry card.

Zilog Z80 and Intel's 16-bit 8086 for its main processors. The Z80 runs the CP/M 2.2 operating system, while the 8086 supports up to 1 megabyte of memory.

Mass storage is supplied by dual 5¼-inch floppy-disk drives, each capable of handling more than 312K bytes of formatted data. User memory is provided by 125K bytes of parity-checking RAM (random-access read/write memory), expandable to 1 megabyte. This system has high-resolution color graphics capabilities that are backed by more than 50K bytes of support RAM. Its dedicated display processor generates high-resolution (640 by 200) color graphics. Other standard features are parallel and serial output ports and a typewriter-style detachable keyboard with a separate numeric keypad and 10 programmable function keys.

The Micro 16S comes with the CP/M-86 operating system, a word processor, an electronic spreadsheet, and a color monitor. Options include a 10-megabyte 5¼-inch Winchester-disk drive, a link to Corvus Systems' Omninet network, and Concurrent CP/M-86, which lets the Micro 16S run four jobs simultaneously with each task using up to 250K bytes of memory. Its base price is \$3995. For full details, contact Fujitsu Ltd., Professional Microsystems Division, 2840 San Tomas Expressway, Santa Clara, CA 95051, (408) 980-0755.

Circle 560 on inquiry card.

SOFTWARE

Software Line for Lisa Unveiled

Open Systems will distribute Xenix-based software products for Apple Computer's recently announced Lisa computer. This line, targeted at the small-business market, will include Science Management Corporation's (SMC's) Business BASIC interpreter, seven interactive accounting applications packages, and a report writer. The accounting packages include order processing, general ledger, accounts receivable with billing and sales analysis, payroll, and job cost. The report writer, to be marketed under the name The Team Manager, will link the accounting applications to a comprehensive data dictionary, which will allow creation of simple or complex reports from all files within the accounting system. It will also permit reformatting of data from the accounting applications for use by word processing, spreadsheet, and other productivity applications available under Xenix.

Open Systems will directly license the Xenix-based software to Apple dealers. In addition, it will provide all packaging, training, and support. For further details, contact Open Systems Inc., 430 Oak Grove, Minneapolis, MN 55403, (612) 870-3515.

Circle 561 on inquiry card.



Dual Processors Provide Flexibility

The Micro 16S personal business computer from Fujitsu Ltd. gives you inte-

grated 8- and 16-bit processing power flexibility. The Micro 16S uses the

What's New?

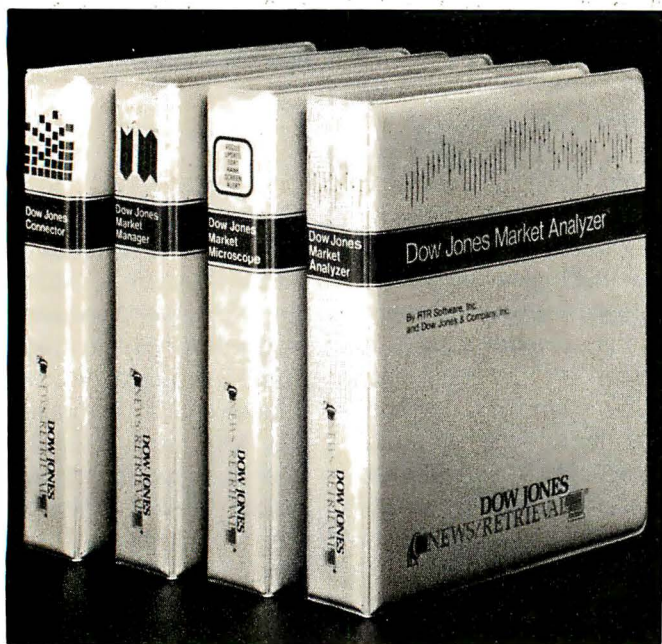

Dow Jones Markets Software

Dow Jones & Company offers software programs designed to meet the business and investment needs of personal computer users. Dow Jones software runs on such systems as the Apple II and the IBM Personal Computer. Customer and dealer support includes a one-year warranty and a toll-free customer service department.

The Dow Jones Market Analyzer automatically collects, stores, and updates stock market data that can be used to construct charts for technical analysis. The Market Microscope sorts and ranks companies and industries by 68 financial indicators. For automatic updates and monitoring of investment portfolios, the Market Manager is offered. Also available is the Dow Jones Connector, which provides users of most microcomputers with access to news, information,

and data contained in the Dow Jones News/Retrieval database.

Prices range from \$95 to \$700. For full hardware details or purchasing information, contact Dow Jones & Co. Inc., POB 300, Princeton, NJ 08540, (800) 257-5114; in New Jersey (609) 452-1511. Circle 562 on inquiry card.

Smart Terminal Program Housed in ROM

The Colorcom/E from Spectrum Projects is a smart terminal program for the Radio Shack Color Computer. Colorcom/E, housed in a ROM (read-only memory) cartridge, provides you with online and offline scrolling, offline printing of data, full- and half-duplex operation, and the ability to receive and send cassette files. It will

support any serial printer, and it permits easy editing before data is printed or written to cassette.

A word mode that eliminates word wrap is offered as an option. Colorcom/E costs \$49.95 and is available from Spectrum Projects, 93-15 86th Dr., Woodhaven, NY 11421, (212) 441-2807.

Circle 563 on inquiry card.

Graphics System for dBASE II

Fox & Geller's dGraph lets you produce high-quality charts from any Ashton-Tate dBASE II database. According to the manufacturer, all you have to do is enter the data or the name of the dBASE II database you wish to chart and dGraph will do the rest. A chart-description procedure lets you create bar, pie, line, and pie-bar charts that include such information as the percent of total based on summing or counting. Other possible uses include summing, counting, and averaging of data fields and automatic selection of data based on ranges and on matched values. dGraph can function as a stand-alone system, and it supports a variety of printers and plotters, including Epson MX-70/80/100, Okidata Microline, and Xerox/Diablo 1750.

The dGraph system runs on CP/M-, CP/M-86-, or MS-DOS-based computers with 64K bytes of memory. A video terminal with clear

screen and cursor-addressing and 240K bytes of disk capacity are required. The suggested retail price is \$295. For further details, contact Fox & Geller Inc., 604 Market, Elmwood Park, NJ 07407, (201) 794-8883.

Circle 564 on inquiry card.

Financial Forecasting Tool

Ashton-Tate's Bottom Line Strategist is an economic forecasting tool. Developed to serve Fortune 1000 forecasting needs, this program generates bottom-line answers for future business ventures without programming, formulas, or complex spreadsheets. It provides complete, sophisticated models that assist executives in analyzing and tracking business scenarios. The Strategist uses direct user input of business assumptions and displays 11 different financial and marketing forecasts. Key considerations include how profitable a business will be, how much money is being risked, and when break-even points will be established.

The Bottom Line Strategist, designed for the IBM Personal Computer and CP/M-based systems, is available for \$400 through Ashton-Tate dealers and distributors. Contact Ashton-Tate, 10150 West Jefferson Blvd., Culver City, CA 90230, (213) 204-5570.

Circle 565 on inquiry card.

What's New?

Database Program for Nonprogrammers

Infostar is a database-management system that doesn't force you to learn a programming language. Produced by Micropro International, this business-applications development package provides onscreen English-language menus that guide you through each step of data-entry form design and report generation. For data entry, a cursor is used to draw forms on the screen. Generating custom applications is said to be four times faster than with other programs because you do not have to write and debug code.

Infostar can generate a preformatted quick report in approximately 60 seconds and has the ability to incorporate data from multiple files. It provides up to nine control breaks, arithmetic calculations within reports, and four levels of help menus. It can sort a file of up to 32 key fields at speeds approaching 560 records per minute, and its report writing and editing feature lets you move data fields, change headings, and insert dollar signs and decimal points. Able to work with dot-matrix or letter-quality printers, Infostar's print features include boldface and underlining of selected data fields. Other specifications include variable-length records and Wordstar compatibility.

Infostar runs on 48K-byte CP/M 2.2-based systems. Dual floppy-disk drives or a single floppy disk with a hard disk is rec-

ommended. With a training guide, Infostar costs \$495. It's available from Micropro International Corp., 33 San Pablo Ave., San Rafael, CA 94903, (415) 499-1200. Circle 566 on inquiry card.

Xenix Now Standard on TRS-80 Model 16

Radio Shack has announced that it will use Microsoft's multiuser, multitasking Xenix operating system as the standard DOS on its TRS-80 Model 16. A Model 16 equipped with Xenix can be expanded to accommodate three users, with all users running programs or sharing the same program, data, or peripherals.

Xenix features tree-structured directories, device-independent I/O, chaining of program input and output, and foreground and background execution. It requires 256K bytes of memory and a hard-disk drive. Xenix can also run on TRS-80 Model 11s outfitted with a hard disk and a Model 16 upgrade kit. All applications software currently offered by Radio Shack for the Model 16 can be moved to the Xenix system. Radio Shack will supply Xenix at no cost to Model 16 owners and include it in all new Model 16 production.

In a related development, Radio Shack also announced that it intends to introduce several multiuser application packages for Xenix-equipped Model 16s.

Future plans call for several interactive accounting programs, a high-capacity inventory control system, versions of Microsoft's BASIC and Multiplan spreadsheet, and a Xenix development system that includes the C language.

For complete details, contact your local Radio Shack Computer Center, selected Radio Shack stores, and participating dealers. Radio Shack 1800 One Tandy Center, Fort Worth, TX 76102. Circle 567 on inquiry card.

Appointments and Records Filed in Shoebox

Shoebox 2.0, an appointment manager and expense recording system from Techland Systems, can track tasks and appointments for any number of executives, limited only by storage capacity. It offers such features as a schedule-handler for tasks that are not appointments, expense recording keyed to particular appointments and categories, reminders for recurring schedule items, and the ability to produce printouts of schedules and expense reports. Using a minimum number of keystrokes, you can review past appointments or reminders involving a given subject or person. Shoebox has the ability to remind you of events up to six months ahead of time, and its multiuser option offers password-protection and a coordinator mode

that allows nonsensitive data to be manipulated. Programming knowledge is not required because most Shoebox commands are single keystrokes.

Shoebox 2.0 runs on 50K-byte MS-DOS-based systems. A cursor-addressable terminal and one or more 160K-byte disk drives are required. An 80-character-per-line printer is recommended. Shoebox costs \$195 and is available from Techland Systems Inc., 39 Carwall Ave., Mount Vernon, NY 10552, (914) 699-8467.

Circle 568 on inquiry card.

L. A. W. S. Support for Law Offices

L. A. W. S. (Litigation support, Accounting, Word processing System) software for law offices is available from Legal Systems Development. Litigation support modules range from a database that stores, manipulates, and retrieves depositions, transcripts, and evidence to a trial preparation program that provides a variety of summary reports. Accounting packages include accounts receivable and payable, billing, and payroll. Lexisoft's Spellbinder is available through Legal Systems Development. This word processor features letter-quality printer support, simple cursor moves, office and data management abilities, and an optional spelling checker. Other modules in the L. A. W. S. product line include a docket-con-

What's New?

trol system and communications software.

The manufacturer recommends a computer system with 10 megabytes of disk storage, 64K bytes of RAM (random-access read/write memory), CP/M, a printer, and a terminal. Prices for individual

modules range from \$100 to \$2495. The complete L. A. W.S. product line can be purchased for \$5295. For full details, contact Legal Systems Development, 460 Main St., Placerville, CA 95667, (916) 626-3351. Circle 569 on inquiry card.

PERIPHERALS



Matrix Printers from GE

The GE 3010 and 3014 are the latest additions to the General Electric GE 3000 series of dot-matrix printers. These microprocessor-based printers are plug-to-plug compatible with such microcomputers as Apple, IBM, and Televideo. They can print up to four copies bidirectionally at 160 cps (characters per second). Each 136-column printer is supplied with a 2K-byte print buffer, a 9-wire printhead for continuous underscoring and lowercase descenders, and selectable print densities and paper widths. Both machines print 6 or 8 lines per vertical inch.

The GE 3010 uses a 4-pin tractor for paper feed-

ing, while the 3014 has a tractor and a friction cut-sheet roller arrangement. The 3014 also features a high-resolution print mode that produces overlapping dots for near-letter-quality printing at 40 cps and a horizontally enhanced 80-cps memo mode. A carbon-film ribbon is being developed for the 3014. Volume pricing ranges from \$850 to \$1150, depending upon model and quantity. Additional information is available from General Electric Co., Data Communication Products Department, Waynesboro, VA 22980, (800) 368-3182; in Virginia, (703) 949-1183.

Circle 570 on inquiry card.

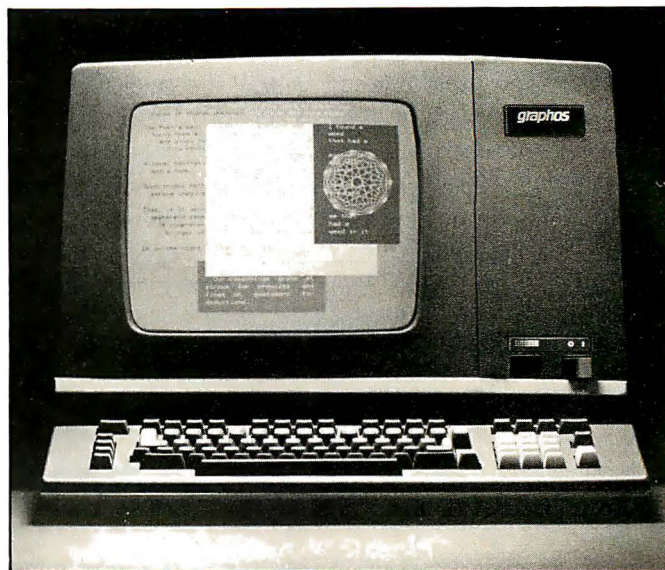

Graphos: Desktop Graphics Terminal

Graphos, a desktop color graphics terminal that can display and manipulate 16 windows, is produced by Ithaca Intersystems. It features resolution of 640 by 480 pixels, two-dimensional segment transformations, high-level primitives, a Motorola MC68000-based device-independent graphics subsystem, multiple fonts, and individual scroll, pan, zoom, and graphics overlay for each window. Input support includes tablets, joysticks, and track balls. Standard alphanumeric support includes character and background color, insert and delete line, and VT-100 compatibility. Three I/O function modules can be incorporated into Graphos, providing a means for such interfaces as RS-232C, RS-422A, and 8- or 16-bit parallel.

The concept behind Graphos is known as Shiftable Cell. The Shiftable Cell, which combines alphanumeric and bit-mapping architecture, dynamically

assigns cells to the 16 on-screen windows. It permits text and graphics scrolling under any fixed window and independent manipulation of any window. Segments are retained in the terminal's memory, enabling them to be rotated, recalled, or shifted without retransmission from the host computer.

A 9-slot card cage is available as an option. Graphos is priced at less than \$8000. For further details, contact Ithaca Intersystems Inc., 1650 Hanshaw Rd., POB 91, Ithaca, NY 14850, (800) 847-2088; in New York, (607) 257-0190.

Circle 571 on inquiry card.

Disk Drive for Atari

The Percom Data AT-88 disk-drive system is compatible with Atari 400/800 computers. This single-density drive offers 88K bytes of formatted storage and features Atari plug compat-

What's New?

ibility and an integral power supply. The AT-88 can use Atari operating system software without modification.

The AT-88 is shipped with the OSA/Plus operat-

ing system. It costs \$488. For further information, contact Percom Data Co. Inc., 11220 Pagemill Rd., Dallas, TX 75243, (214) 340-7081.

Circle 572 on inquiry card.

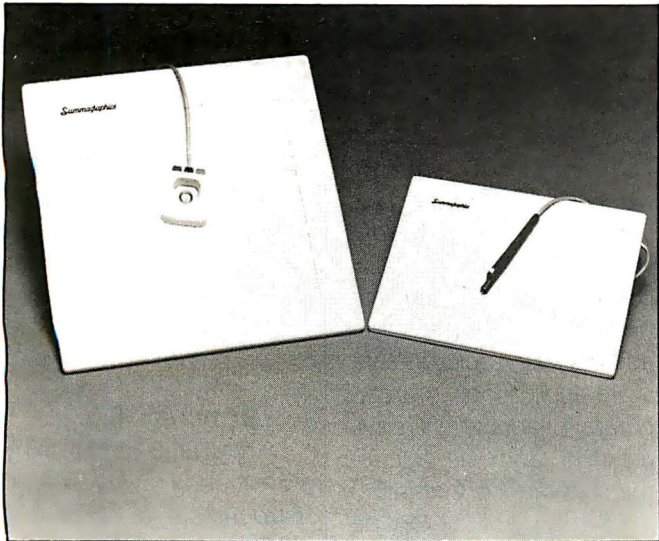

Compact Digitizers for OEM Market

Summagraphics has announced a family of compact, ergonomically designed digitizers for the OEM (original equipment manufacturer) graphics systems market. The MM series will perform all cursor steering, menu picking, and graphics digitizing tasks. The digitizers can provide absolute and delta coordinate output and can automatically scale output both horizontally and vertically to match video-display resolution and orientation. Standard features include resolution of up to 500 lines per inch, single printed-circuit grid electronics, and built-in diagnostic modes to check electronics, communications, tablet, and stylus or cursor. A three-button cursor that

can be used either as a mouse or as a digitizer cursor is supplied with this system. The stylus is equipped with a pen-tip switch and a user-assignable barrel activation button.

Interface options include either RS-232C or TTL (transistor-transistor logic) ports. The MM 960 digitizer has a 6- by 9-inch (152- by 228-mm) active area that provides 3000 by 4500 points of resolution. The MM 1200's active area measures 12 by 12 inches and offers 6000 by 6000 points of resolution. For detailed price and product information, contact Summagraphics Corp., 35 Brentwood Ave., POB 781, Fairfield, CT 06430, (203) 384-1344. Circle 573 on inquiry card.

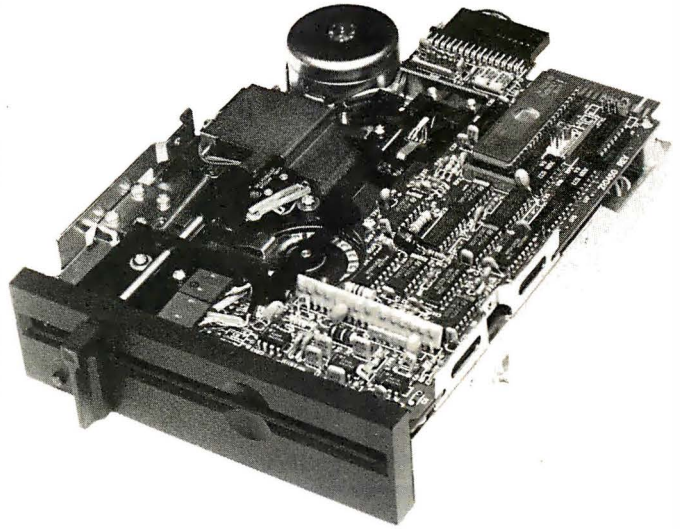

Half-Height Drives Handle Full Load

The storage capacity and performance of the Tandon TM55 Thinline family of half-height 5 1/4-inch floppy-disk drives are said to be equivalent to that of Tandon's full-sized drives. TM55 Thinline drives are 1 5/8 inches tall, 5 3/4 inches wide, and 8 inches long. They weigh 3 pounds. Standard features include maximum data storage of up to 1 megabyte, a 3-millisecond track-to-track access time, and a transfer rate of 250,000 bytes per second. An on-board microprocessor controls spindle speed, centers the media, positions the head for minimum hysteresis, and switches the write current for optimum recording quality. TM55 drives use IBM-formatted 5 1/4-inch floppy disks.

Two models are offered. The Thinline TM55-2, a double-sided 48-tpi (track-per-inch) drive, has a storage capacity of half a megabyte. The TM55-4 is a double-sided 96-tpi drive with 1 megabyte of stor-

age. Prices begin at less than \$200. Complete technical specifications are available from Tandon Corp., 20320 Prairie St., Chatsworth, CA 91311, (213) 993-6644.

Circle 574 on inquiry card.



Pint-Size Modem Fits Anywhere

Novation is marketing a 300-bit-per-second direct-connect automatic ans-

What's New?

wer/originate modem that's almost one-fifth the size of conventional units. The J-Cat measures 5 by 1.9 by 1.3 inches, small enough to fit almost anywhere. It plugs into any modular RJ11C telephone jack and has the ability to automatically switch into answer or originate modes. J-Cat comes with an audio beep that sounds for busy signals, dial tones, and when a carrier is detected.

Built-in features include LED (light-emitting diode) status displays, a disconnect/test key, a connect/break key, and self-test. J-Cat is RS-232C-compatible.

The suggested retail price for the J-Cat modem is \$149. Address inquiries to Novation Inc., 18664 Oxnard St., Tarzana, CA 91356, (800) 423-5419; in California, (213) 996-5060. Circle 575 on inquiry card.

PUBLICATIONS

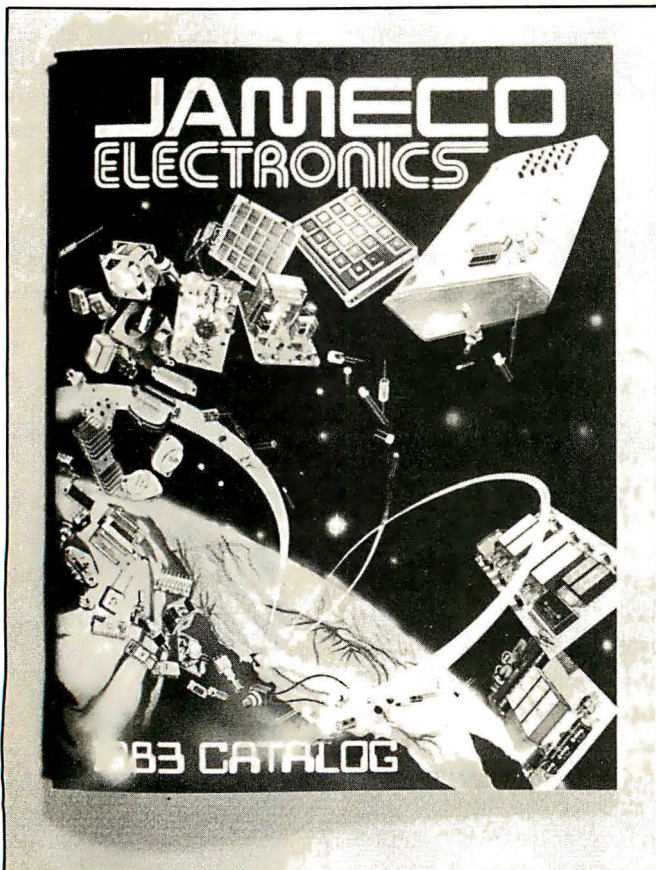

Jameco Issues Catalog

Jameco Electronics has produced a 64-page illustrated catalog listing more than 2000 electronic products ranging from integrated circuits to power

supplies. For a copy, contact Jameco Electronics, 1355 Shoreway Rd., Belmont, CA 94002, (415) 592-8097.

Circle 576 on inquiry card.

Software Guide

The Online Micro-Software Guide and Directory, 1983-84, is available from Online Inc., publisher of Database magazine. Edited by Helen A. Gordon, this guide contains full-page descriptions of software packages, resource information, an annotated bibliography, and listings of resources. To assist readers in locating programs for specific needs, four indices are provided: applications, software, producer, and distributor. Also included are nontechnical articles that address such topics as software applications in a corporate headquarters environment and the role of the software consultant.

Each copy of the Online Micro-Software Guide and Directory comes with an up-to-the-minute addendum that includes new benchmarks and less familiar programs. Single copies cost \$40. Four or more copies are \$30 each, including the annual supplements. Two annual supplements cost \$30 each. Contact Online Inc., 11 Tanney Lane, Weston, CT 06883, (203) 227-8466. Circle 577 on inquiry card.

Guide Aids Standards Developers

A FORTRAN coding guide that assists software departments in formulating standards has been produced by Associated Technology. This 46-page reference work is said to pro-

vide software managers, designers, and quality-assurance teams a methodology made up of a set of company standards and examples. The publisher asserts that these features ensure the construction of top-down programs that are structured, testable, and easily maintainable.

The FORTRAN guide costs \$20. It's available from Associated Technology, Route 2, Box 448, Estill Springs, TN 37330. Circle 578 on inquiry card.

Armchair BASIC

Armchair BASIC by Annie and David Fox is an introductory book on the BASIC programming language from Osborne/McGraw-Hill. It's written for computer neophytes who do not have access to microcomputers but who want to be familiar with programming concepts. This 180-page book presents programming fundamentals that are applicable to any computer that runs BASIC, such as the Apple or Commodore PET. Topics covered include the working parts of a computer, variables, data inputs, if . . . then statements, controlled loops, random numbers, and subroutines.

Armchair BASIC is available in paperback for \$11.95. Contact Osborne/McGraw-Hill, 630 Bancroft Way, Berkeley, CA 94710, (415) 548-2805. Circle 579 on inquiry card.

What's New?

MISCELLANEOUS



Robot Recalls Its Actions

RB5X, an intelligent robot, detects and responds to objects in its path. Manufactured by RB Robot Corporation, RB5X has 8K bytes of memory, programs, and tactile sensors. The company asserts that once RB5X achieves a successful random response, it remembers its actions and repeats the correct response when confronted with the same situation again.

For program entry and data transfers, RB5X is supplied with an RS-232C port, making it compatible with such microcomputers as the Apple, Radio Shack TRS-80, and IBM Personal Computer. This port, for example, lets you transfer RB5X's memory to your computer, where you can study and alter its patterns and programs. RB5X is

equipped with a circuit that automatically charges its batteries. Other standard features include a sonar sensor and a pulsating light. It has an aluminum body with polycarbonate dome and measures 13 by 24 inches. RB5X weighs 10 pounds and uses two rechargeable 6-volt gelled electrolyte batteries (supplied).

Options include 16K bytes of additional memory, data telemetry, and a mechanical arm. A voice-recognition system and a speech synthesizer are under development. The basic RB5X is \$1495. Address all inquiries to RB Robot Corp., Suite 201, 14618 West Sixth Ave., Golden, CO 80401, (303) 279-5525.

Circle 580 on inquiry card.

Data Encryption Board

The Encryptor from Jones Futurex is a high-speed data encryption/decryption plug-in board. Practical applications include protecting financial statistics, market strategies, and technical and personal records. It has a transfer rate of 1.1 megabits per second and offers programmed I/O operation for key, data, commands, and states. The Encryptor is said to be able to encrypt or decrypt 8 bytes of data in less than 50 microseconds. No cables are required. The Encryptor provides supporting software for CP/M, MP/M, and Oasis operating systems and works with S-100, Apple, and IBM Personal Computers.

The Encryptor, model number ENC 300, uses the Western Digital Data Encryption/Decryption VLSI (very large-scale integration) device, as certified by the National Bureau of Standards. It costs \$299.95 and is available from Jones Futurex Inc., Suite G, 9700 Fair Oaks Blvd., Fair Oaks, CA 95628, (916) 966-6836. Circle 581 on inquiry card.

Intelligent Clocking Machine

Digitech's DC-999 is an intelligent clocking ma-

chine that can be controlled by any computer through an RS-232C port. It's suitable for applications involving time-recording and card identification, such as security access and professional time tracking. The DC-999 responds to a set system of commands, and it can be reprogrammed for different applications. Standard features include a built-in microprocessor and memory and the ability to handle all front-end processing independently or to work as a stand-alone terminal. It's able to collect, check, edit, compute, store, and transfer data to a host computer. Data is collected through an optical card reader or through keyboard entry. The DC-999 has LED (light-emitting diode) displays for verifying data entry and a buzzer alarm that alerts the key operator of misuse or tampering.

A 15-column printer and a magnetic tape drive are offered as backup storage options. A 12-digit version with programmable digit length for job-costing and a keyboard option for entering external data relating to an incoming card number are also available. The suggested price is \$1500; dealer inquiries are invited. Contact Digitech PTE Ltd., 303 Pearls Center, 100 Eu Tong Sen St., Singapore 0105, Republic of Singapore; tel: 2237740; Telex: RS28171 DGTECH. In the U.S., contact Hiram H. Samuel, Onondaga International, (315) 471-1251. Circle 582 on inquiry card.

What's New?

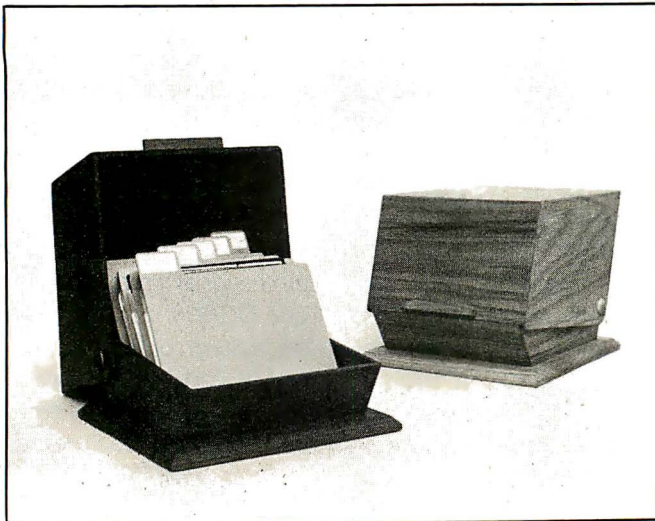

Hardwood Disk Storage Box

Systems Integration's Disk Niche is a solid hardwood storage box for 5 1/4-inch floppy disks. It provides a dust-proof, static-free environment for as many as 50 floppy disks and has 5 movable, tabbed dividers to aid organization.

The Disk Niche is avail-

able in walnut, cherry, or oak, with a hand-rubbed oil finish. It costs \$49.95, plus \$3 postage and handling. Contact Systems Integration, 1519 North Nevada Ave., Colorado Springs, CO 80907, (303) 635-4477.

Circle 583 on inquiry card.

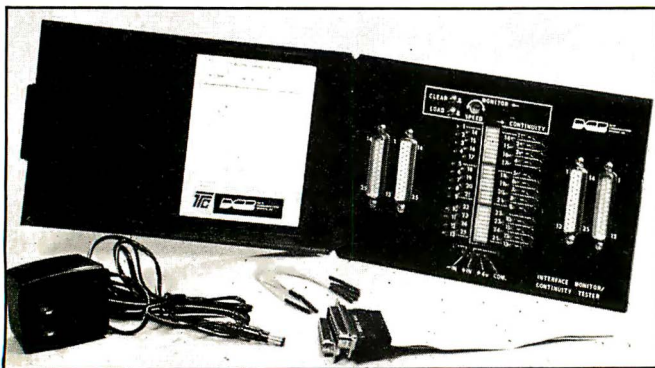

Cable Tester Doubles As Breakout Box

The CT-1 Cable Tester and Breakout Box lets your technicians test RS-232C cables on-site. Made by Data Communications Brokers, the CT-1 checks for cable continuity and indicates leads that are tied together or crossed over. A speed adjustment for setting the rate for cable tester scans and an LED

(light-emitting diode) for each of the RS-232C's 25 connections are provided. The CT-1 can be placed into an RS-232C link and used as a breakout box by flipping a switch.

The CT-1 comes with jumpers, a short extension cable, rechargeable batteries, and a battery charger. It costs \$255 and

can be purchased directly from Data Communications Brokers, 3000 Research Rd., POB 3658, Champaign, IL 61820, (800) 637-1127; in Illinois, (217) 352-3207.

Circle 585 on inquiry card.

Compact Disk Has Large Disk Abilities

The CFD (compact floppy disk) is a 3-inch floppy disk from Maxell Corporation of America. The CFD's rotation speed, data transfer rate, recording capacity per track, and other technical specifications are identical to those of 5 1/4-inch floppy disks. The CFD has a high-recording-density magnetic coating with the same capacity as that of a standard disk, which lets you transfer all the data from a 5 1/4-inch disk to it. The magnetic coating features a hardened plastic center for improved reliability.

The CFD, which was released late last month, is designed to work with such 3-inch disk drives as the one manufactured by Hitachi. Each CFD costs approximately \$6.50. Further information is available from Maxell Corporation of America, Computer Products Division, 60 Oxford Dr., Moonachie, NJ 07074.

Circle 584 on inquiry card.

Slot-Independent Bubble Memory for the Apple II

Ap-Bub, a slot-independent 128K-byte nonvolatile bubble-memory module for

the Apple II, is marketed by MPC Peripherals Corporation. Standard features include disk-emulation software for DOS 3.3 and a boot PROM (programmable read-only memory) that permits the user to boot directly from the module. Ap-Bub is said to be able to execute DOS read and write commands at speeds three times faster than the standard floppy-disk drive. Its data reliability is purported to be 1000 times greater than that of tapes and disks.

Ap-Bub has an \$875 suggested retail price. For more information, contact MPC Peripherals Corp., 9424 Chesapeake Dr., San Diego, CA 92123, (619) 278-0630.

Circle 586 on inquiry card.

Where Do New Products Items Come From?

The information printed in the new products pages of BYTE is obtained from "new product" or "press release" copy sent by the promoters of new products. If in our judgment the information might be of interest to the personal computing experimenters and homebrewers who read BYTE, we print it in some form. We openly solicit releases and photos from manufacturers and suppliers to this marketplace. The information is printed more or less as a first-in first-out queue, subject to occasional priority modifications. While we would not knowingly print untrue or inaccurate data, or data from unreliable companies, our capacity to evaluate the products and companies appearing in the "What's New?" feature is necessarily limited. We therefore cannot be responsible for product quality or company performance.

DISK DRIVE For APPLE!!

- metal cabinet ☆☆☆
- 35 track \$279.95
- w/cable

Computer Games:
APPLE & ATARI (specify)

- Choplifter → \$24.95ea.
- Frogger → \$24.95ea.
- Apple Panic → \$21.95ea.
- Crossfire → \$21.95ea.
- Raster Blaster → \$21.95ea.

SUPER 3.5amp POWER SUPPLY
for APPLE → \$95.00 ☆

Diskette Storage BOX

5 1/4 in. → \$2.50ea. 5 → \$10.00; 8 in. → \$3.50 → \$15.00

Bare Bones APPLE II EURO
= 48K RAM =

w/o Keyboard \$399.

w/o Pwr. Supply

Microswitch: \$75.00
Power Supply: \$89.00
Apple Reference Manl.: \$18.00

SPECIALS

3inch Mini FAN → \$8.95

2111 → \$2.45
8155 → \$11.50
ER2501 → \$4.95
AY5 1013A → \$2.95
8202 → \$29.95
6522 → \$5.25

8255 → \$4.50
8748-B → \$31.00
MC6800 → \$7.75
MC6802 → \$14.95
MC6850 → \$4.50
MC6821 → \$4.95
6331 → \$1.25

4116-2 → 8/9.95
2716(5v) → 3.25ea
2732(5v) → 5.25ea
2532(5v) → 8.75ea.
Z80 A CPU → 5.25ea.

IC. Master \$49.95

Diskette SALE!!

call for Qty Price "Wabash"

SS/SD 5 1/4	8inch
SS/SD 18.50	21.50
SS/DD soft 27.40	30.40
DS/SD 0	34.90
DS/DD 32.40	37.40

CONCORD COMPUTER PRODUCTS

2910 B. E. LA PALMA ANAHEIM CA 92806 (714) 632-6790 CHECK - M O

10 MIN ORDER. CA RES ADD 6. ALLOW WKS DEL. Y. PERSONAL CHECK S SENT

Freight \$10-49 \$200 \$250-499 \$300 send \$100
50-99 -400 500-999 -1100 for catalog
100-240 -800 1000-UP -Call

MONITORS ☆☆☆

ZENITH # ZVM-121

12in. 15MHz./GREEN Phos
I → \$99.00 ☆

BMC # BM-1200SU

12in. 18MHz./GREEN Phos. Non-Glare Screen
I → \$118.00 ☆

BMC # BM1401RGB

13in. "RGB" COLOR with Apple interface!!
I → \$425.00 ☆

REAL-TIME CLOCK CALENDAR (MSM 5832)
\$6.25 / \$1.25 xtl.

Syntron II Computer

- ★ 48K RAM
- ★ Runs Apple Software

\$699.00

COMPONENTS

7400 SERIES		745 SERIES	
7400	18	74500	35
7401	18	74502	38
7402	18	74503	38
7403	18	74504	45
7404	18	74505	65
7405	23	74506	40
7406	18	74507	55
7407	18	74508	40
7408	18	74509	55
7409	18	74510	55
7410	18	74511	55
7411	22	74512	55
7412	18	74513	30
7413	18	74514	30
7414	18	74515	35
7415	18	74516	35
7416	18	74517	35
7417	18	74518	35
7418	18	74519	35
7419	18	74520	35
7420	18	74521	35
7421	18	74522	35
7422	18	74523	35
7423	18	74524	35
7424	18	74525	35
7425	18	74526	35
7426	18	74527	35
7427	18	74528	35
7428	18	74529	35
7429	18	74530	35
7430	18	74531	35
7431	18	74532	35
7432	18	74533	35
7433	18	74534	35
7434	18	74535	35
7435	18	74536	35
7436	18	74537	35
7437	18	74538	35
7438	18	74539	35
7439	18	74540	35
7440	18	74541	35
7441	18	74542	35
7442	18	74543	35
7443	18	74544	35
7444	18	74545	35
7445	18	74546	35
7446	18	74547	35
7447	18	74548	35
7448	18	74549	35
7449	18	74550	35
7450	18	74551	35
7451	18	74552	35
7452	18	74553	35
7453	18	74554	35
7454	18	74555	35
7455	18	74556	35
7456	18	74557	35
7457	18	74558	35
7458	18	74559	35
7459	18	74560	35
7460	18	74561	35
7461	18	74562	35
7462	18	74563	35
7463	18	74564	35
7464	18	74565	35
7465	18	74566	35
7466	18	74567	35
7467	18	74568	35
7468	18	74569	35
7469	18	74570	35
7470	18	74571	35
7471	18	74572	35
7472	18	74573	35
7473	18	74574	35
7474	18	74575	35
7475	18	74576	35
7476	18	74577	35
7477	18	74578	35
7478	18	74579	35
7479	18	74580	35
7480	18	74581	35
7481	18	74582	35
7482	18	74583	35
7483	18	74584	35
7484	18	74585	35
7485	18	74586	35
7486	18	74587	35
7487	18	74588	35
7488	18	74589	35
7489	18	74590	35
7490	18	74591	35
7491	18	74592	35
7492	18	74593	35
7493	18	74594	35
7494	18	74595	35
7495	18	74596	35
7496	18	74597	35
7497	18	74598	35
7498	18	74599	35
7499	18	74600	35

STATIC RAMS		DYNAMIC RAMS	
2111	2.85	8/2	50ea
2112	2.85	8/2	50ea
2114	2.00	8/14	00
2114L	2.25	4/2	00ea
HM6116	8.25		
4027	2.00	8/17	5ea
4116	1.50		
4164	200ns	7.95	

MISC		EPROMS	
8126	1.20	1702	4.25
8128	1.20	2708	3.25
8038	2.75	2716(5V)	3.95
8080A	3.75	TMS2716	8.95
8155	10.50	2732(5V)	8.95
8255	4.50	TMS2532	11.50
MC1330	1.45		
MC1350	1.10		
MC1358	1.35		
MC1458	5.5		
LM380	1.10		
LM386	1.40		
LM565	95		
LM741	25		
LM1310	2.90		

VOLTAGE REGULATORS		CPU S	
7805	85	Z80	8.50
7808	85	Z80A	6.00
7812	85	Z80A PIO	6.00
7818	85	6502	6.00
7905	85	6502A	12.00
7908	85	8085A	8.50
7912	85	MC6800	7.75
7918	85		

SUNNY LOW LOW COST POWER SUPPLIES (LINEAR & SWITCHING) FOR S-100, DISK DRIVES

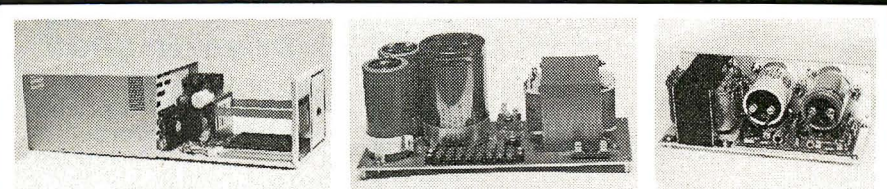

S-100 & DISK POWER SUPPLIES: OPEN FRAME, ASSY. & TESTED, 6 OUTPUTS, ADJU. & FUSES PROTECT.

ITEM	IDEAL FOR	+5V OVP	-5V	+24V(OR +12V)	+8V	+16V	SIZE W x D x H	PRICE
S ₃	12 SLOT & 2 FLOPPY (1 Floppy & 1 Hard Disk)	5A	1A	5-7A PEAK	13A	3A	10" x 6" x 5"	102.95
S ₄	6 SLOT & 2 FLOPPY	4A	1A	4-5A PEAK	8A	3A	8 3/8" x 5" x 4 3/4"	92.95

DISK POWER SUPPLIES: OPEN FRAME, ASSY. & TESTED, REGULATED, ADJUSTABLE & FUSES PROTECT.

ITEM	IDEAL FOR	+5V OVP	-5V	+24V (or +12V)	+8V Unreg.	+12V	SIZE W x D x H	PRICE
R ₀	2 x 8" SLIMLINE	2.5A		2.5A - 5A Peak			5" x 4" x 4"	49.95
R ₁	2 x 8" or 2 x 5 1/4" DISK	4A	1A	3A - 5A Peak	2A		8" x 4" x 3 3/4"	54.95
R ₂	3 x 8" (or 5 1/4") FLOPPY	6A	1A	6A - 8A Peak			10" x 4 7/8" x 3 3/4"	69.95
R ₃	or 1x Floppy & 1x Hard	6A	1A	6A - 8A Peak		1A	9" x 6 1/4" x 4 3/8"	81.95

AC & DC POWER CABLES WITH CONNECTOR FOR 2 DRIVES 8.00

S-100 POWER SUPPLY KITS (OPEN FRAME WITH BASE PLATE, 3 HRS. ASSY. TIME)

ITEM	(IDEAL FOR)	+8V	-8V	+16V	-16V	+28V	SIZE: WxDxH	PRICE
KIT 1	15 CARDS	15A	---	2.5A	2.5A	---	12" x 5" x 4 7/8"	54.95
KIT 2	20 CARDS	25A	---	3A	3A	---	12" x 5" x 4 7/8"	61.95
KIT 3	DISK SYSTEM	15A	1A	3A	3A	5A	13 1/2" x 5" x 4 7/8"	69.95

SHIPPING FOR EA. PWR SUPPLY: \$5.50 IN CALIF.; \$8.00 IN OTHER STATES; \$18.00 IN CANADA. FOR EA. TRANSFORMER: \$5.00 IN ALL STATES; \$12.00 IN CANADA. CALIF. RESIDENTS ADD 6.5% SALES TAX.

DEALER INQUIRIES INVITED

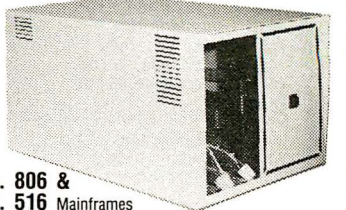

6 SLOT MAINFRAME ASSY. & TESTED ONLY \$399.95 + SHIPPING \$18.00

EACH MAINFRAME (ITEM NO. 806 OR 516) CONTAINS: EMI FILTER • FUSE HOLDER • AC POWER CORD • POWER SWITCH & INDICATOR • RESET SWITCH • 4 1/2" COOLING FAN • S-100 BUS 6 SLOT CARD CAGE • (110/220 VAC, 50/60 HZ) POWER SUPPLY FOR DISK DRIVES & S-100 SLOTS • 2 EA. DC POWER CABLES WITH CONNECTOR AND MOUNTING HARDWARE FOR DISK DRIVES • 9 EA. CUT-OUTS: 7 FOR 025 CONNECTOR, 1 FOR 50 PIN CONNECTOR & 1 FOR CENTRONICS • CUSTOM FINISH & LOGO-LESS • COMPACT SIZE • LIGHTWEIGHT, 28 LBS. ITEM #806 FOR 2 EA. 8" THINLINE FLOPPY (TANDON TM848-1 & 848-2 OR EQUIV.), OR ONE HARD DISK, POWER SUPPLY: +8V/8A, ±16V/3A, +5V/5A OVP, -5V/1A & 24V/5A, SIZE: 12"(W) x 19.5"(D) x 9.8"(H). ITEM #516 FOR 2 EA. 5 1/4" FLOPPY (TANDON TM-100 - 1, 2, 3, 4 OR EQUIV.), OR ONE 5 1/4" FLOPPY & ONE 5 1/4" WINCHESTER HARD DISK (TANDON TM 600-2, 3 OR EQUIV.), POWER SUPPLY: +8V/8A, ±16V/3A OVP, +5V/6A OVP, +12V/6A, 8A PEAK. SIZE: 13.75"(W) x 19.5"(D) x 7"(H).

MAILING ADDRESS: SUNNY INTERNATIONAL (TRANSFORMERS MANUFACTURER) TORRANCE, CA 90510 (213) 328-2425 MON-SAT 9-6

SHIPPING ADDRESS: 22129 1/2 S. VERMONT AVE TORRANCE, CA 90502

C LANGUAGE PROGRAMMERS

c-systems
C COMPILER

Now with: c-window™

The first c language source level program testing and debugging tool.

- Single step by c source line.
- Set breakpoints at line numbers.
- Display and alter variables by symbol name, using c expression syntax.
- No more print or assembler level debugging!

c-window™ is a support package for the c-systems C COMPILER for 8086/8088 based systems.

Contact:

c-systems
P.O. Box 3253

Fullerton, CA 92634

714-637-5362

TM c-systems

JOIN US!
COMPUTER PRICES
SAN FRANCISCO CIVIC CENTER MARCH 18 20 1983
TELEVISION ROOM #48

Circle 67 on inquiry card.

IBM® Quality Printing for Your Computer

NOW!



Complete system with top-quality IBM Electronic typewriter is ready to plug into your computer. Or, you can convert your own IBM Electronic or Selectric®.

- IBM approved since 1978.
- For all popular computers.
- No special software required.
- Money back guarantee.



*** MORE SUPER SPECIALS! ***

Smith-Corona TP-1 \$629 Teletext 925 \$788
Teletek Systemaster \$792 Anadex DP9500A \$1388
Software, other products Call! Star Printers Call!

Call our professionals for best service and price.



IPEX

(213) 710-1444

IBM and SELECTRIC are trademarks of IBM Corp.

IPEX INTERNATIONAL, INC.
5115 Douglas Fir Road
Calabasas, CA 91302 U.S.A.
Telex/TWX 910-494-2100

- We export to all countries. •

Circle 217 on inquiry card.

CHIPS & DALE

THE INFLATION FIGHTERS!

4116 250ns 8/\$9.50 100+ 1.05 ea.
4116 200ns 8/\$10.00 100+ \$1.05 ea.
4116 150ns 8/\$11.50 100+ \$1.25 ea.
4116 120ns 8/\$14.50 100+ \$1.50 ea.
4116 120ns 8/\$15.50 100+ \$1.50 ea.
2114L 300ns 8/\$10.50
2114L 200ns 8/\$12.00
*4164 200ns \$4.65 ea.
*4164 150ns \$5.10 ea.
*6116 150ns \$4.00 ea.
*6116 200ns \$3.85 ea.
*6116LP 150ns \$4.75 ea.
*1791 Disk Controller \$20.00
1777 Disk Controller \$17.50
Z80A, Z80ACTC, Z80A PIO \$3.00 ea.
8255 \$4.25
2718-1 5V 350ns 8/\$4.25 ea. \$5.00 ea.
2716 5V 450ns \$3.00 ea.
*2732 5V 450ns \$3.85 ea.
*2532 5V 450ns \$4.25 ea.
*2764 5V 300ns 28 pin \$9.00 ea.
*2764 5V 24 pin CALL
*2564 5V CALL
*8087 CALL
68000 CALL

Allow up to 3 wks. for personal checks to clear. Please include phone number. Prices subject to change without notice. Shipping & Handling for Chips \$3.50, FOB Bellevue, WA. for all else. Wash. residents add 6.5% Sales Tax.

CHIPS & DALE 1-206-451-9770
10655 N.E. 4th St., Suite 400
Bellevue, WA 98004

Circle 77 on inquiry card.

ONE BOARD CP/M® SYSTEM FOR NETWORKS

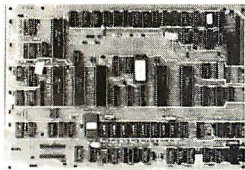

Features:

- 8½ x 12½ inches
- 10 MHZ 8085 CPU
- 64K RAM
- 880 KBIT/SEC Network Port
- CRT Controller
- 8272 FD Controller
- Winchester Interface
- 2 RS-232 Channels

Documentation \$20
CP/M Floppy Disk Op. System \$180
Check or Money Order

autocontrol
INCORPORATED

11400 Dorsett Rd.
Maryland Heights, MO 63043
(314) 739-0055

Circle 42 on inquiry card.

Bargain Boards™

Best prices around on



boards.

RAM 21-\$766.
M-Drive/H-\$998.

Call or write for additional board prices or to place orders.

Include \$5.00 per board for shipping and handling.

6331 Fairmont Ave. #701
El Cerrito, Ca. 94530
(415) 524-8352

CompuPro is a registered trademark of Godbout Electronics

Circle 41 on inquiry card.

BREAKTHROUGH

Originate/Answer UDS 212 LP Modem

~~\$495~~

\$395



IMMEDIATE DELIVERY

- Compatible with Bell 212 modems (1200 bps only)
- Telco powered—no AC connection required
- Simplified controls—talk/data and originate/answer only
- Direct-connect to dial-up network

INNOVATIVE COMM.

1111 W. Dundas Road
Wheeling, IL 60090
Sales—(312) 459-8866
Service—(312) 459-8874

Circle 213 on inquiry card.

SAVE 50%
on
Scotch® Diskettes



Dealer Inquiries Invited

5¼" Specify Soft 10 or 16 Sector prices/10

744D 1 side/dbl dens. \$22.30
745 2 sides/dbl dens. \$31.00
746 1 side/quad 96 tpi. \$33.80
747 2 sides/quad 96 tpi. \$45.50

8" Specify Soft or 32 Sector

740 1 side sgl/dens. \$23.60
741 1 side/dbl dens. \$29.00
743 2 sides/dbl dens. \$37.80

Checks-VISA-MC-C.O.D./Add \$2 Shipping
Call or write for our complete list.

LYBEN COMPUTER SYSTEMS

27204 Harper Ave., St. Clair Shores, MI 48081
Phone: (313) 777-7780

Authorized Distributor
Information Processing Products **3M**

Circle 239 on inquiry card.

TAXMAN-83

An Interactive TAX MANAGEMENT Program for
VisiCalc™ & SuperCalc™ Users

TAXMAN-83 provides you with the capability to easily calculate your 1982 taxes by using the already proven VisiCalc™ and SuperCalc™ electronic spreadsheets.

TAXMAN-83 prepares and prints 1982 individual income tax returns. TAXMAN-83 considers all tax alternatives, computes the lowest tax possible, tests reasonableness and tells you which forms are necessary for filing. TAXMAN-83 includes the following forms/schedules: Federal 1040; Schedules A, B, C, D, E, F, G, R, RP, SE, ES, U, W, Forms 1116, 2106, 2119, 2210, 2440, 2441, 3468, 3903, 4136, 4137, 4255, 4562, 4563, 4625, 4684, 4797, 4798, 4835, 4952, 4970, 4972, 5329, 5544, 5695, 5884, 6249, 6251, 6252, 6478, 6765, 6781; Tax schedules X, YS, YJ, Z; Tax tables; Sales tax tables for all states.

TAXMAN-83 is now available for most microcomputers utilizing VisiCalc™ or SuperCalc™.



PRICED AT ONLY
\$95.00
Call: 1-205-533-7590



acel ATSUKO
COMPUTING
INTERNATIONAL
303 Williams Avenue, Huntsville, AL 35801

Direct orders please add \$4.00 for shipping/handling and sales tax where applicable. VisiCalc is a trademark of VisiCorp. SuperCalc is a trademark of SORCIM Corporation.

Circle 41 on inquiry card.

I WILL BEAT ANY COMPETITOR'S PRICE PROVIDED IT IS NOT BELOW MY COST. TRY TO BEAT THESE IC PRICES:

DYNAMIC RAM		
64K	200 ns	\$4.79
64K	150 ns	4.99
64K	120 ns	5.90
16K	200 ns	1.25
EPROM		
2764	250 ns	\$9.90
2732	450 ns	4.15
2716	450 ns	3.25
2532	450 ns	4.70
STATIC RAM		
6116P-3	150 ns	\$4.24
2016	100 ns	4.00
2114	200 ns	1.60
Z80A FAMILY		
CPU, CTC, or PIO		\$3.39
DART		8.25
DMA or SIO/0		12.50

MasterCard/VISA or UPS CASH COD
Factory New, Prime Parts

MICROPROCESSORS UNLIMITED

24,000 South Peoria Ave.
BEGGS, OK 74421
(918) 267-4961

Prices 3/1/83

Prices subject to change. Call for volume prices. Subject to available quantities. Shipping & Insurance extra. Cash discount prices shown.

Circle 284 on inquiry card.

CHECK OUR NEW ★ LOW PRICES ★

NEW for Sinclair ZX-81

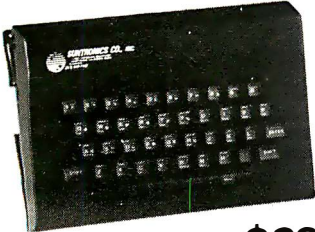

KD-81 Full Size Keyboard \$69.95

KD-81 Full Size Keyboard with Space Bar for easy touch typing and the keys are marked the same as Sinclair's.

MX-16 RAM Module \$49.95

The MX-16 Stackable RAM Module adds 16K of additional RAM to your ZX-81/TS1000.

S-100 Computer Systems

SYSTEM I \$2499.00

Z80A CPU with Serial/Parallel Ports, Floppy Disk Controller with Dual 8" SSDD Drives, 64K RAM, CPM, Clock and 1M Byte Storage.

SYSTEM II \$2699.00

Z80A CPU with Serial/Parallel Ports, Floppy Disk Controller with Dual 8" DSDD Drives, 64K RAM, CPM, Clock and 2M Byte Storage.

S-100 Products

SBC-880 Z80A CPU, A&T \$235.00

SBC-880 Z80A CPU, Kit \$215.00
4MHz Z80A CPU Board with Serial/Parallel Ports

UFDC-1 Floppy Controller, A&T \$245.00

UFDC-1 Floppy Controller, Kit \$225.00
The UFDC-1 Floppy Controller uses the WD1795 chip which runs either and/or 8" 5/4" Disk Drives.

CLOCK CALENDAR A&T \$115.00

CLOCK CALENDAR Kit \$95.00
This S-100 Clock Calendar Board has 4 Interrupts, Time, Day of Week and Battery Backup.

SUN-721 S-100 Prototype Board \$17.85

Double Sided with gold contacts and holes drilled on .15" x .1" spacing.

S-100 Mainframes 6-12 Slots

DMF8800T 6 Slot, Dual Thin 8" Drives . . . \$699.00

DMF8800 6 Slot, Dual Std. 8" Drives . . . \$699.00

DMF5550 6 Slot, Up to 3-5/4" Drives . . . \$679.00

DMF2200 6, 8, 12, 18, 22 Slot MB. \$ Call

All Mainframe Power Supplies rated at 8V @ 18A, ±16V @ 23A, 24V @ 5A, 12V @ 5A & 5V @ 5A.

Mother Boards & Card Cages

SLOTS	Bare Bd	KIT	A & T	w/CAGE
6	\$12.00	\$34.00	\$49.00	\$74.00
8	16.00	45.00	70.00	105.00
12	22.00	65.00	100.00	140.00

10MHz, No termination Required!

NEW for VIC-20

VC-MB Expansion Mother Board Call

The VC-MB Expansion Mother Board for the Commodore VIC-20 has 6 Slots with 22/44 Pins. Call today for our Special Introductory Price.

VC-24 24K RAM Call

Expand your VIC-20 to a full 64K Bytes with our new VC-24 24K Byte RAM.

Terminals

TELEVIDEO 912 \$660.00

TELEVIDEO 925 \$789.00

TELEVIDEO 950 \$995.00

ADDS VIEWPOINT 3A/PLUS \$545.00

Video Monitors

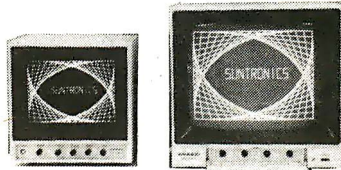

SAMWOOD B/W 9" 18MHz \$117.00

SAMWOOD GREEN 9" 18MHz \$121.00

SAMWOOD AMBER 9" 18MHz \$125.00

SAMWOOD B/W 12" 12MHz \$127.00

SAMWOOD GREEN 12" 12MHz \$130.00

SAMWOOD AMBER 12" 12MHz \$134.00

Composite video in/out, 750 lines resolution, 75/10K ohm impedance.

Printers

Prowriter 1 C. Itoh, 120cps, Parallel \$455.00

Prowriter 2 C. Itoh, 120cps, Parallel \$689.00

Starwriter C. Itoh, 40cps, Ser/Par \$1369.00

Printmaster C. Itoh, Serial/Parallel \$1529.00

NEC Spinwriters 3500, 5500, 7700 Call

Disk Drives

TM100-1 Tandon 5 1/4" SSDD, 40 track . . . \$215.00

TM100-2 Tandon 5 1/4" DSDD, 40 track . . . \$289.00

TM100-4 Tandon 5 1/4" DSDD, 80 track . . . \$400.00

TM848-1 Tandon 8" Thin Line \$397.00

Mitsubishi 5 1/4" Thin DSDD, 40 track . . . \$310.00

Mitsubishi 8" Thin DSDD, 77 track \$450.00

Diskettes

5 1/4" SS/DD 40 Track, Box of 10 \$22.50

8" SS/DD Soft with Library Case \$26.00

8" DS/DD Soft Memorex, Box of 10 \$44.99

ABA Diskette Storage Cases

5 1/4" Case for 40 Diskettes \$24.99

8" Case for 40 Diskettes \$36.99

5 1/4" Case for 90 Diskettes \$41.99

8" Case for 90 Diskettes \$54.99

64K 6MHz Static RAM/EPROM

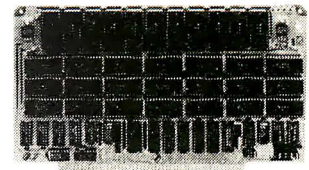

64KSM A&T without RAM \$155.00

64KSM A&T with 64K RAM (32 - 6116's) . . . 339.00

S-100 Board Uses 6MHz 6116's, 1/2 max. power, Bank Select plus Extended Addressing allow for multi-memory board set up, 4 Independent 16K Blocks make easy use with multi-user systems, Any 2K RAM may be replaced by 2716 EPROM.

256K/1M Byte Dynamic RAM

256KDM A&T without RAM \$290.00

256KDM A&T with 64K RAM (8-4164s) . . . 340.00

256KDM A&T w/ 256K RAM (32-4164s) . . . 489.00

S-100 Board, 4 Banks uses either 64Kx1 or 256Kx1 RAMS. Allows for 64K to 1M Byte RAM on just one S-100 Card. 24 Bit Addressing, Phantom Mode, Error Trap Opt., Parity Check, 4MHz Transparent Refresh, Front Panel Operation. Optional M1 Wait for 6MHz Operation.

Apple Compatible Products

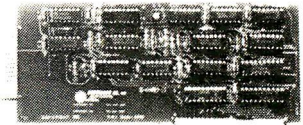

FDC-1 Floppy Disk Controller \$99.95

Runs DOS 3.3 with any standard Shugart compatible 5 1/4" Disk Drive. (2 Drives Each Card)



ASCII KEYBOARD A&T \$99.00

Plug in compatible with Apple II, has shiftlock, under score, [] and back slash characters.

SUN-722 Apple Prototype Board \$13.75

Double Sided with gold contacts, holes drilled on .15" x .1" centers.

NEC Computers & Monitors

We are an Authorized NEC Service Center

Call for Official Service Agreement

PC8001A Keyboard Computer \$769.00

PC8012 I/O Expansion Unit \$499.00

PC8031 Disk Drive Subsystem \$769.00

JC1203RGB 13" Color Monitor \$720.00

This Monitor is excellent for use with IBM PC

JC1203 13" Composite Color Monitor \$349.00

EPROMs, RAMs, CPUs, & Misc

P/N	1-7	8 up	P/N	1-7	8 up
2716	\$3.95	\$3.95	6116P-3(150nS)	\$6.10	\$5.75
2732	4.75	4.40	2114L-2(200nS)	1.62	1.62
2532	7.65	5.95	4164	6.25	6.25
2764	9.95	9.95	Z80A CPU	5.29	5.29



SUNTRONICS CO., INC.

12621 Crenshaw Blvd., Hawthorne, CA 90250

STORE HOURS: MON.-FRI. 9:00am to 6:30pm
SATURDAY 10:00am to 5:00pm

CALIFORNIA 213-644-1149

(for Tech Info and Calif. orders)

Mail Order—Minimum Order: \$10. Send Check or Money Order to: P.O. BOX 1957—Dept. B, HAWTHORNE, CA 90250. VISA or Mastercard (please include expiration date). Add \$4.00 postage and handling to order. CA residents add 6% sales tax.

OUTSIDE CALIFORNIA TOLL FREE 1-800-421-5775

(Order Desk Only)

Circle 395 on inquiry card.

micro-PROLOG the fifth generation language for micros

- μ -PROLOG is an interactive version of PROLOG currently available for CP/M 2.xx Z80's.
- PROLOG is the Artificial Intelligence language chosen by Japan as the core language for their Fifth Generation Computers.
- PROLOG grew out of AI research in computational logic. PROLOG means PROgramming in LOGic.
- A PROLOG program comprises a set of facts and rules. It unifies:
 - *relational data and relational queries,
 - *recursive list processing,
 - *pattern directed rule based programming, within a single framework of logic programming.
- Current applications: Expert Systems, Natural Language Understanding, Intelligent Data Bases.

Distribution Formats
 5": North Star, Zenith Z89, IBM PC (with Z80 card)
 Apple II (Z80 card, lower case rec'd, Osborne
 8": S5/SD IBM 3740

Need more info? Prices
 Sample the language with the 160 page Primer. Price can be set against software.

Software (with \$275 Manual & Primer)
 Primer \$15
 Prices include air P&P

LA LOGIC PROGRAMMING ASSOCIATES Ltd.
 10 BURTWOOD CLOSE,
 LONDON SW18, ENGLAND

CP/M TM Digital Research Inc., Z80 TM Zilog Corporation, micro-PROLOG & μ -PROLOG TM LPA Ltd.

Circle 235 on inquiry card.

RAMS EPROMS

2708	2716	2516
2732	2532	2765
4116	4164	6116

HD 68000-8
 Large quantity 74S/74LS

HANDWELL CORP.
 (415) 962-9265
 4962 El Camino Real, #119
 Los Altos, CA 94022

WHOLESALE — RETAIL

Circle 184 on inquiry card.

☆☆ **SUPER™** ☆☆☆
ISA's DATABASE

The only DBMS with all these features:

- ★ PROVEN in one year of test marketing
- ★ TOUGH, reliable file structure
- ★ MENU driven for simplicity and easy use
- ★ ARITHMETIC with stored calculations
- ★ FAST set-up and report formatting
- ★ CLEAR user-oriented documentation
- ★ PRINTS totals & subtotals — mail labels
- ★ REFORMATS and merges data files
- ★ MULTI-DISK files: Up to 128K records
- ★ SORTS full disks on up to 40 fields
- ★ PRODUCTION input of repetitive data
- ★ USE existing data files
- ★ COUPLES to word processors
- ★ POSTS transactions to master file
- ★ SEARCH by strings, ranges, comparisons
- ★ DATA COMPRESSION: Over twice as many labels as the other system

For TRS-80* Models I, II, III, E 16 — 250.00
 CP/M† — 295.00

Ask your Dealer or Write:
 Institute for Scientific Analysis, Inc.
 P. O. Box 7186, Dept. B-2
 Wilmington, DE 19803 (215) 358-3735

*T.M. Tandy Corp. †T.M. Digital Research

Circle 203 on Inquiry card.

ScreenGen FULL SCREEN CONTROL

An assembler subprogram you call from your BASIC or COBOL programs to handle screen input/output as IBM mainframes do.

You just define a table/array in your program specifying screen formats, and call ScreenGen to do all the I/O for you.

- Input or display a full screen with one single command
- Use all of your CRT video attributes
- Define up to 24 function keys
- Define templates for display and input. Six standard editing templates built-in.
- Validate input while keying. Insert and delete characters to correct fields
- Tab fields forward and backward
- Superfast screen operation

Available now for

Microsoft	BASIC-80	} CP/M	\$99
	COBOL-80		TRS-80
Dig. Research	CBASIC	} Apple II*	\$75
Ryan McFarland	RM/COBOL		Manual
Radio Shack	BASIC	Only	\$25
	RS/COBOL	*requires softcard	

Source code included
 IBM PC available soon

INTERDATA SYSTEMS INC.
 1051 Clinton St., Buffalo, N.Y. 14206
 (416) 493-8675

VISA
 MASTERCARD

Circle 214 on inquiry card.

APPLE® COMPATIBLE SYSTEM SALES

A W/P Package Incl:

APPLE® COMPATIBLE W/64K
 RANA ELITE ONE W/CNTR
 12" AMBER MONITOR
 SMITH/CORONA TP-I PRINTER
 WORD PROCESSING SOFT.

ON SALE \$1899

AND MORE—Savings & Selection

Apple IIe	CALL
KayPro II	\$1499
Franklin Ace 1000	\$ 929
Colt mbia MPC	\$2295
Syscom 2	\$ 649
IBM P/IC	On Sale
Smith-Corona TP-I	\$ 559
Gemini 10 Dot Matrix	\$ 329

For Complete Selection and
 Lowest Prices — Free Catalog

COMPUTERS and more

2420 University Ave., Suite 3, San Diego, Ca. 92104
 (619) 291-1442, Telex 697120, Datamax Attn: Dept. 322

Circle 108 on inquiry card.

NEW IBM® PC SOFTWARE

ONLY \$68 FOR ALL THREE!!

PERSONALPAC™: 3 menu-driven "user friendly" time savers.

BILLTIME: Program expense categories w/o programming experience. Easily add, delete, update bills. Sort several ways.

BANKBAL: Reconcile checkbook fast! Flexible and handles all types of income and expenses.

APPTCAL: Keep track of all engagements. Easily add, delete, update, and list appointments.

USE AT HOME OR AT THE OFFICE
 Sold on PC DOS-formatted diskette. Send check, money order or C.O.D. to:

SEARS ELECTRONICS INC.
 "time saving software designers"
 Tirrell Hill, Goffstown, NH 03045
 (603) 497-3074

Circle 377 on inquiry card.

Touch Tone Decoding Modem

Convert Touch Tones to ASCII. The Touch Tone Decoder Modem offers a low cost solution to remote monitoring and data entry applications. It autoanswers and connects any host computer's asynchronous RS-232 port with the telephone system. Select 300, 600, or 1200 baud data rate or optional external audio input. \$500 single quantity. Touch Tone send/1200 baud receive terminal available.

the microperepheral corporation
 2565 152nd Avenue NE
 Redmond, WA 98052
 (206) 881-7544

Circle 283 on inquiry card.

DISKETTES 3M Scotch® BRAND

AT SUPER LOW PRICES
 WE WILL SHIP YOUR ORDER WITHIN 24 HOURS AND WE PAY THE SHIPPING CHARGES

 COD ACCEPTED

DEALER INQUIRIES INVITED

 **CALL TOLL FREE 800 922-8193**

IN CALIFORNIA
 800 468-1068

 **TAYCO**
 Tayco Business Forms
 Computer Supplies
 Post Office Box 605
 Newbury Park, CA 91320

Circle 403 on inquiry card.

NEW!! The Apple users group software library bonanza at truly affordable prices. For the first time enjoy your Apple to its fullest capacity using specially packed disks with over 60 outstanding programs each. Not available from any other source!

• Applesoft • 3.3 DOS

PROGRAMS \$1-EACH

APPLEWARE INC. offers
 An extensive variety of interesting, useful and entertaining programs indispensable to the serious computerist including:

Business	• Educational	• Graphics
Games	• Music	• Science
Utilities	• Data Base	• Finance ...

Library disks 1, 2 & 3 are mixed categories and new disks 4 (Games), 5 (Utilities), 6 (Graphics) & 7 (Integer) at \$59.95 each. Why pay more?

Order direct from this ad and Save up to \$136. Buy disk library package 1, 2 & 3 and get a special bonus disk FREE — over 260 programs for \$179.95 + shipping. For best value, get all 8 disks for \$349, postage prepaid, for over 530 of our best programs at 65¢ each! Call now toll free: 1-800-327-8664

Florida: 1-305-987-8665
 6400 Hayes St.
 Hollywood, FL 33024

Circle 29 on Inquiry card.

Alspa Computer, Inc.

The price-performance leader. Includes Z80A, 1 or 2 full 8" drives (double density, double sided), 3 serial and 1 parallel port, and winchester port. Prices start at less than \$2000. DEALER and OEM inquiries invited.

SPECIALS on INTREGATED CIRCUITS

6502	7.45	10/ 6.95	50/ 6.55	100/ 6.15
6502A/6512A	8.40	10/ 7.95	50/ 7.35	100/ 6.90
6520 PIA	5.15	10/ 4.90	50/ 4.45	100/ 4.15
6522 VIA	6.45	10/ 6.10	50/ 5.75	100/ 5.45
6532	7.90	10/ 7.40	50/ 7.00	100/ 6.60
2114-L200	2.45	25/ 2.30	100/ 2.15	
2716 EPROM	4.90	5/ 4.50	10/ 4.00	
2532 EPROM	7.90	5/ 7.45	10/ 6.90	
6116 2Kx8 CMOS RAM	7.90	5/ 7.45	10/ 6.90	
4116 RAM			8 for 14	
Zero Insertion Force 24 pin Socket (Scanbe)				2.00

Hewlett Packard



Write or call for prices.

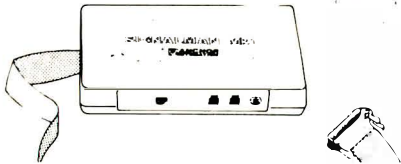

Anchor Automation Signalman Modems

FREE SOURCE MEMBERSHIP WITH SIGNALMAN
All Signalman Modems are Direct Connect, and include cables to connect to your computer and to the telephone. Signalman Modems provide the best price-performance values, and start at less than \$100. Dealer and OEM inquiries invited

- Mark I RS232
- Mark II for Atari 850
- Mark IV for CBM/PET with software
- Mark V for Osborne (software available)
- Mark VI for IBM Personal Computer
- Mark VII Auto Dial/Auto Answer
- Mark VIII Bell 212 Auto Dial/Answer

DC HAYES Smartmodem	229
DC Hayes Smartmodem 1200	545

We carry Apple II+ from Bell & Howell



16K RAM Card for Apple	65
Solid Oak 2 Level Stand for Apple	29
Apple LOGO	150
Video Recorder Interface	545
Super Serial Card	149
Thunderclock Plus	119
Z80 Softcard and CP/M (Microsoft)	235
Parallel Printer Interface/Cable	80
Grappler Interface	139
TG Products Joystick for Apple	48
TG Paddles	32
DC Hayes Micromodem II	299
Videx 80 Column Card	239
Hayden Software for Apple 20% OFF	
Apple PASCAL Language	195
Apple FORTRAN	160
We stock EDUWARE Software	
GENIS I Courseware Development System	90
Unicom Grade Reporting or School Inventory	250
Executive Briefing System with fonts	225
Apple Dumping (Microtek) Printer Interface	115
Apple Dumping with 16K Buffer	160
PIE Writer Word Processor	120

Commodore

See us for Personal, Business, and Educational requirements. Educational Discounts available.

PETSCAN \$245 base price

Allows you to connect up to 35 CBM/PET Computers to shared disk drives and printers. Completely transparent to the user. Perfect for schools or multiple word processing configurations. Base configuration supports 2 computers. Additional computer hookups \$100 each.

Commodore COMMUNICATES! COMPACT \$115

Intelligent Terminal Package includes: ACIA hardware based interface; DB25 Cable and STCP Software with remote telemetry, transfer to/from disk, printer output, XON-XOFF control, user program control, and status line.

VE-2 IEEE to Parallel Interface 110

Includes case, power supply, full 8-bit transmission, and switch selectable character conversion to ASCII.

VIC 20 Products			
Backup V1.0	20	VIC Sargon II Chess	32
VIC RAM Cards in stock		VIC GORF	32
VIC SuperExpander	53	Meteor Run (UMI)	39
VIC 16K RAM	95	VIC Radar Ratrace	24
Thorn EMI Software		Amok (UMI)	20
HES Software		Snakman	15
VIC Omega Race	32	Rubik's Cube	13
Spiders of Mars (UMI)	39	Programmers Reference	15
Programmers Aid	45	Renaissance (UMI)	39
		VIC Adventure Series	
		VICTORY Software for VIC and C64	
Street Sweepers	12	Maze in 3-D	12
Night Rider	12	Cosmic Debris	12
Treasures of Bat Cave	11	Grave Robbers Advent.	11
Games Pack I	12	Games Pack II	12
Victory Casino	8	Adventure Pack I	12
Adventure Pack II	12	Trek	11

Commodore 64 Programmers Reference Guide	17
Compute!'s First Book of PET/CBM	11
POWER ROM Utilities for PET/CBM	78
WordPro 3+ - 32K CBM, disk, printer	195
WordPro 3+/64	70
WordPro 4+ - 8032, disk, printer	300
SPELLMASTER spelling checker for WordPro	170
VISCALC for PET, ATARI, or Apple	190
PETRIX PET to Epson Graphics Software	40
SM-KIT enhanced PET/CBM ROM Utilities	40
Programmers Toolkit - PET ROM Utilities	35
PET Spacemaker II ROM Switch	36
2 Meter PET to IEEE or IEEE to IEEE Cable	40
Dust Cover for PET, CBM, 4040, or 8050	8
VIC or C64 Parallel Printer Interface	79
CmC IEEE-RS232 Printer Interface - PET	120
SADI Intelligent IEEE-RS232 or parallel	235
ZRAM - CBM 64K RAM, Z80, CP/M	550
Programming the PET/CBM (Compute!) - R. West	20
Compute! First Book of VIC	11
Whole PET Catalog (Midnight Gazette)	8
Color Chart Video Board for PET	125
PET Fun and Games (Cursor)	11

FlexFile for PET CBM, C64 \$110

Database, Report Writer with Calculations, Mailing Lists

FORTH for PET full FIG model - Cargill/Riley	\$50
Metacompiler for FORTH for independent object code	30
KMMM PASCAL for PET/CBM/C64	85
EARL for PET/CBM Disk-based ASSEMBLER	65
Super Graphics - BASIC Language Exercises	45
Fast machine language graphics routines for PET/CBM	
RAM/ROM for PET/CBM	4K \$75 8K \$90

DISK SPECIALS



Scotch (3M) 5" ss/dd	10/ 2.25	50/ 2.10	100/ 2.05
Scotch (3M) 5" ds/dd	10/ 3.15	50/ 2.90	100/ 2.85
Scotch (3M) 8" ss/sd	10/ 2.40	50/ 2.20	100/ 2.15
Scotch (3M) 8" ss/dd	10/ 2.95	50/ 2.70	100/ 2.65

We stock VERBATIM DISKS

Write for Dealer and OEM prices.

BASF 5" or 8"	10/ 2.00	20/ 1.95	100/ 1.85
NEW BASF Qualimetric Disks also in stock.			
Wabash 5" ss/sd	10/ 1.80	50/ 1.75	100/ 1.70
Wabash 5" ss/dd	10/ 2.00	50/ 1.95	100/ 1.90
Wabash 8" ss/sd	10/ 2.00	50/ 1.95	100/ 1.90

We stock MAXELL DISKS

Write for dealer and OEM prices.

Disk Storage Pages	10 for \$5	Hub Rings 50 for \$6
Disk Library Cases	8"-3.00	5"-2.25
Head Cleaning Kits	11	

CASSETTES-AGFA PE-611 PREMIUM

High output, low noise, 5 screw housings.

C-10	10/ .61	50/ .58	100/ .50
C-30	10/ .85	50/ .82	100/ .70

SPECIALS

Zenith ZVM-121 Green Phosphor Monitor	109
VOICE BOX Speech Synthesizer (Apple or Atari)	
Many printers available (Star, Brother, OKI, etc.)	
We Stock AMDEK Monitors	
Watanabe Intelligent Plotter 990	6-pen 1290
ISOBAR 4 Outlet Surge Suptressor/Noise Filter	49
We stock Electrohome Monitors	
dBASE II	390
Panasonic TR-120M1P 12" Monitor (20 MHz)	149
Panasonic CT-160 Dual Mode Color Monitor	285
Franklin Computers - special system price	
Hewlett Packard Calculators available	

USI Video Monitors-Green or AMBER 20 MHz hi-res. Dealer and OEM inquiries invited

ALL BOOK AND SOFTWARE PRICES DISCOUNTED

A P Products 15% OFF

Synertek SYM-1 Microcomputer	SALE 189
KTM-2/80 Synertek Video and Keyboard	349

ZENITH data systems

Z29 Terminal (VT100, VT-52, ADM3A, Haz1500 compatible)	680
ZT-1 Intelligent Communications Terminal	479
Z100 16-bit/8-bit System	CALL

We stock entire Zenith line.



ATARI SPECIALS

800 Computer	499	Microsoft BASIC	72
400-16K	199	MISSILE COMMAND	29
810 Disk Drive	440	ASTEROIDS	29
Thorn EMI Software		STAR RAIDERS	34
850 Interface	170	Space Invaders	29
Inside Atari DOS	18	Atari Graph. (Compute!)	11
Joysticks or Paddles	19	Caverns of Mars	33
Microtek RAM Cards		PAC-MAN	36
EduFun Software		CENTIPEDE	36
Pilot	65	First Book of Atari	11
Super Breakout	29	Anchor Modem-Atari	85
APX Software	Call	Other Atari products	Call

WRITE FOR CATALOG

Add \$1.25 per order for shipping. We pay balance of UPS surface charges on all prepaid orders. Prices listed are on cash discount basis. Regular prices slightly higher. Prices subject to change.

252 Bethlehem Pike
Colmar, PA 18915

215-822-7727

A B Computers

8087 SUPPORT

For the **IBMPC and CP/M-86.**

8087 CHIP.....\$223

APPLICATIONS

FFTs.....\$75

MATRIXPAK.....\$75

87/88 GUIDE VOLUME I ...\$19.95

LANGUAGE SUPPORT

87MACRO™.....\$150

87BASIC™.....\$150

87PASCAL™.....\$150

87FORTRAN™.....\$150

IBM Personal Computer is a registered trademark of IBM Corp. CP/M-86 is a trademark of Digital Research, Inc. 8087 is a trademark of Intel Corp. 87/88GUIDE, 87MACRO, 87BASIC, 87PASCAL, 87FORTRAN and MicroWare are trademarks of MicroWare, Inc.

MicroWare

P.O. Box 79
Kingston, MA
02364
(617) 746-7341

Circle 287 on Inquiry card.

ELIZA IS HERE!

AT LAST! A FULL IMPLEMENTATION of the original ELIZA program is now available to run on your microcomputer!

Created at MIT in 1966, ELIZA has become the world's most celebrated artificial intelligence demonstration program. ELIZA is a non-directive psychotherapist who analyzes each statement as you type it in and then responds with her own comment or question — and her remarks are often startlingly appropriate!

Designed to run on a large mainframe, ELIZA has hitherto been unavailable to personal computer users except in greatly stripped down versions lacking the sophistication which made the original program so fascinating.

Now, our new microcomputer version possessing the FULL power and range of expression of the original is being offered at the introductory price of only \$25. And if you want to find out how she does it (or teach her to do more) we will include the complete Source Program for only \$20 additional.

Order your copy of ELIZA today and you'll never again wonder how to respond when you hear someone say "Okay, let's see what this computer of yours can actually do!"

ELIZA IS AVAILABLE IN THE FOLLOWING DISK FORMATS:

- Standard 8 inch single density for all CP/M based computers \$25 for ELIZA.COM - add \$20 for Microsoft BASIC-80 Source
- 5 1/4 inch CP/M for Apple II equipped with 2-80 SoftCard \$25 for ELIZA.COM - add \$20 for Microsoft BASIC-80 Source
- 5 1/4 inch for 48K Apple II with Applesoft ROM and DOS 3.3 \$25 for Protected File - add \$20 for Applesoft Source
- 5 1/4 inch for 64K IBM Personal Computer \$25 for Protected File - add \$20 for IBM Disk BASIC Source
- 5 1/4 inch for Osborne I Microcomputer \$25 for Protected File - add \$20 for Microsoft BASIC-80 Source

ARTIFICIAL INTELLIGENCE RESEARCH GROUP
921 NORTH LA JOLLA AVENUE
LOS ANGELES, CALIFORNIA 90046
(213) 656-7368 (213) 654-2214
MC, VISA and CHECKS ACCEPTED

Circle 33 on Inquiry card.

EDGE-86
AN INDUSTRIAL QUALITY
8086 OEM SYSTEM

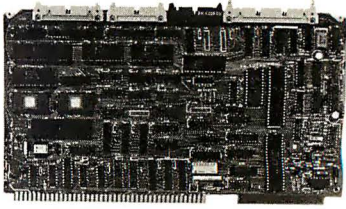

• HARDWARE

- A Multibus® COMPATIBLE 8086 CPU BOARD WITH DMA FLOPPY CONTROLLER, INTERRUPT CONTROLLER, PROGRAMMABLE TIMERS, 3 SERIAL PORTS, TWO PARALLEL I/O PORTS, AND 8K BYTES OF PROM WITH BOOT STRAP LOADER FOR CP/M®86™.
- 128K BYTES DYNAMIC RAM BOARD.
- 4-SLOT MULTIBUS CARD CAGE, WITH COMPLETE DOCUMENTATION AND SCHEMATICS; ALL FOR.....\$1250.

• SOFTWARE

- CPM/86.S. WITH COMPLETE UTILITIES...\$250.
- OFF THE SHELF DELIVERY —

EDGE MICRO SYSTEMS
195 W. EL CAMINO REAL, SUNNYVALE, CA 94086
TELEPHONE: 408-738-4729

® Multibus TM of Intel.™CPM/86 TM of Digital Research.

Circle 155 on Inquiry card.

SUPER I/O™

Low Cost I/O Expansion Board

Build and interface projects in minutes. Use with any Z80* processor. Use simple In/Out instructions. No complicated controllers to install. Features I/O memory map.

- *32 byte wide channels.
- *16 Input/16 Output.
- *256 bits of I/O. Options for TRS*, SINCLAIR* and Z80* socket interface cables.

*Trade marks

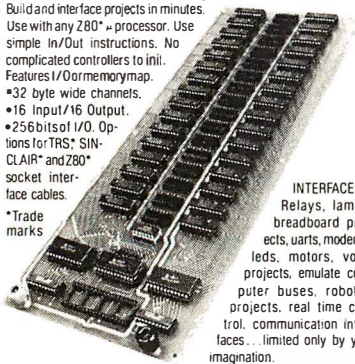

INTERFACE:
Relays, lamps, breadboard projects, UARTs, modems, LEDs, motors, voice projects, emulate computer buses, robotics projects, real time control, communication interfaces... limited only by your imagination.

WIN/MILL Research, Inc.
INNOVATIVE PRODUCTS FOR INNOVATIVE PEOPLE
453 Crampton Avenue | ORDER PHONE (only) (702) 329-0441
Reno, Nevada 89502 | For priority info, send SASE.

Circle 446 on Inquiry card.

5 1/4" Tandon Drives

- TM 100-1** \$189
[single sided, 40 TRK, single or double density] Free Shipping
- TM 100-2** \$259
[double sided, 40 TRK/side single or double density] Free Shipping
- TM 100-4** \$349
[double sided, 80 TRK/side 96 TPI, double density] Free Shipping

ORDER — TOLL FREE

1-800-531-5475 (If outside of Texas)
(512) 250-1523 (If inside of Texas)

"If we can't ship the next working day, we won't take the order."

Master Card/Visa or check.
Texas Residents add 5% sales tax.

CompuAdd Corp.
13010 Research Blvd - # 218
Austin, Texas 78750

Circle 89 on Inquiry card.

ANALOG ↔ DIGITAL
DIGITAL ↔ ANALOG

CONVERSION MODULES

SOFTWARE
GAIN CONTROL

High accuracy — programmable gain instrumentation amplifier — custom board test — 5-100 — 2 to 15 kHz conversion time — mixable high and low inputs — gain from 1 to 1024 — 12-bit — sample and hold amplifier 8-channel differential — 16-channel — analog to digital high accuracy — programmable gain instrumentation amplifier — custom board test — 5-100 — 2 to 15 kHz conversion time — mixable high and low inputs — gain from 1 to 1024 — 12-bit — sample and hold amplifier 8-channel differential — 16-channel — analog to digital high accuracy — programmable gain instrumentation amplifier — custom board test — 5-100 — 2 to 15 kHz

For additional details about the AD-100-4 and other fine California Data Corporation 100% individually tested, high reliability products, circle the reader service card number below or for faster response write or call us.

CALIFORNIA DATA CORPORATION
3475 Old Conejo Road, Suite C-10
Newbury Park, CA 91320
(805) 498-3651

Circle 70 on Inquiry card.

ZENITH/ Heath Users

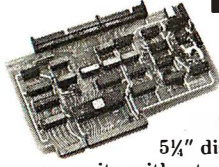

Double Your 5 1/4" disk storage capacity without adding a drive.

Get twice as much from your H88 or H89 microcomputer. Our FDC-880H floppy disk controller, in conjunction with your 5 1/4" drives, for example, expands memory capacity from 256 bytes to 512 bytes per sector.

And it handles single and double-sided, single and double-density, 8" and 5 1/4" drives — simultaneously.

C.D.R. Systems Inc.
Controlled Data Recording Systems Inc.
7210 Clairmont Mesa Blvd., San Diego, CA 92111
(714) 560-1272

Circle 71 on Inquiry card.

SMITH-CORONA TP-1

Letter Quality Daisy Wheel Printer



• SERIAL OR PARALLEL INTERFACE
• MICROPROCESSOR ELECTRONICS

ORDER TOLL FREE FREE SHIPPING \$569

(800) 531-5475 (if outside of Texas)
(512) 250-1523 (in Texas)

CompuAdd Corp.
13010 Research Blvd. No. 218
Austin, Texas 78705

Circle 90 on Inquiry card.

wabash®

When it comes to Flexible Disks, nobody does it better than Wabash.

MasterCard, Visa Accepted.
Call Free: (800) 235-4137

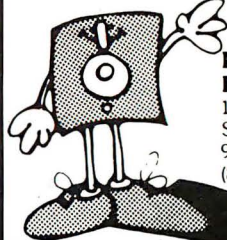

PACIFIC EXCHANGES
100 Foothill Blvd
San Luis Obispo, CA
93401 (In Cal call
(805) 543-1037)

Circle 319 on inquiry card.

DRIVES

IBM • APPLE II • APPLE III

QUENTIN OR MICRO-SCI

APPLE II 5 1/4" **\$249⁰⁰**

OKIDATA

82A 83A 84 93

CALL FOR LOWEST PRICES

BASIS 108

APPLE COMPATIBLE
COMPUTER
CALL FOR LOWEST PRICE

QUADRAM Corporation

**MICROFAZER
QUADBOARD
QUAD 512 +**

SMITH-CORONA TP-1



LETTER QUALITY
DAISY WHEEL
\$575⁰⁰

SOFTWARE

WE HAVE IT ALL!
OVER 500 TITLES

IBM • APPLE • CP/M
PARTIAL LISTING

BEAGLE BROS:

APPLE MECHANIC	22.00
DOSS BOSS	17.50
FLEX TEXT	22.00
PRONTODOS	22.00
TIP DISK #1	15.00
TYPEFACES	15.00
UTILITY CITY	22.00
BPI, GL, AP, AR	299.00
BRODERBUND	SCALL
DATAMOST	SCALL
FROGGER	30.00
HOME ACCOUNTANT	59.00
HOME ACCT + (IBM)	119.00
MICROPRO	SCALL
MICROSOFT	SCALL
MULTIPLAN	199.00
PEACHTREE	SCALL
PIE WRITER	119.00
SCREENWRITER II	99.00
SUPERCALC	215.00
TRANSEND	119.00
WIZARDRY	35.00
WORDHANDLER II	139.00

HARDWARE

WE CARRY MOST
PRODUCTS. PLEASE
CALL IF NOT LISTED

PARTIAL LISTING

ALS-Z-CARD	159.00
APPLESURANCE (Cont)	100.00
DISK LIBRARY CASE	2.50
FLIP FILE	20.00
GRAPPLER +	139.00
HAYES MICROMODEM II	269.00
KRAFT JOYSTICK	47.00
MX-80 PRINTER STAND	19.00
MX-PLUS	45.00
MICROBUFFER II 32K	239.00
MICROSOFT SOFTCARD	239.00
NOVATION PRODUCTS	SCALL
PAYMAR L/CASE, REV. 7	20.00
PKASO	159.00
PRACTICAL PERIPHERALS	SCALL
PROMETHEUS	SCALL
SHIFT KEY MODIFICATION	12.00
WILDCARD	119.00
WIZARD BPO, EPSON	149.00
WIZARD SOB	209.00
WIZARD SPOOLER (IBM)	219.00

VISICORP

IBM-APPLE II-APPLE III

Visilink (Apple)	179.00
Visicalc (IBM or Apple)	179.00
Desktop Plan II (Apple)	179.00
Desktop Plan (IBM)	249.00
Visidex (IBM or Apple)	179.00
Visifile (Apple)	179.00
Visifile (IBM)	249.00
Visiplot (Apple)	145.00
Visischedule (Apple)	229.00
Visiterm (Apple)	75.00
Visitrend/Plot (Apple)	229.00

16 RAM CARD

Compatible with:
DOS 3.3, CP/M,
Visicalc, PASCAL **\$59⁰⁰**
2 YR. WARRANTY

SATURN SYSTEMS

64K	\$319 ⁰⁰
128K	459 ⁰⁰
V-C Expand 80	99 ⁰⁰

Mountain Computer

CPS Card	159.00
Mtn Cables	SCALL
Ramplus-32K	145.00
Rom Writer	145.00
Clock	195.00
Music System	299.00
Super Talker	149.00
Expansion Chassis	559.00
Card Reader	SCALL
A/D-D/A	269.00
Visicalc Expander	SCALL

Legend Industries

64K (Includes V-C plus)	\$299 ⁰⁰
128K ^(inc. Videx V-CALC 80 w/mem. exp.)	479 ⁰⁰
Pascal Super Systems	SCALL

Verbatim

5 1/4" (100)	\$239 ⁹⁵
5 1/4" (10)	25 ⁹⁵
8" (10)	39 ⁹⁵
Head Cleaning Kit	7 ⁵⁰

KENSINGTON MICROWARE

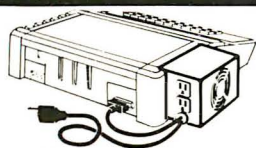

SYSTEM SAVER

- Surge Suppression
- Dual Outlet
- U.L. Listed
- Fits Apple Stand

\$65

TG Products

Paddles	\$29 ⁰⁰
Joystick II	40 ⁰⁰
Select-A-Port	47 ⁰⁰
All of Above	109 ⁰⁰
Trakball	59 ⁰⁰
Joystick III	45 ⁰⁰
Joystick IBM	45 ⁰⁰

MONITORS

AMDEK	SCALL
BMC 12" Green Au	88 ⁰⁰
BMC 12" Green Eu	129 ⁰⁰
BMC 9191 Color	349 ⁰⁰
TAXAN AMBER	149 ⁰⁰
TAXAN RGB I	349 ⁰⁰
USI PI3-12" Amber	169 ⁰⁰
USI PI4-9" Amber	159 ⁰⁰

Videx

80 Column	\$239 ⁰⁰
Enhancer II	119 ⁰⁰
Softswitch	25 ⁰⁰
Function Strip	59 ⁰⁰
Inverse Video	19 ⁰⁰
Applewriter Pre-Boot	19 ⁰⁰
Visicalc 80 Software	49 ⁰⁰
Visicalc 80 w/mem. exp.	74 ⁰⁰

EPSON RIBBONS

MX 80 \$ 7⁰⁰ ea Or 3 for 20⁰⁰
MX 100 11⁰⁰ ea Or 3 for 32⁰⁰

**DEALER
INQUIRIES
INVITED**



**COMPUTER
DISCOUNT
PRODUCTS**

MAIL ORDERS & RETAIL STORE

860 S. Winchester Blvd.
San Jose, CA 95128

(408) 985-0400

HOURS: MON-FRI 8AM - 5PM - SAT & SUN 10AM - 4PM

PRICES SUBJECT TO CHANGE - ALL ORDERS FOB SAN JOSE



TeleVideo™ USERS!

COGITATE Fast Dump/Restore System for TS 802H, 806.

- Back-up files twice as fast as PIP.
- Double the storage, up to 700K/diskette, with multiple diskette capability **\$90.00**

COGITATE Type Ahead With Print Screen

- Print key prints screen.
- 64 character typeahead buffer **\$90.00**

TurboDOS

- MULTI-USER **\$750.00**
- SEMINARS **\$250.00**

CP/M® is registered trademark of Digital Research, Inc.

TurboDOS is a registered trademark of Software 2000, Inc.

PLUS OTHER GOOD TELEVIDEO STUFF!

COGITATE, Inc.

SPECIALISTS IN UNIQUE TELEVIDEO SOFTWARE
24000 Telegraph Road, Southfield, MI 48034
(313) 352-2345

VISA/MASTER CARD Accepted

Circle 79 on inquiry card.

Verbatim flexible disks

Call Free **(800) 235-4137** for prices and information. Dealer inquiries invited. C.O.D. and charge cards accepted.

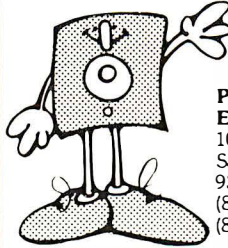

VISA

PACIFIC EXCHANGES
 100 Foothill Blvd.
 San Luis Obispo, CA
 93401. In Cal. call
 (800) 592-5935 or
 (805) 543-1037.

Circle 319 on inquiry card.

Electronic Circuit Analysis

- DC and AC analysis
- Very fast, machine language
- Infinite circuits on multiple passes
- Worst case, sensitivity analysis
- Dynamic modification
- 64 Nodes, 127 branches
- Compare circuits
- Log or linear sweep
- Full file handling
- Frequency response, magnitude and phase
- Complete manual with examples
- TRS-80 (TRSDOS) \$90.00
- CP/M \$150.00

Tatum Labs
P.O. Box 722
Hawleyville, CT
06440
(203) 426-2184

Circle 402 on inquiry card.

5 1/4" Floppy Disk Drives

(Direct IBM® Plug-in)

- TANDON Model TM 100-1 **\$189*** ea.
- TANDON Model TM 100-2 **\$249*** ea.
- 12" Green Phosphor Zenith Monitor **\$109*** ea.

IBM EXPANSION BOARDS

- 64K Memory **\$275*** ea.
 - 128K Memory **\$375*** ea.
 - 192K Memory **\$450*** ea.
 - 256K Memory **\$510*** ea.
 - Floppy Controller **\$180*** ea.
 - 16K System BD Memory **\$ 25*** ea.
- MC / VISA or C.O.D. with certified check or money order. Arkansas residents add sales tax.

For information or orders, call
501-777-9859

G-H Computer Systems, Inc.
 P.O. Box 871 • Hope, AR 71801
 * Plus Shipping.

Circle 174 on inquiry card.

FREE! FREE! FREE! FREE! FREE!

FREE! FREE! FREE! FREE! FREE!

FREE! FREE! FREE! FREE! FREE!

SEND FOR OUR NEW 1983 PARTS CATALOG

THOUSANDS OF SURPLUS ELECTRONIC PARTS, SUPPLIES AND DEVICES.

ALL ELECTRONICS CORP

905 S. Vermont Ave.
 P.O. Box 20406
 Los Angeles, Cal. 90006

Circle 18 on Inquiry card.

NEW REPLACEMENT RIBBON CARTRIDGES

EPSON MX 70-80 **\$4.75 ea.**
 MX 100 **10.75 ea.**

Please add \$.75 ea. shipping/handling.

WE HANDLE MOST POPULAR CARTRIDGES. SEND FOR PRICE LIST

LABELS \$12.00/5000

STOCK #10350-1 15/16" x 3 1/2" x 1 wide.

White—pressure sensitive—pin feed—4 1/4" carrier, packed 5000 per box.

Add \$2.50 per box handling/shipping.

COMPLETE LINE OF OTHER LABELS AVAILABLE. SEND FOR PRICE LIST

TERMS: MIN. ORDER \$12.00.

VISA & MC (add 4%), check or money order. C.O.D.'s add \$2.00. CA residents add Sales Tax.

S&W COMPUTER SUPPLY CO.

25422 TRABUCO RD. SUITE #200A EL TORO, CA. 92630 • (714) 768-0370

Circle 373 on inquiry card.

PC/FORTH™

Complete FORTH program development systems for the IBM® Personal Computer. Packages include interpreter/compiler with virtual memory management, line editor, custom screen editor, assembler, decompiler, utilities, file and record access modules, and many demonstration programs. 150 page user manual. **\$100.00**

Software floating point, Intel 8087 support, color graphics extensions, and target compiler available at additional cost.

Specify PC-DOS or CP/M-86®. One disk drive and 48 kbytes RAM required. Software supported on 5 1/4 inch single sided soft sectored double density diskettes.

Laboratory Microsystems
 4147 Beethoven Street
 Los Angeles, CA 90066
(213) 306-7412

IBM is a registered trademark of International Business Machines Corp.
 CP/M is a registered trademark of Digital Research, Inc.

Circle 226 on inquiry card.

NEW PRODUCT!

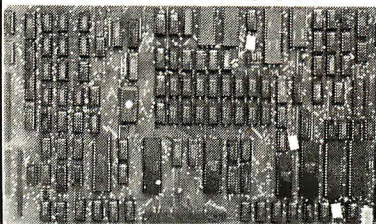

CP/M Z80-A SINGLE BOARD COMPUTER

- On board video • Wide line and thin line graphics
- 128K of RAM • Sasi interface • Floppy disk controller for up to four 5-1/4 and four 8 inch drives, single/double density simultaneously • 4 serial ports • Full Centronics printer port • Expansion bus • Extended track buffer • 16K printer buffer
- DMA • Compact size (8-1/4 x 12-1/4)

\$600.00 on orders placed and paid for prior to March 1, 1983 FOB Los Angeles, CA \$7.00 shipping

INSIGHT ENTERPRISES, CORPORATION
 373 N. Western Ave., Suite 12,
 Los Angeles, CA 90004 (213) 461-3262
 Dealer, OEM, International Inquiries Welcome



Circle 202 on Inquiry card.

ULTRA-RES (1) GRAPHICS

- IEEE-696 S/100 Monochrome **\$495.00 (2)**
 - 512 x 512 Pixel
 - Single Board
- IEEE-696 S/100 Monochrome **\$995.00 (2)**
 - 1024 x 1024 Pixel
 - Expandable to 8 x 1024 x 1024 Pixel
- IEEE-696 S/100 Eight Color **\$1250.00 (2)**
 - 3 x 512 x 512 Pixel
 - 8 Color RGB TTL
 - 2 Board System
- MultiBus (3) Eight Color **\$1995.00 (2)**
 - 3 x 1024 x 1024 Pixel
 - 8 Color RGB TTL
 - Single Board
- IBM PC Monochrome **\$995.00 (2)**
 - 1024 x 1024 Pixel
 - Expandable to 8 x 1024 x 1024

FEATURES INCLUDE—Software Drivers, Hardware Zoom, Programmable Display Resolution, Windowing, Multi-Controller Capability, NEC UPD7220 Graphic Controller.

- 1) ULTRA-RES Trademark CSD Incorporated
- 2) Starting Prices
- 3) MultiBus Trademark Intel Corporation

C.S.D. Incorporated
 P.O. Box 253 Sudbury, Massachusetts 01776
(617) 443-2750

Circle 68 on inquiry card.

NEW!

"THE ORIGINAL BIG BOARD" OEM - INDUSTRIAL - BUSINESS - SCIENTIFIC SINGLE BOARD COMPUTER KIT! Z-80 CPU! 64K RAM! (DO NOT CONFUSE WITH ANY OF OUR FLATTERING IMITATORS!)

**NEW
LOWER PRICES**

PARTIALLY ASSEMBLED KITS
For All Sockets Installed
And Soldered Add \$50.
(Not For Blank PCB)

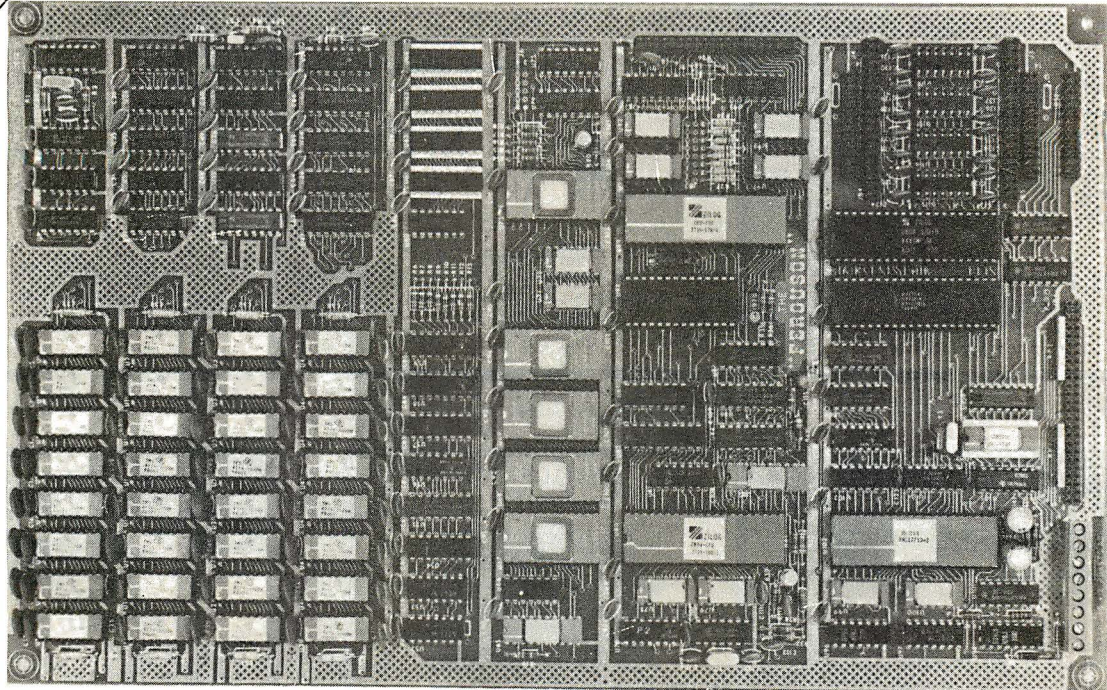

WANT MORE INFO?
Full Documentation and
Schematics — \$5.

THE BIG BOARD PROJECT: With thousands sold worldwide and over two years of field experience, the Big Board may just be one of the most reliable single board computers available today. This is the same design that was licensed by Xerox Corp. as the basis for their 820 computer.

The Big Board gives you the right mix of most needed computing features all on one board. The Big Board was designed from scratch to run the latest version of CP/M*. Just imagine all the off-the-shelf software that can be run on the Big Board without any modifications needed.

\$319⁰⁰** (64K KIT
BASIC I/O)

SIZE: 8 1/2 x 13 3/4 IN.
SAME AS AN 8 IN. DRIVE.
REQUIRES: +5V @ 3 AMPS
+ - 12V @ .5 AMPS.

FULLY SOCKETED! FEATURES: (Remember, all this on one board!)

64K RAM

Uses Industry standard 4116 RAM's. All 64K is available to the user, our VIDEO and EPROM sections do not make holes in system RAM. Also, very special care was taken in the RAM array PC layout to eliminate potential noise and glitches.

Z-80 CPU

Running at 2.5 MHZ. Handles all 4116 RAM refresh and supports Mode 2 INTERRUPTS. Fully buffered and runs 8080 software.

SERIAL I/O (OPTIONAL)

Full 2 channels using the Z80 SIO and the SMC 8116 Baud Rate Generator. FULL RS232! For synchronous or asynchronous communication. In synchronous mode, the clocks can be transmitted or received by a modem. Both channels can be set up for either data-communication or data-terminals. Supports mode 2 Int. Price for all parts and connectors: \$39.95

BASIC I/O

Consists of separate parallel port (Z80 PIO) for use with an ASCII encoded keyboard for input. Output would be on the 80 x 24 Video Display.

BLANK PC BOARD — \$119

The blank Big Board PC Board comes complete with full documentation (including schematics), the character ROM, the PFM 3.3 MONITOR ROM, and a diskette with the source of our BIOS, BOOT, and PFM 3.3 MONITOR.

24 x 80 CHARACTER VIDEO

With a crisp, flicker-free display that looks extremely sharp even on small monitors. Hardware scroll and full cursor control. Composite video or split video and sync. Character set is supplied on a 2716 style ROM, making customized fonts easy. Sync pulses can be any desired length or polarity. Video may be inverted or true. 5 x 7 Matrix - Upper & Lower Case.

FLOPPY DISC CONTROLLER

Uses WD1771 controller chip with a TTL Data Separator for enhanced reliability. IBM 3740 compatible. Supports up to four 8 inch disc drives. Directly compatible with standard Shugart drives such as the SA800 or SA801. Drives can be configured for remote AC off-on. Runs CP/M* 2.2.

TWO PORT PARALLEL I/O (OPTIONAL)

Uses Z-80 PIO. Full 16 bits, fully buffered, bi-directional. Uses selectable hand shake polarity. Set of all parts and connectors for parallel I/O: \$19.95

REAL TIME CLOCK (OPTIONAL)

Uses Z-80 CTC. Can be configured as a Counter on Real Time Clock. Set of all parts: \$9.95

CP/M* 2.2 FOR BIG BOARD

The popular CP/M* D.O.S. to run on Big Board is available for \$139.00.

BIG BOARD SOFTWARE SPECIAL — \$149

Through special arrangement with CDL we offer a powerful package of TDL Z-80 software that has a suggested retail of almost \$600. Includes: Extended Disk Business Basic, ZEDIT text editor, MACRO II Macro Assembler, LINKER, DEBUG I and DEBUG II. Supplied on 8 in. diskette with extensive manual.

PFM 3.3 2K SYSTEM MONITOR

The real power of the Big Board lies in its PFM 3.3 on board monitor. PFM commands include: Dump Memory, Boot CP/M*, Copy, Examine, Fill Memory, Test Memory, Go To, Read and Write I/O Ports, Disc Read (Drive, Track, Sector), and Search PFM occupies one of the four 2716 EPROM locations provided. Z-80 is a Trademark of Zilog.

Digital Research Computers

(OF TEXAS)

P.O. BOX 401565 • GARLAND, TEXAS 75040 • (214) 271-3538

TERMS: Shipments will be made approximately 3 to 6 weeks after we receive your order. VISA, MC, cash accepted. We will accept COD's (for the Big Board only) with a \$75 deposit. Balance UPS COD. Add \$4.00 shipping.
USA AND CANADA ONLY

RTL

Relocatable Threaded Language **\$150**

RTL is a new language which retains the speed and extensibility of Fort but adds many additional advantages as a result of its more structured dictionary. Names, code, and variables are all stored in separate areas for easy generation of headerless, romable code. All code is relocatable. RTL supports local variables, multitasking, redirected I/O, and even allows definitions to be changed retroactively. All source code is included. Versions are currently available or under development for 68000, 6809, 8080, 280, 8086, 8088, and 6502.

RTL Programming Aids
10844 Deerwood SE
Lowell, MI 49331
(616) 897-5672

Circle 371 on Inquiry card.



Scotch[®] DISKETTES

Call Toll-Free
1-800-328-DISC for prices and information. Dealer inquiries invited. C.O.D. and charge cards accepted.
All orders shipped from stock, within 24 hours. Call toll FREE



North Hills Corporation
3564 Rolling View Dr.
White Bear Lake, MN 55110
1-800-328-DISC
MN Call Collect 1-612-770-0485

Circle 304 on inquiry card.

MicroScript[™]

Are you wasting valuable time trying to format complex documents with a word processor or obsolete text formatter?

MicroScript[™] is a state of the art text formatter specifically designed for the production of technical manuals, specifications, and other complex documents. This powerful tool pays for itself the first time you use it. Featuring:

- generalized markup
- left alignment
- center alignment
- right alignment
- justification
- left indentation
- right indentation
- bold text
- underscored text
- proportional spacing
- fully definable page
- multiple columns
- headers and footers
- floating text blocks
- footnotes
- variable line spacing
- widow suppression
- section numbering
- imbedded documents
- automatic lists
- macro processing
- symbol processing
- table of contents
- direct printer control
- initialization profile
- page numbering

\$99 postpaid within U.S., outside U.S. add \$10. CA residents add 6%. Specify CP/M-80*, CP/M-86*, MS-DOS*, or PC-DOS*; printer type: disk format.

Software Technique[™]

6531 Crown Blvd., Suite 3A • San Jose, CA 95120
(408) 997-5026

* CP/M-80, CP/M-86 trademarks of Digital Research, MS-DOS trademark of Microsoft, PC-DOS trademark of IBM Corporation.

Circle 386 on inquiry card.

QUIET YOUR MICRO-PRINTER

FIRST TIME AVAILABLE

- For Radio Shack* Line Printers II thru VII and other printers lacking sound absorbing material
- Full 1/2" premium acoustic foam
- Precision Die Cut
- Pressure Sens. Adhesive Backing
- Complete Instructions
- Installs in Minutes
- Money Back Guarantee
- Only \$19.95 + \$2.00 P/H
- Get add'l Quieting with Wall & Desk Top Pads \$5.00 ea. w/ kit, else \$7.50 ea. + \$2.00 P/H

Send Check or Money Order
(Specify Printer)

ACOUSTIC RESEARCH
9560 S.W. Barbur Blvd. Suite 67-C
Portland, OR 97219
(503) 625-6845



*Trademark of Tandy Corp.



Circle 8 on inquiry card.

\$99 SINGLE BOARD COMPUTER/CONTROLLER

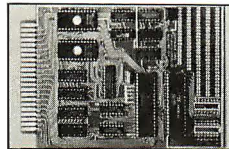

MODEL MCG-85 FEATURES:

- 8085A CPU
- 2K System Monitor ROM
- 256 Bytes of RAM
- RS232C Port
- Parallel & Serial I/O
- Two 8 Bit Prog Ports
- One 6 Bit Prog Port
- 4 1/2 x 6 1/2 PCB
- Automatic Baud Rate
- 5 Interrupts
- 14 Bit Counter/Timer
- Onboard Prototyping
- 6.144 MHz Crystal
- Onboard Expansion
- * 4K ROM &/or
- * 4K RAM or CMOS RAM

STOCK \$99 Kit \$135 A&T.

Expansion Boards available. Visa, M.C., Amex & COD accepted.

ATLANTIS COMPUTERS
31-14 Broadway
Astoria, N.Y. 11106
212/728-6700

Circle 40 on Inquiry card.

TIMEX-SINGLAIR ZX81 1000



1983 Directory

- * **Where to find:** Disk Drives, RAM Extensions, Printers, Modems, Keyboards, Game & Serious Software, Books, Periodicals, Programming Aids, and other Exciting Accessories!
- * **Articles on:** Special applications like Control Circuitry, Enhanced Graphics, Voice Generation, Music Synthesis, Video Inversion, Light Pens, Joysticks, etc.
- * **Complete Descriptions:** We'll tell you what it is, what it does, how much it costs, and where to buy it.
- * **Jam-packed w/photographs:** We knew you'd want to see what these products look like. So, we got pictures and put them in!

Only \$5.00 ... Postpaid!

To Order: Send check, money order, or VISA/MC number and expiration date. MN residents add 6% sales tax.

Dealer Inquiries Welcome.

E. Arthur Brown Company
Dept. 1702 Oak Knoll Drive
Alexandria, MN 56308 Ph: 612/762-8847

Circle 380 on Inquiry card.

Hayes Smartmodem 1200 BDRS232 **\$495.**

Rana Systems

Elite One	\$289.
Elite Two	\$435.
Elite Three	\$575.
Rana Controller	\$ 75.

COMMUNICATIONS PAK SALE

Micromodem II	\$259.00
Source Subscription	\$ 75.00
ASCII Express	\$ 49.95
ALL THREE PIECES	\$379.00
Verbatim 5 1/4" SSDD (10)	\$ 25.50



WE CARRY A FULL LINE OF APPLE//E
HARDWARE & SOFTWARE

GARDEN OF EDEN COMPUTERS

13147 Cedar Street, Westminster, CA 92683



714-894-9528

24 Hours - 7 Days

Ask for our Price List!



Circle 175 on inquiry card.

S-100 REAL TIME CLOCK AND TIMER

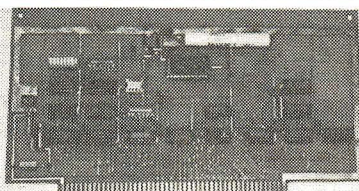

THE MOST VERSATILE

S-100 SYSTEM CLOCK FEATURING:

- 12/24 hr. clock with hours, minutes, seconds, etc.
- Port Select Switch selectable.
- Polled or jumper selected interrupt driven.
- On board recharging battery back up.
- Programmable interrupt on any future time/date.
- Can be used to turn system power on.
- System tick as fast as 1 mSec.

Introductory Offer \$129.95 assembled and tested
Plus \$5.00 shipping & handling

Send check or money order to:

RON SAN ELECTRONICS

1491 Stubbins Way
San Jose, CA 95132

Evening calls accepted after 6 pm California time at
408 - 251-9279

Circle 369 on inquiry card.

SUPER-FAST! Z80 DISASSEMBLER \$69.95

Uses Ziog Mnemonics, allows user defined labels, strings, and data spaces. Source or listing-type output with Xref to any device. Available for Z80 CP/M or TRS-80.

SLR Systems

200 Homewood Drive
Butler, PA 16001
(412) 282-0864

Add \$2.00 shipping. Specify format required. Check, money order, VISA, Master Card, C.O.D. PA residents add 6% sales tax. Dealer Inquiries invited. CP/M, TRS-80 TM of Digital Research, Tandy Corp.

Circle 380 on Inquiry card.

SIEMENS 1 MEGABYTE

8" Double Sided/Double Density

1-\$299.00 ea.*

2-\$289.00* ea. 10-\$269.00* ea.

FDD200-8 Floppy
Disk Drive
Shugart Compatible



Shipping Wgt.
15 lbs.
Factory New
and Packaged

Fully Guaranteed
90 Day Warranty
Service
Contracts
Available
Full
Documentation

DUAL DOUBLE SIDED 8" SUBSYSTEM ASSEMBLED & TESTED \$850.00 complete

Includes:

2-Siemens, FDD200-8 Disk Drives Strong, Thick, Aluminum Cabinet, Rugged Heavy Duty Power Supply, Whisper Quiet 4" Fan, Etc.

KEYBOARD by KEYTRONIC \$14.95 each

66 Keys Unencoded, Low Profile
Gold Plated Card Edge Connectors.

REGULATORS

All 7800 (LM340T) Series 3 for \$2.00
All 7900 (LM320T) Series 3 for \$2.25
LM323k, 5 Volt, 3 Amp. \$2.95 each
LM350k, Adjustable 3 Amp. \$4.95 each

MONTHLY SPECIAL SHUGART SA400 DISK DRIVES \$169.00 each 2 for \$325.00 CONNECTORS

50 Pin Edge, ST, for S-100 Bus \$3.49
34 Pin, Edge, Ribbon for SA400 Drive \$2.95
50 Pin, Edge, Ribbon for FDD200-8 Drive \$3.95
50 Pin, RA, PC, MT Amp #206973-1 \$3.49

Since the magazine has not come out as of this advertisement placement date I have not been able to judge your reception. I'll do my best as a supplier to serve you our customers. Also if there are any special requirements from Groups, Clubs, Schools etc. please let me know and I'll try to help. See you next month.

Sincerely,

Sam DeLisi

*Orders accepted by Visa/MasterCharge (add 3%) Money Order or certified check. Price does not include shipping charges. Specify method of shipment desired and include approximate shipping charge. N.J. residents add 6% sales tax.

QUME 55CPS—HIGH SPEED DAISEY WHEEL LETTER QUALITY PRINTERS

\$950.00 ea.*

Quantity Pricing Available

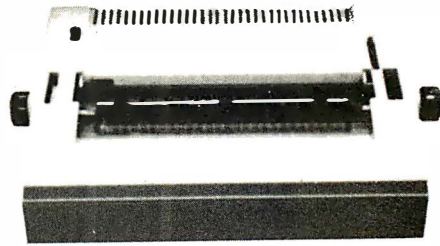

Proportional Spacing, 2K Buffer, RS-232 or Centronics Parallel

Shipping Wgt. 46 lbs.

The Qume Sprint 3-55 with Interface is Compatible with most Computers having RS-232 or Centronics Parallel A or B, such as Radio Shack, Apple, IBM, etc. Also works with most popular word processing programs like Micropro™ Wordstar.

These Qume Printers were used by a major typesetting company under maintenance until replaced by laser printers on an exchange basis. We had their technicians refurbish and completely exercise them to give you many years of reliable service at a price you can live with.

CIRCUITS (a sampling)

Z-80A CPU — \$4.50
Z-80 PIO — \$3.75
Z-80 CTC — \$2.95
21L02 RAM —
250NS — \$1.49 ea.
350NS — \$1.29 ea.
650NS — 10 for \$3.95
TL082P — \$.89
TL496P — \$1.29
LM311P — \$.59
LF355 — \$.59
LM324N — \$.59
LM358N — \$.49

ELECTRONIC TAPE READER Decitek Model 26167-002 \$24.95

Includes Stepper Motor & Electronics

CAPACITORS

.1uf Monolithic 100 for \$12.95
.1uf Disk 100 for \$6.95

BRIDGES

25 Amp 400 Volt 3 for \$4.95
10 Amp 200 Volt 3 for \$2.95

OPTO DEVICES

4N26 (Trans. Out.) — \$.89
MCA2-55 (Darlington) — \$.99
H11AX (Trans. Out.) — \$.89
H11CX (SCR Out.) — \$.99
T1L31 (Infra. Red. Em.) — \$.59
ILD-74
(Dual Trans. Out.) -- \$1.99 ea.

LED'S

Red - all sizes — 10 for \$.89
Green or Yellow — 5 for \$.89
Micro Red — 100 for \$5.95
Panel Mounts — 10 for \$.59

DISPLAYS:

HP5082-7340 — \$5.95 ea.
Hexidecimal
FND560 & 567 — \$1.49 ea.

HOBB-Y-TRONIX, INC.

Division of Tope Industries, Inc.

957 Ball Ave., Union, N.J. 07083
(201) 687-1330

IBM[®] Personal Computer

COMBO CARD (9 FUNCTION)

IBM Compatible Features:

- EXPANDABLE 64K TO 256K MEMORY
- SERIAL and PARALLEL I/O
- CLOCK CALENDAR (BATTERY BACKED-UP)
- GAME PORT/DUAL JOYSTICK INPUT
- BSR X-10 AC LINE INTERFACE
- PROGRAMMABLE 8 BIT I/O and 4 BIT OUTPUT PORT
- RAM DISK and PRINT SPOOLER SOFTWARE

ACT NOW AND RECEIVE A FREE BSR X-10 AC CONTROL SYSTEM WITH CARD PURCHASE. ALL NINE FEATURES WITH 64K MEMORY--\$595

WRITE OR CALL FOR A FREE CATALOG

DEALER INQUIRIES INVITED



Advanced Data Technology

13600 Ventura Blvd.
Sherman Oaks, CA 91423
(213) 986-6835

Circle 16 on inquiry card.

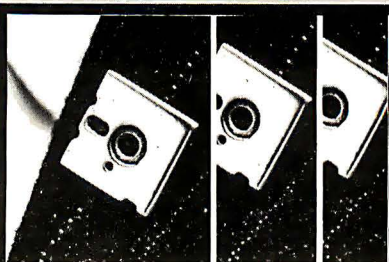

WEAR IT WITH PRIDE! Computer Jewelry

Be identified as a micro professional
Lapel Pins • Tie Tacks • Stick Pins
Available in Sterling Silver or 18K over sterling
Size: 1/2" square Silver \$10 • Gold \$12
(Add \$2 for S/H) • (CA add sales tax)
Visa • Mastercard or check payable to MC/N, Inc.
Money Back Guarantee
Dealer & Corporate Discounts Available
Allow 2-3 weeks for delivery



MC/N, Inc.
SIMMS CENTER/Box 9393
San Rafael, CA 94912
(415) 453-7033

Circle 255 on inquiry card.

MediScript

MediScript I is a powerful word processor designed for the IBM-PC and newcomer to word processing. Simple to use yet has all common functions (such as word wrap and paragraph relocate). Additional functions in MediScript II include right justification, character graphics, fielded forms, and mailing list generation.

MediScript I - - - - - \$49.50
MediScript II - - - - - \$99.50
(plus 6% in CA) 30 day satisfaction guaranteed or your money back, minus \$4.00 for shipping and handling.

MediSoft



Medical Professions Building
1595 Soquel Drive, Suite 350
Santa Cruz, CA 95065

Circle 258 on inquiry card.



Solve your disc problems, buy 100% surface tested Dysan diskettes. All orders shipped from stock, within 24 hours. Call toll FREE (800) 235-4137 for prices and information. Visa and Master Card accepted.

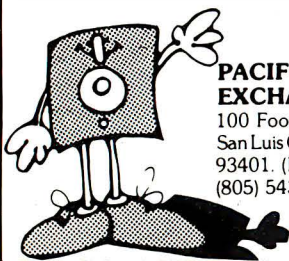

PACIFIC EXCHANGES
100 Foothill Blvd.
San Luis Obispo, CA
93401. (In Cal. call
(805) 543-1037.)

Circle 319 on inquiry card.

DISK DRIVES (For PC, Mod I & II)

TANDON TM100-1..... \$189
TANDON TM100-2..... \$249
TANDON TM100-4..... \$339
Case and PS..... \$ 45

PC EXPANSIONS

MAYNARD
DISK CONTROLLER..... \$155
PP add \$50 SP add \$70
All cables, hardware and instructions included - no soldering.

QUADRAM
Four Function 256K capacity
with 64K installed..... \$399

AST
ComboPlus:
64K+SPC+SuperDrive
+SuperSpool..... \$395
MegaPlus:
64K+SC+SuperDrive
+SuperSpool..... \$395
User installed.
2nd S or P..... \$ 35

VLM Computer Electronics
10 Park Place • Morristown, NJ 07960
(201) 267-3268 Visa, MC, Check or COD.

Circle 432 on inquiry card.

BIG STEPPER Stepping-Motor Driver Box

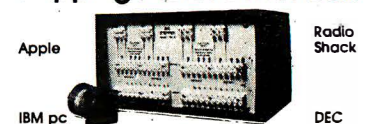

SELF-CONTAINED! HOOKUP AND GO!

Provides all required power

Drives 4 motors while sensing 8 limit switches
Up to 5 amps per winding
with complete optoisolation

PARALLEL BIG STEPPER: \$450
*Direct program control
SERIAL BIG STEPPER: \$850
*RS232 compatible, obeys simple commands
STEPPING-MOTOR TIPS COOKBOOK \$5

Centre Computer Consultants
P.O. Box 739
State College, PA 16801
(814) 237-4535

Circle 73 on inquiry card.

BOOKKEEPING AND PAYROLL FOR SMALL BUSINESS

For CP/M and MS-DOS Systems. Source code provided.

	LIST	PLAN-A	PLAN-B	PLAN-C
Bookkeeping	\$300	\$279	\$292	\$225
Payroll	\$400	\$372	\$336	\$300

Other CP/M, MS-DOS, Apple and MDOS software available with same terms. Write or call for full spec sheets or further information.

PLANS:

- A - Phone support, exchange privileges, 90 days
- B - Phone support, exchange privileges, 30 days
- C - Support limited to supplied documentation, no exchange except for bad disk replacement.

(Additional support available at \$20/hour.)

TERMS:

Prices include cash discount. Add 4% for charge or COD orders. Visa and Master Card accepted. Add \$4.00 for shipping and handling.

Suite 14
3322 Mem.
Pkwy., S.W.



(205) 883-8113
Huntsville,
AL 35801

Circle 128 on inquiry card.

NORTH STAR USERS UNITE!

- ★ Get the information you need from the user's point of view
 - ★ Over 150 pages of members newsletter articles last year
 - ★ DOs and cp/m disk library for members
 - ★ Solve problems
 - ★ Get assistance
- Membership dues \$20

International North Star Users Association
P.O. Box 2789 B Fairfield, CA 94533

Circle 205 on inquiry card.

TOP QUALITY 5 1/4 DISKETTES

SPECIFY SOFT. 10 or 16 SECTORS

	\$/10	\$/50	\$/100
wabash			
SSDD (M13A411X)	23.45	112.00	218.00
DSDD (M14A411X)	30.43	146.00	286.00
controldata			
SSDD (CDC1242-00)	23.00	112.00	215.00
DSDD (CDC1244-00)	32.00	156.00	295.00
verbatim			
SSDD (MD525-01-18158)	27.20	134.00	265.00
DSDD (MD550-01-18188)	40.00	196.00	385.00
3Mscotch			
SSDD (3M 744D-0)	26.00	125.00	233.00
DSDD (3M 745 0)	36.00	175.00	309.00
dysan			
SSDD (DYS 104-1D)	40.40	188.00	3 1.00
DSDD (DYS 104-2D)	47.30	231.00	426.50

CALL TOLL 800-852-7777 (CALIF.)
FREE 800-824-7888 (ALL OTHERS)
(ORDERS ONLY) OPERATOR 906
AFTER APRIL 30, 1993. CALL 800 824 7888 (OPERATOR 906)

creativity Unlimited FREE CATALOG
• CHECKS, M.O., VISA, M.C. P.O. BOX 3304
• ADD \$2.00 SHIPPING SERRATO, CA 95070
• CA RESIDENTS ADD (408) 252-4210
• 6% SALES TAX

Circle 122 on inquiry card.

wabash[®] diskettes for as low as \$1.39 each!

Now...Get High Quality at a Low Price

Wabash means quality products that you can depend on. For over 16 years, Wabash has been making high quality computer products. Wabash diskettes are made to provide error-free performance on your computer system. Every Wabash diskette is individually tested and is 100% certified to insure premium performance.

Why Wabash is Special

The quality of Wabash diskettes is stressed throughout the entire manufacturing process. After coating, all Wabash diskettes go through a unique burnishing process that gives each diskette a mirror-smooth appearance. Wabash then carefully applies a lubricant that is specially formulated to increase diskette life. This saves you money, since your discs may last longer. It also assists your disk drives in maintaining constant speed which can reduce read and write errors.

Special Seal...Helps Prevent Contamination

To keep out foreign particles, a unique heat seal bonds the jacket and liner together. A special thermal seal which avoids contamination from adhesives, is then used to fold and seal the jacket. This results in outstanding performance and true reliability. Wabash then packages each diskette, (except bulk pack) in a super strong and tear resistant Tyvek[®] envelope. The final Wabash product is then shrink-wrapped to insure cleanliness and reduce contamination during shipment.

Each Diskette is 100% Critically Tested

Since each step in the Wabash diskette manufacturing process is subject to strict quality control procedures, you can be sure Wabash diskettes will perform for you. And every Wabash diskette meets the ultra-high standards of ANSI, ECMA, IBM and ISO in addition to the many critical quality control tests performed by Wabash. Wabash does all of this testing to provide you with consistently high quality diskettes. Reliability and data integrity - that's what Wabash quality is all about.

Flexible Disc Quantity Discounts Available

Wabash diskettes are packed 10 discs to a carton and 10 cartons to a case. The economy bulk pack is packaged 100 discs to a case without envelopes or labels. Please order only in increments of 100 units for quantity 100 pricing. With the exception of bulk pack, we are also willing to accommodate your smaller orders. Quantities less than 100 units are available in increments of 10 units at a 10% surcharge. **Quantity discounts** are also available. Order 500 or more discs at the same time and deduct 1%; 1,000 or more saves you 2%; 2,000 or more saves you 3%; 5,000 or more saves you 4%; 10,000 or more saves you 5%; 25,000 or more saves you 6%; 50,000 or more saves you 7% and 100,000 or more discs earns you an 8% discount off our super low quantity 100 price. Almost all Wabash diskettes are immediately available from CE. Our warehouse facilities are equipped to help us get you the quality product you need, when you need it. If you need further assistance to find the flexible disc that's right for you, call the Wabash diskette compatibility hotline. Dial toll-free 800-323-9868 and ask for your compatibility representative. In Illinois or outside the United States dial 312-593-6363 between 9 AM to 4 PM Central Time.

Circle 84 on inquiry card.

SAVE ON WABASH DISKETTES

Product Description	Part #	CE quant. 100 price per disc (\$)
8" SSSD IBM Compatible (128 B/S, 26 Sectors)	F111	1.99
8" Same as above, but bulk pack w/o envelope	F111B	1.79
8" SSSD Shugart Compatible, 32 Hard Sector	F31A	1.99
8" SSDD IBM Compatible (128 B/S, 26 Sectors)	F131	2.49
8" DSDD Soft Sector (Unformatted)	F14A	3.19
8" DSDD Soft Sector (256 B/S, 26 Sectors)	F144	3.19
8" DSDD Soft Sector (512 B/S, 15 Sectors)	F145	3.19
8" DSDD Soft Sector (1024 B/S, 8 Sectors)	F147	3.19
5 1/4" SSSD Soft Sector w/Hub Ring	M11A	1.59
5 1/4" Same as above, but bulk pack w/o envelope	M11AB	1.39
5 1/4" SSSD 10 Hard Sector w/Hub Ring	M41A	1.59
5 1/4" SSSD 16 Hard Sector w/Hub Ring	M51A	1.59
5 1/4" SSDD Lanier No-problem compatible	M51F	2.99
5 1/4" SSDD Soft Sector w/Hub Ring	M13A	1.89
5 1/4" Same as above, but bulk pack w/o envelope	M13AB	1.69
5 1/4" SSDD Soft Sector Flippy Disk (use both sides)	M18A	2.79
5 1/4" SSDD 10 Hard Sector w/Hub Ring	M43A	1.89
5 1/4" SSDD 16 Hard Sector w/Hub Ring	M53A	1.89
5 1/4" DSDD Soft Sector w/Hub Ring	M14A	2.79
5 1/4" DSDD 10 Hard Sector w/Hub Ring	M44A	2.79
5 1/4" DSDD 16 Hard Sector w/Hub Ring	M54A	2.79
5 1/4" SSQD Soft Sector w/Hub Ring (96 TPI)	M15A	2.69
5 1/4" DSQD Soft Sector w/Hub Ring (96 TPI)	M16A	3.79

SSSD = Single Sided Single Density; SSDD = Single Sided Double Density; DSDD = Double Sided Double Density; SSQD = Single Sided Quad Density; DSQD = Double Sided Quad Density; TPI = Tracks per inch.

Buy with Confidence

To get the fastest delivery from CE of your Wabash computer products, send or phone your order directly to our Computer Products Division. Be sure to calculate your price using the CE prices in this ad. Michigan residents please add 4% sales tax or supply your tax I.D. number. Written purchase orders are accepted from approved government agencies and most well rated firms at a 30% surcharge for net 30 billing. All sales are subject to availability, acceptance and verification. All sales are final. Prices, terms and specifications are subject to change without notice. All prices are in U.S. dollars. Out of stock items will be placed on backorder automatically unless CE is instructed differently. Minimum *prepaid* order \$50.00. Minimum *purchase order* \$200.00. International orders are invited with a \$20.00 surcharge for special handling in addition to shipping charges. All shipments are F.O.B. Ann Arbor, Michigan. No COD's please. Non-certified and foreign checks require bank clearance.

For **shipping charges** add \$8.00 per case or partial-case of 100 8-inch discs or \$6.00 per case or partial-case of 100 5 1/4-inch mini-discs for U.P.S. ground shipping and handling in the continental United States.

Mail orders to: Communications Electronics, Box 1002, Ann Arbor, Michigan 48106 U.S.A. If you have a Master Card or Visa card, you may call and place a credit card order. Order toll-free in the U.S. Dial 800-521-4414. If you are outside the U.S. or in Michigan, dial 313-994-4444. Order your Wabash diskettes from Communications Electronics today.

Copyright ©1982 Communications Electronics™

Ad # 110582



Order Toll-Free!
800-521-4414

In Michigan 313-994-4444

wabash
error-free
diskettes

COMMUNICATIONS
ELECTRONICS™

Computer Products Division

854 Phoenix □ Box 1002 □ Ann Arbor, Michigan 48106 U.S.A.
Call TOLL-FREE (800) 521-4414 or outside U.S.A. (313) 994-4444

BYTE April 1983 507



Sure it's insured?

SAFWARE™ Insurance provides full replacement of hardware, media and purchased software. As little as \$35/yr covers:

- Fire • Theft • Power Surges
- Earthquake • Water Damage • Auto Accident

For information or immediate coverage call:
1-800-848-3469
(In Ohio call 1-800-848-2112)

CNGA
 COLUMBIA NATIONAL GENERAL AGENCY

Circle 82 on Inquiry card.

Y.E.S., We have the best... prices available on I.C.'s.

2114	200ns	1.35
4116	150ns	1.25
4164 Pla.	200ns	4.80
4164 Cer.	200ns	5.25
4164 Cer.	150ns	5.75
6116P-3	150ns	4.35
6116LP-3	150ns	5.40
58725 NMOS	200ns	4.50
2716	450ns	3.30
2732	450ns	4.00
2764	250ns	9.50
2532	450ns	4.65
2564	450ns	14.00
280A CPU,CTC,PIO		3.35
280A SIO		12.00
8255A-5		3.00
D8080A 2MHZ		3.90
280B CPU		10.00

*C.O.D., Master Charge and Visa accepted.
 *Ask for OEM quantity prices.

Yang Electronic Systems, Inc.
 307 Compton Ave., Laurel, MD 20707
(301)776-0076

Circle 454 on Inquiry card.

DATAWARE

tools for dBASEII application development

PREPAID/COD

DEVELOPING APPLICATIONS FOR MICRO-COMPUTER DATABASES: Concepts, Tools and Techniques. by Steve Patchen \$29/32

The DATAWARE MENU SYSTEM for dBASEII (with development and backup utilities) User's manual and 8"SD diskette \$65/69

dBASEII \$525/535

Look for our data dictionary system 

DATAWARE SYSTEMS
 255 Chippewa
 Pontiac, Mich. 48053
 (313) 338-4358

Circle 135 on Inquiry card.

SearchLit

SearchLit stores and searches information related to your own personal literature collection. References are retrieved based on key words of your choosing. Great for "rippers." Just circle key phrases and hand reference to secretary. Read it later when the need arises. Order by 6/01, mention Byte, and receive a free copy of MediScript I, a multi function word processor. \$49.50 (plus 6% in CA). 30 day satisfaction guaranteed or your money back, minus \$4.00 for shipping and handling.

MediSoft 

Medical Professions Building
 1595 Soquel Drive, Suite 350
 Santa Cruz, CA 95065

Circle 259 on Inquiry card.

MEMOREX FLEXIBLE DISCS

WE WILL NOT BE UNDER-SOLD!! Call Free **(800)235-4137** for prices and information. Dealer inquiries invited and C.O.D.'s accepted.



PACIFIC EXCHANGES
 100 Foothill Blvd.
 San Luis Obispo, CA
 93401 In Cal. call
 (800)592-5935 or
 (805)543-1037



Circle 319 on Inquiry card.

NEW VIC-20 VOICE SYNTHESIZER

\$79⁰⁰ sale price

Limited Quantities
 VOTRAX based
 Unlimited words
 Adjustable volume and pitch

PROTECTO ENTERPRIZES
 Box 550 • Barrington, IL 60010
 Phone Orders: (312) 382-5244

Circle 348 on Inquiry card.

Transmit **any** data between almost two computers

Self instructing—Easy to modify

- Error correction • Progress indication
- Error count • Link quality measurement
- Non-locking • Auto receive

Microcomputers \$150.00
 5% discount for money order or bank check.

10% discount if ordered by June 1, 1983
 Documentation \$10.00
 Check or money order only.
 Specify exact make and model of computer and the diskette configuration

Mini and large machine users write or call for prices.

MKS P.O. Box 09558
 Columbus, Ohio 43209-0558
 614-460-5251

Circle 245 on Inquiry card.

PROGRAMMABLE COMMUNICATIONS TRANSLATOR

by MSJ

THE PCT-100 IS AN IN-LINE RS-232 COMMUNICATIONS TRANSLATOR AND IS COMPLETELY USER CONFIGURABLE. YOUR SYSTEM REQUIRES NO HARDWARE OR SOFTWARE MODIFICATIONS TO INSTALL AND QUICKLY PROGRAM THE PCT-100, PROVIDING:

- TERMINAL OR PRINTER EMULATION
- COMPATIBILITY AND MACRO-FUNCTION KEYS FOR WORD PROCESSING, ACCOUNTING AND OTHER SOFTWARE PACKAGES
- INTELLIGENT 2-DIRECTIONAL CHARACTER SEQUENCE TRANSLATION
- DEC-FAMILY OR IBM-FAMILY COMPATIBILITY
- "TYPE-HEAD" AND DATA BUFFERING
- HANDSHAKE PROTOCOL CONVERSION (EG. CTS/RTS, XON/XOFF)
- BAUD RATE ADAPTATION
- PRINTER FORMAT CONTROLS

BUY THE PCT-100 AS A CIRCUIT BOARD TO MOUNT INSIDE YOUR TERMINAL OR PRINTER, OR AS A STAND ALONE DEVICE WITH A WALL PLUG-IN SUPPLY. EITHER WAY, YOU'VE ADDED A POWERFUL UPGRADE TO YOUR SYSTEM AT AN UNBELIEVABLY LOW PRICE!

PCT-100-PCB (PRINTED CIRCUIT BOARD ONLY) \$ 289
 PCT-100-ASM (PRINTED CIRCUIT BOARD WITH CASE) \$ 399
 PCT-100-MOD (WALL PLUG-IN TRIPLE OUTPUT SUPPLY) \$ 59

PURCHASE THE PCT-100 BY CHECK, MONEY ORDER OR C.O.D. (ADD \$4.50 TO C.O.D. ORDERS FOR SHIPPING AND HANDLING.)

DEALER INQUIRIES INVITED

MSJ
 METHOD SYSTEMS INCORPORATED
 19751 SOUTH LAKESHORE BOULEVARD
 CLEVELAND, OHIO 44119
 (216) 531-8004

(PLEASE ALLOW 4 TO 6 WEEKS FOR DELIVERY)

Circle 262 on Inquiry card.

SL-MICRO

formerly SP-MICRO

STATISTICAL LANGUAGE for MICROCOMPUTERS

features

VALUE and VAR LABELS
 FREQUENCIES CROSSTABS
 PEARSON CORR REGRESSION

ONLY \$250. MANUAL \$15
 REQUIRES CP/M. MANY FORMATS

QSC BOX 23056
LANSING, MI 48909
PHONE (517) 641-4428

Circle 359 on Inquiry card.



WE WILL BEAT OR MEET ALL PRICES ON ALL PRODUCTS IN THIS MAGAZINE TO PLACE ORDER CALL (213) 219-0808 NOW!

Circle 85 on inquiry card.

48K APPLE COMPATIBLE COMPUTER

1 yr. Warranty
Introductory Price \$595
Call for Availability

ALL COMPUTERS

Apple II E	\$	Call
Commodore 64	469	
Kaypro	1649	
Osborne	Call	
Sanyo MBC 1000	1599	
Apple Compatible Computer	595	
S-100 System	Call for lowest price	
IBM PC	Call	

IBM PC PRODUCTS

Ast Research

Combo Plus 64K w/clock, Par. Port, Serial Port, Software	\$359
Mega Plus 64K Expandable to 512	430

Tandon

TM100-2 Dbl Side Dbl Density	\$ 235
------------------------------	--------

5 1/4" & 8" DISK DRIVES

Shugart

SA400, 40 Track	\$ 145
SA801R, Sgl Side/Dbl Den	369
SA851R, Dbl Side/Dbl Den	479

Tandon

TM 100-1, Sgl Side/Dbl Den	\$ 179
TM 100-2, Dbl Side/Dbl Den	235
TM 848-1, Sgl Side/Dbl Den	369
TM 848-2, Dbl Side/Dbl Den	449

Qume

DT-8 Dbl Side/Dbl Den	\$ 465
-----------------------	--------

Siemens 8"

FDD 100-8, Sgl Side/Dbl Den	\$ 209
-----------------------------	--------

Mitsubishi

8" Dbl Side/Dbl Den	\$ 409
---------------------	--------

FOR FRANKLIN & APPLE

All Apple Products Not Seen in This Ad Are Available-Call for Guaranteed Lowest Price

Grappler + Par. Interface Card & Cable	\$118
TG Joystick	49
16K Memory Card	39
80 Column Card (View Max 80)	44
RH Fan	169
RF Modulator	69
	25

UNBEATABLE PRINTER PRICING

Star Micronics

Gemini 10 (100 cps)	\$ 355
Gemini 15 (15" carriage)	465

C. Ioth

Prowriter 8S10AP (120 cps)	\$ 365
Prowriter 8510ACD (Serial)	549
Starwriter F-1040pu	1249

Okidata

Microline 82A	\$ 375
Microline 83A	649
Microline 84P	940
Microline 84S	1050
Microline 92	509

Nec

Nec 8023 (price reduction)	\$ 449
Spinwriters	Call

Toshiba

P1350	\$1699
-------	--------

SPECIALS OF THE MONTH

5 1/4" Disk Drive
SA400L Shugart
90 Day Warranty
ONLY \$145.00

MODEM

Smart Modem 300
Hayes Top of the Line
ONLY \$195.00

DRIVE FOR APPLE OR FRANKLIN

Micro Sci A-2
Fully Compatible
\$249.00

PRINTER

Gemini 10
Same as Epson MX80FT
\$355.00

MONITOR

Sanyo 2112 Green Screen
• 15MHZ • Composite
ONLY \$79.00

USI Amber 12"
• 1000 Lines
• Horizontal Resolution
\$149.00

All Products Carry at least a 90 Day Warranty

MODEMS

Hayes

Smart Modem 300	\$ 199
Smart Modem 1200	498

Novation

D-Cat	Call
Apple Cat	Call

TERMINALS

Televideo

925C Green Screen	\$ 699
950 Detachable Keyboard	899

Adds

Viewpoint 1A, 2A, 3A	Call
----------------------	------

DISKETTES

All packages of diskettes come with free library case and reinforced hub. Full 1 year warranty. Prices are for Packs of 10.

5 1/4" Disks

Sgl Side/Sgl Density	\$18.50/10
Sgl Side/Dbl Density	20.50/10
Dbl Side/Dbl Density	26.50/10

8" Disks

Sgl Side/Sgl Density	\$25.00/10
Sgl Side/Dbl Den	29.00/10

CABINETS & MAINFRAMES

QT Computer Systems

DDC-8 Cabinet w/pwr. supply & fan
ONLY \$209.00

DDC-88-H Dual Cabinet w/pwr. supply & fan
ONLY \$259.00

Mainframe

6 slot w/2, 8" cutouts, pwr. supply, fan, filter, Connector Cutouts
ONLY \$549.00

5 1/4" Cabinets

Single Cabinet w/pwr. supply	\$ 59
Dual Cabinet w/pwr. supply	89

DISK DRIVES FOR FRANKLIN & APPLE

Rana Systems

Rana Elite I	\$ 285
Rana Elite II	439
Rana Elite III	569
Controller	89

Micro Sci

A-2 (35 Track)	\$ 249
Controller	75
Apple III Drives Available	Call

Quentin Research

Apple Mate	\$ 249
Controller	60

MONITORS

Sanyo

12" Green Screen, 2112 Composite	\$ 79
----------------------------------	-------

BMC

12A (15MHz) Composite	84
12EUN (20MHz) Composite	129
9191 Color Composite	309

Taxan

12" Green (18MHz) Composite	\$ 129
12" Amber (18MHz) Composite	129
RGB 1 Color	319

Zenith

ZVM 121 12" Green (15MHz)	\$ 94
---------------------------	-------

USI

9" Green (20MHz)	\$ 139
12" Green (20MHz)	139
12" Amber (20MHz)	149

CABLES

IBM to Printer	\$ 32
Osborne to Printer	32
Kaypro to Printer	32
Call for all cable configurations	

DISKETTE STORAGE

Mini Files—Holds 70 Disks	\$16.50
Maxi Files—Holds 70 Disks	24.00
5 1/4" Library Cases	3.00
8" Library Cases	4.00

Computer Components Unlimited

NEW RETAIL STORE:
11976 Aviation Blvd.
Inglewood, CA 90304

MAIL ORDER:
P.O. Box 1936
Hawthorne, CA 90250

ORDER DESK:
(213) 219-0808

No Surcharge for Credit Cards



All merchandise new. We accept MC, Visa, Wire Transfer, COD call, Certified Check, P.O.'s from qualified firms, APO accepted. Shipping: Minimum \$3.50 first 5 pounds. Tax: California Res. Only add 6 1/2% sales tax.

Mon.-Fri. 8 a.m. to 7 p.m.
Sat. & Sun. 11 a.m. to 4 p.m.



INDUSTRIAL CONTROL MICROCOMPUTERS

We have six single board computers, two video boards and 20 other control products. You can use our products for security systems, heat control, light control, automated slide show, traffic lights, irrigation systems, home computer systems, automated process control, and robot control just to name a few. OEM prices available. For catalog call or write to:

JOHN BELL ENGINEERING, INC.
1014 CENTER STREET
SAN CARLOS, CA. 94070
(415) 592-8411

Circle 51 on Inquiry card.

DATA COMMUNICATIONS SPECIALISTS FOR IBM PC & SEATTLE COMPUTERS

Teleprocessing software available for above computers to time-sharing host or between two users (send binary files, also). Version 2 software. \$60; Version 3. IBM PC \$45, SEATTLE \$160. Write for details or \$4.00 for manuals.

SEATTLE 8086 GAZELLE Computer system.

SPECIAL PRICE for SEATTLE SYSTEM (desktop) + 4-port serial board + cables. US ROBOTICS modems. TELEVIDEO BUSINESS SOFTWARE for IBM, SEATTLE. Write for literature and prices on above systems, or call for quote.

CSCS
COMPUTER & STATISTICAL CONSULTING SERVICES
P.O. Box 5351
Terre Haute, IN 47805
(812) 466-4111

Circle 124 on inquiry card.

SimPaLink Makes PAL* Simple For Only \$500

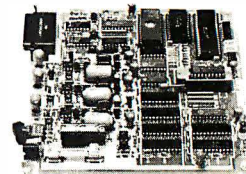

- Use with IBM Personal Computer** (CP/M-80 and Apple II versions available soon).
 - Programs AMD, MMI, National, and TI 20-pin PAL's
 - Includes resident PALASM* to assemble equations
- IBM PC software: \$40
You've got PAL... now get SimPaLink to keep it simple!

Structured Design, Inc.
1700 Wyatt Drive, Santa Clara, CA 95054
408 / 988-0725 • Telex 172931

*PAL and PALASM are registered trademarks of Monolithic Memories, Inc.
**IBM is a trademark of International Business Machines.

Circle 393 on Inquiry card.



A word for this Punch/Reader Combo is

Speed! Model 510 punches paper tape at 110cps, reads at 150cps. This rugged machine is computer compatible offering RS232C, current loop, parallel inputs. The ASCII-to-Baudot code conversion permits direct keyboard entry for Telex/TWX transmission. Plus: 256 character storage. 75-9600 baud rate. 5-8 level tape. stock. ADDMASTER CORP. 416 Junipero Serra Dr. San Gabriel, CA 91776 * 213/285-1121.

Circle 11 on Inquiry card.

Free

Microprocessor Catalog

42 page catalog of 6800-family single-board computers, interface modules and development systems. Also, resident and cross software including assemblers, compilers, BASIC interpreters and operating systems. To qualify for your free copy, call or write on your letterhead to:

Wintek Corporation
1804 South Street
Lafayette, IN 47904
(317) 742-8428

Circle 448 on Inquiry card.

MICRO SOLUTIONS

8 To 16 BIT UPGRADE

TRUE 16 BIT PROCESSING

- Z8001 Microprocessor (upgradable to Z8003)
- 2 Kx16 Eprom with Monitor Program (E²Rom optional)
- 16 Vectored Interrupts
- Full IEEE-696 (S100) Compatibility
- All Z8001 Features available
- Battery backup time of day clock
- Requires ram capable of word transfers

*Model M8000 CPU Board \$425⁰⁰
*Model M8000 EE optional E²Rom \$75⁰⁰

SPECIAL (until May 31, 1983), M8000 EE Free with purchase of M8000 CPU Board

*6 month limited warranty

To order
Call 1-800-821-8858. In New Mexico 1-505-523-0975
or
Write Micio Solution Inc.
Suite 199 B
1608 El Paseo Rd
Las Cruces, NM 88001

Visa and Master Card welcome
Include check or money order
New Mexico residents add 4.5% sales tax

Circle 277 on Inquiry card.

Maxell Floppy Disks The Mini-Disks with maximum quality.



Dealer inquiries invited. C.O.D.'s accepted. Call FREE (800) 235-4137.

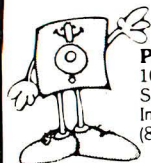

PACIFIC EXCHANGES
100 Foothill Blvd., San Luis
San Luis Obispo, CA 93401.
In Cal. call (800) 592-5935 or
(805) 543-1037.

Circle 319 on Inquiry card.

NEW SOFTWARE

STOCK MARKET ANALYSIS: Follow market trends and keep track of actual values relative to costs and commissions, set buying and selling points, determine your own market priorities. Monitor your portfolio of stocks, commodities and foreign currencies using graphic displays to maximize your profits. Designed with the help of Merrill Lynch and Dean Witter agents. — \$50.00

REAL ESTATE ANALYSIS: Project profits and costs before you buy or sell property. Calculate amortization of loans, value of property, relationship of income, expenses, depreciation and debt to the prospect of sale. A set of real estate analysis programs no real estate agent or property owner can afford to be without. — \$50.00

DATA SECURITY: CENSOR — provides you with data security from prying eyes or unauthorized access to company information, personal data, private reports. Data security is vital to anyone who deals with important and sensitive information. — \$25.00

CROSS REFERENCE: Produces individual lists of program variables, strings, keywords, constants, automatically generates lines number when needed, and more. Cross reference for ALL MAJOR LANGUAGES — INCL.: MBASIC, CBASIC, PASCALS, FORTRAN, COBOL, LISP, ASSEMBLER LANGUAGES, and more. — \$25.00

UTILITIES: Package (Both)
FILE-COMPARER — The fastest way possible to compare two files for discrepancies and changes. A must for when you have back-up copies or do numerous revisions while programming or word processing.

FILE-PRINT — Display data files, programs or word processing data for customized output to printer or disk. Set headers, date, line numbers, special printer hardware characteristics, allows for (.) commands and more... Utility Package... \$25.00

ComSilk PROGRAMS RUN ON: CP/M, Northstar, 32 W. Annapolis Street, Suite 159 TRS-90, Apple, IBM (PC) Santa Barbara, Ca. 93101 (Specify hardware)
VISA & MASTERCARD — Order phone (only) (805) 965-4336
Shipping \$4.00, outside U.S. \$10.00 / CA. residents add 6%

Circle 113 on inquiry card.

RS-232 Multi-Adapter

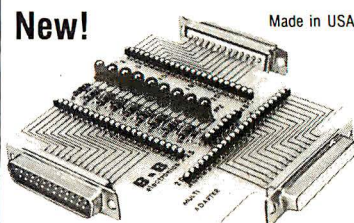

Versatile Multi-Adapter features one male and two female connectors with pins 2-25 of each connector attached to socket strips. Male connector has LED's which monitor status of pins 2-6, 8, and 20. Two spare LED's. Satisfaction guaranteed. **ORDER NOW! Only \$79.95**, plus \$1.75 shipping & handling; we accept MC, Visa. Get our new illustrated catalog of interface & monitoring equipment FREE on request. Phone 815/539-5827. Make checks payable to:

B&B electronics
Box 475B, MENDOTA, IL 61342

Circle 46 on inquiry card.

True MAIL ORDER Prices

With so many so-called Mail Order establishments using "toll free" lines, and gaudy advertising, how can you, the customer, expect to receive true mail order savings? We have done away with large ads, and free phone lines to offer comparable service passing on the savings to you. Our reputation for low prices and satisfaction is outstanding.

DISKETTES	PRINTERS	MONITORS
<p>*Kangaroo: (w/library case) SS/DD \$19.35 DS/DD \$28.00 — 10 yr. Warranty —</p> <p>Elephant: SS/DD \$21.95 DS/DD \$28.95</p> <p>Verbatim: 5¼" SS/DD \$22.95 5¼" DS/DD \$38.95 8" SS/DD \$38.95 8" DS/DD \$43.95 — Available soft/hard sector — Library Case 5¼" \$1.75</p>	<p>Okidata: Microline 92 \$565.00 Microline 93 \$985.00</p> <p>Pacemark 2350 Parallel \$2100.00 Serial \$2200.00</p> <p>Pacemark 2410 Parallel \$2400.00 Serial \$2500.00</p> <p>Call for prices on the entire line of Okidata Printers.</p> <p>Call for the New Epson FX Printers.</p>	<p>Amdek: Color I \$295.00 Color II \$695.00 300G Green \$155.00 300A Amber \$155.00 310G Green \$175.00 310A Amber \$175.00</p> <p>Zenith: 12" Green \$ 99.00 USI: Amber \$159.00 *Taxan: Amber \$139.00 PGS: RGB Monitor \$CALL BMC: Green 12" \$ 80.00</p>
MODEMS	TEC/C.I.TOH	DISK DRIVES
<p>Hayes: MicroModem II with Terminal Program \$285.00 without Terminal Program .. \$255.00</p> <p>Hayes Smartmodem: 300 Baud \$199.00 1200 Baud \$505.00</p> <p>Novation: J-Cat \$104.00 Applecat II \$285.00 Smartcat 1200 Baud \$440.00 Hayes Chronograph \$179.00</p>	<p>Prowriter 1 Parallel \$369.00 Prowriter 1 Parallel/Serial \$489.00 Prowriter 2 Parallel \$639.00 Prowriter 2 Parallel/Serial \$689.00 F-10 Starwriter Parallel \$1185.00 or Serial \$CALL F-10 Printmaster Parallel \$CALL or Serial \$CALL</p> <p>Brither HRI: \$795.00 Smith Corona TPI: \$559.00</p> <p>Star: *Gemini 10 & 15 .. Call for low prices!</p>	<p>Apple: Fourth Dimension: w/o controller \$250.00 w/ controller \$319.00</p> <p>Rana Elite I: w/o controller \$270.00 w/ controller \$339.00</p> <p>IBM: *Tandon TM-50 \$CALL The New Thin-Line \$235.00</p>
COMPUTER PRODUCTS FOR IBM	TANDON DISK DRIVE SPECIAL	COMPUTER PRODUCTS FOR APPLE
<p>The Ultimate Peripheral MONTE CARLO™ CARD</p> <p>64K \$390.00 128K \$450.00 192K \$510.00 256K \$570.00</p> <p>T & G Products: Joysticks \$49.00 Trakball \$49.00</p> <p>BUSINESS Visicorp: Visidex \$180.00 Visifiles \$180.00 256K Visicalc \$180.00 Visitrend/Plot \$225.00</p> <p>ENTERTAINMENT: Infocom: Zork I \$27.00 Zork II \$27.00 Zork III \$27.00</p>	<p>TM-100-2 DS/DD 320K Bytes \$239.00 TM-50 320K Bytes Half Height \$235.00</p>	<p>MBI: VIP Graphics Card \$119.00 Appletime Clockcard \$ 85.00</p> <p>Silicon Valley Systems: Final Analysis \$149.00 Word Handler \$115.00</p> <p>Continental: Home Acct. \$ 49.00</p> <p>On-Line: Screenwriter II Pro \$139.00</p> <p>Visicorp: Visidex \$180.00 Visifiles \$180.00 Visicalc \$180.00 Visitrend/Plot \$225.00</p> <p>Denver Software: Financial Partner \$139.00 Pascal Tutor \$ 82.00 Pascal Programmer \$189.00</p> <p>Stoneware: DB Master \$149.00 DB Utility Pak \$ 65.00</p> <p>T & G Products: Joysticks \$42.00 Select-a-Port \$42.00 Game Paddles \$28.00</p> <p>Davong Hard Disks 5 Megabytes \$1450.00 10 Megabytes \$1850.00 15 Megabytes \$2250.00</p> <p>Ram Cards Microsoft 16K \$75.00 Generic 16K \$60.00 CP/M Microsoft Z80 Card \$259.00 80 Column Cards Videx w/soft .. \$269.00</p>
<p>Send orders and inquiries to:</p> <p>Computer Apparatus™</p> <p>P. O. Box 32063 • Aurora, Colorado 80041 Telephone Inquiries: (303) 759-9251 Monday thru Friday — 9:00 a.m. to 5:00 p.m. (Mountain Standard Time)</p> <p>We built our reputation on low prices for the informed computer user.</p>	<p>QuadRam Quadboard 64K \$390.00 128K \$450.00 192K \$510.00 256K \$570.00</p> <p>Kraft Products: Joysticks \$55.00 Game Paddle \$29.00</p> <p>Davong Hard Disks 5 Megabyte \$1450.00 10 Megabyte \$1850.00 15 Megabyte \$2250.00</p> <p>Maynard Electronics Floppy Controllers w/Parallel . \$209.00 Floppy Controllers w/Serial ... \$239.00</p>	<p>DELIVERIES: 2 - 4 weeks average. PERSONAL CHECKS: Cashier's check and money order will receive shipping preference. VISA & MASTERCARD: Add 4% to total. We CHARGE only WHEN we ship. CATALOG: Send for full pricing details. Prices subject to change without notice. SHIPPING: UPS add \$2.00 plus 2% of order total.</p>

WE WILL NOT BE UNDERSOLD

TERMINALS

Zenith ZT-1	\$595.00
Zenith Z-19	\$679.00
Televideo 910+	\$599.00
Televideo 925	\$779.00
Televideo 950	\$979.00
Sanyo CRX-1100	CALL

COMPUTERS

Sanyo MBC 1000 64K	CALL
Sanyo MBC 1200	CALL
Sanyo MBC 2000 dual 5 1/4"	CALL
Sanyo MBC 3000 dual 8"	CALL
Sanyo MBC 4000 16 BIT	CALL
ALL SANYO COMPUTERS INCLUDE	
WordStar, MailMerge, CalcStar, SpellStar, InfoStar	
Franklin Ace 1000 64K	CALL
Franklin Ace 1200 128K	CALL
Call for our Special System Packages!	

TELECOMMUNICATIONS

Novation Cat	\$139.00
Novation J Cat	\$119.00
Novation D Cat	\$155.00
Novation Apple Cat	\$299.00
Novation Apple Cat 1200 baud	\$629.00
Novation Smart Cat	\$199.00
Novation Smart Cat 1200 baud	\$495.00
Hayes Micromodem II	\$299.00
Hayes Smartmodem	\$239.00
Hayes Smartmodem 1200 baud	\$569.00
Hayes Chronograph	\$229.00
Signalman Mark I	\$89.00
Signalman-IBM	\$189.00

DISKETTES

Verex 5 1/4"	\$23.95
Verbatim 5 1/2"	\$26.95
Verbatim 8"	\$36.95
Verbatim Head Cleaning Diskette	\$9.95
Maxell MD1 5 1/4"	\$29.95
Maxell MD2 5 1/4"	\$44.95
Maxell FD1 8"	\$37.95
Maxell FD28"	\$44.95
5 1/4" File Box	\$19.95
8" File Box	\$21.95

MONITORS

Sanyo 9" B&W	\$159.00
Sanyo 9" Green	\$165.00
Sanyo 12" B&W	\$179.00
Sanyo 12" Green	\$199.00
Sanyo 13" Color	\$399.00
SMD 13" Color	\$339.00
Comrex 13" Color	\$329.00
Amdek 13" Color	\$329.00
Zenith 13" Color RGB	\$589.00
Zenith 12" Green	\$99.00
Electrohome 13" Color RGB	\$599.00
Taxan 12" Amber	\$139.00
Taxan 12" Green	\$129.00
Taxan 12" Medium Res Color	\$319.00
Taxan 12" Hi Res Color	\$529.00

The CPU Computer Corporation
Announces:

CPU net™

The Local Area Network that uses
real CP/M™ for Apples. CPU net™
allows you to run hundreds of
popular CP/M™ programs, on your
Apple terminals, without disk drives!
Call for more information.

\$2995.00



The CPU Shop

DEALER INQUIRIES PLEASE CALL 1-800-343-7036

420-438 Rutherford Ave., Dept. BY-4, Charlestown, Massachusetts 02129

Hours 9 AM - 9 PM (EST) Mon.-Fri. (Sat. till 6)
Technical information call 617/242-3361

TWX- 710-348-1796

Massachusetts Residents call 617/242-3361
Massachusetts Residents add 5% Sales Tax

Circle 121 on inquiry card.

BYTE April 1983 513

APPLE ACCESSORIES

16K Card by Microsoft	\$79.00
32K Card by Saturn	\$199.00
64K Card by Saturn	\$419.00
128K Card by Saturn	\$585.00
SoftCard Plus by Microsoft	CALL
Keyboard Enhancer by Videx	\$125.00
Videoterm by Videx	\$259.00
Game Paddle by TG	\$49.00
Joystick by TG	\$49.00
Pkaso ID-12 Card	\$159.00
Pkaso EP-12 Card	\$159.00
Pkaso AP-12 Card	\$159.00
Pkaso NE-12 Card	\$159.00
System Saver by Kensington	\$75.00
Microbuffer II 16K (Apple)	\$229.00
Microbuffer II 32K (InLine)	\$259.00
Microbuffer II 64K (InLine)	\$319.00
Add-Ram 16K by ALS	\$79.00
Z-Card w/CPM by ALS	\$225.00
Z-Card 64K by ALS	\$299.00
Smarterm by ALS	\$249.00
Smarterm II by ALS	\$149.00
Dirt Cheap Video by ALS	\$75.00
Color II Card by ALS	\$149.00

APPLE SOFTWARE

MICROPRO	
WordStar	\$379.00
MailMerge	\$190.00
SpellStar	\$190.00
DataStar	\$259.00
CalcStar	\$115.00
VISICORP	
VisiCalc	\$199.00
VisiTerm	\$89.00
VisiDex	\$199.00
VisiPlot	\$169.00
VisiFile	\$199.00
VisiSchedule	\$259.00
VisiTrend/Plot	\$259.00
VisiLink	\$199.00
Visicalc Business Model	\$89.00
MISCELLANEOUS	
MicroTerminal	\$69.00
Screenwriter II	\$99.00
Dictionary	\$79.00
DB Master	\$169.00
PFS Filing System	\$99.00
PFS Report	\$75.00
PFS Graph	\$99.00
Easy Writer Pro	\$199.00
Easy Mailer Pro	\$79.00
Z-Term Pro	\$129.00
Word Handler	\$149.00
MultiPlan by Microsoft	\$229.00
dBase II	\$489.00
HowardSoft Tax Preparer	\$149.00

IBM PC HARDWARE

Quadram 128K Ram Card	\$599.00
Quadram 192K Ram Card	\$719.00
Quadram 256K Ram Card	\$795.00
Microsoft 64K Ram Card	\$399.00
Microsoft 192K Ram Card	\$699.00
Microsoft 256K Ram Card	\$799.00
Joystick by TG	\$49.00
Tandon TM 100-2 Raw Drive	\$279.00

IBM PC SOFTWARE

INFORMATION UNLIMITED	
Easy Writer	\$289.00
Easy Speller	\$149.00
Easy Filer	\$319.00
VISICORP	
VisiCalc 256K	\$199.00
VisiDex	\$209.00
VisiFile	\$259.00
VisiTrend/Plot	\$259.00
VisiSchedule	\$259.00
VisiWord	\$329.00
MICROPRO	
WordStar	\$379.00
MailMerge	\$195.00
MISCELLANEOUS	
SuperCalc	\$279.00
SuperWriter	\$289.00
Home Accountant +	\$129.00
dBase II	\$495.00

DISK DRIVES

CCI 121 add-on for Sanyo MBC 1000	\$359.00
CCI 100 for the TRS 80 Model I	
5 1/4" 50 track	\$299.00
Corvus 5M with Mirror	\$2895.00
Corvus 10M with Mirror	\$3679.00
Corvus 20M with Mirror	\$4579.00
Rana Systems for the Apple II	
Elite One 40 track	CALL
Elite Two 80 track	CALL
Elite Three 80 track, double side	CALL
Elite Controller	CALL
Sanyo EFD 160	\$699.00

RAM

16K Ram Kit for Apple II	
and TRS 80. 4116 chips	
200 nano seconds	\$17.50

PRINTERS

NEC 3510 Serial	\$1595.00
NEC 3530 Parallel	\$1629.00
NEC 3550 for the IBM PC	\$1995.00
NEC 7710 Serial	\$2250.00
NEC 7720 KSR	\$2675.00
NEC 7730 Parallel	\$2250.00
Epson MX 80	CALL
Epson MX 80 FT	CALL
Epson MX 100 FT	CALL
Epson FX Series	CALL
Epson RX Series	CALL
IDS Microprism	CALL
IDS Prism 80	CALL
IDS Prism 132	CALL
Okidata 82A	\$479.00
Okidata 83A	\$729.00
Okidata 84	\$1149.00
Sanyo PR 5500 Letter Quality	\$859.00
Brother HR 1 Letter Quality	\$899.00
Toshiba P 1350 160 CPS	
Letter Quality	CALL

Call For More IBM Software And Accessories
CP/M is a registered trademark of Digital Research.

SPECIAL OF THE MONTH
SANYO PR 5500
LETTER QUALITY
PRINTER
18 CPS—DAISY WHEEL
BI-DIRECTIONAL
\$ CALLS

Now, Interconnect Any Two RS232 Devices

American Made

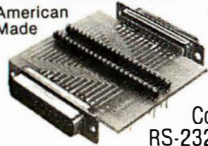

WIRING ADAPTER

\$24.95

Connects any two RS-232 devices in any pattern. Temporary or permanent. Comes complete with ten plug-in jumper wires. Wiring Adapter just \$24.95 plus \$1.75 for postage and handling, (IL res. add 5% sales tax); we accept MC, Visa, and Purchase Orders from rated firms. Get FREE illustrated catalog of interface and monitoring equipment.



B&B electronics

P.O. Box 475 B • Mendota, IL 61342
Phone: (815) 539-5827

Circle 45 on Inquiry card.

Convert your TRS-80 into a DEVELOPMENT SYSTEM

Z-80 In-Circuit emulation and EPROM/EEPROM programming in a single compact unit.



Debug stand-alone systems with program in TRS-80 RAM, then copy working program into PROM.

Only \$329 including personality module for 2716, 2516, 2758, 2508, 2532, 2816, 2808, 48016. (2732A, 2764 PM's \$15 ea.)

ORION INSTRUMENTS

172 Otis Ave, Woodside, CA 94062
(415) 851-1172

Circle 314 on Inquiry card.

BASF DISKETTES

BASF Diskettes at competitive price. Call TOLL FREE (800) 235-4137 for prices and information. Visa and Master Card accepted.

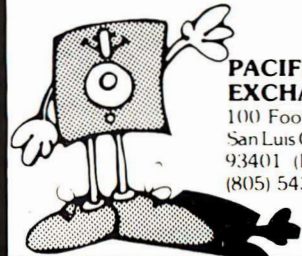

PACIFIC EXCHANGES

100 Foothill Blvd
San Luis Obispo, CA
93401 (In Cal call
(805) 543-1037)

Circle 319 on Inquiry card.

Expand Your Networking Capabilities

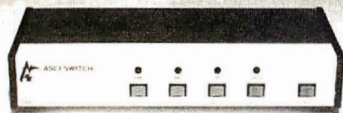

With the new ASCI Four Port intelligent switch all your RS-232C networking problems can be solved. Whatever your switching applications the ASCI Switch allows you to switch with ease. Because the switch is intelligent it allows you to change between peripherals from your keyboard. The code can even be imbedded in your text. When you consider the time you saved due to the simplicity of installation, the elimination of extra cabling and the exclusion of knob turning the ASCI Four Port intelligent switch is the perfect way to expand your networking capabilities.



Advanced Systems Concepts, Inc.
PO BOX 0 • ALTADENA CALIFORNIA 91001
(213) 793-8971

Circle 14 on Inquiry card.

Get Smart!



Get Your Computer An Automatic Port Selector (ASU-3)

Our ASC-3 will connect your CPU or CRT to any one of 3 peripherals. Just enter a command from your keyboard and the desired peripheral is automatically connected. Also available for 5 and for 7 peripherals. The baud rate is set automatically. Many options are available. The only low cost, smart switch on the market.

SWITCH TO GILTRONIX.



970 San Antonio Rd., Palo Alto, CA 94306. Call (415) 493-1300

Circle 181 on Inquiry card.

LOOK TO THE FUTURE...

EPROM-32

The only EPROM programmer you need!

- IEEE-696 (S-100) EPROM programmer for single supply (+5V) EPROMs.
- Programs current 1K through 16K (byte) EPROMs plus future 32K EPROMs.
- EPROM can be verified through a port or located in memory space for verification and use.
- Personality Modules adapt board to different EPROM types:
PM-1—2508, 2758 PM-3—2732, 2732A PM-6—68764
2516, 2716 PM-4—2564 PM-7—2528
PM-2—2532 PM-5—2764 PM-8—27128
- Single zero-insertion-pressure socket accommodates both 24-pin and 28-pin EPROM packages.
- On-board DC-to-DC converter with adjustable regulator for programming voltage.
- Double-sided PC board with solder masks, silkscreen and gold-plated contact fingers.
- 8080/280 control software includes commands for programming, verification and non-seasonal editing.
- Comprehensive user's manual contains source listing of control software.

MicroDynamics

\$269.95
(assembled & tested)

Corporation
P.O. Box 17577
Memphis, TN 38117
(901)-755-0619

Price includes EPROM-32, documentation and two Personality Modules (specify). Additional Modules—\$7.95. Control software on 5 1/4 inch single density CP/M-compatible diskette—\$9.95.

MasterCard & Visa

TN residents add 6% sales tax.

Circle 281 on Inquiry card.

Structured Services builds engineering and manufacturing muscle

You bet I want to fly!



Running lean sometimes means pushing aside projects because you're short staff and space. Structured Services lets you trim operations without cutting effectiveness. We provide:

- Full Manufacturing Services
- High-Tech Engineering Services
- Disk Drive Repair for 5 1/4" & 8" Floppies
- Prototype Assembly
- Short Production Runs

Structured Services: Short-term services with long-term results.

Structured Services

2000 Wyatt Drive, Santa Clara, CA 95054
408/988-5512 • Telex 172931

Circle 392 on Inquiry card.

UNIFORTH

Check with us before you order FORTH from any other distributor. UNIFORTH is available for most Z-80, 8086/8088, LSI/PDP-11, 68000 or 16032 computers, either stand-alone or as a task under an operating system. UNIFORTH adheres to the FORTH-79 standard, and includes a video editor, floating point routines, and an assembler. We offer a solid, professional system with extensive documentation and option packages. Prices: \$60 (basic) to \$300 (multi-user).

Requires 8" floppies.

Unified Software Systems
P.O. Box 2644
New Carrollton, Md 20784
(301) 552-1295

Circle 427 on Inquiry card.

STATISTICAL SOFTWARE

ELF—Stepwise regression, factor analysis, correlation coefficients, cross-tabs, simple statistics, t-tests, ANOVA, stepwise discriminant analysis, all BASIC transformations and more. \$200.00.

TWG/ARIMA—Box-Jenkins for seasonal and non-seasonal models. \$300.00.

EASI/ARIMA—Automatic Box-Jenkins program for stock and commodity traders. \$300.00

All are for the Apple II* with 48K of memory, Applesoft* and DOS 3.3.

Visa and MasterCard accepted.
Call or write:

The Winchendon Group
3907 Lakota Road
P.O. Box 10114
Alexandria, VA 22310
(703) 960-2587

*Trademarks of Apple Computer, Inc.

Circle 447 on Inquiry card.

DATA IMPACT PRODUCTS SETS THE NEW INDUSTRY STANDARD A HIGH QUALITY PRINTER FOR ONLY \$399.



THE NEW D-92 DUAL MODE MODULAR PRINTER

WE DARE YOU TO COMPARE!

But don't just look at the price, consider the features, reliability and flexibility of the D-92 dual mode modular printer.

FEATURES

- 7×9 Font For Data Processing printing
- 11×9 Font For Crisp Clear Business Letters
- 100 CPS Bidirectional Printing
- Short Line Seeking Logic
- 800 Character Buffer Sizes
- Six Different Character Sizes
- 100% Duty Cycle
- Parallel Interface

RELIABILITY

All *Data Impact Products* printers are built with superior materials right here in the United States. Each unit is inspected, tested and burned in at the factory to insure superior quality.

- Other measures of reliability
- 100 Million Character User-Replaceable Printhead
 - 5 Million Character Ribbon Cartridge
 - Easy Access and Serviceable Single Circuit Board
 - Full Factory Warranty On Parts and Labor

FLEXIBILITY

The D-92 was built with your future in mind. The highly modular design provides several upgradeable options such as:

- Adjustable Tractor Feed
- Dot Addressable Graphics
- 2K Buffer
- X-ON/X-OFF
- RS232 Serial Interface
- 9600 Baud
- Single Sheet Feeder

Naturally, *Data Impact Products* printers will interface with all popular computers whether it is IBM, Osborne, TRS, Apple, Atari, etc.

SPECIAL PROMOTION FOR APPLE USERS

INTERFACE CARD AND CABLE ONLY \$75.00 WITH PRINTER PURCHASE

1-800-327-1525

Circle 145 on inquiry card.



DATA IMPACT PRODUCTS, INC.

745 ATLANTIC AVE., BOSTON, MA 02110 TEL: 617-482-4214
TELEX: 951047 DIP INC BSN

NETRONICS NEW 16 BIT EXPLORER 88-PC ... \$399.95 IBM COMPATIBLE

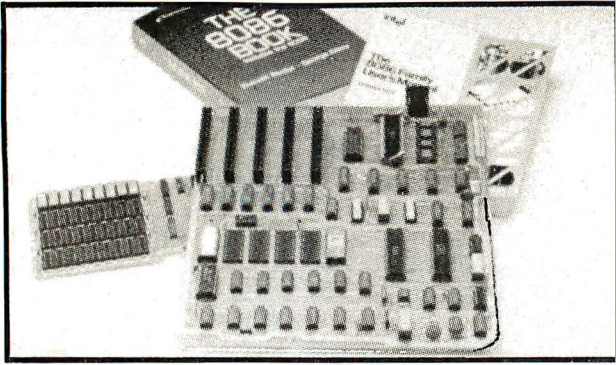

LEARN 16 BIT TECHNOLOGY IN EASY LOW-COST STEPS. This 2-board system features (1) an 8088 mother board with a 5-slot expansion bus that will accept any hardware designed for the IBM personal computer and (2) a 64K (expandable to 256K) memory board that also features an IBM compatible RS 232 communications port. All circuits are functionally equivalent to the IBM except for the cassette ROMS. This means that all programs written in basic designed to run on an IBM can be compiled to run in this system and that any disk-operating system that will run on an IBM will work directly in the EXPLORER 88-PC. The system monitor ROM included in the Starter's system features a user-friendly operating system that allows easy program generation and debugging. The commands include display/modify memory... display/modify registers...input/output data to I/O ports...block moves...single-step trace mode...go/run with optional breakpoint and register reports...cassette load/save with file labels...plus a complete system test program that tests and reports condition of ROM, RAM, cassette interface, timer, DMA controller, interrupt controller, and the communications port. These test programs not only allow easy debugging of software but they serve as hardware and software learning tools.

The EXPLORER 88-PC STARTER'S KIT includes a mother board, memory/ I/O board, all components needed, sockets for IC's used, one 62-pin bus connector and complete assembly/ test instructions. All you need is a soldering iron, solder, a +5 volt @ 3 amps & -5 & +/- 12 volt @.5 amp power supply, and a standard RS 232 terminal (Netronics has 2 low-cost ones to choose from).

- Explorer 88-PC Starter's Kit ...\$399.95 + 10.00 p&i (wired & tested, add 100.00).
- Extra 62-pin connectors @ 4.25 ea. + 1.00 p&i.

If you do not own a terminal you may want to consider using our IBM compatible keyboard (see photo) in conjunction with an IBM compatible color graphics board. This combination, although not necessary at the introductory level, may be desirable if you plan to expand the EXPLORER 88-PC to be fully IBM compatible. These items require additional power and are only available wired and tested as follows:

- IBM compatible keyboard...\$299.95 + 10.00 p&i
- IBM compatible color board...\$299.95 + 10.00 p&i
- Additional ROM required...\$35.00

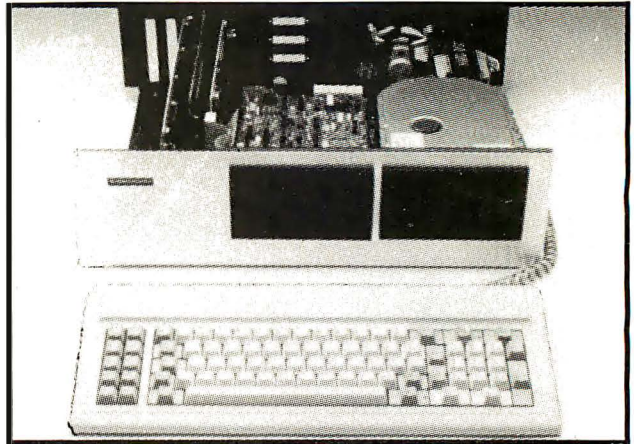

The EXPLORER 88-PC can be expanded at any pace you decide. Invest and learn at a pace that is comfortable for you. Netronics is dedicated to supplying the finest hardware and software to make this a meaningful learning experience. Hard disks, built-in modem board, ethernet board, print buffer system plus more will be available shortly. The following items are available now:

- Deluxe heavy-duty steel cabinet that houses either two 5 1/4" floppies or a 5 1/4" hard disk with one floppy. This cabinet features a brush-finish front panel and a wood-grained sleeve that gives the unit a real professional look.
- EXPLORER 88-PC Cabinet...\$199.95 + 18.00 p&i.
- A heavy-duty open frame power supply with fan that can be used in your own cabinet or installed into the Netronic cabinet is available as follows:
 - 10 amp power supply for system + 2 floppies...\$149.95 + 8.00 p&i.
 - As above + extra power for 1 hard disk...\$169.95 + 8.00 p&i.
 - IBM compatible disk controller board. Controls four 5 1/4" floppy drives (w/2 drive cable)
 - Available wired and tested only...\$250.00 + 8.00 p&i.
 - The monitors and BIOS source listings are available on either disk or hard copy of \$35.00.
- Please specify format and system required.
- INTEL 8086/8088 user manual...\$15.00 + 1.50 p&i.
- THE 8086 BOOK by RECTOR & ALEX...\$16.00 + 1.50 p&i.
- Special IBM compatible system: with keyboard, color graphics board, floppy disk controller, 64K RAM, cabinet, standard power supply and a single 5 1/4" floppy drive...\$1899.95 + 25.00 p & i.

*IBM PC is a registered trademark of IBM Corporation.

EXPLORER 88

Learn computing from the ground up. Start with the Explorer/85 Level 'A' kit which includes an expandable mother board. The Kit Includes the 8085 CPU, 2K Monitor program used to enter, test, run and save programs plus the parts to allow you to start programming. Just add a power supply and terminal or hex keyboard. LEVEL 'A' Terminal version or Hex Keypad version 129.95 + 3.00 p&i. Add Level 'B' 49.95 + 2.00 + two 100 pin connectors @ 4.85 ea. and have a powerful S-100 computer. Add Level 'C' 39.95 + 2.00



p&i + five 100 pin connectors to increase S-100 slots to 6. Add memory using the JAWS 16-64K S-100 board or add Level 'D' 4K to main board 49.95 + 2.00 p&i. Level 'E' 5.95 + 1.50 p&i adds decoding for 8K of 2716 eeproms. Need a power supply? Use the 5 amp AP-1 at 39.95 + 2.00 p&i. Select one of our low-cost terminals or use the Hex keypad w/display at 69.95 + 2.00 p&i. Deluxe system cabinet 49.95 + 3.00 p&i. Optional tan 16.50. Now add Microsoft 8K basic & a powerful Text editor/Assembler in ROMS, just 99.95 ea. Add 8" floppy 499.95 + 12.00 p&i. Floppy controller board 199.95 + 2.00 p&i. Floppy cabinets & power supply 69.95 + 3.00 p&i. Two drive cable 29.95 + 1.50 p&i. Hard disk also available (see insert).

ORDER A SPECIAL-PRICE EXPLORER/85 PAK

Beginner Pak (Save \$26.00) - You get Level A (Terminal Version) with Monitor Source Listing (\$25 value) AP-1 5-amp power supply. Intel 8085 Users Manual...(Reg. \$199.95) SPECIAL \$169.95 plus \$4 p&i.

Experimenter Pak (Save \$53.40) - You get Level A (Hex Keypad/Display Version) with Hex Keypad/Display, Intel 8085 User Manual, Level A Hex Monitor Source Listing and AP-1 5-amp. power supply...(Reg. \$279.95) SPECIAL \$219.95 plus \$6 p&i.

Special Microsoft BASIC Pak (Save \$103.) - You get Levels A (Terminal Version), 8.0, (4K RAM) E. 8K Microsoft in ROM, Intel 8085 User Manual-Level A Monitor Source Listing and AP-1 5-amp. power supply...(Reg. \$439.70) SPECIAL \$329.95 plus \$7 p&i. Add a Rom-Version Text Editor/Assembler (Requires Levels B and O or S100 Memory)...\$99.95 plus \$2 p&i.

Starter 8" Disk System - Includes Level A, B floppy disk controller, one CDC 8" disk-drive, two drive cable, two S100 connectors; just add your own power supplies, cabinets and hardware... (Reg. \$1065.00) SPECIAL \$999.95 plus \$13 p&i. 32k Starter System. \$1045.95 plus \$13 p&i. 48k Starter System. \$1095.95 plus \$13 p&i. 64k Starter System. \$1145.95 plus \$13 p&i.

Add to any of above Explorer steel cabinet. AP-1 five amp. power supply, Level C with two S100 connectors, disk drive cabinet and power supply, two sub-D connectors for connecting your printer and terminal...(Reg. \$225.95) SPECIAL \$199.95 plus \$13 p&i.

Complete 64K System. Wired & Tested... \$1650.00 plus \$26 p&i.

S-100 BOARDS

JAWS MEMORY BOARD. Features the INTEL 8202 for invisible refresh. Designed to be used with 8080, 8085 and 280 CPU's. Works in all well designed S-100 computers, 10 day refund (or exchange wired unit for a Kit) on wired units.

- 16K Kit 149.95*
- 32K Kit 199.95*
- 48K Kit 249.95*
- 64K Kit 299.95*
- 16K wired 179.95*
- 32K wired 239.95*
- 48K wired 299.95*
- 64K wired 359.95*

*Add \$2.00 p&i to all above.

4 DRIVE 8" FLOPPY CONTROLLER BOARD Single density (single or double sided) controller using the WD 1771. Includes two serial ports. Plugs into any S-100 computer.

8K 2716 EPROM BOARD. addressable on 8K page boundaries complete with sockets 69.95 + 2.00 p&i.

S-100 ELECTRIC MOUTH. Give your computer the power of speech. Uses National's DIGITALPKR with 143 words 99.95 + 2.00 p&i. second word set 39.95 + 1.00 p&i. Board accepts up to 4 word sets or your own custom word rom chips.

UNIVERSAL SPEECH SYNTHESIZER



Use 90 preprogrammed words or generate your own words using phonemes. Perfect for any project that needs speech or for speech development system. Connects to any RS 232 serial or 8 bit parallel port or can be used in a stand alone mode. Speak-easy (board only) 159.95 + 3.00 p&i. Cabinet and power transformer 25.00 + 2.00 p&i. **TRS 80 ELECTRIC MOUTH.** Plugs into the expansion slot on the TRS 80 models 1 or 3 (specify type) with 143 word set 119.95 + 3.00 p&i. Includes separate power supply, second word set 39.95 + 1.00 p&i, same specs as S-100 model.

APPLE ELECTRIC MOUTH. Same as above except this board plugs into any of the Apple expansion slots with 143 word set 99.95 + 3.00 p&i. second word set 39.95 + 1.00 p&i. Accepts 3 word sets or custom word ROMs.

TERMINALS & VIDEO

FASTERM 64 199.95 + 3.00 p&i. Display format: 64 or 32 char/16 lines...96 ASCII characters (w/1 case)...8 baud rates, 150 to 19,200...line output: RS 232C or 20 ma loop...video output: 1V P/P...cursor modes: home

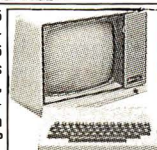

& clear screen, erase to end of line, erase cursor line, cursor up and down, auto carriage return/line feed at ends of line and auto scrolling...reverse video...blinking cursor...parity: off, even, or odd...stop bits: 1, 1.5, 2...data bits per character: 5, 6, 7 or 8...printer output: prints all incoming data...1k on-board RAM...2k on-board ROM...complete with power supply, cabinet & 56-key ASCII encoded keyboard. Optional graphics mode: includes 34 Greek & math plus 30 special graphic characters: 19.95 prepaid.

FASTERM VIDEO BOARD: 99.95 + 3.00 p&i. **SMARTERM 80** 299.95 + 3.00 p&i. Display format: specify either 80 by 24 or 40 by 16...128 ASCII characters (w/1 case)...8 baud rates: 110 to 19,200...line output: RS232C or 20 ma current loop...video output: 1V P/P...editing features: insert/delete line, insert/delete character, forward/back tab...line or page transmit...page print function...cursor positioning: up, down, right, left, plus absolute cursor positioning with read back...visual attributes: underline, blink, reverse video, half intensity & blank...graphics: 12,000 pixel resolution block plus line graphics...on-screen parity indicator...parity: off, even or odd...stop bits: 110 baud 2, all others 1...printer output...60 or 50 Hz vertical re-

fresh...blinking block cursor...2k on-board RAM...ASCII encoded keyboard: 56 keys, 128 characters...4k on-board ROM...complete with power supply & cabinet.

SMARTERM, VIDEO BOARD: 199.95 + 3.00 p&i **ZENITH VIDEO MONITOR** (green phosphor): 149.95 + 6.00 p&i **RF MODULATOR** (kit only): 8.95 + 1.00 p&i **3-ft. cable with DB 25 connectors:** 14.95 + 2.00 p&i

HARD DISK

Add up to four 6 or 12 megabyte hard disks to your S-100 system. Automatically installs itself to any standard CPM 2.2 BIOS. 6 megabytes 2495.00 + 15.00 p&i. 12 megabytes 2995.00 + 15.00 p&i. Disk to test your system compatibility 5.00.

SOFTWARE

We are distributors for all Systems Plus & Micro pro software. Call for prices. CPM/2 150.00 Microsoft disk basic 325.00... Special Business Pac includes CPM, BASIC, GL, AR, AP & Payroll 699.95 (save 625.00).

CLIP AND MAIL ENTIRE AD

"p&i stands for "postage & insurance." For Canadian orders, double this amount. CPM is a reg. trademark of Digital Research.

TO ORDER Call Toll Free

800-243-7428

To order from Connecticut or for technical assistance call (203) 354-9375. Conn. residents add sales tax.

VISA MASTERCARD (Bank No. _____)

Acct. No. _____

Exp. Date _____

SEND ME THE ITEMS CHECKED IN AD

Signature _____

Print Name _____

Address _____

City _____

State _____

Zip _____

NETRONICS R & D LTD.
333 Litchfield Road,
New Milford, CT 06776

IBM PC Accessories

ADD ON DISK DRIVE for IBM PC- Tandon

Single sided or double sided, double density disk drives for IBM PC, these are exactly the same disk drives used by IBM at half the price

- MSM-551001 TM100-1 single sided _____ \$219.95
MSM-551002 TM100-2 double sided _____ \$294.95

SERIAL I/O for IBM PC - Profit Systems

- Two asynchronous serial RS-232C I/O ports, real time clock-calender, includes software
IOI-8100A Card with 1 port _____ \$159.95
IOI-8101A Card with 2 ports _____ \$189.95

SERIAL/PARALLEL for IBM PC - Profit Sys

- Two asynchronous serial RS-232C I/O ports, one parallel printer I/O port, real time clock-calender, includes software
IOI-8110A 1 serial & 1 parallel _____ \$199.95
IOI-8111A 2 serial & 1 parallel _____ \$229.95

EXTENDER CARD for IBM PC - Profit System

- All bus signals extended, signal names silk screened on top of board, gold-plated card edge, low noise
TSX-300A IBM PC extender _____ \$45.00

PROTOTYPING CARD for PC - Profit Systems

- Highly versatile wire-wrap or solder prototyping board for your IBM PC, large bread board area, power and ground planes to reduce noise, all holes are plated through, card is solder masked on both sides, all signals names are silk screened on both sides
TSX-310A _____ \$59.95

Video Monitors

HI-RES 12" GREEN SCREEN - Zenith

15 MHz bandwidth 700 lines/inch, P31 green phosphor, switchable 40 or 80 columns, small, light-weight & portable.
VDM-201201 List price \$189.95 _____ \$115.95

HI-RES GREEN MONITORS - NEC

- 20 MHz bandwidth, P31 phosphor ultra-high resolution video monitor, high quality, extremely reliable.
VDM-651200 Deluxe 12" _____ \$199.95
VDM-651260 Economy 12" _____ \$149.95
VDM-65092 Deluxe 9" _____ \$179.95

12" COLOR MONITORS - Taxan

- 18 MHz high resolution RGB color monitors fully compatible with Apple II and IBM PC, unlimited colors available.
VDC-821210 RGBvision I, 380 lines _____ \$389.95
VCD-821230 RGBvision III, 630 lines _____ \$689.95
VDA-821200 RGB card for Apple II _____ \$99.95

COLOR MONITORS - Amdek

- Reasonably priced color video monitors.
VDC-80130 13" Color I _____ \$379.95
VDC-801320 13" Color II _____ \$894.95
IOV-2300A DVM board for Apple _____ \$199.95

AMBER or GREEN MONITORS - USI

- High resolution 18 MHz compact video monitors.
VDM-751210 12" Amber phosphor _____ \$139.95
VDM-751220 12" Green phosphor _____ \$129.95
VDM-750910 9" Amber phosphor _____ \$129.95
VDM-750920 9" Green phosphor _____ \$ 99.95

Single Board Computer

SUPERQUAD - Adv. Micro Digital

- Single board, standard size S-100 computer system, 4 MHz Z-80A, single or double density disk controller for 5 1/4" or 8" drives, 64K RAM, extended addressing, up to 4K of EPROM, 2 serial & 2 parallel I/O ports, real time interrupt clock, CP/M compatible.
CPC-30800A A & T _____ \$724.95
IOX-4232A Serial I/O adapter _____ \$29.95

Dual Disk Sub-Systems

Disk Sub-Systems - Jade

Handsome metal cabinet with proportionally balanced air flow system, rugged dual drive power supply, power cable kit, power switch, line cord, fuse holder, cooling fan, neversmar rubber feet, all necessary hardware to mount 2-8" disk drives, power supply, and fan, does not include signal cable.

Dual 8" Sub-Assembly Cabinet

- END-000420 Bare cabinet _____ \$49.95
END-000421 Cabinet kit _____ \$199.95
END-000431 A & T _____ \$249.95

8" Sub-Systems - Single Sided, Double Density

- END-000423 Kit w/2 FD100-8Ds _____ \$650.00
END-000424 A & T w/2 FD100-8Ds _____ \$695.00
END-000433 Kit w/2 SA-801Rs _____ \$999.95
END-000434 A & T w/2 SA-801Rs _____ \$1195.00

8" Sub-Systems - Double Sided, Double Density

- END-000426 Kit w/2 DT-8s _____ \$1224.95
END-000427 A & T w/2 DT-8s _____ \$1424.95
END-000436 Kit w/2 SA-851Rs _____ \$1274.95
END-000437 A & T w/2 SA-851Rs _____ \$1474.95

8" Slimline Sub-Systems

Dual Slimline Sub-Systems - Jade

Handsome vertical cabinet with scratch resistant baked enamel finish, proportionally balanced air flow system, quiet cooling fan, rugged dual drive power supply, power cables, power switch, line cord, fuse holder, cooling fan, all necessary hardware to mount 2-8" slimline disk drives, does not include signal cable.

Dual 8" Slimline Cabinet

- END-000820 Bare cabinet _____ \$59.95
END-000822 A & T w/o drives _____ \$179.95

Dual 8" Slimline Sub-Systems

- END-000823 Kit w/2 TM848-1 _____ \$919.95
END-000824 A & T w/2 TM848-1 _____ \$949.95
END-000833 Kit w/2 TM848-2 _____ \$1149.95
END-000834 A & T w/2 TM848-2 _____ \$1179.95

5 1/4" Disk Drives

- Tandon TM100-1 single-sided double-density 48 TPI
MSM-551001 _____ \$219.95 ea 2 for \$199.95 ea
Shugart SA400L single-sided double-density 40 track
MSM-104000 _____ \$234.95 ea 2 for \$224.95 ea

- Shugart SA455 half-size double-sided 48 TPI
MSM-104550 _____ \$349.95 ea 2 for \$329.95 ea

- Shugart SA465 half-size double-sided 96 TPI
MSM-104650 _____ \$399.95 ea 2 for \$379.95 ea

- Tandon TM100-2 double-sided double-density 48 TPI
MSM-551002 _____ \$294.95 ea 2 for \$269.95 ea

- Shugart SA450 double-sided double-density 35 track
MSM-104500 _____ \$349.95 ea 2 for \$329.95 ea

- Tandon TM100-3 single-sided double-density 96 TPI
MSM-551003 _____ \$294.95 ea 2 for \$269.95 ea

- Tandon TM100-4 double-sided double-density 96 TPI
MSM-551004 _____ \$394.95 ea 2 for \$374.95 ea

- MPI B-51 single-sided double-density 40 track
MSM-155100 _____ \$234.95 ea 2 for \$224.95 ea

- MPI B-52 double-sided double-density 40 track
MSM-155200 _____ \$344.95 ea 2 for \$334.95 ea

5 1/4" Cabinets with Power Supply

- END-000216 Single cab w/power supply _____ \$69.95
END-000226 Dual cab w/power supply _____ \$94.95

S-100 EPROM Boards

PB-1 - SSM Microcomputer

- 2708, 2716 EPROM board with on-board programmer.
MEM-99510K Kit with manual _____ \$154.95
MEM-99510A A & T with manual _____ \$219.95

PROM-100 - SD Systems

- 2708, 2716, 2732 EPROM programmer with software.
MEM-99520K Kit with software _____ \$189.95
MEM-99520A A & T with software _____ \$249.95

Printers on Sale

STARMICRONICS GEMINI

High speed dot matrix printers with all the features of the higher-priced best-selling machines for a lot less money!!!
100 CPS, 9 x 9 dot matrix with true lower case descenders, high-resolution bit image and block graphics, superscript & subscript, underlining, backspacing, double strike and emphasized print modes, proportional space font, friction feed, tractor feed, and roll paper, 5, 6, 8 1/2, 10, 12, & 17 pitch, programmable line spacing, FREE 2.3K buffer, Epson pin and plug compatible, user replaceable print head, extended 6 month factory warranty.

- PRM-66010 10" wide carriage _____ \$399.95
PRM-66015 15" wide carriage _____ \$529.95
PRA-66200 Serial interlace card _____ \$69.95

NEW OKIDATA 92 & 93!!

Microline 82A 80/132 column, 120 CPS, 9 x 9 dot matrix, friction feed, pin feed, adjustable tractor feed (optional), handles 4 part forms up to 9.5" wide, rear & bottom feed, paper tear bar, 100% duty cycle/200,000,000 character print head, bi-directional logic seeking, both serial & parallel interfaces included, front panel switch & program control of 10 different form lengths, uses inexpensive spool type ribbons, double width & condensed characters, true lower case descenders & graphics
PRM-43082 with FREE tractor _____ CALL

Microline 83A 132/232 column, 120 CPS, forms up to 15" wide, removable tractor, plus all the features of the 82A.
PRM-43083 with FREE tractor _____ CALL

Microline 84 132/232 column, Hi-speed 200 CPS, full dot graphics built in, plus all the features of the 83A.
PRM-43084 Centronics parallel _____ CALL
PRM-43085 Serial with 2K buffer _____ CALL

- IOP-2100A Apple card and cable _____ \$69.95
PRA-27087 TRS-80 cable _____ \$24.95
PRA-43081 2K hi speed serial card _____ \$149.95
PRA-43082 Hi-res graphics ROMs 82A _____ \$49.95
PRA-43083 Hi-graphics ROMs 83A _____ \$49.95
PRA-43088 Tractor option for 82A _____ \$49.95

EPROM Erasers

ULTRA-VIOLET EPROM ERASERS

- Inexpensive erasers for industry or home.
XME-3100A Spectronics w/o timer _____ \$69.50
XME-3101A Spectronics with timer _____ \$94.50
XME-3200A Economy model _____ \$49.95

Letter Quality Printers

LETTER QUALITY PRINTER - COMREX

Uses standard daisy wheels and ribbon cartridges, 16 CPS bi-directional printing, semi-automatic paper loader (single sheet or fan fold), 10/12/15 pitch, up to 16" paper, built-in noise suppression cover.

- PRD-11001 Centronics parallel _____ \$899.95
PRD-11002 RS-232C serial model _____ \$969.95
PRA-11000 Tractor Option _____ \$119.95

STARWRITER F-10 - C. Itoh

New 40 CPS daisy wheel printer with full 15" carriage, uses standard Diablo print wheels and ribbons, both parallel and serial interfaces included.
PRD-22010 Starwriter F-10 _____ \$1495.95

S-100 MotherBoards

ISO-BUS - Jade

- Silent, simple, and on sale - a better motherboard
6 Slot (5 1/4" x 8 3/8")
MBS-061B Bare board _____ \$22.95
MBS-061K Kit _____ \$39.95
MBS-061A A & T _____ \$69.95
12 Slot (9 1/4" x 8 3/8")
MBS-121B Bare board _____ \$34.95
MBS-121K Kit _____ \$69.95
MBS-121A A & T _____ \$109.95
18 Slot (14 1/2" x 8 3/8")
MBS-181B Bare board _____ \$54.95
MBS-181K Kit _____ \$99.95
MBS-181A A & T _____ \$149.95

JADE
Computer Products

Place Orders Toll Free
Inside California Continental U.S.
800-262-1710 800-421-5500

JADE
Computer Products
Circle 474 on inquiry card.

NEW PRODUCTS

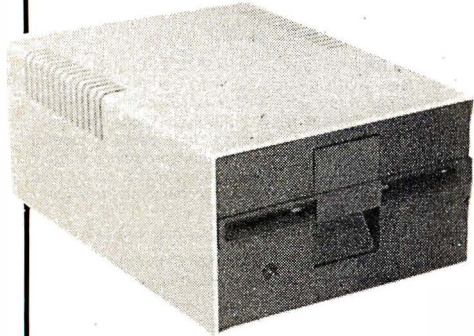

APPLE II ACCESSORIES

APPLE DISK DRIVE - Apple Compatible

Totally Apple compatible, 143,360 bytes per drive on DOS 3.3, full one year factory warranty, half-track capability reads all Apple software, plugs right into Apple controller as second drive, DOS 3.3, 3.2.1, Pascal, & CP/M compatible.

MSM-123200 Add-on Apple Drive _____ \$269.95
MSM-123100 Controller _____ \$99.95

16K RAM CARD - for Apple II

Expand your Apple II to 64K, use as language card, full 1 year warranty. Why spend \$175.00?

MEX-16700A Save over \$115.00 _____ \$59.95

Z-CARD for Apple II - A.L.S.

Two computers in one, Z-80 & 6502, more than doubles the power and potential of your Apple, includes Z-80 CPU card CP/M 2.2 and complete manual set, Pascal compatible, utilities are menu-driven, one year warranty.

CPX-62800A A & T with CP/M 2.2 _____ \$159.95

SMARTERM II - A.L.S.

80 column x 24 line video card for Apple II, addressable 25th status line, normal/inverse or high/low video, 128 ASCII characters, upper and lower case, 7 x 9 dot matrix with true descenders, standard Data Media terminal control codes, CP/M Pascal & Fortran compatible, 50/60 Hz, 40/80 column selection from keyboard.

IOV-2500A ALS Smarterm II _____ \$169.95

SERIAL I/O CARD - A.L.S.

Full feature serial card for modems & printers, baud rates from 110 to 19,200, CTC/RTS & X-on/X-off protocols, auto line feed, RS-232C cable interface included.

IOI-1000A A & T "Dispatcher Card" _____ \$129.95

CP/M 3.0 CARD for APPLE - A.L.S.

The most powerful card availability for your Apple - 6 MHz, Z-80B, additional 164K of RAM, CP/M plus 3.0, 100% CP/M 2.2 compatibility, C basic, CP/M Graphics, 3005 faster than any other CP/M for Apple. One year warranty.

CPX-62810A A.L.S. CP/M Card _____ \$349.95

2 MEGABYTES for Apple II

Complete package includes: Two 8" double-density disk drives. Vista double-density 8" disk controller, cabinet, power supply, & cables, DOS 3.2/3.3, CP/M 2.2, & Pascal compatible.

- 1 MegaByte Package Kit _____ \$1495.00
- 1 MegaByte Package A & T _____ \$1695.00
- 2 MegaByte Package Kit _____ \$1795.00
- 2 MegaByte Package A & T _____ \$1995.95

MODEM CARD FOR APPLE - SSM

Better than Hayes!! Better than Novation!! Direct connect ModemCard plugs directly into Apple - no external components, auto-dial, auto-answer, Bell 103 compatible, full and half duplex, touch-tone or pulse dialing generated on board, Micromodem II software compatible, displays modem information on screen, audio monitoring of phone line, no serial port required, two year factory warranty, FREE Source Subscription with purchase of Transend software.

- IOM-2430A ModemCard _____ \$289.95
- SFA-55770010M Transend 1 w/Source _____ \$79.95
- SFA-55770010M Transend 2 w/Source _____ \$129.95
- SFA-55770030M Transend 3 w/Source _____ \$239.95

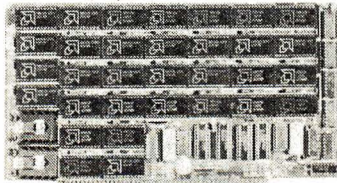

S-100 MEMORY BOARDS

64K STATIC RAM - Jade

Uses new 2K x 8 static RAMs, fully supports IEEE 696 24 bit extended addressing, 200ns RAMs, lower 32K or entire board phantomable, 2716 EPROMs may be subbed for RAMs, any 2K segment of upper 8K may be disabled, low power typically less than 500ma.

- MEM-99152B Bare board _____ \$49.95
- MEM-99152K Kit less RAM _____ \$99.95
- MEM-32152K 32K kit _____ \$199.95
- MEM-56152K 56K kit _____ \$289.95
- MEM-64152K 64K kit _____ \$299.95
- Assembled & Tested _____ add \$50.00

256 RAMDISK - SD Systems

ExpandoRAM III expandable from 64K to 256K using 64Kx1 RAM chips, compatible with CP/M, MP/M, Oasis, & most other Z-80 based systems, functions as ultra-high speed disk drive when used with optional RAMDISK software.

- MEM-65064A 64K A & T _____ \$474.95
- MEM-65128A 128K A & T _____ \$574.95
- MEM-65192A 192K A & T _____ \$674.95
- MEM-65256A 256K A & T _____ \$774.95
- SFC-55009000F RAMDISK stwr CP/M 2.2 _____ \$44.95
- SFC-55009000F RAMDISK with EXRAM III _____ \$24.95

64K RAM BOARD - C.C.S.

IEEE S-100, supports front panels, bank select, fail-safe refresh 4MHz, extended addressing, list price \$575.00 - less than half price!!!

MEM-64565A _____ \$199.95

S-100 VIDEO BOARDS

MICROANGELO - Scion

Ultra-high-resolution 512 x 480, 256 color or black & white S-100 video board

IOV-1500A A & T _____ \$799.95

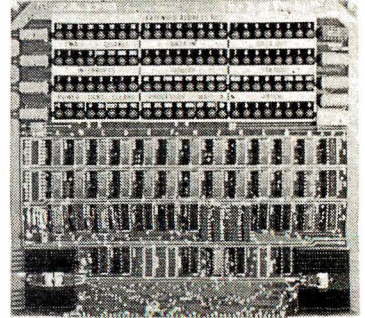

S-100 I/O BOARDS

THE BUS PROBE - Jade

Inexpensive S-100 Diagnostic Analyzer

So your computer is down. And you don't have an oscilloscope. And you don't have a front panel... You're not alone - most computers have their occasional bad days. But without diagnostic equipment such as an oscilloscope (expensive!) or a front panel (expensive!), it can be very difficult to pinpoint the problem. Even if you have an extender board with a superfast logic probe, you can't see more than one signal at a time. You're stuck, right?

Not anymore; Jade is proud to offer our cost-effective solution to the problems mentioned above: **THE BUS PROBE**.

Whether you're a hobbyist with a cantankerous kluge or a field technician with an anxious computer owner breathing down your neck, you'll find **THE BUS PROBE** speeds your repair time remarkably. Just plug in **THE BUS PROBE** and you'll be able to see all the IEEE S-100 signals in action. **THE BUS PROBE** allows you to see inputs, outputs, memory reads and writes, instruction latches, DMA channels vectored interrupts, 8 or 16 bit wide data transfers, plus the three bus supply voltages.

- TSX-200B Bare board _____ \$59.95
- TSX-200K Kit _____ 129.95
- TSX-200A A & T _____ \$159.95

I/O-4 - SSM Microcomputer

- 2 serial I/O ports plus 2 parallel I/O ports.
- IOI-1010B Bare board w/manual _____ \$35.95
 - IOI-1010K Kit with Manual _____ \$179.95
 - IOI-1010A A & T _____ \$249.95

I/O-5 - SSM Microcomputer

- Two serial & 3 parallel I/O ports, 110-19.2K Baud
- IOI-1015A A & T _____ \$289.95

INTERFACER 4 - CompuPro

- 3 serial, 1 parallel, 1 Centronics parallel.
- IOI-1840A A & T _____ \$314.95
 - IOI-1840C CSC _____ \$414.95

PLACE ORDERS TOLL FREE

Continental U.S.
800-421-5500

Inside California
800-262-1710

For Technical Inquires
or Customer Service call:
213-973-7707

We accept cash, checks, credit cards, or Purchase Orders from qualified firms and institutions. Minimum prepaid order \$15.00 California residents add 6 1/2% tax. Export customers outside the US or Canada please add 10% to all prices. Prices and availability subject to change without notice. Shipping and handling charges via UPS Ground 50¢/lb. UPS Air \$1.00/lb. minimum charge \$3.00

LOWER PRICES !!!

S-100 CPU BOARDS

SBC-200 - SD Systems

4 MHz Z-80A CPU with serial & parallel I/O, 1K RAM, 8K ROM space, monitor PROM included.
CPC-30200A A & T _____ \$329.95

THE BIG Z - Jade

2 or 4 MHz switchable Z-80 CPU board with serial I/O, accommodates 2708, 2716, or 2732 EPROM, baud rates from 75 to 9600.

CPU-30201B Bare board w/manual _____ \$35.00
CPU-30201K Kit with Manual _____ \$149.95
CPU-30201A A & T with Manual _____ \$199.95

2810 Z-80 CPU - C.C.S.

2 or 4 MHz Z-80 CPU with serial I/O port & on board monitor PROM, front panel compatible.
CPU-30400A A & T with PROM _____ \$289.95

CPU-Z - CompuPro

2/4 MHz Z80A CPU, 24 bit addressing.
CPU-30500A 2/4 MHz A & T _____ \$279.95
CPU-30500C 3/6 MHz CSC _____ \$374.95

8085/8088 - CompuPro

Both 8 & 16 bit CPUs, standard 8 bit S-100 bus, upto 8 MHz, accesses 16 Megabytes of memory.
CPU-20510A 6 MHz A & T _____ \$398.95
CPU-20510C 6/8 MHz CSC _____ \$497.95

8" DISK DRIVES

Siemens FDD 100-8 single-sided double-density
MSF-201120 _____ \$274.95 ea 2 for \$249.95 ea

Shugart SA810 half-size single-sided double-density
MSF-108100 _____ \$424.95 ea 2 for \$394.95 ea

Shugart SA860 half-size double-sided double-density
MSF-108600 _____ \$574.95 ea 2 for \$549.95 ea

Shugart SA801R single-sided double-density
MSF-10801R _____ \$394.95 ea 2 for \$389.95 ea

Shugart SA851R double-sided double-density
MSF-10851R _____ \$554.95 ea 2 for \$529.95 ea

Tandon TM848-1 single-sided double-den thin-line
MSF-558481 _____ \$379.95 ea 2 for \$369.95 ea

Tandon TM848-2 double-sided double-den thin-line
MSF-558482 _____ \$494.95 ea 2 for \$484.95 ea

Qume DT-8 double-sided double-density
MSF-750080 _____ \$524.95 ea 2 for \$498.95 ea

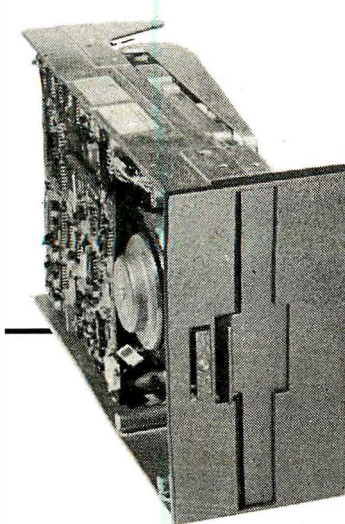

MODEMS

SMART BUY In MODEMS - Signalman

1200 and/or 300 baud, direct connect, automatic answer or originate selection, auto-answer/auto-dial on deluxe models, IBM model plugs directly into an IBM option slot and does not require a serial port (a \$300.00 savings!), 9v battery allows total portability, full one year warranty.

IOM-5600A 300 baud direct connect _____ \$89.95
IOM-5610A 300 baud Deluxe _____ \$149.95
IOM-5620A 1200/300 baud Deluxe _____ \$369.95
IOM-5630A 300 baud for IBM PC _____ \$269.95
IOM-5640A 300 baud for TI 99/4 _____ \$119.95
IOM-5650A 300 baud for Osborne _____ \$119.95
IOM-5660A 300 baud Atari 850 _____ \$99.95
IOM-5670A 300 baud PET/CBM _____ \$169.95

1200 BAUD SMARTMODEM - Hayes

1200 and 300 baud, all the features of the standard Smartmodem plus 1200 baud, 212 compatible, full or half duplex.

IOM-5500A Smartmodem 1200 _____ \$599.95

SMARTMODEM - Hayes

Sophisticated direct-connect auto-answer/auto-dial modem, touch-tone or pulse dialing, RS-232C interface, programmable

IOM-5400A Smartmodem _____ \$224.95
IOM-1500A Hayes Chronograph _____ \$218.95
IOM-2010A Micromodem II w/Term prgm _____ \$329.95
IOM-2012A Terminal program for MMII _____ \$89.95
IOM-1100A Micromodem 100 _____ \$368.95

1200 BAUD SMART CAT - Novaton

103/212 Smart Cat & 103 Smart Cat, 1200 & 300 baud, built-in dialer, auto re-dial if busy, auto answer/disconnect, direct connect, LED readout displays mode, analog/digital loop-back self tests, usable with multi-line phones.

IOM-5241A 300 baud 103 Smart Cat _____ \$229.95
IOM-5251A 1200 baud 212/103 Smart Cat _____ \$549.95
IOM-5261A 300 baud 103 J-Cat _____ \$129.95

J-CAT™ MODEM - Novation

1/5 the size of ordinary modems, Bell 103, manual or auto-answer, automatic answer/originate, direct connect, built-in self-test, two LED's and audio "beeps" provide complete status information.

IOM-5261A Novation _____ \$149.95

S-100 DISK CONTROLLERS

DISK 1 - CompuPro

8" or 5 1/4" DMA disk controller, single or double density, single or double sided, 10 MHz.

IOD-1810A A & T _____ \$449.95
IOD-1810C CSC _____ \$554.95

VERSALFLOPPY II - SD Systems

Double density disk controller for any combination of 5 1/4" and 8" single or double sided, analog phase-locked loop data separator, vectored interrupts, CP/M 2.2 & Oasis compatible, control/diagnostic software PROM included.

IOD-1160A A & T with PROM _____ \$359.95
SFC-55009047F CP/M 3.0 with VF II _____ \$99.95

2242 DISK CONTROLLER - C.C.S.

5 1/4" or 8" double density disk controller with on-board boot loader ROM, free CP/M 2.2 & manual set.

IOD-1300A A & T with CP/M 2.2 _____ \$399.95

DOUBLE D - Jade

High reliability double density disk controller with on-board Z-80A, auxiliary printer port, IEEE S-100, can function in multi-user interrupt driven bus.

IOD-1200B Bare board & hdwr man _____ \$59.95
IOD-1200K Kit w/hdwr & stfwr man _____ \$299.95
IOD-1200A A & T w/hdwr & stfwr man _____ \$325.95
SFC-59002001F CP/M 2.2 with Double D _____ \$99.95

NEW! CP/M PLUS 3.0

CP/M 3.0 is Digital Research's latest version of the industry standard disk operating system. It features many performance improvements such as intelligent record buffering, improved directory handling, "HELP" facility, time/date stamping of files and many more improvements. AND A TREMENDOUS INCREASE IN SPEED !!!, it is fully CP/M 2.2 compatible and requires no changes to your existing application software. Available only to Versafloppy II owners with SBC-200 CPU's

- CP/M 2.2 compatible
 - Easily customized
 - Easier to learn and use
 - High performance file system
 - Automatic disk log-in of removable media
 - Support for 1 to 16 banks of RAM
 - Supports up to 16 drives of 512 Megabytes each
 - Up to ten times faster than CP/M 2.2
 - Console I/O re-direction
 - Easy to use system utilities with HELP facility
 - Power batch facility
 - Designed for application programmers
 - Resident system extensions
- SFC-55009057F CP/M 3.0 8" with manuals _____ \$200.00
SFC-55009057M CP/M 3.0 Manual _____ \$30.00

THREE BOARD SET — SD Systems

FREE CP/M 3.0

Save \$800.00

S-100 board set with 4 MHz Z-80A, 64K of RAM expandable to 256K, serial and parallel I/O ports, double-density disk controller for 5 1/4" and 8" disk drives, new and improved CP/M 3.0 manual set, system monitor, control and diagnostic software. Includes SD Systems SBC-200, 64K ExpandoRAM III, Versafloppy II, and FREE CP/M 3.0 - all boards are assembled & tested.

* 64K Board Set with FREE CP/M 3.0 _____ \$1195.00
256K Board Set with FREE CP/M 3.0 _____ \$1395.00

LIMITED QUANTITY

JADIE

Computer Products

4901 West Rosecrans, Hawthorne, California 90250

California Digital

Post Office Box 3097 B • Torrance, California 90503

★ **FREE** ★

Plastic library case supplied with all diskettes purchased from California Digital

\$19.95

New Low Price

Private labeled for California Digital by one of the most respected producers of magnetic media. Each diskette is certified double density at 40 tracks. To insure extended media life all diskettes are manufactured with a reinforced hub. Each box of diskettes is supplied with a free plastic library case. Split sector CAL-501, Ten sector CAL-510



5 1/4" DISKETTES WITH LIBRARY CASE

\$26.50

Your Choice
**SCOTCH
MEMOREX
VERBATIM**

Single Side Double Density

Soft Sector 10 Sector 16 Sector

SCOTCH	744D-0	744D-10	744D-16	26.50
MEMOREX	3481	3483	3485	26.50
VERBATIM	525-01	525-10	NA	26.50
MAXELL	MD1	MH1-10	MH1-16	29.85
DYSAN	104/1D	107/1D	NA	45.00

Double Side Double Density

SCOTCH	745-0	745-10	745-16	42.50
VERBATIM	550-01	550-10	NA	42.50
MAXELL	MD2-D	MH2-10D	MH2-16D	45.00
DYSAN	104/2D	107/2D	NA	49.50
DYSAN 96	204/2D	NA	NA	59.50

EIGHT INCH DISKETTES

Single Side Single Density		Single Side Double Density		
SCOTCH	740-0	29.50	SCOTCH 741-0	39.00
MEMOREX	3060	29.50	MEMOREX 3090	35.00
DYSAN	3740/1	39.50	DYSAN 3740/D	57.50
Thirty Two Sector		Double Side Double Density		
SCOTCH	740-32	29.50	SCOTCH 743-0	47.50
			MEMOREX 3114	39.50
			DYSAN 3740/2D	65.00

Microswitch
**ASCII
KEYBOARD
\$79**



Each keyboard contains 81 high reliability Hall Effect keys. Outputs seven bit parallel ASCII MIC-81SD5 3 Lbs.



**HITEX
KEYBOARD
\$24.95**

This Hitex keyboard is the same unit used by Lear Siegler in their middle line CRT terminals. The keyboard features 58 unencoded metal on metal contacts (HIK-58). Matching numeric cluster with 15 keys is available for \$9.95 (HIK-15). Buy both of these units for only \$29.90 and save \$5.00 (HIK-5815)

MEMORY

16K DYNAMIC 1.95 4116 150ns.	2732 EPROM 4.95 450ns.
64K DYNAMIC 6.95 4164 150ns.	16K STATIC 4.95 6116 200ns.



2764 EPROM SALE \$9.95

DYNAMIC MEMORY

40274K dynamic 250ns	ICM-402750	1.31	32+	100+
4116 150ns 16K	ICM-4116150	1.99	1.85	1.75
4164 150ns 64K 128 refresh	ICM-4164150	1.95	1.85	1.75
41256 150ns 256K	ICM-41256150	1.75	1.65	1.50
		6.95	6.50	5.00
			Available	March 83

STATIC MEMORY

21L02 200ns 1K static	ICM-21L02200	1.49	1.29	1.15
21L02 450ns 1K static	ICM-21L02450	1.25	1.15	.99
2112 450ns 2K static	ICM-2112450	2.99	2.85	2.75
2114 300ns 1K x 4	ICM-2114300	1.95	1.85	1.75
4044TMS 450ns 4K x 1	ICM-4044450	3.49	3.25	2.99
5257 300ns 4K x 1	ICM-5257300	2.50	2.25	1.99
6116 P4 200ns 2K x 8	ICM-6116200	4.95	4.80	4.65
6116 P3 150ns 2K x 8	ICM-6116150	5.95	5.75	5.60
6167/2167 100ns 16K x 1 (20pin)	ICM-6167100	8.95	8.50	7.90

EPROMS

2708 450ns 1K x 8	ICE-2708	4.95	4.75	4.55
2716 450ns 2K x 8	ICE-2716	4.95	4.75	4.55
2716 TMS450ns Tri-voltage	ICE-2716TMS	7.95	7.65	7.25
2732 450ns 4K x 8	ICE-2732	4.95	4.75	4.55
2732350ns 4K x 8	ICE-2732350	8.50	8.00	7.60
2532 450ns 4K x 8	ICE-2532	10.50	9.90	9.50
2764 350ns 8K x 8	ICE-2764	10.95	10.50	9.95
27128 350ns 16K x 8	ICE-27128		Available	March 83

CONNECTORS



S-100 Gold
\$2.95

DB25P

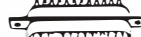

\$2.50

GOLD EDGE CONNECTORS

S-100 125" centers	each	10+	\$2.95
Insul wire wrap (170)			3.25
Sullins Hi-Rel. 250"			3.50
Sullins Hi-Rel. W/W			4.00
Sullins/Altair 140"			4.50

158" Centers (standard)

22/74 Cent. Exter.	2.50	2.10
36/72 Digital Group S/T	3.95	3.50
36/72 Digital Group W/W	6.00	6.15
43/86 Sullins Hi-Rel. S/T	6.50	6.15
43/86 Sullins Hi-Rel. W/W	7.00	6.85

INTEGRATED CIRCUIT SOCKETS

Low Profile Wire Wrap	each	100+	\$2.95
8 pin	\$1.10	\$4.00	\$4.11
14 pin	1.00	4.15	4.11
16 pin	1.12	4.11	4.15
18 pin	1.15	4.11	4.15
24 pin	2.26	4.11	4.15
40 pin	4.21	4.10	1.60

"D" Type	each	10-24	2.1
D120P male	\$1.60	\$4.10	\$1.40
D125S female	2.25	2.00	1.90
D126P male	1.50	1.35	1.20
D131P male	3.55	2.15	2.00
D135S female	3.25	3.10	2.90
D140P male	1.60	1.35	1.30
D112P male	2.50	2.35	2.25
D123S female	3.25	3.15	3.05
D126P male	1.35	1.15	1.05
DC-27P male	4.20	4.00	3.70
DC-27S female	6.90	5.75	5.50
DC-28P male	2.25	2.00	1.75
D131P male	5.50	5.10	4.75
D135S female	6.40	6.00	5.60
D135P male	2.30	2.10	

CENTRONICS

57-30360	7.95	6.75	5.75
----------	------	------	------

MINI-DIN CABLE CONNECTORS

17/34 5" disk	4.85	4.15	3.95
20/40 TRS-10	5.65	5.05	4.70
25/50 11" disk	5.90	5.15	4.70

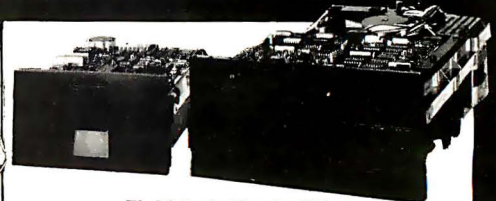

Eight Inch Single Sided

	One	Two	Ten
SHUGART SA801R	\$395	385	375
SIEMENS FDD100-8	259	259	225
TANDON 848-1 SLIMLINE	379	369	359

Eight Inch Double Sided

SHUGART SA851R	525	495	475
QUME DATA TRACK 8	525	495	475
MITSUBISHI M2894-63	485	475	469
OLIVETTI 802/851	369	359	349
TANDON 848-2 SLIMLINE	495	485	475
SHUGART 860 THINLINE	569	549	539

Five Inch Single Sided

SHUGART SA400	215	209	199
TANDON TM 100-1	209	199	195

Five Inch Double Sided

SHUGART SA450	349	329	315
TANDON TM 100-2	295	269	259
TANDON 96TPI TM100-4	369	355	350
OLIVETTI 502 2/3 height	239	225	215

Three Inch Rigid Floppy

HITACHI-AMDEK	call for pricing
---------------	------------------

Five Inch Winchester

SEAGATE 506	6 Megabyte	759	725	695
SEAGATE 512	12 Megabyte	995	960	960
TANDON 603SE	14 Megabyte	995	960	895
WESTERN DYNAX	removable	995	960	950

Upon request, all drives are supplied with power connectors and manual



\$750

Eight Inch Subsystem

Two Siemens FDD100-8 disk drives with power supply, 4" exhaust fan complete with all necessary power cables.

Same as above but with:

Shugart 801R	MSD2801	*1195	Olivetti 802	CAL280Z	*1250
Shugart 851R	MSD2851	1450	Qume DT8	MSD8DT	1450

**ECLIPSE
100
\$695**



INDUSTRIAL S-100 MAINFRAME

Suitable for hospital and industrial applications. Constructed from 304 brushed stainless steel. Modular 500 watt toroid power supply provides -8 volts at 30 Amps and +16 volts at 4 Amps. Supplied with standard 18 slot Faraday mother board. Auxiliary switched AC receptacles. The Eclipse 100 can be either table or rack mounted. Provisions for internally mounting a ten megabyte Winchester disk drive. The Eclipse 100 is the perfect mainframe to fill the void left by the now defunct TEI Corporation. EPS-100 50 lbs.

23" COMPOSITE MONITOR \$159

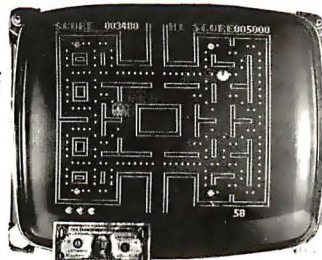

Ideal monitor for classroom demonstrations.

Ever try gathering a classroom of students around a 12" monitor? Here is your opportunity to purchase a 23" high resolution monitor at a reasonable price. These units accept standard composite video signals generated by most personal computers including the Apple and IBM. Attach to your computer and in second you are shooting down Kingpins in wide screen video. MCT-BW23 35 Lbs. Monitors are open frame and for safety should be enclosed. Wood grained enclosure for about \$35.00 additional CAL-ENC23 15 Lbs.



Shipping: First five pounds \$3.00. Each additional \$.50. Foreign orders: 10% shipping. Excess will be refunded. California residents add 6 1/2% sales tax. COD's discouraged. Open accounts extended to state supported educational institutions and companies with a "strong" Dun & Bradstreet. Warehouse: 15608 Inglewood Blvd. Visitors by appointment.

TOLL FREE ORDER LINE
(800) 421-5041
TECHNICAL & CALIFORNIA
(213) 679-9001

California Digital

Post Office Box 3097 B • Torrance, California 90503

Super Buy \$219

SIEMENS FDD100-8 8" DISK DRIVE

10 Drives \$209 • 100 Drives \$175

California Digital has recently participated in the purchase of several thousand Siemens FDD 100-8 floppy disk drives. These units are electronically and physically similar to that of the Shugart 80iR. Any application that will accept the Shugart will work with the Siemens FDD 100-8. All units are new and shipped in factory sealed boxes. Because of the extremely low price we expect a quick sell out. SEA-F1008 17 lbs. Manual and power connectors supplied free upon request. Also available: Two drive subsystem supplied in metal enclosure with power supply and exhaust fan. \$750.00 CAL-2F1008.

FREEDOM 50 SPECIAL SALE \$475

California Digital gives you a great price on the Freedom 50 terminal! Includes detachable keyboard with 93 keys including 10 function keys, 15 graphic symbols, and DIP-switch selectable character set for 7 foreign languages. The 12 inch etched non glare green phosphor screen displays 24 rows by 80 characters in 7x9 matrix with true descenders. Self test and 25th data display row also msk. del. Switch-selectable baud rates from 110-19,200 baud. Bi-directional auxiliary serial port with baud rates from 110-19,200 baud. Other standard features include both block and conversion modes. Screen attributes do not use display memory, allowing operator to display a full 1920 character. Emulates 5 popular CRT terminals for easy software configuration. Switch selectable between 115 and 230 volt. We have never seen a terminal with all these features for the incredibly low price of \$475.

PRINTERS

ECLIPSE 80FT

\$297



MATRIX PRINTERS

Star Gemini-10 friction & tractor 100 char/sec. parallel	STR-G10	359.00
Star Eclipse 80FT friction & tractor	STR-E80FT	297.00
Okidata 824 serial & parallel 9's paper	OKI-824	459.00
Okidata 834 serial & parallel 15" paper	OKI-834	595.00
Okidata 844 serial & parallel 15" paper	OKI-844	1079.00
Okidata 2350 (new) 350 char/sec	OKI-2350	1995.00
Epson MX80FT with graphics, friction & tractor feed	EPS-MX80FT	519.00
Epson MX100 with graphics, 15" paper	EPS-MX100	695.00
NEC8023A parallel 9's paper, graphics	NEC-8023A	485.00
ANEX 9500A high speed 15" paper	ANEX-9500A	1279.00
Analex 9501A high speed with graphics	ADX-9501A	1279.00
Datasouth 180 high speed 180 cps 15"	DSI-180	1295.00
Quantex 7030 coresponder equality 180 char/sec.	QT-X-7030	1535.00
Quantex 8510 parallel 9's paper	PRO-8510P	495.00
Prowriter 8510 serial 9's paper	PRO-8510S	639.00
Prowriter 15" paper	PRO-ZP	750.00
Printonix P300 high speed printer 300 lines per minute	PTX-P300	4500.00
Printonix P600 ultra high speed 600 lines per minute	PTX-P600	6150.00
Mannesmann Tally 1805 200 char/sec serial	MAN-1805	1650.00

WORD PROCESSING PRINTERS

NEC7710 55char/sec serial, serial interface	NEC-7710	2379.00
NEC7730 same as above only parallel interface	NEC-7730	2379.00
NEC8310 15 serial	NEC-8310	1775.00
Dobler 630 40 char/sec serial	DBL-630	2250.00
Brother HR11 daisy wheel	BTH-HR11S	855.00
Brother HR11 serial interface	BTH-HR1S	895.00
Smith Corona TP-1 daisy wheel printer, serial	SCM-TP1S	659.00
Starwriter F10 serial	PRO-F10S	1475.00
Starwriter F10 parallel	PRO-F10P	1475.00

EPSON MX80 RIBBONS \$6.95

MONITORS

Zenith Z121 green phosphor 12" 40/80 column switch ZTH-Z121	115.00
BMC 12A green phosphor 15 Mhz. composite video BMC-12A	88.00
BMC 122N green phosphor 20 Mhz. high resolution BMC-122N	139.00
NEC JB1201 green phosphor 16 Mhz composite video NEC-JB1201	169.00
NEC JB1206 green phosphor commercial grade composite NEC-1260	129.00
Motorola Z3 open frame b/w white composite video MOT-BWZ3	159.00
Motorola Z12 open frame b/w white requires horiz. sync & pow.MOT-1BW12	59.00
Comaq 9" open frame requires horiz. sync & power supply CON-BW9 [COLOR]	69.00
NEC JC1201 composite color NEC-JC1201	325.00
NEC RGB monitor NEC-1202DM	199.00
BMC 13" Composite video BMC-1400CL	273.00
BMC 13" RGB color monitor BMC-1401RGB	329.00
BMC interface card for Apple II for above RGB BMC-8iRGB	149.00
Comex/Hitachi 13" RGB high res. monitor COM-6500	539.00
Comex/Hitachi 13" Composite color monitor COM-6500	395.00
Amdel color #1 composite video AMD-100	349.00
Amdel color #2 high res. RGB color monitor AMD-200	739.00
Amdel color #3 commercial grade color RGB AMD-300	475.00

DIRECT CONNECT MODEMS

Universal Data 103LP, line power, answer & originate	UDS-103LP	169.00
Universal Data 103LPJ, auto answer	UDS-103LPJ	209.00
Universal Data 202, 1200 baud, half duplex only	UDS-202LP	209.00
Universal Data 212LP, full 1200 baud duplex, line power	UDS-212LP	450.00
Universal Data 212A, 300/1200 baud, auto dial	UDS-212A	595.00
Hayes Smart Modem 1200, auto answer, auto dial	HYS-212AD	575.00
Hayes Smart Modem 300 baud only, auto answer, auto dial	HYS-103AD	229.00
Hayes Micro Modem 11, 100 Apple direct connect	HYS-MM2	279.00
Hayes Micro Modem 10, S-100, auto answer, auto dial	HYS-100	319.00
Hayes Chronograph, time date	HYS-CHP232	199.00
Novation J3, Cat. direct connect, auto answer	NOV-JCAT	119.00
Novation Cat. acoustic connect	NOV-CAT	159.00
Novation J2, Cat. direct connect via handset not phone line	NOV-J2CAT	169.00
Novation SmartCat 103, auto answer, auto dial	NOV-SC103	219.00
Novation SmartCat 103/212, 1200 baud auto dial	NOV-SC212	529.00
Signalman Mark I, direct connect with terminal cable	SGM-212A	579.00
U.S. Robotics 212A, 300/1200 baud	USR-MK1	88.00
	USR-212A	485.00

TERMINALS



Freedom 50, split screen, detachable keyboard
Visual 50, detachable, keyboard selectable settings.
Visual 50 Green screen
Visual 500, emulates DEC, DG, LSI, green
Amplex Dialogue 80 green screen, two page, func. keys
Amplex Dialogue 80 amber screen, two page, func. keys
Wyse 100, horiz. & vert. split screen, metal enclosure
Televideo 910 Plus, block mode
Televideo 925, detachable keyboard, 22 function keys
Televideo 950, graph. char. split screen, 22 func.
Televideo 970, 14 green screen, 132 column, European
Zenith 10 terminal, VT52 compatible
ADDS Viewpoint A1, detachable keyboard
ADDS Viewpoint A2, cursor

LIB-F50	475.00
VSI-50	635.00
VSI-50G	650.00
VSL-330G	995.00
APX-380G	685.00
APX-380A	685.00
WYS-100	825.00
TVI-910P	535.00
TVI-925	795.00
TVI-950	985.00
TVI-970	March
ZTH-Z10	769.00
ADD-VP1	585.00
ADD-VP2	585.00

APPLE 48K Plus \$1089



APPLE BRAND PRODUCTS

APL-48P	Apple Plus 48K RAM	
APL-DSK1	Apple disk with controller card	560.00
APL-DSK2	Apple disk without controller card	495.00

XITEN

XIN-G10	Xiten 10 Megabyte Gallium hard disk	1,950.00
XIN-16K	16K RAM card for Apple II	69.00

RANA SYSTEMS

RAN-APL1	Apple add on disk drive with controller	525.00
RAN-APL2	Apple add on drive without controller	395.00

CALIFORNIA COMPUTER SYSTEMS

CCS-7710	Asynchronous Serial Interface	125.00
CCS-7728	Centronics Parallel Interface	95.00
CCS-7720	Apple Parallel Interface	95.00
CCS-7714	12K Rom/Print Module	115.00
CCS-7472	Caltech/Clock Module	95.00
CCS-7440	Programmable Timer	95.00
CCS-7818B	Arithmetic Processor for Apple II plus	319.00

MOUNTAIN COMPUTERS, INC.

MTN-CPS	CPS Multifunction Card	169.00
MTN-CLK	Clock/Calendar	149.00
MTN-STLK	SuperTalker 30200	169.00
MTN-RDMF	Rom Plus with Keyboard filter	145.00
MTN-RDMR	Rom Writer with Epson socket	269.00
MTN-ADDA	A/D/A Converter	149.00
MTN-BSR	X-10 Control Card for BSR system	149.00

MICRO SOFT

MSF-SFTCR0	Microsoft Z-80 CPU card	2490.00
MSF-16KRAM	Microsoft 16K RAM	125.00

VISTA

VSA-AR00	Vista 8" controller card	4890.00
VSA-VIS00	Vista Vision80	289.00
MCI-CNTRL	MicroSci disk drive controller	80.00

FOURTH DIMENSION

FON-SPDRVR	Super Drive-35 track Apple add on	329.00
------------	-----------------------------------	--------

SORRENTO VALLEY ASSOC

SV-A-221	Single sided, single density controller	360.00
SV-A-222	Double sided, single density controller	360.00
SV-A-223	Single or double sided, double density	475.00

ADVANCED BUSINESS TECH

ABT-13KEYN	13-Key pad for New Apple	95.00
------------	--------------------------	-------

S-100 BOARDS

16 BIT MICROPROCESSORS

GB1-8667	Godbout 8086/8088 Microprocessor board	495.00
GB1-8667	Godbout 8088/8085 dual 8 bit microprocessor	359.00
SEA-8066	Seattle Computer 16 bit micro two board set	669.00
IEE-8086	Tecmar Computer 16 bit microprocessor	595.00
LOM-8086	Loma Data Systems LightLine	595.00

SINGLE BOARD COMPUTERS

WAV-B111	WaveMate Bullet I with floppy 256k (incl. I/O)	755.00
AA0-280	Advanced Microdigital floppy & 64k Teresa T801 SingleBoard PC/XTS controller	673.00

8 BIT MICROPROCESSORS

GB1-780	Godbout 280 8 bit CPU/24 bit extended address	250.00
CCS-2810	California Computer Z-80 microprocessor	275.00
SOS-SBC200	SO Systems SBC-200 Z-80 microprocessor	275.00
MSM-280	Measurement System Z-80/2810 microprocessor	425.00
TAR-280	Talith Electronics Z-80 into VHS32 2810	395.00

FLOPPY DISK CONTROLLERS

GB1-DSK1	Godbout Disk Double density NEC 755	350.00
MDS-DJ2	Monrow Despis Disk Jockey with DPA1 density	395.00
MDS-DJ1	Monrow Despis Disk Jockey 1 single density	225.00
CCS-2422	California Computer 2422 with DPA1 density	375.00
TAR-DDC	Talith Electronics double density controller	119.00
TAR-SDC	Talith Electronics single density controller	279.00

CPM OPERATING SYSTEM

GB1-CPM22	Godbout CPM 2.2 for Disk One 8 bit operation	160.00
GB1-CPM28	Godbout CPM 86 for Disk One for use with 8088	265.00
GB1-CPM86	Godbout CPM 86 for operation with 8088 boards	265.00

HARD DISK CONTROLLER

GB1-DSK2	Godbout Disk II hard disk controller	695.00
GB1-DSK3	Godbout Disk III hard disk controller	695.00
MDS-W806	Monrow Winchester 8" Singlepage 506	185.00
WBI-1800	Western Digital WD 1000 mini S-Disk	495.00

EPROM BOARDS

ADS-P1800	Advanced Data Systems 1800	275.00
SIS-F100	SD Systems F100 100 pin	260.00
SSM-P81	SSA from program users 100 pin	195.00
DGR-P32	Digital Research 32K EPROM read only board	105.00

256K DYNAMIC MEMORY BOARD \$495

- 256 kilobytes memory using 64K dynamic RAM
- Over one megabyte of memory using the new 256K dynamic RAM chips.
- Error detection-trap capability.
- Individual 16K blocks can be relocated to any boundary within a megabyte of RAM.
- 24 bit addressing and phantom mode capability.

The California Digital 256K RAM board represents an outstanding value in S-100 memory technology. Priced slightly over earlier generation 64K dynamic ram boards it gives you these additional features. 256K of memory with parity. Parity error location can be jumped to any of the interest lines, a status port, EPROM LED, or IEEE-696 EPROM status signal. 24 or 16 bit addressing with memory management. Proper operation with front panel equipped systems, DMA disk controllers, and IEEE-696 Temporary Bus Masters assured with an on board M1 generator for memory refresh timing. CAS and RAS timing is controlled with tapped digital delay lines for proper operation over the entire operating temperature range. The board is very recent in design using the National Semiconductor DP-8409 RAM Controller chip. Split termination networks are used on all address lines, CAS line, and RAS lines eliminating the last traces of ringing. The board uses two separate voltage regulators. One for the DRAMs and one for the interface logic increasing the noise immunity. Documentation includes theory of operation, configuration guide, a schematic, and application notes on the use of the memory management options. CAL-256K 2 Lbs.

TOLL FREE ORDER LINE
(800) 421-5041
TECHNICAL & CALIFORNIA
(213) 679-9001



Shipping: First five pounds \$3.00. Each additional \$.50. Foreign orders: 10% shipping. Excess will be refunded. California residents add 6 1/2% sales tax. COD's discouraged. Open accounts extended to state supported educational institutions and companies with a "strong" Dun & Bradstreet. Warehouse: 15608 Inglewood Blvd. Visitors by appointment.

17400

*Number of Pins of each I.C. for easy Socket purchase

MICROPROCESSOR COMPONENTS

Part No.	**Pins	Price	Part No.	**Pins	Price	Part No.	**Pins	Price
SN7400N	14	19	SN7472N	14	29	SN74157N	16	59
SN7401N	14	19	SN7473N	14	35	SN74157N	16	59
SN7402N	14	25	SN7474N	14	35	SN74160N	16	69
SN7403N	14	25	SN7475N	14	35	SN74162N	16	69
SN7404N	14	25	SN7476N	14	35	SN74162N	16	69
SN7405N	14	25	SN7477N	14	45	SN74163N	16	69
SN7406N	14	25	SN7478N	14	45	SN74164N	16	69
SN7407N	14	25	SN7479N	14	45	SN74165N	16	69
SN7408N	14	25	SN7480N	14	45	SN74165N	16	69
SN7409N	14	25	SN7481N	14	45	SN74166N	16	69
SN7410N	14	25	SN7482N	14	45	SN74167N	16	69
SN7411N	14	25	SN7483N	14	45	SN74167N	16	69
SN7412N	14	35	SN7484N	14	45	SN74170N	16	69
SN7413N	14	35	SN7485N	14	45	SN74171N	16	69
SN7414N	14	49	SN7486N	14	45	SN74172N	16	69
SN7415N	14	49	SN7487N	14	45	SN74173N	16	69
SN7416N	14	49	SN7488N	14	45	SN74174N	16	69
SN7417N	14	49	SN7489N	14	45	SN74175N	16	69
SN7420N	14	49	SN7490N	14	49	SN74176N	16	69
SN7421N	14	49	SN7491N	14	49	SN74177N	16	69
SN7422N	14	49	SN7492N	14	49	SN74178N	16	69
SN7423N	14	49	SN7493N	14	49	SN74179N	16	69
SN7424N	14	49	SN7494N	14	49	SN74180N	14	69
SN7425N	14	49	SN7495N	14	49	SN74181N	14	69
SN7426N	14	49	SN7496N	14	49	SN74182N	14	69
SN7427N	14	49	SN7497N	14	49	SN74183N	14	69
SN7428N	14	49	SN7498N	14	49	SN74184N	14	69
SN7429N	14	49	SN7499N	14	49	SN74185N	14	69
SN7430N	14	49	SN7500N	14	49	SN74186N	14	69
SN7431N	14	49	SN7501N	14	49	SN74187N	14	69
SN7432N	14	49	SN7502N	14	49	SN74188N	14	69
SN7433N	14	49	SN7503N	14	49	SN74189N	14	69
SN7434N	14	49	SN7504N	14	49	SN74190N	14	69
SN7435N	14	49	SN7505N	14	49	SN74191N	14	69
SN7436N	14	49	SN7506N	14	49	SN74192N	14	69
SN7437N	14	49	SN7507N	14	49	SN74193N	14	69
SN7438N	14	49	SN7508N	14	49	SN74194N	14	69
SN7439N	14	49	SN7509N	14	49	SN74195N	14	69
SN7440N	14	49	SN7510N	14	49	SN74196N	14	69
SN7441N	14	49	SN7511N	14	49	SN74197N	14	69
SN7442N	14	49	SN7512N	14	49	SN74198N	14	69
SN7443N	14	49	SN7513N	14	49	SN74199N	14	69
SN7444N	14	49	SN7514N	14	49	SN74200N	14	69
SN7445N	14	49	SN7515N	14	49	SN74201N	14	69
SN7446N	14	49	SN7516N	14	49	SN74202N	14	69
SN7447N	14	49	SN7517N	14	49	SN74203N	14	69
SN7448N	14	49	SN7518N	14	49	SN74204N	14	69
SN7449N	14	49	SN7519N	14	49	SN74205N	14	69
SN7450N	14	49	SN7520N	14	49	SN74206N	14	69
SN7451N	14	49	SN7521N	14	49	SN74207N	14	69
SN7452N	14	49	SN7522N	14	49	SN74208N	14	69
SN7453N	14	49	SN7523N	14	49	SN74209N	14	69
SN7454N	14	49	SN7524N	14	49	SN74210N	14	69
SN7455A	14	49	SN7525N	14	49	SN74211N	14	69
SN7456N	14	49	SN7526N	14	49	SN74212N	14	69
SN7457N	14	49	SN7527N	14	49	SN74213N	14	69
SN7458N	14	49	SN7528N	14	49	SN74214N	14	69
SN7459N	14	49	SN7529N	14	49	SN74215N	14	69
SN7460N	14	49	SN7530N	14	49	SN74216N	14	69
SN7470N	14	29	SN74333N	14	49			

MICROPROCESSOR CHIPS

Part No.	Function	Price
CDP1802	40 CPU	59.95
4001	80 CPU	149.95
4002	80 CPU	149.95
4003	80 CPU	149.95
4004	80 CPU	149.95
4005	80 CPU	149.95
4006	80 CPU	149.95
4007	80 CPU	149.95
4008	80 CPU	149.95
4009	80 CPU	149.95
4010	80 CPU	149.95
4011	80 CPU	149.95
4012	80 CPU	149.95
4013	80 CPU	149.95
4014	80 CPU	149.95
4015	80 CPU	149.95
4016	80 CPU	149.95
4017	80 CPU	149.95
4018	80 CPU	149.95
4019	80 CPU	149.95
4020	80 CPU	149.95
4021	80 CPU	149.95
4022	80 CPU	149.95
4023	80 CPU	149.95
4024	80 CPU	149.95
4025	80 CPU	149.95
4026	80 CPU	149.95
4027	80 CPU	149.95
4028	80 CPU	149.95
4029	80 CPU	149.95
4030	80 CPU	149.95
4031	80 CPU	149.95
4032	80 CPU	149.95
4033	80 CPU	149.95
4034	80 CPU	149.95
4035	80 CPU	149.95
4036	80 CPU	149.95
4037	80 CPU	149.95
4038	80 CPU	149.95
4039	80 CPU	149.95
4040	80 CPU	149.95
4041	80 CPU	149.95
4042	80 CPU	149.95
4043	80 CPU	149.95
4044	80 CPU	149.95
4045	80 CPU	149.95
4046	80 CPU	149.95
4047	80 CPU	149.95
4048	80 CPU	149.95
4049	80 CPU	149.95
4050	80 CPU	149.95
4051	80 CPU	149.95
4052	80 CPU	149.95
4053	80 CPU	149.95
4054	80 CPU	149.95
4055	80 CPU	149.95
4056	80 CPU	149.95
4057	80 CPU	149.95
4058	80 CPU	149.95
4059	80 CPU	149.95
4060	80 CPU	149.95
4061	80 CPU	149.95
4062	80 CPU	149.95
4063	80 CPU	149.95
4064	80 CPU	149.95
4065	80 CPU	149.95
4066	80 CPU	149.95
4067	80 CPU	149.95
4068	80 CPU	149.95
4069	80 CPU	149.95
4070	80 CPU	149.95
4071	80 CPU	149.95
4072	80 CPU	149.95
4073	80 CPU	149.95
4074	80 CPU	149.95
4075	80 CPU	149.95
4076	80 CPU	149.95
4077	80 CPU	149.95
4078	80 CPU	149.95
4079	80 CPU	149.95
4080	80 CPU	149.95
4081	80 CPU	149.95
4082	80 CPU	149.95
4083	80 CPU	149.95
4084	80 CPU	149.95
4085	80 CPU	149.95
4086	80 CPU	149.95
4087	80 CPU	149.95
4088	80 CPU	149.95
4089	80 CPU	149.95
4090	80 CPU	149.95
4091	80 CPU	149.95
4092	80 CPU	149.95
4093	80 CPU	149.95
4094	80 CPU	149.95
4095	80 CPU	149.95
4096	80 CPU	149.95
4097	80 CPU	149.95
4098	80 CPU	149.95
4099	80 CPU	149.95
4100	80 CPU	149.95

DYNAMIC RAMS

Part No.	**Pins	Price	
1103	18	1024x1 (300ns)	3.99
1104	18	1024x1 (250ns)	3.99
4116N-2	16	16,384x1 (150ns)	1.89/8/14/95
4116N-3	16	16,384x1 (100ns)	1.89/8/14/95
4116N-4	16	16,384x1 (75ns)	1.45/8/10/95
4164N-100	16	65,536x1 (120ns)	7.95/8/95/95
4164N-200	16	65,536x1 (100ns)	7.49/8/95/95
4164N-300	16	65,536x1 (75ns)	7.49/8/95/95
MM5270	18	4096x1 (250ns)	4.95
MM5271	18	4096x1 (200ns)	4.95
MM5272	18	4096x1 (150ns)	4.95
MM5273	18	4096x1 (100ns)	4.95
MM5274	18	4096x1 (75ns)	4.95
MM5275	18	4096x1 (50ns)	4.95
MM5276	18	4096x1 (25ns)	4.95
MM5277	18	4096x1 (15ns)	4.95
MM5278	18	4096x1 (10ns)	4.95
MM5279	18	4096x1 (7.5ns)	4.95
MM5280	18	4096x1 (5ns)	4.95
MM5281	18	4096x1 (3.5ns)	4.95
MM5282	22	2048x1 (35ns)	4.95
MM5283	22	2048x1 (30ns)	4.95
MM5284	22	2048x1 (25ns)	4.95
MM5285	22	2048x1 (20ns)	4.95
MM5286	22	2048x1 (15ns)	4.95
MM5287	22	2048x1 (10ns)	4.95
MM5288	22	2048x1 (7.5ns)	4.95
MM5289	22	2048x1 (5ns)	4.95
MM5290	22	2048x1 (3.5ns)	4.95
MM5291	22	2048x1 (2.5ns)	4.95
MM5292	22	2048x1 (1.5ns)	4.95
MM5293	22	2048x1 (1ns)	4.95
MM5294	22	2048x1 (750ps)	4.95
MM5295	22	2048x1 (500ps)	4.95
MM5296	22	2048x1 (350ps)	4.95
MM5297	22	2048x1 (250ps)	4.95
MM5298	22	2048x1 (150ps)	4.95
MM5299	22	2048x1 (100ps)	4.95
MM5300	22	2048x1 (75ps)	4.95
MM5301	22	2048x1 (50ps)	4.95
MM5302	22	2048x1 (35ps)	4.95
MM5303	22	2048x1 (25ps)	4.95
MM5304	22	2048x1 (15ps)	4.95
MM5305	22	2048x1 (10ps)	4.95
MM5306	22	2048x1 (7.5ps)	4.95
MM5307	22	2048x1 (5ps)	4.95
MM5308	22	2048x1 (3.5ps)	4.95
MM5309	22	2048x1 (2.5ps)	4.95
MM5310	22	2048x1 (1.5ps)	4.95
MM5311	22	2048x1 (1ps)	4.95
MM5312	22	2048x1 (750ps)	4.95
MM5313	22	2048x1 (500ps)	4.95
MM5314	22	2048x1 (350ps)	4.95
MM5315	22	2048x1 (250ps)	4.95
MM5316	22	2048x1 (150ps)	4.95
MM5317	22	2048x1 (100ps)	4.95
MM5318	22	2048x1 (75ps)	4.95
MM5319	22	2048x1 (50ps)	4.95
MM5320	22	2048x1 (35ps)	4.95
MM5321	22	2048x1 (25ps)	4.95
MM5322	22	2048x1 (15ps)	4.95
MM5323	22	2048x1 (10ps)	4.95
MM5324	22	2048x1 (7.5ps)	4.95
MM5325	22	2048x1 (5ps)	4.95
MM5326	22	2048x1 (3.5ps)	4.95
MM5327	22	2048x1 (2.5ps)	4.95
MM5328	22	2048x1 (1.5ps)	4.95
MM5329	22	2048x1 (1ps)	4.95
MM5330	22	2048x1 (750ps)	4.95
MM5331	22	2048x1 (500ps)	4.95
MM5332	22	2048x1 (350ps)	4.95
MM5333	22	2048x1 (250ps)	4.95
MM5334	22	2048x1 (150ps)	4.95
MM5335	22	2048x1 (100ps)	4.95
MM5336	22	2048x1 (75ps)	4.95
MM5337	22	2048x1 (50ps)	4.95
MM5338	22	2048x1 (35ps)	4.95
MM5339	22	2048x1 (25ps)	4.95
MM5340	22	2048x1 (15ps)	4.95
MM5341			

Portable Speakers For "Walkman" Style Stereos



Portable Stereo Speakers with Carrying Case

After skating, skiing, jogging or any other outdoor activity, just plug these portable stereo speakers into your stereo and you and your friends can enjoy your favorite tapes reproduced by the full range speakers. Great for motel rooms, the beach, or in your car. They weigh just 1.3 lbs. and measure 5 1/2" x 4 1/2" x 2 1/2". This unit uses 3" x 5" 80hm speakers with 2 ohm, 8 ohm, and 16 ohm impedances. Speaker system includes two speakers, a carrying case, auxiliary speaker connector cable, and signal connector cable. Uses 8 "AA" batteries. Can be used with both portable stereo systems shown below, and is compatible with most portable stereo cassettes and FM stereo units.

Part No. TSU-012 \$29.95
AM3-8 8 AA Alkaline Batteries 8 for \$7.90

Stereo Cassette Player

with FM Stereo Tuner Pack

- Lightweight Headphones
- Cr2/Metal/Normal Tape Selector
- Anti-Rolling Mechanism

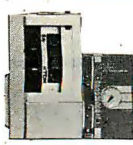

FEATURES: • Blue carrying case, shoulder strap, belt strap, lightweight headphones, FM stereo tuner pack & instruction manual • Talk-Inc. Tone selector • Cr2/Metal/Normal tape selector • LED operation indicator • Built-in microphone • Stop/Eject, play, rewind/inductor, fast forward/cue, tape/record selector functions • Vol. control • Ext. power input jack • Headphone jacks • Auto stop mechanism (shuts off player when tape ends) • Anti-rolling mechanism (prevents sound from quivering when walking, jogging, etc.) • Weight: 1.3 oz. • Requires 4 AA batteries (not included) • Size: 6 1/2" x 4 1/2" x 1 1/8"

Model TWF-802 \$69.95
AM3-4 AA Alkaline Batteries 4/\$3.95

CREDIT CARD AM/FM RADIO

World's Thinnest Stereo HI-FI

This is a pocketable AM/FM stereo radio with a folding stereo head phone. It weighs just 5 oz. and measures 4 1/2" x 2 1/2" x 1/4". Comes complete with radio, headphones and carrying case. Uses two AAA batteries (not included).

Part No. TCR-809 \$29.95 each

JOYSTICKS

JS-5K	5K Linear Taper Pots	\$5.25
JS-100K	100K Linear Taper Pots	\$4.95
JS-150K	150K Linear Taper Pots	\$4.75
JVC-40K	40K (2) Video Controller in Case	\$4.95

JS KNOB Knob for JS5K, 100K, 150K \$.99 ea.
JVC KNOB Knob for JVC-40 \$.99 ea.

Jameco Digital Thermometer Kit

Dual sensors - switch controls for indoor/outdoor or dual monitoring - can be extended to 500 feet. Continuous LED 8" ht. display. Range: -40°F to 199°F. Accuracy: ±1° nominal. Calibrate for Fahrenheit or Celsius. Simulated walnut case. AC wall adapter included. Size: 6 1/2" x 3 1/4" x 1 1/4".

JE300 \$39.95

BOOKS

NATIONAL SEMICONDUCTOR - INTERSIL - INTEL		
30001	National CMOS Data Book (1981) (640 pages) 74C, CD40, and A/D Converters	\$6.95
30002	National Interface Data Book (1980) (704 pages) DR, DS8000, DS3500, DS5700, etc	\$6.95
30003	National Linear Data Book (1982) (1376 pages) LM, LF, ADC, OAC, LH Series	\$11.95
30004	National Series 80 - Board-Level Computer (1980) (224 pages)	\$4.95
30005	National TTL Logic Data Book (1981) (624 pages) 7400, LS, L, H, and DM8000 Series	\$9.95
30006 Above (3) 30001, 3, 5 as set \$24.95		
30008	National Memory Data Book (1980) (464 pages) RAMs, ROMs, PROMs, EPROMs Series	\$6.95
30009	Intersil Data Book (1983) (1356 pages) Complete line.	\$9.95
30010	National Audio/Radio Handbook (1980) (240 pages) Pre-Amps, AM, FM & Hi-Fi Stereo, Power Amps	\$5.95
30011	National Linear Application Handbook (1980) (736 pages) Application Notes, Linear Briefs, etc.	\$15.95
30012	National PAL Data Book (1982) (176 pages) Data Sheet, PAL Design	\$5.95
30013	Zilog Data Book (1983) (641 pages) Microprocessors and Support Chips	\$7.95
010400	Intel Component Data Book (1980) (1405 pg.) Full data sheets for Intel's products incl. mem. devices, microproc., periph. & ind./mil. products	\$14.95
205610	Intel Peripheral Design Handbook (1981) (628 pages) Full data sheets, application notes for Intel peripheral device components	\$9.95

Universal Computer Keyboard Enclosures
 "DTE" Blank Desk-Top Enclosures are designed for easy modification. High strength epoxy molded end pieces in mocha brown finish. Sliding rear/bottom panel for service/component access. Top/bottom panels 80° thick. alodine type 1200 finish (gold color) for best paint adhesion after modification. Vertically slotted bottom panels for cooling efficiency. Rigid construction provides unlimited applications. Assembly instructions included.

DTE-8 Panel Width 7.5" \$24.95
 DTE-11 Panel Width 10.13" \$27.95
 DTE-14 Panel Width 13.5" \$29.95
 DTE-20 Panel Width 19.25" \$34.95

KEYBOARDS — POWER SUPPLIES

	DATAMATEX 73-KEY KEYBOARD (ASCII) Data Entry Keyboard uses MM5740 BEE/N encoder chip (Included). 73-Key Keyboard features 11-key numeric keypad, SPST switching, 24-pin edge card connection. Includes pin-out. Part No. KD261 (Fits DTE-20 Enclosure) \$49.95 each	Apple Compatible Data Entry Keyboard uses MM5740 BEE/N encoder chip (Included). 73-Key Keyboard features 11-key numeric keypad, SPST switching, 24-pin edge card connection. Includes pin-out. Part No. KD261 (Fits DTE-20 Enclosure) \$49.95 each
	MICRO SWITCH 69-KEY KEYBOARD Data Entry Keyboard, Encoded Output: 8-bit Parallel EBC DIC. Switching: Half Effect. 24-pin Edge Card Connection. Complete w/ Pin Connection. Can easily be modified to ASCII code. Part No. KB69SD12-2 (Fits into DTE-20 Enclosure) \$19.95 each	
	MICRO SWITCH 85-KEY KEYBOARD Word Processing Keyboard, 26 Pin Edge Card Connection. Supply Voltage +5VDC. Main Keyboard is QWERTY. Additional Key Pad for cursor and word processing. Part No. 85SD18-1 \$29.95 each	
	HI-TEK 55-KEY KEYBOARD SPST switching, mechanical, monolithic housing, charcoal grey keycaps. Keyboard is not mounted on circuit board (each key is individually accessible). Part No. K-58 (Fits DTE-14 Enclosure) \$19.95 each	
	HI-TEK 14-KEY NUMERIC KEYPAD SPST switching, Charcoal grey keycaps, matches HI-TEK K-58 Keyboard (above). Mounted on printed circuit board. Part No. K-14 \$9.95 each	
	ALPS 29-KEY CALCULATOR KEYBOARD Features one 8-position digital select switch, one 3-position switch, and two 2-position switches, mechanical SPST switching. 25-pin edge card connection. Pin-out included. Part No. KB29T040 (Fits DTE-11 Enclosure) \$4.95 each	
	POWER SUPPLY +5VDC @ 1 AMP REGULATED Output: +5VDC @ 1A (also +30VDC) reg. Input: 115VAC 60Hz. 2-tone (black/beige) self-enclosed case. 5 1/2" x 3 1/2" x 1 1/2" w/ 0" x 2 1/4" H. Wt. 3 lbs. Data sheet incl. Part No. PSS1194 \$19.95 each	Transaction Tech Output: +5VDC @ 1A (also +30VDC) reg. Input: 115VAC 60Hz. 2-tone (black/beige) self-enclosed case. 5 1/2" x 3 1/2" x 1 1/2" w/ 0" x 2 1/4" H. Wt. 3 lbs. Data sheet incl. Part No. PSS1194 \$19.95 each
	POWER SUPPLY +5VDC @ 3 AMP REGULATED Output: 115VAC, 47-440Hz. Output: 5VDC Adjustable @ 3 amp, 5VDC @ 2.5 amp. Adjustable current limit. Ripple & Noise: 1mV rms. 5MV p-p - 2 mounting surfaces. UL recognized. Size: 4 1/2" x 4 1/2" x 2 7/16" H. - wt. 2 lbs. Data sheet included. Part No. PS94V0 \$29.95 each	Deltron Output: 115VAC, 47-440Hz. Output: 5VDC Adjustable @ 3 amp, 5VDC @ 2.5 amp. Adjustable current limit. Ripple & Noise: 1mV rms. 5MV p-p - 2 mounting surfaces. UL recognized. Size: 4 1/2" x 4 1/2" x 2 7/16" H. - wt. 2 lbs. Data sheet included. Part No. PS94V0 \$29.95 each
	POWER SUPPLY +5VDC @ 7.5 AMP, 12VDC @ 1.5 AMP SWITCHING Input: 115VAC, 50-60Hz @ 3 amp, 230VAC, 50Hz @ 1.5 amp. Fan w/ power supply select switch (115/230VAC). Output: 5VDC @ 7.5 amp, 12VDC @ 1.5 amp. 8 1/2" h. blk. pow. cord. 11 1/2" x 13 3/4" x 3 1/4" H. Wt. 6 lbs. Part No. PS94V0 \$49.95 each	
	POWER SUPPLY 4-Channel Switching Power Supply Microprocessor, mini-computer, terminal, medical equipment and process control applications. Input: 90-130VAC 47-440Hz. Output: +5VDC @ 5A, -5VDC @ 1A, +12VDC @ 1A, -12VDC @ 1A. Line reg. ±0.2%. Ripple: 30mV p-p. Load reg. ±1%. Overcurrent protection. Adj. 5V main output only. 6-3/8" h. x 1-7/8" w. x 1-1/8" H. Wt. 1 1/2 lbs. Part No. FCS-604A \$69.95 each	
	POWER SUPPLY Adjustable Switching 4-24VDC to 5 Amps Adj. 4-24VDC, 5VDC @ 5A, 5VDC @ 4.8A, 9VDC @ 4.1A, 12VDC @ 3.3A, 18VDC @ 1.9A, 24VDC @ 1.5A. Overvoltage Protection. Input: 115VAC 50/60Hz. Output variations within 20mV. 8.25" L x 4.25" W x 2.25" H. Wt. 3.25 lbs. JE224 Kit \$79.95 each JE224A Assembled & Tested \$99.95 each	

	84-Key Keyboard White, (Y) Yellow CA153A \$69.95	CONTROL DATA Data Entry Keyboards Parallel Output FTZ Shielded Base SPST Switching CA154A \$79.95		104-Key Keyboard White, (Y) Yellow CA148 \$99.95
	95-Key Keyboard White, (Y) Yellow CA154A \$79.95	ASCII OUTPUT 30" Interface Cable Attractive Case CA150C \$89.95		80-Key Keyboard White, (Y) Yellow CA150C \$89.95

Color; keycaps: black, blue, red - cover: black w/beige base. 21 1/2" x 9" x 3 1/2". 6lbs.

BUG BOX™ STORAGE SYSTEMS	
BUG BOX™ - 30 or 14 individual compartments • Stores 60 6-pin or 30 14 or 16 pin DPs • Bug bumps not included • Clear plastic cover slides & locks • Cover marked w/runners 1-30 • Compartment size: 1" x 3.75" x .5" deep • Box size: 4.9" x 3.3" x .6" • Weight: 1.75 oz.	BUG CAGE™ (BGC-001-...) with Bug Boxes LSI BIG BUG BOX™ - Designed to store large IC's. Resistors, Capacitors and Diodes • Divided into three compartments measuring 1" x 4.15" x .5" deep • Three vertical and three horizontal dividers included • Bug Rugs not included • Box size: 4.9" x 3.3" x .6" • Weight: 1.75 oz.
BUG BOX™ - 30 or 14 individual compartments • Stores 60 6-pin or 30 14 or 16 pin DPs • Bug bumps not included • Clear plastic cover slides & locks • Cover marked w/runners 1-30 • Compartment size: 1" x 3.75" x .5" deep • Box size: 4.9" x 3.3" x .6" • Weight: 1.75 oz.	LSI BIG BUG BOX™ Please specify color code: (B) Blue, (R) Red, (W) White, (Y) Yellow PART NO./COLOR CODE QTY PRICE BGX-001-() 1 \$ 2.29 BGX-010- 10 19.99
BUG CAGE™ - 12 locations store Bug Boxes, Bug Bug Boxes or Bug Trays • Modular and interlocking • Heavy duty injection molded plastic • Each cage has 6 slots on locations • 2 cages/1 pkg. • Cage size: 5-1/8" x 5" x 3/16" • 4 colors available - please specify color code: (B) Blue, (R) Red, (W) White, (Y) Yellow Part No./Color Code Price BGC-001-() 2 Cages(6 loc. ea.) \$11.95/pkg.	LSI BIG BUG BOX™ Please specify color code: (B) Blue, (R) Red, (W) White, (Y) Yellow PART NO./COLOR CODE QTY PRICE BLX-001-() 1 \$ 4.29 BLX-010-() 10 37.89

BUG TRAY™ - Stores in Bug Cage • Molded plastic • Three styles: Open (1 compartment 3.05" x 4.5" x .6"); Vertical (5 compartments 5" x 4.5" x .6"); and Horizontal (8 compartments 4" x 9.5" x .6") • Ideal for tools, hardware, components, etc. • Tray size: 3.55" x 5.05" x .6" • Black color only Part No. Description Price BTH-001 Horizontal Bug Tray \$1.95 BTV-001 Vertical Bug Tray 1.95 BTO-001 Open Bug Tray 1.95 BTX-003 1 of each Bug Tray(s) 4.98	BACK PACK™ - Self-adhesive labels for the back of IC's • Shows exact internal logic in relation to IC pinning • 532 labels in each package (including special blank labels) • Each package contains 6, 14, 16, 24, 28 and 40 pin IC's • Combo package includes 1,028 labels for TTL and CMOS IC's • Microprocessor package contains 744 labels. Part No. Description Price BPT-012 TTL \$7.95 BPC-012 CMOS 8.95 BPM-012 Combo 14.95 BPU-012 Microprocessor 9.95
--	---

BUG RUG™ - Static discharge protection for CMOS and MOSFET devices • Pre-cut to dimensions of BUG BOX (1" x 3.5") Part No. Description Price BRG-030 30 foam rectangles for Bug Box \$1.98 BRR-036 6 foam rec. for LSI Big Bug Box. 1.98	BUG TAGS™ - Self-adhesive, easy-to-read labels for marking Bug Box and LSI Big Bug Box • Most popular components PART NO. DESCRIPTION QTY. PRICE BTT-200 TTL 200 \$4.98 BTC-200 CMOS 200 4.98 BTS-200 LS Schottky 200 4.98 BTM-800 Mixer 800 13.95
--	--

CAGE KEEPER™ - Pins column of Bug Boxes in Bug Cage
 CKP-005 5 inch \$4.98/pkg.
 CKP-010 10 inch 6.98/pkg.

*** **BUG BOX SYSTEMS 2-BUG BOXES (12 LOCATIONS); 3-BUG BOXES; 3-LSI BIG BUG BOX; 1-HORIZONTAL BUG TRAY; 1-OPEN BUG TRAY; 1-VERTICAL BUG TRAY; 1 PACKAGE BUG RUG FOR REGULAR BUG BOXES; 1 PACKAGE BUG RUG FOR LSI BIG BUG BOXES; 1 PACKAGE MIXER LABELS (800 EACH). COLOR: Bug Boxes and Cages - Blue, Bug Trays - Black.** ***

SP-BUG Regular (Retail value \$59.45) Sale Price \$49.95
SP-BUG-AS Anti-Static (Retail value \$67.45) Sale Price \$59.95

\$10.00 Minimum Order - U.S. Funds Only
 California Residents Add 6 1/2% Sales Tax
 Shipping - Add 5% plus \$1.50 Insurance
 Send S.A.S.E. for Monthly Sales Flyer!

Spec Sheets - 30c each
 Send \$1.00 Postage for your
FREE 1993 JAMECO CATALOG
 Prices Subject to Change

Call for Quantity Discounts

Jameco ELECTRONICS
 1355 SHOREWAY ROAD, BELMONT, CA 94002
 4183 PHONE ORDERS WELCOME - (415) 592-8097 Telex: 176043

8K, 16K, 32K, 64K EPROM Programmer

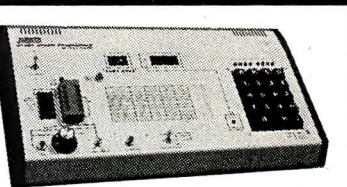

2708, 2716, 2732 & 2764 EPROM Programmer
JE664 EPROM PROGRAMMER
8K TO 64K EPROMS - 24 AND 28 PIN PACKAGES
 Self-Contained - Requires No Additional Systems for Operation

Program, validates, and checks for properly erased EPROMs • Emulates PROMs or EPROMs • RS232C Computer Interface for editing/program loading • Loads data into RAM by keyboard • Changes data in RAM by keyboard • Loads RAM from an EPROM • Compares EPROMs for content differences • Copies EPROMs • Power input: 115VAC, 60Hz. • 10W power consumption • Enclosure: Color-coordinated, light tan panels w/molded mocha brown end pieces • Size: 15-5/8" L x 8-3/4" D x 2 1/4" H. Wt. 8 lbs.

JE664-A EPROM Programmer \$995.00
 Assembled & Tested (Includes JM16A Module)

JE665 - RS232C INTERFACE OPTION - The JE665 RS232C Interface Option implements computer access to the JE664's RAM. Sample software written in BASIC provided for TRS-80 Model I, Level II Computer. Baud rate 9600. Word length 8 bits - odd parity. Stop bits 2. Option may be adapted to other computers.

JE664-ARS EPROM Prog. w/JE665 Option \$1195.00
 Assembled and Tested (Includes JM16A Module)

EPROM JUMPER MODULES

No.	EPROM	EPROM MANUFACTURER	PRICE
JM08A	2708	AMD, Motorola, National, Intel, TI	\$14.95
JM16A	2716, TMS2516	Intel, Motorola, National, NEC, TI	\$14.95
JM16B	TMS2716	Motorola, TI, +5, -12, +12C	\$14.95
JM32A	TMS2532	AMD, TI, +5, -12, +12C	\$14.95
JM32B	2732	AMD, Fujitsu, NEC, Hitachi, Intel	\$14.95
JM64A	MCM68764	Motorola	\$14.95
JM64B	MCM68764	Motorola	\$14.95
JM64C	TMS2564	TI	\$14.95

Siemens 8" Floppy Disk Drive

- Shugart 801R compatible
- Single-Sided
- 77 Tracks
- 400/800 Bytes Capacity
- Industry Standard

The FDD100-8 8" Floppy Disk Drive (Industry Standard) features single or double density Recording mode: FM single, MFM double density. Transfer rate: 250K bits/sec. single density; 500K bits/sec. double density. The FDD100-8 is designed to work with the single-sided soft sector IBM Diskette I, or, eq. disk cartridge. Power: 115VAC @ 50/60Hz. • 24VDC @ 1.7 amps max. • 5VDC @ 1.2 amps max. Unit as pictured above (does not include case, power supply, or cables). Size: 8.55" W x 14" L x 4.5" H. Weighs 12 lbs. incl. 96pg. manual. Part No. Price
FDD100-8 Buy 1 for \$269.95 each
FDD100-8 Buy 2 for \$529.95 each
FDD100-8 Buy 10 for \$249.95 each

5 1/4" Mini-Floppy Disk Drive
 FOR TRS-80 MODEL I (Industry Standard)
 Features single or double density. Recording mode: FM single, MFM double density. Power: +12VDC (±0.5V) 1.6A max. • 5VDC (±0.25V) 0.8A max. Unit as pic. left (does not incl. case, power supply, cables). 30pg. daa book incl. Wt. 3 1/2 lbs. Size: 5 1/4" W x 8 1/4" x 3 1/4" H. Part No. Limited Quantity! Price
FD200 \$179.95
 Single-sided, 40 tracks, 250K bytes capacity
FD250 \$199.95
 Double-sided, 35 tracks, 438K bytes capacity

EXPAND YOUR MEMORY

TRS-80 to 16K, 32K, or 48K
 **Model 1 = From 4K to 16K Requires (1) One Kit
 Model 3 = From 4K to 48K Requires (3) Three Kits
 Kit = From 4K to 16K Requires (1) One Kit
 **Model 1 equipped with Expansion Board up to 48K Two Kits Required - One Kit Required for each 16K of Expansion -

TRS-16K3 *20ns for Color & Model III \$12.95
TRS-16K4 *20ns for Model I \$10.95

TRS-80 Color 32K or 64K Conversion Kit
 Kit comes complete with 8 each 4164-2 (20ns) 64K dynamic RAMs and conversion documentation. Converts TRS-80 color computers with D and E circuit boards, and all new color computers to 32K. Minor modifications of 32K memory will allow the use of all 64K of the dynamic RAM.
TRS-64K2 \$54.95

Sprite-style Fan

- 36cfm free air delivery
- 3.125" sq. x 1.665" depth
- 10 yrs. cont. duty at 20°C
- 115V 50/60Hz 14W 17 oz.

PWS2107U (Cleaned & tested (used)) \$ 9.95 ea.
***PWS2107F** New \$14.95 ea.

Muffin-style Fan

- 105cfm free air delivery
- 4.68" sq. x 1.50" depth
- 10 yrs. cont. duty at 20°C
- Impedance protected. ambient temps. to 70°C
- 115V 50/60Hz 14W 17 oz.

MU2A1-U Cleaned & tested (used) \$9.95 ea.
***MU2A1-N** New \$14.95 ea.

Mostek DC/DC Converter
 +5 VOLTS TO -9 VOLTS
 Input: +5V. Output: -9V regulated @ 30mA.
 Printed circuit mounting. Specifications incl.
DC10 \$2.95 ea. or 2/\$4.95

DoKay Computer Products, Inc.

VISIT OUR RETAIL STORE
AND RECEIVE A 5% DISCOUNT!

3250 KELLER STREET, #9 • SANTA CLARA, CA 95050

16K APPLE II RAM CARD

BARE BOARD KIT 14.00
ASSEMBLED 42.50

*Apple is a trademark of Apple Computer, Inc.

EPROMS

1702	Ins	2.95
2708	450ns	2.98
2758	5V450ns	9.70
TMS 2516	5V450ns	5.70
2716	5V450ns	3.44
2716-1	5V 350ns	5.70
TMS 2716	450ns	8.70
2532	5V450ns	7.80
2732	5V450ns	4.15
2764	5V450ns	12.95
MC68764	5V450ns (24pin)	39.00

DYNAMIC RAMS

TMS 4027	250	1.99
MK 4108	200ns	1.74
MM 5298	250ns	1.74
4116	150ns	1.74
4116	200ns	1.24
4116	250ns	1.14
2118	5V 150ns	4.90
MK 4816	5V300ns	5.25
4164-200	5V 200ns	5.45
4164-150	5V150ns	6.35

STATIC RAMS

2101	450ns	1.80
2101-1	450ns	.78
2101L-2	250ns LP	1.54
2112	450ns	2.48
2112	450ns	2.68
2114	450ns	1.74
2114 L-3	300ns LP	1.84
2114 L-2	200ns LP	1.94
2147	55ns	8.90
TMS 4044-4	450ns	3.15
TMS 4044-3	300ns	3.45
TMS 4044-2	200ns	3.90
MK 4118	250ns	9.70
TMM2016	200ns	4.15
TMM2016	150ns	5.44
TMM2016	100ns	7.44
HM6116-4	200ns	4.90
HM6616-3	150ns	5.75
HM6116-2	120ns	6.95
Z-6132	300ns	32.95

LP = Low Power

INTERFACE

8T26	1.65
8T28	1.95
8T95	.95
8T96	.95
8T97	.95
8T98	.95
DM8131	2.90
DP8304	2.25
DS8836	1.25

RESISTORS

1/4 WATT 5% CARBON FILM
ALL STANDARD VALUES
FROM 1 OHM TO 10 MEG OHM

50 PCS. SAME VALUE	.0200
100 PCS. SAME VALUE	.0150
1000 PCS. SAME VALUE	.0125

6500

1 MHZ

6502	5.44
6504	6.85
6505	7.60
6507	9.85
6520	4.30
6522	7.90
6532	9.90
6545	16.95
6551	

2 MHZ

6502A	9.95
6522A	10.90
6532A	11.90
6545A	27.90
6551A	11.90

3 MHZ

6502B	11.90
-------	-------

We Will Beat
Any Competitors'
Prices!

74LS00	.23	74LS123	.94	74LS253	.58
74LS01	.23	74LS124	2.89	74LS257	.58
74LS02	.23	74LS125	.94	74LS258	.78
74LS03	.23	74LS126	.78	74LS259	2.74
74LS04	.23	74LS132	.74	74LS260	.59
74LS05	.23	74LS136	.48	74LS266	1.48
74LS08	.23	74LS137	.74	74LS273	3.20
74LS10	.23	74LS138	.94	74LS275	.48
74LS11	.29	74LS139	.74	74LS279	1.94
74LS12	.29	74LS145	.74	74LS280	.94
74LS13	.39	74LS147	1.09	74LS283	.94
74LS14	.58	74LS148	2.19	74LS290	.88
74LS15	.29	74LS151	1.19	74LS293	.88
74LS20	.23	74LS153	.54	74LS295	.98
74LS21	.29	74LS154	1.74	74LS298	.88
74LS22	.23	74LS155	.68	74LS324	1.74
74LS26	.29	74LS156	.68	74LS352	1.28
74LS27	.24	74LS157	.64	74LS353	1.28
74LS28	.29	74LS158	.58	74LS363	1.34
74LS30	.24	74LS160	.68	74LS364	1.94
74LS32	.28	74LS161	.64	74LS365	.48
74LS33	.54	74LS162	.68	74LS366	.48
74LS37	.54	74LS163	.68	74LS367	.44
74LS38	.34	74LS164	.68	74LS368	.44
74LS40	.24	74LS165	.68	74LS373	.98
74LS42	.48	74LS166	1.94	74LS374	.98
74LS47	.74	74LS168	1.68	74LS377	1.39
74LS48	.74	74LS169	1.68	74LS378	1.14
74LS49	.74	74LS170	1.68	74LS379	1.34
74LS51	.24	74LS173	.68	74LS385	1.88
74LS54	.24	74LS174	.54	74LS386	.44
74LS55	.28	74LS175	.88	74LS390	1.18
74LS63	1.19	74LS181	1.48	74LS393	1.18
74LS73	.35	74LS189	8.90	74LS395	1.18
74LS74	.38	74LS190	.78	74LS399	1.58
74LS75	.38	74LS191	.88	74LS424	2.88
74LS76	.38	74LS192	.68	74LS447	.36
74LS78	.48	74LS193	.68	74LS490	1.88
74LS83	.59	74LS194	.88	74LS668	1.64
74LS85	.95	74LS195	.74	74LS669	1.84
74LS86	.38	74LS196	.78	74LS670	1.48
74LS90	.54	74LS197	.78	74LS674	9.45
74LS91	.74	74LS221	1.09	74LS682	2.98
74LS92	.54	74LS240	.94	74LS683	2.38
74LS93	.54	74LS241	.94	74LS684	2.38
74LS95	.74	74LS242	.64	74LS685	2.38
74LS96	.78	74LS243	.64	74LS688	2.38
74LS107	.38	74LS244	.89	74LS689	2.38
74LS109	.38	74LS245	1.89		
74LS112	.38	74LS247	.74	81LS95	1.48
74LS113	.38	74LS248	1.19	81LS96	1.48
74LS114	.38	74LS249	.88	81LS97	1.48
74LS122	.44	74LS251	.58	81LS98	1.48

UARTS

AY3 1014	5.80
AY5 1013	3.90
AY5 2376	10.90
TR 1602	3.85
1M 6402	7.80
1M 6403	8.80

LEDS

Jumbo Red	10/1.00
Jumbo Green	6/1.00
Jumbo Yellow	6/1.00

DIP SWITCHES

4 Position	.84
5 Position	.94
6 Position	2.74
7 Position	2.48
8 Position	1.24

EXAR

XR 2206	3.70
XR 2207	3.70
XR 2208	3.85
XR 2211	5.20
XR 2240	3.20

RCA

CA 3010	.94
CA 3013	1.98
CA 3023	2.74
CA 3035	2.48
CA 3039	1.24
CA 3046	1.45
CA 3053	2.89
CA 3059	2.89
CA 3060	1.74
CA 3065	1.09
CA 3080	1.64
CA 3081	1.64
CA 3082	1.64
CA 3083	1.64
CA 3086	.80
CA 3089	2.89
CA 3130	1.24
CA 3140	1.14
CA 3146	1.74
CA 3160	1.14
CA 3401	.58
CA 3600	3.40

CMOS

4000	.24	4066	.89	74C89	4.45
4001	.29	4093	.90	74C90	1.74
4002	.24	4098	2.48	74C93	.98
4006	.89	4099	1.89	74C95	.88
4007	.24	4502	.89	74C107	5.70
4008	.89	4503	.59	74C150	2.25
4009	.44	4508	1.89	74C151	3.25
4010	.44	4510	.84	74C154	1.75
4011	.29	4511	.84	74C157	1.18
4012	.24	4512	.84	74C160	1.18
4013	.38	4514	1.19	74C161	1.99
4014	.78	4515	1.78	74C162	1.18
4015	.38	4516	1.49	74C163	1.38
4016	.38	4518	.89	74C164	1.99
4017	.68	4519	.38	74C165	.78
4018	.78	4520	.78	74C173	1.18
4019	.38	4522	1.19	74C174	1.18
4020	.74	4526	1.19	74C175	1.48
4021	.78	4527	1.89	74C192	1.48
4022	.78	4528	1.19	74C193	1.38
4023	.34	4531	.89	74C195	5.70
4025	.74	4532	1.89	74C200	1.74
4026	.34	4538	1.89	74C221	2.44
4027	.59	4543	1.89	74C374	2.74
4028	.44	4555	1.19	74C377	.38
4029	.68	4556	.89	74C901	.84
4030	.78	4581	.89	74C902	.84
4034	.38	4582	1.18	74C903	10.90
4035	1.94	4584	1.90	74C905	.94
4040	.84	4585	.74	74C906	.99
4041	.73			74C907	.99
4042	.74	80C07	.89	74C908	1.99
4043	.68	80C95	.89	74C909	2.74
4044	.74	80C96	.89	74C910	9.90
4046	.74	80C98	.89	74C911	8.90
4047	.84	80C97	.89	74C912	8.90
4049	.89	80C98	1.14	74C914	1.94
4050	.34			74C915	1.18
4051	.34	74C00	.34	74C918	2.74
4053	.34	74C02	.34	74C920	2.74
4060	.78	74C04	.34	74C921	15.95
4066	.88	74C08	.34	74C922	4.45
4068	.88	74C10	.34	74C923	4.90
4069	.38	74C14	.58	74C925	5.90
4070	.39	74C20	.34	74C926	7.90
4071	.28	74C30	.34	74C927	7.90
4072	.35	74C32	.49	74C928	7.90
4073	.29	74C42	1.28	74C929	7.90
4075	.29	74C48	1.19	74C930	16.95
4076	.29	74C73	.64		
4078	.29	74C74	.64	14409	12.85
4081	.78	74C76	.79	14410	12.85
4082	.28	74C83	1.94	14411	11.85
4085	.89	74C85	1.94	14412	12.85
		74C86	.38	14419	4.85

DoKay Computer Products, Inc.

3250 Keller Street, #9
Santa Clara, CA 95050
(800) 538-8800

Calif. Residents
(800) 848-8008

Local Phone
(408) 988-0697



TERMS: For shipping include \$2.00 for UPS Ground. \$3.00 for UPS Blue Label Air. \$10.00 minimum order. Bay Area residents add 6 1/2% Sales Tax. California residents add 6% Sales Tax. We reserve the right to limit quantities and substitute manufacturer. Prices subject to change without notice. Send SASE for complete list.

APPLE II USERS DISK DRIVE!

- Includes metal cabinet
- Color matches Apple
- 35 Tracks/single side
- Includes cable
- Use with Apple II Controller

265.00

WITH CONTROLLER CARD - 359.95

APPLE **UPGRADE** **TRS-80**
4116 - 200_{ns}
8/10.00

2.5 MHZ	
Z80-CPU	3.75
Z80-PIO	4.90
Z80-CTC	14.90
Z80-DMA	13.95
Z80-DART	16.95
Z80-SIO/0	16.95
Z80-SIO/1	16.95
Z80-SIO/2	15.95
Z80-SIO/9	16.95
4.0 MHZ	
Z80A-CPU	4.90
Z80A-PIO	4.90
Z80A-CTC	6.90

Z80 SERIES

Z80A-DMA	21.95
Z80A-DART	15.95
Z80A-SIO/0	20.95
Z80A-SIO/1	21.95
Z80A-SIO/2	21.95
Z80A-SIO/9	18.95
6.0 MHZ	
Z80B-CPU	14.95
Z80B-PIO	12.95
Z80B-CTC	12.95
ZILOG	
Z6132	32.95
Z8671	38.95

DoKay Computer Products, Inc.

VISIT OUR RETAIL STORE
AND RECEIVE A 5% DISCOUNT!

3250 KELLER STREET, #9 • SANTA CLARA, CA 95050

5 1/4 Diskettes

NASHUA	
SS DD	18.95
NASHUA	
SS DD	20.95
NASHUA	
DS DD	27.95
Five year warranty on NASHUA DISKETTES	

LINEAR			
LM301	.32	LM711	.29
LM308	.75	LM717	.75
LM309K	1.25	LM718	.49
LM311	.64	LM1310	2.45
LM317T	1.65	MC1330	1.69
LM317K	1.70	MC1350	1.25
LM318	1.49	MC1358	1.69
LM323K	3.75	LM1111	1.49
LM324	.59	LM1458	.55
LM337K	3.90	LM1488	.95
LM339	.79	LM1489	.95
LM377	2.25	LM1600	2.45
LM380	1.25	LM1889	2.45
LM386	1.00	LM3900	.59
LM555	.38	LM3909	.95
LM556	.65	LM3914	3.70
LM565	.95	LM3915	3.70
LM566	1.45	LM3916	3.70
LM567	.99	75451	.35
LM723	.49	75452	.35
LM733	.95	75453	.35

CLOCK CIRCUITS	
MM 5314	4.90
MM 5369	3.90
MM 5375	4.90
MM 58167	8.90
MM 58174	10.95
MSM 5832	6.90

ORDER TOLL FREE

(800) 538-8800

(800) 848-8008

(CALIFORNIA RESIDENTS)
ALL MERCHANDISE IS 100% GUARANTEED

Disc Controllers

1771	16.00
1791	27.95
1793	29.95
1795	49.95
1797	49.95
1691	17.95
UPD 765	34.95

6800

1 MHZ	
6800	4.75
6802	8.65
6808	8.45
6809	11.95
6809 E	17.95
6810	2.90
6820	3.50
6821	3.50
6828	14.90
6840	7.95
6843	32.95
6844	32.95
6845	16.90
6847	11.95
6850	3.20
6852	3.50
6860	10.90
6862	11.90
6875	6.90
6880	1.80
6883	22.95

2 MHZ

68B00	10.00
68B02	21.95
68B09	28.95
68B09 E	29.90
68B10	7.90
68B21	12.00
68B45	34.00
68B50	12.00

8 MHZ

68000	95.95
-------	-------

IC Sockets

	ST	W/W
8 PIN	.10	.49
14 PIN	.12	.50
16 PIN	.15	.57
18 PIN	.20	.85
20 PIN	.25	.99
22 PIN	.25	1.30
24 PIN	.25	1.40
28 PIN	.35	1.50
40 PIN	.40	1.80

ST = Soldertail
W/W = Wirewrap

Power Supplies

MOUNTED ON PC BOARD
MANUFACTURED BY CONVER
+5 VOLT 4 AMP
±12 VOLT 1 AMP



34.95



9000 SERIES	MISC.
9316	.95
9334	2.39
9368	3.69
9401	8.95
9601	.69
9602	1.39
96S02	1.79
11 C 90	12.95
3242	6.95
MC 3470	7.95
MC 3480	8.95
ULN 2003	5.95
CA 3146	1.75
2513-001 up	9.69
2513-002 low	9.69

VOLTAGE REGULATORS

7805T	.75	7908T	.85
7808T	.75	7912T	.85
7812T	.75	7915T	.85
7815T	.75	7924T	.95
7824T	.85	7905K	1.39
7805K	1.29	7912K	1.39
7812K	1.29	7915K	1.39
7815K	1.29	7924K	1.39
7824K	1.29		
7905T	.85		
		T = TO-220	
		K = TO-3	

CONNECTORS

RS232 Male	2.99
RS232 Female	3.45
RS232 Female Right Angle	4.90
RS232 Hood	1.19
30 pin Edge	2.45
44 pin Edge	2.48
50 pin Edge	2.48
86 pin Edge	2.68
100 pin ST	3.85
100 pin W/W	4.90

CRYSTALS			
32.768 KHZ	1.90	5.185	3.90
10 MHZ	4.50	5.7143	3.90
1.8432	4.50	6.5536	3.90
2.0	3.90	8.0	3.00
2.097152	3.90	10.0	3.00
2.4576	3.90	14.31818	3.90
3.2768	3.90	18.0	3.00
3.579545	3.00	18.432	3.00
4.0	3.00	20.0	3.00
5.0	3.00	22.1184	3.00
5.0688	3.90	32.0	3.90

8000

8035	6.95	8239	4.75
8039	7.59	8243	4.75
8080A	3.90	8250	14.90
8085A	7.95	8251	4.50
8088	34.95	8253	8.75
8155	7.75	8253-5	9.75
8156	8.75	8255	4.50
8185	29.00	8255-5	5.20
8741	39.00	8257	8.50
8748	14.95	8259	6.85
8755	29.95	8272	39.00
8202	27.95	8275	29.00
8205	3.45	8279	9.25
8212	1.80	8279-5	9.95
8214	3.75	8282	6.50
8216	1.75	8283	6.50
8224	2.45	8284	5.50
8226	1.80	8286	6.50
8228	4.50	8287	6.50
8237	19.00	8288	25.00
8238	4.75	8289	49.00

DoKay Computer Products, Inc.

3250 Keller Street, #9
Santa Clara, CA 95050

(800) 538-8800

Calif. Residents
(800) 848-8008

Local Phone
(408) 988-0697



TERMS: For shipping include \$2.00 for UPS Ground. \$3.00 for UPS Blue Label Air. \$10.00 minimum order. Bay Area residents add 6% Sales Tax. California residents add 6% Sales Tax. We reserve the right to limit quantities and substitute manufacturer. Prices subject to change without notice. Send SASE for complete list.

ADVANCED COMPUTER PRODUCTS

SEND \$2.00 for 1988 CATALOG

16K Apple™ Ramcard

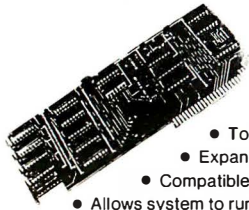

LIST 195 ACP

\$59.95

- Full 1 year warranty
- Top quality — gold fingers
- Expand Apple II 48K to 64K
- Compatible with Z-80 Softcard™
- Allows system to run with CP/M™, PASCAL, DOS 3.3, COBAL, Visicalc, etc.
- Supplied with extra 16K RAM & has (2) LED's

32K STATIC RAM



2 or 4 MHz Expandable Uses 2114's

- 16K 4 MHz Kit \$159.95
- 16K 4 MHz A&T \$217.95
- 32K 4 MHz Kit \$129.95
- 32K 4 MHz A&T \$339.00
- BARE BOARD \$39.95
- Bare Bd/w/all parts less mem. \$9.95

REPEAT OF SELL-OUT

58 Key Unencoded Keyboard



This is a new 58 key terminal Keyboard manufactured by a major manufacturer. It is unencoded with SPST keys unattached to any PC board. Solid molded plastic 11" x 4" base.

Unencoded Key Pad

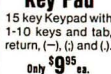

15 Key Keypad with 1-10 keys and tab, return, (-), (.), and (0).

Only \$9.95 ea.

UV "EPROM" ERASER

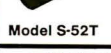

Model DE-4 \$89.95 Holds 4 EPROM's at a time.

Model S-52T \$325.00

16K Memory Expansion Kits

8 pcs 4116 16K 200/250ns \$12.95

CALL FOR VOLUME PRICING

CORCOM FILTER

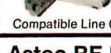

Popular CORCOM Filter \$4.95 Compatible Line Cord Add...\$3.50

Astec RF Modulator



for COLOR & B/W P/N 1082 Channel 3 or 4 \$6.95

AMD MODEM IC



P/N AM7910 1200Baud 5 Volts Special ACP Price \$99.00

PARALLEL ALPHA NUMERIC PRINTER

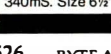

19 Column Printer prints 16 numerical columns plus 3 columns which have math, alpha and other notations. Each wheel has 12 positions with position 12 blank. Position 11 on numerical columns have decimal point or #. Utilizes 2.75" wide adding machine tape and a dual color ink ribbon. Input data parallel with four bit BCD comparator circuit (schematic provided). Print rate, 3 lines per second. Operating voltage 22-28VDC with typical cycle time of 340ms. Size 6 1/2" W x 3 3/4" H x 5 3/4" Dp. New. \$9.95 ea. 3/\$27

MICROPROCESSORS

Z8001	\$99.00	8008-1	\$14.95	6802P	14.95
Z8002	69.00	2901	9.90	8035	14.95
Z8003	9.95	2901A	14.95	8039	12.95
Z8003L	11.95	1200L	49.95	8073A	14.95
F-8 (3850)	16.95	6502	9.95	8755	49.95
2650	16.95	6502A	16.95	8748	49.95
1802	9.75	IM8100	29.95	8609	30.00
8090A	4.75	6800A	11.75	8096	49.95
8085	14.95	6800B	19.95	68000	129.95

RAMS

6116/2016	\$7.95	2147	\$5.99	5290	\$1.99
6264-64K	5.95	411	5.99	6598	1.49
4116-2	1.99	414	4.69	6598	4.50
4116-2	8/125	1101	99	6518	6.79
2101	3.99	1103	99	6561	3.79
2102	.79	4027	4.69	6604	3.99
21102-2	1.49	4044	3.99	6605	7.99
21102-4	1.29	4050	4.69	9130	6.99
2111	3.49	4060	4.69	9140	6.99
2112	3.49	4096	3.99	93415	6.99
2114	1.99	4115	1.49	93425	6.99
2114L-2	3.25	4200	7.95		
2114L-4	2.29	4402	1.99		
2125	6.99	5280	4.60		

SUPPORT

8155	\$9.95	8259	\$8.95	68047	\$2.95
8156	9.95	8275	19.95	68488	19.95
8202	29.95	8279	9.50	46505	22.95
8205	2.69	6810	4.75	6520	6.95
8212	2.75	6820	6.50	6522	9.95
8211	4.95	6821	6.50	6530-X	24.95
8216	2.75	6828	10.50	6532	17.95
8224	2.95	6834	16.95	6531	19.95
8226	2.95	6845	22.95	Z80-PIO	6.50
8228	3.95	6847	27.95	Z80-PIO	9.50
8243	9.50	6850	5.25	Z80-CTC	6.50
8250	14.95	6852	5.25	Z80-DMA	9.50
8251	6.50	6850	10.95	Z80-DMA	19.95
8253	11.95	6862	10.95	Z80-DMA	27.95
8255	4.50	6875	5.95	Z80-SIO	24.95
8257	9.50	6880	2.49	Z80-SIO	29.95

TOS PROMS

2764 (8Kx8)	\$5.95	2708 (450ns)	\$5.75	
2732 (4Kx8)	12.95	2728 (650ns)	5.25	
2716/2516	5V	1702A	5.75	
(2Kx8) TS	7.95	MM250QA4	14.50	
TMS2716	5V, 12V	17.95	MM250QA0	9.95
2758, 5V, (450ns)		3.50		

HI-TECH

2513-001 (5V) Upper	\$5.50	DA08	\$9.95
2513-005 (5V) Lower	10.95	DA00	9.95
2513-AD03 (5V) Lower	44.95	8038 Function Generator	4.50
MC166710 ASCII Shifted 1395	MC4024 VCO	2.95	
MC166740 Math Symbol 12.95	LM566 VCO	1.95	
MC166750 Alpha Control 13.45	22328 Function Generator	9.50	
1771-01 8-Multiplex 24.50	TR16028 (5V, 12V)	3.95	
1781 Dual Flipflop	29.95	AV51013 (5V, 12V)	4.55
1791-01 Dual Flipflop	36.95	AV51014A/1612 (5-16V)	6.95
1791-02 Dual Flipflop	44.95	AV51015A/1863 (5V)	6.95
1793 DD, DS Flipflop	44.95	IM6402	7.95
1797 DD, DS Flipflop	54.95	IM6403	6.95
1691 Data Separator	18.95	2350 USRT	9.95
2143 Clock Generator	18.95	16718 Astros	24.95
8700 8 bit Binary	13.50	MC14111	11.95
8701 10 bit Binary	22.00	4702	14.95
8703 8 bit TS	13.50	WD1941	9.95
9400 Volt to Freq Conv.	7.25	COM510	16.95
8750 3in. Digit CD	13.95	MS8350	15.95
1408L6 6 bit	9.95	AV5-2376	13.75
1408L8 8 bit	9.95	AV5-3600	13.75
DA0010 to A	5.95	MM5740AC	8.95

SOCKETS

4 pin LP	.16	.15	.14
8 pin LP	.20	.19	.18
16 pin LP	.22	.21	.20
18 pin LP	.24	.23	.22
20 pin LP	.34	.32	.30
22 pin LP	.29	.27	.24
24 pin LP	.38	.37	.36
28 pin LP	.45	.44	.43
40 pin LP	.60	.59	.58

LOW PROFILE SOCKETS (TIN)

1-24	25-49	50-100	
8 pin LP	.16	.15	.14
14 pin WW (Tin)	.65	.63	.58
16 pin WW	.75	.73	.67
18 pin WW	.80	.77	.70
18 pin WW	.95	.90	.81
20 pin WW	1.15	1.10	.99
22 pin WW	1.45	1.35	1.21
24 pin WW	1.35	1.26	1.14
28 pin WW	1.60	1.53	1.38
40 pin WW	2.20	2.09	1.89

3L WIREWRAP SOCKETS (GOLD)

8 pin WW	.55	.54	.49
10 pin WW (Tin)	.65	.63	.58
14 pin WW	.75	.73	.67
16 pin WW	.80	.77	.70
18 pin WW	.95	.90	.81
20 pin WW	1.15	1.10	.99
22 pin WW	1.45	1.35	1.21
24 pin WW	1.35	1.26	1.14
28 pin WW	1.60	1.53	1.38
40 pin WW	2.20	2.09	1.89

CONNECTORS

DB25P (RS232)	\$3.25
DB25S Female	3.75
Hood	1.25
Set with Hood, Sale	7.50
22/44 S/T, Kit	2.95
43/86 S/T, MOT	6.50
50/100 S-100 Connector W/W	4.95
50/100 S-100 Connector S/T	3.95

PARALLEL ALPHA NUMERIC PRINTER

14411	\$7.95	6571A	\$6.95	8080A CPU	\$2.95	5027 CRT	\$9.95	
74LS668	31.99	82C 2652	3.95	2102 RAM	.75	2901	3.95	
74LS377	21.99	82S3	6.95	4080 RAM	1.40	8039	3.95	
74LS241	21.99	2768 EPROM	2.95	2731Z	7.72	6395	MM5320	5.99
8259	6.95	1800 CPU	8.95	UPD410	2.98	9131 RAM	1.99	
6561 RAM	2.95	Z80A CPU	4.95	UPD411	2.98	EMM4402	1.99	
LM733CN	31.99	6522	6.95	2708 EPROM	8/29.95	10415	4.95	
LM323K	3.95	6520 CPU	5.95	2114	8/14.50	8700 A/D	2/16.95	

TOLL FREE

800-854-8230
910-595-1565

LINEAR

78H05K	\$5.95	LM1414N	\$1.90
78M05	1.49	LM1458CN/N	.49
78L05	1.49	MC1468N	.99
LM1084H	2.95	MC1489N	.99
LM300H	.99	LM1496N	.89
LM301CN	.35	LM1556N	1.50
LM304H	1.98	LM1820N	.95
LM305H	1.89	LM1850N	.95
LM305H	3.25	LM1899N	3.10
LM307CN	.29	LM2111N	.95
LM308CN	.98	LM2900N	.99
LM309K	1.49	LM2901N	2.50
LM310CN	1.25	LM2917N	2.95
LM311D/CN	.89	CA3013T	2.19
LM312H	1.75	CA3018T	1.99
LM317T	1.70	CA3021T	2.49
LM318CN	1.45	CA3023T	2.99
LM319H/V	1.29	CA3035T	2.75
LM320K-XX*	1.35	CA3039T	1.29
LM320T-XX*	1.39	CA3046N	1.29
LM320T-XX*	1.25	LM3053N	1.49
LM323K	.95	CA3059N	3.19
LM324AN	4.95	CA3060N	3.19
LM337K	5.95	CA3062N	4.95
LM339K	6.95	LM3065N	1.49
LM339N	.95	CA3080T	1.29
LM340K-XX*	1.75	CA3081N	1.69
LM340T-XX*	1.25	CA3082N	1.69
LM343A-XX*	1.25	CA3083N	1.69
LM344H	.95	CA3086N	.80
LM348N	1.20	CA3089N	2.99
LM350K	5.60	CA3096N	3.49
LM358CN	.98	CA3097N	1.99
LM360N	1.49	CA3130T	1.30
LM372N	1.95	CA3140T	1.19
LM376N	2.75	CA3146N	2.49
LM377N	3.75	CA3160T	1.19
LM380CN/N	1.25	CA3190N	1.95
LM381N	1.79	CA3410N	.59
LM383T	1.95	MC3423N	1.49
LM388N	1.25	MC3460N	3.95
LM390N	1.40	SG3524N	3.95
LM390N	1.95	CA3600N	3.39
NE531V/T	3.75	LM3900N	.59
NE555V	.39	LM3905N	1.19
NE556N	.98	LM3909N	.98
NE561T	19.95	LM3914N	3.75
NE568N/V	1.25	LM3915N	3.95
NE569N/V	1.75	LM3968N	2.75
NE567V/H	1.50	RC4131N	2.95
NE592N	2.75	RC4136N	1.10
LM702H	1.99	RC4151N	3.70
LM709N/H	.29	RC41947K	

ADVANCED COMPUTER PRODUCTS

SEND \$2.00 for 1983 CATALOG



HARDWARE

NOW AVAILABLE FREE IBM PC Catalog

Vista Computer Company

apple computer Authorized Dealer



SIEMEN'S SALE

You can now purchase Shugart compatible 8" Disk Drives below your existing factory direct pricing!



These Prices are the lowest ever published.

*Siemens' SDDD FDD100-8 ... \$199.00

Also, with purchase of Disk Drives you can buy the Vista V-1000 Dual Case with Power Supply and Cable for only \$375.00..... Regular Price \$495.00

See Special Offer on this page for additional disk savings!

OFFER LIMITED! SHIPPED IMMEDIATELY FROM STOCK! FACTORY WARRANTY 90 DAYS! *QEM QUANTITIES

S-100 64K "CMOS" RAMCARD

Unbelievable Price!

\$299.00

Assembled and Tested

ACP has sold over 1000 of these IEEE compatible, low-priced, high-reliability 64K Static RAM Cards.

Single 5-Volt operation.

LPS II
Light Pen System for Apple II Computers
ACP Price **\$299.00**

COEX COEX 80-FT
Best of all, the price...
\$299.00
only



Optional COEX Inter ace Card to Apple \$39.95

MODEMS

SIGNALMAN Mark I (RS232)	List	ACP
\$99	\$79	
HAYES Smartmodem (RS232)	289	225
Smartmodem 1200	699	549
IBM PC to Modem Cable	40	30

IBM LOW COST MEMORY

MEMORY PLUS AT LOW PRICES!

Now! "Multicard" expandable from 64 - 256K with (1) PARALLEL (1) SERIAL (1) CLOCK/CALENDAR

P/N V-064PSC with 64K **\$199.00**
P/N V-256PSC with 256K **\$335.00**

FLOPPY DISK DRIVES

MFG	P/N	SINGLE-SIDED 8"		DOUBLE-SIDED 8"	
		1	2	1	2
Shugart	SA801R	\$385	\$379	\$269	\$269
Siemens	FDD100-8	199	199	Call	Call
Shugart	SA851R	519	485	489	489
Qume	Datatrack 8	519	480	485	485
Shugart	860 Thin	559	539	519	519
Shugart	SA400	210	208	198	198
MPi	B51	210	208	198	198
Shugart	SA450	345	325	313	313
Perfec	FD250	159	159	149	149
TEAC	5 1/4" Thinline	375	385	359	359
Hitachi	Call Call Call				
Seagate	ST506(6Mb)	699	679	599	599
IMI	5006(6Mb)	865	850	819	819
IMI	5018(18Mb)	1313	1299	1225	1225

SPECIAL LIQUIDATION - SMALL QTY SHUGART 4004 14" WINCHESTER

Only 10 Available - So Hurry!
14.5 MEGABYTES
List 2495.00
Special Sale Price ... **\$995.00**



ABM	List	ACP
BSR-X10 Interface	\$95	\$85
Color to Mono I/O Module	95	85
Telephone Receptionist adapt	995	875
RS232C/Bisyn Emulator	1295	1150
AMDEK Dual3" Amdisk (2) Hitachi DS (250K)	899	649
AST Megaplus Card P/N MG-064, 64K, Ser, Clk	595	449
P/N MG-064SP add'l Ser, Par	695	499
P/N MG-256, 256K, Ser, Clk	695	685
P/N MG-256SP add'l Ser, Par	1095	749
AST I/O Plus Card P/N I/O-SP, Clk, (2) Ser, Par	265	199
AST Combo Plus Card P/N MC256SPC 256K, clk P/S	995	695
AST PC Disk+ Card P/N MD-064, 64K, Host, Par	655	495
CACTUS TECHNOLOGY 200 Baud Direct Modem	349	299
COEX Extender Card	40	19
Prototype Card	69	42
37 Pin "D" Connector	19	5
Snap-in Card Guides (5)	8	5
CORONA Hard Disk System	Call	Call
CORVUS Hard Disk System	Call	Call
DAVING 5Mb Hard Disk	1995	1490
12MB Hard Disk	2495	2295
MAYNARD Disk Card Floppy Card w/Parallel	295	249
Floppy Card w/Serial	325	260
ORCHID Hi-Res Graphics Adapter	495	429
PERSYST Spectrum (64-256K) P/N SP64CP, 64K, S, S, P	499	499
P/N SP64, 64K	375	375
64K Upgrade Kit (9 chips)	130	50
QUADRAM Quadboard (64-256K) P/N Q64, 64K w/4 functions	595	429
TANDON TM 100-1 (160K)	295	195
TM 100-2 (320K)	395	289
TG PRODUCTS Joystick	65	49
Track Ball	65	52
VISTA "Multicard" (exp. 64-256K) P/N V-064, 64K	199	199
P/N V-064PSC 256K w/PSC	495	335
64K Upgrade Kit (9 chips)	50	50
"MAXICARD" - 576K	1295	995
"PC MASTER" 7 I/O's	669	499
"8" Disk Controller"	Call	Call
XEDEX BabyBPC/PM	600	445

PRINTERS

COEX 80F/T 80cps	\$499	\$299
STAR MICRONICS - NEW! Gemini 10 100cps	499	379
Gemini 15 15"	649	479
EPSON MX80 II	645	429
MX80T III	745	499
MX100III	995	679
INTEGRAL DATA Microprint 480	799	689
Prism 80 Color (all)	1795	1495
Prism 32 Color (all)	1295	1095
BROTHER Hi-1	1195	895
Daisywriter	1495	1295
IBM PC to EPSON Cable	60	45
OKIDATA Microline 82A	599	489
Microline 83A	899	729
Microline 84AP	1399	1099

MONITORS

AMDEKCORP 300 Green 12"	\$199	\$155
310 Amber 12"	175	135
Color I Composite	399	339
Color II RGB Hi-Res	899	790
Color III RGB Comm'l	499	445
Color IV RGB Analog	1299	1059
NEC 12" Green-NEW	169	155
BULL SPECIAL SS 10/25	895	795
SONY Prefeel 19" Color RGB	895	819
PRINCETON GRAPHICS RGB IBM Lookalike	700	599

DISKETTES

DYSAN 5 1/4" SS SD	10/555	\$38
DYSAN 5 1/4" DS SD	10/655	48
IBM 5 1/4" SS SD	10/655	47
IBM 5 1/4" DS SD	10/655	47
VERBATIM 550-01 DS	10/555	34
MAXELL MD1 SS	10/550	29
MAXELL MD2 DS	10/650	39
AMDEK Hitachi 3" DS Micro	5/99	49
BULL SPECIAL SS	10/25	19
With Sleeve and Box	100/195	149

MORE IBM GOODIES

CURTIS PC Pedestal	\$80	\$65
Extension Cable	50	44
INTEL 8087 IC	199	
RAM EXPANSION 16K Motherboard (16 IC's)	19	19
64K Memory Exp. (9 IC's)	70	50
KRAFT IBM Joystick	70	50
IBM Paddles	50	40

APPLE System Saver FAN

Surge Suppressor Fan Double Outlet Receptacle **\$79.95**

"SOLO" Apple II/IIe Compatible Disk Drive

Totally compatible to Apple Drives.

only **\$249.00**
Controller \$99.00
Just plug in and run.

Vista Quartet

Equivalent to 4 Apple Drives

only... **\$699.00**



Add 8" Disk Drives To Your Apple II/IIe

Up To 2.4 Megabyte!
Now "TRIMLINE V1100" with Tandon Thinline DS DD Drives.
Tandon Dual DS DD \$1895.00
Qume Dual DS DD 1699.00
Shugart Dual 801R 1295.00

SPECIAL OFFER

(2) Siemen's 8" Disk Drives
(1) Vista V-1000 Enclosure
(1) Power Supply w/Fan, w/Cable

ACP Low Price **\$699.00**

Apple Compatible Software

SAVE UP TO 40%

BUSINESS	HOBBY	ACP	HOBBY
Screen Writer	\$29	Bag of Tricks	\$32
Word Handler	149	Graphics Magic'n	45
BD Master	155	DOS Boss	19
VisualC 3.3	185	Zoom Graphics	32
Master Type	29	Utility Guy	22
Desk Top Plan II	179	Locksmith 4.0	90
Desk Top Plan III	225	Compl Graph Sys	55
Visiplot	159	Apple Mechanic 24	35
PFS, File II	115	Nibbles Away II	35
PFS, File III	155	GAMES	
Visirend/Visiplot	25	The Missing Ring	29
PFS, Graph II	115	Croquetier	26
PFS, Graph III	155	Frogger	23
Multiplan	199	Wizardy	29
Versaform	279	Snack Attack	24
Wordstar	365	Castle Wolfenstein 24	
Format II	179	Arcade Machine	44
dBASE II	439	Canyon Climber	24
Supercalc	169	Atzac	29
PFS, Report II	95	Mask of the Sun	29
PFS, Report III	115	Cannonball Blitz	26
Act Plus G/L	299	Knight Diamonds	26
G/L, A/P, A/R	599	Zork I	29
Above-Inventory	799	Zork II	29
Magic Window	115	Siarcross	29
HOME		Serenity	25
Home Accountant	59	Star Blazer	25
Transend I	76	Deadline	39
Transend II	119	Tubeway	25
Data Capture 4.0	49	Flight Simulator	25
Vistterm	89	Space Vikings	25
Per. Finance Mgr	85	Sargon II	29
ASCII Exprs. Prof.	99	Spitfire Simulator	29
Electronic Duet	25	Apple Panic	22
Tap. Prep. 1983	149	Olympic Decath	23

Apple II Plus w/48K	LIST \$153.00	ACP \$99.00
Apple II Plus w/64K	179.00	1049.00
Apple II System Special w/64K, Z80Card, Vision80	2519.00	1499.00
Apple III w/128K	3495.00	2695.00
Apple III w/256K	4295.00	2995.00
Profile Hard Disk Drive	3499.00	2095.00
Vista Apple III Timescard	195.00	169.00

APPLE HARDWARE

Apple II Disk II w/Controlr	LIST \$645.00	ACP \$449.00
Apple II Disk II w/o	525.00	389.00
Apple Family System	2495.00	CALL
Prototype Card	24.00	21.95
IEEE-488 Interface	450.00	375.00
Extended Warranty - 1 yr	225.00	199.00
Super Serial Card	195.00	174.95
LanguageCard	195.00	149.95
Graphic Tablet w/I/O	795.00	695.00

MORE HARDWARE

MICROSOFT Z80 Softcard	LIST \$395.00	ACP \$249.00
16K Ramcard	195.00	89.00
The Premium Package	899.00	579.00
SSM AI/O-II Function Serial/Parallel	225.00	179.00
AI/O Serial/Parallel	195.00	165.00
KEYBOARD COMPANY Numeric Keypad	149.95	124.95
Apple II Joystick	49.95	44.50
Apple II Handcontrollers	29.95	25.95
KRAFT Joystick	49.00	49.00
Hand Controller	40.00	40.00
PROMETHEUS VERSABox Spool/Bufr	249.00	199.00
VERSAcard Four-in-1	199.00	166.00
AUTO-DOC diagnostics	99.00	82.00
VISTA COMPUTER CO. Vision 80 80x24 Card	395.00	269.00
Vision 40 40 col. enhance	199.00	149.00
Vision 20 Lo case ROM	29.95	25.00
ABOO 8" DS, DD	595.00	399.00
Quartet Disk Drive	699.00	699.00
Dual Disk Drive	499.00	499.00
Solo Disk Drive	269.00	269.00
40 Char Type-ahead	49.95	35.00
Wild Card	129.95	115.00

VIDEX Videoterm 80x24 Card	345.00	279.00
Keyboard Enhancer II	149.00	129.00
Soft Switch	35.00	30.00
Function Strip Keys	79.00	69.00
PRACTICAL PERIPHERALS 16K Microbuffer	259.00	220.00
32K Microbuffer	299.00	253.00
Snapshot Option	149.00	109.00
VOTRAX Type II Talk Speech	375.00	339.00
SCOTT INSTRUMENTS Voice Recognizer VET80	799.00	675.00
CORVUS 5 Mb Hard Disk	3750.00	2495.00
10 Mb Hard Disk	5350.00	2895.00
20 Mb Hard Disk	6450.00	3995.00
ORANGE MICRO The Grappler I/O (Plus)	195.00	129.95
SATURN SYSTEMS 32K RAM Card	239.00	189.00
64K RAM Card	425.00	355.00
128K RAM Card	599.00	505.00
NOVATION Apple-Cat II	389.00	329.00
Apple Cat 212	625.00	525.00
HAYES MICROCOMPUTER Hayes Chronograph	249.00	229.00
Micromodem II	349.00	289.00
Smartmodem	299.00	229.00
MOUNTAIN COMPUTER CPS Multifunction Music System	239.00	169.00
A/D plus D/A	350.00	299.00
Supertalker	199.00	169.00
Introl X-10 Controller	200.00	175.00
ROM Filter ROM	155.00	129.00
Keyboard Filter ROM	55.00	44.00
Copy ROM	55.00	44.00
ROM Writer	175.00	159.00
MAR ENTERPRISES Sup'term 80x24 Card	395.00	279.00
Sup'l Switcher 6 Amp Power Supply	295.00	239.00
Sup'Mod II RF Modulator	69.00	49.00
Apple Fan	55.00	

THERE ARE NO BETTER BOARDS — THERE ARE NO BETTER PRICES!

CompuPro FROM PRIORITY ONE ELECTRONICS
SYSTEMS

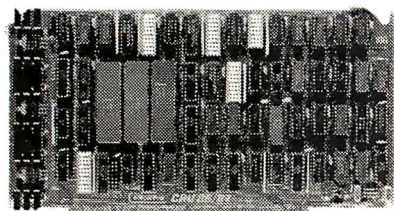

**CPU BOARDS
CO-PROCESSOR 8086/8087**

16 bit 8 or 10 MHz 8086 CPU with sockets for 8087 and 80130

Part No.	Description	List Price	Our Price
BPGBT186A	A&T 8MHz 8086 only	\$750.00	\$669.00
BPGBT186C	CSC 10MHz 8086 only	\$850.00	\$764.89
BPGBT186A87	A&T with 8087 option	\$1050.00	\$939.00
BPGBT186C87	CSC with 8087 option	\$1150.00	\$1065.00

*8087 Limits clock speed to 5MHz
(816) DUAL PROCESSOR 8085-8088
6 or 8 MHz provides true 16 Bit Power with a standard 8 bit S-100 bus

BPGBT1612A	A&T 6MHz	\$495.00	\$439.00
BPGBT1612C	CSC 6/8 MHz	\$595.00	\$529.00

68K - 68000 16 BIT CPU

16 bit 8 or 10 MHz on-board sockets for 2716, 2732, or 2764 EPROMs for up to 8K x 16 of memory

BPGBT184A	A&T 8MHz	\$695.00	\$625.00
BPGBT184C	CSC 10MHz	\$850.00	\$765.00

FORTH OPERATING SYSTEM FOR 68K CPU

Requires a DISK 1, 64K of CompuPro memory, and an INTERFACER 3 or 4.

BPGBT68K0S	FORTH operating system	\$200.00	
------------	------------------------	----------	--

CPUZ - Z80D CPU NOW 6MHz!

3/6 MHz Z80B CPU with 24 Bit Addressing. FASTEST Z80 CPU AVAILABLE!

BPGBT160A	3/6 MHz A&T	\$325.00	\$289.00
BPGBT160C	3/6 MHz CSC	\$425.00	\$379.00



*When 2 or more 8" disk drives are purchased with Disk 1 Controller.

DISK CONTROLLERS

DISK 1 FLOPPY CONTROLLER - OUR DEST!
Fast DMA, Soft Sector, Controls Up to Four 8" or 5 1/4" Single or Double Density Drives.

BPPOB171ACPM	A&T w/CPM 2.2 & BIOS	\$670.00	\$495.00
	*When purchased with two 8" disk drives only.		\$450.00

BPPOB171CCPM	CSC w/CP/M 2.2 & BIOS	\$770.00	\$595.00
BPGBT171A	Disk 1 Controller A&T	\$495.00	\$449.89
BPGBT171C	Disk 1 Controller CSC	\$595.00	\$550.00
BPGBTCPMBD	CP/M 2.2 for Z80/8085 w/manual & BIOS 8" S/D disk	\$174.89	
BPGBTCPMB6	CP/M 2.2 for 8086 w/manuals & BIOS 8" S/D disk	\$299.89	

**DISK 2/SELECTOR CHANNEL
HARD DISK CONTROLLER**

Fast DMA 2 board set, controls 4 Shugart 4000 series or Fujitsu 2300 type drives. Includes CP/M 2.2.

BPGBT177A	Assembled & Tested	\$795.00	\$750.00
BPGBT177C	CSC	\$895.00	\$850.00



**CMOS RAM SALE!
RAM 17 - 64K CMOS STATIC RAM**

12 MHz, RAM 17, 2 Watt, DMA Compatible 24 Bit Addressing

Part No.	Description	List Price	Our Price
BPGBT175A64	64K A&T 12MHz	\$499.00	\$460.00
BPGBT175C64	64K CSC 12MHz	\$599.00	\$550.00

RAM 16 - 32K x 16 BIT CMOS STATIC RAM

8 and/or 16 Bit
(816) 12 MHz, RAM 16, 32K x 16 or 64K x 8 IEEE/696 16 Bit 2 Watt, 24 Bit Addressing

BPGBT180A	64K A&T 12MHz	\$550.00	\$510.00
BPGBT180C	64K CSC 12MHz	\$650.00	\$610.00



NEW! RAM 21 - 128K STATIC RAM

(816) 816 RAM 21 12MHz, 128K x 8 or 64K x 16 IEEE/696 8 or 16 Bit, 1.2 Amps, 24 Bit Addressing

BPGBT190A	128K A&T	\$1095.00	\$995.00
BPGBT190C	128K CSC	\$1245.00	\$1125.00

**M-DRIVE SOLID STATE DISK DRIVE,
3500% FASTER!!**

Not really, but the next best thing for CompuPro 8085/88 Users. Call for Details on M-Drive.

M-Drive requires a 6MHz CPU 8085/88 dual processor. Disk 1 DMA disk controller and System Support 1 Multifunction Board.

BPGBTM0128KA	128K of A&T memory & M-Drive Software	\$1198.00	
BPGBTM0128KC	128K of CSC memory & M-Drive Software	\$1398.00	
BPGBTM0256KA	256K of A&T memory & M-Drive Software	\$2395.00	
BPGBTM0256KC	256K of CSC memory & M-Drive Software	\$2795.00	

M-DRIVE/H HARDWARE LOGICAL DISK SYSTEM

Interfaces through two I/O ports, and runs at 10MHz. IEEE 696 compatible. Requires any CompuPro CPU and a Disk 1. Each board contains 512K of fast, low power (900mA) RAM, with parity checking.

BPGBT197A	M-DRIVE/H w/software, A&T	\$1895.00	\$1295.00
BPGBT197C	M-DRIVE/H w/software, CSC	\$2095.00	\$1495.00

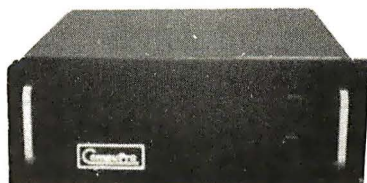

S-100 MAINFRAME

110V 60Hz CVT Mainframe uses famous 20 slot CompuPro Motherboard (55 lbs.)

BPGBTENC20RM	20 Slot Rackmount	\$895.00	\$825.00
BPGBTENC20DK	20 Slot Desk Top	\$825.00	\$760.00

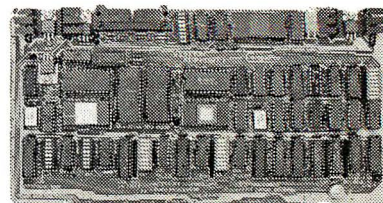

I/O BOARDS

SYSTEM SUPPORT 1 MULTIFUNCTION BOARD

Serial port (software prog. baud), 4K RAM included, 15 levels of interrupt, real time clock, optional math processor.

Part No.	Description	List Price	Our Price
BPGBT162A	Assembled & Tested	\$450.00	\$395.00
BPGBT162C	CSC	\$550.00	\$495.00
BPGBT8231	Math Chip		\$195.00
BPGBT8232	Math Chip		\$195.00
BPGBT162AM1	A&T w/8231 Math Chip		\$570.00
BPGBT162CM1	CSC w/8231 Math Chip		\$670.00
BPGBT162AM2	A&T w/8232 Math Chip		\$570.00
BPGBT162CM2	CSC w/8232 Math Chip		\$670.00

MPX CHANNEL BOARDS

I/O Multiplexer, using 8085A-2 CPU on board w/16K RAM

BPGBT166A16	Assembled & Tested	\$649.00	\$584.89
BPGBT166C16	CSC	\$749.00	\$674.89

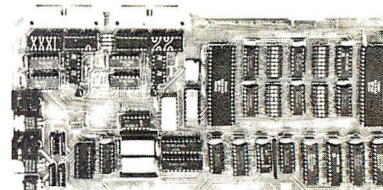

INTERFACER 1

Two Serial I/O

BPGBT133A	Assembled & Tested	\$295.00	\$259.00
BPGBT133C	CSC	\$370.00	\$329.00

INTERFACER 2

Three parallel, one serial I/O board

BPGBT150A	Assembled & Tested	\$325.00	\$289.00
BPGBT150C	CSC	\$399.00	\$359.00

INTERFACER 3

Eight-channel multi-user serial I/O board

BPGBT1748A	Assembled & Tested	\$699.00	\$628.89
BPGBT1748C	CSC 200 hr. 8 port	\$849.00	\$748.89
BPGBT1745A	Assembled & Tested	\$599.00	\$558.89
BPGBT1745C	CSC 200 hr. 5 port	\$699.00	\$628.89

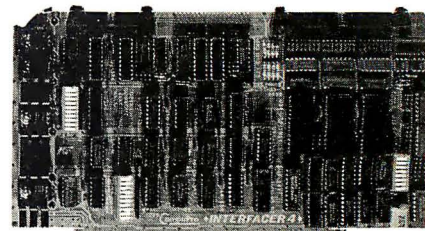

INTERFACER 4

Three Serial, 1 Parallel, 1 Centronics Parallel

BPGBT187A	Assembled & Tested	\$450.00	\$399.00
BPGBT187C	CSC	\$540.00	\$479.00

S-100 MOTHERBOARDS

Active termination, 6-12-20 Slot

BPGBT153A	A&T 6 slot, 2 lbs.	\$140.00	\$125.00
BPGBT153C	CSC 6 slot, 2 lbs.	\$190.00	\$155.00
BPGBT154A	A&T 12 slot, 3 lbs.	\$175.00	\$155.00
BPGBT154C	CSC 12 slot, 3 lbs.	\$240.00	\$220.00
BPGBT155A	A&T 20 slot, 4 lbs.	\$265.00	\$235.00
BPGBT155C	CSC 20 slot, 4 lbs.	\$340.00	\$310.00

PRIORITY ONE ELECTRONICS



WORLD'S BEST SELLING TERMINAL
Extra Memory Pages
FREE!

- BPDPBTLV9252P* \$749.00
*TeleVideo 925 w/free 2nd page memory kit, a \$95.00 Value!
- BPDPBTLV9504P* \$949.00
*TeleVideo 950 w/free 2nd, 3rd & 4th page memory kit, \$285.00 value!
- BPTLV910 \$649.00
With emulations & foreign languages



BEST BUYS!

(Shipping Weight 37 lbs.)

1200 BAUD AUTO-DIAL HAYES SMARTMODEM COMPATIBLE



MODEMS
\$495.00

The AUTO DIAL 212A Modem is a direct connect 0-300 or 1200 baud modem capable of dialing and calling for you. The AUTO DIAL 212A is compatible in function to the DC Hayes SMARTMODEM™.

Part No.	Description	List	SALE Price
BPUSRADIAL212A	0-300/1200 baud dialing modem	\$599.00	\$495.00

SIERRA DATA SCIENCES & MICROPOLIS™
Z80 35MB SUBSYSTEM

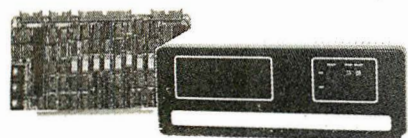

- Z80A 4MHz CPU • 64K RAM • 35 MegaByte Winchester Hard Disk Drive, Cabinet, and Power Supply • Hard Disk Drive BIOS • 2 RS-232 I/O Ports • Floppy Disk Controller • user Friendly Menu Driven CP/M 2.2™ • Drive Interface Cable

ALL OF THIS FOR ONLY:

\$4495.00 **SAVE \$950!!**

If purchased separately: \$5445.00
BPPDBSBCSY1 (Shipped Freight Collect)



64K IEEE/S-100 DYNAMIC RAM

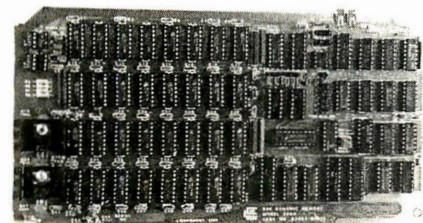

2 or 4MHz BANK SELECTABLE

- 2 or 4MHz operation • Designed to IEEE proposed S-100 bus standard • Operates with either an 8080 or Z-80 based S-100 system providing processor transparent refreshes with both • Bank-select system allows system memory expansion • Any 16K block can be made bank-independent • All 64K can be made bank-enabled on and reset • Supports DMA • Jumper-selectable Phantom input • Assembled & Tested • Uses Popular 4 116 RAMs

REGULAR LIST PRICE IS \$375.00

\$199.00

BPCCS20653 (Sh. Wt. 2 lbs.)

DUAL QUME 8" FLOPPY DRIVE, CABINET, DMA S-100 CONTROLLER, AND CP/M® FROM

CompuPro

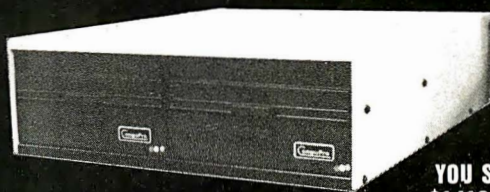

YOU SAVE \$1419.77!!

ABSOLUTELY THE MOST COST EFFECTIVE DISK SUBSYSTEM EVER OFFERED BY PRIORITY ONE ELECTRONICS!!

- 2 Double sided 8" QUME DT8 disk drives
- DMA Floppy Controller (controls up to 4 drives)
- CP/M™ 2.2 w/bios written for the Disk 1 Controller
- Cabinet includes power supply & internal data cable
- External data cable included

	List Price
1 BBT206SP	\$2325.00
1 BBT171A	\$495.00
1 BBTCPM80	\$175.00
1 BPC50S80S	\$ 19.77
	\$3014.77

(Shipping Charge \$21.80, shipped in two boxes)

CABINET AND 2 QUME DT8 DOUBLE SIDED DRIVES PROVIDE 2.4 MBYTES OF MASS STORAGE!!

List: \$2325.00 SAVE \$1030.00! BBT206SP

CompuPro™ UN-SYSTEM 816

FOR THOSE WHO DEMAND EXCELLENCE!

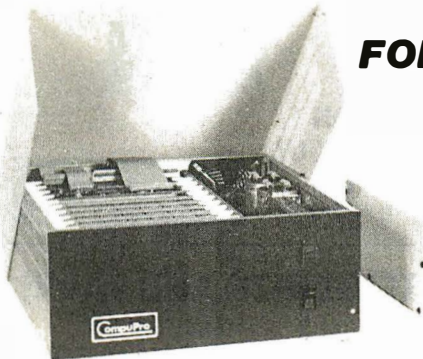

Each CompuPro system contains the same nucleus of common hardware and software. This insures compatibility between systems as well as allowing you to expand as your needs grow. The following is a list of the basic hardware components as well as software.

- HARDWARE:**
- Desk top Enclosure 20 slots
 - Floppy disk enclosure with 2 Qume DT8 drives
 - DMA Floppy Controller
 - 80/85/8088 CPU operates 8 or 16 software
 - Memory in the form of RAM 17s
 - System support 1 (Clock calendar, RAM/ROM/math processor options, RS-232 Serial port, dual interrupt controllers, triple interval timers and more!)
 - All internal cables

- SOFTWARE:**
- CP/M 2.2™ and CP/M 86™
 - M Drive Software - allows the use of memory as another disk drive
 - Sorcim's SUPERCALC 86™
 - Ashton Tate's DBase II

DIG DEEP!! Now is the time to buy the CompuPro UN-SYSTEM 816!!

SAVE MONEY, and have an UN-SYSTEM 816 for your very own! All UN-SYSTEMS contain the very same components as the SYSTEM 816s listed in our Winter 1983 Engineering Selection Guide, but are not installed or configured. All it takes is your professional computer experience and knowledge to have the highest performing S-100 computer system on the market today. BEWARE! This is not for the novice and inexperienced user, as it requires a well-matured knowledge in system integration procedures.

So, WHY WAIT!? Don't Pass Up This Incredible Deal!!

Each component of the UN-SYSTEM 816 has been assembled and individually tested. Final installation and configuration are the sole responsibility of the purchaser.

UN-SYSTEM 816/A
ENTRY LEVEL - SINGLE USER
Disk storage: 2.4 Megabytes. Expandable to 4.8 Megabytes.
Main memory: 128K - expandable to 1 Megabyte
Serial Ports: 4 / Parallel Ports: 1
Centronics/Epson ports: 1
Software: CP/M 2.2™, CP/M-86™, M-Drive, SuperCalc-86, dBase.
Component List Price: \$6705.00
BP6BTUNSYSA16

OUR SALE PRICE: **\$4795.00** **SAVE \$1910.00!!**

UN-SYSTEM 816/B
ENHANCED HIGH PERFORMANCE SINGLE USER SYSTEM
Disk Storage: 2.4 Megabytes. Expandable to 4.8 Megabytes.
Main memory: 256K - expandable to 1 Megabyte
Serial ports: 6
Software: CP/M 2.2™, CP/M-86™, M-Drive, SuperCalc-86™, dBase II™
Component List Price: \$8497.00
BP6BTUNSYSB16

OUR SALE PRICE: **\$5795.00** **SAVE \$2702.00!!**

UN-SYSTEM 816/C
HIGH PERFORMANCE MULTI-USER SYSTEM
Disk storage: 2.4 Megabytes. Expandable to 4.8 Megabytes.
Main memory: 384K - expandable to 1 Megabyte
Serial ports: 9
Software: CP/M 2.2™, CP/M-86™, MP/M 8-16™, M-Drive, SuperCalc-86™, dBase II™
Component List Price: \$10,636.00
BP6BTUNSYSC16

OUR SALE PRICE: **\$7595.00** **SAVE \$3041.00!!**

PRIORITY ONE ELECTRONICS

ORDER TOLL FREE (800) 423-5922 - CA, AK, HI CALL (213) 709-5111

Terms: U.S. VISA, MC, BAC, Check, Money Order, U.S. Funds Only. CA resident add 6 1/2% Sales Tax. MINIMUM PREPAID ORDER \$15.00. Include MINIMUM SHIPPING & HANDLING of \$3.00 for the first 3 lbs. plus 40¢ for each additional pound. Orders over 50 lbs. sent freight collect. Just in case, please include your phone number. Prices subject to change without notice. We will do our best to maintain prices through April, 1983. Credit Card orders will be charged appropriate freight if you haven't received your Winter '83 Engineering Selection Guide, send \$1.00 for your copy today! Sale prices for prepaid orders only.

RETAIL STORE PHONE NUMBERS: (Chatsworth:) (213) 709-5464 - (Irvine:) (714) 660-1411

SIEMENS FDD100-8
8" FLOPPY DISK DRIVE
SINGLE SIDED, DOUBLE DENSITY
SHUGART 801R COMPATIBLE

90 DAY WARRANTY!

ONCE AGAIN YOU RECEIVE THE BENEFIT OF OUR UNEQUALLED PURCHASING POWER!



Ea. ~~\$225.00~~
2-9 \$199.00
10+ CALL

ORDER NOW AND SAVE!

OEM INQUIRIES INVITED
 (Include \$7.00 per drive for shipping)
BPSIEFDD1008

NEW LOW PRICES!



5 1/4" DISK DRIVES

BPMP151*	Single-Sided Double-Density 48 TPI	\$200.00
BPMP152*	Double-Sided Double-Density 48 TPI	\$270.00
BPMP191*	Single-Sided Double-Density 96 TPI	\$275.00
BPMP192*	Double-Sided Double-Density 96 TPI	\$400.00

*Replace "" when ordering, with "m" for MPI style bezel, or "s" for Shugart style bezel. (Shipping Weight 5 lbs.)

2" HIGH 8" DISK DRIVES



The first 2" high 8" disk drive allows for mounting under the keyboard on CRT, etc.
 NO AC Required +5V +24VDC only
 FAST 3 msec track to track!

BPMP141M	1/2 High 1 side double-density	\$380.00
BPMP142M	1/2 High 2 side double-density	\$460.00
BPMP141S	Full height 1 side single drive, dble-density	\$380.00
BPMP142S	Full height 2 sided single drive, dble-density	\$480.00
BPMP1410	Full height 1 side dual drive, dble-density	\$780.00
BPMP1420	Full height 2 side dual drive, dble-density	\$920.00

(Shipping Weight: 11 lbs. per drive)

S-100 DUAL 8" SUBSYSTEM

BPCCS2422A	S-100 Disk Controller with CP/M 2.2	1 \$399.00
BPSIEFDD1008	Siemens Double Density 8" drive	2 \$398.00
BPIIFDE002	Dual Horizontal Cabinet with Power Supply and Data Cable	1 \$295.00

\$1127.00

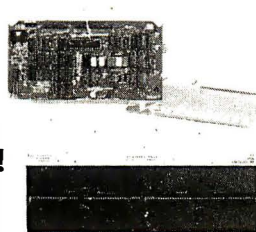

SAVE \$132.00!!
\$995.00
 (include \$30.00 for shipping)

DON'T MISS OUT!
 Order No. **BP PDBSIESUB1**

BUY DRIVE AND CABINET TOGETHER AND SAVE!

DUAL 8" SIEMENS FDD1008, DUAL 8" CABINET POWER SUPPLY AND INTERNAL POWER CABLES

IF BOUGHT SEPARATELY: \$890.00

PRICED AT: \$675.00

BPPDBIISIE ENVIRONMENT MONITOR PANEL

Temperature and voltage monitor with visual and audible alarm for overtemp condition. Direct Digital Readout of Internal Temperature in C on standard DVM

BPIIFDE002	CABINET ONLY (SH Wt 38 lbs)	\$295.00
BP PDBIISIEEM	2 Drives, Cabinet & disk environment monitor	\$775.00
BPIIFDE002EM	Cabinet only with disk environment monitor	\$375.00
BPPDBSOM18E18E	Dual Data Cable	\$ 31.15
BPPGCS0S60S	External Data Cable	\$ 19.77

International Instrumentation Incorporated

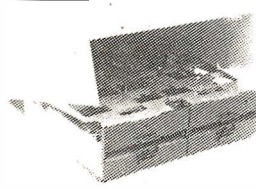
- Positive Pressure Filter Cooling
- Power Supply 4A @ +5V 3A @ +24V 1A @ -5V
- Each output is individually fused
- Hinged top for easy access
- Heavy non-flex .090 aluminum base
- Modular power connectors

OUR FINEST 8" DUAL DISK DRIVE CABINET

International Instrumentation Incorporated

Compare these features listed and you'll see why this cabinet is our FINEST DISK CABINET



STANDARD UNIVERSAL DISK ENCLOSURE

	List Price	OUR Price
BPIIUE004	\$495.00	\$425.00

With augmented power supply to handle Tandon Slimline, or Winchester disk drives. Includes the disk environment monitor.

BPIIUE004A46E	\$733.00	\$625.00
----------------------	----------	-----------------

With Disk Environment Monitor for cool, reliable operation.

BPIIUE004EM	\$584.95	\$495.00
--------------------	----------	-----------------

FEATURES

- Positive pressure forced air cooling for reliable disk drive operation
- AC input via 3 wire 7 foot international cord/socket set
- AC input EMI filtered to six amps to help prevent disk crashes due to power spikes and line noise
- 14 gauge main chassis
- Integral power supply with 5V @ 6A/-5V 3 1A/24V @ 6A
- Double-sided custom PC power board and supply
- Each DC supply and AC separately fused

Tandon

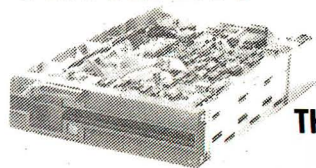

8-INCH THIN LINE

Exactly one-half the height of any other model
 Proprietary, high-resolution, read-write heads patented by Tandon
 D.C. only operation - no A.C. required
 Industry standard interface
 Three millisecond track-to-track access time (9 lbs.)

TANDON 8" DRIVES

BPTNDTM8481	Single Sided: \$380.00	2 or more: \$370.00 ea.
BPTNDTM8482	Double Sided: \$495.00	2 or more: \$485.00 ea.

TANDON 5 1/4" DRIVES

BPTNDTM1001	Single Sided, 250KB (5 lbs)	\$220.00 ea.
	2 or More: \$200.00 each	
BPTNDTM1002	Double Sided, 500KB	\$295.00 ea.
	2 or More: \$270.00 each	
BPTNDTM1003	Single Sided, 500KB	\$295.00 ea.
	2 or More: \$270.00 each	
BPTNDTM1004	Double Sided, 1000KB	\$395.00 ea.
	2 or More: \$375.00 each	

DUAL 8" HALF HEIGHT FLOPPY CABINET

- 24V @ 4A 5V @ 3A
- -5V @ 800ma
- Fan cooled
- Socketed power connectors
- All supplies regulated

INTERNATIONAL INSTRUMENTATION, INC.

	List Price	SALE
BPIIIDL002	Dual Thin Line Cabinet (12 lbs.)	\$225.00 \$165.00

BUY THE CABINET & DRIVES AND SAVE!
 With 2 Tandon Thinlines

BPPDBIITND1	Cabinet w/2 TNDTM8481 - 1 sided (30 lbs.)	\$885.00
BPPDBIITND2	Cabinet w/2 TNDTM8482 - 2 sided (30 lbs.)	\$1115.00

With 2 MPI Slimlines

BPPDBIIMP11	Cabinet w/2 MPI41M - 1 sided (30 lbs.)	\$920.00
BPPDBIIMP12	Cabinet w/2 MPI42M - 2 sided (30 lbs.)	\$1080.00

Options

BPIIIDLMPKIT	MPI drive adaptor monitor kit (2 lbs.)	\$24.95
BPIIIOCCSHU	Shugart / AC/DC power connector kit (2 lbs.)	\$14.95

(For full size single S4801 or compatible drives)

PRIORITY ONE ELECTRONICS

SANYO
12" DATA DISPLAY MONITOR
24 Lines x 64 Characters



SAVE OVER 50% !!

BPSY00M2112 List Price: \$160.00

SALE PRICE:

\$75.00 !!

SAVE \$85.00!!
(Sh. Wt. 16 lbs.)

LOWEST COST PRINTERS AVAILABLE
\$299.00 !!



COEX 80 F/T
(Sh. Wt. 21 lbs.)

- 80 cps • 10, 12 or 16.5 cpi • 3 selectable line spacing • Vertical format control • Centronics parallel or RS232 serial interface • Uses a standard Underwood spooled ribbon • Friction and tractor feed

	List Price	OUR Price
BPCOX80FT Parallel int	\$399.00	\$299.00
BPCOX80FTSER Serial int	\$399.00	\$299.00
BPCOXPLINTP Appl. parallel interface w. cable		\$49.95

\$229.00

AXIOM
AXIOM CORPORATION

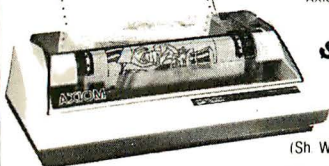

SAVE \$160.00!!
(Sh. Wt. 11 lbs.)

- 5 x 7 Dot Matrix • Parallel Interface (Centronics) • Tractor Feed • Dot Addressable Graphics • Up to 3-Part Paper • Self Test • One Year Warranty • 30 CPS 80 Column Unidirectional • Uses Regular Paper

BPAXM6P100A Dot Matrix Printer \$389.00 **\$229.00**

THE COMPATIBLE P1350

TOSHIDA

100 CPS LETTER QUALITY, 200 CPS DRAFT MODE

LETTER QUALITY DOT MATRIX PRINTER!

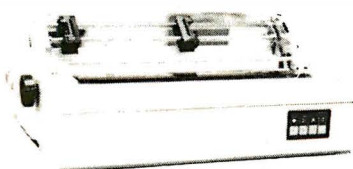

\$1895.00

BPCCCP1350 List Price: \$2195.00

- Serial Interface
- Fast 200 cps draft mode
- High quality Word Processing mode for letter quality
- Full graphics capabilities (dot addressable)
- Software or switch selectable type styles
- Complete plotter capability with bidirectional tractor
- Unique 24 pin MICRO DOT matrix print head

List Price OUR Price

BPCCCP1350T Bidirectional tractor \$295.00 **\$275.00**
You won't believe the print quality of the COMPATIBLE in its letter quality mode! If we didn't tell you it was dot matrix, you would have never known!
(Shipping Weight 48 lbs.)

IBM MULTICARD

Vista™ MEMORY & I/O CARD

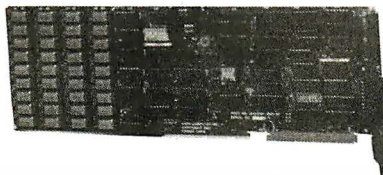

- 64K RAM Expandable to 256K
- One RS232 Serial Port
- One Parallel Printer Port
- Real Time Clock Calendar with Battery Backup (Sh. Wt. 1 lb.)

BPVIS025665 List Price \$595.00

SALE PRICE:

\$399.00

IBM MAXICARD

Vista™ PERSONAL COMPUTER RAM CARD
POPULATED IN 64K, 256K, or 576K

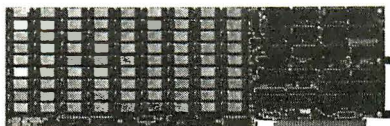

- Runs at full speed with no wait states
- Parity can be disabled at User's option
- On board parity bit on each Byte
- Fully expanded, a full 576KB on one card
- One board fills entire primary RAM address space available
- Full Vista 120 Day Warranty

64K \$199.00
BPVIS057664 List Price \$379.00
SAVE \$180.00

256K \$449.00
BPVIS0576256 List Price \$789.00
SAVE \$340.00

576K \$950.00
BPVIS0576576 List Price \$1299.00
SAVE \$349.00

(IBM is a trademark of International Business Machines)

EIA/RS232 WALL PLATES

(Does not include connectors)

BPIIWPDB251 Single punched

4/\$10.00

BPIIWPDB252 Dual Punched

4/\$12.00

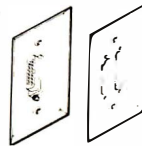

RS-232 "D" SUB-MINIATURE CONNECTORS

	1-9	10-24	25-99	100-UP
BPCNDB25P 25 Pin Male	\$2.75	\$2.50	\$2.25	\$1.95
BPCNDB25S 25 Pin Female	\$4.00	\$3.50	\$3.25	\$3.00
BPCNDB51212 1 Pc Grey Hood	\$1.65	\$1.40	\$1.25	\$1.15
BPCNDB25H 2 Pc Grey Hood	\$1.50	\$1.25	\$1.10	\$1.00
BPCNDB51226 2 Pc Black Hood	\$1.75	\$1.50	\$1.35	\$1.20
BPCNDB020418 Hardware set 2/Pr	\$1.00	\$.80	\$.70	\$.60

TEXA INSTRUMENTS

16 PIN GOLD AND TIN DIP SOLDER TAIL SOCKETS



	TIN	GOLD
QTY BPTIS16LP BPTIG16LP		
50	\$ 8.00	\$ 10.00
1000	\$ 60.00	\$ 80.00
4500	\$225.00	\$315.00

DIRECT CONNECT MODEM

\$79.00

0 - 300 BAUD MURA MM-100



- 0 - 300 baud
- RS232C interface
- Full duplex
- Carrier detect indicator
- Bell 103 compatible
- Low voltage
- Originate/Answer switch selectable

	List Price	SALE
BPMURMM100 0 - 300 baud modem (Shipping Weight: 2 lbs.)	\$99.95	\$79.00
BPCNDRS232BF RS232 cable		\$19.95

SUPER LOW PRICES!
DOUBLE DENSITY!

5 1/4" FLOPPY DISKETTES

LIFETIME WARRANTY!

- Includes reinforcement ring
- Write protect with tabs
- 100% Surface tested
- Lifetime warranty



SALE!

Description	Box of 10	2 Boxes	10 Boxes
BPULT52401 Soft sector, 40 track, 2 side	\$35.00	\$60.00	\$280.00
BPULT52410 10 sector, 40 track, 2 side			
BPULT52416 16 sector, 40 track, 2 side			
BPULT51801 Soft sector, 80 track, 1 side	\$30.00	\$50.00	\$220.00
BPULT51810 10 sector, 80 track, 1 side			
BPULT51816 16 sector, 80 track, 1 side			
BPULT52801 Soft sector, 80 track, 2 sided	\$40.00	\$70.00	\$320.00
BPULT52810 10 sector, 80 track, 2 sided			
BPULT52816 16 Sector, 80 track, 2 sided			

(Sh. Wt. 2 lbs)

(Sh. Wt. 4 lbs.)

(Sh. Wt. 20 lbs.)

MasterCard VISA PRIORITY ONE ELECTRONICS
9161 DEERING AVE. CHATSWORTH, CA 91311

ORDER TOLL FREE (800) 423-5922 - CA, AK, HI CALL (213) 709-5111

Terms: U.S. VISA, MC, BAC, Check, Money Order, U.S. Funds Only. CA residents add 6 1/2% Sales Tax. MINIMUM PREPAID ORDER \$15.00. Include MINIMUM SHIPPING & HANDLING of \$3.00 for the first 3 lbs. plus 40¢ for each additional pound. Orders over 50 lbs. sent freight collect. Just in case, please include your phone number. Prices subject to change without notice. We will do our best to maintain prices through April, 1983. Credit Card orders will be charged appropriate freight. If you haven't received your Winter '83 Engineering Selection Guide, send \$1.00 for your copy today! Sale prices for prepaid orders only.

RETAIL STORE PHONE NUMBERS: (Chatsworth:) (213) 709-5464 - (Irvine:) (714) 660-1411

Circle 472 on inquiry card.

16,000,000 BYTES OF STORAGE

S-100 16MBYTE DMA HARAD DISK SUBSYSTEM

\$1595.00

**MORROW
DESIGNS**

SAVE OVER 45% !!

There are price barriers to be broken, and then there are **PRICE BARRIERS TO BE S-H-A-T-T-E-R-E-D!!** Priority One Electronics prides itself on breaking price barriers — but never like the one you see here! We're talking about 16 **M-E-G-A-B-Y-T-E-S** FOR ONLY **\$1595.00!!**

That's the storage capacity of THIRTY TWO Shugart SA801Rs — at one tenth the price! And there can be no comparisons between the performance of this system and floppy disk drives!



BPMDSDMAM16

PURE SPEED

That's what you get when you operate this subsystem. Imagine data access virtually without wait! By using DMA technology, the actual time required to send and retrieve data is greatly reduced. With the additional speed and high density of the 5¼" Winchester disk drive from COMPUTER MEMORIES, you will have enormous files at your own fingertips without the frustration of searching for the right floppy disk! The throughput of this subsystem is further increased by having all low level disk drive routines resident on the DMA controller, thus relieving the computer for other tasks.

COMPATIBILITY

MORROW DESIGNS engineers have invested thousands of man-hours to assure that this M16 hard disk subsystem will be compatible with almost all S-100 IEEE/696 computer systems. Each M16 hard disk subsystem is supplied with CP/M 2.2™, and MICROSOFT BASIC V5.2™. **MORROW DESIGNS** has even included an INSTALL program on 8" disk so you can easily custom configure your M16 subsystem to operate flawlessly with any system that is fully IEEE/696 compatible and has no other DMA devices on line.

EXPANDABLE

The M16 subsystem can grow with your needs. The DMA controller can operate up to four drives at one time. Just imagine — 64 MBytes on line! Also, as technologies progress, you will be prepared with a controller designed with the future in mind!

KEY FEATURES:

DISK DRIVE:

- DISCUS M16 Computer Memories CMI5616, 16Mb formatted capacity
- Same physical size and mounting as the minifloppy
- Same DC voltages as the minifloppy
- Band actuator and stepper motor head positioning
- 5.0 megabit/second transfer rate
- Same track capacity as a double density 8 inch floppy
- 170 millisecond random average access time, reduceable to 95 ms via a simple software algorithm

CONTROLLER:

- Fully compatible with high speed 6MHz and 8 MHz CPU of today and tomorrow
- DMA bus arbitration as outlined by the IEEE 696 standard
- Controls 1 to 4 soft sectored Winchester drives
- Variable sector length (256, 512, 1024, or 2048 byte sectors)
- Automatic CRC generation and checking
- Addresses 1 to 16 heads
- Addresses an infinite number of tracks
- 24-bit address burst DMA transfers
- Due to this high transferrate, a minimum CPU speed of 2.5MHz is required

**WITH CP/M 2.2™ AND
MICROSOFT
BASIC V5.2™!**

**NO KIDDING!
16,000,000 BYTES FOR**

**ONLY
\$1595.00
SAVE \$1400.00!!**

**DON'T WAIT!!!
WE HAVE ONLY A LIMITED QUANTITY
THAT WILL BE AVAILABLE ON A FIRST
COME FIRST SERVE BASIS!
AND THESE WON'T LAST LONG!**

RETAIL STORE PHONE NUMBERS: (Chatsworth:) (213) 709-5464 - (Irvine:) (714) 660-1411

NO ONE ELSE HAS LOWER SCOPE PRICES!

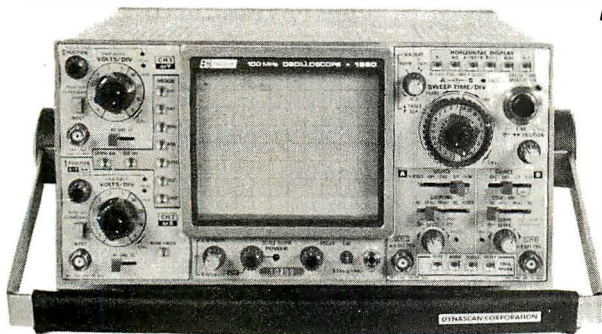

SALE!!

2 Probes Included With Each Scope!

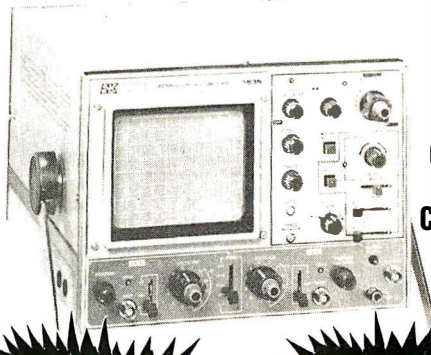

DIRECT FACTORY CONSUMER REBATE CERTIFICATE INCLUDED!

\$75.00 REBATE!

\$50.00 REBATE!

DUAL TIME BASE! CALIBRATED DELAYED SWEEP!

- 100MHz BKP1590, 70MHz BKP1570
- 1mV/division sensitivity
- 500 μ V/division cascade sensitivity
- Four-input operation provides trigger view on 4 separate inputs
- Alternate time base operation
- 20 MHz bandwidth limiter CH1 & CH2

- Lighted function pushbuttons employing electronic switching with non-volatile RAM memory
- 8 x 10 cm internal graticule CRT
- Video sync separator standard
- Dual intensity controls
- Voltage and current probe calibrators (BKP1590 only)

BKP1535 SPECIFICATIONS:

- 35MHz response, usable beyond 50 MHz • 2 mV/cm vertical sensitivity • Signal delay line for accurate view of high frequency pulse leading edge
- Alternate trigger capability • Automatic or manual selection of CHOP AND ALTERNATE dual-trace display • Variable hold-off for accurate pulse train display • Video sync separators standard • Built-in triggering filters • PDA CRT with P31 phosphor • 10:1/ref/direct probes included • Differential input capability

BKP1530 SPECIFICATIONS:

- Delayed sweep operation for sweep expansion up to 1000V • 5 mV division sensitivity selectable 2 mV to 20MHz • Variable hold-off pulse train display • Single-sweep for nonrepetitive waveforms • Built-in triggering filters • Video sync separator standard • CHOP or ALTERNATE display • Differential input capability • 11.7 nS rise time for short duration pulses • Alternate trigger capability • Front panel x-y operation • 10:1/ref/direct probes included



100 MHz
8 TRACE - 4 CHANNEL
BPBKP1590 List Price: \$1995.00
\$1449.00
(Shipping Weight 18 lbs.)
SAVE \$546.00!!

70 MHz
8 TRACE - 4 CHANNEL
BPBKP1570 List Price: \$1395.00
\$995.00
(Shipping Weight 18 lbs.)
SAVE \$400.00!!

35 MHz
DUAL TRACE - TRIGGERED
BPBKP1535 List Price \$950.00
\$695.00
(Shipping Weight 20 lbs.)
SAVE \$430.00!!
INCLUDING REBATE

30 MHz
DUAL TRACE - DELAYED SWEEP
BPBKP1530 List Price: \$875.00
\$625.00
(Shipping Weight 20 lbs.)
SAVE \$301.00!!
INCLUDING REBATE

H-P QUALITY AND PERFORMANCE AT OUR LOW PRICES!

SERIES 10 - Programmable Calculators

- RPN Logic
- Continuous Memory
- Convenient Design
- Automatic Turn-off Function
- LCD
- Self Diagnosis
- Rugged Construction

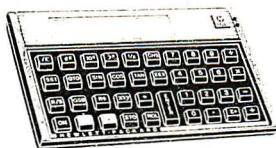

Part No.	Description	List Price	SALE
BP HP-10C	Scientific (Sh. Wt. 3 lbs.)	\$ 70.00	\$ 59.00
BP HP-11C	Advanced Scientific (3 lbs.)	\$ 90.00	\$ 79.00
BP HP-12C	Advanced Financial	\$120.00	\$ 99.00
BP HP-15C	Advanced Scientific w/matrices (3 lbs.)	\$120.00	\$ 99.00
BP HP-16C	For Digital Electronics and Computer Science (Sh. Wt. 3 lbs.)	\$120.00	\$ 99.00

HP-41C/CV - Handheld Computer System

hp HEWLETT PACKARD SUPER LOW PRICES - FREE EXTRAS!*

Buy a Series 40 Computer or Peripheral and get an enhancement module FREE* — Up to a \$125.00 Value! One Free Module with each Computer or Peripheral!



Buy one of these:

BP HP-41C	Handheld computer with HP82106A memory module included (Wt. 5 lbs.)	\$195.00	\$275.00
BP HP-41CV	Handheld Computer w/5X Memory (5 lbs.)	\$195.00	\$219.00
BP HP82104A	Plug-in Card Reader (Sh. Wt. 5 lbs.)	\$195.00	\$159.00
BP HP82153A	Optical Wand (Sh. Wt. 5 lbs.)	\$125.00	\$ 99.00
BP HP82161A	Digital Cassette Drive (Sh. Wt. 5 lbs.)	\$450.00	\$349.00
BP HP82162A	Thermal Printer/Plotter (Sh. Wt. 5 lbs.)	\$450.00	\$349.00
BP HP82163A	Video Interface (Sh. Wt. 5 lbs.)	\$225.00	\$179.00

Get One of These Enhancement Modules FREE!*

BP HP82160A	HP-IL Module	\$125.00	\$59.00
BP HP82170A	Quad RAM	\$ 75.00	\$59.00
BP HP82180A	Extended Functions/Memory Module	\$ 75.00	\$59.00
BP HP82181A	Extended Memory Module	\$ 75.00	\$59.00
BP HP82182A	Time Module	\$ 75.00	\$59.00

*Each Computer or Peripheral is shipped with a coupon for free Enhancement Module direct from Hewlett-Packard (Offer expires 4/30/83).

hp HEWLETT PACKARD HP-75C Portable Computer



- Accepts 48K of applications ROM
- Touch-type typewriter-like keyboard
- Powerful BASIC Language
- Uses same peripherals as Series 40

BP HP-75C (Sh. Wt. 5 lbs.) List Price: \$995.00

SALE PRICE: \$849.00



PRIORITY ONE ELECTRONICS

9161 DEERING AVE. CHATSWORTH, CA 91311

ORDER TOLL FREE (800) 423-5922 - CA, AK, HI CALL (213) 709-5111

Terms: U.S. VISA, MC, BAC, Check, Money Order, U.S. Funds Only. CA resident s add 6 1/2% Sales Tax. MINIMUM PREPAID ORDER \$15.00. Include MINIMUM SHIPPING & HANDLING of \$3.00 for the first 3 lbs. plus 40¢ for each additional pound. Orders over 50 lbs. sent freight collect. Just in case, please include your phone number. Prices subject to change without notice. We will do our best to maintain prices through April, 1983. Credit Card orders will be charged appropriate freight. If you haven't received your Winter '83 Engineering Selection guide, send \$1.00 for your copy today! Sale prices for prepaid orders only.



RETAIL STORE PHONE NUMBERS: (Chatsworth:) (213) 709-5464 - (Irvine:) (714) 660-1411

S-100-4 MINI'S

Choose the System that fits your needs!
A complete computer system ready to add on a terminal and printer. All Systems include CP/M® software and system manual set. Full six-month parts and labor warranty excluding drives which carry the full O.E.M. manufacturers warranty.

MINI FLOPPY

Only \$1395.00 COMPLETE



- ★ with 48 TPI single sided double density 5¼" . \$1395.00
- ★ with 48 TPI double sided double density 5¼" . \$1495.00
- ★ with 96 TPI double sided double density 5¼" . \$1650.00

An inexpensive but powerful system featuring a 4 slot S-100 bus chassis with the XOR S-100 board set; 4-MHZ Z-80 CPU ★ 64K dynamic memory ★ multi-sector mixed density disk controller ★ 2-RS232 output ports in the rear for your terminal and printer ★ 3 eight-bit parallel ports on the CPU ready to add a cable and interface to your printer ★ All above systems are in stock ★ Includes CP/M® 2.2.
CP/M is a trademark of Digital Research

DUAL DRIVE SUBSYSTEMS



HORIZONTAL OR VERTICAL
Fully Assembled and Tested Units

- w/two Shugart 801R SS/DD \$ 975.00
- w/two Shugart 851R DS/DD 1225.00
- w/two Siemens 120-8 SS/DD 675.00
- w/two Qume DT-8 DS/DD 1250.00
- w/two Tandon 848-1 SS/DD 995.00
- w/two Tandon 848-2 DS/DD 1195.00
- Cabinet A & T w/Power Supply and Accs. . 235.00
- Cabinet Top and Bottom Only—69.50

California Computer Systems SPECIAL!



CCS SYSTEM 2410 . . \$1995.00

- Includes CP/M® 2.2
- DMA Disk Controller
- 2-Serial/1-Parallel Port
- Hardware Vectored Interrupts
- 2-Real Time Clocks
- Supports CP/M®, MP/M®, OASIS

CCS 2300 System, A & T . . 1695.00

- 2810 CPU Only—255.00
- 2422 Disk Controller Only—330.00
- 2066 64K Only—360.00
- 2300A Mainframe NEW! . . . Only—455.00
- CCS Apple Boards . . . Call Toll Free For Prices

HARD DISK

Only \$2995.00 COMPLETE

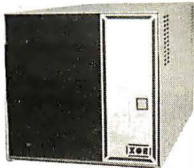

These S-100-4 Systems may be very small in size (9"H x 9½"W x 18½"L) but look at the size of the ATASI® 5¼" Winchester hard disks we offer!

4 models to choose from

- ★ Seagate 5 Megabyte System \$2995.00
- ★ #3020 15.6 Megabyte* System \$3495.00
- ★ #3033 26 Megabyte* System \$3995.00
- ★ #3046 36 Megabyte* System \$4495.00

The above systems include a 96 TPI double sided double density 5¼" floppy as standard. The hard disk is controlled by Western Digital's controller for hard disks. Other features are the same as system at left.
*Megabyte sizes mentioned above are the available storage space after formatting.

TAPE BACKUP

WITH HARD DISK Only \$4250.00 COMPLETE

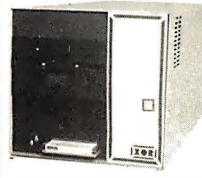

Now available through U.S. Micro Sales, the XOR IRWIN 510 S-100-4 tape backup system with 10 megabytes of hard disk storage. Back up your hard disk on a mini-tape (we're talking 10 meg.) in less than 3½ minutes! The above system includes a 96 TPI DS/DD floppy drive and this system's modular design allows you to add a second floppy for only \$395.00.

A MAJOR BREAKTHROUGH IN TECHNOLOGY . . .

IOMEGA™ CORP. ANNOUNCES THE ALPHA-10™



10 Megabyte Flexible Media Storage Sub-System

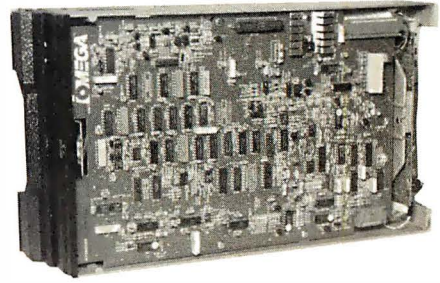

IOMEGA Technology

IOMEGA has combined the **reliability** of Winchester Technology with the **low cost removability** of flexible media recording to create a new generation of information storage technology. A unique system of media stabilization enables the flexible media to fly at close proximity to the head, resulting in high density, non-contact recording. Embedded servo and IOMEGA's Parity-Sector Error Correction further enhance the high density and data reliability achieved with the new technology. IOMEGA TECHNOLOGY is the step forward the industry has been awaiting.

High performance and reliability of any Removable Disk Drive. Lowest-cost 10 megabyte Disk Cartridge. More resistant to shock and vibration than any other Fixed or Removable Disk Drive. More resistant to contamination than any other Removable Disk Drive. Fastest start/stop (cartridge replacement) time of any high performance Disk Drive. Only Disk Cartridge Subsystem (drive, controller and cartridge) to dimensionally conform to the diskette standard. (size and mounting), i.e. identical size to Shugart 801/851.

Below is pictured XOR Data Science brand new S-100-12PLUS employing a fantastic 10 Meg floppy system. This new product is absolutely the greatest thing to hit the market in the last five years! Think of it, no more backup problems or head crash! 100 Meg of your data in the space the size of a shoe-box — and you can take it home with you. Call and ask for our folder before you buy your new computer system. It is definitely the best investment you can make.

(#S1000-75) Complete **\$3995.00**

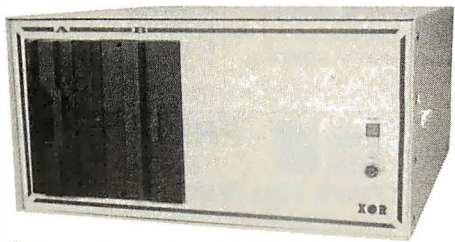

* Extra cartridges available (#M-2000-51). \$50.00
ALPHA-10™ is a product manufactured by IOMEGA™ CORP.

IOMEGA Alpha 10

- 10 megabyte formatted capacity.
- Removable 10 megabyte flexible media cartridge.
- 1.13 megabyte/sec. data rate (instantaneous)
- 35 msec average access time.
- Low power: 35 watts including integrated controller.
- 8000 hours MTBF.
- Embedded servo for track following and track accessing.
- Parity-Sector Error Correction that insures non-recoverable data errors will be less than one in 10¹² bits transferred to the host.
- Dimensions: Disk Drive 4.5" x 8.5" x 14.3" Cartridge ¾" x 8.23" x 11"



Visit Our Retail Stores

ORDER TOLL FREE

☆ EAST ☆ WEST ☆

1 (800) 435-9357 1 (800) 854-8174

In Ill. 1 (815) 485-4002 In Calif. 1 (714) 891-2677

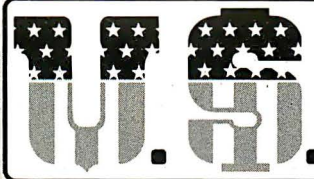

MICRO SALES

★ MADE IN U.S.A. BY AMERICANS ★

★ EAST ★ 11 Edison Drive, New Lenox, Illinois 60451
★ WEST ★ 6182 Garden Grove Blvd., Westminster, CA 92683

TERMS: We accept VISA/MC, prepay, check or money order. Please allow personal check two weeks to clear before shipment. \$5.00 handling charge on all orders under \$50.00. 15% Restocking Fee. All orders shipped via U.P.S. unless otherwise specified. All UPS C.O.D. orders over \$100.00 require a Cashiers Check. * Our products carry a full 6 months parts and labor warranty excluding drives, printers and terminals which carry the full O.E.M. factory warranty. PRICES SUBJECT TO CHANGE WITHOUT NOTICE.

UNIVERSAL POWER SUPPLY

For Big Board, Apple or Aim 65
+5VDC @ 3 Amps
+12VDC @ .750 Amps
-12VDC @ .750Amps
-5VDC @ .500 Amps
Dimensions: 4" x 4" x 11"



\$69.95

DISK DRIVE POWER SUPPLY

For 2 - 8" or 5" Drives
+ 5VDC @ 4 Amps
+24VDC @ 3 Amps
- 5VDC @ 1 Amp

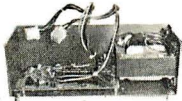

AC Cables for 2 Drives \$7.50

Dimensions: 4" x 4" x 11"

\$59.95

S-100 POWER SUPPLY

+8VDC @ 30 Amps
+16VDC @ 6 Amps
-16VDC @ 6 Amps
PC Board Design



\$89.50

Dimensions: 5" x 6" x 11"

TERMINALS

Televideo 910+ with green screen... \$575.00
T.V. 925... 739.00 T.V. 950... 945.00
Adds Viewpoint Model 3A+ 519.00
Zenith Z-19 740.00

PRINTERS

Okidata 82A 80 Column 465.00
Okidata 83A 132 Column 745.00
C-I-TOH Prowriter I 525.00
I.D.S. Microprism Model 480 565.00
★★★★★ STAR MICRONICS ★★★★★
Gemini 10 Serial \$130 OFF
Gemini 10 Parallel 120 OFF
Gemini 15 Serial 150 OFF
Gemini 15 Parallel 140 OFF

8" DISK DRIVES

Shugart 801R... \$388.00ea. Two for \$379.00ea.
Shugart 851R... 535.00ea. Two for 529.00ea.
Qume DT-8... 540.00ea. Two for 529.00ea.
Tandon 848-1... 395.00ea. Two for 388.00ea.
Tandon 848-2... 525.00ea. Two for 519.00ea.
Siemens 120-8... 235.00ea. Two for 225.00ea.
All Shugart Drives now carry a full One Year Parts and Labor Warranty!

S-100 MOD KIT
by XOR

For test or systems applications.
Complete S-100 12 Slot Main-frame with Disk Drive Power Supply for 4 Drives.

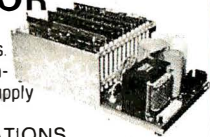

SPECIFICATIONS

Unregulated	Regulated
+8V @ 30A	+5V @ 5A
±16V @ 6A	+24V @ 3A
	-5V @ 1A

\$225.00 Kit with 12 S-100 Bus Connectors
\$255.00 Assem. and Tested with 12 Bus Connectors
\$15.00 AC/DC Drive Cable Set for 2 Drives
Dimensions 6" x 10" x 18" - Shipping Weight 25 lbs.

Cooling Power
4 1/8"

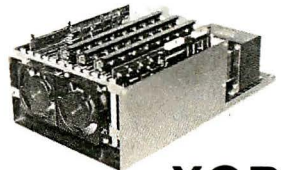

Low Velocity
Whisper® Fans
Only \$18.00 ea.
Finger Guards
\$2.50 each.

XOR
S-100 MOD

CUSTOMER SERVICE HOTLINE 1 - (714) 898-5525

S-100-4

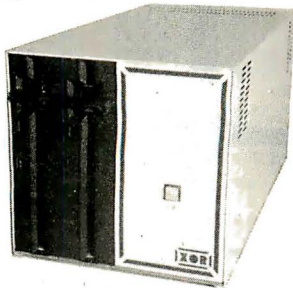

\$1695.00

- ★ 4 Slot S-100 Bus
- ★ Two Separate Power Supplies
- ★ XOR S-100 Board Set
- ★ Includes CP/M® 22 and Manual
- ★ All Cables Provided
- ★ Dimension only 9" x 9" x 18 1/2"

S-100-4 System Complete with:

2-Tandon Thinline 8" (Model TM-848-1 SS/DD)
Part #S-1000-40 **\$1695.00**
2-Tandon Thinline 8" (Model TM-848-2 DS/DD)
Part #S-1000-39 **\$1950.00**

★★★ SPECIAL OF THE MONTH ★★★

8" Dual Drive Subsystem 1.2 Meg Includes two Siemens 120-8 SS/DD Drives, Cables, Power Supplies and Cabinet. A & T **Only—\$675.00**

S-100-8



\$1795.00

- ★ Feather Touch Capacitance Kybrd
- ★ SOROC Type Screen Attribute Set
- ★ Half Intensity
- ★ 60 Key Standard ASCII
- ★ 8 Special Function Keys
- ★ 20 Screen Editing Keys

COMPUTER

★ XOR S-100 Board set
★ Programmable Keyboard Set
★ Includes CP/M® 2.2
★ 8 Slot S-100 Bus
S-100-8 System Complete With:
Shugart 801R Subsystem* (#S-1000-22) ... \$2675.00
Shugart 851R Subsystem* (#S-1000-23) ... 2925.00
Qume DT-8 Subsystem* (#S-1000-24) 2950.00
Shugart SA 400 Minis (#S-1000-25) 2350.00
Complete System, No Drives (#S-1000-21) .. 1795.00

*Available in Horizontal or Vertical Cabinet

S-100-12



\$1350.00

- ★ With the XOR S-100 MOD
- ★ +8V @ 30A
- ★ DC Power to Run up to 4 Drives
- ★ XOR S-100 Board set
- ★ Includes CP/M® 22 Software and Manual
- ★ All Cables Provided
- ★ Complete Manual Set

S-100-12 System Complete With:

2-Shugart 801R (#S-1000-30) \$ 2125.00
2-Shugart 851R (#S-1000-31) 2425.00
2-Qume DT-8 (#S-1000-32) 2450.00
Complete System, no drives 1350.00
Cabinet only - Includes Switches, Fan & AC/DC Wiring (#S-1000-28) 250.00
Dimensions 11" x 21" x 22"
CP/M® is a trademark of Digital Research

Apple 8" Disk Controller Card **\$395.00**

ZVX4 Dual Density, Single & Double Sided - Auto Boot
Disk 2 + 2 Single Density Single or Dual Sided

SVI **300.00**

**Complete line of add on drives for Apple
CALL TOLL FREE FOR PRICES**

Ask about our Low Cost MODEM Software

Hayes-MicroModem 100 Ser/Par 110/300 Baud **\$275.00**
Hayes-Smart Modem 300 Baud Orig/Ans Director 250.00
Novation-DCAT300 Baud Direct Con. Ans/Orig 165.00
Novation-AUTOCAT Auto/Ans/Orig Direct Con. 235.00
Novation-APPLECAT 300/1200 Baud Direct Con. 350.00
PMMI-MM103 300/600 Baud (S-100 BUS) 359.00

SOFTWARE

BASIC 80 **\$290.00**
BASIC COMPILER 320.00
CALCSTAR 150.00
C BASIC 118.00
C COMPILER 175.00
MACRO ASSEMBLER 90.00
MAILMERGE 115.00

4164 64K DYNAMIC \$595

200 NS

TMM2016 2KX8 STATIC \$415

200 NS

STATIC RAMS

2101	256 x 4 (450ns)	1.95
5101	256 x 4 (450ns) (cmos)	3.95
2102-1	1024 x 1 (450ns)	.89
2102L-4	1024 x 1 (450ns) (LP)	.99
2102L-2	1024 x 1 (250ns) (LP)	1.49
2111	256 x 4 (450ns)	2.49
2112	256 x 4 (450ns)	2.99
2114	1024 x 4 (450ns)	8/9.95
2114L-4	1024 x 4 (450ns) (LP)	8/12.95
2114L-3	1024 x 4 (300ns) (LP)	8/13.45
2114L-2	1024 x 4 (200ns) (LP)	8/13.95
2147	4096 x 1 (55ns)	4.95
TMS4044-4	4096 x 1 (450ns)	3.49
TMS4044-3	4096 x 1 (300ns)	3.99
TMS4044-2	4096 x 1 (200ns)	4.49
MK4118	1024 x 8 (250ns)	9.95
TMM2016-200	2048 x 8 (200ns)	4.15
TMM2016-150	2048 x 8 (150ns)	4.95
TMM2016-100	2048 x 8 (100ns)	6.15
HM6116-4	2048 x 8 (200ns) (cmos)	4.75
HM6116-3	2048 x 8 (150ns) (cmos)	4.95
HM6116-2	2048 x 8 (120ns) (cmos)	8.95
HM6116LP-4	2048 x 8 (200ns) (cmos)(LP)	5.95
HM6116LP-3	2048 x 8 (150ns) (cmos)(LP)	6.95
HM6116LP-2	2048 x 8 (120ns) (cmos)(LP)	10.95
Z-6132	4096 x 8 (300ns) (Qstat)	34.95

LP = Low Power Qstat = Quasi-Static

DYNAMIC RAMS

TMS4027	4096 x 1 (250ns)	1.99
UPD411	4096 x 1 (300ns)	3.00
MM5280	4096 x 1 (300ns)	3.00
MK4108	8192 x 1 (200ns)	1.95
MM5298	8192 x 1 (250ns)	1.85
4116-300	16384 x 1 (300ns)	8/11.75
4116-250	16384 x 1 (250ns)	8/11.95
4116-200	16384 x 1 (200ns)	8/12.95
4116-150	16384 x 1 (150ns)	8/14.95
4116-120	16384 x 1 (120ns)	8/29.95
2118	16384 x 1 (150ns) (5v)	4.95
4164-200	65536 x 1 (200ns) (5v)	5.95
4164-150	65536 x 1 (150ns) (5v)	6.95

5V = single 5 volt supply

EPROMS

1702	256 x 8 (1us)	4.50
2708	1024 x 8 (450ns)	3.95
2758	1024 x 8 (450ns) (5v)	5.95
2716	2048 x 8 (450ns) (5v)	3.95
2716-1	2048 x 8 (350ns) (5v)	5.95
TMS2516	2048 x 8 (450ns) (5v)	5.50
TMS2716	2048 x 8 (450ns)	7.95
TMS2532	4096 x 8 (450ns) (5v)	5.95
2732	4096 x 8 (450ns) (5v)	8.95
2732-250	4096 x 8 (250ns) (5v)	8.95
2732-200	4096 x 8 (200ns) (5v)	11.95
2764	8192 x 8 (450ns) (5v)	9.95
2764-250	8192 x 8 (250ns) (5v)	14.95
2764-200	8192 x 8 (200ns) (5v)	24.95
TMS2564	8192 x 8 (450ns) (5v)	17.95
MC68764	8192 x 8 (450ns) (5v)(24 pin)	39.95

5v = Single 5 Volt Supply

EPROM ERASERS

	Timer	Capacity Chip	Intensity (uW/Cm ²)	
PE-14		6	5,200	83.00
PE-14T	X	6	5,200	119.00
PE-24T	X	9	6,700	175.00
PL-265T	X	20	6,700	255.00
PR-125T	X	16	15,000	349.00
PR-320	X	32	15,000	595.00

Z-80

2.5 Mhz

Z80-CPU	3.95
Z80-CTC	4.49
Z80-DART	10.95
Z80-DMA	14.95
Z80-PIO	4.49
Z80-SIO/0	16.95
Z80-SIO/1	16.95
Z80-SIO/2	16.95
Z80-SIO/9	16.95

4.0 Mhz

Z80A-CPU	4.95
Z80A-CTC	4.95
Z80A-DART	11.95
Z80A-DMA	16.95
Z80A-PIO	4.95
Z80A-SIO/0	16.95
Z80A-SIO/1	16.95
Z80A-SIO/2	16.95
Z80A-SIO/9	16.95

6.0 Mhz

Z80B-CPU	11.95
Z80B-CTC	13.95
Z80B-PIO	13.95
Z80B-DART	19.95

ZILOG

Z6132	34.95
Z8671	39.95

CRYSTALS

32.768 khz	1.95
1.0 mhz	4.95
1.8432	4.95
2.0	3.95
2.097152	3.95
2.4576	3.95
3.2768	3.95
3.579535	3.95
4.0	3.95
5.0	3.95
5.0688	3.95
5.185	3.95
5.7143	3.95
6.0	3.95
6.144	3.95
6.5536	3.95
8.0	3.95
10.738635	3.95
14.31818	3.95
15.0	3.95
16.0	3.95
17.430	3.95
18.0	3.95
18.432	3.95
20.0	3.95
22.1184	3.95
32.0	3.95

CRT CONTROLLERS

6845	14.95
68B45	35.95
HD46505SP	15.95
6847	12.25
MC1372	6.95
68047	24.95
8275	29.95
7220	99.95
CRT5027	39.95
CRT5037	49.95
TMS9918A	39.95
DP8350	49.95

KEYBOARD CHIPS

AY5-2376	11.95
AY5-3600	11.95

8000

8035	5.95
8039	6.95
INS-8060	17.95
INS-8073	24.95
8080	3.95
8085	5.95
8085A-2	11.95
8086	29.95
8087	CALL
8088	39.95
8089	89.95
8155	6.95
8155-2	7.95
8156	6.95
8185	29.95
8185-2	39.95
8741	39.95
8748	24.95
8755	24.95

8200

8202	24.95
8203	39.95
8205	3.50
8212	1.80
8214	3.85
8216	1.75
8224	2.25
8226	1.80
8228	3.49
8231	call
8237	19.95
8237-5	21.95
8238	4.49
8243	4.45
8250	10.95
8251	4.49
8253	6.95
8253-5	7.95
8255	4.49
8255-5	5.25
8257	7.95
8257-5	8.95
8259	6.90
8259-5	7.50
8271	39.95
8272	39.95
8275	29.95
8279	8.95
8279-5	10.00
8282	6.50
8283	6.50
8284	5.50
8286	6.50
8287	6.50
8288	25.00
8289	49.95

DISC CONTROLLERS

1771	16.95
1791	24.95
1793	26.95
1795	49.95
1797	49.95
2791	54.95
2793	54.95
2795	59.95
2797	59.95
6843	34.95
8272	39.95
UPD765	39.95
1691	17.95
2143	18.95

CONNECTORS

RS232 MALE	2.50
RS232 FEMALE	3.25
RS232 HOOD	1.25
S-100 ST	3.95

6800

68000	59.95
6800	3.95
6802	7.95
6808	13.90
6809E	19.95
6809	11.95
6810	2.95
6820	4.35
6821	3.25
6828	14.95
6840	12.95
6843	34.95
6844	25.95
6845	14.95
6847	11.95
6850	3.25
6852	5.75
6860	9.95
6862	11.95
6875	6.95
6880	2.25
6883	22.95
68047	24.95
68488	19.95

6800 = 1MHZ

68B00	10.95
68B02	22.25
68B09E	29.95
68B09	29.95
68B10	6.95
68B21	6.95
68B45	19.95
68B50	5.95

68B00 = 2 MHZ

6500

1 MHZ	
6502	4.95
6504	6.95
6505	8.95
6507	9.95
6520	4.35
6522	7.95
6532	9.95
6545	22.50
6551	11.85
2 MHZ	
6502A	6.95
6522A	9.95
6532A	11.95
6545A	27.95
6551A	11.95
3 MHZ	
6502B	14.95

UARTS

AY3-1014	6.95
AY5-1013	3.95
AY3-1015	6.95
PT1472	9.95
TR1602	3.95
2350	9.95
2651	8.95
TMS6011	5.95
IM6402	7.95
IM6403	8.95
INS8250	10.95

GENERATORS BIT-RATE

MC14411	11.95
BR1941	11.95
4702	12.95
COM5016	16.95
COM8116	10.95
MM5307	10.95

FUNCTION

MC4024	3.95
LM566	1.49
XR2206	3.75
8038	3.95

74LS00

74LS00	.24	74LS173	.69
74LS01	.25	74LS174	.55
74LS02	.25	74LS175	.55
74LS03	.25	74LS181	2.15
74LS04	.24	74LS189	8.95
74LS05	.25	74LS190	.89
74LS08	.28	74LS191	.89
74LS09	.29	74LS192	.79
74LS10	.25	74LS193	.79
74LS11	.35	74LS194	.69
74LS12	.35	74LS195	.69
74LS13	.45	74LS196	.79
74LS14	.59	74LS197	.79
74LS15	.35	74LS221	.89
74LS20	.25	74LS240	.95
74LS21	.29	74LS241	.99
74LS22	.25	74LS242	.99
74LS26	.29	74LS243	.99
74LS27	.29	74LS244	.99
74LS28	.35	74LS245	1.49
74LS30	.25	74LS247	.75
74LS32	.29	74LS248	.99
74LS33	.55	74LS249	.99
74LS37	.35	74LS251	.59
74LS38	.35	74LS253	.59
74LS40	.25	74LS257	.59
74LS42	.49	74LS258	.59
74LS47	.75	74LS259	2.75
74LS48	.75	74LS260	.59
74LS49	.75	74LS266	.55
74LS51	.25	74LS273	1.49
74LS54	.29	74LS275	3.35
74LS55	.29	74LS279	.49
74LS63	1.25	74LS280	1.98
74LS73	.39	74LS283	.69
74LS74	.35	74LS290	.89
74LS75	.39	74LS293	.89
74LS76	.39	74LS295	.99
74LS78	.49	74LS298	.89
74LS83	.60	74LS299	1.75
74LS85	.69	74LS323	3.50
74LS86	.39	74LS324	1.75
74LS90	.55	74LS352	1.29
74LS91	.89	74LS353	1.29
74LS92	.55	74LS363	1.35
74LS93	.55	74LS364	1.95
74LS95	.75	74LS365	.49
74LS96	.89	74LS366	.49
74LS107	.39	74LS367	.45
74LS109	.39	74LS368	.45
74LS112	.39	74LS373	.99
74LS113	.39	74LS374	.99
74LS114	.39	74LS377	1.39
74LS122	.45	74LS378	1.18
74LS123	.79	74LS379	1.35
74LS124	2.90	74LS385	1.90
74LS125	.49	74LS386	.45
7			

2114

450 NS

8/\$995

2114

250 NS

8/\$1095

7400

7400	.19	74132	.45
7401	.19	74136	.50
7402	.19	74141	.65
7403	.19	74142	2.95
7404	.19	74143	2.95
7405	.25	74145	.60
7406	.29	74147	1.75
7407	.29	74148	1.20
7408	.24	74150	1.35
7409	.19	74151	.55
7410	.19	74152	.65
7411	.25	74153	.55
7412	.30	74154	1.25
7413	.35	74155	.75
7414	.49	74156	.65
7416	.25	74157	.55
7417	.25	74159	1.65
7420	.19	74160	.85
7421	.35	74161	.69
7422	.35	74162	.85
7423	.29	74163	.69
7425	.29	74164	.85
7426	.29	74165	.85
7427	.29	74166	1.00
7428	.45	74167	2.95
7430	.19	74170	1.65
7432	.29	74172	5.95
7433	.45	74173	.75
7437	.29	74174	.89
7438	.29	74175	.89
7440	.19	74176	.89
7442	.49	74177	.75
7443	.65	74178	1.15
7444	.69	74179	1.75
7445	.69	74180	.75
7446	.69	74181	2.25
7447	.69	74182	.75
7448	.69	74184	2.00
7450	.19	74185	2.00
7451	.23	74190	1.15
7453	.23	74191	1.15
7454	.23	74192	.79
7460	.23	74193	.79
7470	.35	74194	.85
7472	.29	74195	.85
7473	.34	74196	.79
7474	.33	74197	.75
7475	.45	74198	1.35
7476	.35	74199	1.35
7480	.59	74221	1.35
7481	1.10	74246	1.35
7482	.95	74247	1.25
7483	.50	74248	1.85
7485	.59	74249	1.95
7486	.35	74251	.75
7489	2.15	74259	2.25
7490	.35	74265	1.35
7491	.40	74273	1.95
7492	.50	74276	1.25
7493	.35	74279	.75
7494	.65	74283	2.00
7495	.55	74284	3.75
7496	.70	74285	3.75
7497	2.75	74290	.95
74100	1.75	74293	.75
74107	.30	74298	.85
74109	.45	74351	2.25
74110	.45	74365	.65
74111	.55	74366	.65
74116	1.55	74367	.65
74120	1.20	74368	.65
74121	.29	74376	2.20
74122	.45	74390	1.75
74123	.49	74393	1.35
74125	.45	74425	3.15
74126	.45	74426	.85
74128	.55	74490	2.55

LINEAR

LM301	.34	LM340 (see 7800)	LM566	1.49	LM1800	2.37
LM301H	.79	LM348	LM567	.89	LM1812	8.25
LM307	.45	LM350K	NE570	3.95	LM1830	3.50
LM308	.69	LM350T	NE571	2.95	LM1871	5.49
LM308H	1.15	LM358	NE592	2.75	LM1872	5.49
LM309H	1.95	LM359	LM709	.59	LM1877	3.25
LM309K	1.25	LM376	LM710	.75	LM1889	1.95
LM310	1.75	LM377	LM711	.79	LM1896	1.75
LM311	.64	LM378	LM723	.49	ULN2003	2.49
LM311H	.89	LM379	LM723H	.55	LM2877	2.05
LM312H	1.75	LM380	LM733	.98	LM2878	2.25
LM317K	3.95	LM380N-8	LM741	.35	LM2900	.85
LM317T	1.19	LM381	LM741N-14	.35	LM2901	1.00
LM318	1.49	LM382	LM741H	.40	LM3900	.59
LM318H	1.59	LM383	LM747	.69	LM3905	1.25
LM319H	1.90	LM384	LM748	.59	LM3909	.98
LM319	1.25	LM386	LM1014	1.19	LM3911	2.25
LM320 (see 7900)	LM387	1.40	LM1303	1.95	LM3914	3.95
LM322	1.65	LM389	LM1310	1.49	LM3915	3.95
LM323K	4.95	LM390	MC1330	1.69	LM3916	3.95
LM324	.59	LM392	MC1349	1.89	MC4024	3.95
LM329	.65	LM394H	MC1350	1.19	MC4044	4.50
LM331	3.95	LM399H	MC1358	1.69	RC4136	1.25
LM334	1.19	NE531	MC1372	6.95	RC4151	3.95
LM335	1.40	NE555	LM1414	1.59	LM4250	1.75
LM336	1.75	NE556	LM1458	.59	LM4500	3.25
LM337K	3.95	NE558	LM1488	.69	RC4558	.69
LM337T	1.95	NE561	LM1489	.69	LM13080	1.29
LM338K	6.95	NE564	LM1496	.85	LM13600	1.49
LM339	.99	LM565	LM1558H	3.10	LM13700	1.49

H = TO-5 CAN

T = TO-220

K = TO-3

RCA

CA 3023	2.75	CA 3082	1.65
CA 3039	1.29	CA 3083	1.55
CA 3046	1.25	CA 3086	.80
CA 3059	2.90	CA 3089	2.99
CA 3060	2.90	CA 3096	3.49
CA 3065	1.75	CA 3130	1.30
CA 3080	1.10	CA 3140	1.15
CA 3081	1.65	CA 3146	1.85
CA 3160	1.19		

TI

TL494	4.20	75365	1.95
TL496	1.65	75450	.59
TL497	3.25	75451	.39
75107	1.49	75452	.39
75110	1.95	75453	.39
75150	1.95	75454	.39
75154	1.95	75491	.79
75188	1.25	75492	.79
75189	1.25	75493	.89
75494	.89		

BI FET

TL071	.79	TL084	2.19
TL072	1.19	LF347	2.19
TL074	2.19	LF351	.60
TL081	.79	LF353	1.00
TL082	1.19	LF355	1.10
TL083	1.19	LF356	1.10
LF357	1.40		

74S00

74S00	.32	74S163	1.95
74S02	.35	74S168	3.95
74S03	.35	74S169	3.95
74S04	.35	74S174	.95
74S05	.35	74S175	.95
74S08	.35	74S181	3.95
74S09	.40	74S182	2.95
74S10	.35	74S188	1.95
74S11	.35	74S189	6.95
74S15	.35	74S194	1.49
74S20	.35	74S195	1.49
74S22	.35	74S196	1.49
74S23	.35	74S197	1.49
74S32	.40	74S201	6.95
74S37	.88	74S225	7.95
74S38	.85	74S240	2.20
74S40	.35	74S241	2.20
74S51	.35	74S244	2.20
74S64	.40	74S251	.95
74S65	.40	74S253	.95
74S74	.50	74S257	.95
74S85	1.99	74S258	.95
74S86	.50	74S260	.79
74S112	.50	74S274	19.95
74S113	.50	74S275	19.95
74S114	.55	74S280	1.95
74S124	2.75	74S287	1.90
74S132	1.24	74S288	1.90
74S133	.45	74S289	6.89
74S134	.50	74S301	6.95
74S135	.89	74S373	2.45
74S138	.85	74S374	2.45
74S139	.85	74S381	7.95
74S140	.55	74S387	1.95
74S151	.95	74S412	2.98
74S153	.95	74S471	4.95
74S157	.95	74S472	4.95
74S158	.95	74S474	4.95
74S161	1.95	74S482	15.25
74S162	1.95	74S570	2.95
		74S571	2.95

INTERFACE

8T26	1.59
8T28	1.89
8T95	.89
8T96	.89
8T97	.89
8T98	.89
DM8131	2.95
DP8304	2.29
DS8835	1.99
DS8836	.99

MISC.

ULN2003	2.49
3242	7.95
3341	4.95
MC3470	4.95
MC3480	9.00
11C90	13.95
95H90	7.95
2513-001 UP	9.95
2513-002 LOW	9.95

VOLTAGE REGULATORS

7805T	.75	7905T	.85
7808T	.75	7908T	.85
7812T	.75	7912T	.85
7815T	.75	7915T	.85
7824T	.75	7924T	.85
7805K	1.39	7905K	1.49
7812K	1.39	7912K	1.49
7815K	1.39	7915K	1.49
7824K	1.39	7924K	1.49
78L05	.69	79L05	.79
78L12	.69	79L12	.79
78L15	.69	79L15	.79
78H05K	9.95	LM323K	4.95
78H12K	9.95	UA78540	1.95

T = TO-220

K = TO-3

L = TO-92

IF YOU CAN FIND A PRICE LOWER ELSEWHERE, LET US KNOW AND WE WILL MEET OR BEAT THEIR PRICE! (SEE TERMS BELOW)

- ★ Computer managed inventory — virtually no back orders!
- ★ Very competitive prices!
- ★ Friendly staff!
- ★ Fast service — most orders shipped within 24 hours!



CLOCK CIRCUITS

MM5314	4.95
MM5369	3.95
MM5375	4.95
MM58167	8.95
MM58174	11.95
MSM5832	6.95

INTERSIL

ICL7103	9.50
ICL7106	9.95
ICL7107	12.95
ICL7660	2.95
ICL8038	3.95
ICM7207A	5.59
ICM7208	15.95

9000

9316	1.00
9334	2.50
9368	3.95
9401	9.95
9601	.75
9602	1.50
96S02	1.95

EXAR

XR 2206	3.75
XR 2207	3.75
XR 2208	3.75
XR 2211	5.25
XR 2240	3.25

DATA ACQUISITION

ADC0800	15.55	DAC0808	2.95
ADC0804	3.49	DAC1020	8.25
ADC0809	4.49	DAC1022	5.95
ADC0817	9.95	MC1408L6	1.95
DAC0800	4.95	MC1408L8	2.95

SOUND CHIPS

76477	3.95
76489	8.95
AY3-8910	12.95
AY3-8912	12.95
MC3340	1.49

ORDER TOLL FREE

800-538-5000

800-662-6279

(CALIFORNIA RESIDENTS)

ALL MERCHANDISE 100% GUARANTEED

CALL US FOR VOLUME QUOTES

2732 32K EPROM

\$495

2764 64K EPROM

\$995

CAPACITORS

TANTALUM

6V	10V	15V	20V	25V	35V	50V	
.22uf					.40		
.27					.40		
.33					.40	.45	
.47			.35		.50		
.68					.45	.50	
1.0		.40	.40	.45	.45		
1.5			.45		.50	.60	
1.8					.75		
2.2	.35	.40	.45		.65	.85	
2.7	.40	.45			.90		
3.3	.45	.50	.55	.60	.65	.90	
3.9	.45						
4.7	.45	.55		.60	.65	.85	.90
6.0		.60					
6.8		.70		.75			
8.2							1.00
10	.55	.65	.80	.85	.90	1.00	
12	.65	.85	.90				
15	.75	.85	.90				
18		1.25					
22	1.00	1.35					
27		2.25					
39	1.50						
47	1.35						
56	1.75						
100	3.25						
270	3.75						

DISC

22	50V	.05	470	50V	.05
25	50V	.05	560	50V	.05
27	50V	.05	680	50V	.05
33	50V	.05	820	50V	.05
47	50V	.05	.001uf	50V	.05
56	50V	.05	.0015	50V	.05
68	50V	.05	.0022	50V	.05
82	50V	.05	.01	50V	.07
100	50V	.05	.02	50V	.07
220	50V	.05	.05	50V	.07
330	50V	.05	.1	12V	.10
			.1	50V	.12

MONOLITHIC

.1uf-mono	50V	.18	.47uf-mono	50V	.25
-----------	-----	-----	------------	-----	-----

ELECTROLYTIC

RADIAL			AXIAL		
.47uf	50V	.14	1uf	50V	.14
1	25V	.14	4.7	16V	.14
2.2	35V	.15	10	16V	.14
4.7	50V	.15	10	50V	.16
10	50V	.15	22	16V	.14
47	35V	.18	47	50V	.20
100	16V	.18	100	15V	.20
220	35V	.20	100	35V	.25
470	25V	.30	150	25V	.25
2200	16V	.60	220	25V	.30
			330	16V	.40
			500	16V	.42
			1000	16V	.60
			1500	16V	.70
			6000	16V	.85

COMPUTER GRADE

26,000uf	30V	3.95	6000	16V	.85
----------	-----	------	------	-----	-----

WIREWRAP CARDS

FR-4 Epoxy Glass Laminate
With Gold-Plated Contact Fingers

S-100 BUSS

P100-1	Bare — No Foil Pads	15.95
P100-2	Horizontal BUSS	22.95
P100-3	Vertical BUSS	22.95
P100-4	Single Foil Pads Per Hole	23.95

APPLE

P500-1	Bare — No Foil Pads	15.95
P500-3	Horizontal BUSS	22.95
P500-4	Single Foil Pads Per Hole	23.95

IBM

IBM-PR	BUSS Lines + Pads	55.00
--------	-------------------	-------

GENERAL PURPOSE

22/44 PIN (.156" SPACING)

P441-3	Vertical BUSS, 4.5" x 6"	13.95
P442-3	Vertical BUSS, 4.5" x 9"	14.95
36/72 PIN (.1" SPACING)		
P721-3	Vertical BUSS, 4.5" x 6"	13.95
P722-3	Vertical BUSS, 4.5" x 9"	14.95

IF YOU CAN FIND A PRICE LOWER ELSEWHERE, LET US KNOW AND WE WILL MEET OR BEAT THEIR PRICE! (SEE TERMS BELOW)

OPTO-ISOLATORS

4N26	1.00	MCA-7	1.50
4N27	1.10	MCA-255	1.75
4N28	.69	IL-1	1.25
4N33	1.75	ILA-30	1.25
4N35	1.25	ILQ-74	2.75
4N37	1.25	H11C5	1.25
MCT-2	1.00	TIL-111	1.00
MCT-6	1.50	TIL-113	1.75

DIODES

1N751	5.1 volt zener	.25
1N759	12.0 volt zener	.25
1N4148	(1N914) switching	25/1.00
1N4004	400PIV rectifier	10/1.00
KBPO2	200PIV 1.5amp bridge	.45
KBPO4	400PIV 1.5amp bridge	.55

**MUFFIN FANS
NEW UN-USED**

4.68" Square	14.95
3.125" Square	14.95

SWITCHES

SPDT mini-toggle	1.25
DPDT mini-toggle	1.50
SPDT push-button	1.49

TRANSISTORS

2N918	.50	MPS3706	.15
MPS918	.25	2N3772	1.85
2N2102	.50	2N3903	.25
2N2218	.50	2N3904	.10
2N2218A	.50	2N3906	.10
2N2219	.50	2N4122	.25
2N2219A	.50	2N4123	.25
2N2222	.25	2N4249	.25
PN2222	.10	2N4304	.75
MPS2369	.25	2N4401	.25
2N2484	.25	2N4402	.25
2N2905	.50	2N4403	.25
2N2907	.25	2N4857	1.00
PN2907	.125	PN4916	.25
2N3055	.79	2N5086	.25
3055T	.69	PN5129	.25
2N3393	.30	PN5139	.25
2N3414	.25	2N5209	.25
2N3563	.40	2N6028	.35
2N3565	.40	2N6043	1.75
PN3565	.25	2N6045	1.75
MPS3638	.25	MPS-A05	.25
MPS3640	.25	MPS-A06	.25
PN3643	.25	MPS-A55	.25
PN3644	.25	TIP29	.65
MPS3704	.15	TIP31	.75
		TIP32	.79

HEAT-SINKS

TO-3 style	.95
TO-220 style	.35

IC SOCKETS

8 pin ST	1-99	100
14 pin ST	.13	.11
16 pin ST	.15	.12
18 pin ST	.17	.08
20 pin ST	.20	.18
22 pin ST	.29	.27
24 pin ST	.30	.27
28 pin ST	.40	.32
40 pin ST	.49	.39
64 pin ST	4.25	call
ST = SOLDERTAIL		
8 pin WW	.59	.49
14 pin WW	.69	.52
16 pin WW	.49	.49
18 pin WW	.99	.90
20 pin WW	1.09	.98
22 pin WW	1.39	1.28
24 pin WW	1.49	1.35
28 pin WW	1.69	1.49
40 pin WW	1.99	1.80
WW = WIREWRAP		
16 pin ZIF	6.75	call
24 pin ZIF	9.95	call
28 pin ZIF	10.95	call
ZIF = TEXTTOOL (Zero Insertion Force)		

DIP SWITCHES

4 POSITION	.85
5 POSITION	.90
6 POSITION	.90
7 POSITION	.95
8 POSITION	.95



LED LAMPS

Jumbo Red	1-99	100-up	.10	.09
Jumbo Green			.18	.15
Jumbo Yellow			.18	.15

LED DISPLAYS

HP 5082-7760	.6"	CC	1.29
MAN 72	.3"	CA	.99
MAN 74	.3"	CC	.99
FND-357 (359)	.375"	CC	1.25
FND-500 (503)	.5"	CC	1.49
FND-507 (510)	.5"	CA	1.49

BYPASS CAPS

.01 UF DISC	100/6.00
.1 UF DISC	100/8.00
.1 UF MONOLITHIC	100/15.00

RESISTORS

1/4 WATT 5% CARBON FILM ALL STANDARD VALUES	
FROM 1 OHM TO 10 MEG OHM	
50 PCS. SAME VALUE	.025
100 PCS. SAME VALUE	.02
1000 PCS. SAME VALUE	.015

VISIT OUR RETAIL STORE

HOURS: M-W-F, 9-5 T-Th., 9-9 Sat. 11-3

PLEASE USE YOUR CUSTOMER NUMBER WHEN ORDERING
TERMS: For shipping include \$2 for UPS Ground or \$3 for UPS Blue Label Air. Items over 5 pounds require additional shipping charges. Foreign orders, include sufficient amount for shipping. There is a \$10 minimum order. Bay Area and Los Angeles Counties add 6 1/2% Sales Tax. Other California residents add 6% Sales Tax. We reserve the right to substitute manufacturer. Not responsible for typographical errors. Prices are subject to change without notice. We will match or beat any competitor's price provided it is not below our cost.

JDR Microdevices

1224 S. Bascom Avenue
San Jose, CA 95128

800-538-5000 • 800-662-6279 (CA)
(408) 995-5430 • Telex 171-110

© 1983 JDR MICRODEVICES, INC.

2716 16K EPROM

\$395

TMS2532 32K EPROM

\$595

**MICROCOMPUTER
HARDWARE HANDBOOK**

FROM ELCOMP — \$14.95

Over 800 pages of manufacturers data sheets on most commonly used IC's.

Includes:

- * TTL — 74/74LS and 74F
- * CMOS
- * Voltage Regulators
- * Memory — RAM, ROM, EPROM
- * CPU's — 6800, 6500, Z80, 8080, 8085, 8086/8
- * MPU support & interface — 6800, 6500, Z80, 8200, etc.

**BEST SELLING
BOOKS**

OSBORNE/MC GRAW-HILL

- Apple II User's Guide 16.95
- CRT Controller's Handbook 9.95
- 68000 Assembly Language Programming 16.99
- CBASIC User Guide 15.00

SYBEX

- Your First Computer 8.95
- The CP/M Handbook 14.95
- The PASCAL Handbook 18.95
- Microprocessor Interfacing Techniques 17.95

TRANSFORMERS

FRAME STYLE

- 12.6VAC 2amp 4.95
- 12.6VAC CT 2amp 5.95
- 12.6VAC CT 4amp 7.95
- 12.6VAC CT 8amp 10.95
- 25.2VAC CT 2amp 7.95

PLUG CASE STYLE

- 12VAC 250ma 3.95
- 12VAC 500ma 4.95
- 12VAC 1amp 5.95
- 12VAC 2amp 6.95

DC ADAPTER

- 6, 9, 12 VDC selectable with universal adapter 8.95

NOTE: Please include sufficient amount for shipping on above items.

**DISK DRIVES
TANDON**

TM100-1 5 1/4" (FOR IBM) SS/DD 229.00

TM100-2 5 1/4" (FOR IBM) DS/DD 295.00

SHUGART

SA 400L 5 1/4" (40 TRACK) SS/DD 199.95

SA 400 5 1/4" (35 TRACK) SS/DD 189.95

SIEMENS

FD100-8 8" SS/DD (801 REPLACEMENT) 259.00

PERTEC

FD-200 5 1/4" SS/DD 179.95

FD-250 5 1/4" DS/DD 199.95

MPI

MP-52 5 1/4" (FOR IBM) DS/DD 295.00

NOTE: Please include sufficient amount for shipping on above items.

**CABINETS FOR 5 1/4"
DISK DRIVES**

CABINET #1 \$29.95

- * DIMENSIONS 8 5/8 x 5 15/16 x 3 15/16"
- * COLOR MATCHES APPLE
- * FITS STANDARD 5 1/4" DRIVES, INCL. SHUGART
- * INCLUDES MOUNTING HARDWARE AND FEET

CABINET #2 \$79.00

- * COMPLETE WITH POWER SUPPLY, SWITCH, LINE CORD, FUSE & STANDARD POWER CONNECTOR
- * DIMENSIONS: 11 1/2 x 5 3/4 x 3 15/16"
- * +5V @ 1 AMP, +12V @ 1.5 AMP
- * FITS STANDARD 5 1/4" DRIVES
- * PLEASE SPECIFY GRAY OR TAN

NOTE: Please include sufficient amount for shipping on above items.

JDR SPRING SPECIALS

SA400 \$189.95

- * 35 TRACKS
 - * REPEAT OF A SELLOUT
 - * LIMITED SUPPLY (AGAIN)
 - * MODIFY FOR USE IN APPLE (EXPERIENCED TECHNICIANS)
 - * USE WITH CABINET #1 TO MAKE A BEAUTIFUL APPLE COMPATIBLE DRIVE
- MODIFICATION INSTRUCTIONS \$1.00
34 PIN EDGE CARD CONNECTOR MATES TO RIBBON CABLE \$3.25

MEMORY SALE

- 2114 450NS (TMS4045) 8/9.95 100 FOR .99 ea.
- 2114 250NS (TMS4045) 8/10.95 100 FOR 1.99 ea.
- 2102L-4 LOW POWER 450NS .55 ea. 100 FOR .49 ea.

- 4164 200NS 5.95 Z80A-CPU 4MHZ 4.95
- HM6116-4 200NS 4.75 8080 2MHZ 3.95
- TMM2016 200NS 4.15 8085 3MHZ 5.95
- 2732 450NS 4.95 8086 5MHZ 29.95
- TMS2532 450NS 5.95 6800 1MHZ 3.95
- 2764 450NS 9.95 68000 8MHZ 59.95

COMPONENTS

- LM1488 or LM1489 .69 ea. 7805T or 7812T .75 ea.
- 16 PIN LOW PROFILE ST IC SOCKETS 100/8.00
- 16 PIN TOOLED WIRE WRAP IC SOCKETS .49 EA.

SPRING SPECIALS ARE GOOD ONLY UNTIL MAY 31, 1983

POWER SUPPLY

MODEL 2 \$39.95

MOUNTED ON PC BOARD
MANUFACTURED BY CONVER

- +5 VOLT 4 AMP
- ±12 VOLT 1 AMP

NOTE: Please include sufficient amount for shipping on above items.

CONNECTORS

- RS232 MALE 2.50
- RS232 FEMALE 3.25
- RS232 FEMALE RIGHT ANGLE 5.25
- RS232 HOOD 1.25
- S-100 ST 3.95
- S-100 WW 4.95
- 44 pin ST 2.95
- 44 pin WW 4.95
- 72 pin ST 6.95
- 72 pin WW 7.95

RIBBON CABLE

CONTACTS	SINGLE COLOR		COLOR CODED	
	1'	10'	1'	10'
10	.50	4.40	.83	7.30
20	.65	5.70	1.25	11.00
26	.75	6.60	1.32	11.60
34	.98	8.60	1.65	14.50
40	1.32	11.60	1.92	16.80
50	1.38	12.10	2.50	22.00

D-SUBMINIATURE

DESCRIPTION	SOLDER		RIGHT ANGLE SOLDER		RIBBON CABLE		HOODS	
	MALE DBxxP	FEMALE DBxxS	MALE DBxxPR	FEMALE DBxxSR	MALE IDBxxP	FEMALE IDBxxS	BLACK HOOD-B	GREY HOOD
ORDER BY								
CONTACTS 9	2.08	2.66	1.65	2.18	3.37	3.69	—	1.60
15	2.69	3.63	2.20	3.03	4.70	5.13	—	1.60
25	2.50	3.25	3.00	4.42	6.23	6.84	1.25	1.25
37	4.80	7.11	4.83	6.19	9.22	10.08	—	2.95
50	6.06	9.24	—	—	—	—	—	3.50

For order instructions see "IDC Connectors" below.

IDC CONNECTORS

DESCRIPTION	SOLDER HEADER	RIGHT ANGLE SOLDER HEADER	WW HEADER	RIGHT ANGLE WW HEADER	RIBBON HEADER SOCKET	RIBBON HEADER	RIBBON EDGE CARD
ORDER BY	IDHxxS	IDHxxSR	IDHxxW	IDHxxWR	IDSxx	IDMxx	IDExx
CONTACTS 10	.82	.85	1.86	2.05	1.15	—	2.25
20	1.29	1.35	2.98	3.28	1.86	5.50	2.36
26	1.68	1.76	3.84	4.22	2.43	6.25	2.65
34	2.20	2.31	4.50	4.45	3.15	7.00	3.25
40	2.58	2.72	5.28	4.80	3.73	7.50	3.80
50	3.24	3.39	6.63	7.30	4.65	8.50	4.74

ORDERING INSTRUCTIONS: Insert the number of contacts in the position marked "xx" of the "order by" part number listed. Example: A 10 pin right angle solder style header would be IDH10SR.

SPRING APPLE SALE!

FD-35 DISK DRIVE

By MA Systems

- ★ Direct Replacement for Apple Disk II
- ★ Compatible with Apple Controller or other Apple compatible controllers
- ★ Specially designed electronics with **low power consumption**
- ★ DOS 3.3 and 3.2 compatible
- ★ Owner's Manual and Warranty Card included
- ★ 90-day Warranty

NEW INTRODUCTORY OFFER **\$229.95**
CONTROLLER CARD \$89.95

APPLE II KEYBOARD \$99.95

From the Keyboard Co.

- ★ Brand New Rev. 7 keyboard — NOT an imitation
- ★ Special Purchase — Supply very limited
- ★ Includes Encoder Board and Cable

APPLE COMPATIBLE POWER SUPPLY \$99.95

- ★ Compact Switching Design
- ★ All Outputs regulated
- ★ Short Circuit and Overload Protection
- ★ Complete with Apple-type plug-in power cord
- ★ Apple Compatible — Yet higher output allows more disk drives and cards without overheating
- ★ +5V @ 5A, +12V @ 3A, -5V @ .5A, -12V @ .5A
- ★ Shielded enclosure: 10 $\frac{3}{4}$ " x 3 $\frac{1}{2}$ " x 2 $\frac{3}{16}$ "

VIEWMAX 80

A Full Function 80 column card for Apple II*

2 YEAR WARRANTY

\$199.95

NEW IMPROVED

JDR COOLING FAN FOR YOUR APPLE II

- ★ Easy modification — no modification of Apple required
- ★ Eliminates overheating problems
- ★ Switch on front controls fan, Apple, and extra outlet
- ★ Rotron whisper fan is the quietest, most reliable on the market

NOW WITH SURGE SUPPRESSION

\$69.95

WITHOUT SURGE SUPPRESSION \$59.95

INTERFACE CARDS

By Perisoft

PRINTERLINK \$79.00

- ★ Centronics Standard Parallel Interface for Apple II
 - ★ Simple to use — Yet supports custom driver applications from ROM or Disk
 - ★ Includes card, cable and user's manual
 - ★ 1 Year Warranty
- ### MESSENGER \$119.00
- ★ Serial I/O for Apple II
 - ★ Connects virtually any RS-232 serial device
 - ★ 6 switch selectable drivers:
 - 4 printer drivers
 - Terminal Driver — 40 or 80 driver
 - ★ Includes card, cable and user's manual
 - ★ 1 Year Warranty

OKIDATA PRINTERS

- ★ 120 cps, 9x9 Dot Matrix
- ★ 50% faster than EPSON
- ★ Parallel and Serial interfaces are standard

ML-82A \$479.50

ML-83A \$699.95

ML-84 PARALLEL . . . \$1059.00

CALL FOR PRICES ON 82A TRACTOR OPTION AND 82A, 83A GRAPHICS OPTION. CABLES AND INTERFACE CARDS AVAILABLE

JDR 16K RAMCARD

For Apple II*

- ★ Expand your 48K Apple to 64K
- ★ Fully compatible with Apple Language System — Use in place of Apple Language card
- ★ Provides extra memory for Visicalc™
- ★ Run PASCAL, FORTRAN, Integer Basic with appropriate software
- ★ Highest quality card features: gold edge connector, sockets for all IC's

NOW WITH 2 YEAR WARRANTY

ASSEMBLED & TESTED WITH WARRANTY **\$44.95**

KIT — INCLUDES ALL PARTS & INSTRUCTIONS . . . **\$40.95**

BARE PC CARD WITH INSTRUCTIONS **\$14.95**

MONITORS

GREEN PHOSPHOR

NEC JB1201M \$169.00

ZENITH ZVM-121 \$119.00

COLOR

AMDEK COLOR 1 \$335.00

ORDER TOLL FREE

800-538-5000

800-662-6279

(CALIFORNIA RESIDENTS)

5 $\frac{1}{4}$ " DISKETTES

ATHANA SS SD SOFT . . . 24.95

MEMOREX SS SD SOFT 26.95

VERBATIM SS DD SOFT 29.95

VERBATIM 10 SECT. HARD 29.95

NASHUA

TOP QUALITY — LOW PRICE!

Single Sided, Single Density
Soft Sektored with Hub Ring

\$19.95 BOX OF 10

VISIT OUR RETAIL STORE

HOURS: M-W-F, 9-5 T-Th., 9-9 Sat. 11-3

PLEASE USE YOUR CUSTOMER NUMBER WHEN ORDERING

TERMS: For shipping include \$2 for UPS Ground or \$3 for UPS Blue Label Air. Items over 5 pounds require additional shipping charges. Foreign orders, include sufficient amount for shipping. There is a \$10 minimum order. Bay Area and Los Angeles Counties add 6 $\frac{1}{2}$ % Sales Tax. Other California residents add 6% Sales Tax. We reserve the right to substitute manufacturer. Not responsible for typographical errors. Prices are subject to change without notice. We will match or beat any competitor's price provided it is not below our cost.

* APPLE IS A TRADEMARK OF APPLE COMPUTER CO.



JDR Microdevices

1224 S. Bascom Avenue

San Jose, CA 95128

800-538-5000 • 800-662-6279 (CA)

(408) 995-5430 • Telex 171-110

© 1983 JDR MICRODEVICES, INC.

Unclassified Ads

WANTED: A French computer science student who has experimented both with minicomputers, Apples, TRS-80s and programming in COBOL, BASIC, ASM seeks a computer-related vacation in the U.S. from July through September 1983. Marchal Patrick, 56 A route de Schirmeck 67200, Strasbourg, France.

WANTED: An owner of an Apple 48K CP/M who is a French computer science student seeks people willing to correspond and to exchange software ideas. Holtzmann Thierry, 24 Grand Rue 68320, Urschenheim, France.

WANTED: A position in a U.S. computer company during the summer of '83 is sought by a French computer science student with experience in CP/M, minicomputers, COBOL, BASIC, FORTRAN, Pascal, Assembler, and PL/I. Meyer Eric, 2 rue Lamartine 68460, Lutterbach, France.

WANTED: Tax-deductible contribution of any home computer equipment to a nonprofit youth organization for use by a disabled teenager in our program. Dan Seidel, Youth Advocates, Foster Care Program, 2317 East John, Seattle, WA 98112, (206) 322-7838.

WANTED: Consider a tax-deductible donation by yourself or your company of obsolete but functional hardware and/or software. Tax-exempt nonprofit historical-preservation organization in archaeology needs data processing, word processing, and accounting capabilities. Our references and IRS information on request. Darrell Fulmer, Mitchell National Historic Landmark, 305 Medical Arts Building, POB 621, Mitchell, SD 57301, (605) 996-5473.

WANTED: A microcomputer user interested in spending a holiday in Italy for free. I am interested in computer science: studying microelectronics, programming mostly in Pascal, and own an Apple II Plus. I will graduate from the University of Turin. He/she will offer me an equal holiday in the States. Send a short curriculum vitae. Roberto Tonetti, POB 9, Brusnengo, VC 13060, Italy.

FOR SALE: Texas Instruments 745 terminals, used. Russ White, (212) 997-6075.

WANTED: New Apple owner would like to purchase back issues of Nibble. Needed are all of volume 1 and all of volume 2 except No. 6. Please send list of available issues and prices requested. Bob Steinberg, 9030 Niles Center Rd., Skokie, IL 60076.

FOR SALE: Full ASCII keyboard, \$50; Dynabyte naked terminal board (Model 57), \$150; Processor Technology 3 parallel and serial I/O board, \$150; New SDS Expandoram 64K board, 150 ns, \$400. New DRC 16K EPROM board, \$175. Send cashier's check or money order plus \$5 shipping and handling per board. William Whitney, 2063-43rd Ave., San Francisco, CA 94116.

FOR SALE: IMSAI S-100 system includes DIO-C, VIO-C, MPU-B, RAM 64, in a 10-slot mainframe; monitor; keyboard; and two sets of Perci dual 8-inch drives. Purchased new in 1981, scarcely used, \$3200 firm. Will sell system with one set of dual 8-inch drives for \$2500, or one set of drives for \$700. Greg Baker, POB 3044, Clinton, IA 52732.

WANTED: Ideas for interesting but not too complex games that I can write for personal use. Games can be of any type. I don't want listings, just ideas. Games will be written for the Commodore VIC-20. A copy of the finished project will be mailed to sender on request. David Alexander, 1667 Midland Dr., East Meadow, NY 11554.

FOR SALE: First 16 issues of BYTE (September 1975 through December 1976). This includes charter issue, #1. Like-new condition. Best offer over \$80. Paul Silagi, 83 Needletree Lane, Glastonbury, CT 06033.

FOR SALE: Sinclair ZX81 BK ROM/16K RAM with full-size typewriter-style keyboard, like new. Have many programs including assembler/disassembler, graphics utility, and games. Will include these programs free with purchase of computer. Best offer. R. Beaber, 803 Euclid, Centralia, WA 98531.

WANTED: Used ZX81 microcomputer in good condition. Derry Bryson, POB 433, Wendell, ID 83355.

FOR SALE: Apple II Plus with 64K RAM. System includes 48K computer (Revision 7), Microsoft Ramcard, Apple II disk with controller, Sup R Mod II, Videx Keyboard Enhancer II, E-Z Port (adds game I/O socket outside computer), all cables and manuals, and over 40 program-filled disks worth over \$1500. Best offer. Also, have Integer Firmware card with old monitor ROM. Best offer. Jonathon Cone, 7921 Garner St., Long Beach, CA 90808, (213) 596-5228.

WANTED: Manuals or tapes with program listings for Central Data Co. 2650 BASIC interpreter, BK and/or extended version. Also, want other Central Data information and documentation, such as manuals/listings for debugger, editor/assembler, assembly-language package, character generator program, disk-operating system, printer interface, etc. G.A. Luce, 2907 Greenlawn Parkway, Austin, TX 78757.

WANTED: Commodity Trading Systems. I am a marketing genius without a system, looking for a programming genius without a market. System must be fully developed, previously unmarketed, extensively tested, and extraordinarily successful. Send details and financial requirements. Hugh Martin, 305 San Anselmo Ave., San Anselmo, CA 94960.

WANTED: Apple II peripherals. Modem, double-density disk drive, color monitor, printer buffer, 80-column board, letter-quality printer, etc. Will trade for what you need. I am a member of a barter/exchange; tell me what you have and what you want. Walter Bristow, Box 11278, Eugene, OR 97440, (503) 485-7001 or 741-1464.

FOR SALE: AIM 65 with Video 1 board, power supply, 16K of memory, and case. Asking \$500. Joe Hootman, 3022 Clover Dr., Grand Forks, ND 58201, (701) 775-8353.

FOR SALE: HP 9845A computer, 16-bit microprocessor, 62K-byte core memory, high-resolution display, built-in printer, two cassette tape I/O, graphics, 4 years old, excellent condition, original price about \$21,000, asking \$6000. R.O. Prindle, 54 Crest Rd., Piedmont, CA 94611, (415) 845-3800 days.

FOR SALE: Z80 Starter Kit with 2K RAM in good condition, \$200. Also, several Tektronix and Hewlett-Packard oscilloscopes, not working: \$50 each. Also, assorted test equipment; send SASE for complete list. Bill Stottmyer, Rt. 1, Box 125, Corinth, MS 38834.

FOR SALE: PRIAM I 5450, 150-MB disk drive, SMART-E controller, power supply and rack slides, all new in the box: \$6200. New Shugart SA-400 disk drive: \$100. Old SD Sales 4K memory boards: \$10 each. Polymorphics 64 by 16 S-100 video board, new factory-assembled and -tested: \$20. Jim Amick, 3009 Collin Court, Plano, TX 75075, (214) 596-3788 evenings.

FOR SALE: Commodore 2001 computer with 32K and assorted software. Also, Commodore 8050 dual-disk drive and Commodore cassette drive. All in mint condition. Items sold individually or as a set. Make an offer. Donald Lemma, POB 130, Holmdel, NJ 07733, (201) 946-8735.

WANTED: To complete my collection of BYTE I need November 1978 and November 1977. In return, I offer BYTE 1976: Numbers 13, 14, 15, 16, and BYTE 1977: Numbers 8 and 10. I am also interested in back issues of Creative Computing, Interface Age, Radio Electronics, and Popular Electronics. Jaroslav Budinsky, Palackeho 956, 282 Ol Cesky Brod, Czechoslovakia.

WANTED: I would like to correspond with someone familiar with both Centronics 700 series printers and Data General equipment, mainly Dasher D-200 video displays. Kleber Viana, 440 Park Ave. S. Apt. 1317, New York, NY 10016, (212) 686-2206.

FOR SALE: Godbout S-100 boards: RAM 20 (32K), \$225; Interface I (two serial I/O), \$140; Spectrum with B105 routine for Epson parallel and Sublogic 2D and 3D software, \$225. Heath H-14 printer, \$250. Zenith green monitor, \$95. All perfect. Jack Hersh, (415) 549-3257.

WANTED: SOL units and 5 1/4-inch floppy-disk readers for use and replacement parts. Tax-deductible donations are most welcome. Mr. Walter Hoy, Principal, Campolindo High School, 300 Moraga Rd., Moraga, CA 94556.

WANTED: 9-inch black-and-white Panasonic video monitor (TR-930), in good condition: \$125 or best offer. HP-34C advanced programmable scientific calculator with continuous memory, owner's handbook, mathematics and statistics applications books: \$70 or best offer. David Body, 1530 Cambridge St. #2, Cambridge, MA 02139.

WANTED: Documentation on programming home video game cartridges for the Atari VCS, Intellivision, etc. Particularly interested in schematics and instruction manuals for the discontinued Magicard module advertised page 450 August 1981 BYTE. Will cover your shipping and printing costs. Rick Roberson, 903 Danville Circle, Knoxville, TN 37923, (615) 690-7765.

FOR SALE: BYTE collection: second issue through current issue. All are in excellent condition with over 80 issues. \$120 plus cost of shipping. J.D. Gray, 6951 North Oatman Ave., Portland, OR 97217, (503) 289-6783. No collect calls.

FOR SALE: 32K Commodore PET with display, 40 columns, and cassette. Includes many programs and games. Asking \$900 plus shipping. Peter Giroux, 2820 Route 158, Ste. Sophie, Quebec, Canada, (514) 436-7214.

WANTED: Atari computer games or other software to swap. Send name, address, and cassette and I'll return different programs. Jim Klein, 1552 Woodbridge Apt. 210, St. Paul, MN 55117.

FOR SALE: OSI CIP, 32K static RAM, disk drive, Model 35 Teletype software includes OS65D operating system (V 3.1 and V 3.3), HEXDOS, S-FORTH, Assembler, Extended Monitor, games, and applications: \$750 or best offer. Computerist Video plus board, new: \$150. Steve McCaughey, 524 East Broadway, Enid, OK 73701, (405) 242-2606, weekends only.

FOR SALE: RCA VP711 microcomputer with 4K static RAM, RF modulator, three programming manuals, game manual, power supply, all necessary cables, hex keypad, CHIP-8, CHIP-BX, and many games on cassette tape. Will sell for \$140 or will trade for a working Shugart 801 disk drive. Tom Babaian, 1450 Beaver Rd., Southampton, PA 18966.

WANTED: New or used Atari 800 with 16K RAM or more. Manuals must be included. Would also like extra peripherals such as the 810 disk drive, Epson MX100 printer (or similar), color monitor, languages, joysticks, paddles, lightpen, or games, etc. Will cover shipping if in Western U.S. Make offer on package. Timothy Hood, 1769B Walnut St., Fountain Valley, CA 92708, (714) 964-7206.

UNCLASSIFIED POLICY: Readers who have computer equipment to buy, sell, or trade or who are requesting or giving advice may send a notice to BYTE for inclusion in the Unclassified Ads section. To be considered for publication, an advertisement must be non-commercial (individuals or bona fide computer clubs only), typed double-spaced on plain white paper, contain 75 words or fewer, and include complete name and address. This service is free of charge; notices are printed once only as space permits. Your confirmation of placement is appearance in an issue of BYTE as we engage in no correspondence. Please allow at least three months for your ad to appear. Send your notices to Unclassified Ads, BYTE/McGraw-Hill, POB 372, Hancock, NH 03449.

Unclassified Ads

FOR SALE: TRS-80 Model III with two double-sided double-density disk drives; RS-232C interface; Daisy Wheel 2 printer; NEWDOS-80; Scripsit/QWERTY word processor; Scripsit Dictionary; other assorted software including mailing lists, utility programs, and several games. Less than one year old. Get the works for only \$3750. Ron Jones, (801) 966-6879.

FOR SALE: Heath H-8 computer, 24K, 4-port serial I/O board (H-8-4), and serial/cassette interface board (H-8-5). Includes all manuals: \$250. Ralph Seiler, 70 East Sunset Ave. #1, Salt Lake City, UT 84115, (801) 484-6808.

FOR SALE: Digital Research PL/I (unopened) with update and manuals for 8-bit system, \$350. Visicalc and FORTRAN with manuals for TRS-80 Model I, \$50 each. Omikron Mapper II (unused) for TRS-80 Model I, \$100. IBM 735 I/O Selectric, black (excellent condition), modified for TRS-80 Model I by Virginia Microsystems, operates as printer or typewriter, \$450. Syd Spain, POB 10107, College Station, TX 77840, (713) 693-2835.

FOR SALE: NEC Spinwriter 7710, with tractor, new, \$2200. IBM PC asynchronous communications, \$100. Ron Swenson, Box 701, Boston, MA 02102, (617) 242-9213, evenings.

WANTED: Users of IBM 5100, 5110, or 5120 or users group to exchange information. I also want to purchase a spreadsheet-type program for this model. Stephen Pottie, POB 697, Montague, Prince Edward Island COA 1R0, Canada, (902) 838-2070 or 962-2279.

FOR SALE: Teletype Model 43 30-cps dot-matrix printer terminal. RS-232C interface, pinfeed, Hall-effect keyboard. Almost new condition. With service and circuit diagram manuals: \$595. Ron Mauzeri, 14433 Dickens St., Sherman Oaks, CA 91423, (213) 906-3517.

WANTED: Consultant to aid in implementation of dial-up database system. Dr. L. Huber, Hampshire Educational Collaborative, 58 Pleasant St., Northampton, MA 01060.

FOR SALE: Novation Cat modem, 300 bps, good condition: \$100 or best offer. Jim Larus, Apt. 4, 2415 College Ave., Berkeley, CA 94704.

WANTED: Commodore 64 owners, send me your games, music, or graphics programs on cassette, with your name and address, and I'll send back your cassette with my adventure game, "Horror Hotel." Would also like to correspond with anyone using the Commodore 64 for music synthesis. Phil Nelson, 3801 Garfield Ave. S, Minneapolis, MN 55409.

FOR SALE: RadioShack Line Printer IV (same as Centronics 747) in excellent condition. Highest offer or best trade-in bid for daisy-wheel printer, new or used. Isai Kamen, 11 Sherman Ave., White Plains, NY 10605.

FOR SALE: Atari 800, new: \$670 COD. Also, every computer magazine available. Send SASE. Jack Gindi, REF301, 2079 East 3 St., Brooklyn, NY 11223.

WANTED: I am interested in obtaining the following publications: PC—The Independent Guide to IBM Personal Computers—Vol. 1, No. 2, 80 Microcomputing—Vol. 2, No. 2 (February 1981). Send asking price. Thomas Kariya, POB 33, Brookeville, MD 20833.

FOR SALE: Back issues of BYTE. January '81, July '81 through July '82: \$10. Nat Stevens, 46 Elm St., North Andover, MA 01845, (617) 687-3421.

FOR SALE: Radio Shack Color Computer plastic dust cover, \$4 with Radio Shack Cassette recorder cover. Also, would like a copy of Eliza written in Microsoft BASIC under 20K. Send price. Bosco T. Tsang, 575 University Ave. W #505, Windsor, Ontario N9A 5R4, Canada.

FOR SALE: SwTPC 6800 with 28K RAM socketed for 48K, three serial I/O ports, LFD-400 disk drive with INDEX DOS, CT-64 terminal with VT-VM green screen monitor and software: \$1400. Jim Benson, 1719 North Woodlawn, Derby, KS 67037, (316) 788-5756.

FOR SALE: ABT Softkey pad for Apples. Accessory-programmable keypad plugs into game port. Can be used as numeric pad or keys may be programmed as command keys. With all documentation, like new (never used). First \$100 takes. Evan Julber, Numismatics Ltd., Suite 600, 9665 Wilshire Blvd., Beverly Hills, CA 90212, (800) 421-0678 or (213) 550-1766.

FOR SALE: S-100 boards. Flashwriter II, \$150. Cromemco Bytesaver, \$100. IMSAI SIO, \$25. Processor Technology: PROM board, \$50; CUTS, \$25; VDM-I video, \$25. Tarbell cassette I/O, \$25. Percom cassette I/O, \$25. Jay Dowling, 804 Bristol Court, Richardson, TX 75080, (214) 690-1752.

FOR SALE: 32K Commodore PET with interfacing and software to control lights, motors, etc. Many games. Asking \$400 or best offer. Ed Jemmings, 688 Ida-Maybee Rd., Monroe, MI 48161, (616) 269-2133.

FOR SALE: TRS-80 Color Computer, 32K Ext. BASIC, original packing. Plus approximately \$400 worth of software, including CBUG, Editor/Assembler, Colorcom[E] V3, Telewriter Word-processor, Space Invaders, Asteroids, Pacman, Berserk, Chess, and many more. Includes manuals. Asking \$525. J.A. Czryryca, 6014 County Line Rd., Perry, NY 14530.

FOR SALE: Universal Data Systems 212LP: 1200 bps, direct-connect, full-duplex modem. New, in original carton, never used. List price is \$495, will sell for \$300 (postpaid), or best offer. Harold Miller, Tumbling Waters, Route 2, Box 2330, Clayton, GA 30525, (404) 782-2843.

FOR SALE: Commodore VIC-20 Color Computer with these extras: BK memory cartridge, Commodore cassette player, joystick, three games, and two instruction books. All like new. \$225 or trade for accessories and equipment for my TRS-80 Color Computer. Hal Mermelstein, RFD 2, Webb Rd., South Windham, ME 04082, (207) 892-9042.

FOR SALE: Qume Sprint 5 daisy-wheel printer in excellent condition. Two printwheels included: \$2000. Steve Kaplan, 661 Wingate Dr., Sunnyvale, CA 94087, (408) 733-4139.

BOMB

BYTE's Ongoing Monitor Box

Article #	Page	Article	Author(s)
1	28	Build an RS-232C Breakout Box	Ciarca
2	53	The National Semiconductor NS16000 Microprocessor Family	Leedy
3	70	Design Philosophy Behind Motorola's MC68000, Part 1	Starnes
4	96	The CRT 9007 Video Processor and Controller	Cayton, Hermon Lemmons
5	110	New Japanese Microcomputers	Zingale
6	132	Intel's 80186: A 16-Bit Computer on a Chip	Simington
7	154	The Intel 8087 Numerics Processor Extension	Levine
8	176	Super Graphics Hardware from NEC	Fleming
9	190	NAPLPS: A New Standard for Text and Graphics, Part 3: Advanced Features	Schmitt
10	210	Virtual Memory for Microcomputers	Lemmons
11	242	BYTE West Coast: Hard Choices for Software Houses	Swank
12	260	The Enhanced VIC-20, Part 3: Interfacing an MX-80 Printer	Lemmons
13	290	Two Ways to Use CP/M-80 on the IBM PC	Alexander
14	304	Building a Hard-Disk Interface for an S-100 Bus System, Part 2: Hardware	Pournelle
15	324	User's Column: Terminal Solutions, Manual Madness, BASIC Bits, and Info Helpers	Spitzer
16	360	Build This Memory, Part 2: Constructing the Memory Card	McCormack, Gleaves
17	385	Modula-2	McDermott
18	398	The Design of an Advanced Logic Simulator	Williams
19	442	Information Hiding: A Brief Example	

Compaq Leads Off

BYTE readers voted Mark Dahmke first-place winner in the January BOMB contest for his product description of "The Compaq Computer," a portable and affordable alternative to the IBM Personal Computer. He will receive the \$100 prize. Second place goes to John Smith for his article, "Public Key Cryptography." He will get the \$50 kitty. Gregg Williams holds third place for his report from London on "Micro-computing, British Style."

Reader Service

Inquiry No.	Page No.	Inquiry No.	Page No.	Inquiry No.	Page No.	Inquiry No.	Page No.
118	1st NATIONAL COMP. 211	90	COMPUADD 500	419	FROBCO 148	265	MICRO BUSN.WORLD 371
469	1 SUPER WAREHOUSE 437	91	COMPUPRO/GODBOU 240, 241	174	G-H COMPUTER SYS. 502	268	MICRO MANAGEMENT SYS. 307
1	800 SOFTWARE 205	*	COMPUPRO/GODBOU 452, 453	175	GARDEN OF EDEN COMP. 504	269	MICRO MART 420
2	A.S.T.RESEARCH 42, 43	92	COMPUSERVE 52	176	GENERAL SOFTWARE INC. 264	270	MICRO MIDWEST 512
4	AB COMPUTERS 499	340	COMPUSHACK 358, 359	177	GENIE COMP.CORP. 368, 369	271	MICRO MINT 384
5	ABACUS DATA INC. 29	343	COMPUSHACK 365	178	GENSTAR REI SALES CO. 76	274	MICRO MINT 420
8	ACOUSITIC RESEARCH 504	93	COMPUTER APPARATUS 511	179	GENSTAR REI SALES CO. 512	262	MICRO MINT 429
6	ACTIVE ELECTRONICS 439	94	COMPUTER CHANNEL 451	180	GIFFORD COMP. SYS. 269	272	MICRO MYSTIQUE 512
11	ADDMASTER CORP. 510	95	COMPUTER DISCOUNT PROD. 501	180	G&G ENGINEERING 269	273	MICRO PRO. INT'L. 294, 295
12	ADV.COMP.PROD. 526, 527	96	COMPUTER EXCHANGE 200, 201	181	GILTRONIX INC. 514	276	MICRO SCI 67
143	ADV.LOGIC SYSTEMS 137	97	COMPUTER EXCHANGE 200, 201	182	GOULD, INC. 195	277	MICRO SOLUTIONS 510
144	ADV.SYS.CONCEPTS 514	98	COMPUTER EXCHANGE 200, 201	183	GTEK INC. 328	278	MICRO WEST 247
16	ADVANCED DATA TECH. 506	99	COMPUTER INNOVATIONS 20	184	HANDWELL CORP. 498	279	MICRO WORKS, THE 172
17	AFTERTHOUGHT ENG. 512	460	COMPUTER LEARNING TREE 338	185	HAYES MICROCOMP.PROD. 191	280	MICROCOMP.BUSN.IND. 208, 209
*	ALF PRODUCTS, INC. 419	101	COMPUTER MAIL ORDER 382, 383	186	HEATH COMPANY 105	281	MICRODYNAMICS 514
18	ALL ELECTRONICS CORP. 502	102	COMPUTER PERIPH. INC. 157	*	HEWLETT-PACKARD 263	282	MICROHOME 10, 11
19	ALPHA BYTE COMP.PROD. 50, 51	103	COMPUTER PLUS 476	*	HEWLETT-PACKARD 456	283	MICROPERIPH.CORP.THE 498
20	ALPHA BYTE COMP.PROD. 266	15	COMPUTER PUBLISHING CO. 218	*	HOBB-Y-TRONIX INC. 505	284	MICROPROCESSORS UNLTD. 496
21	ALTOS COMP.SYS. 127	104	COMPUTER SPLICIES 219	187	HUMAN DESIGNED SYSTEMS 135	*	MICROSOFT 75
22	AMER.SMALL BUSN.COMP. 474	*	COMPUTER WAREHOUSE 379	188	HUMAN SOFT 163	*	MICROSOFT 177
23	AMER.SQUARE COMP. 173	105	COMPUTERLINE INT'L-A 252, 253	189	I X O 129	*	MICROSOFT 297
24	AMPERSAND INC. 474	107	COMPUTERLINE INT'L-B 409	192	I/O TECHNOLOGY 325	*	MICROSOFT 336, 337
25	ANCIE LABS 332	108	COMPUTERS & MORE 498	193	IBM CORP. 232, 233	285	MICROSTUF, INC. 121
26	APPARAT INC. 257	110	COMPUTERS WHOLESALE 444	194	IDE CORPORATION 152, 153	286	MICROTECH EXPORTS 204
27	APPLE COMPUTER INC. CII, 1	111	COMPUTERWARE 111	195	IMS INTERNATIONAL 239	287	MICROWARE 500
29	APPLEWARE, INC. 498	112	COMPUVIEW PROD. INC. 49	196	INCOMM 475	289	MITSUBA 160
*	APPLIED CREATIVE TECH. INC. 18	113	COMSILK 510	197	INFO. REDUCTION RESEARCH 340	245	MKS 508
465	ARBA 464	114	CONCORD COMP.PROD. 495	*	INFOCOM, INC. 322, 323	290	MODERN SOFTWARE SYS. 412
30	ARBITUS TOTALSOFT INC. 443	115	CONCURRENT CORP. 128	479	INFOPRO SYSTEMS 309	370	MORROW DESIGNS 180, 181
31	ARK MICROSYSTEMS 477	116	CONDOR COMP.CORP. 440, 441	200	INMAC 465	291	MORROW DESIGNS 265
32	ARTEL ART & ELECTRONICS 97	*	CONNECTICUT MICRO COMP. 192	213	INNOVATIVE COMM. 496	292	MOUNTAIN VIEW PRESS 435
33	ARTIFICIAL INT'L. RESRCH. 500	117	CONSOLINK 34	201	INNOVATIVE SOFTWARE 103	293	MTI SYSTEMS CORP. 418
34	ASHTON-TATE 119	120	COST PLUS COMP. 512	202	INSIGHT ENTERPRISES 502	294	MULTITECH ELECTRONICS INC. 199
485	ASHTON-TATE 207	121	CPU SHOP, THE 513	203	INT'L.MICRO SYS. 425	295	MUSYS 282
35	ASHTON-TATE 221	122	CREATIVITY UNLTD. 506	205	INT'L.NORTH STAR 506	296	NEBS 144
36	ASHTON-TATE 312, 313	123	CROMEMCO 2	206	INTEGRAL DATA SYS. 333	297	NEC HOME ELECTR.USA 215
37	ASPEN SFTW.CO. 92	124	CSCS 510	207	INTEGRAL QUALITY 106	298	NEC HOME ELECTR.USA 217
38	ATARI 68, 69	76	CSX CORP-FAMILY LINES SYS. 62	208	INTEGRAND 254	299	NEC HOME ELECTR.USA 305
39	ATLANTIC CABINET CORP. 512	125	CUESTA SYSTEMS 443	210	INTERACTIVE MICROWRE. 481	300	NEC INFORMATION SYS. 17
40	ATLANTIS COMP.SERV. 504	126	CUSTOM COMP.TECH. 330	211	INTERACTIVE STRUCT. 122	*	NETRONICS 516
41	ATSUKO COMPUTING INT'L. 496	*	CYBERNETICS INC. 73	212	INTERACTIVE STRUCT. 143	301	NETWORK CONSULTING CORP. 74
42	AUSTIN DATA MANAGEMENT 439	127	D/PUNCH CO. 235	214	INTERDATA SYSTEMS INC. 498	303	NEWTech CO. LTD. 416
43	AUTOCONTROL INC. 496	463	DAISY SYSTEMS 151	215	INTERTEC DATA SYS. 9	304	NORTH HILLS CORP. 504
44	AUTOMATED EQUIPMNT. 301	128	DAMAN 506	216	INTEX SYSTEMS 339	305	NORTH HILLS CORP. 412
45	AVOCET 413	129	DATA EXCHANGE 443	217	IPEX INT'L. 496	306	NOVATION 94, 95
46	B&B ELECTR. 514	209	DATA MAIL 459	218	IRONSIDES COMP. CORP. 343	307	NOVELL DATA SYS. 81
47	B&B ELECTR. 510	130	DATA SOURCE SYS.CORP. 327	219	J.C.SYSTEMS 32	*	NRI SCHOOLS ELECTR.DIV. 353
*	BARGAIN BOARDS 496	132	DATA TRANSLATION INC. 347	474	JADE COMP.PROD. 517	309	O'HANLON COMP.SYS. 403
48	BASF SYSTEMS 77	133	DATASOUTH COMP.CORP. 37	475	JADE COMP.PROD. 518, 519	310	ORANGE MICRO 140
49	BAUSCH & LOMB INSTR.SYS. 83	134	DATASOUTH COMP.CORP. 248	221	JAMECO ELECTR. 522, 523	311	ORANGE MICRO 141
50	BAUSCH & LOMB INSTR.SYS. 83	135	DATABASE SYSTEMS 508	222	JDR MICRODEVICES 536, 537	314	ORION INSTRUMENTS 514
59	BAY TECHNICAL ASSOC. 146	136	DENNISON KYBE CORP. 249	223	JDR MICRODEVICES 538, 539	315	ORTHO CODE GROUP 346
51	BELL, JOHN ENGR. 510	137	DHD INC. 156	224	JDR MICRODEVICES 540	316	ORyx SOFTWARE 267
52	BHRT 147	138	DIGISOFT 161	*	JRT SYSTEMS 344, 345	*	OSBORNE COMPUTERS 31
53	BHRT 288	139	DIGITAL DIMENSIONS 354	462	KADAK PRODUCTS, LTD. 355	*	OWENS ASSOC. 84
54	BI-COMM SYSTEM 451	*	DIGITAL EQUIPMNT.CORP. 130, 131	226	LABORATORY MICROSYS. 502	319	PACIFIC EXCHANGES 406
55	BISON PROD INC. 245	140	DIGITAL MARKETING 6	227	LANIER BUSN.PROD. 422, 423	319	PACIFIC EXCHANGES 500
56	BISON PROD INC. 245	141	DIGITAL PRESS 300	228	LANIER DICTATING SYSTEMS 167	319	PACIFIC EXCHANGES 502
57	BISON PROD INC. 245	142	DIGITAL RESEARCH 39	229	LEADING EDGE PROD. CIII	319	PACIFIC EXCHANGES 506
58	BISON PROD INC. 245	143	DIGITAL RESEARCH 137	231	LIBERTY COMP. SALES 317	319	PACIFIC EXCHANGES 508
59	BISON PROD INC. 245	144	DIGITAL RESEARCH 279	232	LIGO RESEARCH INC. 231	319	PACIFIC EXCHANGES 510
61	BOTTOM LINE, THE 283	*	DIGITAL RESEARCH COMP. 503	*	LINK FLIGHT SIMULATION 445	319	PACIFIC EXCHANGES 514
62	BUSINESS MANAGER 401	145	DIP INC. 515	234	LOCKHEED DIALOG 107	326	PALOMAR COMP.EQUIP. 374, 375
64	BUSINESS SOLUTIONS 404	146	DISCOUNT SOFTWARE 187	235	LOGIC PROGRAMMING ASSOC. 498	327	PAN AMERICAN ELEC.INC. 328
*	BYTE BACK ISSUES 426	148	DOKAY COMP.PROD. INC. 524, 525	236	LOGICAL DEVICES 482	328	PERCOM DATA 7
*	BYTE BOOK CLUB 289	*	DOW JONES INFO.SERV. 63	237	LOGICAL MICROCOMPUTER 155	480	PERSCI 309
*	BYTE PUBL. INC. 478	149	DRIVER-HARRIS SYSTEMS INC. 443	238	LOMAS DATA PRODUCTS 275	481	PERSCI 420
65	BYTEK COMP. SYS. 481	150	DUAL SYS.CONTROL CORP. 246	488	LOTUS DEVELOPMENT 396, 397	330	PERSONAL SYS.TECHN. 99
66	BYTEWRITER 30	151	DYSAN CORP. 287	239	LYBEN COMP.SYS. 496	331	PETRO-LEWIS FUNDS INC. 251
67	CSYSTEMS 496	152	DYSAN CORP. 311	240	LYCO COMPUTER 261	332	PH ASSOCIATES 482
68	C.S.D.INC. 502	230	E. ARTHUR BROWN CO. 504	241	MACROTECH COMP.PROD. 473	333	PHASER 193
69	CAB-TEK, INC. 340	153	EASTERN ENTERPRISES 315	242	MACROTECH INT'L. 281	334	PICKLES & TROUT 222
70	CALIF. DATA CORP. 500	154	EZ ASSOC. 406	243	MAILCOMP INC. 291	335	PION INC. 142
*	CALIF. DIGITAL 520, 521	155	ECOSOFT 439	244	MAI SORBUS SERVICE 341	336	PRACTICAL PERIPH. 26, 27
*	CALIF.MICRO.COMP. 462	157	EDGE MICROSYSYSTEMS 500	247	MANX SOFTWARE 89	337	PRAGMATIC DESIGN 82
71	CDEX CORP. 93	461	EEM 149	248	MANNESMANN TALLY 223	338	PRINCETON GRAPHIC SYS. 123
72	CDR SYSTEMS 500	158	E.F. JOHNSON 224	249	MARK OF THE UNICORN 331	470	PRINTER STORE, THE 352
73	CENTENNIAL SOFTWARE 330	159	ELEK-TEK 334	250	MARYMAC INDUSTRIES 469	471	PRIORITY ONE 528, 529
77	CENTRE COMP.CONSTNTS. 506	160	ELLIS COMPUTING 373	251	MASON COMPUTERS 226	472	PRIORITY ONE 530, 531
74	CHECK-MATE 473	161	EMC DISTRIBUTING 443	*	MAXTEK 156	473	PRIORITY ONE 532, 533
75	CHECKS-TO-GO 235	156	EMERGING TECH.CONSLT. 184	106	MBI 5	344	PROGRAMMERS SFTW. EX. 280
77	CHIPS & DALE 496	163	EMPIRICAL RESRCH.GRP. 114	252	MC NEILL 416	345	PROGRAMMING INT'L. 454, 455
78	CHRISLIN INDUSTRIES 285	164	EMS 226	253	MC NEILL 416	346	PROCTO ENTERPR. 88
466	CMC INT'L. 417	165	ENERCOMP 136	254	MC NEILL 416	347	PROCTO ENTERPR. 214
476	CMC INT'L. 468	166	ENGINEERING SPECIALTIES 412	255	MC/N INC. 506	348	PROCTO ENTERPR. 508
79	COGIGATE 502	168	EPSON AMERICA 108, 109	257	MEDIA DISTRIBUTING 164	349	PROTOCOL 64
80	COLONIAL DATA SERV. 86	169	EPSON AMERICA 410, 411	258	MEDISOFT 506	350	PROTOCOL 184
81	COLUMBIA DATA PROD. 19	170	EXPOTEK 150	259	MEDISOFT 508	351	PROTOCOL 296
82	COLUMBIA NATIONAL 508	*	EXTENDED PROCESSING 512	260	MEMORY MERCHANT 23	352	PROTOSYS 349
83	COMMUNICAL, INC. 395	171	FACIT DATAROYAL 407	464	METAMORPHIC SYS.INC. 183	487	PRYOR COMP. SUPPLIES 348
84	COMMUNICATIONS ELECTR. 507	172	FAMOUS PROGRAMMERS' SCHOOL 433	262	METHOD SYSTEMS 508	353	PURCHASING AGENT, THE 118
85	COMP.COMPNTS.UNLTD. 509	173	FORMULA INT'L. 427	263	MFJ ENTERPRISES INC. 356	354	QANTEX DIV. 255
86	COMPAQ COMPUTER CORP. 25	172	FOX & GELLER INC. 237	264	MICRO AGE COMP.STORE 326	355	QT/COMPATIBLE 351
87	COMPONENTS EXPRESS 206	173	FRANKLIN COMP.CORP. 71			356	QUADRAM CORP. 78, 79
89	COMPUADD 500					357	QUADRAM CORP. 272, 273
						358	QUARK ENGINEERING 65
						450	QUBIE DISTRIBUTING 115
						359	QUESTIONNAIRE SERV.CO. 508
						362	R.R.SOFTWARE 149
						363	RACAL VADIC 185
						364	RACET COMPUTES LTD. 262
						365	RADIO SHACK CIV
						477	RANDOM HOUSE 451
						312	RED BARON COMP.PROD. 188, 189
						367	RED GATE PUBL.CO. 125
						368	ROCKY MT.MICRO INC. 203

To get further information on the products advertised in BYTE, fill out the reader service card with your name and address. Then circle the appropriate numbers for the advertisers you select from the list. Add a 20-cent stamp to the card, then drop it in the mail. Not only do you gain information, but our advertisers are encouraged to use the marketplace provided by BYTE. This helps us bring you a bigger BYTE. The index is provided as an additional service by the publisher, who assumes no liability for errors or omissions. *Correspond directly with company.

Reader Service

Inquiry No.	Page No.	Inquiry No.	Page No.	Inquiry No.	Page No.	Inquiry No.	Page No.
369	RON SAN ELECTRONICS 504	388	SONY VIDEO PRODUCTS 447	406	TELECON SYSTEMS 8	431	VISUAL TECH.INC. 145
371	RTL PROGRAMMING AIDS 504	389	STARBUCK DATA CO. 414	407	TELETEK 13	432	VLM COMPUTER ELECTR. 506
486	RUTISHAUSER DATA AG 318	*	STEMMOS LTD. 256	408	TERMINALS TERRIFIC 298	433	VOTRAX 415
372	S C DIGITAL 448	391	STREET ELECTR. CORP. 80	409	TEXAS COMP.SYS. 216	435	WADSWORTH ELECT.PUBL. 357
373	S&W COMPUTER SUPPLY 502	392	STRUCTURED DESIGN 514	*	TEXAS INSTRUMENTS 168, 169	*	WAREHOUSE SOFTWARE 378
374	S-100 INC. 405	393	STRUCTURED DESIGN 510	410	TEXAS INSTRUMENTS 91	437	WARNER BOOKS 342
375	SAGE COMP.TECH. 33	394	SUNNY INT'L. 495	411	THOUGHTWARE INC. 165	438	WASHINGTON COMP.SERV. 178
376	SATURN SYSTEMS 225	478	SUNTRONICS 309	412	THUNDERHAWK CORP. 293	439	WASHINGTON COMP.SERV. 483
*	SCOTSDALE SYSTEMS 229	395	SUNTRONICS 497	415	TOTAL ACCESS 243	440	WEST STAR MICRO 162
377	SEARS ELECTRONICS INC. 498	396	SUPERSOFT 133	*	TRANS WORLD AIRLINES 250	*	WESTICO INC. 277
467	SHERATON HOTELS	397	SUPERSOFT 197	417	TRANSTAR 87	442	WESTINGHOUSE/LIGHTING DIV 377
	WORLDWIDE 329	398	SYSTEMED 512	418	TRANSTAR 399	443	WHITESMITHS LTD 14
378	SIERRA DATA SCIENCES 35	399	SYSTEMS STRATEGIES 380	420	TRIOLOG 302	444	WHOLESALE SUPPLIERS 443
*	SINCLAIR RESEARCH 227	400	TALLGRASS TECH. 47	421	TRIOLOG 303	445	WILD HARE COMP.SYS. 213
380	SLR 504	401	TARBELL ELECTR. 280	468	TRISTAR DATA SYS. 128	446	WIN/MILL RESEARCH INC. 500
381	SLUDER 380	402	TATUM LABS 502	422	TSI MARKETING 236	447	WINCHENDON GRP., THE 514
482	SNAVE SYSTEMS 420	341	TAVA CORP 361	423	TSK ELECTR.CORP. 85	448	WINTEK CORP. 510
382	SOFTTECH MICROSYS 117	342	TAVA CORP 363	424	U.S. MICRO SALES 534, 535	449	WINTERHALTER & ASSOC. 462
383	SOFTWARE ARTS 158, 159	403	TAYCO BUSINESS FORMS 498	425	U.S. ROBOTICS 22	451	X COMP 271
385	SOFTWARE BANC 381	413	TDI 148	426	U.S. EXCHANGE 512	452	XEDEX CORP. 90
386	SOFTWARE TECHNIQUE 504	404	TECH-DATA CORP. 406	427	UNIFIED SOFTWARE SYS. 514	453	XEDEX CORP. 331
167	SOFTWARE TOOLWORKS 476	*	TECHNICAL SYS.CONSLTNS. 259	428	USI INT'L. 101	456	XEROX PRINTING SYS. 367
*	SOLID STATE SALES 244	405	TECMAR INC. 15	429	VIDEX 21	454	YANG ELECTRONIC 508
387	SONICS MICRO SYS. 335	*	TEKTRONIX INC. 45	430	VISTA COMPUTER CO 16		

*Correspond directly with company.

National Advertising Sales Representatives:

Northeast

ME, NH, VT, MA, CT, RI, DE, MD, VA,
WV, OK, TX, Upstate NY, Eastern
Canada

Hajar Associates
280 Hillside Ave.
Needham Heights, MA 02194
(617) 444-3946

Mid Atlantic

NY, NYC, NJ, PA

Hajar Associates
321 Broad St.
Red Bank, NJ 07701
(201) 741-7744

Southeast

NC, SC, GA, FL, AL, MS, TN,
KY, LA

Maggie McClelland
McGraw-Hill Publication
4170 Ashford Dunwoody Road
Suite 420
Atlanta, GA 30319
(404) 252-0626

Midwest

MN, WI, MI, IA, IL, IN, OH,
MO, NE, KS, ND, SD, AR

Hajar Associates
5225 Old Orchard Rd.
Suite 50
Skokie, IL 60076
(312) 966-0160

Northwest

AK, HI, WA, OR, ID, MT, WY, Northern
California, Nevada Except Las Vegas,
Western Canada

Bill McAfee
McGraw-Hill Publications
1000 Elwell Court
Suite 124
Palo Alto, CA 94303
(415) 968-0280

David Jern
McGraw-Hill Publications
425 Battery St.
San Francisco, CA 94111
(415) 362-4600

Southwest

UT, CO, AZ, NM, Las Vegas, Southern
California

Page Goodrich
McGraw-Hill Publications
3001 Red Hill Avenue
Building #1-Suite 222
Costa Mesa, CA 92626
(714) 557-6292

Karen Niles

McGraw-Hill Publications
3200 Wilshire Boulevard
Los Angeles, CA 90010
(213) 480-5243
(213) 487-1160

West Coast Surplus and Retail Accounts

Tom Harvey
3463 State Street
Suite 256
Santa Barbara, CA 93105
(805) 964-8577

European Advertising Sales Representatives:

Mrs. Marla Sarmento
Pedro Telxeira 8, Off. 320
Iberia Mart 1
Madrid 4, Spain
45 52 891

Mr. Andrew Karnig
Andrew Karnig & Associates
Kungsholmsgatan 10
112 27 Stockholm, Sweden
08 51 68 70

Mr. Hans Csokor
Publmedla
Relsnerstrasse 61
A-1037 Vienna, Austria

Mrs. Gurit Gepner
McGraw-Hill Publishing Co.
115 Yosephtal St.
Bat Yam, Israel
866 561 321 39

Mr. Fritz Krusebecker
McGraw-Hill Publishing Co.
Lieblgstrasse 27C
D-6000 Frankfurt/Main 1
West Germany
72 01 81

Mr. Michael Sales
McGraw-Hill Publishing Co.
17 rue Georges Bizet
F 75116 Paris
France
720 33 42

Mr. Simon Smith
McGraw-Hill Publishing Co.
34 Dover St.
London W1X 3RA
England
01 493 1451

Mr. Ello Gonzaga
McGraw-Hill Publishing Co.
Via Baracchini 1
20123 Milan, Italy
86 90 617

Far East/Pacific
Seavex Ltd.
05-49/50 Tanglin Shopping Center
19 Tanglin Rd. Singapore 1024
Republic of Singapore

Seavex, Ltd.
Room 102, Yu Yuet Lal Bldg.
43-55 Wyndham St. Central
Hong Kong

BYTE READER SERVICE



For fastest service transfer mailer label from wrapper to coupon provided at the right. Requests cannot be honored unless zip code is given. This card valid for 90 days only. **NOTE**—If label is missing or defaced fill out coupon carefully—**PLEASE PRINT**—this is the only way to get requested material to you.

Name _____
 (Title) _____ (Company) _____
 Address _____
 City _____ State _____ Zip _____

1 21 41 61 81	101 121 141 161 181	201 221 241 261 281	301 321 341 361 381	401 421 441 461 481	501 521 541 561 581	601 621 641 661 681
2 22 42 62 82	102 122 142 162 182	202 222 242 262 282	302 322 342 362 382	402 422 442 462 482	502 522 542 562 582	602 622 642 662 682
3 23 43 63 83	103 123 143 163 183	203 223 243 263 283	303 323 343 363 383	403 423 443 463 483	503 523 543 563 583	603 623 643 663 683
4 24 44 64 84	104 124 144 164 184	204 224 244 264 284	304 324 344 364 384	404 424 444 464 484	504 524 544 564 584	604 624 644 664 684
5 25 45 65 85	105 125 145 165 185	205 225 245 265 285	305 325 345 365 385	405 425 445 465 485	505 525 545 565 585	605 625 645 665 685
6 26 46 66 86	106 126 146 166 186	206 226 246 266 286	306 326 346 366 386	406 426 446 466 486	506 526 546 566 586	606 626 646 666 686
7 27 47 67 87	107 127 147 167 187	207 227 247 267 287	307 327 347 367 387	407 427 447 467 487	507 527 547 567 587	607 627 647 667 687
8 28 48 68 88	108 128 148 168 188	208 228 248 268 288	308 328 348 368 388	408 428 448 468 488	508 528 548 568 588	608 628 648 668 688
9 29 49 69 89	109 129 149 169 189	209 229 249 269 289	309 329 349 369 389	409 429 449 469 489	509 529 549 569 589	609 629 649 669 689
10 30 50 70 90	110 130 150 170 190	210 230 250 270 290	310 330 350 370 390	410 430 450 470 490	510 530 550 570 590	610 630 650 670 690
11 31 51 71 91	111 131 151 171 191	211 231 251 271 291	311 331 351 371 391	411 431 451 471 491	511 531 551 571 591	611 631 651 671 691
12 32 52 72 92	112 132 152 172 192	212 232 252 272 292	312 332 352 372 392	412 432 452 472 492	512 532 552 572 592	612 632 652 672 692
13 33 53 73 93	113 133 153 173 193	213 233 253 273 293	313 333 353 373 393	413 433 453 473 493	513 533 553 573 593	613 633 653 673 693
14 34 54 74 94	114 134 154 174 194	214 234 254 274 294	314 334 354 374 394	414 434 454 474 494	514 534 554 574 594	614 634 654 674 694
15 35 55 75 95	115 135 155 175 195	215 235 255 275 295	315 335 355 375 395	415 435 455 475 495	515 535 555 575 595	615 635 655 675 695
16 36 56 76 96	116 136 156 176 196	216 236 256 276 296	316 336 356 376 396	416 436 456 476 496	516 536 556 576 596	616 636 656 676 696
17 37 57 77 97	117 137 157 177 197	217 237 257 277 297	317 337 357 377 397	417 437 457 477 497	517 537 557 577 597	617 637 657 677 697
18 38 58 78 98	118 138 158 178 198	218 238 258 278 298	318 338 358 378 398	418 438 458 478 498	518 538 558 578 598	618 638 658 678 698
19 39 59 79 99	119 139 159 179 199	219 239 259 279 299	319 339 359 379 399	419 439 459 479 499	519 539 559 579 599	619 639 659 679 699
20 40 60 80 100	120 140 160 180 200	220 240 260 280 300	320 340 360 380 400	420 440 460 480 500	520 540 560 580 600	620 640 660 680 700

BYTE'S BOMB is your direct line to the editor's desk. Each month, the authors of the two top-rated articles receive bonuses based on your evaluation. First look at the list of this month's articles and corresponding article numbers (located in the unclassified ads section on the page preceding the Reader Service list), then rate each article you've read as **Excellent, Good, Fair,** or **Poor**, based on your overall impression of the article, by circling the appropriate number in each column below. Your feedback helps to produce the best possible magazine each month.

Article No.	1	2	3	4	5	6	7	8	9	10	11	12	13	14	15	16	17	18	19	20	21	22	23	24	25
Excellent	801	805	809	813	817	821	825	829	833	837	841	845	849	853	857	861	865	869	873	877	881	885	889	893	897
Good	802	806	810	814	818	822	826	830	834	838	842	846	850	854	858	862	866	870	874	878	882	886	890	894	898
Fair	803	807	811	815	819	823	827	831	835	839	843	847	851	855	859	863	867	871	875	879	883	887	891	895	899
Poor	804	808	812	816	820	824	828	832	836	840	844	848	852	856	860	864	868	872	876	880	884	888	892	896	900

Comments _____

BYTE READER SERVICE



For fastest service transfer mailer label from wrapper to coupon provided at the right. Requests cannot be honored unless zip code is given. This card valid for 90 days only. **NOTE**—If label is missing or defaced fill out coupon carefully—**PLEASE PRINT**—this is the only way to get requested material to you.

Name _____
 (Title) _____ (Company) _____
 Address _____
 City _____ State _____ Zip _____

1 21 41 61 81	101 121 141 161 181	201 221 241 261 281	301 321 341 361 381	401 421 441 461 481	501 521 541 561 581	601 621 641 661 681
2 22 42 62 82	102 122 142 162 182	202 222 242 262 282	302 322 342 362 382	402 422 442 462 482	502 522 542 562 582	602 622 642 662 682
3 23 43 63 83	103 123 143 163 183	203 223 243 263 283	303 323 343 363 383	403 423 443 463 483	503 523 543 563 583	603 623 643 663 683
4 24 44 64 84	104 124 144 164 184	204 224 244 264 284	304 324 344 364 384	404 424 444 464 484	504 524 544 564 584	604 624 644 664 684
5 25 45 65 85	105 125 145 165 185	205 225 245 265 285	305 325 345 365 385	405 425 445 465 485	505 525 545 565 585	605 625 645 665 685
6 26 46 66 86	106 126 146 166 186	206 226 246 266 286	306 326 346 366 386	406 426 446 466 486	506 526 546 566 586	606 626 646 666 686
7 27 47 67 87	107 127 147 167 187	207 227 247 267 287	307 327 347 367 387	407 427 447 467 487	507 527 547 567 587	607 627 647 667 687
8 28 48 68 88	108 128 148 168 188	208 228 248 268 288	308 328 348 368 388	408 428 448 468 488	508 528 548 568 588	608 628 648 668 688
9 29 49 69 89	109 129 149 169 189	209 229 249 269 289	309 329 349 369 389	409 429 449 469 489	509 529 549 569 589	609 629 649 669 689
10 30 50 70 90	110 130 150 170 190	210 230 250 270 290	310 330 350 370 390	410 430 450 470 490	510 530 550 570 590	610 630 650 670 690
11 31 51 71 91	111 131 151 171 191	211 231 251 271 291	311 331 351 371 391	411 431 451 471 491	511 531 551 571 591	611 631 651 671 691
12 32 52 72 92	112 132 152 172 192	212 232 252 272 292	312 332 352 372 392	412 432 452 472 492	512 532 552 572 592	612 632 652 672 692
13 33 53 73 93	113 133 153 173 193	213 233 253 273 293	313 333 353 373 393	413 433 453 473 493	513 533 553 573 593	613 633 653 673 693
14 34 54 74 94	114 134 154 174 194	214 234 254 274 294	314 334 354 374 394	414 434 454 474 494	514 534 554 574 594	614 634 654 674 694
15 35 55 75 95	115 135 155 175 195	215 235 255 275 295	315 335 355 375 395	415 435 455 475 495	515 535 555 575 595	615 635 655 675 695
16 36 56 76 96	116 136 156 176 196	216 236 256 276 296	316 336 356 376 396	416 436 456 476 496	516 536 556 576 596	616 636 656 676 696
17 37 57 77 97	117 137 157 177 197	217 237 257 277 297	317 337 357 377 397	417 437 457 477 497	517 537 557 577 597	617 637 657 677 697
18 38 58 78 98	118 138 158 178 198	218 238 258 278 298	318 338 358 378 398	418 438 458 478 498	518 538 558 578 598	618 638 658 678 698
19 39 59 79 99	119 139 159 179 199	219 239 259 279 299	319 339 359 379 399	419 439 459 479 499	519 539 559 579 599	619 639 659 679 699
20 40 60 80 100	120 140 160 180 200	220 240 260 280 300	320 340 360 380 400	420 440 460 480 500	520 540 560 580 600	620 640 660 680 700

To get further information on the products advertised in BYTE, fill out the reader service card with your name and address. Then circle the appropriate numbers for the advertisers you select from the list. Add a 20-cent stamp to the card, then drop it in the mail. Not only do you gain information, but our advertisers are encouraged to use the marketplace provided by BYTE. This helps us bring you a bigger BYTE. The index is provided as an additional service by the publisher, who assumes no liability for errors or omissions.

PLACE
STAMP
HERE

BYTE

READER SERVICE
PO BOX 298
DALTON, MA 01226
USA

PLACE
STAMP
HERE

BYTE

READER SERVICE
PO BOX 298
DALTON, MA 01226
USA

BYTE

SUBSCRIPTIONS



4143

For a subscription to BYTE, please complete this card.

Name _____

Address _____

City _____

State _____ Zip _____ Country _____

Card No. _____

Expiration date _____

Four digits above name—Master Charge only _____

Signature _____ Date _____

Please allow eight weeks for processing. Thank you.

USA

Canada
Mexico

- | | | |
|----------------------------------|-------------------------------|-------------------------------|
| <input type="checkbox"/> 1 year | <input type="checkbox"/> \$21 | <input type="checkbox"/> \$23 |
| <input type="checkbox"/> 2 years | <input type="checkbox"/> \$38 | <input type="checkbox"/> \$42 |
| <input type="checkbox"/> 3 years | <input type="checkbox"/> \$55 | <input type="checkbox"/> \$61 |

- \$53 Europe (air delivery) payment enclosed
 \$37 Elsewhere (surface mail) payment enclosed

(Air mail rates available upon request)

Please remit in US funds drawn on a US bank. Thank you.

- Check enclosed (**Bonus:** [North America only] one EXTRA issue—receive 13 issues for the price of 12)



- Bill me (North America only)

BYTE

SUBSCRIPTIONS



4143

For a subscription to BYTE, please complete this card.

Name _____

Address _____

City _____

State _____ Zip _____ Country _____

Card No. _____

Expiration date _____

Four digits above name—Master Charge only _____

Signature _____ Date _____

Please allow eight weeks for processing. Thank you.

USA

Canada
Mexico

- | | | |
|----------------------------------|-------------------------------|-------------------------------|
| <input type="checkbox"/> 1 year | <input type="checkbox"/> \$21 | <input type="checkbox"/> \$23 |
| <input type="checkbox"/> 2 years | <input type="checkbox"/> \$38 | <input type="checkbox"/> \$42 |
| <input type="checkbox"/> 3 years | <input type="checkbox"/> \$55 | <input type="checkbox"/> \$61 |

- \$53 Europe (air delivery) payment enclosed
 \$37 Elsewhere (surface mail) payment enclosed

(Air mail rates available upon request)

Please remit in US funds drawn on a US bank. Thank you.

- Check enclosed (**Bonus:** [North America only] one EXTRA issue—receive 13 issues for the price of 12)



- Bill me (North America only)

*Note our special offer!
 Send cash with your order
 and receive 13 issues
 for the price of 12 for
 each year you subscribe.
 (North America only, please.)*

Don't Miss An Issue!

Have BYTE delivered to your door.

Each month BYTE will bring you the latest in microcomputer technology.

DISCOVER and IMPLEMENT new ideas. Don't miss the original information presented in the pages of BYTE.

With BYTE you'll always be among the first to know about the important breakthroughs, worthwhile new equipment, and innovative projects in the world of computing.

CHALLENGE US to deliver the very best ideas in microcomputers and advanced technology to you. Return the attached card today!

Subscribe to BYTE—the world's leading computer magazine.

PLACE
STAMP
HERE

BYTE SUBSCRIPTIONS
PO Box 590
Martinsville NJ 08836
USA

PLACE
STAMP
HERE

BYTE SUBSCRIPTIONS
PO Box 590
Martinsville NJ 08836
USA

THE LEADING EDGE IN PRINTERS

ONE GREAT LINE. ONE GREAT WARRANTY.

Finally, there's one full family of printers that covers every business or word processing application—all from C. Itoh, a company known for packing more product into less price; and all distributed exclusively by Leading Edge, a company known for searching out and providing that very thing. Which means that one call to one source can get you any printer, any time you need it, for any purpose. All backed by a full year's warranty from Leading Edge. (Try *that* on any other line of printers.)

THE PRO'S.

The Prowriters: business printers—and more. The “more” is a dot-matrix process with more dots. It gives you denser, correspondence quality copy (as opposed to business quality copy, which looks like a bad job of spray-painting).

Prowriter: 120 cps. 80 columns dot matrix compressible to 136. 10" carriage. Parallel or serial interface.

Prowriter 2: Same as Prowriter, except 15" carriage allows full 136 columns in normal print mode. Parallel or serial interface.

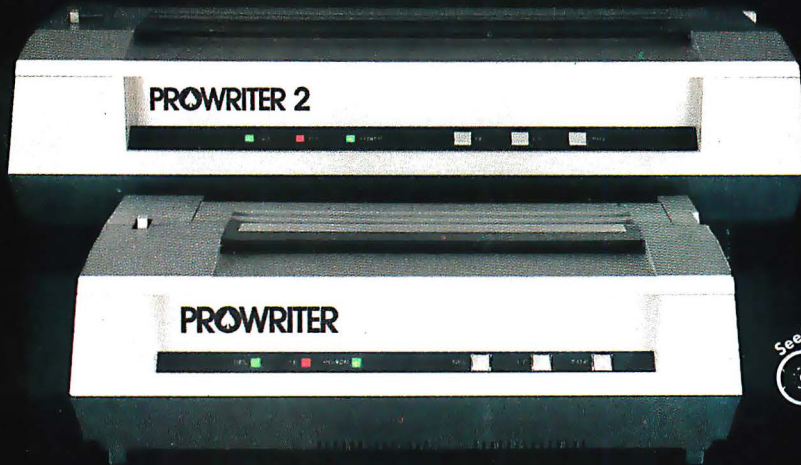

See Us At Booth #1146
COMDEX / SPRING '83
April 26-29, 1983
The Atlanta World Congress Center, and
Atlanta, Georgia

THE STAR.

The Starwriter F-10. In short (or more precisely, in a sleek 6" high, 30-pound unit), it gives you more of just about everything—except bulk and noise—than any other printer in its price range. It's a 40 cps letter-quality daisy-wheel with a bunch of built-in functions to simplify and speed up word processing.

It plugs into almost any micro on the market, serial or parallel.



THE MASTER.

The Printmaster F-10. Does all the same good stuff as the Starwriter except, at 55 cps, the Master does it faster.



Distributed Exclusively by Leading Edge Products, Inc., 225 Turnpike Street, Canton, Massachusetts 02021.
Call: toll-free 1-800-343-6833; or in Massachusetts call collect (617) 828-8150. Telex 951-624.

Circle 229 on inquiry card.

Two Important Reasons to Choose Your Printer from Radio Shack: Selection and Support

Choose from These Four Printers . . . and Five More!

799⁰⁰
DMP-200
 Cat. No. 26-1254



1795⁰⁰
DMP-500
 Cat. No. 26-1252



1195⁰⁰
DMP-400
 Cat. No. 26-1251



1495⁰⁰
DWP-410
 Cat. No. 26-1250

Your Printer Source. At Radio Shack, you can select from nine top-quality dot-matrix and daisy wheel printers and multi-pen plotters. More importantly, they're supported with ribbons, paper, custom business forms, print wheels, cables—everything you'll need to make your work go faster and smoother.

Triple-Mode Versatility. Our DMP-200, 400 and 500 dot-matrix printers give you a word processing mode for mono and proportionally-spaced correspondence characters, boldface, underline, super and subscripts; a bit-image mode—with repeat and column addressing codes—for superb graphics—at no extra cost; and a data processing mode that increases print speed without sacrificing print quality.

There's a DMP for You. The low-cost DMP-200 is compact, but doesn't compromise on features. It prints an 80-column line at 120 characters per second. The 132-column DMP-400 gives you 140 cps output. And the DMP-500 prints at 220 cps, and is designed especially for heavy business use.

Need Letter-Perfect Originals? Then get the affordable DWP-410 Daisy Wheel Printer. It uses interchangeable print wheels, and produces correspondence and reports with that crisp, clean "electric typewriter" look at 25 characters per second. That's 300 words per minute!

Available Nationwide. Why shop anywhere else? We also offer a 500 wpm daisy wheel printer, a low-priced dot-matrix printer that's ideal for the TRS-80® Color Computer and three multi-color plotters. Best of all, our complete line of printers and support accessories are in stock now at the Radio Shack Computer Center, store or participating dealer near you. See them all today.

Radio Shack®
 The biggest name in little computers®
 A DIVISION OF TANDY CORPORATION

Send me your free TRS-80 Computer Catalog today!

Mail To: Radio Shack, Dept. 83-A-163
 300 One Tandy Center, Fort Worth, Texas 76102

NAME _____
 ADDRESS _____
 CITY _____ STATE _____ ZIP _____
 PHONE _____

Retail prices may vary at individual stores and dealers. Special order may be required.

Circle 365 on inquiry card.