

BYTE[®]

JANUARY 1982 Vol. 7, No. 1
\$2.95 in USA/\$3.50 in Canada
A McGraw-Hill Publication

the small systems journal



THE IBM PERSONAL COMPUTER

A new small computer that won't limit you tomorrow



New Cromemco System One shown with our
high-capability terminal and printer.

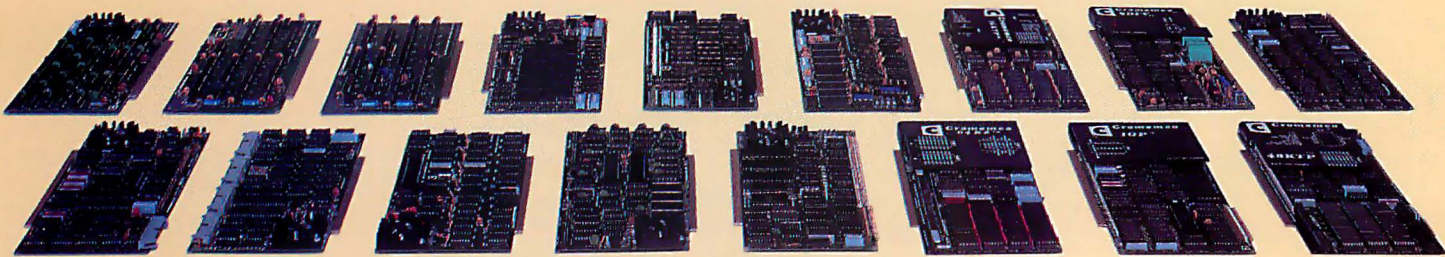

Expandability

Here's a low-priced computer that won't run out of memory capacity or expandability halfway through your project.

Typically, computer usage tends to grow, requiring more capability, more memory, more storage. Without a lot of capability and expandability, your computer can be obsolete from the start.

The new System One is a real building-block machine. It has capability and expandability by the carload.

Look at these features:

- **Z80-A processor**
- **64K of RAM**
- **780K of disk storage**
- **CRT and printer interfaces**
- **Eight S-100 card slots, allowing expansion with**
 - **color graphics**
 - **additional memory**
 - **additional interfaces for telecommunications, data acquisition, etc.**
- **Small size**

GENEROUS DISK STORAGE

The 780K of disk storage in the System One Model CS-1 is much greater than what is typically available in small computers. But here, too, you have a choice since a second version, Model CS-1H, has a 5" Winchester drive that gives you 5 megabytes of disk storage.

MULTI-USER, MULTI-TASKING CAPABILITY

Believe it or not, this new computer even offers multi-user capability when used with our advanced CROMIX* operating system option. Not only does this outstanding O/S support multiple users on this computer but does so with powerful features like multi-

ple directories, file protection and record level lock. CROMIX lets you run multiple jobs as well.

In addition to our highly-acclaimed CROMIX, there is our CDOS*. This is an enhanced CP/M† type system designed for single-user applications. CP/M and a wealth of CP/M-compatible software are also available for the new System One through third-party vendors:

COLOR GRAPHICS/WORD PROCESSING

This small computer even gives you the option of outstanding high-resolution color graphics with our Model SDI interface and two-port RAM cards.

Then there's our tremendously wide range of Cromemco software including packages for word processing, business, and much more, all usable with the new System One.

ANTI-OBSOLESCENCE/LOW-PRICED

As you can see, the new One offers you a lot of performance. It's obviously designed with anti-obsolence in mind.

What's more, it's priced at only \$3,995. That's considerably less than many machines with much less capability. And it's not that much more than many machines that have little or nothing in the way of expandability.

Physically, the One is small — 7" high. And it's all-metal in construction. It's only 14 1/8" wide, ideal for desk top use. A rack mount option is also available.

CONTACT YOUR REP NOW

Get all the details on this important building-block computer. Get in touch with your Cromemco rep now. He'll show you how the new System One can grow with your task.

*CROMIX and CDOS are trademarks of Cromemco Inc.
†CP/M is a trademark of Digital Research

 **Cromemco**™
i n c o r p o r a t e d
280 BERNARDO AVE., MOUNTAIN VIEW, CA 94040 • (415) 964-7400
Tomorrow's computers today

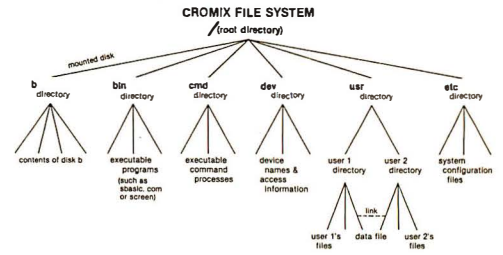

CROMIX* — Cromemco's outstanding UNIX[†]—like operating system

CROMIX is just the kind of major development you've come to expect from Cromemco. After all, we're already well-known for the most respected software in the microcomputer field.

And now we've come up with the industry's first UNIX-lookalike for microcomputers. It's a tried and proven operating system. It's available on both 5" and 8" diskettes for Cromemco systems with 128K or more of memory.

Here are just some of the features you get in this powerful Cromemco system:

- Multi-user and multi-tasking capability
- Hierarchical directories
- Completely compatible file, device, and interprocess I/O
- Extensive subsystem support

FILE SYSTEM

One of the important features of our CROMIX is its file system comprised of hierarchical directories. It's a tree structure of three types of files: data files,

*CROMIX is a trademark of Cromemco, Inc.
†UNIX is a trademark of Bell Telephone Laboratories

directories, and device files. File, device, and interprocess I/O are compatible among these file types (input and output may be redirected interchangeably from and to any source or destination).

The tree structure allows different directories to be maintained for different users or functions with no chance of conflict.

PROTECTED FILES

Because of the hierarchical structure of the file system, CROMIX maintains separate ownership of every file and directory. All files can thus be protected from access by other users of the system. In fact, each file is protected by **four separate access privileges** in each of the three user categories.

TREMENDOUS ADDRESS SPACE, FAST ACCESS

The flexible file system and generalized disk structure of CROMIX give a disk address space in excess of one gigabyte per volume — file size is limited only by available disk capacity.

Speed of access to disk files has also been optimized. Average access speeds far surpass any yet implemented on microcomputers.

'C' COMPILER AVAILABLE, TOO

Cromemco offers a wide range of languages that operate under CROMIX. These include a high-level command process language and extensive sub-system support such as COBOL, FORTRAN IV, RATFOR, LISP, and 32K and 16K BASICS.

There is even our highly-acclaimed 'C' compiler which allows a programmer fingertip access to CROMIX system calls.

THE STANDARD O-S FOR THE FUTURE

The power and breadth of its features make CROMIX the standard for the next generation of microcomputer operating systems.

And yet it is available for a surprisingly low \$595.

The thing to do is to get all this capability working for you now. Get in touch with your Cromemco rep today.

Cromemco™
 i n c o r p o r a t e d
 280 BERNARDO AVE., MOUNTAIN VIEW, CA 94040 • (415) 964-7400
 Tomorrow's computers today

Features

26 **The Atari Tutorial, Part 5: Scrolling** by Chris Crawford / Coarse and fine scrolling, both horizontally and vertically, let the display screen become a window for viewing large amounts of data.

36 **A Closer Look at the IBM Personal Computer** by Gregg Williams / The Personal Computer is a versatile microcomputer that can be used in almost any application.

72 **Analog Interfacing In the Real World** by Steve Ciarcia / Learn how to design and build economical analog interfaces.

100 **MIKBUG and the TRS-80, Part 2: A File Transfer and Debugging Package** by Robert Labenski / Use your TRS-80 as a file-transfer terminal and debugging monitor for a 6800 system.

132 **User's Column: Operating Systems, Languages, Statistics, Pirates, and the Lone Wolf** by Jerry Pournelle / Straight talk on a variety of new products from a hard-to-please computer user.

160 **Build a Joystick A-to-D Converter for the TRS-80 Model I or III, Second In a Series** by William Barden, Jr. / A hardware/software project to make your TRS-80 "sensitive" to the analog world.

190 **Troubleshooting with Electronic Signatures** by Kenneth M. Piggott / A "free-running" microprocessor can help to fix a malfunctioning computer system.

216 **Memory Expansion for the ZX-80** by Hilton K. Ernede / Upgrade your Sinclair ZX-80 for under \$200 with a 16 K-byte memory-expansion project.

239 **An 8080-Based Remote Appliance Controller** by David C. Staehlin / BSR X-10 strikes again.

304 **Clocked Interrupts for the COSMAC Elf** by Gary H. Price / Hardware and software provide video-display and variable-period interrupts.

344 **COSMAC EPROM Programmer** by Dan Rubis / How to build a low-cost EPROM programmer based on an RCA 1802 microprocessor.

366 **An Apple Talks with the Deaf** by Ned W. Rhodes / With the hardware and software described here, you can pick up the phone and wish a deaf friend a good day.

397 **An Effective Text-Compression Algorithm** by David Cortesi / Reduce the size of text files by identifying common pairs of letters.

410 **Structured Programming In BASIC** by Mark Sobell / An introduction to the principles of structured programming with examples in Cromemco 32 K Structured BASIC.

420 **The GEOSAT Program** by Steve Emmett / How to tell if your location is suitable for a satellite-receiving antenna.

Reviews

123 The RCA VP-3301 Data Terminal by Tim Daneliuk

332 SD Systems' Z80 Starter Kit by Wayne Angevine

Nucleus

6 Editorial: Of IBM, Operating Systems, and Rosetta Stones

14 Letters

114, 206, 433 Technical Forum: Floppy-Disk Performance; Analyze Audio by Visualizing; Z80 Starting Address, One Jump Further

118 Education Forum: AC Motor Control: Simple Algorithms and Hardware

186 Programming Quickies: Thirty More Days to a Faster Input

234, 324, 436 System Notes: Accidental Reset Protection for the Apple II; Add a Peripheral Interface Adapter to Your Apple II; SOFTIM, A Software Timer

296 BYTELINES

387 Books Received

388 Event Queue

393 Clubs and Newsletters

394 Software Received

404 Ask BYTE

416 Product Description: CMOS: Memory with a Future, Ideas Behind CompuPro's RAM 17

440 What's New?

494 Unclassified Ads

495 Reader Service

496 BOMB, BOMB Results

BYTE

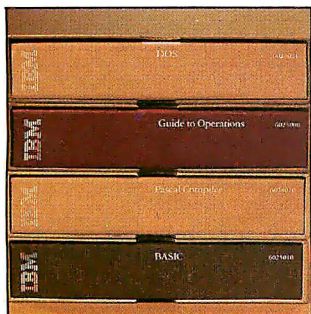

Page 36

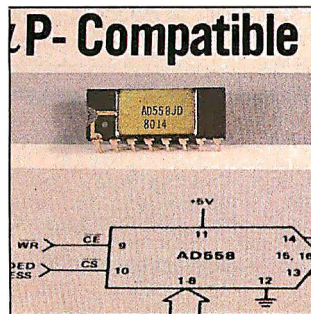

Page 72



Page 123

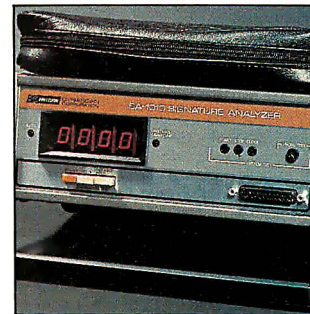

Page 190



Editor in Chief

Christopher Morgan

Managing Editor

Mark Haas

Technical Editors

Gregg Williams, Senior Editor;
Richard S. Shuford; Curtis P. Feigel;
George Stewart; Arthur Little;
Stanley Wszola; Steve Ciarcia; Mark Dahmke;
Philip Lemmons; Allan Lundell, Consulting
Editors; Jon Swanson, Drafting Editor

Copy Editors

Beverly Cronin, Chief; Faith Hanson;
Warren Williamson; Anthony J. Lockwood;
Ann Graves; David R. Anderson;
Linda M. Evers

Assistants

Faith Ferry; Debe Wheeler;
Karen A. Cilley; Susan Ferber;
Marie Hennessy

Production

Nancy Estle, Director; Christine Destrempe,
Asst. Director; Jonathan M. Graves, Creative
Consultant; Patrice Scribner; Damian
Henriques; Jan Muller; Linda J. Sweeney;
Sherry McCarthy, Chief Typographer;
Debi Fredericks; Donna Sweeney;
Valerie Horn

Advertising

Thomas Harvey, Director; Marion Carlson;
Rob Hannings; Marilyn Williams;
Deborah Porter; Vicki Reynolds;
Cathy A. R. Drew; Jacqueline Earnshaw,
Reader Service Coordinator; Wai Chiu Li,
Advertising/Production Coordinator

Circulation

Gregory Spitzfaden, Manager;
Andrew Jackson, Asst. Manager;
Agnes E. Perry; Barbara Varnum;
Louise Menegus; Pinky Krulis;
James Bingham, Dealer Sales;
Deborah J. Cadwell, Asst.
Kathleen Reckhart

Controller's Office

Daniel Rodrigues, Controller;
Mary E. Fluhr, Acct. & D/P Mgr.; Karen
Burgess; Jeanne Cilley; Linda Fluhr;
Vicki Bennett

Traffic

N. Scott Gagnon; Michael Bacon;
Scott Jackson

Publishers

Virginia Londoner; Gordon R. Williamson;
John E. Hayes, Associate Publisher;
Cheryl A. Hurd; Michele P. Verville, Publisher's
Assistants;

Officers of McGraw-Hill Publications Company: Paul F. McPherson, President; Executive Vice Presidents: James E. Boddorf, Daniel A. McMillan, III, Gene W. Simpson; Senior Vice President-Editorial: Ralph R. Schulz; Vice Presidents: Kemp Anderson, Business Systems Development; Robert B. Doll, Circulation; James E. Hackett, Controller; Eric B. Herr, Planning and Development; H. John Sweger, Jr., Marketing. Officers of the Corporation: Harold W. McGraw Jr., Chairman and Chief Executive Officer; Joseph L. Dionne, President and Chief Operating Officer; Robert F. Landes, Senior Vice President and Secretary; Ralph J. Webb, Treasurer.



In This Issue

IBM's entry into the small-computer market with its Personal Computer was a big event in the industry. And that's why we've taken a second look. Showcased in our cover photo by Paul Avis, the IBM Personal Computer is a versatile machine. For an in-depth report on its many features and capabilities read Gregg Williams' article, "A Closer Look at the IBM Personal Computer."

Hardware is our theme this month and among the many articles on that topic are Bill Barden's second in a series, "Build a Joystick A-to-D Converter for the TRS-80 Model I or III," and Kenneth Piggott's "Troubleshooting with Electronic Signatures." As well, learn how to expand your ZX-80's memory, control motors and appliances, and interrupt your Elf. All this plus our regular features and reviews.

BYTE is published monthly by BYTE Publications Inc, 70 Main St, Peterborough NH 03458, phone (603) 924-9281, a wholly-owned subsidiary of McGraw-Hill, Inc. Address subscriptions, change of address, USPS Form 3579, and fulfillment questions to BYTE Subscriptions, POB 590, Martinsville NJ 08836. Second class postage paid at Waseca, Minnesota 56093 - USPS Publication No. 528890 (ISSN 0360-5280). Canadian second class registration number 9321. Subscriptions are \$19 for one year, \$34 for two years, and \$49 for three years in the USA and its possessions. In Canada and Mexico, \$21 for one year, \$38 for two years, \$55 for three years. \$43 for one year air delivery to Europe. \$35 surface delivery elsewhere. Air delivery to selected areas at additional rates upon request. Single copy price is \$2.95 in the USA and its possessions, \$3.50 in Canada and Mexico, \$4.50 in Europe, and \$5.00 elsewhere. Foreign subscriptions and sales should be remitted in United States funds drawn on a US bank. Printed in United States of America.

Address all editorial correspondence to the editor at BYTE, POB 372, Hancock NH 03449. Unacceptable manuscripts will be returned if accompanied by sufficient first class postage. Not responsible for lost manuscripts or photos. Opinions expressed by the authors are not necessarily those of BYTE. Entire contents copyright © 1982 by BYTE Publications Inc. All rights reserved. Where necessary, permission is granted by the copyright owner for libraries and others registered with the Copyright Clearance Center (CCC) to photocopy any article herein for the base fee of \$1.00 per copy of the article or item plus 25 cents per page. Payment should be sent directly to the CCC, 21 Congress St, Salem MA 01970. Copying done for other than personal or internal reference use without the permission of McGraw-Hill is prohibited. Requests for special permission or bulk orders should be addressed to the publisher.

BYTE® is available in microform from University Microfilms International, 300 N Zeeb Rd, Dept PR, Ann Arbor MI 48106 USA or 18 Bedford Row, Dept PR, London WC1R 4EJ England.



Subscription WATS Line: (800) 258-5485

Office hours: Mon-Thur 8:30 AM - 4:30 PM, Friday 8:30 AM - Noon, Eastern Time

NATIONAL ADVERTISING SALES REPRESENTATIVES:

NORTHEAST (617) 444-3946 Hajar Associates 280 Hillside Ave Needham Heights MA 02194	MID ATLANTIC (201) 741-7744 Hajar Associates 321 Broad Street Red Bank NJ 07701 New York NY (212) 682-5844	SOUTHEAST (305) 886-7210 Hajar Associates 1220 Prairie Lane Apopka FL 32703
MIDWEST (312) 966-0160 Hajar Associates 5225 Old Orchard Road Suite 50 Skokie IL 60076	NORTHWEST (415) 964-0706 Hajar Associates 1000 Elwell Ct, Suite 227 Palo Alto CA 94303	SOUTHWEST (714) 540-3554 Hajar Associates 3303 Harbor Blvd Suite K-4 Costa Mesa CA 92626

MicroAngelo™ and beyond.

SCION Corporation pioneered advanced information display systems with the elegantly simple MicroAngelo™ high resolution S100 single board graphics computer. With MicroAngelo™ came a powerful, flexible CP/M* compatible, high level firmware called Screenware.™ For MicroAngelo™ Color System, Colorpak software evolved. Easy to integrate, easy to convert and easy to use. This software gave MicroAngelo™ unparalleled capacity to manipulate color transparencies. Beyond MicroAngelo™ with the prototype Advanced Congressional Workstation developed for the U.S. Congress, SCION Corporation proved an interactive, very high resolution text/graphics display system can be built with existing technology. SCION Corporation grows at its unprecedented rate by evolving beyond today's triumphs, to develop graphics engines to solve tomorrow's problems.

SCION Corporation. More than a graphics company.

For information on the next generation of advanced information display systems, call today. If the image is important, it has to be SCION.

SCION
If the image is important.

12310 Pinecrest Road/Reston, Virginia 22091
703/476-6100 TWX: 710-833-0684

foot-note, *n.* 1. a note or comment at the end of a page, referring to a specific part of the text on the page.
2. an essential program for the serious WordStar user.

FOOTNOTE™ brings full footnoting capabilities to WordStar™.

FOOTNOTE automatically numbers both footnote calls and footnotes, and formats the text, placing footnotes on the bottom of the correct page. At the user's option, the footnotes can also be removed from the text file to a separate note file.

Footnotes can be entered singly or in groups, in the middle or at the end of paragraphs, or in a completely separate note file. After running FOOTNOTE the user can re-edit the text, add or delete notes, and run FOOTNOTE again to re-number and re-format the WordStar file.

The price is \$125., and includes PAIR, a companion program that checks that printer commands to underline or set in **BOLDFACE**, are properly terminated. FOOTNOTE and PAIR require CP/M™, WordStar, 48K RAM and a Z80 or 8080/85 computer.

SOFTWARE
SOFTWARE
DIGITAL MARKETING
DIGITAL MARKETING™

2670 Cherry Lane • Walnut Creek • CA 94596

(415) 938-2880

Telex #17-1852 (DIGMKTG WNCK)

Products of

PRO/TEM T.M.
PRO/TEM SOFTWARE

FOOTNOTE and PAIR trademarks of PRO/TEM Software, Inc.
WordStar trademark of Micropro Int'l
CP/M trademark of Digital Research

Editorial

Of IBM, Operating Systems, and Rosetta Stones

by Chris Morgan, Editor in Chief

The story behind the creation of the IBM Personal Computer is as interesting as the machine itself. In this issue Gregg Williams discusses in great detail IBM's most recent offering to the microcomputer field (see "A Closer Look at the IBM Personal Computer," page 36). In this editorial I'll tell you the story of its development, talk about the machine's operating system, and discuss the possibility of establishing a standard for operating systems.

Breaking the Speed Barrier

As IBM watchers know, it usually takes about five years from the time a project at IBM is conceived to the first shipments of the completed product. This is typical for complex computer projects at large companies. Amazingly, the total time for the IBM Personal Computer project was about 13 months. How did this happen?

One answer is that IBM limited the number of in-house innovations. Instead it used existing hardware and software components from outside vendors—a departure for the normally vertically integrated giant. Imagine how bizarre an Intel-manufactured processor would have seemed in an IBM product of, say, five years ago.

Another factor in IBM's speed is that the company gave its design team a wide latitude and a great deal of autonomy. The rest of the company left the designers, based in Boca Raton, Florida, alone to do their job, although IBM's quality-assurance group did keep a close eye on the software chosen for the machine.

One of the most interesting aspects of the Personal Computer is that its design team included many computer hobbyists and "hackers"—people who owned and were familiar with existing microcomputers. And the IBM machine reflects their experience. I'm glad they avoided many design mistakes of the past. The keyboard alone is one of the best I've seen, though I wish the shift keys were more conventionally positioned. (Oh well.)

Operating Systems

IBM has decided to let the marketplace determine which of its three operating systems will become dominant (if any). Thus, you can get UCSD Pascal, CP/M-86, or the IBM Personal Computer operating system from Microsoft. You can have all three if you want; it's a nice choice.

I'm particularly excited about Microsoft's approach to the IBM Personal Computer. As you may know, Microsoft recently introduced Xenix, its superset of Unix, Western Electric's popular multiuser operating system for small- and medium-sized computers. It turns out that Xenix is at the top of a pyramid of upward-compatible operating systems to be made available by

Percom's DOUBLER II™ tolerates wide variations in media, drives

GARLAND, TEXAS — May 22, 1981 — Harold Mauch, president of Percom Data Company, announced here today that an improved version of the Company's innovative DOUBLER™ adapter, a double-density plug-in module for TRS-80* Model I computers, is now available.

Reflecting design refinements based on both theoretical analyses and field testing, the DOUBLER II™, so named, permits even greater tolerance in variations among media and drives than the previous design.

Like the original DOUBLER, the DOUBLER II plugs into the drive controller IC socket of a TRS-80 Model I Expansion Interface and permits a user to run either single- or double-density diskettes on a Model I.

With a DOUBLER II installed, over four times more formatted data — as much as 364 Kbytes — can be stored on one side of a five-inch diskette than can be stored using a standard Tandy Model I drive system.

Moreover, a DOUBLER II equips a Model I with the hardware required to run Model III diskettes.

(Ed. Note: See "OS-80™: Bridging the TRS-80* software compatibility gap" elsewhere on this page.)

The critical clock-data separation circuitry of the DOUBLER II is a proprietary design called a ROM-programmed digital phase-lock loop data separator.

According to Mauch, this design is more tolerant of differences from diskette to diskette and drive to drive, and also provides immunity to performance degradation caused by circuit component aging.

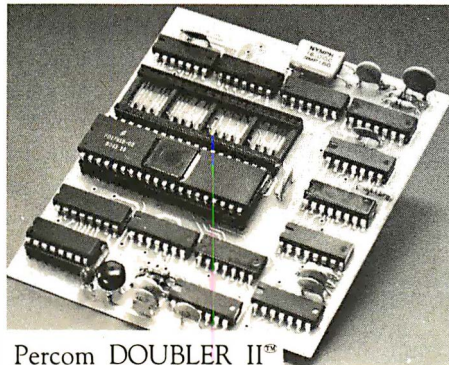

Percom DOUBLER II™

Mauch said "A DOUBLER II will operate just as reliably two years after it is installed as it will two days after installation."

The digital phase-lock loop also eliminates the need for trimmer adjustments typical of analog phase-lock loop circuits.

"You plug in a Percom DOUBLER II, and then forget it," he said.

The DOUBLER II also features a refined Write Precompensation circuit that more effectively minimizes the phenomena of bit-and-peak-shifting, a reliability-impairing characteristic of magnetic data recording.

The DOUBLER II, which is fully software compatible with the previous DOUBLER, is supplied with DBLDOS™, a TRSDOS*-compatible disk operating system.

The DOUBLER II sells for \$29.95, including the DBLDOS diskette.

~~\$29.95~~
Now \$16.95!

Owners of original DOUBLERS may purchase a DOUBLER II upgrade kit, without the disk controller IC, for \$30.00. Proof of purchase of an original DOUBLER is required, and each DOUBLER owner may purchase only one DOUBLER II at the \$30.00 price.

The Percom DOUBLER II is available from authorized Percom retailers, or may be ordered direct from the factory. The factory toll-free order number is 1-800-527-1222.

Ed. note: Opening the TRS-80 Expansion Interface may void the Tandy limited 90-day warranty. Circle 300 on inquiry card.

All that glitters is not gold OS-80™ Bridging the TRS-80* software compatibility gap

Compatibility between TRS-80* Model I diskettes and the new Model III is about as genuine as a gold-plated lead Krugerrand.

True, Model I TRSDOS* diskettes can be read on a Model III. But first they must be converted and re-recorded for Model III operation.

And you cannot write to a Model I TRSDOS* diskette. Not with a Model III. You cannot add a file. Delete a file. Or in any way modify a Model I TRSDOS diskette with a Model III computer.

Furthermore, your converted TRSDOS diskettes cannot be converted back for Model I operation.

TRSDOS is a one-way street. And there's no retreating. A point to consider before switching the company's payroll to your new Model III.

Real software compatibility should allow the direct, immediate interchangeability of Model I and Model III diskettes. No read-only limitations, no conversion/re-recording steps and no chance to be left high and dry with Model III diskettes that can't be run on a Model I.

What's the answer? The answer is Percom's OS-80™ family of TRS-80 disk operating systems.

OS-80 programs allow direct, immediate interchangeability of Model I and Model III diskettes.

You can run Model I single-density diskettes on a Model III; install Percom's plug-in DOUBLER™ adapter in your Model I, and you can run double-density Model III diskettes on a Model I.

There's no conversion, no re-recording. Slip an OS-80 diskette out of your Model I and insert it directly in a Model III.

And vice-versa. Just have the correct OS-80 disk operating system — OS-80, OS-80D or OS-80/III — in each computer.

Moreover, with OS-80 systems, you can add, delete, and update files. You can read and write diskettes regardless of the system of origin.

OS-80 is the original Percom TRS-80 DOS for BASIC programmers.

Even OS-80 utilities are written in BASIC. OS-80 is the Percom system about which a user wrote, in Creative Computing magazine, "... the best \$30.00 you will ever spend."[†]

Requiring only seven Kbytes of memory, OS-80 disk operating systems reside completely in RAM. There's no need to dedicate a drive exclusively for a system diskette.

And, unlike TRSDOS, you can work at the track sector level, defining and controlling data formats — in BASIC — to create simple or complex data structures that execute more quickly than TRSDOS files.

The Percom OS-80 DOS supports single-density operation of the Model I computer — price is \$29.95; the OS-80D supports double-density operation of Model I computers equipped with a DOUBLER or DOUBLER II; and, OS-80/III — for the Model III of course — supports both single- and double-density operation. OS-80D and OS-80/III each sell for \$49.95. Circle 301 on inquiry card.

Circuit misapplication causes diskette read, format problems. High resolution key to reliable data separation

GARLAND, TEXAS — The Percom SEPARATOR™ does very well for the Radio Shack TRS-80* Model I computer what the Tandy disk controller does poorly at best: reliably separates clock and data signals during disk-read operations.

Unreliable data-clock separation causes format verification failures and repeated read retries.

CRC ERROR—TRACK LOCKED OUT

The problem is most severe on high-number (high-density) inner file tracks.

As reported earlier, the clock-data separation problem was traced by Percom to misapplication of the internal separator of the 1771 drive controller IC used in the Model I.

The Percom Separator substitutes a high-resolution digital data separator circuit, one which operates at 16 megahertz, for the low-resolution one-megahertz circuit of the Tandy design.

Separator circuits that operate at lower frequencies — for example, two- or four-

megahertz — were found by Percom to provide only marginally improved performance over the original Tandy circuit.

The Percom solution is a simple adapter that plugs into the drive controller of the Expansion Interface (EI).

Not a kit — some vendors supply an untested separator kit of resistors, ICs and other paraphernalia that may be installed by modifying the computer — the Percom SEPARATOR is a fully assembled, fully tested plug-in module.

Installation involves merely plugging the SEPARATOR into the Model I EI disk controller chip socket, and plugging the controller chip into a socket on the SEPARATOR.

The SEPARATOR, which sells for only \$29.95, may be purchased from authorized Percom retailers or ordered directly from the factory. The factory toll-free order number is 1-800-527-1222.

Ed. note: Opening the TRS-80 Expansion Interface may void the Tandy limited 90-day warranty. Circle 299 on inquiry card.

PROFESSIONAL PASCAL

Pascal/Z

NEW 4.0

SYMBOLIC DEBUGGER

This fourth generation version of our reliable, Z-80 native code compiler adds the two features professionals ask for:

- ◆ **SWAT™**—an interactive symbolic Pascal debugger that allows easy error detection.
- ◆ **Overlays**—that allow larger programs to run in limited memory.

A compiler for Professional programmers

Pascal/Z is a true Pascal. It closely follows the Jensen and Wirth standard with a minimum of extensions designed to aid the serious program developer in producing extremely compact, bug-free code that runs FAST.

Pascal/Z generates Z-80 native code that is ROMable and Re-entrant. Permits separate compilation, direct file access, external routines and includes a relocating macro assembler and Microsoft compatible linker.

And code written for Pascal/Z is fully compatible with I·PAS 8000, our new native code Pascal compiler for Z-8000, to guarantee graceful migration to 16 bit operation.

Get "The FACTS about Pascal"

Confused about which Pascal to buy? Pseudo-code... Native code... M, MT or Z? Compare the *unbiased* benchmarks in our new booklet. **Don't buy a Pascal compiler until you've read it.**

Call us for a free copy:

800-847-2088

(outside NYS)

or 607-257-0190

And ask your local full-service computer dealer about our Pascal/Z demo package.



InterSystems™

Ithaca Intersystems Inc.

Micros for bigger ideas.

Ithaca Intersystems Inc.

1650 Hanshaw Rd • Ithaca, NY 14850 • TWX 510 255-4346

U.K. Distributor:

Ithaca Intersystems (U.K.) Ltd.

Coleridge Road London N8 8ED Phone: 01-341 2447 Telex: 299568

Editorial

Microsoft. At the bottom is the IBM DOS (called MSDOS by Microsoft). In the middle will be XEDOS, a new operating system written in the C language for the 68000, Z-8000, 8086, and LSI-11 processors. XEDOS will contain Xenix-like features and will be essentially a single-user version of Xenix.

XEDOS and Xenix are processor-independent. Because the different versions of XEDOS are written in C with a minimal amount of native assembly-language code, programs written for one 16-bit processor can be readily transferred to another. Microsoft demonstrated this capability, at the recent COMDEX show in Las Vegas, by exchanging unmodified code between four machines: a 68000, a Z-8000, an 8086, and a PDP-11.

Standards, Anyone?

Unix has become well entrenched in the nation's colleges and universities due to Western Electric's extensive, inexpensive licensing of the system. As a result, many of today's graduating computer scientists are familiar with it. (See "The Unix Operating System and the Xenix Standard Operating Environment" by Robert Greenberg, June 1981 BYTE, page 248.)

Microsoft's proposed family of operating systems will also incorporate a significant feature—a graphics device driver that uses AT&T's proposed videotex graphics standard called PLP (Presentation Level Protocol). It's a minimal standard, admittedly (it's hardly high-resolution graphics), but think what it would mean if *all* 16-bit operating systems could support PLP. At last we'd have a *least common denominator* for graphics. And keep in mind that the creative use of graphics will be a vital part of the future of our field.

Digital Research, for its part, is promoting its latest efforts, CP/M-86 and its multiuser, multitasking version, MP/M-86, as candidates for the standard 16-bit operating systems of the future. (See "CP/M: A Family of 8- and 16-Bit Operating Systems," by Gary Kildall in June 1981 BYTE, page 216.) More than twenty OEMs (original equipment manufacturers) have made commitments to use the two operating systems. Both the IBM Personal Computer and the IBM Displaywriter use CP/M-86. MP/M-86 will soon be available for the IBM Personal Computer. One good feature of MP/M-86 is its foreground/background structure, which, for example, lets the user access the editor while compiling a program.

Of more importance than CP/M-86 is MP/M-2, Digital Research's new multiuser operating system. It will be a real contender against Microsoft's operating system. It includes file locking and record locking, 32-megabyte file capacity, and other sophisticated features. Significantly, the company also currently supports Unix through C BASIC and Pascal. Digital's official stand is that it is not "philosophically opposed" to the Unix concept, thus holding open the possibility for a future operating system standard.

Circle 192 on inquiry card.



The ultimate single user machine

The PDS-80™ with Cache BIOS™ is a professional system designed for the most rigorous single user CP/M* environments... in business, software development, scientific, educational and industrial research... where speed and program space are critical factors.

SymBIOSis quadruples speed

No matter what high-level language you use... Cobol, Basic, Fortran, PL/1, or Pascal... PDS-80 offers more speed, power and reliability than any other floppy based CP/M system currently on the market. The InterSystems Cache BIOS fully exploits the advanced DMA and interrupt features of our reliable Series II hardware to buffer whole tracks in extended memory so most operations run two to four times faster than on other floppy based systems... actually equals the speed of many small hard disk systems. And Cache BIOS also provides many sophisticated system test and protection features to assure reliable operation.

An advanced CP/M application system

PDS-80 has all you need for commercial systems integration and applications software development... including a choice of the industry's only integral 8 bit front panel. Best of all, PDS-80 allows the systems integrator or applications developer addressing a vertical market to develop on the same components he configures for resale. The highly expandable modular design with

20slot S-100 mainframe allows almost unlimited options to suit any end use environment... including a choice of tabletop or rackmount design.

InterSystems will work with you at whatever level is appropriate to configure the target system you need... right up to fully assembled and tested systems with floppy and Winchester disk drives.

Full software support

In addition to InterSystems' Cache BIOS and the CP/M operating system, models of PDS-80 can include Pascal/Z,



our highly acclaimed Z-80® native code Pascal compiler, and InterPak 80™, a special set of utilities including a powerful screen editor and versatile spelling editor to assist in the rapid editing, proofing and documentation of your code. These powerful programming aids are also available as standalone products.

It's upgradeable!

Both hardware and software are designed to provide for upgrade to 16 bit operation. Programs written for Pascal/Z are fully compatible with I-Pas 8000™, our Z-8000® native code compiler, and all PDS-80 systems are upgradeable to our 16 bit multi-user DPS-8000.

We build micros for bigger ideas.

Your big ideas. We're dedicated to providing the computer professional... Systems Integrators, commercial program developers, scientific and industrial programmers... with professional hardware and software tools. And we support our customers to the fullest, with complete, professional documentation, application engineering consultation, and prompt, responsive service both from the factory and through factory-authorized service centers.

Call us toll free: 800-847-2088

for complete information on any of our 8 or 16 bit systems and software products.



Distributor Inquiries Invited

InterSystems™
Ithaca Intersystems Inc.

Circle 193 on inquiry card.

Micros for bigger ideas.

Ithaca Intersystems Inc. • 1650 Hanshaw Road • Ithaca, NY 14850 • Phone (607) 257-0190 • TWX: 510 255 4346
U.K. Distributor Ithaca Intersystems (U.K.) Ltd. Coleridge Road London N8 8ED Phone: 01-341 2447 Telex: 299568

*Z-80 and Z-8000 are registered trademarks of Zilog, Inc. **Trademarks of Ithaca Intersystems Inc. ***Registered trademark of Digital Research

MODEMS

All Modems connect to any RS232 Computer or Terminal!

1200 Baud and 300 Baud-Bell 212A Style. Penril 300/1200\$799
Originate/answer/auto-answer. Full duplex, RS232. Phone line connection via standard phone jack. 1 yr. warranty.
Auto-dial option\$350

300 Baud. Phone Link\$129
Originate/answer. Sleek, low profile. 15 ozs. Half/full duplex. Self test. RS232. Light displays for On Carrier, Test, Send & Receive Data. 1 yr. warranty.

300 Baud. USR-330D\$249
Originate/answer/auto-answer. Phone line connection via standard jack. 1 yr. warranty.

300 Baud. USR-330A\$299
Same as USR-330D PLUS Auto-Dial. Call for quote and technical information on higher speed modems and multiplexors.



Printing Terminals

The new generation of printing terminals from General Electric.



30/60 CPS. GE Terminet 2030\$999
110/300/60/1200 Baud. User selectable lines per inch and chars. per inch. True descenders and underlining. Up to 217 cols per line. Top of form, vert. and hor. tabs. Friction feed std., tractor feed opt. Answerback. 1 yr. warranty on parts. Nationwide servicing. Extremely compact. 15 in. paper. Only 22 lbs. **SUPERIOR TO DEC LA34AA** at lower cost.

120/150 CPS. GE Terminet 2120\$1,799
Housed in same compact package as the 2030 with all the features of the 2030 PLUS 150 char. per. sec. print rate.

Slash Your Connect Time and Printer Delay Time
Text Editor For GE2030 & 2120\$799
Includes 32K buffer inside terminal for data receipt and transmission at up to 9600 baud. Also Available: Receive only/Printer only versions of GE2030 & 2120.

Letter Quality. NEC 7720 KSR with keyboard\$2,695
55 CPS. RS232 and Centronics parallel. Interchangeable print thimbles for a wide variety of perfect, letter quality output.

Teletype 43 KSR with RS232 cable\$1,149

DEC LA34AA\$1,099

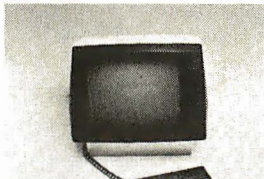

CRTs

ADDS Viewpoint\$619
Detachable keyboard. Numeric keypad. Tiltable screen. Cursor control keys. Function keys. Auto-repeat on all keys. 110 to 19,200 baud. Transparent mode. Printer Port. Compact, 20 lbs. Visual attributes.

DEC VT101—NEW from DEC\$1,299
Identical to standard VT100. Detachable keyboard. Separate numeric keypad. Bidirectional smooth scrolling. Split screen. Key click. 80 Cols or 132 cols per line.

DEC VT131—NEW from DEC\$1,699
Same as VT101 plus advanced video option for enhanced screen programming and printer port.

Perkin-Elmer 550B\$728

Perkin-Elmer 1251\$1,599

Televideo 950\$999

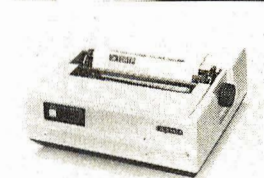

Printers

OKIDATA Microline 82A. 120 CPS. 80/132 Columns per line\$619
User selectable char. Sizes. Top-of-form bi-directional. Short line seeking print techniques for greater throughput. RS232 & Centronics parallel interfaces.

Letter Quality, NEC 7710 RO\$2,395
Same features as the 7720KSR listed above but without keyboard.

Editorial

The Battle

Who's going to win the 16-bit operating system sweepstakes? My guess is that there'll be no clear winner for several years; maybe never. Competing software and languages tend to coexist in our field, and this situation is no exception. IBM has set the tone by making *both* CP/M-86 and MSDOS available for its machine. Yet when I look at the mistakes made in the 8-bit world, I hope a standard will emerge.

A New "Rosetta Stone"

In 1799 the Rosetta stone was discovered in Egypt. It contained the same message inscribed in three different languages: Greek, Demotic, and Egyptian hieroglyphics. Using the familiar texts of the Greek and Demotic, scientists were able to painstakingly translate Egyptian hieroglyphics for the first time—a triumph of scholarship that would have been virtually impossible without the decoding stone.

But translating is a slow, arduous job. Creative software designers waste a lot of time customizing their programs for different machines. Today, we need an entire set of "Rosetta stones," translating tools to disseminate software for all of the popular machines. But these tools have become more like a set of millstones around our necks.

We need a new approach to operating systems to cure the ills that still beset us from the footloose days of 8-bit machines. A standard 16-bit operating system is still the best way out of the linguistic woods. ■

Articles Policy

BYTE is continually seeking quality manuscripts written by individuals who are applying personal computer systems, designing such systems, or who have knowledge which will prove useful to our readers. For a more formal description of procedures and requirements, potential authors should send a large (9 by 12 inch, 30.5 by 22.8 cm), self-addressed envelope, with 28 cents US postage affixed, to BYTE Author's Guide, 70 Main St, Peterborough NH 03458.

Articles which are accepted are purchased with a rate of up to \$50 per magazine page, based on technical quality and suitability for BYTE's readership. Each month, the authors of the two leading articles in the reader poll (BYTE's Ongoing Monitor Box or "BOMB") are presented with bonus checks of \$100 and \$50. Unsolicited materials should be accompanied by full name and address, as well as return postage.



VISA/MasterCard Accepted. Corporation and Institution purchase orders accepted. Leasing rates available on request. Your satisfaction Guaranteed. All equipment may be returned for full credit. We offer full service, on-site maintenance plans on all equipment. All equipment in stock.

U.S. ROBOTICS INC.

203 N. WABASH SALES (312) 346-5650
SUITE 1718 GENERAL OFFICES (312) 346-5651
CHICAGO, ILL 60601 SERVICE (312) 733-0497



A Public Service of This Magazine & The Advertising Council



Need help?
Call us.
Want to help?
Call us.

 Red Cross is counting on you.

S-100 Fast-Aid.

Including 3 new boards for system design relief.

The MB64.

An economical, high-performance 64K static RAM memory.

Just what the doctor ordered. A new 64K static RAM configured as two 32K blocks that's fast (in excess of 6MHz), reliable and economical. The MB64 supports IEEE 696/S-100 24-bit extended addressing for up to 16MB of RAM. Bank switching permits compatibility with popular multi-user computer systems (such as CROMIX*). Up to 8K can be replaced with 2716 EPROMs. The MB64 offers low power consumption (typically less than 600 milliamps). And a provision for optional battery backup.

(The MB64 is priced at less than \$850.)

*CROMIX is a trademark of Cromemco, Inc.

The IO8.

An I/O board featuring eight serial interfaces, individually programmable baud rates, and an interrupt clock.

Give your system fast-aid—including easier testing and speedier diagnosis—with SSM's new IO8. This board features eight asynchronous serial RS-232 I/O ports with LED data transfer indicators. Individually programmable I/O port baud rates (110-19,200) meet all your specific configuration requirements. A timer (50/60 Hz) supports real-time or multi-user applications.

And all our Fast-Aid boards offer:

- Card ejectors for painless card removal.
- LEDs for easy troubleshooting and monitoring.
- IEEE 696/S-100 compatibility.

The IO5.

A two-serial/three-parallel I/O board with programmable timer.

The perfect remedy for fast system integration, more precise diagnosis, and far healthier system operation. The IO5 features two RS-232 asynchronous serial interfaces for maximum peripheral compatibility. The board supports a variety of devices with high-speed serial data transmission (110-19,200 baud). Three parallel ports, providing a total of 32 bits, support various I/O configurations: a 16-bit software programmable bi-directional interface, and two 8-bit interfaces. One 8-bit interface supports direct connection to Centronics-compatible printers. The other provides 8 bits of parallel input for such devices as keyboards. The IO5 also offers a software-programmable timer for real-time or multi-user applications.

For more details about these new boards, or any of SSM's S-100 compatible boards (including various CPU, EPROM, video and development boards), just call your local dealer or SSM today.



SSM Microcomputer Products, Inc.
2190 Paragon Drive
San Jose, CA 95131
(408) 946-7400 Telex: 171171
TWX: 910-338-2077

Circle 342 on inquiry card.



NOW!
MORE THAN EVER

When You Have To Face A Deadline...

Since its introduction, Pascal/MT+[®] has been used to produce thousands of professional solutions to industrial, business and systems level application problems. In addition to implementing the complete ISO STANDARD, Pascal/MT+[®] contains a host of powerful features and facilities which make program construction a snap!

Pascal/MT+[®] is a total programming system including our native machine code compiler, linker, Pascal-level debugger, disassembler, run-time subroutine library and the exclusive SpeedProgramming™ Package.

With the advent of 16-bit machines and increasing customer demands, you can no longer afford to write programs in anything but a professionally constructed and professionally supported package like Pascal/MT+[®]. MT MicroSYSTEMS has demonstrated its commitment to keeping your programs and programmers productive with our recent introduction of Pascal/MT+86 and Pascal/MT+68K for the 8086 and 68000. While Pascal/MT+[®] provides the capability to write non-portable programs when the need arises, true portability between radically different machines is a reality while still translating

into efficient, optimized native machine code.

Our Pascal/MT+[®] compilers and SpeedProgramming Package are available on a wide variety of processors and operating systems, with more to come! We are continually working to provide innovative solutions to the ever present problem of translating your ideas into software solutions.

The Pascal/MT+[®] System Compiler:

Generates ROMable Native Code • Complete ISO Standard (superset of Jensen & Wirth).

Powerful Extensions include:

Modular Compilation, Direct production of binary relocatable modules • Dynamic strings • Chaining • Powerful Overlay system • Address and Size returning functions • Bit manipulation (test, set, clear, shifts) • Byte manipulation (high, low, swap) • Imbedded assembly language • Easy linkage to external assembly language • Full NEW and DISPOSE procedures • Direct access to I/O ports • Fast floating point, both software and AMD 9511 • Accurate 18 digit BCD (fixed point, 14.4) • Include files • Hex literal numbers • and more...

...Arm Yourself With Pascal/MT+®



Linker:

Combines relocatable modules into executable files • Can generate Hex format for use with PROM programming.

Interactive Symbolic Debugger:

Variable display • High-level breakpoints by procedure/function name • Tracing/single step by Pascal statement • Procedure/function entry and exit trace available.

Disassembler:

Combines a relocatable module with its listing file to produce interleaved Pascal and approximate assembly language code.

The SpeedProgramming Package™:

The SpeedProgramming Package is an integrated set of tools which allows you to create Pascal/MT+ programs, check them for correct syntax and undefined identifiers, format them to display flow of control, and do this all within the editing environment before you ever invoke the compiler. Programmers like SpeedProgramming because it frees them from the time consuming chore of repeated compilations to correct simple syntactic and typing errors. Managers find that SpeedProgramming improves productivity, thereby reducing development costs. SpeedProgramming combined with our field tested Pascal/MT+ package gives you a comfortable, powerful, interactive programming environment in which to create your professional quality software. Your products demand production quality tools. Order Pascal/MT+ with SpeedProgramming today!

Screen Editor:

User configurable • Standard random cursor movement, file access, search and replace, insert, delete, exchange, etc. • Structured language editing features such as automatic indent, line adjustment, reading from and writing to a file, block text insertion and duplication. • Requires: 24 x 80 CRT (or larger), ASCII Keyboard (7 bit data), random cursor addressing.

Interactive Syntax Scanner:

Finds syntax errors in text being edited • Enters SPEED, puts cursor at error, prints error text.

Variable Checker:

Catches undefined and mis-spelled variables before the compiler is invoked.

On-Line Reformatter:

Beautify programs in seconds • Clearly shows structure and program flow.

Source Code Management Tools:

Automatic Modification Log and Backup utility program.

PRICING: *Read carefully, some systems do not include the SpeedProgramming Package but do include the compiler, linker, disassembler, debugger and other utilities.

AVAILABLE NOW!

*8080/8085/Z80 without SpeedProgramming Price \$350.00
 56K or larger CP/M-80 or Heath/Zenith HDOS
 8080/8085/Z80 complete including SpeedProgramming Price \$475.00
 56K or larger CP/M-80 (not available for HDOS)
 8080/8085/Z80 for special MP/M environments Contact Factory

*8086/8088 without SpeedProgramming Price \$600.00
 CP/M-86 or MP/M-86, requires 116K program area
 8086/8088 complete including SpeedProgramming Price \$800.00
 *8086/8088 without SpeedProgramming for RMX-86 Price \$1500.00

All 8086/8088 packages include 9511 and 8087 support and program to convert MT object files into Intel .OBJ 8086 files.

COMING SOON:

68000 Cross Compiler System Price (to be announced)
 68000 Resident System with and without SpeedProgramming Price (to be announced)

Available on 8" (3740) Single Density Disks. Contact Distributors For Other Formats.

CP/M, MP/M are trademarks of Digital Research, Inc.

Heath, Zenith and HDOS are trademarks of Zenith Data Systems.

FOR: 8080/8085/Z80/8086/68000

Payment Terms:

Cash, Check, UPS, C.O.D.,
 Mastercard, VISA.

MT Micro SYSTEMS

1562 Kings Cross Drive
 Cardiff, California 92007 (714) 434-6101

*Pricing:

8080/Z80 — \$475.00
 Others Call

*All prices and speculations are subject to change without notice.

Letters

Park Your Benchmark Here

Jim Gilbreath's article "A High-Level Language Benchmark" was very useful. (See the September 1981 BYTE, page 180.) The comparisons between different languages and microprocessors are particularly relevant, since we are considering getting several microcomputers for word-processing and control tasks here at the Arecibo Observatory.

**Peter M. B. Shames, Head
Computer Department
Arecibo Observatory
POB 995
Arecibo, Puerto Rico 00612**

My thanks to Jim Gilbreath for "A High-Level Language Benchmark." It was far and away the most immediately valuable article I have seen in BYTE.

I was, however, disappointed by the numerous "omissions" in Mr. Gilbreath's tables. For example, how long was the program in 68000 assembly language? In 8086 assembly language? I would dearly like to know how those machines compare to each other (and to the 8-bit machines) in code-storage efficiency.

I do most of my programming in FORTH, so I wanted to compare that language to others in the article. I was disappointed to find that Mr. Gilbreath left blanks in the "compiled bytes," "total size," and "compile and load [time]" columns for FORTH. (See table 2, page 192.) When I tried to collect the missing figures, I found that the FORTH benchmark in the article would not compile. (See listing 9, page 190.) The word PRIME, used in the seventh line of the definition of DO-PRIME, should have been FLAGS. PRIME is not defined in the program.

I hope that readers who can augment the information in Mr. Gilbreath's article will share their knowledge. We badly need more information of this sort.

**Jonathan Sachs
6713 Richmond Ave.
Richmond, CA 94805**

I read Jim Gilbreath's article with interest. I realize that the purpose of a benchmark program is not efficiency in any one particular language or machine, but to compare the execution times of many languages or machines. But some languages are more efficient than others at

particular aspects of data processing, such as data access, I/O (input/output), etc. One of these aspects is looping. APL, for instance, is designed to handle arrays of any dimension with ease, but program loops are, in fact, not its forte. If I understand Mr. Gilbreath's benchmark program correctly, by the time it has looped 63 times ($I=62$, producing 127, the largest odd integer less than the square root of the highest number to be searched), all non-prime numbers in the list have been flagged and the remaining loops will find no new nonprime numbers. Eliminating the extra looping causes the BASIC program to require about half the execution time. I don't know about the other languages.

The extra loops seem to penalize those languages that do not loop well but may have some efficient alternate method of addressing vector or array elements (rather than addressing each element by the use of a loop). It may well be that this objection does not apply to any of the 10 languages tried in this article, in which case my point is moot. But as Mr. Gilbreath points out, an efficient algorithm is the best way to speed up a program.

Thank you, Jim Gilbreath, for the useful compilation of execution times as a function of language and machine.

**Dwight Divine III
2735 Gelid Court
Anaheim, CA 92806**

I found a few errors in Jim Gilbreath's article and programs. Zero and 1 are not prime numbers. Prime numbers are defined on the set of natural numbers, otherwise known as counting numbers, which consists of positive integers. Thus, 0 cannot be a prime number any more than can -7 , 1.3 , or π . The idea that 1 is a prime number arises from the common (inaccurate) definition of a prime number as "a number divisible only by itself and 1." The actual definition is "a natural number which has two and only two distinct divisors." Thus, 1 cannot be a prime number, as it has only one distinct divisor, 1.

In reading the program listings, I noticed the statement $PRIME=I+I+3$ in various forms. It seemed somehow wrong to me, and I felt that $PRIME=I+I+1$ would be right. On analyzing the algorithm, I discovered that the former arises from the use of 0 as the first subscript and

that $PRIME=2*(I+1)+1$ is the primitive form, which converts to the one Gilbreath used.

**James C. Fairfield
4414 East Addington Dr.
Anaheim, CA 92807**

Congratulations are due Jim Gilbreath for his fine article. His comparisons were very informative due to the wide range of hardware and software covered. He noticed the same thing that I have discovered: PL/I generates very efficient code! I disassembled CP/M version 2.2 (written in PL/I) so that I could interface a digital-tape system as the primary storage device. I needed to know how the disk allocation was accomplished. More or less as a "labor of love," I went through the disassembled code with an editor, adding meaningful labels and comments. The resulting code is very readable and understandable thanks to the excellent code generated by the PL/I compiler. The sub-routines look as if an assembly-language programmer wrote them: no wasted instructions anywhere.

**Clark A. Calkins
2564 Walnut Blvd. #106
Walnut Creek, CA 94598**

The comparing of apples and oranges is a job sorely in need of doing. And Jim Gilbreath has done a fine piece of work, part of its merit being the arguments it will generate. I'm sure the COBOL folks are not happy. Nor are we BASIC people, although we could salve our wounds with the excuse that interpreters have to be slow.

The dogma of true BASIC people is that structure is in the mind. Let those who want structured languages have them. But treat us fairly. Since our language isn't supposed to be structured, don't force us to use little-bitty short lines like Jim's listing 7 because we know it takes our interpreter time to hop down lines. And we have different kinds of variables just like the big boys, so let us use integers too. And we suspect that most compilers don't include similar checking, so let us use NEXT without the index. Note that these aren't tricks or innovations. What some might call tricky, but certainly not innovative at this date, is the use of FOR . . . NEXT loops in preference to GOTOs.

The moral: we agree strongly with Jim

Your computer.

Compute.

Compute.

Compute.

Compute.

Compute.

Dump...

Compute.

Compute.

Compute.

Compute.

Compute.

Your printer.

...Print.

Print.

Print.

Print.

Print.

Print.

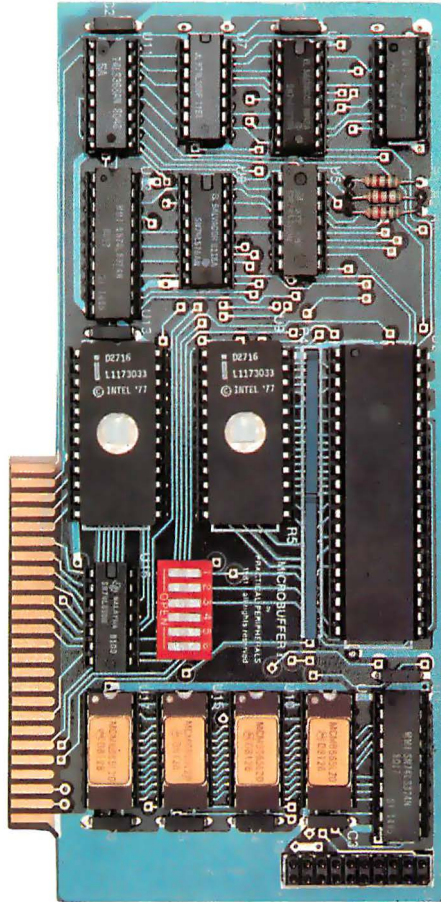

New Microbuffer II lets you use your printer without tying up your computer.

Time. As an important resource it shouldn't be wasted. One such waste is in printing, where your computer must wait for your printer. Now there's a way to eliminate this waste.

Introducing the Microbuffer II™, a buffered parallel printer interface for the Apple II® computer with 16K characters of memory (user expandable to 32K). It accepts data as fast as your computer can send it, allowing you to use your computer while the Microbuffer II is in control of your printing.

The Microbuffer II, compatible

with Applesoft, CP/M® and Pascal, comes with complete print formatting features as well as advanced graphics dump routines for most popular graphics printers.

The Snapshot™ option permits you to dump the text screen or graphics picture to the printer while any program is

running — without interruption.

The 16K Microbuffer II is available for \$259. And the 32K version, for \$299. The Snapshot option is \$69.

So why waste time while your computer waits for your printer? Ask your computer dealer for the Microbuffer II or call us for the name of a dealer near you.

Microbuffer II and Snapshot are trademarks of Practical Peripherals, Inc.
CP/M is a registered trademark of Digital Research, Inc.
Apple II is a registered trademark of Apple Computer, Inc.

MICROBUFFER II

MI

PRACTICAL PERIPHERALS, Inc.
31245 La Baya Drive
Westlake Village, California 91362
(213) 706-0339

Letters

Gilbreath on the necessity of choosing the best algorithm for the job. To that we add, know your language and use its power. There is no language that will turn bad writing into good writing.

James D. Childress
5108 Springlake Way
Baltimore, MD 21212

Jim Gilreath Replies

The response to my article has been very gratifying, and I have received so many letters that it is beyond my ability

to respond to them individually. All are appreciated, especially those that pointed out errors and supplied data for machines and languages I did not have the opportunity to time. All contributed data will be reported in a subsequent article.

I regret the error in the FORTH program. It was caused by me, not BYTE, and occurred in transcribing the program from paper to a file. The word PRIME should be changed to FLAGS. Thanks to Dick Miller and Jonathan Sachs for finding this.

This was not a commissioned assign-

ment, it was simply a computer hobbyist's report of his experiences and data collected in a project for presentation at the local computer club. The intent was to report, not to review. The data were collected over a nine-month period whenever an opportunity presented itself.

Much of the data was obtained in computer stores and computer-conference environments with limited time, so there are gaps in the tabular data for program sizes when that data were not readily obtained without detailed knowledge of the operating system. There was little time to dig deeply into nuances. It was never intended to be a Consumer's Union quality project. Think what that would cost! Hundreds of hours were spent just doing what I did.

It is not surprising that the programs listed required a bit of customization before running on some systems. There were several slightly differing versions of the program in all of the languages, but only one was printed for each case to save space.

The FORTRAN program used 0 as the first-element array subscript for consistency and because this is allowed in some (but not all) compilers. In retrospect, this was a poor choice because it violates fundamental FORTRAN-language definitions.

The BASIC program only does one iteration, which helps you avoid staying up all night (this axiom was removed from my article by the BYTE editor). Thus, these times have been multiplied by 10 for comparison with the others.

On the PET, the array would not fit, so the program was run on a smaller array, and the results were extrapolated linearly (this works—try it). The same was done for Microsoft COBOL and FORTH.

Mr. Divine's insightful observation that the algorithm has flagged all nonprime numbers after looping only 63 times nicely reinforces my contention that a better method is often more fruitful than changing languages.

It seems that my lack of COBOL expertise was quite obvious, and thanks are due to James Fairfield and others who supplied improved programs that run much faster.

It is worth reiterating that a simple benchmark such as mine is but one point on a long curve and many more specifics should be considered carefully in selecting a language or computer.

THE BACKUP SYSTEM WITH MORE BYTE.



More byte than any other system on the market, in fact **MCSave (Magnetic Cartridge Save)** is not just another backup system—but a true file-oriented archive system. It gives you a full 67 megabytes of on-line archive/backup storage. So you can easily access, store, delete or transfer files with greater speed, and backup even the largest of most hard disks. **MCSave** combines the cost effective 3M HCD-75 Tape Drive with CP/M* to give you the kind of

performance you can really sink your teeth into. **MCSave** can handle 13,000 files per drive. You can transfer file-by-file from disk to tape, tape to disk, or tape to tape. MCSave runs on any S-100 Z-80 48K CP/M,* CDOS,* or CROMIX* system. Ask your dealer about **MCSave**... the backup system with more byte!

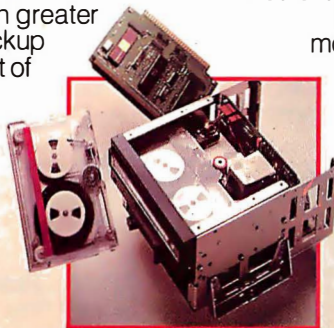

MCS
Microcomputer
Consulting
Services

8308 Juniper
Ft. Worth, Texas 76180
(817) 498-6390

Dealer & OEM
inquiries invited

*CP/M is a trademark of Digital Research. *CDOS and CROMIX are trademarks of Cromemco, Inc.

The small business computer big business wouldn't build.

3000 FOR 48 MONTHS AT 18 PERCENT

MONTH	-----INTEREST-----	
	PRINCIPAL	TO-DAYE
1	71.58	75.88
2	72.56	73.92
3	74.85	72.65
4	73.16	71.72
5	76.29	70.59
6	77.44	69.44
7	78.68	68.28
8	79.78	67.18
9	80.97	65.91
10	82.19	64.69
11	83.42	63.46
12	84.67	62.21
13	85.94	60.94
14	87.23	59.65
15	88.54	58.34
16	89.87	57.01
17	91.21	55.67
18	92.58	54.30

PRESS "*" FOR TOTALS, ANY OTHER KEY TO CONTINUE

MicroMaster outperforms all of the small business computers from IBM, NCR, Burroughs, Honeywell, Radio Shack and others whose size should give them an advantage. Outperforms them in computational speed (cycle time), memory capacity, flexibility, software availability and just plain productivity.

Yet the MicroMaster is base priced far lower than most (\$12,500), and includes important features which

are available only as options, if at all, on the others. Why haven't the giants built one like it? We can only guess. But we do know that there's no magic in what we've done. The technology was available. We simply applied it to the real needs of small business: needs which we are small enough to hear and understand.

That's why we're anxious to discuss, in detail, the capabilities of

the MicroMaster compared with other machines you might be considering.

We'll also talk about things like operator convenience, available programs, expansion potential and reliability.

And we'll bring a machine with us, because nowadays a computer doesn't have to be big to be good.



Circle 49 on inquiry card.

See it for yourself.

- Please send specifications and information on the MicroMaster small business computer.
- I'd like to see the MicroMaster. Please have a sales representative call.

Name _____ Title _____

Company _____

Address _____

City _____ State _____ Zip _____

Application(s) _____

You don't have to be big to be good.

Barreto & Associates, Inc., P.O. Box 874, Sedalia, Missouri (816) 826-0689

B 182

Open Letter to Potential SuperBrain Buyers

Our company recently purchased four Intertec SuperBrain QD computers from a local mail-order firm, whose advertisement stated that "all equipment is in factory cartons with the manufacturer's warranty." After one of the units failed, we discovered that the warranty had lapsed while the computers were still in the dealer's stock and we would have to pay Intertec nearly \$400 to repair the unit.

Intertec's policy is that the warranty period begins when it ships the unit to the dealer. This policy is contrary to industry standards and discourages dealer stocking. A letter to Intertec regarding the above evoked this response from Andrea K. Welch, Intertec's Marketing Support Manager: "I do sincerely regret the misunderstanding that appears to exist between your organization and the company from which you purchased this equipment. I can assure you that all of our dealers are intimately familiar with our warranty policy." The dealer's response was that he was totally unaware of Intertec's policy

and that it was our problem to work out with Intertec.

Any SuperBrain buyer should be sure that he or she is going to receive an adequate warranty from the dealer after receipt of the computer. After our computer failed, we were informed by the dealer that he has had problems with SuperBrains being "dead on arrival." We could have received units that were inoperable when the cartons were first opened and we would have had to pay repair charges.

James E. Ford
Paoluccio Willis Nau Associates
Civil Mechanical Electrical Engineers
7175 Construction Court
San Diego, CA 92121

Intertec Data Systems Replies

Since the initial production of the SuperBrain in 1979, Intertec has enjoyed an enviable position as the microcomputer industry's price/performance leader. Because of our commitment to total vertical integration, Intertec manufactures a product of exceptional quality at an extremely competitive price.

In keeping with this commitment to quality and leadership, Intertec offers an impressive 120-day warranty on its products. This warranty covers all parts and components deemed to be originally defective by Intertec Data Systems Corporation. We at Intertec feel that this four-month warranty offers our customers excellent coverage and that it is in keeping with our marketing endeavors. In addition, our Customer Services Department is fully staffed to insure our customers of fast, efficient service.

Like Ms. Welch, Intertec's Marketing Support Manager, I, too, regret that Mr. Ford and the company from which he purchased his SuperBrain appear to have had a misunderstanding with regard to our warranty and assure BYTE readers that all of our dealers are well informed as to its specifics. Our warranty is clearly and carefully explained in Section Six of our Master Agreement and is reiterated in virtually every manual and document issued by Intertec. It is unlikely that our dealer was "totally unaware of [our] policy."

We at Intertec are very proud of our Customer Services Department and our warranty. Intertec has carved its place in the microcomputer industry by offering our dealers products and services that we feel are better than the industry standards.

Karen K. Hubbard, Manager
Public Relations
Intertec Data Systems Corporation
2300 Broad River Rd.
Columbia, SC 29210

Fallout from BYTE's BOMB

Editor's Note: Since the beginning of 1981, BYTE has gone through some substantial changes, both in format and size. Here are some comments about BYTE that we have received from our readers on the monthly BOMB cards (for an explanation of the cards, see the back of this issue):

- This issue almost gave me a hernia. I love reading all the ads.
- At first I was only interested in the ads, but then I accidentally read an article!
- I enjoyed reading all the articles (fast reader), but why so many ads?
- I can't read all those ads.
- I don't read any of the articles.
- It's too big to read!
- More, more, more!
- Thank you for always making BYTE interesting, stimulating, and pregnant.



**Easy
 Winchester
 Subsystem
 By
 AMT**

AMT has available a 5, 10, 15 and 20 megabyte Winchester Hard Disk subsystem that is very EASY for any user to interface with his existing system.

Subsystem includes:

- Winchester Disk Drive(s)
 - Controller
 - Power Supply
 - Enclosure
 - All Interface Cabling
 - CP/M* 2.2 Support and Diagnostic Programs on Floppy Disk
 - Host System Interface Card
 - Dedicated Telephone Number for Technical Assistance
- *Registered Trademark of Digital Research Corp.

System available for:

- S-100
- Heath/Zenith Z-89
- TRS-80 Model III
- Xerox 820
- IBM Personal Computer System

5-Megabyte System
Retail Complete \$2995.00

Write or call for Attractive distributor program

Applied Micro Technologies, Inc.
 Route 30 West, Greengate Professional Bldg.
 Greensburg, Pa. 15601
1-800-245-6908 In Pennsylvania [412] 837-7255

IMMEDIATE SHIPPING!
ALMOST ALL ITEMS
IN STOCK!

THE
GREAT
HOLIDAY
Clean up

SuperSoft:

DIAGNOSTICS II 84.
DISK DOCTOR 84.
FORTRAN 218.
SSS FORTRAN with RATFOR 285.
TINY PASCAL 74.
TERM 131.

Hayden:

APPLESOFT COMPILER 167.

Ashton-Tate:

dBASE II 599.
(With 30 day return policy.)

TeleVideo Terminals:

950 950.
920 779.
912 745.
910 595.

C. Itoh Printers:

PROWRITER PARALLEL 599.
PROWRITER SERIAL 680.
STARWRITER I PARALLEL 1435.
STARWRITER I SERIAL 1500.

Okidata:

MICROLINE 82A 535.

Epson:

CALL for the latest prices on all printers!

Modems:

HAYES MICROMODEM II 307.
HAYES SMARTMODEM 230.
NOVATION D-CAT 156.
NOVATION AUTO-CAT 213.
NOVATION APPLE-CAT 335.

Accessories:

Z-80 CARD 299.
MICROSOFT 16K RAM 150.
MOUNTAIN COMPUTER
MULTI I/O 178.

All Maxell and Wabash disks in stock!

MICROHOUSE Software Support:
215-868-1330

PRICES AND SPECIFICATIONS SUBJECT TO CHANGE
WITHOUT NOTICE.

MicroPro:

WORDSTAR 3.0 299.
SUPERSORT 170.
MAILMERGE 105.
DATASTAR 244.
SPELLSTAR 165.
CALCSTAR 225.

For Apple:

WORDSTAR 245.
SUPERSORT 130.
MAILMERGE 85.
DATASTAR 207.
SPELLSTAR 145.

Personal Software:

VISICALC II 155.
VISIDEX 159.
VISIFILE 200.
VISIPILOT 149.
VISITERM 128.
VISITREND-VISIPILOT 220.
VIDEX VIDEOTERM 290.
DESKTOP PLAN II 160.

TCS Atlanta:

BASIC ACCOUNTING SYSTEM 269.
TOTAL SYSTEM 1295.

MicroSoft:

BASIC 80 285.
BASIC COMPILER 315.
COBOL 80 568.
FORTRAN 345.
muSIMP-muMATH 215.
MACRO 80 140.
APPLESOFT COMPILER 150.

Formats Available:

8 INCH, SUPERBRAIN, NORTHSTAR,
and APPLE.

MASTERCARD AND VISA WELCOME!

Shipping:

ADD \$5.00 PER MANUAL OR SOFTWARE PACKAGE.
ADD \$2.50 FOR C.O.D.
PA RESIDENTS ADD 6 PERCENT SALES TAX.
(Call for other charges.)

Microhouse™

P.O. BOX 498
BETHLEHEM, PA 18016
215-868-8219

Circle 238 on inquiry card.

Letters

Many of our readers had comments on some of BYTE's particular features:

- I like the Programming Quickies. I seem to find your Nucleus section more useful than the feature articles (the long ones take too much time to read).
- Wow! Computing e to 116,000 places! [That's] a really worthwhile endeavor.
- I find the comparative software reviews to be of great help.
- Forget about the numbers and the philosophical articles; get back to the guts of personal computing: homebrew hardware!

- I very much liked the Color Computer article. What about software for it?
- The article on Extended Color BASIC for the Color Computer was fantastic.
- The Color Computer is sadly deficient in software. Manufacturers should apologize for saddling users with BASIC as the only available language; a giant step backwards.
- Most articles too technical.
- I enjoyed Ciarcia's articles on constructing speech synthesizers.
- Great, now they talk back!
- It did my heart good to see Steve [Ciarcia] do something I can use on my

- Apple II directly, without translating it from TRS-80.
- I'm going to love building my super-simple floppy-disk interface.
- As usual, BYTE has too many do-it-yourself tinkerer's projects. Can't you get more out of Pournelle?
- Gregg Williams has really hit the bull's-eye with BYTE's Arcade; please make it a monthly feature.
- My kids rush to read BYTE's Arcade each month and are very disappointed if it's not there.
- I hate to see all those pages wasted. Please review nothing but games from now on.
- I do not wish to judge your writers.

While others only made suggestions:

- Articles #6 and #7 seemed to disagree. There should never be any question as to the true static [sic] of things.
- I do wish you could pick articles that are more appealing to us, but it's probably not your fault.
- With the new 16-bit processors now available, perhaps BYTE should change its name to CHOMP.
- Why don't you make the Reader Service Card computer readable?

The requests for future articles would fill volumes. Let's have more . . .

- construction articles
- software reviews
- hardware reviews
- Programming Quickies
- on the TRS-80 Model (I, II, III, Color Computer)
- on the Apple (II, III, IV, V)
- on Heath/Zenith systems
- on the Sinclair systems
- on the CompuColor II
- on the Osborne I
- on the new (CP/M, Unix, Xenix, Zeus, Unica) operating systems
- C programs
- Pascal programs
- machine-language programs
- FORTH programs
- robotics articles
- music articles
- printer tests

There were even an amazing few who predicted articles that we had planned before they were published:

- An in-depth series on the Atari is about due. ("The Atari Tutorial, Part 1" appears

Checkmate your communications testing problems with Supercheck

Here's the latest move in Navtel's winning line of portable data test equipment. Supercheck! The indispensable service aid. It joins our other proven test units, Supertest — Datatest — Datacheck.

Just check these Supercheck features:

- Provides access to all 25 conductors on EIA RS-232C interface
- 25 miniature SPST switches allow interruption of all interface conductors for testing and observing terminal and modem signals
- 12 LED monitors,

separated by source, allow easy monitoring of primary interface signals

- 2 LED's detect mark/space or clocking signals
- Contains RS-232C patch cable
- **\$139.00**

Order your Supercheck today and we promise fast delivery. For each unit enclose cheque or money order for \$139.00 payable to Navtel Limited at address shown below.

Dealer inquiries invited.

NAVTEL
FOR THE TESTING TIMES

8481 Keele St., Unit 12A
Concord, Ontario L4K 1B1
Telephone (416) 669-9918



897 N.W. Grant Ave. • Corvallis, Oregon 97330

THE DAWN OF A NEW ERA FOR APPLE II: THE ENHANCER II

Introducing the Enhancer II: a new Standard which is improving the relationship between Humans and Apples. The Enhancer II can help your Apple II's keyboard become more sociable by remembering words or phrases which can be entered into the Apple by the mere touch of a key. Life can become even easier because the Enhancer II can remember what you typed while your Apple was busy talking to your disc (or doing other things). Naturally, it knows the difference between upper and lower case letters and what shift keys are supposed to do. It even knows to auto repeat any key held down. The Enhancer II replaces the encoder board making installation simple.

Suggested retail price: \$149.00.

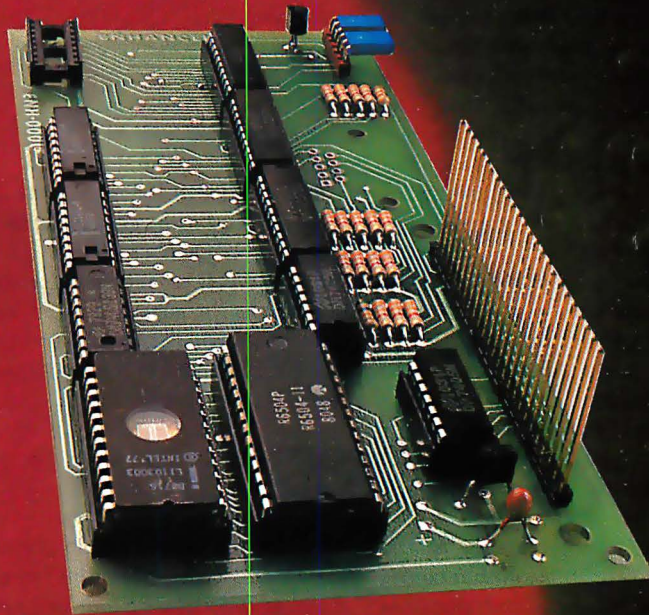

VIDEO TERM

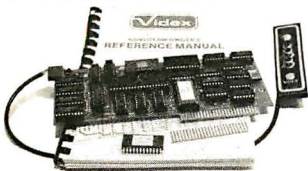

The time tested Videoterm 80 column card:

- 80 characters x 24 lines
 - True decoders
 - 7 x 9 character resolution
 - Low power consumption
 - Compatible with most word processors
 - Softcard and CP/M compatible
 - Modem compatible
 - Most popular character set of any 80 column card
 - Alternate character fonts available
- Suggested retail price \$345.00

SOFT VIDEO SWITCH

The Soft Video Switch is an automatic version of the popular Switch-plate. It knows whether it should display 40 or 80 columns or Apple graphics. It does the tedious work of switching video-out signals so you don't have to. The Soft Video Switch can be controlled by software. Any Videoterm with Firmware 2.0 or greater may be used with the Soft Video Switch. The single wire shift mod is also supported. Package price is \$35.00.

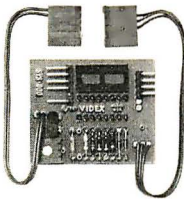

KEYBOARD AND DISPLAY ENHANCER

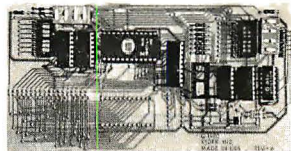

The original Keyboard and Display Enhancer is still available for Revision 0-5 Apples (on which the new Enhancer II will not fit). These Apples have memory select sockets at chip locations D1, E1 & F1. The Keyboard and Display Enhancer allows entry and display of upper & lower case letters with fully functional shift keys. It does NOT have user definable keys nor a type ahead buffer. The price is \$129.00.

Circle 375 on inquiry card.

ACCESSORIES:

Videoterm Utilities Disc \$37.00 (includes)

- Font Editor
 - Pascal Mid-Res Graphics
 - Applesoft Read Screen Utility
 - Top & Bottom Scrolling
 - Pascal Vidpatch
 - Graphics Template
- Character Set EPROMs \$29.00 ea
- Half Intensity
 - Inverse
 - German
 - Katakana (Japanese)
 - Line Drawing Graphics (Expanded)
 - Spanish
 - French
 - Math & Greek Symbols
 - Super & Subscript

Dvorak EPROM (Enhancer) \$29.00
Lower Case Chip \$29.00

in the September 1981 BYTE, page 284.)

• What we really need is a comparison of the languages available on microcomputers. ("A High-Level Language Benchmark" appears in the September 1981 BYTE, page 180.)

• Doesn't anyone realize the problems small business has with software? ("Bridging the 10-Percent Gap" appears in the October 1981 BYTE, page 264.)

• When are you going to tackle database systems? ("Database Management Systems" is the theme of the November 1981 BYTE.)

Thank you all for writing; we scrutinize every word.

A New Small-Computer Company: IBM

As an owner of a two-year old Apple II computer system, I read with great interest Phil Lemmons' first impressions of IBM's new Personal Computer. (See "The IBM Personal Computer: First Impressions," October 1981 BYTE, page 26.) What surprised me is that Mr. Lemmons said little about documentation for the system. Is this because it doesn't yet exist? If it does not, it certainly would not be the first time a personal computer was put up for sale with meager documentation. The documentation for the Apple II was also meager at the beginning, but then that was a very different stage in the history of microcomputers, and Apple Computer Inc. did not quite have the resources of IBM.

One of the excellent features of the Apple II is the documentation that comes with it. I know of no other personal computer that comes with documentation of the quality of Apple's. Documentation is an important point, and I think BYTE a bit remiss for not insisting that Mr. Lemmons pay more explicit attention to this.

I hope that in future, fuller reviews of IBM's new system, BYTE will treat the documentation issue more extensively.

Stephen E. Bach
Rte. 2, Box 89
Scottsville, VA 24590

For a more in-depth description of IBM's documentation and its machine, see Gregg Williams' article on page 36 of this issue. . . . MH

Pushing Relatives

My thanks to George S. Losey for his article "Use a Relative Subroutine Call for Relocatable Z80 Programs" (see the October 1981 BYTE, page 366); it's a feature I could have used in the past.

The only problem, as stated by Mr. Losey, is that returns are limited to the unconditional types because of the use of the JP(HL) instruction to cause the return instead of the RET instruction. Also, programming is restricted because the HL register pair is tied up storing the return address.

Both these problems can be eliminated by making the first instruction of each subroutine PUSH HL (E5 hexadecimal). This places the return address on the stack as would a CALL instruction. This allows returns to be made in the usual manner. It also frees the HL register pair for programming.

Grant S. Killey
736 Michigan Ave. Apt. 13
Ontonagon, MI 49953

Some of the weaknesses of the Z80 relative-call technique proposed by George Losey in his October 1981 BYTE Technical Forum can be avoided at a cost of 10 more bytes in page 0 and an execution time longer by 23.25 microseconds. Instead of E1 E5 23 23 C9 hexadecimal at the reset location, try:

```
E5 E5 E1 E1 E1 23 23 E5 2B 2B
E5 3B 3B E1 C9
```

The advantages are that no changes need to be made in the subroutine being called; it still ends with a RET, it can use conditional returns, and no registers are altered. Nested subroutines will work this way; they won't with George's method.

Lee Bonnifield
1025 Chalk Level Rd.
Durham, NC 27704

BeamIn' Report

I want to tell BYTE readers about the service and the product that I received when I responded to an ad carried in the September 1981 BYTE. The ad was for the PowerText system by Beaman Porter, Inc. (see page 269). Both the product and the service provided by this company are outstanding, which is why I have taken the

time to write about them. The growth of an industry often depends upon the commitment of the vendors to customer service. Beaman Porter is certainly an outstanding example of a commitment to customer service.

Several weeks ago, I was in the middle of preparing a lengthy report for a client when hardware problems caused me to lose not only all the text that I had created but also the use of the hardware to continue with the report. In a minor panic, I called Beaman Porter to order a copy of its Pascal-based text formatter. I sent payment special delivery, the company also used special delivery, and I had the package in four days. Included was a note indicating times when the author would be available to help me as I attempted to reproduce my report.

The PowerText package has performed without any problems. For the sort of consulting work that I do, it allows even greater productivity than the package I previously used. I called the company once for assistance and received it quickly and accurately.

Microcomputing is a mass market. It is encouraging to see that firms like Beaman Porter maintain a commitment to customer service.

My thanks to them.

Alan D. Tompkins
R.D. #1, Box 122C
Waitsfield, VT 05673

BYTE

TOLL-FREE
SUBSCRIPTION LINE

1-800-258-5485

New Hampshire Residents Dial 924-9281

The Quickest Way To

- Order a Subscription
- Renew a Subscription
- Change or Correct an Address
- Give a Friend a Gift Subscription
- Inquire about a Subscription

We are waiting to help you.
Call us between:
8:30-4:00 Mon.- Fri.

(Eastern Time)

BYTE the small systems journal

Personal computers are full of promises. MBA makes them deliver.

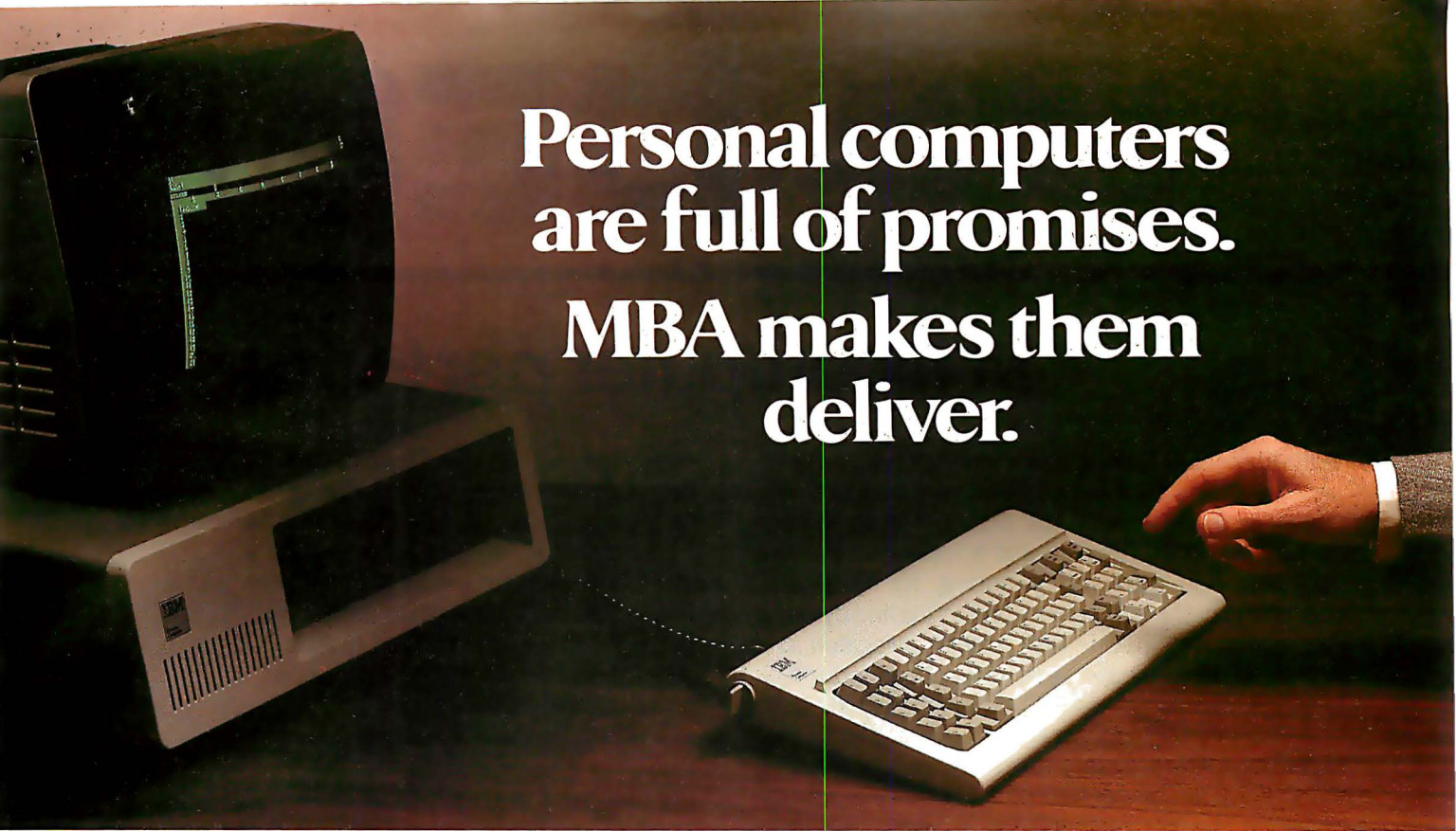

You've heard how the personal computer is going to revolutionize the way you work.

So far, the reality hasn't measured up to the promises.

But now there's a remarkable new software package that transforms the IBM Personal Computer into an incredibly powerful management tool (Apple and Xerox owners: read on).

The first totally integrated management software.

There are a lot of useful programs available for personal computers.

Unfortunately, they all seem to use different commands and different ways of storing data. This creates two major problems:

1. Every time you want to add a new function, you have to learn a whole new command language.
2. You may not be able to exchange data between different programs.

But now there's a better way. It's called the MBA, and it was created by a blue-chip management consultant, an MIT-trained systems designer, and some of the country's most experienced business programmers.

For the first time, MBA combines all the essential management functions in one easy-to-use package:

Electronic Spreadsheet. The ultimate financial modeling tool that lets you create a giant spreadsheet of figures and text. Change one number, and every affected item is instantly re-calculated.

Word Processing. Compose, edit, and print any kind of document. Make revisions yourself — faster than you can explain them to your secretary. Because MBA is an *integrated* system, it's easy to incorporate data from its other modules into a report you're writing.

Data Management. A sophisticated electronic filing system that lets you store information — ANY information — then retrieve it, analyze it, and generate reports to your specifications.

Graphic Output. For those occasions when a picture tells your story better than words, you can easily generate clear, readable graphs.

Communications. Tie into your company data center, a financial information service, or virtually any other computer system. MBA automatically retrieves the information you want, and lets you edit or rearrange it with a few keystrokes.

Easy to learn. Easy to use.

MBA's designers devoted great care to giving it a simple, consistent set of commands. So when you've learned one module, you'll immediately be comfortable with the others.

What, where, and how.

MBA is offered through selected computer retailers who have qualified people to demonstrate and answer questions.

It runs on the IBM Personal Computer, with Xerox and Apple versions available soon. But whichever machine you use, MBA will make a dramatic improvement in your personal productivity.

And that's a promise.



Context Management Systems, Inc.

Management software for personal computers.

23864 Hawthorne Blvd., Suite 101
Torrance, California 90505
(213) 378-8277

© Copyright 1982 Context Management Systems, Inc.

DECIS

Minicomputer performance in

Multi-user. Multi Tasking. Decision I™ memory management hardware includes a memory map that is similar to the IBM 360® and IBM 370®. It supports up to 16 tasks or 15 users and a supervisor without swapping. And, more with swapping. Each task or user enjoys complete memory protection and dynamic memory allocation. One task may be delegated as a supervisor to privileged system functions forbidden to ordinary tasks or users. Such functions (I/O calls, unauthorized memory access, etc.), will trap to the supervisor. If supervisory functions are not required the system can be configured for turnkey multi-user operation.

Multi-purpose IEEE696/S-100. Decision I utilizes the Morrow Designs IEEE Standard S-100 Wunderbuss®. That means you can configure it to your specific applications. Add a floating point processor, add memory (to a full megabyte), add I/O, add controllers...add boards from dozens of manufacturers. And S-100 has a major advantage over single-board computers: If a board goes down, you simply replace it. And keep running. If you want to expand your system. Add boards and terminals.

An unmatched software base. Decision I runs on the M/OS™ operating system. M/OS supports all system calls source

compatibly with UNIX®. Thus, UNIX programs will compile directly and UNIX documentation is almost totally applicable. Morrow CP/M® has been configured to run under M/OS and communicate with both CP/M and UNIX standard media for maximum portability. Languages available include BASIC, COBOL, FORTRAN, RATFOR, Pascal and C. That means Decision I offers you a software base unmatched in its price/performance arena.

The OEM machine. A basic multi-user system at \$5,225 includes the Decision I, 4 Mhz Z80A-based CPU, sophisticated memory

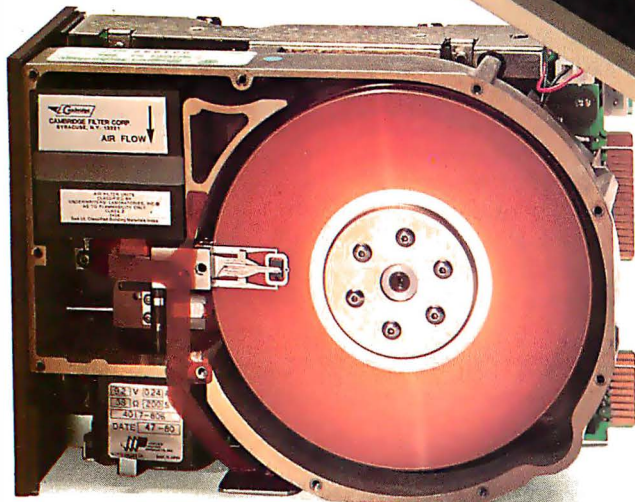

IBM 360 and 370 are trademarks of IBM Corp.
Wunderbuss is a registered trademark of Morrow Designs
Decision I and M/OS are trademarks of Morrow Designs
UNIX is a trademark of Bell Laboratories, Inc.
CP/M is a trademark of Digital Research Corp.

ION 1

a multi-user Microcomputer.

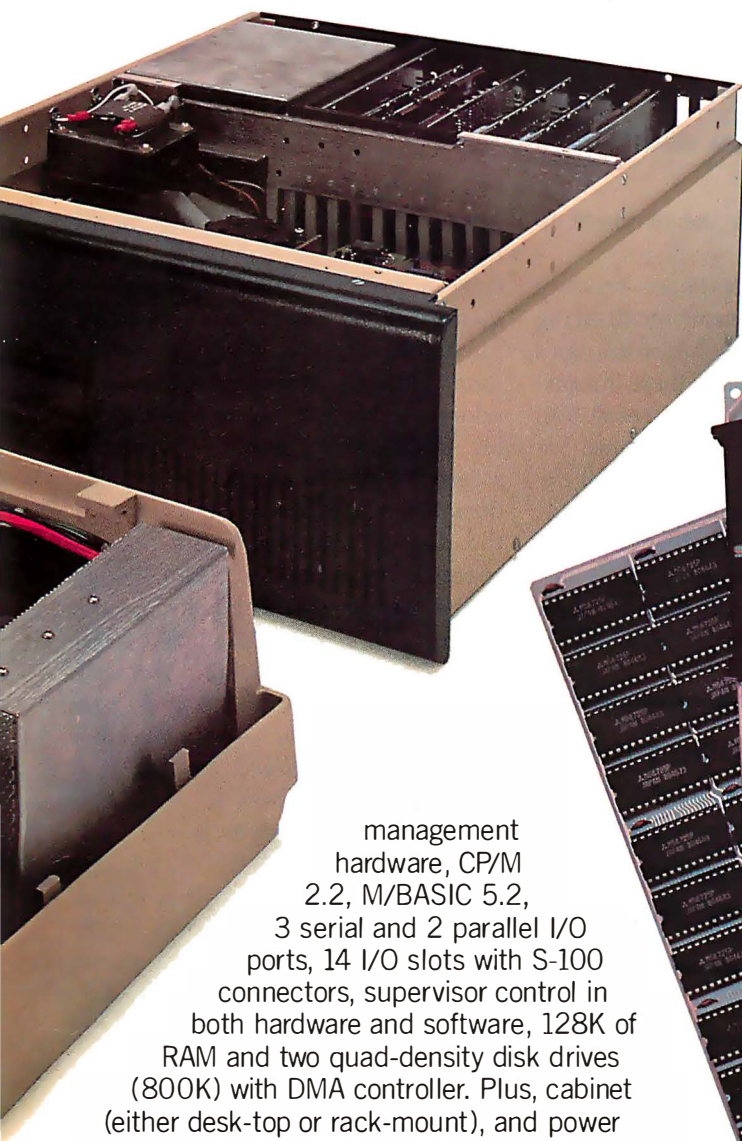

management hardware, CP/M 2.2, M/BASIC 5.2, 3 serial and 2 parallel I/O ports, 14 I/O slots with S-100 connectors, supervisor control in both hardware and software, 128K of RAM and two quad-density disk drives (800K) with DMA controller. Plus, cabinet (either desk-top or rack-mount), and power supply. The same system with 8" floppies and a full Megabyte of formatted storage costs \$5,659. And, we offer OEM pricing.

A better microcomputer. Whether you're building a single or multi-user system, the Decision I offers you a hardware/software combination unmatched in the field. Decision I is not simply an improved 8-bit microcomputer. It's a breakthrough. In both computing power and price.

Systems your way. Morrow Designs' full range of hard and floppy disk memory, add-in memory boards, I/O

boards, controllers and software allow you to configure your system your way...through a single supplier.

The decision is yours. Compare the Decision I, feature-for-feature with mini or microcomputers on the market today. Compare capabilities. Compare flexibility. Compare utility. Then, compare price. We think Decision I will change the way you think about microcomputer systems.

Complete information? See your computer dealer. Or, write Morrow Designs.

LOOK TO MORROW FOR ANSWERS.

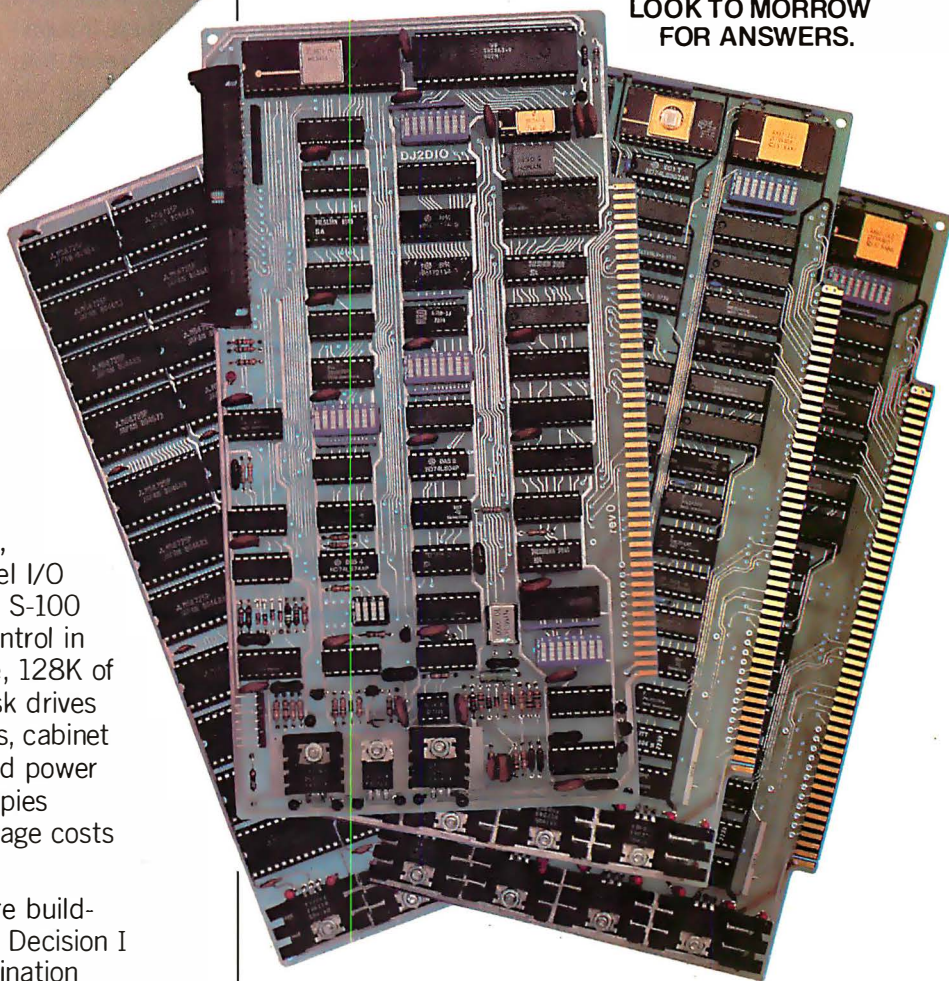

MORROW DESIGNS

5221 Central Avenue, Richmond, CA 94804
(415) 524-2101

Circle 259 on inquiry card.



The Atari Tutorial

Part 5: Scrolling

Chris Crawford
Atari Inc.
1265 Borregas Ave.
POB 427
Sunnyvale, CA 94086

Quite frequently, the amount of information that a programmer wants to display exceeds the amount of information that can fit on the screen. One way of solving this problem is to scroll the information across the display. For example, listings of BASIC programs scroll vertically from the bottom of the screen to the top. All personal computers implement this type of scrolling. The Atari personal computer system, however, has two additional scrolling facilities that offer exciting possibilities. The first is Load Memory Scan (LMS) coarse scrolling; the second is fine scrolling.

Conventional computers use coarse scrolling. With this type of scrolling, the pixels that hold the characters are fixed in position on the screen and the text is scrolled by moving bytes through the screen random-access read/write memory (RAM). The resolution of the scrolling is a single character pixel, which is very coarse. (Throughout this article, the term pixel refers to an entire character, not to the smaller dots that make up a character.) This produces a jerky and quite unpleasant scrolling. Furthermore, it is achieved by moving up to a thousand bytes around in memory, a slow and clumsy task. In essence, the program must

move data through the playfield to scroll.

Some personal computers produce a somewhat finer scroll by drawing images in a higher-resolution graphics mode and then scrolling these images. Although higher scrolling resolution is achieved, more data must be moved to attain the scrolling and the program is consequently slowed.

The fundamental problem in both methods is that the scrolling is implemented by moving data through the screen area.

By manipulating just two address bytes, you can produce an effect identical to moving the entire screen RAM.

Coarse Scrolling

A better way to achieve coarse scrolling with the Atari 400/800 is to move the screen area over the data. The display-list op codes support a feature called Load Memory Scan (LMS). The LMS instruction was described in part 1 of this series. Briefly, it tells ANTIC where the screen memory is. A normal display list has one LMS instruction at the beginning of the display list. The RAM area it points to provides the screen data for the entire screen in a

linear sequence. By manipulating the operand bytes of the LMS instruction, a primitive scroll can be implemented. In effect, this moves the playfield window over the screen data. Thus, by manipulating just two address bytes, you can produce an effect identical to moving the entire screen RAM. The program in listing 1 does just that. This program sweeps the display over the entire address space of the computer. The contents of the memory are dumped onto the screen. The scroll is a clumsy serial scroll combining horizontal scrolling with vertical scrolling. A pure vertical scroll can be achieved by adding or subtracting a fixed amount (the line length in bytes) to the LMS operand. The program in listing 2 does that.

A pure horizontal scroll is not as simple to do as a pure vertical scroll because the screen RAM for a simple display list is organized serially. The screen-data bytes for the lines are strung in sequence, with the bytes for one line immediately following the bytes for the previous line. We can horizontally scroll the lines by shifting all the bytes to the left: this is done by decrementing the LMS operand. The leftmost byte on each line, however, will then be scrolled into the rightmost position in the next higher line. The sample program in listing 1 illustrated this.

The solution is to expand the screen-data area and break it into a series of independent, horizontal-line

This article appears in slightly different form in De Re Atari, published by Atari, Inc., and is reproduced with its express permission.



META TECHNOLOGIES



26111 Brush Avenue, Euclid Ohio 44132
CALL TOLL FREE 1-800-321-3552 TO ORDER
IN OHIO, call (216) 289-7500 (COLLECT)

1001 THINGS TO DO WITH YOUR PERSONAL COMPUTER
BY MARK SAWUSCH
333 pages \$10.95

333 pages, written in simple terms, of "what-to-do" and "how-to-do-it". Suitable not only for microcomputers, but for programmable calculators as well. Includes program listings, formulas, a glossary of computer terms and more! Definitely a MUST BUY!

"TRS-80™ DISK AND OTHER MYSTERIES"
by Harvard C. Pennington

132 pages written in PLAIN ENGLISH packed with HOWTO information with details, examples and in-depth explanations. Recover lost files and directories, remove file protection, make BASIC programs unlistable. How to use SUPERZAP, recover from DOS errors and MORE!

TRS-80™ DISK \$19.95

"OTHER MYSTERIES" VOLUME II
by James Farvour

Call now and place your order for this new book, "MICROSOFT™ BASIC DECODED & OTHER MYSTERIES for the TRS-80™", from IJG, Inc. A primer for cassette and disk BASIC on the TRS-80™, the information provided applies to similar MICROSOFT™ BASIC interpreters. MICROSOFT™ BASIC DECODED . \$24.95

"OTHER MYSTERIES" VOLUME III
by Dennis Kitsz

THE CUSTOM TRS-80™ \$29.00
CALL FOR AVAILABILITY

"OTHER MYSTERIES" VOLUME IV
"BASIC FASTER AND BETTER"

If you program in BASIC, you want this book! Time-tested and proven, the techniques and routines can be used in thousands of ways to make your programs smaller, faster, and look truly professional.

BASIC FASTER & BETTER \$24.95

EPSON
MX-80, MX-80FT, MX-100
PRINTERS
NEW LOW PRICES!

EXTRA LONG RIBBON
CABLE
\$24⁹⁵

CONNECTS EPSON PRINTER & TRS-80 MICROCOMPUTER

40-TRACK, SINGLE/DOUBLE-DENSITY, FAST ACCESS,
5 1/4-inch TANDON

DISK DRIVES
\$289⁹⁵ complete

FOR MODEL I and MODEL III

Includes Case, Power Supply and External Drive Connector

DISK DRIVE
EXTENDER CABLE
\$9⁹⁵

for VISTA, MICROPOLIS, MTI, PERTEC, SHUGART, PERCOM & OTHERS

Single Sided, Soft-Sector 5 1/4-inch,
PARAGON MAGNETICS™
PLAIN JANE™
DISKETTES
\$19⁹⁵ box of 10

These are factory fresh, absolutely first quality (no seconds!) mini-floppies. They are complete with envelopes, labels and write-protect tabs in a shrink-wrapped box.

Box of 10 Diskettes \$19.95

PARAGON
magnetics™
Gold

Introducing MTC's premium generic diskette. Single-Sided, Soft-Sector, DOUBLE-DENSITY, 5 1/4-inch diskettes with reinforcing HUB-RINGS. Individually 100% ERROR-FREE certified. Invest in GOLD!

PARAGON MAGNETICS GOLD \$23.95

VERBATIM'S PREMIUM DISKETTES
DATALIFE™

Seven data-shielding improvements mean greater durability and longer data life. These individually, 100% error-free certified diskettes feature thicker oxide coating, longer-lasting lubricant, improved liner, superior polishing and more! Meets or exceeds IBM, Shugart, ANSI, ECMA and ISO standards.

VERBATIM DATALIFE™ DISKETTES
5 1/4-inch (box of 10)
MD525-01 \$26.95
8-inch FLOPPIES
Double-Density, FD34-8000 . \$43.95

'RINGS' & THINGS

HUB RING KIT for 5 1/4" disks \$10.95
HUB RING KIT for 8" disks \$12.95
REFILLS (50 Hub Rings) \$ 5.95
CLEANING KIT for 5 1/4" drives . . . \$24.95
5 1/4-inch diskette case \$3.50
8-inch diskette case \$3.95
5 1/4-inch File Box for
50 diskettes \$24.95
8-inch File Box for
50 diskettes \$29.95

TRS-80 is a trademark of the Radio Shack Division of Tandy Corporation. DATALIFE is a trademark of VERBATIM. PLAIN JANE, PARAGON MAGNETICS, are trademarks of MTC.
© 1981 by Metatechnologies Corporation, Inc.

MOST ORDERS SHIPPED WITHIN ONE BUSINESS DAY
Products damaged in transit will be exchanged.

PRICES IN EFFECT
Jan. 1, 1982 THRU
January 31, 1982
Prices, Specifications, and Offerings subject to change without notice.

WE ACCEPT
• VISA
• MASTER CHARGE
• CHECKS
• MONEY ORDERS
• C.O.D.

• Add \$3.00 for shipping & handling
• \$3.00 EXTRA for C.O.D.
• Ohio residents add 6.6% sales tax.

Listing 1: A simple program in Atari BASIC demonstrating coarse scrolling. Both horizontal and vertical scrolling are combined, but the end result is rather clumsy. The entire address space of the computer will be displayed.

```

10 DLIST = PEEK(560) + 256*PEEK(561):REM    find display list
20 LMSLOW = DLIST + 4:REM                  get low address of LMS operand
30 LMSHIGH = DLIST + 5:REM                 get high address of LMS operand
40 FOR I = 0 TO 255:REM                    outer loop
50 POKE LMSHIGH,I                          .
60 FOR J = 0 TO 255:REM                    inner loop
70 POKE LMSLOW,J
80 FOR Y = 1 TO 50:NEXT Y:REM              delay loop
90 NEXT J
100 NEXT I

```

Listing 2: An Atari BASIC program demonstrating a pure vertical scroll. The line length (in bytes) is either added to or subtracted from the LMS operand to achieve upward and downward scrolling, respectively. Lines 70, 120, and 130 accomplish this for upward scrolling only.

```

10 GRAPHICS 0
20 DLIST = PEEK(560) + 256*PEEK(561)
30 LMSLOW = DLIST + 4
40 LMSHIGH = DLIST + 5
50 SCREENLOW = 0
60 SCREENHIGH = 0
70 SCREENLOW = SCREENLOW + 40:REM          next line
80 IF SCREENLOW < 256 THEN GOTO 120:REM    overflow?
90 SCREENLOW = SCREENLOW - 256:REM        yes, adjust pointer
100 SCREENHIGH = SCREENHIGH + 1
110 IF SCREENHIGH = 256 THEN END
120 POKE LMSLOW,SCREENLOW
130 POKE LMSHIGH,SCREENHIGH
140 GOTO 70

```

Listing 3: An Atari BASIC program demonstrating pure horizontal scrolling. Each display line is actually 256 characters (bytes) long, though only 20 can be observed at any time. The 256-byte line is used in this example to simplify the program by avoiding the use of 2-byte address manipulations. The display produced scrolls from right to left. Upon reaching the end of the line, it starts over from the beginning.

```

10 REM first set up the display list
20 POKE 1536,112:REM                      8 blank lines
30 POKE 1537,112:REM                      8 blank lines
40 POKE 1538,112:REM                      8 blank lines
50 FOR I = 1 TO 12:REM                     loop to put in display list
60 POKE 1536 + 3*I,71:REM                  BASIC mode 2 with LMS set
70 POKE 1536 + 3*I + 1,0:REM              low byte of LMS operand
80 POKE 1536 + 3*I + 2,I:REM              high byte of LMS operand
90 NEXT I
110 POKE 1575,65:REM                       ANTIC JVB instruction
110 POKE 1576,0:REM                        display list starts at $0600
120 POKE 1577,6
130 REM tell ANTIC where display list is
140 POKE 560,0
150 POKE 561,6
160 REM now scroll horizontally
170 FOR I = 0 TO 235:REM                    loop through LMS low bytes
175 REM we use 235—not 255—because screen width is 20 characters
180 FOR J = 1 TO 12:REM                     for each mode line
190 POKE 1536 + 3*J + 1,I:REM              put in new LMS low byte
200 NEXT J
210 NEXT I
220 GOTO 170:REM                            endless loop

```

data areas. Figure 1 illustrates this idea. On the left is the normal arrangement. One-dimensional serial RAM is stacked in linear sequence to create the screen-data area. On the right is the arrangement needed for proper horizontal scrolling. The RAM is still one-dimensional and serial, but it is now used differently. The RAM for each horizontal line extends much further than the screen can show. This is no accident. The whole point of scrolling is to let a program display more information than the screen can hold. We can't show all that extra information if we don't allocate the RAM to hold it. With this arrangement we can implement true horizontal scrolling. We can move the screen window over the screen data without the undesirable vertical roll of the earlier approach.

The first step in implementing pure horizontal scrolling is to determine the total horizontal line length and allocate RAM accordingly. Next, a completely new display list with an LMS instruction on each mode line is written. The display list will, of course, be longer than usual, but there is no reason why we cannot write such a list. What values are used for the LMS operands? It is most convenient to use the address of the first byte of each horizontal screen-data line, the points marked with Xs in figure 1. Each mode line on the screen will have one such address. Once the new display list is in place, ANTIC must be informed of it and screen data must be written to populate the screen. To execute a scroll, each and every LMS operand in the display list must be incremented for a rightward scroll or decremented for a leftward scroll. Program logic must insure that the image does not scroll beyond the limits of the allocated RAM areas; otherwise, garbage displays will result. In setting up such logic, the programmer must remember that the LMS operand points to the first screen-data byte in the displayed line. The maximum value of the LMS operand is equal to the address of the last byte in the long horizontal line minus the number of bytes in one displayed line. As this process is

Systems Group System 2800 computers. They're making people stand up and take notice.

But then Systems Group products have always appealed to those who appreciate sensible value, high performance, unmatched reliability and prompt, courteous service.

Through the years, Systems Group product acceptance in Z80 CPU, disk controller, I/O and memory boards have been the result of some very purposeful and carefully thought out engineering. Not to mention strict industrial quality production standards.

That same effort has made System Group's new family of expandable System 2800 computers what they are today.

Fast, reliable and powerful.

System 2800 computer systems are designed for a single user with 64K of memory or for up to as many as six separate users with additional add-in memory. They can easily expand as your organization's needs grow.

You can handle up to 8000 customers and 24,000 inventory items in our lowest cost dual floppy model and much, much more in our 40M byte hard disk models. And you can connect up to 12 terminals or printers and other add-on Systems Group floppy, tape and hard disk single or dual drive subsystems.

Select CP/M¹, MP/M¹ or OASIS^{††} operating systems to run all your word processing and

accounting programs. No matter what size organization you control, controlling will be easier from now on.

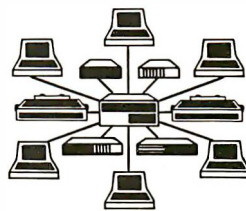

See the System 2800 from Systems Group, they're

what computers should have been in the first place.

[†] registered trademark of Digital Research
^{††} registered trademark of Phase One Systems

Dealer Inquiries Invited

For dealers only, circle 351
All other inquiries, circle 352

Systems Group

A Division of MEASUREMENT systems & controls
incorporated

1601 Orangewood Avenue
Orange, California 92668. (714) 633-4460
TWX/TELEX 910 593 1350 SYSTEMGRP ORGE

Be Permanently Impressed.

The Expandable Computer Family from Systems Group.



1981

Today's Requirements

Dual floppy single or multi-user system

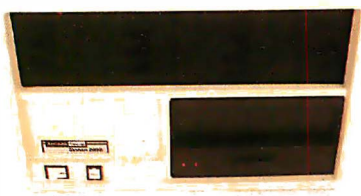

1983

Tomorrow's Requirements

10M byte hard disk and floppy drive, single or multi-user system



1985

Your Future Requirements

40M byte hard disk and 20M byte tape back-up, single or multi-user system

rather intricate, let us work out an example.

First, the total horizontal line length is selected. For this example, we shall use a horizontal line length of 256 bytes. This will simplify address calculations. Each horizontal line will then require one page of RAM. Since we will use BASIC mode 2, 12 mode lines will be on screen; thus, 12 pages, or 3 K bytes, of RAM will be required. For simplicity (and to guarantee that our screen RAM will be populated with nonzero data) we will use the bottom 3 K bytes of RAM. Since this area is used by the operating system and disk operating system, it should be full of interesting data. To make matters more interesting, we'll put the display list on page 6 so that we can display it on the screen as we are scrolling. The initial values of the LMS operands will thus be particularly easy to calculate: the low-order bytes will all be zeros and the high-order bytes will be (in order) 0, 1, 2, etc.

The program in listing 3 performs these operations and scrolls the screen horizontally. This program scrolls the data from right to left. When the end of a page is reached, it simply starts over at the beginning. When executing this program, the display list is found on the sixth line down (it's on

page 6). It appears as a sequence of double quotation marks.

The next step is to mix vertical and horizontal scrolling to get diagonal scrolling. Horizontal scrolling is achieved by adding 1 to or subtracting 1 from the LMS operand. Vertical scrolling is achieved by adding the line length to or subtracting the line length from the LMS operand. Diagonal scrolling is achieved by executing both operations. Four diagonal-scroll directions are possible. If, for example, the line length is 256 bytes and we wish to scroll down and to the right, we must add $256 + (-1) = 255$ to each LMS operand in the display list. This is a 2-byte add; the BASIC program example given in listing 3 avoids the difficulties of 2-byte address manipulations. However, most programs will not be so contrived. For truly fast two-dimensional scrolling, assembly language is necessary.

All sorts of weird arrangements are possible if we differentially manipulate the LMS bytes. Lines could scroll relative to each other, or hop over each other. Some of this could be done with a conventional display, but more data would have to be moved to do it. The real advantage of LMS scrolling is its speed. Instead of manipulating an entire screen full of

data many thousands of bytes in size, a program need only manipulate perhaps a few dozen bytes.

Fine Scrolling

The second important scrolling facility of the Atari 400/800 is the fine-scrolling capability, scrolling a pixel in steps smaller than the pixel size. Coarse scrolls proceed in steps equal to one pixel dimension; fine scrolls proceed in steps of one scan line vertically and one color clock horizontally. Fine scrolling can only be carried so far. To get full fine scrolling over the entire screen, we must use fine scrolling with coarse scrolling.

Only two steps are required to implement fine scrolling. First, we set the fine-scroll enable bits in the display-list instruction bytes for the mode lines in which we want fine scrolling. (Since we generally want the entire screen to scroll, we set all the scroll enable bits in all the display-list instruction bytes.) Bit D5 of the display-list instruction is the vertical-scroll enable bit; bit D4 of the display-list instruction is the horizontal-scroll enable bit. We then store the scrolling value desired into the appropriate scrolling register.

Two scrolling registers are available, one for horizontal scrolling and one for vertical scrolling. The horizontal-scroll register (HSCROL) is at hexadecimal address D404; the vertical-scroll register (VSCROL) is at hexadecimal address D405. For horizontal scrolling, we store in HSCROL the number of color clocks by which we want the mode line scrolled. For vertical scrolling, we store in VSCROL the number of scan lines that we want the mode line scrolled. These scroll values will be applied to

NORMAL DATA ARRANGEMENT

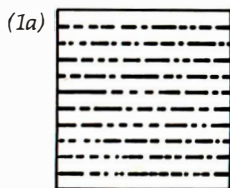

ARRANGEMENT FOR HORIZONTAL SCROLL



Figure 1: Figure 1a shows how screen data are normally organized. Horizontal scrolling can be accomplished by arranging the screen-data area as shown in figure 1b.

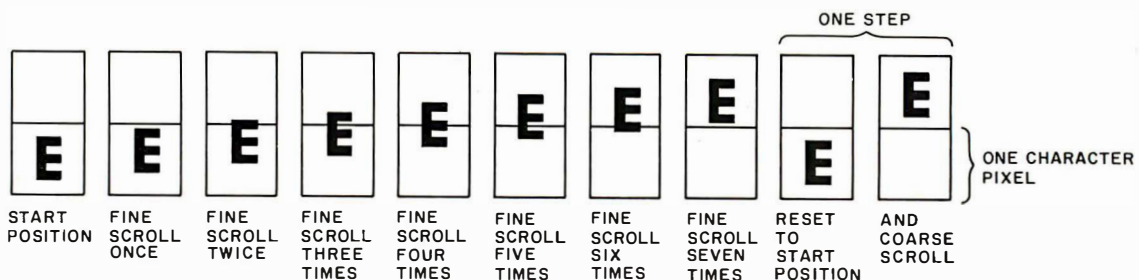

Figure 2: In order to achieve fine scrolling over the entire display screen, a combination of fine and coarse scrolling is used. After the seventh fine scroll is performed, the fine-scroll register is reset and a coarse scroll is performed.

THE DAWN OF A NEW AGE

The 2nd Generation™ is here!

MEASUREMENT systems & controls proudly introduces its new and exciting "2nd Generation" family of S-100* compatible products. Each has been specifically designed for use with multi-user and network operating systems such as MP/M, CP/NET, and OASIS. Every product is fully tested and burned-in, comes with a 1 year guarantee, and offers you features not currently available from any other source.

Z80 PROCESSOR BOARD — The most powerful CPU board available today. Outstanding features include 4MHz operation, high-speed serial and parallel I/O utilizing DMA or programmed control, eight vectored priority interrupts, and a real time clock.

MULTI-USER SERIAL I/O BOARD — For use in expanded systems requiring up to eight additional serial I/O ports. Features include: 16 maskable

vectored priority interrupts, RS-232C interfaces with full handshake, asynchronous or synchronous operation with asynchronous baud rates to 19,200. Available in four or eight channel versions.

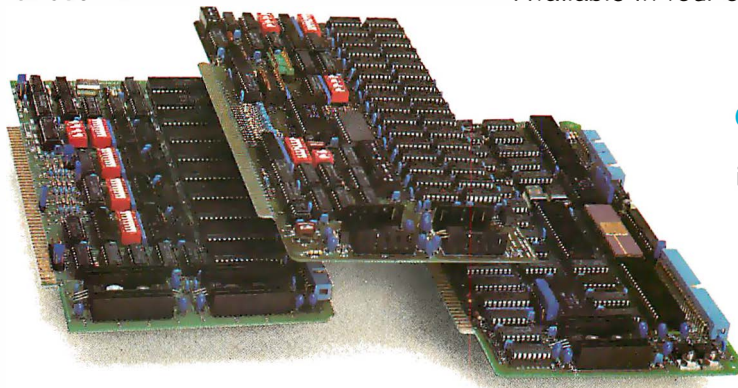

DOUBLE DENSITY FLOPPY DISK CONTROLLER BOARD— controls up to four 5¼-inch or 8-inch disk drives using IBM soft sectored formats. It features 1K of on-board buffering, DMA controlled data transfers and the performance characteristics of the superior NEC 765 chip.

64K BANK SELECTABLE MEMORY BOARD — Features include I/O port addressing for bank select with 256 switch selectable I/O ports for the memory bank addressing. The memory is configured as four totally independent 16K software-selectable banks, with each bank addressable on any 16K boundary.

*All products meet the new IEEE standards.

"Attractive Dealer & OEM Prices"

See your nearest computer dealer, or contact us for the complete story on The 2nd Generation.

Systems Group

A Division of MEASUREMENT systems & controls incorporated

1601 Orangewood Ave., Orange, CA 92668
TWX/TELEX: 910 593 1350 SYSTEMGRP ORGE
714-633-4460

For dealers only, circle 409
All other inquiries, circle 410

Save \$2500⁰⁰

Are you faced with having to spend \$3000 and up for a letter-quality printer?

Mediamix offers an alternative.



For only \$500 the **Mediamix ETI²** lets you connect the IBM Electronic Typewriter Models 50,60, or 75 to **any** computer. Why invest in two separate machines? Your office typewriter can do both jobs, yielding better type quality, a consistent corporate image and renowned IBM service.

The **ETI²** is no simple black box, either. It is a sophisticated micro-computer with 2000 characters



of memory, over 39 special commands and the option of doing typesetting on the IBM Model 50.

Write or Call

MEDIAMIX

P.O. Box 67B57
Los Angeles, California 90067
(213)475-9949

Listing 4: An Atari BASIC program demonstrating fine scrolling. Scroll registers should be changed only during vertical blanking, necessitating assembly-language programming for most applications. Otherwise, ANTIC gets confused and causes the screen to jerk.

```

1 HSCROL = 54276
2 VSCROL = 54277
10 GRAPHICS 0:LIST
20 DLIST = PEEK(560) + 256*PEEK(561)
30 POKE DLIST + 10,50:REM          enable both scrolls
40 POKE DLIST + 11,50:REM          do it for two mode lines
50 FOR Y=0 TO 7
60 POKE VSCROL,Y:REM              vertical scroll
70 GOSUB 200:REM                   delay
80 NEXT Y
90 FOR X=0 TO 3
100 POKE HSCROL,X:REM             horizontal scroll
110 GOSUB 200:REM                  delay
120 NEXT X
130 GOTO 40
200 FOR J=1 TO 200
210 NEXT J:RETURN

```

every line for which the respective fine scroll is enabled.

Two complicating factors are encountered when we use fine scrolling. Both arise from the fact that a partially scrolled display shows more information than a normal display. Consider, for example, what happens when we horizontally scroll a line by half a character to the left. The 40th character scrolls to the left, but what takes its place? Half of a new 41st character should scroll over to take the place of the now scrolled 40th character. But there are only 40 characters in a normal line.

The solution to this problem has already been built into the hardware with three display options for line widths: the narrow playfield (128 color clocks wide), the normal playfield (160 color clocks wide), and the wide playfield (192 color clocks wide). These options are chosen by setting appropriate bits in the DMACTL register. (DMACTL is at address D400 hexadecimal; most users will access shadow register SDMACTL at address 22F hexadecimal.) When using horizontal fine scrolling, ANTIC automatically retrieves more data from RAM than it displays. For example, if DMACTL is set for normal playfield, which in BASIC mode 0 has 40 bytes per line, ANTIC will actually retrieve data at a rate appropriate to wide playfield—48 bytes per line. This will throw lines off

horizontally if it is not taken into account. The problem does not appear if the programmer has already organized screen RAM into long horizontal lines as in figure 1.

The corresponding problem for vertical scrolling can be handled in two ways. The sloppy way is to ignore it. We will not get half images at both ends of the display. Instead, the images at the bottom of the display will not scroll properly; they will suddenly pop into view. The proper way takes very little work.

To get proper fine scrolling into and out of the display region, we must dedicate one mode line to act as a buffer. This is done by refraining from setting the vertical-scroll bit in the display-list instruction of the last mode line of the vertically scrolled zone. The window will now scroll without the unpleasant jerk and the screen image will be shortened by one mode line. An advantage of scrolling displays now becomes apparent. It is quite possible to create screen images that have more than 192 scan lines in the display. This could be disastrous with a static display. However, with a scrolling display, images above or below the displayed region can always be scrolled into view.

Fine scrolling will only scroll so far. The vertical limit is 16 scan lines; the horizontal limit is 16 color clocks. If we attempt to scroll beyond these limits, ANTIC simply ignores the

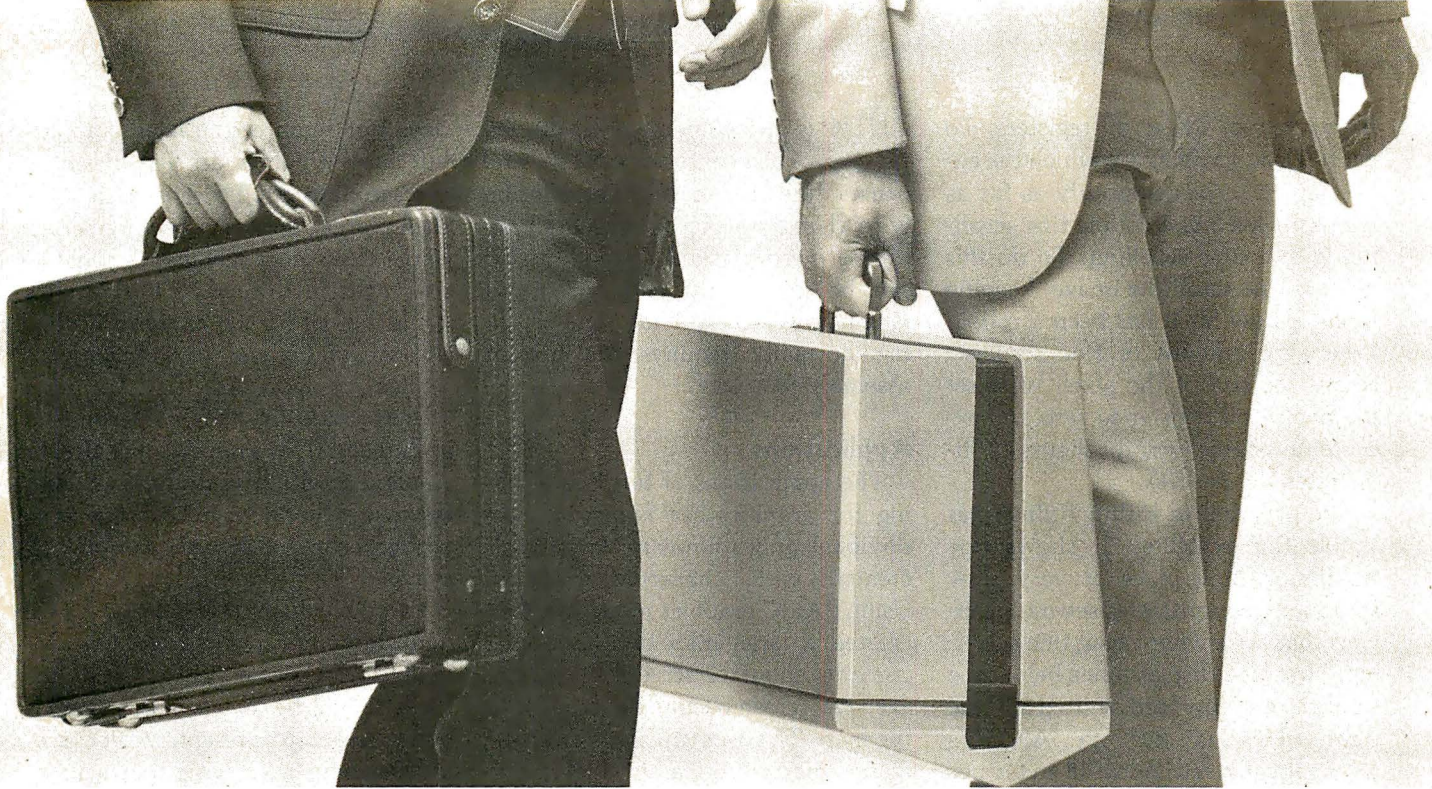

The guy on the left doesn't stand a chance.

The guy on the left has two file folders, a news magazine, and a sandwich.

The guy on the right has the OSBORNE 1®, a fully functional computer system in a portable package the size of a briefcase. Also in the case are the equivalent of over 1600 typed pages, stored on floppy diskettes.

The owner of the OSBORNE 1 is going to get more work done—and *better* work done—in less time, and with less effort.

Unfold it, plug it in, and go to work like you've never worked before. . . .

Go to work with WORDSTAR® word processing, so your correspondence, reports, and memos take less time to produce, and say more of what you wanted to say. And with MAILMERGE®—the mailing system that turns out personalized mass mailings in the time you'd spend on a rough draft.

Go to work with SUPERCALC®, the electronic spreadsheet package that handles complex projections, financial planning, statistics, and "what if" questions instantly. For the more technically minded, SUPERCALC will process scientific data and calculate results.

Go to work with powerful BASIC language tools—the CBASIC-2® business BASIC, or the Microsoft BASIC® interpreter.

That's standard equipment.

Options include about a thousand different software packages from a host of vendors designed to run on the CP/M® computer system.

Go to work at the office, at home, or in the field.

Or anywhere. Optional battery packs and telephone

transmission couplers mean you need never work without the capabilities of the OSBORNE 1. That's good, because you won't want to work again without it.

All for \$1795. It's inevitable.

The OSBORNE 1 is the productivity machine that's changing the way people work. Put simply, the machine delivers a significant productivity edge—day in and day out—to virtually anyone who deals with words or numbers. Or both.

Since the entire system is only \$1795, it won't be too long before the guy on the left has an OSBORNE 1 of his own. The same probably goes for the person reading this ad. In fact, we think it's inevitable.

The OSBORNE 1 includes a Z80A® CPU, 64K bytes of RAM memory, two 100 kilobyte floppy disk drives, a business keyboard, built-in monitor, IEEE 488 and RS232 interfaces for printers and other things that get connected to computers, plus CP/M, CBASIC-2, Microsoft BASIC, WORDSTAR, and SUPERCALC. The system is available from computer retailers nationally.

\$1795. It's inevitable.

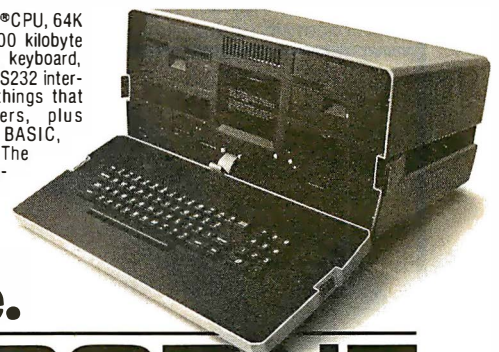

OSBORNE
COMPUTER CORPORATION

26500 Corporate Avenue Hayward, California 94545
Phone (415) 887-8080 TWX (910) 383-2021

higher bits of the scroll registers. To get full fine scrolling (in which the entire screen scrolls smoothly as far as we wish), we must couple fine scrolling with coarse scrolling. To do this we first fine scroll the image, keeping track of how far it has been scrolled. When the amount of fine scrolling equals the size of the pixel, we reset the fine-scroll register to zero and execute a coarse scroll. Figure 2 illustrates the process.

The program in listing 4 illustrates simple fine scrolling. It shows fine scrolling taking place at very slow speed and demonstrates several problems that arise when using fine scrolling. First, the display lines below the scrolled window are shifted to the right. This is due to ANTIC's automatically retrieving 48 bytes per line instead of 40. The problem arises only in unrealistic demonstration programs such as this one. In real scrolling applications, the arrangement of the screen data (as shown in figure 1) precludes this problem. A more serious problem arises when the scroll registers are modified while

ANTIC is in the middle of its display process. This confuses ANTIC and causes the screen to jerk. The solution is to change the scroll registers only during vertical-blank periods. This can be done only with assembly-language routines. Thus, fine scrolling normally requires the use of assembly language.

Applications

The applications of full fine scrolling for graphics are numerous. An obvious application is for large maps created with character graphics. Using BASIC graphics mode 2, I have created a large map of Russia that contains about 10 screens full of image. The screen becomes a window to the map. The user can scroll over the entire map with a joystick. The system is very memory efficient: the entire map program, data, display list, and character-set definitions require a total of about 4 K bytes of RAM.

Any very large image that can be drawn with character graphics is amenable to this system. (Scrolling

does not require character graphics, but map graphics are less desirable for scrolling applications because of their large memory requirements.) Large electronics schematics could be presented in this way. The joystick could be used both to scroll around the schematic and to indicate particular components that the user wishes to address. Large blueprints or architectural diagrams could also be displayed with this technique. Any big image that need not be seen in its entirety can be presented with this system.

Large blocks of text are also usable here, although it might not be practical to read continuous blocks of text by scrolling the image. This system is better suited to presenting blocks of independent text. One particularly exciting idea is to apply this system to menus. The program starts by presenting a welcome sign on the screen with signs pointing to submenus in other regions of the larger image. "This way to addition" might point up; "this way to subtraction" might point down. Users scroll around the menu with the joystick perusing their options. When making a choice, a cursor is placed on the option and the red button is pressed. Although this system could not be applied to all programs, it could be of great value to certain types of programs.

. . . And More

Two blue-sky applications of fine scrolling have not yet been fully explored. The first is selective fine scrolling, in which different mode lines of the display have different scroll bits enabled. Normally, we would want the entire screen to scroll, but it is not necessary to do so. We could select one line for horizontal scrolling only, another line for vertical scrolling only, and so forth. The second blue-sky feature is the prospect of using display-list interrupts to change the HSCROL or VSCROL registers "on the fly." Changing VSCROL on the fly is a tricky operation; it would probably confuse ANTIC and produce undesirable results. Changing HSCROL is also tricky, but might be easier. ■

"We Bring Quality Forms To The Micro Industry"

- 7 working day RUSH service
- FREE demo samples
- Quality design
- Very COMPETITIVE PRICES
- Personalized assistance
- FREE shipping - in continental U.S.
- COMPLIMENTARY quotes on custom forms



Currently providing forms support for:

Systems Plus • Vector • TCS • Alpha Micro
Radio Shack • Insoft • IMS • Continental • DIBS
Libra • Structured Systems Group • Peachtree
Anchor • Accounting Plus • BPI • Designer • MCS
Graham Dorian • MCBA • Durango • Dynabyte

Call NOW for FREE sample forms packet. Your customer service representative is waiting to assist you with your continuous forms needs!

 **Checks** 8384 Hercules St.
 **To-Go** La Mesa, CA 92041

CALL TOLL FREE: (800) 854-2750; (800) 552-8817 in CA

Tired of writing (and rewriting) customized and friendly error free code?

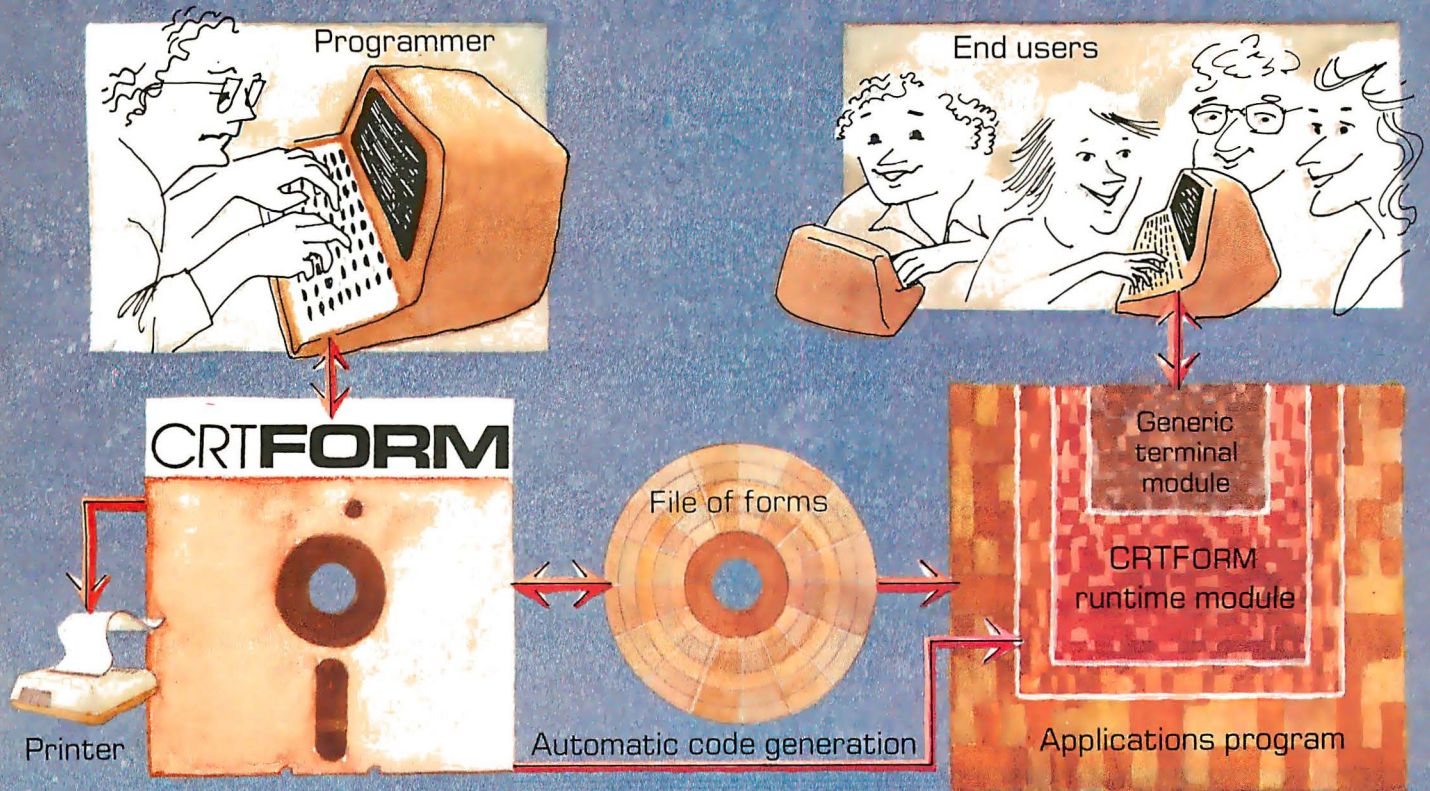

CRTForm™ is a programmer productivity tool that saves time.

CRTFORM produces a friendly bug free interface between end users and the applications programmer.

CRTFORM makes sure that end users enter information correctly, and gives error messages (in plain English) if they don't. It guarantees that programmers will receive correct information without having to write hundreds of lines of error checking code.

CRTFORM allows you to modify program input specifications without requiring expensive and time consuming changes in applications code. It even generates a source code skeleton (Pascal, BASIC, COBOL, FORTRAN, PL/I, and Ada) to interface the programmers' application code to the CRTFORM runtime module.

The CRTFORM package consists of:

- A forms manager that manipulates random access files of input specification forms.
- An editor that creates and modifies the specifications forms.
- A print utility that produces hard copy of forms and their specifications.
- A code generator that writes source code skeletons for ease of program interfacing.
- A terminal-independent runtime module in the machine language of your host processor.

CRTFORM is available under the CP/M, UCSD, and Apple Pascal operating systems. Please call or write for further information on OEM licensing arrangements, or for the name of your nearest CRTFORM dealer.

PROGRAMS THAT WRITE PROGRAMS
STATCOM
CORPORATION

5766 BALCONES SUITE 202
AUSTIN, TEXAS 78731
PHONE 512/451-0221

A Closer Look at the IBM Personal Computer

Gregg Williams
Senior Editor

What microcomputer has color graphics like the Apple II, an 80-column display like the TRS-80 Model II, a redefinable character set like the Atari 800, a 16-bit microprocessor like the Texas Instruments TI 99/4, an expanded memory space like the Apple III, a full-function uppercase and lowercase keyboard like the TRS-80 Model III, and BASIC color graphics like the TRS-80 Color Computer? Answer: the IBM Personal Computer, which is a synthesis of the best the microcomputer industry has offered to date. It has a

number of interesting features and a few flaws, but it is easily the best-designed microcomputer to date. In this article, I will take a closer look at the IBM Personal Computer, inside and outside.

An Overview

The IBM Personal Computer (photos 1 and 2) is housed in two units, the keyboard and the System Unit. The keyboard (photo 3) has a standard typewriter layout with the addition of a numeric keypad to the right, a set of function keys to the

left, and miscellaneous other keys to bring the total number to 83. It is connected by a coiled cable to the System Unit, which houses the Intel 8088 microprocessor, the 40 K-byte extended Microsoft BASIC in ROM (read-only memory), up to 64 K bytes of dynamic memory, up to two disk drives, a cassette interface, a built-in speaker, and five expansion slots. (Extra dynamic memory cards placed in expansion slots can bring the total up to 256 K bytes.)

Other peripherals include the IBM Monochrome Display (shown in photo 2) and the IBM 80 CPS (characters per second) Matrix

Photo 1: The IBM Personal Computer System with a non-IBM color monitor.

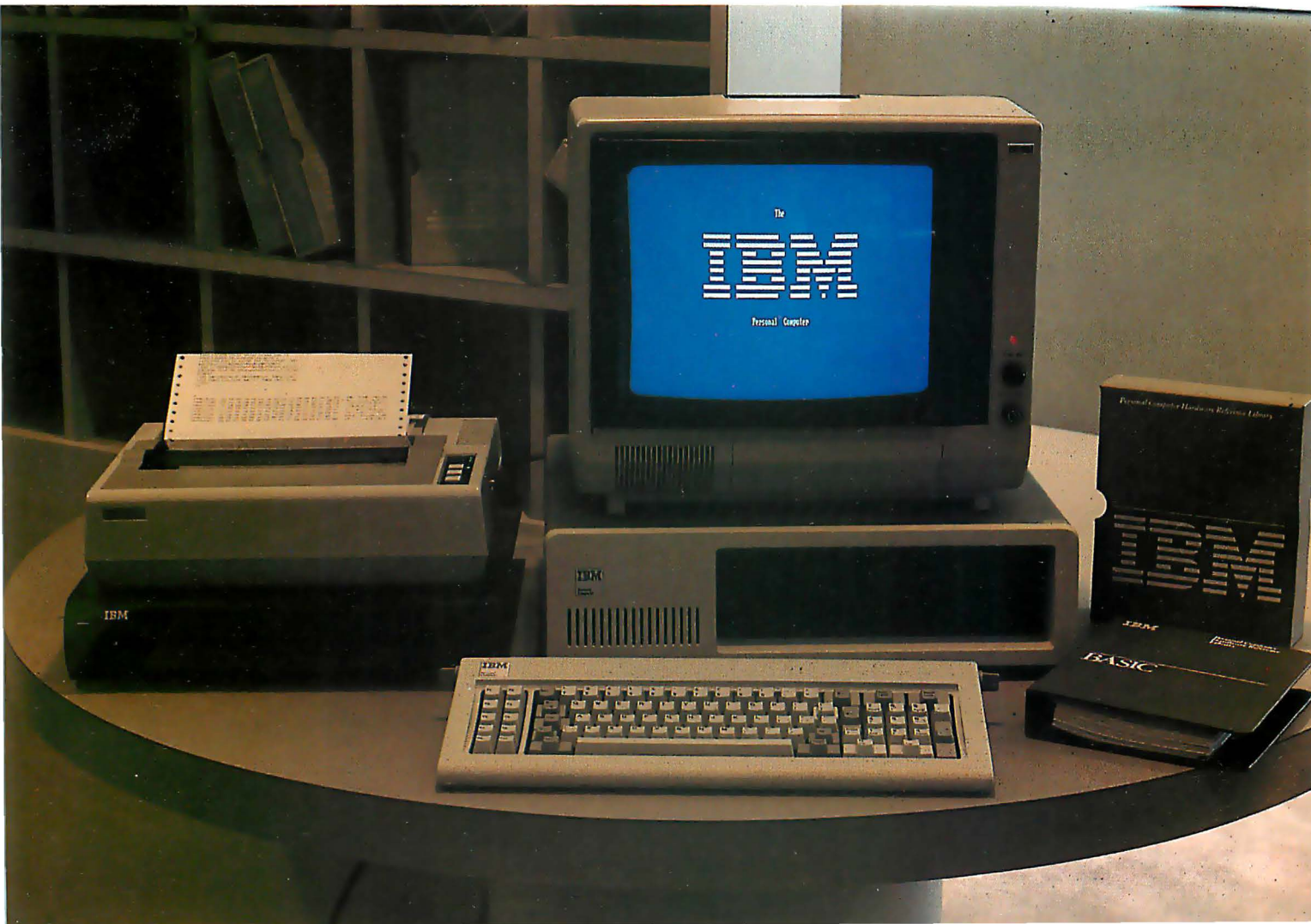

Printer (shown with the optional printer stand in photo 1).

What's It Going to Cost?

The IBM Personal Computer is an impressive unit. But how much is it going to cost? Although the component prices in the "At a Glance" text-box look reasonable (the System Unit and keyboard are only \$1265), the price of a usable configuration is somewhat higher. The higher cost is due to a marketing technique called *unbundling*, which is common in the computer industry and a trademark of IBM in particular. When a system is unbundled, components that usually are priced as one are priced separately. In the case of the IBM Personal Computer, the main unit needs one of two video-display adapter cards, a monitor or television set, a cable, and perhaps an external radio-frequency (RF) modulator.

Table 1a shows several sample configurations of the IBM Personal Computer, and tables 1b and 1c show the list prices of comparable Apple II and Radio Shack TRS-80 Model III units with 48 K bytes of memory and one disk drive. The IBM unit is somewhat more expensive than the standard configurations (note that the Apple II Plus is less expensive if you want only 40-column uppercase output). Still, you get a *lot* more for your money.

Video-Display Options

One thing not commonly understood about the IBM Personal Computer is that you must choose between two separate ways of getting video output. The Monochrome Display and Printer Adapter gives high-quality black-and-white output only, while the Color/Graphics Monitor Adapter can produce color graphics or text. Each takes one of the five expansion slots available on the IBM motherboard (called the System Board by IBM). While you could have both kinds of output by using both adapter cards, most people will not want to tie up the extra slot (more on that later).

The monochrome adapter card is most suited to IBM machines that will be used in an office environment only. The adapter card gives you a



Photo 2: The IBM Personal Computer System with the IBM Monochrome Display.

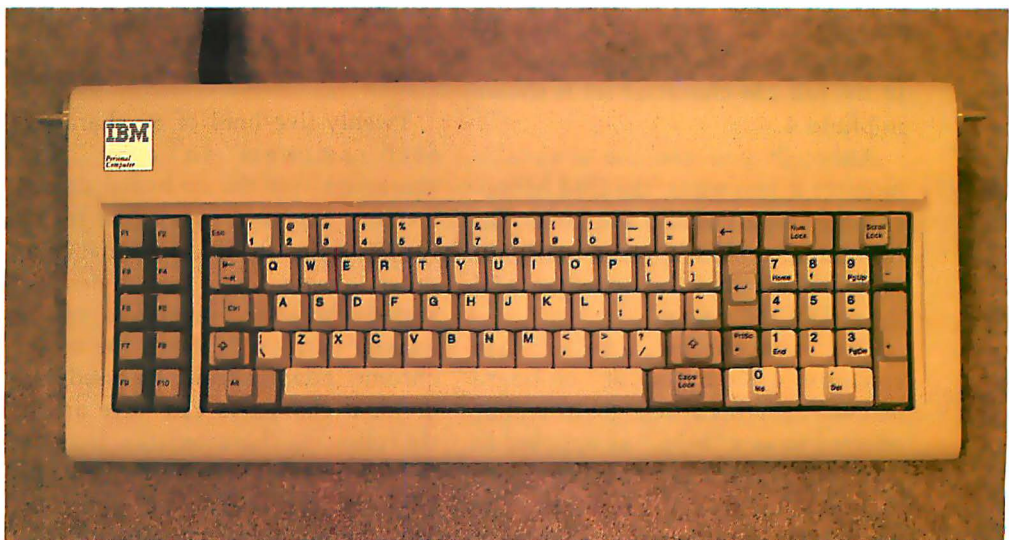

Photo 3: The IBM Personal Computer keyboard unit.

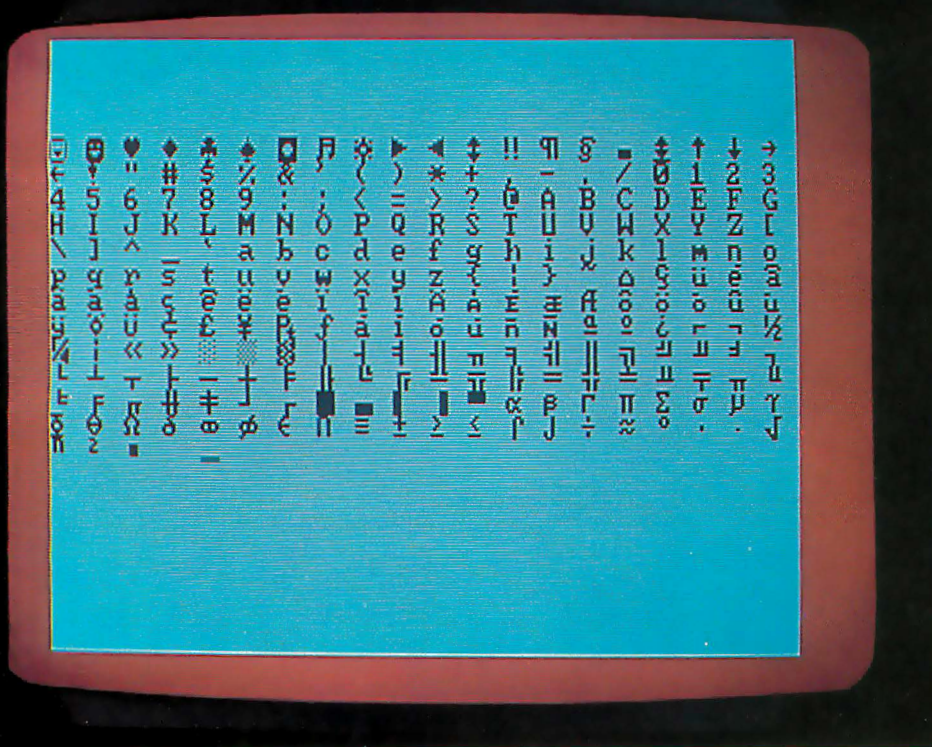

Photo 4: The 256 characters available on the IBM Personal Computer video display.

sharp 25-line by 80-column display with well-formed characters. A 9 by 14 dot matrix is used, and characters are displayed within a 7 by 9 dot matrix; this makes for an extremely readable screen, an important factor if you are using the computer for long periods of time.

Among the 256 characters available are miscellaneous graphics characters (musical note, male and female symbols), all standard uppercase and lowercase letters, numbers, punctuation, some familiar foreign-language, Greek, and mathematics symbols, and a set of rectangular shapes that can be combined to create rectangles and lined tables. A display of the full 256-character set is shown in photo 4.

Although you can use a suitable monitor if you want, the IBM Monochrome Display is also available. The IBM monitor has a green-phosphor tube and matches the appearance of the rest of the system.

The monochrome adapter card contains 4 K bytes of on-board memory. (In this article, 8 bits will be referred to as a "byte," as opposed to a 16-bit "word.") The on-board display memory prevents the available system memory from being steadily decreased by peripheral

cards. In addition, due to the architecture of the 8088 microprocessor, the on-board memory itself does not reduce the main memory address space available to the IBM microcomputer; in contrast, the memory taken by the video display of an 8-bit microcomputer always reduces its 64 K-byte workspace.

The manuals will set the standard for all microcomputer documentation in the future.

Twenty-five lines of 80 characters each amounts to only 2000 characters, yet the on-board display memory has 4096 bytes. The reason for this is that the IBM Personal Computer *always* uses two bytes per stored character, regardless of the adapter card used. When the monochrome adapter card is used, individual characters can have any of the following characteristics: invisible (white-on-white, black-on-black), blinking, high-intensity, or underline. The permissible combinations of these are shown in figure 1.

One final advantage of the monochrome adapter card is that it includes an interface to the IBM 80 CPS Matrix Printer, which saves you the expense of an IBM Printer Adapter card (around \$150) and one expansion slot.

Of course, the main disadvantage of the monochrome adapter card is that it does not produce color graphics. As you can see from photos 5a through 5d, this is some disadvantage. The graphics available through the color/graphics adapter card are very good—slightly better than color graphics on existing microcomputers, and they are more versatile and easier to use.

Color/Graphics Monitor Adapter

Residing in one of the five expansion slots in the System Unit, the Color/Graphics Monitor Adapter has 16 K bytes of on-board memory, can display two kinds of text and two (actually, three) kinds of graphics, and allows you to connect to a black-and-white monitor or to a color monitor with composite or RGB (red-green-blue) input, or to a color television. The color pictures accompanying this article were made with a \$1000 RGB color monitor, so don't expect such stunning graphics to come from your composite monitor or an ordinary color television. (RGB monitors are more expensive and produce better images because they have separate red, green, and blue inputs to get a more detailed image. For an RGB monitor to work properly with the color/graphics adapter card, it must accept the following signals: red, green, blue, intensity, horizontal drive, vertical drive, and ground. RGB monitors that do not have an intensity signal can display only 8 of the possible 16 colors.)

Let's consider graphics first. The IBM color/graphics adapter card has three color-graphics resolutions, only two of which are supported by the system software in ROM. The first mode, the IBM low-resolution mode, is unsupported by IBM. It gives you a display of 100 rows and 160 pixels (picture elements), each of which can be any of the standard 16 colors (for the color list, see table 2). IBM

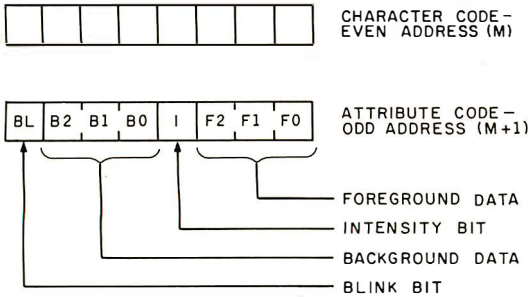

BACKGROUND			FOREGROUND			RESULTING CHARACTER
B2	B1	B0	F2	F1	F0	
0	0	0	0	0	0	NON DISPLAY (BLACK ON BLACK)
0	0	0	0	0	1	NORMAL UNDERLINED CHARACTER
0	0	0	1	1	1	NORMAL CHARACTER
1	1	1	0	0	0	REVERSE CHARACTER (BLACK ON WHITE)
1	1	1	1	1	1	NONDISPLAY (WHITE ON WHITE)

Figure 1: Character storage within the monochrome adapter board.

representatives told me that the only way to use this mode is to directly address the Motorola 6845 CRT Controller, which is at the heart of both the monochrome and color/graphics adapter cards. (For both units, the 6845 device is addressed through two ports: hexadecimal 3D4 and 3D5; more information on this is given in *Technical Reference*, the IBM Personal Computer manual.)

The IBM medium-resolution mode is comparable to what Apple calls its high-resolution mode. It allows 200 rows of 320 pixels each, with four possible colors. (The Apple II allows four colors plus black and white.) The colors are referred to in memory as colors 0 through 3. Color 0 can be any of the 16 colors available, while colors 1 through 3 are set by choosing one of two three-color sets. Set 1 produces cyan, magenta, and white, while set 2 produces green, red, and brown; only the colors from one set are available at any one time. Each byte represents 4 pixels; the mapping scheme is shown in figure 2.

The IBM high-resolution mode uses a white-on-black image and gives you control of 200 rows of 640 pixels each. (Although it is not a well-known fact, the Apple II can display a resolution of 192 by 560 on a black-and-white monitor, although there are some limitations to pixel locations

and the mode must be supported by user-supplied software.) In the IBM high-resolution mode, the mapping of graphics bytes to video scan lines is the same as for medium-resolution graphics, but each byte represents 8 pixels.

Photos 6a and 6b show one edge of the screen to highlight the differences between IBM medium-resolution and high-resolution graphics. As you would expect, corresponding lines in the IBM high-resolution mode are finer drawn, but I can't see that much difference between the two modes.

The color/graphics adapter card supports two text formats: the first, suitable for color televisions and composite monitors, is 25 rows of 40 characters each, while the second, usable by RGB monitors only, is 25 rows of 80 characters each. The card displays characters in an 8 by 8 dot matrix, with characters being drawn in a 5 by 7 dot matrix.

Although the IBM microcomputer has separate text and graphics modes, text can be displayed while in the graphics mode. If you are in graphics mode and want to print text, you simply give the appropriate command (for example, PRINT when in BASIC) and the computer draws the

Photos 5a-5d: Four examples of IBM medium-resolution color graphics.

5a

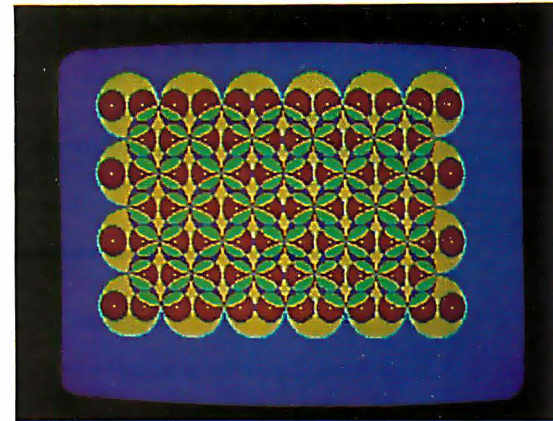

5b

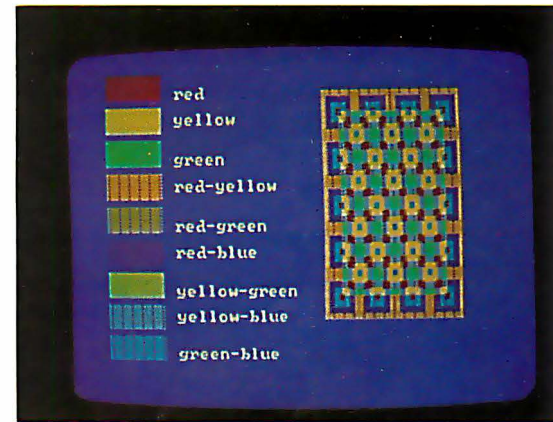

5c

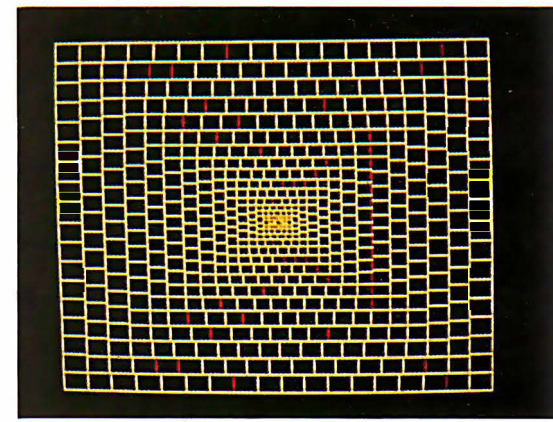

5d

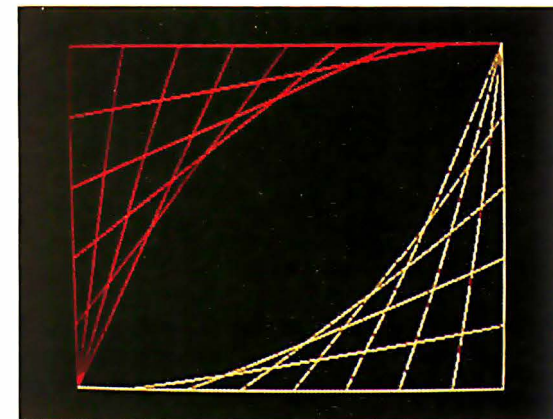

characters on the graphics screen automatically. An example of this is shown in photo 7. While using a text screen, you have access to the same 256-character set used by the monochrome adapter card. If you are using a graphics screen, you have access to only the bottom 128

characters (some symbols, all punctuation, digits, uppercase and lowercase letters). The top 128 characters can be user defined by pointing interrupt vector hexadecimal 1F (contained in hexadecimal memory locations 7C through 7F) to the beginning of a 1 K-byte area that defines the

dot pattern of the top 128 characters, 8 bytes per character.

In the text modes, each character can be one of sixteen colors, with the background of that character being one of eight colors, or the text can be displayed without a color signal (for black-and-white monitors). This is done automatically in BASIC with the COLOR statement. The data that cause a given combination are stored in the attribute byte for each character. Figure 3 shows the layout of the data in the attribute byte, and photo 8 shows an example of multiple background and foreground colors used with text.

Since the color/graphics adapter card has 16 K bytes of memory and the two kinds of text pages take only 2000 and 4000 bytes, respectively, you can store up to four 80-column pages of text or eight 40-column pages at once. In addition, you can specify the display of a page independent of the page actually being written to at the moment. In BASIC, all this is available from the SCREEN statement.

Inside the Main Unit

The IBM Personal Computer is as well designed on the inside as it is on the outside. As shown in photo 9a, the five expansion slots are in the upper left corner, the memory and an internal speaker are in the lower left corner, and the floppy-disk drives (if any) are in the lower right corner. Figure 4 shows the signals on the IBM expansion slot, and table 3 gives the full names of the signals. The bus allows four DMA (direct-memory access) channels, one of which is used to refresh the dynamic memory, the others for high-speed DMA data transfer between memory and peripheral cards. In addition, the bus supports eight levels of interrupts, six of which are available to the user.

The system memory is shown in detail in photo 9b. The set of eight large integrated circuits with gold faces is the 40 K-byte extended Microsoft BASIC in ROM. Notice the empty socket at the bottom of the same row; this can house an 8 K-byte ROM or EPROM (erasable programmable read-only memory). Just to the

1a IBM Personal Computer (suggested retail prices)	
48 K-byte cassette-based unit with color/graphics adapter card	\$1745
all the above, plus one floppy-disk drive, adapter card, and DOS software	\$2575
all the above, plus 16 K bytes more (total, 64 K bytes) and game adapter card	\$2720
all the above, plus a second disk drive	\$3290
all the above, plus one 64 K-byte card (total, 128 K bytes)	\$3830
1b Apple II Plus	
48 K-byte Apple II Plus with one floppy-disk drive and DOS software	\$2175
all of the above, plus Videx Videoterm and Enhancer II (to modify Apple for 80-column display and upper- and lowercase keyboard)	\$2788
1c Radio Shack TRS-80 Model III	
48 K-byte unit with one floppy-disk drive and DOS software	\$1995

Table 1: Prices for several versions of the IBM Personal Computer and roughly comparable Apple II Plus and Radio Shack TRS-80 Model III microcomputers. The versions to be compared are shaded.

Intensity	Red Bit	Green Bit	Blue Bit	Color
0	0	0	0	Black
0	0	0	1	Blue
0	0	1	0	Green
0	0	1	1	Cyan
0	1	0	0	Red
0	1	0	1	Magenta
0	1	1	0	Brown
0	1	1	1	Light Gray
1	0	0	0	Dark Gray
1	0	0	1	Light Blue
1	0	1	0	Light Green
1	0	1	1	Light Cyan
1	1	0	0	Light Red
1	1	0	1	Light Magenta
1	1	1	0	Yellow
1	1	1	1	White

Table 2: The 16 available colors on the IBM Personal Computer, and their representation in memory. When only the first eight colors are available (intensity=0), they can be represented with only the bottom three bits.

right of the ROMs are four rows of 4116 dynamic memory rated with an access time of 250 ns. Only the first row is filled in a 16 K-byte IBM microcomputer; successive rows are filled to bring the microcomputer to 64 K bytes before additional memory is added through the expansion slots.

Notice that there are nine integrated circuits per row. The device on the extreme left is used as a parity bit. To increase the reliability of the system, IBM has made all user memory (i.e., all the memory used for programs and data) 9 bits wide. When a parity error is detected, the IBM microcomputer issues the appropriate error message and stops whatever program is running; this prevents an application program from continuing if it has read the memory incorrectly.

In the middle of the right half of the board are two DIP (dual inline package) switches that set certain parameters of the system. The positions of these switches tell the IBM microcomputer how many disk drives are installed, what kind of video device is attached, and how much memory is in the system. These switches are usually hidden by the

floppy-disk-drive cables, as shown in photo 9a.

Photo 9c shows the Intel 8088 microprocessor (the large device in the center) and, above it, an integrated circuit socket identified by IBM only as an "auxiliary processor socket." An IBM representative would only say that the slot could house "any architecturally compatible processor," but it is probable that the device to go in that slot is an Intel 8087, a mathematics coprocessor device. With the appropriate software, the Intel 8087 or something similar could improve the performance of the IBM microcomputer.

Photo 9d shows one of the IBM peripheral cards, the 64KB Memory Expansion Option. This card is interesting in that it uses two modified 4116 16 K-bit dynamic memory devices "piggybacked" into each 18-pin socket. IBM was buying a lot of these two years ago—now we know where they went.

The Intel 8088 itself is functionally equivalent to the 16-bit Intel 8086 microprocessor, except that all 16-bit input/output (I/O) is done 8 bits at a time, with the help of a few extra support devices. Even though the 8088

has the same instruction set as the 16-bit 8086 microprocessor, the necessity of funneling all data through an 8-bit path degrades the 8088's performance to the point

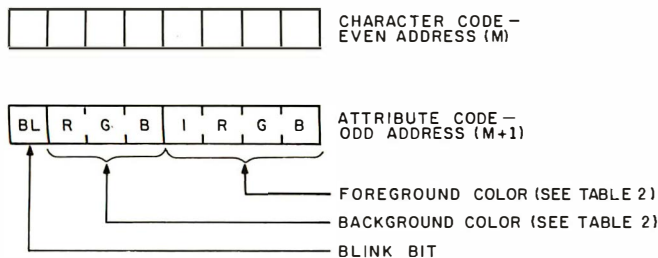

Figure 2: IBM medium-resolution-graphics storage within the color/graphics adapter board.

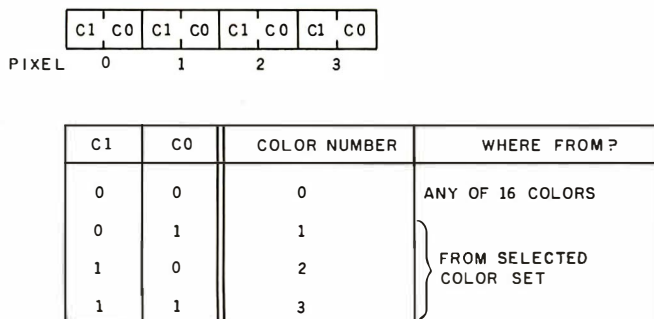

Figure 3: Character storage within the color/graphics adapter board.

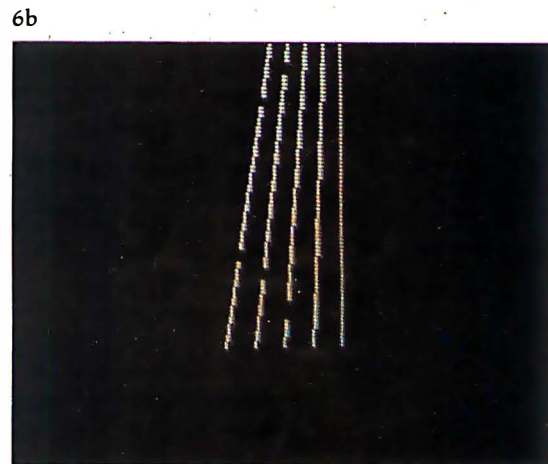
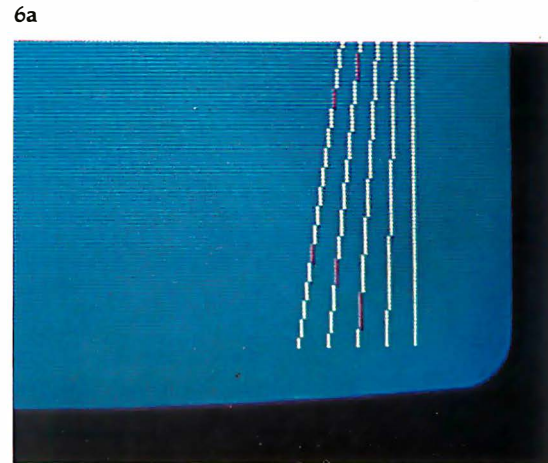

Photo 6: Close-up views of equivalent screen images using IBM medium-resolution (photo 6a) and high-resolution (photo 6b) graphics.



Photo 7: An example of combining text and graphics on the same video screen. The program shown, when run, generates the circular image just above it.

Signal Name	Description
OSC	14.31818 MHz oscillator signal
CLK	4.77 MHz system clock
RESET DRV	reset driver; resets system logic
A0 through A19	address bits 0 (low) through 19 (high)
D0 through D7	data bits 0 through 7
ALE	address latch enable
$\overline{\text{I/O CH CK}}$	I/O channel check
$\overline{\text{I/O CH RDY}}$	I/O channel ready
IRQ2 through IRQ7	interrupt request 2 (highest priority) through 7 (lowest)
$\overline{\text{IOR}}$	I/O read command line
$\overline{\text{IOW}}$	I/O write command line
$\overline{\text{MEMR}}$	memory read command line
$\overline{\text{MEMW}}$	memory write command line
DRQ1 through DRQ3	DMA request 1 through 3
DACK0 through DACK3	DMA acknowledge 0 through 3
AEN	address enable
T/C	terminal count

Table 3: Signal names and descriptions for the IBM Personal Computer System Board I/O Channel (expansion slot). See also figure 4.

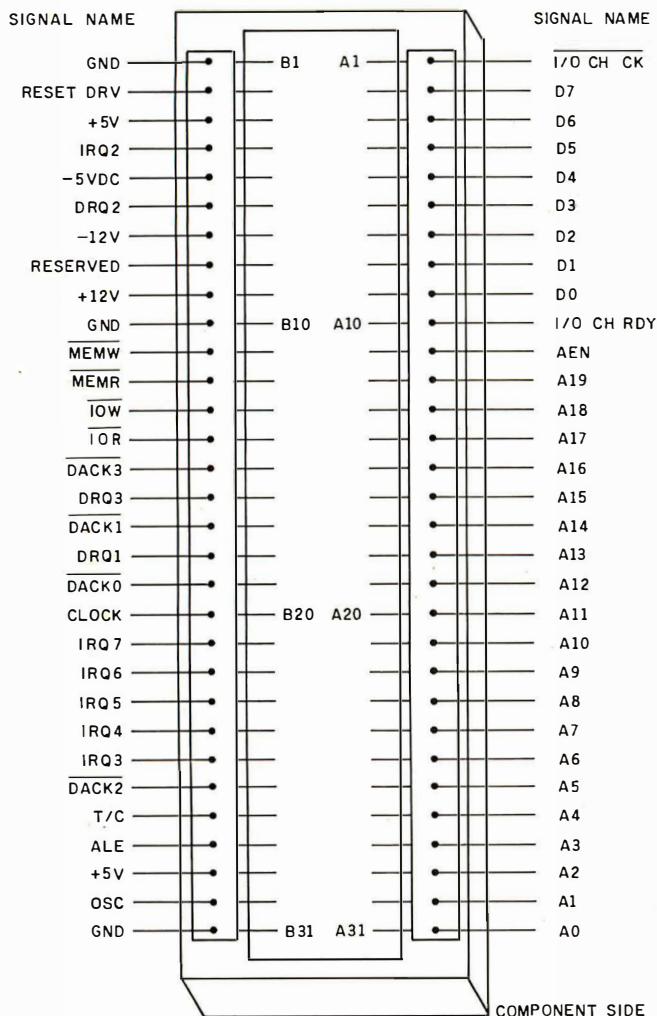

Figure 4: Electrical signals on the IBM System Board I/O Channel (expansion slot). See table 3 for signal descriptions.

where it is more like a fast 8-bit microprocessor with an extended instruction set than it is a 16-bit microprocessor. After all, how much processing can you do on a number without accessing memory again?

Still, the IBM microcomputer combines the architecture of a 16-bit machine with the cost advantages of using familiar 8-bit memory and system design. The 8088 microprocessor in the IBM microcomputer runs at 4.77 MHz.

The disk drives are soft-sectored, double-density, single-sided drives that use MFM (modified frequency modulation) encoding. The floppy-disk drive uses 40 tracks per disk, with eight 512-byte sectors per track. This results in 163,840 bytes of storage per drive. The drive has a motor-start time of 500 ms, a track-to-track seek time of 8 ms, and a data transfer rate of 250 K bits (not bytes) per second.

The IBM Personal Computer includes a cassette-recorder interface that connects to any good-quality cassette recorder through a user-supplied cable. The IBM microcomputer can be configured to use either the microphone or the auxiliary input of the recorder by changing a jumper on the bottom of the main printed-circuit board in the System Unit. The data-transfer rate is between 1000 and 2000 bits per second (bps), depending on the content of the data. The signals used to control a cassette recorder are motor control, ground, data in, and data out.

The right side of the back panel of the main unit (photo 10) contains whatever sockets are made available by the peripheral cards plugged into the expansion slots. Unused slots are masked by metal plates to prevent the escape of any RF radiation. The bottom left corner of the panel contains the power plug to the IBM Monochrome Display and the plug for the main power supply. In the bottom center of the panel are 5-pin DIN plugs that go to the keyboard (left) and the cassette tape recorder (right).

The Keyboard

The keyboard (see photo 3) is one

of the most important components of any computer because it is the primary device through which you give instructions to the computer. Most existing microcomputers have something wrong with their keyboard design; the most common errors are functions unavailable from the keyboard and poor keyboard layout. With one exception, the IBM keyboard seems to be faultless. It is, bar none, the best keyboard on any microcomputer.

The IBM keyboard abounds with good features. The keys have a nice "feel" to them and give tactile and audible feedback when pressed. The keyboard is a separate unit that can be placed up to several feet away from the main unit. It is light enough to rest and use in your lap. The keys themselves are "sculpted"—that is, an imaginary plane touching all the key tops has a slight concave curve to it. The keyboard has two plastic feet that can be used to tilt it up when it is used on a flat surface. A plastic ledge just above the top row of keys can be used to prop an open book between the video display and the keyboard.

Several keyboard features deserve more description. The right side of the keyboard contains a numeric keypad that doubles, in certain situations, as a set of text and cursor-movement keys. The left side contains ten function keys, whose functions can change with the application. (The twenty-fifth line of the video display can be used to illustrate their current use, and you can redefine these keys at any time from BASIC.)

Three keys must be pressed simultaneously to restart the system: Ctrl, Alt, and Del; it takes two hands to do this. Depressing the Ctrl and Scroll Lock/Break keys interrupts a running BASIC program. The up-arrow (shift) and PrtSc keys cause the text contents of the video display to be printed. Ctrl plus Num Lock causes the executing BASIC program to pause; the next key pressed causes it to resume.

The Alt key lets you generate any extended ASCII value from 1 to 255, even if that code is not otherwise generated by the keyboard. By holding down the Alt key and typing

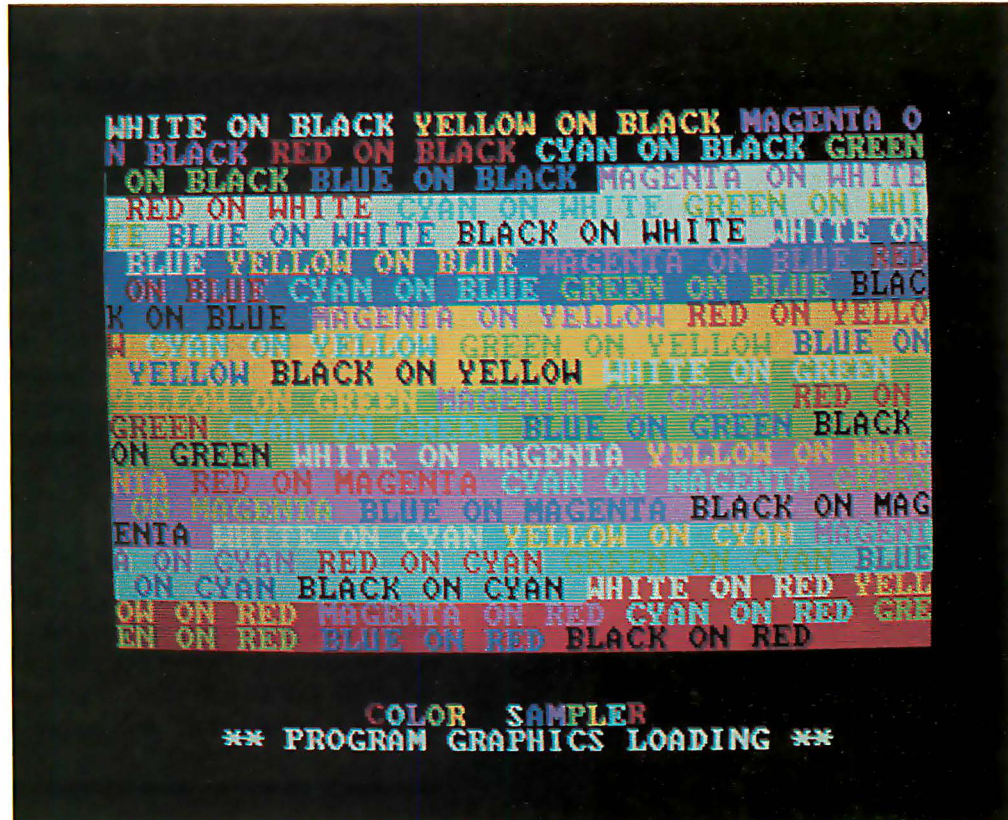

Photo 8: An example showing the independence of foreground and background colors when using the text mode of the color/graphics adapter board.

a number between 1 and 255 on the numeric keypad, that code is generated when the Alt key is released. (For some reason, the IBM unit I tried would not generate 0 with the Alt key. However, 0 could be generated by Ctrl plus the 2 key on the top row of the keyboard.)

By not having a full product line, the IBM Personal Computer may fall prey to hardware and software incompatibility.

Another nice feature of the IBM keyboard is its 10-character type-ahead buffer, which keeps you from losing keystrokes if you type information into the IBM microcomputer before it is ready to receive it. In addition, the system software is written such that every key has an auto-repeat feature; i.e., every key repeats its function if it is held down for more than half a second.

My one complaint against the keyboard is minor. The right and left shift keys are one key farther away from the center of the board than most people are used to. This means that, until you get used to reaching for the shift keys, you will accidentally type the slash and reverse-slash keys instead. This problem is minor, however, compared to some of the gigantic mistakes made on almost every other microcomputer keyboard. The IBM Personal Computer is a delight to use largely because of its keyboard.

System Startup

When the IBM Personal Computer is first turned on, a series of fourteen tests are performed on the system, and any errors are reported immediately. These include tests of the 8088 microprocessor, the internal ROM, the main memory, the video-display adapter card, the keyboard, the cassette recorder (if attached), and the floppy-disk system. The memory test includes five different read/write tests of the entire user-memory area, each using a different

9a

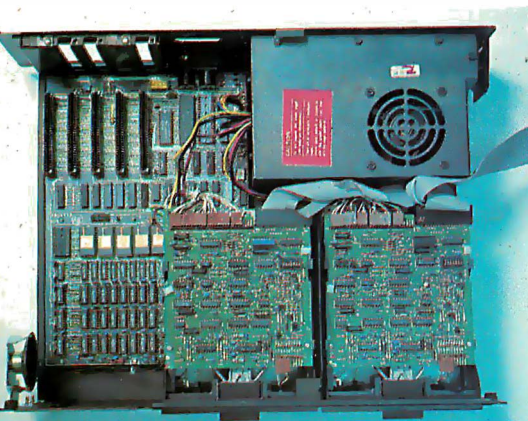

9b

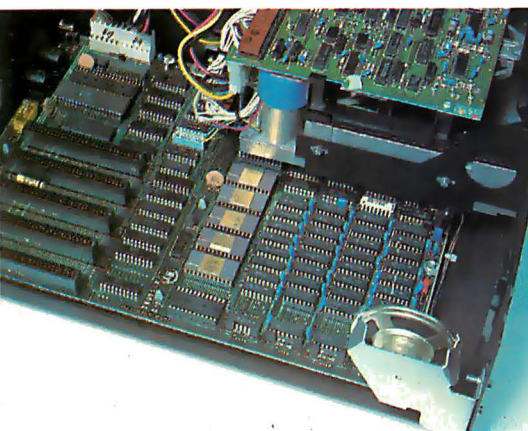

9c

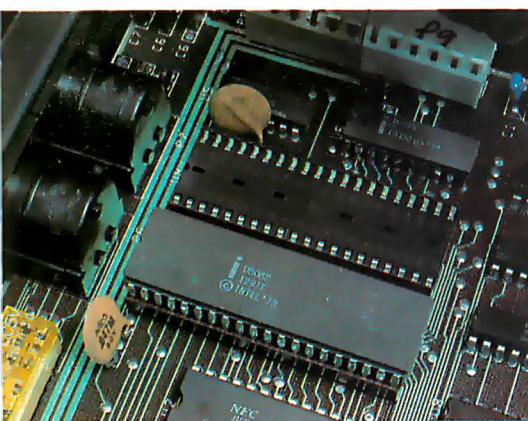

9d

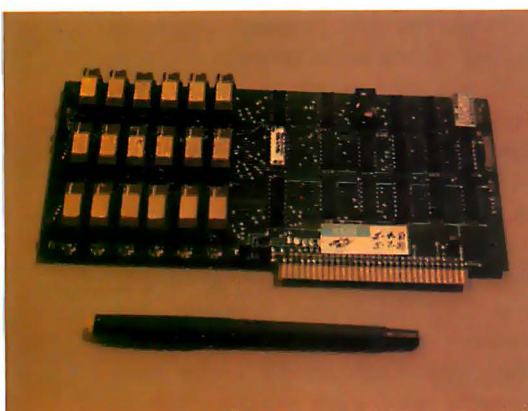

bit pattern for testing. Because of this, the initial startup of the IBM microcomputer may take between 5 seconds and about 1.5 minutes, depending on how much memory is in the machine. For example, in my test a 64 K-byte, disk-based machine took about 18 seconds to complete its initial tests and about 25 seconds more to complete the bootup of the machine. When the system is restarted from the keyboard with the Ctrl-Alt-Del triad of keys, the system tests are omitted, thus greatly reducing the delay associated with rebooting.

Three Levels of BASIC

Because BASIC is the most commonly used programming language, I plan to describe some of the features of the 40 K-byte extended Microsoft BASIC in great detail. But before I

start talking about the more prominent features of BASIC, I'll look at the three kinds of BASIC that are available with the IBM Personal Computer.

Cassette BASIC is the simplest BASIC you can get. It is available on every IBM microcomputer, and it is contained in the 40 K bytes of ROM mentioned before. In addition to the standard features that are associated with Microsoft BASIC, Cassette BASIC gives you the ability to plot points and draw lines in both the IBM medium- and high-resolution modes, to make sounds through the internal speaker, and to use light pens and joysticks.

Disk BASIC, which requires at least 32 K bytes of memory and one floppy-disk drive, occupies extra user memory which can be added to the ROM version of BASIC. The IBM

Command	Description
AUTO	generates line numbers automatically
BLOAD	load machine-language (binary) program
BSAVE	save machine-language program
CLEAR	clear program variables
CONT	continue interrupted program
DELETE	deletes a range of BASIC lines
EDIT	edit a line of BASIC
FILES	list all or selected files on disk
KILL	delete a disk file
LIST	list BASIC lines
LLIST	list BASIC lines to printer
LOAD	load a BASIC program file
MERGE	merge a BASIC program file into an existing program
NAME	rename a disk file
NEW	erase current program
RENUM	renumber BASIC program
RESET	close all disk files
RUN	load and run program
SAVE	save current program
SYSTEM	exit BASIC and return to DOS
TRON, TROFF	turn tracing option on and off

Table 4a: A summary of IBM BASIC commands.

Photo 9: Inside the IBM Personal Computer System Unit. Photo 9a shows the overall interior of the unit; the floppy-disk drives are in the lower right corner, and the expansion slots are in the upper left. Photo 9b is a detailed shot of the expansion slots (left), the BASIC in ROM (large devices with gold faces, center), and the workspace memory (right). Photo 9c shows the Intel 8088 microprocessor (bottom) and the empty "auxiliary processor socket" (just above the 8088). Photo 9d shows the IBM 64KB Memory Expansion Option card, which holds 64 K bytes of memory. Notice that two 4116-like devices are "piggybacked" into one socket.

DOS (disk operating system) takes 12 K bytes of user memory, and disk BASIC adds about another 12 K bytes (depending on certain options). Disk BASIC adds a large number of disk input and output options, access to a date and time-of-day clock, the ability to store and redraw rectangular areas of graphic images, communications support using a standard RS-232C port, and software support for two extra printers. Disk BASIC is called by typing "BASIC" from the DOS prompt.

Advanced BASIC, which requires at least 48 K bytes of memory and one floppy-disk drive, occupies an additional 5 K bytes of user memory (for a total overhead of about 29 K bytes). Advanced BASIC adds event trapping, some advanced graphics commands, and an advanced music-playing command (all of these are covered in greater detail later). Advanced BASIC is called by typing "BASICA" from the DOS prompt.

Tables 4a, 4b, and 4c list the commands, statements, and functions of IBM BASIC.

The BASIC Program Editor

The BASIC Program Editor, common to all the versions of IBM BASIC, allows you to make changes far more quickly and easily than is possible on other microcomputers. It is a full-screen editor in that changes can be made to a program line by use of the four arrow keys and the Ctrl (control), Ins (insert), Del (delete), and End keys. If the new line (enter) key is pressed while the cursor is *anywhere* on the program line where changes have just been made, the changed line takes the place of the old line. With the BASIC Program Editor, changing a program is as easy as it would be if the text of the program were being manipulated by a word processor.

In addition, the Alt key has a special function within BASIC. Simultaneously pressing Alt and a letter of the alphabet causes a pre-defined BASIC keyword to be printed on the screen. For example, Alt plus C causes the word "COLOR" to be printed. This "shorthand" method is often helpful when you are typing in

a long BASIC program.

Along the same lines, all levels of IBM BASIC have the AUTO (automatic line numbering), RENUM (re-number a BASIC program), and MERGE (merge two programs) commands—all very useful commands that are often absent or awkward to use in other microcomputers.

Graphics in BASIC

The following summarizes most of the graphics commands available from BASIC:

- COLOR (all BASICs) is used to choose the four colors available in the IBM medium-resolution mode. As stated before, color 0 can be any of

At a Glance

Product Name

The IBM Personal Computer

Manufacturer

International Business Machines Corporation
Information Systems Division
Entry Systems Business
POB 1328
Boca Raton, FL 33432

Components

System Unit

Size: width 20 inches, depth 16 inches, height 5.5 inches; weight (without disk drives) 21 pounds, (with two disk drives) 28 pounds

Electrical needs: 120 VAC

Processor: Intel 8088

Cycle Time: main storage, 410 nanoseconds; access, 250 nanoseconds

Memory: 40 K bytes of built-in ROM (read-only memory),
16 K bytes of user RAM (random-access read/write memory); expandable to 256 K bytes

Standard: keyboard for data and text entry; audio-cassette recorder connector; five expansion slots for memory, display, printer, communications, and game adapters; built-in speaker for music programming; power-on automatic self-test of system components; BASIC-language interpreter; 16 K bytes of user RAM (all user RAM includes parity bit)

Keyboard: total of 83 keys for data and text entry; includes 10 keys for numeric entry and cursor control, 10 special function keys, and ASCII characters and special graphics characters (total 256 characters); automatic repeat on all keys; adjustable typing angle; detachable six-foot coil cable

Disk drives: up to two 5-inch floppy-disk drives, 160 K bytes each (will accommodate 4 drives in future)

Operating Systems

IBM Personal Computer DOS (Microsoft)

Software Available for IBM Personal Computer DOS

BASIC interpreter (Microsoft) standard; extended BASIC interpreter (Microsoft) \$40; Pascal compiler (Microsoft) \$300; VisiCalc (Personal Software) \$200; EasyWriter (Information Unlimited Software) \$175; General Ledger, Accounts Receivable, Accounts Payable (Peachtree Software) \$595 each; asynchronous communications support \$40; Adventure (Microsoft) \$30; Advanced diagnostics package \$155

Hardware Prices

System Unit, 16 K-byte RAM, keyboard	\$1 265
System Unit, 48 K-byte RAM, keyboard, single floppy-disk drive, disk-drive adapter	2 235
Monochrome video display	345
Combination monochrome-display adapter and printer adapter	335
Color-graphics-monitor adapter	300
16 K-byte memory-expansion kit	90
32 K-byte memory-expansion kit	325
64 K-byte memory-expansion kit	540
Disk-drive adapter	220
Disk drive (5-inch floppy disks)	570
Asynchronous communications adapter	150
Game-control adapter	55
Keyboard	270
Printer	755
Printer adapter	150
Printer cable	55
Printer stand	55

the 16 available colors, while colors 1 through 3 are chosen from two available color sets. (In the text mode, COLOR sets the foreground, background, and border colors.)

- LINE (all BASICs) allows you to draw a line, outline a box, or fill in a box in whatever colors are available.

- SCREEN (all BASICs): "SCREEN *n*" is used to choose text mode (*n*=0), IBM medium-resolution graphics (*n*=1), or IBM high-resolution graphics (*n*=2). In text mode, SCREEN can also generate a black-and-white text image and choose which of several pages are to be independently viewed and written to.

- GET and PUT (disk BASIC): GET allows you to save the graphic image within a specified rectangular area into a BASIC array. PUT allows the stored image to be redrawn at any point on the screen, in one of five ways: PSET (replace the existing image with the stored image), PRESET (replace with the inverse of the stored image), XOR (exclusive-or the existing and stored images), OR (add the stored image to the existing image), AND (selectively restore the stored image, using the existing image as a logical mask).

- CIRCLE (advanced BASIC) allows you to draw a circle or ellipse with a given center, color, radius, and eccentricity. In addition, an arc (partial circle) may be drawn (the begin and end points of the arc can be specified); optionally, either or both endpoints can be connected to the center point. (This last feature exists but is not documented in the description of the CIRCLE command in the IBM BASIC manual. The end points must have an absolute value less than or equal to 2π . The same arc is drawn regardless of the sign of the end point; if the end point is negative, however, it is connected to the center point.)

- PAINT (advanced BASIC) lets you specify a starting point, a color, and a boundary color. PAINT then starts painting the screen the given color from the starting point outward until it reaches the boundary color.

Subroutine Interrupts in BASIC

A very unusual and useful feature of the IBM BASIC is its ability to stop

Statement	Description
BEEP	beep the internal speaker
CALL	call machine-language subroutine from BASIC
CHAIN	execute a new program, retaining values of program variables
CIRCLE	draw circle, ellipse, arc, or pie-shaped wedge
CLOSE	close data file
CLS	clear video screen
COLOR	set foreground and background colors
COM...ON/OFF/STOP	enable/disable activation of ON COM...GOSUB
COMMON	mechanism to pass variables to CHAINED program
DATA	standard DATA statement
DATE\$	set date
DEF FN...	user-defined function
DEF SEG	define current segment of memory
DEF USR	define starting address for USR call
DIM	dimension arrays
DRAW	draw a graphics command string
END	end program
ERASE	reclaim memory from arrays no longer being used
ERROR	simulate a given error condition
FIELD	defines fields within a file buffer
FOR...TO...STEP	standard FOR loop
GET (disk I/O)	get a record from a random-access file
GET (graphics)	put graphics information from screen to array
GOSUB	execute subroutine
GOTO	continue execution at specified line
IF...THEN...ELSE	standard IF statement
INPUT	read data from keyboard or data file
KEY ON/OFF	turn display of function keys on 25th line on or off
KEY	redefine one of ten function keys
KEY...ON/OFF	enable/disable activation of ON KEY GOSUB
LET	standard assignment statement (e.g., LET A= 3)
LINE	draw line, box, or solid box on graphics screen
LINE INPUT	read an entire line from keyboard or data file
LOCATE	position cursor
LPRINT	print to printer
LPRINT USING	print to printer according to a given format

Table 4b: A summary of IBM BASIC statements.

execution of a BASIC program to service an external interrupt before continuing the BASIC program. What makes this interrupt capability different from that of any other micro-computer is that the interrupt routine is *not* a machine-language program but a BASIC subroutine within the BASIC program being used. The interrupting events are: a keypress from any of the four cursor-movement keys or the ten function keys, incoming information from the IBM Asynchronous Communications

Adapter card, activation of the light pen, or a keypress from a joystick trigger button.

The form of these statements is

ON *event* GOSUB *line*

where *event* is COM*n*, KEY(*n*), PEN, or STRIG(*n*) (joystick trigger), and *line* is the beginning line number of a BASIC subroutine. Another condition for the execution of the subroutine is for the event to be *activated*, which is done by an

Statement	Description
LSET	left-justify a string within a field
MID\$	substring substitution statement
MOTOR	control cassette recorder motor
NEXT	ends FOR loop
ON COM/KEY/PEN/ STRIG...GOSUB	interrupt by given event to BASIC subroutine (see text for details)
ON ERROR GOTO	enable error-trapping routine
ON...GOSUB	standard computed GOSUB statement
ON...GOTO	standard computed GOTO statement
OPEN	open a disk or communications file
OPTION BASE	allows array subscripts to start at 0 or 1
OUT	output a byte to a port
PAINT	fill an area of the graphics screen with color
PEN ON/OFF/STOP	enable/disable activation of ON PEN GOSUB
POKE	put a specified value into a byte
PRINT	print to video display or file
PRINT USING	print to video display or file according to a given format
PRESET	plot a graphics point in the background color
PSET	plot a graphics point in a given color
PUT (disk I/O)	write a record to a random-access file
PUT (graphics)	draw a stored image onto the graphics screen
RANDOMIZE	start a new pseudo-random number sequence
READ	read information from DATA statements
REM	standard remark statement
RESTORE	reset pointer to DATA statements
RESUME	return from an error routine
RETURN	return from a subroutine
RSET	right-justify a string within a field
SCREEN	choose text or graphics screen for video display
SOUND	generate sound from the speaker
STOP	stop program execution
STRIG ON/OFF	enable/disable joystick button
STRIG...ON/OFF	enable/disable activation of ON STRIG...GOSUB
SWAP	exchange the values of two variables
TIMES	set time
WAIT	standard Microsoft WAIT statement
WEND	end WHILE loop
WHILE	program loop that executes as long as a given condition is true
WRITE	output data to video screen or file

associated set of BASIC commands. For example, if the statement

PEN ON

is executed and the ON PEN statement exists in the program, the subroutine will be executed the next time the light pen is used. If

PEN OFF

is executed, the use of the light pen will *not* cause the subroutine to be executed. If the statement

PEN STOP

is executed, using the light pen causes the subroutine to be executed as soon as a PEN ON statement is executed. Similar statements are available for COM n and KEY(n), but not for STRIG(n).

With these statements, a program can immediately respond to certain events that may or may not happen.

DRAW and PLAY

One of the most innovative features of the IBM BASIC is the use of predefined BASIC strings to specify a series of draw commands (for DRAW) or note-playing com-

mands (for PLAY). These strings have their origins in the Apple II shape tables; but, by extending the syntax and allowing the "table" to take the form of standard strings that can be manipulated by the BASIC program itself, the concept has been greatly improved.

Table 5 lists the commands available within a DRAW string. To draw a long, narrow rectangle, we simply define

A\$="R40;U10;L40;D10"

This draws 40 units to the right, 10 up, 40 to the left, and 10 down. If we execute the statement

DRAW A\$

the rectangle will be drawn from wherever the graphics cursor happens to be at that time.

One of the most powerful features of this graphics-command language is the ability to call one string from another. For example, to rotate this box 90 degrees counterclockwise, we could simply command

DRAW "A1;XA\$;"

(A1 calls for a 90-degree rotation, and XA\$; executes string A\$.) In addition, any command can take its argument from an existing variable, so that if we say

DRAW "A=I;XA\$;"

the image will be rotated an I-multiple of 90 degrees before being drawn. Note the presence of the semicolon at the end of the X command; this is necessary for the command to work.

Photo 11 shows the listing and the run of a program that first draws the string A\$, then draws it in all its rotations. The PSET statement simply moves the graphics cursor to a new location before drawing.

The PLAY statement works similarly to the DRAW statement, but with a different set of commands. For example, the statement

PLAY "C1;D#2;G-4"

Function	Description
ABS	absolute value
ASC	convert ASCII character to its numeric value
ATN	arctangent
CDBL	convert to double-precision number
CHR\$	converts number to equivalent ASCII character
CINT	round to nearest integer
COS	cosine
CSNG	convert to single-precision number
CSRLIN	returns row number of current cursor position
CVD	convert string to double-precision number
CVI	convert string to integer
CVS	convert string to single-precision number
EOF	logical test for end-of-file condition
ERL	line number of an error that has just occurred
ERR	error code of an error that has just occurred
EXP	exponential function, base e
FIX	truncate to an integer value
FRE	amount of workspace left unused
HEX\$	converts number to a string containing a hexadecimal number equivalent to the original number
INKEY\$	read a character from the keyboard
INP	read 8-bit value from port
INPUT\$	read characters from a file
INSTR	find substring within a given string
INT	largest integer less than or equal to argument
LEFT\$	take substring starting with first character
LEN	length of a string
LOF	amount of space in a file
LOG	natural logarithm
LPOS	carriage position of printer
MID\$	extract a substring from a given string
MKD\$	convert a double-precision number to a string
MKI\$	convert an integer to a string
MKS\$	convert a single-precision number to a string
OCT\$	converts number to a string containing an octal number equivalent to the original number
PEEK	read value of byte in memory
PEN	read light pen
POINT	get color number point on graphics screen
POS	cursor column position
RIGHT\$	take substring ending with last character
RND	random number
SCREEN	character or color at given position (text mode only)
SGN	sign of argument
SIN	sine
SPACE\$	creates a string full of spaces
SPC	prints spaces
SQR	square root
STICK	get coordinates of joystick
STR\$	converts a number to a string
STRING\$	creates a string filled with one ASCII constant
TAB	spaces over to an absolute print position
TAN	tangent
USR	call machine-language subroutine
VAL	converts string to numeric value
VARPTR	get address of variable; or get file control block of a file

Table 4c: A summary of IBM BASIC functions.

plays a whole C note, a half D-sharp note, and a quarter G-flat note. Many variations are possible, including octave and tempo change, note length, pauses, substring execution, and variable command parameters. In addition, a sequence of up to 32 notes can be stored in a buffer and played in background—that is, the BASIC program continues to execute, and the music is played independently by the buffer.

Communications Files

If the IBM Asynchronous Communications Adapter is installed in the IBM Personal Computer, a BASIC program can interact with a remote device as if it were a simple disk file. GET and PUT can be used, as well as the I/O statements INPUT #f, LINE INPUT #f, INPUT\$, PRINT #f, PRINT #f USING, and WRITE#f. In all these cases, f is a file specification that has a device name of COM1: or COM2:. Thus more people can write programs that use remote devices, because BASIC automatically takes care of most of the communication details.

The IBM DOS

The IBM disk operating system (DOS) (written by Microsoft with help from Seattle Computer Products) bears a superficial resemblance to Digital Research's CP/M operating system. (For example, the IBM DOS gives the prompt "A>".) However, the IBM DOS is a scaled-down version of Microsoft's 16-bit Unix look-alike, the Xenix operating system. In addition, the commands are better worded than in CP/M. For example, the cryptic

```
PIP B:NEWFILE1=A:MYFILE1
```

of CP/M is replaced by

```
COPY A:MYFILE1 B:NEWFILE1
```

which copies MYFILE1 from drive A to drive B, where it will be named NEWFILE1. Other commands include ERASE (to delete a file), FORMAT (to format a floppy disk), RENAME (to rename a file), DIR (to list the directory of a disk), DATE (to set the



Choose the System the Experts Are Raving About—Radio Shack's TRS-80 Color Computer!

"The Color Computer is THE best buy in the market today. It's jam-packed with hardware capabilities and the graphics commands of Extended Color BASIC are excellent. Look at it!"
—William Barden, Jr., Author

"Radio Shack's Extended Color BASIC is a breakthrough in color graphics for personal computers. It's fast, easy-to-use, and capable of producing striking graphics."
—Stan Miastkowski
BYTE Magazine

"Anyone seeking a machine that will serve well as a teacher and a base for a home communication and entertainment center will find the TRS-80 Color Computer a strong contender."
—Carl Warren
Popular Electronics

"The TRS-80 Color Computer has the most potential of any computer on the market today; more versatile, more expandable, easily interfaced, and easier to use—bar none!"
—H.C. Pennington, Author

The experts agree . . . the Radio Shack TRS-80® Color Computer lets you create spectacular high-resolution color graphics at an amazingly low price!

A Programmer's Dream at Only \$599. Our 16K Color Computer with Extended Color BASIC uses one-line commands to make the creation of sophisticated graphics easy. Now you can produce color diagrams, business and engineering charts, even simple animation with a screen resolution of up to 49,152 programmable pixel points (256x192). You get eight vivid colors, sound, a 32x16 screen format, editing, user-definable keys, error messages, PEEK, POKE, a built-in RS-232 serial interface, and much more.

We Don't Skimp on Documentation. Our easy-to-understand tutorial manuals on our Standard and Extended Color BASIC will quickly have you using the full potential of your TRS-80 Color Computer.

Instant Fun and Games! Just plug-in a Program Pak™ for exciting game action! Our TRS-80 Color Computer connects to any standard TV set, including our \$399 TRS-80 Color Video Receiver.

Expand At Any Time. Add a disk drive for only \$599, and get 156K-bytes of on-line storage. Add more memory, a printer, and other accessories, too.

See It Today! Come in for a demonstration at a Radio Shack Computer Center, store or dealer near you.



Radio Shack®
The biggest name in little computers™
A DIVISION OF TANDY CORPORATION

Tell me more! Please send me your free TRS-80 Computer Catalog.

Mail To: Radio Shack, Dept. 82-A-126
1300 One Tandy Center, Fort Worth, TX 76102

NAME _____
COMPANY _____
ADDRESS _____
CITY _____ STATE _____ ZIP _____

CP/M-86™ The Standard in the 16-Bit World

The Growth Market & Proven Tools

The 16-bit world answers universal demands for greater performance, more address space and increased resources. This market's unprecedented growth fuels a profit-driven supply curve for software and hardware, where compatibility reigns. Our upward compatible CP/M® based family of 16-bit products, plus our commitment to our customers' success eases and speeds your entry, your conversion, to the 16-bit world of opportunities — the Digital Research world.

Single user solution: CP/M-86 features efficiency and power. For over a year, its dramatic user acceptance has generated impressive quantities of code. While others are just entering the market, Digital Research's CP/M-86 is already offering a broad array of languages and applications. This simplifies your conversion to 16-bit systems.

For concurrent single user applications, MP/M-86™ performs simultaneous, multiple operations such as communications, printing, computation, etc. It features compact, time-tested modular code. And it's available today.

In multiple computer environments, MP/M-86 lets you sell your same programs into this market segment. You solve multi-user needs with a field proven product, not a "newcomer." Increased sales of multi-user products mean more profit potential for you.

Expand to network: CP/NET-86™ interconnects multiple 16 or 8-bit systems. It allows you to expand your product's capabilities.

High level languages (over 20 languages) under CP/M-86, handily support your 16-bit applications. Our XLT86™ utility speeds conversion to 16-bit code by reducing R&D time. It makes program development and maintenance easier.

Documentation in a comprehensive set of manuals clarify your use of CP/M-86, MP/M-86 and XLT86.



BDA

Over 2 Million CP/M-86 Units

Software Writer Benefits

2,800,000 CP/M-86 based systems by 1986. This market projection identifies the type and scope of your future sales.

Independent Software Vendor (ISV) benefits from Digital Research can make you more profitable. Here's a glimpse. Call for the complete repertoire of sales and development aids.

16-bit laboratory for your use features many different 16-bit machines. This one stop development reduces the conversion time of your application or language. First to call means first to enjoy this resource, and first to start sales rolling.

ISV selling aid: Descriptive listings of your products in our ISV Compatible Software Catalog have worldwide exposure.

IBM Display Writers and Personal Computers running CP/M-86 guarantee a large installed base for your 16-bit products.



Apple/Tandy software writers:

Personal and professional computer applications increasingly require 16-bit resources. Our established "how-to" aids simplify and speed your conversion to 16-bit applications. Just let us help.

The Standard Is Digital Research

We are the most experienced microcomputer software company in the industry. Over 300,000 microcomputers use our operating systems. Over 400 OEMs and 500 independent software vendors use our products. Hundreds of 8-bit applications now run under our 16-bit products. Across the board, we set the standard. And these people help us set it, with languages under CP/M-86 or MP/M-86:

The Code Works
Computer Innovations
Compuview Products, Inc.
Digital Research
Microfocus, Inc.
Micropro Int'l Corp.
Microsoft
Midwest Micro-Tek, Inc.
Ryan-McFarland Corp.
The Soft Warehouse
Sorcim Corp.
Stackworks
Supersoft Associates
Thomas W. Yonkman
Vanguard Systems Corp.

OEM Strategy

New sales. New markets. New applications become realities when you convert to 16-bits. New demand curves. New and larger profit centers are yours with our 16-bit products. To immediately capture increased market share, make a priority call to our marketing group for our 16-bit product briefs, OEM pricelist and contract information.

C compiler
C compiler
VEDIT, screen editor
CBASIC-86, PASCAL MT
CIS COBOL
WORDMASTER, WORDSTAR
BASIC, FORTRAN, COBOL, PASCAL
BASIC-compiler
RM/COBOL
LISP compiler, MuMATH
PASCAL/M, TRANS-86
FORTH
C compiler
LISP/86
APL/V86

Turn Opportunity into Success.

Stop following the competition. Help lead the field. Today. We provide the capability, and we have the desire, to accelerate your profitability. There's no other software product on the market today that can help make you more successful than Digital Research's CP/M-86. And there's no other company. We stand ready. It's your move.

Call (408) 649-3896, or write: Digital Research, P.O. Box 579, Pacific Grove, CA 93950. Europe: Vector, Int'l., Leuven, Belgium, 32(16)202496. Far East: Microsoft Assoc., Tokyo, Japan, 03-403-2120.

Circle 125 on inquiry card.

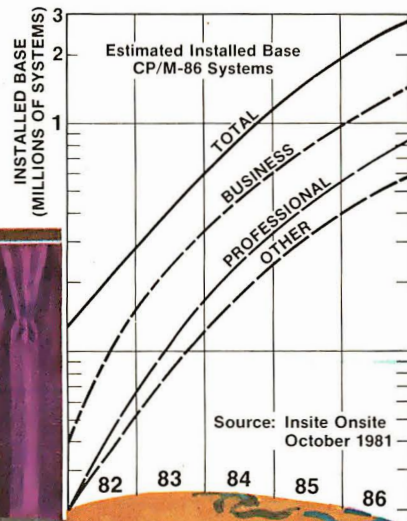

DIGITAL RESEARCH®

CP/M is a registered trademark of Digital Research. CP/M-86, MP/M-86, CP/NET-86, XLT86 and PASCAL MT are trademarks of Digital Research. © Copyright 1981 Digital Research.

date), and TIME (to set the system clock).

The IBM DOS floppy disk contains BASIC and BASICA (the disk and advanced BASICs), as well as some disk utility programs. LINK combines object files (created by an assembler or compiler) into a form that can be executed. DEBUG allows you to examine both memory and disk files and debug a machine-language program. Photo 12 shows the DEBUG program tracing the execution of a program and displaying all the 8088 registers.

Another feature of the IBM DOS is the file AUTOEXEC.BAT. If a disk file with this name is present on the disk used to start the system, it is automatically executed as soon as the

IBM microcomputer is working. The ".BAT" suffix marks it as a *batch file*, which is a text file of statements that are executed sequentially as if they had been typed in from the keyboard in a manner similar to a CP/M submit (.SUB) file or an Apple II EXEC file. Because the AUTOEXEC.BAT file is a batch file, it can perform many operations before giving control to the user.

The IBM BIOS

All software interacts with the hardware of the IBM microcomputer through part of the DOS called the BIOS (basic input/output system). In the IBM microcomputer, all calls to the BIOS are done as 8088 software interrupts. There are 256 such inter-

rups available on the 8088, of which 193 are used by DOS and BASIC.

BASIC uses many of the reserved interrupts to interact with the rest of the machine. By using the interrupts as "hooks" to the actual routines, which are stored in high memory (see table 6), the system can add new devices and change the behavior of existing ones by writing new routines in user memory and changing the appropriate interrupt vectors to point to the new code. In fact, this is how the disk and advanced BASICs add features to the cassette BASIC in ROM. In the same way, a programmer with sufficient skill can extend the behavior of the IBM Personal Computer by modifying the BIOS and placing the commands needed to patch them into the system into an AUTOEXEC.BAT file; the batch file should end with a program that executes an INT 27 interrupt, which allows the code to remain in the system until it is turned off. Much technical information (including an 80-page fully documented listing of the IBM BIOS) is included in the manual *Technical Reference*.

One interesting use of the IBM BIOS relates to the IBM keyboard. The keyboard, which contains an Intel 8048 microprocessor, does not deliver ASCII codes to the System Unit. Instead, it delivers two *scan codes* per keypress: one when the key is pressed, and a different one when the key is released. The IBM BIOS decodes the scan codes into an extended ASCII code that can return 256 one-byte codes and several two-byte codes for each keypress.

How Fast Is IBM BASIC?

Surprisingly, IBM BASIC is not much faster than its 8-bit counterparts. Table 7 compares the execution times of five BASIC programs on several popular microcomputers; the programs themselves are in listing 1. The first four benchmarks test an empty do-loop, division, subroutine jumps, and the MID\$ string function. The fifth test is a slightly modified version of Jim Gilbreath's Sieve of Eratosthenes benchmark program (see "A High-Level Language Benchmark," September 1981 BYTE, page

Command	Description
Un	move up <i>n</i> steps
Dn	move down <i>n</i> steps
Ln	move left <i>n</i> steps
Rn	move right <i>n</i> steps
En	move diagonally up and to the right <i>n</i> steps
Fn	move diagonally down and to the right <i>n</i> steps
Gn	move diagonally down and to the left <i>n</i> steps
Hn	move diagonally up and to the left <i>n</i> steps
Mx,y	move to point (x,y) or (if in relative mode) move (x,y) units from current position; plot a point
Bx,y	same as M, but no point is plotted
Nx,y	same as M, but return to original location when finished
An	set angle as a multiple of 90 degrees (<i>n</i> =0 through 3)
Cn	set current color to <i>n</i>
Sn	set scale factor (step size)
Xstring\$;	execute substring <i>string</i> \$

Table 5: Commands for the DRAW statement.

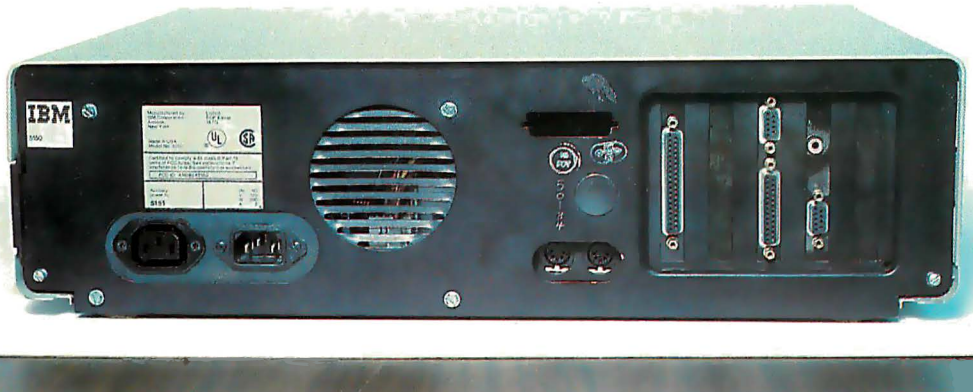

Photo 10: The back panel of the IBM Personal Computer. See the text for a description of the plugs and sockets.

PUT ONE OVER ON APPLE II.

Introducing Station II. The Apple II Support System.



What happens when you put one over on Apple II? You make it better. Because Station II organizes, simplifies, protects, secures and lets you control access to your Apple. In other words, it makes your Apple II your personal computer.

IT'S DESIGNED FOR II-GETHERNESS.

Station II is designed specifically for Apple II by design consultants to Apple Computer. It pulls your Apple and peripherals together into an attractive, easy-to-use, integrated system.

Your Apple is free to slide in and out, so there's no unstacking and restacking peripherals everytime you need to get inside. And you can choose the distance from keyboard to monitor that's most comfortable for you. Station II even positions your monitor at just the right angle for maximum viewing ease.

IT CLEARS YOUR DESK OF CORDS AND CABLES.

Station II is equipped with three built-in power outlets, so the cords and cables that normally clutter your work area are tucked away neatly inside. Now one cord, Station II's own, powers your entire system.

THE KEY IS SECURITY AND CONVENIENCE.

You're not the only one who's discovered the value of Apple II, so Station II has a key. And a lock. And two ways to secure it. Now you can slide your Apple inside, lock it and leave it. Safe and sound. It puts the clamps on theft, and beyond that, you control who gets inside your Apple and who doesn't.

Your programs are safe, too. Because Station II has a line voltage surge suppressor, ready to intercept power surges before they can wipe out your program.

What's more, the key means convenience. With one twist of the wrist you can power up your entire system. Plus, you can lock your Apple "on" or "off." **IT MAKES YOUR APPLE MORE FRUITFUL.**

That's what happens when you put one over on Apple II. So look for Station II at your computer dealer.

trace

Trace Systems, Inc. 1928 Old Middlefield Way
Mountain View, CA 94043 (415) 964-3115

180); note that the algorithm accesses lots of memory but uses only addition and subtraction.

The results of these comparisons are not encouraging. For example, IBM BASIC is somewhat faster than Applesoft, but the difference is modest, and Applesoft is one of the slower microcomputer BASICs. (All the BASICs tested are versions of Microsoft BASIC.) A comparison of IBM BASIC to Microsoft MBASIC 4.51 running on a 4-MHz Z80-based machine shows MBASIC to be faster in everything but division; this last

makes sense in that the 8088 microprocessor has a hardware divide instruction, which accounts for its better performance in the division benchmark. Still, it seems that IBM BASIC does not have a definite superiority over its 8-bit counterparts.

Although I hesitate to draw conclusions about the IBM microcomputer's performance in disk-based or machine-language programs, it is obvious that the IBM microcomputer does not gain a speed advantage from its memory access—the 8088 micro-

Listing 1: BASIC benchmark programs used in table 7. Listing 1a tests an empty do-loop; the two constants are included to allow the isolation of the features being tested in listings 1b and 1c. Listing 1b tests the division operation. Listing 1c tests a subroutine call-and-return sequence. Listing 1d tests the MID\$ (substring extraction) operation. Listing 1e is the Sieve of Eratosthenes algorithm to generate prime numbers; it is used as a composite benchmark of several BASIC features working together in a short, but non-trivial, program.

1a

```
60 A=2.71828
80 B=3.14159
100 FOR I=1 TO 5000
320 NEXT I
```

1b

```
60 A=2.71828
80 B=3.14159
100 FOR I=1 TO 5000
120 C=A/B
320 NEXT I
```

1c

```
60 A=2.71828
80 B=3.14159
100 FOR I=1 TO 5000
120 GOSUB 1000
320 NEXT I
340 END
1000 RETURN
```

1d

```
80 A$="abcdefghijklm"
100 FOR I=1 TO 5000
120 B$=MID$(A$,6,6)
320 NEXT I
```

1e

```
1 SIZE=7000
2 DIM FLAGS(7001)
3 PRINT "only 1 iteration"
5 COUNT=0
6 FOR I=1 TO SIZE
7 FLAGS(I)=1
8 NEXT I
9 FOR I=0 TO SIZE
10 IF FLAGS(I)=0 THEN 18
11 PRIME=I+I+3
12 K=I+PRIME
13 IF K>SIZE THEN 17
14 FLAGS(K)=0
15 K=K+PRIME
16 GOTO 13
17 COUNT=COUNT+1
18 NEXT I
19 PRINT COUNT, " primes:"
```

Address (in Hexadecimal)	Location	Type	Function
00000	on System Board	RAM	BIOS interrupt vectors
00080	"	"	BIOS available interrupt vectors
00400	"	"	BIOS data area
00500	"	"	workspace memory
10000 (decimal 64 K)	on memory card	"	workspace memory
40000 (256 K)	not available now; reserved for future expansion	"	proposed workspace memory
A0000 (640 K)	?	?	reserved
A4000 (656 K)	on video boards	RAM	reserved for all forms of video display (note 1)
C0000 (786 K)	?	?	memory expansion area
F0000 (960 K)	?	?	reserved
F4000 (976 K)	on System Board	ROM/PROM	8 K-byte slot available for user programs
F6000 (984 K)	"	ROM	40 K-byte BASIC in ROM
FE000 (1016 K)	"	"	BIOS code in ROM

Note 1: Not all this space is currently in use. The memory for the monochrome adapter card starts at hexadecimal B0000 (704 K bytes), and the memory for the color/graphics card starts at hexadecimal B8000 (736 K bytes).

Table 6: Memory map of the IBM Personal Computer.

Benchmark	IBM		Applesoft		4 MHz Z80 MBASIC 4.51		Radio Shack TRS-80 Model II	
	time	ratio to IBM	time	ratio to IBM	time	ratio to IBM	time	ratio to IBM
empty do-loop	6.43	1.04	6.66	1.04	5.81	0.904	7.98	1.24
division	23.8	1.22	29.0	1.22	24.9	1.05	19.4	0.815
subroutine jump	12.4	1.12	13.9	1.12	9.4	0.758	17.1	1.38
MID\$ (substring)	23.0	1.40	32.3	1.40	18.6	0.809	24.8	1.08
prime number program	190	1.27	241	1.27	151	0.795	189	0.995

Table 7: Benchmark results for the IBM Personal Computer against several 8-bit microcomputers: an Apple II Plus running Applesoft BASIC, a 4 MHz Z80 microcomputer running MBASIC 4.51, and a Radio Shack TRS-80 Model II running Model II BASIC. All times (given in seconds) and ratios are valid to three significant digits. See listing 1 for the actual benchmark programs.

Give your system some NEC, and watch its performance soar.

NEC's crisp, clear, high-performance JC1202 RGB color monitor, an industry standard. Also available: the JC1201 composite video version.

NEC's classic green monitor, (JB1201), one of microcomputing's performance legends. Easy on the eye, and the checkbook.

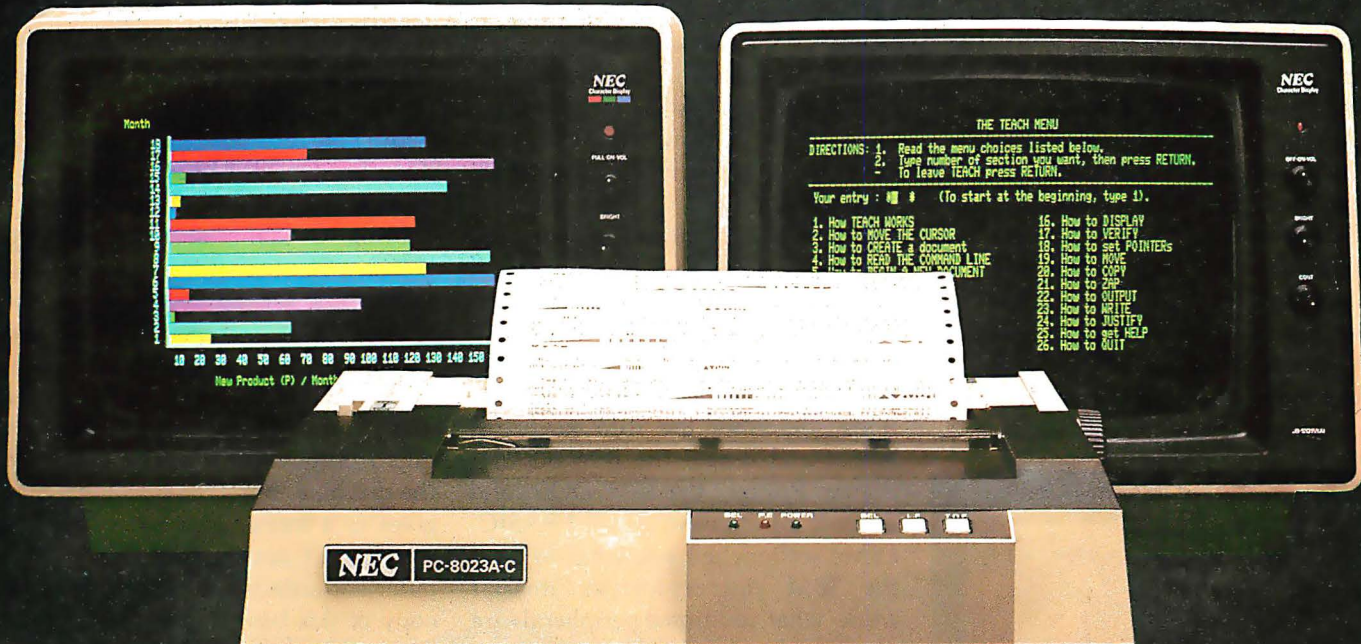

The impressive new NEC dot matrix printer. Parallel interface, 100 cps, 2K buffer, pin or friction feed. Stunning performance and versatility in the hottest new peripheral of the year.

You don't need an all-NEC system to benefit from NEC components.

Owners of Apple®, Radio Shack®, Atari®, IBM®, and many other microcomputers will find their equipment to be perfectly compatible* with NEC's famous monitors, as well as our highly-featured new PC-8023A dot matrix printer.

Ask your dealer for a demonstration.

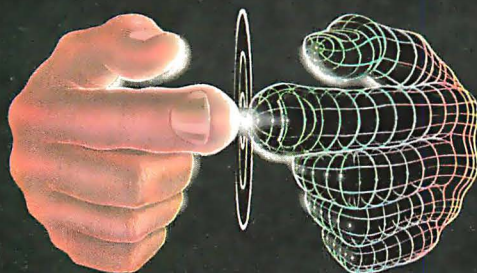

**Productivity
at your fingertips**

NEC

**NEC Home Electronics USA
Personal Computer Division**
1401 Estes Avenue
Elk Grove Village IL 60007

*SOME MICROCOMPUTERS MAY REQUIRE
A DIFFERENT INTERFACE. CONSULT YOUR DEALER

processor has to get memory one byte at a time, like the 8-bit 6502 and Z80. Still, this does not fully account for the IBM microcomputer's modest performance. Perhaps IBM's BASIC has only been translated from its 8-bit predecessors and not optimized for the 8088's instruction set.

Documentation

IBM uses the slogan "The IBM of Personal Computers" in one of its advertisements. The manuals that accompany the IBM microcomputer and various pieces of software could likewise be called "The IBM of Documentation." They will set the standard for all microcomputer documentation in the future. Not only are they well packaged, well organized, and easy to understand, but they are also *complete*. With the inclusion of the manual *Technical Reference*, the IBM Personal Com-

puter is as well documented as any existing microcomputer, and the documentation is available much earlier in the life of this machine than it has been for other machines.

Each manual is in a hardcover D-ring binder with its own slip cover. The pages are 14 by 21.6 cm (5.5 by 8.5 inches), and the binder is built so that the opened book lies flat. Included with the minimal configuration IBM microcomputer are manuals titled *Guide to Operations* and *BASIC*. A separate boxed manual is given with each software package; some IBM Personal Computer products have softcover documentation booklets.

Guide to Operations explains the capabilities of the IBM Personal Computer system and provides information to be used in the setup and initial operation of the microcomputer. A 145-page section called "Operations" describes the IBM keyboard layout and usage, the IBM 80 CPS Matrix Printer, the IBM DOS, and selected information on IBM BASIC. Other sections tell you what to do if the IBM microcomputer doesn't work, what additional peripherals are available for the system, and how to prepare the system to physically move it to another location. The manual is written in a friendly, tutorial manner and includes the basic information that most manuals take for granted (i.e., how to turn the machine on, how to start BASIC).

BASIC is 406 pages long and contains a 258-page section that fully describes each BASIC command, function, statement, and variable. Each BASIC keyword is documented under several headings: format (the syntax of the keyword), versions (the version or versions of IBM BASIC under which the keyword is available), remarks (a commentary that further explains the use of the keyword), and an example. Other sections describe the use of the BASIC Program Editor, floppy-disk I/O, communications files, and other topics.

The Reference Manual

The manual *Technical Reference* deserves special recognition simply

for its existence. It is 372 pages long and is in three sections, plus appendices; its price is a modest \$36. Section 1 gives a short overview of the IBM Personal Computer System and some of its internal workings. Section 2, which is 147 pages long, gives a functional specification for every piece of hardware in the IBM Personal Computer product line. This includes highly detailed specifications of the operation of the hardware, pinouts for peripheral connectors, and connection diagrams showing how to interface IBM peripheral cards with non-IBM devices. Section 3 describes the IBM BIOS. Five appendices give additional information, including a complete, commented listing of the IBM BIOS and schematics for all hardware in the system.

I'm sure that adventurous microcomputer enthusiasts will discover many more things about the IBM microcomputer as they buy and use the machine. But *Technical Reference* gives us a tremendous amount of information from the start. Most computer enthusiasts will want to have a copy of this book.

Sales and Service

Many companies are trying to become authorized IBM dealers; at the time of this writing, all Computerland stores are authorized dealers, and Sears Roebuck and Company has announced plans to sell the IBM Personal Computer through its Sears Business Systems Centers. IBM itself will sell its microcomputer through the IBM Product Centers in Baltimore, Philadelphia, and San Francisco. Since a potential dealer has to qualify as an authorized repair center before a dealership will be awarded, service will always be available from the dealer that sold you the unit.

IBM is also offering warranty extensions to increase the 90-day warranty that comes with the machine to one year, as well as annual maintenance contracts. The prices are reasonable; for example, the prices for a 48 K-byte system with one floppy disk and the monochrome display are \$154 for the warranty extension



Photo 11: A demonstration of the DRAW command. See the text for details.



Photo 12: An example of the DEBUG program at work.

TAKE A TEST DRIVE.



With a reliable
TRAXX™ 100/200/300
series add-on
drive system.

Our drives feature excellent engineering, and all of the advanced performance features you've come to expect from the nation's leading disk drive manufacturers. All systems are completely burned-in and tested. And, you'll see at least five quality assurance stamps on each and every drive, which is how we make sure our drives will run and will continue to run past our optional two year extended warranty.

Our drive packages start at \$250.00 and include a comprehensive operations manual and an attractive static free, dust free cover.

Systems available for Altos,¹ Apple™, Atari, Heath™, North Star™, S-100,² TRS-80™ (Model I, II, III, Color), Zenith™.

If one of our drives fails to meet your highest expectations of how trouble free and reliable a disk drive can be, then return it to us for a complete refund.*

So, before you buy another drive, take a test drive with one of ours. We're sure that you'll find TRAXX to be the finest.

IT'S GUARANTEED!

TRAXX
COMPUTER CORPORATION

Call our toll-free TRAXX LINE: 1-800-621-3102. In Illinois, call: (312) 987-1024. 10AM-6PM CST, Monday thru Friday. *For full refund drives must be returned within 10 days of purchase.

¹Apple is a registered trademark of Apple Computer Inc.

²TRS-80 is a registered trademark of Radio Shack, a Tandy Company.

read cards... economically!



The new HEI Model 121-4 card reader handles marked and punched cards interchangeably, including many colors of pen or pencil. Absolutely no operator adjustment required. Includes a number of switch-selectable features for application tailoring without extra cost.

- Reads strobe marks right or left, or self-clocking on both 80 column punch and mark-sense cards.
- RS-232 ASCII output (with Hollerith to ASCII conversion if necessary), or parallel TTL output.
- Six in-per-sec. card feedthru, or auto return to the front after read.

A built-in self test feature checks all 13 channels with a diagnostic card. The Model 121-4 operates on 50/60 CPS. Specify voltage as either 110 or 230 VAC.

The Model 121-4 is the most flexible and capable hand-fed card reader on the market at any price, and the price is right. You'll find it to be ideal for a variety of inventory control and data collection tasks. Call or write for more information on the latest optoelectronic solution from HEI.

The Optoelectronic Specialists

 **HEI inc.**

Victoria, MN 55386 • 612-443-2500

Circle 166 on inquiry card.

and \$196 for the annual maintenance contract. On the other hand, the prices for the IBM 80 CPS Matrix Printer (which has a lot of moving parts) are \$141 and \$179, respectively.

Prices may become a source of potential bad feelings between you and the dealer. The prices quoted in the "At a Glance" textbox are suggested retail prices that are guaranteed to be in effect *only* at the three IBM Product Centers, listed above. Dealer prices may vary from this somewhat—expect a variation between \$10 and \$100 on most products, depending on their suggested price. However, at the time of this writing, one authorized IBM dealer is selling the Peachtree Software business packages (General Ledger, Accounts Receivable, and Accounts Payable) at \$995 each, a full \$400 above the IBM suggested price of

Advanced BASIC adds event trapping, some advanced graphics commands, and an advanced music-playing command.

\$595. Since the IBM suggested price includes a sufficient profit margin for most products, I think this price (which I confirmed with the dealer) is exorbitant.

The moral is to shop around for the best prices, if you can. However, this may be difficult for two reasons. First, IBM is probably going to authorize only one dealer per geographic area, at least initially. Second, the IBM microcomputer product line is probably not going to be available by mail for quite some time. Another problem with buying software from a dealer in a distant city is that the dealer is going to be responsible for software support. Still, for \$400, I would be tempted to buy my software in another city and make some long-distance calls when I needed software support.

Other Vendors

When the IBM Personal Computer was introduced last fall, IBM was the

Circle 248 on inquiry card. →



The Manager Series* from Microsoft™ turns a personal computer into an executive toolbox.

Better management tools. The Manager Series from Microsoft turns an inexpensive personal computer into an executive's toolbox. Not a computer programmer's toolbox. An executive toolbox. Computerized management tools for non-computer people.

Time, people, projects. The Series is a system of software tools that work together to help you plan, organize, schedule and record your business and personal affairs. Time Manager,* Project Manager* and Personnel Manager* are the first packages in the Series.

Write it once. All programs in the Manager Series allow you to transfer information between programs. That means you can enter information in one program and transfer it for management by another.

Time Manager. The key. Time Manager helps you manage your personal time, appointments and priorities. It can also help you manage expenses, costs and job schedules. Or, keep a running tally of costs and hours by day, week, month or year. And Time Manager can act as an "executive" to manage other programs in the Series.

Project Manager. Describe the components of a project to Project Manager. It will create timing, task and resource charts to help you focus on critical tasks. Change one piece of information and Project Manager will



recalculate the entire project. Project Manager even flags overcommitted personnel resources.

Personnel Manager. Manage information about people, companies, customers or prospects. From names and addresses to skills, position, and characteristics. Personnel Manager lets you enter any kind of people-related information. Then, organize and retrieve it almost any way you want.

Management software. Even if you've never used a computer before, you should be able to productively use the Manager Series in a very short time.

And, when you've learned to use one in the Series, you've virtually learned them all.

Seeing is believing. Ask your local computer store for a demonstration of the Manager Series. It's a series of management tools that could be your best reason to own a personal computer.

*Trademarks of The Image Producers, Inc.

MICROSOFT CONSUMER PRODUCTS

A Division of Microsoft, Inc.
10700 Northrup Way • Bellevue, WA 98004

sole supplier of both hardware and software. But potential hardware and software vendors have wasted no time in providing products for what they feel will be a very popular microcomputer. In particular, Lifeboat Associates announced last October that it is "making available most of its existing applications programs to serve users of IBM's new 16-bit Personal Computer." When this is accomplished, it will do a lot to ease the shortage of business and applications software that currently exists for the IBM Personal Computer.

(In a related development, Lifeboat also announced that it will be selling all its 16-bit software for the SB-86 operating system, which is its name for the IBM disk operating system. The fact that IBM, Microsoft, and Lifeboat have put their names behind this 16-bit operating system poses a serious threat to Digital Research's prospects of dominating the 16-bit market with its new CP/M-86 8086

operating system, as it has the 8-bit arena with its popular CP/M 8080 operating system.)

As for hardware, several gaps will, for the moment, be filled by outside vendors. IBM does not currently supply a high-quality RGB color monitor, a letter-quality printer, or any of the special input devices provided for in the system (joystick, light pen, paddles). IBM's position is that the potential demand for these products will cause third-party vendors to independently market them. (In the next section, I will discuss some problems with this philosophy.) In addition, the expansion slots provide the opportunity to interface the IBM microcomputer with many outside devices. Given a reasonable period of time, plenty of hardware and software will probably be developed for the IBM Personal Computer.

One other item of interest is the announcement of a new magazine called *PC: The Independent Guide to the IBM Personal Computer*. It is

published by David Bunell, of Software Communications, Inc., 44 Montgomery St., San Francisco, CA 94104; subscriptions are \$12 for 12 issues. It should be of great interest to owners of the IBM Personal Computer.

Current Weaknesses

The IBM Personal Computer is a very good machine, but it does have some shortcomings. This is no reflection on IBM's ability to design a microcomputer; rather, it is a reflection of the trade-offs between capability and cost that had to be made to make the machine competitive in the existing market.

The most serious weakness of the IBM Personal Computer is the small number of expansion slots available for future use. Note that I say "for future use"; one slot is taken up by a video adapter card (or two if you want both kinds of display), and another is taken up for each of the following devices: the 5¼-inch Diskette Adapter card (if you want a floppy disk), the Asynchronous Communications Adapter card (if you want an RS-232C port), the Printer Adapter card (if you have the color/graphics video card and want a parallel printer), and the Game Control Adapter card (if you want joysticks or game paddles). Since you need an empty expansion slot for each 64 K bytes of memory above the first 64 K bytes, it is obvious that you cannot put everything into the IBM microcomputer that you might want to. The most frequently encountered limitation is the amount of memory you can have in the microcomputer; if you want a floppy disk and the RS-232C card, you can have only (!) 192 K bytes of memory—all five slots are filled. With a moment's reflection, you will see that the expansion slots in the IBM Personal Computer will fill rather quickly.

At the moment, the IBM Personal Computer system is weak with respect to word processing. First, IBM does not market a letter-quality printer. This means that, if you want to do word processing on the IBM microcomputer, you have to trust that your IBM dealer will also sell

DUAL/68000

... Hard Power from
the Soft Support of

UNIX®



A new and powerful computer has been born... the System 83. The versatile UNIX* operating system pilots the System 83's raw power through a myriad of software such as "C", FORTRAN, PASCAL, BASIC, COBOL, and even Networking. Step into a bold new frontier with more power than you ever dreamed possible.

- UNIX V7 configured by UNISOFT**
- Full IEEE 696/S-100 Compatibility
- MC68000 8MHz Processor
- 32-Bit Data Operations with 32-Bit Internal Registers
- 16-Bit Data Transfer Operations
- Memory Management Allows Concurrent Use of Mapped and Non-mapped Address space
- 16 Mb of Main Memory Directly Addressable
- 7 Vectored Interrupt Levels
- 256 Kb of RAM with Parity Per Board Slot

* UNIX is a trademark of Bell Laboratories and is supported on the DUAL System 83 by UNISOFT
**UNISOFT is a trademark of UNISOFT Corporation of Berkeley, CA.





DUAL SYSTEMS
system reliability/system integrity

720 Channing Way • Berkeley • CA 94710 • (415) 549-3854 • Telex: 172029 SPX

"My own IBM computer. Imagine that."

One nice thing about having your own IBM Personal Computer is that it's *yours*. For your business, your project, your department, your class, your family and, indeed, for yourself.

Of course, you might have thought owning a computer was too expensive. But now you can relax.

The IBM Personal Computer starts at less than \$1,600[†] for a system that, with the addition of one simple device, hooks up to your home TV and uses your audio cassette recorder.

You might also have thought running a computer was too difficult. But you can relax again.

Getting started is easier than you might think, because IBM has structured the learning process for you. Our literature is in *your* language, not in "computerese." Our software *involves* you, the system *interacts* with you as if it was made to—and it was.

That's why you can be running programs in just one day. Maybe even writing your *own* programs in a matter of weeks.

For ease of use, flexibility and performance, no other personal computer offers as many advanced capabilities. (See the box.)

But what makes the IBM Personal Computer a truly useful tool are software programs selected by IBM's Personal Computer Software Publishing Department. You can have programs in business, professional, word processing, computer language, personal and entertainment categories.

You can see the system and the software in action at any ComputerLand[®] store or Sears Business Systems Center. Or try it out at one of our IBM Product Centers. The IBM Data Processing Division will serve those customers who want to purchase in quantity.

Your IBM Personal Computer. Once you start working with it, you'll discover more than the answers and solutions you seek: you'll discover that getting there is half the fun. Imagine that.



IBM PERSONAL COMPUTER SPECIFICATIONS		
*ADVANCED FEATURES FOR PERSONAL COMPUTERS		
User Memory 16K - 256K bytes*	Display Screen High-resolution (720h x 350v)*	Color/Graphics <i>Text mode:</i> 16 colors*
Permanent Memory (ROM) 40K bytes*	80 characters x 25 lines Upper and lower case Green phosphor screen*	256 characters and symbols in ROM*
Microprocessor High speed, 8088*	Diagnostics Power-on self testing* Parity checking*	<i>Graphics mode:</i> 4-color resolution: 320h x 200v*
Auxiliary Memory 2 optional internal diskette drives, 5¼", 160K bytes per diskette	Languages BASIC, Pascal	Black & white resolution: 640h x 200v*
Keyboard 83 keys, 6 ft. cord attaches to system unit*	Printer Bidirectional* 80 characters/second 12 character styles, up to 132 characters/line* 9 x 9 character matrix*	Simultaneous graphics & text capability*
10 function keys* 10-key numeric pad Tactile feedback*		Communications RS-232-C interface Asynchronous (start/stop) protocol Up to 9600 bits per second

The IBM Personal Computer and me.



[†]This price applies to IBM Product Centers. Prices may vary at other stores.

For the IBM Personal Computer dealer nearest you, call (800) 447-4700. In Illinois, (800) 322-4400. In Alaska or Hawaii, (800) 447-0890.

TWO TO REMEMBER

The Ultimate Dynamic IEEE 696/S-100 Memory...

Available now from Dual Systems: DMEM/256 memory boards. Put the most density of memory ever available on your IEEE/S-100 bus. Get industrial-grade quality with this ruggedly built board; it's been burned in for 168 hours.

- FULL 256 Kb on a single board.
- TWO INDEPENDANTLY ADDRESSABLE 128 Kb BLOCKS.
- RUNS IN 8 MHz System.
- RUNS AT 4 MHz BUS SPEED (no wait states).
- RUNS IN 8 OR 16-BIT systems with 8 or 16-bit wide data paths.
- EXTENDED 24-BIT ADDRESSING
- PARITY ERROR DETECTION — generates either interrupt or bus error signals on error.
- DMEM/256K \$1245
- DMEM/256KP (Parity) ... \$1345

Static IEEE/S-100 Memory with Non-Volatility

The Dual Systems CMEM memory boards combine high speed CMOS memories with new 5-10 year lithium batteries to give you the nonvolatility of an EPROM board while retaining the instant writability of a high-speed read/write RAM.

- RUNS AT 6 MHz (no wait states).
- 8 OR 16-BIT with 8 or 16-bit wide data paths.
- EXTENDED 24-BIT ADDRESSING and bank select.
- CMEM/32K \$895
- CMEM/16K \$795
- CMEM/8K \$695

OEM and Dealer pricing is available.

Sales representatives in most metropolitan areas.



system reliability/system integrity

DUAL SYSTEMS

720 Channing Way, Berkeley 94710
(415) 549-3854 • Telex: 172029 SPX

you a letter-quality printer and cable that will work properly with your software. This problem of compatibility has been very common in the microcomputer industry to date. It is surprising that IBM, which has worked so hard in some other areas to avoid this problem, has literally left it to chance here.

Of course, the explanation of "limited resources" can be given here, too. That is, if IBM had waited until it had *everything* lined up, the product would not have been introduced as early as it has been. Still, the criticism stands that, by not providing a full product line, *the IBM Personal Computer system, through no fault of its own, may fall prey to hardware and software incompatibility*, thus creating still more disappointed microcomputer users.

Another weakness of the IBM Personal Computer as a word processor is the lack of versatile word-processing software to drive the machine. The only word processor available at the time of this writing is Information Unlimited's EasyWriter. I was given a chance to work with the EasyWriter word processor on the IBM microcomputer, and I found a few things I didn't like about it. In general, the software didn't seem to be of the same caliber as, say, VisiCalc or the Peachtree business packages. Specifically, at times the software left me not knowing exactly what to do next, and I found the scrolling—both up *and* down—to be slow. (Scrolling down is understandably slow because the entire screen has to be rewritten, but scrolling up is usually fast, whether it be on a memory-mapped video display or a terminal. On the IBM EasyWriter, the scrolling is as slow going up as it is going down.) I have used the Apple II version of EasyWriter extensively, and my opinion of it is the same as for the IBM version: it is a good piece of software for the money, but it isn't as versatile as some applications require.

I'm sure that Magic Wand, Word-Star, or something similar will be available very soon for the IBM microcomputer, but EasyWriter is the only choice for the moment. My ad-

vice is: if you have an IBM Personal Computer, use the EasyWriter package a lot before you buy it. If you are looking for a system to be used primarily for word processing and you can't afford to wait for better software, I suggest that you look at other existing systems, such as the Radio Shack TRS-80 Model II or the Xerox 820. The IBM system, as it currently stands, does not compare favorably with these other systems.

Another limitation of the IBM Personal Computer is that, even though up to 256 K bytes of memory are available, the extended Microsoft BASIC cannot access more than a 64 K-byte workspace (I assume this includes both program and data), even though the IBM Pascal Compiler (also by Microsoft) and other proposed system software are said to be able to access all the workspace memory in the machine. Sixty-four K bytes seems to be so much memory, especially since we are used to program, data, *and* the BASIC interpreter fitting into 64 K bytes. Still, it's unfortunate that all that extra memory (which is one of the main reasons for buying the machine) can't be used by BASIC, the computer language that will probably most often be used on the machine.

Another weakness that must be mentioned is an extension of one previously discussed: the IBM dealer will have to supply certain useful or even vital components of a complete IBM microcomputer system. IBM says it has no interest in manufacturing color monitors, letter-quality printers, joysticks, or light pens, nor can IBM supply you with the cables that will have to be made to connect these devices to the IBM microcomputer. In addition, if you want to connect your IBM microcomputer to a standard color TV (which is what most people will do), you will have to rely again on the judgment of your IBM dealer for the correct cable and RF modulator. I'm sure that in most cases no serious problems will arise, but by not making the entire product line itself, IBM has lost its guarantee of total system compatibility.

As someone not unacquainted with the programming of games, I found a

CONGRATULATIONS IBM!

Your Personal Computer is Great!
—and now, it is even better,
with the **TECMATE™** Series of
Add-In and Add-On Products

*TECMATE™ is the first and only complete line
of Add-In and Add-On Products available for
the IBM Personal Computer.*

*Expand, enhance or simply make your system
more useful and exciting with any of the more
than twenty **TECMATE™** Products currently
available.*

Personal Computer Expansion Chassis
System Clock with Battery Backup
BSR X10™ Device Controller
Voice Synthesizer
Winchester Disk Drive and Controller
High Capacity (192K/256K) Dynamic Memory Board
High Speed Static Memory (RAM/ROM)
Electrically Erasable *E* PROM Board
Parallel Medium Speed Input/Output Interface
Parallel High Speed Input/Output Interface
Serial Medium Speed Input/Output Interface
Serial High Speed Input/Output Interface
Multi-System Printer Sharing Facility
IEEE 488 Interface
Analog to Digital Converter -8, 12, 14, 16 Bit
Digital to Analog Converter -8 and 12 Bit
Video Image Digitizer
Stepping Motor Controller
Music Synthesizer
Prototyping Board
Extender Board



*Additional products are already
under development, so if we don't now have
what you need, chances are good that we
soon will!*

Tecmar Inc. PERSONAL COMPUTER PRODUCTS DIVISION
23600 Mercantile Rd., Cleveland, OH 44122 (216) 464-7410

Toughest Boards in Town... IEEE 696/S-100

NON-STOP CLOCK

Keeps time with power off. Our industrial clock utilizes a new lithium battery for 3-9 years use. Easiest clock to program you'll ever see. Runs in all S-100 systems.

- Year, date, hrs, mins, secs, msecs.
- Uses new LSI CMOS chip.
- Vectored interrupts.
- CLK-24 \$250

A/D CONVERTER

IEEE696/S-100 AIM-12 industrial standard module designed for industrial analog-to-digital use.

- Runs in all S-100 systems.
- 32-channel, 16-differential 12-bit resolution/accuracy. 25-microsecond conversions.
- Instrumentation amplifier.
- BASIC program provided. AIM-12, \$695 or \$785 w/1-1000 gain transducer amplifier.

D/A CONVERTER

AOM-12 IEEE696/S-100 industrial level digital-to-analog (D/A) converter.

- 12-bit $\pm 1/2$ L.S.B. accuracy over full 0-70°C temperature range.
- Outputs 0-10, ± 5 , or ± 10 volts.
- Short circuit protection, all outputs.
- Switch-programmable for multiple boards.
- AOM-12, \$575

VIC 4-20

Standard output for industrial control 4-20 mA D/A converter. Used in conjunction with the D/A board.

VIC4-20, \$445.

DUAL 77 Data Acquisition and Control System-

Built to industrial standards; designed for severe environments. BASIC language makes programming easy. Access to hundreds of sensors. Expandability to meet your increased needs. Nonvolatile memory. Power interruption recovery with automatic restart. DUAL 77 is economical; \$5985 & up.



system reliability/system integrity

DUAL SYSTEMS

720 Channing Way, Berkeley 94710
(415) 549-3854 • Telex: 172029 SPX

few inadequacies with the graphics commands of the extended Microsoft BASIC. Although the graphics-definition language is excellent, shapes are allowed to rotate only in 90-degree increments. In addition, the only way I found to detect the collision of a drawn shape with the contents of the screen is through a POINT function that gives the color number of a given point on the screen. Although this *can*, with some effort, be used for that purpose, it falls far short of the methods of detecting collisions available on the Apple II and the Atari 400/800 computers. Perhaps some enthusiastic programmer will find a memory location that indicates whether or not a drawn shape has collided with another image on the screen. In any case, these are small criticisms of a machine that does so many things so well.

Speculations

One interesting thing about IBM is that it refuses to acknowledge the existence of any product that is not ready to be put on dealers' shelves tomorrow. Although this is frustrating at times, it is a refreshing change from some companies' practice of announcing a product even before its design is finished. Here are some speculations about future IBM Personal Computer products. The first two are almost assured, while the rest follow in increasing degree of uncertainty.

- *Two more disk drives.* Although, at the time of this writing, IBM maintains that only two disk drives are available for the IBM microcomputer, *Technical Reference* indicates in several places that provision is made for two external disk drives to be connected to the 5¼-inch Diskette Drive Adapter via the DB-37 connector on the back of the adapter card. (See the leftmost plug in the expansion slot area in photo 10.)

- *An 8086/8088 macro assembler.* The *Technical Reference* bibliography lists a manual for the *IBM Personal Computer Macro Assembler*. It may be available by the time you read this article.

Now we start with the speculations:

- *SofTech Microsystems' UCSD p-System.* IBM announced that this operating system would be available for the IBM Personal Computer; this would make UCSD Pascal, FORTRAN, and BASIC available, and it would allow the IBM microcomputer to run the same programs as other UCSD systems. However, IBM would not give me any availability dates.

- *A typing tutorial program.* This was mentioned once in the front of the *IBM Guide to Operations*—but then, so were joysticks and RF modulators. Microsoft may adapt its *Typing Tutor* for the IBM Personal Computer.

- *An official letter-quality printer and a major-league word processor.* IBM may have plans to do this, or it may be relying on manufacturers' eagerness to expand their potential market. Someone will probably do it, but it may not be IBM.

- *An "expansion box" to increase the number of peripheral cards that can be placed in the computer at one time.* This would resolve a design limitation of the IBM Personal Computer as it now exists.

- *A 128 K-byte (or more) memory board.* As the 64 K-bit memory ICs decrease in price and become more available, IBM may market expansion boards that hold more than their current 64 K-byte limit. This would free up one or two expansion slots, but it might also allow the IBM Personal Computer to hold more than 256 K bytes.

- *A database management system.* This, like many other business packages, is needed to strengthen the position of the IBM microcomputer in the business area.

- *An official RGB color monitor.* I don't think IBM is going to go for this one, but it should. I have seen three separate IBM Personal Computers with RGB monitors. In all three cases, the monitor used did not have an input for the intensity signal and so could display only eight of the sixteen

Text continued on page 68

CLEAR. QUICK. QUIET. ALL THREE, ONLY \$1,095.*

You get sharp, easy-to-read printouts. You get them fast, over 150 characters per second, from a printer that's loaded with convenience features.

The Heath/Zenith 25 Printer is a heavy-duty, high-speed, dot matrix printer. It produces up to 300 lines per minute with whisper-quiet smoothness. The entire 95-character ASCII set prints in upper case and lower case with descenders, in a 9x9 matrix. All functions and timing are microprocessor-controlled.

The features described below tell only part of the story. You have to see it in action to know how good it really is.

See your telephone white pages for the store nearest you. And stop in today for a demonstration of the Heath/Zenith 25 Printer. If you can't get to a store, send \$1.00 for the new Zenith Data Systems Catalog of assembled commercial computers and also receive free the latest Heathkit Catalog. Write Heath Co., Dept. 334-854, Benton Harbor, MI 49022.

HEATH/ZENITH

Your strong partner

Adjustable tractor-feed width with dual sets of tractors for smooth, bi-directional paper movement. Adjustable vertical and horizontal tabs.

Character pitch is hardware or software-selectable at 10, 12, 13.2 and 16.5 characters per inch, for a maximum of 222 characters per line. That gives you great flexibility in setting up forms.

Standard RS-232C interfacing for compatibility with most systems. Also 20mA current loop serial interface.

Uses standard edge-punched papers in single or multiple forms or fanfold.

Software- or hardware-selectable baud rates at 110, 150, 300, 600, 1200, 4800 and 9600.

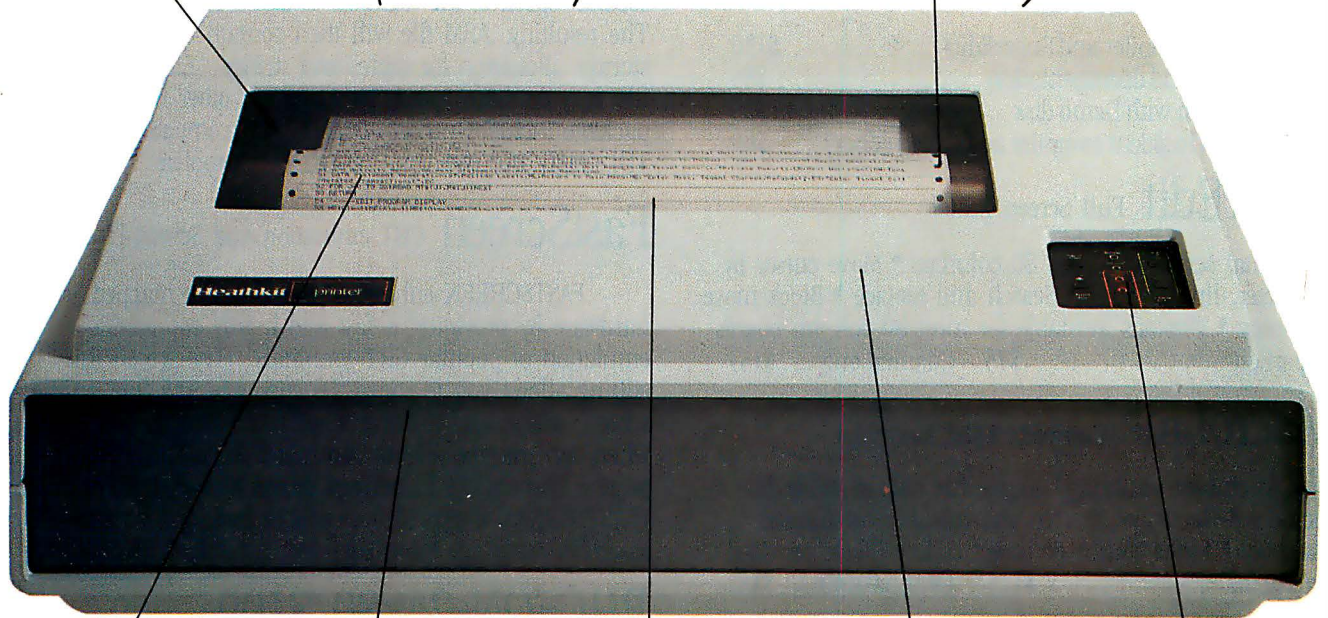

Character set includes 33 block graphic characters for charts and graphs.

Heavy-duty construction for reliable operation and long life under daily use.

Convenient cartridge ribbon for quick, no-mess replacement.

Completely enclosed cabinet muffles sound for quiet operation.

Special detectors tell you when you're out of paper or when paper jams.

*In kit form, F.O.B. Benton Harbor, MI. Also available completely assembled and tested at \$1,595. Prices and specifications are subject to change without notice.

New CompuView Software

Apple/6502 Software
Development Tools from
MicroCraft Systems, Inc.

RGL Real-time Graphics

With RGL you can write programs for Apple II HI-RES graphics that move and rotate 3-D objects at real-time speeds--fast enough to make interactive animations possible. RGL is ideal for educational uses, interactive graphics are easy to program, even for beginners. An object is created by drawing lines in 3-D Space, and as it moves and rotates, its size and perspective are automatically adjusted. The source code library of example programs includes several two player games, a function to print a HI-RES screen, and many other graphics programs. Programs are very short, our tank battle animation, with game paddles controlling two tanks is only 4 pages long.

A text file is compiled into a BRUNable program. RGL is a very efficient structured language, similar to 'C'. No additional hardware or software is needed. Also available on Apple CP/M disk.

RGL System (Compiler and SuperEdit) \$130
RGL compiler and documentation \$85
Documentation with Demo disk \$25
Cassette vers. (Resident compiler and screen editor) . . \$60

SuperEdit Full Screen Editor

Horizontal scrolling allows 80 columns • Move cursor by character, line or page • Search and replace • Block move and copy • Versions available for most 80 column boards
SuperEdit \$75 (Manual only . . \$15)

MacroLink Complete 6502 Assembler

Disk Assembler, unlimited source file size, nestable file includes • Recursive macros and nestable conditional assembly • Links source or object code • Editor provided
MacroLink \$125 (Manual only . . \$15)

DiskScreen Disk Utility

Display a complete disk sector in hex and ASCII using HI-RES screen, edit sector by typing over display. With Source listing. \$40

Note: All programs require a single disk drive and 48K. When ordering please specify configuration.

Inquire about 6800 and 8080/Z80 cross-assemblers.

8086 Software

- VEDIT full screen editor for CP/M-86, SCP 86-DOS and IBM Personal Computer.
- CP/M-86 BIOS for popular S-100 disk controllers and SCP 8086 computer. Source Code \$90

V-COM Disassembler

Finally a Z-80 disassembler for CP/M which produces easy to read code, a cross reference table and handles INTEL and ZILOG mnemonics. V-COM is exceptionally fast and produces an .ASM file directly from a .COM file. V-COM can accept two user created information files. One contains assignments of labels to 8 and 16 bit values; the second specifies the location of tables and ASCII strings. The resulting .ASM file will then contain labels and proper storage allocation for tables and strings. Each information file may contain nested 'INCLUDE' to other files. Each package includes variations of V-COM compatible with the TDL, MAC and two types of ZILOG assemblers. \$80

FastScreen CRT emulation and Screen Line Editor

FASTSCREEN enhances your memory mapped hardware by providing a fast and highly compatible emulation of popular CRT terminals. The screen line editing allows you to move the cursor to any line on the screen, edit it and re-enter it without retyping. (Great when you mistype a long command line). It also includes paging and optional interrupt driven keyboard routines. (FASTSCREEN is provided as source code and requires assembly language knowledge for installation.) \$85

PIICEON 24x80 S100 Video Board

The PIICEON V-100 offers memory mapped speed, but being I/O mapped, uses no memory space nor bank select. FASTSCREEN is the perfect software driver for the V-100. Fully assembled and tested by PIICEON, the company known by OEMs for reliability.

PIICEON with FASTSCREEN \$480
PIICEON board only \$460

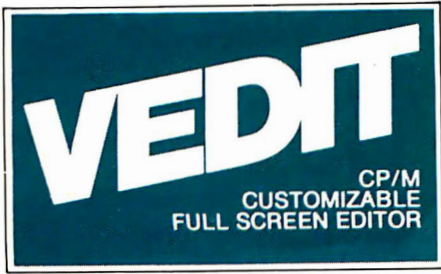

The Industry Standard is Uniquely User Oriented

VEDIT is user oriented to make your editing for program development and word processing as fast and easy as possible. Particularly unique is the customization (installation) process which makes VEDIT the only editing package that allows you to determine your own keyboard layout and use any available cursor and function keys. Just think of the difference it makes in your ease of learning and usage to type cursor and function keys instead of memorizing obscure control characters. The customization extends to much more, takes only a few minutes and requires no programming knowledge.

Unequaled Hardware Support

The CRT version directly supports over 35 terminals (including ANSI standard) in its installation menu and utilizes 'smart' terminal features such as line insert/delete, reverse scroll, status line and reverse video. Function keys on terminals like the Televideo 920/950, Heath H19, IBM 3101 and XEROX 820 are all supported. The memory mapped version is extremely flexible, supports bank select such as on the SSM VB3 and screen sizes up to 70 X 200. With this level of customizability and hardware support, VEDIT will be fully integrated into your system.

User Oriented Features

You get the features you need, like searching, a scratchpad buffer for moving and rearranging sections of text, complete file handling on multiple drives and iteration macros. For ease of use VEDIT has features you won't find elsewhere, like automatic indenting for use with structured languages such as Pascal and PL/I. You are less likely to make a mistake with VEDIT, but if you do, one key will 'Undo' the changes you made to a screen line. And if you run out of disk space with VEDIT, you can easily recover by deleting old files or even inserting another diskette. Take a hint from our customers who have other editors and word processors. They find VEDIT the fastest and most comfortable to use.

Full Screen Editing with Exceptional Speed

VEDIT gives you true 'what you see is what you get' full screen editing. It creates and edits standard text files of up to one diskette in length, which are fully compatible with all compilers and text processors.

VEDIT's unequalled speed is partly due to its ability to edit up to 47K of a file entirely in memory. There is no slow and annoying continuous disk accessing as found on most other editors/word processors. Yet you can still handle multiple files, insert a specified line range of another file anywhere in the text and even change diskettes.

New Word Processing

The new word-wrap and ability to print any part of the file makes VEDIT suitable for simple stand-alone word processing, or it may be used in conjunction with a text processor. Printer control characters can be imbedded in the file. The cursor's line and column positions can optionally be displayed.

Now for
Xerox 820
IBM 8088

Ordering

Many dealers carry VEDIT, or you may contact us for fast delivery. Specify your microcomputer, video board or the CRT terminal version, the 8080, Z80 or 8086 code version and disk format required. Demonstration versions available for some machines.

VEDIT - Disk and manual
For 8080 or Z80 \$145
For CP/M-86 or IBM 8086 . . \$195
Manual only \$15

VISA or MASTERCARD Welcomed

Apple II Softcard • TRS-80 II and I
SuperBrain • Heath H8/H89 • Altos
NorthStar • Vector • MP/M • IBM

CP/M and MP/M are registered trademarks of Digital Research, Inc. Apple II is registered trademark of Apple Computer, Inc. SoftCard is a trademark of Microsoft. TRS-80 is a trademark of Tandy Corp.

1955 Pauline Blvd., Suite 200
Ann Arbor, Michigan 48103
(313) 996-1299

CompuView

PRODUCTS, INC.

Circle 102 on inquiry card.

Turn your TV into a time-sharing videotex display for \$399.*

Now you can connect your family to the informative and entertaining world of CompuServe, The Source, Dow Jones News/Retrieval and other time-sharing and data-base networks.

All you need is the RCA VP-3501 Videotex Data Terminal (with built-in modem and RF modulator), your telephone and your TV set. You can get instant access to regional newspapers and newsletters...weather reports and sports results...computer games and more. You can use the VP-3501 to make airline reservations...find restaurant recommendations in cities around the world. Plus stock market and corporate data. Or access your school or business computer. You can even send electronic mail and buy products.

In addition to information retrieval, the VP-3501 provides full interactive communications with a host computer. What you have working for you is a versatile, feature-packed interactive data terminal which can be worth far more to you than its low price. Its unique color-locking circuitry gives you sharp color graphics and rainbow-free characters. You get 20- and 40- character formats in one of eight foreground colors and separate color backgrounds.

With reverse video, you can emphasize certain letters, words, or sentences. A built-in tone generator...plus a white noise generator...let you create everything from the sound of explosions to the sound of music. The spill-proof, easy-to-clean keyboard is highly suitable for hostile environments. And its membrane key switches give you a natural feel.

The VP-3501 is truly a fine Videotex Data Terminal. And don't forget, it's made by RCA...the first name in television...now the foremost name in videotex terminals.

See a demonstration at your computer or electronics dealer, or contact RCA. Order now and you'll get a free password and a free hour's time-sharing on both CompuServe and Dow Jones News/Retrieval! (Limited time offer.)

For more information or to order, call toll-free, 800-233-0094. (In Pennsylvania, call 717-393-0446.) Visa or MasterCard orders accepted by phone. Or send a check including \$3.00 delivery charge plus your local sales tax to RCA MicroComputer Products, New Holland Avenue, Lancaster, PA 17604.

**Suggested User Price.*

PRIME TIME-SHARING



RCA

Text continued from page 64:

possible colors. This is, again, a situation where IBM has surrendered the guarantee of complete compatibility by not manufacturing the product itself.

● *A Winchester hard disk* (the bigger, the better). Admittedly, this is a real guess, but it would make the IBM Personal Computer more attractive for certain business applications. The Apple III, a direct competitor to the IBM microcomputer, is now being offered with a Winchester disk. Is IBM going to ignore this?

● *Memory expansion past 256 K bytes.* It may be possible to replace the 16 K-bit 4116 dynamic memory integrated circuits with the new 64 K-bit devices, both on the main printed-circuit board and on the memory-expansion cards. If this can be done, the theoretical memory limit is the 20-bit, one-megabyte addressing limit of the 8088 microprocessor. The actual limit is somewhat less than that—a memory map in the *Technical Reference* manual (see table 6) allows room for "future expansion" of 576 K bytes, for a total of 832 K bytes.

Summary

When I look at the several inches of IBM Personal Computer manuals that fill my bookshelf, I am reminded that there is so much about this system that I have left out. Still, I have tried to talk about the most exciting and most important aspects of the system. The genius of the people who designed the IBM microcomputer is that they managed to do everything conventionally but well—the IBM Personal Computer doesn't have any startling innovations, but it also lacks the moderate-to-fatal design problems that have plagued other microcomputers.

The IBM Personal Computer isn't as well supported as the Radio Shack TRS-80 family or the Apple II, but then it hasn't been around very long. In two years or so, I think the IBM microcomputer will be one of the most popular and best-supported microcomputers around. This microcomputer is as close as I've ever seen to being all things to everybody. IBM should be proud of the people who designed it. ■



State-of-the-art hardware demands state-of-the-art software

Operating Systems & Support Software from Technical Systems Consultants

To perform to its fullest capabilities, your hardware demands software designed to meet the specialized requirements of today's microprocessors. State-of-the-art software from Technical Systems Consultants keeps pace with the rapid advancements in computer technology so your hardware can live up to its full potential. Our complete line of state-of-the-art software includes:

The UniFLEX™ Operating System

UniFLEX, a true multi-user, multi-tasking system for the 6809 and 68000 microprocessors, supports such features as:

- hierarchical file systems
- device independent I/O
- four Gigabyte disk capacities
- full file protection
- inter-task communication via pipes
- I/O redirection
- task swapping
- full random-access files
- comprehensive shell command language

UniFLEX, structured for large-scale microprocessor systems, will not run with minimal systems and thus has avoided design compromise. (Off-the-shelf versions and OEM licenses are available.)

The FLEX™ Operating System

FLEX, a powerful, easy-to-use operating system designed for the 6800 and 6809 microprocessors, includes:

- dynamic filespace allocation
- random files
- batch job entry
- automatic space compression
- English error messages
- user environment control
- disk resident commands
- flexible device I/O
- printer spooling

Plus, FLEX can accommodate hard disks as well as floppies. The System is available off-the-shelf for a variety of systems and in a field-adaptable version. (OEM licenses available.)

FLEX and UniFLEX are trademarks of Technical Systems Consultants, Inc.

Support Software

Technical Systems Consultants offers a full line of state-of-the-art support software compatible to FLEX and UniFLEX, some of which are:

- native C and Pascal compilers for advanced programming
- extended BASIC for business and educational applications
- text editing and processing software
- sort/merge package for business applications
- variety of absolute and relocatable assemblers
- debug and diagnostic packages

... and more. Write or call today for our brochures describing our complete product line.



Box 2570, 1208 Kent Avenue
West Lafayette, Indiana 47906
(317) 463-2502 Telex: 27-6143

Sculpture by Joann Chaney

PRINTERS 10 DAY FREE RETURN

EPSON MX-80
Now in stock!

C-ITOH STARWRITER: LETTER QUALITY PRINTING FOR UNDER \$1900! This daisy wheel printer gives high quality at a low price. 25 cps. Parallel and serial interfaces available.

NEW INTEGRAL DATA'S 560 PRINTER/All the exciting features of the 400 series plus 14 1/2" paper capacity, 132 col. graphics printer.

IDS 445/Lower price and improved print head. Available with or without graphics.

IDS 460/Features include correspondence quality printing. High resolution graphics.

NEC SPINWRITER FROM THE FIRST NAME IN LETTER QUALITY PRINTERS/ Spin writer 7700 series. Compumart offers beautiful print quality with NEC Spinwriter Terminals. We carry all models from RO THRU KSR WITH NUMERIC KEY-PAD- 7710-7730. All versions give unsurpassed hard copy output!

CENTRONICS 739/The latest innovations from the industry leader, and quiet too!

Visit our giant
ANN ARBOR STORE
1250 North Main Street
Ann Arbor, Michigan

MONITORS TERMINALS CONFIGURATION HELP

CLEARANCE ZENITH COLOR VIDEO MONITOR \$275.

SUPER SELLING TERMINALS FROM LEAR SIGLER/Call for quotes.

ADM-3A/Industry's favorite dumb terminal for some very smart reasons.

**ADM-5/More features for less than you think!
IT IS HERE! It is the new Intermediate Terminal from Lear Siegler.**

NEC COLOR MONITOR/RECEIVER HIGH RESOLUTION/ Composite video using BNC connectors, 8-Pin connector for VCR/ VTR video loop In/Out and television reception.

SANYO MONITORS AT LOW COMPUMART PRICES/Sanyo's new line of CRT data display monitors are designed for the display of alphanumeric or graphic data.

9" SANYO B/W	\$169.
12" SANYO B/W	\$289.
12" SANYO W/ GREEN SCREEN	\$299.
13" SANYO COLOR	\$495.

WRITE FOR YOUR CHOICE OF FREE CATALOGS WITH YOUR LETTERHEAD OR BUSINESS CARD.

MICRO

The most complete catalog of micro-computers, accessories and peripherals.

DEC PDP/LSI-11

Systems configured and integrated with other manufacturers compatibles.

CALCULATORS MODEMS TOLL FREE ORDERING

NOVATION CAT ACOUSTIC MODEM Answer Originate. NEW! D-CAT Direct Connect Modem from Novation.

MATROX PRODUCTS/the complete line.

DYSAN DISKETTES/The standard. Available in 5 1/4", 8" soft or hard sectored, single or double density.

MEMOREX DISKETTES/5 1/4" disks with hub ring for Apple drives

MOTOROLA 4116-2/200 nano second, plastic case. \$3.50 ea.

NEW! GILTRONIX RS 232 SWITCH/ You can connect three peripherals to one computer or three computers to one peripheral. Switches the eight most important RS 232 signals.

DEC LSI-11/Compumart now offers the entire product line. CALL FOR PRICES AND DELIVERY

HP-41C CALCULATORS

MEMORY MODULES for storing programs of up to 2000 lines of program memory.

"EXTRA SMART" CARD READER. Records programs and data back onto blank magcards.

THE PRINTER. Upper and lower case. High resolution plotting.

APPLICATION MODULES

NEW SUPER 41-CV SYSTEMS with Quad RAMS built-in. Maximum memory on-board leaves slots open for Application Pacs and peripherals.

**82104A CARD READER
82143A + PRINTER**

SYSTEMS SOFTWARE LEASING AVAILABLE

RAM EXPANSION ACCESSORIES FOR AIM—CALL SPECS AND PRICES

APPLE III IS IN STOCK/Apple III Information Analyst Package—128K Apple III, Black and White Monitor 12", and information analyst software.

TOP SOFTWARE PACKAGES FROM COMPUMART

VISICALC/FOR APPLE/FOR HP/ FOR COMMODORE/FOR ATARI

SOFTWARE FROM APPLE/Apple Plot (the perfect graphic complement for Visicalc/Dow Jones News & Quotes/Apple Fortrom/Apple Writer/Pascal Language System/ Controller Business System

PERSONAL SOFTWARE/ Visidex/ Visitrend/ Visiplot/ Visiterm

MUSE/Super Text

MOUNTAIN COMPUTER/ Expansion accessories for Apple/ Super Talker/The Music System/ ROM plus board with Keyboard filter/ROM Writer/Clock Calendar/A to D and D to A Converter/ Clock for Apple/CPS Multifunction Board

VIDEX/Video Term (80 col. x 24 line, 7x9 Matrix plug in compatible board for Apple II) w/wo graphics EPROM/SSM Serial & Parallel, Apple Interface/ABT's Numeric Key Plan/California Microcomputer Keyboard

VIC 20 PERSONAL COMPUTER FROM COMMODORE



IMPORTANT ORDERING INFORMATION

CALL: 800 343-5504, in Massachusetts: (617) 491-2700, phones open from 8:30 a.m. to 7:00 p.m. Mon-Fri. 11:00 a.m. to 4:00 p.m. Sat. PO's: Accepted from Dun & Bradstreet rated companies—shipment

contingent upon receipts of signed purchase order.

SALE PRICES. Valid for month of magazine date only—all prices subject to change without notice. Our Ann Arbor retail store is open 11:00 a.m. to 7:00 p.m. Tues-Fri. 11:00 a.m. to 5:00 p.m. on Saturdays.

SYSTEMS

XEROX 820

WE HAVE IT! \$5699

At last a CPM based system that looks like it belongs in your office. The 820 can be ordered with 5 1/4" or 8" drive and a family of printers from NEC SPINWRITERS, for letter quality, to the many currently available dot matrix printers.

We recommend this system to our professional/business customers.

A GREAT PRICE FOR A LOT OF MACHINE. SPECS: SCREEN 24 LINES x 80 CHARACTERS. DISK 5 1/4 DUAL OR 8" DUAL. KEYBOARD TYPEWRITER STYLE WITH 20 KEY PADS. PORTS INCLUDE SERIAL AND PARALLEL (1 EACH).

SPECIAL INTRODUCTORY SYSTEM PRICE **SAVE \$1000.**

**820 SYSTEM I (5 1/4" DUAL) W/
SPINWRITER CPM AND WORD-
STAR—\$5699.**

**820 SYSTEM II (8" DUAL) W/
SPINWRITER CPM AND WORD-
STAR—\$6699.**



SYSTEMS

CORVUS NETWORK

CONSTELLATION/Up to 64 computers connected to a 5, 10 or 20 megabyte winchester.

MIRROR/Interface for video backup system.

OMNI NET/ Unlimited number of computers and peripherals connected by two wire twisted pair cable. Maximum of 4000 feet end to end.

CALL US FOR PRICES ON YOUR SPECIFIC CONFIGURATION.



 **Rockwell International**
Authorized Dealer
Accept No Less

 **apple computer**
Authorized Dealer
Accept No Less

 **HEWLETT
PACKARD**
Authorized Dealer
Accept No Less

 **commodore**
Authorized Dealer
Accept No Less

Systems *Customized* / **COMPUMART**

65 Bent Street, Dept 101
PO Box 568, Cambridge, MA 02139
TELEX: 921401 COMPUMART CAM

800-343-5504

IN MASS CALL 617-491-2700
IF YOU PREFER, CALL OUR ANN ARBOR MICHIGAN STORE:
(313) 994-6344.

From THE LEADER ...

We just might be the largest independent small systems dealer in the country. Here's why: COMPUMART has been serving the computer needs of industry since 1971.

We stock, for immediate shipment, only those products from the finest micro-computer manufacturers.

And any product, except software, can be returned within 10 days for a full refund—even if you just change your mind. We also honor all manufacturers' warranties. Our expert technicians will service any product we sell.

Call us for more information on products, product configuration and service. Our phones are open Monday thru Friday, 8:30 a.m. to 7:00 p.m. and Saturday 11:00 a.m. to 4:00 p.m.

We have a staff of highly knowledgeable sales people waiting to hear from you, and to help. Because service is what we're all about.



Analog Interfacing in the Real World

Steve Ciarcia
POB 582
Glastonbury, CT 06033

Most Circuit Cellar articles present basic concepts of digital electronics in the form of novel construction projects. Sometimes, however, I have to cover a significant subject without a disguise.

One such subject area is analog-to-digital (A/D) and digital-to-analog (D/A) conversion. It has been about three years since I last wrote an article discussing these essential processes. Judging from my mail, many new readers of BYTE are just now discovering that their computers can be connected to more than a printer and modem. With these readers in mind, I am presenting basic information on A/D and D/A conversion in addition to the usual construction project.

Meet the Real World

Many applications for computer controls exist around the home, such as energy management, security, and environmental monitoring. All these applications require measurement inputs and control outputs in quantities

not easily expressed in the 0- and +5-volt (V) transistor-transistor logic (TTL) levels present in your computer.

An energy-management system,

for example, may need to monitor a temperature range of 0 to 100°C with a resolution of 0.1°. The thermocouple sensing this temperature range might generate only 1 or 2 millivolts

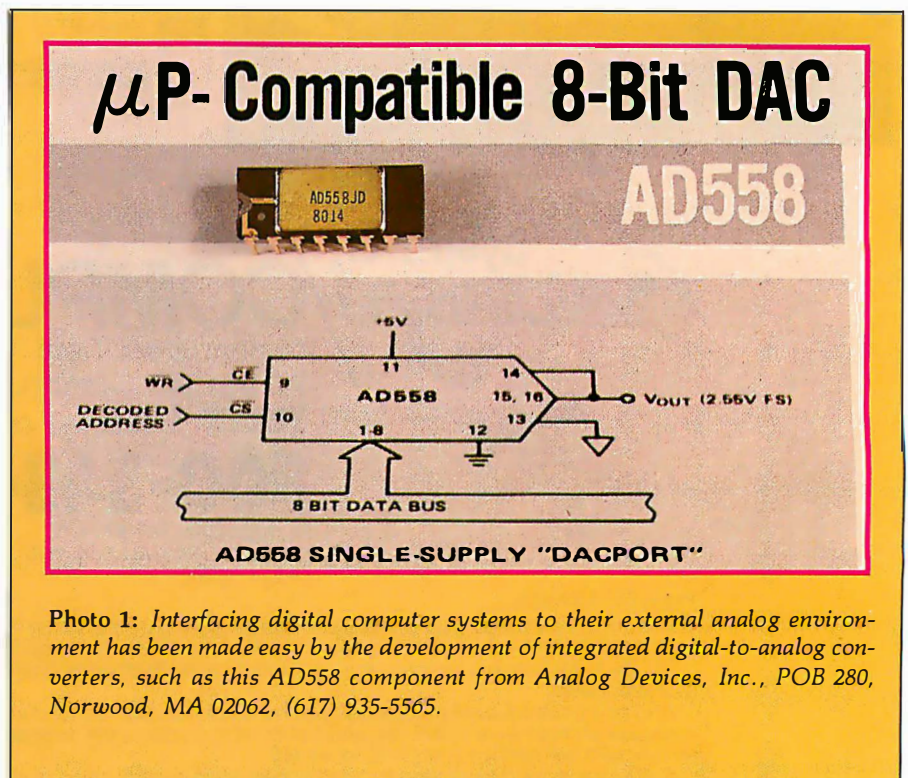
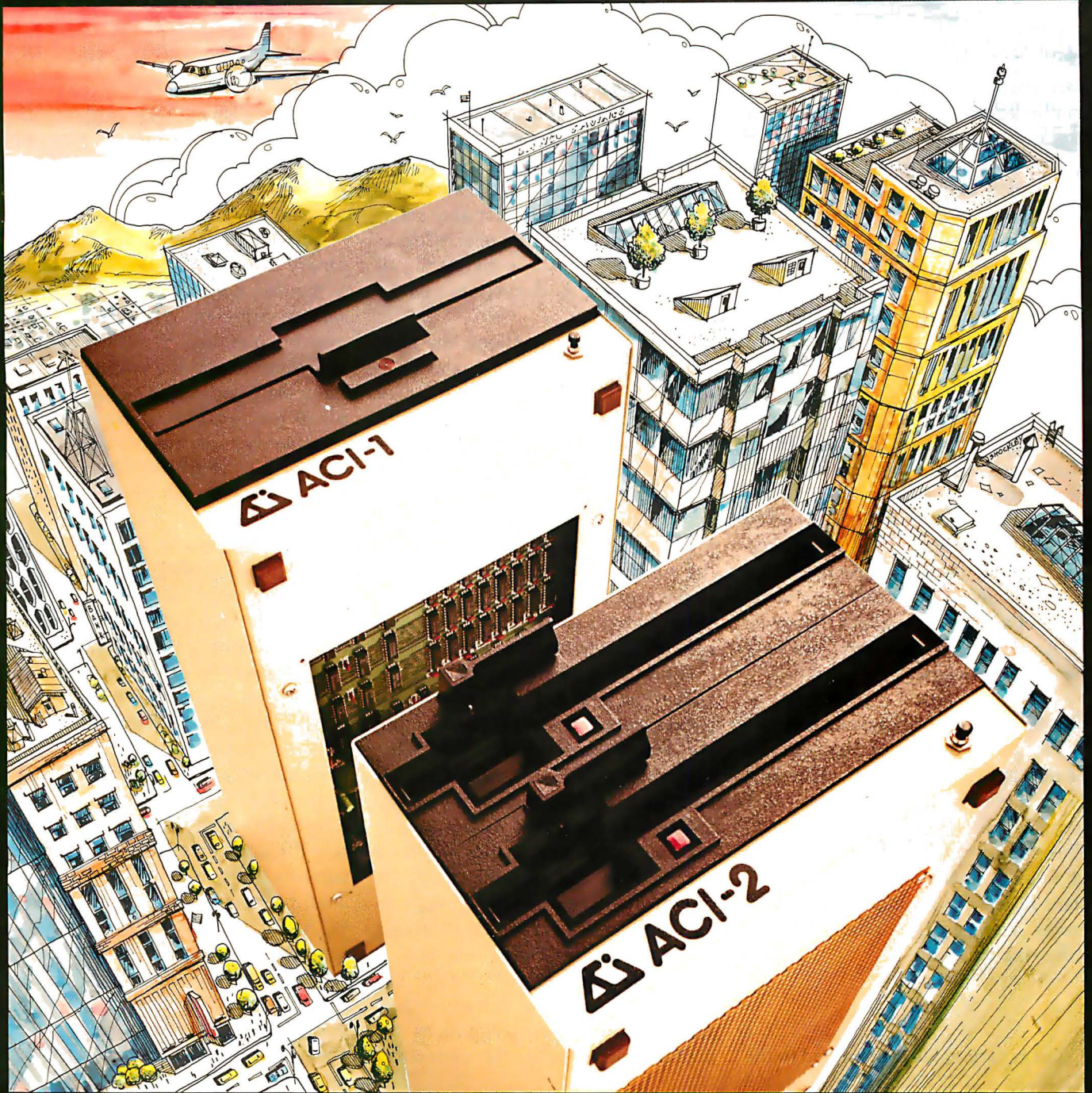

Photo 1: Interfacing digital computer systems to their external analog environment has been made easy by the development of integrated digital-to-analog converters, such as this AD558 component from Analog Devices, Inc., POB 280, Norwood, MA 02062, (617) 935-5565.



Full Computer Power Minimum Real Estate

ACI-1

\$1995

CP/M*

ACI-2

\$2995

A complete computer in the space of an 8 inch disk drive! ACI computers will run standard CP/M* software and work with any terminal or printer which has an RS-232 interface. Ask your computer dealer, or contact us for full information. *Dealer/Distributor inquiries invited.*



Alspa Computer, Inc.

300 HARVEY WEST BOULEVARD, SANTA CRUZ, CALIFORNIA, 95060 408-429-6000

CP/M is a trademark of Digital Research Inc.

(mV) per degree. A proportional-drive pump motor in the same system might require a 2.40-V set-point control input to produce the proper flow rate through the system.

Systems such as these are in the "real world," the continuous, analog environment outside the binary logic-0 and logic-1 domain of digital computers. A computer system's interaction with the real world requires some scheme for translating analog measurements to and from quantized binary equivalents.

In this article, therefore, we'll look at the design and construction of economical analog interfaces. I shall first outline the basics of digital-to-analog conversion and then go on to analog-to-digital conversion, describing the design of a low-cost circuit for each. Finally, I'll describe the characteristics and use of some of the newer D/A- and A/D-converter components on the market.

Digital-to-Analog Conversion

The digital-to-analog converter can be thought of as a digitally controlled programmable potentiometer that produces an analog output voltage. This output voltage V_O is the product of a digital signal D , a multiplier constant K (usually 1), and an analog reference voltage V_{REF} , related by the following equation:

$$V_O = KD V_{REF}$$

The binary value transmitted to the

D/A converter by the computer is a binary fraction representing what portion of the full possible output voltage is to be emitted. The fraction is multiplied by a reference voltage, which can be either fixed or variable. D/A converters with variable reference voltages are often referred to as "multiplying" D/A converters, although all D/A converters can be said to multiply.

In finite binary fractions, the most significant bit (MSB) has a value of $\frac{1}{2}$ (that is, 2^{-1}), the next most significant bit is $\frac{1}{4}$ (2^{-2}), and the least significant bit (LSB) is $(\frac{1}{2})^n$ or 2^{-n} , where n is the number of bits in the binary fraction. If all the bits in the fraction are added, the sum approaches 1; the more bits in the fraction, the closer the sum is to 1. The difference between 1 and the approach to 1 is the *quantization error* of the digital system. I'll discuss this later.

Different implementations of D/A converters (and A/D converters, too) use different formats for representing the binary digital quantities. One basic difference is the systems' capacities for representing negative binary numbers and negative voltages; some can and some can't. Analog-interface systems that can represent both are called *bipolar* converters; systems that can handle only positive voltages and quantities are called *unipolar*.

Unipolar converters chiefly use straight binary and binary-coded-decimal (BCD) representations of digital quantities. Bipolar converters

use a variety of representations, including offset binary, one's- and two's-complement formats, and Gray code. For brevity, I will limit this discussion to converters using straight binary and offset binary representations.

Offset binary differs from straight binary only slightly. In offset binary, a number consisting of all zeros is said to represent the most negative possible quantity. The most obvious consequence of this convention is that the most significant bit acts as a sign bit, 0 for negative values and 1 for positive. For instance, in offset notation the bit string 01000000 represents -64 , while the bit string 11000000 stands for $+64$.

The translation of digital values to proportional analog values is performed by either of two basic D/A-conversion circuits: the weighted-resistor circuit or the R-2R circuit. The *weighted-resistor* converter is by far the simpler and more straightforward. This parallel decoder requires only one resistor per input bit.

In the weighted-resistor D/A converter, solid-state switches are driven directly from the signals that represent the digital number D . Individual currents with voltage magnitudes related by powers of 2 (magnitudes of $\frac{1}{2}$, $\frac{1}{4}$, $\frac{1}{8}$, ..., 2^{-n}) are generated and summed by connecting a network of resistors with values of R , $2R$, $4R$, ..., $2^n R$ between the reference voltage $-V_{REF}$ and the summing point of an operational amplifier (op amp) by means of the set of electronic switches. After being summed, the various currents are converted to a voltage by the op amp, as shown in figure 1.

While this may appear to be a simple answer to an otherwise complex problem, this method has some significant drawbacks. The accuracy of this type of converter is a function of the combined accuracies of the resistors, switches (all switches have some resistance), and the output amplifier. In D/A-conversion systems of greater than 10 bits resolution, the values of the resistors become extremely large, and the resultant current flow is reduced to such a low value as to be lost in circuit noise.

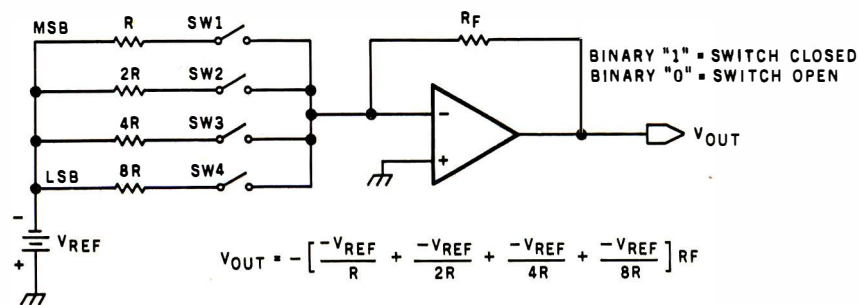
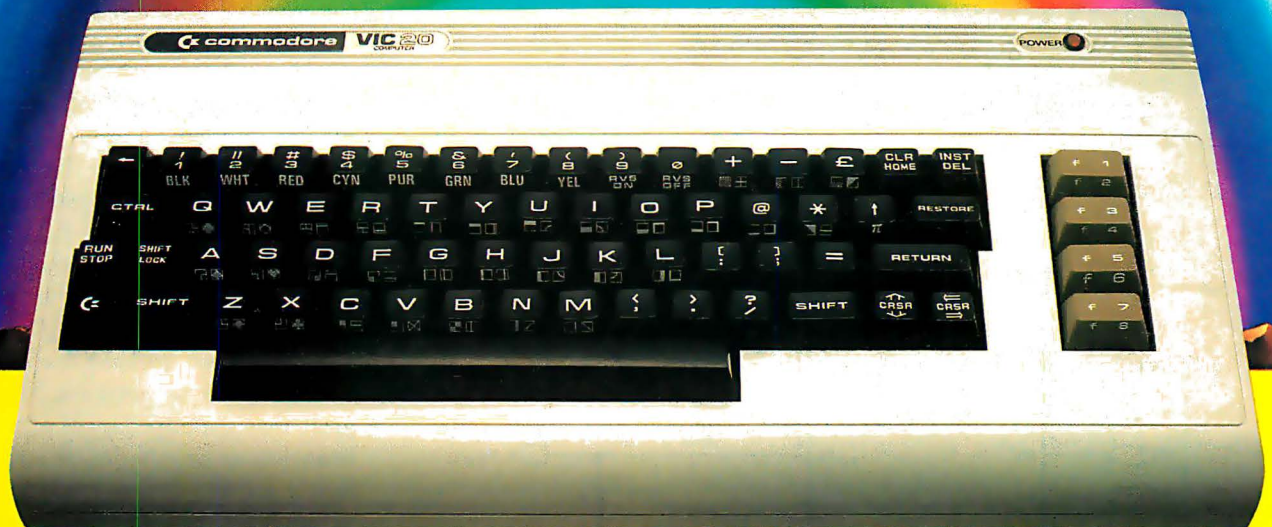

Figure 1: A 4-bit weighted-resistor digital-to-analog converter. A 4-bit word is used to control four single-pole, single-throw solid-state switches. Each switch is in series with a resistor. The resistor values are related as powers of 2. The other sides of the switches are connected together at the summing point of an operational amplifier. Currents with magnitudes inversely proportional to the resistors are generated when the switches are closed. They are summed by the operational amplifier and converted to a corresponding voltage.

VIC-20

The Friendly Computer

\$299.95



- Full Computer Keyboard
- 16 Colors/4 Sound Generators
- 66 Graphics Characters
- Memory Expansion to 32K RAM
- Includes Microsoft™/PET® BASIC
- Connects to TV or Monitor
- Recreation, Education & Personal Computing Programs
- Peripheral Equipment: Joystick, Paddles, Disk Drive, Printer, Cassette unit
- Telephone Modem for Communicating with outside Information Sources
- 4 Programmable Function Keys

For more information on the VIC-20's exciting
Space Games, Personal Software, and Programming capabilities,
visit your Commodore Dealer, or write:

VIC-20, Commodore Business Machines, 681 Moore Road, King of Prussia, PA 19406

 **commodore**
COMPUTER

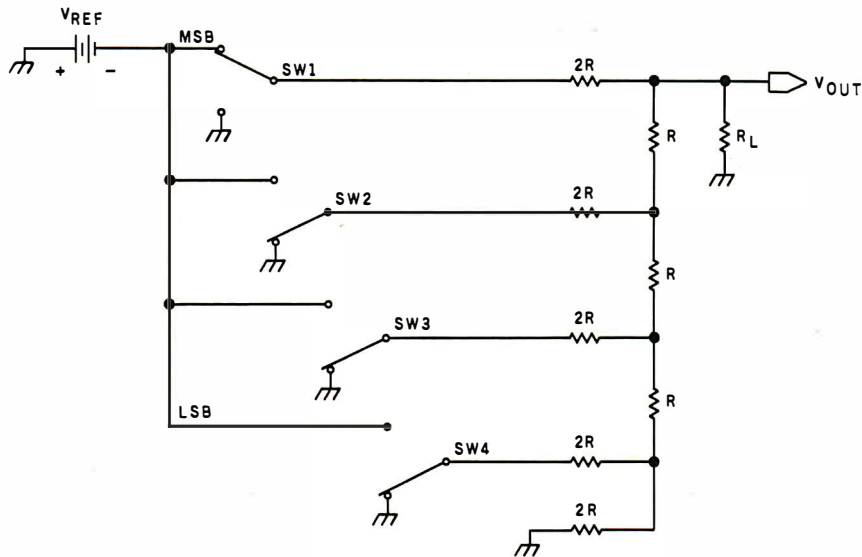

Figure 2: A 4-bit R-2R-type resistor-ladder digital-to-analog converter. This type of D/A converter makes use of a resistor-ladder network constructed with resistors of value R and 2R. The topology of this network is such that the current flowing into any branch of a three-branch node will divide itself equally through the two remaining branches. Because of this, the current will divide itself in half as it passes through each node on its way to the end of the ladder. The four switches are again related as powers of 2. The position of each switch with respect to its distance from the end of the ladder determines its binary significance.

For example, in an 8-bit D/A converter with R (the value of the resistor for the most significant bit) set to 10 k ohms, the value of the resistor for the least significant bit turns out to be 1.28 megohms. With a reference voltage of 10.00 V, only 7.8 microamperes would flow into the operational amplifier. This current is significantly below the response threshold of most low-cost op amps and would not be detected. Lowering the value of R to 100 ohms creates the opposite problem. At a reference voltage of 10.00 V, the input current to the amplifier would be 100 milliamperes (mA), more than most op amps can handle.

A reasonable alternative to the weighted-resistor D/A converter is the R-2R D/A converter, often referred to as a resistor-ladder converter. The R-2R D/A converter is the more widely used type even though it uses more components than the weighted-resistor type. A simple R-2R design is shown in the schematic diagram of figure 2 on page 76, including the reference voltage, a set of binary switches, and an output amplifier. The basis of this converter is a ladder network constructed with resistors of two values, R and 2R.

In each bit position of the network, one resistor (2R) is in series with the bit switch, and the other (R) is in the summing line, so that the combination forms a pi network. This suggests that the impedances of the three branches of any node are equal, and that a current I, flowing into a node through one branch, flows out as I/2 through the other two branches. In other words, the current produced in the network by closing a bit switch is cut by half as it passes through each node on the way to the end of the ladder. Simply stated, the position of a switch with respect to the point where the current is measured determines the binary significance of the particular switch closure.

The R-2R D/A converter is easy to manufacture because only two resistor values are needed. The component stock could be reduced to one resistor value if two are used in series for each bit. Keeping matched resistor

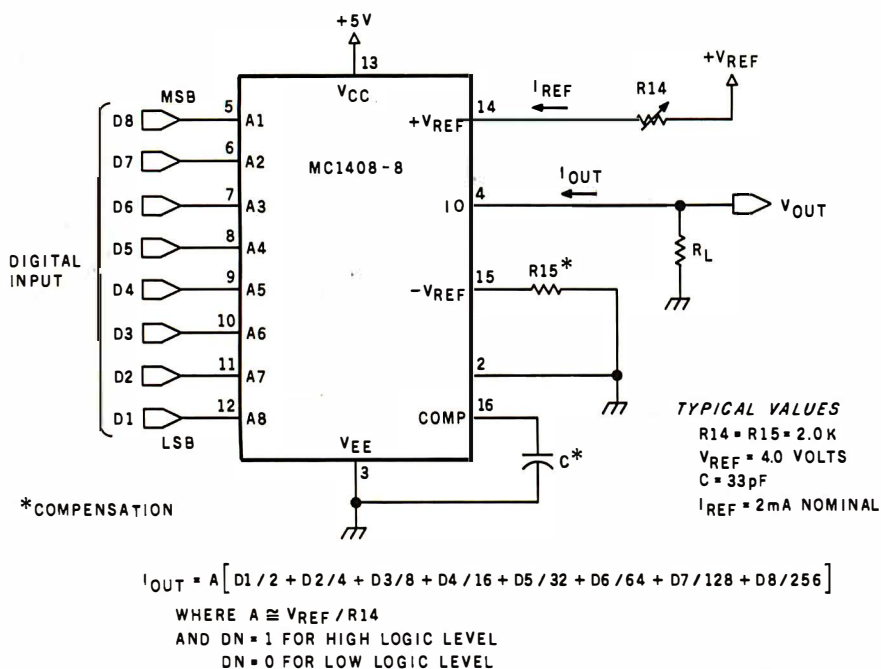

Figure 3: A circuit employing the Motorola MC1408-8, a typical 8-bit current-output monolithic multiplying D/A converter. This integrated circuit contains an R-2R network like the one in figure 2, plus additional current-switching logic.

Stop the Floppy Shuffle



Announcing The David Hard Disk Subsystem

Compared to cassettes, floppies were the greatest thing since the integrated chip. But with increased applications, data bases, and speed requirements, a lot of business people are spending more time doing the "Floppy Shuffle" and less time doing work.

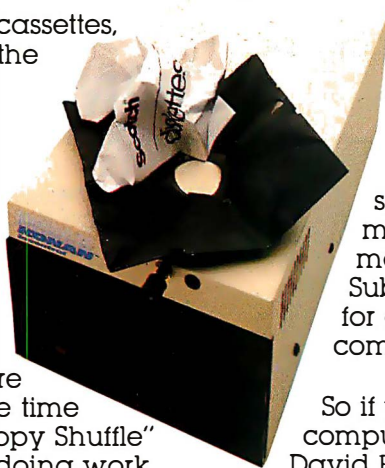

Now with Konan's David Hard Disk Subsystem you can have 32 times the storage of a mini-floppy in about the same amount of space. At a cost per megabyte that really makes sense, the David Subsystem is available for a variety of micro-computers.

So if you own a personal computer, check into the David Hard Disk Subsystem at

your local dealer and stop doing the Floppy Shuffle. And if you want real timesharing capabilities, a networking card is available.

The David Subsystem is available immediately.

Toll-free Information Line
800-528-4563

**KONAN
KONAN
KONAN**™

KONAN CORPORATION
1448 NORTH 27TH AVE, PHOENIX, AZ 85009
(602) 269-2649, TWX/TELEX 9109511552

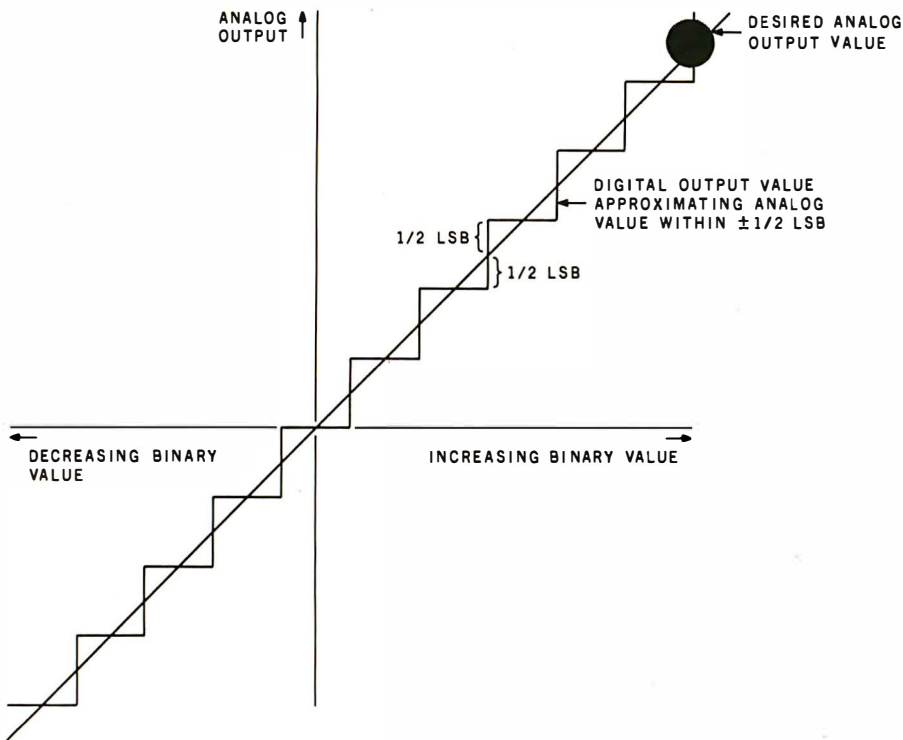

Figure 4: Output characteristics of a digital-to-analog converter showing least-significant-bit quantization.

values that have the same temperature coefficients contributes to a very stable design. Certain trade-offs are required between ladder resistance values and current flow to balance accuracy and noise.

One form of the R-2R ladder circuit is found in the multiplying digital-to-analog converter. Multiplying D/A converters, which utilize external variable analog reference voltages, produce outputs that are directly proportional to the product of the digital input multiplied by this reference. Functionally, these converters are available as current- or voltage-output types. The current-output devices are faster and less complex because they do not include additional output-amplifier stages. Therefore, they cost less than voltage types.

Probably the most economical current-output 8-bit multiplying D/A converter is the Motorola MC1408-8, shown in figure 3. It is duplicated by

Z8000 or 68000

X-8000 (System 3) \$7053

- Z8000 CPU with memory management
- 256K bytes RAM
- 8 serial I/O ports
- Dual 8" floppy disk drives
- Multi-user operating system
- 15 slot backplane, 40 amp power supply
- Meets IEEE Multibus standard

X-6000 (System 4) \$7099

- 68000 CPU (8 Mhz)
- 256K bytes RAM
- 2 serial, 4 parallel I/O ports
- Dual 8" floppy disk drives
- Operating system
- 15 slot backplane, 40 amp power supply
- Meets IEEE Multibus standard

Options (X-8000 or X-6000)

- Up to 16 megabytes RAM
- Winchester disk drives
- Cartridge disk drives
- Intelligent I/O board

Peripherals

- Ampex Dialogue 80 CRT \$1045
- Dual Qume floppy disk drives with case and power supply \$1545

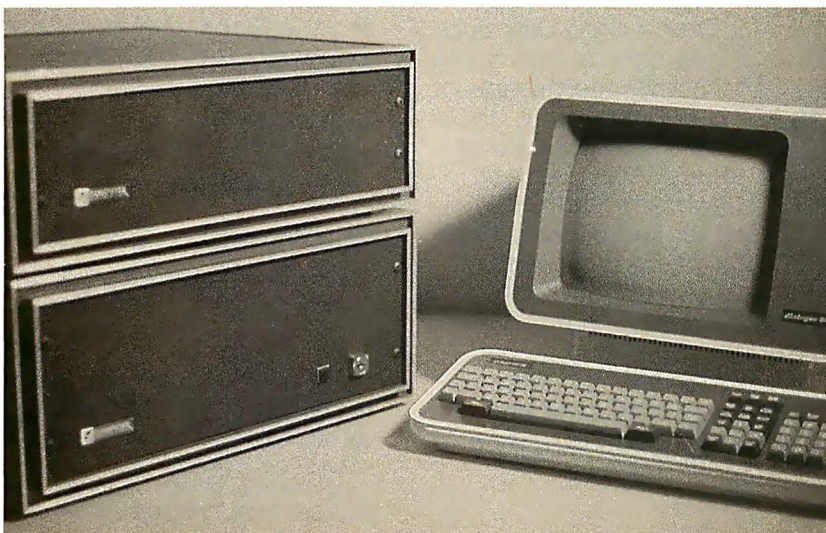

COMPUTEX

MICROCOMPUTER SYSTEMS

5710 Drexel Avenue
Chicago, Illinois 60637

312 684-3183

the Norpak Color Raster Display Generator

the only
thing
better
than our
picture
is our
price



Satisfy your demand for text and sophisticated graphics

Features

- compact single board display controller
- high efficiency 6809 microprocessor
- Telidon alpha-numeric/geometric Videotex software in ROM
- RS232C full duplex communication
- independent transmit/receive baud rates, strap selectable from 75 to 9600 baud (odd, even or no parity).
- 200 x 256 x 4 bit high speed raster video RAM
- 8 grey levels (black to white), 6 colors and blinking white
- RS170 RGB video and composite sync outputs.
- input device interface for optional keypad or keyboard.
- 8 character sizes including a maximum of 20 lines of 40 characters each.



Block Mosaic



Geometric

Ease of Operation

By virtue of the Picture Description Instruction (PDI) protocol used in Telidon Systems, images may be created from familiar graphic primitives such as points, lines, arcs and polygons. This same presentation level protocol is recognized as an international videotex standard and forms the kernel of the protocol selected by AT & T for their image communication networks. The use of an 8 bit data format, ASCII standard characters and RS232C serial communication, enhances the general purpose nature of the NORPAK display generator.

Applications

The compact size and low power consumption of the basic module facilitates integration into a complete display unit which may include a monitor and other specialized communications interfaces. It may be used as a simple output device connected to a computer or may form part of a stand-alone workstation. Many users who have been introduced to the potential of color graphics, through low resolution mosaic displays, will enjoy the increased spatial resolution of the pixel oriented raster bit plane technology. Some of the many potential applications include:

- display generator for VIDEOTEX applications
- output device for system status in a process control environment
- business graphics generation
- student display for educational applications
- graphic artists sketchpad
- video games

This color display generator is available from stock for \$499.00 (U.S.) For more information contact our sales office. (OEM discounts available).

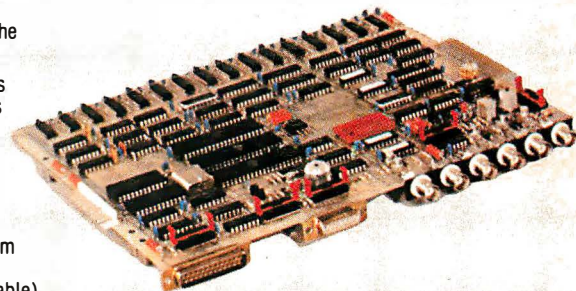

norpak

NORPAK LIMITED
10 Hearst Way
Kanata, Ontario
Canada, K2L 2P4
(613) 592-4164

NORPAK LIMITED
Bridge Administration Building
Suite 101
Ogdensburg, New York
U.S.A. 13669

Circle 384 on inquiry card.

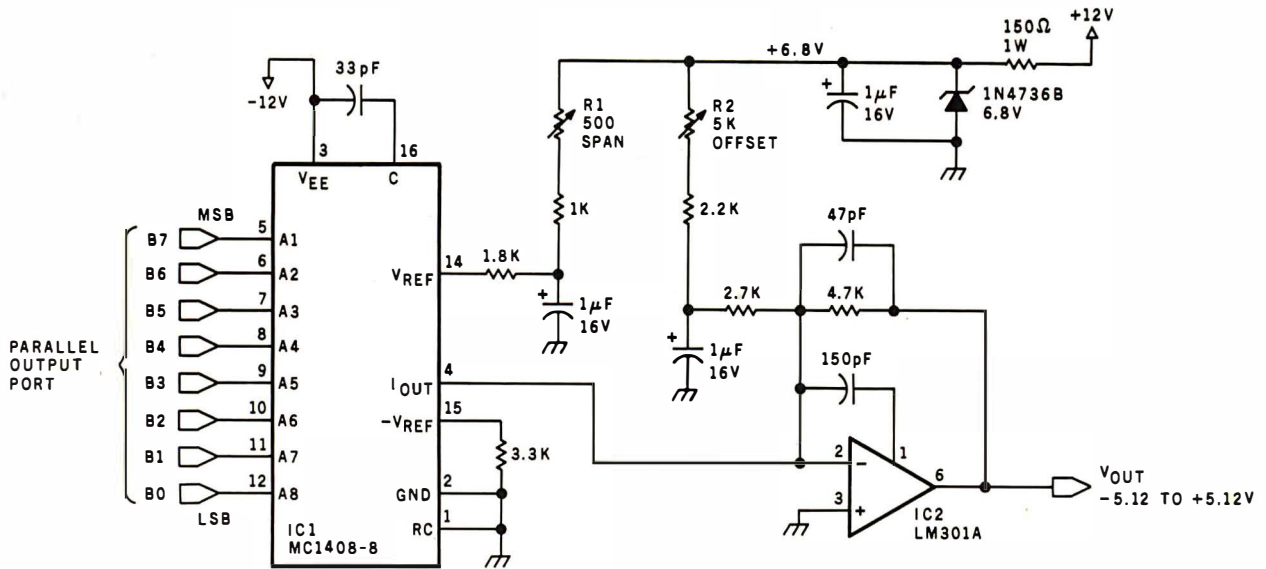

Figure 5: Schematic diagram of the final 8-bit MC1408-8-based multiplying digital-to-analog converter with span and offset adjustments.

Number	Type	+5 V	GND	-12 V	+12 V
IC1	MC1408	13	7	3	7
IC2	LM301A			4	7

a number of companies under similar names. (For instance, Analog Devices, Inc., calls its version the AD1408.) This monolithic integrated circuit contains an R-2R ladder network and current-switching logic. Each binary bit controls a switch that regulates the current flowing through the ladder. If an 8-bit digital input of binary 11000000 (decimal 192) and a 2-mA reference current (derived from V_{REF}) are applied to the control lines of the converter, the output current

would be equal to $192/256 \times 2 \text{ mA}$ or 1.50 mA.

Note that when binary 11111111 (decimal 255) is applied, there is always a remainder current equal to the least significant bit. This current is shunted to ground, and the maximum output current differs from the reference-amplifier current by a factor of $255/256$. It comes out to be 1.992 mA for a 2.0-mA reference current. The relative accuracy of the MC1408-8 version is $\pm 1/2$ of the least

significant bit, or 0.19 percent of full scale (see figure 4). This is more than adequate for most personal computer analog-control applications.

The final such circuit (see figure 5 on page 80) is an 8-bit multiplying D/A converter that uses the MC1408-8. As previously outlined, "multiplying" means that it uses an external variable reference voltage. In this case, a 6.8-V zener-diode-regulated voltage is passed through a resistor that sets the current flowing

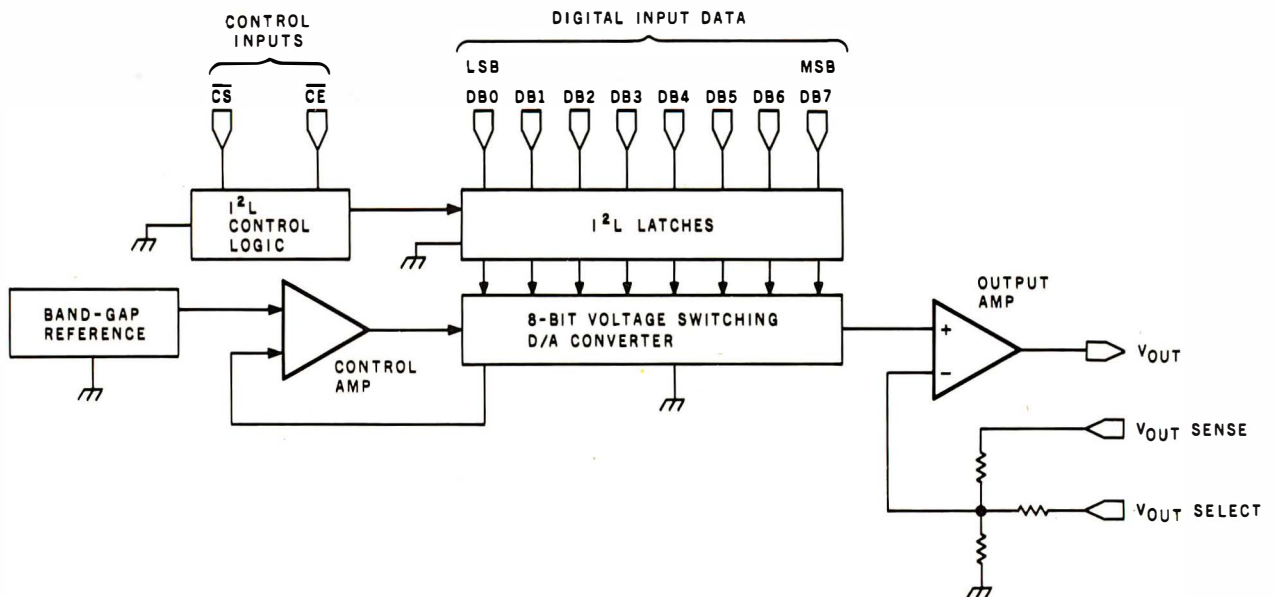
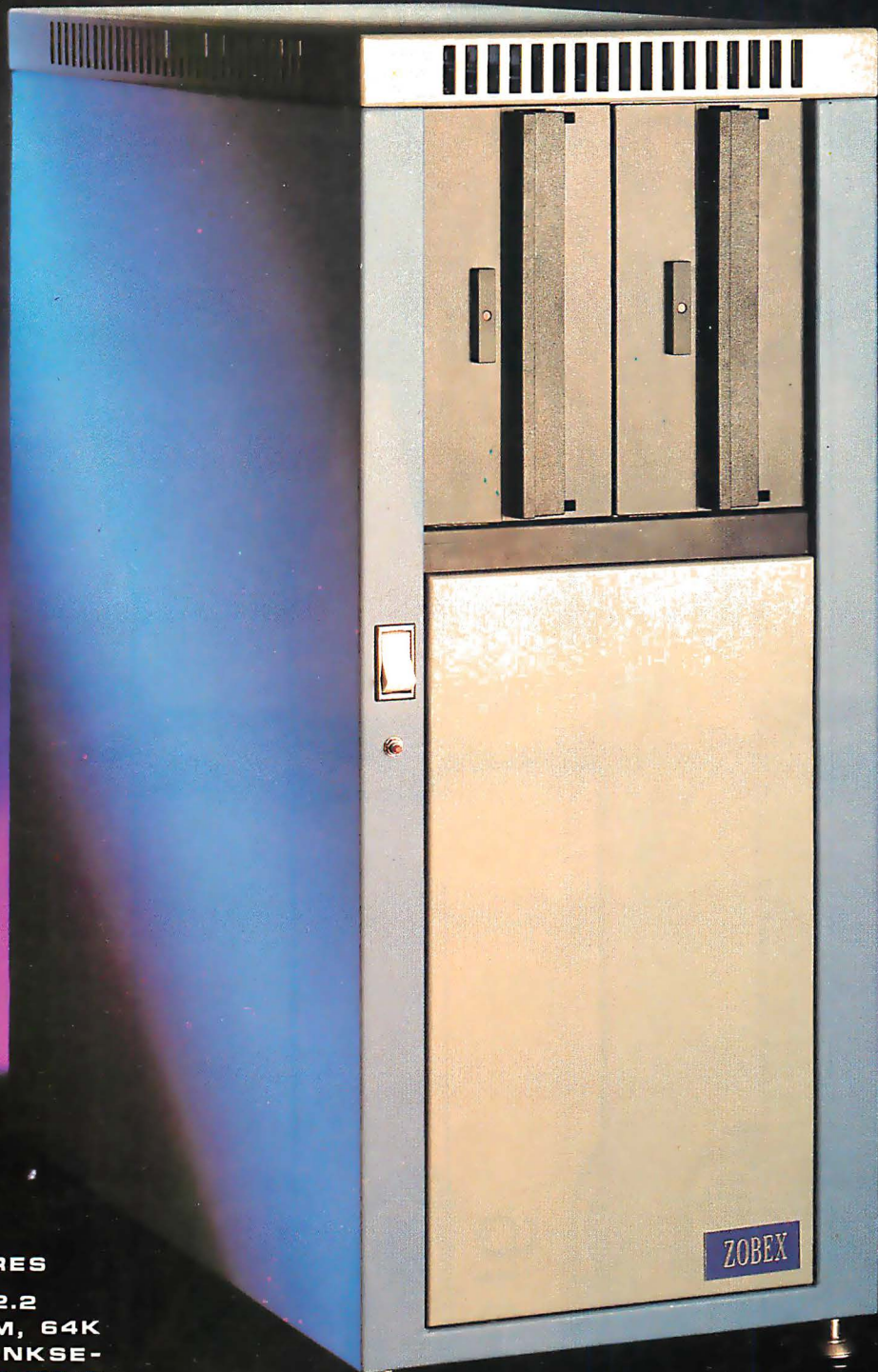

Figure 6: Functional block diagram of the Analog Devices AD558 digital-to-analog converter.

MULTIUSER



COMPUTER
ON S-100 BUS
DESIGNED TO
SATISFY A WIDE
VARIETY OF
APPLICATIONS.

STANDARD FEATURES
INCLUDE: CP/M 2.2
OPERATING SYSTEM, 64K
EXPANDABLE, BANKSE-
LECTABLE MEMORY, 4MHZ
Z80A CPU WITH 4 SERIAL
AND 3 PARALLEL PORTS,
RELIABLE 8" FLOPPY DISK
DRIVES IN A STURDY ALL
METAL CABINET.

\$4900

MP/M OPTIONAL.

CP/M AND MP/M REGISTERED TRADE MARKS OF DIGITAL RESEARCH

ZOBEX[®]

P.O. BOX 1847 SAN DIEGO, CA. 92112
7343-J RONSON RD, SAN DIEGO, CA. 92111
(714) 571-6971

*In kindergarten, Miss Crenshaw
introduced you to affordable color
printing.*



Crayola is a trademark of Binney & Smith Co., Inc.

BINNEY & SMITH INC., EASTON, PA. 18044
MADE IN U.S.A.

Today, Integral Data Systems introduces you to  TM PRISM affordable color printing.

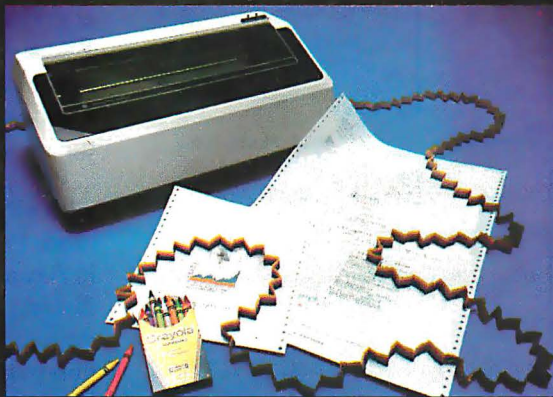

The PRISM PRINTERTM just rewrote the primer on hard copy output. It transforms dull statistical data into crisp, colorful output. Your text, charts and graphs will come to life in full color.

PRISM color makes the most complex data elementary. It does for information processing what instant color film did for photography: it makes getting the picture faster and easier. And communicates your information more effectively.

But today's most important lesson is that for the first time, color printing is affordable. Now. At a fraction of the price you'd expect. The PRISM PRINTER, by Integral Data Systems. It'll help you keep the cost of color inside your bottom line.

For more information, or the name of your nearest Integral Data dealer, call toll free (800) 258-1386 (in N.H., Alaska, and Hawaii, call (603) 673-9100).



Integral Data Systems, Inc.

A Whole New Spectrum of Imaging Ideas

Milford, NH 03055

Telex: 953032

Circle 185 on inquiry card.

BUNNEY & SMITH INC. EASTON, PA. 18046

CRAYON

into pin 14 to approximately 2 mA.

An additional resistor of value R1 (also in this current leg) allows the current to be varied by a small percentage and provides the ability to adjust the full-scale range of the converter. The output of the converter is a current equivalent to the product of the reference current and the binary data on the control lines. The current is converted to a voltage through IC2.

When used in the offset-binary mode, the converter output is zero-offset through the use of the offset-adjustment potentiometer R2.

In offset binary, a value of hexadecimal 00 produces an output of -5 V from the converter. Hexadecimal FF produces an output of +5 V. In offset binary, if the most significant bit is 0, the output is negative; if the most significant bit is

1, the output is positive. Since the converter has a range of 10 V and is an 8-bit device, the resolution of the converter is 1/256 of 10 V, or approximately 40 mV. This means that the smallest output increments will be in 40-mV steps. Changing this to finer increments requires that the range be shorter, such as +2.56 V to -2.56 V. By adjusting the span and zeroing potentiometers, any reasonable range may be chosen. The resolution, however, will always be equal to the least significant bit or 1/256 of the range. With the 1408, the accuracy will be $\pm \frac{1}{2}$ of the least significant bit.

Using this circuit is simply a matter of connecting the input lines of IC1 to a convenient latched parallel-output port. Any 8-bit value sent to that port will be converted to a voltage proportioned to that output.

While we don't have to contend with wiring up the actual ladder network to construct the D/A converter in figure 5, a parallel port and many discrete components are still required. Fortunately, analog I/O (input/output) technology has developed quickly in recent years, and sophisticated integrated circuits have become available, such as the Analog Devices AD558.

This 8-bit D/A converter can replace all the components previously discussed, including the parallel port, with a single chip. The AD558, shown in the block diagram of figure 6, contains an 8-bit latch, R-2R ladder network, reference voltage source, and output amplifier. The AD558 can run on a +5- to +15-V power supply and can be jumper-selected for 0- to 2.56-V or 0- to -10-V ranges. Using a separate operational amplifier, an offset converter can be configured or the ranges modified.

The AD558 can be used as a transparent D/A converter similar to the 1408 by holding the chip-enable and chip-select lines constantly low. However, it was primarily designed to be bus operated and appear as a "write-only" location in memory or I/O address space. Typical connections consist of a decoded address strobe, a write-enable signal, and the 8-bit data bus (illustrated in figure 7).

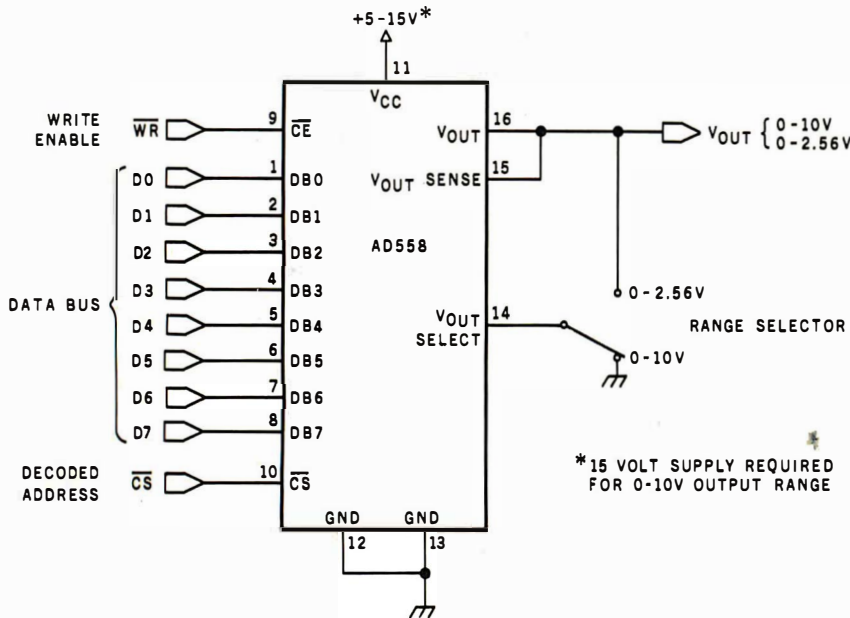

Figure 7: Schematic diagram outlining typical connection of the AD558.

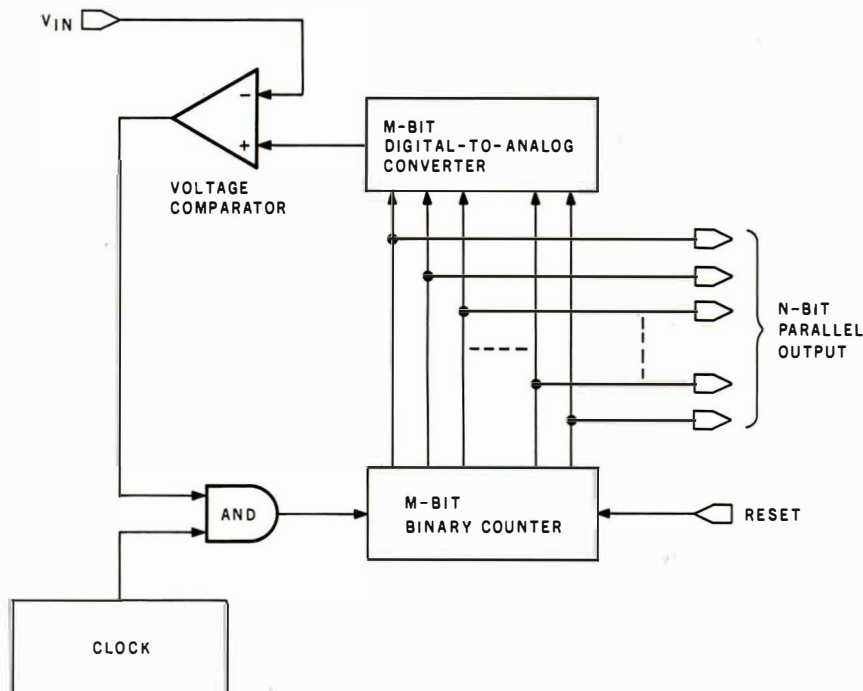
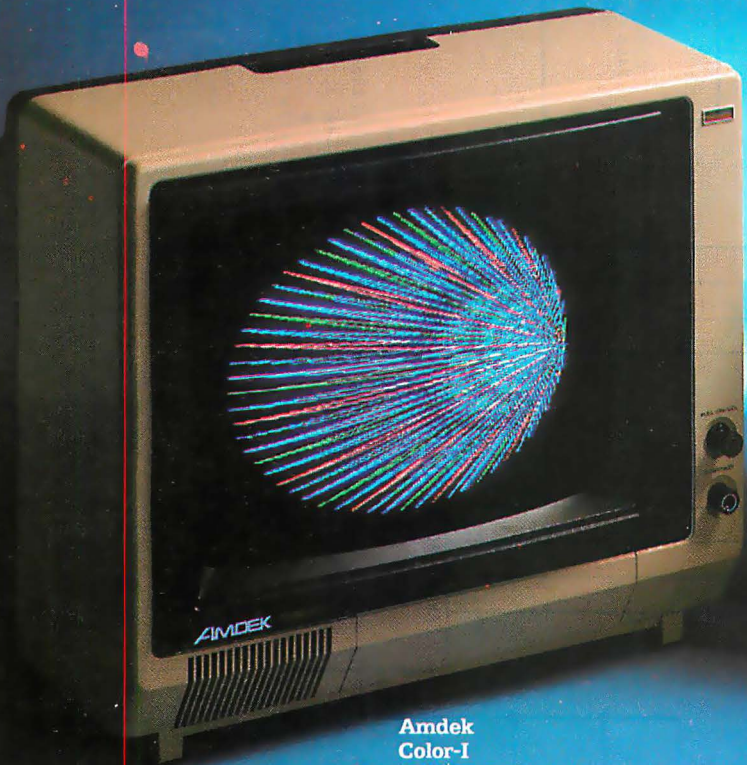

Figure 8: Block diagram of a basic binary-ramp-counter A/D converter.

Amdek

From picture perfect.

To letter perfect.



Amdek
Color-I
FCC/UL approved



Amdek
Video-300

At Amdek, we make monitors for people who demand state-of-the-art color. And for people who know that crisp, clear text display is an art in itself.

Our versatile Color-I 13" video monitor features standard NTSC composite input, front-mounted controls and a built-in speaker with audio circuit. Our popular Video-300 12" Green Phosphor monitor has an easy-to-read, non-glare screen, 18 MHZ band width and 80 x 24 character display.

Both offer easy portability, with lightweight cabinetry and molded-in handles. And both are fully

compatible with most computer and word processing systems. So compare our performance with other monitors. Then compare prices. For quality and value, you'll choose Amdek.

NEW THIS FALL: our advanced high resolution Color-II monitor with interface board for Apple II compatibility. Color-II features RGB, TTL input and 560(H) x 260(V) resolution for crisp 80 x 24 character display and exceptionally sharp color graphics. Ask your dealer about an Amdek Color-II, Color-I, or Video-300 monitor today.

AMDEK

2420 E. Oakton Street, Suite "E," Arlington Heights, Illinois 60005 (312) 364-1180 TLX: 25-4786

Number	Type	+5V	GND	-12V	+12V
IC1	LM301A	7		4	7
IC2	LM301A			4	3
IC3	MC1408	13	7	10	
IC4	7493	5	10		
IC5	7493	5	10		
IC6	7486	14	7		
IC7	7400	14	7		
IC8	NE555	8	1		
IC9	7495	14	7		
IC10	7495	14	7		

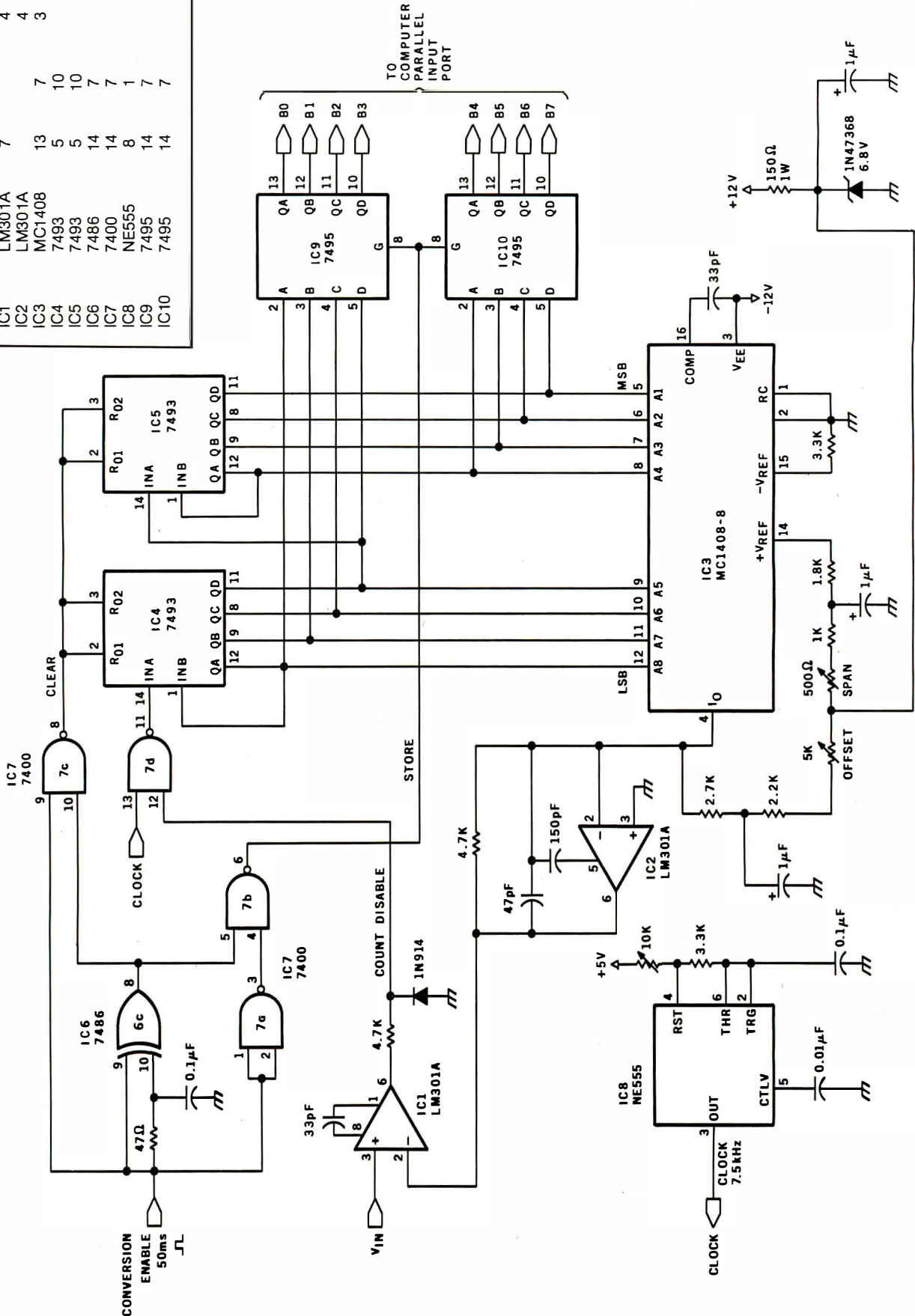
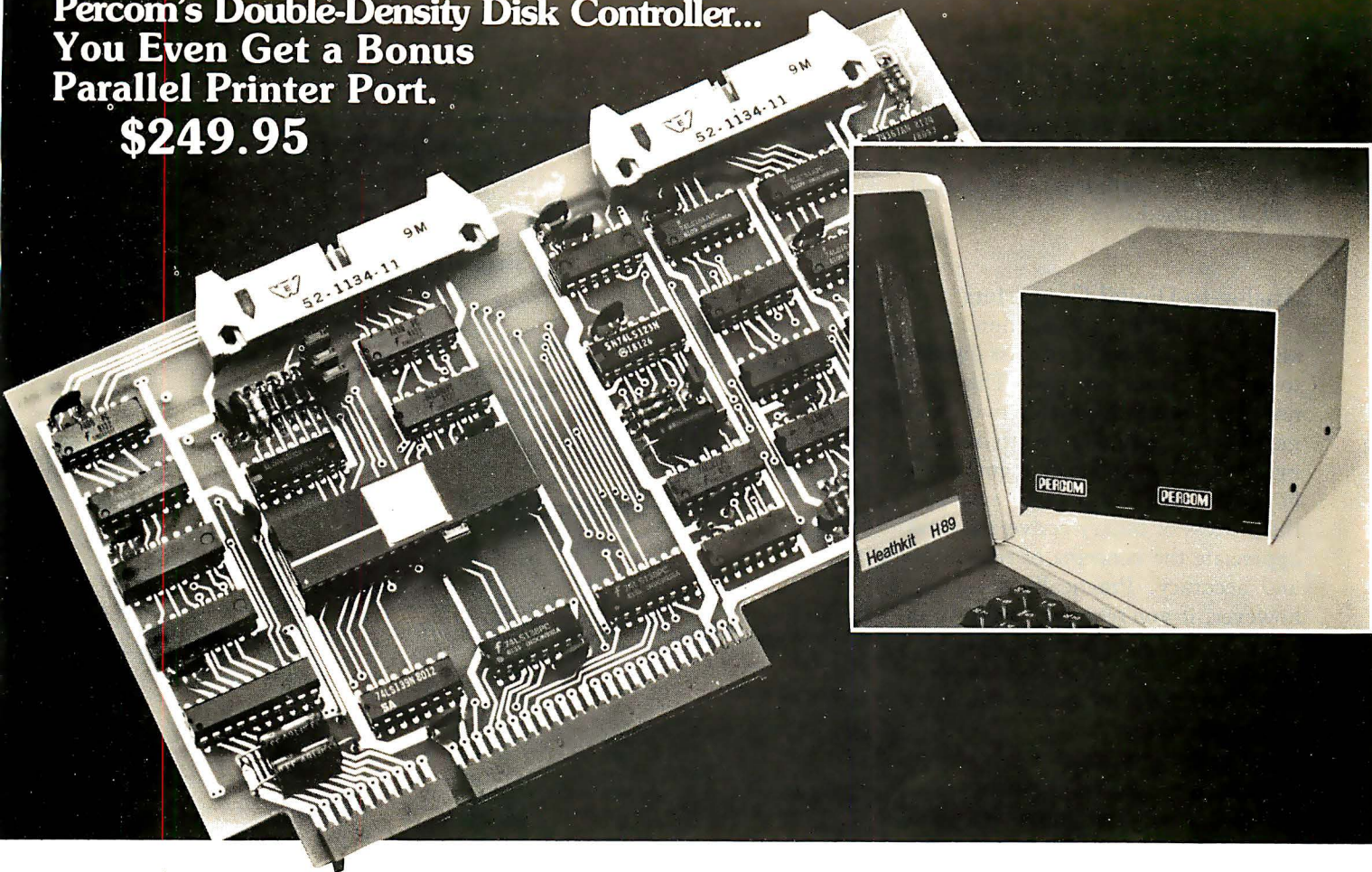

Figure 9: Schematic diagram of an 8-bit binary-ramp-counter A/D-converter circuit.

**Percom's Double-Density Disk Controller...
You Even Get a Bonus
Parallel Printer Port.
\$249.95**



Expect more from Percom. You won't be disappointed.

Percom's double-density Z Controller for the H-89 is now available. Besides its many outstanding drive control features, the Z Controller includes a bonus parallel port that lets you directly connect your computer to a standard, off-the-shelf Epson MX-80, Oki-data Microline 80 or other low-cost printer.

- Controls up to four single- or double-headed mini-disk drives.
- Handles 35-, 40-, 77- and 80-track drives, and other standard track densities.
- Formatted data storage capacity of 80-track diskettes is over 368 Kbytes. Forty-track diskettes store over 184 Kbytes. Capacities for other track densities are proportional. A Z system with four double-headed, 80-track drives provides almost 3 megabytes of on-line data.
- The Z Controller co-resides with your H-89 disk drive controller. Your software can select either, and you don't have to move drives around when switching between systems.
- The Z Controller includes Percom's proven digital data separator circuit and a dependable write-precompensation circuit. Expect reliable disk operation for a long, long time under 'Z' control.
- The Percom Z Controller is priced at only \$249.95, complete with HDOS-compatible disk drivers on diskette, internal interconnecting cable and comprehensive users manual.

System requirements – H-89 Computer with 24 Kbytes memory (min), Replacement ROM Kit H-88-7 and HDOS 2.0.



PERCOM DATA COMPANY, INC.
11220 PAGEMILL RD. DALLAS, TX 75243
(214) 340-7081

Toll-Free Order Number: **1-800-527-1222**

Add-On Z Drives for H-89, H-8 Computers

- Forty- and eighty-track densities in either 1- or 2-drive modules.
- All drives are rated for single- and double-density operation. With a Z Controller, an 80-track drive can store over 364 Kbytes (formatted, one-side), a 40-track drive can store over 184 Kbytes.
- Some models permit "flippy" storage, letting you flip a diskette and store files on the second side.
- Z drives are fully tested, including a 48-hour operating burn-in to prevent shipment of drives with latent defects.
- Assembled and tested one-drive units from only \$399, two-drive units from only \$795.

System requirements – H-89 or H-8 computer with 16-Kbyte RAM, Heath first-drive floppy disk system, HDOS and drives interconnecting cable. (Two-drive interconnecting cable optionally available from Percom)

PRICES AND SPECIFICATIONS SUBJECT TO CHANGE WITHOUT NOTICE.

Watch for announcement of 'Z' CP/M.

Yes... I'd like to know more about Percom Z drives and the Z Controller. Rush me free literature.

Send to
PERCOM DATA COMPANY, Inc., Dept. 26-B03
11220 Pagemill Rd. Dallas, TX 75243

name _____

street _____

city _____ state _____

zip _____ phone number _____

MAIL TODAY!

(Many readers have written to me requesting circuits that facilitate connecting an analog x,y -coordinate chart recorder to a computer. Two AD558s addressed separately are all that is required.)

Analog-to-Digital Converters

In this sort of presentation, it is always a good idea to discuss digital-to-analog converters first. They are not complex and have only two basic methods of conversion worth discussing. Also, by introducing them first, I hope that you will become aware of the process of binary conversion and appreciate the concepts of resolution and accuracy. Practically speaking, however, if you're going to use your computer in a data-acquisition mode, say reading and recording temperatures, you need an analog-to-digital (A/D) converter.

An A/D converter converts analog voltages into a digital representation compatible with the computer's input needs. Akin to the 8-bit D/A converter, an A/D converter is subject to the same conversion rules. If you are trying to read a 10-V signal with an 8-bit converter, the resolution will be $1/256$ of 10 V (approximately 40 mV), and the accuracy will be $\pm 1/2$ the least significant bit.

For greater resolution, more output bits are necessary. The number of bits does not set the input voltage range of a converter; it only determines with what precision the output value is represented. An 8-bit converter (either A/D or D/A) can be set up just as easily to cover a range of 0 to -1 V as it can be to cover 0 to $+1000$ V. Often the same circuitry is used with only a final amplification stage or resistor-divider network changed. Note that an 8-bit converter with a range of 1000 V has a resolution of only 4 V, and it would be useless to measure 0- to 10-V signals. The problem can be reconciled in a number of ways. The easiest solution is to use a converter with more bits. A 16-bit converter, which has 65,536 steps instead of 256, would cover the same 1000-V range in 15-mV increments.

For personal computing, a reason-

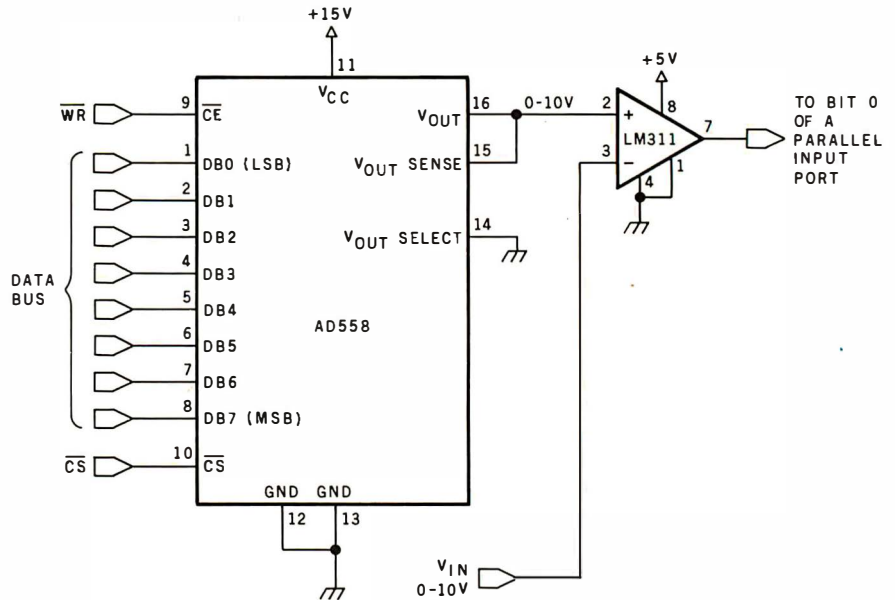

Figure 10: A software-driven 8-bit A/D converter.

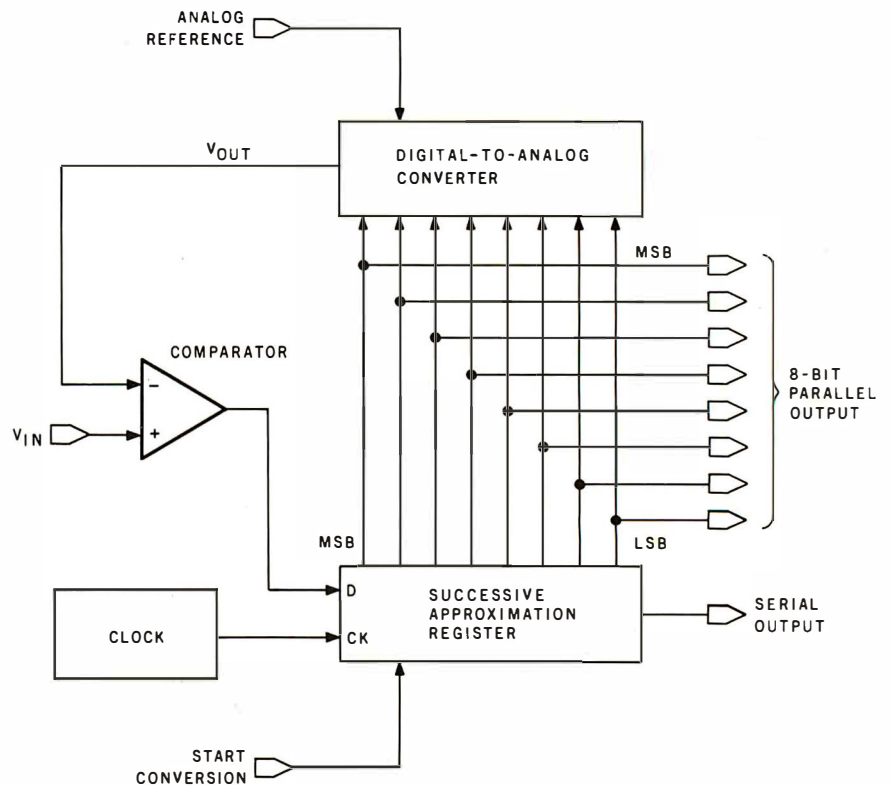
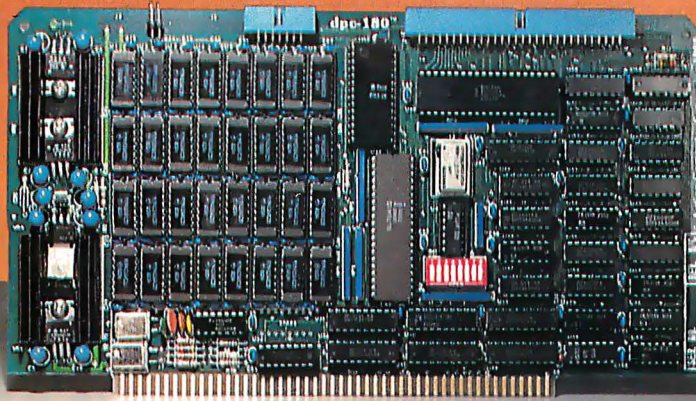
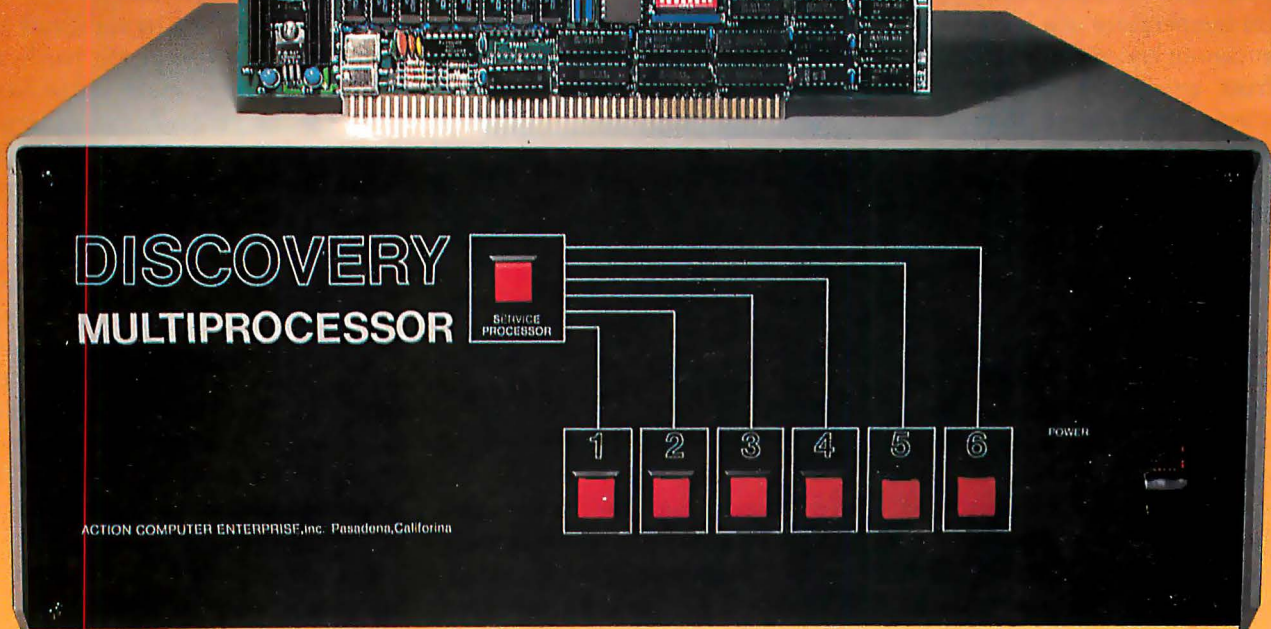

Figure 11: Block diagram of a typical 8-bit successive-approximation A/D-conversion system.

**This
Single
Board...**



**...is the Heart
of the
Microprocessor
World's
Best Multi-User
System ...**



THE DISCOVERY MULTIPROCESSOR

The dedicated power of this complete single board computer is provided to each user, making the DISCOVERY MULTIPROCESSOR unique among multi-user systems. With the power and expandability of distributed processing • With the economy of shared peripherals • With the flexibility of shared and public files • And all of this with full CP/M* and S-100 compatibility.

Multiprocessing Software Multiprocessing Hardware

Our Distributed Processing Operating System, **dpc/os**[®], resides in the Service Processor, establishing a CP/M environment for each user and managing access to the shared system resources. Multiuser facilities are provided for print spooling, for interprocessor communication and for private, public and shared-update files. Several processors can be employed concurrently by a single user via the enhanced batch submit facilities. And with **DISCOVERY** all CP/M compatible programs will execute without modification, thus protecting your software investment.

The ACE 64K Distributed Processing Single Board Computer, the **dpc-180**[™] gives the **DISCOVERY** MULTIPROCESSOR its own unique architecture. One DPC is dedicated to each user providing exclusive use of the onboard Z-80, 64K ram and serial I/O. Access to the shared resources is provided by an expanded DPC used as a Service Processor. Additional users can be added at any time by simply inserting additional DPC's into the standard S-100 bus — up to a total of sixteen user processors in a single chassis!

*CP/M is a registered TM of Digital Research, Inc.

DISCOVERY has been proven in installations throughout the World. If you need the Power of Multiprocessing... it's time you discovered us!

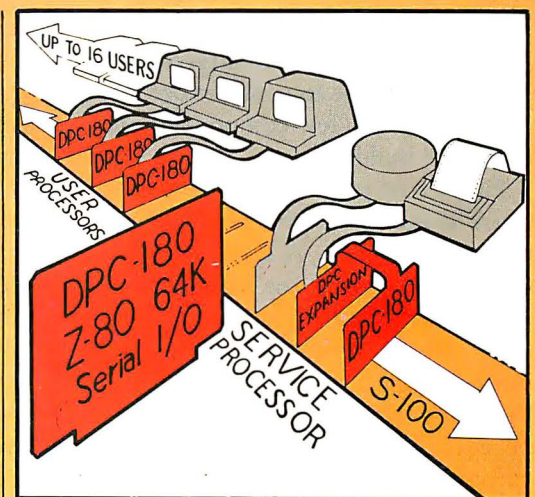

The ACE **DISCOVERY MULTIPROCESSOR** dedicates a complete 64K Z-80 Distributed Processing single board Computer, the **dpc-180**[™] to each user. An expanded DPC coordinates all of the system activities.

Multiuser mainframes with 192K ram start at under \$6000. The 64K **dpc-180**[™] is priced at \$1395. Immediate delivery. A complete line of standard peripherals including a 26M byte hard disk subsystem can be supplied on request. Dealer and OEM inquiries are invited.

Action Computer Enterprise, Inc.
The Multiprocessing Company

55 West Del Mar Boulevard, Pasadena, California 91105 USA • Cable ACEPAS Pasadena • (213) 793-2440

able price/performance ratio is often more important than wide-range capability. Analog-to-digital conversion is considerably more expensive than digital-to-analog conversion, and price is directly related to resolution and accuracy.

The A/D converter that scans thermistor probes and controls the ambient temperature in a large supermarket cannot encode video information from an optical scanner. A/D converters, much more than D/A converters, are specifically tailored to an application. Speed, accuracy, and resolution are variables in any converter design, but the blending of these choices can greatly affect the cost in A/D conversion.

Most confusing is the variety of A/D-converter designs. They range from very slow, inexpensive techniques to ultrafast, expensive ones. Ultimately, you get what you pay for. In the limited space available, I shall present the more practical approaches. For further information on other techniques, I recommend the sources listed at the end of the article.

Binary-Counter A/D Converter

If you plan to build an analog-to-digital converter, the binary-counter design is the type to consider because it uses relatively few components and is easy to build.

Figure 8 on page 84 shows the basic block diagram for the binary-ramp-counter converter. A D/A converter is used to reconvert the digital output of a binary counter back to analog form for comparison against the analog input. If at any instant during the count the two signals are found to be equal, whatever binary value is currently set on the D/A input is deemed to be our A/D output.

The simplest way to operate the system is to start the counter initially at a zero count and allow it to count until the D/A reading equals or exceeds the analog input. The only consideration to keep in mind when designing this type of circuit is that the clock frequency sent to the D/A converter cannot be faster than the combined response of the comparator and D/A converter. If it takes 100

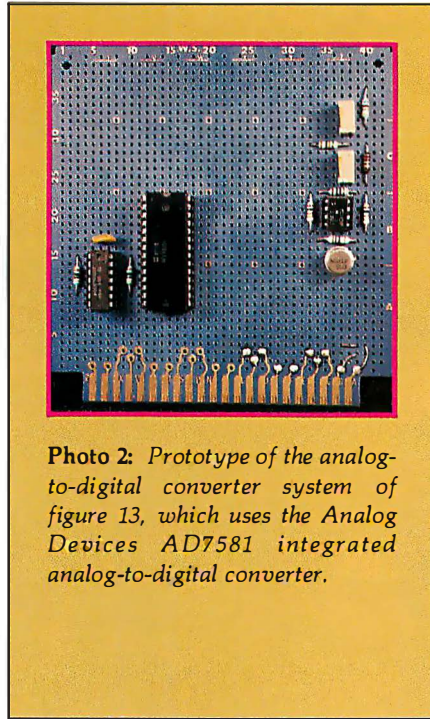

Photo 2: Prototype of the analog-to-digital converter system of figure 13, which uses the Analog Devices AD7581 integrated analog-to-digital converter.

microseconds (μs) for these components to settle out, the maximum counter-incrementing rate should be 10 kilohertz. For an 8-bit converter (counting from 0 to 256 each sample period), the maximum sample rate is 10,000/256, or about 39 samples a second. In practice, however, 5 μs is a more reasonable settling time, with about 750 samples per second.

Figure 9 on page 86 shows the schematic diagram of a binary-ramp converter. The counter output is connected to the MC1408-8 to provide a direct-feedback analog comparison of the value set on the counter.

Initially, IC4 and IC5 are cleared, and the D/A-converter output should be at whatever the minimum input voltage will be. For a 0- to 5.12-V converter, this would be 0 V; for a -2.56- to +2.56-V unit, it would be -2.56. If the output of IC1 is less than V_{IN} , the clock pulses are allowed to reach the counter. As each pulse increments the counter, the output of the D/A converter keeps rising until it eventually equals or just exceeds V_{IN} on the comparator. When this happens, additional clock pulses are inhibited. At the end of the sample period, the count values on IC4 and IC5 are stored in a separate register.

For the computer to read this data, it is merely necessary to connect this

register to an input port and read it directly.

The circuit of figure 9 can stand alone. It does not require a computer for operation. The A/D converter updates itself at a preselected sample rate and loads this value into an 8-bit latch. All functions of the conversion are performed in hardware.

If you are willing to substitute the computer for a few of the hardware blocks in figure 9, much of the hardware can be reduced. For example, parameters for an AD558 D/A converter can be loaded directly from a program and its output compared to the unknown input voltage.

If the comparison is negative when read through an input port, the AD558 is incremented and the comparison repeated. At some point the comparison has a true result, and that value is the desired digital result. Shown in figure 10 on page 88, the entire circuit requires only two chips.

Successive Approximation

A simple binary-ramp counter should suffice for noncritical data acquisition. However, such devices are slow. Each sample can take as many as 256 iterations of the program. This is especially critical in a software-driven converter where each iteration may take 20 or 30 μs for execution of all the instructions. For faster sampling rates, a technique called *successive approximation* is used.

Figure 11 is a block diagram of a typical successive-approximation A/D converter. Like the binary-ramp converter just discussed, this converter also uses a D/A converter in the feedback loop, but the binary counters are replaced with a special successive-approximation register (SAR).

Initially, the outputs of the successive-approximation register and the mutually connected D/A converter are at a zero level. After a start-conversion pulse is received, the SAR enables its bits one at a time starting with the most significant bit. As each bit is enabled, the comparator gives an output signifying that the input signal is greater or less in amplitude than the output of the

Development Software For Texas Instruments TM990 Micro Modules

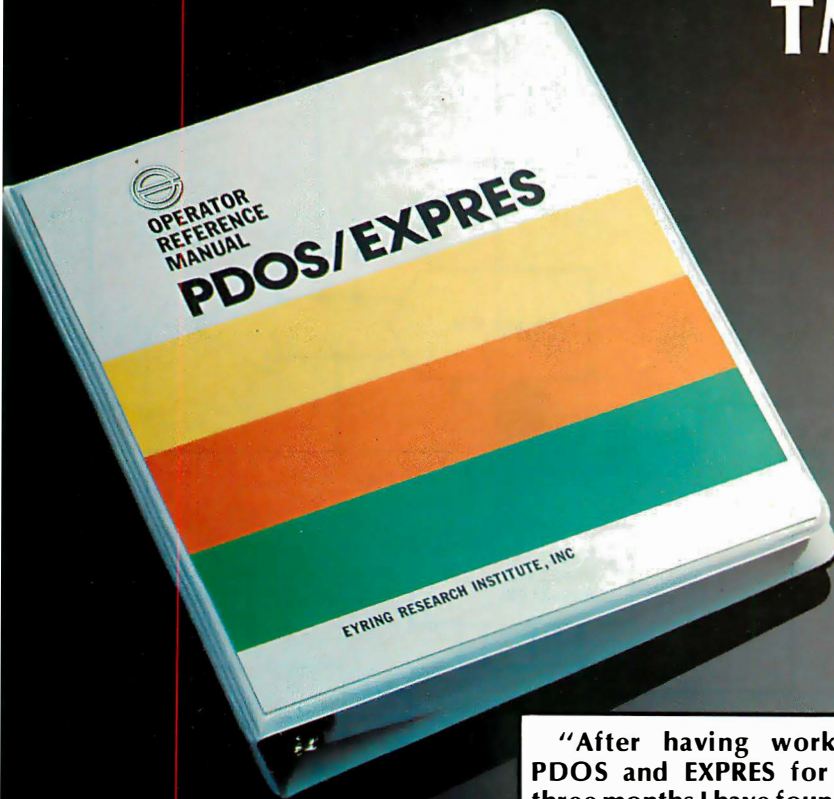

"After having worked with PDOS and EXPRES for the past three months I have found them to be a powerful and versatile combination. The true multi-user, multi-tasking capability has made it a pleasure to use in our laboratory environment where programs are being used simultaneously for controlling laboratory apparatus taking and reducing data. . . We are enthused by the product. . ."

Tom Ochs
Assistant Research Professor
Desert Research Institute

Eyring Research Institute, Inc., authors of TI's POWER BASIC™ and UNIVERSITY BASIC™, is pleased to release development software for use on the TM 990 microcomputer modules. PDOS/EXPRES™ is a powerful multi-user, multi-tasking operating system designed for development, scientific and industrial applications.

The PDOS/EXPRES™ system includes:

- 8k byte PDOS multi-tasking operating system
- Advanced EXPRESS BASIC language interpreter
- Stand alone run module support

PDOS supports up to 16 concurrent user tasks with prioritized round robin clock swapping. Up to 32 contiguous or non-contiguous files can be simultaneously open in sequential, random, shared and read only access modes. Large or small floppy disks, bubble memory, hard disks

and extended memory capabilities of up to 256k bytes are handled by the operating system. Named files on 256 directory levels are easily accessible from EXPRES BASIC and assembly language programs. Disk files are time stamped with date of creation and last update. I/O drivers are a simple extension to the PDOS file structure.

The EXPRES BASIC interpreter uses advanced interpreting techniques which approach execution speeds of common threaded code compilers while maintaining the highly advantage-

ous interactive approach to program development. Other features include:

- Multi-line recursive functions with local variables
- Variable names of unlimited length
- Reverse Polish pseudo-source token storage

PDOS/EXPRES™ is available for either an EPROM based system or a RAM based system. A handsome 250 page Operator Reference Manual walks you through the features and use. All for an attractive price of \$1500.00*.

Order your PDOS/EXPRES™ software from your nearest authorized Texas Instruments distributor or contact Eyring Research Institute, Inc. for further information and a free color brochure. Write or call Eyring Research Institute, Inc., Software Marketing Dept., 1455 West 820 North, Provo, Utah 84601, phone (801) 375-2434.

© Eyring Research Institute, Inc.

*U.S. price, subject to change without notice

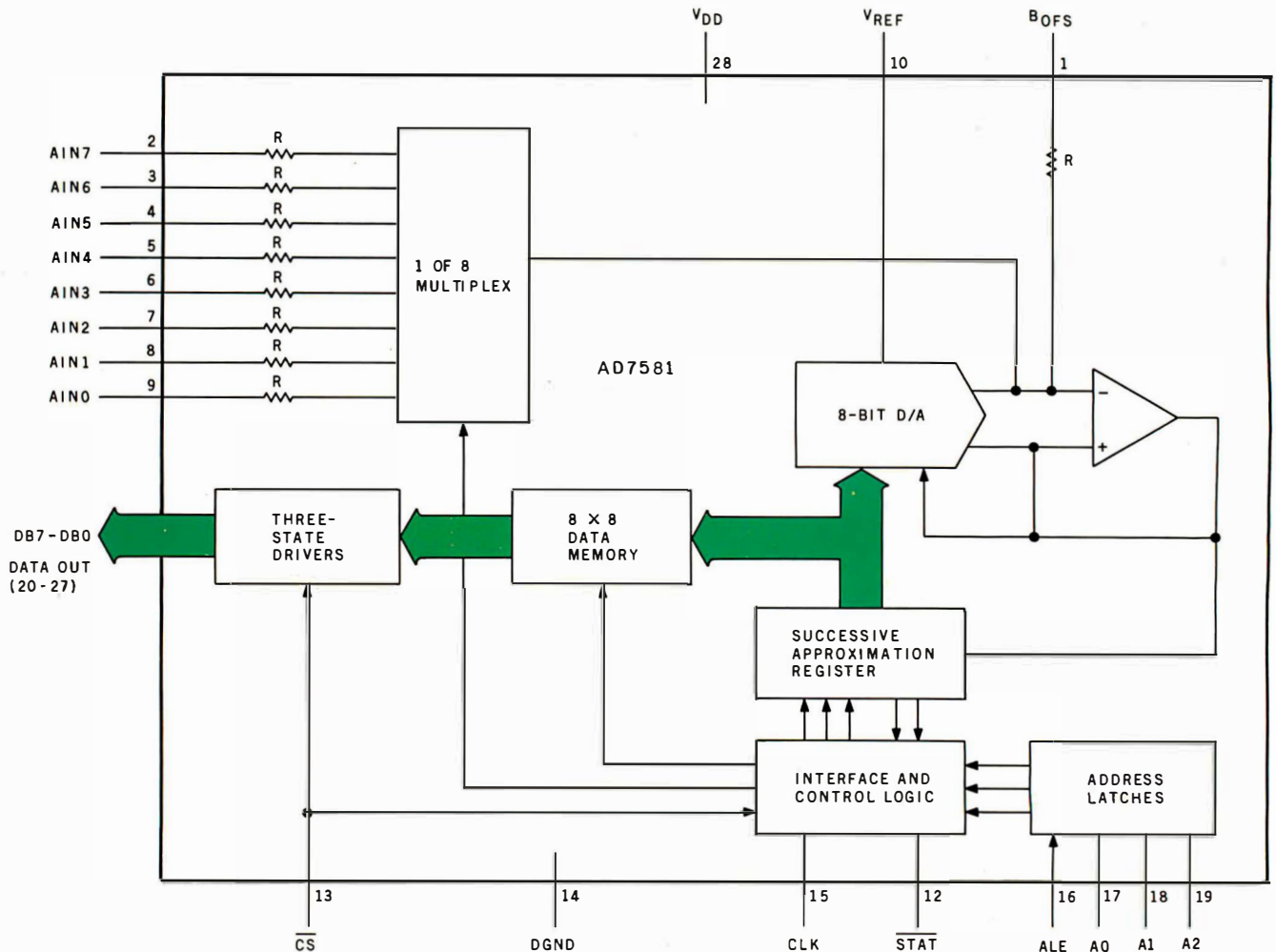

Figure 12: Functional block diagram of the Analog Devices AD7581 A/D converter.

D/A converter. If the D/A output is greater than the input signal, a 0 is set as the value of the corresponding output bit. If the D/A output is less than the input signal, the circuit sets the corresponding bit to a 1. The register successively moves to the next bit (retaining the settings on the previously tested bits) and performs the same test. After all the bits have been tested, the conversion cycle is complete. In contrast to the 256 clock pulses of the binary-counter method, the entire conversion period of the successive-approximation A/D converter takes only eight cycles. (It is possible to use the circuit of figure 10 as an SAR converter simply by having the program perform a successive-approximation comparison rather than a strict binary addition.)

8-Channel 8-Bit Converter

The majority of commercial monolithic A/D converters presently

available use SAR-conversion techniques. Advances in integration processes have arrived at the point where almost an entire data-acquisition system can be built on a single chip. This is the case with the Analog Devices AD7581 8-bit 8-channel data-acquisition system. A block diagram is shown in figure 12.

The AD7581 connects directly to the microcomputer bus through three-state bus drivers and appears to the computer as eight sequential memory or input-port locations. This single 5-V CMOS (complementary metal-oxide semiconductor) chip contains an 8-channel successive-approximation A/D converter and an on-chip 8- by 8-bit dual-port memory.

In functioning, the AD7581 scans the eight inputs and loads the values in an 8-byte register. When the computer reads data from these address locations, it reads the value stored

during the converter's most recent scan. Each conversion requires 80 μ s (at a 1-megahertz clock rate) and 640 μ s for a complete channel scan. The normal conversion range is 0 to +10 V on each input.

Figure 13 is the schematic diagram of a typical AD7581 interface. IC1 and IC2 are an AD581 voltage-reference chip and MC1458 op amp. IC2 inverts the output of IC1 to produce a -10.00-V reference input for the AD7581. The other half of IC2 is used as an offset-adjustment input for the AD7581.

Two control lines, ALE (address latch enable) and \overline{CS} (chip select), facilitate computer synchronization. Normally, the ALE line can be tied high on computers that send the address out on the address-bus lines A0 through A7 during memory and I/O transfers. Reading the proper input channel requires only logical-

Text continued on page 98

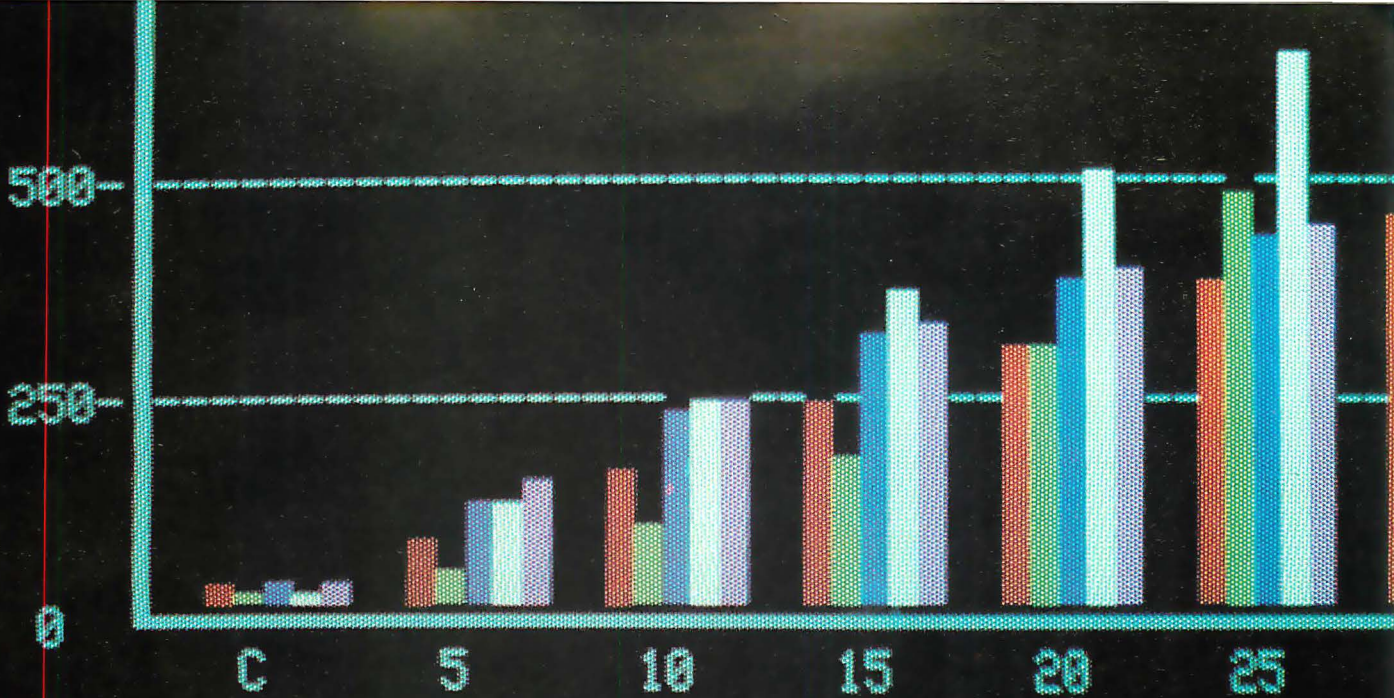

Money-back guarantee for computer professionals:

Buy factory-direct from Intelligent Systems.

It took hard work and experience for you to become a leader. Same here. Founded in 1973, we were the first company to ship 20,000 color graphics units. We sell to computer professionals—not through computer stores. So, if you don't need a salesman to tell you what you need, try this unique offer:

A factory-direct, money-back guarantee for our 3650 color graphic desktop computer with 56K of memory for only \$1995—plus your choice of either an internal 5¼" 92K Floppy Mini Disk Drive for \$395, or an external 8" Floppy Disk Drive for \$895! (These prices good only with this offer.) You can buy only one unit before 12/31/81, cash with order. Use it for 30 days; if you're not sold on the merits of your color graphic computer, return it. We will refund the full purchase price

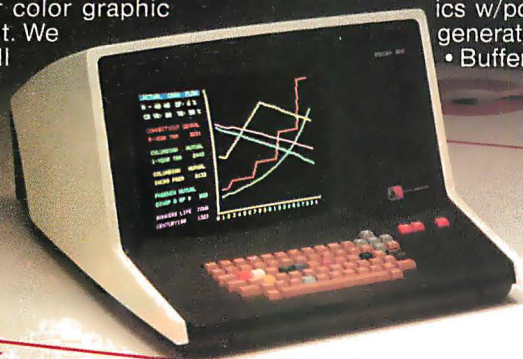

\$1995
Money-Back Guarantee

and your only cost would be transportation charges to and from Norcross, Georgia.

Why such a dramatic offer? Intelligent Systems was built around the needs of computer

professionals. We sell primarily through OEM's and want to introduce the dynamics of color graphics to professionals like yourself—so you can help us introduce color graphics in your company.

Features Included for \$1995:

- 56K total memory, 32K user RAM, 4K disk buffer RAM, 4K refresh RAM, 16K ROM (includes extended disk BASIC)
- 13" raster scan color CRT • 8 foreground colors w/blink and 8 background colors • 64 col./32 line • 64 ASCII & 64 graphics characters • 128H x 128V graphics w/point, bar & vector generators • RS232C port • Buffered bus connector

- 72 key professional keyboard • User's Manual & sampler disk • Factory Warranty: 90 days parts & labor

And Your Choice of:

- Internal 5¼" 92K disk drive: \$395 • External 8" 295K disk drive: \$895 (These prices good only with this offer.)

Options Include:

- 101 key keyboard: \$100 • 117 key keyboard: \$250 • blank 8K board for add-on EPROM: \$75 • One-year Factory Service Contract: \$350

Software Available: BASIC is standard; you can add Fortran for \$75. Text editors, assemblers, other utilities available. Also, hundreds of additional programs, including ColorCalc™, ColorGraph™, as well as programs for education, accounting, WP, statistics, etc.

Will your information processing be more comprehensible in color graphics (or color slides) in management meetings? If so, act now. For details, call Marketing Services at 404/449-5295.



Intelligent Systems

COLOR COMMUNICATES BETTER

Intecolor Drive • 225 Technology Park/Atlanta
Norcross, Georgia 30092/Phone 404/449-5295

Unretouched photos of screens.
This offer, not available through computer stores,
expires 12/31/81. U.S. domestic prices.



OUR MEDIA IS

Over the past seven years we've earned a name for ourselves by making the best magnetic media in the business. Precision magnetic media — Diskettes, Mini Diskettes, Diagnostic Diskettes, Rigid Discs, Disc Packs, and Disc Cartridges — all certified to be 100% error free both on-track **and** between the tracks.

Now we're making it easier for you to buy the best. Just dial Dysan direct TOLL FREE at 800/538-8150 or 408/988-3472 (in California) or contact your local Dysan office listed below.

Precision magnetic media from Dysan. Our media says it all.



Dysan
CORPORATION

5440 Patrick Henry Drive
Santa Clara, CA 95050
408/988-3472



Call your local Dysan office:

- Irvine, CA (714) 851-9462
- Sunnyvale, CA (408) 730-2145
- Atlanta, GA (404) 952-0919
- Schaumburg, IL (312) 882-8176
- Burlington, MA (617) 273-5955
- St. Louis, MO (314) 434-4011
- Glendora, NJ (609) 939-4762
- New York, NY (212) 687-7122
- Bellevue, WA (206) 455-4725

Watch for new offices opening soon. For further information, call our Corporate Marketing Department at (800) 538-8150.

Circle 137 on inquiry card.

OUR MESSAGE.

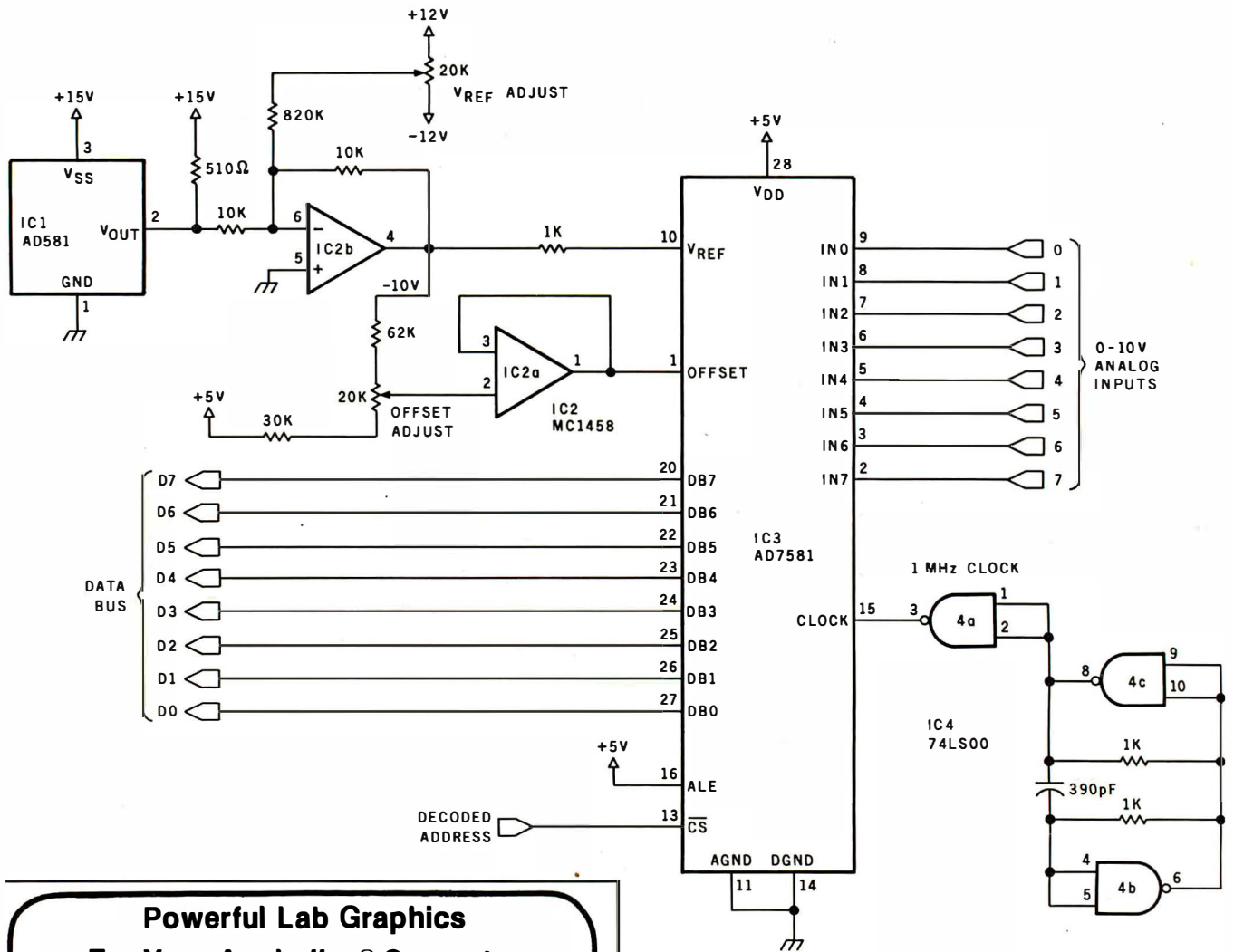

Number	Type	+ 5 V	GND	- 15 V	+ 15 V
IC1	AD581		1		3
IC2	MC1458			4	8
IC3	AD7581	28	14		
IC4	74LS00	14	7		

Figure 13: Schematic of an 8-channel 8-bit data-acquisition system using the AD7581. Because of the dual-port memory design of the AD7581, the eight analog-input channels appear to the host processor as eight addressable memory locations.

Powerful Lab Graphics For Your Apple II+® Computer

SCIENTIFIC PLOTTER

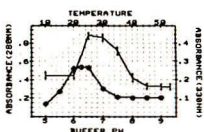

VIDICHART™



CURVE FITTER

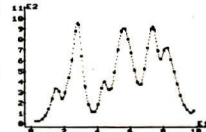

SCIENTIFIC PLOTTER

48K APPLE II+, \$25
Draws professional-looking graphs of your data. EASIER, FASTER, NEATER and more ACCURATE than handplotting. You choose data format, length and position of axes, 20 symbols, error bars, labels anywhere in 4 orientations, etc. Includes 5 DEMOS on disk with 30-PAGE MANUAL.

CURVE FITTER

48K APPLE II+, \$35
Selects the best curve to fit your data. SCALE, TRANSFORM, AVERAGE, SMOOTH, INTERPOLATE (3 types), LEAST SQUARES FIT (3 types), EVALUATE UNKNOWNNS from fitted curve. Includes 5 DEMOS on disk with 33-PAGE MANUAL.

VIDICHART™

48K APPLE II+, \$75
NEW tools for lab data management. FAST plots of 4 data sets with SCROLLING in 4 directions, ZOOM scaling on X and Y axes, 2 types of graphic CURSORS and on-screen STATUS REPORT. PLOTS A/D INPUT while sampling. ADD, SUBTRACT, MULTIPLY, DIVIDE, INTEGRATE, DIFFERENTIATE, AVERAGE or NORMALIZE data sets with SIMPLE COMMANDS. Ideal for spectra, chromatograms, rate curves, etc. Includes SAMPLE DATA on disk with 28-PAGE MANUAL.

SPECIAL! All 3 programs on one disk, only \$120. Since each program uses the same data format on disk, data may be shared.

BUY THESE PROGRAMS AT YOUR LOCAL DEALER OR ORDER DIRECT. For more information, ask for FREE brochure or send \$5 for any manual (\$12 for all 3), deductible with purchase. Add \$1.50 shipping on all orders. For fastest service, call in your VISA or Master Card order.



INTERACTIVE MICROWARE, INC.
P.O. Box 771, Dept. B State College, PA 16801
CALL (814) 238-8294 for IMMEDIATE ACTION

® Trademark of Apple Computer, Inc.

No business is too **NORTH STAR** small for a



Our new HORIZON computer lets you make beautiful music.

HORIZON® is our multi-user system that supports up to five simultaneous users at a cost per user that is the best in the industry.

With it, you can use up to five terminals performing word processing, accounting activities and information management—in perfect harmony.

Two packaged systems are available—the TSS/5, a 5Mb version and the TSS/18, an 18Mb version. Solo HORIZONS can expand to duets, trios, quartets or quintets with North Star's TSS/A Application System or North Star's TSS/C Multi-user CP/M®.

When you purchase the HORIZON multi-user system, you receive worldwide service, support and the most widely used small business computer in the world. (There are some 30,000 HORIZONS conducting

business around the world.)

To find out how you can orchestrate your own kind of beautiful music, clip and mail this coupon, or call TOLL FREE 800-447-4700. (Illinois 800-322-4400, Alaska/Hawaii 800-447-0890.)

North Star Computers, Inc.
14440 Catalina St., San Leandro,
CA 94577 USA (415) 357-8500
TWX/Telex (910) 366-7001



Yes, I'd like more information on North Star's multi-user system performance.

NAME _____

COMPANY _____

ADDRESS _____

CITY _____

STATE _____ ZIP _____

PHONE _____

B1281

The North Star logo and HORIZON are trademarks or registered trademarks of North Star Computers, Inc.
©1981. North Star Computers, Inc.

FOLLOW THE STAR
NorthStar™

**NEVER
UNDERSOLD!**

**We Meet or Beat
Any Advertised Price!
NORTHSTAR**

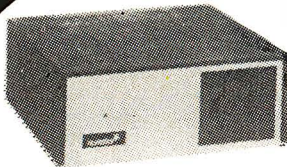

**HORIZON II
64k Quad Density**
•2 5/8" Dbl Side
Dbl. Density Drives
•Full Factory Warranty
•List \$4495

**PCB PRICE
ONLY**

\$3275

**HORIZON II
32k Double Density**
Reg. \$3695 **\$2695**

**HORIZON II
64k Double Density**
Reg. \$4195 **\$3050**

**HORIZON II
32k Quad Density**
Reg. \$3995 **\$2895**

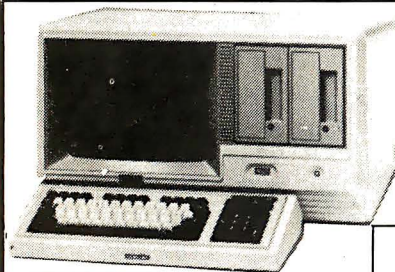

**TOSHIBA
WORD PROCESSING**

64k Main Memory, 2-5 1/4" floppydrives,
45 cps daisy wheel printer. LIST 7995

\$6695

TOSHIBA

64k Quad density, 5 1/4" drives. CP/M, MBasic80 and CBasic II

\$3495

64k QD, 8" drives, 2mb storage.
CP/M, MBasic80 and CBasic II
\$4495

SUPERBRAIN™

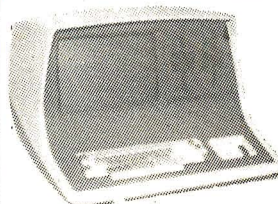

64k Quad Density

\$2950

64k Double Density

\$2650

PRINTERS

COMET 8300 C.1toh	\$450
COMET II C.1toh parallel	\$795
EPSON MX80 parallel	\$479
EPSON MX80 RS232	\$549
EPSON GRAFTRAX UPGRADE	\$90
STARWRITER 25cps parallel	\$1495
STARWRITER 25cps RS232	\$1650
STARWRITER II 45cps parallel	\$1795
STARWRITER III 40 cps RS232	\$1750
NEC 7710 RS232	\$2395
NEC 3510 RS232	\$1895
MPI 88G List \$749	\$550

5 1/4" DISK DRIVES

Tandon CDC Single Side Double Density	\$225
Tandon CDC Double Side Double Density	\$350
Tandon 100-4 80 track	\$600
Seagate 5mb Hard Disc ST-506	\$1350

DISKETTES

Verbatim 525-01	Box of 10 \$29
Dysan 5 1/4, SS, DD Soft.	Box of 10 \$34

HARD DISKS

CMC 5mb for TRS-80, Superbrain, Heath H-89, S-100	\$3495
\$2795	
CORVUS 10mb LIST \$5350	\$4295
20mb LIST \$6450	\$5300
Mirror Backup	\$650
Multiplexer	\$775

TELEVIDEO

910C	\$595
912C	\$665
920C	\$720
950	\$950

LANGUAGES

C Basic II	\$98
M Basic 80	\$275
MT Pascal	\$430
Fortran 80	\$450
Cobol 80	\$650
M Basic Compiler	\$329

SUPERBRAIN

S-100 Bus Adapter	LIST \$595 \$475
SUPERBRAIN Parallel Port	LIST \$90 \$75
	LIST \$205
SBE Prom	\$155

GRAPHICS

Graphics board	\$895
Symbol Generator	\$200
Graphics Plotter	\$200
3-D Graphics	\$400
Surface Plotter	\$450
Graphics Terminal	
Emulator	\$450

To Order Call (206) 453-8159

Mail and telephone orders only. Mastercharge, VISA add 3%. No COD. All prices FOB origin. Send for catalog. Mail all correspondence to P.O. Box 3952, Bellevue, Wa. 98009

PACIFIC COMPUTER BROKERS

11056 Palatine North, Seattle, WA 98133

Text continued from page 92:

ANDING the read-enable line and a chip-select signal.

In Conclusion

Anyone who has ever built an analog I/O interface for a computer will immediately recognize the significance of these two products from Analog Devices. For the first time, analog-interfacing components are being correctly referred to as data-acquisition systems, rightly so because virtually everything is provided.

Another important consequence of such cost-effective components is their eventual integration into many more computer-based systems. Some day, even games and pocket calculators will be able to make an instant inventory of their "real-world" environment and react accordingly.

Next Month:

Build a computerized weather monitor.

References

1. *Analog-Digital Conversion Handbook*. Norwood, MA: Analog Devices, Inc., 1976.
2. Carr, Joseph J. *Microcomputer Interfacing Handbook: A/D and D/A*. East Norwalk, CT: Tab Books, Inc., 1980.
3. Ciarcia, Steve. *Build Your Own Z80 Computer*. Peterborough, NH: BYTE Books, 1981.
4. Ciarcia, Steve. "Control the World! (Or at Least a Few Analog Points)." *BYTE*, September 1977, page 30. Reprinted in *Ciarcia's Circuit Cellar*, Volume I. Peterborough, NH: BYTE Books, 1979, page 47.
5. *Digital-to-Analog Converter Handbook*. Bedford, MA: Hybrid Systems Corporation, 1970.
6. Garrett, Patrick H. *Analog I/O Design*. Reston, VA: Reston Publishing, 1981.
7. Hnatek, Eugene R. *A User's Handbook of D/A and A/D Converters*. New York: Wiley-Interscience, 1976.

Editor's Note: Steve often refers to previous *Circuit Cellar* articles as reference material for the articles he presents each month. These articles are available in reprint books from *BYTE Books*, 70 Main St., Peterborough, NH 03458. Ciarcia's *Circuit Cellar* covers articles appearing in *BYTE* from September 1977 through November 1978. Ciarcia's *Circuit Cellar*, Volume II presents articles from December 1978 through June 1980.

To receive a complete list of Ciarcia's *Circuit Cellar* kits available from the Micromint, circle 100 on the inquiry card.

C ~~AND~~ Pascal

Efficiency ~~AND~~ Portability

Flexibility ~~AND~~ Strong Typing

Now you don't have to compromise!

Whitesmiths Ltd. now offers portable language development systems for four families of computers. Approximately one thousand installations use our software.

We support complete versions of both C and Pascal, as compilers and cross-compilers. You get C automatically when you license Pascal, and you get native support with each cross-compiler. Test the software on your VAX before burning PROMs for your 68000 or 8080.

Whitesmiths Ltd. offers a variety of licensing arrangements, the simplest being a binary license for use on a single CPU. The full source code is available with internal documentation. Maintenance, training and sublicensing rights may also be obtained.

Call or write for more information.

Source Operating Systems	Target Machines			
	8080/Z80	LSI-11/PDP-11	VAX-11	M68000
8080/Z80 CP/M	C: \$750 Pascal: \$950	*	*	*
LSI-11/PDP-11: Ildris, Unix, RT11, RSX-11/M, RSTS/E, IAS	C: \$1350 Pascal: \$1550	C: \$750 Pascal: \$950	*	C: \$1350 Pascal: \$1550
VAX-11 Unix/V32 VMS	C: \$1350 Pascal: \$1550	*	C: \$750 Pascal: \$950	C: \$1350 Pascal: \$1550
M68000 VERSA dos	*	*	*	C: \$750 Pascal: \$950

Ildris is a trademark of Whitesmiths, Ltd. ■ Unix is a trademark of Bell Laboratories ■ CP/M is a trademark of Digital Research Company ■ VMS, RSX-11/M, RSTS/E, LSI-11, VAX, are trademarks of Digital Equipment Corporation ■ VERSA dos is a trademark of Motorola Corporation

* Special Order

Protect your software investment.

Whitesmiths, Ltd.

P.O. Box 1132 Ansonia Station New York, N.Y. 10023 (212) 799-1200 Telex 645 592

Distributors: **Australia**
Fawnray Pty Ltd.
Hurstville, NSW
02 570 6100

Japan
Advance Industries
Chiyoda-ku, Tokyo
03-258-0839

United Kingdom
Real Time Systems
Newcastle upon Tyne
0632 733131

MIKBUG and the TRS-80

Part 2: A File Transfer and Debugging Package

Robert Labenski
145 Steele Rd.
West Hartford, CT 06119

Last month in part 1, I presented a 6800 editor/cross-assembler that allows a TRS-80 Model I to produce object code for a MIKBUG system. In this concluding part, I'll present a file-transfer and debugging package called the MOM6800. It can make your TRS-80 act like an enhanced MIKBUG terminal with disk storage of your 6800 object-code files. (Your

TRS-80 must be equipped with a disk drive and an RS-232C interface. Your 6800 system should be equivalent to the Motorola MEK 6800 D1 with the MIKBUG monitor.)

Features of the MOM6800

The 6800 MIKBUG and TRS-80 are linked via their RS-232C interfaces. MIKBUG thinks the TRS-80 is an I/O

(input/output) terminal, which means that the TRS-80 can communicate only via standard MIKBUG commands. However, the MOM6800 program interprets your input, allowing you to use MIKBUG commands plus some extras, including file transfer, display of 16 bytes of memory (Dxxxx), and execution at a specified address (Gxxxx).

When you're running the MOM6800 program, you'll see the "*" prompt (à la MIKBUG). Whenever this is displayed, you can enter a normal MIKBUG command. To use one of my added commands, press the "@" key. This produces a new prompt, CMD=>, that indicates that you may enter any of the commands given in table 1.

Some of these enhanced commands may take a while for completion, since they require a fair amount of communication between computers.

How to Use the MOM6800

There are two parts to the MOM6800 package: an initialization program, written in Z80 assembler code, and an enhanced monitor program, written in BASIC. The initialization program is given in listing 1; the monitor program in listing 2.

Using a Z80 editor/assembler,

Text continued on page 107

Command	Description
L	Load an assembled program into the 6800 system. Unless you've already used this command in this session, you will be prompted for the name of the TRS-80 disk file containing the object code. You can only load programs created by the cross-assembler presented last month. The program will be loaded and transferred automatically to the 6800 system. Each byte will be echoed in hexadecimal on the TRS-80 screen.
Dxxxx	Display 16 bytes of 6800 memory starting at hexadecimal xxxx.
Gxxxx	Start execution at hexadecimal xxxx. (Using ordinary MIKBUG commands, this would be equivalent to loading xxxx into hexadecimal addresses A048-A049 and executing a G (go).)
S	List the source code currently in TRS-80 memory. The format will be that of my cross-assembler. To pause the scrolling display, press SHIFT @. To continue, press ENTER.
B	Set or reset a breakpoint. Up to ten are available, numbered 0-9. When you set a breakpoint, the monitor will enter an SWI into the address you specify and save the previous contents of that address. When the breakpoint is taken during execution, MIKBUG will stop and display the register contents. The PC (program counter) will point to the breakpoint address. To continue after a breakpoint, reset the breakpoint and use the G command.
H	Display a "help" menu.

Table 1: A summary of commands available in the MOM6800 monitor program. Notice the additions to the ordinary MIKBUG commands. In addition to these, you can use any of the standard MIKBUG commands: Mxxxx, G, R, P, and L.

We give you one thing other car rental companies don't. Everything.

Guaranteed pricing.

There are no surprises at Hertz. Just ask us and we'll tell you in writing what your final rental charges are before you go.*



Special deals on vacation wheels.

Whether you're going to Florida, California or anywhere in the world, Hertz has special

deals to make your vacation dollars go farther.



No charge for mileage.

At Hertz, we give you free, unlimited mileage—any car, anywhere, round-trip or one-way.*

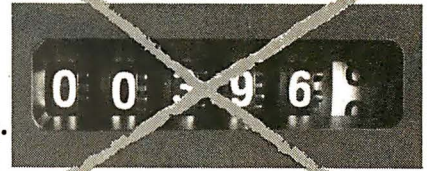

Fast take-offs from airports. When you reserve your Hertz car, ask for our #1 Express Service™ and you can go right from your plane to your car without stopping at the rental counter.

(Available at most major airports.)



More help to help.

Hertz has more friendly people ready to help you than anyone. So call 1-800-654-3131 for reservations and we'll take it from there.



The world's largest fleet. With a fleet of cars big enough to stretch from Detroit to New York, chances are we've got the car you want—when you want it.



*Guaranteed Pricing available at all Hertz corporate and participating licensee locations in the U.S. Refueling charges and state and local taxes are not included. On some one-way there may be a drop-off charge.

#1 For Everyone.

Hertz rents Fords and other fine cars.

Buy with Confidence from the best

GREAT PRICES. GREAT SERVICE. GUARANTEED COMPUTERS, PRINTERS, TERMINALS

Apple IEEE-488 card now available

CALL TOLL FREE: 1 800 421-1520 In Calif. 213 320-4772

COMPUTERS & TERMINALS

COMPUTERS:
 Altos
 Apple
 Atari
 Commodore
 Hewlett-Packard
 B.M.C.
 Interlec/Superbrain
 N.E.C.
 Northstar
 Onyx
 Point Four
 Sharp
 Televideo
 Vector

VIDEO TERMINALS & MONITORS:
 Xerox
 Zenith
 ADDS
 Amdek
 Ampex
 Apple
 B.M.C.
 Hazeltine
 I.B.M.
 Lear-Siegler
 N.E.C.
 Sanyo
 Soroc
 Televideo
 Zenith



PRINTERS

THERMAL
 Apple
 Trendcom

DOT MATRIX
 Anacom
 Anadex
 Centronix
 Commodore

LETTER QUALITY
 Epson
 I.D.S./Paper Tiger
 Microline/Okidata
 M.P.I.
 Novell
 Texas Instruments
 Diablo/Xerox
 N.E.C.



ACCESSORIES

80 COLUMN VIDEO CARDS
 Double Vision
 Smart-Term
 Videx

LOWER CASE ADAPTERS
 Dan Paymar

INTERFACE CARDS
 Apple
 California Computer
 Mountain Computer
 Microsoft
 S.S.M. Products
 Thunderclock

LANGUAGES
 Basic Compiler
 C.I.S. Cobol

OTHER PRODUCTS
 Bar Code Readers
 Card Readers
 Game Controls
 Graphics Tablet
 Music System
 Numeric Keypads
 Programming Aids
 Type-and-Talk
 Video Digitizers
 Voice Entry

CP/M
 Fortran
 Pascal
 Vanguard AP/L

The best non-technical "How to Choose a Computer Book for Laymen," \$12.95. Complete Directory for Apple Software only \$14.95.



PRINTERS - MONITORS

MONITORS
 BMC & NEC Green Screen
 NOW IN STOCK

EDUCATORS
 We have the CORVUS systems to hook up several Apple computers at once!

NEC & DIABLO PRINTERS
 Anadex, Paper Tiger. CALL for latest prices

The new 136 column Epson printer with graphics and the Friction/tractor MX 80 are in stock. WE HAVE THE GRAPHIC PACKAGE FOR MX 80. coil.

SILENTYPE PRINTER ONLY \$284.00



ACCESSORIES - SOFTWARE

Amazing Mountain Hardware
 CPS Multi-function card
ALL IN ONE: Parallel/Serial/Clock/Calen

SOFTWARE

Visicalc 33	\$159/Reg	\$199	
BPI GL/INV/AR/etc	299/Reg	399	PLOTTERS
Tax Preparer by Howardsoft	79/Reg	99	Bauschn&Lomb plotters
Real Estate Analyzer Howardsoft	125/Reg	150	for your computer by
Creative Financing, Howardsoft	125/Reg	150	Houston Instruments
ASCII Express II by SDS	55/Reg	65	CALL!
Z-TERM (CPM) (16 sectors)	85/Reg	100	
TRS 80 & ATARI SOFTWARE TOO			

CALL TOLL FREE

MICROSOFT 16K Ramcard \$155

Dysan Disks for Apple, only \$3.95. Avery mailing labels, 5000 for only \$14.95.

20% OFF ALL SOFTWARE

Visit our retail store
 Net Profit Computers
 521 W. Chapman Ave
 Anaheim, Cal 92802
 714 750-7318

Mail orders ONLY:
 NET PROFIT COMPUTERS
 2908 Oregon Court, Bid G1
 Torrance, Ca 90503
 1(800)421-1520
 in Cal 213 320-4772

Listing 1: The Z80 program to initialize the RS-232C interface and set up input/output linkages from the TRS-80 to the MIKBUG system. Some of the code is from my Dasher printer driver; hence, the Dasher references.

Memory Location	Object Code	Statement Number	Source Code
		00020	; 6800 MIKBUG:TRS80 DRIVER PROGRAM
		00030	; WRITTEN BY ROBERT LABENSKI
		00040	
		00050	; 6800 DRIVER PROGRAM
		00060	; LPRINT FOR OUTPUT
		00070	; INPUT DEFSUBROUTINE
		00080	; B\$="" : B=USRO(CHARPTR(B\$))
		00090	; B#= DATA FROM 6800 : B=LENGTH OF DATA
4025		00100	ORG 4026H
4026	AFFE	00110	DEFW DOUT ; SET PRINTER JOB ADDRESS
4049		00120	ORG 4049H ; SET BASIC UPPER LIMIT
4049	ADFE	00130	DEFW DOUT-2
40B1		00140	ORG 40B1H ; SET BASIC MEM
40B1	ADFE	00150	DEFW DOUT-2
F800		00160	ORG 0FE80H
F800	D3E0	00170	START OUT (0E9H),A ; RESET SWITCH
F800	D8E9	00180	IN A,(0E9H) ; READ SWITCH
F804	E6F8	00190	AND 0F8H
F806	F604	00200	OR 04H
F808	D3EA	00210	OUT (0E9H),A ; SET CHR+SS+PARITY
F804	D8E9	00220	IN A,(0E9H)
F80C	E607	00230	AND 07H
F80E	21A7FE	00240	LD HL, TABLE
F810	0500	00250	LD B, 00H
F813	4F	00260	LD C, A
F814	09	00270	ADD HL, BC
F815	7E	00280	LD A, (HL)
F816	D3E9	00290	OUT (0E9H),A ; SET BAUD RATE
		00300	; INIT KEYBOARD
F816	2A1640	00310	LD HL, (4016H)
F817	23F8FE	00320	LD (KEND+1), HL
F818	21CAFE	00330	LD HL, KBFIX
F819	231640	00340	LD (4016H), HL
F81A	032040	00350	JP 4020H ; GO BACK TO DOS
F81B	22	00360	TABLE
F81C	44	00370	DEFB 22H
F81D	55	00380	DEFB 44H
F81E	66	00390	DEFB 55H
F81F	77	00400	DEFB 66H
F820	AA	00410	DEFB 77H
F821	CC	00420	DEFB 0AAH
F822	EE	00430	DEFB 0CCH
		00440	DEFB 0EEH
F823	E5	00450	; SEND DATA FOR THE PRINTER THERE
F824	05	00460	DOUT PUSH HL
F825	79	00470	PUSH BC
F826	F80D	00480	LD A, C ; TEST FOR
F827	2808	00490	CP 00H ; CR
F828	F80A	00500	JR Z, STATIN ; OK PASS
F829	2804	00510	CP 0AH ; LF
F82A	F820	00520	JR Z, STATIN ; OK PASS
F82B	3809	00530	CP 20H ; CONTROL CHARACTER
F82C	0BEA	00540	JR C, RETX ; DON'T PRINT
F82D	0877	00550	STATIN IN A, (0EAH) ; LOAD STATUS
F82E	28FA	00560	BIT 6, A ; TEST READY
		00570	JR Z, STATIN ; PTR BUSY LOOP
F82F	79	00580	; OUTPUT CHR
F830	D3EB	00590	LD A, C
F831	C1	00600	OUT (0EBH), A ; SEND IT OUT
F832	E1	00610	POP BC
F833	C9	00620	POP HL
		00630	RET
F834	32F6FE	00640	; GET DATA FROM DASHER
F835	D8EA	00650	LD (ASAVE+1), A ; SAVE ACC
F836	0BEA	00660	IN A, (0EAH) ; ANY DATA
F837	8BF7	00670	BIT 7, A ; FROM THE DASHER
F838	2822	00680	JR Z, ASAVE ; NO EXIT TO CK THE TRS KB
F839	D8EB	00690	IN A, (0EBH) ; GET DASHER DATA
F83A	E67F	00700	AND 7FH ; GET RID OF PARITY BIT
F83B	F80D	00710	CP 00H
F83C	2804	00720	JR Z, KEY1
F83D	F820	00730	CP 20H ; CTL CHAR
F83E	FE20	00740	JR C, ASAVE ; FORGET IT
F83F	3816	00750	; DATA FROM 6800 CAPTURED HERE
F840	E5	00760	KEY1 PUSH HL
F841	2A38FF	00770	LD HL, (CURR) ; GET CURRENT ADDRESS
F842	77	00780	LD (HL), A
F843	3A3AFF	00790	LD A, (LEN)
F844	FE40	00800	CP 64 ; ONLY 64 CHARACTERS
F845	CAF4FE	00810	JP Z, NOSAVE
F846	23	00820	INC HL
F847	2238FF	00830	LD (CURR), HL
F848	3C	00840	INC A
F849	323AFF	00850	LD (LEN), A
F84A	E1	00860	POP HL
		00870	NOSAVE

Listing 1 continued on page 107

TRANSWAVE'S **Tiny BASIC** MICROCOMPUTER **K-8073**

The Computer That

Recaptures Simplicity

STD (MOD) BUS 4.5 x 6.5 in.
5 Volt Only—Cassette
Tape In/Out—2 Sense—
3 Flags—Interrupts

INS8073 Microinterpreter
Tiny BASIC Processor

1K Byte Local RAM
[Expandable to 33K]

ART/RC Master, For Single
Wire Data I/O Of 128 Slave Units

Autostart EPROM
2K Byte

Real Time Clock
W/Ext. Battery Backup
Yr, Mo, Wk, Day, Hour, Sec.

Utilities Firmware, For
Software Dev., EPROM 2K

RS-232 For CRT
110—4800 Baud

EPROM—2K Byte
[Expandable to 24K]

EPROM Programmer, 2K
Byte Prm. Decoded—Req.
Ext. 25V Only

PPI, Programmable I/O,
24 Lines

PPI Interface Ribbon
Connector

PS-5/25
Development Station
\$225

DO-8028
8 CHN TRIAC
Controller
\$296

DI-8020
20 CHN A/D
\$262

K-8073
Microcomputer
\$388
SINGLE UNIT



INPUT ►►►►► DECISION ►►►►► OUTPUT

TODAY'S NEEDS

How many times have you thought about designing or purchasing the ultimate intelligent control system but were discouraged by the R&D time or price? Transwave took the initiative of designing one for you. Combining versatility with low cost, the K-8073 Tiny BASIC Microcomputer has already taken the lead in the process control market. Programming is reduced to mere hours because of the on-chip Tiny BASIC Microinterpreter. I/O is extended to previously unheard of limits because of the on-board ART/RC (Asynchronous Receiver Transmitter/Remote Controller).

This processor-like chip provides bi-directional serial communication between the K-8073 and its remotely located peripheral I/O devices. In addition, the K-8073 can operate in a stand-alone, satellite, or host mode. When interfaced thru RS-232, you can utilize your host computer, large or small, for polling, editing and mass data storage.

INPUT

The DI-8020 is a 20 channel A/D input module designed to collect data from remote sensors monitoring temperature, humidity, light, pressure, etc. Each A/D module is capable of monitoring 16 analog and 4 digital signals. Remarkably versatile, the DI-8020 is adaptable to any environment.

In addition to an extensive input range, this A/D module eliminates the usual installation hassles because of the unique ART/RC communications route. A single twisted pair or coaxial wire serves as the bi-directional DPW (Data Pathway) between the DI-8020 and the K-8073 Tiny BASIC Microcomputer.

DECISION

After receiving data, the K-8073 executes from your EPROM based Tiny BASIC program.

OUTPUT

Completing the cycle of I→D→O is the DO-8028; an 8 channel TRIAC Control Module. This board features 8 optically

isolated TRIACS with a maximum rating of up to 300 Watts AC control per channel. Receiving commands from the K-8073 via the full duplex DPW, you can daisy chain as many as 128 of these "slave" stations.

STAND ALONE SIMPLICITY

Whether you free your mainframe, free your mini or start from scratch, you can let closed loop control be the minimum configuration it should be. These cards are exactly the fundamental pieces needed for today's control applications. To order your K-8073 or for further information on the Vanderbilt Series 8000 Product Line, write or call: TRANSWAVE CORPORATION, Cedar Valley Building, Vanderbilt, PA 15486 Phone: (412) 628-6370.

TRANSWAVE
COMPUTER DIVISION OF UTSC

Performance.

Quality.

Reliability.



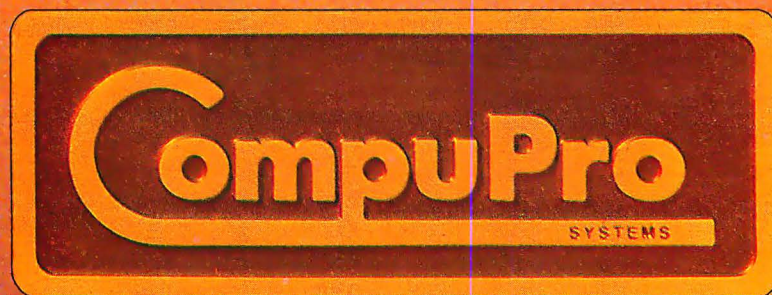

**For business, industrial, and scientific computing solutions,
contact your nearest CompuPro systems center.**

CompuPro means performance, quality, reliability.

There is no need to make the best of slow memory, slow processors, and me-too engineering: **CompuPro** delivers answers for the toughest business, scientific, and industrial computing problems. Backed by a one year limited warranty (2 years for boards qualified under the Certified System Component high-reliability program), **CompuPro** system components are the leading choice of systems integrators world-wide.

When you depend on your computer, choose a computer on which you can depend...IEEE 696/S-100 from **CompuPro**.

Disk 1. High Performance DMA Floppy Disk Controller. \$495 A/T, \$595 CSC. C/PM® 2.2 \$175 C/PM 86® \$300.

System Support 1. Battery clock/calendar; dual interrupt controllers; power fail interrupt; RS-232C port; 3 timers. \$395 A/T \$495 CSC. Options: 4 MHz 9511A or 9512 \$195. 4K RAM/ROM.

CPU Z. Z80® 4 MHz \$295 A/T, 6MHz \$395 CSC.

CPU 8085/8088 Dual Processor. Executes 8 and 16 bit software. 6MHz A/T \$425, 8MHz CSC \$525.

Supersixteen Special.

Includes CPU 8085/88, Disk 1, System Support 1, Interfacer I/O, 128K of static RAM, CP/M 2.2, CP/M-86, and cables. \$3495 A/T, \$4095 CSC.

High Speed Static

Memory. **RAM 20.** Extended addressing or bank select. RAM 20-8K: \$210 A/T, \$280 CSC. -16K: \$285 A/T, \$355 CSC. -24K: \$355 A/T, \$425 CSC. -32K: \$425 A/T, \$495 CSC.

RAM 17. Ultra low power (1.6 Watts typical for 64K). RAM 17-48K: \$650 A/T, \$750 CSC. -64K:

\$795 A/T, \$895 CSC. **RAM 16.** 64K X 8 or 32K X 16. \$895 A/T, \$995 CSC. **RAM 21.** 128K X 8 or 64K X 16. \$1695 A/T, \$1895 CSC.

M-Drive. Runs **CompuPro** RAM under CP/M 2.2 to eliminate disk waits. Requires 6MHz or faster CPU 8085/88, Disk 1, and System Support 1. Includes RAM and M-Drive software. Return **CompuPro** CP/M master disk and CPU 8085/88 for modification. 128K M-Drive: \$1590 A/T; 256K M-Drive: \$3100 A/T.

Interfacers. **Interfacer 1:**

two RS-232C ports, full handshake and selectable Baud rates. \$249 A/T, \$324 CSC. **Interfacer 2:** three

full duplex parallel ports plus one serial port; \$249 A/T, \$324 CSC. **Interfacer 3-8:** eight RS-232C ports (2 sync/async, 6 async) full handshake, software programmable Baud rates etc. \$699 A/T, \$849 CSC.

Interfacer 3-5: (2 sync/async, 3 async); \$599 A/T, \$699 CSC.

Enclosure 2.

Rugged metal construction, includes constant voltage power supply, shielded, terminated, 20 slots, high speed motherboard, quiet fan, line filter, more. Desk \$825, Rack \$895.

Documentation.

"CompuPro Product User Manuals: 1975-1980". This 250+ page book includes Interfacers 1 and 2,

CPU Z, CPU 8085/88, and all products released prior to 1981. \$20. "CompuPro Product User Manuals Vol.

2". This 300+ page book includes Interfacer 3, Disk 1, System Support 1, product updates and more. \$25.

CP/M is a trademark of Digital Research.
Z80 is a trademark of Zilog.

CompuPro™

division

GODBOUT ELECTRONICS

OAKLAND AIRPORT, CA 94614-O355 (415)562-0636

Your authorized **CompuPro** sales center specializes in business, industrial, and scientific computing. Call **415-562-0636** for the name of the sales center nearest you, or for placing factory direct VISA® /Mastercard® orders. Prices shown do not include tax, shipping charges, or dealer installation/support services.

Circle 85 on inquiry card.

Listing 1 continued:

Memory Location	Object Code	Statement Number	Source Code
FEF5 3E00	00860	ASAVE	LD A,00H ; RESTORE ACCM
FEF7 C3F7FE	00870	KEND	JP KEND
FEFA F5	00880	BASIN	PUSH AF
FEFB 2E00	00890		LD H,00H
FEFD 2E00	00900		LD L,00H
FEFF 3A3AFF	00910		LD A,<LEN>
FF02 FE00	00920		CP 00H ; NO DATA HAS COME IN
FF04 282E	00930		JR Z,BEXIT
FF06 C5	00940		PUSH BC
FF07 D5	00950		PUSH DE
FF08 CD7F0A	00960		CALL 0A7FH ; GET BUFF ADDRESS
FF0E E5	00970		PUSH HL
FF0C D1	00980		POP DE
FF0D 213AFF	00990		LD HL,LEN
FF10 0E00	01000		LD B,00H
FF12 0E03	01010		LD C,03H
FF14 E0B0	01020	PMOV	LDIR ; MOVE PARMS
FF16 213DFF	01030		LD HL,BUFF
FF19 1182FF	01040		LD DE,BBUFF
FF1C 3A3AFF	01050		LD A,<LEN>
FF1F 4F	01060		LD C,A
FF20 E0B0	01070	DMOV	LDIR ; MOVE BUFF
FF22 213DFF	01080		LD HL,BUFF
FF25 2238FF	01090		LD <CURR>,HL
FF28 3A3AFF	01100		LD A,<LEN>
FF2B 2E00	01110		LD H,00H
FF2D 6F	01120		LD L,A
FF2E 4F	01130		XOR A
FF2F 323AFF	01140		LD <LEN>,A
FF32 D1	01150		POP DE

Memory Location	Object Code	Statement Number	Source Code
FF33 C1	01160		POP BC
FF34 F1	01170		POP AF
FF35 039A0A	01180		BACK JP 0A9AH
FF38 3DFF	01190		CURR DEFW BUFF
FF3A 00	01200		LEN DEFS 00
FF3B 82FF	01210		DEFW BBUFF
0045	01220		DEFS 69
0040	01230		BBUFF DEFS 64
FE80	01240		END START
00000	TOTAL ERRORS		
ASAVE	FEF5 00860	00640	00670 00730
BACK	FF35 01180		
BASIN	FEFA 00880		
BBUFF	FF82 01230	01040	01210
BEXIT	FF34 01170		00930
BUFF	FF30 01070	01030	01080 01190
CURR	FF38 01190	00760	00820 01090
DMOV	FF30 01070		
DOUT	FEAF 00450	00110	00130 00150
KBFIX	FECA 00640		00330
KEND	FEF7 00870	00320	00870
KEY1	FE0F 00750		00710
LEN	FE3A 01200	00780	00840 00910 00930 01050 01100 01140
NOSAVE	FEF4 00850		00880
PMOV	FF14 01020		
RETX	FE07 00600		00530
START	FE80 00170		01240
STARTIN	FE8E 00540	00490	00510 00560
TABLE	FEA7 00360		00240

Text continued from page 100:

create a program file for the initialization routine. You will have to execute this program under TRSDOS READY before starting BASIC and loading the monitor program. The initialization program does the following:

- It sets the RS-232C protocol (word length, parity, bit rate, etc.) according to the setting of the sense switches on the Radio Shack RS-232C circuit board. (Be sure these switches are set to match your 6800 system's requirements.)
- It routes all BASIC printer output (LPRINT) to the RS-232C port.
- It uses the 25-millisecond (ms) interrupt of the TRS-80 expansion interface to check for any data transmitted from the MIKBUG system.

Here's a breakdown of the program's functional segments (numbers refer to source statement numbers):

20-430 Set bit rate as determined by switches, put a hook into the printer and keyboard DCBs (device control blocks), and return to TRSDOS.

440-620 Route all LPRINTs to the

Text continued on page 110

PHONE 1 FILLS THE VOID IN DATA COMMUNICATION

Powerful Z-80® communications software tools are now available. Fill the void between your microcomputer and mainframe.

Z-80 is a registered trademark of Zilog.



PHONE 1

1011 River Lane • Loves Park, Illinois 61111 • 815/877-9008

THE ONLY NAME

YOU NEED

TO KNOW FOR KEYED
FILE ACCESSING IS

MICRO B+™

Since 1979, MICRO B+
has delivered:

- **PERFORMANCE:** search an index of over 10,000 key values in less than one second on a floppy.
- **CONVENIENCE:** no need to re-organize index files.
- **SUPPORT:** our bug-free code is backed by the best programmer support in the industry; just call us to see.
- **INNOVATION:** the 1st and most complete implementation of B-Tree index structures for micros.
- **DOCUMENTATION** that you can read.

AND NOW

FairCom has added

- **MULTI-USER** support under MP/M for MICRO B+.

IF YOU PROGRAM IN:

MICROSOFT's BASIC, COBOL,
or FORTRAN
DIGITAL's PL/I-80
CBASIC-2
PASCAL/MT+

WE'VE GOT WHAT
YOU NEED

for \$260. Manual alone \$20. Shipping \$4 North America, \$8 elsewhere.

LANGUAGE C VERSION
OF OUR B-TREE ALGORITHM
IS AVAILABLE FOR \$2600.

FAIRCOM

© 1981 FairCom

2606 Johnson Drive
Columbia, MO 65201
(314) 445-3304

WE ACCEPT VISA &
MASTERCHARGE

MP/M & PL/I-80 are trademarks of Digital Research. CBASIC is a trademark of Compiler Systems, Inc. PASCAL/MT+ is a trademark of MT Micro Systems.

Listing 2: The BASIC monitor program that makes the TRS-80 act like an enhanced MIKBUG terminal.

```
100 ' MIKBUG MONITOR
110 ' WRITTEN BY ROBERT LAESENSKI
120 ' WEST HARTFORD CONNECTICUT
130 '
140 CLS:DEFINT A-Z:CLEAR 5000
150 DIMS$(100) ' SOURCE
160 DIMOB$(100) ' OBJECT
170 DIMAD$(100) 'ADDRESS
180 DEFUSR0=SHFEF0
190 GOSUB 210 :GOSUB 240 :GOTO190
200 ' TRS KEYBOARD INPUT
210 A$="":A$=INKEY$:IF A$="0" THEN 260 ELSEIF A$<>" " LPRINTA$:
220 RETURN
230 ' 6800 INPUT
240 B$="":B=USR0(UARPTR(B$)):IF B<>0 S=INSTR(B$,"1")*PRINT:RIGHT$(B$,LEN(B$)-S)
250 RETURN
260 'CMD PROCESSOR
270 INPUT"CMD=>";A$
280 IF A$="0" RETURN
290 IF LEFT$(A$,1)="D" GOSUB 360
300 IF LEFT$(A$,1)="G" GOSUB 400
310 IF LEFT$(A$,1)="L" GOSUB 510
320 IF A$="S" GOSUB 660
330 IF A$="H" GOSUB 690
340 IF A$="B" GOSUB 820
350 RETURN
360 'DUMP 32 BYTES
370 LPRINT "M";W=90:GOSUB 440 :LPRINT RIGHT$(A$,4)
380 W=200:FOR L=1TO16:GOSUB440 :B$="":B=USR0(UARPTR(B$)):PRINT RIGHT$(B$,3):L
PRINT :NEXT L:PRINT:GOSUB440 :LPRINT " "
390 S$="":B=USR0(UARPTR(B$)):RETURN
400 ' G XXXX
410 LPRINT "M";W=90:GOSUB440 :LPRINT "A048"
420 W=200:GOSUB 440 :LPRINT " ";MID$(A$,2,2):GOSUB 440 :LPRINT " ";RIGHT$(A$,
2):GOSUB 440 :LPRINT " ";GOSUB 440
430 LPRINT "G";W=20:GOSUB 440 :GOTO 390
440 FOR Z=1 TO W:NEXT Z :RETURN'WAIT LOOP
450 ' DEC TO HEX
460 C$="":X=INT(AD(Z)/256):GOSUB 490
470 X=INT((AD(Z)-(X*256))/16):GOSUB 490
480 X=INT(AD(Z)-(INT(AD(Z)/16)*16))
490 IF X>9 THEN C$=C$+CHR$(X+55) ELSE C$=C$+RIGHT$(STR$(X),1)
500 RETURN
510 'LOAD
520 IF OK THEN 560
530 INPUT "FILE SPEC'S >";A$:IF A$="" RETURN ELSE OPEN "1".1.A$:INPUT#1,OK,N
540 FOR Z=0TON-1:INPUT#1,S$(Z),OB$(Z),AD(Z):NEXT
550 CLOSE
560 LPRINT"M";W=90:GOSUB 440 :Z=0:GOSUB 450 :LPRINT "0";C$
570 PRINT "ADDRESS =>";C$:S=AD(0)
580 W=200:FOR X=0TON-1:IF OB$(X)="" THEN 640
590 IF S=AD(X) THEN 600 ELSE GOSUB440 :LPRINT " " :GOSUB 440 :LPRINT "M";0
=X:Z=X:GOSUB 450 :GOSUB 440 :LPRINT "0";C$:GOSUB 440 :X=0:PRINT:PRINT"ADRES
S=>";C$
600 FOR Y=1 TO LEN(OB$(X)) STEP 2
610 PRINT MID$(OB$(X),Y,2);
620 GOSUB440 :LPRINT " ";MID$(OB$(X),Y,2):NEXT Y
630 S=S+(LEN(OB$(X))/2)
640 NEXT X:GOSUB 440 :LPRINT " "
650 PRINT "DONE":GOTO 390
660 'SHOW SOURCE
670 IF OK THENFOR Z=0TON-1:GOSUB 450 :PRINT Z;TAB(6)C$;" ";OB$(Z);TAB(22);S$(
Z):NEXT:RETURN
680 PRINT "NO SOURCE":RETURN
690 ' HELP SCREEN
700 PRINT">>> MIKBUG COMMAND'S < * PROMPT> <<<"
710 PRINT " M XXXX DISPLAY/MODIFY MEMORY"
720 PRINT " G EXECUTE PROGRAM POINTED TO BY PC (A048-49)"
730 PRINT " R DISPLAY REGS < CC BB AA XXXX PPPP SSSS >"
740 PRINT " P/L PUNCH/LOAD ADDRESS A002-3 TO A004-5"
750 PRINT:PRINT">>> M0M6800 COMMANDS (0 FOR CMD=> PROMPT) <<<"
760 PRINT " L LOAD ASSEMBLED PROGRAM FROM DISK FILE"
770 PRINT " DXXXX DISPLAY 16 BYTES AT XXXX"
780 PRINT " GXXXX EXECUTE PROGRAM AT XXXX"
790 PRINT " S SHOW SOURCE OF PROGRAM FROM DISK"
800 PRINT " B SET (SX) RESET (RX) BREAKPOINT 0-9"
810 RETURN
820 'BREAK POINT PROCESSOR E$(10)=ADDRESS + INSTR
830 INPUT "(S)ET OR (R)ESET NUMBER";A$:B$=LEFT$(A$,1)
840 IF B$<>"S" AND B$<>"R" RETURN
850 IF LEN(A$)>2 OR VAL(RIGHT$(A$,1))>9 PRINT " BREAK POINT NUMBER INCORRECT":
RETURN
860 X=VAL(RIGHT$(A$,1))
870 IF B$="S" THEN 900
880 IF E$(X)="" PRINT " NO BREAKPOINT SET":RETURN
890 W=200:LPRINT "M";GOSUB 440 :LPRINT LEFT$(E$(X),4):GOSUB 440 :LPRINT " ";R
IGHT$(E$(X),3):GOSUB440 :LPRINT " " :PRINT "ADDRESS WAS ";LEFT$(E$(X),4)-E$(X)
):":GOTO 390
900 INPUT " ADDRESS ";E$(X)
910 W=200:LPRINT "M";GOSUB440 :LPRINT LEFT$(E$(X),4):GOSUB440
920 B$="":B=USR0(UARPTR(B$)):E$(X)=E$(X)+RIGHT$(B$,3)
930 GOSUB 440 :LPRINT " 3F";GOSUB 440 :LPRINT " " :GOTO 390
```

INTRODUCING CALCSTAR.TM ANOTHER INDISPENSABLE BUSINESS PROGRAM FROM MICROPRO,TM THE WORDSTARTM PEOPLE.

Presenting CalcStar — another standard-setting software product in the WordStar tradition.

CalcStar is MicroPro's new electronic spread sheet and financial modeling program — a sophisticated, yet easy to use, calculating and planning tool for CP/M[®]-based computers.

The ultimate electronic spread sheet.

CalcStar calculates solutions to complex numerical problems in business and finance. Helps you make budget plans and sales forecasts with greater speed and accuracy. And projects figures into the future to answer the "what if" questions you face in business.

And CalcStar also has a unique MicroPro advantage: It joins with WordStar to combine spread-sheet and word-processing capabilities in several powerful ways.

CalcStar software eliminates the need to use ledger paper ever again. It turns your video screen into a "window" on a giant electronic ledger sheet, with up to 600 entries arranged the way you want. Then, by inserting formulas into CalcStar, you create financial models that simulate the future numerically. And predict the outcomes of your business decisions.

When you notice what CalcStar can do for your business, you'll wonder how you ever got along without it. (If you're now a WordStar user, you probably already know the feeling.)

The MicroPro bonus. Like WordStar, CalcStar is packed with innovative features that make it versatile and easy to use. Features like Automatic Forms Mode, which lets an inexperienced user enter data into a spread sheet quickly and with less chance of error.

CalcStar's greatest innovation is its ability to join with WordStar. Which means, for example, you can use WordStar's printing options, like boldface and underlining, to dress up financial documents. And you can insert sections of CalcStar's spread sheets into your WordStar documents.

This kind of flexibility should come as no surprise if you're already familiar with the MicroPro software family — a line of programs designed to work together to multiply your problem-solving power. Visit your MicroPro dealer to find out just how big a difference *all* our products can make in your business. We predict you'll discover it's not just CalcStar or WordStar that's indispensable. It's MicroPro.

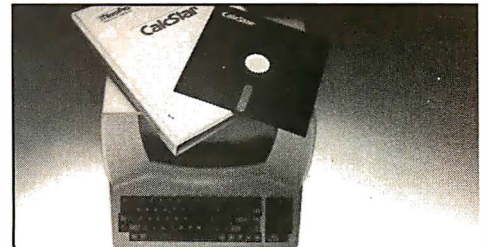

A glance at CalcStar features

Runs on CP/M version 2.0 or above, with 80-column screen, addressable cursor, and at least 48K memory. 56K or more is recommended for fullest utilization.

Highly user friendly: Call up full screen of help or use help menu. WordStar-like cursor commands. User's guide shows you the basics. Install from menu OR a WordStar file.

Stores formulas and formats along with data, for convenience and less chance of error.

Math functions include average, minimum, maximum, logarithms, exponents, and regression analysis.

SOFTWARE
THAT MEANS BUSINESS

MicroProTM

INTERNATIONAL CORPORATION

1299 Fourth Street, San Rafael, California 94901
(415) 457-8990; Telex: 340-388

CP/M is a trademark of Digital Research, Inc.
Dealer and distributor inquiries invited.

DataStarTM

MailMergeTM

WordStarTM

WordMasterTM

SuperSortTM

SpellStarTM

CalcStarTM

Text continued from page 107:

RS-232C interface.

630-870 On the 25-ms interrupt used by the keyboard routine, capture any data transmitted by MIKBUG. Nulls and other control characters are stripped off. The data are collected in BUFF for a maximum of 64 characters.

880-1180 The entry point BASIC uses

to get the MIKBUG data. See statements 60-90 for the protocol.

1190-1240 Buffers and other required storage areas.

Once you've set up the system, you are ready to run the BASIC monitor program (listing 2). Start BASIC, ask for at least one file, and answer the memory-size question with an

address at or below 65151 (if you change the origination address of the Z80 program, you'll have to change the memory-size answer, too).

We've already described the commands available in the monitor, so let's look at the function segments of the program (numbers refer to program line numbers):

100-180 Define variables and set up the machine-language subroutine calls.

190 Start the main program loop. Because the main loop and subroutines are in BASIC, the keyboard may feel "mushy."

210-220 Scan the TRS-80 keyboard and check for the "@" key. Input will be passed to MIKBUG or, in case of the "@" key, to the special command processor.

230-250 Process a special command. If you want to add any special commands, put them here.

360-390 Dump 16 bytes in hexadecimal by repeating the MIKBUG M command 16 times.

400-440 Load program counter and go (Gxxxx).

450-500 Convert decimal to hexadecimal.

510-650 Load object code into the 6800 system. The code is transferred one byte at a time, and each byte is echoed in hexadecimal form on the TRS-80 screen.

660-680 Display the code currently in memory (source and object will be displayed).

690-810 Display a "help" screen.

820-930 Process (set or reset) a breakpoint.

A few words about the bit rate: the variable W determines how long BASIC will wait for a byte from the 6800 system. The value I have given is appropriate when you use 300 bits per second (bps). If you change bit rates, you'll have to change the value of W (for a higher bps, use a smaller value; for a lower bps, use a larger value). ■

FOR ALMOST A DECADE...

\$24.95

...AND STILL HOLDING

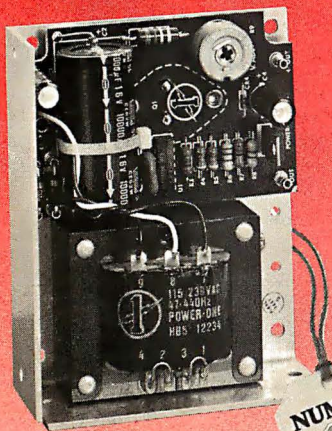

Model HB5-3/OVP
\$24.95 Single Qty.

5V at 3A with Built-in OVP

Power One's Case models started at \$24.95. Over 200,000 models later, they're *still* only \$24.95!

- 115/230 VAC Input
- OVP Built-in
- .05% Regulation
- 2-Year Warranty
- 2-Hour Burn-in
- UL Recognized
- CSA Certified

Get all the details on our 125 standard linear and switching power supplies.



FREE!

New 1981 Product Catalog... plus our new Tour Guide. Phone or write for your copies today!

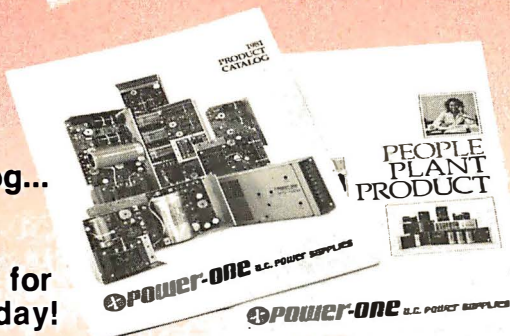

POWER-ONE D.C. POWER SUPPLIES

Power-One, Inc. • Power One Drive • Camarillo, CA 93010
(805) 484-2806 • (805) 987-3891 • TWX 910-336-1297

SEE OUR COMPLETE PRODUCT LISTING IN EEM & GOLDBOOK

With the Hayes direct-connect Micromodem II,[™] your Apple II can communicate by phone with the outside world. You can access information networks like The Source for a variety of business and personal applications, exchange programs with friends anywhere in North America, and even use your Apple II when you're away from your home or office.

Dependable. The Micromodem II is so dependable it comes with a *two-year* limited

warranty. That's another reason why it's the largest selling direct-connect modem for Apple II computers.



Programmable. Automatic dialing and answering? Of course! We include programs on disk that dial phone numbers for you, send messages while you're away, and much more!

Complete. You get everything you need to communicate with other Bell 103 compatible modems at 110 or 300 baud. The serial interface

is built-in, and we even include our FCC-approved Microcoupler[™] that plugs directly into any modular telephone jack in the U.S. — you don't even need the phone!

S-100, too. The Hayes Micromodem 100 gives S-100 microcomputers all the advantages of our Micromodem II!

Put the outside world *inside* your computer with a data communications system from Hayes. Available at computer stores nationwide — call or write for the location nearest you. And don't settle for anything less than Hayes.



Hayes

tionwide — call or write for the location nearest you. And

don't settle for anything less than Hayes.

The Hayes Micromodem II opens up your Apple II to the outside world.



Hayes Microcomputer Products Inc. 5835 Peachtree Corners East, Norcross, Georgia 30092 (404) 449-8791

Micromodem II, Micromodem 100 and Microcoupler are trademarks of Hayes Microcomputer Products Inc.

[™] Apple Computer Inc. Micromodem II can also be used with the Bell & Howell computer. © 1981 Hayes Microcomputer Products Inc.

The New Idea Computer from TeleVideo® Systems.



Two great single-user computers that can grow for multi-user applications when you need it.

We're bursting with new ideas when it comes to small business computers and peripherals designed to give you much more value for your money. That's why we've zoomed to our No. 1 position among independent suppliers of CRT terminals. We make it our business to get new ideas to market first. So, meet our latest new idea. The Model TS 802.

The new TS 802 has been designed with upgradeability and growth in mind. You can start out with a Model TS 802, using it as a powerful, single-user work station with a full data processing and word processing capability. Then, as your computer needs expand, you can add our TS 806 or TS 816 multi-user hard disk system to build a versatile multi-station mass storage computer for up to 16 users and 70 Mbytes of on-line storage.

The TeleVideo TS 802 computer. It can grow as your needs grow. That's computer power with no restrictions or hassles. Now, that's *a real new idea!*

New Technology Galore

Looking at the hardware, our new idea TS 802 Series comes in two different versions. The TS 802 features two 5¼-inch floppy disks for 1 Mbyte of on-line storage, a Z80A micro-processor, 64K or RAM memory, and a 4K EPROM for diagnostics. The TS 802H computer has one 5¼-inch Winchester disk drive with 10 Mbytes of on-line storage, and a single 500 Kbyte minifloppy disk unit. Both versions come in an attractive, low-profile desktop enclosure that can enhance any modern office decor.

Nationwide Service:

All computers are backed and serviced by General Electric's Instrumentation and Communication Equipment Service Centers.

Worth Looking Into

Both versions of the TS 802 computer offer an easy-to-read green phosphor CRT display with an exclusive patented character resolution that spells goodbye to eyestrain. The telescreen gives you advanced editing with wraparound, smooth scrolling, special graphics characters, and versatile screen attributes. And the detachable keyboard can be placed conveniently anywhere you want it.

Just the Software You Want

In its stand-alone mode, our new TS 802 Series uses the *CP/M® operating system. In the multi-user mode, each TS 802 satellite user station runs CP/M under TeleVideo's unique ‡MmmOST™ Service processing system that provides scheduling, file/record locking, and data base access control formerly only possible with much more expensive and sophisticated multi-user operating systems.

The Price is Right, Too!

Our *new idea* Model TS 802 computer is priced at just \$3495. And the Model TS 802H is only \$6995. These two revolutionaries can deliver *new idea* features you might have to pay \$30,000 for elsewhere. If you want to get down to business, try a new idea computer from TeleVideo today.



TeleVideo Systems, Inc.

1170 Morse Avenue
Sunnyvale, CA 94086

(408) 745-7760

(800) 538-8725 (Toll free outside California)

*CP/M® is a registered trademark of Digital Research, Inc.
‡MmmOST™ (Multi-User, multi-task, multi-processor Operating System Technology) is a trademark of TeleVideo Systems, Inc.

ELECTRIC SYSTEMS CORPORATION

Authorized Commodore service center
 Repair of the complete line of Commodore products
 In a hurry? Check our modular exchange program



HARDWARE:

CBM8032 Computer, 80 Column	\$1095
CBM 8050 Disk Drive	1340
CBM 4032 Computer, 40 Column	995
CBM 4040 Disk Drive	995
CBM 4022 Printer	649
CBM VIC 20 Computer	263
CBM VS100 Cassette	68
PET to IEEE Cable	33
IEEE to IEEE Cable	39
BASF Diskette, Box of 10	30

SOFTWARE:

OZZ	\$299
Wordcraft 80	299
Tax Preparation System	380
IRMA	380
Dow Jones Portfolio Management System	115
Personal Tax	55
Pascal	229
Assembler Development Package	77
Wordpro 4+	329

**Order TOLL FREE
 1+800-527-3135**

10 AM to 4 PM CDT Monday through Friday

Texas residents call 1+214-661-1370

VISA, MASTER CHARGE, MONEY ORDERS, AND C.O.D.
 "Certified Check" accepted.

Units in stock shipped within 24 hours, F.O.B. Dallas, Texas.
 All equipment shipped with manufacturer's warranty.

Residents of Texas, Louisiana, Oklahoma City and Tulsa,
 Oklahoma must add applicable taxes.

Eclectic shortly will be announcing products that are designed to work with CBM systems.

1. ROMIO: two RS232 ports—three parallel ports—26K EPROM memory-managed alternate character set, software controlled—EDOS (extended DOS).
2. Terminal program (options with ROMIO)
3. EPROM programmer
4. Front-end processor
5. Additional firmware to be announced

Be sure to write the address below for more information;
 dealer inquiries welcome.

**P.O. Box 1166 • 16260 Midway Road
 Addison, Texas 75001 • (214) 661-1370**

Technical Forum

Floppy-Disk Performance

N. Yalirakis
 53-55 Kodringtonos St.
 Athens 104, Greece

Dennis Nendza's article "Comparing Floppy-Disk Drives by Software Simulation" (see the May 1980 BYTE, page 130) contained the principles of drive operation and timing plus a comparison of a number of disk drives from various manufacturers.

Nendza's conclusions were:

- The performance of sequential read operations are practically the same for like-sized drives.
- There is a sizable difference between the predicted and actual performance of many drives.
- Despite the theoretical figures given by many manufacturers, actual floppy-disk performance is low.

In random operations, the situation is even worse. Since transfer efficiency is dependent on the file structuring and file searching involved, I will restrict my observations to sequential performance.

In attempting to explain the discrepancy between the theoretical prediction for reading 500 records (about 43 seconds) and the actual time (109 seconds), I noticed that Nendza's program assumes that the read head is in a random position before reading the next record in sequence. It is my belief that the random-position assumption is incorrect since the timing of the appearance under the head of each sequential record or sector is exactly known. In fact, if we assume that the software requires a period of time to transfer the record to memory and process it, when the head goes to read the next sequential sector it will have passed the beginning and will have to wait until the next revolution to continue the read.

If we make this assumption, we can estimate the time to read one sector to be equal to the time of disk revolution (about 1/30 second) for an 8-inch disk. Therefore, the

8086 Super-micro

8 Mhz. - 16-bit - S-100 bus - 128K 70 nsec. RAM

Computer Benchmarks - All systems running the same BASIC program.

Manufacture - Model	Class	Operating System	Language (Type*)	Run Time (Seconds)
IBM 3033	Mainframe	VS2-10RVYL	Stanford BASIC	10
Seattle Computer System 2	Micro	MS-DOS	Microsoft BASIC (C)	33
Digital Equipment PDP 11/70	Mini	n/a	BASIC (I)	45
Prime 550	Mainframe	PRIMOS	BASIC V16.4 (I)	63
Digital Equipment PDP-10	Mainframe	TOPS-10	BASIC (I)	65
IBM System 34	Mainframe	Release 05	BASIC (I)	129
TEI System 48	Micro	MAGIC 1.0	Microsoft BASIC (C)	178
Hewlett-Packard HP3000	Mini	Time Share	BASIC (I)	250
Seattle Computer System 2	Micro	MS-DOS	Microsoft BASIC (I)	310
Alpha Micro AM-100/T	Micro	AMOS 4.3a	Alpha BASIC (SC)	317
Digital Equipment PDP 11/45	Mini	n/a	BASIC (I)	330
Data General NOVA 3	Mini	Time Share	BASIC 5.32	517
Ohio Scientific C4-P	Micro	OS65D 3.2	Level 1 BASIC (I)	680
North Star Floating Point	Micro	NSDOS	NorthStar BASIC (I)	685
Radio Shack TRS-80 II	Micro	TRSDOS 1.2	BASIC (I)	792
Apple II +	Micro	DOS 3.2	Applesoft II (I)	960
Cromemco System 3	Micro	CDOS	32K BASIC (I)	1074
Commodore Pet 2001	Micro	n/a	Microsoft BASIC (I)	1374
IBM 5100	Micro	n/a	BASIC (I)	1951
Vector MZ	Micro	n/a	Micropolis BASIC (I)	2251

* C = Compiler; I = Interpreter. Times (except for Seattle Computer) taken from August 1981 issue of Interface Age.

Seattle Computer System 2 consists of 8 Mhz. 8086 CPU set, 128K of 70 nsec. static RAM, double-density disk controller, 22-slot TEI constant voltage mainframe, a cable for two 8' drives, and MS-DOS operating system (also called 86-DOS, IBM PC-DOS, Lifeboat SB-86). The system is fully assembled and tested and ready to run with the addition of disk drives (we can supply) and terminal. Price: \$4185. 8087 Adapter also available.

Call for location of our nearest dealer

Software
We have the following Microsoft high-level languages running under MS-DOS.

- BASIC-86 Interpreter \$400
- BASIC-86 Compiler \$400
- Fortran-86 \$600
- Pascal-86 \$600
- Cobol-86 \$900
- Macro-86 Assembler \$300

Check for new additions



1114 Industry Dr. Seattle WA 98188

Information Hotline
206/575-1830

time required to read 500 records is 83.3 seconds. An extra one to two seconds is required for the initial seek, head load, and the subsequent track-to-track accessing (if not absorbed within the sector-waiting time). This gives a total read time of approximately 85 seconds for 500 records, which is much closer to the actual figure.

The question remains: Is this the best performance we can expect from a floppy-disk drive? Reading a 128-byte sector every 166 milliseconds (768 bytes per second) is very far from the theoretical floppy-disk transfer rate of 30,000 bytes per second. Looking at it another way, it's only an eightfold improvement over a cassette that operates at 1200 bits per second.

I ran across this problem when developing an 8-inch floppy-disk system for a minicomputer. I was told there was no way to improve the performance but decided to give it a try.

The most obvious way to improve the transfer rate is to increase the sector size (at the expense of departing from the IBM standard) and the memory requirements. This encouraged the choice of hard sectoring, allowing easy selection of multiples of the standard sector size plus an increased capacity per track of 32 standard-sized sectors rather than 26.

The selection of 256-byte sectors automatically doubles

the transfer rate. Further improvement can be obtained if you are prepared to go as far as half-track sectors. This sacrifices about 2 K bytes of memory per opened file but results in an *eightfold* increase in transfer efficiency. However, it should be noted that this is not the best way to obtain fast transfer rates, because large record sizes not only waste memory but are also unsuitable for many applications.

Another alternative was therefore considered: make sure that the next sequential sector to be read is optimally positioned after the previous sector is read. Using this technique, sequential sectors are not dictated by the time needed for a complete disk revolution.

Since the processing time of the information retrieved from the disk varies, the time between the reading of sectors also is variable. In many cases, only record transfers are performed with little need for processing. Therefore, the time of sector processing should be no greater than the time required to read the sector (32 microseconds per byte). In the ideal situation, if the next sector to be read is positioned two sectors away from the previously read sector, one full track could be read in two disk revolutions.

If this method is used, you must depart from the "one every other" rule. In my application, I used the following format: each track was divided into 16 sectors of 256 bytes each. Access of sequential sectors was adjusted to one every three (i.e., the record/read sequence was 0,3,6,9,12,15,2,5,8,11,14,1,4,7,10,13, etc.; the numbers represent the physical location of each sector relative to the index hole). With this format, I obtained a transfer rate of one sector (256 bytes) every 30 microseconds, or about 8000 bytes per second.

The time available to transfer each sector from the operating-system buffer to the memory is 20 microseconds, which leaves ample time for processing the data. Also, since the sector number is continually monitored by the hardware, there is in most cases sufficient time to access the next track without waiting for another revolution of the disk.

This method works particularly well in applications where you have to frequently load large programs. For example, the 500 records mentioned in Nendza's article could be loaded in 8 seconds if the timing is not lost during access of the track, or in 11 seconds if one revolution is lost on each of the 20 tracks to be accessed.

I have to stress that there is still room for further improvement in the transfer ratio. For example, a variable spacing of sequential sectors can be adopted to suit various needs for record processing. Odd numbers of sectors per track can give the maximum transfer rate. Also, synchronizing dual drives can yield optimum disk-to-disk transfer performance.

The fact remains that the capabilities of the floppy disk have not been fully exploited. As it stands now, the most impressive figures remain in the specification sheets of the disk-drive manufacturers. ■

ROBOTS

The Future Arrives

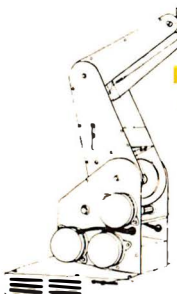

Intelligent machines are rapidly appearing in homes, automobiles, offices and factories. Affordable cameras, speech synthesizers, and even robot arms are now on the market. Such advances are giving microcomputers the power to see, hear, grasp objects, and to move around the room. Where can you learn about this technology? In **Robotics Age Magazine**, the journal of intelligent machines.

Robotics Age reports the experience of hobbyists building their own robots, the latest products from industry, and the most powerful techniques from research labs. The face of the world is changing. Join us as we enter the Robotics Age.

YES! I want to stay up-to-date on this fascinating new technology!

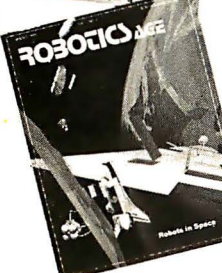
Name		Title	
Company	Address		
City/State/Province/Country		Postal Code	
<input type="checkbox"/> 1 year (6 issues)	United States \$15	Canada \$17	Foreign Rates* \$19
<input type="checkbox"/> 2 years (12 issues)	\$28	\$32	\$36
<input type="checkbox"/> 3 years (18 issues)	\$39	\$45	\$51

*US Funds on US Bank
 Bill VISA MasterCard Bill me (N. America only)

Card No. _____
Exp. _____

Signature _____

Send to: **ROBOTICS AGE**, PO Box 512, Tujunga, CA 91042

If you don't know a baud from a floppy ... **YOU NEED TO KNOW THE QDP-100 MICROCOMPUTER**

Most people who need computers don't have the time, or desire, to become full-time computer "wizards."

With the budget-priced QDP-100 you get all the time-saving precision information you want from a computer, now and in the future, without all the unnecessary complexity associated with less considerate computers.

QDP-100 IS A FULL-SCALE 8-bit computer, readily upgradeable to 16 bits as your business or professional information-processing needs grow. It uses the IEEE S-100 bus, compatible with CP/M and MP/M disk operating systems.

QDP-100 HANDLES BOTH floppy disks and hard disks to give you total software versatility.

QDP-100 CONNECTS INSTANTLY to any standard terminal and printer. Both serial and parallel ports are available. Features most microcomputers can't match.

It does more, does it easier, and costs a lot less.

QDP-100 HAS SINGLE BOARD SIMPLICITY. Eliminates the hassle of complex multi-chip, multi-board computers.

QDP-100 IS EASY to learn and to operate. Most owners use their QDP-100 with professional skill and results in short order. Our instruction manual doesn't need an interpreter.

If you'd rather be a wizard with computer results, than with computers, choose the QDP-100. Call or write for literature and full details.

QDP NEEDS A FEW MORE GOOD DEALERS. Attractive, profitable, protected dealerships are still available in several high-potential computer market areas.



Quasar Data Products

10330 Brecksville Road
Cleveland, Ohio 44141
216/526-0838 Telex: 241596

CP/M and MP/M
are registered trademarks
of Digital Research Corp.



AC Motor Control

Simple Algorithms and Hardware

Jostein Nyberg
Odv. Solbergsv. 100
Oslo 9 Norway

Connecting a microcomputer to an external device is an efficient way to acquire a realistic understanding of the possibilities offered by the microprocessor. As a teacher of computer science, I illustrate techniques for interfacing such devices to a computer through a series of experiments performed by the engineering students in the laboratory. In most of these experiments some quantity (like speed or temperature) is measured, or some external device is controlled.

Ideally, the experiments should be interesting and instructive, yet not too complex or time consuming. Also, they should involve components and devices that are easily obtainable and not too expensive. I believe the following two applications will satisfy these demands.

Measuring Rotational Speed

The hardware used to measure rotational speed is shown in figure 1. An electric fan is placed between a phototransistor and a light source (an ordinary incandescent lamp). Each time the light beam is interrupted by the rotating blades of the fan, the output of IC1, the 74LS14 Schmitt trigger, goes low. As a result, the input line to the computer, called PHOTO in the figure, goes low. The pulses thus generated are counted for a set duration. I use a fan with five blades, and the number of rotations per second will then be directly given by the number of pulses counted during 1/5 second.

Selecting a suitable phototransistor should not be difficult; I have tried several common types, and they all worked satisfactorily. If necessary, you can modify the resistor value in figure 1.

You may find it convenient to mount all components on a breadboard with spring-type connections. The breadboard may be connected to the computer with a ribbon cable. To perform the experiment, the breadboard is held in such a position that the phototransistor "sees" the light source between the fan blades. Spurious light sources should be kept away from the phototransistor.

Of course, to measure the speed of a motor in an actual

application, a somewhat different arrangement would have to be used. For example, a small disk, either perforated or with alternately transparent and opaque segments, could be attached to the motor shaft. Or a special optical switch, containing an LED (light-emitting diode) and a phototransistor in the same unit, could be used. However, these more sophisticated approaches tend to require mechanical arrangements that are harder to set up and get working. For experimental purposes, I prefer the simple use of a fan. (After all, the aim of the experiment is to illustrate principles, not to produce commercial equipment).

Obviously, the program for measuring time and counting pulses will depend on the computer you use: its language, input/output ports, clock frequency, etc. Whether the computer is based on the 6502, the Z80, the 8085, or some other microprocessor, writing the assembly-language program for this experiment is an instructive exer-

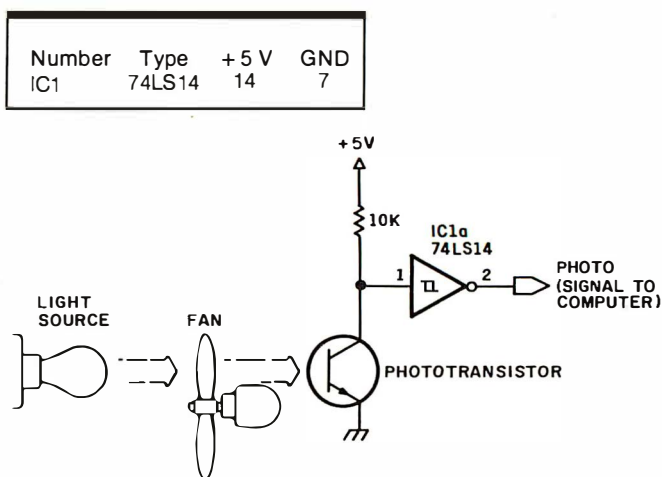

Figure 1: A sensing circuit for measuring rotational speed. The blades of the fan cast a shadow on the phototransistor as they pass between it and the light; the signal thus created is conditioned by a 74LS14 Schmitt trigger prior to being presented to the computer.

DIAGNOSTICS II

Diagnostics II is simply the finest set of system maintenance routines ever written for micro-computers. Diagnostics II locates and pinpoints problems by thoroughly testing the five areas of your system:

- Memory
- Terminal
- Printer
- CPU
- Disk

Also, a QUICK TEST will check the memory, disk drives, and CPU in less than 4 minutes!

Requires 32K CP/M
Diagnostics II: \$100.00
Manual only: \$ 15.00

DISK DOCTOR

DISK DOCTOR for CP/M: a program to recover "crashed" discettes AUTOMATICALLY!

DISK DOCTOR is comprised of five "wards":

- Ward A: Verifies discettes and locks out bad sectors.
- Ward B: Copies whatever can be read from a "crashed" file.
- Ward C: Copies discettes without stopping for bad sectors.
- Ward D: Recovers accidentally erased disk files.
- Ward E: Displays directory of recoverable erased files.

Requires 48K CP/M, two drives needed for complete operation.

DISK DOCTOR:
Manual only: \$100.00
\$ 10.00

FORTRAN IV & RATFOR

The SSS FORTRAN compiler is fast, efficient, and complete (full 1966 ANSI standard with extensions). SSS FORTRAN makes full FORTRAN IV available to micro-computers, supporting many advanced features not found in less complete implementations, including: complex arithmetic, character variables, and functions. Recursive sub-routines with static variables are supported, and ".COM" files may be generated. SSS RATFOR is also available and supplied with source code.

Requires 32K CP/M, Z80 only
SSS FORTRAN with RATFOR: \$325.00
SSS FORTRAN alone: \$250.00
RATFOR alone: \$100.00
FORTRAN manual only: \$ 25.00

"C"-compiler

The SuperSoft "C" compiler supports most of version 7 Unix standard "C". Several special and widely desired features are supported.

SuperSoft "C" is a two pass compiler. The first pass produces an intermediate code. Pass two optimizes the intermediate code and assembly code is output to disk file. The optimizer typically results in 40% code reduction. This means that compiled object code will run nearly as fast as that which was written in assembler.

With the compiler comes the complete source code to the I/O libraries. Also, a complete library of useful functions is included.

Compile time options include listing file, console output, syntax checking, and others.

Requires 48K CP/M, (more recommended)
8080 version: \$200.00
8086 version: \$500.00
Manual only: \$ 20.00
Z8000 cross-compiler: \$500.00
(CP/M to Z8000 code, requires Z8000 assembler)
Source code for in-house use available.

NEMESIS

An adventure in NEMESIS is a quest that brings you to the shadowy edges of imagination and the forefront of game technology. You alone can help your character grow in power from person to demigod.

- You may create and play any number of different characters.
- Follows Dungeons and Dragons* character statistics format.
- Maintains a complete map of your character's travels and displays it on your CRT as you play.

Also available is Dungeon Master, a program which allows you to create a variety of new dungeons to challenge your skill.

Requires 46K CP/M and terminal with cursor addressing, clear line, and clear screen functions.
NEMESIS: \$40.00
Dungeon Master: \$35.00
Manual only: \$10.00

...from *SuperSoft*

Five programs no CP/M user should be without!

Software available for virtually all CP/M systems. Specify your system.

Available from fine dealers everywhere, or directly from:
SUPERSOFT, INC.
P.O. BOX 1628
CHAMPAIGN, IL 61820
217-359-2112 Telex: 270365
Technical Hot Line: 217-359-2691

U.K. and Europe:
DIGITAL DEVICES
134 LONDON ROAD
SOUTHBOROUGH KENT
TUNBRIDGE WELLS
TN4 0PL
ENGLAND
Tel: Tunbridge Wells (0892) 379779
Telex: 95582
Japan:
ASR CORPORATION INTERNATIONAL
1-2-8, SHIBA DAIMON
TOKYO 105
JAPAN
Tel. (03) 437-3901 Telex: 242-3296

Wizard-16K™

16K RAM APPLE MEMORY CARD

Unleashes your Apple II* and Apple II Plus* computer.

ON TO MAXIMUM MEMORY

Wizard-16K gives your 48K Apple II or Apple II Plus the last bit of directly accessible add-on memory it can accept. And, it interfaces with all Z80** cards to give you CP/M***

- Fully compatible with Apple II and Apple II Plus
- Adds 16K bytes of Random Access Memory (RAM)
- Fully compatible with Z80 microprocessor cards for CP/M
- Used with Z80 card, it turns your Apple II into a two-microprocessor system with 56K of usable memory
- With a Z80 card, it lets you run BASIC-80****

- COBOL-80****
- FORTRAN-80****, BASIC Compiler****, and Assembly Language Development System****, plus Applesoft BASIC*, Integer BASIC*, Apple Pascal System*, Apple FORTRAN* and Apple Pilot*
- Utilizes Apple DOS 3.3* 16-sector system to permit loading both Applesoft* and Integer BASIC*
- Compatible with VisiCalc****
- Offers all features of Apple Language Card* (except Autostart RAM)
- LED indicators show which banks and functions are selected (deselected)

 **WESPER MICRO Systems™**

SUBSIDIARY OF WESPERCORP

*Registered trademarks of Apple Computer Inc.

**Registered trademark of Zilog

***Registered trademark of Digital Research

****Registered trademarks of Microsoft

*****Registered trademark of Personal Software



\$169.00

AVAILABLE AT ALL FINE
COMPUTER STORES

Education Forum

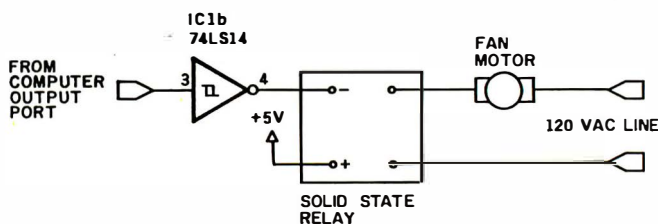

Figure 2: The interface used to turn the fan motor on and off. A solid-state relay is simply driven from the computer's output port via a 74LS14 Schmitt trigger. This circuit is used in conjunction with the one shown in figure 1 to form a closed-loop control system. If the fan speed is too fast, the motor is turned off; if it is too slow, it is turned on.

cise. I will present a fairly detailed algorithm here, leaving the actual programming up to you.

1. Initialize the time counter to 200 decimal. (Use a register for this purpose. When the measurement starts, the time counter will be decremented every millisecond (ms), so that when zero is reached, 1/5 second has elapsed.)
2. Initialize the pulse counter to zero. (Use a register as a pulse counter.)
3. Read PHOTO. Is it low? If yes, go to 3. (In steps 3 and 4 the input line is sensed continuously to detect a high-to-low transition. When this occurs, the measurement starts.)
4. Read PHOTO. Is it high? If yes, go to 4. (See the preceding comment.)
5. Increment the pulse counter. (A fan blade is now cutting the light beam.)
6. Call a delay subroutine to obtain a 1-ms delay. (The subroutine should execute a delay loop of 1 ms duration.)
7. Decrement the time counter. Is the result zero? If yes, go to 13.
8. Read PHOTO. Is it low? If yes, go to 6. (Low means that the fan blade is still interrupting the beam.)
9. Call the same delay subroutine as above.
10. Decrement the time counter. Is the result zero? If yes, go to 13.
11. Read PHOTO. Is it high? If yes, go to 9. (Repeat from 9 while waiting for the next fan blade.)
12. Go to 5.
13. The measurement is now complete. The pulse counter contains the number of times the light beam has been cut by the fan blades during 1/5 second. Display the result, and repeat from step 1. The execution of the program may terminate here if only a single measurement is required.

Note that if your computer is equipped with a programmable interrupt timer, this device can be used as a real-time clock. Thus, an interrupt timer may provide an alternative to using a delay subroutine for time measurement.

Controlling a Motor

Several methods are available to control the rotational speed of a motor. One of these is sometimes called "on-off control." Admittedly, this technique does not regulate the speed with great precision under all conditions. It is, however, the simplest method, and for this reason it will be used here.

The "on-off control" method measures the motor speed periodically and compares it to a desired value. If the motor runs too fast, it is turned off. If it runs too slowly, power is applied. Thus, this experiment will demonstrate the principle of a closed-loop control system, where the input sensed by the computer is used to determine the control output. This experiment also provides an example of how to interface AC appliances to a computer.

A phototransistor and a fan are used, as in the first experiment. However, in this case the fan is connected to the AC outlet through a solid-state relay, as shown in figure 2. The fan motor is turned on and off by sending 1 and 0, respectively, to the output port. A Schmitt trigger is used to drive the relay. Many other gates could drive the relay equally well, but the 74LS14 contains six Schmitt triggers. Many models of solid-state relays are available, with various current ratings, and most of them can be used for this experiment.

As in the previous experiment, the actual writing of the program is left up to you. The program should operate as follows:

1. Initialize the time counter to 100 decimal. (Note that a relatively short measuring period is chosen, in order to obtain a well-regulated speed. In this example 1/10 second is used.)
2. Initialize the pulse counter to zero.
3. Read PHOTO. Is it low? If yes, go to 7.
4. Call a 1-ms delay subroutine.
5. Decrement the time counter. Is the result zero? If yes, go to 12.
6. Go to 3.
7. Increment the pulse counter.
8. Call the delay subroutine.
9. Decrement the time counter. Is the result zero? If yes, go to 12.
10. Read PHOTO. Is it high? If yes, go to 4.
11. Go to 8.
12. Turn on the motor if the rotation is too slow; turn it off if the rotation is too fast. (The value of the pulse counter is compared to a value you have stored in a memory location before running the program. If the rotation is too slow, 1 is sent to the output port. Otherwise 0 is sent.)
13. Repeat from step 1.

When the experiment is performed, various speeds should be tried, high as well as low. You may also try to vary the load by applying moderate pressure to the motor shaft, if the design of the fan permits this. ■

Circle 382 on inquiry card.

Wizard-80™

INSTANT 80 COLUMN APPLE*

The miracle of the 80's... everything you want in an 80-column card.

STOP STARING AT 40 COLUMNS

WIZARD-80 lets you see exactly what you will get when typing 80-column format. It gives you a full 80-column by 24-line display with all these features.

- Fully compatible with Apple II and Apple II Plus *
- Fully compatible with most word processors, micro-modems and prom programmers, plus all current Apple II expansion boards
- Lists BASIC programs, integer and Applesoft
- Fully compatible with Pascal
- Uses software to switch between 40 and 80 column formats

- Displays 7 x 9 matrix characters
- Provides upper/lower case characters with full descenders
- Fully edits... uses ESCape key for cursor movement
- Scrolling stop/start uses standard Control-S entry
- Retains text on screen while it is being printed
- Contains crystal clock for flicker-free character display
- Has low power consumption for cool reliable operation
- Leads soldered directly to board for maximum reliability
- 2K on-board RAM, 50 or 60 Hz operation
- Inverse video selection standard



SUBSIDIARY OF WESPERCORP

*Registered trademarks of Apple Computer Inc.

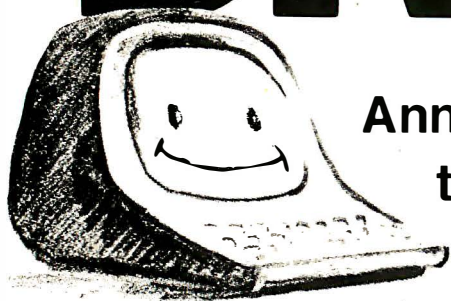

\$345.00 AVAILABLE AT ALL FINE COMPUTER STORES

\$395 BASIC DIVORCE



Announcing the new quick and easy way
to write custom business applications
in hours instead of weeks.

At last, you can get a microcomputer business application development system that is designed for one purpose only... fast production of bug-free professional-looking custom business applications.

"Thinks" the Way Business Thinks

Quic-N-Easi is the revolutionary screen-format-oriented application development system that thinks in terms of transactions, records and fields. The same way business thinks. **Quic-N-Easi** expects an application to include custom formatted key entry. It lets you set up the character, field, and record validity checks business wants by merely filling in the blanks. It automatically signals in real time when errors occur and "explains" what is wrong in plain English messages you select for each custom application.

Much Faster than BASIC

Quic-N-Easi programming is much faster than BASIC because the standard business applications (key input, file handling, and output reporting) are handled via pre-programmed parameter driven sub-routines. To produce finished professional looking custom business programs, you merely:

- Draw the business formats directly on the CRT in minutes.
- Fill in the blanks for field attributes, validations, tables, etc.
- Invoke the **Quic-N-Easi** interpreter to check fields against tables, check limits, access data files, and perform business calculations, etc.

- Optionally define file and output formats right on the screen.

Pays for Itself in a Week

By eliminating the coding drudgery of writing screen, field, file, and format programs in BASIC, programmers are free to concentrate on the unique business aspects of each custom application. No professional programmer can afford to develop one more business application without **Quic-N-Easi**. The savings are so significant with **Quic-N-Easi**, it can actually pay for itself in only one week.

Gives You Much More than a Screen Builder... the Only Complete Business Development System for Microcomputers

Quic-N-Easi handles the entire application development job from key entry to final output. You get everything you need, including detailed documentation to begin writing professional programs the first day. **You get...**

- A singularly capable **Quic-N-Easi** screen builder
- A comprehensive parameter driven **Quic-N-Easi** content editor
- A full **Quic-N-Easi** interpreter language
- A complete **Quic-N-Easi** file management system with Index Sequential, Random, and Sequential File Access Method
- A complete **Quic-N-Easi** print format handler
- A detailed **Quic-N-Easi** reference manual

- A **Quic-N-Easi** self-teaching guide
- A **Quic-N-Easi** quick reference card
- An interface to other program files

ORDER NOW—Don't Waste One More Day Coding BASIC

Your time is too valuable to waste hours on end writing BASIC code. The first week you use **Quic-N-Easi**, your finished business programs will look better, run better, and return more dollars to you. Don't delay. Order **Quic-N-Easi** today. Phone... **215 968-0689**

QUIC-N-EASI™

STANDARD MICROSYSTEMS INC.
136 GRANITE HILL COURT, LANGHORNE, PA 19047

Pricing Information

- Complete **Quic-N-Easi** system **\$395**
- Manual only **\$60**
- Visa and Mastercard accepted
- Dealer Inquiries Invited

Minimum System Requirements

- Z80 • 48K • Floppy Disc
- CP/M (except TRS80 Mod III)

Other Disk Formats • 8" Single Density Vector Graphics • Micropolis Model 2

Customized Versions • TRS80 Mod II, TRS80 Mod III, APPLE, OSBORNE, INTERTEC, VECTOR, ZENITH

Apple, CP/M, Intertec, Micropolis, and TRS80 are trademarks of Apple Computer, Digital Research, Intertec Data Systems, Micropolis Corp., and Tandy Corp.

The RCA VP-3301 Data Terminal

Tim Daneliuk
4927 N Rockwell
Chicago, IL 60625

With the cost of most computer hardware decreasing, RCA's introduction of an inexpensive data-entry terminal hardly comes as a surprise. For a modest investment, the VP-3301 delivers many features formerly available only on more expensive terminals.

The terminal comes complete with an RS-232C interface and a 20-milliamp (mA) current-loop interface. It is capable of directly driving a standard television monitor, or it can be connected to a television receiver if an RF (radio-frequency) modulator is used.

Physical Features

The VP-3301 is small and lightweight enough to fit into a briefcase for use as a portable/remote data-entry ter-

terminal. The keyboard is a flat membrane type in the standard 58-key typewriter format, and two-key rollover is also provided. The unit has two extra keys that can activate switch closures for controlling user-supplied hardware. The switches are rated at 30 volts, 0.2 ampere, and 1 watt maximum.

The terminal also includes a small audio amplifier and speaker that can provide audio feedback when a key is pressed. A slide switch on the rear of the unit can turn this function off. With the control and escape keys, you can program the speaker and amplifier to produce a wide range of tones and sounds.

The terminal can interface to a standard RS-232 device or to a 20-mA current loop through a 25-pin sub-miniature "D" connector located on the back of the unit. Included as part of the RS-232 interface is a group of switches that control the serial port operating parameters and certain video-display characteristics. Using these switches, you can choose from:

- uppercase only/uppercase and lowercase
- even/odd parity (RS-232)
- mark/space (current loop)
- two stop bits/one stop bit
- full duplex/half duplex
- enable/disable control features
- display/no display of control characters
- 40/20 characters per line (24/12 lines on screen)
- current loop/RS-232
- local/line
- data rate (110 to 19,200 bps)

A small AC adapter comes with the terminal. To incorporate the terminal as a more permanent part of a larger system, you need only provide 8.3 volts DC at 900 mA.

Operating Features

One of the strengths of the VP-3301 is its flexibility; many options can be exercised from the keyboard under

At a Glance

Name

RCA VP-3301 Data Terminal

Use

Data entry and communication

Manufacturer

RCA
New Holland Ave.
Lancaster, PA 17604

Price

\$369

Dimensions

13.1 inches long by 7 inches deep by 2 inches high

Features

RS-232C and 20-mA current loop interfaces, color video output

Hardware needed

Video monitor or RF modulator and TV set

Hardware options

VP-3303 includes built-in RF modulator for \$389

You're looking at the lowest prices in the magazine. Period.

If you can find anything lower, check the fine print.

This is a bold statement to make, but our large and ever-growing customer base believes it to be true. The way we see it, the real price of mail order purchasing goes further than listed prices. It has to do with bottom line satisfaction. Period.

Are the salespeople knowledgeable? Does the company add extra charges for using your credit card? Do they stand behind the product more than just offering factory warranty? Who pays the shipping for returned items? And, most importantly, is the price fair?

At Alpha Byte we built our reputation on our prices and your satisfaction.

16K RAM KITS . . . 13.95

Set of 8 NEC 4116 200 ns. Guaranteed one full year.

DISKETTES

ALPHA DISKS® . . . 21.95

Single sided, certified Double Density 40 Tracks, with Hub-ring. Box of 10. Guaranteed one full year.

VERBATIM DATALIFE

MD 525-01, 10, 16	26.50
MD 550-01, 10, 16	44.50
MD 557-01, 10, 16	45.60
MD 577-01, 10, 16	34.80
FD 32 or 34-9000	36.00
FD 32 or 34-8000	44.95
FD 34-4001	48.60

DISKETTE STORAGE

5 1/4" PLASTIC LIBRARY CASE	2.50
8" PLASTIC LIBRARY CASE	3.50
PLASTIC STORAGE BINDER w/ Inserts	9.95
PROTECTOR 5 1/4" (50 Disk Capacity)	21.95
PROTECTOR 8" (50 Disk Capacity)	24.95

INTEGRATED COMPUTER SYSTEMS

NORTHSTAR	SCALL
ALTOS	SCALL
ZENITH Z89	SCALL
CALIF. COMPUTER SYSTEMS	SCALL
MORROW DESIGNS	SCALL

PRINTERS

ANADEX DP 9500	1295.00
ANADEX DP 9501	1295.00
CENTRONICS 739	765.00

C-I-TOH 25 CPS PARALLEL	1440.00
C-I-TOH 25 CPS SERIAL	1495.00
C-I-TOH 45 CPS PARALLEL	1770.00
C-I-TOH 40 CPS SERIAL	1870.00
EPSON MX-80	SCALL
EPSON MX-80 F/T	SCALL
EPSON MX-100 GRAPHIC	SCALL
EPSON GRAPHIC ROM	90.00
IDS-445G PAPER TIGER	779.00
IDS-460G PAPER TIGER	945.00
IDS-560G PAPER TIGER	1195.00
NEC SPINWRITER 3510 S. RO	2195.00
NEC SPINWRITER 3530 P. RO	2195.00
NEC SPINWRITER 7710 S. RO	2645.00
NEC SPINWRITER 7730 P. RO	2645.00
NEC SPINWRITER 7700 D SELLUM	2795.00
NEC SPINWRITER 3500 SELLUM	2295.00
OKIDATA MICROLINE 80	389.00
OKIDATA MICROLINE 82A	549.00
OKIDATA MICROLINE 83A	799.00
OKIDATA MICROLINE 84	1199.00
OUME 9/45	2149.00
MALIBU 200 DUAL MODE	2695.00

CORVUS

FOR S-100, APPLE OR TRS-80 MOD I, III

Controller, Case/P.S., Operating System, A & T.	3245.00
5 MEGABYTES	3245.00
10 MEGABYTES	4645.00
20 MEGABYTES	5545.00
MIRROR BACK-UP	725.00

APPLE HARDWARE

VERSA WRITER DIGITIZER	259.00
ABT APPLE KEYPAD	119.00
MICROSOFT Z-80 SOFTWARE	299.00
MICROSOFT RAMCARD	159.00
VIDEX 80 x 24 VIDEO CARD	299.00
VIDEX KEYBOARD ENHANCER II	129.00
VIDEX ENHANCER REV O-6	99.00
M & R SUPERTERM 80 x 24 VIDEO BD.	315.00

NEC 12" GREEN MONITOR	199.00
NEC 13" COLOR MONITOR	399.00
SANYO 12" MONITOR (B & W)	249.00
SANYO 12" MONITOR (GREEN)	269.00
SANYO 13" COLOR MONITOR	469.00
SSM AIO BOARD (INTERFACE) A & T	165.00
SSM AIO BOARD (INTERFACE) KIT	135.00
ZENITH 13" HI RES. GREEN MON.	139.00
APPLE FAN	44.95
T/G JOYSTICK	54.95
T/G PADDLE	34.95
VERSA E-Z PORT	21.95
MICRO SCI A40 W/CONTROLLER	479.00
MICRO SCI A40 W/O CONTROLLER	409.00
MICRO SCI A70 W/CONTROLLER	629.00
MICRO SCI A70 W/O CONTROLLER	549.00

MOUNTAIN HARDWARE

CPS MULTIFUNCTION BOARD	199.00
SUPERTALKER SD200	259.00
ROMPLUS W/ KEYBOARD FILTER	179.00
ROMPLUS W/O KEYBOARD FILTER	130.00
KEYBOARD FILTER ROM	49.00
COPYROM	49.00
MUSIC SYSTEM	399.00
ROMWRITER	149.00
APPLE CLOCK	252.00
A/D + D/A	299.00
EXPANSION CHASSIS	625.00

CALIF. COMPUTER SYSTEMS

S-100 BOARDS

2200A MAINFRAME	459.00
2065C 64K DYNAMIC RAM	539.00
2422 FLOPPY DISK CONT. & CP/M®	359.00
2710 FOUR SERIAL I/O	279.00
2718 TWO SERIAL/TWO PARALLEL I/O	269.00
2720 FOUR PARALLEL I/O	199.00
2810 Z-80 CPU	259.00

APPLE BOARDS

7710A ASYNCHRONOUS S. INTERFACE	139.00
7712A SYNCHRONOUS S. INTERFACE	159.00
7424A CALENDAR CLOCK	99.00
7728A CENTRONICS INTERFACE	105.00

VISTA COMPUTER CO.

APPLE 40 TK. DRIVE A40 (163K Bytes)	389.00
APPLE 80 TK. DRIVE A80 (326K Bytes)	549.00
APPLE 160 TK. DRIVE A160 (652K Bytes)	799.00
APPLE 80 COLUMN CARD	329.00
APPLE 8" DISK DRIVE CONTROLLER	549.00

MODEMS

NOVATION CAT ACOUSTIC MODEM	145.00
NOVATION D-CAT DIRECT CONNECT	165.00
NOVATION AUTO-CAT AUTO ANS	219.00
NOVATION APPLE-CAT	349.00
UDS 103 LP DIRECT CONNECT	175.00
UDS 103 JLP AUTO ANS	209.00
D.C. HAYES MICROMODEM II (APPLE)	299.00
D.C. HAYES 100 MODEM (S-100)	325.00
D.C. HAYES SMART MODEM (RS-232)	249.00
LEXICON LX-11 MODEM	109.00

TERMINALS

TELEVIDEO 910	639.00
TELEVIDEO 912C	745.00
TELEVIDEO 920C	830.00
TELEVIDEO 950C	995.00
ZENITH Z-19	799.00

TRS-80 MOD I HARDWARE

PERCOM DATA SEPARATOR	27.00
PERCOM DOUBLER II	159.00
TANDON 80 TRACK DISK DRIVE	429.00
TANDON 40 TRACK DISK DRIVE	289.00
LNW DOUBLER W/ DOSPLUS 3.30	159.00

MORROW DESIGNS FLOPPY DISK SYSTEMS

Controller, P.S., Microsoft Basic, CP/M® A & T	
DISCUS 20 (Single Drive — 500K)	869.00
DISCUS 20 (Dual Drive — 1 MEG)	1499.00
DISCUS 2 + 2 (Single Drive — 1 MEG)	1099.00
DISCUS 2 + 2 (Dual Drive — 2 MEG)	1999.00

HARD DISK SYSTEMS

Controller, P.S., Microsoft Basic, CP/M® A & T	
DISCUS M 10 (10 Megabytes)	3099.00
DISCUS M26 (26 Megabytes)	3749.00

ISOLATORS

ISO-1 3-SOCKET	53.95
ISO-2 6-SOCKET	53.95

MICRO PRO APPLE CP/M®

WORDSTAR*	259.00
SUPERSORT*	145.00
MAILMERGE*	90.00
DATASTAR*	215.00
SPELLSTAR*	169.00

CP/M®	
WORDSTAR	310.00
SUPERSORT	195.00
MAILMERGE	110.00
DATASTAR	245.00
SPELLSTAR	195.00

MICROSOFT APPLE

FORTRAN*	165.00
BASIC COMPILER*	315.00

COBOL*	595.00
Z-80 SOFTCARD	299.00
RAMCARD	159.00
TYPING TUTOR	17.95
OLYMPIC DECATHLON	24.95
TASC APPLESOFT COMPILER	159.00

CP/M®	
BASIC 80	299.00
BASIC COMPILER	319.00
FORTRAN 80	369.00
COBOL 80	595.00

PEACHTREE APPLE CP/M®

GENERAL LEDGER	295.00
ACCT. RECEIVABLE	295.00
ACCT. PAYABLE	295.00
PAYROLL	295.00
INVENTORY	295.00

CP/M®	
GENERAL LEDGER	595.00
ACCT. RECEIVABLE	595.00
ACCT. PAYABLE	595.00
PAYROLL	595.00
INVENTORY	595.00
PROPERTY MGMT.	799.00
CPA CLIENT WRITE-UP	799.00

APPLE SOFTWARE

MAGIC WINDOW	79.00
DB MASTER (NEW)	179.00
PFS: PERSONAL FILING SYSTEM	79.00
PFS: REPORT	79.00
Z-TERM*	89.95
ASCII EXPRESS	63.95
HAYDEN APPLESOFT COMPILER	149.00
EASY WRITER-PRO	199.00
EXPEDITER II APPLESOFT COMPILER	73.95
A-STAT COMP. STATISTICS PKG.	119.00
SUPER TEXT II	129.00

PERSONAL SOFTWARE

DESKTOP PLAN II	159.00
CCA DATA MGMT. SYSTEM	89.00
VISIPILOT	159.00
VISITREND/VISIPILOT	199.00
VISIDEX	159.00
VISITERM	129.00
VISICALC 3.3	159.00

CP/M® SOFTWARE

d BASE II	599.00
SUPER CALC	229.00
MAGIC WAND	279.00
SPELLGUARD	239.00
P & T CP/M® MOD II TRS-80	175.00

TRS-80 GAMES

TEMPLE OF APASHAI	34.95
HELLFIRE WARRIOR	34.95
STAR WARRIOR	34.55
RESCUE AT RIGEL	24.95
CRUSH, CRUMBLE AND CHOMP	24.95
INVADERS FROM SPACE	17.95
PINBALL	17.95
STAR TREK 3.5	17.95
MISSILE ATTACK	18.95
STAR FIGHTER	24.95

TRS-80 SOFTWARE

NEWDOS/80 2.0 MOD I	139.00
LAZY WRITER MOD I	125.00
PROSOFT NEWSOFT MOD I, III	99.00
SPECIAL DELIVERY MOD I, III	119.00
X-TRA SPECIAL DELIVERY MOD I, III	199.00
TRACKCESS MOD I	24.95
OMNI TERM SMART TERM. MOD I, III	89.95
MICROSOFT BASIC COMP. FOR MOD I	165.

APPLE GAMES

PERSONAL SOFTWARE

CHECKER KING	21.95
GAMMON GAMBLER	21.95
BRIDGE PARTNER	21.95
MONTY PLAYS MONOPOLY	29.95
ZORK	32.95
MONTY PLAYS SCRABBLE	34.95

BRODERBUND

TAWALA'S LAST REDOUBT	24.95
GALAXY WARS	20.95
ALIEN RAIN (AKA GALAXIAN)	20.95
SNOGGLE (REO JOYSTICK)	27.95
ALIEN TYPHOON	20.95
APPLE PANIC	24.95
SPACE WARRIOR	20.95

AUTOMATED SIMULATIONS

INVASION ORION	20.95
STAR WARRIOR	32.95
TUES. MORNING QUARTERBACK	25.95
CRUSH, CRUMBLE AND CHOMP	24.95
THE DRAGON'S EYE	20.95

MUSE SOFTWARE

ROBOT WARS	32.95
THREE MILE ISLAND	32.95
A.B.M.	20.95
GLOBAL WAR	20.95
CASTLE WOLFENSTEIN	24.95

ON-LINE SYSTEMS

MYSTERY HOUSE	20.95
WIZARD AND PRINCES	29.95
H/R FOOTBALL	32.95
H/R CRIBBAGE	20.95
MISSILE DEFENSE	25.95
CRANSTON MANOR	29.95
SABOTAGE	20.95
GOBBLERS	20.95
SOFT PORN ADVENTURE	24.95
PEGASUS II	25.95
EXPEDITER	73.95

SIRIUS SOFTWARE

PHANTOMS FIVE	24.95
SPACE EGGS	24.95
AUTOBAHN	24.95
PULSAR II	24.95
GAMMA GOBLINS	24.95
GORGON	32.95
SNEAKERS	24.95
EPOCK	29.95
COPS AND ROBBERS	29.95

EDU-WARE

PERCEPTION PKG.	19.95
COMPU-READ	24.95
STORY TELLER	18.95
COMPU-MATH: ARITHMETIC	39.95
COMPU-MATH: FRACTIONS	34.95
COMPU-MATH: DECIMALS	34.95

TO ORDER, or for information, CALL: **(213) 706-0333**

We guarantee everything we sell for 30 days. If anything is wrong, just return the item and we'll make it right. And, of course, we'll pay the shipping charges.

We accept Visa and Master Card on all orders. COD orders accepted up to \$300.00.

Please add \$2.00 for standard UPS shipping and handling on orders under 50 pounds, delivered in the continental U.S. Call us for shipping charges on items that weigh more than 50 pounds. Foreign, FPO and APO orders please add 15% for shipping. California residents add 6% sales tax.

The prices quoted are only valid for stock on hand and all prices are subject to change without notice.

31245 LA BAYA DRIVE, WESTLAKE VILLAGE, CALIF 91362

COMPU-SPELL (REQ. DATA DISK)	24.95
COMPU SPELL DATA DISKS 1-4, ea.	17.95

MORE GREAT APPLE GAMES

COMPUTER QUARTERBACK	32.95
THE WARP FACTOR	32.95
CARTELS AND CUTTHROATS	32.95
TORPEDO FIRE	49.95
THE SHATTERED ALLIANCE	49.95
COMPUTER BASEBALL	32.95
POOL 1.5	29.95
ULTIMA	33.95
RASTER BLASTER	24.95
FLIGHT SIMULATOR	27.95
INTERNATIONAL GRAND PRIX	25.95
COSMO MISSION	24.95
SARGON II	28.95
SHUFFLE BOARD	29.95

SUPPLIES

AVERY TABULABLES

1,000 3 1/2 x 15/16	8.49
3,000 3 1/2 x 15/16	14.95
5,000 3 1/2 x 15/16	19.95

FAN FOLD PAPER

(Prices F.O.B. S.P.)

9 1/2 x 11 18lb WHITE 3,000 ct.	29.00
14 7/8 x 11 18lb WHITE 3,000 ct.	39.00

CP/M is a registered trademark of Digital Research.

*Requires Z-80 Softcard.

We built a reputation on our prices and your satisfaction.

Alpha Byte

COMPUTER PRODUCTS

software control. For example, you can redefine any character on the keyboard to display custom characters on a 6 by 8 matrix. Up to 128 characters can be redefined at any one time, allowing you to use almost any key on the keyboard to make the alphanumeric or graphics character of your choice appear on the screen. Similarly, foreground/background color, sound-generator pitch and dynamics, cursor operation, and reverse video can all be controlled from the keyboard.

A beeping sound that signifies a data input overrun makes the terminal particularly useful for remote data-entry or timesharing applications.

The VP-3301 offers an impressive array of graphics- and video-related features. The character set is suitable for word processing, with lowercase and true descenders. You can select either 40 characters per line and 24 lines per page, or 20 characters per line and 12 lines per page. The cursor can be on, off, or blinking. The terminal also offers a choice of eight colors or seven levels of gray for both foreground and background video, and the color parameters can be redefined in the middle of a line.

The terminal does not, however, allow character size to be changed in the middle of a line. For example, if you change from 20 to 40 characters per line in the middle of the screen, the change will affect the entire screen, not just the subsequent characters.

You can also use the keyboard to program the ter-

terminal's sophisticated sound generator. The choices include pitch over about four octaves on the musical scale and loudness of tone. A white-noise generator is available for various sound effects.

Conclusions

I used the RCA VP-3301 in conjunction with an RF modulator, color television receiver, and 300-bps acoustic modem to access the computer facilities at a university in Chicago. Although it is difficult to second-guess a manufacturer's reasons for doing things a certain way, I did have a few problems with the terminal. For example, the VP-3301 is very limited in timesharing applications because it lacks a second serial or parallel port for printer support.

In addition, I would gladly give up all the video-display options in favor of an 80-character-per-line display format. I also question the usefulness of color graphics, as you can buy a complete color computer system for about the same cost. Because the graphics on the VP-3301 are not suitable for serious industrial-quality displays, perhaps RCA should have made the terminal more compatible with remote computing applications.

Despite the thin overlay that helps you feel the position of the keys, I found the flat membrane keyboard really cumbersome to use. I would gladly trade it for a standard keyboard. The membrane keyboard does, however, have



Thousands of copies of the original CP/M™ spelling checker are used every day. Now, introducing SPELLGUARD, VERSION 2.0 . . .

1.5 Times Faster Proofreading

Tested at 50 pages (12,500 words) per minute on 8" floppy disks.

3.0 Times More Powerful Dictionary

20,000 word dictionary fits in one third the original space (54K). All user-built dictionaries are similarly compressed.

Words Removed From Dictionary in a Single Step

Words can be added or deleted from any SPELLGUARD dictionary at a single keystroke **without** the use of utility programs and extra diskette space.

Legal Dictionary Available

19,000 word dictionary of legal terms is available.

And it's still the easiest spelling checker to use with its menu driven design and extensive on-line help feature.

Spellguard 2.0 offers the full dictionary and program on Apple™ format (required CP/M™ and 80 column card.)

SpELLGUARD™ - THE SPELLING CHECKER FOR PROFESSIONALS

Contact your local Microcomputer Dealer or write to ISA for information. Suggested retail price of SPELLGUARD \$295, the legal dictionary \$125, and the upgrade from SPELLGUARD 1.0 to 2.0 \$35.

Apple is a registered trademark of Apple Computer Co.
CP/M is a registered trademark of Digital Research.

INNOVATIVE SOFTWARE APPLICATIONS

260 Sheridan Avenue., Suite 300
Palo Alto, CA 94306
P.O. Box 2797 Menlo Park, CA 94025
(415) 326-0805

CASH FLOW PROBLEMS?

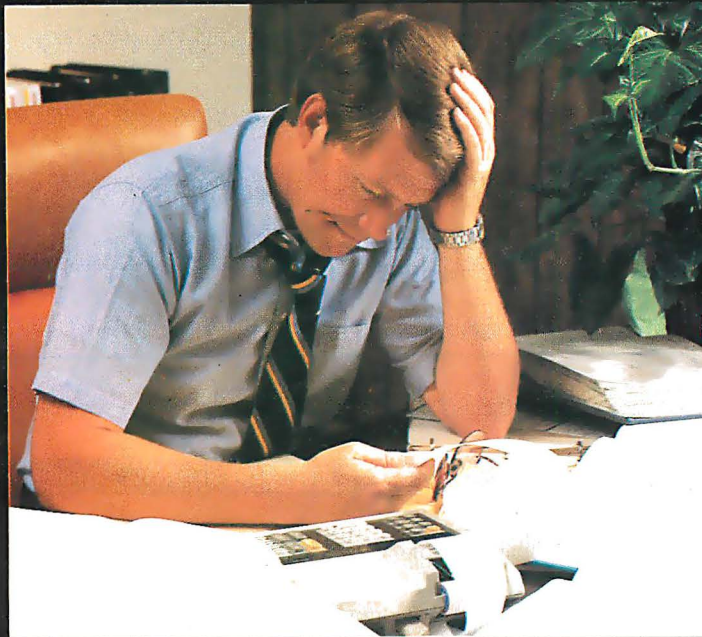

IT'S NICE TO KNOW SOMEONE WHO HAS THE SOLUTION.



MicroAge is your Solution Store . . . that means at MicroAge Computer Stores we have a wide selection of time-saving computerized business systems designed specifically to solve the daily cash flow problems every businessman faces.

MicroAge has computerized business systems that

quickly and affordably allow you to regain control of your critical accounts receivable . . . at last making it possible for you to carry out effective collection procedures on a consistent basis. MicroAge has accounts receivable program packages to automatically display and update account information; prepare trial balance including a balance-due and delinquency aging

report, and take care of dozens of other tasks that eat into your time and profit!

Computerized business systems from the MicroAge Computer Store are available in the \$5,000 to \$15,000 range, to suit the individual budget of your small business or professional practice. MicroAge backs up every system with personalized service, warranty service and repair, installation, systems consulting, even customer training. Visit the MicroAge Computer Store in your area soon with your business problems, and let us help you with the solution.

MicroAge.
COMPUTER STORE

"The Solution Store" SM

VISIT THE STORE IN YOUR AREA:

El Paso, Texas
(915) 591-3349

Rockville, Maryland
(301) 762-7585

Tucson, Arizona
(602) 790-8959

Albuquerque, New Mexico
(505) 883-0955

Pleasant Hill, California
(415) 680-1489

Aurora, Colorado
(303) 696-6950

Rochester, New York
(716) 244-9000

Hurst, Texas
(817) 284-3413

Salina, Kansas
(913) 823-7596

Orland Park, Illinois
(312) 349-8080

Milwaukee, Wisconsin
(414) 257-1100

Mountain View, California
(415) 964-7063

Scottsdale, Arizona
(602) 941-8794

Anchorage, Alaska
(907) 279-6688

San Diego, California
(714) 278-0623

Richardson, Texas
(214) 234-5955

Minneapolis, Minnesota
(612) 338-1777

Omaha, Nebraska
(402) 339-7441

Phoenix, Arizona
(602) 265-0065

Columbus, Ohio
(614) 868-1550

Indianapolis, Indiana
(317) 849-5161

Portland, Oregon
(503) 256-4713

Norwalk, Connecticut
(203) 846-0851

St. Louis, Missouri
(314) 567-7644

Oklahoma City, Oklahoma
(405) 728-1837

Houston, Texas
(713) 440-7547

W. Palm Beach, Florida
(305) 683-5779

Toronto, Canada
(416) 487-5551

Houston, Texas
(713) 270-9647

Wilmington, Delaware
(302) 368-3672

Allentown, Pennsylvania
(215) 434-4301

FOR FRANCHISE OPPORTUNITY INFORMATION CALL (602) 968-3168

the advantage of being impervious to moisture, dust, and other contaminants because it is completely sealed.

Most disturbing, I found the documentation for the VP-3301 poor to awful. To be fair, the manual I used was only a preliminary edition, which may explain its incoherence. Although the manual did cover all facets of the terminal, it lacked complete examples, did not clearly explain many of the control and escape sequences, and contained almost no technical information. It did include interfacing schematics.

Despite these drawbacks, the terminal provides good performance for the price. RCA wins high marks for the construction of the VP-3301, a well-built piece of hardware that promises to remain trouble-free. None of its problems is insurmountable, and the terminal offers enough versatility to find its way into many diversified applications. ■



Photo 1: The RCA VP-3301 Data Terminal.

IMPORTS

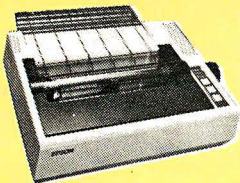

- Epson 80's/100's call
- Okidata M80 \$349
- Okidata M82A \$469
- Okidata M83A \$749
- Okidata M84 \$1059

HIGH SPEED

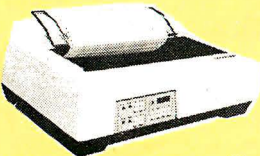

- Anadex 9500/9501 \$1245
- TI 810 Basic \$1249
- Datasouth - 180
- New CP-Graphics call

LETTER QUALITY

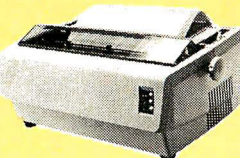

- C.Itoh Starwriter-IP \$1324
- C.Itoh Starwriter II 5 \$1595
- NEC 3500 \$1995
- NEC 7710/7730 \$2340
- Diablo 630
- w/tractors \$2295

COMPUTERS



NORTHSTAR

Burned and tested - backed by fast warranty service. Exclusive Soli® CP/M® increases drive capacity. Octals and Winchester available. Our Northstars are better than "factory sealed" - call us - we'll tell you why. (free games disk).

- HRZ II 64K DD \$2795.00
- HRZ II 64K Quad \$3095.00
- Advantage Call

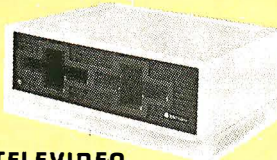

TELEVIDEO

A new line of micros-serviced locally by General Electric. System I includes 64K RAM. CP/M® 1MG on floppy. and diagnostics.

- SYSTEM I \$2385
- SYSTEM II \$5349

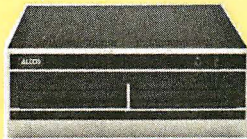

ALTOS

Single user 8000-2 Includes dual 8" double density drives (1 Mg. capacity). two serial ports. two parallel ports. and CP/M®. Call for other Altos prices.

- ACS-8000-2 w/CP/M® \$2749
- ACS-8000-15 w/MP/M® \$4195



ZENITH

The all-in-one computer that's backed by your local Zenith/Heath service center. Green Screen. CP/M®. and Supercalc incl.

- Z89 w/48K \$2135
- Z90 w/64K, DD \$2295

LOW COST



- Adds Viewpoint \$544
- Televideo 910 \$589
- ADM 3A \$569
- Soroc IQ 130 \$589

TELEVIDEO



- Televideo 912 \$699
- Televideo 920 \$728
- Televideo 950 \$927

TERMINALS



- Ampex D80 \$925
- Dialogue 80 Amber \$969
- Mime Act 5A \$799
- Soroc IQ 120 \$729
- Volker Craig 404 \$599



Scottsdale Systems Ltd.

6730 E. McDowell Road, Suite 110, Scottsdale, Arizona 85257



(602) 941-5856



Call 8-5 Mon.-Fri.

(We Export) TWX 910-950-0082 (IMEC SCOT)

MORE PRINTERS

- Paper Tiger 460G \$789
- Paper Tiger 560G \$1129
- Centronics 739P \$649
- Centronics 739S \$729
- DEC LA34AA \$1049
- NEC PC-8023A \$639
- C.Itoh Prowriter \$579
- Malibu 200 \$2395
- M.P.I. 99G \$719
- Tally MT 1805 \$1645

ORDERING

MAIL ORDER ONLY

2% cash discount included/charge cards add 2%. Prices subject to change, product subject to availability. Arizona residents add 5%. F.O.B. point of shipment Scottsdale. 0-20% restocking fee for returned merchandise. Warranties included on all products. Personal checks take 3 weeks to clear.

CP/M and MP/M are registered trademarks of Digital Research.



**Don't make your
computer old
before its time**

**Now there's Palantir™ — Word Processing and Accounting
Software for Today's Computers**

You've just gotten a brand new computer. Don't tie it down with old software. Two-year-old software will make it run like a two-year-old computer.

The microcomputer industry is the fastest growing, most exciting industry in the world. Today's printers, terminals and disk drives can do things no one even dreamed of two years ago.

But a computer is just a dumb piece of metal until software gives it life, and, unfortunately, microcomputer software has not kept up with the hardware.

Until now.

There's a commonly held belief that you should not buy new software because it hasn't been tested. We say, "Hogwash!"

At one time those complaints might have been valid, but the software industry has come of age. We do our testing *before* we release a product, not afterwards.

More importantly, we've learned that quality cannot be

tested into a product; it must be *built* in from the beginning by people who know what they are doing.

And we do.

We formed Designer Software because we believed that the quality hardware of today demanded software of equal quality. It took a lot of time, sweat, money, care, experience and talent to make that belief a reality.

We set high standards, but our team of CPA's, systems analysts, programmers, writers, artists and marketers that created *Palantir*™ Word Processing and Accounting have exceeded all of our expectations.

Palantir™ is the most professional packaged software ever to be offered to the CP/M® market.

We don't expect to convince you of that with just one ad, and we won't try. But if you're in the market for business software, we hope we've convinced you to find out more about *Palantir*™ — today's software for today's computers.



For more information and the name of a dealer near you, please write, call, telex or use *The Source*. Dealer, distributor and OEM inquiries invited.

**3400 Montrose Blvd. • Suite 718 • Houston, Texas 77006
(713) 520-8221 • Telex 790510 • Source TCU671**

CP/M is a registered trademark of Digital Research.

Designer Software and Palantir are trademarks of Palantir, Inc.

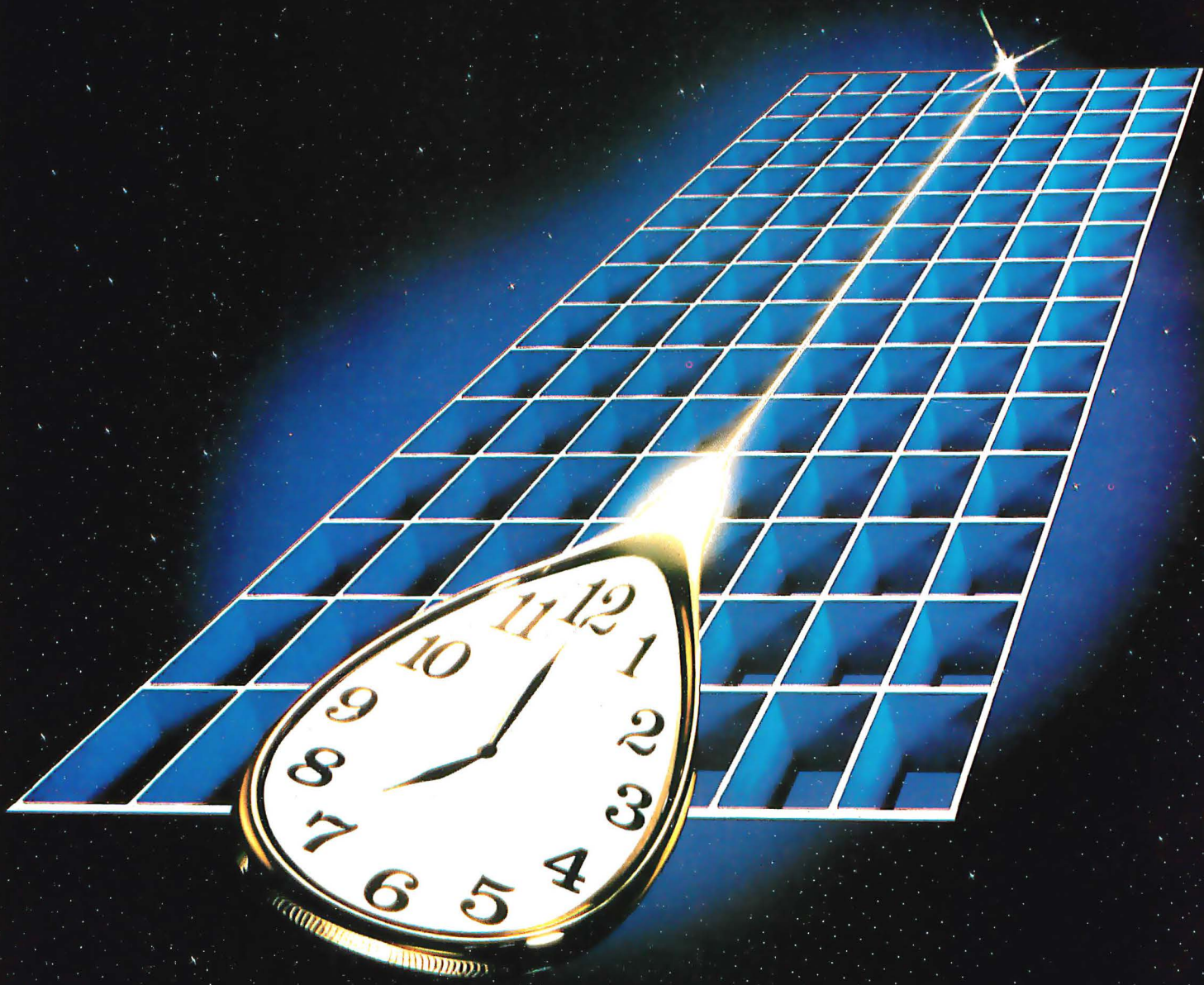

Introducing, for PDP-11 RSX, RSTS/E, and RT-11 users

Pascal-2TM

The Time Machine

The First Dimension: Performance

Pascal-2 performs.

Pascal-2 programs run as fast as FORTRAN IV-PLUS programs—or faster. (FORTRAN IV-PLUS is Digital's fastest PDP-11 high-level language.) Pascal-2 code is as small as code generated by any Digital PDP-11 compiler or interpreter—or smaller. And Pascal-2 typically compiles at 1000 lines per minute.

The Second Dimension: Structure and Portability

As a programmer, you can write in a language close to your thoughts. With Pascal's structured methods, you can do the job right the first time. It's easier to *design* in Pascal than it is to *debug* in FORTRAN, assembler, BASIC, or COBOL.

As a software manager, you will see the value of Pascal in improved communication among team members: they can understand one another's code. Pascal's portability will protect your software investment: your programs will outlive your current hardware.

The Third Dimension: Tools, Tools, Tools

The compiler precisely reports typographic or syntactic errors. The interactive, source-level debugger helps detect deep-rooted logical errors. The profiler helps identify code that can be rewritten to speed program

execution. Also included are formatters, index generators, and documentation aids—a total of 70,000 lines of Pascal code.

Our 2,000 customers use Pascal for such diverse applications as general ledger and payroll, integrated circuit design graphics, word processing, typesetting, and off-track betting; for trimming integrated circuits, monitoring particle accelerators, real-time ballistics modeling, and controlling saws in a lumber mill.

The Fourth Dimension: Our Past and Future

The core of our technical group has been together more than a decade. Our Pascal-1 compiler entered commercial use in 1975. Before releasing our PDP-11 product, we delivered Pascal-2 under contract to two major computer manufacturers for three different processors. Now we're moving Pascal-2 to Motorola's MC68000, to Digital's VAX-11, and to the UNIX operating system. We're committed to Pascal for the long term.

Call or write. We'll send benchmark details, a product description, and a free copy of the Pascal-2 manual (specify RSX, RT-11, RSTS/E).

PDP, VAX, RSX, RSTS/E, RT-11, and FORTRAN IV-PLUS are trademarks of Digital Equipment Corporation. MC68000 is a trademark of Motorola Inc. UNIX is a trademark of Bell Laboratories.

Pascal-2: The Dimensions of Performance

Ask for a free 18" x 24" poster of this photograph.

Network Computer Services
6 Cunningham Street
Sydney 2000, Australia
Telephone: 211-2322
TLX: 25523

Valley Software, Inc.
6400 Roberts Street, #390
Burnaby, BC Canada V5G 4G2
Telephone: 604-291-0651

Hours Computing, Ltd.
7-8 Mill Street
Stafford ST16 2AJ, England
Telephone: 0785-44221
TLX: 36540

Real Time Products
1 Paul Street
London EC2A 4JJ, England
Telephone: 01-588-0667
TLX: 884971

Rikei Corporation
1-26-2 Nishi Shinjuku
4316 Shinjuku-ku
Tokyo 160, Japan
TLX: 24208

AC Copy
Kurbrunnenstrasse 30
D-5100 Aachen
W. Germany
Telephone: 0241-506096
TLX: 832368

Periphere Computer Systems GmbH
Pfalzer-Wald-Strasse 36
D-8000 Munchen 90
W. Germany
Telephone: 089/681021
TLX: 523271

Oregon Software

2340 S.W. Canyon Road
Portland, Oregon 97201
(503) 226-7760
TWX: 910-464-4779

Operating Systems, Languages, Statistics, Pirates, and the Lone Wolf

Jerry Pournelle
c/o BYTE Publications
POB 372
Hancock, NH 03449

"People do strange things," said my mad friend Mac Lean. "They invent things like this new operating system, OS-1."

"You mean it doesn't work?"

"No, it works fine," he said. "And it's about as useful as a chocolate-covered wristwatch. Or maybe a triple hernia. If you like to play with operating systems, and God knows I do, OS-1 will give you hours of delight. But if you want to *use* it, you get hours of tedium."

"Why? Isn't it like Unix?"

"Well, yes, it is, sort of."

"But then why isn't OS-1 useful? Everyone likes Unix . . ."

"Do they? Well, maybe a lot of programmers do, as they ought to. I'm not so sure other users are going to like Unix all that much, but maybe they will. Besides, OS-1 isn't *quite* Unix. OS-1 has a tree-structured directory system, but there's no mechanism for finding a file in there unless you've kept lists. And you can't make lists. Although the 'SET TTY' command will set the screen width, it won't set the printer width, so you can't even list for hard copy unless you've got a 132-wide printout device. If you don't remember what's in those directories, you'll never find the files!"

"What, never?" I asked.

"Well, hardly ever. The idea is that you can have multiple directories, so a lot of different users can each have their own, right? But floppy disks are too small for that kind of structure. Look, your utilities occupy most of one disk, and your operating system and its directories take up another disk. On top of that, the OS is so big that you've only got about 32 K bytes of RAM left over. That's not enough to work in. The PL/I compiler can't do much in that. Whitesmiths' C compiler won't even start to work. Leor Zolman's [excellent!] BDS C compiler hasn't got room to breathe. What use is a Unix-like system that won't let you compile C programs?"

I still wasn't convinced. "Look," I said. "OS-1 is supposed to have all kinds of nifty features taken from Unix . . ."

"It almost does," my mad friend said. "The notion

behind the Unix system, with pipelines and all that groovy stuff, is great. Unix treats *everything* like a file, and you can build 'pipelines' from your directory to the device you want the file to go to, or between programs. But OS-1 doesn't do that. Instead, it has pseudopipelines, with intermediate file structures. Why do that? Better to use CP/M and a submit program than that. With OS-1 you just don't have enough RAM, and you have trouble keeping track of where you are, and the command strings are long and tedious if you want to look at other directories. They really tried hard, and you ought to give them an A for effort, but only about a C for usefulness."

"And if we go to 16-bit machines?" I asked. "Such as the 8086? Where we've got plenty of RAM to play with, and hard disks and fast access and . . ."

He shrugged. "Who knows? But I suspect that if you want a Unix-like system, you might as well have Unix and be done with it. Why compromise with something else?"

And on reflection I have to agree. OS-1 is a heroic effort, but it somehow just doesn't make it.

Future Operating Systems

So what *will* be the operating system for future micros? Will we, as Chris Morgan wrote in his recent editorial "The New 16-Bit Operating Systems, or, The Search for Benutzerfreundlichkeit" (June 1981 BYTE, page 6), "get it right the second time"? Or are we stuck with CP/M forever and aye?

Well—first, what does "stuck" mean? For all its problems—and Lord knows it has plenty—CP/M isn't all that bad, for *users*. Programming hackers really hate it, but true hackers hate almost anything they didn't grow up with. Users don't know some of the inconveniences of CP/M. Worse, most users don't know all its nifty features because of the wretched documentation for which Digital Research is notorious, but CP/M is fairly easy to learn and use, even for beginners. It gets the job done.

And now that Xerox has adopted CP/M for its much-



NEECO

WHY BUY FROM THE BEST?

Service... Support... Software...



MULTI-CLUSTER

For Commodore Systems, allows 3 CPU's (Expandable to 8) to access a single Commodore Disk.

MULTI-CLUSTER (3 CPU's) \$ 795
Each Additional CPU (up to 8) ... \$ 199



16K B (16K RAM-40 Column) - Lim. Qty	\$ 995
32K B (32K RAM-40 Clm.) - Lim. Qty	\$1295
4016 (16K RAM 4.0 Basic-40 Clm.)	\$ 995
4032 (32K RAM 4.0 Basic-40 Clm.)	\$1295
8032 (32K RAM 4.0 Basic-80 Clm.)	\$1495
8050 Dual Disk (1 Meg Storage)	\$1795
4040 Dual Disk (343K Storage)	\$1295
8010 IEEE Modem	\$ 280
C2N Cassette Drive	\$ 95
CBM - IEEE Interface Cable	\$ 40
IEEE - IEEE Interface Cable	\$ 50
VIC 20 Home/Personal Computer	\$ 295

CALL NEECO FOR ANY OF YOUR COMMODORE COMPUTER NEEDS

EPSON PRINTERS

MX-80 PRINTER	\$ 645
MX-80 FT	\$ 745
MX-100	\$ 945
MX-70	\$ 459

INTERFACE CARDS

8141 (RS-232)	\$ 75
8150 (2K Buffered RS-232)	\$ 150
8161 (IEEE 488)	\$ 55
8131 (Apple Card)	\$ 85
8230 (Apple Card)	\$ 25
8220 (TRS-80 Cable)	\$ 35

DIABLO 630 PRINTER

DIABLO 630 - Serial - RS-232	\$2710
Tractor Option	\$ 250

AMDEK MONITORS

Video 100 12" B+W	\$ 179
Video 300 12" Green	\$ 249
Color I 13" Low Res	\$ 449
Color II 13" High Res	\$ 999

INTERTEC COMPUTERS

64K Superbrain (360 Disk Storage), CP/M™	\$3495
64K QD Superbrain (700K Disk Storage), CP/M™	\$3995

*CP/M is a registered trademark of Digital Research.

NEC SPINWRITER PRINTERS

5530 (Parallel)	\$3055
5510 (Serial)	\$3055
5520 (KSR-Serial)	\$3415
Tractor Option	\$ 225

APPLE

16K APPLE II+	\$1330
32K APPLE II+	\$1430
48K APPLE II+	\$1530
APPLE DISK w/3.3 DOS	\$ 650
APPLE DRIVE Only	\$ 490
APPLE III 128K - In Stock! w/Monitor + Info Analystpak	\$4740

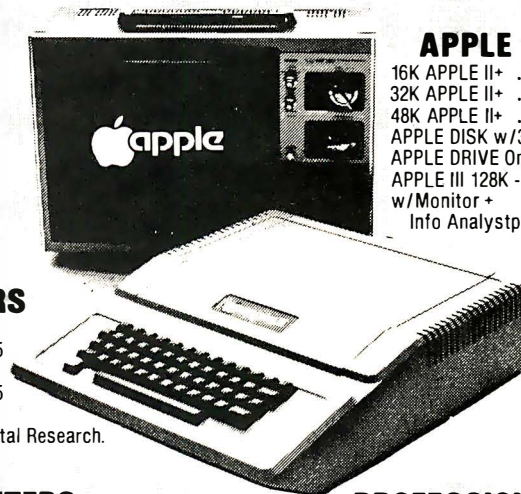

ATARI COMPUTERS

Atari 400 (16K RAM)	\$ 399
Atari 800 (32K RAM) - good thru 8/31	\$1080
Atari 410 RECORDER	\$ 89.95
Atari 810 DISK DRIVE	\$ 599.95

NEECO carries all available ATARI Software and Peripherals.

PROFESSIONAL SOFTWARE

WordPro 1 8K	\$ 29.95
WordPro 3 (40 Clm.) 16K	\$ 199.95
WordPro 3+	\$ 295
WordPro 4 (80 Clm.) 32K	\$ 375
WordPro 4+	\$ 450



JUST A SAMPLE OF THE MANY PRODUCTS WE CARRY, CALL US FOR OUR NEW 60-PAGE CATALOG.
WE WILL MATCH SOME ADVERTISED PRICES ON CERTAIN PRODUCTS LISTED UNDER SIMILAR "IN STOCK" CONDITIONS.



NEECO

679 HIGHLAND AVE.
NEEDHAM, MA 02194

(617) 449-1760

Telex: 951021

MON-FRI 9:00 - 5:00



MasterCharge and VISA Accepted

MEGABYTER

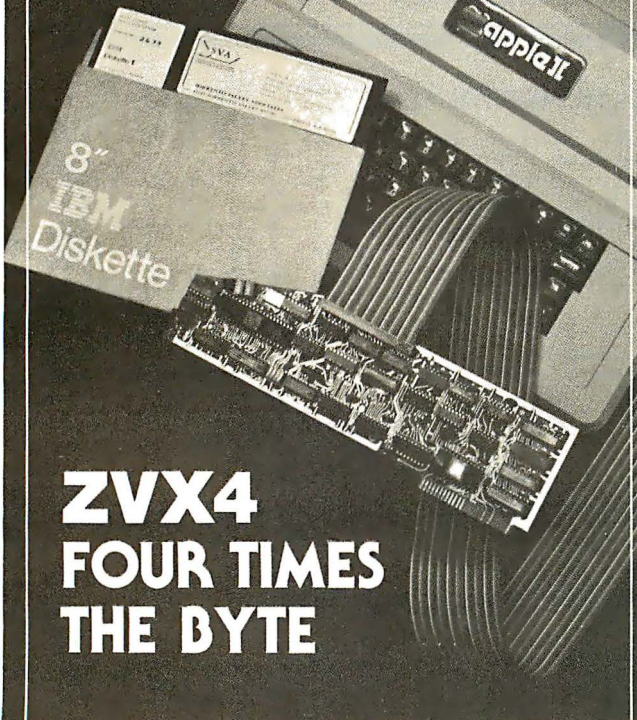

ZVX4 FOUR TIMES THE BYTE

The ZVX4 MEGABYTER is for the APPLE II user who wants to DOUBLE file size, expand the capability of existing business software, and make other SERIOUS applications more viable.

Now you can have compatibility with IBM, INTEL, CP/M*, Z80 Softcard*, UCSD Pascal, and others.

Look what the MEGABYTER dual density 8" floppy disk controller, with its LSI circuitry and reliable industry standard IBM 3740 format, means to you:

INCREASED STORAGE

- Increase online storage to 2 Mega bytes
- Double your maximum accounts and file size
- Add high capacity efficient hard disk backup
- Control up to 4 Shugart SA800/SA850 drives

IMPROVED COMPATIBILITY

- Operate APPLE DOS 3.1/3.2/3.3, mini disks
- Preserve existing software investment
- Interchange data with other computers

SIMPLIFIED OPERATION

- Reduce disk handling and I/O slot usage
- Gain automatic single/double density operation
- Change to double sided drives with one switch

Available at your Apple dealer. Call or write today!!



SORRENTO VALLEY ASSOCIATES
11722 SORRENTO VALLEY ROAD
SAN DIEGO, CA 92121-1084
(714) 452-0101—TWX 910-335-2047

*CP/M trademark of Digital Research, Inc.
Z80 Softcard trademark of Microsoft, Inc.

User's Column

advertised systems, one conclusion is plain: any popular system of the future will have to be upward compatible with CP/M, because there's just so much good software running under CP/M. Digital Research did us all a good turn by coming up with something approaching a *standard* in this field. I remember when we had to use F-DOS.

And then there are the CP/M utilities. You don't have to understand CP/M, as long as someone else does. I've mentioned the CP/M User's Group (CPMUG) before; it's an outfit that distributes all kinds of nifty utilities, like COPY routines, and FAST (which speeds up CP/M 1.4), and the like. The problems with CPMUG are selectivity and updating: there are more than 50 disks in the

Items Reviewed

Workman & Associates

112 Marion Ave.
Pasadena, CA 91106

CP/M Disk Utilities	8-inch single-density disk	Disk I \$27.50
		Disk II \$27.50

Ecosoft

POB 68602
Indianapolis, IN 46268

Microstat	8-inch CP/M or 5-inch North Star disk	\$250
-----------	---------------------------------------	-------

Software Labs, Inc.

735 Loma Verde
Palo Alto, CA 94303

OS-1		price information unavailable
------	--	-------------------------------

Ashton-Tate

Suite 1510
3600 Wilshire Blvd.
Los Angeles, CA 90010

dBASE II	8-inch CP/M	\$700
----------	-------------	-------

Lobo Drives International

354 South Fairview Ave.
Goleta, CA 93117

LX-80 (expansion interface for TRS-80)		price under \$1000 as tested
LDOS (operating system for TRS-80)		\$169

Digital Research

POB 579
Pacific Grove, CA 93950

PL/I-80 with LINK-80 linker		\$600
-----------------------------	--	-------

Book Reviewed

Winston, P. H. and B. K. P. Horn.
LISP

Reading, MA: Addison-Wesley Publishing Company, 1976

\$11.95

In this age of runaway inflation...

Look what \$895* will buy

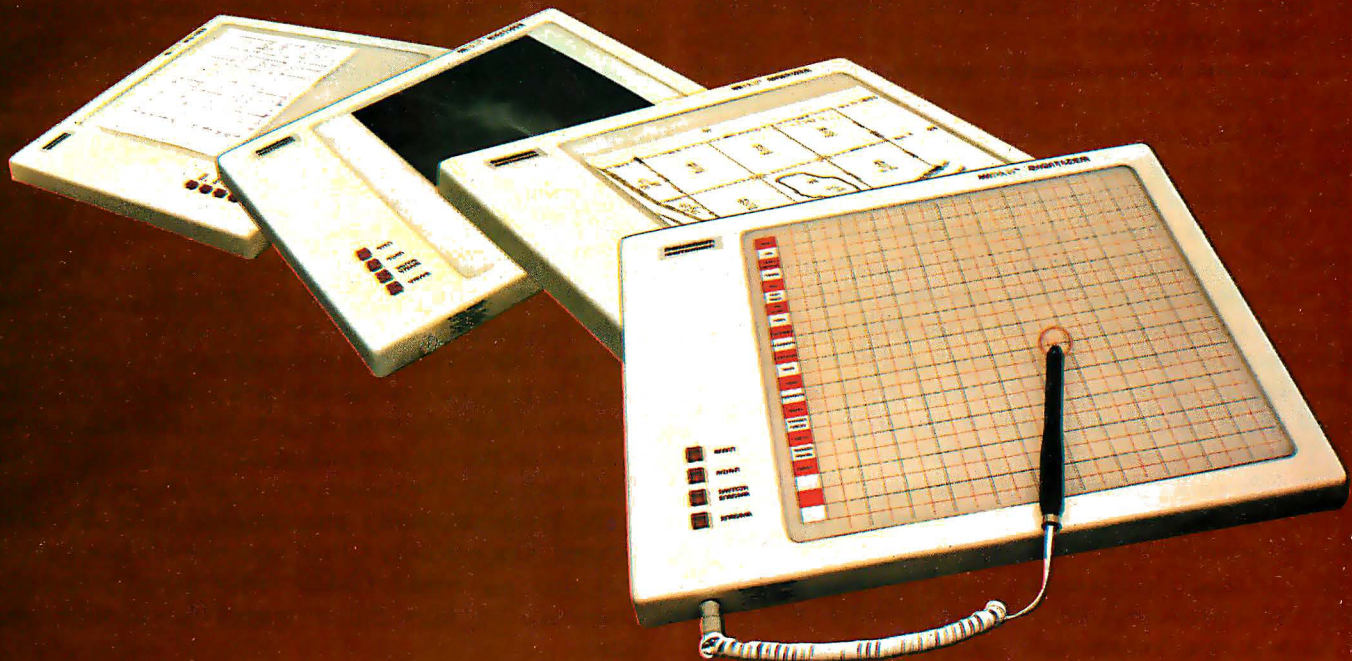

FCC Class B Tested.
UL Listed.



The ideal input device for the small system user.

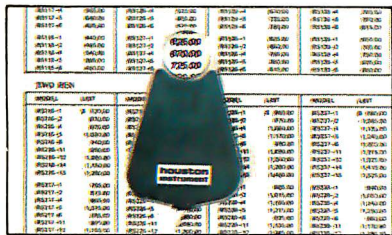

Available with stylus or optional cursor.

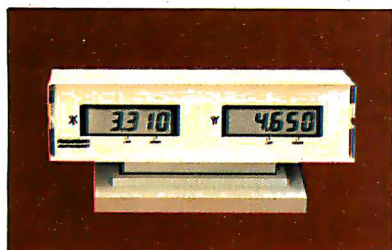

Available with optional display.

The HIPAD™ digitizer

Inexpensive input to your computer

The HIPAD™ digitizer can be used for both converting graphic information into digital values and as a menu. Utilizing either the stylus or the optional cursor, the operator can input graphic data into the computer by locating individual points on the digitizers 11" x 11" (28cm x 28cm) active area. In the "stream mode" a continuance of placements of coordinate pairs may be input.

Not a kit, the HIPAD™ comes complete with both RS-232-C and parallel interfaces and has its own built-in power source. The origin is completely relocatable so coordinates may be positive or negative for a true reference value and oversized material may be input by simply resetting the origin.

Accurate positional information, free form sketches, even keyboard simulation

All can be entered using the multi-faceted HIPAD™ digitizer. Its capabilities and low price make the UL listed HIPAD™ a natural selection over keyboard entry, inaccurate joysticks, or expensive approximating light pens. It's perfect for inputting isometric drawings, schematics, X-rays, architectural drawings, business graphs, and many other forms of graphic information, as well as creating your own graphics.

Use it with Apple II™, TRS-80 Level II™, PET™ or other popular computers

The HIPAD's™ built-in RS-232-C and parallel 8 bit interfaces make it all possible. (For Apple II order DT-11A, for TRS-80 or PET order DT-11). Furthermore, you get English or metric scaling, data format (Binary/BCD/ASCII), selectable baud rates, and resolution of either .005" or .01".

For complete information, contact Houston Instrument, One Houston Square, Austin, Texas 78753 (512) 835-0900. For rush literature requests, outside Texas, call toll free: 1-800-531-5205. For technical information ask for operator #5. In Europe, contact Houston Instrument, Rochesterlaan 6, 8240 Gistel Belgium. Phone 059/27 74 45

TM HIPAD is a trademark of Houston Instrument
TRS-80 is a trademark of Tandy Corporation
APPLE is a trademark of Apple Computer Inc.
PET is a trademark of Commodore Business Machines, Inc.

Circle 173 for literature
Circle 174 to have representative call

houston instrument

GRAPHICS DIVISION OF

BAUSCH & LOMB



Visit us at NCC-Booth 911

*U.S. Suggested retail price

CPMUG library, most filled with junk, useless games, or obsolete versions of programs since updated.

There are other sources of utilities. Various user networks distribute all kinds of nifty programs—modem emulators, catalog programs, library routines, you name it. And these get revised all the time. So how could you tell which ones to use?

The answer is, you couldn't—until Barry Workman, of Workman & Associates, came along. Barry sifts through the CPMUG and other public-domain sources and puts together disks of utilities, which he'll sell for \$27.50 a disk. Right now he's got two such disks.

"Utility Disk One will always be the most useful CP/M utilities I can find," Workman says. "The latest and fastest copy routines, command-line processors, directory programs, a good modem program to use with The Source or Micronet or whatever. Comparators and filters, stuff like that. Ward Christenson's disk catalog utility, which is by itself worth more than the disk if you don't have it."

"How do you select the programs?"

"Mostly I ask people like you what you'd like to have."

The documentation on the Workman disks is adequate, generally better than what was on the CPMUG disks. At least it had better be: Barry, by supplying quantities of a wonderful liquor called slivovitz, which he finds in some unknown place, gets me to go over the stuff

for him. I do *not* rewrite it, but I do smooth out some of the ambiguities.

Workman's Utility Disk Two has Ward Christenson's disassembler, some comments on how disassemblers work, and instructions. It also has some other utilities probably more useful to programmers than users, although again Workman has tried to keep things simple and provide what he thinks will be most useful.

I can't list exactly what's on each of the disks, because that changes according to what Barry thinks is the most useful selection he can put together each month. He does try to send out the latest versions of the various utilities as he gets them.

The Workman utilities are public-domain programs, and almost all of them could be obtained by swapping with other people—for that matter, the only copyrighted materials on the Workman disks are some documentation files. The price may be just a bit steep, but Barry says he can't afford to produce the disks for less. He's selling them as a service; he won't get rich at \$27.50 per disk. If your time is valuable, the utilities are worth the price.

The Workman utility programs are for 8-inch soft-sectored, single-density CP/M systems only, the kind of stuff that my friend Ezekial, who happens to be a Cromemco Z-2, likes. But of course I have another computer. . . .

Lobo to the Rescue

It was at the West Coast Computer Faire. I was talking to Roger Billings, president of Lobo Drives International, about their hard disks.

"I'm in big trouble," I said.

"Why?"

"Here I am at the Faire. I'll be bringing home a lot of new software. Automated Simulations has some great new games. And when I get home my kids are going to kill me, because Ezekial is running fine, but *their* computer isn't. And my name is mud if I can't get that TRS-80 going again"

"What happens?" Roger asked.

"Won't boot. Drives spin, but the system won't come up."

"Hmm. Can we come see you next week?"

"Sure," I said, and promptly forgot the conversation, there being so much to see and do at the Faire. Precisely a week later I was talking on the telephone when the doorbell rang. Here at Chaos Manor that's a big deal. Dogs bark and madly skid on rugs to the door, followed by shouting boys trying to restrain the dogs. Anyone who waits for the door to open is *determined*.

Eventually I got off the phone to find Eliot Lane, Lobo's product engineering manager. He had a van outside. "I've come to fix up your TRS-80," he said.

And fix it up he did. The first step was to replace my Percom disk drives with two new Lobo drives. That turns out to be easy: Lobo drives have the cable connector on the back where you can get at it without taking out

**ATTENTION S-100
USERS, OEMs & ISOs!**

**MM-103 IS THE ONLY MODEM
FOR YOUR NEEDS!**

In previous issues, we listed more than 50 reasons why PMMI MM-103 modems are superior, along with a list of satisfied users that is now too long to print. Quality, integrity and low cost have made the MM-103 America's most popular modem. PMMI was the first to gain FCC approval and meet IEEE-696 S-100 standards. You won't find another modem for the S-100 bus with a wider range of Baud rates, more extensive and controllable software and such an unbeatable warranty. And since PMMI has eliminated the need for an acoustic coupler or an RS 232 adapter, your connection is more reliable and you buy no unnecessary hardware.

**SO DON'T DELAY!
GO WITH THE MODEM WITH EXPERIENCE!**

PMMI COMMUNICATIONS
(POTOMAC MICRO-MAGIC, INC.)

For further information, call or write:
Three Skyline Place
5201 Leesburg Pike, Suite 604
Falls Church, VA 22041
(703) 379-9660
Or dial into our 24 hour-a-day Modem Test Center:
(703) 379-9303 (300 Baud)

**AFTER ALL...
ALL MODEMS ARE NOT
CREATED EQUAL!**

COMPUSTAR™

INTERTEC'S INCREDIBLE 255 USER SMALL BUSINESS COMPUTER

At last, there's a multi-user micro-computer system designed and built the way it should be. The CompuStar™. Our new, low-cost "shared-disk" multi-user system with mainframe performance.

Unlike any other system, our new CompuStar offers what we believe to be the most practical approach to almost any multi-user application. Data entry. Distributed processing. Small business. Scientific. Whatever! And never before has such powerful performance been available at such modest cost. Here's how we did it . . .

The system architecture of the CompuStar is based on four types of video display terminals, each of which can be connected into an auxiliary hard disk storage system. Up to 255 terminals can be connected into a single network! Each terminal (called a Video Processing Unit) contains its own microprocessor and 64K of dynamic RAM. The result? Lightning fast program execution! Even when all users are on-line performing different tasks! A special "multiplexor" in the CompuStar Disk Storage System ties all external users together to "share" the system's disk resources. So, no single user ever need wait on another. An exciting concept . . . with some awesome application possibilities!

CompuStar™ user stations can be configured in almost as many ways as you can imagine. The wide variety of terminals offered gives you the flexibility and versatility you've always wanted (but never had) in a multi-user system. The CompuStar Model 10 is a programmable, intelligent terminal with 64K of RAM. It's a real workhorse if your requirement is a data entry

or inquiry/response application. And if your terminal needs are more sophisticated, select either the CompuStar Model 20, 30 or 40. Each can be used as either a stand-alone workstation or tied into a multi-user network. The Model 20 incorporates all of the features of the Model 10 with the addition of two, double-density mini-floppies built right in. And it boasts over 350,000 bytes of local, off-line user storage. The Model 30 also features a dual drive system but offers over 700,000 bytes of disk storage. And, the Model 40 boasts nearly 1½ million bytes of dual disk storage. But no matter which model you select, you'll enjoy unparalleled versatility in configuring your multi-user network.

Add as many terminals as you like - at prices starting at less than \$2500. Now that's truly incredible!

No matter what your application, the CompuStar can handle it! Three disk storage options are available. A tabletop 10 megabyte 8" winchester-type drive complete with power supply and our special controller and multiplexor costs just \$4995. Or, if your disk storage needs are more demanding, select either a 32 or 96 megabyte Control Data CMD drive with a 16 megabyte removable, top loading cartridge. Plus, there's no fuss in getting a CompuStar system up and running. Just plug in a Video Processing Unit and you're ready to go . . . with up to 254 more terminals in the network by simply connecting them together in a "daisy-chain" fashion. CompuStar's special parallel interface allows for system cable lengths of up to one mile . . . with data transfer rates of 1.6 million BPS!

Software costs are low, too.

CompuStar's disk operating system is the industry standard CP/M*. With an impressive array of application software already available and several communication packages offered, the CompuStar can tackle even your most difficult programming tasks.

Compare for yourself. Of all the microcomputer-based multi-user systems available today, we know of only one which offers exactly what you need and should expect. Exceptional value and upward growth capability. The CompuStar™. A true price and performance leader!

 **INTERTEC
DATA
SYSTEMS®**

2300 Broad River Rd. Columbia, SC 29210
(803) 798-9100 TWX: 810-666-2115



TEXAS COMPUTER SYSTEMS

Offers Lowest Prices on

TRS-80

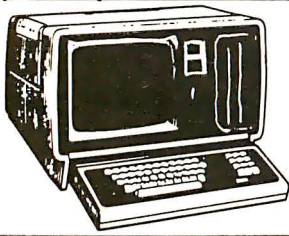

Model II 64K \$3288

An excellent computer for your business needs. Easy expandability & compatibility. No formal operator training needed. All accessories available—disk expansions, printers, software, at our low discount prices. Our fast, fully insured air freight service can assure most deliveries within seven days after payment is received.

Epson Printers \$Call

MX-70 Tractor Feed MX-80 FT Fric. & Trac.
MX-80 Tractor Feed MX-100 FT Fric. & Trac.

Radio Shack Printers

Daisy Wheel II \$1695
Line Printer V \$1599
Line Printer VI \$995
Line Printer VII \$325
Line Printer VIII \$699

Epson Interfaces

Graphtrax option for MX-80 only \$79
Model I exp. int., Model III cable \$35
Model I keyboard, card & cable \$85
Apple interface card & cable \$89
Pet 1 EEE interface & cable \$79
Serial RS-232 unbuffered card \$65
2K buffered serial RS-232 card \$159

Model III 16K \$835

With TCS Memory:

Model III 32K \$979 Model III 32K \$909
Model III 48K \$1089 Model III 48K \$969
Model III 48K 2 Disk RS232 \$2075

Color Computer

4K Level 1 \$319
16K Level 1 \$439
16K Extended Basic \$469
32K Ex. Basic \$569
Color Disk "0" \$519
Color Disk "1" \$349

With TCS Memory:

16K Level I \$369
16K Extended Basic \$449
32K Extended Basic \$529
32K Upgrade Kits \$79

↔ TCS EXCLUSIVE ↔
Epson to Color Computer card & cable \$59

Model III 48K 2 Disks \$1895 TCS

We use quality fiberglass disk controller boards & gold plated contacts. No soldering or modification to existing RS circuitry. For RS 232, add \$105. 80-160 track drives, \$Call. TCS limited warranty.

Model III Disk Kits — high quality disk controller board uses gold plated contacts on double sided glass epoxy board for long life reliability.

Kit #1 Controller, power supply, hardware \$379
Kit #2 Also includes 1 drive 40 track \$595
Kit #3 Also includes 2 drives 40 track \$849

No soldering or modifications to existing circuits.

Corvus Hard Disks \$Call

5, 10, or 20 megabytes of storage for the Model I, II, or III. We can configure a system for you with either TRSDOS, NEWDOS 80, or CP/M for one, or several computers sharing a single hard drive simultaneously. For example, from 1 to 8 Model II's may share a single large data base with the Corvus Constellation Multiplexer.

For fast, efficient service. **Heart of** we can air freight from Dallas

TEXAS COMPUTER SYSTEMS

P.O. Box 1327 Arlington, Texas 76004-1327

★ Toll Free Number 800 433-5184

Texas Residents 817 274-5625
Dallas Metroplex 265-1524

* Payment: Money Order, Cashier's Check, Certified Check. Personal checks take 3 wks. VISA, MC, add 3%.

* Prices subject to change any time.
* No tax out-of-state. Texans add 5%.
* Delivery subject to availability.

Free shipping on all software and small items over \$100 per order. Other items, shipping extra, quoted by phone.

User's Column

screws (and I wish the Percoms were built that way; it's bloody easy to have one of the power cables come loose inside the drive when you put it together after connecting the data cable). But when we tried booting the system, nothing happened. At least we knew it wasn't the fault of the Percoms, which had always worked well and still do, except for the inconvenient placement of those cable connectors.

Next we installed Lobo's LX-80 expansion interface to replace my TRS-80 interface. My TRS-80 Model I is one of the intermediate versions; in addition to the ribbon cable (with flat booster box) connecting the keyboard to the expansion interface, there's also a round cable—which makes it pretty crowded and hard to get at the RESET button. There's no connection for anything like that on Lobo's LX-80.

"Just ignore it," Eliot said. He proceeded to connect the LX-80. It didn't work, so we took apart the TRS-80 keyboard, and lo, there was a broken wire in the ribbon cable connecting the two halves of the system. Eliot soldered jumpers around the broken parts and tried again, and all worked fine.

It still does. We're now running the Lobo LX-80 with LDOS operating system, and both work splendidly. The disk drives are a pair of Lobo 5¼-inch and another pair of Lobo 8-inch; all four are running at double density and doing fine, and with this system you can move everything from small disks to big ones and back again, giving you a lot of storage.

Now, about the LX-80: this is an excellent product. It's well made, in a metal case, with precisely located components. The insides look professional, as opposed to the TRS-80 expansion interface with its jumpers and cut traces and soft plastics and such. The one I've got is the full-blown model, with two serial ports and a parallel port, and cable outlets for both 5¼- and 8-inch drives, and 32 K bytes of memory. There's an on-board PROM (programmable read-only memory) that brings the system up into LDOS. It supplies power for all the ports from a single wall plug that works through a positive action switch. There's a good pilot light. The LX-80 comes with documents that explain what's going on. It connects to your TRS-80 with a single cable and with no booster-box. You don't need the various kludges that Radio Shack threw in to keep its Model I working.

The LX-80 will reformat and run both 5¼- and 8-inch disks, at either single or double density. It will let you transfer files from single density to double density. It has an external data separator (which separates data signals from timing signals), so that you don't get the disk errors for which TRS-80s are notorious. (The TRS-80 system uses the data separator internal to the disk-controller chip; even Western Digital, which makes the chip, recommends that you don't do that.)

In other words, I like the Lobo LX-80.

The problem is that it's expensive; the model I tested would probably retail for just under \$1000. It's really bet-

Please call (213) 706-0333.

Our Epson prices are so low, we're not allowed to print them.

EPSON MX-80.....\$CALL

80 cps/9x9 matrix/Lower case with true descenders/Bi-directional & Logic seeking/Adjustable tractor/Expanded printing/Block graphics/Forms control/Compressed printing/Double-strike printing/Correspondence quality/Emphasized printing mode/Standard parallel interface.

EPSON MX-80 F/T.....\$CALL

Same features as the MX-80 plus Friction Feed. Adjustable removable tractor is standard for ease of handling forms and single sheets.

EPSON MX-100.....\$CALL

Most of same features as the MX-80 & MX-80 F/T but on 15½ inch carriage for printing 132 columns with standard 10 cpi font or 236 columns in the compressed character font. The MX-100 is complete with Dot Resolution Graphics.

EPSON INTERFACES & OPTIONS

TRS-80 MODEL I, III CABLE.....	30.00	SERIAL CABLE Male to Male.....	30.00
TRS-80 MODEL I Keyboard Interface.....	95.00	DOT RESOLUTION GRAPHICS.....	90.00
TRS-80 MODEL II CABLE.....	30.00	MX-80 REPLACEMENT RIBBON.....	13.00
APPLE INTERFACE & CABLE.....	100.00	MX-100 REPLACEMENT RIBBON.....	24.50
IEEE 488 INTERFACE.....	60.00	MX-80 PRINT HEAD.....	40.00
SERIAL INTERFACE.....	70.00	MX-100 PRINT HEAD.....	45.00
ATARI CABLE.....	35.00	EPSON SERVICE MANUAL.....	40.00
SERIAL INTERFACE (2K Buffer).....	149.00	IBM PC CABLE.....	37.95

Alpha Byte COMPUTER PRODUCTS

31245 LA BAYA DRIVE, WESTLAKE VILLAGE, CALIFORNIA 91362

We built a reputation on our prices and your satisfaction.

We guarantee everything we sell for 30 days. If anything is wrong, just return the item and we'll make it right. And, of course, we'll pay the shipping charges.

We accept Visa and Master Card on all orders. COD orders accepted up to \$300.00.

Please add \$2.00 for standard UPS shipping and handling on orders under 50 pounds, delivered in the continental U.S. Call us for shipping charges on items that weigh more than 50 pounds. Foreign, FPO and APO orders please add 15% for shipping. California residents add 6% sales tax.

The prices quoted are only valid for stock on hand and all prices are subject to change without notice.

ter than the computer it supports. Lobo was a bit late getting the LX-80 on the market. Most of the people who need one may already have a Radio Shack expansion interface, and now Percom will sell you a doubler to allow double-density operations and an external data separator to add to your Radio Shack interface. If you're using the TRS-80 Model I, and you're thinking about an expansion interface and disk drives, the LX-80 won't cost much more than the Radio Shack plus Percom's separator and doubler. And if you want quiet, trouble-free operation, if you want to be *sure* your expansion interface isn't giving you trouble, and you're willing to pay for that assurance, then the LX-80 is a very good way to go. Lobo builds quality products, and it stands behind them.

There's one more problem with the LX-80: it won't work with George Gardener's Omikron Mapper. The Mapper is a device for letting you run CP/M with a TRS-80 Model I; I reviewed the Mapper more than a year ago (see "Omikron TRS-80 Boards, NEWDOS+, and Sundry Other Matters," July 1980 BYTE, page 198), and I'm pleased to say ours has never given us any trouble. (True, the broken wires in my TRS-80 probably came from the flexing during installation and removal of the Mapper, but after all, I did that about 20 times in order to put in other stuff for test, so that hardly counts against Omikron.) There's no reason why the LX-80 and the Omikron Mapper *can't* work together; it's just that the

LX-80's PROM is geared to disable certain parts of the TRS-80, and to readdress some of the system's ports. A good software expert could make the two work together, and I think Lobo ought to consider doing that. The ability to convert the TRS-80 Model I for CP/M and still run regular TRS-80 stuff as well adds greatly to the computer's value.

Lobo's Disk Operating System

The TRS-80 used to drive me mad because of the operating system. I always used NEWDOS instead of Tandy's standard TRSDOS. Now there's LDOS, Lobo's disk operating system for the TRS-80 Model I. Although I still think it's needlessly complex, LDOS is now the best TRS-80 operating system going. It's a *lot* better than TRSDOS.

Although it was designed to work with the LX-80, LDOS will work fine with a TRS-80 Model I and a Radio Shack expansion interface. With LDOS you can run 40 tracks per drive if your disks can do that. (TRSDOS is limited to 35 tracks no matter what your disks are.) LDOS will also work with the Percom doubler and data separator. LDOS knows whether your disks are formatted for single or double density and stores the files accordingly. You don't need to keep track of that, or to use special commands.

Peachtree Software™ Word Processing Is A MAGIC WAND™

As if by magic, word processing from Peachtree Software transforms your business' most time-consuming typing projects into computerized ease.

You'll be amazed how easily Magic Wand glides you through "cut and paste" tasks. The system includes a full-screen text editor and extraordinary memory capabilities. You can save all or part of your output on a disk—even print one file while editing another. The user's manual, written in simple, non-technical English, includes a step-by-step instructional program. And Magic Spell™, one of a whole new series of "Magic" packages, will add to your productivity. It checks



your spelling against an internal "dictionary" of up to 20,000 words.

Once you've used any Peachtree Software Package, you'll find it amazingly simple to add others. Our easy-to-use manuals enable you to quickly make the transition from word processing to our general accounting programs.

Peachtree Software reflects years of development, refinement and user testing. That's why there are more than 20,000 Peachtree Software packages in use. To get yours, see your nearest dealer or call, 800-835-2245, ext. 35 (in Kansas, 800-362-2421, ext. 35).

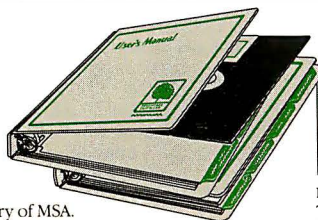

The Very Best "Off-The-Shelf" Software Is "Off-The-Tree."



A Subsidiary of MSA.

PEACHTREE SOFTWARE, 3 Corporate Square, Suite 700, Atlanta, Georgia 30329 (404) 325-8533
Telex 11: 810-751-0273 PEACHTREE ATL.

Peachtree Software, Magic Wand, Magic Spell, and Sales Trackers are trademarks of Peachtree Software, Incorporated.

SuperCalcTM . . . The Only Electronic Spreadsheet You'll Ever Need.

Rave Reviews from InfoWorld

InfoWorld				
Software Report Card				
SuperCalc, Rev 1.0				
	Poor	Fair	Good	Excellent
Usefulness	<input type="checkbox"/>	<input type="checkbox"/>	<input type="checkbox"/>	<input checked="" type="checkbox"/>
Documentation	<input type="checkbox"/>	<input type="checkbox"/>	<input checked="" type="checkbox"/>	<input type="checkbox"/>
Ease of Use	<input type="checkbox"/>	<input type="checkbox"/>	<input type="checkbox"/>	<input checked="" type="checkbox"/>
Error Handling	<input type="checkbox"/>	<input type="checkbox"/>	<input type="checkbox"/>	<input checked="" type="checkbox"/>

"SuperCalc has now brought the full utility of a spreadsheet simulator to the CP/M world. . . The program worked flawlessly.

"Most of the other CP/M spreadsheet simulators sidestep the terminal problem by not doing an actual real-time spreadsheet. . .

"SuperCalc solves this problem neatly by providing an install program that matches the attributes of the terminal. . . The result is impressive.

"While there is no way to enumerate all of SuperCalc's features, a few of the useful ones bear mentioning. You can adjust the width of all columns. . . row titles can be as long as you want. . . The program has an efficient memory manager, and you can pull in sections of other models as inputs to the model you're using. . . You can flip the screen to display either results, or the actual model equations. . .

"You can protect the contents of any row, column or individual cell. . . split the screen either horizontally or vertically. . .

"The SuperCalc manual is well written. . . It is easy to read and presents information on a variety of levels. . .

"SuperCalc is easier to use than any other spreadsheet simulator I have encountered, and I have encountered most of them. . .

"I predict that Sorcim's user support will be excellent."

Tim Barry, InfoWorld, October 5, 1981.

Financial Planning and Report Generation

If you run a business, if you're an accountant, business planner, or engineer, find answers to all your "what if" and "what now" questions with the SuperCalc program. This single package lets you generate reports, combine sections of separate spreadsheets, and create formatted printed reports. And SuperCalc has powerful editing capabilities not found in other packages. Delete entire commands with a single stroke. Or plug in a repeating formula—just once. And protect important information from unintentional entries.

These and more features give you beautifully formatted reports, exactly as you want them.

	Jan	Jul	Dec	Total
ASSETS				
Receivables	1000.00	1276.20	1340.10	1710.34
Cash	250.00	510.75	520.14	810.45
Fixed Goods	250.00	310.87	335.82	425.25
Total Assets	1500.00	2283.11	2313.26	2952.37
LIABILITIES				
Accounts Payable	1000.00	500.00	83.33	6500.00
Storage Costs	50.00	50.00	50.00	50.00
Labour	100.00	127.63	134.01	171.04
Materials	50.00	63.81	67.80	85.52
Total Liabilities	1200.00	824.70	751.01	309.00

The AnswerKeyTM



Wouldn't your operation be simple if help were just a keystroke away? Well, it is. We call it The AnswerKey. It's like having the entire SuperCalc Tutorial and Reference Guide at your fingertips.

Touch the questionmark key and the program explains itself with simple English messages. You'll see it all on your screen. Or you can refer to the handy AnswerCardTM reference guide.

The AnswerKey brings novices up to speed. And keeps you there when you've become a veteran SuperCalc user.

Whether you're developing management strategies, financial analyses, marketing plans, or sales projections, you get bottom line results. Instantly.

SuperCalcTM

SORCIM

Sorcim Corporation
405 Aldo Avenue, Dept. A1
Santa Clara, California 95050

(408) 727-7634
Telex: 910-338-2003

SuperCalc, The AnswerKey, and The AnswerCard are trademarks of Sorcim Corporation.



Only \$295

© 1981, Sorcim Corporation

The TELERAM S-100 Bubble Memory System

A whole lot more... at 25% less

Now there is a bubble memory system that is fully compatible with IEEE S100. And it's available from Teleram at 25% less cost compared to other bubble memory systems currently available—plus—it requires *only* 25% of the physical space. Each board has a capacity of 128K or 256K bytes of non-volatile storage and can be daisy chained to provide one megabyte.

FEATURES:

- DATA IS RETAINED AFTER POWER OFF
- 40 MILLISECOND ACCESS TIME
- CORRECTION FOR UP TO 5 BIT BURST ERRORS
- CP/M COMPATIBLE
- UNAFFECTED BY DUST
- VERY HIGH RELIABILITY
- OPERATES IN VERY HARSH ENVIRONMENTS
- COMPLETELY MANUFACTURED IN THE U.S.
- IDEALLY SUITED FOR PORTABLE AND PROCESS CONTROL APPLICATIONS

The Teleram S-100 Bubble Memory System can provide the opportunity for new design concepts.

For a free data sheet call or write:

TELERAM COMMUNICATIONS CORPORATION,
2 CORPORATE PARK DRIVE,
WHITE PLAINS, N.Y. 10604, (914) 694-9270

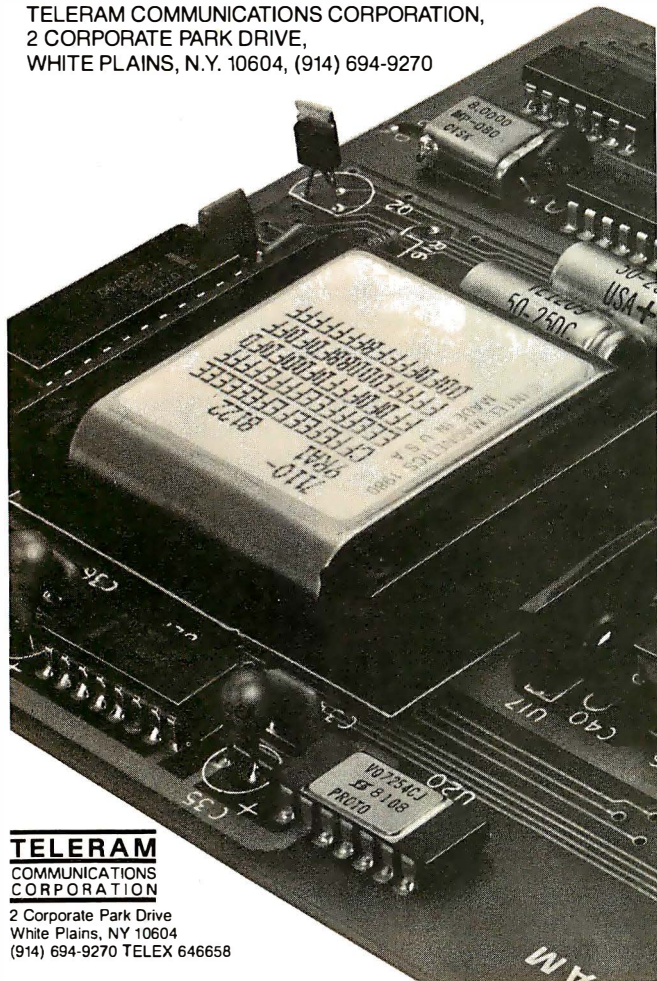

TELERAM
COMMUNICATIONS
CORPORATION

2 Corporate Park Drive
White Plains, NY 10604
(914) 694-9270 TELEX 646658

User's Column

A major feature is that files created with LDOS can be transferred from a TRS-80 Model I to a Model III, and they say you can get from a Model I to a Model II also, although I'm not sure how.

LDOS is superficially similar to TRSDOS. It has all the inanities about passwords and protection levels and such that TRSDOS sticks us with. Fortunately, though, with LDOS you can get rid of all that stuff—as you should. Anyone who trusts those “password” and “protection” systems should get his head examined. Any of those systems can be defeated by any half-competent programmer.

You get all kinds of utilities with LDOS: a debugger, a job-control language, and a patch to Microsoft (Tandy) BASIC that allows you to renumber selectively, use random-access files, step through a BASIC program one statement at a time, and cross-reference programs. There's also a spooler to allow printouts while you work on other programs.

The system is easier to use than TRSDOS, but you do have to learn it. The LDOS documentation is fairly clear, but dense in places; you really have to read through most of the document, then go back and start over. The usual hacker's way of plunging in and doing this and that while thumbing through the manual probably won't work—at least it didn't for me.

On the other hand, LDOS comes with a toll-free number that you can call to get help. I called it several times and found myself speaking to systems programmers who really know LDOS. They tended to think I was nuts—the answers to almost all the questions I had were right there in the manual (and if I'd read through the manual instead of jumping right in like any hacker, I'd have known that). They also tended to expect me to know more than I'd expect a typical user to know; but then I had an early copy of LDOS, and they hadn't had a lot of experience with naive questioners yet. By now I bet they know better.

The documentation is nothing to brag about, but it's adequate, provided that the reader is patient and will go through it twice. There are plenty of examples, most of them informative. It needs a good index and an analytical table of contents and a better introduction to the “philosophy” behind LDOS, but you can, with patience, learn the LDOS system from the manual. That beats the daylights out of some system manuals I know of.

One reason LDOS is complex is that it really is an operating system not just for the disks, but for the whole TRS-80. It has the ability to set logical devices, and trace programs, and do lots of neat things you don't associate with the TRS-80. LDOS with the LX-80 gives you a fairly powerful system, with a real monitor just like regular computers, and even with the Tandy interface you still get a lot more control over your machine than you get with either NEWDOS or TRSDOS.

As far as I can tell, you can run any programs under LDOS that you can run under TRSDOS, except for those

S-100 STATIC MEMORY BREAKTHROUGH

MEMORY MERCHANT
MEMORY MERCHANT
MEMORY MERCHANT
MEMORY MERCHANT

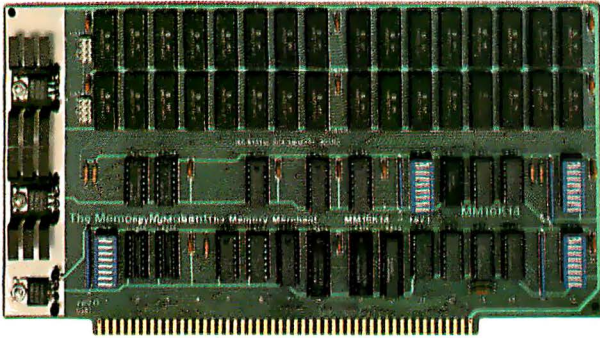

16K STATIC RAM \$169

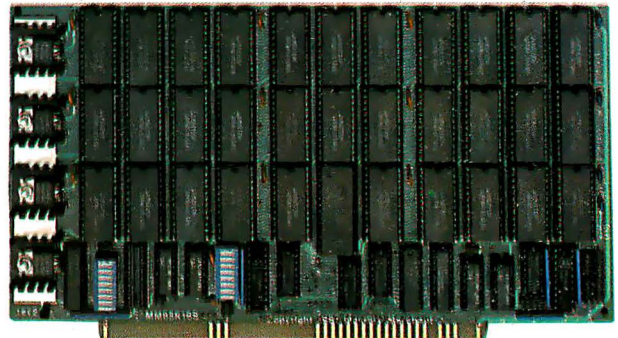

64K STATIC RAM \$795

32K PARTIALLY POPULATED \$479 48K PARTIALLY POPULATED \$659

Finally, you can buy state-of-the-art S-100 static memory for your computer at unprecedented savings.

Memory Merchant's memory boards provide the advanced features, quality and reliability you need for the kind of operational performance demanded by new high-speed processors.

COMPLETELY ASSEMBLED

These memory boards are not kits, nor skeletons—but top quality, high performance memories that are shipped to you completely assembled, burned-in, socketed, tested and insured with one of the industry's best warranties.

SUPERIOR DESIGN & QUALITY

Memory Merchant's boards are created by a designer, well-known for his proven ability in advanced, cost-efficient memory design. Innovative circuitry provides you with highly desired features and incredible versatility.

Only first quality components are used throughout, and each board is rigorously tested to assure perfect and dependable performance.

SHIPPED DIRECT FROM STOCK

All Memory Merchant's boards are shipped direct from stock, normally within 48 hours of receipt of your order.

NO RISK TRIAL

We are so convinced that you will be absolutely delighted with our boards that we extend a no risk trial offer. After purchasing one of our boards, you may return it (intact) for any reason within 15 days after shipment and we will refund the purchase price.

NEW 18 MONTH LIMITED WARRANTY!

The reliability of our boards, through quality controlled production and proven performance, has enabled us to extend our warranty to a full 18 months. This includes a 6 month exchange program for defective units.

HOW TO ORDER

Please send check, money order, VISA or MASTERCHARGE (add ICA#) with your order. Sorry, no C.O.D.'s. Specify model number, and quantity desired. Shipping and handling charge is \$5.00 per board. California residents add 6% Sales Tax. Credit card purchases may be telephoned to (415) 483-1008.

OEM and DEALER inquiries invited.



14666 Doolittle Drive
San Leandro, CA 94577
(415) 483-1008

64K RAM, Model MM65K16S

Cool running operation to 10 MHz
Ultra low-power consumption

Fully loaded 64K board draws:
Typ. 350 Ma. (Max. current 550 Ma.)

Bank Select Capability

Extended Addressing Capability

One 16K submodule equipped with a 2K window which may be located in any of the 2K segments

2716 (5V) EPROM Compatibility:
Programmed 2716 EPROM's may replace any or all of the RAM

Four independently addressable 16K submodules on one board organized as two pair of independent 32K banks or as one 64K Extended Address Page. Each 32K bank responds independently to phantom. Bank Select logic is compatible with either Cromemco Cromix* or standard Bank Select software.

*Cromix is a trademark of Cromemco.

New 16K (2K X 8) 150ns Static RAM
Runs on any S-100, 8-bit system
MPM Conversion Option: Write for details.

16K RAM, Model MM16K14

Bank Select Capability

Extended Addressing Capability

One 4K segment equipped with 1K windows

Four independent 4K X 8 byte segments

Uses field proven 2114 (1K X 4)

Low-power consumption (Typ. 1.3 Amps)

Runs on any S-100 8080, 4 MHz Z-80 or 5 MHz 8085 system.

FREE Computer Forms Catalog

with 32 pages of continuous business forms for small computer systems

Send today for our NEW full color 32 page catalog with programming guides, prices and order forms for continuous checks, invoices, statements, envelopes, stock paper and labels.

- Quality products at low prices
- Available in small quantities
- Fast Service
- Money Back Guarantee
- Convenient TOLL-FREE ordering

Fast Service by mail or...PHONE TOLL FREE
1 + 800-225-9550
 Mass. residents 1+800-922-8560
 8:30 a.m. to 5:00 p.m. Eastern Time Monday — Friday

Please rush a new computer forms catalog to: **CODE 22460**

Name _____

Company _____

Street _____

City, State and Zip _____

Phone _____

Computer make & model _____

Neb's
Computer Forms
 78 Hollis Street, Groton, Mass. 01471
 A division of New England Business Service, Inc.

User's Column

programs that are artificially protected with goofy sectoring and other strange tricks to keep you from copying them. And anyone who uses such programs is, in my judgment, not doing the profession much of a favor to begin with. On that, more later.

The bottom line on LDOS is that I like it. It's kind to the user, and it's a fairly complete operating system. I still prefer to convert my TRS-80 Model I to CP/M, but I'll keep LDOS around to use when I'm running it as a TRS-80, since it will work on Omikron's Mapper if you get an LDOS patch from Omikron.

Code and Swash

"Do you read BYTE?" my mad friend asked.

"Stupid question. I write for BYTE."

"What's that got to do with reading it? Anyway, did you read the editorial on software piracy?" (See "How Can We Stop Software Piracy," by Chris Morgan, May 1981 BYTE, page 6.) I admitted that I had.

"What did you think of it?"

"Didn't think about it a lot"

"You should. It's dead wrong," Mac Lean said. "Look. Your editor, Chris Morgan, says that software piracy is a major problem"

"And it really isn't, for users," I mused.

"Well, it's sure going to be," Mac Lean said. "Because look what they're doing. Making programs complicated and uncopyable to 'protect' the publishers. What that really does is make the user's life impossible. Disks are fragile things. I've got to have copies of them. Suppose I have a brownout. Ever have that happen to you?"

I nodded. Once we had a power failure while I was copying a disk. It took Mac Lean and a program called SPAT and a lot of work to recover most of what was on either disk.

"And it's worse than that," Mac Lean said. "They worry about pirates, and the result is that the programs are fragile. They can't recover from mistakes, because instead of error traps they've put in some kind of 'security'."

And he's right. The more I think about "uncopyable" programs, the more I hate the idea. I wouldn't bet any part of my income on an "uncopyable" program — and I'm unlikely ever to recommend one in this column.

But, then, how do we protect the rights of programmers?

Rights to what? If you mean the right to several hundred bucks for a program, why should we protect that? I mean, if people can get that for a program, more power to them, but why is it my concern to help publishers get that much? I want the price of software to come down.

"But," I mused, "if the price comes down, will we still get good software?"

My mad friend chortled. "Ever meet a true hacker who didn't write software? True, they won't do adequate documentation, they never do no matter what you're paying, but try to stop them from writing programs."

And of course he has a point. There's another argument: that software takes a long time to write, maybe

One of the great masters?

Although the Datasouth DS180 matrix printer may not exactly rate as a work of art, our customers have a *very* high opinion of its value. Over the past year, we have shipped thousands of DS180 printers to customers throughout the world. Many of our sales now come in the form of repeat business—a strong testimonial to the acceptance of a product.

The success of the DS180 in a very competitive market did not happen by accident; rather through our sensitivity to the needs of the industry. This sensitivity we carry through research and development, production and quality control and finally, to after sales support and service.

Recently we introduced new enhancements to make the DS180 printer even more versatile. Dot addressable raster scan graphics produces output of computer generated charts, maps and graphs at a resolution of 75 x 72 dots per inch. Variable horizontal pitch selection allows printing at 10, 12 or 16.5 characters per inch plus double wide printing at 5, 6 or 8.25 characters per inch. The expanded 2K FIFO print buffer handles a full CRT screen dump at up to 9600 baud without delaying the host system. We also offer transparent mode for isolating communications problems, and for APL users, the dual ASCII/APL character set option.

Check our list of features and we think you will agree that the DS180 offers the most complete performance package in matrix printers.



DS180 PRINTER STANDARD FEATURES

- Microprocessor Control
- 180 CPS Print Speed
- Bidirectional/Logic Seeking
- 1000 Character Buffer (Expandable)
- 9x7 Dot Matrix
- Expanded Characters
- Adjustable Printhead/1-6 Copies
- 96 ASCII Character Set
- Cartridge Ribbon
- 132 Column Print Width
- Tractor Feed (Front or Bottom)
- Non-Volatile Format Retention
- Top of Form
- Horizontal Tabs

- Vertical Tabs
- Perforation Skip-Over
- Auto Line Feed
- 6/8 LPI
- Auto End of Line Carriage Return
- 5 IPS Paper Slew
- Parallel and Serial Interfaces
- 110-9600 Baud Communications
- Terminal Status Indicators
- Audio Alarm
- Self-Test
- X-on, X-off
- Paper Out Detection

OPTIONAL FEATURES

- Compressed Print—10, 12, 16.5 cpi
- High Resolution Dot—Addressable Graphics
- 2k Expanded Print Buffer
- APL/ASCII Character Set

The DS180 is available nationwide through our network of sales/service distributors.

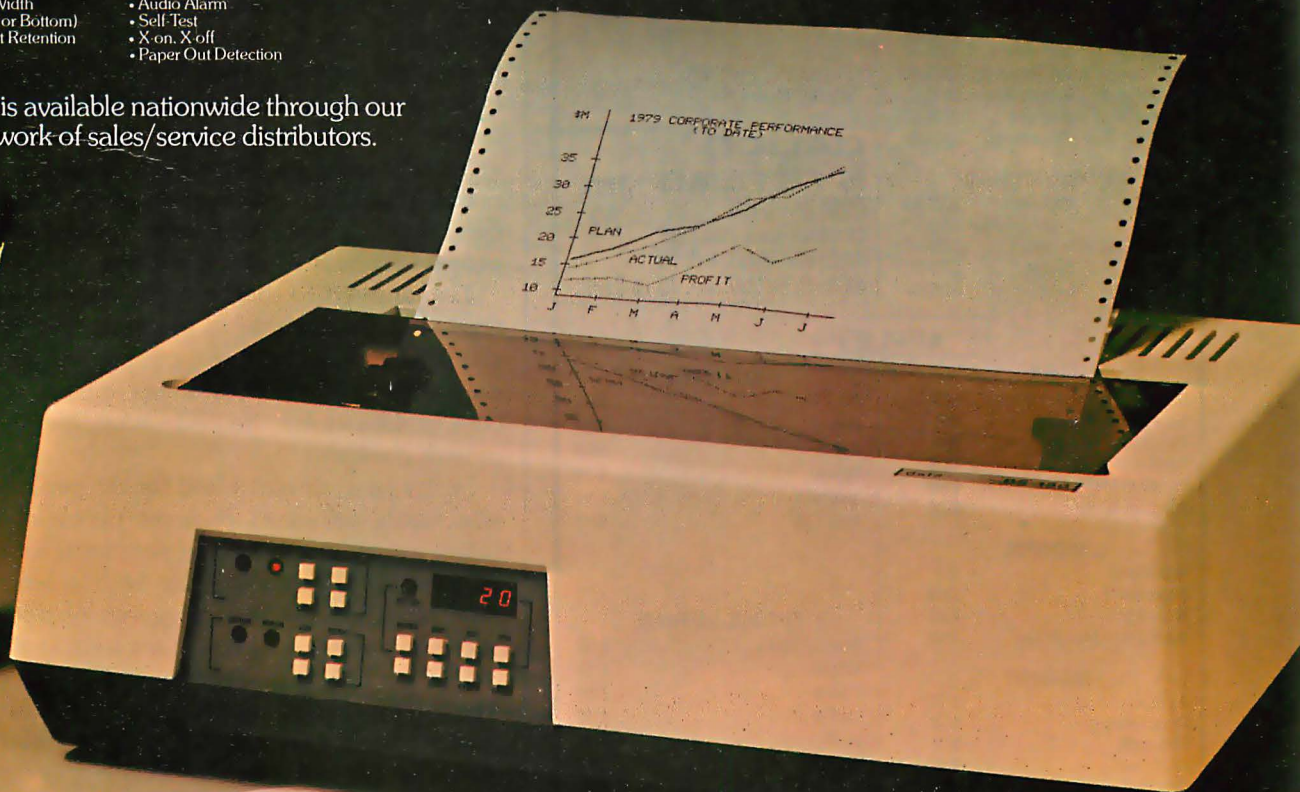

datasouth
computer corporation

P.O. Box 240947 • Charlotte, NC 28224 • 704/523-8500

software ... with lots of technical support

CALICO SYSTEMS

(213) 641-5456
 ORDERS
 (800) 854-2003, ext. 75
 (800) 522-1500, ext. 75 in Calif.

CP/M®

Specify format.
 Most disk formats available.

LANGUAGES

	disk with manual / manual only	price
Basic	Microsoft	\$289/-
Basic Compiler	Microsoft	\$329/-
C-Basic	Dig. Research	\$110/20
CB 80	Dig. Research	\$437/37
COBOL 80	Microsoft	\$574/-
C Compiler	Supersoft	\$169/-
Forth	Supersoft	\$169/45
Fortran	Supersoft	\$209/30
Fortran 80	Microsoft	\$349/30
muLISP	Microsoft	\$169/-
Pascal/M	Sorcim	\$316/30
Pascal Z	Ith. Intersys.	\$349/30
RATFOR	Supersoft	\$85/-
Fortran + RATFOR		\$289/35
S-Basic	Micro AP	\$269/25
Tiny Pascal	Supersoft	\$79/25

ASSEMBLERS/UTILITIES

ACT I	Sorcim	\$109/25
Despool	Dig. Research	\$50/-
Diagnostic II	Supersoft	\$84/20
Macro 80	Microsoft	\$162/-
MAC	Dig. Research	\$85/15
P/L I-80	Dig. Research	\$469/40
SID	Dig. Research	\$70/15
ZSID	Dig. Research	\$90/15

WORD/TEXT PROCESSING

Edit80	Microsoft	\$90/-
Magic Wand	Peachtree	\$289/45
Mail Merge	MicroPro	\$108/25
Spellguard	ISA	\$225/25
Spell Star	MicroPro	\$175/40
TEX	Dig. Research	\$100/10
Textwriter III	Organic Softwr	\$110/-
Word Star	MicroPro	\$318/60
Word Star + Mail Merge		\$415/85

ANALYSIS/MODELING

Calc Star	MicroPro	\$229/45
Milestone	Organic Softwr	\$269/-
muMATH/muSIMP	Microsoft	\$225/-
Supercalc	Sorcim	\$275/50
Worksheet	Soho Group	\$185/-

DATA BASE MANAGEMENT

dBASE II	Ashton-Tate	\$599/40
DBMS-1	Condor	\$567/50
DBMS-2	Condor	\$889/50
Data Star	MicroPro	\$245/60
FMS-80	Systems Plus	\$698/55

ACCOUNTING GRAHAM-DORIAN TOPS Interactive

G/L	\$739/35
A/P	\$739/35
A/R	\$739/35
Inventory II	\$739/35
Payroll II	\$739/35

SYSTEMS PLUS

G/L	\$439/67
A/P	\$375
A/R	\$375
Payroll	\$375
Inventory	\$375
Sales Order	\$375
Point of Sale	\$375
Purch. Order	\$375

PEACHTREE-SERIES 5

G/L	\$437/40
A/P	\$437/40
A/R	\$437/40
Payroll	\$319/40
Inventory	\$437/40
Sales Invoice	\$437/40

CP/M®

TRS-80®/Mod. II (P & T) \$169/-

CALICO SYSTEMS Jan. '82
 (213) 641-5456
 TO ORDER, CALL TOLL FREE
 (800) 854-2003, ext. 75
 (800) 522-1500, ext. 75 in Calif.

APPLE II®

I.U.S.

Datadex	\$258
Easy Writer (40 col)	\$88
Easy Mailer (40 col)	\$61
Forth	\$123
Pro. Easy Mailer	\$149
Pro. Easy Writer	\$225

MICROPRO

Mail Merge	\$97
Super Sort I	\$159
Word Star	\$260
Word Star + Mail Merger	\$349

MICROSOFT

A.L.D.S.	\$105
Basic Compiler	\$320
Fortran-80	\$175
RAM Card	\$149
Soft Card	\$295

PEACHTREE

G/L	\$219
A/R	\$219
A/P	\$219
Payroll	\$219
Inventory	\$219
Mail. List	\$219

PERSONAL SOFTWARE

Desktop Plan II	\$159
VisiCalc	\$159
VisiDex	\$159
VisiFile	\$199
VisiPlot	\$149
VisiTerm	\$149
VisiTrend/VisiPlot	\$229

MASTER CHARGE/VISA

CALICO SYSTEMS

8921 Sepulveda Blvd., Suite 202
 Los Angeles, CA 90045
 (213) 641-5456

Add \$2.50/item for shipping, handling. Overseas add \$10. California residents add 6% sales tax. Allow time for checks to clear. Prices subject to change without notice. ®Registered trademark.

User's Column

months and months or even a year, so doesn't the programmer deserve high prices?

Well, it takes me a year or so to write a book, and I don't notice anyone getting \$400 per copy. And as for piracy, I even pay taxes to support public institutions whose purpose is to lend my books *free*. Yet I'm not starving, and neither are my publishers. The average paperback book sells about 40,000 copies, at perhaps \$2.25, and makes a little money for the publisher, the distributor, and the author. Nobody gets rich on that; the money is in best-sellers, which sell a million and more copies.

Or there's the textbook situation. Take Kernigan and Plauger's excellent *Software Tools* (Addison-Wesley, 1976), or Grogono's *Programming in Pascal* (Addison-Wesley, 1978), as examples. They sell for around \$15, and I suppose they sell 30,000 to 40,000 copies. Maybe more. Does anyone seriously contend that it's harder to write a good program than to write a good book? I've done both, and programs are easier, if a bit more tedious; there's more of the equivalent of reading galley proofs (we call it galley slavery) in programming than in writing. But both are hard work.

As to thefts: look, it's really in everyone's interest to bring the price of software down. The more good software—and by good, I mean stuff that ordinary people can use to do worthwhile things, programs that are self-instructing and have really good documentation—the more good software available at a reasonable price, the more machines will be sold, and the larger the software market will become—and I believe it's *already* approaching the book-buying market.

But, pleads the software developer, book publishers don't have to maintain their books; they don't have people telephoning with questions

Two answers to that. First, if you make sure the software and its documents are right the first time, you shouldn't be getting those complaints. Book publishers don't depend on their customers to be an unpaid quality-control department. Second—why, the pirates *can't* call in with questions.

So my heart doesn't bleed for the publishers. After all, who steals software? Business people? Nonsense. Try selling a computer system to your local architect and then tell him you're furnishing him with stolen programs. Oh boy! No, there are two categories of thieves: hobbyists and shady systems houses. Let's look at them.

First the hobbyist. This poor joker is typically broke. The computer industry gets every nickel he has. Since he *couldn't* pay for what he steals, he wouldn't have bought the stolen program anyway. Furthermore, he'll spend the saved money on something else that's computer-related. Nobody is losing that much money, even in the case of the clubs where members line up and make copy after copy, because darn few of those present would ever buy \$500 programs. These people want programs to play with, not to sell, and probably not even to use.

S-100 Computer Owners...

Looking for more capacity, speed and reliability?

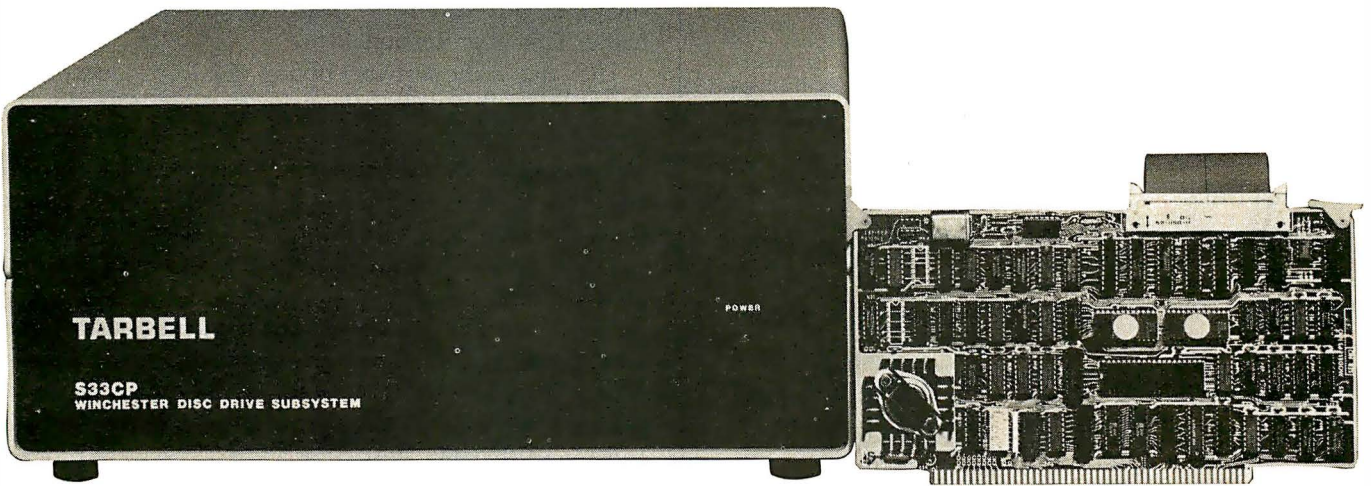

Tarbell 33 megabyte winchester subsystem

CAPACITY

Are you finding you need more disk memory for business applications? Tarbell's hard disk subsystems allow expansion from 10 to over 200 megabytes. And our ATTACH program provides a way to get up-and-running quickly. Start with a small system, if you like, then add up to four drives of any capacity.

SPEED

In most business applications, speed of the disk subsystem is the limiting factor for overall system speed. Major factors which affect disk speed are access time and data transfer rate. All Tarbell hard disk subsystems 33 megabytes and above use a voice-coil actuator which provides an average access time of 50 milliseconds. Data comes off the disk into your deblocking buffer at the maximum possible speed of 1 megabyte per second, meaning that a 24 kilobyte file can be loaded into memory in about one second!

RELIABILITY

Winchester drives have higher inherent reliability because the media and heads are in an air-sealed environment. Other types of drives are open to contamination from smoke, chemicals, and other particles in the air.

ADDITIONAL FEATURES

- Uses only one S-100 board slot
- On-board CRC performed on data
- Automatic alternate sector assignment
- 512-byte on-board deblock buffer

Subsystem includes S-100 interface, drive, cabinet, power supply, cables, software, and all documentation.

Tarbell
Electronics

**MANUFACTURER OF COMPUTERS,
COMPONENTS AND SOFTWARE**

950 Dovlen Place
Suite B
Carson, CA 90746
(213) 538-4251

DISKETTES

as low as
\$21⁷⁵
 per box
 of ten

MAJOR BRANDS AT LOW PRICES PRICE PER BOX OF TEN

	5 ¹ / ₄ Soft Sector Single Sided Single Density	5 ¹ / ₄ Hard Sector Single Sided Double Density	5 ¹ / ₄ Soft Sector Double Sided Double Density
National Data			
Private Label	21.75	23.50	31.50
Memorex	24.25	27.00	34.50
Wabash	25.95	27.95	35.50
Verbatim*			
Data Life	26.60	26.60	37.80
3-M	28.75	N/A	N/A
Maxell	39.50	40.50	47.50
Dysan	39.50	40.50	47.50

For Hub Rings Add 70¢ Per Box

* Hub Ring Included

**Master Charge, VISA or C.O.D. Freight Prepaid
 On Orders of 100 or more units**

NATIONAL DATA PRODUCTS INC.



**8510 SUNSTATE ST.
 TAMPA, FLORIDA 33614**

TO ORDER OR FOR ADDITIONAL INFORMATION

CALL TOLL FREE

800-237-3875

User's Column

What are the alternatives? To preserve those \$500 price tags by making the programs unstable? Doggone it, that's precisely what some outfits have done. In an attempt to thwart pirates, they've made their software fragile. One database outfit has sent me *four separate copies* of its widely advertised program, each supposedly configured just for me. We have *yet* to make one work. I've given up on them.

Then there's what Mac Lean calls "Levitical Programming"; the first half of the manual is filled with "Thou Shalt Not" statements, and the licensing agreement is such that you have to be insane to give them your right name. This is professionalism?

Then too, if the software houses did decent documents, they'd make their pile selling those. Adam Osborne got rich giving away programs and selling books. So can anyone else. You just won't convince me that I ought to feel sorry for an outfit that can palm off some wretched document at \$30 and sell hundreds of copies of it at discounts that would set a major publisher's eyes gleaming with greed.

And that's the answer to the systems-house pirate, who, if the truth be known, isn't all that great a threat either. True, he does soak up legitimate profits. I know a writer who bought a system from a fly-by-night company and found that his WordStar and CP/M were pirated. But when he went back to demand satisfaction, the systems house was gone—as, indeed, such houses usually will be. If they're successful, they *have* to go legitimate eventually; there's just no way to keep their pirate acts secret forever. And if they're not successful, they just can't have stolen that much. (Oh, true, at the hideously inflated prices software publishers charge, the total dollar value is high; but in fact we're talking about fewer than a hundred copies at most, and many of those wouldn't have been sold, but could only be given away. Not everyone who takes low-priced software will pay a high price for it.)

But if the documentation were useful, well written, had lots of examples, and was professionally printed—which, coming with something that sells for hundreds of bucks, darn well *ought* to be the case, even though very few programming documents meet any of those criteria—then even the pirate software houses would have to buy the books.

The answer to software piracy, it seems to me, is about the same as the answer to book piracy: sell decent products at reasonable prices and write decent documentation for sale at prices competitive with the price of photocopying the book. And stop worrying so much about protecting \$500 and \$600 price tags, because it isn't in the interest of the user community for software prices to stay that high. Very few programs are worth that much.

PL/I-80

What is a program worth? Well, there's a legal maxim: "the value of a thing is what that thing will bring," which is to say that something's worth what people are willing

INTERNATIONAL

Price Performance Reliability



CMC IS MEETING TODAY'S HIGH STANDARD OF EXCELLENCE WITH TOSHIBA, CMC'S OWN SUPERFIVE AND SUPERTEN, 5- AND 10-MBYTE MICROCOMPUTERS, AND OTHER FINE PRODUCTS

TOSHIBA DESKTOP COMPUTERS

CMC International offers dealers the new Toshiba computer line, CP/M® -based micros with lots of flexibility...your choice of one or two drives, either 5¼ or 8 inch. Toshiba computers come with C/PM, Microsoft Basic80 and CBasic®. We're proud to offer a system with day-in, day-out dependability, backed by one of the world's largest electronics manufacturers. And, we offer a comprehensive dealer program including parts and module inventory, and prepaid freight for warranty repairs (if you ever need it).

ALSO DISTRIBUTING:

- | | | |
|-----------|-------------|------------------|
| •Corvus | •Tandon | •C. Itoh |
| •NEC | •Seagate | •MicroPro |
| •Dysan | •MPI | •Accounting Plus |
| •Epson | •Superbrain | •Peachtree |
| •Verbatim | •CompuStar | •dBase II |

YOUR STOCKING DISTRIBUTOR



A Division of Computer Marketing Corporation

CMC INTERNATIONAL

11058 Main, Suite 125 Bellevue, WA 98004

PHONE (206) 453-9777

TELEX: 152 556 SEATAC

T-200 64k RAM, 80x24 12" green phosphor screen, complete with CP/M, MBasic80 and CBasic..

Model 1 One 5¼" 280k Disk Drive List \$3995	Model 2 Two 5¼" 280k Disk Drives List \$4495
---	--

T-250 64k RAM, 80x24 12" screen, complete with CP/M, MBasic80, and CBasic.

Model 3 One 8" 1mbyte Disk Drive List \$4795	Model 4 Two 8" 1mbyte Disk Drives List \$5695
--	---

EXCELLENT DEALER DISCOUNTS

To Order Call Toll Free
1-800-426-2963

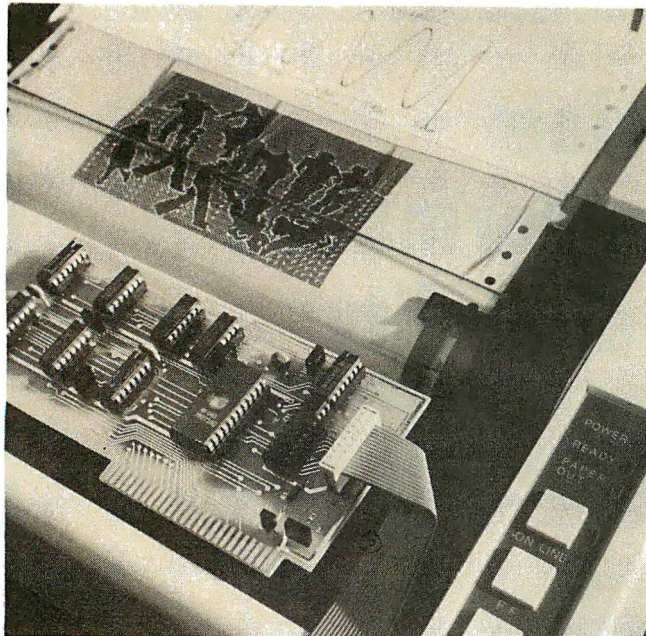

Astonishing!

The EP12 interface card for the Apple II and Apple /// Computers* and Epson MX70, MX80 and MX100 Printers* * is astonishing. All the features you've ever seen in printers for the Apple, plus some new features you'd never expect from a low-cost printing system. All in firmware for the first time, so no more disk juggling to do a graphics print! All features are simple built-in commands . . .

3 Varieties of Screen Dumps

- Hires Graphics — 24 different formats
- Lores Graphics — 16 level gray scale
- Text — Prints exactly what's on the screen

Special Graphics Features

- Dot plotting-960x2160 points on a page
- Special Characters you define in Software
- 16-level gray scale print mode

Versatile Line and Page Control

- Variable line spacing and page length
- Variable line length
- Tabs for indentation and column printing

Built-in convenient human features

- Indication on the screen if paper runs out.
- All functions are short mnemonic commands
- Manual is written for the Apple owner

See your Apple Dealer today.

IS Interactive Structures, Inc.
 112 Bala Avenue
 P.O. Box 404
 Bala Cynwyd, PA 19004
 215-667-1713

*Apple Computer, Inc.
 **Epson America, Inc.

User's Column

to pay for it.

And you can bet that a program worth \$600 had better *work*, and do so with minimum effort, and have decent instructions that can be read by a human being.

And just how many of those are around?

There are a few. My mad friend is ecstatic about Digital Research's PL/I compiler, PL/I-80.

"No bugs. It runs. It does what it says it will do."

"How did you learn the language?" I asked.

"Well, you need Digital's documents, of course," he said. "And two or three standard references on PL/I, one of them certainly being the Joan Hughes book [*PL/I Programming: A Structured Approach*, John Wiley and Sons, 1979] that you mentioned last time."

"You do need other reference works, then?"

"Oh, yeah. As usual, Digital has encrypted its documents. But they're up to Digital's usual standards of clarity, meaning that you'll need a Swahili interpreter . . ."

Well, Mac Lean tends to exaggerate. They're not *that* bad. Not quite. It is true that Digital is a company that seems determined never to hire any writers, but its documents *are* complete, if confusing.

And Mac Lean remains as enamored of PL/I now as he was six weeks ago, which for him is quite a long time. I think we can safely add Digital's PL/I to the armory of good stuff—programs that work properly and are useful.

PL/I does have difficulties. There's no CASE (SWITCH) statement, which means you'll have far too many *if . . . then . . . else* statements; but everything necessary for rigidly structured code is in the language. The error reports are excellent. PL/I is not as fussy about declarations as Pascal. The language doesn't come out as compact as Pascal, and the programs don't run as fast, but they're easier to write. PL/I forgives quite a few errors.

There are other problems. The input/output is confusing, and worse, that's the part that you have to rely on Digital to tell you about. But you can learn it, and having done that, you're safe in programming with PL/I, because Digital is committed to support PL/I compilers for all its operating systems. You'll be able to transport your programs from your present micro to whatever machine—8086, Z8000, whatever—you eventually replace it with.

Thus, I'll stick my neck out this far: it's worth the time investment—a couple of weeks—to become mildly proficient in PL/I, always assuming that you're going to do some programming of your own, of course. If you're *strictly* a user, though, you're still safe in investing in PL/I programs, since you're probably guaranteed they'll be useful on the next generation of machines.

Digital PL/I also comes with a really groovy linker and library-management routine, allowing you to build up a raft of software tools that you can stick into other routines. The method for calling in outside procedures and passing them variables is straightforward, and again

FRIENDLINESS.

Informative HP manuals, helpful error messages, and automatic syntax checking make BASIC language programming easy.

EXPANDABILITY.

Just plug in the HP interface bus (HP-IB) and add up to 14 peripherals without disassembly.

FULL-SCREEN EDITING.

Edit the easy way – without retyping entire statements. Insert, change, or delete characters at the touch of a key.

12-DIGIT ACCURACY.

(Not just 9!) Thanks to BCD math capability.

HP SOFTWARE.

Powerful, time-saving solutions to your everyday problems.

PORTABILITY.

Keyboard, CRT, printer and storage – all in a 20-lb. package. So you'll have computing power wherever you need it... office, lab, field, or home.

INTEGRATED GRAPHICS.

Analyze a better way – with graphics. Document your results with hard-copy plots.



Hewlett-Packard put it all together.



The HP-85 personal computing system.

Leave it to Hewlett-Packard to put a lot of power in a little package. Plus flexibility, portability, and all the other features you'd expect to find in a personal, professional, integrated computing system.

Turn it on and the HP-85 is ready to go. You're off and running using HP software or creating your own programming solutions. There's no bootstrapping. And since the operating system and powerful BASIC language exist in ROM, they use almost none of the available RAM.

If you've been looking for a friendly, integrated

computer with power and dependability, look at the HP-85.

We put it all together for you!

For further information, phone toll-free, 800-547-3400, Dept. 276G, except Alaska/Hawaii. In Oregon, call 758-1010. Or, write Hewlett-Packard, Corvallis, OR 97330, Dept. 276G.

611/22

When performance must be measured by results.



HEWLETT PACKARD

MULTIPROCESSOR PASCAL

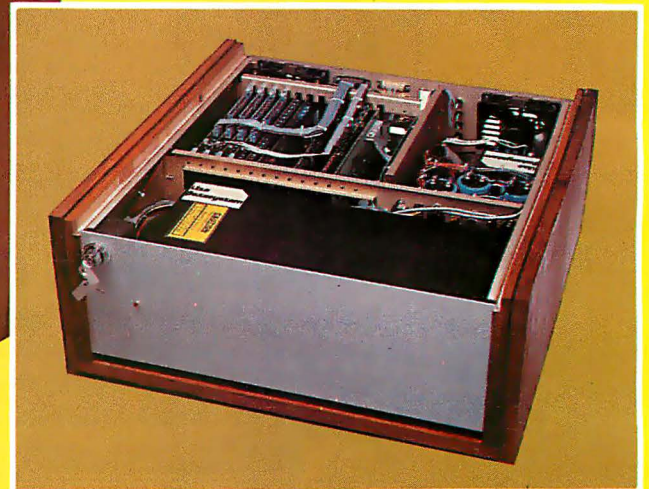

ibs betasystem II

- SIMULTANEOUS Timeshared & Multiprocessor Operation
- FULL UCSD™ PASCAL II Compatibility with IBS™PASCAL, SEMAPHORES, CONCURRENCY, CHAINING, TRUE WORD PROCESSING
- 5, 10, 20, Mbyte FIXED DISK SYSTEMS, 5", 8" FLOPPY DISK SYSTEMS
- TWO Timeshared Users on EACH Slave Processor, plus 128K RAM plus PARITY, 2K EPROM, Full Interrupts, Hardware Floating Point, IEEE S-100, Software Bank Boundary, 2 Serial Ports for Synchronous or Asynchronous Protocol
- VIDEO TAPE ARCHIVING
- CP/M™ Compatibility with MuDOS™
- LARGE DEALER MARGINS and GOOD DEALER SUPPORT

ibs

(415) 443-3131

INDEPENDENT BUSINESS SYSTEMS, Inc.
1328 Concannon Blvd., Livermore, CA 94550

Interested?

OUR DEALERS: FOREIGN • Philip Baksh, London England, Tel: 44 1 7413707 • EEI, Sharjah, UAR, Tel: 354688 • Elif, Inc., Montreal, Quebec, Tel: (514) 337-3214 • FDM, Madrid, Spain, Tel: 402 24 97 • JH Systems, Etobicoke, Ontario, Canada, Tel: (416) 621-0538 • S.A. Micro Service, Paris, France, Tel: 205 38 71 • Servonic, Munich, West Germany, Tel: 089 483253 • GBK, The Netherlands, Tel: 20-733376 • Terrace Computer Svcs., LTD, Terrace, BC, Tel: (604) 635-7606 • DOMESTIC - CEB3, San Jose, CA, Tel: (408) 267-3547 • Donald Coffman, Cupertino, CA, Tel: (408) 253-2327 • ERS, Brea, CA, Tel: (714) 524-2470 • Innovative Interfaces, Berkeley, CA, Tel: (415) 524-8416 • ICE Services, Gaithersburg, Maryland, Tel: (301) 869-2896 • Khalsa Consultants, Cambridge, MA, Tel: (617) 864-3638 • Link Systems, Santa Monica, CA, Tel: (213) 453-1851 • EDS, Frazer, PA, Tel: (215) 296-7300 • Quali-Type, Inc., Livermore, CA, Tel: (415) 447-6121 • SPI, San Diego, CA, Tel: (714) 268-4346 • Khalsa International, Herndon, VA, Tel: (703) 437-0404

UCSD PASCAL is a trademark of Regents of U. of C

CP/M is a trademark of Digital Research, Inc.

MuDOS is a trademark of MuSYS Corp.

IBS is a trademark of IBS, Inc.

THE **IBS** **SLAVENET 128**™

ITS FEATURES POINT TO YOUR SUCCESS

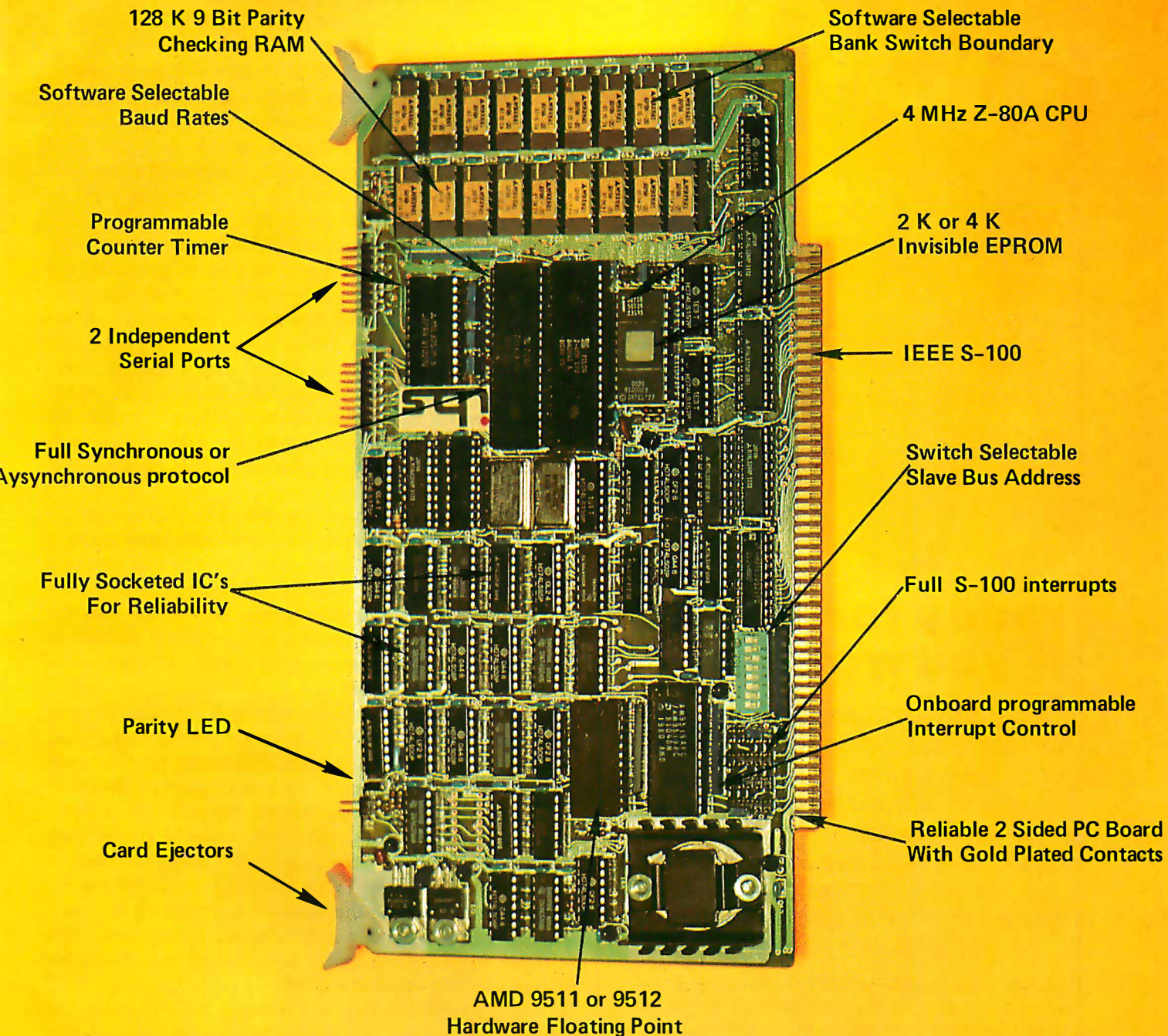

The IBS SLAVENET 128 is a totally independent and complete computer capable of supporting two timeshared users. The SLAVENET 128 communicates with your own CPU as an I/O mapped device, for easy interfacing. The SLAVENET 128 is fully supported by IBS PASCAL™ for UCSD™ PASCAL compatibility, and by Mu DOS™ for full CP/M™ compatibility.



Independent Business Systems

Circle 179 on inquiry card.

1328 Concannon Blvd. Livermore, CA 94550 (415) 443-3131

ARE YOU READY?



You are ready for MICRO if you want to...

- Go beyond canned software
- Use your computer for more than games
- Learn advanced programming techniques
- Understand the inner workings of your computer
- Get the most out of your 6502/6809 system

Month after month, MICRO gives readers sophisticated software applications, detailed discussions of programming languages, and in-depth hardware tutorials.

To get the most out of your machine, say YES to MICRO today! We accept VISA or Mastercard. **\$24.00** per year in the U.S., **\$27.00** elsewhere.

Use Our 24-hour Toll-free Service

800-227-1617 Ext.546

In California: 800-772-3545, Ext.546

MICRO

34 Chelmsford Street
P.O. Box 6502
Chelmsford, MA 01824

User's Column

preserves maximum portability from machine to machine.

PL/I is a good language for learning structured program concepts, and the Digital implementation is much better than acceptable. Recommended.

Bilge and Circumstance

Now we come to dBASE II versus the bilge pumps.

First: dBASE II is what used to be called VULCAN. The original VULCAN programmer formed a partnership with Messrs. Ashton and Tate, and now Ashton-Tate markets it. I'm told my evaluation was crucial in the decision to rewrite and expand the documentation, but to keep the program (with some fixes).

My original evaluation of VULCAN was "infuriatingly excellent"; it was potentially a very useful program, but fatally flawed by the worst user instructions I'd ever seen.

I'm pleased to say that now it's not infuriating, just excellent. The flaws are (almost) all gone, the program documents have been rewritten and expanded until almost anyone can learn to use dBASE II, and VULCAN always was a darn good database program. I think it's overpriced at \$700, but apparently Ashton-Tate gets away with it. If any program is worth that price, dBASE II is.

dBASE II is a *relational database*. This is in contrast to tree-structured databases. Relational databases make a kind of matrix of data; you can then structure the data any way you want, examine relationships you hadn't realized were there, and in general play about with the data. Tree-structured systems of the CODASYL variety require you to do the structuring in advance, and woe to you if you get it wrong.

It's a bit hard to describe dBASE II, because it's very versatile and powerful. For instance, you can build a full accounting system from dBASE II, tailoring it to your needs, and it really would work. (I think you'd be better off buying an accounting system, but that's for another article.) You can put up libraries in dBASE II, and then take the same data and reorganize it by subject matter to make bibliographies. What dBASE II preserves are the *relationships* among the mass of data entered; the exact structure of the data can be changed at any time. This makes for a very powerful tool, one whose capabilities aren't entirely realized just yet.

And, dBASE II is now well documented. What they did was keep the old documentation, which was a really complete reference manual but sans examples or sane organization, and add, up front where it belongs, a complete new program-user's guide, done by someone just learning to use the VULCAN system. Thus you can go through the first set of documents and learn how to use dBASE II, after which you can use the second chunk as a handbook, which, once you actually understand dBASE II, isn't all that bad. (It remains, however, the most frustratingly miserable excuse for a way to *learn* a system that I've ever seen.)

How to maximize your Model III:

You don't have to settle for standard equipment. Let MTI and Alpha Byte help you build the Model III you want.

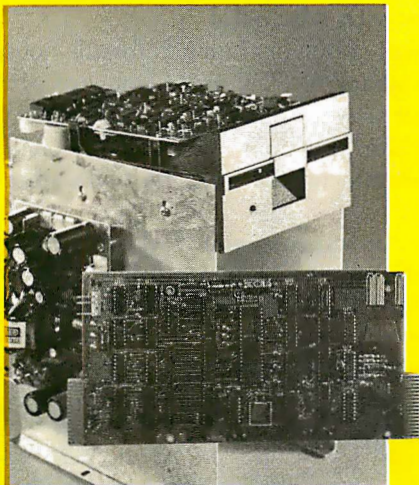

MTI FLOPPY DISK ADD-ON KITS

Now you can upgrade your 16K level II Model III to a full 48K Disk System the easy way with MTI's Double Density Disk Controller and your choice of Disk Drives. You can choose 40 track, Double-Sided 40 track or Double-Sided 80 track Drives to supply your disk storage needs. Forty Track Drives store 175K, Double-sided 40 Track drives store 350K. Four Double-Sided 80 Track Drives provide up to 3 MEGABYTES of On-Line storage.

INTERNAL DISK DRIVE KITS

The first drive kit includes one Tandem Disk Drive, MTI Double Density Controller. Switching power supply, 32K of RAM, all mounting hardware, cables and Detailed Installation Instructions. The second internal drive kit includes a second drive and the necessary installation hardware.

40 TRACK DRIVE SYSTEM	
DRIVE NO. 1 KIT	695.00
DRIVE NO. 2 KIT	279.00
40 TRACK DUAL HEAD SYSTEM	
DRIVE NO. 1	779.00
DRIVE NO. 2	389.00
80 TRACK DUAL HEAD SYSTEM	
DRIVE NO. 1	929.00
DRIVE NO. 2	569.00

EXTERNAL DRIVE KITS

Two external drives can be attached to any dual drive Model III Computer.

40 TRACK EXTERNAL DRIVES	
DRIVE NO. 3	379.00
DRIVE NO. 4	359.00
DUAL HEAD 40 TRACK EXTERNAL DRIVES	
DRIVE NO. 3	499.00
DRIVE NO. 4	479.00
DUAL HEAD 80 TRACK EXTERNAL DRIVES	
DRIVE NO. 3	679.00
DRIVE NO. 4	659.00

FIVE MEGABYTE EXTERNAL WINCHESTER HARD DRIVE 2795.00

Add the Ultimate in Fast High Capacity Disk Storage to any Model III Floppy Disk system. Reliable Winchester technology provides enough storage for the largest business files. Winchester disk drives have greatly increased data transfer rates and that means faster program and file loading. This is a complete self contained system that connects to a standard Model III Disk System in minutes without any modification to the computer.

MODEL III DIAGNOSTIC PROGRAM 49.95

A complete diagnostic program for the Model III. Tests RAM and ROM, video display and all disk drives. Catch problems while they're small and be sure that your Model III is in perfect running condition.

MODEL III CP/M-80 NOW AVAILABLE! . . . 849.00 CP/M & 80 Column Kit.

Now you can run proven CP/M based software on your Model III, with standard 80 column display. A simple internal modification will transform your Model III into a NEW computer and allow you to run CP/M the industry-standard operating system and assure you of a large supply of fine software. Includes CP/M 2.2.

MODEL III SPEED-UP MOD 149.00

Now you can run your Model III at 4 MEGAHERTZ, that's almost double the standard speed. This simple-to-install kit does require some soldering.

MODEL III DISK DRIVE CLEANING KIT . . . 24.95

Uses soft non-abrasive cleaning material and includes a disk head exercising program to insure thorough cleaning.

DOSPLUS OPERATING SYSTEMS FOR THE MODEL III

Solid BUG-FREE operating systems for the Model III. Supports different size drives on the same system and Basic Program Chaining with variables saved in memory.

40 TRACK	99.00
80 TRACK	119.00
EXPANDED DOSPLUS 3.3.8	149.00
Read and Write 40 Track Diskettes on an 80 Track System.	
HARD DISK DOSPLUS	299.00
Supports the MTI 5 MEG HARD DISK.	

We built a reputation on our prices and your satisfaction.

We guarantee everything we sell for 30 days. If anything is wrong, just return the item and we'll make it right. And, of course, we'll pay the shipping charges.

We accept Visa and Master Card on all orders. COD orders accepted up to \$300.00.

Please add \$2.00 for standard UPS shipping and handling on orders under 50 pounds, delivered in the continental U.S. Call us for shipping charges on items that weigh more than 50 pounds. Foreign, FPO and APO orders please add 15% for shipping. California residents add 6% sales tax.

The prices quoted are only valid for stock on hand and all prices are subject to change without notice.

Alpha Byte

COMPUTER PRODUCTS

TO ORDER, or for information, CALL:
(213) 706-0333

31245 LA BAYA DRIVE, WESTLAKE VILLAGE, CALIFORNIA 91362

User's Column

Second, the bugs have been fixed. Not that there ever were many; VULCAN was always excellent, even if infuriating.

And finally, the program remains very powerful. dBASE II isn't just a means of storing and retrieving data. It contains what amounts to a whole data-handling language with the ability to do sorts and restructures, to copy data from one place to another, and to do conditional arithmetic. For example,

```
REPLACE ALL FOR (BILL:DATE <= 791031)
COST WITH COST*1.1
```

would be a command to search the database to find records that had BILL:DATE older than October 31, 1979 and for those records to replace the value of the variable COST by the current value plus ten percent.

Other forms of magic are possible. You have to study dBASE II; it can do things you wouldn't think of. But it's well worth the study. I'm using it to organize my files, by subject, type, date, date of last access, and drawer number, and also adding keywords; eventually I'll have this place organized, and this time for sure. (The last time I got this ambitious I was using VULCAN, and the documentation drove me to quit in disgust, but this time things seem to be going much better.) And my time wasn't wasted last year, since dBASE II can read the old

VULCAN files and then reshape them into the new system I've designed. What happens is that dBASE II copies the old records into new ones, ignoring any in the old database that aren't in the new structure; while if it finds variables in the new structure that weren't in the old records, it fills them with blanks, leaving room for you to enter the data at your leisure.

dBASE II, I'm pleased to say, makes no attempt to prevent you from making backup copies. Far from it: all through the documentation, you're urged to make a safety copy of both data and program, just in case. That advice is worth taking, given the relative costs of data-entry labor as opposed to floppy disks. I expect people will try to rip off the dBASE II software, given the price, but I guarantee they'll get zero use of it without a complete set of documents

Statistical Analysis with Microstat

Microstat by Ecosoft. I don't care much for the house name—I'm growing weary of "ecology" names for software companies, since they make me think their products may contain significant portions of natural organic waste—but I can recommend the program, with warnings.

First warning: you, or someone you work with, better know quite a lot about statistics. Microstat will do some very sophisticated statistical analyses, but it will not tell

		
MX80 — \$469	APPLE II	M83A — \$749
APPLE GRAPHICS PARALLEL INTERFACE Full Hi Res Graphics for Epson, Okidata, etc.	\$89	TRS80 BIDIRECTIONAL I/O PORT Cascadable with Selectable Addressing
		\$39
ADDS Viewpoint — \$559 ALTOS ACS 8000-15 — \$4750 ANADEX 9500 — \$1225 9501 — \$1225 ATARI 400 16K — \$349 800 16K — \$740 CENTRONICS 730 — \$600 737 — \$750 DATASOUTH DS120 — \$595 DS180 — \$1269 DIABLO 630 — \$2095 1640 — \$2575 DISKETTES Scotch — \$2.50 Dysan — \$3.50 EPSON MX80FT — \$599 MX100 — \$739 HAZELTINE 1500 — \$995 Esprit — \$675	INTERFACES SSM-AIO — \$160 CPS-CARD — \$199 NORTHSTAR HR64DD — \$2875 HR64QD — \$3150 LOBO Apple Drive/Card — \$390/\$90 TRS80 Drive/Interface — \$390/\$90 Apple DD Drive — \$2740 MODEMS HAYS-MICROMODEM — \$285 Novation-Cat — \$155 Penril - 300/1200 (212A) — \$795 MONITORS APF — \$125 SANYO-BW — \$159 Sanyo-Green — \$249 Color — \$425 Amdek-Green — \$159 Color — \$350 MPI 88G — \$575 99G — \$675 NEC 5510 — \$2540 5520 — \$2900	SOROC 120 — \$729 135 — \$799 SOFTWARE All Major Brands — \$CALL TELEVIDEO 912 — \$669 950 — \$930 TI 810 — \$1275 820 — \$1795 OKIDATA M80 — \$369 SL125 — \$3150 M82A — \$489 SL250 — \$4200 M83A — \$739 M84 — \$1099 APPLE XTRAS Memory-16K 200ns — \$19.95 Game Paddle Extension — \$14.95 Prototyping P.C. Board — \$19.95 C IOTH 25CPS-P — \$1379 45CPS-P — \$1699 ZENITH Z19 — \$775 Z89 — \$2195
DISCOUNT LINE 1-800-528-8960	EXPOTEK CORPORATION INTERNATIONAL 2231-R West Shangri La Road, Phoenix, AZ 85029	ARIZONA 1-602-246-1783 EXPORT TWX - 910-950-1194

RM/COBOL MAKES IT ACROSS!

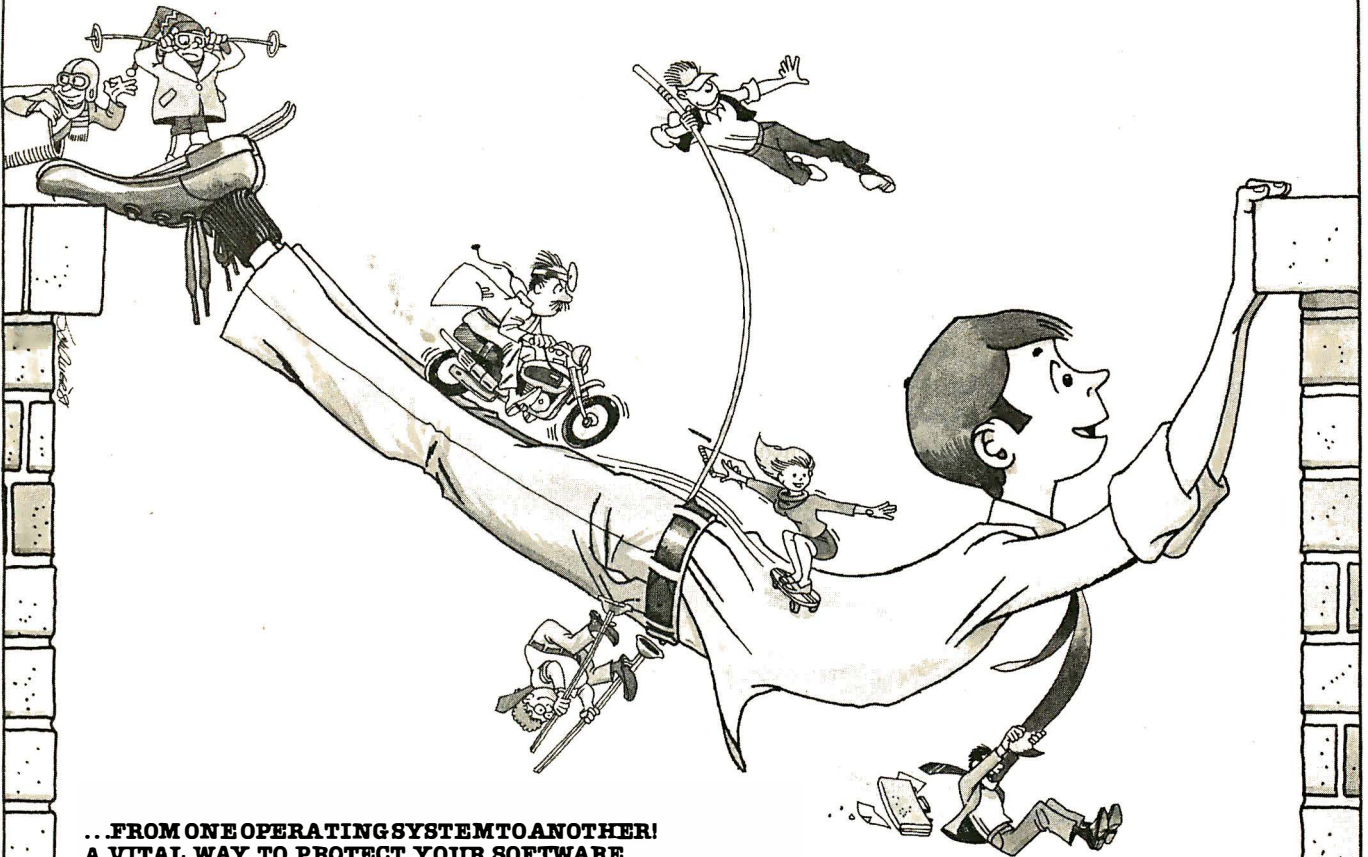

**... FROM ONE OPERATING SYSTEM TO ANOTHER!
A VITAL WAY TO PROTECT YOUR SOFTWARE
INVESTMENT FOR THE FUTURE!!**

The RM/COBOL language runs on more different Operating Systems and more different-sized computers than any other similar language. For starters, it runs on NCR and TI minicomputers and, in the micro field, on the CP/M², MP/M², TRSDOS³, OASIS⁴, MOASIS⁴, and UNIX (ONYX version) Operating Systems...to mention only a few.

Until now, serious business software of the scope and flexibility seen in the minicomputer world has not been available on micros. RM/COBOL now allows transfer of such software with a minimum of fuss.

We have participated in such a mini-to-micro transfer of a major set of general business software...using RM/COBOL as the transfer mechanism, of course. Running on literally thousands of minicomputers, these refined, enhanced, and proven software packages cover A/R, A/P, G/L, P/R, Order Entry (with Invoicing and Inventory Control) as well as Sales Analysis. The packages define a new level of achievement for features and flexibility in micro applications software and offer top quality at a reasonable price.

For immediate information, call 714-848-1922 for your complete product descriptions.

... PLUS ALL THE OLD, FAMILIAR FAVORITES that we continue to offer, such as:

General Business—Client Accounting (CPA Write-up)
FMS⁶ (Financial Modeling System)
NAD⁷ (Name and Address System)

Real Estate—REAP (Real Estate Acquisition Programs)
PMS (Property Management System)
MLS⁶ (Multiple Listing System)

Health Care—APH⁸ (Automated Patient History)

Word Processing and System Software—Magic Wand⁹
QSORT⁷
CBASIC²¹⁰

and Cybernetics' unique TRS-80³, Model II CP/M offering high performance, hard disk support, and CP/M compatibility.

Trademarks of:

1—Ryan McFarland Corp; 2—Digital Research, Inc.; 3—Tandy Corp; 4—Phase One Systems, Inc.; 5—Bell Telephone Laboratories, Inc.; 6—American Business Systems, Inc.; 7—Structured Systems Group, Inc.; 8—Cybernetics, Inc.; 9—Peachtree Software, Inc.; 10—Compiler Systems, Inc.

SO YOU'RE SERIOUS ABOUT RUNNING A SKELETON CREW.
HE'S NEW TO THE SYSTEM, BUT HE CAN BONE UP ON IT.



8041 NEWMAN AVE., SUITE 208
HUNTINGTON BEACH, CA 92647

User's Column

you which of its many features you want to use.

On the other hand, you can make up your data files rather easily, then manipulate the daylight's out of them with Microstat's various routines; so you don't have to know in advance that you'll want to employ the Kolmogorov-Smirnov Two Group Test (whatever that is) in order to use it later.

I wish I'd had Microstat last fall. About a year ago I quit smoking and took up running (and yes, I'm still at running, and it's a year today since I last smoked). Like many new converts, I began reading the various running magazines, and one of them rates running shoes. It gave a fairly low rating to the shoes I like, and I got interested in why. (It shouldn't have; one of the measures was shoe weight, rank ordered to a *tenth of a gram!* I doubt the magazine has balances that sensitive, and a few drops of sweat would change the ratings.)

The magazine published its data—more or less—as well as its ratings, so I decided to do a fairly complete statistical analysis to see just how much confidence you could put in those ratings. (Not a lot, I concluded. Many of the measures are highly correlated and not sufficiently thought out.) I didn't have a decent stat program, so I had to write my own, based mostly on Paul Horst's matrix algebra routines I learned way back when. My routine will do a couple of things Microstat doesn't do, such as generate a new data file with the data entries transformed

to "Z" scores (in which the mean is 0 and the standard deviation is 1), and my system preserves a "name and comment" string field associated with each data case. But I'd still have been far better off using Microstat with its much more complete statistical analyses. The Microstat package has a data-entry routine with some elementary error-correction procedures, including an EDIT routine; I could have used that.

Microstat does what you'd expect: means, variances, correlation matrices, etc. It also does auto-correlation (a variable correlated with itself). It does analysis of variance, "Student's" T test, the F test, and various non-parametric tests such as chi-square. It tries different distributions and checks goodness of fit. About the only thing missing that I'd like to see is Chebyshev's criterion. But *note this well:* if this paragraph is meaningless to you, you will not understand Microstat's documentation. This is not a program intended for the casual "cookbook" stat user. It *has* everything the cookbook experimenter would need, but in a fairly intimidating context. In fact, Ecosoft (which seems to be some professors at a Midwestern university) would do well to write a simple-minded cookbook to accompany its programs.

On the other hand, if you do know a bit about statistics—if you've mastered something beyond the elementary textbooks—then Microstat can help you. It has a surprising number of features, and if you know what statistics you want, or can find someone to advise you on the math theory, the Microstat documentation is more than adequate to tell you how to use the program. Given that caveat, I recommend Microstat; but do be warned that the book is written with graduate-level experimental statistics students in mind.

5 or 10 Mbyte Storage for Heath/Zenith, TRS-80, SuperBrain, S-100 microcomputers.

Now, 5¼" hard disk add-on storage for your computer, at a price you can afford.

Available for a surprisingly low \$3495 for the 5 Mbyte hard disk, \$4350 for the 10 Mbyte disk. Disk drives and controller cards also available.

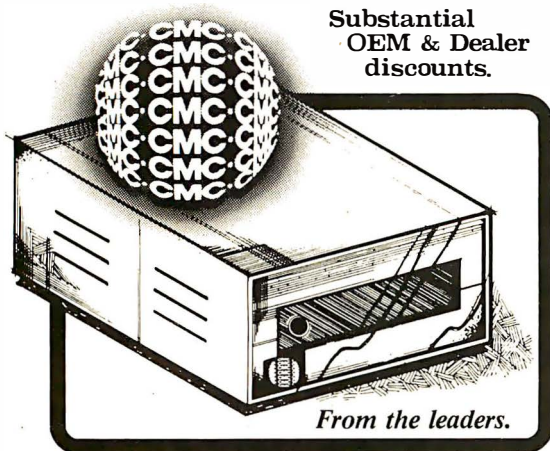

Substantial
OEM & Dealer
discounts.

CMC International

A Division of Computer Marketing Corporation

11058 Main, Suite 125, Bellevue, WA 98004
Telephone (206) 453-9777 Telex 152556 SEA

Soothing the Savage LISPer

And finally we have a good book on LISP. I confess I'm slowly beginning to appreciate just how powerful the LISP programming language is, and I will now concede that anyone intending to make a career in computer science should become aware of the language. I'm still not convinced LISP can be learned without tutorial help, but certainly *LISP*, by Patrick Henry Winston and Berthold Klaus Paul Horn, will help. The book is intelligently written. There are a lot of examples; the most useful are given as exercises, which made me furious until I realized there were answers in the back of the book. It has a good table of contents.

I'm still not at all convinced that LISP programs will ever be comprehensible to anyone who doesn't spend a lot of time working with the language. The claims that they're easy to read and don't require comments are, in my view, just wrong and would only be made by a maniacal LISPer (and a lot of LISP users do tend to be maniacs, as witness the hate mail I get for not sufficiently praising the language).

Anyway, the book is the best I've seen on the subject and tells a lot about LISP. ■

Osborne Welcomes You to the World of Microcomputers

INTRODUCTORY BOOKS

Business System Buyer's Guide
by Adam Osborne and Steven Cook
Purchasing a computer for any business is a complex process, but this book will help. Before you buy any computer, read this book. You'll never make a better investment.
#47-0, \$7.95 □

Introduction to Microcomputers
Volume 0: The Beginner's Book
by Adam Osborne
Here's the book to start with if you know nothing about microcomputers but wish to learn. Provides the concepts you'll need to understand this technology.
#26-8, \$7.95 □

An Introduction to Microcomputers
Volume I: Basic Concepts
by Adam Osborne
The world's best selling textbook on microcomputers uses concepts that are common to all microprocessor systems. Shows what a microcomputer can do, and how it does what it does. This edition is the most comprehensive and up-to-date introduction to microprocessor systems available anywhere.
#34-9, \$12.99 □

**Running Wild-
The Next Industrial Revolution**
by Adam Osborne
An insider's look at the microelectronics revolution. Will the coming years prove to be a dream or a nightmare? Running Wild tells the story.
#28-4, \$3.95 □

GUIDES

Apple II™ User's Guide
by Lon Poole, Martin McNiff and Steven Cook
Complements your Apple II owners manual. Our guide will tell you more about your Apple II or Apple II plus computer than any other single source. It covers all the special features of the Apple computer.
#46-2, \$15.00 □

PET/CBM™ Personal Computer Guide
by Adam Osborne and Carroll Donahue
A step-by-step guide which takes you from the "on" switch to assembly language subroutines for your Commodore system. It's a BASIC tutorial and covers many recent CBM products.
#55-1, \$15.00 □

PROGRAMMING BOOKS

Science and Engineering BASIC Programs
ed. by John Heilborn
An important collection of the most valuable programs for scientists and engineers. Easily used on most popular microcomputers #63-2, \$15.99 □

Some Common BASIC Programs
by Lon Poole and Mary Borchers
76 well designed and brilliantly documented programs that solve a variety of problems in statistics, finance, and math.
#06-3, \$14.99 □

Generalized BASIC Edition
#06-3, \$14.99 □

PET/CBM™ Edition #40-3, \$14.99 □

TRS-80™ Level II Edition #54-3, \$14.99 □

Atari™ Edition #53-5, \$14.99 □

All 76 programs ready to run on:
PET/CBM™ floppy disk #33-0, \$22.50 □

PET/CBM™ cassette #25-X, \$15.00 □

TRS-80™ Level II cassette #32-2, \$15.00 □

Practical BASIC Programs
Here are 40 useful and fully documented programs designed to run on most microcomputers. Especially useful in small business and household applications. (Generalized BASIC).
#38-1, \$15.99 □

Osborne CP/M™ User Guide
by Thom Hogan
The most complete and up-to-date CP/M book you can find. It will make your first use of CP/M easy. If you already own CP/M, it will help you modify your system. #44-6, \$12.99 □

CBASIC™ User's Guide
by Adam Osborne, Gordon Eubanks and Martin McNiff
Co-authored by Gordon Eubanks, the creator of CBASIC, this is more than a self-teaching textbook, it is the definitive reference of the CBASIC language.
#61-6, \$15.00 □

BUSINESS BOOKS

by Lon Poole and co-authors
Osborne's three business systems are renowned for excellence in design and documentation. Our books explain in detail how to use the programs. They contain complete programs listings, supporting technical documentation, and specific information on changing and installing the programs.

Payroll with Cost Accounting #22-5, \$20.00 □

Accounts Payable and Accounts Receivable #23-3, \$20.00 □

General Ledger #24-1, \$20.00 □

ASSEMBLY LANGUAGE PROGRAMMING SERIES

by Lance Leventhal and co-authors
You needn't know anything about assembly language to use these books. Each one is a straightforward, self-teaching textbook that is both precise and easy to understand.

ASSEMBLY LANGUAGE PROGRAM SERIES

- 88000 #62-4, \$16.99 □
 - 6809 #35-7, \$16.99 □
 - 6502 #27-6, \$16.99 □
 - Z80 #21-7, \$16.99 □
 - Z8000 #36-5, \$19.99 □
 - 6800 #12-8, \$15.99 □
 - 8080A/8085 #10-1, \$15.99 □
- The 8086 Book**
by Russell Rector and George Alexy
Part assembly language text and part hardware reference, this book covers all of the 8086's most important features.
#29-2, \$16.99 □

Osborne McGraw-Hill Dept. B23
630 Bancroft Way, Berkeley, CA 94710
Call Toll Free: 800-227-2895
in California (415) 548-2805

Name _____
Address _____
City/State/Zip _____

Plus: .75/item 4th class \$1.50/item UPS
 \$2.50/item Air Mail \$10.00/item Overseas
(California residents add applicable tax.)

Total amount enclosed \$ _____
or charge my Visa Mastercharge

Card# _____ Exp. Dt. _____

Book#, Price: _____



Build a Joystick A-to-D Converter for the TRS-80 Model I or III

Second in a Series

William Barden Jr.
28122 Orsola
Mission Viejo, CA 92692

[Editor's Note: This series of articles describes hardware and software projects for the Radio Shack TRS-80 (Model I, Model III, and Color Computer).]

Last month I examined the Color Computer's built-in analog-to-digital converter ("Color Computer from A to D," page 134). I described the software that reads the joysticks and showed how other analog input devices can be connected to the Color Computer.

This month I'll give equal time to Model I and III users by presenting a hardware/software project that allows joystick and other analog inputs to these computers. Since the Model I and III don't have built-in analog-to-digital (A/D) conversion circuitry, we'll have to make our own. It's a simple project requiring two common integrated circuits, a few resistors, and some other components—costing less than \$20 (not bad for a two-channel, 64-step A/D converter). You won't have to modify your computer at all—the A/D circuit plugs in as

a printer does. Since the device connects to the line-printer bus, you'll need a Model I with Level II BASIC and an expansion interface or a Model III with Model III BASIC.

I'll provide step-by-step instructions for fabricating and testing the circuit. Finally, I'll show you how to use the A/D converter with a joystick and other analog input devices.

General Description

The block diagram of the circuit we'll build is shown in figure 1. Note that it connects to the TRS-80's printer (a.k.a. Centronics) bus. Therefore, you won't be able to use the line printer during joystick operations and vice versa.

The A/D circuit largely duplicates that found in the Color Computer. (For further background, see the discussion in last month's article.) It consists of a digital-to-analog converter (DAC) and two comparators—one each for the joystick's X and Y channels. Using a reference voltage from the DAC, the comparators allow you to perform successive approximations of the voltage levels input from the X and Y joystick channels.

Six outputs go from the line-printer bus to the DAC;

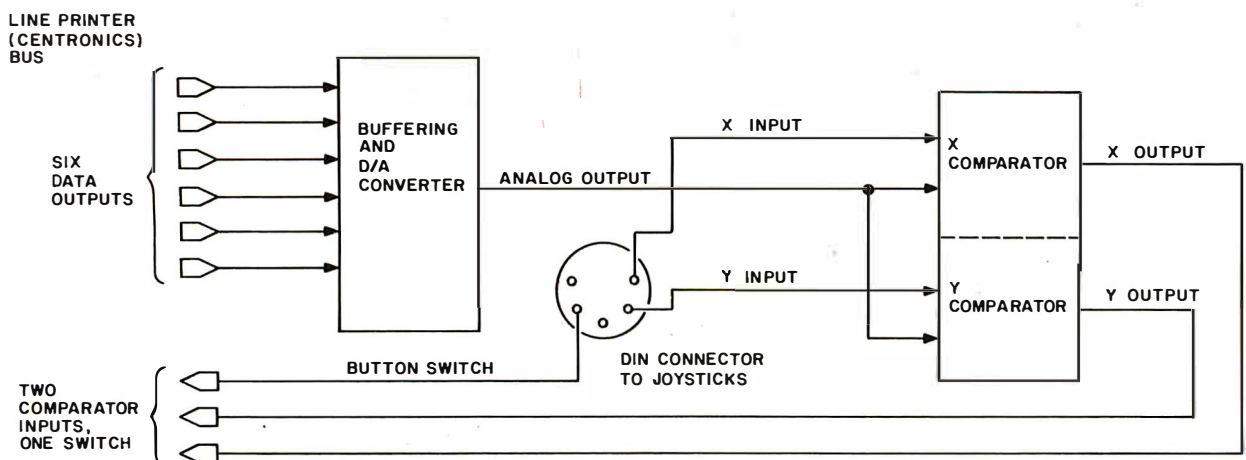
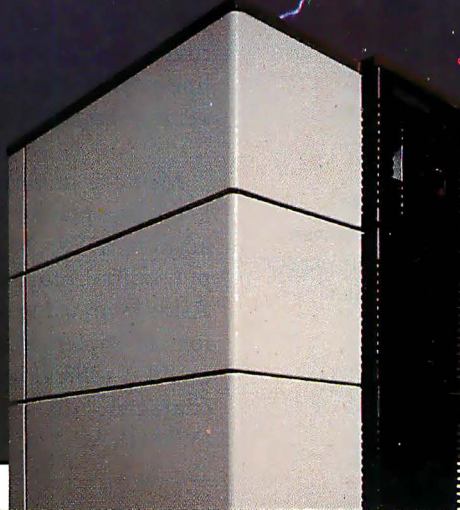

Figure 1: Block diagram of the A/D circuit. The DAC is driven by outputs from the line-printer port. Its output goes into two comparators, one comparing the DAC voltage with the X channel, and the second comparing the DAC voltage with the Y channel. The comparator outputs are fed back into the line-printer port.

ALL COMPUTERS ARE NOT CREATED EQUAL



**ZEμS™ is a minicomputer
AND a microcomputer.**

Through multiprocessor technology, each user has a dedicated Z-80A-based single-board microcomputer module, housed in the system mainframe.

But users enjoy minicomputer performance and capacity. Including modular hard disk storage of 34 to 600 megabytes. Tape backup. Shared printers with spooling and queuing. Disk caching. Access to a common database.

Unequaled flexibility and reliability. The completely modular, stackable system can expand to 64 users. To add a user, add only a dumb terminal and an inexpensive user microcomputer module.

OSM

**ZEμS sounds powerful.
Now prove it.**

Name _____

Company _____

Address _____

City/State/Zip _____

Phone _____

Trademarks
ZEμS, MUSE: OSM Computer Corporation
Registered trademark:
CP/M: Digital Research

And ZEμS isn't fazed by lightning, voltage variations, or power failures. Power for the entire system is "buffered" through a battery/recharger system that provides up to 20 minutes of operating power.

Unequaled value. MUSE™ multiprocessor operating system is compatible with CP/M®. Minicomputer performance and capacity. New levels of reliability and flexibility. All at a per-user price that is shockingly competitive. If the coupon isn't fast enough, call.

OSM Computer Corporation
2364 Walsh Avenue
Santa Clara, CA 95051
(408) 496-6910 TWX 910-338-2099

these make up a 6-bit digital value that is converted into a 64-step range of reference voltages by the DAC. Three inputs go to the line-printer bus: one for the X channel, one for the Y channel, and an optional one for a joystick push-button switch.

The TRS-80 printer bus. To some extent, our A/D circuitry must emulate a printer, strange as that may sound. Therefore, before getting into the details of the A/D and joystick circuits, I'll briefly explain the TRS-80 printer logic. Figure 2 gives a simplified version of the Model I printer-bus circuit. (The Model III's circuitry is slightly different, but for our purposes the Model I description will suffice.) It consists of two 74LS175 integrated circuits (ICs), each containing four flip-flops; four buffers of a 74LS367 IC; and a one-shot strobe implemented by half of a 74LS123 monostable multivibrator.

Writing a character to hexadecimal address 37E8 in the Model I causes the clock signal (CLK) to strobe the 8 bits

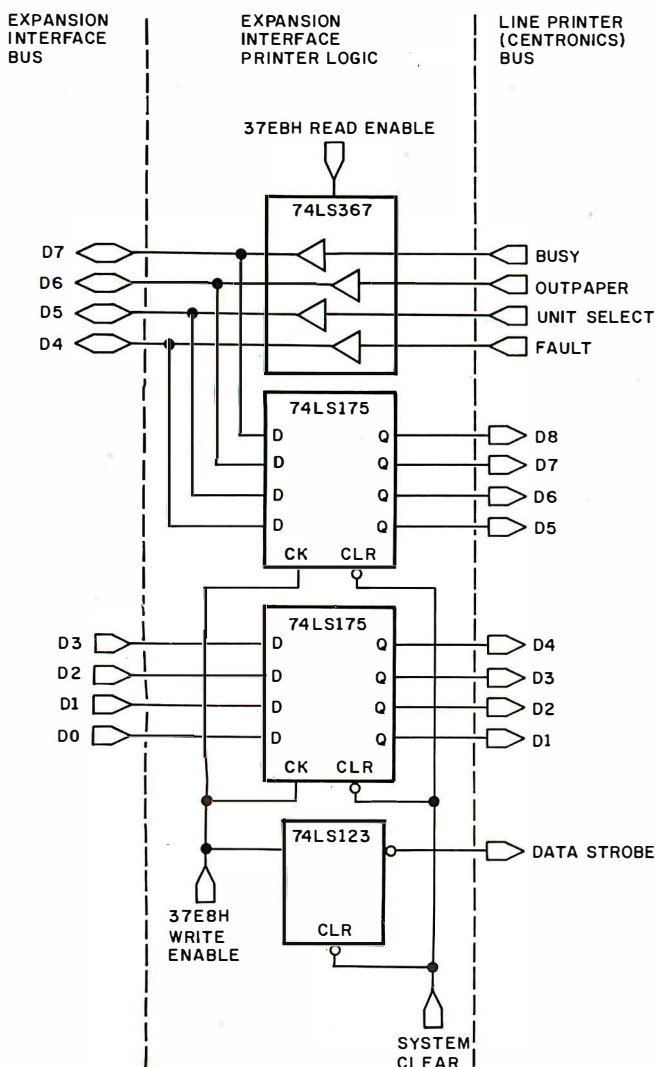

Figure 2: Model I line-printer controller. Two 4-bit registers strobe in the 8 bits of the character to be printed. At the same time, the one-shot is set to allow the output line-printer electronics to strobe in the data from the register. Four status lines are gated to the computer's data bus on a read.

of data into the two 74LS175s, and also triggers a one-shot strobe (DATA STROBE) telling the printer that data are available on lines DATA8-DATA1 of the line-printer bus. The data remain in the 74LS175s until a new character is written or a system clear (CLR) is done.

Reading hexadecimal address 37E8 in the Model I causes the four signals BUSY, OUTPAPER, UNIT SELECT, and FAULT to be gated onto data lines D7-D4 of the expansion-interface bus.

A typical Model I printing cycle goes like this:

1. The Model I reads the line-printer status by executing the Z80 instruction LD A,(37E8H).
2. It tests status bits 7 (BUSY) and 6 (OUTPAPER). If both are zero, the line printer is ready to accept more data; otherwise, it is not ready, and the Model I loops back to step 1.
3. If the line printer is ready, the Model I loads the character to be printed into the accumulator and then writes it to the printer logic with the instruction LD (37E8H),A. This activates the one-shot strobe, putting the 8 bits of data into the two 74LS175s. The one-shot resets itself after a short delay, strobing the data into the line-printer electronics, starting the printing cycle, and setting the BUSY status bit.

Memory mapping versus I/O mapping. In the Model I, the line-printer bus is memory-mapped to hexadecimal address 37E8. In the Model III, the printer bus is input/output-mapped to Z80 port 0F8 (hexadecimal). Aside from using different ICs, the Model III has the same logical implementation as the Model I. To test status, do an IN A,(0F8H) instead of an LD A,(37E8H). To output a character, do an OUT (0F8H),A instead of an LD (37E8H),A.

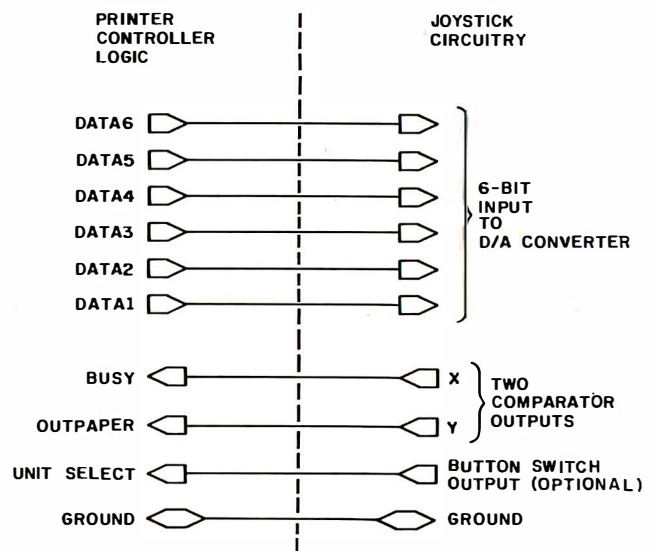

Figure 3: Line-printer lines used in the A/D circuit. Six output lines transmit a digital value to the DAC. Two input lines read the comparator values. One optional input line allows checking the button switch on a joystick.

Solve the Great Software Mystery!

You spent a lot of time searching and researching to find just the right computer. But when it comes to compatible software, you're stymied. Where do you turn? What is the key that unlocks the software mystery? The answer is elementary. It takes a company with the expertise and research facilities to discover and develop a wide variety of quality software programs — a company with a staff of experts who understand both software and hardware — a company that is not only reliable but offers unique 24-hour services and — a company dedicated to being your software company.

With all these pluses there's no mystery as to why Westico is so popular with knowledgeable software buyers. But look! There's more.

The Westico 24-Hour Computer Hotline (203) 853-0816

(300 baud) for detailed program information and quick access ordering.

- A full range of professional software.
- Support for a wide variety of CP/M® and other computer systems, including: TRS-80 Model II, Apple, Vector Graphic, Cromemco, North Star, Micropolis, Ohio Scientific, Altos, Dynabyte, IBM, SuperBrain, Xerox, Zenith and more.

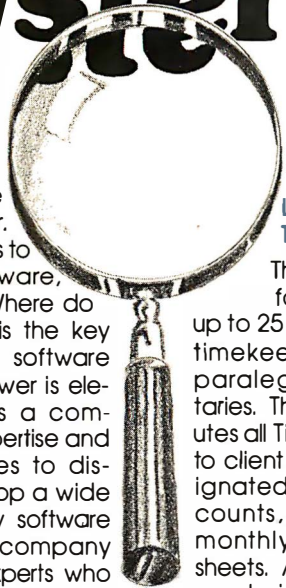

Two new solutions from Westico

LEGAL BILLING & TIMEKEEPING

The LBS is designed for law offices with up to 25 attorneys and 35 timekeepers, including paralegals and secretaries. The system distributes all Time and Expenses to client accounts or designated Overhead Accounts, and produces monthly Client Review sheets. After any adjustments it also provides: ready-to-mail itemized bills, monthly Office Management Summary, Aged Receivables Report. An Accounts List is also built into the system.

Complex transactions recording is reduced to a minimum because the LBS system is based on daily timesheets prepared by each timekeeper with a complete system for coding client matters and expenses. The attorney auditing the pre-billing review form can choose various predetermined rates, or bill on retainer, contingency fee or an adjusted basis.

The Office Management Summary provides a financial analysis of each attorney's billings, aging of his accounts receivable and an analysis of the work effort of each timekeeper and total

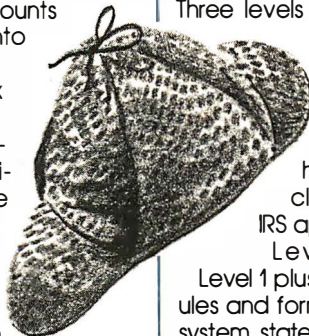

for the firm. The Accounts List summarizes current activity and status of each client.

The LBS is designed so that even first-time computer operators can install the system without expert help.

System/documentation-\$895
Demonstration System-\$ 75
Documentation alone-\$ 40

MICRO-TAX

Micro-Tax provides in-house computerized tax capability for the tax practitioner or serious investor. The system is designed to accept information, summarize data, compute tax and print the returns required by the Internal Revenue Service. The system's immediate response capability gives both tax specialist and clients immediate results of the computation.

The system reduces time required to complete a return while also minimizing the tax obligation of the taxpayer within the limit of the law. Three levels of tax preparation systems are available:

Level 1 —

Uses 23 schedules and forms, handles multiple clients, and prints IRS approved forms.

Level 2 — All of

Level 1 plus six more schedules and forms, depreciation system, state tax interface, integrated data base for year to year data storage, and batch compute and print functions.

Level 3 — All of Level 1 plus partnership schedules and forms.

State tax computation for the following states is available at additional cost: Arizona, California, Illinois, Ohio, Oregon, Maryland, New York,

Utah, Virginia and Washington, D.C.

Other states and municipalities are being added.

Prices:

Level 1 — \$250

Level 2 — \$1,000

Level 3 — \$750

Level 2 plus Level 3 — \$1,500

State Tax — Call for prices

Demonstration system — \$75

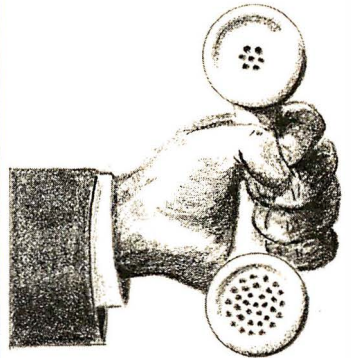

4 WAYS TO ORDER

- Write Westico, Inc., 25 Van Zant Street, Norwalk, CT 06855.
- Call (203) 853-6880.
- Telex 643-788.
- Dial-up our 24-hour computer (300 baud) (203) 853-0816.

COD, MasterCard and VISA accepted.

Prices do not include shipping and are subject to change. In CT add 7½% sales tax. All sales final.

Manual price may be credited toward purchase of software.

Dealer inquiries invited.

Copyright © 1981 Westico, Inc.
WES-40

Send for FREE catalog

WESTICO

The Software Express Service

25 Van Zant Street • Norwalk, Connecticut 06855
(203) 853-6880 • Telex 643-788

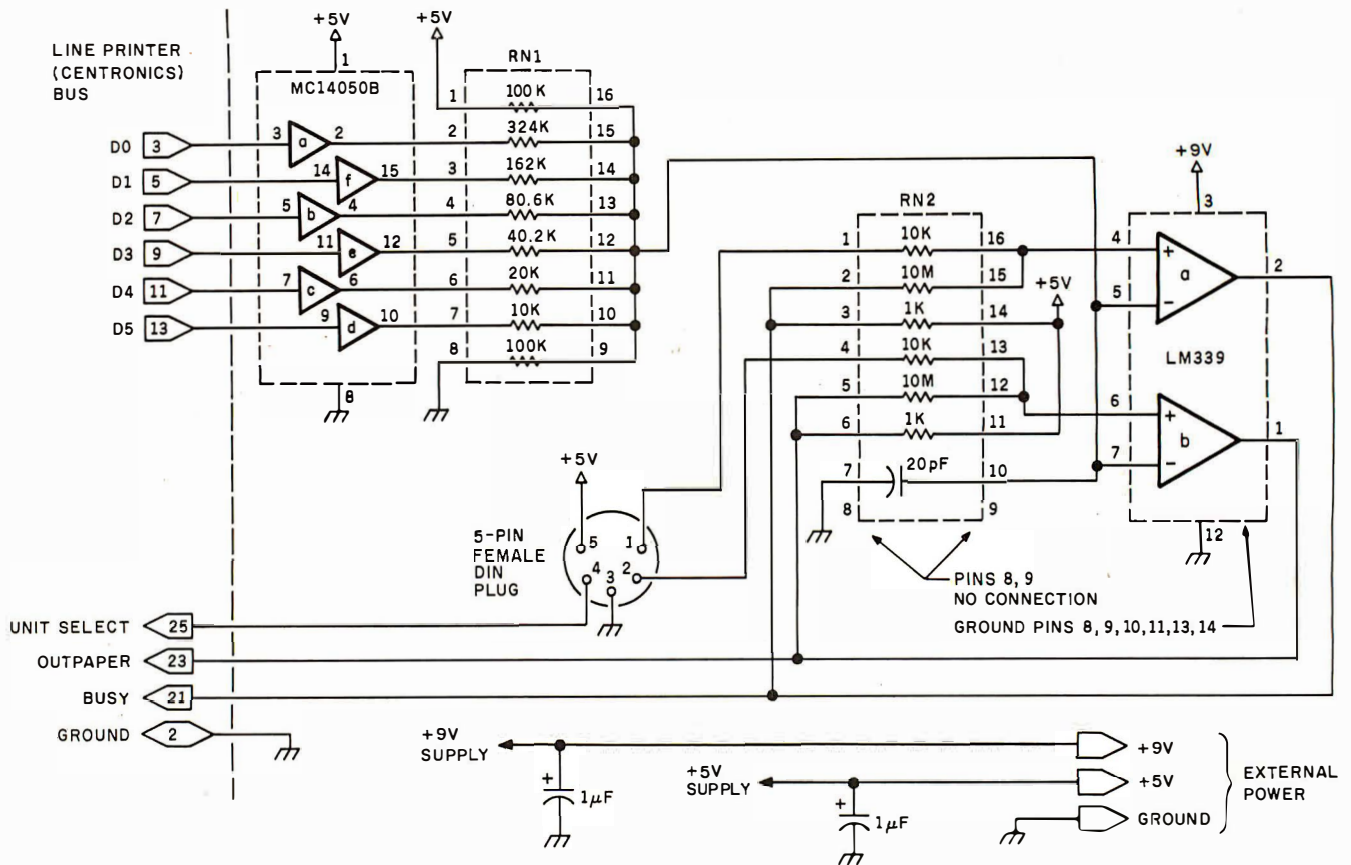

Figure 4: Detailed logic diagram of the A/D circuit. Power is supplied by a 9-V transistor battery and a 5-V power supply.

So far, we've done all the printer I/O using Z80 machine instructions. You can also use BASIC:

	Model I	Model III
Get Status	PEEK(14312)	INP(248)
Output Character (x)	POKE14312,x	OUT 248,x

Detailed Circuit Description

We can easily make the joystick circuitry emulate a line

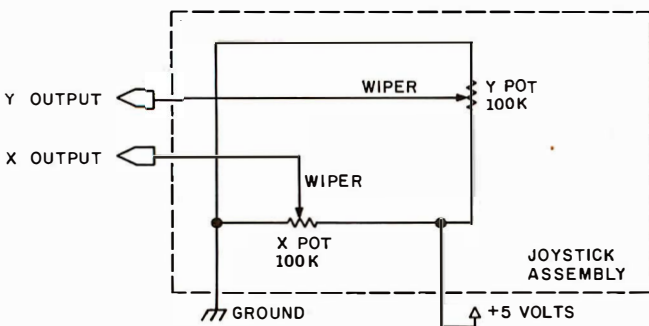

Figure 5: Joystick schematic. Two 100-k-ohm potentiometers are connected to ground and +5 V. Each wiper outputs a voltage of 0 to 5 V depending upon the joystick position along the X and Y axes.

printer. First, forget about the DATA STROBE output. It's only there for the line-printer electronics. Since data stay in the 74LS175s (or their Model III equivalents), we can simply write to hexadecimal address 37E8 (or 0F8) to output 8 bits to DATA8-DATA1. Whenever we want to read in data, we just read hexadecimal address 37E8 (or 0F8) to input 4 bits.

I've chosen to dedicate DATA6-DATA1 as outputs from the program to the DAC, the BUSY input as the X-channel comparator input, and the OUTPAPER input as the Y-channel comparator input. These eight lines plus ground are all that are needed to perform the basic joystick operation. They're shown in figure 3. A ninth line is optional as a joystick button input.

The detailed A/D circuit is shown in figure 4. Its physical layout corresponds to that of the block diagram in figure 1.

A typical joystick schematic is shown in figure 5. It is comprised essentially of two potentiometers with the two ends of each connected between +5 volts (V) and ground. The wiper of each potentiometer varies with the position of the joystick. Output from the wiper varies between 0 and +5 V. The X-channel 0-V position is toward the left; the Y-channel 0-V position is toward the top.

You can buy a bare-bones joystick (dual 100-k-ohm potentiometers) from Radio Shack for \$4.95 (catalog number 271-1705). You can also use one of the Color Computer's joysticks, sold as a pair for \$24.95 (catalog number 26-3008). Figure 6 shows the bare-bones joystick

ORDER TOLL-FREE consumer computers Mail Order DISCOUNTS

FREE SHIPPING*
*on all pre-paid cash orders

SEE OUR ADS ON PAGES 271 AND 469 FOR MORE EXCITING DISCOUNTS



NEC Microcomputer

SAVE! CALL FOR BEST PRICE

If you're considering a computer, consider this:

- 4 Mhz Z-80A Operation
 - 80 or 40 column modes STANDARD
 - Built-in Centronics printer port
 - Full ASCII keyboard with Shift lock
 - Real Time Clock STANDARD
 - RGB Color Output
 - Mixed text and graphics
 - Numerica Keyboard STANDARD
 - CP/M Compatibility
 - 5 programmable FUNCTION keys
 - 24K Microsoft NBASIC in ROM with enhanced color graphic commands
- The NEC PC-8001A has all these features and much more. Expandability you want, expandability you get. Through the use of the PC-8012A I/O unit, total system RAM can be extended to 160K. The PC-8031 Dual Disk Drive puts 286K of floppy disk storage at your command.

The NEC PC-8001A has so many things that are options on other computers built right in that you may never have to buy another accessory! The quality that the NEC name has come to stand for has been built-in, too. Compare the competition, and then call Consumer Computers for the NEC PC-8001.

NEC COMPATIBLE SOFTWARE

- CP/M Operating system with graphics control... CALL SUPERCALC Financial & Scientific Modeling (requires CP/M) ... CALL
 - WORDSTAR Word Processing System (requires CP/M) ... CALL
 - SYSTEMS PLUS Complete Accounting System (requires CP/M) ... CALL
 - MICROSOFT BASIC-80 (requires CP/M) ... CALL
 - MICROSOFT FORTRAN-80 (requires CP/M) ... CALL
 - MICROSOFT COBOL-80 (requires CP/M) ... CALL
- SPECIAL NEC CATALOG AVAILABLE



ATARI PERSONAL COMPUTERS ATARI 800 16K PLEASE CALL FOR BEST PRICE

- Atari 400 w/16K 349
 - 410 Program Recorder 65
 - 810 Disk Drive 449
 - 825 80 col. 7x8 Dot matrix impact printer 699
 - 822 40 col. Quiet Thermal Printer 349
 - 850 Interface Module 159
 - Atari 16K Ram Module 69
 - Axlon Ramcram 32K Module 189
 - Asteroids, Missile Command and Star Raiders ... 35 ea.
- SPECIAL ATARI CATALOG AVAILABLE

Commodore



CBM Business Computer

- 73 Key Typewriter Style Keyboard
 - 80 x 25 Column/Line Video Display
 - Integrated 9" Green Phosphor Monitor Standard
 - Inverse & Overstrike Characters
 - Full Screen editing capability Built-In
 - Built-In Parallel I/O Port
 - IEEE-488 Bus Interface Capability Standard!
 - 2 Cassette Ports
 - 18K ROM BASIC (Version 4.0)
 - 9 Digit Floating Point Binary Arithmetic
 - Sophisticated Disk & Tape Handling Software
- We couldn't tell you all the things the Commodore CBM system could do for your home or office, but think about hiring a secretary, an accountant, and a financial advisor all for the price of a Commodore CBM 8000 Computer! Just add the Commodore 4040 or 8050 dual floppy disk drive, and a printer of your choice, and you've got a fully integrated system, ready to bring the computer revolution into your home or business! Start your revolution now at Consumer Computers. MASS STORAGE DISK DRIVES AVAILABLE ACCOUNTING SOFTWARE AND SPECIALIZED MARKET SOFTWARE TOO! CALL OR WRITE FOR BEST PRICES. COMPLETE CBM CATALOG AVAILABLE.

Commodore PET Personal Computer



16K's, 32K's, & 48K's AVAILABLE CALL FOR BEST PRICE

- Introducing the Commodore PET! All the things you need to start computing today are built right in. Things like 18K PET BASIC, 9" Green Phosphor Video Monitor, 74 key professional keyboard, numeric keypad, and more. As if this weren't enough, the PET comes has a parallel I/O port that is just waiting for a printer, and the industry standard IEEE-488 bus for expansion
- 40 x 25 Column/Line Video Display
 - Integrated 9" Green Phosphor Monitor Standard
 - Inverse & Overstrike Characters
 - Full Screen editing capability Built-In
 - Built-In Parallel I/O Port
 - IEEE-488 Bus Interface Capability Standard!
 - 2 Cassette Ports
 - 18K ROM BASIC (Version 4.0)
 - 9 Digit Floating Point Binary Arithmetic
 - Sophisticated Disk & Tape Handling Software
- Other PET accessories and equipment available at great prices. Complete Commodore catalog available.

Apple Computer Authorized Dealer



APPLE II PLUS

16K's, 48K's, 64k's*
*48K Apple with 16K RamBoard

CALL FOR BEST PRICES

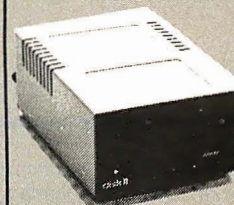

APPLE DISK DRIVES
DRIVE ONLY OR W/CONT & DOS 3.3
CALL FOR PRICES

SPECIAL APPLE CATALOG AVAILABLE

ORDER TOLL FREE 800-854-6654

In California and outside continental U.S. (714) 698-8088 Telex 695-000 Beta CCMO

Ordering information: Phone orders using VISA, MASTERCARD, AMERICAN EXPRESS, DINER'S CLUB, CARTE BLANCHE, bank wire transfer, cashier's or certified check, money order, or personal check (allow ten days to clear). Unless prepaid with cash, please add 5% for shipping, handling and insurance. (minimum 5.00). California residents add 6% sales tax. We accept CODs. OEM's, Institutions and corporations please send for a written quotation. All equipment is subject to price change and availability without notice. All equipment is new and complete with manufacturer's warranty (usually 90 days). Showroom prices may differ from mail order prices.

Send Orders To:
consumer computers Mail Order
8314 Parkway Drive
La Mesa, Calif. 92041

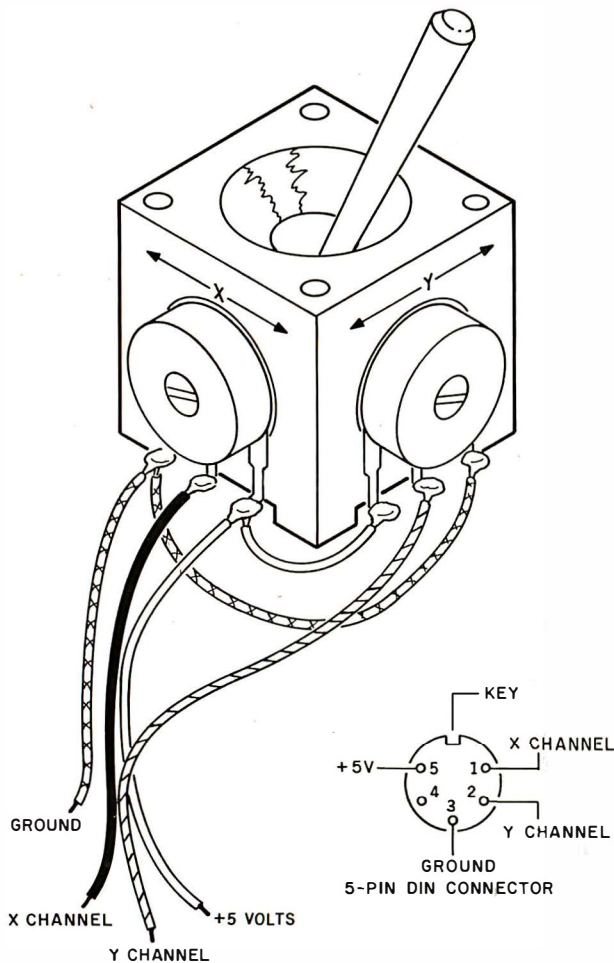

Figure 6: A prebuilt joystick available from Radio Shack. The device comes with a 5-pin male DIN plug.

- 1 experimenter's PC board or prototype board
- 1 5-pin female DIN socket, chassis mounting
- 3 16-pin wire-wrap sockets
- 1 14-pin wire-wrap socket
- 1 34-pin edge connector for PC board
- 2 16-pin DIP headers
- 2 100-k-ohm $\frac{1}{8}$ watt or greater 5% resistors
- 2 10-M-ohm $\frac{1}{8}$ watt or greater 5% resistors
- 2 10-k-ohm $\frac{1}{8}$ watt or greater 5% resistors
- 2 1-k-ohm $\frac{1}{8}$ watt or greater 5% resistors
- 1 324-k-ohm $\frac{1}{8}$ watt or greater 1% resistor
- 1 162-k-ohm $\frac{1}{8}$ watt or greater 1% resistor
- 1 80.6-k-ohm $\frac{1}{8}$ watt or greater 1% resistor
- 1 40.2-k-ohm $\frac{1}{8}$ watt or greater 1% resistor
- 1 20-k-ohm $\frac{1}{8}$ watt or greater 1% resistor
- 1 10-k-ohm $\frac{1}{8}$ watt or greater 1% resistor
- 1 20- or 47-pF disk capacitor
- 2 1- μ F electrolytic capacitors
- 1 MC14050B (4050B) hex buffer/converter (noninverting) IC
- 1 LM339 quad comparator IC
- wire-wrap and hook-up wire
- 1 joystick potentiometer, 100-k-ohm, with
- 1 5-pin male DIN plug
- 1 9-V transistor battery

Table 1: Parts list for the A/D circuit and joystick controller.

with the required connections.

Each of the joystick voltage outputs goes into one of the comparator's plus (+) inputs. The minus (-) input for both comparators comes from the output of the DAC. Each comparator compares the current joystick voltage with the DAC output. If the joystick voltage is lower than the DAC output, a logic 0 is output from the comparator. Otherwise, a logic 1 is output. The results of both comparators go to the input lines BUSY (X-coordinate) and OUTPAPER (Y-coordinate).

To determine the voltage level on either joystick channel, we just vary the DAC output from 0 to +5 V until we get a comparator output of 1 for the channel. That's easy to do with the DAC.

The DAC converts a 6-bit digital value into an analog voltage. Each of its resistors has approximately double the resistance of the next lower resistor. Each resistor is connected to the output of one bit of the MC14050B. This is a complementary metal-oxide semiconductor (CMOS) buffer with an output of close to 0 V for a logical 0 input, and about +4.95 V for a logical 1 input. By varying the 6-bit input from 000000 to 111111, we will get a voltage range from about 0.25 V to 4.75 V in 64 steps of about 70 millivolts (mV) each (see figure 7).

As a side issue, for a digital-to-analog conversion, we can simply forget about the comparator output and take the output from pin 12 of the MC14050B. The voltage output will be the analog equivalent of the 6-bit input value.

Circuit Construction

A parts list for the joystick circuit is shown in table 1. All the parts can be obtained from Radio Shack or other electronics suppliers. The resistor tolerances are somewhat critical. If you cannot get 1% resistors with the values indicated, you can use hand-selected 5% resistors. Measure the resistance with a multimeter and choose values within 2 to 3% of the listed values. There is enough variation in most resistors that you should be able to come fairly close. Two resistors can be used in

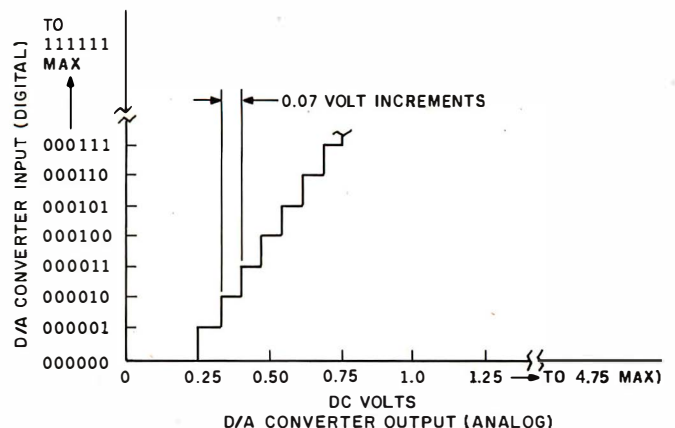
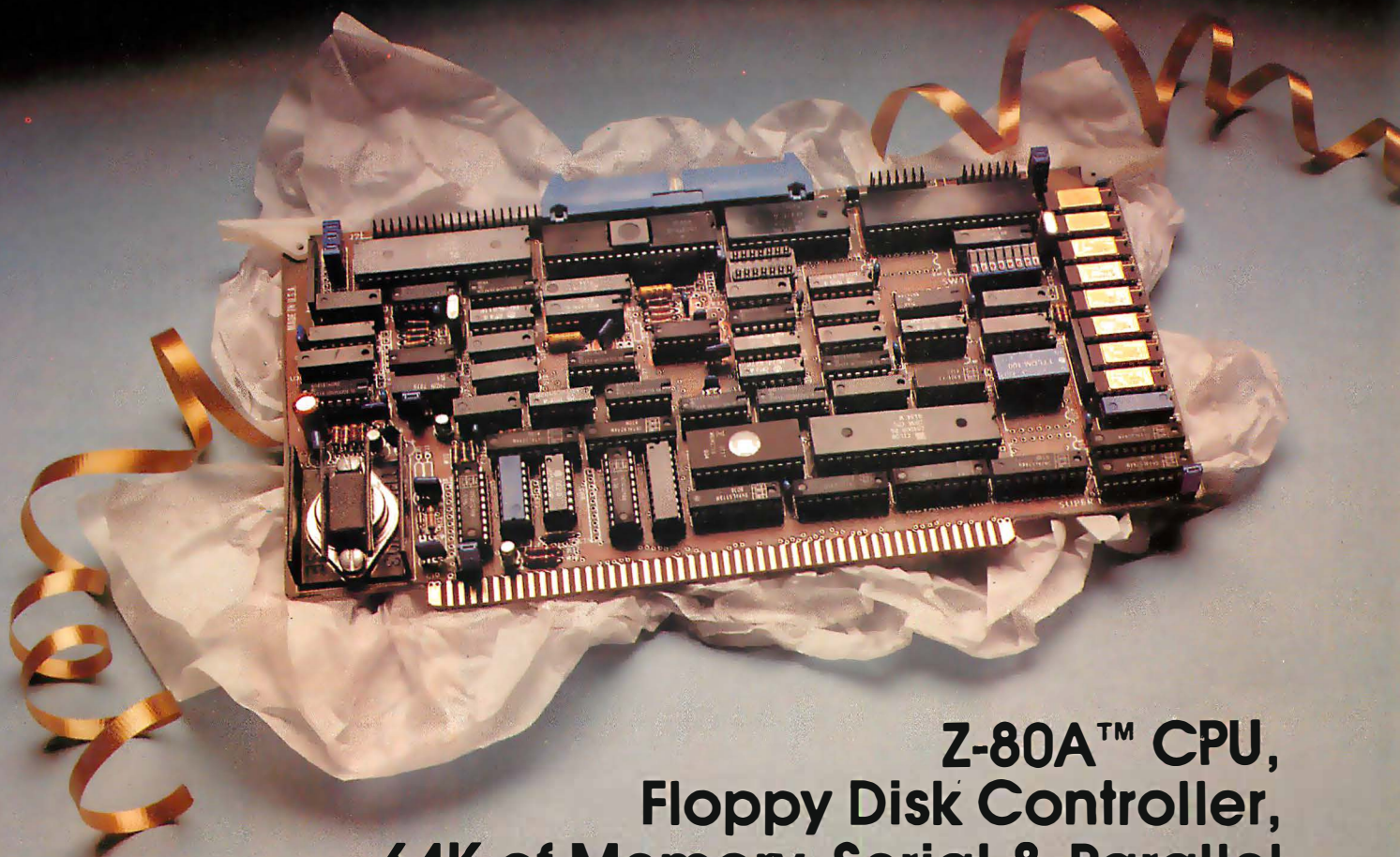

Figure 7: DAC output as a function of digital input. The output should increase monotonically as shown.

A Good-Buy Present.



Z-80A™ CPU, Floppy Disk Controller, 64K of Memory, Serial & Parallel I/O Ports . . . all on a SINGLE S-100 BOARD!

Your business computer market has problems—expensive, power-hungry machines that are hard to expand and even harder to service. Advanced Micro Digital Corporation has the solution—SUPER/NET®, a TRULY single S-100 board computer that will seem like a dream to skeptical technicians and salesmen—not to mention your customers. SUPER/NET® is less expensive, less difficult to service and expand and requires less power than traditional four board S-100 systems; yet it contains all their popular features:

- IEEE S-100 Standard
- Z-80A™ CPU
- 64K Bank Select Memory
- Both 8" or 5¼" Floppy Disk Controller (WD 1793 chip)
- 2 Serial & 2 Parallel I/O Ports
- Real Time Clock Interrupts
- 2K Monitor EPROM
- Extended Addressing
- Runs with CP/M™, MP/M™ and CP/NET™
- One Year Warranty

Advanced Micro Digital Corporation is dedicated to the research and development of S-100 computer technology. The maintenance of superb quality in our product line is our priority.

Now you can say "Good-Bye!" to all your old S-100 boards without giving up convenience and configurability, because now its all on a single S-100 computer board.

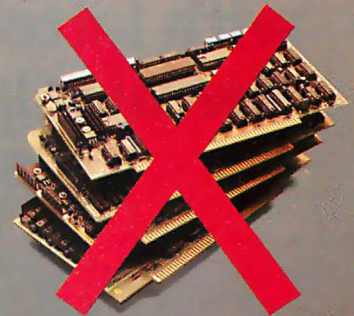

 **ADVANCED
MICRO DIGITAL
CORPORATION**

For more information
on SUPER/NET® write or call:

7201 Garden Grove Blvd. • Suite E • Garden Grove CA 92641 • (714) 891-4004 • TELEX: 678401 tab irin

™ Registered Trademark of Digital Research Corp.

© Copyright 1981 Advanced Micro Digital Corp

ALTOS BUSINESS C

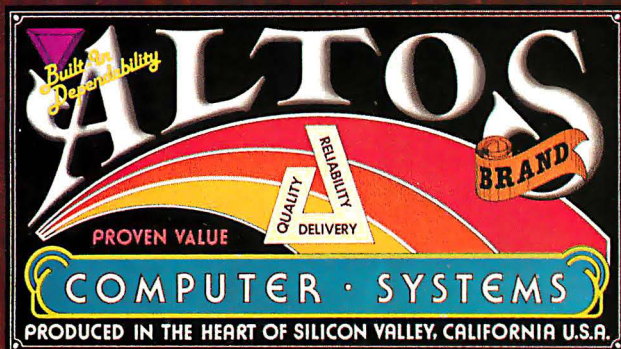

**Now—A four station,
hard disk business computer
with letter quality printer,
terminals and get-rolling
software for less
than \$15 a day.***

The Altos Business Computer Special. The most powerful, reliable, easy-to-use system in its price range. And Altos backs it up with on-site, nationwide service.

The hardworking engines of our system are the Altos ACS8000-10, -12 and -14 computers. Any one of them can cost-effectively hook-up with from one to four stations, as your needs demand. Their rapid access, 10, 20 or 40 MByte Winchester hard disks let you file from a 3,000 to 12,000 page load.

COMPUTER SPECIAL



Our get rolling business software package includes multi-user systems software, Wordstar™ for word processing and Microplan™ for business analysis. And when you need more, your local Altos representative can route you through to hundreds of other business and accounting programs, to meet virtually any requirement. Plus Altos also lets you communicate with other computers, mainframes, and even allows networking.

Get on the right track! Join

thousands of professionals, institutions and businesses who rely on Altos computer systems. Call our toll free number or write today for the Altos sales and service depot nearest you.

All aboard!

*Price approximate and may vary in your area. Daily lease based on: \$17,000 principal. 20% annual interest. 5-year term. Includes: Altos ACS8000-10 computer, letter quality printer, four Altos "smart" terminals and get-rolling software. Does not include tax, installation, training and maintenance. Offer expires February 28, 1982.

Wordstar is a trademark of MicroPro International Corp. Microplan is a trademark of Chang Laboratories, Inc.

© 1981 Altos Computer Systems

**Packed with
fresh ideas
for business**

ALTOS
COMPUTER SYSTEMS

2360 Bering Drive
San Jose, California 95131

800-538-7872
(In Calif. 800-662-6265)

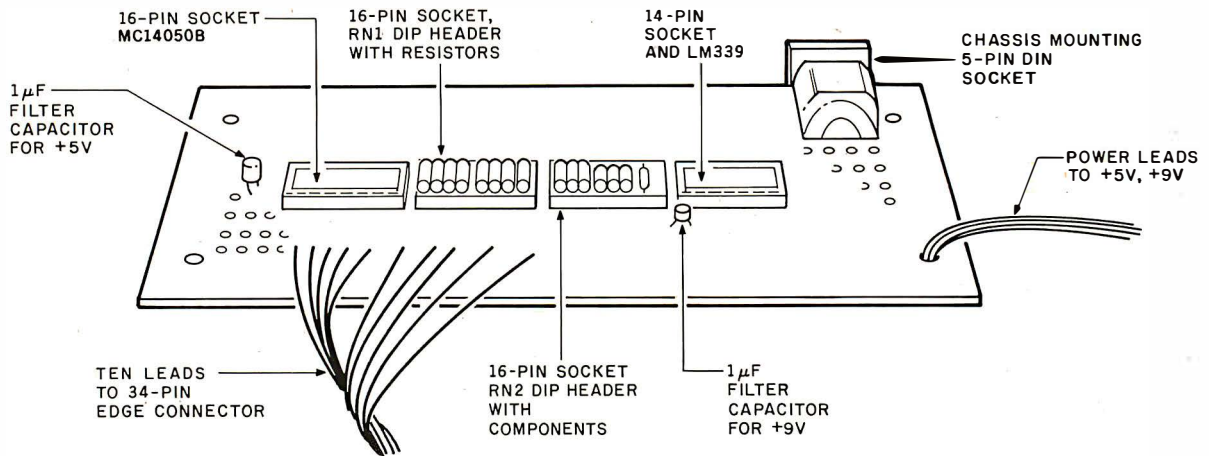

Figure 8: Physical layout of the A/D circuit as laid out on a prototype board.

series to get a total resistance that is correct. The prototype circuit, which works well, was made using hand-selected 5% resistors.

Soldering and wire-wrapping. You will need a small (30-watt (W)) soldering iron, rosin-core solder, and a wire-wrap tool or gun. If you've never wire-wrapped, don't worry—it's easy to do and you can make about one connection per minute. Assuming you have all the tools and parts, it will probably take about an hour and a half for the entire job.

Mounting the parts. The circuit is mounted on a small prototype board (Radio Shack catalog number 276-170). The general layout is shown in figure 8. The board is bare on one side and has 55 rows with solder pads on the other. The spacing of the holes is compatible with the spacing on the pins of the four wire-wrap IC sockets.

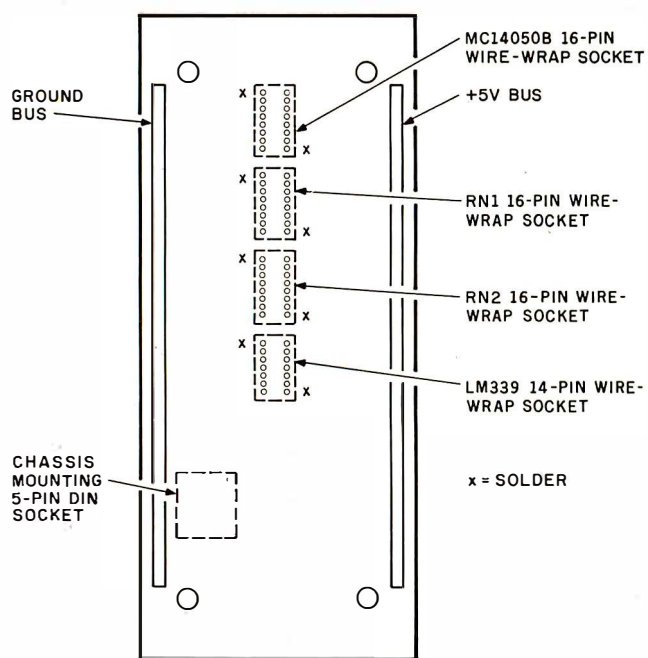

Figure 9: Underside of the A/D prototype board showing positions of ground and +5-V buses and solder points for the wire-wrap sockets.

Mount the four IC sockets by soldering opposite corners of each socket, as shown in figure 9.

Use the left-hand strip for the ground bus and the right-hand strip for the +5-V bus.

The 34-pin edge connector may be difficult to find even though Radio Shack is now carrying it. For Model Is, you can get by with their 40-pin edge connector by inserting a cardboard "filler" in one side to properly "key" the edge connector. For Model IIIs, you *have* to use a 34-pin connector because the cutout in the cover will only pass a 34-pin width.

I soldered the wires to the pins of the edge connector even though the edge connector was really meant as an insulation displacement type that pokes metal contacts through a ribbon cable. The pin layout for the edge connectors is shown in figure 10. The edge connector is designated EC.

The 5-pin DIN connector is another problem. If you use the Color Computer joysticks, the matching 5-pin plug will probably have incompatible spacing. Consider

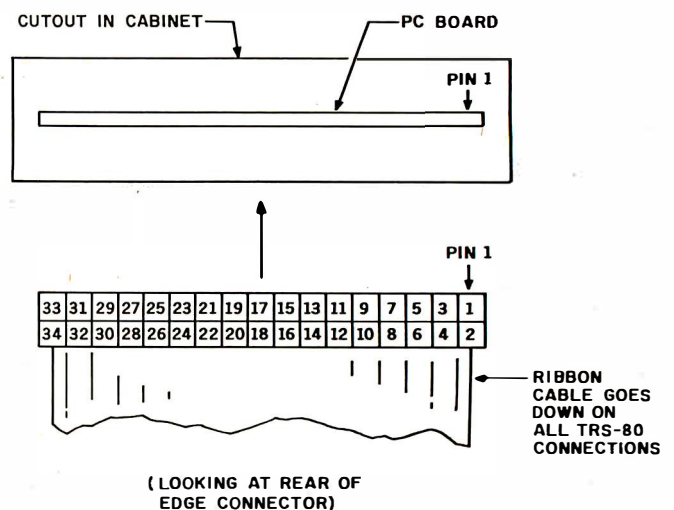

Figure 10: Pinouts for the card-edge plug that connects the A/D circuit to the TRS-80 line-printer bus. Use a displacement-type ribbon connector and solder the hook-up wires to the connector pins.

Wild Hare Software Systems Multiply the Capabilities of Data General's

**RDOS
INFOS®
ICOS
DOS**

Wild Hare gives Data General users a choice when upgrading to a multi-user environment and eliminates the need to use AOS.

Wild Hare makes it easy for you. It creates a true multi-lingual, multi-user environment for your current system. No user software modifications are necessary. There is no need to install a new operating system. And, no expensive hardware upgrade is required.

Features

- Each user is totally independent of all other users.
- Each user may run all standard Data General software.
- Each user may independently edit, compile, execute and debug programs written in any language supported by RDOS, INFOS®, ICOS and DOS.
- Standard languages supported include: Fortran IV, Fortran V, COBOL, ALGOL, RPG, DG/L™, BASIC, PASCAL, MAC, etc.
- All NOVA's® and ECLIPSE's® are supported.
- Wild Hare guarantees its software systems on a money back basis.

**Wild Hare's Software
Gives Data General Users
A Choice!**

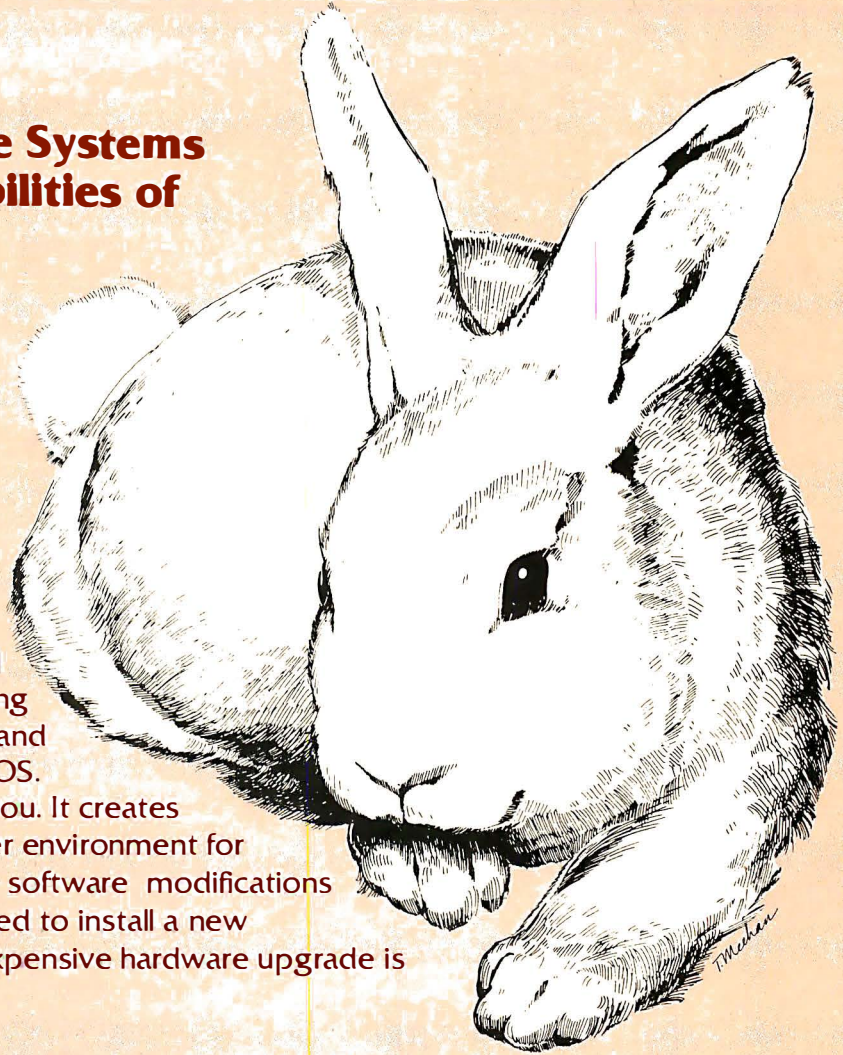

**WILD
HARE** COMPUTER
SYSTEMS, INC.

P.O. Box 3581, Boulder, Colorado 80307
(303) 494-0221

NOVA®, ECLIPSE®, and INFOS® are registered trademarks of Data General Corporation.

34-pin edge connector to other components			RN1		
EC-3	to	MC14050B-3	RN1-16	to	RN1-15
-5	to	-14	-15	to	-14
-7	to	-5	-14	to	-13
-9	to	-11	-13	to	-12
-11	to	-7	-12	to	-11
-13	to	-9	-11	to	-10
-21	to	LM339-2	-10	to	-9
-23	to	-1	-12	to	LM339-5
-25	to	DIN-4			
MC14050B to RN1			RN-2		
MC14050B-2	to	RN1-2	RN2-1	to	DIN-1
-15	to	-3	-2	to	LM339-2
-4	to	-4	-2	to	RN2-3
-12	to	-5	-4	to	DIN-2
-6	to	-6	-5	to	LM339-1
-10	to	-7	-5	to	RN2-6
			-10	to	LM339-7
			-12	to	-6
LM339			-12	to	RN2-13
LM339-7	to	LM339-5	-15	to	LM339-4
			-15	to	RN2-16

Table 2: Wire-wrap list for the A/D circuit.

cutting off the plug and attaching the cable to an audio-type DIN plug or attaching the wires directly. If you are

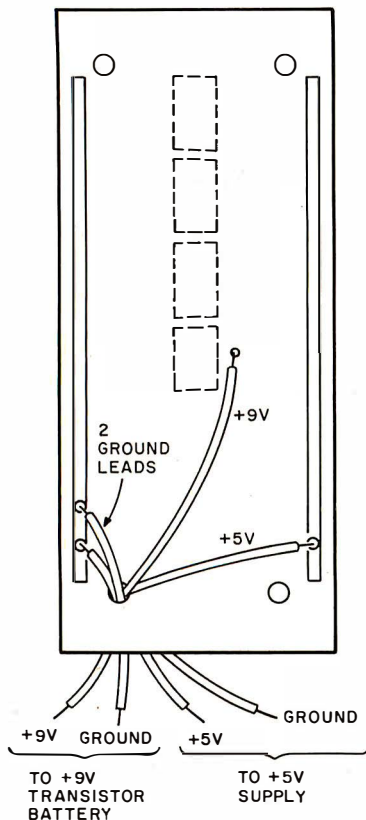

Figure 11: Power connections for the A/D circuit. For +5 V, use a regulated 5-V power supply, such as Radio Shack's 277-125 (a kit).

using the joystick potentiometer, it comes with a 5-pin male DIN plug attached. For the A/D circuit, get a 5-pin female DIN chassis-mounting jack.

Wire-wrap connections. Make the wire-wrap connections shown in table 2. Most of these are wire-wrap to wire-wrap, although some will be wire-wrap to solder. These connections can be made with 30-gauge wire-wrap wire. However, you might consider 22-gauge stranded wire for cable running to the edge-connector leads. Route the edge-connector leads through board holes for strain relief.

Now connect the ground points shown in table 3a. You can wire-wrap common ground pins onto the same point and then route a single wire to the ground bus. Make the +5-V connections in table 3b in similar fashion.

Power connections. Now run four wires as shown in figure 11. Two "hook-up" wire (22-gauge stranded) leads run from the ground bus. One +5-V lead runs from the

	(3a)	(3b)
	LM339-12, 8, 9, 10, 11, 13, 14	MC14050B-1
	MC14050B-8	RN1-1
	RN1-8	RN-2, 11, 14
	DIN-3	DIN-5
	RN2-7	
	EC-2	

Table 3: Ground connections are shown in table 3a. Table 3b gives the +5-V connections.

+5-V bus. One +9-V lead runs from pin 3 of the LM339. These leads can be combined in a four-wire ribbon cable and routed through one hole for convenience. Two of the leads, one ground lead and the +9-V lead, attach to a 9-V transistor battery. The other two leads connect to a regulated +5-V supply. (In case you don't have one already, I suggest you get Radio Shack's \$6.99 kit, catalog number 277-125.) Leave the power leads unconnected for the time being.

Without plugging in any chips, test the connections with a multimeter or continuity checker. A common straight pin works fine for getting into the IC socket holes. As each circuit checks out, cross it out on the schematic. This check takes little time and saves a lot of grief later on due to connection errors.

Solder one 1-microfarad (μF) filter capacitor between +9 V and ground and another between +5 V and ground, as shown in figure 8. Make certain that the polarity of the capacitors (note the + or - sign) is oriented properly.

Construct two dual-inline package (DIP) headers as shown in figure 12. One of these contains the DAC resistors; the other has the resistors and other components for the LM339. If you apply much heat during the soldering, you should remeasure the values for the six DAC resistors; they may have changed due to the heat.

Listing 1: Using a voltmeter and this BASIC program, you can measure the voltage levels produced by the DAC when the digital input ranges from binary 000000 to 111111. Table 4 shows the values obtained by the author.

```
100 REM DAC TEST. OUTPUT VOLTAGES FROM 0 TO 63.
110 FOR V=0 TO 63
120 POKE 14312,V
130 CLS: PRINT @ 534,"DAC VALUE=";V
140 IF INKEY#="" GOTO 140
150 NEXT V
```

Listing 2: For Model I computers, this BASIC program compares the voltages at the X and Y joystick channels with stepped voltages from the DAC.

```
100 REM COMPARATOR TEST
110 FOR V=0 TO 63
120 POKE 14312,V: CLS
130 PRINT @ 520,"VALUE=";V;
140 PRINT @ 540,"X=";(PEEK(14312) AND 128)/128;
150 PRINT @ 560,"Y=";(PEEK(14312) AND 64)/64;
160 FOR I=0 TO 1000:NEXT I
170 NEXT V
```

Listing 3: The same as listing 2, but for Model III computers.

```
100 REM COMPARATOR TEST
110 FOR V=0 TO 63
120 OUT 248,V: CLS
130 PRINT @ 520,"VALUE=";V;
140 PRINT @ 540,"X=";(INP(248) AND 128)/128;
150 PRINT @ 560,"Y=";(INP(248) AND 64)/64;
160 FOR I=0 TO 1000:NEXT I
170 NEXT V
```

Now plug in the DIP headers, the MC14050B, and the LM339. The A/D converter is (hopefully) complete. Connect it to the line-printer card-edge connector (pin 1 is on the top right), turn on the Model I or III, and connect the +5-V and +9-V supplies. Make the following test: watch for smoke and try a fingertip test of the board components. They should be warm but not hot. If everything seems okay, plug in the joystick connector and repeat the test. You're now ready for program debugging.

Program Testing

The following preliminary tests are included as a means to "bring up" the circuit one step at a time. If you feel like going directly to the final program instead of following this procedure, by all means do so. If you have problems, fall back on these preliminary tests.

DAC output. The first program tests the output of the DAC. A voltmeter is required to run it. If you don't have one, go on to the next test.

Hook the voltmeter between ground and the output of the DAC—pin 12 of the MC14050B. Run the program in listing 1. Substitute 120 OUT 248,V for statement 120 if you are using a Model III.

The program steps the DAC through the range of output voltages by sending it the values 000000-111111. Each voltage step should be approximately 70 mV over the

Digital Input	Analog Output	Digital Input	Analog Output
0	0.240	32	2.48
1	0.312	33	2.55
2	0.387	34	2.63
3	0.460	35	2.70
4	0.530	36	2.77
5	0.602	37	2.84
6	0.677	38	2.92
7	0.749	39	2.99
8	0.785	40	3.03
9	0.857	41	3.10
10	0.932	42	3.18
11	1.005	43	3.25
12	1.075	44	3.32
13	1.147	45	3.39
14	1.222	46	3.47
15	1.294	47	3.54
16	1.419	48	3.67
17	1.492	49	3.74
18	1.568	50	3.82
19	1.640	51	3.89
20	1.710	52	3.96
21	1.782	53	4.04
22	1.858	54	4.12
23	1.930	55	4.19
24	1.966	56	4.22
25	2.03	57	4.30
26	2.11	58	4.37
27	2.18	59	4.44
28	2.25	60	4.52
29	2.32	61	4.59
30	2.40	62	4.67
31	2.47	63	4.74

Table 4: Values obtained from DAC test of author's prototype.

MORROW DESIGNS

Now, Complete 5 1/4" System
5 Mbytes \$2,495

Leading edge technology in hard disk systems.

Complete systems. Morrow Designs hard disk subsystems are delivered complete with hard disk, controller, cabinet, power supply, fan, cables and CP/M^{*} 2.2 operating system.

Widest range. Morrow Designs offers the widest range of hard disk systems available from a single supplier. 5 1/4," 8," 14." Five to over 100 megabytes of formatted hard disk storage. \$2,995 to \$17,980. Cost effective systems that work. And keep working.

S-100 and more. Morrow Designs hard disk systems are designed for use with the CP/M operating system. Available software packages allow our systems to run on any IEEE696/S-100 Standard system with no hardware modification.

Plus, Cromemco^{***}, North Star^{**}, Vector Graphics, Godbout, Dynabyte, Exidy^{****}, IMSAI, Micro-mation, Processor Technology and California Computer Systems.

Reliable systems. Morrow Designs is committed to hard disk system reliability. Not simply with a 90-day warranty, but with a money back guarantee. If our system fails to perform to specification, send it back. We'll send back your money.

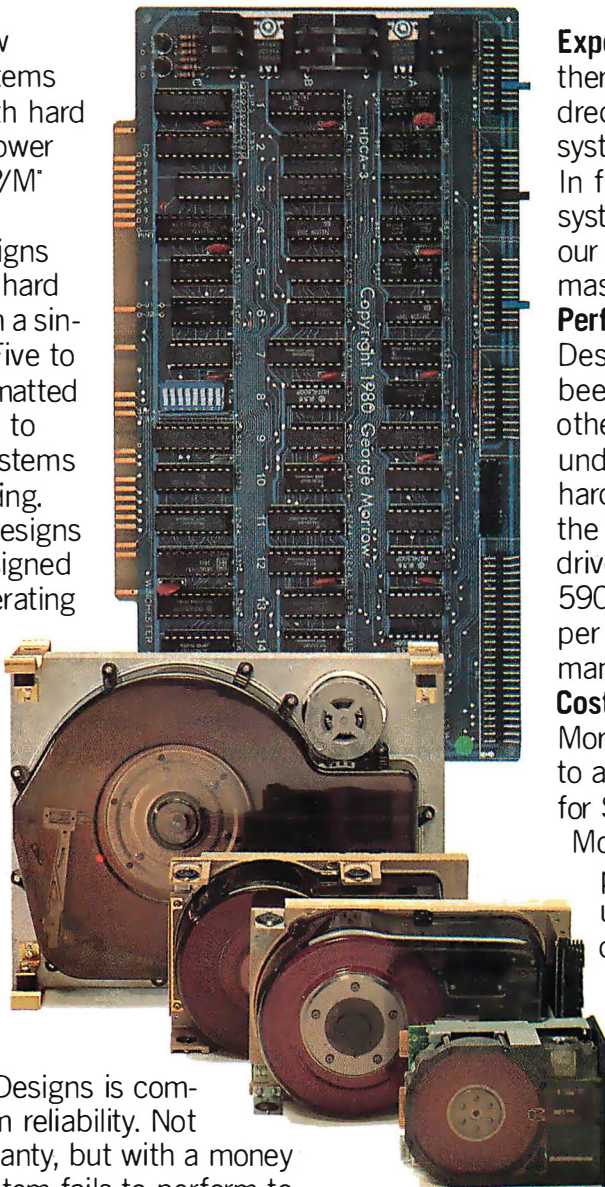

Experience. As of April, 1981, there were over fifteen hundred Morrow Designs hard disk systems successfully installed. In fact, over 200 independent systems integrators now use our hard disks to solve their mass storage problems.

Performance answers. Morrow Designs hard disk systems have been benchmarked against all other systems. None is faster under CP/M. Morrow Designs hard disks operate at 10 times the speed of a floppy disk drive. Transfer rates range from 590,000 bytes to 900,000 bytes per second. That kind of performance can become addictive.

Cost effective answers. Compare Morrow prices and performance to anything presently available for S-100 systems. You'll find Morrow's price/megabyte/performance ratio to be unmatched. Leadership in disk systems technology earned us leadership in price/performance. And that may have earned us a call from you. Circle the Reader Service Number for our full line data sheets. Can't wait? Call us at (415)

524-2101. And yes, OEM quantity prices are available. **LOOK TO MORROW FOR ANSWERS.**

MORROW DESIGNS

5221 Central Avenue, Richmond, CA 94804
(415) 524-2101



Circle 260 on inquiry card.

^{*}CP/M is a trademark of Digital Research.
^{**}Northstar is a trademark of North Star Computers, Inc.
^{***}Cromemco is a trademark of Cromemco, Inc.
^{****}Exidy is a trademark of Exidy Corporation.

preceding step. Table 4 shows the values I obtained with the prototype.

If you do not get what my calculus instructor called a "monotonically increasing" set of voltages (see figure 13), you have a problem. In other words, if any successive output is *lower* than the previous one, you must recheck the resistance values. One of your resistors is probably "out of spec." If not corrected, this will lead to problems in determining the voltage level at the analog input.

Comparator outputs. Listings 2 and 3 show the comparator tests for Models I and III, respectively. This test steps the DAC from 0 through 63 (+0.25 V through +4.75 V) and displays the step number, X input, and Y input. The X and Y inputs will be either 0 or 1.

If the input is a 0, the X or Y voltage is less than the current DAC voltage. Move the joystick and observe that the comparator inputs change. Moving the joystick to the upper-left corner should reset both comparator inputs to 0 after several steps, for example. Also observe that when the input changes from 0 to 1, all successive inputs remain at 1. If there is a 1 followed by several zeros, you

have the "not monotonically increasing" problem (in case you didn't have a voltmeter to diagnose it previously). If so, recheck the resistance values in the DAC array (RN1).

If all seems well with this test, you're ready for a machine-language driver for the joysticks.

Joystick Software

Listings 4 and 5 show Z80 assembly-language drivers for the Model I and III, respectively. The only difference is that one uses a memory-mapped LD instruction; the other uses I/O-mapped INs and OUTs. Both programs are completely relocatable even though they are assembled at hexadecimal address 8000.

You can reassemble using your own editor/assembler or simply key in the object code using DEBUG. Another alternative is to convert the hexadecimal code to decimal and incorporate the 62 bytes in DATA statements that can then be READ and POKEd into a block of memory.

The calling sequence in Disk BASIC, the same for Model I and III, is shown in listing 6. This program clears the screen and defines the USR0 routine at hexadecimal address 8000. Next, a call is made to the USR0 routine. The X,Y position of the joystick is returned in variable A. The X position is in the most-significant byte; the Y position is in the least-significant byte.

Both X and Y are returned as values of 0-63. For display purposes, the X value (B) is multiplied by 2 and used in a SET command. The Y value is converted from a range of 0-63 to a range of 0-48 and used in the same SET command. As long as the cursor position remains fixed, one pixel of the SET appears on the screen. If the joystick is moved, the last pixel is RESET and the new one is SET. The result is a joystick-controlled cursor.

The pixel may have a tendency to jump from one spot to another. This is normal and occurs when the reference increment is close to the input-voltage value. For most positions, however, pixel motion will be reasonably steady. Although a resolution of 64 X and 48 Y is not very precise, it is more than adequate for positioning the cursor. The mechanical limitations of the joystick make it very difficult to avoid vertical "drift" when moving horizontally; therefore, greater resolution, as with 7 bits instead of 6, would be wasted.

How the Program Works

The programs in listings 4 and 5 consist of two parts. SRCHJY is the actual search program that finds the comparator value for the current joystick channel. This program is called twice by the driver routine READJY. The CALL is made by loading the C register with 128 or 64 and executing a JR instruction to SRCHJY.

The value in C serves two purposes—it acts as a flag for the return point and serves as a mask value for the X/Y comparator bit. The X-channel comparator bit is found by performing a logical AND of the A/D input with 128. The Y-channel comparator bit is found by performing a logical AND of the A/D input with 64.

Text continued on page 184

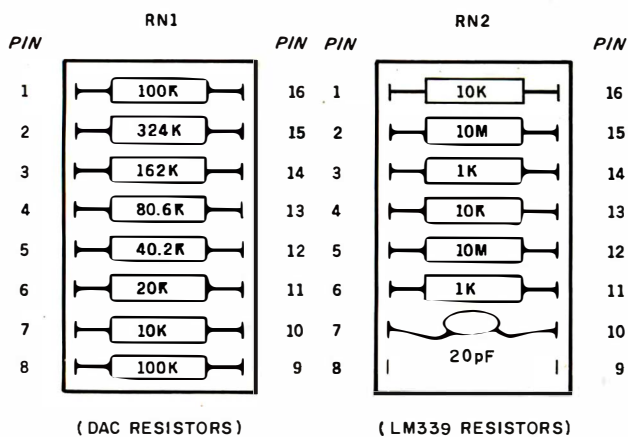

Figure 12: Layouts for the DIP headers. One position on RN2 is not used.

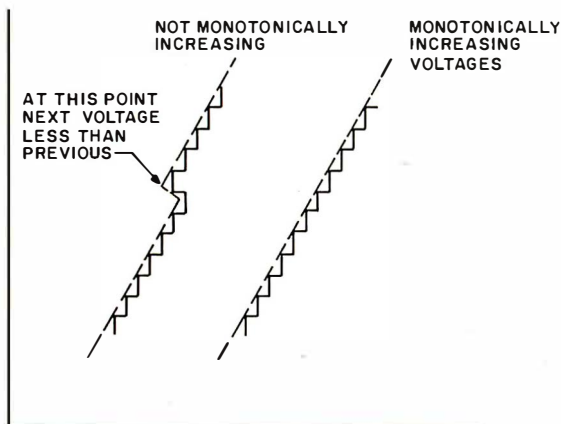

Figure 13: For digital inputs from 0 to 63, the output from the DAC should increase monotonically (as in the curve on the right). Otherwise, the A/D circuit will give invalid readings for analog values in that voltage region.

Next to keeping all your data on Verbatim Datalife™ flexible disks, the best thing you can do for your computer or word processor is to keep it running clean and error-free.

And the way to do just that is with Verbatim's new Datalife Head Cleaning Kit. It can remove up to 90% of the debris contaminating your drive heads. Dust, dirt and debris that causes data loss and errors, hinders system performance.

Quick and easy to use

All you have to do is remove a Cleaning Disk from its protective pouch, put the disk in the special jacket, insert it into your drive and turn it on.

In just 30-60 seconds, your drive heads are cleaned.

Cleaning, with no cleaning mess

With your Datalife Head Cleaning Kit there's no hit-and-miss applying solvents that can splash and spill.

What's more, with Datalife Cleaning Disks every time you clean your heads, you can do it with a fresh, clean, disposable disk.

Cleans both Single and Dual Head Drives Safely

There's no worry about damaging your system with Datalife Cleaning Disks. And you can use them on single or dual head drives.

Protect your investment

The Datalife Head Cleaning Kit will help you guard against data loss, errors, and degradation of system performance because of debris contamination.

So if you want your data back verbatim, keep it on Verbatim disks. And keep your disk drives clean with Verbatim's Datalife Head Cleaning Kit.

Call (800) 538-1793 for the name of your nearest Verbatim dealer. (In California and outside the U.S. call (408) 737-7771 collect.)

Verbatim®

Introducing the second best thing you can do for your computer.

Datalife™
By Verbatim®

Head Cleaning Kit
Includes Special Jacket And 2 Cleaning Disks

FREE INTRODUCTORY OFFER!
Take this coupon to your Verbatim dealer/distributor and Get a Datalife™ Head Cleaning Kit FREE when you buy 10 Datalife Head Cleaning Disks.

Name _____ State _____ Zip _____
Address _____
City _____ Dealer/Distributor _____

To the Consumer: This coupon good only on required purchase of specified product. Cash value 1/20 cent. Void where prohibited.
Consumer must pay any sales tax.
To Seller: Verbatim Corporation authorizes you to accept this coupon for redemption. We will reimburse you in accordance with our Cleaning Disk Promotion Plan 10/1/81. A copy of the Promotion Plan is available from Verbatim Corporation or any authorized Verbatim distributor. Limit: One coupon per customer. Offer expires 1/29/82.

Listing 5: The same as listing 4, but for the Model III.

```

0000          00100          ORG          8000H
00110 :*****
00120 :* SUBROUTINE TO READ JOYSTICK *
00130 :* ENTRY: NO PARAMETERS *
00140 :* EXIT: (H,L)=X VALUE 0-63, Y VALUE 0-63 *
00150 :* SUBROUTINE IS RELOCATABLE ANYWHERE IN RAM. SUBROU- *
00160 :* TINE IS SETUP FOR STANDARD MODEL I/III BASIC USR *
00170 :* CALL. *
00180 :*****
00190 ;
8000 0E80 00200 READJY LD C,128 ;MASK FOR X
8002 180A 00210 JR SRCHJY ;READ X VALUE
8004 F5 00220 REAO10 PUSH AF ;SAVE X VALUE
8005 0E40 00230 LD C,64 ;MASK FOR Y VALUE
8007 1805 00240 JR SRCHJY ;READ Y VALUE
8009 E1 00250 REAO20 POP HL ;X TO H
800A 6F 00260 LD L,A ;Y TO L
800B C39A0A 00270 JP 0A9AH ;***BASIC RTN***
00280 ;
00290 :*****
00300 :* SUBROUTINE TO SEARCH FOR X OR Y VALUE *
00310 :* ENTRY: (C)=128 FOR X, 64 FOR Y *
00320 :* EXIT: (A)=ANALOG VALUE 0-63 *
00330 :* SUBROUTINE FINDS ANALOG VALUE WITH 8 RETRIES. *
00340 :*****
00350 ;
800E 21FFFF 00360 SRCHJY LD HL,-1 ;DUMMY VALUE FOR COMPARE
8011 E5 00370 PUSH HL ;INITIALIZE LAST VALUE
8012 0608 00380 LD B,8 ;8 TRIES
8014 1640 00390 SRC005 LD D,40H ;START VALUE=64
8016 1E20 00400 LD E,20H ;START DELTA=32
8018 0B1A 00410 SRC010 RR D ;ALIGN TO H'WARE FORM
801A 7A 00420 LD A,D ;PUT IN A FOR OUTPUT
801B D3F8 00430 OUT (0FBH),A ;OUTPUT VALUE TO DAC
801D 0B12 00440 RL D ;BACK TO SCALED DELTA
801F DBF8 00450 IN A,(0FBH) ;GET COMPARATOR INP
8021 A1 00460 AND C ;TEST CHANNEL
8022 7A 00470 LD A,D ;CURRENT VALUE TO A
8023 2003 00480 JR NZ, SRC020 ;GO IF COMP=1
8025 83 00490 ADD A,E ;TOO LOW-ADD 1/2
8026 1801 00500 JR SRC030 ;CONTINUE
8028 93 00510 SRC020 SUB E ;TOO HIGH-SUB 1/2
8029 57 00520 SRC030 LD D,A ;SAVE ADJUSTED VALUE
802A 0B3B 00530 SRL E ;DELTA/2
802C 20EA 00540 JR NZ, SRC010 ;GO IF DELTA NOT 0
802E 0B3A 00550 SRL D ;CONVERT TO 0-63 FORM
8030 F1 00560 POP AF ;GET LAST VALUE
8031 BA 00570 CP D ;TEST WITH CURRENT
8032 D5 00580 PUSH DE ;SAVE CURRENT
8033 2802 00590 JR Z, SRC040 ;GO IF EQUAL
8035 10DD 00600 DJNZ SRC005 ;NOT EQUAL-8 RETRIES
8037 F1 00610 SRC040 POP AF ;RESTORE LAST
8038 0B79 00620 BIT 7,C ;TEST FOR RETURN POINT
803A 20C8 00630 JR NZ, REAO10 ;X CASE
803C 18C8 00640 JR REAO20 ;Y CASE
8000 00650 END READJY
000000 Total errors

```

**\$1=1/3
of a business
phone call**

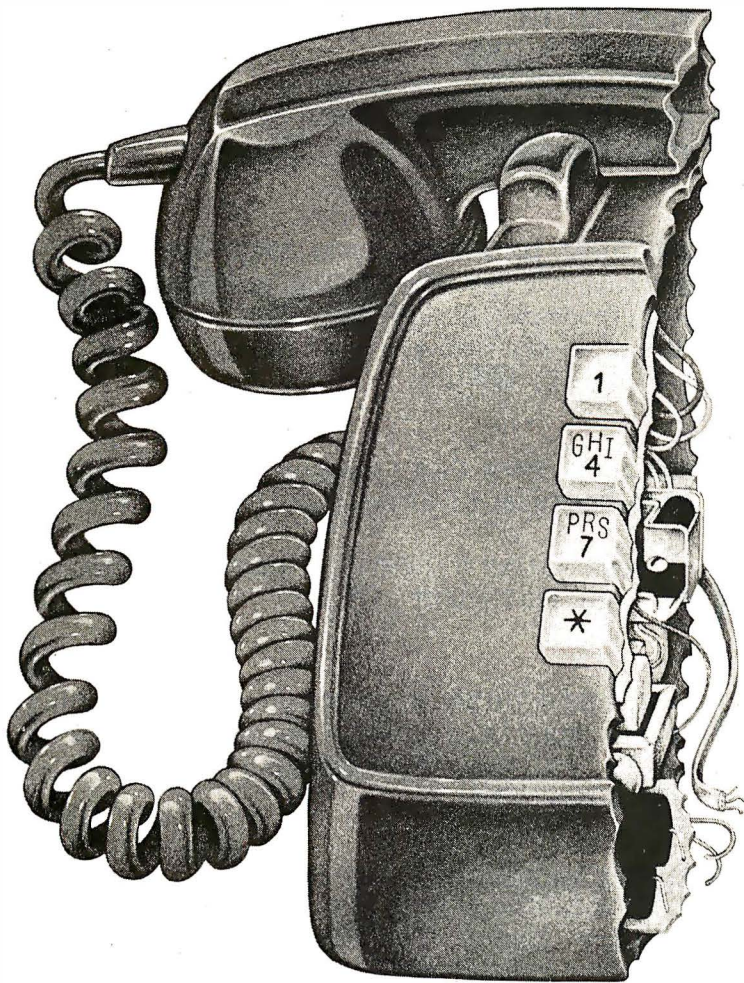

**\$1=6 1/4 actual
McGraw-Hill
readers***



**As your selling dollar buys less and less,
it pays more and more to advertise
in McGraw-Hill magazines.**



With inflation, we're an even better buy.

*One reader-noted impression in the average McGraw-Hill publication.

BRAINS-MAINFRAMES

SUPERBRAINS

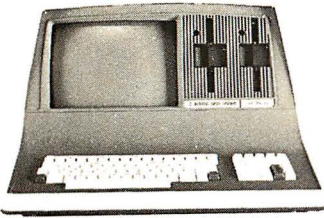

SUPERBRAIN QD 64K
List \$3995 only \$2949



Z-89 48K
LIST \$2895 ONLY \$2099
Z-90 64K DD 3195 ONLY \$2489

ADVANTAGE



NORTH STARS

MINICOMPUTER
PERFORMANCE
GREEN PHOSPHOR
OPTIONS:
GRAPHICS + CP/M
LIST \$3999
ONLY \$2999



MONITOR GREEN PHOSPHOR \$118
GREEN

TERMINALS Z-19 \$718
INTERTUBE III SUPER SMART \$710

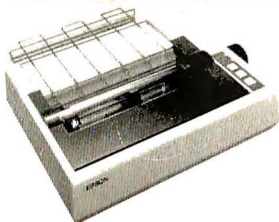

EPSON

MX70 GRAPHICS 299
MX80 FT 598
MX-80 474
MX-100 749

ANADEX 9501 \$1290
NEC LETTER QUAL FRICTION & TRACTOR CALL
ZENITH PRINTER Z-25 LIST 1595 ONLY \$1256
DIP-84 FT GRAPHICS \$ 595
STARWRITER LETTER QUAL FT \$1824
EPSON MX70 WITH GRAPHICS SALE!
6 ONLY \$ 299
QANTEX W/BUFFER \$1299



400 LIST 399 ONLY 340
800 1080 799

WONDERFUL GAMES-EDUCATION
RCA COSMAC VP-711 199
GAMES-BASIC-PROGRAMS-MUSIC
GUIDED SATELLITE TO SATURN

TARBELL's Empire I, II, & III have two 8" disk drives. The I is single sided, the II is double sided, and the Empire III has one of the floppies replaced by an 8-Megabyte Hard Disk. FREE BUSINESS SOFTWARE EMP 1 \$4888 ONLY \$3666

CALIFORNIA COMPUTER 2210A
\$2195 ONLY \$1795 Z80, 64K, I/O, DMA Disk controller + CP/M.

Model 300-1A is the larger system: 2.4 Mb 8", Z80, 64K, and optional OASIS, CP/M, or MP/M operating system. LIST \$5695 ONLY \$4995

MORROW DESIGNS Decision 1
OPTIONAL UNIX FREE CP/M. Multi user & Multi processing, 4 to 6 Mhz Z80, and optional Floating Point Processor, or Hard Disk 26 M6. A very powerful system at a saving.
LIST \$1725 ONLY \$1380.

GODBOUT COMPUPRO Big 8:
6MHz Z80, DMA Disk Controller, 32K fast static RAM, Interfacer 1 I/O board, + CP/M. LIST \$1995 ONLY \$1595

Super Sixteen 8085/8088 is the fastest combo 8-16 CPU. LIST \$3495 ONLY \$2795

SYSTEMS GROUP System 2812
runs CP/M or OASIS. Supports single user & multi-user & multi task. Up to 5 megabytes with 8" drives optional 10-megabyte hard disk.
LIST \$5035 ONLY \$3775

AMERICAN SQUARE COMPUTERS is organizing a World-Wide FRANCHISE of Computer Stores. Be a WINNER! Join our SUCCESSFUL TEAM selling powerful Computers. Write or Phone us.

SEATTLE's 16 bit COMPUTER is here! 8 MHz 8086 CPU the fastest S-100 computer! 128K Static RAM, DD Disk Controller, 22-slot Main Frame, 86-DOS #2 128K LIST \$4185 ONLY \$3349 #1 As above but 64K LIST \$3190 ONLY \$2649

WE SELL GOOD HARDWARE

square

WE SELL GOOD SOFTWARE

American



Computers

919-889-4577

KIVETT DR. JAMESTOWN N.C. 27282

919-883-1105

LOWEST PRICE - BEST QUALITY

NORTH STAR

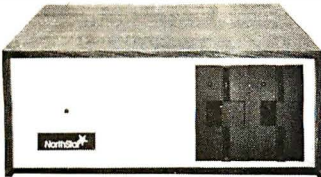

North Star Horizon 2

2-5 1/2 Disk Drives
64K Double Den
Factory assem. & tested
Factory guaranteed
List \$4195

only **\$2875**

**POWERFUL NORTH STAR BASIC FREE
SUPERB FOR BUSINESS & SCIENCE**

FACTORY ASSEMBLED & TESTED	LIST	ONLY
HORIZON-2 32K-DOUBLE DEN	\$3695	\$2625
HORIZON-2-32K-QUAD DENSITY	\$3995	\$2799
HORIZON-2-64K-QUAD	\$4495	\$3150
HORIZON-1-64K-Q-HD5	\$6695	\$4685
HORIZON RAM ASSM	48K = \$679	64K = \$879
BIG SALE ON MULTI-USER TIME-SHARING		CALL
ENGLISH TO BASIC TRANSLATOR		\$ 99
NORTH STAR HARD DISK 18 Mb	\$5375	\$3923
NORTH STAR TIME SHARING MULTI-USER		CALL
ZBASIC 2 TO 5 TIMES FASTER!		\$350
SECRETARY WORD PROCESSOR		\$99
WORDSTAR WORD PROCESSOR		\$318
FLOATING POINT BOARD	\$399	\$319
OASIS MULTI-USER SOFTWARE	SAVE	CALL
CP/M FOR N* Extra features	\$230	\$220
MICRO MIKE SOFTWARE	SAVE	CALL
ECOSOFT ACCOUNTING \$355	MICROSTAT	\$265
UCSD PASCAL II.0	\$199	\$159
EXTRA PRECISION BASIC		\$50
NORTHWORD	\$399	\$299
MAILMANAGER	\$299	\$224
INFOMANAGER	\$499	\$374
GENERAL LEDGER	\$999	\$749
ACCOUNTS RECEIVABLE	\$599	\$449
ACCOUNTS PAYABLE	\$599	\$449
INVENTORY	\$999	\$749
ORDER ENTRY	\$999	\$749

InterSystems

ITHACA INTERSYSTEMS 2A

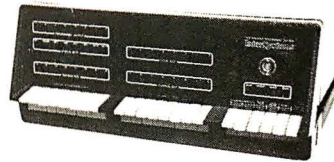

Z-80A CPU 4 MHz
64K Dynamic RAM
Front panel
V I/O—with interrupts
FDCII Disk Controller
20 slot motherboard

LIST \$3795 ONLY **\$2839**

PASCAL/Z + THE FASTEST PASCAL \$375

	LIST	ONLY
PASCAL SYSTEM 128K 2 DRIVES	\$7295	SAVE
CACHE BIOS SYSTEM 128K2 DRIVES	\$6995	CALL
CP/M SYSTEM 64K 2 DRIVES	\$6295	SAVE
DPS-1 MAINFRAME WITH Z80A	\$1795	CALL
Z80 MACRO ASSEMBLER	\$125	SAVE
SPELL—PERFECT SPELLING	\$295	CALL
COMPARE—UTILITY SOFTWARE	\$295	SAVE
INTEREDIT—TEXT EDITOR	\$295	CALL

MORROW 8" DISK

DISCUS 20 + CP/M® 600K ONLY \$848
DISCUS 2 + 2 + CP/M² 1.2 MEGA B. \$1099
ADD DRIVES 2D = \$599 2 + 2 = \$795
DISCUS 20-DUAL + CP/M® ONLY \$1388
FREE MICROSOFT BASIC FROM MORROW WITH
DISCUS SYSTEM OR HARD DISK



MORROW HARD DISK
26,000,000 BYTES!!
LIST \$4495 ONLY **\$3395**
CP/M² IS INCLUDED!

AMERICAN SQUARE COMPUTERS is organizing a
World-Wide FRANCHISE of Computer Stores. Be a
WINNER! Join our SUCCESSFUL TEAM selling
powerful Computers. Write or Phone us.

SAVE ON MEMORY AND PROGRAMS

SYSTEMS MEMORY 64K A&T	\$549	CORVUS HARD DISK	SAVE	ECOSOFT FULL ACCOUNTING	355	Which Computers are BEST?	FREE
SYSTEMS MEMORY 64K BANK	684	SSM VIDEO BRD VB3 4Mhz	412	CAT NOVATION MODEM	169	INSURED SHIPPING AT LOW RATES	
MICROANGELO	985	SPECTRUM COLOR ASM	326	MEMORY MERCHANT 16K	159	CALL FOR LATEST PRICES, DETAILS	
ITHACA MEMORY 8/16 BIT 64K	845	EZ-CODER English to BASIC	99	WICAT 68000 16-BIT	CALL	WE BEAT ADVERTISED PRICES	

FACTORY GUARANTEES

square

EXPERT ADVICE

American Computers

919-889-4577

KIVETT DR. JAMESTOWN N.C. 27282

919-883-1105

Listing 4: Z80 assembly-language subroutine to read both channels of the joystick input (Model I version).

```

8000      00100      ORG      8000H
00110 ;*****
00120 ;* SUBROUTINE TO READ JOYSTICK *
00130 ;*      ENTRY: NO PARAMETERS *
00140 ;*      EXIT: (H,L)=X VALUE 0-63, Y VALUE 0-63 *
00150 ;* SUBROUTINE IS RELOCATABLE ANYWHERE IN RAM. SUBROU- *
00160 ;* TIME IS SETUP FOR STANDARD MODEL I/III BASIC USR *
00170 ;* CALL. *
00180 ;*****
00190 ;
8000 0E80      00200 READJY LD      C,128      ;MASK FOR X
8002 180A      00210      JR      SRCHJY      ;READ X VALUE
8004 F5        00220 REA010 PUSH     AF        ;SAVE X VALUE
8005 0E40      00230      LD      C,64      ;MASK FOR Y VALUE
8007 1805      00240      JR      SRCHJY      ;READ Y VALUE
8009 E1        00250 REA020 POP      HL        ;X TO H
800A 6F        00260      LD      L,A        ;Y TO L
800B C39A0A    00270      JP      0A9AH      ;***BASIC RTN***
00280 ;
00290 ;*****
00300 ;* SUBROUTINE TO SEARCH FOR X OR Y VALUE *
00310 ;*      ENTRY: (C)=128 FOR X, 64 FOR Y *
00320 ;*      EXIT: (A)=ANALOG VALUE 0-63 *
00330 ;* SUBROUTINE FINDS ANALOG VALUE WITH 8 RETRIES. *
00340 ;*****
00350 ;
800E 21FFF      00360 SRCHJY LD      HL,-1      ;DUMMY VALUE FOR COMPARE
8011 E5        00370      PUSH    HL        ;INITIALIZE LAST VALUE
8012 21E837    00380      LD      HL,37E8H    ;PRINTER ADDRESS
8015 0608      00390      LD      B,8        ;8 TRIES
8017 1640      00400 SRC005 LD      D,40H      ;START VALUE=64
8019 1E20      00410      LD      E,20H      ;START DELTA=32
801B CB1A      00420 SRC010 RR      D        ;ALIGN TO H'WARE FORM
801D 72        00430      LD      (HL),D     ;OUTPUT VALUE TO DAC
801E CB12      00440      RL      D        ;BACK TO SCALED DELTA
8020 7E        00450      LD      A,(HL)    ;GET COMPARATOR INP
8021 A1        00460      AND     C        ;TEST CHANNEL
8022 7A        00470      LD      A,D        ;CURRENT VALUE TO A
8023 2003      00480      JR      NZ, SRC020 ;GO IF COMP=1
8025 83        00490      ADD     A,E        ;TOO LOW-ADD 1/2
8026 1801      00500      JR      SRC030    ;CONTINUE
8028 93        00510 SRC020 SUB     E        ;TOO HIGH-SUB 1/2
8029 57        00520 SRC030 LD      D,A        ;SAVE ADJUSTED VALUE
802A CB3B      00530      SRL     E        ;DELTA/2
802C 20ED      00540      JR      NZ, SRC010 ;GO IF DELTA NOT 0
802E CB3A      00550      SRL     D        ;CONVERT TO 0-63 FORM
8030 F1        00560      POP     AF        ;GET LAST VALUE
8031 BA        00570      CP      D        ;TEST WITH CURRENT
8032 D5        00580      PUSH    DE        ;SAVE CURRENT
8033 2802      00590      JR      Z, SRC040 ;GO IF EQUAL
8035 10E0      00600      DJNZ   SRC005    ;NOT EQUAL-8 RETRIES
8037 F1        00610 SRC040 POP     AF        ;RESTORE LAST
8038 CB79      00620      BIT     7,C        ;TEST FOR RETURN POINT
803A 20C8      00630      JR      NZ, REA010 ;X CASE
803C 18CB      00640      JR      REA020    ;Y CASE
8000      00650      END     READJY
00000 Total errors

```



“We provide business programs as individual as your business needs.”

“Allow me to introduce myself. I'm a Vector computer, dedicated to the advancement of society. And I'd like to tell you how a computer can help you manage your business more efficiently. Especially if that computer is a Vector, like me. Because we're probably the most flexible and cost-effective computers you can find.

“Our programs are the key. Because they enable me to handle sales forecasting, budgeting, job costing and proposals, commissions, personalized mass mailings, charts and graphs. We Vectors can even talk to each other and to other bigger computers.

“Unique combinations of our individual programs can actually customize me to meet your specific requirements. Any combination of our software packages can be assembled right off the shelf, to help you realize your full potential as a salesman, merchant, stockbroker, clergyman, contractor, real estate or insurance agent or whatever your business.

“Choose from Memorite III for word processing and mail list management, Execuplan for financial planning and forecasting, Business Accounting, Data Management for filing and sorting information, Communications and a host of others. And, of course, all we Vectors come with the popular CP/M operating system.

“For more information and your local dealer, call us at (805) 499-5831 or (800) 235-3547. In California, call (800) 322-3577. Or write to us at 500 North Ventu Park Road, Thousand Oaks, CA 91320.

“We'll show you how we small information systems can mean big business for you.”

Circle 373 on inquiry card.

VECTOR
Vector Graphic, Inc.

COMPUTERS FOR THE ADVANCEMENT OF SOCIETY.

Sold and supported by 400 dealers worldwide.
Vector Products are approved on General Services Administration authorized ADP scheduled price list.

Text continued from page 176:

READY calls SRCHJY twice and merges the result into the HL register for return. H will contain an X value of 0-63, and L a Y value of 0-63. The JP 0A9AH is the standard BASIC method of returning an argument to BASIC from a machine-language subroutine. Convert this to a normal RET if the program will be "stand-alone" (non-BASIC).

The SRCHJY subroutine operates similarly to the Color Computer joystick subroutine discussed in last month's article. A successive-approximation, analog-to-digital conversion is performed. A start value of 32, or half the voltage range, is first output to the DAC and a "delta" value of 16 is initialized. The comparator output is then read in. Depending upon the comparator output,

Listing 6: A BASIC program to call the joystick input subroutine (listings 4 and 5).

```
100 REM JOYSTICK-CONTROLLED CURSOR
110 FOR I=15360 TO 16383
120 POKE I,128
130 NEXT I
140 D=0: E=0
150 DEFUSR0=&H8000
160 A=USR0(0)
170 B=INT(A/256)
180 C=(A-B*256)*47/63
190 IF (D<>B) OR (E<>C) THEN RESET (D*2,E)
200 SET (B*2,C)
210 D=B: E=C
220 GOTO 160
```

the next value tried is 32 plus or minus the delta. The delta is then halved. This successive approximation continues until the delta has been reduced to 1/2 unit (the value is "scaled up" by two to permit the last delta of 1/2).

As the input may change rapidly, eight tries are made to obtain a steady X or Y input value. The minimum number of times through SRCHJY will be two, the maximum eight. If the value does not match the previous value after eight tries, the last value is used.

Other Uses for the A/D Circuit

In the previous article of this series, I described some "real-world" analog inputs that could be used in place of the joystick. Basically, anything that can be converted into a voltage can be used as an input to the DIN connector and converted to an increment of 0-63.

One example used was a cadmium sulfide photocell that had a variable resistance dependent upon the amount of light striking it. When used with a resistor in a divider network, a varying input voltage is generated. The second example used was a thermistor, a resistor whose resistance varied inversely to the temperature. These devices and many others may be connected to the A/D circuit in this fashion.

No, you can't control the world with the TRS-80 (at least not yet!). But you can *measure* it with your new A/D input circuit. ■

DATAFACE GRQ SERIES INTERFACE

URNS YOUR ELECTRONIC TYPEWRITER INTO A PRINTER/TYPEWRITER

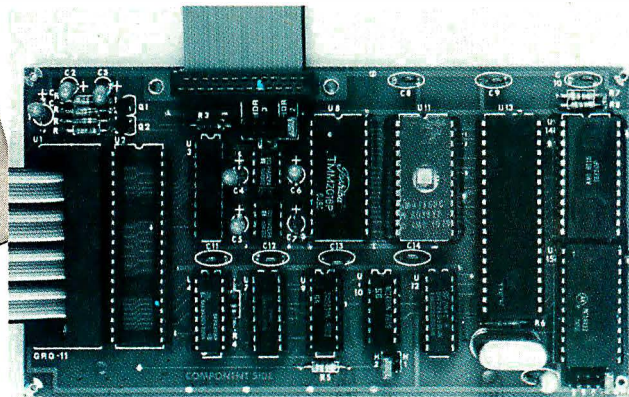

The Dataface GRQ-11 Interface expands your Olympia ES Series electronic typewriter into a letter press quality printer for your personal or business computer. And, you still have a fully featured electronic typewriter—two machines in one.

The GRQ Series Interface features:

1. Standard EIA RS-232-C Serial Interface and Parallel (Centronics compatible).
2. Standard asynchronous ASC11 code, 7 bit data; 1 start bit; accommodates 1 or 2 stop bits automatically; accommodates odd, even or absence of parity bit.
3. Fifty thru 9600 Baud data rate options.
4. Two K buffer; supports X-on, X-off protocol as well as RTS signals.

5. Circuit board is installed inside typewriter back panel along side logic board. The connection between boards accomplished by 40 pin jumper cable using existing socket. No soldering required. Power is provided to the GRQ thru two pins of the 40 lead cable. Installation in 10 minutes.

GRQ-10 — CALL FOR SPECIAL WHOLESALE PRICE. SUGGESTED RETAIL \$349.50.

DATAFACE INC.

2372 A WALSH AVE., SANTA CLARA, CA 95050
(408) 727-6704

Circle 116 on inquiry card.

Announcing A Media Event From IMS



Configuration shown includes two slimline double sided, double density drives, 40 M byte Winchester subsystem with tape back up.

The New 8000 SX Micro Computer System With Winchester And Floppy And Tape

Winchester technology brought a tremendous increase in capacity, but it also dumped a big problem in your lap.

How to dump all that data?

Trying to transfer 10 to 40M bytes of data between Winchester and floppies takes an armload of diskettes and a lot of time.

Cartridge tape is fast, but not efficient for random file handling.

Answer?

The new 8000 SX Micro Computer System with Winchester plus Floppy and Tape. It lets you back up and restore a single file or a complete drive with maximum efficiency.

Choose from 10, 20 and 40M byte Winchester subsystems, with error detection and correction, capable of loading a 20K byte system program in less than a second.

The floppy subsystem offers up to 1.2M byte per 8" drive.

The bulk memory subsystem, an incremental cartridge tape drive, stores up to 17M byte on a single cartridge.

And, of course, the computer itself offers proven IMS top performance and reliability. Compare its full 2-year warranty.

Operating systems include CP/M, MP/M, and the incredibly

powerful TurboDOS.

For all the facts and the location of your nearest IMS International dealer, call us today at (714) 978-6966. Or write:

IMS
INTERNATIONAL

We Build Computers As If Your Business
Depended On Them.
2800 Lockheed Way, Carson City, NV 89701
Telex: 910-395-6051

Thirty More Days to a Faster Input

Edward M. Roberts
19 Smith St.
Glen Head, NY 11545

The program in Arthur Armstrong's article "Thirty Days to a Faster Input" was intended to help you learn touch-typing on a home computer. (See the December 1979 BYTE, page 250.) However, when I tried to copy his listing into my machine, it was a nightmare. The listing was apparently a facsimile of a printout done on an ancient Teletype. I finally decoded it, however, and modified it so that it would run on my Radio Shack

TRS-80 running Level II BASIC.

Listing 1 shows my version of the program written the way I would have liked to have seen it—clear, nicely spaced, with the loops inset and the index variables spelled out in DO LOOPS (like NEXT I instead of just NEXT) for clarity. I hope BYTE readers enjoy using this program. ■

Listing 1: A typing program for the Radio Shack TRS-80. This is a modified version of a program given in the article "Thirty Days to a Faster Input," by Arthur Armstrong in the December 1979 BYTE.

```
10 REM *** TYPING DRILL***
20 REM ** BY ART ARMSTRONG 9/8/77 **
30 REM * PUBLISHED 'BYTE' MAGAZINE 12/79 *
40 REM # ADAPTED TO R/S LEVEL II BASIC BY ED ROBERTS
   12/20/79 #
50 CLEAR 200
90 CLS: PRINT@ 145, "TYPING DRILL": PRINT
100 INPUT "WHAT CHARACTERS DO YOU WANT";C$
105 L = LEN(C$): DIM A(L)
110 INPUT "HOW MANY LETTERS IN EACH WORD"; WL
120 INPUT "DO YOU WANT ECHO"; A$
125 IF LEFT$(A$,1) = "Y" THEN E = 1
130 INPUT "HOW MANY TRIALS"; NT
195 CLS
200 FOR T = 1 TO NT
210 NP = NP + WL
220 A$ = ""
230 FOR I = 1 TO WL
240 R = INT(L * RND(0)+1)
250 A$ = A$ + MID$(C$,R,1)
260 NEXT I
270 PRINT:PRINT CHR$(23): PRINT A$
300 FOR I = 1 TO WL
310 E$ = INKEY$: IF E$ = "" THEN 310
320 IF E = 0 THEN 350
330 PRINT E$;
350 IF E$ <> MID$(A$,I,1) THEN 500
360 NR = NR + 1
370 NEXT I
375 IF E = 1 THEN PRINT
380 NEXT T
400 CLS:PRINT:PRINT "YOUR SCORE IS "; INT(100 * NR/NP);"%
402 IF NR = NP THEN 415
405 PRINT "ERRORS:":FOR I = 1 TO L: IF A(I) = 0 THEN 410
407 PRINT MID$(C$,I,1);A(I)
410 NEXT I
415 PRINT: INPUT "SELECT:
      REPEAT W/ SAME SPECS, CUME SCORING & ERRORS
      (R)
      REPEAT WITH NEW SPECIFICATIONS (N)
      DONE — GOODNIGHT — (D)      ";A$
420 IF A$ = "R" THEN 195
425 IF A$ = "N" THEN 50
430 IF A$ = "D" PRINT:PRINT " SAY GOODNIGHT,
      GRACIE.":END
500 FOR J = 1 TO L
510 IF MID$(C$,J,1) <> MID$(A$,I,1) THEN NEXT J: GOTO 520
515 A(J) = A(I)+1
520 PRINT:PRINT "ERROR ON "; MID$(A$,I,1)
530 FOR I = 1 TO 300: NEXT I
540 GOTO 380
550 END
```

LETTER PERFECT

T.M. LJK

WORD PROCESSING

ATARI 400/800

APPLE II & II+

EASY TO USE — Letter Perfect is a single load easy to use program. It is a menu driven, character orientated processor with the user in mind. FAST machine language operation, ability to send control codes within the body of the program, mnemonics that make sense, and a full printed page of buffer space for text editing are but a few features. Screen Format allows you to preview printed text. Indented margins are allowed. Data Base Merge with **DATA PERFECT** by LJK, form letters, accounting files and mailing labels only with MAIL MERGE/UTILITY by LJK. **FEATURES** — Proportional/Incremental spacing * Right Justification * File Merging * Block movement * Headers * Footers * Print Multiple Copies * Auto Page Numbering * Scroll forward/backward * Search and Replaces * Full cursor control * Underlining * Boldface * Superscripts * Subscripts * Auto page numbering * Insert character/line * Delete character/line * Centering * Horizontal tabs/changeable * Multifunction format line (line spacing — left margin — page width — lines/page — change fonts — top/bot margin adjust) **MUCH MORE!** \$149.95

ATARI VERSION 2.0 #2001

Compatible with Atari DOS. Uses proportional font, right justified with Atari 825/Centronics* 737, 739 printers. Uses EPSON MX* Series + Graftrax/italicized font. Can mix type fonts on same page; mix boldface and enhanced font in same line with justification. Can be used with 16K Atari/400.

"Compared to the price of many other word processors, this package is a steal. It does everything the advertisement claims and more. On top of this the software is very easy to use." A.N.A.L.O.G. MAGAZINE

APPLE VERSION 5.0 #1001

DOS 3.3 compatible — Use 40 or 80 column interchangeably (Smarterm — ALS; Videoterm-Videx; Full View 80 — Bit 3 Inc.; Vision 80 — Vista; Sup-R-Term — M&R Ent.) Reconfigurable at any time for different video, printer, or interface. USE HAYES MICROMODEM II*LCA necessary if no 80 column board, need at least 24 K of memory. Files saved as either Text or Binary. Shift key modification allowed. Data Base Merge compatible with **DATA PERFECT*** by LJK.

"For \$150, Letter Perfect offers the type of software that can provide quality word processing on inexpensive micro-computer systems at a competitive price." INFOWORLD

DATA PERFECT

T.M. LJK

Complete Data Base System. User orientated for easy and fast operation. 100% Assembly language. Easy to use. You may create your own screen mask for your needs. Searches and Sorts allowed, Configurable to use with any of the 80 column boards of Letter Perfect word processing, or use 40 column Apple video. Lower case supported in 40 column video. Utility enables user to convert standard files to Data Perfect format. Complete report generation capability. **Much More!**

EDIT 6502

T.M. LJK

This is a coresident — two pass **ASSEMBLER, DIS-ASSEMBLER, TEXT EDITOR, and MACHINE LANGUAGE MONITOR.** Editing is both character and line oriented. Disassemblies create editable source files with ability to use predefined labels. Complete control with 41 commands, 5 disassembly modes, 24 monitor commands including step, trace, and read/write disk. Twenty pseudo opcodes, allows linked assemblies, software stacking (single and multiple page) plus complete printer control, i.e. pagination, titles and tab setting. User can move source, object and symbol table anywhere in memory. Feel as if you never left the environment of BASIC. Use any of the 80 column boards as supported by **LETTER PERFECT**, Lower Case optional with LCG.

LJK DISK UTILITY

APPLE \$29.95

This menu driven program allows the user to manipulate a variety of different file types. Binary, Text, and Source files may be easily converted into each other. The program may be used with **APPLESOFT***, **VISCALC***, and other programs. These program files may be readily adapted for multiple use including editing with **LETTER PERFECT** word processings.

APPLE & ATARI

DATA BASE MANAGEMENT

\$99.95

MAIL MERGE/UTILITY

APPLE & ATARI

\$29.95

This menu driven program combined with **LETTER PERFECT** allows user to generate form letters and print mailing labels. With the Atari, you may **CONVERT ATARI DOS FILES**, or Visicalc files compatible for editing with **LETTER PERFECT**. Utility creates Data Base files for Letter Perfect.

LOWER CASE CHARACTER GENERATOR

\$34.95

!@#\$%^&*~ - /0123456789 ; <=>?@ABCDEF GHIJKLMNOPQRSTUVWXYZ \] ^ _ ` abcdefghijklmnopqrstuvwxyz{|}~

Lower Case Character Generator for the Rev. 7, Apple II or II+ computers. When installed, this Eprom will generate lower case characters to the video screen. Lower case characters set has two dot true descenders. Installation instruction included. Manual includes listing of software for full support and complete instructions for shift key modification. Compatible with **LETTER PERFECT**.

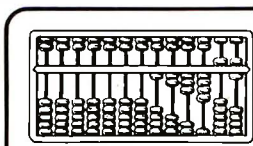

LJK ENTERPRISES INC.

P.O. Box 10827

St. Louis, MO 63129

(314) 846-6124

**DEALER
INQUIRES
INVITED**

*Trademarks of: Apple Computer — Atari Computer — Epson America — Hayes Microcomputers — Personal Software — Videx — Bit 3 Inc. — M&R Ent. — Advanced Logic Systems — Vista Computers

REQUIREMENTS

A SELF-COMPILING RELATIONAL DATABASE & APPLICATION SYSTEMS GENERATOR

DATABASE SELECTION —

- Uses English-like language to form query
- Provides extensive search capabilities
- Search arguments can include arithmetic/boolean functions, multi-field comparisons
- Queries can generate input for automatic database maintenance
- Queries can be stored in "Query Library" and executed from menu on demand
- Any number of fields can be queried concurrently
- Query output can be routed to disk, CRT report formatter, VISICALC™ or SOURCE™

DATABASE MAINTENANCE—

- Uses sophisticated screen formatting & data entry, like on IBM 3270's!
- Generates it's own screens automatically!
- Handles records up to 4K in length, using multiple screen "Pages"!
- Automatic data compression for increased disk capacity
- Uses SuperKram access method for incredibly fast access, **LESS THAN .2 SECONDS FOR A RECORD!**
- Automatic index creation/maintenance
- Automatic maintenance capabilities
- "Goof-Proof" error handling
- Input can come from VISICALC™ or SOURCE™

DATABASE REPORTING—

- Automatic headlines
- Automatic field editing
- Report fields can be calculated, sub-totaled & cross-footed in any manner desired
- Optional counter breaks may be set
- Automatic grand totals
- Automatic statistics

REQUIREMENTS —

SuperKram (available separately) and: Commodore Pet 32K (40 or 80 col.) and 2040/4040/8050 disk OR Apple II 48K with Applesoft or language system and 2 disk drives or CORVUS.

ONLY \$225 WITH SUPERKRAM FIRMWARE **\$325**

USA UNITED SOFTWARE OF AMERICA
750 THIRD AVE. NEW YORK NY 10017

Look for the RED-WHITE-BLUE United Software Display at your local computer dealer, or send check or moneyorder, plus \$3.00 shipping

(212) 682-0347 Telex 640055

SUPER KRAM II™

VERSION 3.02

MULTI-KEYED RANDOM ACCESS METHOD

Many times more powerful and efficient than the primitive "relative record" method used by Apple & Commodore.

FOR APPLE II & COMMODORE PET

SUPER KRAM II is the *FASTEST & MOST POWERFUL* keyed access method available for the Apple & Commodore CBM (Pet) Computers. Written entirely for 6502 machine code, **SUPER KRAM II** is extremely fast, comprehensive in scope, very compact, and easy to use. Using the sophisticated capabilities of **SUPER KRAM II** the Apple & CBM (Pet) can now fully meet the requirements of information management applications, such as: Accounts Receivable/Payable, Inventory Control, General Ledger, Payroll, Mailing Lists, and Database Management. Programs can now be 30% to 90% shorter and run many times faster.

10 FEATURES OF SUPER KRAM II

MULTI-KEY SUPPORT — Allowing simultaneous access to a KRAM file by more than one key field.

IMPROVED INDEX ARCHITECTURE — Allowing faster index searches and more efficient disk space utilization. Alternate indexes are compressed for greater capacity.

INTEGRATED BASIC COMMANDS — Allowing **SUPER KRAM II** commands to be coded in-line with Basic, providing easier usage.

USER SPECIFIABLE BUFFER POOL — Allowing the user to specify how many files are allowed open at one time.

LOGICAL RECORDS (KEYS MAY BE NON-UNIQUE) — Records added to the files are immediately accessible by any of the defined keys for the file (Automatic Upgrade).

ACCESS BY ANY KEY IN .2 SEC. (.1 sec. with Corvus disk)

SUPPORTS MULTIPLE DISKS

DYNAMIC SPACE ALLOCATION

DYNAMIC INDEX COMPRESSION

FILES NEVER NEED REORGANIZATION

**ONLY
\$175**

PET & APPLE REQUIREMENTS

SUPER KRAM II is designed to work with both Apple's Disk II, or Corvus Systems Winchester Disk, and Commodore's 2040, and 8050 disk units.

SUPER KRAM II requires an Apple or Apple Plus and at least one disk drive. **SUPER KRAM II** works on any 40/80 column 32K Pet.

UNITED SOFTWARE USES MAXELL
ECLUSIVELY IN ORDER TO ASSURE
MAXIMUM QUALITY

Maxell Floppy Disks

The Mini-Disks
with maximum quality.



maxell®

PERSONAL COMPUTER PRODUCTS



Troubleshooting with Electronic Signatures

Kenneth M. Piggott
16166 Chesterfield
East Detroit, MI 48021

Until recently, the tools available for finding hardware errors in microprocessor systems have been meager. Logic probes are satisfactory for detecting logic levels and the presence of pulses but are unable to detect errors in data streams. An oscilloscope is of limited use because all data pulses tend to look alike. Logic analyzers let you store long data streams (250 bits and longer) for later evaluation. But in order to check for single-bit errors, each bit stored has to be compared to a known good pattern (a long and tedious job). Additionally, using a logic analyzer generally requires a certain amount of expertise. A technique known as *signature analysis*, however, allows easy detection of hardware-related data-stream errors.

Signature Analysis

Signature analysis is a technique, pioneered by Hewlett-Packard, that detects errors in data streams caused by hardware failure. Much as waveforms in an analog circuit being tested can be compared with ideal waveforms shown on a schematic, signatures derived from a digital system can be compared with known good signature values in order to isolate defective components. Single-bit errors can be detected with greater than 99.99 percent certainty using signature analysis.

Signature analysis reduces a data stream into a four-digit hexadecimal sequence. This four-digit sequence is the signature. By supplying known data streams to a digital system,

unique signatures can be obtained at various points in the circuit. These correct signatures can be recorded and later compared with the results obtained from a malfunctioning system. (Any signatures that are different indicate a problem.) With proper documentation and troubleshooting procedures, the faulty components causing the hardware failures can be pinpointed.

With signature analysis, single-bit errors can be detected with almost 100% accuracy.

One of the real advantages of signature analysis is that only one data line is sampled at a time. In the case of bus-oriented microprocessors, it is very easy to check each individual address-bus line and detect such difficult problems as shorts between two bus lines.

Inside an Analyzer

The basic component of the signature analyzer is a 16-bit shift register. Data is shifted through the register by means of a clock signal supplied by the system under test. This signal indicates when the data is valid. Connected to the input of the shift register is the output of a modulo-2 adder. There are two groups of inputs to the adder. One is the incoming data stream and the

other is feedback from the shift register.

If an incorrect bit is in the data stream, it will be shifted and fed back, so an incorrect output from the modulo-2 adder will result. This result enters the shift register and is again shifted and fed back; it will again affect future inputs to the shift register. This process will repeat until a stop signal is received. The remaining contents in the shift register result in an incorrect four-digit signature on the unit's hexadecimal display.

In order to generate a signature, certain control signals are required. The first is the start signal, which tells the signature analyzer when the data stream starts and resets all the bits in the shift register to logic 0. Note that this and all other control signals are *edge-triggered* signals that may be selected to trigger on either the positive- or the negative-going edge.

The next signal of interest is the clock signal. Do not confuse this signal with the microprocessor clock. The clock signal is used to indicate when the incoming data to the signature analyzer is valid.

The last control signal of concern is the stop signal, which initiates the transfer of the contents of the shift register to the displays. In the reference literature, the period between the start and stop signals is often referred to as the *measurement window*.

A Simplified Example

Let's look at a simplified example with a 4-bit shift register and one



THE WORD FROM SYBEX...

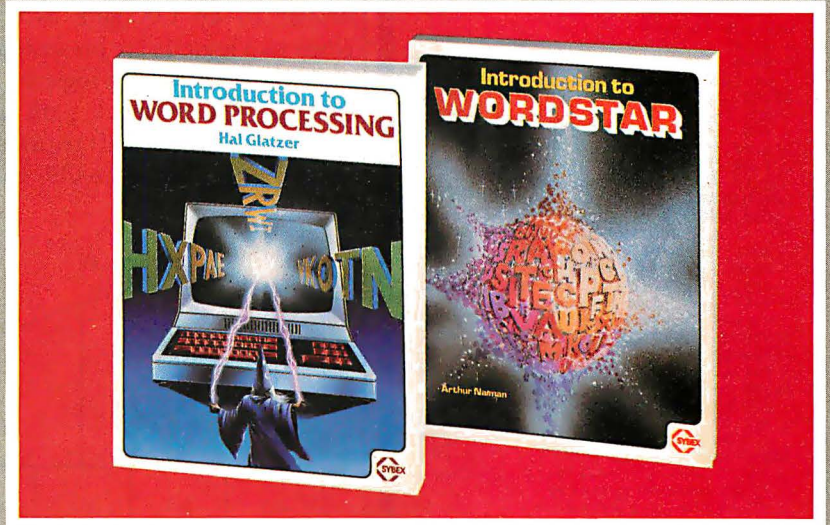

Introduction to WordStar™

by Arthur Naiman

Learn the wonders of WordStar. A guide through the many important features of this powerful CP/M-based word processing system—from simple cursor movements, editing, boldfacing, and right-justifying, to sophisticated commands like global editing and electronic “cut and paste.” This book is for anyone who has WordStar, is considering buying it, or simply wants to know what a high-powered word processing program can do. Includes special sections on the Apple and TRS-80 versions of WordStar.

200 pp., 30 illustr., Ref. W110
ISBN: 0-89588-077-6, \$8.95

Introduction to Word Processing

by Hal Glatzer

The latest word on word processors. Learn how a word processor can save you time and improve accuracy. Discover how word processing improves productivity in homes and offices. Find out what to look for when you buy one. An important introduction to an essential new technology.

232 pp., 70 illustr., Ref. W101
ISBN: 0-89588-076-8, \$12.95

WordStar™ is a trademark of
Micro Pro Int'l Corp.

PLEASE SEND ME INTRODUCTION TO WORD PROCESSING INTRODUCTION TO WORDSTAR

SYBEX
MAIL TO:
SYBEX DEPT. 2B
2344 SIXTH STREET
BERKELEY, CA 94710
PHONE ORDERS:
INSIDE CA 415-848-8233
TOLL FREE OUTSIDE CA 800-227-2346

NAME _____ SEND ME YOUR FREE CATALOG
ADDRESS _____
CITY _____ STATE _____ ZIP _____
ADD \$1.50/book UPS or 75¢/book 4th class mail or \$8/book overseas airmail (CA add tax)
Total Amt. Enclosed _____ OR CHARGE MY VISA MC AM EX.
CARD NO. _____ EXP. DATE _____
SIGNATURE _____

\$ SAVE \$

CALL MBC. . . (203) 342 2747

COMPUTERS

NORTH STAR
 HRZ-1Q-64K-HD5 Save over \$1600.00!!
 ADVANTAGE 64K-QD \$3550
 HRZ-2D-64K-ASM \$Call
 HRZ-64K-QD-ASM \$Call
 HEWLETT-PACKARD
 HP-85 \$2795
 HP-83 \$Call
 HP Calculators In Stock 15% OFF!!!
 ATARI
 800 16K \$ 759
 400 16K \$ 345
 ZENITH
 Z-89 GA \$2068
 Z-89 All-In-One-Computer \$2275
 COMMODORE
 CBM,PET 32K COMPUTER \$ 975
 LIMITED TIME & QUANTITY
 8032 Large 80 Col. Screen \$Call
 8050 Dual Disk Drive 1 Meg \$Call
 4032 B or N 40 Col. Screen \$Call
 4040 Dual Disk Drive 360K \$Call
 Vic-20 Color Computer \$ 275
 INTERTEC SUPERBRAIN
 64K-DD \$2775
 64K-QD \$3180
 ALTOS SYSTEMS
 ACS 8000-2 1 Meg FD \$3150
 ACS 8000-2D 2 Meg \$4390
 ACS 8000-10 4 User \$6795
 ONYX C8002 \$14900

 Verbatim Disketts
 525-01,10 (box of 10) 24.50
 550-01,10 (box of 10) 37.50

PRINTERS

DIABLO 630 SCALL
 NEC SPINWRITER 7730/7710 SCALL
 NEC 7720 KSR \$2890
 NEC 3510/3530 (35 CPS) \$1950
 C.ITOH \$1499
 OLYMPIA ES-100 Typewriter/Inter \$1250
 IDS Paper Tiger 445G SCALL
 460G SCALL
 560G \$1150
 ANADEX 9500/9501 \$1290
 CENTRONICS 730-1 \$ 550
 737-1 \$ 699
 EPSON-MX80 W/Friction Opt. SCALL
 MX-70 \$ 395
 MX-100 SCALL
 OKIDATA MICROLINE 80 \$ 375
 82 \$ 495
 83 \$ 750

TERMINALS

TELEVIDEO 920C \$ 850
 950 \$1050
 INTERTUBE III/Emulator \$ 725
 ZENITH Z-19 \$ 820
 ZENITH 12" Green Monitor \$ 139
 LEEDEX/AMDEK 100 Green Monitor \$ 165

Above items may be ordered by mail or phone. Visa & Master Charge accepted. Factory Sealed, Manufacturers Warranty ---Prices Subject To Change---

(203) 342-2747

Multi-Business Computer Systems Inc.

28 MARLBOROUGH STREET
 PORTLAND, CONN. 06480
 TWX/TELEX 710-428-6345

feedback point that will generate a single-hexadecimal-digit signature (see figure 1 and table 1). For convenience, let's substitute an exclusive-OR gate for the adder, as it will perform the same function as a modulo-2 adder when only one feedback path in addition to the input signal is present.

The output of the exclusive-OR gate goes to the input of the shift register. (An exclusive-OR gate is similar to an OR gate except that when two logic 1s are presented to the inputs, the output is a logic 0.) In this example, the feedback path is from the third bit of the shift register to the input of the exclusive-OR gate. (In

the 16-bit shift register version, the four feedback paths are from bits 7, 9, 12, and 16.)

In the correct signature example, when the start pulse is applied, the bits in the shift register are all set to logic 0. At the end of the third clock pulse, a logic 1 is fed back to the input of the exclusive-OR gate. Since the fourth data bit is a logic 0, the input to the shift register is a logic 1. When the data stream is completed and the stop signal is received, the bits present in the shift register are transferred to the display register and an "H" is displayed. (For clarity, the output digits are represented by one of the numerals 0 through 9 or the letters A,

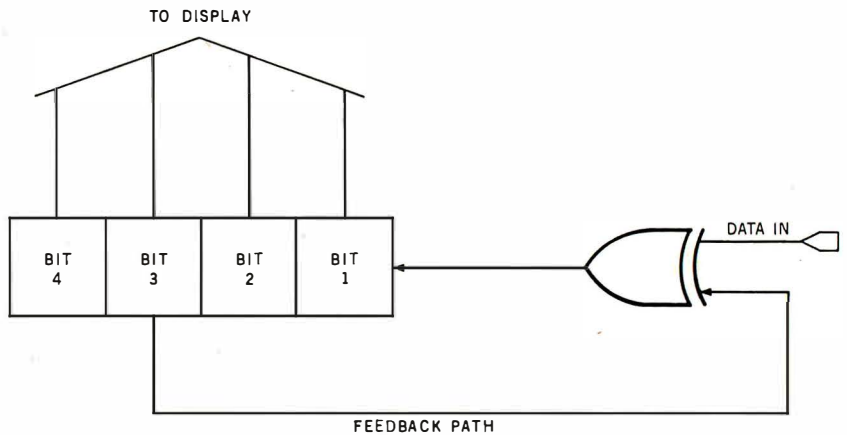

Figure 1: A simplified version of a signature analyzer. In this scaled-down unit, only four bits are used in a shift register (as opposed to 16), and a simple exclusive-OR gate is used in place of the adder. Each bit of the incoming data stream is fed back to the exclusive-OR gate as it reaches the third position in the shift register.

Control Signal	Correct Signature Data Stream = 10101010		Incorrect Signature Data Stream = 10001010	
	Shift Register Contents	Data Remaining	Shift Register Contents	Data Remaining
Start	0000	10101010	0000	10001010
Clock (1)	0001	0101010	0001	0001010
(2)	0010	101010	0010	001010
(3)	0101	01010	0100	01010
(4)	1011	1010	1001	1010
(5)	0111	010	0011	010
(6)	1111	10	0110	10
(7)	1110	0	1100	0
(8)	1101		1001	
Stop Displayed Digit	H		9	

Table 1: The contents of the shift register as two slightly different data streams are fed in. In the incorrect signature example, the third bit from the left has been changed from a 1 to a 0; the final results (after the eighth clock pulse) are quite different.

AH-HA!



EUREKA!

ALL-RIGHT!

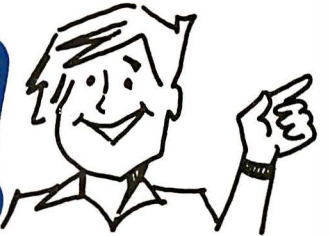

Introducing "Popular Computing," the key to understanding.

Now you don't have to be a computer professional to unlock all the mysteries, potential, and pleasures of home and small business computers. *Popular Computing*, the new monthly magazine from McGraw-Hill, is the key.

Created in response to growing demand for our informative quarterly *onComputing*, *Popular Computing* explores every aspect of personal computers and their use. All reported in easy-to-understand nontechnical language.

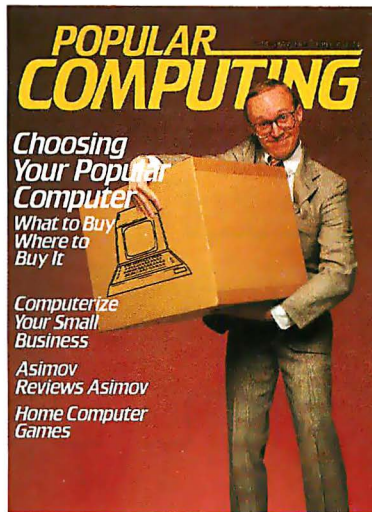

The answer to "Computerphobia."

Even the most computer-unsophisticated reader will find *Popular Computing* interesting and stimulating. Every issue will contain straight-talking product reviews,

special news briefs, and feature articles by famous guest contributors (like Isaac Asimov). There'll even be a helpful glossary of computer jargon we couldn't avoid using, and much, much more.

Special Introductory Offer.

Send in this coupon today, and take advantage of *Popular Computing's* Special Introductory Offer.



POPULAR COMPUTING

THE KEY TO UNDERSTANDING
P.O. Box 397, Hancock, NH 03449

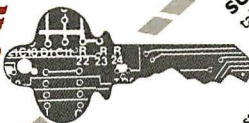

Mail Today to:
POPULAR COMPUTING
 P.O. Box 307, Martinsville, NJ 08836

SUPER SAVINGS FOR ME...! I'm taking advantage of this super introductory offer of 12 issues for only \$11.97 saving me \$3.03 on the basic rate of \$15.00 and saving me \$18.03 off the 12 issue newsstand rate of \$30.00. If my 30-day review of your subscription and you will promptly refund ALL my money or give me a FULL credit on my charge card marked below:

Check Enclosed for \$11.97
 Charge \$11.97 to:
 Visa Mastercard

Card No. _____ Expires _____
 Signature _____
 Name (Please Print) _____
 Address _____
 City _____ State _____ Zip _____

more . . . SPECTACULAR OFFERS



BASF



WABASH



MAXELL



OPUS

We stock the complete line of BASF diskettes, reel-to-reel tapes, mag cards, disk packs and cartridges. We also carry MAXELL, OPUS and WABASH products. All are 100% certified and fully guaranteed.

Box of 10 diskettes:	5 1/4"	8"
OPUS ss/sd	\$20	\$21
BASF ss/sd	23	24
WABASH ss/sd	23	24
MAXELL . TOO LOW TO QUOTE.	CALL	
5 1/4" -10 sector-now available		
Sectoring must be specified.		

5 1/4" or 8" Vinyl Storage Pages 10/\$5

LIBRARY CASES

8" Kas-sette/10	\$2.99
5 1/4" Mini Kas-sette/10	\$2.49



HARDHOLE DISK PROTECTORS
Reinforcing rings of tough mylar protect disk hole edge from damage.

Applicators	5 1/4"	8"
Hardhole Rings (50)	\$3	\$4
	\$6	\$8

DISK DRIVE HEAD CLEANING KITS

Prevent head crashes and ensure error-free operation.
5 1/4" or 8" \$19.50



SFD C-10 CASSETTES 10/\$7
(All cassettes include box and labels.)



Get 8 cassettes, C-10 Sonic, and Cassette/8 Library-Album, as illustrated, for only \$8

SNAP-IT POWER CENTER

Turns 1 outlet into 6. Wall mount or portable. Circuit breaker, lighted switch and UL approved.



4"x3"x2" \$19.95

We also offer printer ribbons, printwheels, type elements, equipment covers, power consoles, paper supplies, storage and filing equipment, furniture and many other accessories for word and data processing systems. Write for our free catalog.

VISA • MASTERCARD • MONEY ORDERS • CERTIFIED CHECK • FOR PERSONAL CHECKS ALLOW TWO WEEKS • C.O.D. REQUIRES A 10% DEPOSIT • CAL. RES. ADD 6% SALES TAX • MIN \$2 SHIPPING & HANDLING • MINIMUM ORDER \$10 • SATISFACTION GUARANTEED OR FULL REFUND

ABM PRODUCTS

8868 CLAIREMONT MESA BLVD.
SAN DIEGO, CALIFORNIA 92123

Toll Free 800-854-1555 Order Only
For Information or California Orders
(714) 268-3537

C, F, H, P, or U, instead of the conventional hexadecimal digits.) Keep in mind that in the actual device the shift register is 16 bits long and the actual signature is four digits.

To demonstrate the effectiveness of the technique, let's look at the same example with the third bit in the data stream set to logic 0 instead of logic 1, to simulate an error (see the incorrect signature example in table 1). Notice that after the third clock pulse, an incorrect bit has entered the shift register. After the fifth clock pulse, this incorrect bit is at the feedback point, which results in an incorrect bit entering the shift register on the sixth clock pulse. After the stop pulse is received, a "9" is transferred to the

display. The correct display should have been an "H".

Applying Signature Analysis

The premise behind signature analysis is that known data streams can be generated by the system. One approach to doing this for micro-computer systems is to have a diagnostic program stored in memory that generates the required data streams. It is then possible to isolate faults at the component level in various parts of the unit under test. This approach, however, is best incorporated into the initial design of a product and, unfortunately, does not help those who already have computer systems; very few personal

TIMING DIAGRAM

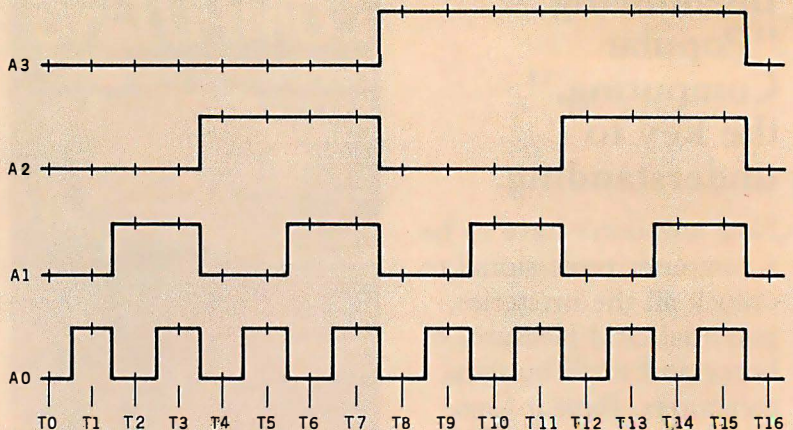

Signatures of a Free-running Microprocessor

It is necessary to recall how a microprocessor operates in order to see how the data stream is generated for use in free-running analysis. When a reset occurs, the program counter in the microprocessor is set to 0000 and the data stored at memory location 0000 is accessed on the next instruction-fetch cycle.

However, when a free-running analysis is occurring, a NOP instruction is placed on the data-in bus to the microprocessor. As a result, after reset occurs, the only action that the microprocessor takes is to read the next memory location (where a NOP instruction is encountered) and increment the program counter.

This process will repeat as long as a NOP instruction is present on the data

bus; but note what occurs when the program counter reaches hexadecimal FFFF. A NOP instruction is encountered, and the program counter increments to 0000. As the cycle repeats, the memory space is sequentially accessed, and the resulting data stream generated on the address lines provides the known data stream required for signature generation.

The timing diagram above shows the data streams generated on address lines A0 through A3. Only four address lines are shown for clarity, but the patterns on address lines A4 through A15 are similarly generated. The pattern shown will repeat as long as the microprocessor is in the free-running mode.

MEET THE MTI FAMILY OF LOW COST COMPUTERS

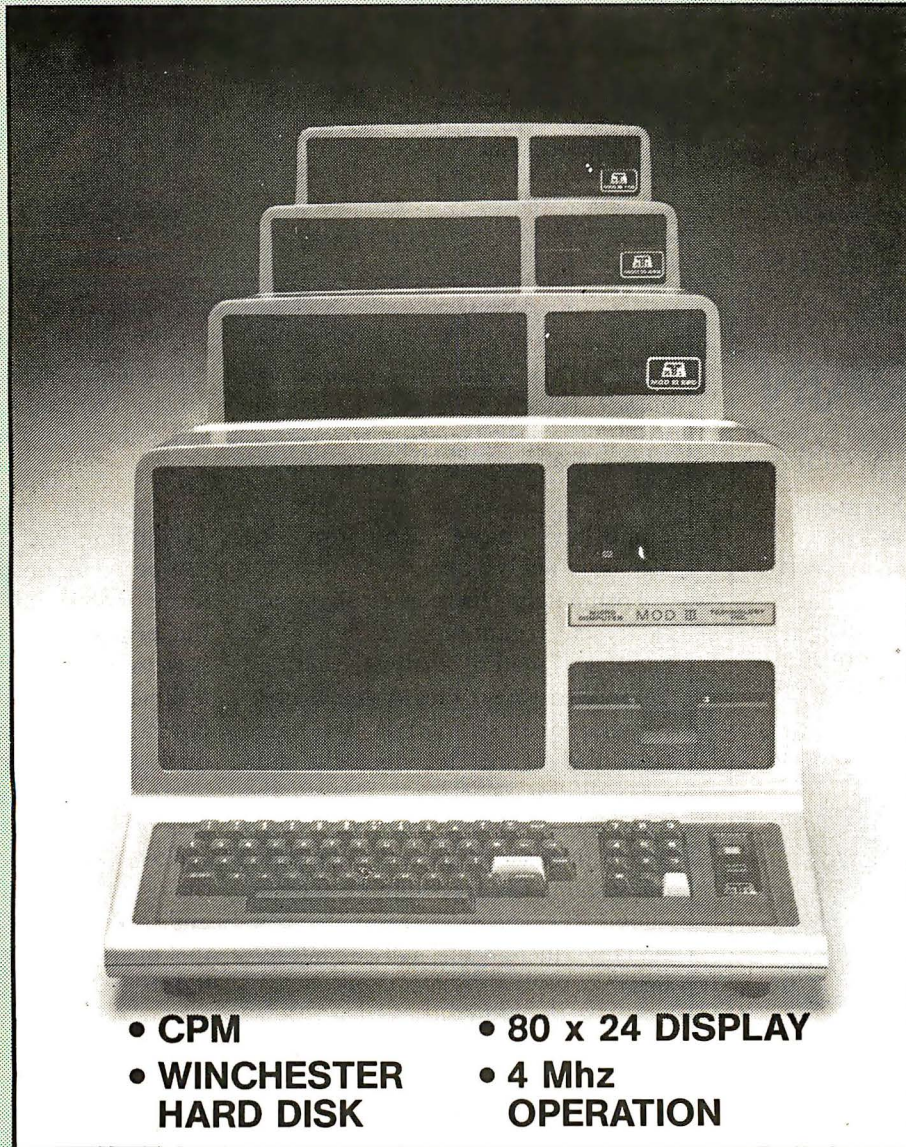

- IMMEDIATE AVAILABILITY
- CPM OPTION
- GREAT DISK STORAGE

- CPM
- WINCHESTER HARD DISK
- 80 x 24 DISPLAY
- 4 Mhz OPERATION

- 90 DAY WARRANTY
- LOCAL DEALER SERVICE
- MODEL III COMPATIBILITY

MOD III PLUS/140
We have taken the basic 16K Model III expanded the memory to 48K and added our MTI Double Density, Dual Disk Drive System. System is fully compatible with Radio Shack DOS and peripherals.

FROM \$1998.

MOD III/240
Same as the MOD III PLUS/140 but has double storage capacity, and 2 dual headed 40 track drives.

\$2449.

CP/M-80; Option to run CP/M 2.2 with 80x24 video board for word processing and many other applications.

\$ 849

MOD III/280
Has 1.5 megabytes of storage and utilizes 2 dual headed 80 track double density disk drives with DOS plus 3.3.

\$2799.

4 Mhz Speed-up enhancement \$149.

MOD III/WINCHESTER
Our largest business computer system. 5.7 megabytes of storage. Includes a 5 megabyte Winchester hard disk drive and 80 track dual head disk drive used as back up and for conventional floppy disk operation. \$5399.

MTI AUTHORIZED SALES AND SERVICE CENTERS

Phoenix, AZ (602) 244-9739
Sierra Vista, AZ (602) 458-2479
Tucson, AZ (602) 323-9391
Anaheim, CA (714) 773-0240
Covina, CA (213) 332-4088
Goleta, CA (805) 967-7628
Huntington Bch., CA (714) 842-1348
Northridge, CA (213) 886-9200
Inglewood, CA (213) 673-3295
Lancaster, CA (805) 942-5747
Montclair, CA (714) 626-4813
Pacheco, CA (415) 689-2260
Port Hueneme, CA (805) 985-2329
Redondo Bch., CA (213) 370-5556

Vallejo, CA (707) 644-7550
San Diego, CA (714) 275-4243
San Jose, CA (408) 946-1265
Santa Cruz, CA (408) 427-0836
Walnut, CA (714) 594-9760
Westlake Vill., CA (213) 706-0333
Groton, CT (203) 445-5166
Wilmington, DE (302) 962-0227
Norcross, GA (404) 449-8942
Lynn Haven, FL (904) 265-6452
Hollywood, FL (305) 981-1011
Blackfoot, ID (208) 785-1497
Belleville, IL (618) 277-2354

Collinsville, IL (618) 345-5068
Rockford, IL (815) 229-0200
Oak Park, IL (312) 386-3323
Shawnee, KS (913) 464-6512
Shreveport, LA (318) 865-7189
Anoka, MN (612) 427-5783
Cameron, MO (816) 632-6528
Joplin, MO (417) 781-1748
Missoula, MT (406) 549-9715
Raleigh, NC (919) 755-1175
Grand Forks, ND (701) 772-7848
Las Vegas, NV (702) 870-4138
Jericho, NY (516) 333-2266

Manhasset, NY (516) 869-8535
Camillus, NY (315) 487-5000
New Rochelle, NY (914) 235-4444
Troy, NY (518) 273-8411
Mexicali, MEX (714) 357-4717
Maumee, OH (419) 893-4288
Dallas, TX (214) 247-6679
San Angelo, TX (915) 658-3781
Cheyenne, WY (307) 632-9132
Ottawa, CAN (613) 741-7937
OVERSEAS
Capetown S.A. 2145-1047
Australia 877-6946



MICROCOMPUTER TECHNOLOGY INC.
3304 W. MACARTHUR, SANTA ANA, CA 92704
(714) 979-9923 • TWX 910-595-1902 MTISNA

Call or write for free brochure:
U.S. PRICES, F.O.B. SANTA ANA
CALIFORNIA AND MAY VARY BY AREA.
CP/M is a registered trademark of Digital
Research, Inc.

COMPUDIAL, INC.
"The Link Between Technology & People"

Cherry Hill Industrial Center
 2 Keystone Avenue / Cherry Hill, N.J. 08003
TELEPHONE
 (609) 424-4700 • (215) 629-1289

**The Leading Intertec Dealer
 In The Northeast**
Dealer and OEM Inquiries Invited
**Special Discounts on
 SUPERBRAINS**

SUPERBRAIN™
 Intelligent Video Terminal Systems
 350K or 700K of Disk Storage

w/64K Double Density, List \$3495
 w/64K Quad Density, List \$3995

CompuStar™
**MAINFRAME PERFORMANCE AT
 MICROCOMPUTER PRICES**
MULTI TASKING - MULTI USER

No networking degradation experienced as
 with single CPU systems. A business system
 priced comparable to the TRS-80™.

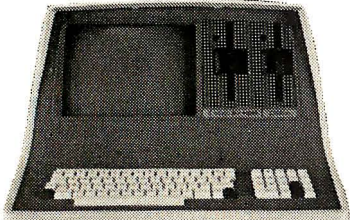

*Government and International
 Inquiries Invited*

PRINTERS
 Nec Spinwriter
 Data South
 Microline

MODEMS
 Racal-Vadic

**SOFTWARE FOR SUPERBRAIN
 AND COMPUSTAR**
 Accounts Payable
 Payroll
 Accounts Receivable
 Word Processing
 Many Others

FAST RELIABLE
 Hardware Service On Our Premises
 Or In Our Area

**For Information Or
 To order call (609) 424-4700**

SUPERBRAIN is a trademark of Intertec Data
 Systems. TRS-80 is a trademark of the Tandy
 Corp.

cut me out

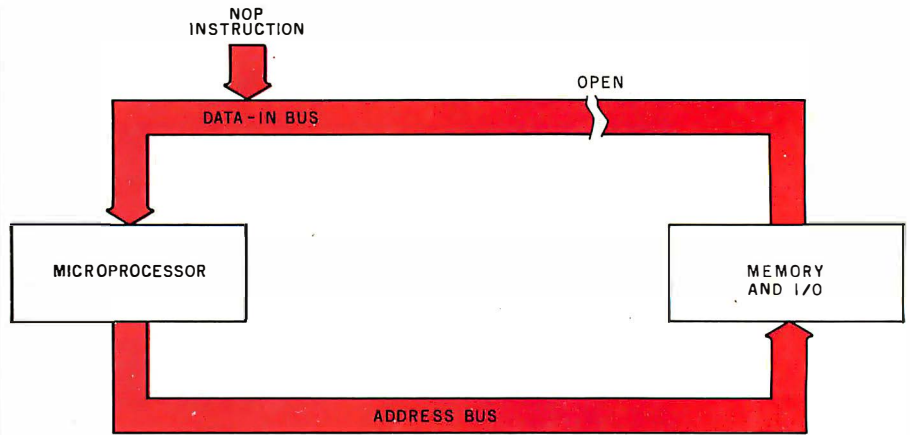

Figure 2: One method for generating signals for signature analysis. The data-in bus is opened, and a NOP instruction is forced on the bus. This causes the processor to constantly increment the program counter, so that a stream of values appears on each address line. Interrupts should be disabled.

computers have provision for signature analysis.

Fortunately, there is a signature-analysis technique, called *free-running* signature analysis, that can be applied to existing systems. Free-running analysis derives its name from the manner in which the data streams are generated. Unlike the diagnostic-program method, which uses a program to generate the data-bit stream, the free-running method allows the microprocessor to continually increment its 16 address lines.

While free-running analysis does not supply as much testing capability as a built-in diagnostic program, it will generate a known data stream on each of the 16 address lines, check the microprocessor for basic operation, and check the operation of the data-in bus. (See the text box Signatures of a Free-running Microprocessor on page 194.) Additionally, other parts of the circuitry that use the address bus can use these data streams for the generation of signatures.

In order to use free-running analysis, two important hardware requirements must be met. First, the feedback loop within the processor must be opened (see figure 2). In most cases, this means opening the incoming bus lines. Second, a NOP (no operation) instruction must be inserted on the data-in bus. (In the case of the Z80 microprocessor, the NOP instruction is hexadecimal 00.)

Fulfilling these two requirements can be accomplished in several ways. If the system has input buffering on the processor board, as most S-100 systems do, the data-in lines can be disabled by removing the buffering devices and replacing them with a dual-inline header that has the NOP instruction hardwired on it. If you are lucky, the integrated circuits will be socketed and easy to remove. If not, they should be unsoldered, removed, and replaced with sockets to facilitate this operation. Any instruction internal to the microprocessor, such as an arithmetic or logical instruction, can be used in place of a NOP instruction, as it will perform the same function—incrementing the program counter to the next address without accessing the data-in bus.

For some S-100 users, the procedure of setting up for signature analysis is easier. The Ithaca Audio (now Ithaca Intersystems) Z80 board has a feature that causes the microprocessor to jump to a preset address upon reset. This transfers control to a monitor program whenever a reset occurs. The data-in buffer from the S-100 bus is disabled, and a NOP instruction is placed on the board's internal data-in bus. The program counter, which is reset to 0, increments each time the NOP instruction is encountered. This incrementing of the program counter continues until the program counter reaches the beginning address of the monitor pro-

Financial Planning...

from SuperSoft

SCRATCHPAD: SUPERSOFT'S ELECTRONIC WORKSHEET

ScratchPad is a user-interactive data modeling program suitable for financial planning or any general purpose modeling. Whether you are an executive, a researcher, or planning the family budget; you will find ScratchPad an invaluable tool in giving you the numeric correlations you need for sound decision making.

ScratchPad provides for labels and corresponding numeric data entries cross-referenced by row and column. Data entries are then defined as dependent variables in a user-created algebraic formula. You can now quickly see how changes in one or more variables affects all others.

ScratchPad includes the following

- Multiple screen splitting which allows two or more sections of the worksheet to be viewed simultaneously.
- Both immediate and deferred calculation modes allowing calculations to be either made as data is entered or deferred until later.

- Flexibility in entry and editing functions so that data can be entered or changed easily.
- Column widths are variable.
- Portions of the worksheet not currently being viewed can be quickly brought to the screen for either single or split screen viewing.
- Any portion of the worksheet can be printed as hardcopy at the user's discretion.

	JAN	FEB	MARCH	APRIL	MAY	JUNE

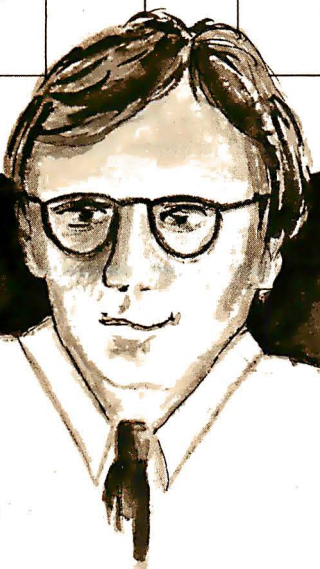
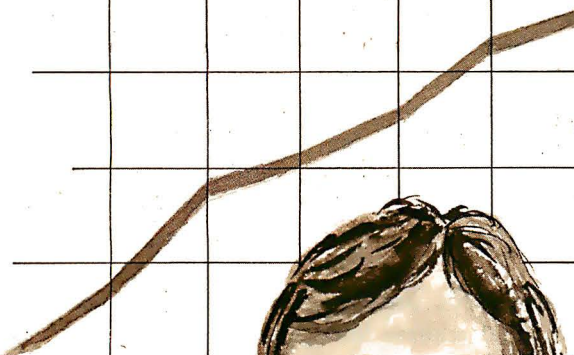

STATS-GRAPH: SUPERSOFT'S STATISTICAL DISPLAY PACKAGE

Stats-graph performs statistical analyses on user data and displays the results in graphic form.

Graphic formats include:

- Pie Graph
- Bar Graph
- Scatter Graph

Statistical Analyses include:

- Mean
- Median
- Minimum and Maximum values
- Standard Deviation
- Regression Analysis

Stats-graph is an easy-to-run, user-interactive program that presents valuable and often complex information in a concise and easily understood form.

Stats-graph performs statistical analyses on user data and displays the results in graphic form.

U.K. and Europe:
DIGITAL DEVICES
134 LONDON ROAD
SOUTHBOROUGH KENT
TUNBRIDGE WELLS
TN4 0PL ENGLAND
Tel.: 09582
Tel.: Tunbridge Wells (0892) 37977/9

Japan:
ASR CORPORATION INTERNATIONAL
1-2-B, SHIBA-DAIMON
TOKYO 105
JAPAN
Tel.: (03) 457-3901 Tel.: 242-3296

DATA-VIEW: THE EXECUTIVE ORGANIZER

Data-view is an easy-to-use, free formatted system for organizing information. It can be used as an electronic filing cabinet, an automated date book, or a computerized listing device. Insertion and retrieval of information is both simple and quick. Data may be retrieved by file, string, or key word, and any type of information can be stored.

ScratchPad:	\$200.00
Stats-graph:	\$200.00
Data-view:	\$200.00
Total Package:	\$500.00
Manuals only:	\$ 15.00

Software available for virtually all CP/M systems. Specify your system.

Available from fine dealers everywhere, or directly from:
SUPERSOFT, INC.
P.O. BOX 1628
CHAMPAIGN, IL 61820
217-359-2112 Telex: 270365
Technical Hot Line: 217-359-2691



First in Software Technology

1981

MICRO-TAX

Microcomputer Taxsystems, Inc.

Are you looking for the best tax package in the USA? Call MICRO-TAX For the 1981 Tax System

INDIVIDUAL PACKAGES

Level 1: 23 Schedules and Forms

: Multiple Clients

\$250 : Prints IRS Approved Forms

Level 2: 30 Schedules and Forms

: Multiple Clients

: Prints IRS Approved Forms

\$1,000 : Prints on IRS Forms or Overlays

: Depreciation System

: State Tax Interface

: Integrated Data Base

: Batch Compute and Print

PARTNERSHIP PACKAGE

Level 3: 20 Partnership Schedules and Forms

\$750 : Multiple Clients

: Prints IRS Approved Forms

: Prints on IRS Forms or Overlays

: Depreciation System

: Integrated Data Base

: Batch Compute and Print

Levels 2 and 3 are discounted to a total of \$1,500 if purchased at the same time.

Updates: Annual Updates are available.

Demonstration Package: Demonstration Packages are available for \$50.

State Systems: Information on Individual State Tax Systems is available upon request.

Transparent Overlays: Transparent Overlay sets are available.

All levels operate under most CP/M* formats including Apple*.

Compiled Microsoft Basic.

Consider the advantages this State-of-the-Art package can bring you:

- Complete System
- Versatility
- Complete In-Office Security
- Time Saving
- Pre Year-end Tax Planning

MICRO-TAX

Microcomputer Taxsystems, Inc.

22713 Ventura Blvd., Suite F
Woodland Hills, CA 91364
(213) 704-7800

Available at most Professional Computer Retailers



*CP/M is a TM of Digital Research.

*Apple is a TM of Apple Computer, Inc.

gram. An on-board decoder detects that the program counter has reached the proper address, removes the NOP instruction from the data-in bus, and enables the S-100 data-in buffer. The address at which all this happens is user-selectable through a set of switches mounted on the board. If all the switches are open, no decoding address is selected, and the program counter will increment continuously. This, in essence, gives you the capability to do a free-running signature analysis simply by performing the following operations:

1. Open all the jump-address switches (switch at IC28 on the Ithaca Intersystems Z80 board).
2. Enable the auto-jump on reset.
3. Connect the Start and Stop lines to A15 (pin 32 on the S-100 bus). Select falling-edge trigger on the signature-analyzer probe.
4. Connect the Clock line to sMEMR (pin 47 on the S-100 bus). Select rising-edge trigger on the signature-analyzer probe.
5. Turn on power to the system and reset.

When the above steps are performed, the individual address lines can be probed with the signature-analyzer probe, and if they are func-

tioning normally, the results will be as shown in table 2. Any other reading indicates a problem with the hardware, assuming, of course, that the setup of the analyzer is correct.

This illustrates another major advantage of signature analysis. The interpretation of the signature is based on a "go/no-go" technique. If the signature observed differs by even one digit from the signature known to be correct, a problem is indicated. Regardless of the type of processor used in the system, as long as the processor can be set up for free-running analysis and has 16 address lines, the results shown in table 2 are valid.

For applications in systems other than that described above, refer to the references listed at the end of this article.

Troubleshooting Techniques

Troubleshooting when using signature analysis can be done in several ways. One is to start with the processor and continue checking with additional buffers, gates, etc., until a bad signature is found. Ideally, the faulty hardware will lie somewhere between the bad reading and the previous good reading.

An equally valid troubleshooting technique is to take a reading midpoint in the circuit. If a bad reading is

Signal Name	S-100 Pin	Signature	Analyzer Control Line	Trigger Edge
Ground	50 and 100	—	Ground	—
sMEMR	47	—	Clock	Rising
A0	79	UUUU	—	—
A1	80	5555	—	—
A2	81	CCCC	—	—
A3	31	7F7F	—	—
A4	30	5H21	—	—
A5	29	OAF A	—	—
A6	82	UPFH	—	—
A7	83	52F8	—	—
A8	84	HC89	—	—
A9	34	2H70	—	—
A10	37	HPP0	—	—
A11	87	1293	—	—
A12	33	HAP7	—	—
A13	85	3C96	—	—
A14	86	3827	—	—
A15	32	755U	Start	Falling
A15	32		Stop	Falling

Table 2: Signals of interest on the S-100 bus. Using free-running analysis, many portions of an S-100 computer system can be tested. The signatures are the same for all computers that use a 16-bit address.

Mindful Machines

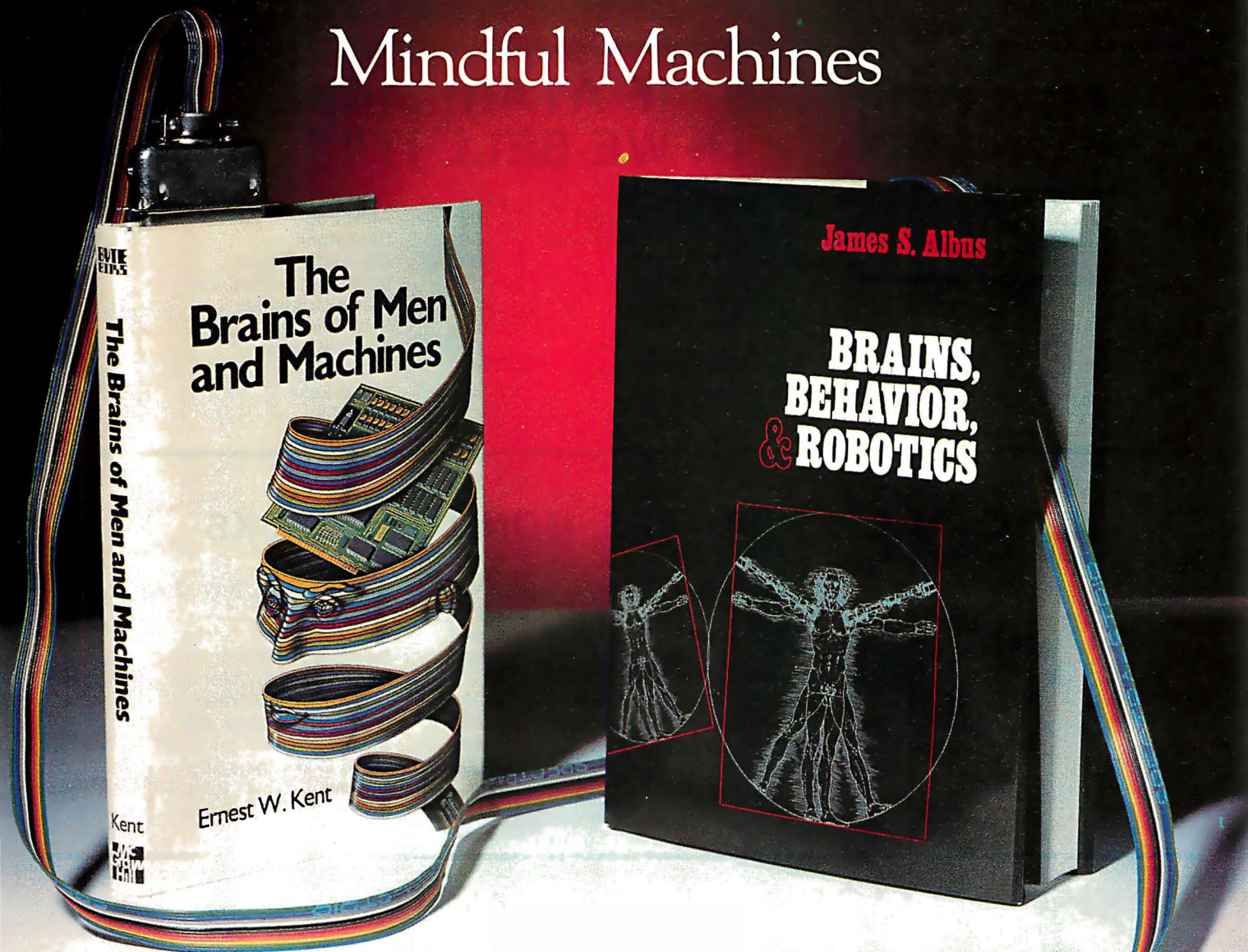

On the leading edge of the current technological revolution, these two books are written by modern thinkers who, like the Renaissance sages of an earlier time, venture across the boundaries of traditional disciplines to create vivid, detailed studies of humanity's quest for self-contained thinking machines.

In *Brains, Behavior, and Robotics*, Dr. James Albus demonstrates through an analysis of the processing hierarchies of the human brain that in our own heads we find the best model for an artificial intelligence computer. He goes on to survey the state of the art of robotics and concludes by portraying the social and economic impact of the coming "robot revolution."

Dr. Ernest W. Kent writes in *The Brains of Men and Machines* of the complex relationship between humans and machines. Drawing on the latest research in physiological psychology, he predicts that the more intelligent our machines become, the more they will resemble their creators in methods of processing information, storing data, solving problems, and even in their very circuitry.

Complete with extensive bibliographies, both *The Brains of Men and Machines* and *Brains, Behavior, and Robotics* will fascinate the layman and challenge the professional.



Please send _____ **Brains, Behavior, and Robotics \$16.95**
 _____ **Brains of Men and Machines \$15.95**

Name _____

Check Enclosed _____

Address _____

Bill Visa/
Master Card # _____

Call Toll-Free 800/258-5420

City _____

State _____

Zip _____

Expiration Date _____

BYTE Books 70 Main Street Peterborough, N.H. 03458

Please add .75 per book to cover shipping cost.

**BYTE
BOOKS**

BI

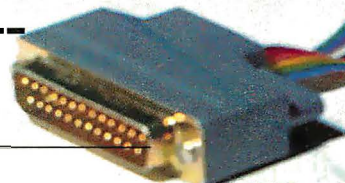

THE RIGHT PRODUCT

ATARI 800™
PERSONAL COMPUTER SYSTEM



\$789



**IF ATARI MAKES IT
WE SELL IT!!**

Atari 400 8K Computer	419	Atari Joysticks	18
Atari 800 16K Computer	789	Atari Paddles	18
Atari 410 Program Recorder....	69	Basketball	30
Atari 810 Disk Drive	499	Computer Chess	30
Atari 820 Printer	429	Invitation to Programming	17
Atari 825 Printer	695	Music Composer	45
Atari 850 Interface	169	Star Raiders	39
16K RAM by Microtek	99	Super Breakout	30
32K RAM by Microtek	189	3-D Tic-Tac-Toe	30
Assembler/Editor	45	Video Easel	30
		Visicalc	180

EPSON

PRINTERS, MONITORS, DISKS

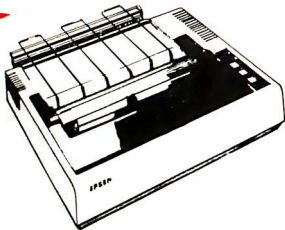

Daisy Wheel Printer by C. Itoh	1750	Amdek/Leedex B/W 12"	
Paper Tiger 445G	725	Monitor	129
Paper Tiger 460G	1194	NEC 12" Green Screen	239
Paper Tiger 560G	1495	Sanyo 9" B/W Monitor	169
Qume (shipped FREIGHT		Sanyo 12" B/W Monitor	255
COLLECT)	2499	Sanyo Green Screen	309
Silentype w/interface	349	Dysan Disks (pkg. 10)	50
Amdek Color Monitor	349	Memorex Disks (pkg. 10)	40
Amdek Green Screen	169	Opus Disks (pkg. 10)	30
		Verbatim "Gold" (pkg. 10)	35

MONTHLY SPECIALS!

VERSA-WRITER DIGITIZER \$239

SSM A10 \$149

CALL FOR PRICE
BASIC UNIT
UNDER \$1200

NEC **PC-8000 Series**
Microcomputer System.

ROM
24K Bytes (expandable to 32K Bytes)

CPU
μPD780c-1 (Z-80A compatible), 4MHz

RAM
32K Bytes (expandable to 160K Bytes
with PC-8012A I/O Unit.

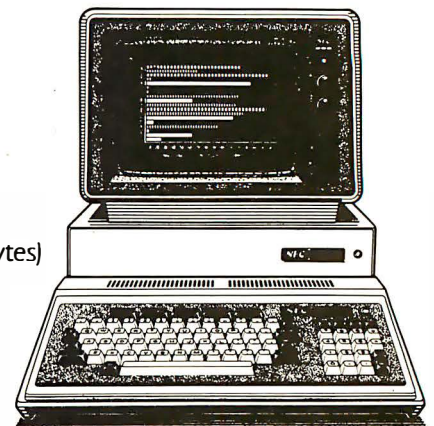

The end of the compromise.

AT THE RIGHT PRICE

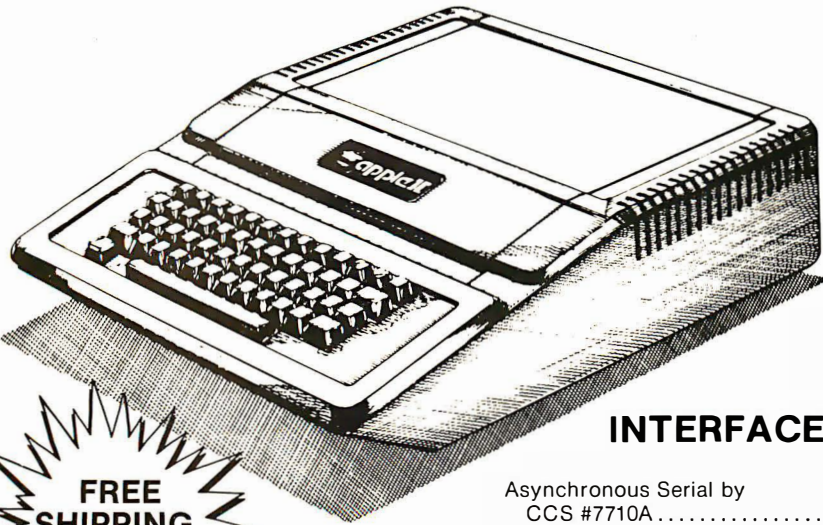

apple II 48k computer

APPLE II 64K
\$1249

DISK WITH CONTROLLER NEW DDO 3.3 \$529
WITHOUT ... \$445 NEARLY EVERYTHING FOR APPLE

INTERFACE CARDS FOR YOUR APPLE

Asynchronous Serial by
CCS #7710A 129
Centronics Printer by
CCS #7728A 99

CPS Multifunction by Mtn. Comp. ... 239
IEEE with Cable by CCS #7490A ... 129
Parallel by CCS #7720A 99
SSM AIO 189

APPLE SOFTWARE

Adventure by Microsoft 27
Alien Rain by Broderbund 19
Apple Pie by Programma 119
Apple-Oids by CPC 25
Apple Panic by Broderbund 24
Asteroid Field by Cavalier 19
Basic Compiler by Microsoft 349
Business Pkgs. by Continental 199
Cosmos Mission by Astar 19
Desktop Plan I® 69
DB Master by Stoneware 199
Data Factory by Microlab 129
Gorgon by Sirius 35
Hungry Boy by Astar 21
Hi-Res Football by On-Line 31
Home Money Minder by Continental 29
Magic Window by Art-Sci 89
Orbitron by Sirius 25
Personal Filing System 84
PFS: Report 84
Phantoms 5 by Sirius 29

Pool 1.5 by IDS 29
Pulsar II by Sirius 25
Raster Blaster by Budgeco 24
Robot War by Muse 31
Sneakers by Sirius 24
Spellstar by Micropro 229
Sargon II Chess Game by Hayden .. 29
Space Game Album by Budgeco ... 39
Space Eggs by Sirius 25
Space Raiders by USA 25
Star Thief by Cavalier 25
Sub-Logic FS-1 Flight Simulator ... 34
Super Single Disk Copy Routine ... 35
Super Stellar Trek by Rainbow 33
Supertext II by Muse 129
Typing Tutor by Microsoft 17
Ultima by CPC 35
Visicalc I® 109
Wizard & The Princess by On-Line.. 32
Wordstar by Micropro 329
Zork by CPC 34

APPLE ACCESSORIES

16k Ramcard by MPC 139
Analog to Digital Converter by CCS
#7470A 99
Clock/Calendar Module by CCS
#7114A 75
Copyrom by Mtn. Comp. 51
DOS 3.3 — 3.2 Switch 29
Epson Printer Stand 29
Expansion Chassis by Mtn. Comp. .. 295
Joystick 47
Lower Case Adapter by MPC 35
Microstand for Apple &
2 Disk Drives 30
Micro-Sci A-40 Disk Drive CALL
Micromodem II by Hayes 299
Sup-R-Term by M&R 319
Paddles by T&G 32
Programmable Timer Module by CCS
#7440A 99
Solder Tail Board by CCS #7510A .. 22
Smartmodem by Hayes 239
Thunderclock by Thunderware Inc. . 129
Versa-Writer Digitizer
Drawing System 239
Keyboard Enhancer by Videx 115
Videoterm (80-column card)
by Videx 319
Wire Wrap Board by CCS #7500A... 21
Z-80 Softcard by Microsoft 299

Complete Line of Mountain Computer & Personal Software Products

CALL FOR FREE BROCHURE! 1-800-854-2833



TO ORDER: Phone or mail orders invited using VISA, MASTERCARD, AMERICAN EXPRESS, cashier's or certified check, money order or personal check (allow 10 business days for personal or company checks to clear). We accept PO's from Fortune 500 companies & U.S. Gov. Agencies. COD's accepted. Include 5% for UPS shipping, handling and insurance on all orders not prepaid with cash. Min. \$5 shipping. APO & FPO include 5% (\$15

min.) for postage. Shipping in CA add 6% sales tax. FOREIGN ORDERS include 1% handling (\$5 min.) shipped air freight collect only. Credit card, COD's & PO's not accepted on foreign orders. Please include phone number on all orders. All equipment is in factory cartons with manufacturer's warranty. Open products not returnable. Restocking fee charge for returned merchandise. Equipment subject to price change & availability. WE SHIP THE SAME DAY ON MOST ORDERS!

(714) 579-0330 • MAIL TO: 1251 BROADWAY, EL CAJON, CA. 92021

AUTHORIZED
APPLE
SALES &
SERVICE



DIV. OF
COMPUTER
METRICS
INC.

discovered, a new reading midway between the processor and the bad reading is made. In this way, the bad component will eventually be located through elimination. Conversely, if a good reading is found at the midpoint, the same technique is used, but in the other half of the circuit.

A good compromise is to take the initial readings at the S-100 bus lines, which can be accomplished quite eas-

ily with the aid of an extender board. This will very quickly indicate if the problem is on the processor board or elsewhere.

It is possible to test the other boards in the system, but keep in mind that the signatures obtained on the boards will vary as the board addresses are changed. Therefore, it is important that signature readings and the switch settings be recorded on the

schematic or on a table when the system is set up initially (see figure 3 and table 2). This will give you something to compare your readings with when a problem does occur.

Memory devices, ROMs (read-only memories), and I/O (input/output) circuits, asynchronous and otherwise, can be checked with the signature-analysis technique. Most often this is done with the aid of

Operating B&K Precision's Model SA-1010 Signature Analyzer

One instrument that will perform signature analysis is the B&K Precision Model SA-1010. It consists of a measurement unit containing the circuitry required to generate the signature, and SPI control and data probes, which are attached to the basic unit with a connector.

The SPI probe assembly consists of a control probe and a data probe. The control probe provides the control-signal interface between the system under test and the signature analyzer. The pod also contains switches to select positive- or negative-edge triggering of the control signals. Additionally, a switch is provided to select between CMOS (complementary metal-oxide semiconductor) and TTL (transistor-transistor logic) threshold levels.

The data probe is used to sample the data stream being measured. Built into the probe is a logic probe, which has LEDs (light-emitting diodes) to indicate the presence of high and low logic levels and pulses. The pulse LED will remain lit for a minimum of 100 ms, allowing the user to observe pulses as short as 10 ns. Also on the probe is a reset button that is used in conjunction with the hold button on the signature analyzer.

The SA-1010 unit contains a 4-digit display, used to show the signatures from the system being tested. To the left of the display is a Gate LED that, when lit, indicates that a measurement is being made. To the right of the display is an Unstable Signature LED. The Unstable Signature LED lights whenever the current signature reading

is different from the previous reading. This is useful in tracking down intermittent faults.

Under the display are three switches. The left switch is the Power switch. In the middle is the Hold switch. When the Hold switch is depressed and the reset button on the SPI data probe is pushed, a new signature will be generated and "held" on the display. When the Hold switch is in the extended position, signatures will be generated as long as a data stream is being sampled. The switch on the right is the Unstable Hold switch. When pressed, it will latch the Unstable Signature LED on whenever a change from one reading to the next occurs. To reset the Unstable Signature LED, the Unstable Hold button should be returned to the extended position. When in the extended position, the Unstable Signature LED will be lit only from the time a difference in two readings occurs until two consecutive identical readings are made.

Above the data-probe connector are connectors used to self-test the unit. When the control and data probe signals are connected to the appropriate points on the front panel, a signature of 0055 will be displayed if the instrument is functioning properly.

On the back panel is an output connector for an internally generated 1 MHz TTL-level clock. This clock can be used if the circuit under test has been removed from a system and clock pulses are required to drive the circuit.

The SA-1010 has a maximum operating speed of 20 MHz. Data must be present on the input line for a minimum of 10 ns prior to the clock pulse. No hold time is required after the clock pulse.



Photo courtesy of Dynascan Corporation.

Now it can be Revealed

GBS

The business software that solves problems your way.

So useful and
adaptable it's like
having an Award
Winning programmer
on staff.

What is GBS?

GBS is both a powerful, relational data base management system . . . and, more importantly, a very powerful applications development tool. As such, it can deliver programs that match **your** specific business requirements . . . not just those of the average business. The final result is increased productivity now and in the future.

Surprisingly Easy to Use

GBS has been honed and refined for two years, so it meets the needs of the user who wants programs that work without a lot of computerese! To that end, GBS operates with a simplified **fill-in-the-blanks** approach. The user merely fills in blanks and GBS does the rest . . . acting like an in-house programming whiz!

Since you need know **only 15 instructions** to utilize the full scope of GBS you should be able, after studying our exceptional documentation for a few hours, to develop your own business programs . . . general ledger, inventory control, order entry, job costing and more.

Relational Data Base

Management of business records is a must for profitability. GBS handles it for you with unbelievable accuracy, speed and ease. For example, three data files of up to 64 thousand records and 1 million characters can be concurrently in use . . . and multiple indexes fully maintained (yes, fully maintained!). GBS . . . truly the quality solution in business software.

Only \$700. On disk, including documentation.
Requires CP/M*

Dealer and distributor inquiries invited.

QUALITY SOFTWARE
6660 Reseda Blvd., Suite 105
Reseda, Calif. 91335
(213) 344-6599



Circle 314 on inquiry card.

*CP/M is a trademark of Digital Research.

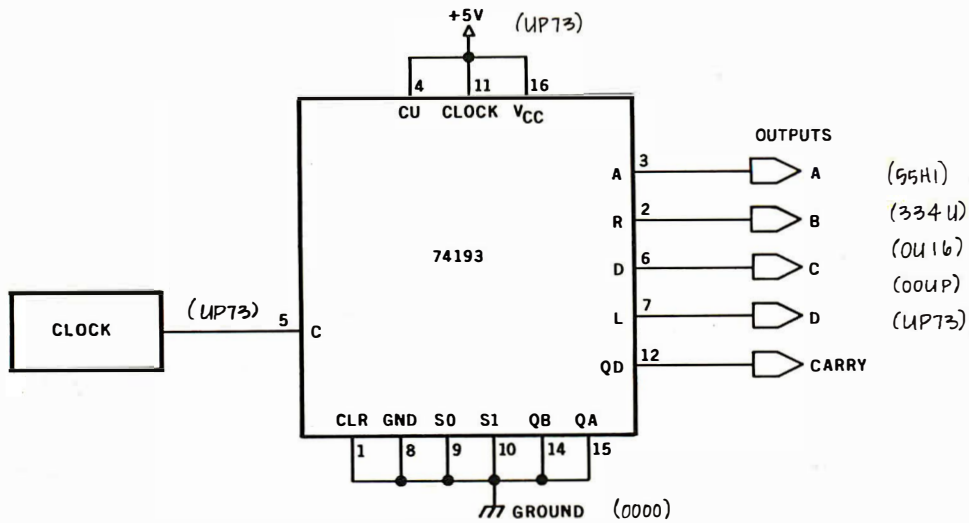

SIGNATURE ANALYZER HOOKUP

CONTROL SIGNAL	TRIGGER EDGE	IC PIN
START	FALLING	7
STOP	FALLING	7
CLOCK	FALLING	5
GROUND		8

Figure 3: An example of how a schematic diagram might be annotated to include signatures.

special diagnostic programs developed for the system. For more information, consult the references listed at the end of this article.

Conclusion

Signature analysis is a troubleshooting technique that is invaluable in locating hardware faults in complicated microprocessor circuits. To make maximum use of the technique, special programs should be used. However, since most systems do not presently incorporate this capability, free-running analysis is a viable alternative. The major limitation of signature analysis should be reemphasized: it is imperative that signatures be generated and recorded on the system before it breaks down. ■

REFERENCES

1. Hewlett-Packard Company. *A Designer's Guide to Signature Analysis*. Application note 222.
2. Ogdon, Gary. *Signature Analysis: A Way to Enhance the Serviceability of Microprocessor-Based Products*. The Hewlett-Packard Conference for Improving Productivity, Chicago, June 28 and 29, 1979.
3. Stefanski, Andrew. "Free Running Signature Analysis Simplifies Trouble Shooting." *EDN*, February 5, 1979.

CROMEMCO GSA SALES TO ALL GOVERNMENT USERS AND PURCHASERS

Systems Support, Inc. is a GSA qualified Cromemco vendor under ADP Schedule Contract No. GS-00C-02901. Purchase directly from us under our generous schedule terms and eliminate the slow bidding process. Our support commitment guarantees reliable product operation.

For more information call or write

SYSTEMS SUPPORT, INC.

1208 Shady Way
South Charleston, WV 25309

(304)766-7762

An Equal Opportunity Employer



JUNE 7-10 • ASTROHALL • HOUSTON, TEXAS

“ADVANCING PROFESSIONALISM”

Register now for the most prestigious computer conference in the world.

- ★ The conference that has progressed in quality each year since its inception.
- ★ The conference that continues its dedication to Advancing Professionalism – through an intensified emphasis on excellence in:
 - Plenaries and technical sessions
 - Professional Development Seminars
 - Services to international visitors
 - Exhibits of the latest technological advances

★ The conference that this year honors the developers of FORTRAN, the pioneer computer language.

To pre-register, just clip and mail this coupon. You'll save money on full conference registration. And you'll avoid time-consuming registration lines at the 1982 National Computer Conference.

★ The one computer conference you can't afford to miss.

A

Yes, I want to pre-register for NCC '82.
Please send me information.

Name _____

Title _____

Company _____

Address _____

City _____ State _____ Zip _____



Mail to: NCC '82
AFIPS
Box 9658
Arlington, VA 22209

Analyze Audio by Visualizing

Dr. Thomas Phillips
22 Newton Ave.
Norwich, NY 13815

Listing 1 is a program that allows you to digitally record approximately 1 second of sound (a word, a phrase, or a musical note), play it back (forward or reverse), and display all or any portion of it on a video screen. A routine is included that allows reverberation with variable delay; both are in 8080 source code.

My system uses a Cromemco D+7A A/D (analog-to-digital) converter and a Cromemco Dazzler as the graphics display. To record 1 second of sound (at the maximum sampling rate), 28 K bytes of programmable memory (from hexadecimal 7000 to E000) are required. In addition to the 219 bytes of memory required by the program, 2 K are used by the Dazzler display (driven by a short point-plotting routine in low memory).

Listing 2 is a North Star BASIC program. It is the main control program and is used to alter the audio parameters. The reverberation routine allows a time delay (adjusted by setting the joystick on the Cromemco console, analog input port 26). As Tom O'Haver discussed in his article "Audio Processing with a Microprocessor" (June 1978 BYTE, page 166), a long delay gives a reverberation

effect and a short delay causes a comb filter effect. With simple modification of the routine, phase phlanging could be performed.

Music enthusiasts can use this program to analyze individual notes of a particular instrument and to determine the amplitude of the major harmonics (via brute force or Fourier transformation). The results can help synthesize that instrument. (See Hal Chamberlin's "Advanced Real-Time Music Synthesis Techniques," April 1980 BYTE, page 70.)

The linguist can *graphically* demonstrate the subtle differences in enunciation, such as the unaspirated "Qui" in Spanish or French versus the aspirated "Key" in English. (See photos 1a and 1b.) Some experimentation may reveal "lie detector" applications involving vocal-stress analysis.

If you're a computer-speech experimenter, detailed analysis of vowel sounds and other phonemes can be made, which could help you develop software for speech simulation without the attendant hardware so common today. ■

Listing 1: 8080 routines for the audio-analysis program.

```

P
0010 * AAP & AAP2
0020 *****
0030 *
0040 * AUDIO ANALYSIS PROGRAM
0050 * BY TOM PHILLIPS 11-30-79
0060 * TO BE LOADED AT 0050H
0070 *
0080 * FUNCTIONS:
0090 * 1 INPUT VOICE SAMPLE
0100 * 2 PLAY VOICE SAMPLE FORWARD
0110 * 3 PLAY VOICE SAMPLE BACKWARD
0120 * 4 REVERBERATION (VARIABLE)
0130 * 5 DISPLAY EACH POINT SAMPLED FROM 7000H TO E000H
0140 * 6 DISPLAY EACH POINT (IN NARROWER RANGE)
0150 *
0160 *****
0170 JMP 2028H JUMP TO NORTH STAR DOS
0180 START JMP CON5 JUMP TO MAIN ROUTINE
0190 PFC DB 253 POINTS PER COLUMN
0200 TOP DB 0E0H TOP ADDRESS IN H OF HL
0210 BOT DB 070H BOTTOM ADDRESS IN D OF DE
0220 *****
0230 *
0240 * THIS ROUTINE COLLECTS THE INPUT SAMPLE IN RAM BUFFER
0250 *
0260 *****
0270 INPUT LXI H,07000H HL -> BOTTOM (BEGINNING) OF SAMPLE
0280 LXI B,0E000H BC -> TOP (END) OF SAMPLE
0290 INP IN 27 GET BYTE FROM A-D PORT
0300 MOV M,A PUT IN SAMPLE BUFFER
0310 INX H INCREMENT POINTER
0320 MOV A,H
0330 CMP B TOP OF SAMPLE?
0340 JZ CON5 YES, GO TO CONSOLE
0350 JMP INP NO, GET NEXT BYTE
0360 *****
0370 *
0380 * THIS IS THE MAIN ROUTINE WHICH SCANS THE CROMEMCO CONSOLE
0390 * 254 = 1 245 = 4 & 2
0400 * 253 = 2 246 = 4 & 1 (BYTE AT PORT 24 = BUTTONS DEPRESSED)

```

```

0410 * 251 = 3 243 = 4 & 3
0420 *
0430 *****
0440 CON5 NOP
0450 IN 24 SCAN CONSOLE
0460 CPI 254 IS IT 1 ?
0470 JZ INPUT YES, GET AUDIO INPUT SAMPLE
0480 CPI 253 IS IT 2 ?
0490 JZ PLAY YES, PLAY SAMPLE
0500 CPI 251 IS IT 3 ?
0510 RZ YES, RETURN TO BASIC CONTROL
0520 CPI 245 IS IT 4 & 2 ?
0530 JZ BACK YES, PLAY SAMPLE BACKWARDS
0540 CPI 246 IS IT 4 & 1 ?
0550 JZ REURB YES, GO REVERBERATE
0560 CPI 243 IS IT 4 & 3 ?
0570 JZ WAVE YES, DISPLAY WAVE
0580 JMP CON5 NO, GO RESCAN CONSOLE
0590 *****
0600 *
0610 * THIS ROUTINE PLAYS THE SAMPLE FORWARDS
0620 *
0630 *****
0640 PLAY LXI H,07000H HL -> BOTTOM OF SAMPLE
0650 LXI B,0E000H BC -> TOP OF SAMPLE
0660 PL MOV A,H GET NEXT BYTE
0670 OUT 25 SOUND IT
0680 INX H INCREMENT POINTER
0690 MOV A,H
0700 CMP B TOP OF SAMPLE?
0710 JZ CON5 YES, JUMP TO CONSOLE
0720 JMP PL NO, GET NEXT BYTE OF SAMPLE
0730 *****
0740 *
0750 * THIS ROUTINE IS THE SAME AS 'PLAY'
0760 * EXCEPT IT PLAYS THE SAMPLE IN REVERSE
0770 *
0780 *****
0790 RACK LXI H,0E000H
0800 LXI B,07000H
0810 RA MOV A,H

```

Listing 1 continued on page 208

“

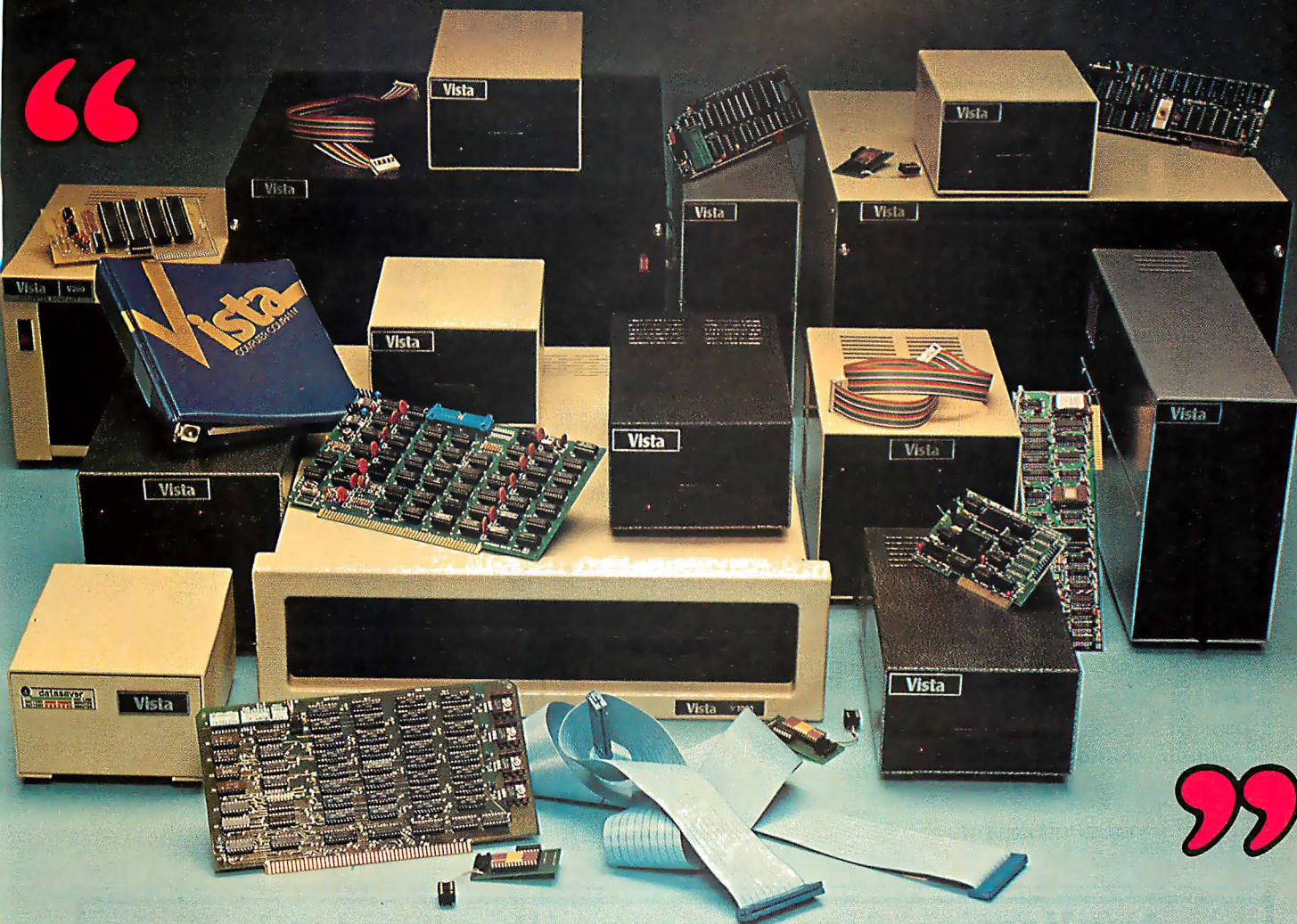

”

Vista Makes a Powerful Statement.

Mass storage. Music and video boards. Memory. Whatever you need to make your computer system more powerful and versatile, Vista Computer Company can provide it.

Ask us about disk drive subsystems. We have complete hardware/software packages for the Apple®, TRS-80™ and S-100 computer systems.

Ask us about advanced components for Apple® computers. We'll describe our Type-Ahead Buffer, Vista Vocalizer, Vision-80 and much more.

Our Products Speak for Themselves.

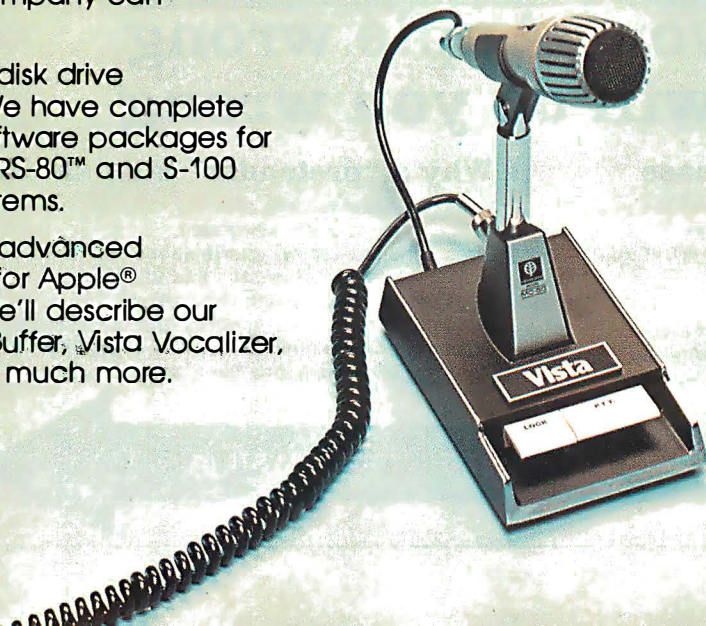

Ask us about our V-1000, a dual, eight-inch subsystem that combines state-of-the-art technology with state-of-the-art your budget pricing.

Ask us about the most innovative peripheral for the Apple®, and we'll give you a complete description of our A800 floppy disk controller.

Ask us for whatever you need to make your particular system fill your particular application. When you supply the questions, we supply the answers.

Vista COMPUTER COMPANY
1317 E. Edinger Avenue
Santa Ana, CA 92705
(714) 953-0523

Call Toll Free (800) 854-8017

© Apple is a registered trademark of Apple Computer, Inc.
™ TRS-80 is a trademark of Radio Shack, a Tandy Co.

```

0820 OUT 25
0830 DCX A
0840 MOV A,H
0850 CMP B
0860 JZ CONS
0870 JMP BA
0880 *****
0890 *
0900 * THIS REVERBERATION ROUTINE TAKES THE
0910 * INPUT SAMPLE CONTINUOUSLY & PLAYS IT
0920 * BACK CONTINUOUSLY. THE DELAY IS
0930 * DETERMINED BY THE DIFFERENCE BETWEEN
0940 * REGISTER PAIRS DE & BC.
0950 *
0960 *****
0970 REVRB LXI B,07000H SET INPUT POINTER
0980 IN 26 GET REVERB DELAY BYTE
0990 SUI 30 SUBTRACT 30 TO CALIBRATE
1000 MOV D,A SET OUTPUT POINTER
1010 MVI E,00H
1020 REV IN 27 GET VOICE BYTE
1030 STAX B PUT IT WHERE BC POINTS
1040 INX B INCREMENT INPUT POINTER
1050 LDAX D FILL A WITH OUTPUT POINTER BYTE
1060 OUT 25 SOUND IT
1070 INX D INCREMENT OUTPUT POINTER
1080 MOV A,B
1090 CPI 0E0H IS INPUT POINTER AT TOP?
1100 CZ RSTB YES; RESET TO BOTTOM
1110 MOV A,D
1120 CPI 0E0H IS OUTPUT POINTER AT TOP?
1130 CZ RSTD YES; RESET TO BOTTOM
1140 IN 24 CHECK CONSOLE
1150 CPI 251 IS 3 DEPRESSED?
1160 JZ 2A04H YES; RETURN TO BASIC CONTROL
1170 CPI 247 IS 4 DEPRESSED?
1180 JZ REVRB YES; GET NEW REVERB DELAY BYTE
1190 JMP REV NO; CONTINUE WITH SAME DELAY BYTE
1200 RSTB LXI B,07000H
1210 RET
1220 RSTD LXI D,07000H
1230 RET
1240 *****
1250 *
1260 * 'WAVE' DISPLAYS THE SAMPLE
1270 * ON THE GRAPHICS DEVICE
1280 *
1290 * 'PIXEL' IS A USER SUPPLIED ROUTINE TO
1300 * PLOT A POINT.
1310 *

```

```

1320 * 'X' IS A MEMORY LOCATION USED FOR STORAGE
1330 * OF THE X-COORDINATE LOCATION.
1340 *
1350 * 'Y' IS A MEMORY LOCATION USED FOR STORAGE
1360 * OF THE Y-COORDINATE LOCATION.
1370 *
1380 *****
1390 WAVE NOP SET UP CONSTANTS
1400 MVI A,1
1410 STA SWB TURN PIXEL ON
1420 MVI A,0 X LOCATION=0 (BEGINNING OF SCREEN)
1430 STA XLDC
1440 LDA PPC POINTS PER COLUMN IN B
1450 MOV B,A
1460 LDA TOP
1470 MOV D,A TOP IN DE
1480 MVI E,0
1490 LDA BOT
1500 MOV H,A BOTTOM IN HL
1510 MVI L,0
1520 WA MOV A,H GET NEXT BYTE (AMPLITUDE)
1530 ADI 68 CALIBRATE CENTER OF SCREEN
1540 STA Y STORE AS Y-COORDINATE
1550 LDA XLDC GET X-COORDINATE
1560 DCR B DECREMENT PPC; LAST POINT?
1570 JNZ W1 NO; CONTINUE
1580 INR A YES; INCREMENT X LOCATION
1590 PUSH PSW SAVE XLDC
1600 LDA PPC
1610 MOV B,A RESET POINTS PER COLUMN
1620 POP PSW RESTORE XLDC
1630 W1 STA XLDC STORE X LOCATION
1640 STA X
1650 PUSH D
1660 PUSH B
1670 CALL PIXEL PLOT A POINT
1680 POP B
1690 POP D
1700 INX H INCREMENT POINTER
1710 MOV A,H
1720 CMP D POINTER AT TOP?
1730 JM WA NO; GET NEXT BYTE
1740 JMP CONS YES; GO SCAM CONSOLE
1750 PIXEL EQU 10 PLOT A POINT
1760 X EQU 13 X LOCATION OF PIXEL
1770 Y EQU 14 Y LOCATION OF PIXEL
1780 SWB EQU 15 I=PIXEL ON 2=PIXEL OFF
1790 XLDC DB 0
1800 *

```

Application development with a "pretender"

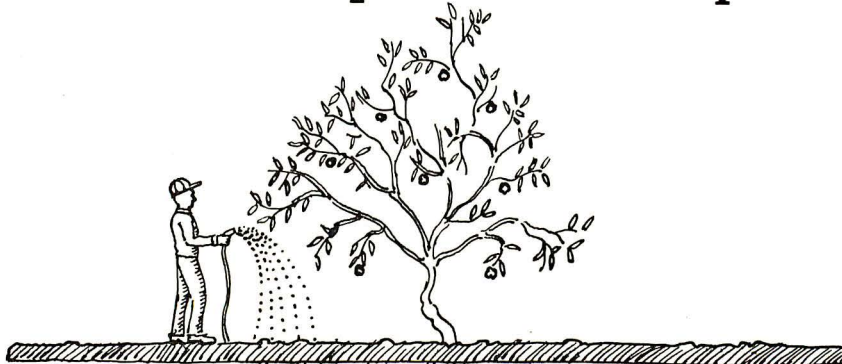

**Treat your Apple wrong
and it will do you wrong**

You need a true data base management system,
not merely a file management system, for
productive application development for an Apple.

What you don't need
is a "pretender",... a so-called "data base
system" that offers no more than ISAM or
b-tree files, sometimes with secondary keys.

Why a "pretender" falls short:

- Does not allow records of many different record types to be integrated.
- Does not allow record interrelationships to be easily represented and utilized.
- Does require forced data redundancy.
- Does not enforce data integrity and consistency.
- Does not provide built-in recovery capability.
- Does not allow performance tuning.

For a real data base management system!

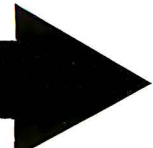

Application development with a **Z-65!**

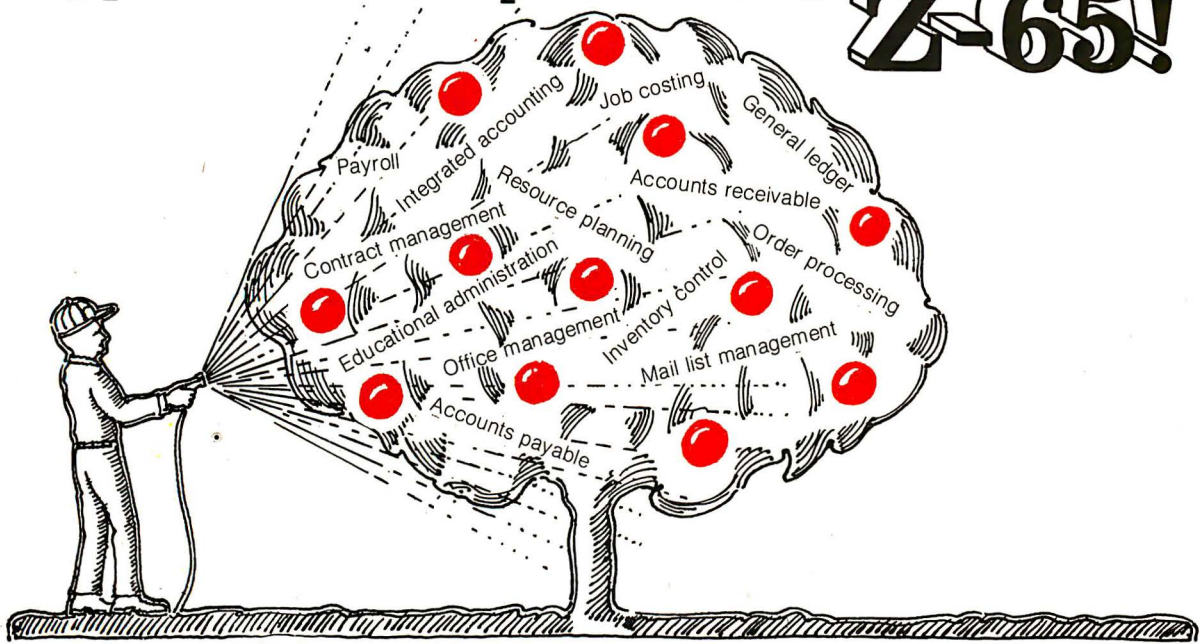

Treat your Apple right (and it will do you right)

To treat your Apple right, you need the

Z-65 DATA BASE PROCESSOR

As an application development tool for the Apple Computer, the Z-65 is unmatched in power, flexibility, and productivity. The Z-65 consists of a Z80 cpu, a 6502-Z80 interface, and a Z-80 implementation of MDBS, the leading data base management system for small computers. With the Z-65 you get:

the convenience of performing all development in the Apple DOS and Applesoft BASIC environment.

a dramatic increase in the memory available for application programs. The Z-65 is only 20Kb, the most compact data base software in existence.

a significant increase in speed; data manipulation is handled by the Z80 cpu.

state-of-the-art data base management features available only in Micro Data Base Systems' MDBS.

Enjoy genuine data base management

MDBS provides host language interface, ad hoc retrieval with a single statement, control over data redundancy, automatic data integrity and security enforcement, automatic transaction logging and recovery, dynamic restructuring... and more.

MDBS is the most widely used genuine data base management system in the world of small computers. It offers extraordinarily flexible data structuring facilities, far superior to the old hierarchical, network, and relational approaches.

The Z-65 is revolutionary!

It will revolutionize your approach to application development. It will enable you to take full advantage of the real potential of your Apple. It will reduce programming effort and increase performance. For further information, call, write, or TWX us today!

Ask about our educational courses on application development with data base.

Setting standards of excellence for data base software... worldwide.

Micro Data Base Systems, inc.

Box 248
Lafayette, Indiana 47902
317-448-1616/TWX 810-342-1881

Dealer/distributor/OEM inquiries invited.

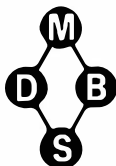

Yes, I'm interested. Please call me.

Please send me the complete MDBS Manual Set (5 Manuals + tutorial materials) at \$85 per Set. Indiana residents please add \$3.40 sales tax.

Name _____ Title _____
(Please print)

Company _____

Address _____

City _____ (State) _____ (Zip) _____

Phone _____

MAIL TO: Micro Data Base Systems, Inc.
P.O. Box 248-B
Lafayette, IN, 47902

Technical Forum

Listing 2: North Star BASIC driver program to be used with listing 1.

```

LIST
100 !*BAAP & BAAP2*
110 REM
120 REM BASIC AUDIO ANALYSIS PROGRAM (BAAP)
130 REM INTEGRATED WITH MACHINE LANG ROUTINE AT 0600H
140 REM BY TOM PHILLIPS 11-30-79
150 REM
160 !CHR$(7);\OUT14;0\FOR A=1 TO 700\ NEXT A \ REM TURN OFF DAZZLER
170 !* 1 - INPUT(1) PLAY(2) REVERSE(4 & 2) REVERB(4 & 1) RETURN(3)*
180 !* 2 - DISPLAY ANY SECTION OF INPUT SAMPLE*
190 !* 3 - AUTOMATIC INCREMENTING SEGMENTAL DISPLAY*
200 INPUT"YOUR CHOICE:";A
210 ON A GOTO 220,320,480
220 REM
230 REM (INPUT - PLAY - REVERSE - REVERB)
240 REM
250 OUT 14;0 \ REM TURN OFF DAZZLER
260 FILL 1544;112 \ REM BOTTOM
270 FILL 1543;224 \ REM TOP
280 FILL 1542;255 \ REM POINTS PER COLUMN
290 A9=CALL(1539) \ REM CALL AUDIO ANALYSIS PROGRAM
300 GOTO 170
310 REM
320 REM DISPLAY ANY SEGMENT OF SAMPLE
330 REM
340 FILL 3;0 \ A9=CALL(0) \ REM CLEAR GRAPHICS DISPLAY
350 !*ENTER '0' TO END*
360 INPUT"BOTTOM:";B \ FILL 1544;B
370 INPUT " TOP:";T \ FILL 1543;T
380 IF B=0 THEN 170
390 FILL 1542;(T-B)*2 \ REM POINTS PER COLUMN
400 FILL 14;127
410 FILL 15;1
420 FOR X=0 TO 128 STEP (128/(T-B)) \ REM OPTIONAL SCREEN DISPLAY OF CALIBRATION
430 FILL 13;X \ A9=CALL(10)
440 NEXT X
450 A9=CALL(1539) \ REM CALL AUDIO ANALYSIS PROGRAM
460 GOTO 320
470 REM
480 REM AUTOMATIC INCREMENTING SEGMENTAL DISPLAY
490 REM
500 INPUT"INCREMENT:";I
510 FOR A=112 TO 224 STEP I
520 FILL 3;0 \ A9=CALL(0) \ REM CLEAR GRAPHICS DISPLAY
530 FILL 1544;A \ REM BOTTOM
540 FILL 1543;A+I \ REM TOP
550 FILL 1542;I&2 \ REM POINTS PER COLUMN
560 IF A+I>224 THEN 610
570 !*NOW DISPLAYING";A;" TO ";A+I;
580 A9=CALL(1692) \ REM DISPLAY WAVE
590 !CHR$(13);
600 NEXT A
610 OUT 14;0 \ REM TURN OFF DAZZLER
620 GOTO 170
READY

```



Announcing...

The Birth of UNIX™

for CP/M™!

Brings to CP/M
Some of the
BEST FEATURES
of UNIX!

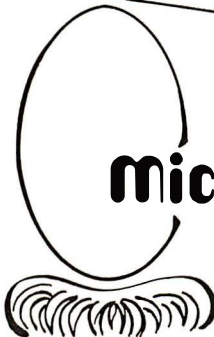

MicroShell™

- POWER of UNIX
- POPULARITY OF CP/M

Available for adoption by: CP/M SOFTWARE DEVELOPERS
CP/M SOFTWARE USERS

Console Input/Output Redirection	<ul style="list-style-type: none"> • Send Console Output to a File instead of or in addition to the screen Example: stat *.* > status - sends "stat" output to file "status" • Take Console Input from a File instead of the Keyboard Example: ed filename < script - takes "ed" commands from the file "script" • Indispensable for: graphic debugging, saving exact Screen Output for documentation, etc.
Automatic Command File Search Path	<ul style="list-style-type: none"> • MicroShell finds your program. User concentrates on the big tasks, MicroShell does the details • Permits development or data files on one drive and all programs on another • User-specified file types for Automatic Search. Example: ".com", ".int", etc. • User-specified Search Path. Example: Current Drive 1st, then Drive A, etc.
Multiple Commands Per Line	<ul style="list-style-type: none"> • User types a logical group of commands to be executed Example: compile file; link file; file • MicroShell executes the commands one at a time
Direct Command File Execution	<ul style="list-style-type: none"> • Files of CP/M or MicroShell commands are executed by MicroShell simply by typing file name • User-specified Command Filetypes. Example: ".sh", ".sub", etc. • Argument substitution (\$1, \$2, etc.) as with CP/M SUBMIT/XSUB
Additional Features	<ul style="list-style-type: none"> • User definable prompt with Disk Drive and/or User Number optional • Install program to customize MicroShell to user's needs & system • Others - ORDER MANUAL FOR FULL DETAILS

CP/M 2.2/32K Required

★ ADOPTION FEE: \$150.00
Manual Only: \$ 25.00
(VA residents add 4% sales tax)
VISA, Check or Money Order



NEW
GENERATION
SYSTEMS, inc.

Mail or Phone Adoption Requests to:
2153 Golf Course Drive
Reston, VA 22091
(703) 476-9143

CP/M - TM of Digital Research Corp
UNIX - TM of Bell Telephone Labs

210 January 1982 © BYTE Publications Inc

Circle 273 on inquiry card.



**Computers
for people.™**

800™ \$699

410 Recorder	\$59.00
810 Disc Drive	\$444.00
822 Printer	\$359.00
825 Printer	\$629.00
830 Modem	\$159.00
820 Printer	\$269.00
850 Interface	\$159.00
New DOS 2 System	\$21.00
CX70 Light Pen	\$64.00
CX30 Paddle	\$18.00
CX40 Joy Stick	\$18.00
CX853 16K RAM	\$89.00
Microtek 16K RAM	\$75.00
Microtek 32K RAM	\$169.00
One year extended warranty	\$50.00

ATARI 400

16K.... \$329
32K.... \$478
48K.... \$555

Intec 48K Board.....\$249

ATARI SOFTWARE

CX404 Word Processor	\$119.00
CX404 PILOT	\$68.00
CX413 Microsoft Basic	\$68.00
CX4101 Invitation To Programing I	\$17.00
CX4102 Kingdom	\$13.00
CX4103 Statistics	\$17.00
CX4104 Mailing List	\$17.00
CX4105 Blackjack	\$13.00
CX4106 Invitation To Programing 2	\$20.00
CX4107 Biorythm	\$13.00
CX4108 Hangman	\$13.00
CX4109 Graph It	\$17.00
CX4110 Touch Typing	\$20.00
CX4111 SPACE INVADERS	\$17.00
CX4112 States & Capitals	\$13.00
CX4114 European Countries & Capitals	\$13.00
CX4115 Mortgage & Loan Analysis	\$13.00
CX4116 Personal Fitness Program	\$59.00
CX4117 Invitation To Programing 3	\$20.00
CX4118-20 Conversational Languages (ea)	\$45.00
CX4121 Energy Czar	\$13.00
CXL4001 Educational Master	\$21.00
CX6001-17 Talk & Teach Series (ea)	\$23.00
CX8106 Bond Analysis	\$20.00
CX8107 Stock Analysis	\$20.00
CX8101 Stock Charting	\$20.00
CXL4002 Basic Computing Language	\$46.00
CXL4003 Assembler Editor	\$46.00
CXL4004 Basketball	\$24.00
CXL4005 Video Easel	\$24.00
CXL4006 Super Breakout	\$30.00
CXL4007 Music Composer	\$45.00
CXL4009 Chess	\$30.00
CXL4010 3D Tic-Tac-Toe	\$24.00
CLS4011 STAR RAIDERS	\$39.00
CXL4012 MISSILE COMMAND	\$32.00
CXL4013 ASTEROIDS	\$32.00
CXL4015 TeleLink	\$20.00
Visicalc	\$149.00
Letter Perfect (Word Processor) Source	\$109.00
	\$89.00



CBM 8032 \$1149

4016	\$799.00
4032	\$999.99
8096	\$1795.00
CBM4022 Printer	\$629.00
Tally 8024	\$1699.00
CBM C2N Cassette Drive	\$69.00
CBM4040 Dual Disk Drive	\$1039.00
CBM8050 Dual Disk Drive	\$1349.00
CBM 2031 Single Disc Drive	\$525.00
CBM 8300 Letter Quality Printer	\$1799.00
CBM 8023P 132 Column Printer	\$799

SOFTWARE

WordPro3 Plus	\$229.00
WordPro4 Plus	\$329.00
Commodore Tax Package	\$399.00
Visicalc	\$149.00
BPI General Ledger	\$329.00
OZZ Information System	\$329.00
Dow Jones Portfolio	\$129.00
Pascal	\$239.00
Legal Time Accounting	\$449.00
Word Craft 80	\$289.00
Create-A-Base	\$249.00
Power	\$89.00
Socket-2-Me	\$20.00
Jrnsam	\$Call
MAGIC	\$ Call

VIC 20 \$259

Vic-TV Modul	\$19.00
Vic Cassette	\$69.00
Vic 6 Pack Program	\$44.00
VIC1530 Commodore Datassette	\$69.00
VIC1540 Disk Drive	\$499.00
VIC1515 VIC Graphic Printer	\$399.00
VIC1210 3K Memory Expander	\$32.00
VIC1110 8K Memory Expander	\$53.00
VIC1011 RS232C Terminal Interface	\$43.00
VIC1112 VIC IEEE-488 Interface	\$86.00
VIC1211 VIC 20 Super Expander	\$53.00
VIC1212 Programmers Aid Cartridge	\$45.00
VIC1213 VICMON Machine Language Monitor	\$45.00
VIC1901 VIC AVENGERS	\$23.00
VIC1904 SUPERSLOT	\$23.00
VIC1906 SUPER ALIEN	\$19.00
VIC1907 SUPER LANDER	\$23.00
VIC1908 DRAW POKER	\$23.00
VIC1909 MIDNIGHT DRIVE	\$23.00
VT106A Recreation Pack A	\$44.00
VT107A Home Calculation Pack A	\$44.00
VT164 Programmable Character/Graphics	\$12.00
VT232 VICTerm I Terminal Emulator	\$9.00



HP•85 \$2595

NEW! HP•125	\$3295.00
HP•83	\$1795.00
HP•85 16K Memory Module	\$249.00
5 1/4" Dual Master Disc Drive	\$2129.00
Graphics Plotter (7225B)	\$2079.00

Call for HP Software Prices & Information.
Call for Calculator prices.

TI-99/4A \$379

PHC 004 TI-99/4 Home Computer	\$399.00
PHP 1600 Telephone Coupler	\$169.00
PHP 1700 RS-232 Accessories Interface	\$169.00
PHP 1800 Disk Drive Controller	\$239.00
PHP 1850 Disk Memory Drive	\$389.00
PHP 2200 Memory Expansion (32K RAM)	\$239.00
PHA 2100 R.F. Modulator	\$43.00
PHP 1100 Wired Remote Controllers(Pair)	\$31.00
PHM 3006 Home Financial Decisions	\$26.00
PHM 3013 Personal Record	\$43.00
PHD 5001 Mailing List	\$60.00
PHD 5021 Checkbook Manager	\$18.00
PHM 3008 Video Chess	\$60.00
PHM 3010 Physical Fitness	\$26.00
PHM 3009 Football	\$26.00
PHM 3018 Video Games I	\$26.00
PHM 3024 Indoor Soccer	\$26.00
PHM 3025 Mind Challengers	\$22.00
PHM 3031 The Attack	\$35.00
PHM 3032 Blast	\$22.00
PHM 3033 Blackjack and Poker	\$22.00
PHM 3034 Hustle	\$22.00
PHM 3036 Zero Zap	\$18.00
PHM 3037 Hangman	\$18.00
PHM 3038 Connect Four	\$18.00
PHM 3039 Yahtzee	\$22.00
PHM 3017 Terminal Emulator I	\$39.00
PHM 3026 Extended Basic	\$88.00
PHM 3035 Terminal Emulator II	\$45.00

Call for the best prices on
PRINTERS
by Epson, Diablo, TEC and Tally.

DISKS
by Atari and Maxell.

NO RISK • NO DEPOSIT ON PHONE, C.O.D. OR CREDIT CARD ORDERS.

east computer mail order west

800-233-8950

800-648-3351

501 East Third Street
Williamsport, PA 17701
(717) 327-9575

OVER 40 YEARS EXPERIENCE IN SOPHISTICATED ELECTRONICS



HOW TO ORDER:



Phone orders invited or send check or money order and receive free shipping in the continental United States. PA residents add 6% sales tax. Add 3% for VISA or MC. Equipment subject to price change and availability without notice.

P.O. Box 6889
State Line, Nevada 89449

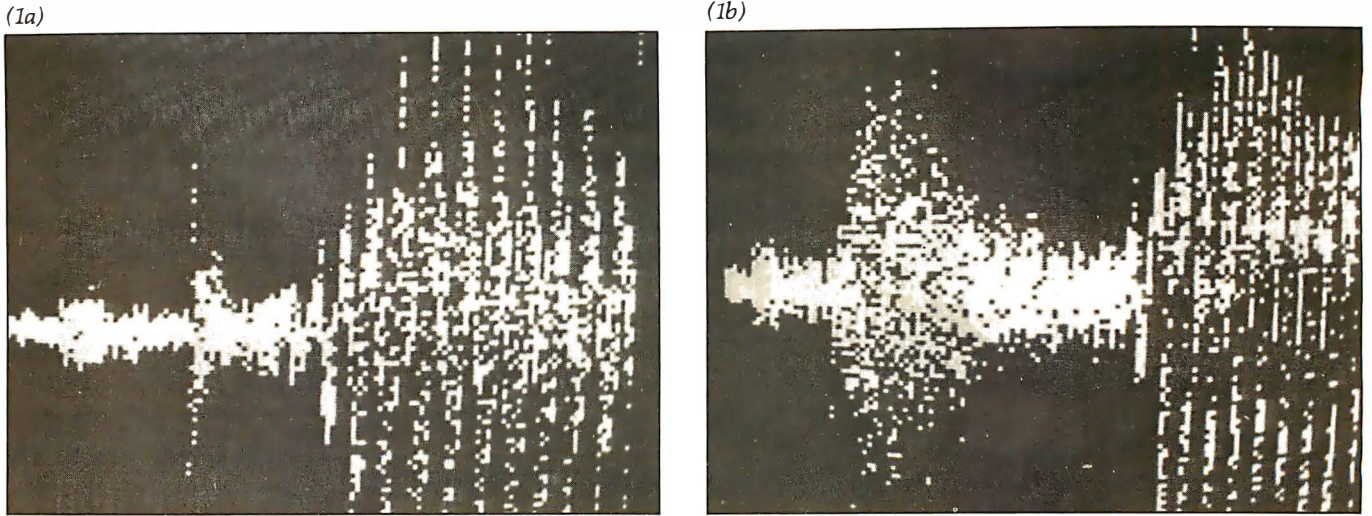

Photo 1: Video display of sample sounds as captured by the audio-analysis routine. Photos 1a and 1b show the difference between aspirated and unaspirated enunciations of the word "Tom."

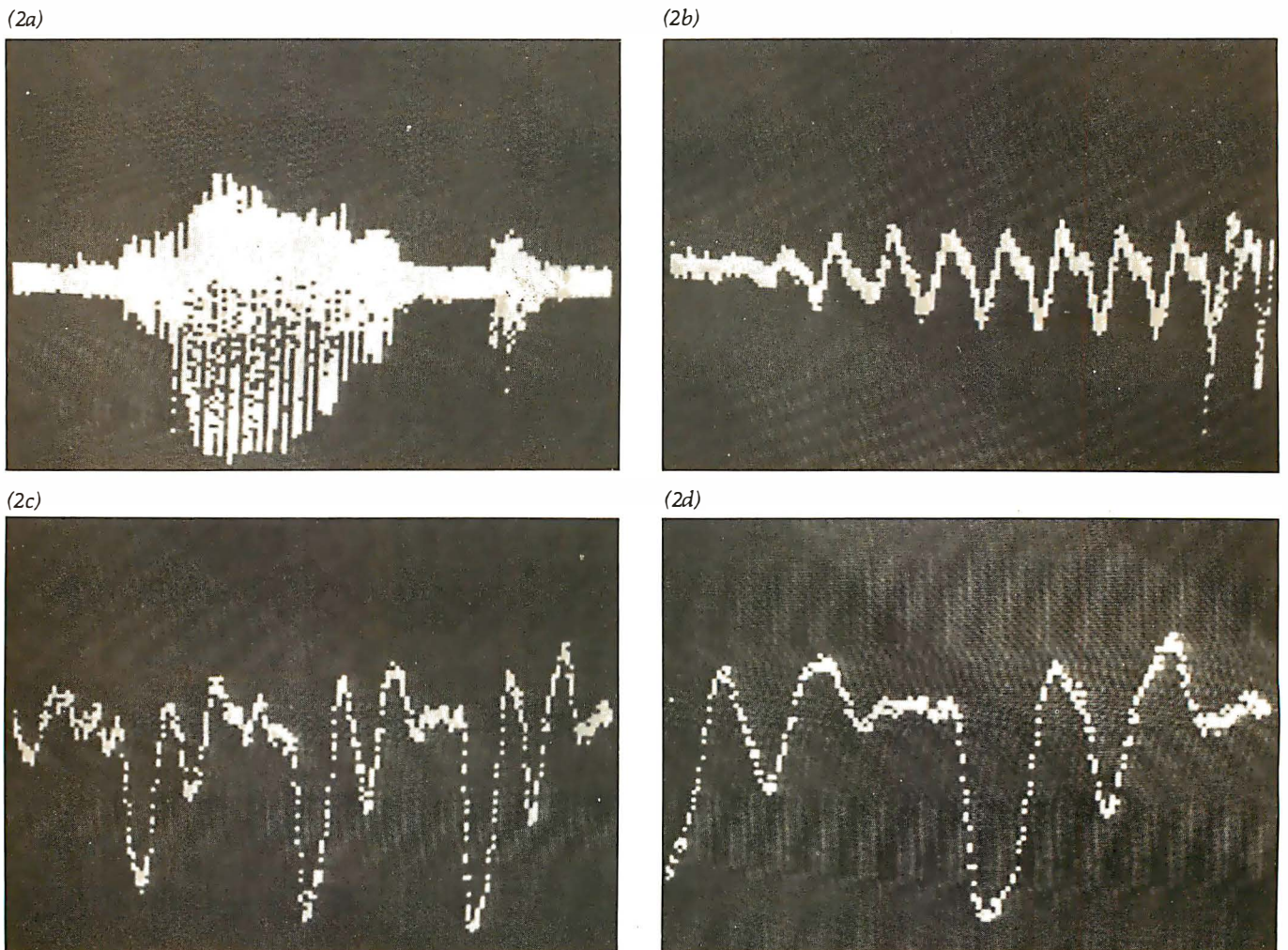

Photo 2: Progressive expansion of the word "boot." Note that the calibration dots at the top of the display provide a reference for the extent of the expansion.

SAVE / on Software for APPLE II[®]

SUPER SPECIAL - 50% OFF ON THE FOLLOWING APPLE PROGRAMS

APEX—The assembly language operating system for the Apple II—Total control of your Apple—fast program loading and execution—Flexibility—Efficiency.

Now only\$50.00

XPLO—A Block Structured—Pascal type high level language operating under APEX

Now only\$40.00

HANDY DISK—Utility programs and device handlers for the APEX operating system—A powerful alternative to Apple DOS.

Now Only\$20.00

THE EXTENDER—Extends Applesoft™ by adding these functions:

- Print using • Auto Line Numbering
- Decimal/Hex Conversion • High Resolution Screen Color Indication
- Single Color Screen Fill and more...

Now Only\$25.00

MORE APPLE SPECIALS

PASCAL GENERAL LEDGER—Menu driven general ledger program based on the Osborne System. Customized utility for a true turn-key general ledger system.
\$149.00

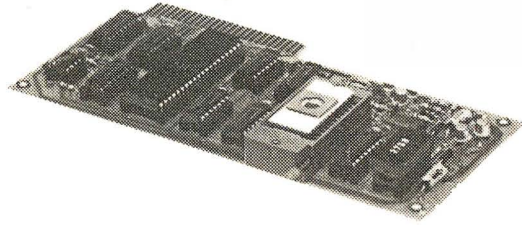

PROM BLASTER—Programs all 1K to 4K PROMS of 25XX & 27XX single or multi-voltage types—With all personality modules and read/write software.
\$149.00

PROFESSIONAL FOOTBALL PREDICTIONS

\$29⁹⁵

- Makes predictions for all 14 NFL games each week.
- Program's data base is updated weekly from your local newspaper's game statistics.
- Keeps complete record of all final scores and standings.
- Re-useable year after year.
- Very sophisticated program, yet easy to operate.

FOR YOUR APPLE II

*NOTE: Start saving your game results at the time of your order, APPARAT will provide the data base for the previous weeks games on the disk.

MISCELLANEOUS SUPPLIES

DISKETTES

Double density, soft sectored, replacement guaranteed, Spindle/Hub protected. (5¼" only)

Verbatim Datalife 5¼" 40 track \$24.95

PAPER

8½"x11" blank white, tractor feed paper, full box \$24.95

8½"x11" blank white, tractor feed paper, half box \$14.95

14½"x11" green bar, tractor feed paper, full box \$34.95

3½"x15/16" tractor feed mailing labels \$19.95

OTHER

5¼" plastic library case \$ 1.95

5¼" Flip-sort \$21.95

16K memory kits \$19.95

APPARAT'S TOP 15 APPLE GAMES SALE PRICE

1. Castle Wolfenstein (Muse).....	\$24.95
2. Gorgon (Sirius).....	33.95
3. Raster Blaster (Budgeco).....	24.95
4. Snoggle (Broderbund).....	20.95
5. Robotwar (Muse).....	33.95
6. Alien Typhoon (Brod.).....	24.95
7. Space Eggs (Sirius).....	24.95
8. ABM (Muse).....	20.95
9. Ultima (Ca. Pacific).....	33.95
10. Pool 1.5 (IDS).....	29.95
11. Voyage of the Valkyrie (AOS).....	33.95
12. Zork (Personal Software).....	33.95
13. Shuffleboard (IDS).....	24.95
14. Olympic Decathlon (Microsoft).....	24.95
15. Apple Panic (Brod.).....	24.95



Apparat, Inc.

"On-going Support for Microcomputers"

4401 S. Tamarac Pkwy. • Denver, CO 80237 • (303) 741-1778 • (800) 525-7674

APPLE IS A REGISTERED TRADEMARK OF APPLE COMPUTER

Freight F O B. Denver-call for shipping charges Foreign Orders shipped Air Freight



EPISODE™

THE VERSATILE COMPUTER

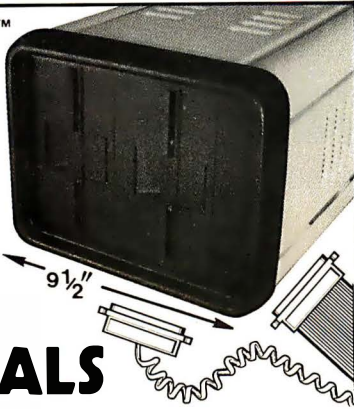

JUST ADD PERIPHERALS

EPISODE is a CP/M® computer with 1.6 M byte of disk storage on dual 5¼ floppies. Its compact design provides a wide range of standalone or network applications including data base sharing.

EPISODE gives you total flexibility. You can add your own CRT and Printer, whatever brand and price range you choose. All the logic including the 64K RAM memory is contained on a single 6" x 8" circuit board ensuring maximum reliability.

EPISODE includes a unique software system called SUPERVYZ™ - a menu based software control system that allows the user to integrate application programs.

Dealer inquiries invited, foreign and domestic.



Epic Computer Corporation
7542 Trade Street
San Diego, CA 92121
Tel: 714-695-3560

*Supervyz is a trademark of Epic Computer Corporation. CP/M is a trademark of Digital Research.

XENIX™-BASED WORK STATION

Here is the complete, no-compromise UNIX™-based package that gives you full UNIX power at truly minimal cost. Your investment is protected against obsolescence because we use industry standard components. Unlike other UNIX or "UNIX-act-alike" systems, this is a true, complete UNIX Version 7 running on a PDP-11. This is exactly as it was meant to be in the original design and conforms to Bell Laboratories UNIX Version 7 documentation.

MSD Corporation is making a special offer on our XENIX-based 23/256 Work Station:

- LSI-11/23 based processor with floating point, 256Kb random access memory, 4 port serial interface, 5 quad slots for expansion.
- Dual floppy subsystem, single sided (double sided may be specified at additional cost), bootstrap loader, formatting and diagnostic software.
- 20.8 Mb Winchester disk with integrated cartridge tape backup.
- One (1) VT-100 terminal with advanced video option.
- One (1) LA38-HA tractor feed printer with keyboard, numeric keypad and stand.
- One (1) Auto-Answer, Auto-Dial 300 Baud Modem.
- Cables for the above.
- XENIX Operating System, a true UNIX Version 7, configured for 4 users.
- Complete manual set and 1 year telephone support.

This system is expandable up to 8 users and 83.2 Mb of disk storage. Multiple work stations, terminals, other UNIX systems, or non-UNIX systems can be networked together with no additional software.

Price: \$23,256. Terms: 25% Down with purchase order, balance 75% upon delivery.



MSD Corporation
2449 Camelot Court, SE
Grand Rapids, MI 49506
(616) 942-5060

MANAGEMENT SYSTEMS DEVELOPMENT

UNIX and XENIX are trademarks of Bell Laboratories and Microsoft respectively.

Technical Forum

(3a)

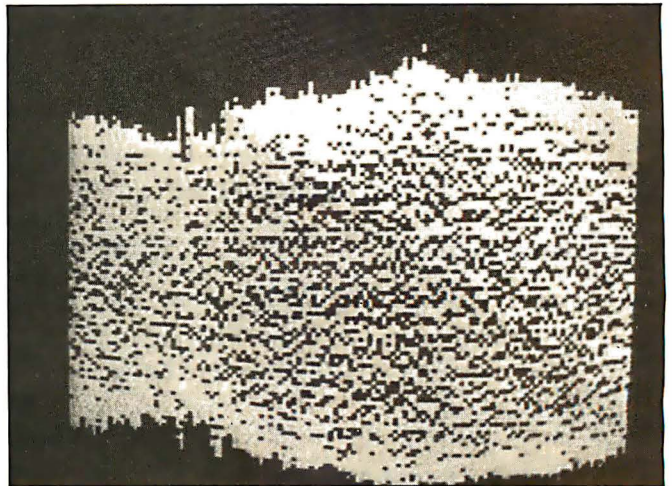

(3b)

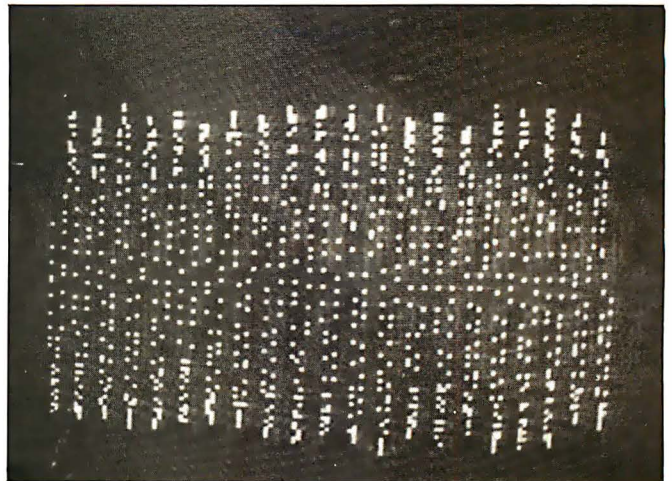

(3c)

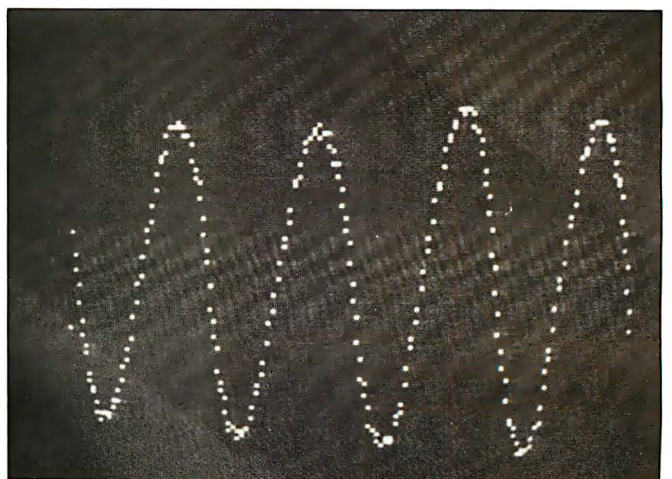

Photo 3: Progressive expansion of the note middle C as played on a recorder.

COMPATIBILITY

...that's the 910

You no longer have to pay high prices for conversational terminals. Now you can get TeleVideo's new 910 terminal at a low price.



- TeleVideo engineering provides you with switchable emulations of the ADDS 25/Viewpoint, Hazeltine 1410, Lear Siegler ADM-3A, 5A. Four switchable character fonts and five independently-controlled video attributes.
- Microprocessor design offers OEM's the flexibility of code changes.
- You will get TeleVideo's high quality value and features.
- The 910 uses the same monitor, keyboard, and case as our popular 912/920. This means field-proven reliability.



TeleVideo Systems, Inc.
1170 Morse Avenue
Sunnyvale, CA 94086
408/745-7760
800/538-8725 (outside CA)
TWX 910-338-7633

Nationwide field service is available from General Electric Co Instrumentation and Communication Equipment Service Centers.

The Value Leaders

Santa Ana, CA 714/557-6095; Sunnyvale, CA 408/745-7760; Dallas, TX 214/980-9978; Atlanta, GA 404/255-9338; Bloomindale, IL 312/351-9350; Morris Plains, NJ 201/267-8805; London 44-9905-6464

Memory Expansion for the ZX-80

Hilton K. Ernde
9357 Gap Rd.
Waynesboro, PA 17268

On first glance, the Sinclair ZX-80 seems to be an ideal personal computer. It is small (very), cheap (\$199), and has video output, cassette storage, plus a high-level language (BASIC). Sinclair is just now offering an expansion of the minuscule 1 K bytes of on-board RAM (programmable memory) to 16 K bytes, for less than \$100, and also offers an 8 K-byte floating-point BASIC for \$40. The machine appears ideal for running some interesting programs.

Though the availability of the 16 K-byte RAM is a recent development, my desire to expand the ZX-80's capabilities took root many months ago and caused me to take action myself. Being impatient, I decided to design my own 16 K-byte expansion using static, not dynamic, memory devices. (After I completed this expansion project, Sinclair's 8 K Extended BASIC became available. I am now using it with my 16 K-byte ZX-80.)

Selecting Memory

I used a commercially available

RAM board for two reasons: first, it is faster, as well as neat and clean, and second, the cost is about the same as a home-fabricated one. Only a few criteria need to be met for adaptability to the ZX-80. Operation at

Thanks to the Sinclair software, the extra memory is easy to check.

4 MHz is essential since the Sinclair clocks at 3.25 MHz, and it must be addressable in a contiguous 16 K-byte block starting at location hexadecimal 4000. Incidentally, trying to increase RAM size by more than 16 K is useless because the BASIC software will not access it. The exact reason for this will be shown in the section on checkout of added memory.

I chose the MEM-16151K board from Jade Computer Products (4901

W. Rosecrans, Hawthorne, CA 90250). It comes in kit form for \$169.95 and includes 16 K bytes of programmable memory in 2114-type static RAM ICs (integrated circuits). The board can contain up to 32 K bytes of RAM, which must be installed at either 0-32767 or 32768-65535, using a jumper to select the desired 32 K-byte block. To suit the requirements of the ZX-80, I installed the 16 K of RAM from 16384 to 32767.

Interfacing

Interface circuitry is required to make the board work with the ZX-80. As shown in figure 1, the Sinclair's edge-connector definitions look like plain old garden-variety Z80 CPU (central processing unit) signals, and they are . . . up to a point. The CPU in this small machine performs a lot of functions other than just number crunching; when not actually computing, it is making video, supplying TV sync, and reading the keyboard, to name a few. Consequently, the data bus (D0'-D7') is split internally

You know how an airplane simplifies business travel. Find out how Beech simplifies owning an airplane.

A company airplane simplifies business travel, many ways.

By freeing you from airline schedules that don't match your schedules.

By providing direct flights to everywhere the airlines go, plus literally thousands of places they don't.

By allowing your scarcest resource, qualified management, to be there, when and where they're needed.

You may know dozens of other ways. But you may not know how Beech simplifies airplane ownership and operation.

It starts with the comprehensive information in your free *Management Guide to Business Aviation* that helps you decide whether a Beechcraft can, indeed, be a profitable investment.

It extends throughout the network of Beechcraft Aviation

The Beechcraft Super King Air gives first class accommodations for 8-15 passengers at near jet speeds for over 2000 miles.



The Pressurized Beechcraft Duke carries six in cabin class comfort and quiet at over 280 mph.

Centers, where aviation professionals can help in every aspect of airplane purchase and operation.

And once you have purchased a Beechcraft, this same organization can teach you to fly or find you a qualified pilot. They can manage your maintenance. They've even gone so far as to operate a customer's airplane for him. Flying it, scheduling it, maintaining it, because that's what the customer wanted.

And finally, simple, reliable operation and fuel-efficiency comes standard with every Beechcraft business airplane. In its uncompromising quality, you find the reason why

Beechcraft owners experience minimum maintenance, low depreciation and a ready resale market.

If you would like to find out more, simply let us know.



Send for your free 1981 kit.

Write us on your company letterhead, and we'll send you everything you need to make an initial decision on the profitable use of a Beechcraft in your company. Write to: Beech Aircraft Corporation, Dept.MND, Wichita, Kansas 67201. If you'd rather call, call collect and ask for Del Chitwood, 316-681-8219. BY1



Member General Aviation Manufacturers Association

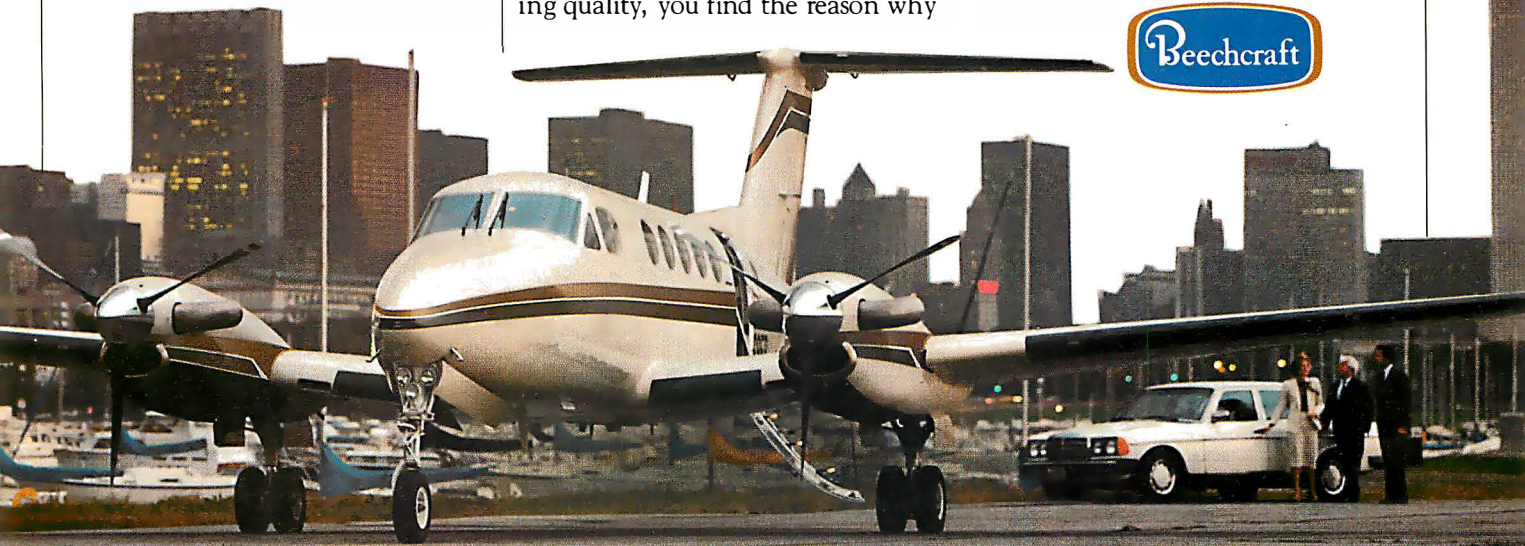

A Raytheon Company

For free information on learning to fly or upgrading your flying skills, plus the location of your nearest Beech Aero Center, call 1-800-331-1750 in the contiguous U.S. (In Oklahoma 1-800-722-3600). ASK FOR OPERATOR 701.

UNCLE SAM HAS YOUR NUMBER.



MICRO-TAX™ HAS HIS.

If any of the numbers in the table look familiar, MICRO-TAX is for you.

Because MICRO-TAX is the professional CP/M tax system that really makes dollars and sense.

FULL PROFESSIONAL FEATURES FOR AS LITTLE AS \$250.

Whether you're a tax professional doing thousands of forms a month or an individual filling in one excruciating return a year, you'll love MICRO-TAX.

MICRO-TAX computes and prints all the schedules and forms in the table. It's menu-driven, so you choose the number of what you want done, then respond to your computer's prompts.

MICRO-TAX prints questionnaires for any or all of the forms you select. Checks out alternatives for income averaging, minimum tax and maximum tax on earned income several different ways, then lets you know where your greatest savings are. Besides just preparing your returns, it's terrific for your tax planning.

And MICRO-TAX even generates IRS-approved forms.

DEPRECIATION, ACRS, BATCH COMPUTING/PRINTING.

For more complex returns, MICRO-TAX has all the sophisticated features you need.

The Partnership and Professional versions can maintain a depreciable asset master file and compute depreciation by individual items and groups.

Both versions handle the Accelerated Cost Recovery

*** MICRO-TAX SYSTEM DIRECTORY ***
1981 FEDERAL INCOME TAX

THE FOLLOWING FUNCTIONS ARE AVAILABLE

- | | |
|-------------------------------|-----------------------------------|
| 1 CREATE NEW FILES FOR CLIENT | 11 INITIALIZE A NEW CLIENT DISK |
| 2 SELECT SCHEDULES AND FORMS | 12 LIST CLIENTS ON FILE |
| 3 DISPLAY ACCOUNT STATUS | 13 ACTIVATE ANOTHER CLIENT |
| 4 PRINT QUESTIONNAIRE | 14 COPY CLIENT FILES |
| 5 ENTER DATA | 15 DELETE CLIENT FILES |
| 6 COMPUTE TAX | 16 EXIT TO STATE TAX TABLE |
| 7 DISPLAY TRIAL RETURN | 17 EXIT TO PARTNERSHIP TAX SYSTEM |
| 8 PRINT RETURN | 18 LOAD SALES TAX TABLE |
| 9 DEPRECIATION MODULE | 19 UPDATE SYSTEM FILE |
| 10 BATCH COMPUTE/PRINT | 20 SET SYSTEM SPECIFICATIONS |

EJ EXIT FROM SYSTEM

PLEASE ENTER FUNCTION NUMBER

System. Both operate in the batch mode, so you can enter data all day then compute and print at night.

And both versions, besides generating IRS-approved forms, can also print on standard IRS forms or on blank sheets for use with overlays.

MICRO-TAX is *the* professional tax planning and preparation system you've been waiting for.

MICRO-TAX IS BETTER THAN EVER.

This year MICRO-TAX is half the size and four times as fast as it was last year. It runs on any 56k CP/M micro, including the Apple, with at least 204k of disk storage (one or more drives, 110k/drive minimum).

It includes all the new 1981 regulations, but if there are any changes, just call CompuServe and they're yours, instantly.

And if you have any questions at all, you'll get your answers fast because we give you *two* technical hot lines: ours and a direct line to MICRO-TAX.

Now what could be finer than that?

OUR MONEY-BACK GUARANTEE.

If MICRO-TAX doesn't do just what you want it to do, return it in 30 days and we'll give you your money back.

But chances are you'll keep it because for the first time, your taxes can be as easy as 5, 6, 8 (see the display).

To get Uncle Sam's number, just use one of ours to order MICRO-TAX today: 800-854-2003 X823.

(CA: 800-522-1500 X823.)

The Discount Software Group, 6520 Selma Avenue, Los Angeles, CA 90028. For additional information, call Mark at (213) 837-5141.

UNCLE'S NUMBERS: MICRO-TAX'S NUMBERS:

SCHEDULES & FORMS	INDIVIDUAL	PROFESSIONAL INDIVIDUAL	PARTNERSHIP
1040, 1040A	•	•	•
1065	•	•	•
A, B, C, D, E, ES, G, R, RP	•	•	•
F, SE	•	•	•
K, K-1	•	•	•
2106	•	•	•
2119	•	•	•
2210	•	•	•
2440	•	•	•
2441	•	•	•
3468	•	•	•
3903	•	•	•
4137	•	•	•
4562	•*	•	•
4625	•	•	•
4684	•	•	•
4726	•	•	•
4797	•	•	•
4952	•	•	•
4972	•	•	•
5695	•	•	•
6251	•	•	•
6252	•	•	•
6765	•	•	•
Accelerated Cost Recovery System	•	•	•
Batch preparation and printing	•	•	•
Print:			
IRS-approved forms	•	•	•
On IRS forms	•	•	•
On blank sheets for overlays	•	•	•
	\$250	\$1000	\$750

*Printed, not computed.

Both: \$1500

Integrated State Income Tax programs from \$250 to \$750.

DISCOUNT SOFTWARE

Circle 127 on inquiry card.

and isolated from the CPU by 1-kilohm resistors.

Any additions to this data bus must not load it except when actually performing a memory read or write. Loading effects are *very* critical. Since several other signals appear to be reaching their maximum fan-out, I decided to build the interface on a separate card and buffer all of the signals to provide for reliable operation as well as future expansion capability without complications.

The interface circuits are shown in figure 2. Six 74LS367s make up buffers for all address and signal lines as well as a bidirectional data bus. Strictly speaking, the address buffers are probably not necessary since the memory card buffers them again (except, curiously, A10, A11 and A12), but I decided to do it anyway just to be safe. The other gate chips control the direction of the data bus and generate pseudo S-100 signals for the Jade board. PSYNC is generated at memory request time (MREQ) except

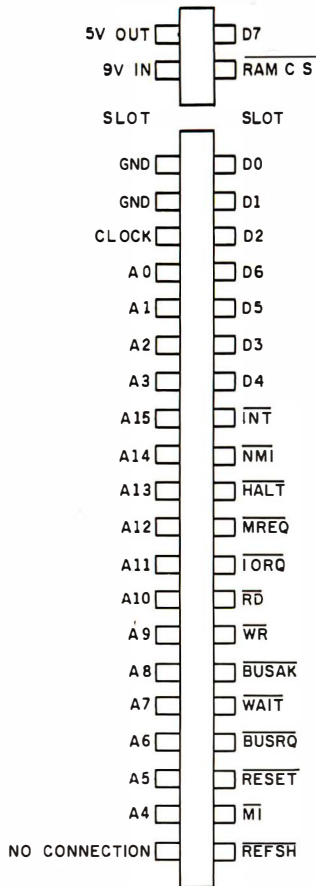

Figure 1: Signal pinouts on the ZX-80 connector as seen from the rear.

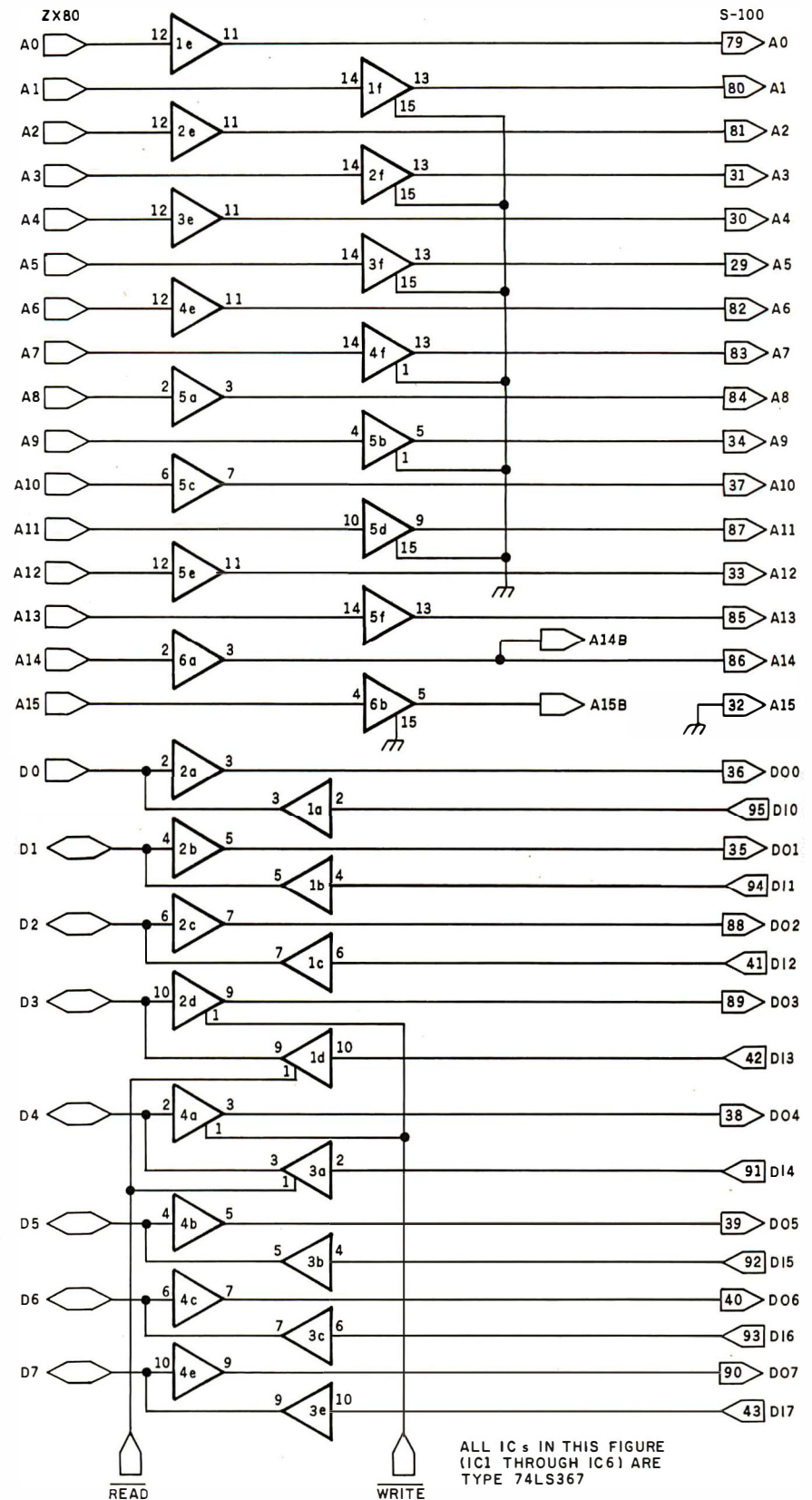

Figure 2: Schematic diagram of the ZX-80/S-100 interface. (Figure 2 continued on page 222.)

AIM 65. The professional's microcomputer.



Printer, display, full keyboard. Only \$465.00.

For professional learning, designing and work, Rockwell's AIM 65 microcomputer gives you an easy, inexpensive head start.

- 20-column printer and display
- Dual cassette, TTY and general purpose I/Os
- R6502 NMOS microprocessor
- System expansion bus
- Read/write RAM memory
- Prom/ROM expansion sockets
- Self-prompt interactive monitor firmware
- Terminal-style keyboard
- Options include:
 - Prom Programmer module
 - RM 65 standard modules and card cages

For more on AIM 65 and how you can develop programs in assembly language, BASIC, PL/65 or FORTH, write Rockwell International, Electronic Devices Division RC55, P.O. Box 3669, Anaheim, CA 92803. For location of nearest distributor or dealer call 800-854-8099 (in California 800-422-4230).



Rockwell International
...where science gets down to business

Circle 323 on inquiry card.



POWER FOR YOUR APPLE

SPEED II AND II+
LANGUAGE SYSTEMS

APPLESOFT: 30.3 MIN.
MICROSPEED II: 3.9 MIN.
MICROSPEED II+: 2.4 MIN.

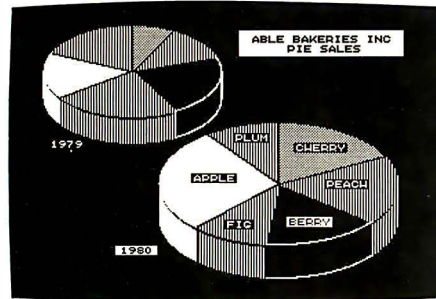

- FASTEST:** UP TO 100 TIMES FASTER THAN APPLESOFT
- MOST POWERFUL:** MORE POWER THAN BASIC PASCAL OR FORTRAN
- EXPANDABLE:** LANGUAGE BASED ON FORTH
- CREATIVE:** GROW YOUR OWN LANGUAGE
- USER-FRIENDLY:** EASIEST FOR YOU TO LEARN

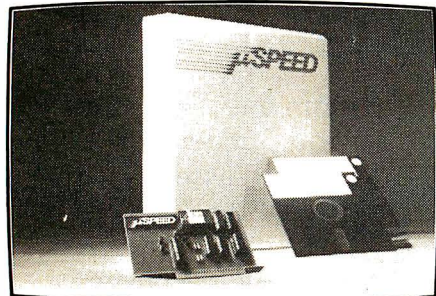

REQUIRES APPLE, SINGLE DISK
μSPEED II USES 2MHz PROCESSOR
μSPEED II+ USES 4MHz PROCESSOR

SEE YOUR DEALER OR CONTACT:

applied analytics incorporated

8910 Brookridge Dr., Suite 607, Upper Mariboro, Md. 20870
(301) 627-6650

I'm Interested: Please Send

μSPEED II \$495. 160 page Manual \$35.
 μSPEED II+ \$645. Detailed Information

Name _____
Address _____
City _____
State _____ Zip _____

Figure 2 continued:

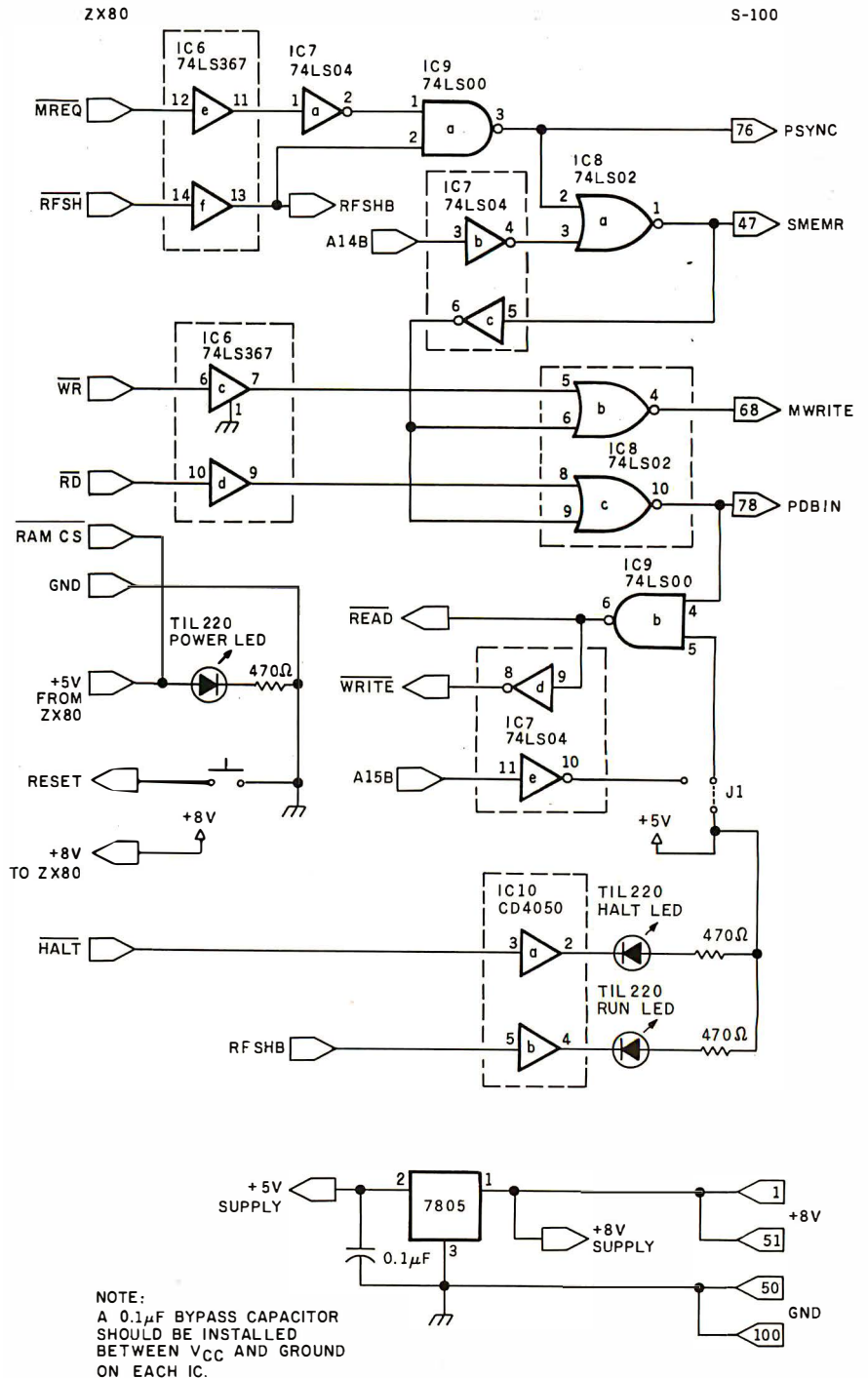

INTRODUCING MetaCard

The future for your Apple II.

MetaCard will turn your Apple II personal computer into tomorrow's high performance machine. It triples the memory of your Apple, and at the same time, greatly increases the processing speed with an Intel 8088 16-bit microprocessor. The future for your Apple is built into MetaCard.

Enough Memory to get the Job Done
MetaCard has up to 128K bytes of onboard memory with parity. Adding

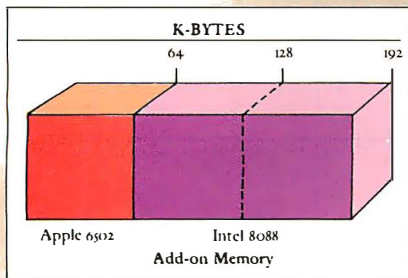

MetaCard to your Apple's existing 64K bytes of memory gives you three times the capacity, and opens the

door to applications never before possible on your system.

Faster Processing Speeds

Speed is just as important as memory. MetaCard is designed to handle all computing tasks at greatly increased speeds. The Intel 8088 operates at the full 5Mhz, running most applications at least 4 times faster than the Apple's 1Mhz 6502. And MetaCard gives you multiprocessing capabilities, allowing both the 8088 and 6502 to run simultaneously at full speed. Increased processing speeds, interprocessor interrupts and a real-time clock enable your Apple to perform like the machine you want.

Compatibility and Reliability

Compatibility has been designed into MetaCard. Metamorphic's processor card runs CP/M-86, which is included with the card at no extra cost. And Metamorphic offers UCSD Pascal 4.0 and the operating system for the IBM Personal Computer as options. Full parity checking,

power-up diagnostics and a 48 hour burn-in will insure the reliable performance of your MetaCard.



Find Out More
Not everyone needs greater memory and speed. If you're one of those who does, MetaCard is for you. At an introductory price of \$980 for the 64K configuration, it's

not the least expensive addition you can make to your system, but high performance products never are. Call us today and find out what Metamorphic Systems has in mind for your Apple's future. Dealer inquiries welcome. Metamorphic Systems, Inc., P.O. Box 1541, Boulder, Colorado 80306, (303) 499-6502.

Intel 8088 is a product of Intel Corporation.
Apple II is a registered trademark of Apple Computer Inc.
CP/M-86 is a registered trademark of Digital Research Corp.
IBM Personal Computer is a registered trademark of IBM.
U.C.S.D. Pascal is a registered trademark of the University of California.

METAMORPHIC SYSTEMS, INC.

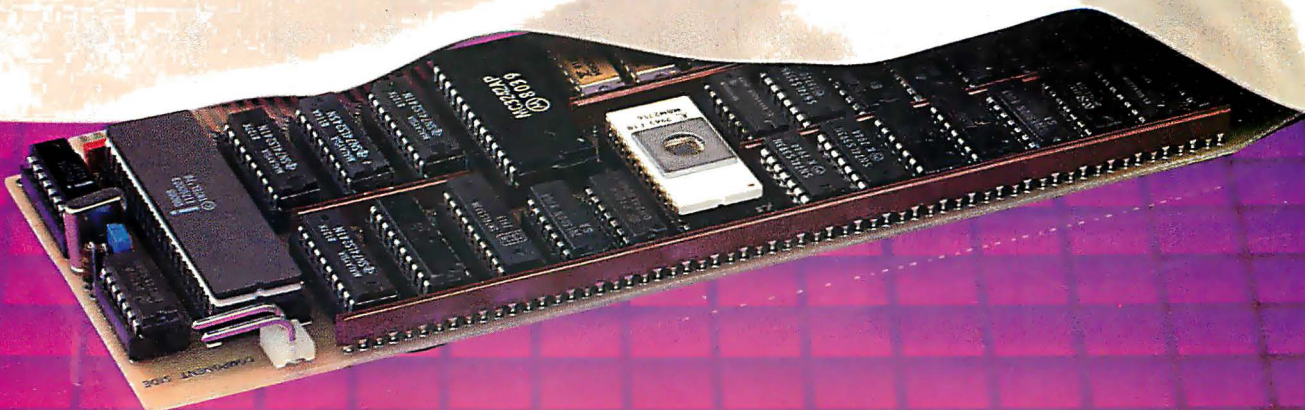

We will meet or beat any price in the U.S.A. on



TRS-80 MICROCOMPUTERS

In fact, no matter what price you see advertised by Micro Management, Perry Oil, Pan American, or any authorized Radio Shack dealer for TRS-80 Computers with pure factory installed memory and full warranty, **we'll beat it!**

ATARI® MICROCOMPUTERS



We have consistently offered the complete TRS-80, ATARI, EPSON, APPLE, and MAXELL lines at the best prices in the U.S.A. And we offer the best delivery from the largest inventory in the Northeast.

If you're looking for the best prices in the U.S.A., check the others but call Computer Discount of America.

TRS-80 and Radio Shack are trademarks of Tandy Co.

CALL TOLL FREE: 800-526-5313

Computer Discount of America

COMPUTER DISCOUNT OF AMERICA, INC.
 15 Marshall Hill Road, West Milford Mall
 West Milford, New Jersey 07480-2198
 In New Jersey Call 201-728-8080

during refresh (\overline{RFSH}), since the ZX-80 uses the refresh cycle in its video-generating mode. All other S-100 signals are dependent on PSYNC. SMEMR will occur during a memory request when A14 is active, an access in the range hexadecimal 4000 to 7FFF where the ZX-80 expects to find programmable memory. MWRITE and PDBIN are keyed by \overline{WR} and \overline{RD} , respectively, plus SMEMR. Refer to the timing diagram in figure 3 for the relationship of these signals.

Data-bus direction is controlled by PDBIN. The bus is normally in the outward direction (away from the CPU) except during a legitimate read operation, when it is switched inward. This is necessary due to the short duration of the ZX-80's \overline{WR} signal (slightly longer than one clock cycle). Since data on the 2114 RAM chips must be stable before write-enable goes low, and since the write pulse is shortened even more by the

memory board's logic, this technique insures proper operation.

Now to A15. As seen in the schematic in figure 2, J1 permanently enables the read/write gate. I had intended to use A15 here to inhibit switching the data bus inward when past the legal limit of hexadecimal 7FFF. However, the ZX-80 uses A15 for certain video-generation tasks, so there are times when A14 and A15 are high at the same time. Consequently, the interface would not work with A15 hooked up. I included this feature as an option in case it is needed for some future modification.

The presence of \overline{RFSH} is a good sign that the CPU is functioning, and it makes a nice run indicator. \overline{HALT} shows what is happening in the software; when the program is generating video, the HALT LED (light-emitting diode) will be lit. Tying $\overline{RAM CS}$ high disables the on-board RAM. There is no decoding of RAM addresses in the ZX-80, and any address

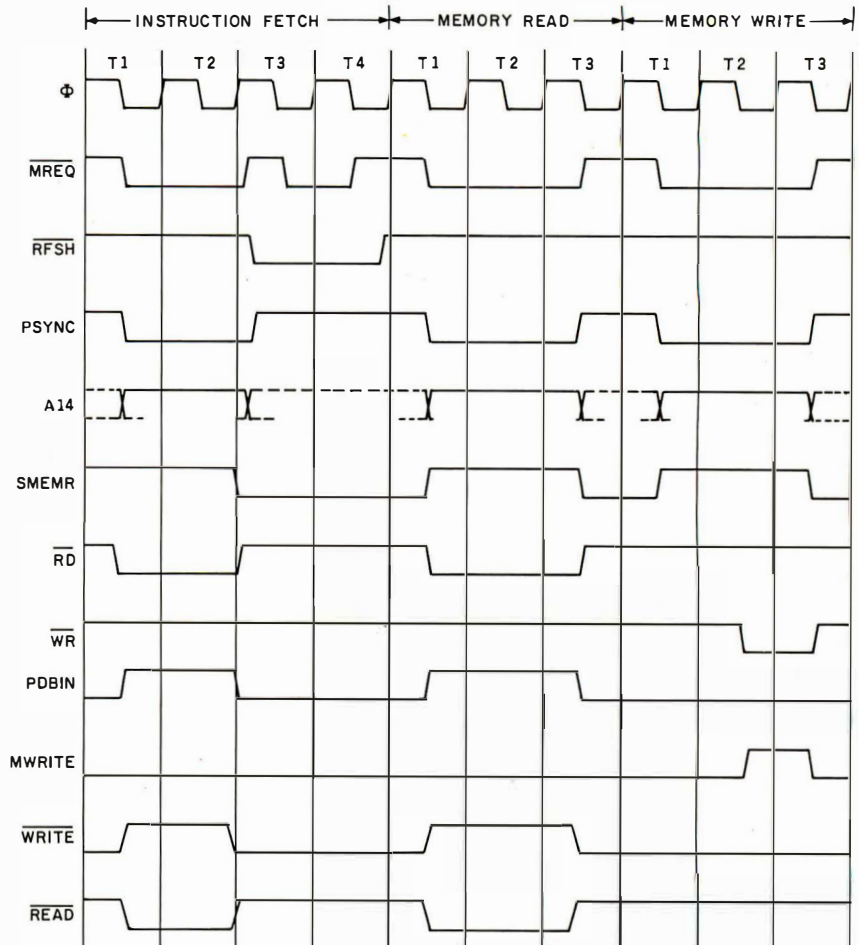
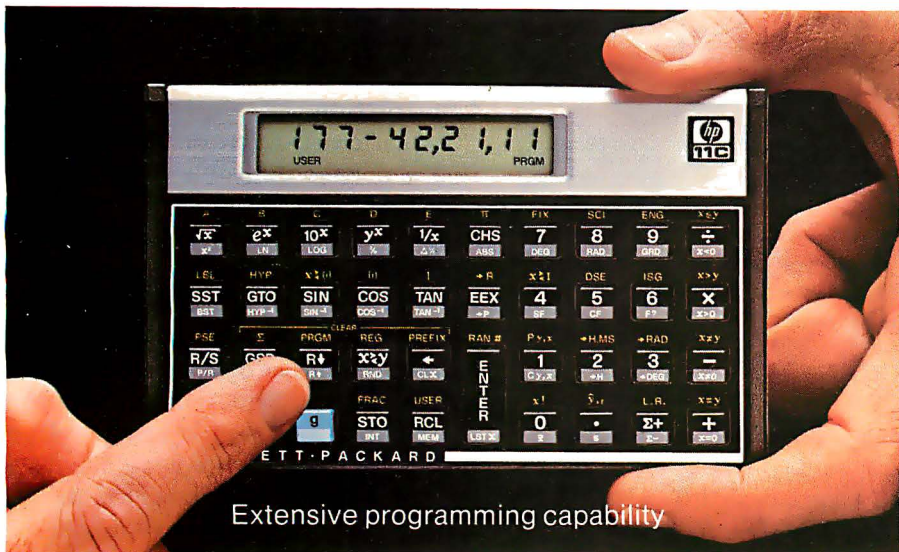

Figure 3: Timing diagram of ZX-80 signals. At 3.25 MHz, one t-state is 307 ns.

Introducing the new HP-11C.

The whole is greater than the sum of its parts.



Extensive programming capability

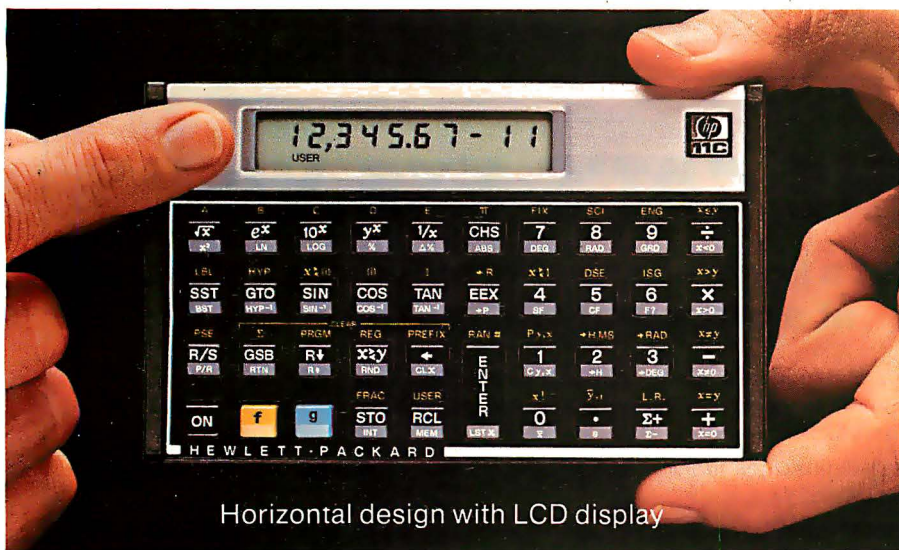

Horizontal design with LCD display

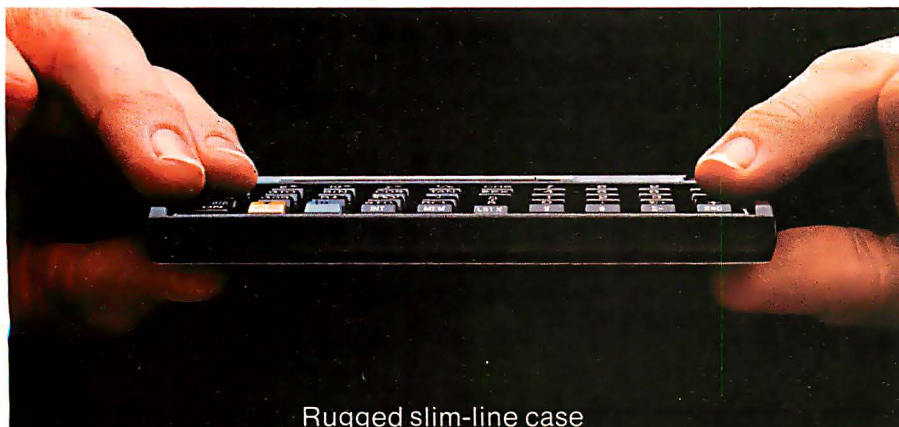

Rugged slim-line case

Leave it to Hewlett-Packard to assemble an ingenious combination of features and functions—in one calculator.

Computer-like programming.

The HP-11C offers over 200 lines of program memory, insert/delete editing, subroutines, indirect addressing, flags—all these powerful programming tools, plus an extensive set of built-in scientific/engineering functions.

Fits easily in your pocket.

The HP-11C's rugged slim-line case fits easily in your pocket. And its horizontal design with LCD display makes it easy to read even in bright sunlight.

Continuous memory.

The HP-11C's Continuous Memory remembers your programs and data even when your calculator is turned off. The calculator is powered by standard, disposable long-life batteries, making it both portable and convenient to operate.

Only from Hewlett-Packard.

Sure, other calculators may offer you some of these features. But Hewlett-Packard gives you all of them in a beautiful slim line design. The new HP-11C is built to the exacting standards of quality and reliability that you've come to expect from Hewlett-Packard.

To see the HP-11C in action, visit your nearest Hewlett-Packard dealer. For the address of the dealer in your area, call toll free: **800-547-3400**, Dept. 288D except Hawaii & Alaska. In Oregon, call 758-1010. Or write Hewlett-Packard, Corvallis, OR 97330, Dept. 288D.

Suggested retail price, \$135, excluding applicable state and local taxes—Continental U.S.A., Alaska, and Hawaii. 611/09

 **HEWLETT
PACKARD**

Circle 172 on inquiry card.

within the range of hexadecimal 4000 to 7FFF activates this on-board RAM. If not disabled, some not too interesting things would happen to a program that used more than 1 K. Extending the reset pin to a momentary switch provides a little extra convenience, as none is present on the ZX-80.

Power-Supply Considerations

Providing power to the ZX-80 through the edge connector makes it possible to get rid of the calculator-type wall transformer. The S-100 memory and the ZX-80 both have on-board regulators, so a well-filtered 8- to 9-V supply will do nicely for both. Altogether, the memory card, computer, and interface circuit draw about 2 A. I used a 6.3-V, 4-A transformer with a bridge rectifier and a 12,000- μ F filter. This combination works fine. Notice also that the power-on LED is fed from the ZX-80's regulator, providing a good telltale sign to proper operation of the entire system.

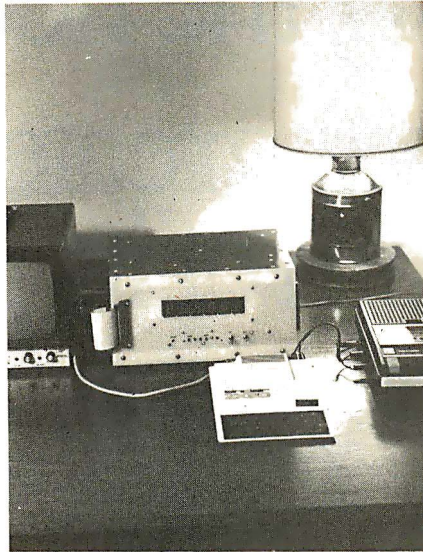

Photo 1: *The complete ZX-80 system. The memory-expansion box dwarfs the ZX-80 unit, making it look rather like a keyboard terminal.*

Memory-Board Modifications

To speed up propagation of signals through the Jade board's CMOS buffer circuitry, the following simple

modifications should be made. Gently bend pins 9, 10, 11, 12, 14, and 15 of IC E3 outward to clear the socket with the chip in place. Do likewise for IC E5 pins 11 and 12. Insert a piece of U-shaped, bare #28 wire in the socket of E3 to short pins 9-10, 11-12, and 14-15, and pins 11-12 of E5. Reinsert the chips in their sockets and the job is done. The board remains unaltered and resaleable in case you should decide to move up from the ZX-80.

Construction

Actual construction of the expansion is not too difficult as long as a few simple rules are followed. Most important, keep the leads as short as possible. I used two 25-conductor ribbon cables and was able to keep the distance to the interface less than four inches. The leads between the interface and the S-100 board should also be short. As seen in photo 1, I used an old Augat wire-wrap board for the interface and mounted the memory card directly above it with

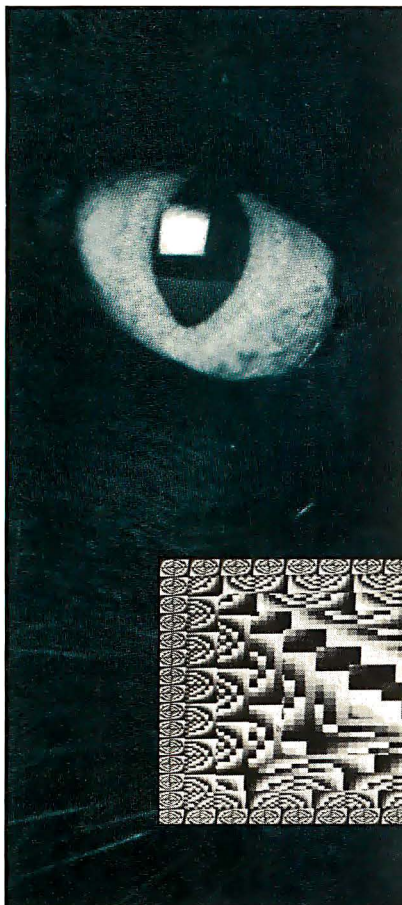

THE CAT'S-EYE VIEW

Get a lion's share of graphic capabilities at a price that will make you purr.

CAT digital graphic systems interface with S-100, PDP-11, LSI-11 and other host computers to create incredibly detailed images. Look at the features that a CAT can deliver:

- **Flash digitizer** to grab your image from camera, broadcast or recording in as little as 1/60 of a second.
- **Highest possible resolution**—up to 484x512x8, 242x512x16 or 242x256x24.
- **Dynamic color mapping** to produce animation and other effects.
 - **Maximum color palette** of 16.7 million hues, with displays of 65,536 simultaneous colors or 256 levels of gray.
 - **Light-pen input** and other useful options.
 - **Flexibility** to fit your computer imaging needs within the CAT-100 through CAT-800 and CBX series. Call us for a CAT that suits your application . . . and your budget.

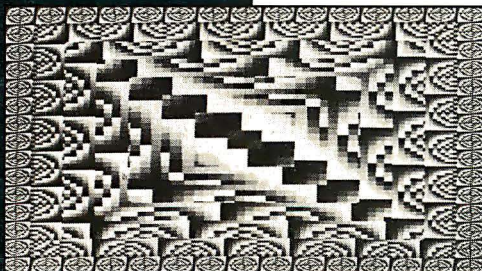

©1981 by J. Pines.

DIGITAL GRAPHIC SYSTEMS, INC.

935 Industrial Avenue, Palo Alto, CA 94303
Call (415) 856-2500

MOST COMPETITIVE PRICES ANYWHERE!

SAVE ON ALL YOUR COMPUTER NEEDS WITH

MID-AMERICA MICRO MART, INC.



Z-89 ZENITH DATA SYSTEM

This stand alone micro computer simplifies operation and installation. With the wide range of CP/M TM Software available this is the ideal small business computer.

Z-80 CPU/2 Serial Ports - Built-in 12" Terminal.
 Z-89 48K RAM/one 5" 100K Drive \$2,140.00
 Z-90 64K RAM/one 5" 200K Drive \$ Call \$

• ORDER TOLL FREE (800) 323-5338
 In Illinois Call Collect (312) 498-5099

• All Merchandising Includes Full Factory Warranty
 • Dealer Inquiries Invited

• Your Order Processed Immediately



QUME SPRINT 9/35

The QUME SPRINT "9" Series Printer has broken the price performance barrier. Letter quality - KSR 35 CPS - Serial RS232 - Daisywheel.

\$1,795.00

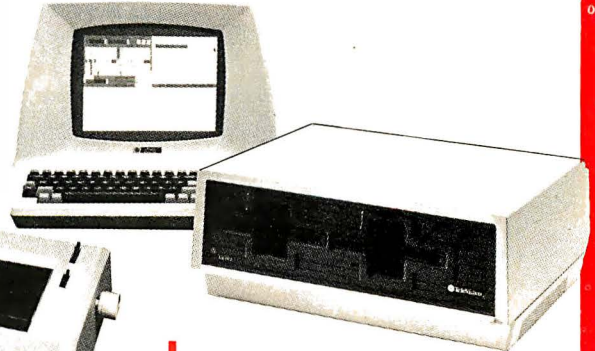

TELEVIDEO SYSTEM I

The System I is the state-of-the-art, single user system designed for reliable performance. Programmable in BASIC, COBOL, P/L and you will be able to transport your software to larger systems. One Televideo 910 CRT Dual 5-1/4" Floppy Drives 1 MG on Floppy - includes CP/M 2.2 and more!!!

\$2,995.00

PRINTERS

QUME

SPRINT "9" SERIES - Serial RS232
 9/45 ltd. 45 CPS - Word processing
 letter quality \$1,995.00
 Full Panel Option \$150.00
 Memory Option \$150.00
 Bi-Directional Tractor \$190.00

NEC

55/7710-1 R/O 55 CPS Serial \$2,193.00
 55/7730-1 R/O 55 CPS Parallel \$2,195.00
 55/7720-1 KSR 55 CPS Serial \$2,449.00

ANADEX

High Resolution 200 CPS
 DP9000 \$1,225.00
 DP9501 \$1,299.00

OKIDATA

MICROLINE SERIES
 80 Friction & Pin Feed \$ Call
 82A \$ Call
 83A \$ Call

C.R.T.S.

VDT - 100

The brilliant CRT \$1,095.00
 ★ Can be programmed from the keyboard to emulate many terminals
 ★ Real time clock
 ★ Detached keyboard
 ★ Emulates the ADM-31, VT-52, TS-1
 ★ VT 100 optional

AMPEX

With detachable keyboard.
 ★ Full featured video terminal
 ★ Display 24 lines/25th status line
 ★ 2 pages display memory
 ★ Green screen
 Dialog 80 \$949.00
 Dialog 30 \$849.00

ADDS

★ Detached keyboard
 ★ Programmable function keys
 ★ 2 position tilt screen
 Viewpoint \$569.00

ZENITH

Z-19 \$749.00
 910 \$569.00
 912 C \$659.00
 920 C \$729.00
 950 Green Screen \$949.00

TELEVIDEO

ACCESSORIES

ATI Cut Sheet Feeder fits most printers. Feeds 8-1/2" x 11" paper, single sheets \$1,195.00

QUME Datatrak 8" drives-Double Sided/Double Density \$549.00
 2 for \$1,049.00

Datatrak 5-1/4" \$325.00
 2 for \$599.00

U.S. ROBOTICS Phone link acoustic MODEM — 300 Baud, Orig/Ans. Self-test RS232 - Half/Full Duplex \$179.00

Universal Printer Stand \$99.00

16K Memory Boards, fast or slow \$149.00
 2 for \$250.00

Athana Diskettes Single Sided/Single Density - Box of 10 \$39.00

TO ORDER: CALL TOLL FREE (800) 323-5338 — In Illinois Call Collect (312) 498-5099. Master Charge and Visa accepted. Prices do not include shipping. For fast delivery send certified check, money order, or bank wire transfer. Allow 10 days for personal checks to clear. Prices subject to change without notice. Please call for latest prices. Prices include 2% cash discount. Illinois residents include sales tax.



MID-AMERICA MICRO MART, INC.

Suite 304
 121 S. Wilke Road
 Arlington Heights, Illinois 60005

NEW FROM NETRONICS AUTO-PATCH HARD DISK

With plug-in multi-user ports
Automatically Installs Itself Into
Your Present CP/M® 2.2 Operating
system & Floppy Disk Hardware.

It's Exclusive!

6 megabytes . . . \$2995.00 12 megabytes . . . \$3495.00



What's the big concern of S100 owners when they consider adding Hard Disks? They worry that it will be difficult to install, that it won't be compatible with their present software and hardware, and that it may cause down-time on their S100 system.

Worry no more — Netronics new AUTOPATCH Hard Disk Systems are here. AUTOPATCH installs in just one two-three: (1) plug in the hard disk S100 card, (2) run three short programs supplied on disk; (3) disable the boot on your floppy controller and enable the boot on your hard disk controller (this step not required if you wish to continue to boot to your floppy drives).

And that's it: The AUTOPATCH feature automatically finds the end of your existing BIOS and then self relocates and patches itself into the existing BIOS. A virgin copy of CCP and BIOS are loaded into memory, a customized SBOOT is added to the front of CCP and the whole memory image is written to the reserved tracks on your hard disk. You can add up to 4 hard disks to the controller supplied. The new BIOS will automatically rename any old devices as B:, C:, and define the hard disk as drive A:. All with the lift of one finger!!! If your BIOS is large you may have to re-sysgen your system down 1 or 2 k. If this is necessary the AUTOPATCH program will prompt you to do so.

AUTOPATCH Hard Disk Systems are available in 6 and 12 megabyte models. Included in the system: 6 or 12 megabyte Hard Disk Drive . . . Controller for up to 4 Hard Disk drives . . . S100 Hard Disk card with provisions for adding 8 additional I/O ports to be used when adding a multi-user operating system . . . Power Supply . . . Deluxe Steel Cabinet . . . All necessary cables . . . AUTOPATCH Programs supplied on either 8" or 5 1/4" IBM formatted single density diskettes (specify style required) . . . Complete installation instructions . . . Fully wired and tested. ready to go.

SPECIFICATIONS

Unformatted Recording Capacity: 6.4 or 11.6 MB . . . No. of tracks: 612 or 1380 . . . Data Transfer Rate: 3 ms . . . Bytes/sector format: 512 . . . Communication Port: DO (other ports available on special order) . . . Programs supplied on 5 1/4" or 8" single density IBM formatted diskettes (North Star CP/M™ version available on special order)

10 DAY MONEY BACK OFFER

Continental U.S.A. Credit Card Buyers Outside Conn.

CALL TOLL FREE 800-243-7428

To Order From Connecticut Or For Tech. Assist.
Call (203) 354-9375

NETRONICS R&D LTD. Dept.

333 Litchfield Road, New Milford, CT 06776

Please send the items checked below:

- AUTOPATCH/6 Hard Disk System . . . \$2995.00
 AUTOPATCH/12 Hard Disk System . . . \$3495.00
 Additional 6-megabyte drive with power supply, cabinet, cables and necessary software . . . \$1995.00
 Additional 12-megabyte drive with power supply, cabinet, cables and necessary software . . . \$2495.00
 All plus \$15.00 P&I (postage & insurance). For Canadian orders, double the postage (\$30.00). Conn. res. add sales tax.

Total Enclosed \$ _____
 Personal Check Cashier's Check/M.O.
 VISA MasterCard (Bank No. _____)
 Acct. No. _____ Exp. Date _____
 Signature _____
 Print Name _____
 Address _____
 City _____ State _____ Zip _____

Big sale on K's!

16K . . . \$149.95
32K . . . \$199.95
48K . . . \$249.95
64K . . . \$299.95

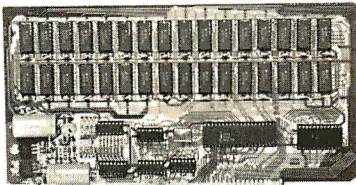

New JAWS-IB

The Ultrabyte Memory Board

Due to the tremendous success of our JAWS I, we were able to make a special purchase of first-quality components at below-cost prices for JAWS-IB. And we are sharing our cost saving with you. But don't be surprised if the next time you see this ad the prices have gone up substantially. Better yet, order now, and get the best memory on the market at the best price on the market.

ONE CHIP DOES IT ALL

JAWS-IB is the Rolls-Royce of all the S100 dynamic boards. Its heart is Intel's single chip 64K dynamic RAM controller. Eliminates high-current logic parts . . . delay lines . . . massive heat sinks . . . unreliable trick circuits. JAWS-IB solves all these problems.

LOOK WHAT JAWS-IB OFFERS YOU

Hidden refresh . . . fast performance . . . low power consumption . . . latched data outputs . . . 200 NS 4116 RAM's . . . on-board crystal . . . RAM Jumper selectable on 8K boundaries . . . fully socketed . . . solder mask on both sides of board . . . phantom line . . . designed for 8080, 8085, and Z80 bus signals . . . works in Explorer, Sol, Horizon, as well as all other well-designed S100 computers.

10-DAY MONEY-BACK TRIAL: Try a fully wired and tested board for 10 days — then either keep it, return it for kit, or simply return it in working condition.

Continental U.S.A. Credit Card Buyers Outside Connecticut:

TO ORDER CALL TOLL FREE 800-243-7428

From Connecticut Or For Assistance:

(203) 354-9375

Please send the items checked below:

JAWS-IB kit:

- 16K . . . \$149.95*
 32K . . . \$199.95*
 48K . . . \$249.95*
 64K . . . \$299.95*

JAWS-IB Fully Assembled, wired & Tested:

- 16K . . . \$179.95*
 32K . . . \$239.95*
 48K . . . \$299.95*
 64K . . . \$359.95*

EXPANSION KIT, 16K RAM Module, to expand JAWS-IB in 16K blocks up to 64K. \$59.95

*All prices plus \$2 postage and insurance (\$4.00 Canada), Connecticut residents add sales tax.

Total enclosed: \$ _____
 Personal Check Money Order or Cashier's Check
 VISA MasterCard (Bank No. _____)
 Acct. No. _____ Exp. Date _____
 Signature _____
 Print Name _____
 Address _____
 City _____
 State _____ Zip _____

NETRONICS R&D Ltd.
 333 Litchfield Road, New Milford, CT 06776

Now with added words! * ELECTRIC MOUTH



for \$100, Elf II, Apple TRS-80, Level II™

From \$99.95 kit

Now — teach your computer to talk, increasing interaction between you and your machine.

That's right: the ELECTRIC MOUTH actually lets your computer talk! Installed and on-line in just minutes it's ready for spoken-language use in office, business, industrial and commercial applications, and in games, special projects, R&D, education, security devices — there's no end to the ELECTRIC MOUTH's usefulness. Look at these features:

- Supplied with 143 letters/words/phonemes/numbers, capable of producing hundreds of words and phrases.
- Expandable on-board up to thousands of words and phrases with additional speech ROMs (see new speech ROM described below).
- Four models that plug directly into S100, Apple, Elf II and TRS-80 Level II computers.
- Get ELECTRIC MOUTH to talk with either Basic or machine language (very easy to use, complete instructions, with examples included).
- Uses National Semiconductor's "DigitalTalker."
- Includes on-board audio amplifier and speaker, with provisions for external speakers.
- Installs in just minutes.

Principle of Operation: The ELECTRIC MOUTH stores the digital equivalents of words in ROMs. When words, phrases and phonemes are desired, they simply are called for by your program and then synthesized into speech. The ELECTRIC MOUTH system requires none of your valuable memory space except for a few addresses if used in memory mapped mode. In most cases, output ports (user selectable) are used.

	SPOKEN MATERIAL INCLUDED (Vox I)										
	one	eighteen	at	dollar	inches	number	ss	c	t		
two	nineteen	cancel	down	is	of	second	d	e	u	v	
three	twenty	case	equal	it	off	sel					
four	thirty	cent	error	kilo	on	space	f	w			
five	forty	40hertz tone	feet	left	out	speed	g	y			
six	fifty	80hertz tone	flow	less	over	star					
seven	sixty	20ms silence	fuel	lesser	parenthesis	start	i	z			
eight	seventy	40ms silence	gallon	limit	percent	stop					
nine	eighty	80ms silence	go	low	please	than	k				
ten	ninety	160ms silence	gram	lower	plus	the	l				
eleven	hundred	320ms silence	great	mark	point	time	m				
twelve	thousand	centi	greater	meter	pound	try	n				
thirteen	million	check	have	mile	pulse	up	o				
fourteen	zero	comma	high	milli	repeat	turn	p				
fifteen	again	control	higher	minus	re	weight	q				
sixteen	an pere	danger	hour	minute	ready	a	r				
seventeen	and	degree	in	near	right	b	s				

ADDITIONAL VOCABULARY NOW AVAILABLE (Vox II)

abort	complete	fifth	light	put	station
add	continue	fire	load	quarter	switch
adjust	copy	first	lock	range	system
alarm	correct	floor	longer	reached	temperature
alert	create	fourth	more	record	test
all	"de"	forward	move	receive	"th"
ask	deposit	from	next	reverse	thank
assistance	dial	gas	no	red	this
attention	door	get	normal	repair	third
blue	east	going	high	repeat	the
brake	"ed"	green	not	replace	under
button	emergency	hale	notice	room	use
call	enter	heat	open	safe	waiting
called	entry	hello	operator	second	warning
caution	"er"	help	or	secure	was
cease	"eth"	hurts	pass	select	water
centigrade	evacuate	hold	hot	power	west
change	exit	in	press	side	wind
circuit	fail	in	press	side	window
cigar	fahrenheit	incorrect	pressure	slow	yellow
close	fast	intruder	process	slower	yes
cold	faster	key	pull	smoke	zone
			push	south	

*Registered Trademarks

Continental U.S.A. Credit Card Buyers Outside Connecticut

TO ORDER

Call Toll Free: 800-243-7428

To Order From Connecticut, or For Technical Assistance, call (203) 354-9375

NETRONICS R&D LTD.
 333 Litchfield Road, New Milford, CT 06776

Please send the items checked below:

- S100 "Electric Mouth" kit w/Vox I . . . \$ 99.95
 Elf II "Electric Mouth" kit w/Vox I . . . \$ 99.95
 Apple "Electric Mouth" kit w/Vox I . . . \$119.95
 TRS-80 Level II "Electric Mouth" kit w/Vox I . . . \$119.95
 VOX II (Second Word Set) . . . \$ 39.95

Add \$20.00 for wired tested units instead of kits. VOX II postage & insurance \$1.00, all others \$3.00 postage and insurance. Conn. res. add sales tax.

Total Enclosed \$ _____
 Personal Check Cashier's Check/Money Order
 VISA Master Charge (Bank No. _____)
 Acct. No. _____ Exp. Date _____
 Signature _____
 Print Name _____
 Address _____
 City _____
 State _____ Zip _____

FOR ONLY \$129.95 Learn Computing From The Ground Up

Build a Computer kit that grows with you, and can expand to 64k RAM, Microsoft BASIC, Text Editor/Assembler, Word Processor, Floppy Disks and more.

EXPLORER/85

Here's the low cost way to learn the fundamentals of computing, the all-important basics you'll need more and more as you advance in computer skills. For just \$129.95 you get the advanced design Explorer/85 motherboard, with all the features you need to learn how to write and use programs. And it can grow into a system that is a match for any personal computer on the market. Look at these features: 8085 Central Processing Unit, the microprocessor "heart" of the Explorer/85, (join the millions who will buy and use the 8080/8085 this year alone)... Four 8-bit plus one 6-bit input/output ports from which you can input and output programs, as well as control exterior switches, relays, lights, etc. ... a cassette interface that lets you store and reload programs you've learned to write... deluxe 2,000 byte operating system/monitor package easy to learn computing... several important ways... It allows simpler, faster writing and entering of programs. It permits access by you to all parts of the system so you can check on the status of any point in the program. It allows tracing each program step by step... It can monitor for displaying all the contents of the CPU (registers, flags, etc.)... and, and, and more!

You get all this in the starting level (Level A) of the Explorer/85 for only \$129.95. Incredible! To use, just plug in your 6VDC power supply and terminal or keyboard/display — if you don't have them, see our special offers below.

Level A computer kit (Terminal Version) ... \$129.95 plus \$3 P&I.*
 Level A kit (Hex Keypad/Display Version) ... \$129.95 plus \$3 P&I.*

LEVEL B — This "building block" converts the motherboard into a two-slot S100 bus (industry standard) computer. Now you can plug in any of the hundreds of S100 cards available.

Level B kit ... \$49.95 plus \$2 P&I.*
 S100 bus connectors (two required) ... \$4.85 each, postpaid.

LEVEL C — Add still more computing power; this "building block" mounts directly on the motherboard and expands the S100 bus to six slots.

Level C kit ... \$39.95 plus \$2 P&I.*
 S100 bus connectors (five required) ... \$4.85 each, postpaid.

LEVEL D — When you reach the point in learning that requires more memory, we offer two choices: either add 4k of a memory directly on the motherboard, or add 16k to 64k of memory by means of a single S100 card, our famous "JAWS".

Level D kit (CHECK ONE) ... 4k on-board ... \$49.95 plus \$2 P&I.*
 Level D kit (CHECK ONE) ... 16k S100 "JAWS" ... \$149.95 plus \$2 P&I.*
 Level D kit (CHECK ONE) ... 32k S100 "JAWS" ... \$199.95 plus \$2 P&I.*
 Level D kit (CHECK ONE) ... 48k S100 "JAWS" ... \$249.95 plus \$2 P&I.*
 Level D kit (CHECK ONE) ... 64k S100 "JAWS" ... \$299.95 plus \$2 P&I.*

LEVEL E — An important "building block," it activates the ROM EPROM space on the motherboard and provides a plug-in in one 8k Microsoft BASIC or your own custom programs.

Level E kit ... \$5.95 plus 50¢ P&I.*
 Microsoft BASIC — It's the language that allows you to talk English to your computer. It is available three ways:

8k cassette version of Microsoft BASIC (requires Level B and 12k of RAM minimum; we suggest a 16k S100 RAM — see above) ... \$64.95 postpaid.

8k ROM version of Microsoft BASIC (requires Level B & level E and 4k RAM) ... \$99.95 plus \$2 P&I.*
 We suggest either the 4k Level D RAM expansion or a 16k S100 "JAWS". ... \$98.95 plus \$2 P&I.*

32k version of Microsoft BASIC (requires Level B, 32k of RAM, floppy disk controller, 8" floppy drive) ... \$325 postpaid.

TEXT EDITOR/ASSEMBLER — The editor/assembler is a software tool (a program) designed to simplify the task of writing programs. As your programs become longer and more complex, the assembler can save you many hours of programming time. This software includes an editor program that enters the programs you write, makes changes, and saves the programs on cassette. The assembler performs the clerical task of translating symbolic code into the computer-readable object code. The editor/assembler program is available either in cassette or a ROM version.

Editor/Assembler (Cassette version; requires Level B and 8k (min.) of RAM — we suggest 16k "JAWS" — see above) ... \$59.95 plus \$2 P&I.*

Editor/Assembler (ROM version, supplied on an S100 card; requires Level B and 4k RAM (min.) — we suggest either Level D or 16k "JAWS") ... \$99.95 plus \$2 P&I.*

8" FLOPPY DISK — A remarkable "building block." Add our 8" floppy disk when you need faster operation, more convenient program storage, perhaps a business application (an access to the literally thousands of programs and program languages available today. You simply plug them into your Explorer/85 disk system — it accepts all IBM formatted CP/M programs.

8" Floppy Disk Drive ... \$499.95 plus \$12 P&I.*
 Floppy Controller Card ... \$199.95 plus \$2 P&I.*
 Disk Drive Cabinet & Power Supply ... \$69.95 plus \$3 P&I.*

Drive Cables (set up for two drives) ... \$25.00 plus \$1.50 P&I.*

CP/M 2.2 Disk Operating System, includes Text Editor/Assembler, dynamic debugger, and other features that give you Explorer/85 access to thousands of existing CP/M-based programs ... \$150.00 postpaid.

NEED A POWER SUPPLY? Consider our AP-1. It can supply all the power you need for a fully expanded Explorer/85 (note: disk drives have their own power supply). Plus the AP-1 fits neatly into the attractive Explorer/85 cabinet (see below).

AP-1 Power Supply kit (8V @ 5 amps) in deluxe steel cabinet ... \$39.95 plus \$2 P&I.*

NEED A TERMINAL? We offer you choices: the least expensive one is our Hex Keypad/Display kit that displays the information on a calculator-type screen. The other choice is our ASCII Keypad/Computer Terminal kit that can be used with either



1. Plug in Netronic's Hex Keypad/Display
2. Add Level B to convert to S100
3. Add 4k RAM
4. Plug in Level E here: connects Microsoft BASIC or Editor/Assembler in ROM
5. Add two S100 boards
6. Add your own custom circuits (prototyping areas)
7. Connect terminal

a CRT monitor or a TV set (if you have an RF modulator).

- Hex Keypad/Display kit ... \$69.95 plus \$2 P&I.*
- ASCII Keypad/Computer Terminal kit featuring a full 128 character set, u&l case, full cursor control, 75 ohm video output, convertible to baudot output, selectable baud rate: RS 232-C or 20 mA I/O, 32 or 64 character by 16 line form ... \$149.95 plus \$3 P&I.*
- Steel Cabinet for ASCII Keypad/Terminal ... \$19.95 plus \$2.50 P&I.*
- RF Modulator kit (allows you to use your TV set as a monitor) ... \$8.95 postpaid.
- 12" Video Monitor (10MHz bandwidth) ... \$139.95 plus \$3 P&I.*
- Deluxe Steel Cabinet for the Explorer/85 ... \$49.95 plus \$3 P&I.*
- Fan for Terminal ... \$15.00 plus \$1.50 P&I.*



ORDER A SPECIAL-PRICE EXPLORER/85 PAK — THERE'S ONE FOR EVERY NEED.

Beginner Pak (Save \$26.00) — You get Level A (Terminal Version) with Monitor Source Listing (\$25 value) AP-1, 5-amp. power supply, Intel 8085 Users Manual ... (Reg. \$199.95) SPECIAL \$169.95 plus \$4 P&I.*

Experimenter Pak (Save \$53.40) — You get Level A (Hex Keypad/Display Version) with Hex Keypad/Display, Intel 8085 User Manual, Level A Hex Monitor Source Listing, and AP-1.5-amp. power supply ... (Reg. \$279.95) SPECIAL \$219.95 plus \$6 P&I.*

Special Microsoft BASIC Pak (Save \$103.00) — You get Levels A (Terminal Version), B, D (4k RAM), E, 8k Microsoft in ROM, Intel 8085 User Manual, Level A Monitor Source Listing, and AP-1, 5-amp. power supply ... (Reg. \$439.70) SPECIAL \$329.95 plus \$7 P&I.*

ADD A ROM-VERSION TEXT EDITOR/ASSEMBLER (Requires Levels B and D or S100 Memory) ... \$99.95 plus \$2 P&I.*

Starter 8" Disk System — Includes Level A/B floppy disk controller, one CDC 8" disk drive, two-drive cable, two S100 connectors; just add your own power supplies, cabinets and hardware ... (Reg. \$1065.00) SPECIAL \$999.95 plus \$13 P&I.* ... 32k Starter System, \$1045.95 plus \$13 P&I.* ... 48k Starter System, \$1095.95 plus \$13 P&I.* ... 64k Starter System, \$1145.95 plus \$13 P&I.*

Add to any of above Explorer steel cabinet, AP-1 5-amp. power supply, Level C with two S100 connectors, disk drive cabinet and power supply, two sub-D connectors for connecting your printer and terminal ... (Reg. \$225.95) SPECIAL \$199.95 plus \$13 P&I.*

Complete 64k System, Wired & Tested ... \$1650.00 plus \$26 P&I.*

Special: Complete Business Software Pak (Save \$625.00) — Includes CP/M 2.2 Microsoft BASIC, General Ledger, Accounts Receivable, Accounts Payable, Payroll Package ... (Reg. \$1325) SPECIAL \$699.95 postpaid.

Continental Credit Card Buyers Outside Connecticut:
TO ORDER
Call Toll Free: 800-243-7428

To Order From Connecticut, or For Technical Assistance, call (203) 354-9375

★ (Clip and mail entire ad) ★

SEND ME THE ITEMS CHECKED ABOVE
 Total Enclosed (Conn. Residents add sales tax): \$ _____
 Paid by:

Personal Check Cashier's Check/Money Order

VISA MASTER CARD (Bank No. _____)

Acct. No. _____ Exp. Date _____

Signature _____

Print Name _____

Address _____

City _____ State _____ Zip _____

NETRONICS Research & Development Ltd.
 333 Litchfield Road, New Milford, CT 06776

ANNOUNCING TWO NEW TERMINALS

Smart • Fast • Graphics • Matching Modem and \$295 Printer

Netronics announces a state of the art breakthrough in terminals. Now at prices you can afford, you can go on-line with data-bank and computer phone-line services. It's all yours: "electronic newspapers," educational services, Dow-Jones stock reports, games, recipes, personal computing with any level language, program exchanges, electronic bulletin boards ... and more every day!!



Netronics offers two new terminals. Both feature a full 56 key/128 character typewriter-style keyboard, baud rates to 19.2 kilobaud, a rugged steel cabinet and power supply. The simplest one, FASTERM-64, is a 16 line by 64 or 32 character per line unit, with a serial printer port for making hard copy of all incoming data, and optional provisions for block and special character graphics. The "smarter" version, SMARTERM-80, features either 24 line by 80 characters per line or 16 by 40 characters per line, it offers on-screen editing with page-at-a-time printing, 12,000 pixel graphics, line graphics, absolute cursor addressing, underlining, reverse video, one-half intensity and much more ... simply plug them into your computer or our phone modem and be on-line instantly. Use your TV set (RF modulator required) or our deluxe green-phosphor monitor pictured above. For hard copy just add our matched printer.

Price breakthrough!!! Own the FASTERM-64, a complete terminal kit, ready to plug in for just \$199.95 or order the SMARTERM-80 kit for just \$299.95 (both available wired and tested.) Be on-line with the million-dollar computers and data services today ... we even supply the necessary subscription forms.

More good news: All the components in our terminals are available separately (see coupon), so you buy only what you need!!!

FASTERM-64 ... DISPLAY FORMAT: 64 or 32 characters/line by 16 lines ... 96 displayable ASCII characters (upper & lower case) ... 8 baud rates: 150, 300, 600, 1200, 2400, 4800, 9600, 19,200, (switch sel.) ... LINE OUTPUT: RS232C or 20 ma current loop ... VIDEO OUTPUT: 1V PIP (EIA RS-170) ... CURSOR MODES: home & clear screen, erase to end of line, erase cursor line, cursor up & down, auto carriage return/line feed at end of line & auto scrolling ... REVERSE VIDEO ... BLINKING CURSOR ... PARITY: off, even or odd ... STOP BITS: 1, 1.5, 2 ... DATA BITS PER CHARACTER: 5, 6, 7 or 8 ... CHARACTER OUTPUT: 5 by 7 dot matrix in a 7 by 12 cell ... PRINTER OUTPUT: prints all incoming data ... 1K ON BOARD RAM ... 2K ON BOARD ROM ... CRYSTAL CONTROLLED ... COMPLETE WITH POWER SUPPLY ... ADDITIONAL GRAPHICS: 34 Greek & math characters plus 30 special graphics characters ... ASCII ENCODED KEYBOARD: 56 key/128 characters.

SMARTERM-80 ... DISPLAY FORMAT: 80 characters by 24 lines or 40 characters by 16 lines 128 displayable ASCII characters (upper & lower case) 9 baud rates: 110, 300, 600, 1200, 2400, 4800, 9600, 19,200 ... LINE OUTPUT: RS232C or 20 ma current loop ... VIDEO OUTPUT: 1V PIP (EIA RS-170) ... EDITING FEATURES: insrt/delete line, insert/delete character, forward/back tab ... LINE OR PAGE TRANSMIT ... PAGE PRINT FUNCTION ... CURSOR POSITIONING: up, down, right, left, plus absolute cursor positioning with read back ... VISUAL ATTRIBUTES: underline, blink, reverse video, high intensity, & blank ... GRAPHICS: 12,000 pixel resolution block plus line graphics ... ON-SCREEN PARITY INDICATOR ... PARITY: off, even or odd ... STOP BITS: 110 baud 2, all others 1 ... CHAR. OUTPUT: 7 by 11 character in a 9 by 12 block ... PRINTER OUTPUT: 60 or 50 Hz VERTICAL REFRESH ... BLINKING BLOCK CURSOR ... CRYSTAL CONTROLLED ... 2K ON BOARD RAM ... ASCII ENCODED KEYBOARD: 56 key/128 character ... 4K ON BOARD ROM ... COMPLETE WITH POWER SUPPLY.

TELEPHONE MODEM 103 0/A ... FULL DUPLEX, FCC APPROVED ... DATA RATE: 300 baud ... INTERFACE: RS232C and TTY ... CONTROLS: talk/data switch (no need to connect and disconnect phone), originate/answer switch on rear panel ... NO POWER SUPPLY REQUIRED.

ASCII KEYBOARD ASCII-3 ... 56 KEY/128 CHARACTER ASCII ENCODED ... UPPER & LOWER CASE ... FULLY DEBOUNDED ... 2 KEY ROLL-OVER ... POS OR NEG LOGIC WITH POS STROBE ... REQUIRES +5 & -12V DC (SUPPLIED FROM VIDEO BOARDS) ... PRINTER COMET I ... SERIAL I/O TO 9600 BAUD ... 80 CHARACTER COLUMN (132 COMPRESSED) ... 10" TRACTOR FEED ... UPPER/LOWER CASE ... INDUSTRY STANDARD RIBBONS ... 4 CHARACTER SIZES ... 9 BY 7 DOT MATRIX ... BI-DIRECTIONAL PRINTING



Continental U.S.A. Credit Card Buyers Outside Connecticut CALL TOLL FREE 800-243-7428

To Order From Connecticut Or For Tech. Assist. Call (203) 354-9375
NETRONICS R&D LTD. Dept.
 333 Litchfield Road, New Milford, CT 06776

Please send the items checked below:

COMPLETE FASTERM-64 TERMINAL (Includes FASTVID-64 video board ASCII-3 keyboard, steel cabinet and power supply) ... kit \$199.95 plus \$3 P&I ... wired & tested \$249.95 plus \$3 P&I ... graphics option: add \$19.95 to each of above

COMPLETE SMARTERM-80 TERMINAL (includes SMARTVID-80 video board, ASCII-3 keyboard, steel cabinet and power supply) ... kit \$299.95 plus \$3 P&I ... wired and tested \$369.95 plus \$3 P&I

FASTVID-64 VIDEO BOARD (requires +5 & -12V DC) ... kit \$99.95 plus \$3 P&I ... graphics option add \$19.95 ... wired & tested \$129.95 plus \$3 P&I ... graphics option add \$19.95

SMARTVID-80 VIDEO BOARD (requires +5 & +/ -12V DC) ... kit \$199.95 plus \$3 P&I ... wired & tested \$249.95 plus \$3 P&I

DELUXE STEEL TERMINAL CABINET ... \$19.95 plus \$3 P&I

ASCII-3 KEYBOARD (requires +5 & -12VDC) ... kit \$69.95 plus \$3 P&I ... wired and tested \$89.95 plus \$3 P&I

POWER SUPPLY (powers ASCII-3 keyboard & video boards) ... kit only \$19.95 plus \$2 P&I

ZENITH VIDEO MONITOR (high resolution green phosphor) ... wired & tested \$149.95 plus \$6 P&I

TELEPHONE MODEM MODEL 103 O/A ... wired & tested \$189.95 plus \$3 P&I

DOT MATRIX PRINTER Comet I ... wired & tested \$299.95 plus \$10 P&I

RF MODULATOR MOD RF-1 ... kit only \$8.95 plus \$1 P&I

3FT-25 LEAD MODEM/TERMINAL OR PRINTER/TERMINAL CONNECTOR CABLE ... \$14.95 ea plus \$2 P&I

For Canadian orders, double the postage. Conn. res. add sales tax.

Total Enclosed \$ _____

Personal Check Cashier's Check/Money Order

VISA MasterCard (Bank No. _____)

Acct. No. _____ Exp. Date _____

Signature _____

Print Name _____

Address _____

City _____ State _____ Zip _____

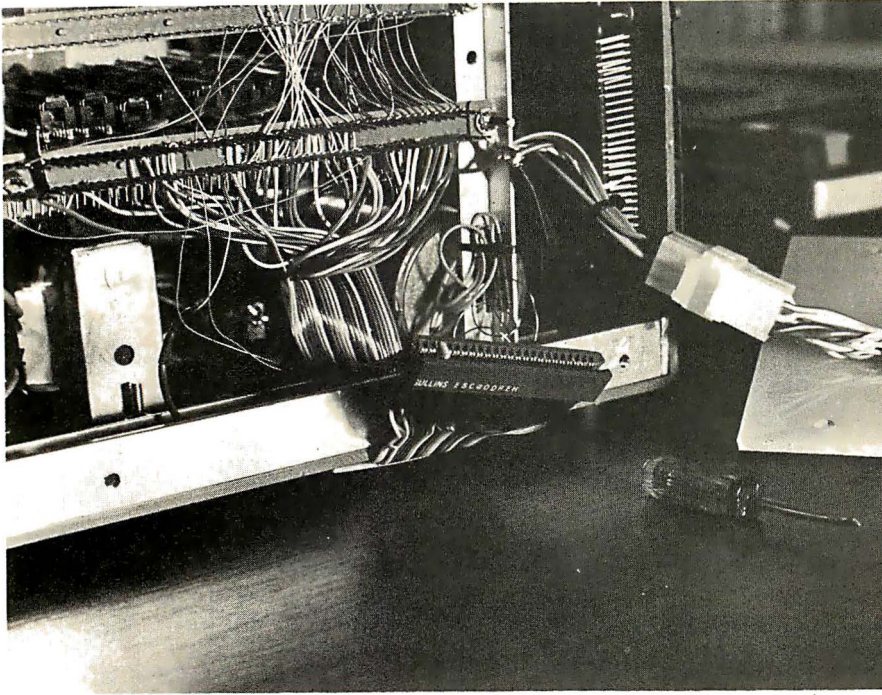

Photo 2: A custom-made edge connector and ribbon cable tie the ZX-80 to the S-100 memory board. Be sure to keep the cables as short as possible.

wire-wrap connections of less than an inch between them. The 7-segment LEDs on the front are not yet functional: they will probably evolve into some kind of front panel at a later date.

Acquiring an edge connector for the ZX-80 can be a problem. The Sinclair uses a dual 26-pin arrangement with 0.100-inch spacing. A search through various catalogs turned up no prospects, so I cut down a Jade #CNE-1108011 40-pin unit with a razor saw and made a polarizing blade from a scrap of PC board epoxied in place. Originally, my enclosure was made of sheet PVC plastic held together with aluminum angle and "pop" rivets, but the assembly was electrically unstable. A stray hand brought near the right spot produced erratic operation. I was forced to line the box with well-grounded PC board to get rid of the problem. Starting with a metallic box would be

BREAKTHROUGH!

View and edit many files simultaneously.

Draw diagrams as easily as typing text.

Cut text from one window and paste it into another.

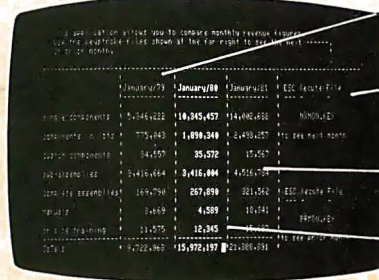
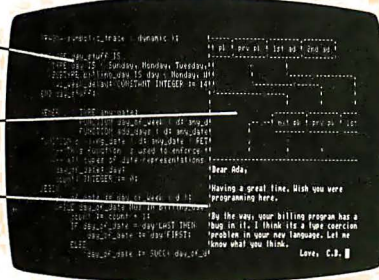

Automatic Horizontal and Vertical scrolling.

Create your own commands for your applications.

Automatic memory management of large files.

Compare, contrast, review or analyze.

A MULTI-WINDOW TEXT EDITOR FOR UNDER \$200.

Imagine this kind of productivity: Your 4 favorite files right before your eyes on the screen of your CRT.

Divide the screen of your CRT into any combination of horizontal and vertical windows, each with its own workspace. Or, windows can share a workspace—so you can edit different parts of the same file.

You get true on-screen editing, plus the ability to add or delete any of 10 windows, at any time, anywhere on the screen.

Using CP/M compatible files and simple, easy to remember commands, THE ELECTRIC BLACKBOARD™ has functions to satisfy the needs of the most demanding professional computer scientist. Yet THE ELECTRIC BLACKBOARD™ can be used just as productively by the novice within minutes. A step-by-step Learning Guide,

designed for the novice, will guide you gently through the learning process.

Unleash the extraordinary power and flexibility of THE ELECTRIC BLACKBOARD™ on your Z80-based micro-computer today.

Requires 48k CP/M or CDOS, Z80 processor, and CRT with cursor addressing. Distributed on SSSD 8" diskette. Includes reference manual, learning guide, and quick reference card. Price: \$198, manuals only: \$30.

Call or write for more information:

SANTA CRUZ SOFTWARE SERVICES

1711 Quail Hollow Road, Ben Lomond, CA 95005
(408) 336-2170

CP/M is a trademark of Digital Research CDOS is a trademark of Cromemco
Z80 is a trademark of Zilog

Surprising Symmetries in Design and Letterforms . . .



"Kim is the Escher-of-the alphabet. He has created a new art-form that blends beauty and ingenuity, and has made it so clear to us that we can try it ourselves"

Issac Asimov, Author

Inversions

A Catalog of Calligraphic Cartwheels by Scott Kim
Foreword by Douglas Hofstadter
Backward by Jef Raskin

The striking designs that grace the pages of Scott Kim's new book appeal to us as both viewers and readers, for words themselves are the subject of his calligraphic creations. With imagination and care, Kim bends, shapes, and sculpts words into novel and intriguing works of art. *Inversions* is more than a showpiece, though, as the author details the theories and techniques that lie behind his art and draws parallels to related perceptual exercises in music, linguistic wordplay, and even mathematics.

ISBN 0-07-034546-5
128 pages; softcover
\$8.95

"Scott Kim has perfected a personal art form—one with grace, elegance, subtlety, and surprises."

*Douglas Hofstadter, author
Gödel, Escher, Bach: an Eternal Golden Braid*

"Scott Kim's *Inversions* . . . is one of the most astonishing and delightful books ever printed."

*Martin Gardner
Scientific American*

". . . sure to dazzle and delight anyone to whom writing is dear"

The New York Times Book Review



B1

A New Frontier Between Sight and Sound . . .

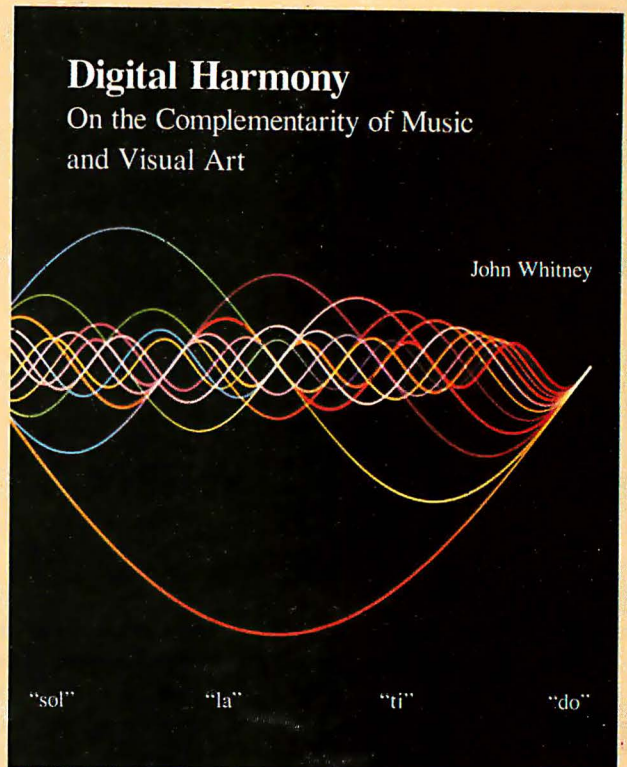

"Here in this beautiful book John Whitney marries art to modern technology. Scenes that previously we would have strained to imagine, Whitney can now show us."

Jearl Walker, Scientific American

Digital Harmony by John Whitney

On the Complementarity of Music and Visual Art

Digital Harmony is the art of music made visible. Already acclaimed for pioneering the striking visual effects in *2001* and *Star Wars*, author John Whitney here establishes a new art form in representing the magic of music through computer-generated color graphics. The author also delves into the technicalities of his work, offering to share his methods with others who would explore this field of vast artistic promise. *Digital Harmony* is the vanguard of what is sure to be one of the most exciting art forms for years to come.

ISBN 0-07-070015-X
240 pages; hardcover
\$21.95

"Digital Harmony is a peek into the future when computerization will bridge the gap between art, science, and self-understanding. I loved it."

*Seymour Papert
Author, Professor Massachusetts Institute of Technology*

Call Toll-Free 800/258-5420
BYTE Books 70 Main St. Peterborough, N.H. 03458

Listing 1: A disassembly of the ZX-80's built-in code to locate the highest address in programmable memory. This code is executed whenever the computer is reset.

Label	Address	Data	Code
RESET	0000	21	LD HL,7FFFH
	0001	FF	
	0002	7F	
	0003	3E	LD A,3FH
	0004	3F	
	0005	C3	JP 0261H(START)
	0006	61	
	0007	02	
START	0261	36	LD (HL),01H
	0262	01	
LOOP1	0263	2B	DEC HL
	0264	BC	CP H
	0265	20	JR NZ,LOOP1
	0266	FA	
LOOP2	0267	23	INC HL
	0268	35	DEC (HL)
	0269	28	JR Z,LOOP2
	026A	FC	
	026B	F9	LD SP,HL

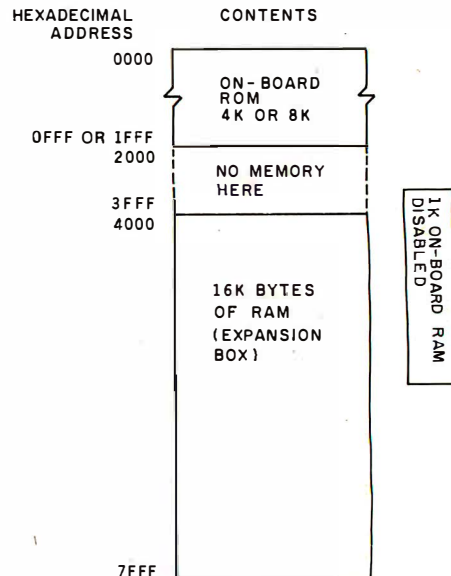

Figure 4: The ZX-80 memory map with the 16 K-byte memory expansion installed.

a much better idea. (See photo 2 for a view of the completed system.)

Checkout

Thanks to the Sinclair software, the extra memory is easy to check. Sinclair's ROM (read-only memory) contains the code to do it! The first few locations of the BASIC ROM decoded to assembly language are shown in listing 1. This piece of code is executed every time the ZX-80 is reset (to location zero); it is computing the highest available memory address where it will set the stack pointer. Hexadecimal 01s are written from hexadecimal location 7FFF all the way down to 4000. Then, working forward, each location is decre-

mented by one and the result compared to zero. The first time the comparison is not true, the address is decremented by one and the stack pointer is set to that location. To see what the ZX-80 found after it is up and running, all you have to do is PEEK a few locations in each 1 K block starting at hexadecimal 4000. If the content is zero, the ZX-80 probably found that location. If the content is one, it was written but not read correctly. If neither, it was probably not written. A word of caution: the last few highest locations will contain data actually stored on the stack by the program, and the first 40 will contain variables used by BASIC, as shown in figure 4.

Summary

Building this expansion was rewarding, not only in terms of the increased capabilities of the machine, but also for the learning involved. The Sinclair is remarkable both from the hardware and the software viewpoints. A word of warning, however, to anyone embarking on this or any other project involving the ZX-80: the only technical documentation Sinclair provides is a poorly reproduced schematic diagram with absolutely no functional description. The same holds true for the software. If it's not in the BASIC manual, forget it. The only way I found out anything was by dumping the ROM and disassembling the machine code. ■

**SMALL PRICE
BIG PERFORMANCE**

- **RUNS ON Z80/8080 CP/M* 5 1/4" OR 8" DISK BASED COMPUTERS**, prom data stored as named files on disk for low cost storage/retrieval. *trademark - Digital Research, Ca
- **RS-232 SERIAL INTERFACE**, selectable 110 to 9600 baud
- **USER ORIENTATED SOFTWARE/DOCUMENTATION**, 19 single keystroke commands.
- **NO PERSONALITY MODULES REQUIRED**
- **PROGRAMS MOST 24 AND 28 PIN PROMS**, single or triple supply 1.0, 2.0 or 50ms proms 2704/08, 2516/2716, 2532/2732, 2732A, 2564/2764, 68732, 68764/66 and more.

\$695.00
DEALER INQUIRIES INVITED

UP-8 PROM PROGRAMMER - CHEAP AT TWICE THE PRICE!

ADVENT PRODUCTS, INC. 965 N. Main Street, Orange, CA 92667 (714) 997-0800

Systems II Ex a total business system.



JOB COSTING MENU

1. TRANSACTION ENTRY/DATE
2. JOB/TASK TABLE MAINTENANCE
3. JOB COST FILE MAINTENANCE
4. JOB COST REPORTING
5. EMPLOYEE TABLE MAINTENANCE
6. RETURN TO MASTER MENU
SELECT (1-6)?

SYSTEMS II EX MASTER MENU

- | | |
|------------------------|--------------------|
| 1. INVENTORY | 7. CHART OF ACCTS. |
| 2. PAYABLES | 8. VENDOR MAINT. |
| 3. RECEIVABLES | 9. CUST. MAINT. |
| 4. PAYROLL | 10. CHANGE DATE |
| 5. LEDGER | 11. SYS./BACKUP |
| 6. JOURNAL | 12. STOP PROCSS'G. |
| 13. OPTIONAL PROCSS'G. | |
- SELECT (1-13)?

DATABASE MENU

1. FILE MAINTENANCE
2. REPORTS/REPORT MAINT.
3. UTILITIES
4. RETURN TO SYSTEM MENU
SELECT (1-4)?

ACCOUNTS PAYABLES MENU

1. FILE MAINTENANCE
2. PAYMENT SELECTION
3. PRINT CHECKS AND REGISTER
4. MONTH END
5. RETURN TO MASTER MENU
SELECT (1-5)?

RECEIVABLES SYSTEM MENU

1. FILE MAINTENANCE
2. RECEIPT OF PAYMENTS
3. GENERATE BILLING
4. MONTH END
5. PAST DUE REPORT
6. APPLY MONTHLY INTEREST
7. RETURN TO MASTER MENU
SELECT (1-7)?

LEDGER SYSTEM MENU

1. FILE MAINTENANCE
2. BAL SHEET/INCOME STATEMENT
3. YEAR END PROCESS
4. RETURN TO MASTER MENU
SELECT (1-4)?

INVENTORY SYSTEM MENU

- | | |
|--------------------------|------|
| TIME | DATE |
| 1. FILE MAINTENANCE | |
| 2. POINT OF SALES | |
| 3. REORDER REPORT | |
| 4. RETURN TO MASTER MENU | |
- SELECT (1-4)?

STATE PAYROLL MENU

1. MISC./TAX TABLE MAINT.
2. TRANSACTION FILE
3. MISC. PAY/DEDUCTION FILE
4. EMPLOYEE MASTER FILE
5. CALCULATE/PRINT CHECKS
6. PRINT W2's
7. RETURN TO MASTER MENU
SELECT (1-7)?

SYSTEMS II EX — EX for EXTENDED PERFORMANCE. Westware brings you the most completely integrated and simplest to use business software for your Apple Computer. The SYSTEMS II EX is complete with an integrated Database. Yes! The DBII Database can move your system's files into Database format for customized reports or labels.

Although the SYSTEMS II EX is a fully integrated system, you may purchase

individual modules and later add additional modules, such as Job Costing for contractors. The power of our system is in the KSAM Firmware card that plugs into the Apple. This card permits high speed searches and eliminates running sort routines to get your files in order.

SYSTEMS II is available on 5¼" drives, and also on the Corvus hard disk. A Corvus based system will give you the power and capacity that challenges larger computers.

COMING SOON — Cash flow analysis with graphics, Database II with graphics, and Bill of Materials for small manufacturers.

CURRENT OPTIONS AVAILABLE — Job Costing, Cycle Invoicing, Order entry, and Layaway.

All Checks, statements and invoices use NEBS forms.

Dealer and OEM inquiries invited.

Apple is a trademark of Apple Computers.



2455 S.W. 4th Ave.
Suite 2
Ontario, OR 97914
(503) 881-1477



Yes, I would like to sample your software. Please send me the Systems II Demo Package. My check for \$25 is enclosed.

Name _____

Title _____

Company Name _____

Address _____

City _____ State _____ Zip _____

2455 S.W. 4th Ave.
Suite 2
Ontario, OR 97914
(503) 881-1477

Accidental Reset Protection for the Apple II

Greg DeWilde, POB 3184, Hillsdale, CA 94403

Since the introduction of the Apple II computer, there have been many references to one major problem with the keyboard: the location of the RESET key. It is located directly above the RETURN key. Accidentally pressing the wrong key has often produced disastrous results.

Many solutions to isolating the RESET function have become available. These have caused Apple Computer Inc. to notice how irritating this problem is. Newer Apple keyboards have an option that requires the CTRL and RESET keys to be pressed at the same time to reset the computer.

I was an owner stuck with the older, single-key RESET. Wanting to modify this, I looked at some of the solutions

Text continued on page 238

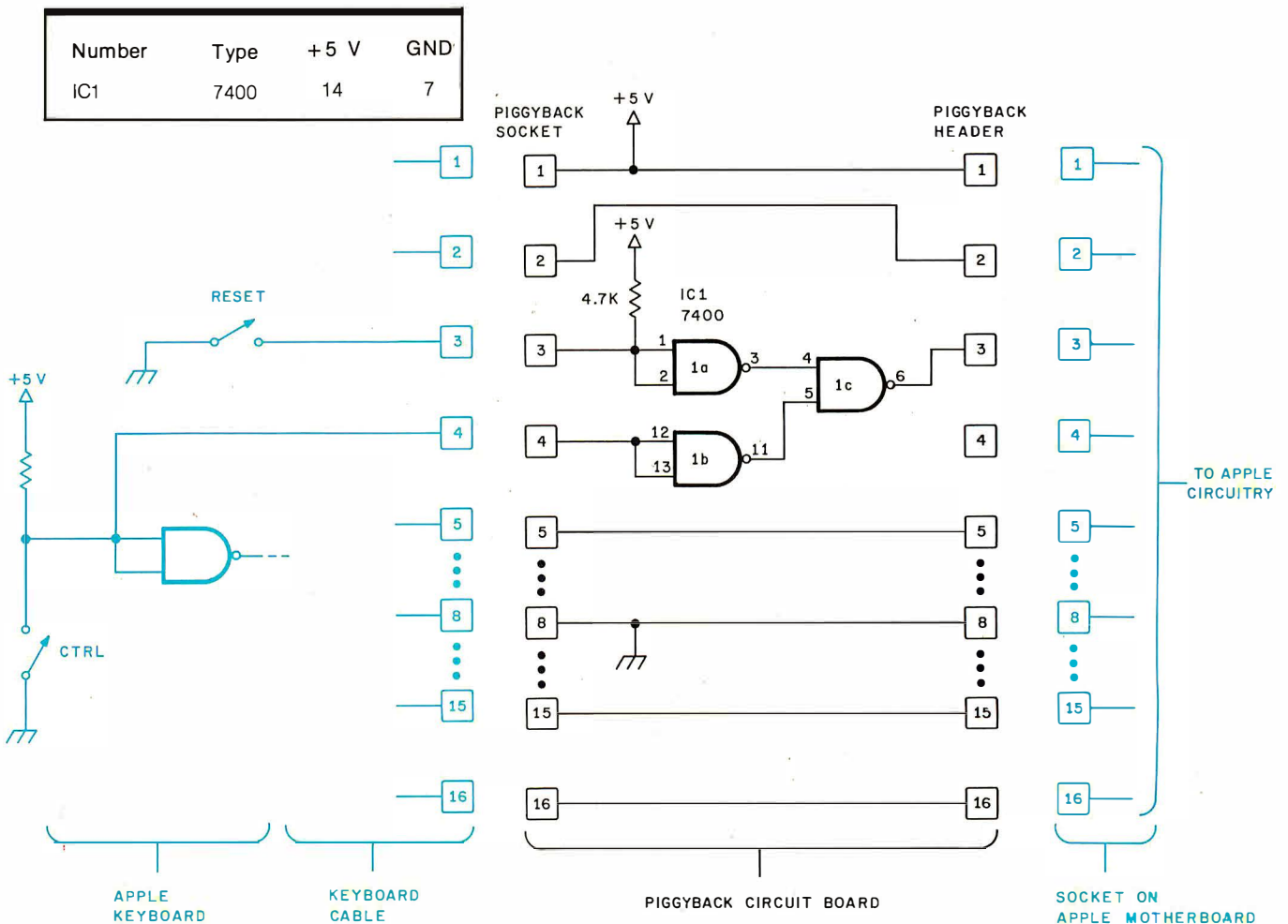

Figure 1: Schematic diagram of the control-plus-reset modification to the Apple II computer. One connection from the control key to pin 4 of the keyboard circuit board is shown in this diagram and figure 2. The cable from the Apple keyboard plugs into the piggyback board socket, and the piggyback board header (on the other side of the printed-circuit board) plugs into the socket on the main Apple board (the motherboard). Pins not shown have connections similar to pin 5.

OMIKRON proudly presents

THE WORKS

a comprehensive package for your TRS-80* Model I

The WORKS includes:

Mapper I & CP/M 2.2, CBASIC II, MBASIC-80 and WordStar

\$399

WordStar is widely recognized as the most advanced product on the market. It is featured by many computer manufacturers, including Xerox, for wordprocessing applications.

List price: \$495

CP/M 2.2 is the latest version of CP/M from Digital Research. Our package also includes the MAPPER I CP/M adapter and a sophisticated set of utilities and drivers designed to optimize the CP/M system for the TRS-80.

List price: \$239

MBASIC-80 is the CP/M version of Microsoft BASIC. The conversion of TRS-DOS BASIC programs to MBASIC is easy because the syntax is almost identical.

List price: \$349

CBASIC II is the most widely used BASIC for CP/M applications programs. This version of BASIC contains all of the features necessary to develop complex business programs.

List price: \$149

OMIKRON also offers:

COUGAR Membership: There is a one time fee of \$29 to join the **COUGAR** group. Membership is open only to qualified MAPPER I owners.

MallMerge: When used with WordStar, this program merges lists of names into form letters.

SuperSort: The product received rave reviews in August 81 Interface Age Magazine. This is the fastest and most versatile sort program available.

WordMaster: This is a text editor that everyone likes. It features the same command structure as the CP/M editor, but it has full screen editing facilities.

OMIKRON

Products that set Precedents

1127 Hearst Street, Berkeley, CA 94702 (415) 845-8013

We'll "drive" you wild with our variety of quality disk drives.

ASAP carries only the highest quality floppy disk drives, to provide you with years of trouble-free service and superior performance.

Data Trak™ 5 (ANSI 5¼" compatibility)	Call for price
Data Trak™ 8 (IBM compatibility)	Call for price
Model 801 (standard floppy)	\$425.00
Model 850	\$640.00
Dual Disk Drive Cabinet	\$225.00

ASAP also provides a full line of high reliability disk drive subsystems*.

HDC8/1-HD — Cabinet with (1) Priam 10 megabyte hard disk drive with Microbyte Controller..... Call for price

HDC8/1F+1HD— Cabinet with (1) Qume® DT-8 double-sided, double-density drive, and (1) Priam 10 megabyte hard disk drive with Microbyte Controller

Call for price
CABBH — Dual cabinet for 8" floppy disk drives (horizontal mounting)

\$ 225.00
CABBV — Cabinet for 8" floppy disk drives (vertical mounting)

\$ 225.00
CABBH/V+1S — Dual cabinet with (1) Shugart SA801R installed (horizontal or vertical mounting)

\$ 750.00
CABBH/V+2S — Dual cabinet with (2) Shugart SA801R's installed (horizontal or vertical mounting)

\$1150.00
CABBH/V+1Q — Dual cabinet with (1) Qume® DT-8 double-sided double-density drive installed (horizontal or vertical mounting)

\$ 830.00
CABBH/V+2Q — Dual cabinet with (2) Qume® DT-8's double-sided double-density drive installed (horizontal or vertical mounting)

\$1350.00
CABBV/2F-9SMB — Desk top cabinet for (2) 8" Shugart or Qume® floppy disk drives, 9-slot motherboard, card cage, fan, dust filter, power supply, all power and drive cables

A New Era for Okidata

Models 82A and 83A from ASAP

OKIDATA's new printer line represents a breakthrough in economical, quality printing. These new printers have more options and features than any previous OKIDATA printer. Faster print speed and throughput, full 96-character ASCII, and both Centronics and RS232C interfaces standard, all at an affordable price. Models

82A and 83A are ideal for home or business, personal or educational applications. And now, ASAP is offering these new printers at prices you won't want to miss. Compare the features below. Then call ASAP to order your OKIDATA printer today.

Features	Okidata 82A 80 Column Printer	Okidata 83A 136 Column Printer
Print speed	120 characters per second	120 characters per second
Throughput @80 characters per line	76 lines per minute	47 lines per minute
Print technique	Bidirectional	Bidirectional
Dot matrix	9 x 9	9 x 9
Character set	Full 96-character ASCII	Full 96-character ASCII
Graphics characters	64 block characters	111 dots per inch
Interface Centronics 8-bit parallel	Standard	Standard
RS232C (1200 bps)	Standard	Standard
Size (inches)	14.2W x 12.9D x 5.2H	20.2W x 12.9D x 5.2H
Ribbon	Standard typewriter	Standard typewriter
Power	100, 115, 220, 240 VAC 50 or 60Hz	100, 115, 220, 240 VAC 50 or 60Hz

asap
computer
products, inc.

ATARI 800

(16K) Personal Business Computer
• Computer console • Atari 8K basic
• 57 full stroke alpha-numeric keyboard
with four function keys • Operator's
manual • RF modulator • Power supply
Price: \$799.00

Special Offer: Additional 16K RAM-FREE
with purchase of system.

Atari Optional Accessories

ATARI® 410™	
Program Recorder	\$ 60.00
ATARI® 810™ Disk Drive	\$455.00
ATARI® 820™ 40-column	
Dot Matrix Impact Printer	\$279.00
ATARI® 822™ Thermal Printer	\$349.00
ATARI® 825™ 80-column	
Dot Matrix Impact Printer	\$625.00
ATARI® 830™ Acoustic Modem	\$159.00
ATARI® 850™ Interface Module	\$159.00
ATARI® Paddle (CX30-04)	
or Joystick (CX40-04)	\$ 17.95
Light Pen (CX-70)	\$ 64.95
Atari 800 16K RAM Module	\$75.00
(1 year warranty parts & labor)	

Atari Software (Many more available)

Super Breakout	\$ 30.00
Chess	\$ 30.00
Video Easel	\$ 30.00
3-D Tic Tac Toe	\$ 30.00
Star Raiders	\$ 34.00
Music Composer	\$ 42.00
Educational System ROM	\$ 19.95
Assembler/Editor	\$ 45.00
Teletalk I	\$ 19.95
Space Invaders	\$ 15.95
Kingdom	\$ 12.95
Biorhythm	\$ 12.95
Graph It	\$ 15.95
Energy Czar	\$ 12.95
Mailing List	\$ 16.95
Statistics I	\$ 16.95
Touch Typing	\$ 19.95
Stock Charting	\$ 19.95
Stock Analysis	\$ 19.95
Bond Analysis	\$ 19.95

SO Systems/S-100 Board

EXPANDORAM	16K	\$240.00
2 MHz DYNAMIC	32K	\$258.00
RAM BOARD	48K	\$276.00
KITS	64K	\$294.00
EXPANDORAM II	16K	\$250.00
4 MHz DYNAMIC	32K	\$268.00
RAM BOARD	48K	\$286.00
KITS	64K	\$304.00
SBC-100 KIT 2.5 MHz/Z80 CPU with Serial I/O Ports & SBC 100 Monitor of your choice at no charge.		\$299.00
SBC-200 KIT 4 MHz/Z80A CPU with Serial & Parallel I/O Ports & SBC 200 Monitor of your choice at no charge.		\$325.00
VERSAFLOPPY I KIT Disk Controller for 5 1/4" or 8" Drives. Single or Double Sided/Single or Double Density. S-100 Compatible		\$250.00
VERSAFLOPPY II KIT Disk Controller for 5 1/4" or 8" Drives. Single or Double Sided/Single or Double Density. S-100 Compatible		\$300.00
PROM 100 KIT S-100/E PROM PROGRAMMER for 2708, 2716, 2732 & (TI) 2516		\$190.00
ALL BOARDS ARE AVAILABLE ASSEMBLED & TESTED. CALL FOR PRICES.		

Apple Parallel Interface:

AEI-1 W/Cable \$69.95

- Standard Interface
- Compatible with Epson & Okidata printers
- On-board firmware (2708)
- Optional cables: \$25.00
- AEC-2/ Atari to Epson printer
- TREC-2/TRS-80 to Epson/Okidata printer
- RSC-1/R5232 (male to male)

Serial Interface SEI-1 \$55.00

- Asynchronous 300, 1200, 2400 or 9600 BPS
- Compatible with Epson printers
- 75 to 9600 BPS

DISKETTES from ASAP

VERBATIM 5 1/4" DISKETTES			
Part #	Sectoring		Price
MDS25-01	Soft		10/\$27.50
MDS25-10	Hard 10		10/\$29.50
MDS25-16	Hard 16		10/\$29.50
VERBATIM B" DISKETTES			
FD32-1000	Hard		10/\$35.00
FD34-1000	Soft		10/\$35.00

MEMOREX 5 1/4" DISKETTES			
Part #	Sides/Density	Sectoring	Price
MEM 3401	1/Single	Soft	10/\$25.00
MEM 3403	1/Single	Hard 10	10/\$25.00
MEM 3405	1/Single	Hard 16	10/\$25.00

MEMOREX B" DISKETTES			
MEM 3060	1/Single	Soft	10/\$35.00
MEM 3101	2/Single	Soft	10/\$45.00
MEM 3090	1/Double	Soft	10/\$45.00
MEM 3102	2/Double	Soft	10/\$55.00

DYSAN 5 1/4" DISKETTES			
D-0130	1/Single	Soft	10/\$45.00
D-0226	1/Double	Soft	10/\$46.00
D-0235	2/Double	Soft	10/\$55.00

DYSAN B" DISKETTES			
Part #	Sides/Density	Sectoring	Price
D-0506	1/Single	Soft	10/\$45.00
D-0605	2/Double	Soft	10/\$65.00

SCOTCH 3M 5 1/4" DISKETTES			
744-0	1/Single	Soft	10/\$33.00
744-10	1/Single	Hard 10	10/\$33.00
744-16	1/Single	Hard 16	10/\$33.00
745-0	2/Double	Soft	10/\$59.00
745-10	2/Double	Hard 10	10/\$59.00
745-16	2/Double	Hard 16	10/\$59.00

MAXELL 5 1/4" DISKETTES			
MD1	1/Single	Soft	10/\$39.00
MD20	2/Double	Soft	10/\$65.00
MH1	1/Single	Hard 16	10/\$39.00
MH20	2/Double	Hard 16	10/\$65.00

MAXELL B" DISKETTES			
FD1-128	1/Single	Soft	10/\$45.00
FH1-32	1/Single	Soft 32	10/\$45.00
FD2-XD	2/Double	Soft	10/\$65.00

SRW MEDIA STORAGE CASES			
Part #	Size		Price
SRW-5	5 1/4"		\$2.50 ea.
SRW-8	8"		\$3.25 ea.

SYSTEMS WITH SPICE from CALIFORNIA COMPUTER SYSTEMS

FOR APPLE II™ USERS

Synchronous Serial Interface Part Number 7712A	Price: \$149.00
Programmable Timer Part Number 7440A	Price: \$ 95.00
Asynchronous Serial Interface Part Number 7710A	Price: \$139.00
Calendar/Clock Module Part Number 7424	Price: \$ 99.00
3 1/4" Digit BCD A-to-D Converter Part Number 7470A	Price: \$ 95.00
12K ROM/PROM Module Part Number 7114A	Price: \$ 85.00
Parallel Interface Part Number 7720A	Price: \$125.00
Arithmetic Processor Part Number 7811A	Price: \$349.00
Centronics Printer Interface Part Number 7728A	Price: \$125.00

FOR S-100 USERS

32K Static RAM Board Part Number 2032C	Price: \$610.00
16K Static RAM Board Part Number 2116C	Price: \$290.00
64K Dynamic RAM Board Part Number 2065C	Price: \$550.00
Z-80A CPU Board Part Number 2810A	Price: \$265.00
Floppy Disk Controller Part Number 2422A	Price: \$365.00
CP/™™ Version 2.2 Free With Purchase	
S-100 Mainframe Part Number 2200A	Price: \$475.00
2201A (220VAC)	\$475.00
S-100 Motherboard Part Number 2501A	Price: \$150.00
4-Port Serial I/O Interface Part Number 2710A	Price: \$245.00
2-Serial, 2-Parallel I/O Board Part Number 2718A	Price: \$275.00
4-Port Parallel I/O Board Part Number 2720A	Price: \$195.00

MICROBYTE 4-PORT I/O BOARD

- Quad RS-232C serial ports. One 20 mA current loop port
- Fully IEEE S-100 Bus compatible
- Asynchronous Communications with Z80A-DART(TM) or synchronous communications with Z80A-SIO/0(TM)
- Full set of modem control signals, including RI (Ring Indicator)
- Easily configurable to any type of terminal interface

\$265.00 Assembled & Tested
Cables Available (Optional)

MICROBYTE FLOPPY DISK CONTROLLER

- DMA to within 16 Mbyte of memory
- State-of-the-art NEC765 LSI Controller
- IEEE S-100 compatible
- DMA arbitration allows use of multiple boards within a system

\$329.00 Assembled & Tested

MICROBYTE Z-80A/ I/O CPU BOARD

- A complete single board Z80A CPU with serial/parallel interface
- Fully compatible with the proposed IEEE S-100 Bus Standard
- Z80A CPU (4MHz version of the Z80)

\$329.00 Assembled & Tested
Optional Monitor Program \$30.00

MICROBYTE 64K DYNAMIC RAM BOARD

- Fully S-100 bus compatible
- 64K x 8 bit dynamic RAM
- Low power:
 - +8VDC @ 700 mA
 - +16VDC @ 100 mA
 - 16VDC @ 25 mA
- Built-in capacity with LED indicator and vector interrupt

\$499.00 Assembled & Tested

Printers

Manufacturer/Model #	Price
Anacom-150	\$ 995.00
Anadex-9501	\$1295.00
Diablo-630R	\$2300.00
C.Itoh Starwriter 45	\$1925.00
Texas Instruments-810	\$1650.00
Epson MX-80	Call For Price

Modems

Manufacturer	Model #	Price
Novation	CAT	\$ 149.00
Novation	d-CAT	\$ 160.00
Novation	Auto-Cat	\$ 229.00
Lexicon	Lex-11	\$ 139.00
Livermore	LIV-Star 20M	\$ 149.00
UDS	UDS 103	\$ 189.00
UDS	UDS 202	\$ 295.00

ASAP offers a 30-day buyer protection policy: full money-back guarantee if not totally satisfied.

Ordering Information: Name, address, phone, ship by: UPS or Mail. Shipping charge; add \$2.50 up to 1 lb. for UPS blue; add \$1.50 for U.S. Mail (U.S. only) (\$25.00 minimum order). Call for larger shipments.

Terms: We accept cash, check, money orders, Visa & Master Charge (U.S. Funds only). Tax: 6% Calif. Res., COD's and terms available on approval (school PO's accepted).

asap
computer
products, inc.

1198 E. Willow St., Signal Hill, CA 90806

Monitors

Manufacturer	Model #	Price
Amdek	100/12" B&W	\$ 139.00
Amdek	100-80	\$ 169.00
Amdek	100G/12" Grn.	\$ 169.00
Amdek	Color-1 13"	\$ 375.00
APF	TVM-10/10" B&W	\$ 149.00
Hitachi	VM 910/9" B&W	\$ 210.00
Hitachi	VM 129/12" B&W	\$ 340.00
Sanyo	OM 5012/12" B&W	\$ 270.00
Sanyo	OM 5112ex/12" Grn.	\$ 290.00
Sanyo	OM C6013/13" Color	\$ 475.00
Zenith	ZVM-121/12" Grn.	\$ 129.00

Terminals

Manufacturer	Model #	Price
Ampex	Dialogue 80	\$ 899.00
Soroc	IO120	\$ 750.00
Soroc	IO140	\$1250.00
Televideo	TVI 910	\$ 650.00
Televideo	TVI 912C	\$ 725.00
Televideo	TVI 950C	\$ 950.00

Components

4116's (200 nS)

Apple, TRS-80, Heath	8/S18.00
16-49	\$2.15 each
50-99	\$2.05 each
100 up	\$1.95 each

2114 L-2/200 nS

Low-Power 1K x 4 Static RAM	
1-16	\$2.95 each
17-49	\$2.85 each
50-99	\$2.75 each
100 up	\$2.65 each

Components

74LS240	\$1.25 each	74LS373	\$1.25 each
74LS241	\$1.10 each	74LS374	\$1.25 each
74LS244	\$1.25 each	8T245	\$1.50 each

2708/450 nS

1K x 8 EPROM	\$3.50 each or 8/\$26.00
--------------	--------------------------

2716/5 Volt

2K x 8 EPROM	\$5.50 each
--------------	-------------

Support Chips

8080A-CPU	\$ 2.50	Z80A-SIO	\$22.00
Z80A-CPU	\$ 8.95	8255AC5	\$ 6.95
Z80A-CTC	\$ 8.95	8257AC5	\$15.00
Z80A-DART	\$13.95		

Regulators

320T5	\$.80	320T12	\$.80
340T5	\$.70	340T12	\$.75

Connectors

	1-9	10-24	25 up
DB25P	\$2.25	\$2.15	\$2.00
DB25S	\$3.25	\$3.10	\$2.90
DB25C	\$.95	\$.85	\$.75

100 Pin IMSAI

Gold/S-100 Solder-tail Connectors
\$2.60 each or 10/\$2.40 each

Capacitors

1 @ 12 Volt Ceramic 8c each or 100/\$7.00

DIP Sockets — Low Profile Tin Solder-tail

Description	19	10-49	50-99	100 up
14 pin tin st	\$.15	\$.13	\$.12	\$.11
16 pin tin st	\$.16	\$.14	\$.13	\$.12
18 pin tin st	\$.19	\$.18	\$.16	\$.14
20 pin tin st	\$.25	\$.23	\$.21	\$.20
24 pin tin st	\$.26	\$.24	\$.22	\$.20
28 pin tin st	\$.32	\$.30	\$.29	\$.27
40 pin tin st	\$.42	\$.40	\$.38	\$.34

Toll free outside California:

(800) 421-7701

Inside California:

(213) 595-6431

(714) 891-2663

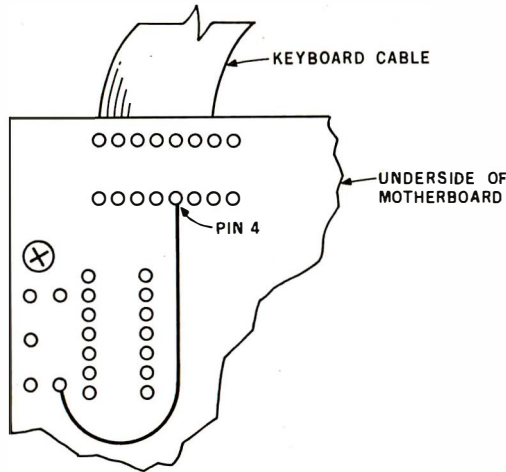

Figure 2: A jumper must be added to the Apple's motherboard to pass a signal from the CTRL key to the reset-enabling circuitry shown in figure 1.

currently available. I found everything from simple cardboard shields, which slip around the RESET key, to switches mounted on the side or rear of the Apple's case that are wired in series with the key. Prices ranged from \$0.15 to \$20 or more.

After careful consideration, I decided I wanted a modification that was invisible from the outside of the case and required both hands to operate. The best way to accomplish this is to duplicate Apple's efforts and use the CTRL key.

Figure 1 is the schematic diagram of my modification with the existing Apple hardware shown in color. Although there are several ways to incorporate the new components, I chose to develop a printed-circuit board

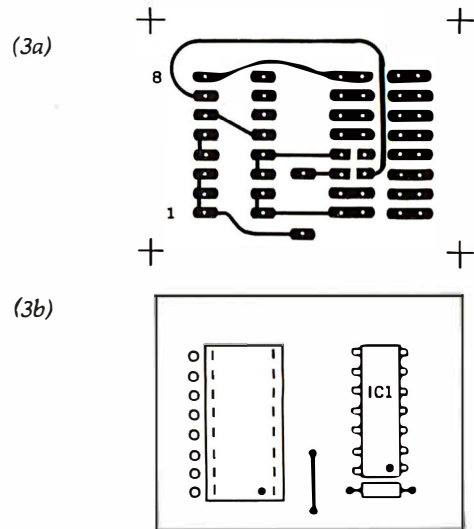

Figure 3: Printed-circuit artwork and layout for the control-plus-reset conversion. The circuit board has a 16-pin socket on the top side to accept the keyboard cable, and a dual in-line 16-pin header on the bottom (foil) side to plug into the motherboard's keyboard socket. As seen from the top (figure 3b), the holes for the socket are located to the right of the holes for the header pins. From the foil side of the printed-circuit board (figure 3a), the situation is reversed—the left holes (on the elongated pads on the right half of the board) are from the socket, and the holes on the right go to the header pins. Also, note the placement of the dot in figure 3b, which marks pin 1 of both IC1 and the 16-pin socket.

that is mounted "piggyback" on the motherboard socket for the keyboard cable. This also required adding a jumper wire to the bottom of the keyboard as shown in figure 2. The foil and component layouts of the board are shown in figures 3a and 3b. ■

64K-256K Parity Memory for IBM Personal Computer

\$495

Includes one year warranty. Single quantity price for MP-064

Also available:

- (A) 2-Port, RS 232; Capable of ASYNC, BISYNC, SDLC & HDLC Model: CC-232 \$240
- (B) Wire-wrap Development Kit (w/w board & Extender) Model: WW-070 \$95

Available Soon:
64K-256K Error Correcting Memory

Price

Model	Capacity	Unit Price
MP-064	64K + parity	\$ 495
MP-128	128K + parity	\$1195
MP-192	192K + parity	\$1695
MP-256	256K + parity	\$2095

All memories are 250 ns Access Time and 410 ns Cycle Time.

AST RESEARCH INC.
17925 Sky Park Circle, Suite B
Irvine, CA 92714 (714) 540-1333

Dealer inquiries welcome.

An 8080-Based Remote Appliance Controller

David C. Staehlin
5430 Candleglow NE
Albuquerque, NM 87111

Many of us are familiar with BSR's console command units and receiving modules that control lights and appliances by transmitting signals over ordinary 115-volt AC wiring. In the January 1980 BYTE ("Computerize a Home," page 28), Steve Ciarca discussed the control signals required to communicate with the BSR console

command unit and presented an interface circuit for controlling the ultrasonic unit.

Being a gadget nut, I had already purchased a console command unit that did not have ultrasonic capabilities. My decision to discard a perfectly good console and purchase one with ultrasonic capabilities met

with stiff opposition from my wife. So I was faced with converting my present unit if I wanted to experiment ("play," as my wife puts it) with computer control of remote appliances.

BSR System Operation

Even though the standard BSR command unit cannot be used with the hand-held ultrasonic controller, serial communications with the unit remain possible. As a preface, I'll briefly review operation of the ultrasonic data link between the hand-held transmitter and the console receiver.

When a command button is pushed on the hand-held controller, a coded series of 40-kHz bursts is transmitted to a receiver section within the console unit. These bursts are amplified and applied to pin 7 of the custom LSI (large-scale integration) integrated circuit (IC) within the console unit, where they are decoded and executed as the desired command. To eliminate the added expense of producing a different custom IC, BSR uses the same device in both the standard and ultrasonic controller models. They differ only in that the 40-kHz transducer and amplifier sections are omitted in the standard model. Since it is always good practice and usually necessary to have all pins of an integrated circuit connected to some-

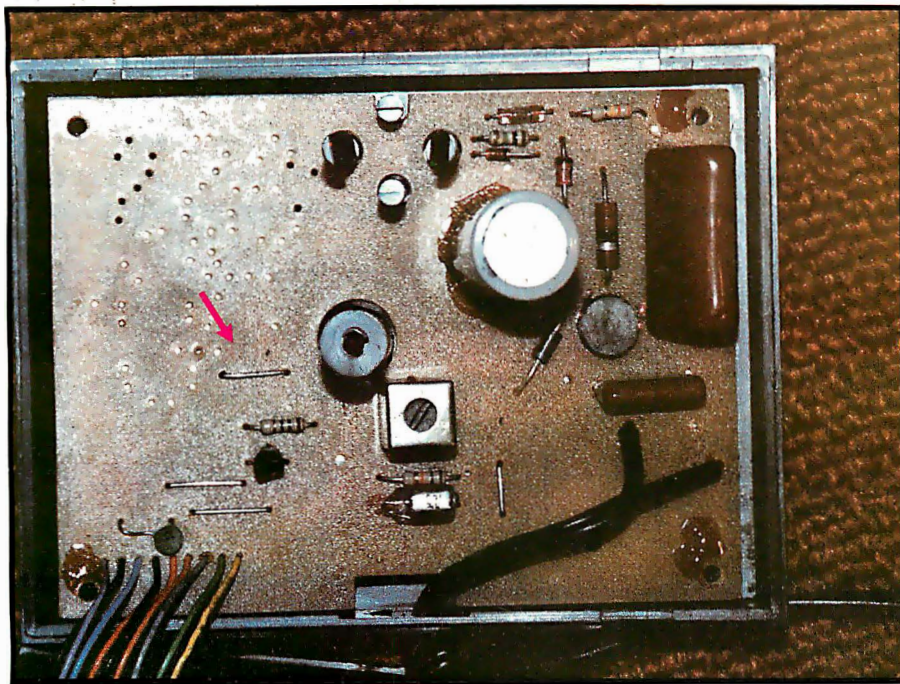
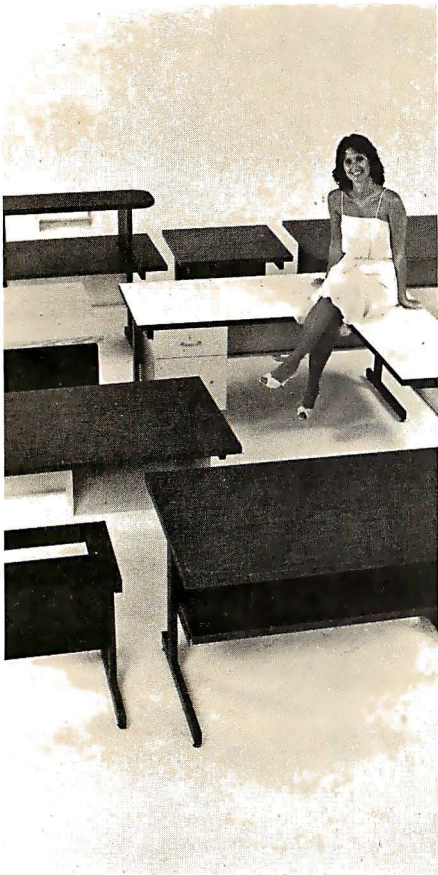

Photo 1: The standard BSR command console. This unit is exactly the same as the ultrasonic version but does not have the 40-kHz transducer and amplifier. The arrow points to a jumper at the input of the custom LSI controller integrated circuit developed by BSR. This is the input that can accept serial information from a computer. (Photo courtesy Dan Thompson)



SITTING PRETTY

You can use just about any desk for a computer terminal stand. But with CF&A, you're sitting pretty. Our full range of desks, workstations, and terminal stands are designed to accommodate a variety of computer equipment. Choose from our Classic Series desks, DR Series desks and enclosures, specialty items like our Apple II desk, or a universal printer stand. You'll be sitting pretty with attractive color selections, durable construction, versatile configurations, useful options, competitive prices, quick delivery, and personal service. It's our way of doing business.

CF&A

Computer Furniture and Accessories, Inc.
 1441 West 132nd Street
 Gardena, CA 90249
 (213) 327-7710

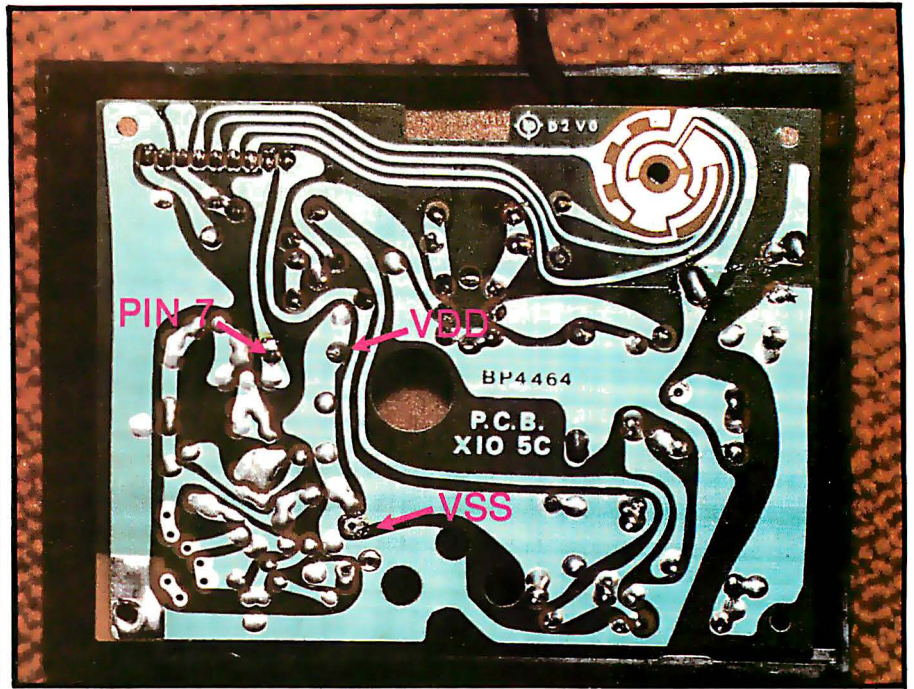

Photo 2: Foil side of the BSR controller. Arrows indicate mounting holes available for use by the experimenter. Be careful not to bridge adjacent foil traces when making connections to the board.

thing, BSR connected pin 7 to ground with a wire jumper (see photo 1). If this jumper is removed, you should be able to "fool" the command unit into accepting your commands when the proper information is injected into it.

Inexpensive Interface Circuit

As stated previously, pin 7, the serial-data-input pin, communicates with the outside world through a properly encoded series of 40-kHz tone bursts. Figure 1 details a circuit

that can generate these 40-kHz waveforms. If you have only a serial port on your computer and can't afford a parallel port, the circuit shown in figure 1 will work with either RS-232C or standard parallel communication levels. All that is needed for RS-232 communications is a device-control or status port that can be toggled between 0 and 1.

The circuit uses an integrated circuit to form the communications link with the computer. IC1, a CD 4001 CMOS (complementary metal-oxide

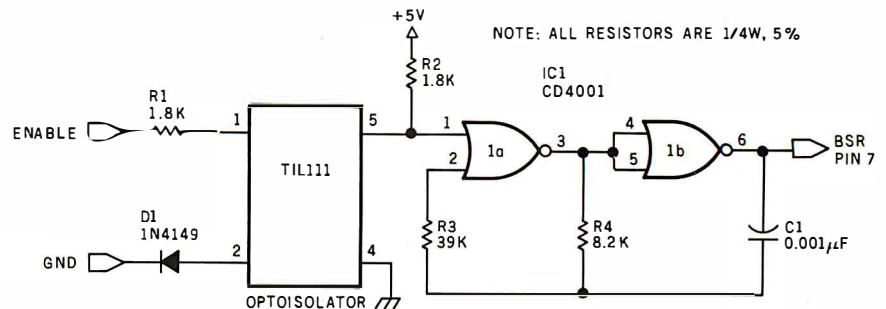

Figure 1: Schematic diagram of the serial interface circuit. The ENABLE signal may be originated by a computer's RS-232 port or from a parallel port driven by the appropriate software. The optoisolator is used to isolate the controller from the computer (the controller's ground "floats" at power-line voltage). The oscillator made from IC1 is designed to produce a

Number	Type	+5V	GND
IC1	CD 4001	14	7

40-kHz "burst" when the ENABLE signal is received, thus mimicking the signals found in a BSR controller with ultrasonic capability.

Our Commander Computer Now Works Three Times As Hard



Not only does Columbia Data Products' Commander Computer give you the largest I/O complement in the industry, we now give you multi-tasking capability to play with.

And by *multi-tasking*, we mean simultaneous execution of several software processes — like performing data entry operations while supporting on-line data communications...or developing software while batch printing...or running a business package while updating your data base...or performing concurrent peripheral operations in an industrial environment.

In fact, we could go even farther. By utilizing the Commander 964+ dual processor architecture, graphic terminal emulation software or even custom user modules, like "Space Commanders" depicted above, can be downloaded to the terminal system processor, while the host Z-80A — 128K processor system under the MP/M II operating system can support independent multi-user, multi-tasking operations.

Other standard features of the Commander 964+ include 512 x 256 graphics display, dual Z-80A processors, 128K RAM host system, 32K RAM terminal, four RS-232 ports, four parallel ports, RS-170 composite video, four channels of programmable

counter/timer, 800K bytes disk storage, and CP/M® and MP/M® II operating systems. Optional features include APU, DMA, IEEE bus controller and expandable disk capacity.

Think about it...resource sharing at its best, from Columbia Data Products.

Contact us for more information.

COLUMBIA

DATA PRODUCTS, INC.

Home Office:
8990 Route 108
Columbia, MD 21045
Telephone 301-992-3400
TWX 710-862-1891

West Coast:
3901 MacArthur Blvd.
Suite 211
Newport Beach, CA 92660
Telephone 714-752-5245
Telex 692 310

Europe:
P.O. Box 1118
4050 Moenchengladbach 1
West Germany
Telephone 021-61-33159
Telex 852 452

® Trademark of Digital Research

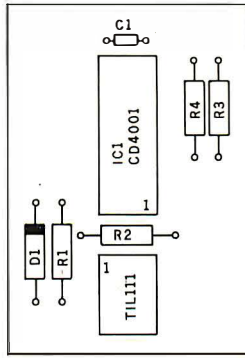
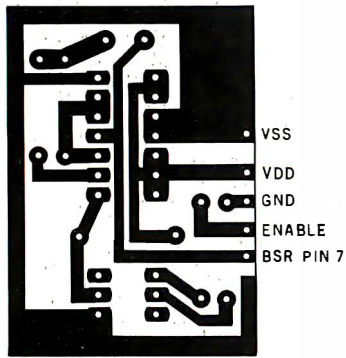

Figure 2: Interface etching, drilling, and component layout. A printed-circuit card of the proper size (the figure is actual size) will fit easily in the controller's case, although other construction techniques may work as well. Note the orientation of pin 1 on each of the integrated circuits.

semiconductor) quad, two-input NOR gate is used to create the 40-kHz output injected into pin 7 of the BSR custom IC. The other IC is an optoisolator that provides electrical isolation between the computer and the BSR unit's ground, which is floating at line voltage. Do *not* try this circuit without the optoisolator; that would be a very expensive mistake.

Operating power for the circuit comes directly from the BSR's internal power supply. BSR has conveniently provided holes in the console circuit board for power and pin 7 connections. Photo 2 shows the foil side of the command unit's printed circuit board, where to pick up the V_{SS} and V_{DD} supplies required for the interface circuit, and where to tie into pin 7 of the custom IC.

The construction technique or component layout for the circuit is not critical. However, to keep the finished circuit small enough to fit inside the existing housing, I recommend using a printed-circuit board. Figure 2 illustrates a full-size etching and drilling layout for this purpose. Photo 3 shows the completed board tucked neatly into the corner of the BSR controller housing. Be sure to cover the foil side of the finished circuit board with an insulative material to prevent the foil patterns from shorting to any jumpers installed on the BSR circuit board.

This circuit is not limited to controllers lacking ultrasonic capabilities. Ultrasonic command units may be used by disconnecting the output of the 40-kHz transducer amplifier section from pin 7 of the custom IC and hooking up this interface circuit in the same manner as the standard control console. With a little work, I'm sure a modification can be made to the interface circuit presented to allow operation of both the interface and the 40-kHz transducer and amplifier. Since I was too frugal to buy an ultrasonic model, I can't say for sure.

Talking to the Controller

Now that we have a method of injecting 40-kHz pulses into the control unit's custom IC, it becomes neces-

\$7500

THE WORDTM

WHY DOES OUR SPELLING CHECKER COST LESS THAN THEIRS?

Maybe we goofed by not charging more for The WORD. Our customers tell us we must be crazy, giving away this much software for only \$75.

What's wrong with it?

Frankly, we're a little hurt when people ask us this question. We guess everyone must be getting used to paying \$200 to \$300 for decent software. Anything that costs less must be junk. Right?... WRONG!!!

The WORD is not only cheaper, it's better!

Available NOW for:
 8" single CP/M[®], CDOSTM
 XEROX 820 (8" only)
 Intertec SuperbrainTM
 AppleTM with CP/M Softcard
 (35,000 word dictionary)
 North StarTM Double/Quad with CP/M
CP/M is a registered trademark of Digital Research

The WORD gives you more!

- The WORD gives you a 45,000 word dictionary that fits into less than 140K of disk space.
- The WORD works with your favorite text editor and marks mistakes in your document for easy, *in-context*, correction.
- The WORD's one-touch word review lets you add new words to the dictionary with a single keypress. You can build your own custom dictionaries too!
- The WORD will look up the correct spelling of misspelled words.
- The WORD analyzes your writing, counting words and showing you how often *each* word was used.
- The WORD has a special *homonym helper* feature to deal with these pesky words.
- The WORD will find rhyming words, solve crossword puzzles, and much more!

CALL TODAY!
(714) 291-9489

OASIS SYSTEMS
 2765 REYNARD WAY, SAN DIEGO, CA 92103

242 January 1982 © BYTE Publications Inc

16 Bit 8086 Multi-User Microcomputer System

\$7595
FOUR
USER
SYSTEM

FOR **MP/M-86™**

ONLY
\$1899*
PER
USER

THE
TEC 86M



1/2 MEGABYTE
OF MEMORY

TWO 8 INCH D.D.
FLOPPY DISKS

STANDARD FEATURES

- 16 BIT 8086 CPU** - Processor performance is the most critical element in a Multi-User System. Speed, power and the increased throughput of our 16 Bit 8086 CPU are just a few of the reasons why our TEC 86M Multi-User Systems really perform.
- 1/2 MEGABYTE OF MEMORY** - The second most important factor which affects system performance is available user memory. Our 1/2 Megabyte, four user system gives each user well over 100K Bytes of memory, eliminating program size compromises which lead to poor Multi-User system performance.
- MP/M-86™ COMPATIBILITY** - The TEC 86M includes a ROM Boot for MP/M-86™ and is designed to provide optimal support for MP/M-86™. The MP/M-86™ Operating System is available separately from Tecmar for \$600. See Software Options listed below for important MP/M-86™ features.
- FULLY INTERRUPT DRIVEN** - The TEC 86M provides terminal and disk I/O interrupts to MP/M-86™, allowing for maximum system performance in Multi-User operation.
- TWO 8 INCH DOUBLE DENSITY FLOPPY DISK DRIVES** - The two Double Density floppy disks total 1.2 Megabytes of storage. Options include double sided floppy disk drives and Winchester drives.
- FOUR SERIAL USER PORTS** - Four serial user ports are provided. Each port can be independently set for speeds from 50 to 19200 Baud.
- MULTIPLE PARALLEL PORTS** - Parallel ports are provided for operating printers as well as other parallel devices.
- EASILY EXPANDABLE** - The modular design of the Tec 86 and Tec 86M assures you of continued system expandability. All options are easily field installable. Available options include: Memory 64K and 256K, additional users, double sided floppy disks, Winchester 31 Megabyte hard disk, terminals, and printers.
- ATTRACTIVE DESKTOP ENCLOSURE** - Tecmar Single and Multi-User systems come in your choice of an attractive desk top enclosure with wood grained side panels to blend nicely into your office surroundings, or an industrial quality cabinet for more hostile environments. Rack mount enclosures are available as options.
- ONE YEAR WARRANTY** - Tecmar Systems are fully assembled and thoroughly tested. All Tecmar Components carry a full One Year Warranty.

SOFTWARE OPTIONS

- MP/M-86™** - Multi-User interrupt driven Operating System for the 16 Bit 8086 TEC 86M Microcomputer System. FILE PASSWORD PROTECTION - Access to user files can be restricted to require proper passwords prior to access. CONCURRENT FILE ACCESS - Files may be accessed by multiple users, each reading and/or writing the same file, with protection provided at both the file and the record level. FILE TIME AND DATE STAMPING - Files contain creation, and modification Times and Dates for ease and accuracy in determining the latest or most useful file versions. PRINT SPOOLER - Files may be submitted to the System Spool file for printing. This frees the user terminal to continue operation during the independent printing function.
- LANGUAGES** - BASIC-86™ FORTRAN-86™ PASCAL-86™ CBASIC/86™ CIS-COBOL™ PASCAL/M86™ FORTH
*NOT INCLUDING MP/M-86 and User Terminals.

OTHER FINE S100 and APPLE PRODUCTS AVAILABLE, INCLUDING:

ANALOG to DIGITAL CONVERTERS (12, 14, 16 bit accuracy; 30, 40, 100, 125 KHz Conversion rates; 16 to 256 Channels; programmable gain; timer/counters). **DIGITAL to ANALOG CONVERTERS** (12 bit accuracy, 3 microsecond conversion rate). 8086 CPU Board, I/O Boards 64K/256K Memory Boards, Real-time Video Digitizer and Display. Complete Systems also available for Data Acquisition, Video Digitization, and General Purpose Applications.

REQUEST OUR CATALOG FOR COMPLETE LISTING, AND SPECIFICATIONS ON THE ENTIRE TECMAR PRODUCT LINE.



DEALER INQUIRIES INVITED

23600 Mercantile Rd. • Cleveland, OH 44122

TECMAR, INC.
(216) 464-7410

CP/M-86 and MP/M-86 are registered trademarks of Digital Research Inc. BASIC-86, FORTRAN-86 and PASCAL-86 are registered trademarks of Microsoft Inc. PASCAL/M86 is a registered trademark of SORDIM. CBASIC/86 is a registered trademark of Compler Systems Inc. CIS-COBOL is a registered trademark of MicroFocus Inc.
CANADA: Our Ontario Distributor is OCTANT COMPUTER SERVICES INC., 146 Front Street West, Suite 485, Toronto, Ontario M5J 2L7 (416) 598-1046

Unbeatable prices.....

Orange Micro



NEW NEC 8023 DOT MATRIX

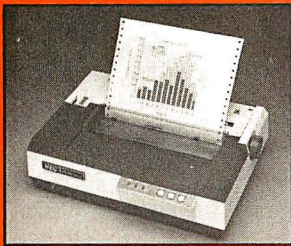

High resolution graphics: 144 x 160 dots/inch · Proportional spacing · Lower case descenders · 9 x N dot matrix · 8 character sizes · 5 unique alphabets · Greek character set · Graphic symbols · 100 cps print speed · Bidirectional, logic seeking printing ·

Adjustable tractors · Single sheet friction feed · Paper empty sensor · Vertical & horizontal tabbing · Bidirectional paper feed · Bold & underlined print

NEC 8023 DOT MATRIX (List \$795) \$ Call

EPSON MX 80/MX 80 FT

9 x 9 dot matrix · Lower case descenders · 80 CPS · Bi-directional, logic seeking · 40, 66, 80, 132 columns per line · 64 special graphic characters · TRS-80 Compatible · Form handling · Multi-page printing · Adjustable tractors

MX 80 . . . (List \$645) \$ Call

Graftrax-80 Dot Graphics Upgrade . . . (List \$95) \$ Call

MX 80 FT includes Friction Feed (List \$745) \$ Call

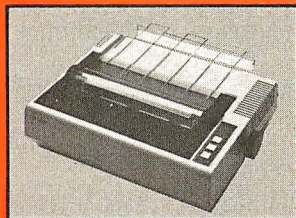

EPSON MX 70

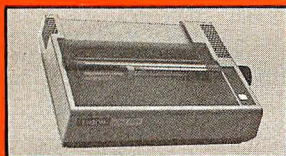

Super low-priced dot resolution graphics · 5 x 7 dot matrix · User replaceable printhead & Top of Form MX 70 . . . (List \$450) \$ Call

EPSON MX 100

Same basic features as the MX 80 · PLUS friction feed for single sheets · PLUS 15" wide carriage MX 100. . . (List \$945) \$ Call

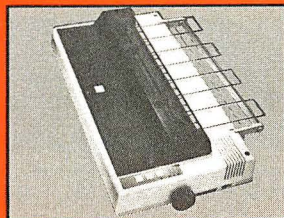

C. ITOH STARWRITER



Daisy Wheel Letter Quality 25 CPS (Optional 45 CPS) · Typewriter quality · Centronics parallel · RS 232 Serial (Optional) · Proportional spacing · Bi-directional · Programmable VFU · Self test · Diablo compatible · Friction feed (Optional tractors) · 136 printable columns · Manufactured by TEC C. ITOH STARWRITER (List \$1895) \$ Call

NEC SPINWRITER

High Speed Letter Quality · 55 CPS · Typewriter quality · Bi-directional · Plotting & Proportional spacing

77XX RO, Serial/Parallel (List \$3055) \$2575

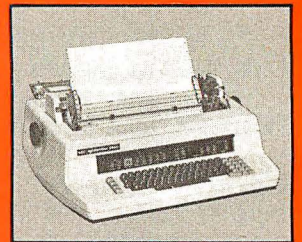

QUME 9/45 typewriter quality \$ Call
DIABLO 630 typewriter quality \$ Call



NEW MALIBU 200

165 cps standard (250 cps optional) · Letter quality font · 12 optional fonts · Bidirectional, logic seeking · 19 x 18 dot matrix · Expanded characters (2x, 4x) · Dot resolution graphics · Underlining **MALIBU 200** (List \$2995) \$ Call

TELEVIDEO CRT'S

TVI910, TVI912C, TVI920C, TVI950— Please call toll free. Prices are too low to advertise. \$ Call

CENTRONICS 739



With graphics and word processing Print Quality · 18 x 9 dot matrix; suitable for word processing · Underlining · proportional spacing · right margin justification · serif typeface · 80/100 CPS · 9½" Pin Feed/Friction feed · Reverse Platen · 80/132 columns · Top of Form

CENTRONICS 739-1 (Parallel) (List \$955) \$Call
CENTRONICS 739-3 (Serial) (List \$1045) \$815

...technical expertise.

The printer specialists.

ANADEX

Dot Graphics, Wide Carriage · 11 x9 dot matrix; lower case descenders · Dot resolution graphics · Bi-directional, logic seeking · Up to 200 CPS · RS 232 Serial & Parallel · Forms control · X-ON/X-OFF · Up to 6 part copy.
ANADEX 9501 (List \$1650) \$1350



IDS PAPER TIGERS



Dot Resolution Graphics, quality print, speed 9 wire staggered printhead with lower case descenders · Over 150 CPS · Bi-directional, logic seeking · 8 character sizes; 80-132 columns · Adjustable tractors · High-resolution dot graphics · Proportional spacing & text justification

IDS 460G (List \$1094) \$ Call
IDS 560G (List \$1394) \$ Call

INTERFACE EQUIPMENT

CCS APPLE SERIAL Interface & Cable \$150
ORANGE INTERFACE for Apple II parallel interface board & cable \$110
TRS-80 CABLES to keyboard or Exp. Interface... \$ Call
NOVATION D-CAT direct connect modem \$ Call
ATARI, NORTHSTAR printer cables \$ Call
ALL EPSON ACCESSORIES \$ Call

THE GRAPPLER™

APPLE INTERFACE AND CABLE by Orange Micro

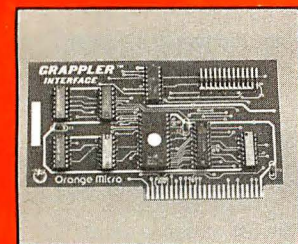

The Grappler™ interface card is the first to provide on-board firmware for Apple high resolution dot graphics. No longer does the user need to load clumsy software routines to dump screen graphics—it's all in a chip. Actually, it's our E-PROM, and it is replace-

able to accommodate the Anadex, Epson MX-70, 80* and 100, IDS Paper Tigers, Centronics 739, NEC 8023, C. ITOH Prowriter, and future graphic printers. The Grappler™ accepts 18 software commands including Hi-Res inverse, 90° rotation, double size, and much more. Invented by, and available from Orange Micro and Orange Micro dealers only. \$ Call for price.

*Requires GRAFTRAX 80

VISIT OUR RETAIL STORES

If you live in California, or are visiting don't miss our two Printer Stores. Expert consultation and know-how is available to assist you in getting the best printer for the application. We provide live demonstrations for a wide selection of Printers.



SHERMAN OAKS, 13604 Ventura Blvd., (213) 501-3486
ANAHEIM, 3150 E. La Palma, Suite I, (714) 630-3622
Store Hours: M-F 10-6, Sat. 10-4

At Orange Micro our printer specialists fit the right printer to your application. Call us today for free consultation (and don't forget to ask for your free catalog).

Phone orders are WELCOME: same day shipment. Free use of VISA and MASTERCARD COD's accepted. Personal checks require 2 weeks to clear. Manufacturers warranty included on all equipment. Prices subject to revision.

CALL FOR FREE CATALOG TOLL FREE (800) 854-8275

CA, AK, HI (714) 630-3322.



Orange Micro inc.

3150 E. La Palma, Suite G, Anaheim, CA 92806

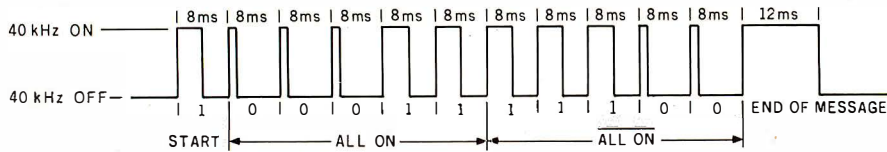

Figure 3: Data format for the ALL ON command. Note that the 5 command bits are complemented and repeated before the end-of-message pulse. Once a command or unit number has been sent, allow a 24-ms interval before the next transmission.

sary to switch this in a manner the controller can understand. Controller communication messages are made up of three main components: logic zeros, logic ones, and the end-of-message signal.

A logic zero is sent to the controller by injecting the 40-kHz burst into pin 7 of the control unit's IC for 1.2 milliseconds (ms) followed by the absence of the 40-kHz signal for 6.8 ms, for a total time of 8 ms. Similarly, a logic one is sent by enabling the 40-kHz burst for 4 ms followed by a 4-ms off-time, again yielding a total time of 8 ms. The end-of-message signal is a 16-ms message composed of a 12-ms burst of 40 kHz followed by a 4-ms off-time.

Table 1 lists the codes required for any given controller function and the channel-number codes required to alert any given receiver module in the system. A complete command is sent to the control module as a series of 12 bits. First, a logic one is sent to alert

the controller that a message is forthcoming. Next, the 5-bit channel number or function code as given in table 1 is sent, followed by the logical inversion of the same five-channel number or function code bits. Lastly, the end-of-message signal is sent to alert the controller the message has been completed. Figure 3 shows how the ALL ON command would be sent to the controller. Keep in mind one important item when using this circuit: a waiting period of at least 24 ms must elapse between command messages, or the controller will only respond to the first command sent.

Putting It All Together

Home Control Package (HCP), a complete manual control program for this interface system, is given in listing 1 (which begins on page 250), along with a sample run listing to show the various features implemented. This program is written in 8080 assembly language for operation under the Heath Disk Operating

D0	D1	D2	D3	D4	FUNCTION
0	0	0	1	1	ALL ON
0	0	0	0	1	ALL OFF
0	0	1	0	1	ON
0	0	1	1	1	OFF
0	1	0	1	1	BRIGHT
0	1	0	0	1	DIM
0	1	1	0	0	CHANNEL 1
1	1	1	0	0	CHANNEL 2
0	0	1	0	0	CHANNEL 3
1	0	1	0	0	CHANNEL 4
0	0	0	1	0	CHANNEL 5
1	0	0	1	0	CHANNEL 6
0	1	0	1	0	CHANNEL 7
1	1	0	1	0	CHANNEL 8
0	1	1	1	0	CHANNEL 9
1	1	1	1	0	CHANNEL 10
0	0	1	1	0	CHANNEL 11
1	0	1	1	0	CHANNEL 12
0	0	0	0	0	CHANNEL 13
1	0	0	0	0	CHANNEL 14
0	1	0	0	0	CHANNEL 15
1	1	0	0	0	CHANNEL 16

Table 1: BSR command codes. These are the 5-bit codes sent to the BSR controller by the computer.

System (HDOS) on a Heath H-8 computer. It uses Heath system calls (SCALLS) for disk functions and various routines stored in the H-8's read-only memory. For users of other systems, table 2 gives the names and functions of these routines.

This program is designed to be extremely modular to allow the inclusion of various subroutines in a clock-driven control routine. Therefore, little program-memory optimization

FUNCTION NAME	FUNCTION
1. \$TYPEX	Outputs the text in the define byte (DB) statement immediately following the function name. The last bit of the string has the parity bit set to signal the end of the string.
2. .SCIN	Inputs a single byte from the console terminal. If the carry flag is set after the function is called, no data was available so a loop for data input is executed.
3. .OPENR	The HDOS open file for read function. The DE register holds a default file device name and extension, HL contains the file name, and the accumulator holds the channel number of the file. A carry flag that is set upon routine exit indicates an error of some type.
4. .READ	Reads data from an open file. The A register contains the number of the channel to be read and the BC register contains the number of bytes to read. The number in BC must be a full sector multiple (i.e., an integer multiple of 256). Again, a set carry flag at exit indicates a read error.
5. .CLOSE	Closes the file on the channel indicated by the accumulator.
6. .EXIT	Exits the program and returns to the HDOS system command level.
7. .SCOUT	Outputs a single character to the console terminal. Carry set indicates that the console is not ready to accept the character.
8. \$HLIHL	Loads the HL register indirectly through the HL register. That is, the data at the address in HL and at HL + are loaded into the HL register pair.
9. \$TJMP	The number in the A register is used to select the proper routine to execute from the list of define word (DW) statements following the command. For example, if the A register contains the number 2 then the address indicated by the third DW statement is where execution continues.
10. .CLRCO	Clears the console terminal's internal buffer when executed.

Table 2: HDOS (Heath Disk Operating System) commands and routines available in read-only memory. These may be used in providing disk I/O and to interface with the operating system. The same functions may be simulated under CP/M.

COMPUTER WAREHOUSE

CALL TOLL FREE **1-800-528-1054**

ATARI

Special 32K 800 System 800 w/32K, recorder, star raiders, joysticks	\$930
Above w/48K	\$990
800 (16K)	\$744
400	Call
810 Disk Drive	\$440
825 Printer	\$575
850 Interface	\$155
410 Recorder	\$60
830 Modem	\$140
16K Memory	\$75
32K Memory	\$150

DISK DRIVES

Lobo	
Apple 1st Drive	\$490
Apple 2nd Drive	\$410

MODEMS

Novation	
CAT	\$140
D-CAT	\$155
Apple Cat II	\$349
Auto Cat	\$235

PRINTERS

C. Itoh	
25CPS - Serial	\$1380
25CPS - Parallel	\$1325
40CPS - Serial	\$1825
45CPS - Parallel	\$1710

Datasouth	
DS 180	\$1275

Diablo	
630 RO	
w/Tractors	\$2275
630 RO	
wo/Tractors	\$2095

Epson	
MX-80	Call
MX-80 F/T	Call
MX-100	Call

Infoscibe	
500	Call
1000	Call

NEC	
PC-8023A	Call

7700 Series	Call
-------------	-------------

3500 Series	Call
-------------	-------------

Okidata	
Microline 80	\$330
Microline 82-A	\$475
Microline 83-A	\$750
Microline 84	Call

Paper Tiger	
560G	\$1060

Texas Instruments	
810 Basic	\$1250
810 Loaded	\$1450

ATARI®

Novation

ZENITH data systems

NorthStar

SOROC TECHNOLOGY, INC.

TeleVideo

3M TEXAS INSTRUMENTS

EPSON EPSON AMERICA, INC.

OKIDATA

ALTOS COMPUTER SYSTEMS

VIDEO TERMINALS

Adds	
Viewpoint	\$545
Soroc	
IQ 120	Call
IQ 130	Call
IQ 135	Call
IQ 140	Call
Televideo	
910 C	\$575
912 C	\$690
920 C	\$735
950 C	\$925
Zenith	
Z-19	\$750

DISKETTS

Scotch	
5 1/4" 0, 10, 16 Sector (Qty 100)	\$250
8" 0, 32 Sector (Qty 100)	\$260

COMPUTERS

Altos	
ACS 8000-15	\$3995
ACS 8000-2 w/CPM	\$2695
NEC	Call
Northstar	
Horizon II 64K DD	\$2750
Horizon II 64K QD	\$3050
Televideo Systems	Call
Zenith	
Z-89 48Kw/CPM	\$2100

MONITORS

Zenith	
12" Green Screen	Call

Prices & availability subject to change without notice. Personal checks will delay shipping two weeks.



2222 E. Indian School Rd. • Phoenix, Arizona 85016
Order Line: 1-800-528-1054
Other Information: 602-954-6109



Store Hours: Tues.-Fri. 10-5 MST Saturday 10-3 MST

Prices reflect 3% cash discount. Product shipped in factory cartons with manufacturers warranty. Add 2% a minimum of \$5. for shipping and handling.

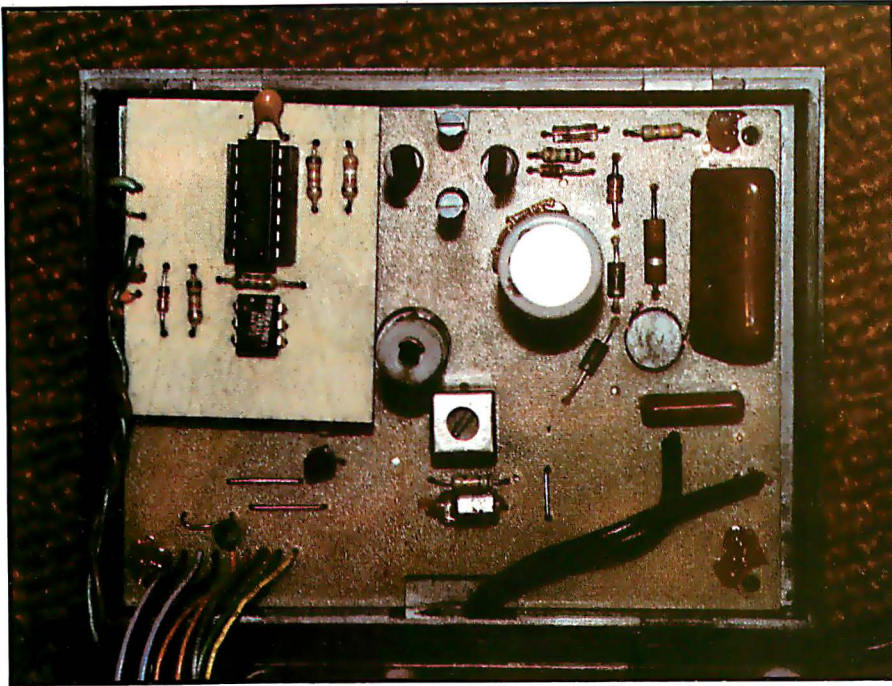

Photo 3: The BSR controller with the serial computer interface installed. Cover the foil side of the interface board to prevent shorts to jumpers on the controller.

through trial and error. If the trial-and-error approach is chosen, I recommend altering all of the timing constants proportionately to preserve the proper timing relationships. Also in this group are routines that update and store the present status of each remote unit and form the command format required by the BSR console command unit.

Summary

So there it is, a complete interface and program package for those of you who want to experiment with home control but don't want to spend the time or money to implement previous BSR interface ideas. Components for the required hardware are inexpensive and readily available from a number of sources. By using a few spare parts lying around the shop, you should be able to build the interface for well under \$10.

Even though the program presented is written in 8080 assembly language, a similar routine could be implemented easily in BASIC once the proper timing loops have been set up. The assembly-language program presented here was written as such to allow the inclusion of various routines in a real-time control system designed for background operation in the H-8 computer system.

The ability to regulate remote devices inexpensively is an important part of any home-control system. The next step in my own system will be to tie in this system with the temperature-sensing circuits presented by Tom Hall in the February 1981 *BYTE* ("A Heating and Cooling Management System," page 326) to allow efficient control of my heating and cooling system. Someday I'll have a computer-controlled sprinkler system tied in with a moisture detector to prevent watering the lawn when it's raining. (How many times have you seen home owners' sprinklers spraying away during a downpour?) Maybe I should link the system to small servo motors in my house's heating and cooling system to regulate room air flow. Then there's always the electric lawn mower. ■

Listings 1 and 2 follow on pages 250 through 292.

has been done. Five major sections of routines are used to make up the complete program package. An explanation of each major routine's function follows.

Title: The program signs on by executing the routine `TITLE`, which clears the computer's terminal screen and prints the name of the program. Users of terminals other than the Heath H-19 will need to examine the control codes used and alter them accordingly. Users of terminals without any sort of graphics capability will probably want to skip this routine entirely, since it will not affect program operation.

Readit: `READIT` reads a data file named `UNITDEF.DAT` and initializes the BSR remote-control units according to the data it contains. `UNITDEF.DAT` also contains all of the remote-control unit name descriptions for use in various menus used later in the program. The `READIT` routine's internal documentation gives the information necessary to set up this file. A sample file is provided in listing 2 (see page 292). Note that all 166 unit locations must be defined in the file even though only those units which have been enabled will be

available for control through HCP's menu routines.

Status: Remote-unit status is displayed by this routine. Information listed includes the channel number, the channel name as defined in `UNITDEF.DAT`, the brightness level of the channel, and the unit's on-off status.

Menu: Program functions are displayed and selected by this routine. All commands the BSR console command unit can execute (in addition to returning to the status display and exiting from the program) are available from this master menu.

Utility Routines: These routines include the timing loops necessary to send commands to the BSR console command unit. Since the H-8 computer uses about 20 percent of its processing time to update its front-panel display, adjustment of these timing loops will be necessary for other systems. I recommend using an oscilloscope to monitor the duration of the signals sent to the BSR command unit; however, if an oscilloscope is not available, the timing constants in the routines that send the signals to the BSR can be changed

SUPERVYZ—THE NEXT INDUSTRY STANDARD

SUPERVYZ is a revolutionary software concept designed to overcome the frustrations of using CP/M®. This allows you to crack any non-technical market without the hassles of teaching the operating system. Instead, users are greeted with a series of self-prompting, self-explaining menus linking the user directly to the application. We'll supply the menus or you create your own, to meet the exact needs of your customers. SUPERVYZ presents unlimited software flexibility by providing a system to coordinate multiple application programs. The menus tie it all together, allowing program interaction. Even the most complicated commands between programs can be a simple menu choice.

Dealer inquiries invited,
foreign or domestic.



Epic Computer Corporation
7542 Trade Street
San Diego, CA 92121
Tel: 714-695-3560

Circle 148 on inquiry card.

MANUFACTURERS

Ship SUPERVYZ with every computer you sell. SUPERVYZ means software support interactive help files . . . dealer confidence . . . instant foreign market access . . . vertical market packaging . . . more computer sales!

DEALERS

Buy SUPERVYZ as a separate program . . . bundle software from different suppliers . . . demonstrate capabilities, not confusion . . . sell computers more efficiently - SUPERVYZ does the teaching . . . end after-the-sale handholding . . .

SOFTWARE SPECIALISTS

Package SUPERVYZ into every system you deliver . . . SUPERVYZ is compatible with over 2000 programs, 300 computers. Target your market with SUPERVYZ.

USERS

Insist on SUPERVYZ . . . don't buy a computer without it.

SUPERVYZ™

YOUR NEW MARKETING TOOL FOR INCREASED SALES OF CP/M COMPUTERS AND APPLICATION SOFTWARE

INTRODUCTORY
RETAIL PRICE

\$95

```
1 SEP 1981          SUPERVYZ Function Selection Menu          12:34:56 PM
1) Set Current Date and Time          6) Accounting (A/R A/P G/L P/R O/E)
2) Select Default Disk and User       7) Data Base Inquiry and Reporting
3) Add or Change SUPERVYZ Menu       8) Word Processing
4) Extended Volume Table of Content   9) Data Entry and Verification
5) File and Disk Support Functions    10) Forecasting and Planning
```

Please enter the number of the desired function (0 if none, ? for help) []

This is the operator/machine conversational text area.

The above menus are easily adaptable to your specific requirements.

```
Default Drive = A          Volume Table of Contents (VTOC)          Default User = 1
A ACCOUNTS MNU             A DATABASE MNU             A DATANTRY MNU
A SUPERVYZ MNU             A FORECAST MNU            A WORDPROC MNU
                             ...
                             ...
                             Push ↓ arrow for more
```

*Supervyz is a trademark of Epic Computer Corporation. CP/M is a trademark of Digital Research.

Listing 1: HCP (Home Control Package) for the BSR interface. This program is written in 8080 assembly language for Heath's HDOS. A sample run is shown at the end of the listing.

```

PORT      ORG      USERFWA      *BEGIN PROGRAM HERE IN MEMORY
          EQU      3740          *OUTPUT PORT ASSIGNMENT

BEGIN     CALL     TITLE          *PRINT THE TITLE
          CALL     READIT         *READ DATA FILE AND INITIALIZE
LOOP      CALL     STATUS        *PRINT UNIT STATUS
          CALL     $TYPTX
          DB      0AH, 'Hit Return For The Command Menu', ' ' +080H
HOLDIT    SCALL   .SCIN          *GET INPUT
          JC      HOLDIT         *LOOP UNTIL READY
          CPI     0AH           *RETURN?
          JNZ     HOLDIT        *WAIT IF NOT
          CALL    MENU          *DISPLAY THE MENU
          JMP     LOOP          *AND DO AGAIN

*READ UNIT DEFINITIONS AND STATUS

*****
* READ IN UNIT DEFINITION FILE
*      FORMAT          COLUMNS          ITEM
*      1              1              STATUS BIT, 1=ON, 2=OFF
*      2              2              LEVEL BIT, 9=BRIGHT, 0=DIM
*      3-4            3-4            UNIT NUMBER, 1 THRU 16
*      5-             5-            UNIT DESCRIPTION, ASCII STRING
*      LAST           LAST           CARRIAGE RETURN
*
*      SEE UNITDEF.DAT FILE FOR DATA FILE EXAMPLE (LISTING 2.)
*

READIT    LXI      D,DEFLT        *LOAD DEFAULT BLOCK
          LXI      H,UNITNAM      *LOAD FILE NAME
          MUI      A,2            *CHANNEL NUMBER
          SCALL   .OPENR         *OPEN FOR READ
          JC      READERR        *ERROR ON CARRY
          MUI      A,2            *CHANNEL NUMBER
          LXI      B,1280        *ATTEMPT TO READ 5 SECTORS
          LXI      D,UNITBUF     *PUT IT HERE
          SCALL   .READ          *READ IT
          JNC     CLOSIT         *CLOSE FILE
          CPI     01H           *IS IT END OF FILE
          JNZ     READERR        *FATAL ERROR IF NOT

CLOSIT    MUI      A,2            *CHANNEL NUMBER
          SCALL   .CLOSE         *CLOSE THE FILE
          JC      READERR        *ERROR ON CARRY

*****
* BREAK DOWN INPUT INTO SEPARATE LINES LOCATED BY UNITLOC

          LXI      B,0FH         *NUMBER OF UNITS
          LXI      D,UNITBUF     *BEGINNING LOCATION
          LXI      H,UNITLOC     *ADDRESS LOCATION
          MOV     M,E            *STORE FIRST LOCATION

```

Listing 1 continued on page 252

THE LAST MEMORY™

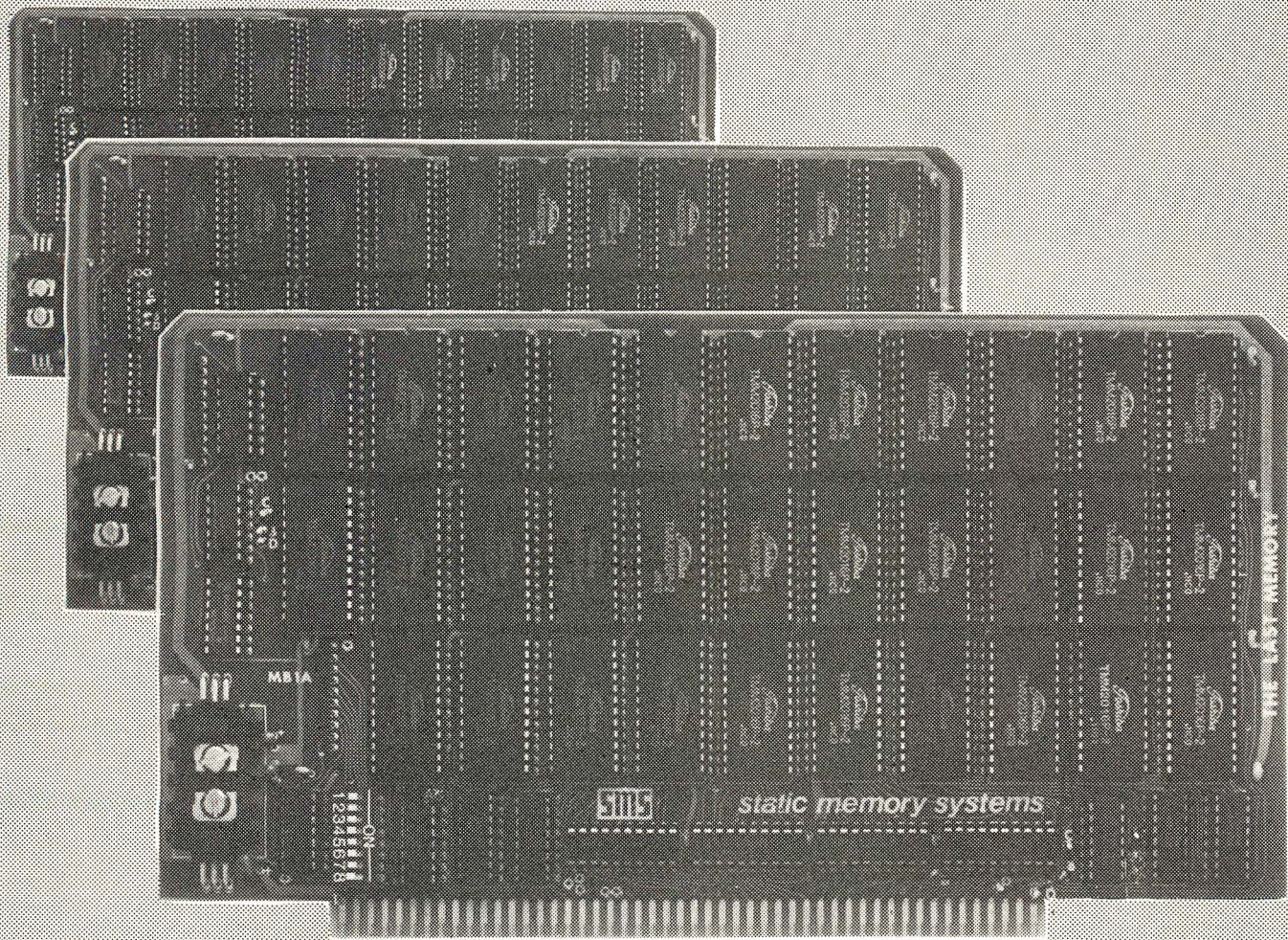

OFFERS MORE FOR LESS

THE LAST MEMORY™, 64K static RAM/EPROM board, sets the industry standard in cost and performance. That's why it's the choice of system integrators, research laboratories, small businesses, large corporations, universities, and hobbyists from Dayton to Tasmania.

Now, how could we make the standard in S100 memory boards better? **BY LOWERING THE PRICE!!**

	<u>KIT</u>	<u>ASSEMBLED & TESTED</u>
Board Without RAM	99.99	139.99
16K	219.99	259.99
64K	549.99	589.99

All boards supplied with 150ns RAM
Any board configuration (i.e. 2K, 4K, 62K, etc.) available.
OEM discounts available.
All prices are F.O.B. Freeport, IL.
Dealer inquiries invited.



static memory systems Inc.

15 So. Van Buren Ave.

Suite 209

Freeport, Illinois 61032

(815) 235-8713



Listing 1 continued:

	INX	H	*INCREMENT MEMORY
	MOV	M,D	*STORE LSB OF ADDRESS
SOFTLP	INX	H	*INCREMENT POINTER (STORAGE)
INLOP	INX	D	*INCREMENT BUFFER POINTER
	LDAX	D	*LOAD A FROM ADDRESS IN DE
	CPI	0AH	*CARRIAGE RETURN?
	JNZ	INLOP	*CONTINUE IF NOT
	INX	D	*NEXT CHAR IS THE ONE WE WANT
	MOV	M,E	*STORE MSB
	INX	H	*INCREMENT POINTER
	MOV	M,D	*STORE LSB
	DCR	C	*COUNT ONE UNIT DONE
	JNZ	SOFTLP	*DO NEXT ONE
	LXI	D,010H	*NUMBER OF UNITS
INIT	PUSH	D	*SAVE D
	MOV	A,E	*GET NUMBER OF UNIT
	SBI	1	*ADJUST FOR OFFSET
	PUSH	PSW	*SAVE IT
	CALL	GETSTAT	*GET STATUS BYTE
	CPI	'0'	*OFF?
	JNZ	NEXT1	*JUMP IF NOT
	POP	PSW	*ELSE RESTORE CHANNEL #
	PUSH	PSW	*SAVE IT AGAIN
	CALL	OFFONE	*TURN IT OFF
	JMP	SKINIT	*AND LOOP
NEXT1	POP	PSW	*RESTORE CHANNEL
	PUSH	PSW	*SAVE IT
	CALL	ONONE	*TURN IT ON
	POP	PSW	*RESTORE CHANNEL
	PUSH	PSW	*SAVE IT
	CALL	GETLVL	*GET LEVEL BYTE
	CPI	'9'	*IS IT NINE?
	JZ	SKINIT	*LOOP IF SO
	MOV	E,A	*ELSE SAVE THE LEVEL
	MVI	D,0	*CLEAR D
	MVI	M,'9'	*STORE 9 AS PRESENT LEVEL
	POP	PSW	*RESTORE CHANNEL NUMBER
	PUSH	PSW	*SAVE IT AGAIN
	CALL	INTEN	*ADJUST INTENSITY
SKINIT	CALL	LONGWT	*WAIT BETWEEN COMMANDS
	POP	PSW	*CLEAR STACK
	POP	D	*RESTORE COUNT
	DCR	E	*COUNT DOWN
	JNZ	INIT	*DO ANOTHER
	RET		*AND RETURN WHEN DONE
LONGWT	LXI	D,25H	*LONG WAIT ROUTINE
LONGLP	PUSH	D	*SAVE COUNTER
	CALL	WAIT	*WAIT
	POP	D	*RESTORE COUNTER
	DCR	E	*DECREMENT COUNT
	JNZ	LONGLP	*LOOP UNTIL DONE
	RET		
READERR	CALL	\$TYPTX	
	DB	0AH,0AH,'DATA FILE MISSING - PROGRAM ABORTED'	
	DB	07H,0AH+030H	
	SCALL	EXIT	

Listing 1 continued on page 254

FMS-80

Organizes Your Organization

FMS-80, a data base management system, offers the user a quick and easy way to organize and efficiently manipulate data so sound decisions can be made on facts displayed.

FMS-80***

is the most powerful stand alone DBM program available to the micro-computer industry.

Completely menu driven and written in assembly language, it offers these features:

- User definable File Definitions
- Screen Displays
- Reports (with math and field break analysis)
- Selection Criteria (on any or all fields)
- Menus (that applications programs can be selected from)
- Instantaneous data query on indexed records.
- Mathematical manipulation of numeric data fields using the report generator or the programming language EFM (Extended File Maintenance)
- Easy to use video "how to" training tapes are available.
- Manipulation of up to 19 different data files (using EFM) at one time and displaying this information on the screen, gener-

rating reports, generating other data files or on-line updating of input files that already exist

- FMS-80 is able to call other programs like sub-routines in EFM
- FMS-80 is able to read data files that other programs have generated
- No restrictions to record size other than available RAM memory space
- Operates under CP/M*, MP/M* or CDOS**

FMS-80 allows the flexibility to quickly create programs that allow data to be entered in a form that a secretary recognizes and generates reports that the manager requires.

If you're continuously asked to do applications programs and don't have time to do it in BASIC, consider FMS-80.

For additional information contact

Systems Plus,
1120 San Antonio Road,
Palo Alto, CA
94303. Phone
415/969/7047

Systems Plus



Listing 1 continued:

*TYPE STATUS OF HOUSEHOLD UNITS

* DISPLAY THE UNIT STATUS

* ENTRY NONE
 * USES ALL

STATUS LXI B,010H *NUMBER OF UNITS
 LXI D,0 *UNIT INDEX OFFSET
 CALL \$TYPTX *PRINT HEADING
 DB 01BH,045H,0AH,09H,09H,09H,
 DB 01BH,'REMOTE UNIT STATUS',01BH,'a',0AH,0AH
 DB 'UNIT',09H,09H,09H,'UNIT NAME',09H,09H,09H
 DB 'LEVEL STATUS',0AH
 DB /
 DB /-----/
 DB /-----/
 DB 0AH+080H

STATLP PUSH B *SAVE BC
 PUSH D *SAVE DE
 MOV A,E *FETCH CHANNEL NUMBER
 PUSH PSW *SAVE CHANNEL NUMBER
 CALL GETCHAN *ADDRESS OF ASCII STRING
 MOV A,M *GET BYTE
 CPI '9' *DISABLED?
 JZ STANEXT *DO NEXT ONE IF SO
 CALL \$TYPTX *INDENT
 DB / '+080H
 CALL STROUT *OUTPUT THE NUMBER
 CALL \$TYPTX *DO TWO TABS
 DB 09H,09H+080H
 POP PSW *RESTORE CHANNEL
 PUSH PSW *SAVE IT AGAIN
 CALL GETDESC *GET ADDRESS DESCRIPTION
 PUSH B *SAVE NUMBER OF CHARS
 CALL STROUT *OUTPUT THE STRING

Listing 1 continued on page 258

PRICE IS OUR MOST IMPORTANT PRODUCT!

CROMEMCO

	Reg. Price	Our Price
System I	\$3995.	\$2999.
System Z2H	9995.	7399.
System III	7995.	5999.

TERMINALS

HAZELTINE	Esprit	\$659.95
	1421	769.95
	1500	979.95
Executive 80	Model 20	CALL
	Model 30	
SOROC		
	Model IQ120	699.95
	Model IQ140	1099.95
TELEVIDEO		
	Model 912	779.95
	Model 920	829.95
	Model 950	1099.95

PRINTERS

QANTEX*		
	Model 6000 Parallel	\$1149.00
	Model 6000 Serial	1195.00
EPSON	Model 80	499.95
	Model 100	759.95
TEXAS INSTRUMENTS		
	Model 810	1399.00
INTERTEC		
	Superbrain 64KDD	2699.00
	Superbrain 64KQD	3299.00
NORTHSTAR		
	Horizon II 64K	3299.00
	Horizon IIQD 64K	3599.00

*Registered trademark of North Atlantic Industries, Corp.

DATA DISCOUNT CENTER, INC.
 P.O. Box 233, Greenvale, N.Y. 11548

Phone Orders Call
516-869-8537

Most items in stock for immediate delivery. Factory sealed cartons. Full manufacturer's guarantee. All products subject to availability. All prices subject to change. N.Y.S. residents add Sales Tax. Shipping F.O.B. N.Y.

SuperSoft's Gallery of CP/M Masterworks

Programming Languages	Disk/Manual Only
BASIC	\$200/20
FORTH	\$200/20
FORTRAN IV	\$225/25
ATFOR	\$100/NA
ASIC	\$200/25
'MINY' PASCAL	\$ 85/10
_LISP	\$150/15
System Maintenance	
Diagnostics II	\$100/15
Diagnostics I	\$ 75/15
DISK DOCTOR	\$100/10
Utilities	
Utility Pack #1	\$ 60/NA
Utility Pack #2	\$ 60/NA
Text Processing	
STAR-EDIT	\$225/10
TFS	\$ 85/15
Super-M-List	\$ 75/10
Software Security	
Encode/Decode II	\$100/20
Encode/Decode I	\$ 50/20
Intercommunications	
TERM	\$150/15
TERM II	\$200/15
Entertainment	
ANALIZA	\$ 35/NA
ANALIZA II	\$ 50/NA
NEMESIS	\$ 40/NA
Dungeon Master (For use with Nemesis)	\$ 35/NA
Miscellaneous	
Z8000 Cross-Assembler	\$500/25
'C' Cross-Compiler (Z8000 Target)	\$500/25

Software available for virtually all CP/M systems. Specify your system.

TERM

A Complete Networking/Intercommunications Package

TERM allows the CP/M user to communicate with other CP/M based systems or with remote timesharing computers. TERM supports file transfers between both timesharing systems and between CP/M systems.

TERM equals or exceeds comparable programs in power and flexibility, but costs less, delivers more and *source code* is provided on discette!

With TERM you can send and receive ASCII, HEX and COM files. You also have a conversational mode, and a timesharing terminal emulator. Below is a partial list of features:

- Engage/disengage printer
- auto error checking with re-try
- conversational mode
- send files
- terminal emulator
- receive files

requires 32K CP/M and a minimal knowledge of assembly language programming.

TERM is supplied with source and user manual: \$150
Manual only: \$15.00 TERM II: \$200

Utility Packs #1 & #2

Utility Packs #1 and #2 are a collection of versatile general purpose routines that can speed program development.

Utility Pack #1 includes:

- GREP : Searches a list of files for the specified string.
- CMP : Compares two files.
- WORD : Searches for a string.
- TOKEN: Searches for a string surrounded by white space.
- UNIQ : Removes duplicate adjacent lines.
- RM : Erases a list of files.
- AR : Archiver. Puts files into one large file.
- SUM : Performs a checksum.
- WC : Counts words and lines.
- SORT : In RAM variable length record shell sort.

Utility Pack #2 includes:

- TR : Translates one user defined set of characters in a list of files to another set.
- RPL : Replaces one user defined string with another string.
- DC : Powerful postfix desk calculator program with 13 digit precision, transcendental functions, and 10 registers.
- DIFF : Compares two source files and displays the differences.
- PR : A multi-column print formatter.
- SLEEP : Processing pause.
- INUSE : Displays 'IN USE' message.
- CAT : Concentrates a list of files.
- DATE : Maintains current date file for PR.
- SPLIT : Splits a file into smaller chunks.

Utility Pack #1: \$60.00
(Requires 24K CP/M)
Utility Pack #2: \$60.00
(Requires 32K CP/M)

Many programs include SuperSoft's online "HELP" system!

For complete information on these and all other SuperSoft products, please write for our free catalogue.

Available from fine dealers everywhere,

or directly from:
SUPERSOFT, INC.

P.O. BOX 1628
CHAMPAIGN, IL 61820
217-359-2112 Telex: 270365
Technical Hot Line: 217-359-2691



U.K. and Europe:
DIGITAL DEVICES
134 LONDON ROAD
SOUTHBOROUGH KENT
TUNBRIDGE WELLS
TN4 0PL
ENGLAND
Tel.: Tunbridge Wells (0892) 37977/9

Japan:
ASR CORPORATION INTERNATIONAL
1-2-8, SHIBA-DAIMON
TOKYO 105
JAPAN
Tel.: (03)-437-3901 Telex: 242-3296

24 hour express service available!

*CP/M REGISTERED TRADEMARK DIGITAL RESEARCH
SSS FORTRAN is the copyright of Small Systems Services, Urbana, Illinois

Prices subject to change without notice.

SuperSoft

First in Software Technology

Circle 350 on inquiry card.

Go with McGraw-Hill's

**TAKE ANY 3 BOOKS
FOR ONLY \$1⁰⁰ EACH**
when you join the
**COMPUTER PROFESSIONALS'
BOOK CLUB (values up to \$75.00)***

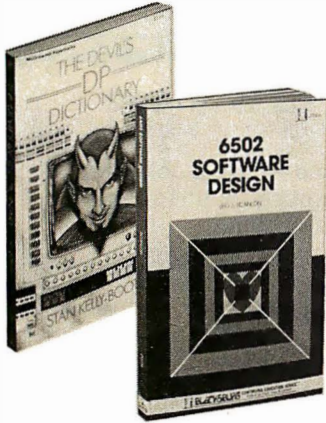

THE PASCAL HANDBOOK. By Jacques Tiberghien. 471 pp. A single reference manual that tames this unruly language. Every feature of Pascal is explained in a brilliantly organized format that covers the major Pascal dialects, including Jensen and Wirth's original definition, with the CDC implementation ... the proposed ISO Standard ... UCSD Pascal ... Pascal 1000 (HP1000) ... OMSI Pascal-1 ... and Pascal/Z.
582365-98 \$27.50
(Counts as 2 of your 3 books)

MICROPROCESSOR APPLICATIONS MANUAL. By Motorola Semiconductor Products, Inc. 720 pp., illus., 8½ x 11 format. With nuts-and-bolts practicality, this manual by the Motorola people (who should know) gives you detailed applications information on microprocessors. Assumes no prior knowledge on your part about MPUs.
435/2788 \$42.50
(Counts as 2 of your 3 books)

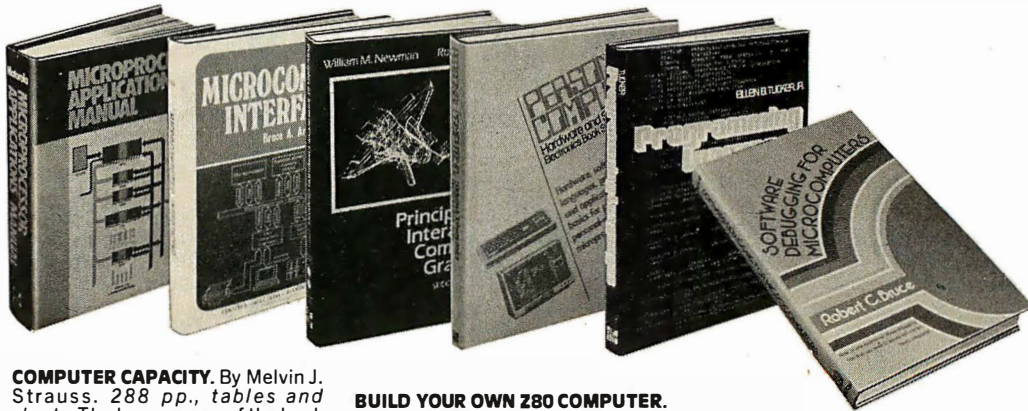

COMPUTER CAPACITY. By Melvin J. Strauss. 288 pp., tables and charts. The key purpose of the book is to provide both senior management and DP practitioners with a methodology for identifying and quantifying issues of capacity and demand within the data center without becoming entrapped by language problems
582317-9 \$24.95

BUILD YOUR OWN Z80 COMPUTER. By Steve Ciarcia. 330 pp., diagrams, softbound. Written for people who don't need an introductory electronics handbook. Its admirably achieved objective is to present a practical, step-by-step analysis of digital computer architecture and the construction details for a complete and functional micro-computer.
109/621 \$12.75

MICROPROCESSORS/MICROCOMPUTERS/SYSTEM DESIGN. By Texas Instruments Learning Center and the Engineering Staff of Texas Instruments, Inc. 634 pp., illus., outsized 7¼ x 10¼ format. The book takes you through the development of memory-to-memory architecture, shows you the components, and details programming methods and techniques.
637/58X \$24.50

DATA STRUCTURES USING PASCAL. By Aaron M. Tenenbaum and Moshe J. Augenstein. 544 pp., illus. With its emphasis on structured design and programming techniques, this definitive work takes you on a trailblazing journey through Pascal. Separate chapters are devoted to the stack, recursion, queues and lists, Pascal list processing, trees, graphs and their applications.
582230-X \$23.95

HOW TO BUILD YOUR OWN WORKING MICROCOMPUTER. By Charles K. Adams. 308 pp., 214 illus. and tables. Everything you need to know to build your own microcomputer with a handful of chips! The author takes you through the hardware ... assembly and running of the system ... and details the instruction set and mechanics of programming.
582267-9 \$14.50

MINICOMPUTER SYSTEMS: Organization, Programming, and Applications. By Richard H. Eckhouse, Jr. and L. Robert Morris. 2nd Ed., 491 pp., illus. Updated, revised, and expanded, this is a book for every systems programmer, systems designer, computer scientist, and application specialist who wants to know more about microcomputer hardware, software, and design.
787/026 \$21.95

AUTOMATIC DATA PROCESSING HANDBOOK. Edited by The Diebold Group. 976 pp., 269 illus. Written by a staff of internationally recognized authorities on ADP, this comprehensive handbook explains systems, programming and the languages, communications processes, and the design and installation of today's computers.
168/0758 \$49.95
(Counts as 2 of your 3 books)

APPLE PASCAL: A Hands-On Approach. By Arthur Luehrmann & Herbert Peckham. 426 pp., spiral-bound. Finally, a how-to-use-PASCAL book for Apple computer users that makes a complex language as easy as (forgive us!) applesauce. Takes you from "total ignorance" all the way up to very impressive competence in the use of that rather complex language, PASCAL.
491/712 \$10.95

SOFTWARE DEBUGGING FOR MICROCOMPUTERS. By Robert C. Bruce. 351 pp., illus. Takes you through the fundamental methods for finding errors, glitches, and faults in programs ... goes on to techniques for tracking down and exterminating program bugs ... then combines these techniques into a complete debugging plan.
582075-7 \$18.95

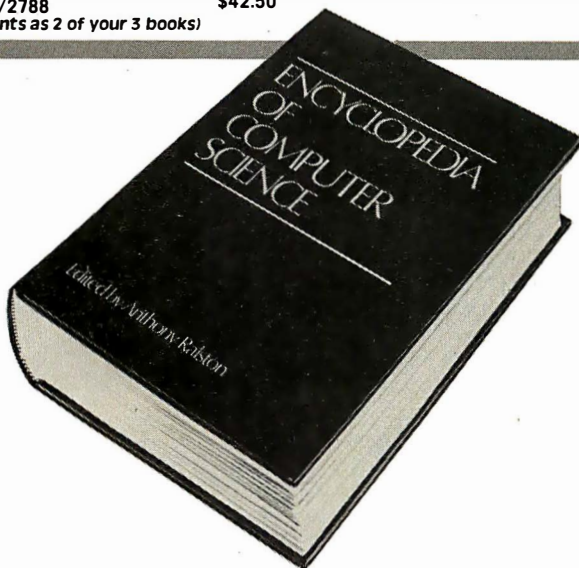

ENCYCLOPEDIA OF COMPUTER SCIENCE. Edited by Anthony Ralston and C. L. Meek. 1,500 pp., 60 illus., 100 charts, 7 x 10 format. This first and only in-depth coverage of the entire field of computer science in a single volume is comprehensive and completely up to date.
769/01X A \$60.00
(counts as 3 of your 3 books)

EXPERIENCE!

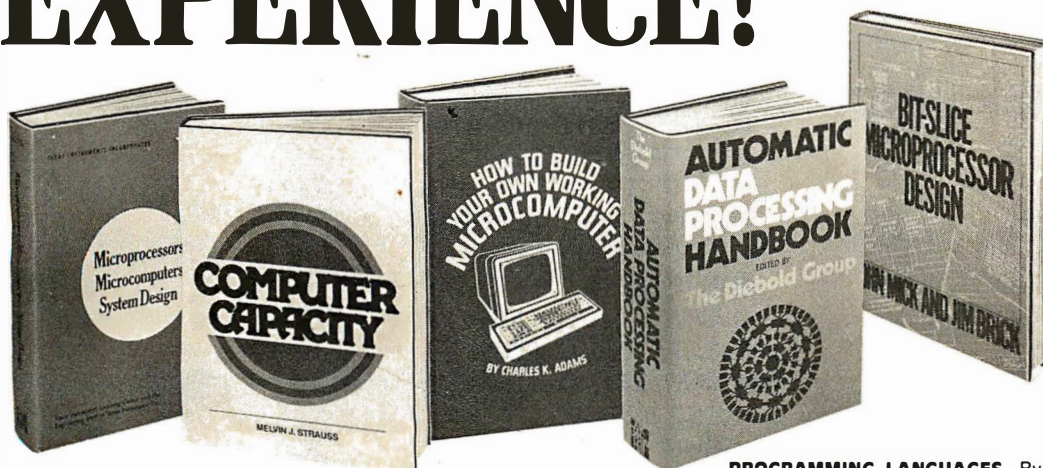

THE DEVIL'S DP DICTIONARY. By Stan Kelley-Bootle. 160 pp., softbound. This devilishly clever little book is guaranteed to fill anyone who has ever slaved over a hot terminal with savage delight. Some 500 computer words and terms are misdefined, from abacus to your program.

340/226 \$7.50

MICROCOMPUTER INTERFACING. By Bruce Artwick. 352 pp., 117 illus. In this up-to-date, complete design guide you'll find the detailed descriptions and explanations necessary to enable you to select, build, and interface microcomputer systems to virtually all applications. Advanced interface devices and methods are thoroughly examined and illustrated.

789/436 \$24.95

PERSONAL COMPUTING: Hardware and Software Basics. Electronics Book Series. 224 pp., 175 illus., 8½ x 11 format. Gives you comprehensive guidance to the present state of the art in personal computers—an overall survey of the technology and methods available to perform various tasks, facts about the work others are doing—and just how they are doing it.

191/514 \$24.50

PROGRAMMING AND INTERFACING THE 6502—With Experiments. By Marvin L. De Jong. 414 pp., heavily illus., softbound. This guide not only teaches you all you must know about programming and interfacing the 6502, but it also carries you to a high level of understanding and proficiency quickly and painlessly.

582080-3 \$15.95

Z80 USERS MANUAL. By Joseph Carr. 326 pp., with diagrams, charts and tables. Takes you through every opportunity the ZAP can offer. It covers Z80 pin definitions, CPU control signals, support chips, interfacing peripherals, and much more. It also includes a 177-page Z80 instruction set you can study the instructions on a one-by-one basis.

582336-5 \$13.95

ELECTRONIC GAMES: Design, Programming, and Troubleshooting. By W. H. Buchsbaum and R. Mauro. 335 pp., 338 illus. Information you need to design, program, and troubleshoot electronic games is right here in this widely popular hands-on guide.

087/2108 \$26.95
(Counts as 2 of your 3 books)

PROGRAMMING LANGUAGES. By Allen B. Tucker, Jr. 439 pp., illus. Gives you not only the principles of design but the applications of six major programming languages. Shows you their strengths and weaknesses in solving various representative "benchmark" problems.

654/1588 \$28.50
(Counts as 2 of your 3 books)

BIT-SLICE MICROPROCESSOR DESIGN. By John Mick and Jim Brick. 398 pp. All in one place—the crucial information you've been needing about the 2900 family of bit-slice microprocessor components. This remarkable "first" designs right before your eyes not just one but two complete 16-bit machines!

417/814 \$24.00

Be sure to consider these important titles as well!

6502 SOFTWARE DESIGN. By L. J. Scanlon. 582138-9 \$10.50

THE GIANT HANDBOOK OF COMPUTER PROJECTS. By the Editors of 73 Magazine. 582012-9 \$15.95

SYNTAX OF PROGRAMMING LANGUAGES: Theory and Practice. By R. C. Backhouse. 582064-18 \$25.95
(Counts as 2 of your 3 books)

STRUCTURED PROGRAMMING: Theory and Practice. By R. C. Linger, H.D. Mills, & B.I. Witt. 788/537 \$20.95

THE BYTEBOOK OF PASCAL. Edited by B. W. Liffick. 789/6738 \$25.00
(Counts as 2 of your 3 books)

COMPILER DESIGN AND CONSTRUCTION. By A. Pyster. 582026-9 \$24.50

THE Z-80 MICROCOMPUTER HANDBOOK. By W. Barden, Jr. 784/914 \$8.95

COMPUTER PERIPHERALS FOR MINICOMPUTERS, MICROPROCESSORS AND PERSONAL COMPUTERS. By L.C. Hohenstein. 294/518 \$19.50

16-BIT MICROPROCESSOR ARCHITECTURE. By T. Dollhoff. 582003-X \$24.95

PRINCIPLES OF INTERACTIVE COMPUTER GRAPHICS. By W. M. Newman & R. Sproull. 463/3878 \$28.95
(Counts as 2 of your 3 books)

* If you join now for a trial period and agree to purchase four more books—at handsome discounts—over the next two years. (Publishers' prices shown)

Why YOU should join now!

- **BEST BOOKS IN YOUR FIELD**—Books are selected from a wide range of publishers by expert editors and consultants to give you continuing access to the latest books in your field.
- **BIG SAVINGS**—Build your library and save money too! We guarantee savings of at least 15% off publishers' list prices on every book. Usually 20%, 25%, or even higher!

• **BONUS BOOKS**—You will immediately begin to participate in our Bonus Book Plan that allows you savings between 70–80% off the publisher's price of many books.

• **CONVENIENCE**—14 times a year you receive the Club Bulletin FREE, fully describing the Main Selection and alternate selections, together with a dated reply card. If you want the Main Selection, you simply do nothing—it will be shipped automatically. If you want an alternate selection—or no book at all—you simply indicate it on the regular reply card and return it by the date specified. You will have at least 10 days to decide. If because of late mail delivery of the Bulletin you should receive a book you do not want, just return it at the Club's expense.

As a Club member, you agree only to the purchase of four more books over a two-year period.

MAIL THIS COUPON TODAY

McGraw-Hill Book Clubs
Computer Professionals' Book Club
P.O. Box 582, Hightstown, New Jersey 08520

Please enroll me as a member and send me either the ENCYCLOPEDIA OF COMPUTER SCIENCE, billing me only \$3.00, or any three other books, billing me only \$1.00 each, plus local tax, postage, and handling. If not satisfied, I may return the books within 10 days and my membership will be canceled. I agree to purchase a minimum of four additional books during the next two years as outlined under the Club plan described in this ad. Membership in the Club is cancelable by me any time after the four-book purchase requirement has been fulfilled.

- Check here if you want ENCYCLOPEDIA OF COMPUTER SCIENCE (769/01X).
- Check here if you prefer three other volumes, and indicate below by number the books you want.
A few expensive books (noted in the description) count as more than one choice.

Name _____

Address/Apt. _____

City/State/Zip _____

Corporate Affiliation _____

This order subject to acceptance by McGraw-Hill. All prices subject to change without notice. Offer good only to new members. A postage and handling charge is added to all shipments.

Orders from outside the U.S. cannot be accepted.

P39543

Listing 1 continued:

```

      POP      B          *RESTORE B
      MOV      A,C        *NUMBER OF CHARS INTO A
      CMA      A          *COMPLEMENT IT
      ADI      02BH       *NUMBER OF SPACES TO PAD
      JNC      STSKIP     *SKIP IF 47 ALREADY OUTPUT
      MOV      C,A        *STORE THE NUMBER
STSPC  MVI      A,' '     *LOAD A SPACE
      SCALL   .SCOUT     *OUTPUT IT
      JC      STSPC      *LOOP UNTIL READY
      DCR      C          *DECREMENT COUNT
      JNZ      STSPC     *LOOP UNTIL DONE
STSKIP POP      PSW       *RESTORE A
      PUSH    PSW        *SAVE IT AGAIN
      CALL   GETLVL     *GET LEVEL BYTE
STWAIT SCALL   .SCOUT     *OUTPUT IT
      JC      STWAIT     *LOOP UNTIL READY
      CALL   $TYPTX    *INDEX OVER TO PROPER COLUMN
      DB     ' ',' ' ,'+080H
      POP      PSW       *GET CHANNEL NUMBER
      PUSH    PSW        *SAVE IT AGAIN
      CALL   GETSTAT    *GET STATUS BYTE
      CPI     '1'        *IS IT ONE?
      PUSH    PSW        *SAVE FLAGS
      CZ      PRON       *PRINT ON IF SO
      POP     PSW        *RESTORE FLAGS
      CNZ     PROFF      *ELSE PRINT OFF
      CALL   CRLF       *OUTPUT CARRIAGE RETURN
STANEXT POP     PSW      *RESTORE A
      POP     D          *RESTORE D
      POP     B          *RESTORE B
      INX     D          *INCREMENT UNIT #
      DCR     C          *DECREMENT COUNT
      JNZ     STATLP    *DO NEXT ONE
      RET              *ALL DONE

```

* PRINT ON OR OFF

```

PRON   CALL    $TYPTX
      DB      01BH,'P ON',01BH,'9'+080H
      RET

```

```

PROFF  CALL    $TYPTX
      DB      'OF','F'+080H
      RET

```

UTILITY ROUTINES

```

* GET ADDRESS OF STATUS BYTE
*   ENTRY   A=CHANNEL NUMBER
*   EXIT    A=STATUS BYTE
*           HL=STATUS BYTE ADDRESS
*   USES   ALL

```

Listing 1 continued on page 260.

H & E COMPUTRONICS INC.

● EVERYTHING FOR YOUR TRS-80* ● ATARI* ● APPLE* ● PET* ●

*TRS-80 is a trademark of the Radio Shack Division of Tandy Corp. - *ATARI is a trademark of Atari Inc. - *Apple is a trademark of Apple Corp. - *Pet is a trademark of Commodore



★ All orders processed within 24-Hours
★ 30-Day money back guarantee on all Software

BUSINESS PAC 100

100 Ready-To-Run

Business Programs

(ON CASSETTE OR DISKETTE).....Includes 110 Page Users Manual.....5 Cassettes (Or Diskettes)
Inventory Control.....Payroll.....Bookkeeping System.....Stock Calculations.....
Checkbook Maintenance.....Accounts Receivable.....Accounts Payable.....

BUSINESS 100 PROGRAM LIST

1 RULE7B	Interest Apportionment by Rule of the 78's
2 ANNU1	Annuity computation program
3 DATE	Time between dates
4 DAYYEAR	Day of year a particular date falls on
5 LEASEINT	Interest rate on lease
6 BREAKEVN	Breakeven analysis
7 DEPRSL	Straightline depreciation
8 DEPRSY	Sum of the digits depreciation
9 DEPRDB	Declining balance depreciation
10 DEPRDDB	Double declining balance depreciation
11 TAXDEP	Cash flow vs. depreciation tables
12 CHECK2	Prints NEBS checks along with daily register
13 CHECKBK1	Checkbook maintenance program
14 MORTGAGE/A	Mortgage amortization table
15 MULTMON	Computes time needed for money to double, triple, etc.
16 SALVAGE	Determines salvage value of an investment
17 RRVARIN	Rate of return on investment with variable inflows
18 RRCONST	Rate of return on investment with constant inflows
19 EFFECT	Effective interest rate of a loan
20 FVAL	Future value of an investment (compound interest)
21 PVAL	Present value of a future amount
22 LOANPAY	Amount of payment on a loan
23 REGWITH	Equal withdrawals from investment to leave 0 over
24 SIMPDISK	Simple discount analysis
25 DATEVAL	Equivalent & nonequivalent dated values for oblig.
26 ANNUDEF	Present value of deferred annuities
27 MARKUP	% Markup analysis for items
28 SINKFUND	Sinking fund amortization program
29 BONDVAL	Value of a bond
30 DEplete	Depletion analysis
31 BLACKSH	Black Scholes options analysis
32 STOCVAL1	Expected return on stock via discounts dividends
33 WARVAL	Value of a warrant
34 BONDVAL2	Value of a bond
35 EPSEST	Estimate of future earnings per share for company
36 BETAALPH	Computes alpha and beta variables for stock
37 SHARPE1	Portfolio selection model-i.e. what stocks to hold
38 OPTWRITE	Option writing computations
39 RTVAL	Value of a right
40 EXPVAL	Expected value analysis
41 BAYES	Bayesian decisions
42 VALPRINF	Value of perfect information
43 VALADINF	Value of additional information
44 UTILITY	Derives utility function
45 SIMPLEX	Linear programming solution by simplex method
46 TRANS	Transportation method for linear programming
47 EOQ	Economic order quantity inventory model
48 QUEUE1	Single server queueing (waiting line) model
49 CVP	Cost-volume-profit analysis
50 CONDPF0F	Conditional profit tables
51 OPTLOSS	Opportunity loss tables
52 FQOQQ	Fixed quantity economic order quantity model

NAME

DESCRIPTION

53 FQEOWSH	As above but with shortages permitted
54 FQEQQPB	As above but with quantity price breaks
55 QUEUECB	Cost-benefit waiting line analysis
56 NCFANAL	Net cash-flow analysis for simple investment
57 PROFIND	Profitability index of a project
58 CAPI	Cap. Asset Pr. Model analysis of project

59 WACC	Weighted average cost of capital
60 COMPBAL	True rate on loan with compensating bal. required
61 DISCBAL	True rate on discounted loan
62 MERGANAL	Merger analysis computations
63 FINRAT	Financial ratios for a firm
64 NPV	Net present value of project
65 PRINDLAS	Laspeyres price index
66 PRINDPA	Paasche price index
67 SEASIND	Constructs seasonal quantity indices for company
68 TIMETR	Time series analysis linear trend
69 TIMEMOV	Time series analysis moving average trend
70 FUPRINF	Future price estimation with inflation
71 MAILPAC	Mailing list system
72 LETWRT	Letter writing system-links with MAILPAC
73 SORT3	Sorts list of names
74 LABEL1	Shipping label maker
75 LABEL2	Name label maker
76 BUSBUD	DOME business bookkeeping system
77 TIMECLCK	Computes weeks total hours from timeclock info.
78 ACCTPAY	In memory accounts payable system-storage permitted
79 INVOICE	Generate invoice on screen and print on printer
80 INVENT2	In memory inventory control system
81 TELDIR	Computerized telephone directory
82 TIMUSAN	Time use analysis
83 ASSIGN	Use of assignment algorithm for optimal job assign.
84 ACCTREC	In memory accounts receivable system-storage ok
85 TERMSPAY	Compares 3 methods of repayment of loans
86 PAYNET	Computes gross pay required for given net
87 SELLPR	Computes selling price for given after tax amount
88 ARBCOMP	Arbitrage computations
89 DEPRSF	Sinking fund depreciation
90 UPSZONE	Finds UPS zones from zip code
91 ENVELOPE	Types envelope including return address
92 AUTOEXP	Automobile expense analysis
93 INSFILF	Insurance policy file
94 PAYROLL2	In memory payroll system
95 DILANAL	Dilution analysis
96 LOANAFFD	Loan amount a borrower can afford
97 RENTPRCH	Purchase price for rental property
98 SALELEAS	Sale-leaseback analysis
99 RRCONVBD	Investor's rate of return on convertible bond
100 PORTVAL9	Stock market portfolio storage-valuation program

- CASSETTE VERSION \$99.95
- DISKETTE VERSION \$99.95
- TRS-80* MODEL II VERSION \$149.95

ADD \$3.00 FOR SHIPPING IN UPS AREAS
ADD \$4.00 FOR C.O.D. OR NON-UPS AREAS
ADD \$5.00 OUTSIDE U.S.A, CANADA & MEXICO

COMPUTRONICS
MATHEMATICAL APPLICATIONS SERVICE

50 N. PASCACK ROAD
SPRING VALLEY, NEW YORK 10977



**NEW TOLL-FREE
ORDER LINE**
(OUTSIDE OF N.Y. STATE)
(800) 431-2818

**24 HOUR
ORDER
LINE**
(914) 425-1535



Listing 1 continued:

```
GETSTAT  MOV     C,A           *CHANNEL NUMBER IN C
          MVI     B,0           *CLEAR B
          LXI     H,UNITLOC     *ADDRESS OF FIRST UNIT
          DAD     B             *ADD OFFSET
          DAD     B             *ADD IT AGAIN
          CALL    $HLIHL        *GET THE ADDRESS
          MOV     A,M           *FETCH THE STATUS BYTE
          RET                    *RETURN
```

```
*****
* GET ADDRESS OF LEVEL BYTE
*   ENTRY   A=CHANNEL NUMBER
*   EXIT    A=LEVEL BYTE
*           HL=LEVEL BYTE ADDRESS
*   USES    ALL
```

```
GETLVL   CALL    GETSTAT       *GET THE STATUS BYTE
          INX     H             *INDEX TO LEVEL BYTE
          MOV     A,M           *LOAD THE BYTE
          RET
```

```
*****
* GET THE DESCRIPTOR STRING ADDRESS
*   ENTRY   A=CHANNEL NUMBER
*   EXIT    C=NUMBER OF CHARACTERS TO PRINT
*           HL=FWA OF STRING
*   USES    ALL
```

```
GETDESC  CALL    GETLVL        *GET LEVEL BYTE
          INX     H             *INCREMENT TO PROPER BYTE
          INX     H
          INX     H
          PUSH   H             *SAVE FWA
          LXI     B,0           *CLEAR BC
DESLOOP  MOV     A,M           *FETCH A CHARACTER
          CPI     0AH          *CARRIAGE RETURN?
          JZ     DESDONE       *RETURN IF SO
          INX     B             *INCREMENT COUNT
          INX     H             *INCREMENT POINTER
          JMP    DESLOOP       *AND DO AGAIN
DESDONE  POP     H             *RESTORE FWA
          RET                    *AND RETURN
```

```
*****
* OUTPUT A GIVEN STRING
*   ENTRY   HL=FWA OF STRING ADDRESS
*           C =NUMBER OF CHARACTERS TO PRINT
*   USES    ALL
```

```
STROUT   MOV     A,C           *GET COUNT
          ANA     A             *SET FLAGS
          JZ     STRDONE       *NOTHING TO OUTPUT
STRLOOP  MOV     A,M           *FETCH A BYTE
          SCALL  $SCOUT        *OUTPUT IT
          JC     STRLOOP       *WAIT UNTIL READY
          INX     H             *NEXT BYTE ADDRESS
          DCR     C             *COUNT ONE DONE
```

Listing 1 continued on page 262

THE ORIGINAL MAGAZINE FOR OWNERS OF THE TRS-80™* MICROCOMPUTER

* TRS-80™ IS A TRADEMARK OF TANDY CORP.

SOFTWARE
FOR TRS-80™
OWNERS

H & E COMPUTRONICS INC.

MONTHLY
NEWSMAGAZINE
FOR TRS-80™
OWNERS

MONTHLY NEWSMAGAZINE Practical Support For Model I, II & III

- PRACTICAL APPLICATIONS
- BUSINESS
- GAMBLING • GAMES
- EDUCATION
- PERSONAL FINANCE
- BEGINNER'S CORNER
- NEW PRODUCTS
- SOFTWARE EXCHANGE
- MARKET PLACE
- QUESTIONS AND ANSWERS
- PROGRAM PRINTOUTS
- AND MORE

NOW IN OUR 4th YEAR

PROGRAMS AND ARTICLES PUBLISHED IN RECENT ISSUES
INCLUDE THE FOLLOWING:

- FINCALC - A COMPLETE FINANCIAL APPLICATIONS PACKAGE
- INFORMATION SYSTEM REVIEW
- STATISTICAL COMBINATIONS
- PASCAL'S TRIANGLE
- ASSEMBLY LANGUAGE FOR BEGINNERS
- DISK FILES
- MOD-III REVIEW
- KEYBOARD THUNDER AND LIGHTING EXPLAINED
- DOS COMMANDS IN LEVEL II
- PROBABILITY CURVE GENERATOR
- CALCULATOR SIMULATIONS
- THE MEGABYTE GAP
- STOCKS AND BONDS
- BUDGET ANALYSIS (FOR BUSINESS AND HOME)
- NEWDOS/80 REVIEW
- DUTCHING - THE HORSE SYSTEM THAT CAN'T LOSE
- A SIMULATED GOLF GAME
- CONTINUOUS FORM SOURCES
- TAX/SAVER REVIEW
- AND MORE

FREE* WITH
YOUR
SUBSCRIPTION
OR
RENEWAL

FINCALC

A Complete Financial Analysis Package Used To Calculate Markup, Margin, Annuities, Compound Interest, Nominal And Effective Rates, Sinking Funds, Mortgage Calculations, Future Value, Savings and Insurance, Percentage Difference Between Two Numbers, Amortization Schedule and More

SEND FOR OUR NEW 64 PAGE SOFTWARE CATALOG (INCLUDING LISTINGS OF HUNDREDS OF TRS-80™ PROGRAMS AVAILABLE ON CASSETTE AND DISKETTE). \$2.00 OR FREE WITH EACH SUBSCRIPTIONS OR SAMPLE ISSUE

* All programs are supplied on cassette (add \$3 for Diskette Version - add \$5 for modified Mod-II Version).

H & E COMPUTRONICS INC.
MATHEMATICAL APPLICATIONS SERVICE™

50 N. PASCACK ROAD
SPRING VALLEY, NEW YORK 10977

ONE YEAR SUBSCRIPTION \$24

TWO YEAR SUBSCRIPTION \$48

SAMPLE OF LATEST ISSUE \$ 4

START MY SUBSCRIPTION WITH ISSUE

(#1 - July 1978 • #12 - June 1979 • #24 - July 1980 • #30 - January 1981)

NEW SUBSCRIPTION..... RENEWAL.....

**NEW TOLL-FREE
ORDER LINE**
(OUTSIDE OF N.Y. STATE)
(800) 431-2818



**24 HOUR
ORDER
LINE**
(914) 425-1535



CREDIT CARD NUMBER _____ EXP. DATE _____

SIGNATURE _____ NAME _____

ADDRESS _____ CITY _____ STATE _____ ZIP _____

*** ADD \$12/YEAR (CANADA, MEXICO) - ADD \$24/YEAR AIR MAIL - OUTSIDE OF U.S.A., CANADA & MEXICO ***

Listing 1 continued:

```
                JNZ      STRLOOP          *LOOP UNTIL DONE
STRDONE RET          *AND RETURN
```

```
*****
* OUTPUT A CARRIAGE RETURN/LINE FEED
```

```
CRLF      CALL      $TYPTX
          DB        @AH+@SCH
          RET
```

```
*****
* GET ADDRESS OF CHANNEL NUMBER ASCII STRING
*      ENTRY      A=CHANNEL NUMBER
*      EXIT       C=NUMBER OF CHARS TO PRINT
*              HL=FWA OF ASCII STRING
*      USES      ALL
```

```
GETCHAN CALL      GETLUL          *GET LEVEL BYTE
          INX      H              *POINT TO CHANNEL
          MVI     C,2            *LOAD CHARS
          RET          *RETURN
```

```
*****
* CALCULATE WAIT REQUIRED
*      ENTRY      A=CHANGE
*      USES      ALL
*      EXIT       BC=COUNT TO WAIT
```

```
CALC      PUSH     PSW           *SAVE A
          ADD      A           *A=2*A
          ADD      A           *A=4*A
          MVI     B,1          *SET B=1
          MOV     C,A          *C=4*A
          POP     PSW          *GET 1*A BACK
          ADD      C           *A=5*A
          MOV     C,A          *C=5*A
          RET
```

```
LULCHG   PUSH     B             *SAVE BC
          CALL    SENDIT        *SEND THE COMMAND
          POP     B             *RESTORE B
```

Listing 1 continued on page 264



Components Express, Inc.

"Have you kissed your computer lately?"

1380 E. Edinger, Unit CC Santa Ana, CA 92705 (714) 558-3972

BROAD BAND MICROWAVE RECEIVER SYSTEM 1.8GHZ to 2.4 GHZ

only
\$295.00



With built-in-converter to channel 2, 3, or 4 of any standard TV set.

RANGE: Line of sight to 250 miles.

SCOPE: Will receive within the frequency band from satellites, primary microwave stations, and repeater microwave booster stations.

CONTENTS: Packaged in 19"x19"x4 1/2" corrugated carton complete with:

- 24" Dish
- Feed-Horn Receiver
- Mounting Bracket
- Mounting Clamp
- Instructions
- 300 Ohm to 75 Ohm Adapter
- 750 Ohm to 300 Ohm Adapter
- 60 Feet Coax Cable with Connectors
- 3 Feet Coax Cable with Connectors

WARRANTY:

180 days for all factory defects and electronic failures for normal usage and handling. Defective sub assemblies will be replaced with new or re-manufactured sub assembly on a 48 hour exchange guarantee.

This system is not a kit and requires no additional devices or equipment other than a TV set to place in operation. **DEALER INQUIRIES INVITED.**

WE HAVE A HARD-ONE FOR YOU!

WHO MAKES A
WINCHESTER HARD DISK for
IBM-PERSONAL COMPUTER,
TRS-80™ MODEL III, etc.?

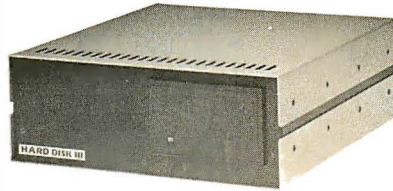

THE VR DATA HARD DISK III™
WINCHESTER SUBSYSTEM
6.5 MEG to 19 MEG per UNIT
FROM \$2895*

*Subsystem includes 6.5 MEG Winchester Drive, Power Supply, Controller, I/O Controller Adaptor, Enclosure, Cables.

Other Quality Products Available

IBM - Personal Computer 2nd Floppy Disk Drive	\$265.00
Superbrain & QD Parallel Output Port	99.00
TRS-80 - Model III Disk III Floppy Subsystem	599.00
2nd Drive	265.00
VR-RS232C	75.00

Quality Products in the QUEUE

IBM - Personal Computer Memory Expansion - 192K
D-CON • Integral Direct Connect Mode VR-RS232C
TRS-80 Mod III D-CON • Integral D.C. Modem Computer w/Integral Hard Disk III and Disk III

DEALERS & OEM'S INVITED

SERVICE • 215-461-5300

800-345-8102 • 215-461-5300 - PA • TELEX 845-124

PRICES SUBJECT TO CHANGE W/O NOTICE
TRS-80 - TRADEMARK OF TANDY CORP.
DISK II, HARD DISK III, D-CON - TRADEMARKS OF VR DATA CORP.

VR Data

VR Data Corporation
777 Henderson Boulevard • Folcroft, PA 19032



Listing 1 continued:

```
DCR    C          *DECREMENT INNER LOOP
JNZ    LULCHG    *LOOP UNTIL ZERO
DCR    B          *DECREMENT OUTER LOOP
JNZ    LULCHG    *LOOP UNTIL DONE
RET
```

```
*          SEND THE CODE
*
* SET UP THE COMMAND BYTES TO REFLECT THE CODE DESIRED
```

```
INDEX  MUI      B,0      *CLEAR B
        MOU      C,A      *OFFSET IN C
        LXI      H,ONE    *FIRST COMMAND LOCATION
        DAD      B        *ADD OFFSET
        MOU      A,M      *GET THE BYTE
SENDIT  STA      COMMAND  *STORE IT
        LDA      COMMAND  *GET THE COMMAND BYTE
        XRI      11111111B *COMPLEMENT THE ACCUMULATOR
        STA      COMMAND+1 *STORE THE COMPLEMENTED BYTE
        LDA      COMMAND  *GET THE ORIGINAL VALUE BACK
```

```
*START SENDING THE CODE
```

```
CALL   SEND1      *ALERT COMMAND MODULE OF MESSAGE
CALL   ROTOUT     *ROTATE A AND SEND BITS
LDA    COMMAND+1  *GET THE COMPLEMENTED COMMAND
CALL   ROTOUT     *SEND THE COMPLEMENTED BYTE
CALL   EOM        *SEND END OF MESSAGE
RET
```

```
* ROUTINES TO SEND LOGIC CONTROL PULSES TO THE BSR
```

```
*
* ROTATE A AND SEND APPROPRIATE LOGICAL BITS
```

```
ROTOUT  MUI      E,05H    *COUNT IN E - 5 BITS TO SEND
ROTLOOP RAL      *PUT A BIT INTO THE CARRY POSITION
        CC       SEND1    *SEND A ONE IF BIT IS 1
        CNC      SEND0    *ELSE SEND A ZERO
        DCR      E        *DECREMENT THE COUNT
        RZ       *RETURN IF DONE
        JMP      ROTLOOP  *ELSE CONTINUE
```

```
*WAIT BETWEEN COMMANDS
```

```
WAIT    PUSH     PSW      *SAVE A AND FLAGS
        LXI     H,075H    *36ms TIMING CONSTANT
        CALL    DELAY    *AND WAIT
        POP     PSW      *RESTORE A AND F
        RET
```

```
* SEND LOGIC '1' ROUTINE
* SEND 4ms ON PULSE AND 4ms OFF PULSE
* (4ms EQUALS 160 STATES)
```

Listing 1 continued on page 266

Ten reasons why your floppy disk should be a BASF FlexyDisk®

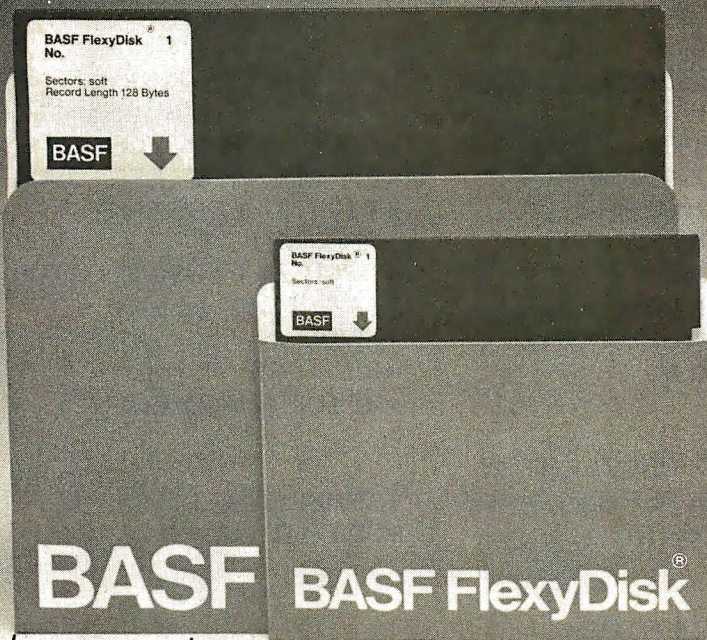

More than four decades of experience in magnetic media—BASF invented magnetic recording tape, the forerunner of today's wide range of magnetic media, back in 1934, and was the first independent manufacturer of IBM-compatible floppy disks.

Tough Tyvek sleeve—no paper dust, no static electricity.

Special self-cleaning jacket and liner help eliminate data errors and media wear and tear.

Packaging to suit your requirements—standard flip-top box, Cassette 10® storage case, or bulk pack.

Center hole diameter punched to more accurate standards than industry specifications, for top performance.

100% certification—every single disk is tested at thresholds 2-3 times higher than system requirements, to be 100% error-free.

Bi-axially oriented polyester substrate—for uniform and reliable performance year after year.

Cross-linked oxide coating—for low head wear and long trouble-free media life.

Total capability—one of two manufacturers in the world that makes both 8" and 5.25" models, has tape and disk experience, and manufactures floppy disk drives.

Double lubrication—lubricants both in the formula and on the disk surface, to minimize media wear due to head friction.

For the name of your nearest supplier, write BASF Systems, Crosby Drive, Bedford, MA 01730, or call 617-271-4030.



BASF

Floppy Disks Mag Cards Cassettes Computer Tapes Disk Packs Computer Peripherals

Listing 1 continued:

```
SEND1  PUSH    PSM          *SAVE A AND FLAGS
        CALL    OSCENA      *ENABLE THE BSR OSCILLATOR
        LXI    H,0EH        *TIMING CONSTANT
        CALL    DELAY       *AND WAIT
        CALL    OSCOFF      *TURN OFF OSCILLATOR
        LXI    H,0EH        *OFF TIME DELAY
        CALL    DELAY       *WAIT
        POP    PSM         *RESTORE A AND F
        RET                *RETURN WHEREVER
```

```
***
*      WAIT 1.2ms ON PULSE AND 6.8 ms OFF PULSE
      (LOGIC ZERO)
```

```
SEND0  PUSH    PSM          *SAVE A AND FLAGS
        CALL    OSCENA      *ENABLE THE BSR OSCILLATOR
        LXI    H,2         *TIMING CONSTANT
        CALL    DELAY       *AND WAIT
        CALL    OSCOFF      *TURN OFF OSCILLATOR
        LXI    H,01AH      *OFF TIME DELAY
        CALL    DELAY       *WAIT
        POP    PSM         *RESTORE A AND F
        RET                *RETURN WHEREVER
```

```
***
*      END OF MESSAGE - 12 ms ON SIGNAL - 4ms OFF
```

```
EOM    PUSH    PSM          *SAVE A AND FLAGS
        CALL    OSCENA      *ENABLE THE BSR OSCILLATOR
        LXI    H,02AH      *TIMING CONSTANT
        CALL    DELAY       *AND WAIT
        CALL    OSCOFF      *TURN OFF OSCILLATOR
        LXI    H,0EH        *OFF TIME DELAY
        CALL    DELAY       *WAIT
        POP    PSM         *RESTORE A AND F
        RET                *RETURN WHEREVER
```

```
*ENABLE THE 40KHZ OSCILLATOR
OSCEA  MVI    A,0FFH      *ENABLE BIT
        OUT    PORT       *OUTPUT IT
        RET
```

```
*DISABLE THE OSCILLATOR
OSCOFF MVI    A,000H      *DISABLE BIT
        OUT    PORT       *OUTPUT IT
        RET
```

```
*TIMING LOOP - ENTER WITH TIMING CONSTANT IN H-L
DELAY  PUSH    D          *SAVE D-E
DELAY1 LXI    D,01EH      *INNER LOOP CONSTANT
DELAY2 DCR    E          *DECREMENT INNER LOOP
        JNZ    DELAY2     *KEEP WAITING
        DCR    L          *ELSE DECREMENT OUTER LOOP
        JNZ    DELAY1     *AND WAIT SOME MORE
        POP    D          *RESTORE D-E
        RET                *AND RETURN
```

Listing 1 continued on page 268

\$399.

Made by Seikosha, AXIOM's new GP-100 is the finest printer a little money can buy. It uses standard 8-1/2 x 11 paper and has AXIOM's fabulous graphics interfaces for Apple, TRS-80, Atari, PET, HP and more! See the GP-100 at your AXIOM dealer today!

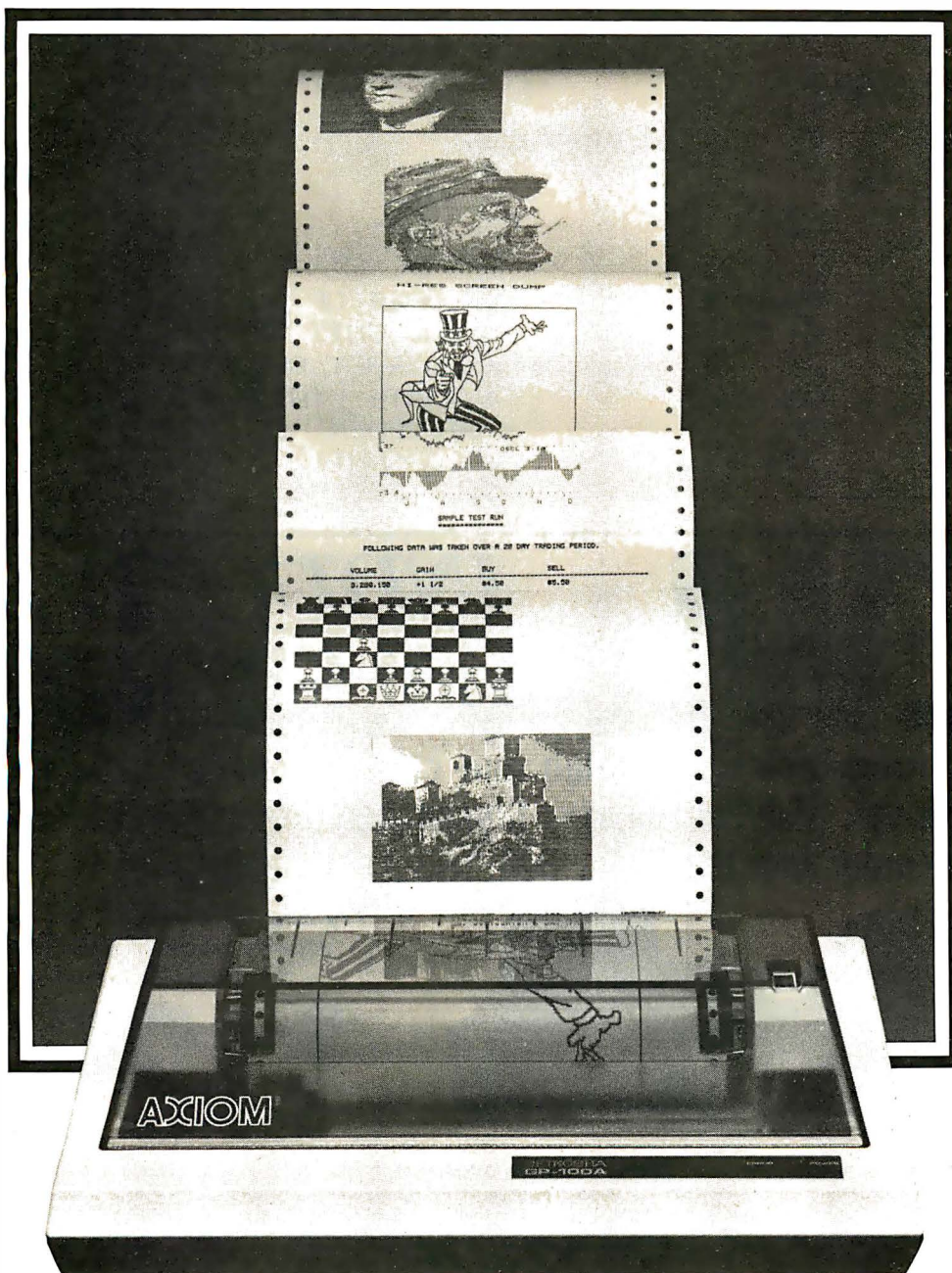

AXIOM

AXIOM CORPORATION

Seikosha is the leading company of the worldwide Seiko Group.

1014 Griswold Avenue, San Fernando, CA 91340 • Telephone: (213) 365-9521 • TWX: 910-496-1746

Circle 46 on inquiry card.

Listing 1 continued:

```
*****
* UPDATE STATUS BYTE TO SHOW IF UNIT IS OFF OR ON
*   ENTRY   A=CHANNEL NUMBER(0-15)
*   USES    ALL

ZEROBIT CALL  GETSTAT      *GET THE BYTE
          MVI    M,'0'      *STORE ZERO
          RET                *AND RETURN

SETBIT  CALL  GETSTAT      *GET THE BYTE
        MVI  M,'1'      *STORE ONE
        RET                *AND RETURN
```

*BSR COMMAND ROUTINES

```
*****
* TURN OFF ALL UNITS
*   ENTRY   NONE
*   USES    ALL

OFFALL LXI    D,'010H      *NUMBER OF UNITS
OFFALL1 MOV   A,E          *LOAD UNIT NUMBER
          SBI    1          *SUBTRACT OFFSET
          CALL  ZEROBIT    *UPDATE STATUS
          DCR   E          *DECREMENT COUNT
          JNZ  OFFALL1     *LOOP UNTIL DONE
```

Listing 1 continued on page 270

NEW! INDUCTIVE COUPLED MODEM

Eliminates room noise, vibration and other acoustic coupled problems. Originate/Answer. Half/Full duplex. Crystal controlled. RS-232, TTL, CMOS, cassette recorder input/outputs. Bell 103 compatible.



Try one for 30 days. No obligation.
Money back if not delighted
(less shipping).

\$129⁹⁵

What makes this MFJ-1230 modem different from other acoustic coupled modems?

First, it uses inductive coupling for receiving. This innovative technique eliminates room noise, vibration and other acoustic coupled problems. The result is more reliable data transfer.

Second, It is RS-232 compatible and provides TTL and CMOS input/outputs. Lets you interface to nearly any computer with proper software.

Third, cassette recorder input/output jacks let you record your transmitted data and load it back to your computer or retransmit it later.

Fourth, it has Originate/Answer modes and Half/Full duplex operation.

Fifth, it is crystal controlled for high stability.

Sixth, it has low price and excellent quality.

Bell 103 compatible. Carrier detect, power "ON" LEDs. 0 to 300 baud. All aluminum cabinet. Simple to install and operate. Made in USA.

No other modem offers you all these features at this affordable price.

Order from MFJ and try it — no obligation. If not delighted, return it within 30 days for refund (less shipping). One year unconditional guarantee.

Order today. Call toll free 800-647-1800. Charge VISA, MC or mail check, money order for \$129.95 plus \$4.00 shipping/handling for MFJ-1230.

Enjoy Micro Net, Source, bulletin boards and others, order now. Call MFJ or see dealers.

CALL TOLL FREE ... 800-647-1800

Call 601-323-5869 in Miss., outside continental USA OR for technical info, order/repair status.

MFJ ENTERPRISES, INCORPORATED

921 Louisville Road, Starkville, MS 39759

Introducing MSP 16-bit Multi-Tasking Systems Software

The real-time system, you can have on-time.

Now you can get a high quality 16-bit multi-tasking operating system for most M68000 and Z8000 based systems.

Hemenway's MSP real-time system is an efficient and comprehensive operating system for industrial or business use.

MSP Systems Software is easily adaptable to any hardware configuration. And because it's designed to be extensible, you can mold your operating system to your needs by adding new features or modifying existing ones. Quickly and easily.

Plus, tasks can start/stop other tasks and communicate with each other through submit functions (pipes) and mail-boxes (tubes).

You can also have macro assemblers, text editors, floating point packages, monitors, scientific packages, linking loaders, single-user operating systems and high-level languages. Off-the-shelf.

For the hard facts on Hemenway software, write or call:

Hemenway Corporation,
101 Tremont St., Boston,
MA 02108. Phone:
617-426-1931.
TWX 710 321 1203.
TELEX
921735.

Listing 1 continued:

```

LDA      ALLOFF      *LOAD THE COMMAND
STA      COMMAND    *STORE IT
CALL     SENDIT     *AND SEND THE COMMAND
RET

*****
* TURN ON ALL UNITS
*      ENTRY  NONE
*      USES   ALL

ONALL    LXI        D,010H      *NUMBER OF UNITS
ONALL1   MOV        A,E        *LOAD UNIT NUMBER
         SBI        1          *SUBTRACT OFFSET
         CALL     SETBIT      *UPDATE STATUS
         DCR        E          *DECREMENT COUNT
         JNZ     ONALL1      *LOOP UNTIL DONE
         LDA      ALLOFF     *LOAD THE COMMAND
         STA      COMMAND    *STORE IT
         CALL     SENDIT     *AND SEND THE COMMAND
         RET

*****
* TURN A SINGLE UNIT OFF OR ON
*      ENTRY  A=CHANNEL OFFSET
*      USES   ALL

OFFONE   PUSH      PSW        *SAVE CHANNEL
         CALL     INDEX      *SEND CHANNEL CODE
         CALL     WAIT      *PAUSE BETWEEN COMMANDS
         POP      PSW        *GET CHANNEL BACK
         CALL     ZEROBIT   *UPDATE STATUS
         LDA      OFF        *LOAD THE COMMAND
         STA      COMMAND    *STORE IT
         CALL     SENDIT    *SEND THE CODE
         RET              *ALL DONE

ONONE    PUSH      PSW        *SAVE CHANNEL
         CALL     INDEX      *SEND CHANNEL CODE
         CALL     WAIT      *PAUSE BETWEEN COMMANDS
         POP      PSW        *GET CHANNEL BACK
         CALL     SETBIT    *UPDATE STATUS
         LDA      ON        *LOAD THE COMMAND
         STA      COMMAND    *STORE IT
         CALL     SENDIT    *SEND THE CODE
         RET              *ALL DONE

*****
* ADJUST LAMP INTENSITY
*      ENTRY  A=CHANNEL NUMBER(0-15)
*            DE=REQUESTED LEVEL(0-9 ASCII)
*      USES   ALL

INTEN    PUSH      D          *SAVE REQUESTED LEVEL
         PUSH     PSW        *SAVE THE CHANNEL NUMBER
         CALL     GETSTAT    *GET THE STATUS BYTE
         CPI     '1'        *IS IT ON?
         JZ      ITSON      *YES - ADJUST LEVEL
         POP      PSW        *GET UNIT NUMBER BACK
```

Listing 1 continued on page 272

**ORDER
TOLL-FREE**

consumer computers Mail Order DISCOUNTS

**FREE
SHIPPING***
on all pre-paid cash orders

SEE OUR ADS ON PAGES 165 AND 469 FOR MORE EXCITING DISCOUNTS

apple computer
Authorized Dealer



**APPLE II PLUS
CALL FOR
BEST PRICES
APPLE DISK DRIVES
AT GREAT PRICES TOO!**

SPECIAL APPLE CATALOG AVAILABLE

Software for the Apple

VisiCalc, version 3.3	159
VisiFile (NEW data base manager)	199
VisiTrend/VisiPlot	219
VisiDex	159
VisiTerm	129
Desktop/Plan II	159
DB Master	169
WordStar (Apple 80 col. version)	249
Dow Jones Portfolio Evaluator	45
The Controller (G/L, A/R & A/P)	499
Apple Post	45
Apple Writer	65
Apple DOS Toolkit	65
DOS 3.3 Upgrade	49
Dow Jones News & Quotes Reporter	85
Apple Fortran (requires 64K memory)	165
Apple Plot	60
Easywriter word processor (80 column)	225
Tax Preparer	99
Real Estate Analyzer	129
Creative Financing	129
Personal Filing System (PSF)	85
Peachtree Accounting Software	CALL
BPI Accounting Software	CALL
Systems Plus Actng Software	CALL
BPI Actng Software	CALL

Apple Entertainment Software

We stock all Apple Special Delivery Software along with HUNDREDS of other games and utilities. Please call or write for a complete price list.

Raster Blaster	29
Gorgon	39
Pool 1.5	34
Ultima	39
Snoggle	
Space Eggs	29
Flight Simulator	33
Gobbler	
Allen Rain	23
Pulsar II	29
Space Warrior	24
Warp Factor	39
Dragon Fire	45

We stock HUNDREDS of software games and utilities.

Apple Cards and Hardware

16K RamBoard by ConComp Industries	130
Language System w/Pascal & BASICS	379
Silentye Printer w/Interface card	349
Hayes Micromodem II	299
Novation Apple-Cat	339
Videx Videoterm 80 column card	269
Videx Keyboard Enhancer	115
Z-80 Softcard by Microsoft	299
16 K RamCard by Microsoft	169
Integer Basic of Applesoft II Firmware Card	145
Graphics Tablet	619
Parallel Printer or Hi-Speed Serial I/F card	135
Communications Card w/cable	185
Centronics Printer interface card	185
Apple IEEE-488 interface card	399
16K Language card by Apple Computer	169
Thunderclock Plus clock/calendar	119
Smarterm 80 column card	299
Corvus Winchester Hard Disk Drives	CALL
ALF 3 Voice Music Card	239
ALF 9 Voice Music Card	169
Lazer Lower Case Plus +	55
Lazer Keyboard Plus +	99
23 Key Numeric Keypad by Keyboard Co	120
Joystick II by Keyboard Co	45
6809 CPU Card (The Mill) by Stellation	319
AIO Serial & Parallel interface by SSM A&T	189
Music System (16 voices)	479
A/D + D/A Interface	289
Expansion Chassis (8 slots)	599
Introl/X-10 Controller card	169
Clock/Calendar card	225
CPS Multi-function card	189
Supertalker SD-200	239
Romplus + card	135
Romwriter card	149
Symtec Hi-Res Light Pen	210
Sup-R-Fan ventilation system for Apple II	45
Sup-R-Terminal 80 column card by M&R	329
SVA ZX4 Megabyte 8" Disk Controller	589
SVA 2 + 2 Single Den. 8" Disk Controller	345
Spechlink 2000 by Heuristics	249
Versawriter Digitizer Tablet	229
Asynchronous Serial interface card by CCS	139
Centronics Parallel interface card by CCS	119
We carry all California Computer System Cards	CALL

We stock many more items for the Apple II.
Please call or write for current price list.

16K RAMBOARD by ConComp for Apple II Computers

FOR ONLY \$ **129⁹⁵**

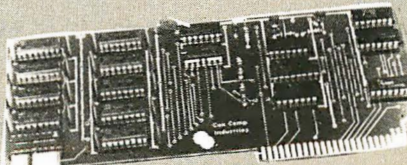

AVAILABLE NOW

**ORDER TOLL FREE
800-854-6654**
In California and
outside continental U.S.
(714) 698-8088
Telex 695-000 Beta CCMO

Printers

**Epson
MX-80 or
MX-80 FT
CALL**



Anadex 9501 w/2K Buffer	1349
C. Itoh Starwriter 25 CPS daisywheel	1449
C. Itoh Starwriter 45 CPS daisy wheel	1649
Epson MX-70	CALL
Epson MX-80 & MX-80 FT	CALL
Epson MX-100	CALL
NEC 8023 Impact Dot Matrix	695
NEC Spinwriters (Latest models)	CALL
Paper Tiger IDS-445G w/graphics	699
Paper Tiger IDS-460G w/graphics	949
Paper Tiger IDS-560G w/graphics	1249
Silentye Printer w/Apple interface	349
Qume Sorint Daisywheels (Latest models)	CALL
Diablo 630 Daisywheel 40 CPS	1795

Video Monitors

Amdek/Leedex Video 100 12" B&W	155
Amdek/Leedex Video 100G 12" Green Phosphor	179
Amdek (Hitachi) 13" Color w/audio output	389
NEC 12" Green Phosphor Display JB-1201M	CALL
NEC 12" Lo-Res Color Display	CALL
NEC 12" Hi-Res RGB Color Display	CALL
Sanyo 9" B&W Display	185
Sanyo 9" Green Phosphor Display	CALL
Sanyo 12" B&W Display	269
Sanyo 12" Green Phosphor Display	285
Sanyo 13" Color Display	449
Zenith 12" Green Phosphor Display ZVM-121	149



**ZENITH
12"
GREEN**

\$149

VIC20™ \$259

**Personal
Computer**

Color * Sound * Graphics
Call or write for more info.
Disk drives available soon!

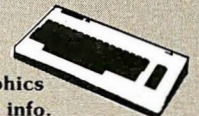

Ordering information: Phone orders using VISA, MASTERCARD, AMERICAN EXPRESS, DINER'S CLUB, CARTE BLANCHE, bank wire transfer, cashier's or certified check, money order, or personal check (allow ten days to clear). Unless prepaid with cash, please add 5% for shipping, handling and insurance. Minimum 5.00. Calif. no residents add 6% sales tax. We accept CODs. OEM's, Institutions and corporations please send for a written quotation. All equipment is subject to price change and availability without notice. All equipment is new and complete with manufacturer's warranty (usually 90 days). Showroom prices may differ from mail order prices.

Send Orders to:
**consumer
computers** Mail Order
8314 Parkway Drive
La Mesa, California 92041

Listing 1 continued:

```

ITSON  PUSH    PSW          *SAVE IT
      CALL    NONE        *TURN ON THE UNIT
      POP     PSW          *RETURN CHANNEL NUMBER
      PUSH    PSW          *SAVE IT AGAIN
      CALL    INDEX       *SELECT UNIT CODE AND TRANSMIT
      CALL    LONGOUT     *WAIT BETWEEN COMMANDS
      POP     PSW          *RESTORE CHANNEL NUMBER
      CALL    GETLVL      *GET THE LEVEL BYTE
      POP     D            *RESTORE REQUESTED LEVEL
      SUB     E            *SUBTRACT REQUESTED LEVEL
      RZ
      JC     BRIGHTR     *NO CHANGE REQUESTED - RETURN
      MOV    M,E          *CARRY - BRIGHTER REQUEST
      CALL   CALC         *STORE NEW LEVEL
      LDA    DIM          *GET WAITING PERIOD
      STA    COMMAND     *GET THE COMMAND
      CALL   LVLCHG      *STORE IT
      RET
BRIGHTR MOV    M,E          *STORE NEW LEVEL
      CMA    A            *COMPLEMENT - NUMBER IN A
      ADI    1            *ADD ONE
      CALL   CALC         *GET WAIT
      LDA    BRIGHT      *GET COMMAND
      STA    COMMAND     *STORE IT
      CALL   LVLCHG      *SENT IT
      RET                *AND RETURN

*****
* PRINT MANUAL CONTROL MENU
* ENTRY NONE
* USES ALL
MENU   CALL   $TYPTX      *PRINT AVAILABLE SELECTIONS
      DB     01BH,045H,0AH,03H,09H,09H
      DB     01BH,'=MANUAL CONTROL MENU',01BH,'a',0AH,0AH,0AH
      DB     'Commands Available:',0AH,0AH
      DB     09H,'0..... Exit Program',0AH
      DB     09H,'1..... All Units Off',0AH
      DB     09H,'2..... All Units On',0AH
      DB     09H,'3..... Single Unit Off',0AH
      DB     09H,'4..... Single Unit On',0AH
      DB     09H,'5..... Single Unit Brightness Adjust'
      DB     0AH
      DB     09H,'6..... Return to Status Display'
      DB     0AH,0AH,0AH
      DB     'Enter Number Of Choice', ' '+080H

MENUIN SCALL   .SCIN      *GET COMMAND
      JC     MENUIN     *LOOP UNTIL READY
      PUSH   PSW        *SAVE IT
      SCALL  .CLRCC      *CLEAR CONSOLE BUFFER
      POP    PSW        *RESTORE COMMAND
      SUI    '0'        *LESS THAN ZERO?
      JC     MENUERR    *ERROR IF SO
      CPI    7          *MORE THAN 6?
      JNC   MENUERR    *ERROR IF SO
      CALL   $TJMP      *JUMP TO PROPER ROUTINE
      DW    EXIT

```

Listing 1 continued on page 274

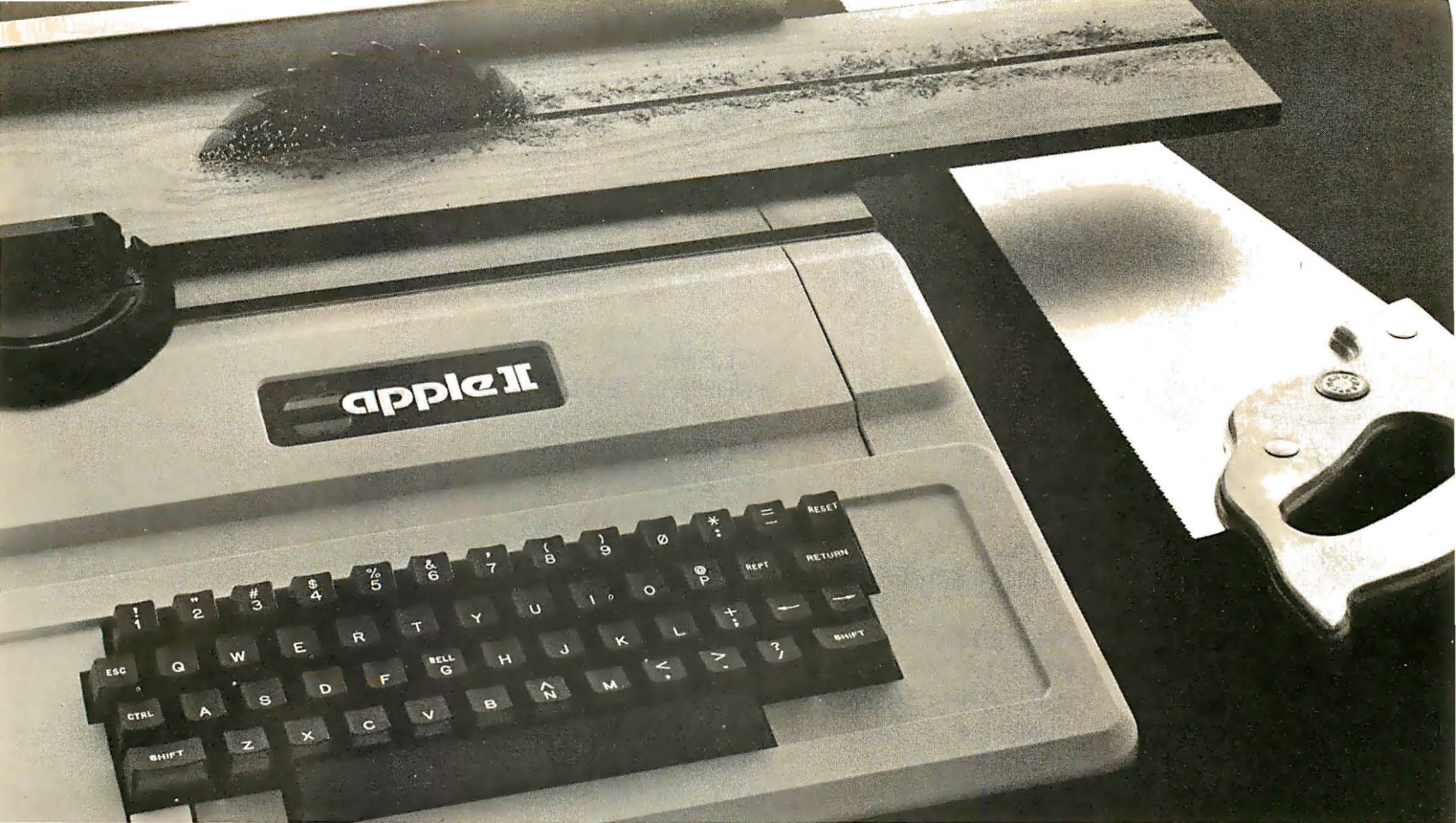

TASC™. The Applesoft* Compiler. It turns your Apple into a power tool.

Step up to speed. TASC, the Applesoft Compiler, converts a standard Applesoft BASIC program into super-fast machine code. By increasing program execution speed up to 20 times, Microsoft gives you a power tool for Applesoft BASIC programming.

Highest capacity available.

TASC will compile and run larger programs than any other Applesoft Compiler. As a disk-based system, it doesn't require the simultaneous presence of compiler and program in memory. The memory you save allows you to compile significantly bigger programs.

Power without bulk. Code expansion of up to 100% severely restricts other compilers. TASC's special code compression schemes typically limit code expansion to only 25%. You'll really appreciate that with complex programs or programs that utilize Apple's hi-res graphic pages.

More BASIC power. TASC's powerful new commands increase Applesoft BASIC programming capability. Chain with COMMON allows compiled programs to share variables, so a main menu

*Applesoft is a trademark of Apple Computer, Inc.

Circle 249 on inquiry card.



supports several programs in a single runtime environment.

TASC's True Integer Arithmetic and Integer FOR...NEXT capabilities maximize the execution speed of compiled programs.

TASC's near total compatibility with Applesoft speeds compilation of existing programs with little or no modification.

What about mistakes? You perfect your programs interactively with Applesoft. If something does slip by, TASC recovers

from errors discovered in compilation and traps all runtime errors. It even permits graceful interruptions during compilation.

See for yourself. Ask for a demonstration of TASC at your Microsoft dealer. Discover the software package that turns your Apple into a power tool.

MICROSOFT

CONSUMER PRODUCTS

A Division of Microsoft Inc.
10700 Northup Way • Bellevue, WA 98004

Listing 1 continued:

```

DW      AOFF
DW      AON
DW      OOFF
DW      OON
DW      ADJUST
DW      MENDONE

EXIT    XRA      A          *CLEAR A
        SCALL   .EXIT      *NORMAL EXIT

AOFF    CALL    OFFALL     *TURN THEM OFF
        JMP     MENDONE    *RETURN

AON     CALL    ONALL      *TURN THEM ON
        JMP     MENDONE    *RETURN

OOFF    CALL    CHAMENU    *PRINT MENU
        CALL   $TYPTX
        DB     @AH,@AH,'Number of Unit to Turn Off?',' '+@80H
        CALL   CHANIN      *GET SELECTION
        CALL   OFFONE     *TURN IT OFF
        JMP     MENDONE    *ALL DONE

OON     CALL    CHAMENU    *PRINT MENU
        CALL   $TYPTX
        DB     @AH,@AH,'Number of Unit to Turn ','@1EH,'FON'
        DB     @1EH,'?',' '+@80H
        CALL   CHANIN      *GET SELECTION
        CALL   ONONE      *TURN IT ON
        JMP     MENDONE    *ALL DONE

ADJUST  CALL    CHAMENU    *PRINT MENU
        CALL   $TYPTX
        DB     @AH,@AH,'Number of Unit on Which to Adjust'
        DB     'Brightness?',' '+@80H
        CALL   CHANIN      *GET CHANNEL NUMBER

```

Listing 1 continued on page 278

The A2-3D1 Graphics Family...

professional graphics
for you
and your Apple II.

subLOGIC

Communications Corp.
713 Edgebrook Drive
Champaign, IL 61820
(217) 359-8482
Telex: 206995

"Apple" is the registered trademark of Apple Computer Inc.

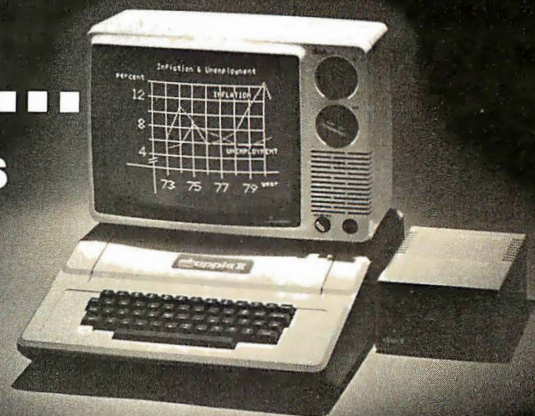

KEEP YOUR EYE ON THE BALL

THE FORMULA™ allows the computer professional to focus on the most important part of business: the needs of the client. Customized systems for any business application can be created in a fraction of the time required by conventional methods.

- Interactive data entry, file updating, and maintenance routines are automatically generated from a definition of the fields.
- Reports can be created through a unique full screen editor simply by typing a sample format.
- Menus and job streams are defined through a preprogrammed parameter-driven procedure.
- Fast response time is insured because each routine can be interpreted directly by the computer and data management is controlled by an efficient ISAM algorithm.

THE FORMULA™ is a complete system language which brings the process of developing applications closer to the user's description of his needs. That's **THE FORMULA™** for success.

Disk and manual, \$595. Manual only, \$60.

THE FORMULA™ will run on any 8080 or Z80 computer with CP/M,* 48K RAM, 300K total disk storage, and a CRT.

DMA • WE SPEAK YOUR LANGUAGE.

THE FORMULA™ For Success can help you build systems. Now, the General Accounting System, created with **THE FORMULA™**, is available at no extra charge.

The General Accounting System includes:

- General Ledger: Journals, Trial Balance, Income Statement, Balance Sheet, etc.
- Accounts Payable: A/P Journals, Checks, Aged Payables, Vendor Report, etc.
- Accounts Receivable: A/R Journals, Aged Receivables, Customer Statements, Customer Activity Report, etc.

**AT NO EXTRA
CHARGE**

In addition, two new optional packages have been developed for use with **THE FORMULA™**:

Professional Time Management \$80

Manager's Billing Report, Employee
Production Report, Client Invoices, etc.

Label Option Pak \$80

Name Inversion, Multiple Up Labels,
Customized Label Size and Format, etc.

Circle 130 on inquiry card.

The Nanocomputer: the professional approach to microcomputers

The Nanocomputer is an integrated educational system based on a powerful microcomputer with education-oriented software and complemented by a series of training books written specially for the system.

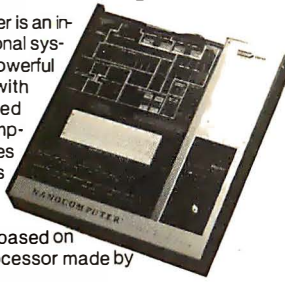

POWERFUL — based on the Z80 microprocessor made by SGS-ATES

COMPLETE — hardware, software and peripherals backed by a series of step-by-step training books on programming, digital electronics and interfacing.

MODULAR — as the student learns, the hardware can be expanded to introduce new concepts and experiments: Z80 code programming, interfacing and high-level languages (BASIC).

NBZ80S Nano Computer Includes the Nano Computer with power supply, the NEZ80 bread board for experiments and interfacing, the card frame, K1Z80 Cable Kit, the technical manual and training books one and three **\$570.00**

K1Z80 Extra K1Z80 Cable Kit **11.00**

K2Z80 Active and experimental component kit **33.10**

K3Z80 Socket kit with 3 40 pin sockets **5.70**



RCZ80/P Cassette recorder for all Nano Computer Systems (requires a W10Z80 see below) **88.60**
W10Z80/P Cable for connecting the RCZ80 cassette recorder **16.60**

NEZ 2KB Experimental Software for the Nano Computer (available on the M2708 EPROM) **32.90**



3 1/2-Digit LCD-Display DIGITAL MULTIMETER

- **HANDY** — easy to hold, to carry, to use, to read.
- **ACCURATE** — basic 0.1% DC accuracy
- **TOUGH** — built to take rough everyday field usage and electrical overload ... yet maintain its calibration
- **VERSATILE** — big, clear, high contrast 3 1/2-digit LCD display, readable anywhere ... a full 0.5" high.
- **PORTABLE** — Palm-sized, lightweight, operates up to 200 hours on a single 9V transistor alkaline battery.
- **EXPANDABLE** — uses standard DMM accessories to extend ranges even further. MODEL 935 **\$175.00**

★ **SPECIAL WITH COUPON \$140.00***

MARK IV LED POWER LEVEL INDICATOR

- Display Range -36dB to +5dB
- Floating or Gradual Output Indicating
- Kit includes transistors, leds, capacitors, resistors, PC Board, and silk screened metal front panel

70 pcs. KIT, **\$31.50**
 ★ **With Coupon \$29.50***

Universal Oscilloscope

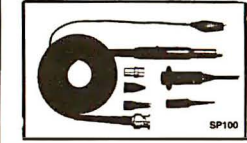

Probe \$36.00

★ **SPECIAL WITH COUPON***
 ★ **\$29.50***

SWITCHABLE X1 and X10 Attenuation Factor KEY ADDITIONAL FEATURES: • 100MHz bandwidth • Heavy duty tip • Break resistant center conductor • Slender, flexible cable

- 6ft. cable length
- Wide compensation range
- Fits all scopes
- Ground reference can be activated at tip • Includes SPRING HOOK, I.C. TIP, BNC ADAPTOR, INSULATING TIP and TRIMMER TOOL ACCESSORIES.



30 MHz HITACHI DUAL TRACE PORTABLE OSCILLOSCOPE

MODEL V-302B **\$995.00**

★ **SPECIAL WITH COUPON \$796.00***

MOTOROLA'S OPTO TRIAC DRIVER COUPLER

Type	Typ. Trg. mA	Min. Peak Block Voltage	Price	Type	Typ. Trg. mA	Min. Peak Block Voltage	Price
MOC3009	16	260	\$2.20	MOC3021	8	400	3.62
MOC3010	8	260	2.71	MOC3030*	15	250	3.96
MOC3011	6	260	2.86	MOC3031*	8	260	6.22
MOC3020	15	400	3.16				

*Zero Crossing

★ **SPECIAL 10% DISCOUNT WITH COUPON***



20 MHz DUAL TRACE

- DC-20 MHz Bandwidth
 - Triggering up to 30 MHz
 - 8cm x 10cm Display
- HM203 \$580.00
 HM203N with long persis \$600.00



10 MHz SINGLE TRACE

- DC-10 MHz Bandwidth
 - LPS-Triggering
 - Component Tester Built-in
 - Timebase 0.2µs-0.2s/cm
- HM307 \$405.00



4-CHANNEL AMPLIFIER

- DC-50 MHz Bandwidth
 - AC/DC Operation
 - Algebraic Addition
 - Compact Shape and Easy-to-use
- HZ64 \$451.00



COMPONENT TESTER

- Easy-to-use
 - Safety Class II
 - Check Semiconductors in circuit
 - Check Electronic Components
- HZ65foruse with all HAMEG scopes ... \$58.00

HAMEG Oscilloscopes to meet every need



20 MHz DUAL TRACE

- Overscanning
- LPSTrigto 40 MHz
- Delayed Sweep
- DC-20 MHz

Internal stabilized power supplies. Both vertical channels incorporate a variable gain control which increases the gain to 2 mV/cm. Channels can be Added or Subtracted. A special feature of the HM412 is the vertical Overscanning facility, location of a "lost" trace is indicated on two LED's. Both the trigger and delayed conditions are indicated by LED's. These facilities coupled with graticule illumination, Z Modulation, and a square-wave calibrator make the HM412 a very versatile instrument.

HM412 with sweep delay \$880.00
 HM412N with delay and long persis \$985.00



70 MHz DUAL TRACE

- DC-70MHz
- Sweep Delay 0.1µs-1s
- Sens. 2mV/cm
- Graticule 8x10cm

General-purpose scope designed for both laboratory and field service. The HM705 triggers even complex signals beyond 100MHz. Two non-synchronous signals, or a composite signal with a non-synchronous component, and also aperiodic events can likewise be triggered. Single-shot operation is also possible. The wide sweep range from 5ns/cm (including x10 magnification) to 2.5s/cm gives an excellent resolution. These features and others make the HM705 an instrument of great flexibility in all fields.

HM705 with delay \$885.00
 HM705N with delay and long persis \$1000.00



50 MHz DUAL TRACE

- 50 MHz Dual Trace Storage Scope Plus Varible Persistence
- Delayed Sweep with After-Delay-Trig.
- Storage of Single-Shot Signals "Automatic Store"
- LED Indication for Overscanning, Single-Shot, Trigger Action, Delay Mode and Automatic Store
- Automatic Blanking

50 MHz Dual Trace Storage Scope Plus Varible Persistence

• Delayed Sweep with After-Delay-Trig.

• Storage of Single-Shot Signals "Automatic Store"

• LED Indication for Overscanning, Single-Shot, Trigger Action, Delay Mode and Automatic Store

• Automatic Blanking

HMB12-2 \$4032.00

Full ASCII Encoded Keyboards

RGA 128-Character, 58-Key Typewriter Format for Alphanumeric Entry

- VP-601 8-bit parallel output \$69.00
- VP-606 Async serial output \$99.00

58-Key Typewriter Format Plus Calculator-Type Keypad for Fast Numeric Entry

- VP-611 8-bit parallel output \$89.00
- VP-616 Asynchronous serial output \$119.00

Operation From Single +5 Volt Supply

TG105 PULSE GENERATOR

• Period: 200nsec to 200ms (5MHz to 5Hz)

• Pulse Width: 100nsec to 100ms

• 50 ohm output range: 0.1V-10V

• TTL output • Sync. output

• Operating Modes: Run, External trigger, External gate, Manual 1-shot or Gate

• Compliment and square wave

TG105 Reg. Price \$219.00
 ★ **SPECIAL WITH COUPON \$195.00***

TAKE ADVANTAGE OF OUR SPECIAL SAVINGS ... USE COUPON ON OPPOSITE PAGE



ANCRONA CORP.

ANCRONA HAS MOTOROLA SEMICONDUCTORS

★SPECIAL 20% DISCOUNT WITH COUPON★													
BFR90	\$1.91	MC858P	\$1.50	MC1488P	\$1.47	MC4024P	\$5.75	MC7906CT	\$2.10	MCMB674P	\$11.17	MP5034	\$1.00
BFR91	2.42	MC862L	2.27	MC1489AL	1.89	MC4026P	3.05	MC7908CT	2.10	MCMB810C	7.47	MP5003	1.19
CA3054	1.54	MC958L	4.43	MC1489L	1.68	MC4044P	5.76	MC7912CT	2.10	MCRI03	.79	MP5U05	1.00
CA3059	3.34	MC1302P	3.72	MC1489P	1.47	MC4558NCP1	3.18	MC7915CT	2.10	MCRI06-2	1.01	MP5U06	1.09
CA3079	2.23	MC1309P	2.86	MC1494L	8.53	MC6800P	13.90	MC7918CT	2.10	MCRI3918-B	7.74	MP5U10	1.23
OAC08CP	3.49	MC1310P	6.29	MC1495L	7.47	MC6808P	13.90	MC7924CT	2.10	MDA100A	2.05	MPSU51A	1.13
MBD101	.73	MC1330A1P	2.20	MC1496G	2.07	MC6809P	45.39	MC10101P	.92	MDA101A	2.21	MPSU56	1.09
MBD102	.88	MC1349P	1.72	MC1568R	13.42	MC6821P	7.33	MC10102P	.92	MDA102A	2.38	MPU131	.91
MBD201	1.03	MC1350P	1.44	MC1594L	12.74	MC6840P	12.22	MC10104P	.92	MDA104A	2.54	MR250-2	2.27
MBD501	1.57	MC1351P	2.10	MC1595L	10.63	MC6844P	45.39	MC10107P	.90	MDA106A	2.83	MR750	.84
MC78L05CP	.66	MC1352P	2.01	MC1710CP	.89	MC6845P	41.20	MC10109P	1.02	MDA108A	3.31	MR751	1.06
MC78L08CP	.66	MC1355P	2.10	MC1733CP	1.30	MC6846P	39.90	MC10115P	.92	MDA110A	3.80	MR752	1.12
MC78L12CP	.66	MC1357P	2.19	MC1756CP1	2.07	MC6847P	16.06	MC10116P	1.10	MDA120A	2.21	MR754	1.26
MC78L18CP	.66	MC1358P	1.91	MC1807P	1.36	MC6850L	14.32	MC10117P	6.80	MDA201A	2.58	MR756	2.10
MC78L24CP	.66	MC1364P	2.01	MC1808P	1.36	MC6850P	6.84	MC10123L	3.39	MDA202	2.39	MR758	2.65
MC78L24CP	.66	MC1372P	2.08	MC1809P	1.36	MC6852P	7.33	MC10124L	2.01	MJE3055T	1.28	MR760	3.21
MC78M05CT	1.47	MC1373P	5.19	MC3062L	4.00	MC6854P	32.26	MC10124P	2.52	MPF102	.66	MR812	.51
MC78M06CT	1.47	MC1391P	1.44	MC3302P	1.12	MC6860P	12.92	MC10125L	3.00	MPS3402	.76	MRF476	2.93
MC78M08CT	1.47	MC14030U	4.08	MC3303P	5.80	MC6875L	13.49	MC10125P	2.52	MPS918	1.28	MRF901	3.15
MC78M12CT	1.47	MC1405L	15.28	MC3325P	2.10	MC6881P	8.91	MC10137L	32.36	MPS3638A	4.87	MRF911	3.04
MC78M15CT	1.47	MC1408L	3.84	MC3340P	2.10	MC6882AL	6.13	MC10176P	6.26	MPS3704	.50	MV209	1.13
MC78M18CT	1.47	MC1408L7	4.75	MC3360P	3.50	MC6885P	2.72	MC10189L	3.27	MPS6514	68	MB939	2.42
MC78M20CT	1.47	MC1408L	6.55	MC3370P	3.72	MC6886P	2.72	MC10195L	2.52	MPS6520	.72	MV2115	2.27
MC78M24CT	1.47	MC14089P	4.40	MC3403P	1.77	MC6887P	2.72	MC10216L	1.83	MPS6521	.83	MV2205	.78
MC78L05CP	1.12	MC1413P	1.68	MC3405P	3.60	MC6888P	2.72	MC14411P	17.26	MPS6522	.76	MV2209	.78
MC78L12CP	1.12	MC1436CU	4.96	MC3438L	3.55	MC6889P	3.14	MC14412VP	15.53	MPS6523	.86	NE922N	1.98
MC78L15CP	1.12	MC1437L	3.99	MC3419L	31.42	MC7805CT	1.65	MC14435P	6.84	MPS6566	.73	SC1368	.98
MC78L24CP	1.12	MC1439L	4.82	MC3417L	14.83	MC7808CT	1.65	MC14457P	6.80	MPS6009	.57	SC1360	1.17
MC6849	3.20	MC1439P1	3.97	MC3420L	10.08	MC7812CK	3.14	MC14458P	13.73	MPS8599	6.00	SC1418	1.76
MC6809	2.05	MC1445G	4.20	MC3423P1	1.66	MC7812CT	1.65	MC14490FP	5.60	MPSA06	.73	SC1410	1.98
MC684P	5.10	MC1446P1	.99	MC3438L	4.33	MC7815CK	3.14	MC14490VP	4.24	MPSA12	.85	TC2008	1.91
MC830L	2.27	MC1445UDS	1.98	MC3448AP	5.80	MC7815CT	1.65	MC14495P	3.96	MPSA13	.65	TIL116	1.32
MC835L	2.46	MC1458CL	1.44	MC3470P	12.64	MC7818CT	1.65	MC34004P	3.52	MPSA20	.38	TIP102	1.91
MC839L	5.88	MC1458CP1	1.08	MC3476P1	3.18	MC7824CK	3.14	MC68488P	32.26	MPSA42	.82	TIP110	1.36
MC848L	3.17	MC1458P1	1.08	MC3480P	12.85	MC7902CT	2.10	MC34255	1.76	MPSA56	.88		
MC847L	2.46	MC1458P1S	1.33	MC3503L	18.62	MC7905CT	2.10	MC68A10P	55.59	MPSA64	.74		
MC857P	1.50	MC1488L	1.68	MC4016P	10.10	MC7906CK	4.20	MC6866L25	4.69	MPSA70	.45		

Listing 1 continued:

```

ADJREQ  PUSH    PSW                *SAVE IT
        CALL    $TYPTX
        DB      01BH,045H,0AH,'Brightness Level (0=Dim,'
        DB      ' 9=Bright)?','+080H
ADJIN   SCALL   .SCIN              *GET THE LEVEL
        JC      ADJIN              *LOOP UNTIL READY
        PUSH    PSW                *SAVE THE INPUT
        SCALL   .CLRCD             *CLEAR THE INPUT BUFFER
        POP     PSW                *GET INPUT BACK
        MOV     E,A                *STORE REQUESTED LEVEL
        MOV     D,0                *CLEAR D
        SBI     '0'                *LESS THAN 0?
        JC      ADJREQ             *ERROR IF SO
        CPI     0AH                *MORE THAN 9?
        JNC     ADJREQ             *ERROR IF SO
        POP     PSW                *RESTORE CHANNEL NUMBER
        CALL    INTEN              *ADJUST THE LEVEL
        JMP     MENDONE            *RETURN.

MENDONE RET                          *RETURN TO MAIN PROGRAM

MENUMERR CALL    $TYPTX
        DB      07H,0AH,0AH,0AH,01BH
        DB      'INVALID INPUT - HIT RETURN TO CONTINUE'
        DB      01BH,' '+080H
ERRWAIT SCALL   .SCIN              *GET CHARACTER
        JC      ERRWAIT            *LOOP UNTIL READY
        CPI     0AH                *RETURN?
        JNZ     ERRWAIT            *LOOP UNTIL TRUE
        JMP     MENU               *AND TRY AGAIN

```

*CHANNEL SELECTION MENU ROUTINES

```

* PRINT CHANNEL NUMBER SELECTION MENU
*     ENTRY    NONE
*     USES     ALL

```

```

CHAMENU CALL    $TYPTX
        DB      01BH,045H,09H,09H,09H,01BH,'CHANNEL SELECTION'
        DB      'MENU',01BH,' ',0AH,0AH+080H
        LXI     D,010H              *NUMBER OF CHANNELS
        LXI     B,0                *CLEAR BC
MENULP  PUSH    D                  *SAVE THE NUMBER
        PUSH    B                  *SAVE BC
        MOV     A,C                *GET CHANNEL NUMBER
        PUSH    PSW                *SAVE IT
        CALL    GETCHAN            *GET LOCATION OF CHANNEL STRING
        MOV     A,M                *GET FIRST BYTE
        CPI     '9'                *DISABLED?
        JZ      MENEXT            *DO NEXT ONE IF SO
        CALL    $TYPTX            *INDENT LINE
        DB      09H+080H
        CALL    STROUT             *PRINT CHANNEL NUMBER
        CALL    $TYPTX
        DB      '.....','+080H
        POP     PSW                *CHANNEL NUMBER

```

Listing 1 continued on page 280

T/Maker II:™ it does a number on VisiCalc!™

VisiCalc is a fine aid for the computation of numerical problems. But it does have two major limitations: it is available only for a small number of systems, and its use is limited strictly to numbers, not words. To overcome these substantial limitations, Lifeboat Associates introduces T/Maker II.

Unlike VisiCalc, T/Maker II is designed to run on most small business computers with CP/M® or similar operating systems and a video terminal with cursor addressing capabilities. And soon there will be T/Maker II versions available for UNIX,™ RT-11™ and other systems.

Works with words as well as numbers. Like VisiCalc, T/Maker II reduces the manual tasks involved in computing and calculating financial documents. But since most business problems and reports involve words as well as numbers, T/Maker II also functions as a full-screen text editor for word processing.

T/Maker II is the most advanced aid for the analysis and presentation of numerical data and text material. In a matter of minutes, an entire document—including all edited text, all figures and all calculations—can be created, reviewed on your screen and reported in printed form.

T/Maker II turns your small business computer into a powerful, sophisticated and convenient tool. A tool that will save you money, time and energy, and eliminate the need for costly time-sharing.

With T/Maker II you can easily perform an unlimited number of analytical and reporting tasks which integrate numerical and text processing. You'll find T/Maker II perfect for such things as:

- Financial Statements
- Price Lists
- Statistics
- Rate Structures
- Profitability Reports
- Expense Accounts
- Revenue and Expense Analyses
- Cash Flow Projections
- Portfolio Evaluations
- Checking Account Reconciliations

... and much, much more.

Easy to learn and use. You don't have to be a programmer to operate T/Maker II. Just follow T/Maker II's easily understood and ordered instructions, set up your data in

rows and columns, define the relationships and T/Maker II will do the rest: it will perform the computations and formatting necessary to prepare your document. When you're finished you can analyze your report on your screen or store it on a diskette. Or, you can have the report printed with presentation quality.

And when any changes have to be made, simply enter the new figure or relationship and tell T/Maker II to adjust and recalculate all the new results.

Editing capabilities. As a full-screen editor for word processing, T/Maker II handles text up to 255 characters wide. It includes features like text formatting and justification, centered titles, a text buffer for block moves and repeated inserts, global search and replace commands for printing your letters, reports and documents. Wide documents are supported by horizontal scrolling.

Low cost. The cost of T/Maker II is only \$275 plus shipping and handling. Dollars well spent once you consider all the time, energy and money it can save. T/Maker II is brought to you exclusively and supported completely by Lifeboat Associates, world's largest computer software publisher. For more information send us the coupon below.

Mail coupon to: Lifeboat Associates, 1651 Third Ave., NY, NY 10028. Or call (212) 860-0300.

Please send me more information on T/Maker II.

Please send me a free Lifeboat Catalog featuring over 200 programs, including integrated accounting and professional practice systems, office tools for bookkeepers and secretaries and sophisticated tools for programmers.

Name _____
Title _____
Company _____
Street _____
City _____
State _____ Zip _____

T/Maker II is a trademark of P. Roizen. Personal Software, Inc. UNIX is a trademark of Digital Research. CP/M is a trademark of Digital Research. mark of Bell Laboratories. RT-11 is a search, Inc. VisiCalc is a trademark of trademark of Digital Equipment Corp.

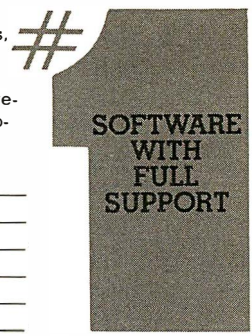

As an example of what T/Maker II can do, see the chart below. The operator entered only the data shown in boldface. T/Maker II calculated and reported all the other values.

	— Actual —		1980	Growth Rate	Average	Total (000's)	— Projected —		
	1978	1979					1981	1982 *	1985
Item A	42,323	51,891	65,123	24.04	53,112	159.34	80,782	100,206	191,262
Item B	45,671	46,128	49,088	3.67	46,962	140.89	50,891	52,761	58,791
Total	87,994	98,019	114,211	13.93	100,075	300.22	131,673	152,966	250,053
% Item	48.10	52.94	57.02	8.88	52.69	158.1	61.35	65.51	76.49
% Item	51.90	47.06	42.98	-9.00	47.31	141.9	38.65	34.49	23.51
Total	100.00	100.00	100.00	—	100.00	300.0	100.00	100.00	100.00

*Two intervening years not shown.

LIFEBOAT WORLDWIDE offers you the world's largest library of software. Contact your nearest dealer or Lifeboat:

Lifeboat Associates
1651 Third Ave.
New York, N.Y. 10028
Tel: (212) 860-0300
Telex: 640693 (LBSOFT NYK)
TWX: 710-581-2524 (LBSOFT NYK)

Lifeboat Inc.
OK Bldg., 5F
1-2-8, Shiba-Daimon
Minato-ku, Tokyo 105, Japan
Tel: 03-437-3901
Telex: 2423296 (LBJTYO)

Lifeboat Associates, Ltd.
PO Box 125
London WC2H 9LJ, England
Tel: 01-836-9028
Telex: 893709 (LBSOFTG)

Lifeboat Associates, GmbH
Hinterbergstrasse
Postfach 251
6330 Cham, Switzerland
Tel: 042/36 8686
Telex: 865265 (MICO CH)

Intersoft GmbH
Schlossgartenweg 5
D-8045 Ismaning, W. Germany
Tel: 089-966-444
Telex: 5213643 (ISOFD)

Lifeboat Associates, SARL
10, Grande Rue Charles de Gaulle
92600 Asnieres, France
Tel: 1-733-08-04
Telex: 250303 (PUBLIC X PARIS)

Copyright © 1981, by Lifeboat Associates

Lifeboat Associates
World's foremost software source

Listing 1 continued:

```

PUSH     PSW                *KEEP STACK STRAIGHT
        CALL     GETDESC    *GET DESCRIPTION ADDRESS
        CALL     STROUT     *PRINT IT
        CALL     CRLF      *NEW LINE
MENEXT   POP     PSW        *RESTORE A
        POP     B          *RESTORE B
        POP     D          *RESTORE D
        INX     B          *INCREMENT CHANNEL NUMBER
        DCR     E          *DECREMENT COUNT
        JNZ     MENULF    *OUTPUT UNTIL DONE
        RET              *ALL DONE

*****
* GET CHANNEL SELECTION
*   ENTRY     NONE
*   EXIT      A=CHANNEL OFFSET(0-15)
*   USES      ALL

CHANIN   SCALL    .SCIN      *GET CHANNEL BYTE
        JC      CHANIN     *LOOP UNTIL READY
        STA     COMMAND    *STORE IT
CHANINI  SCALL    .SCIN      *GET SECOND BYTE
        JC      CHANINI    *LOOP UNTIL READY
        CPI     @AH        *CARRIAGE RETURN?
        JZ     ONLY1      *ONLY ONE INPUT BYTE IF SO
        STA     COMMAND+1  *ELSE STORE IT
        SCALL   .CLRCC     *CLEAR THE BUFFER
        LDA     COMMAND    *GET FIRST BYTE
        CPI     '1'       *ONE?
        JNZ    CHANERR    *ERROR IF NOT
        LDA     COMMAND+1  *FETCH SECOND BYTE
        SBI     '0'       *LESS THAN ZERO?
        JC      CHANERR    *ERROR IF SO
        CPI     7         *MORE THAN 6?
        JNC    CHANERR    *ERROR IF SO
        ADI     @9        *ADD TENS DIGIT OFFSET
        JMP     CHADONE    *ALL DONE
ONLY1    LDA     COMMAND    *GET BYTE
        SBI     '1'       *LESS THAN 1?
        JC      CHANERR    *ERROR IF SO
        CPI     @AH        *MORE THAN 9?
        JNC    CHANERR    *ERROR IF SO
CHADONE  PUSH    PSW        *SAVE CHANNEL NUMBER
        CALL   VALID      *CHANNEL ENABLED?
        JZ     DISAB     *ERROR IF Z CLEAR
        POP    PSW        *RESTORE CHANNEL NUMBER
        RET              *AND RETURN

CHANERR  CALL    $TYPTX
        DB     @AH,@AH,@7H,@1BH
        DB     ' CHANNEL NUMBER INPUT ERROR - HIT RETURN'
        DB     ' TO CONTINUE',@1BH,' '+@8@H

ERRIN    SCALL   .SCIN      *GET INPUT
        JC     ERRIN      *LOOP UNTIL READY
        CPI    @AH        *RETURN?
        JNZ    ERRIN      *LOOP IF NOT
        POP    PSW        *CLEAR THE RETURN ADDRESS

```

Listing 1 continued on page 282

Introducing the fastest processor board
available on the S100 bus today...

The Lightning One™

8086/8087/8089 CPU Board

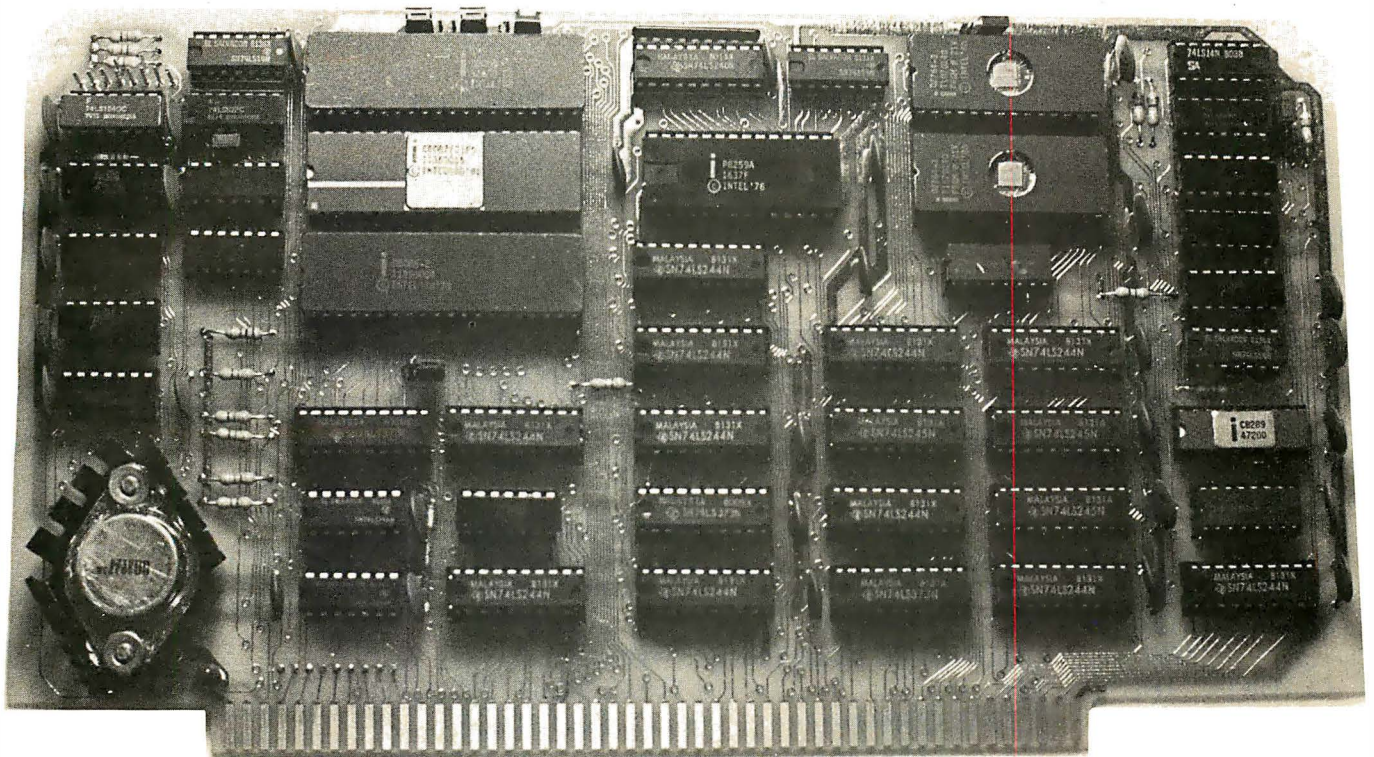

Features:

- 4, 5, 8 or 10 MHz operation jumper selectable
- 8086 or 8088 main processor
- Independent I/O and memory waitstate generator
- Up to 16K bytes of onboard EPROM
- 9 vectored interrupts expandable to 65
- EPROM monitor with diagnostics and disk utilities
- 8087 and 8089 co-processors available onboard
- CP/M-86* and MS-DOS** software support

The *Lightning One*™ contains not one processor, but three processors all working in parallel. It uses the Intel 8086 as the main processor. The math capability is augmented with the 8087 math processor and the I/O handling capabilities are augmented with the 8089 dual channel I/O processor. The board complies with all IEEE-696 specifications.

If you have an 8 bit system presently, don't despair. The *Lightning One* is available with the 8088. The 8088 is fully software compatible with the 8086, but utilizes an 8 bit bus allowing use of your present 8 bit memories. When you are ready to upgrade to full 16 bit operation, you need only to unplug the 8088 and plug in an 8086 in its place. When using an 8088, the 8087 and 8089 may still be utilized.

In addition to the *Lightning One*, Lomas Data Products has a full line of S100 bus support cards including: memory, disk controllers, and serial and parallel I/O.

Prices for the Lightning One start at \$425.

For 16 bit computing on the S100 bus, come to the leader...

LOMAS DATA PRODUCTS

11 Cross Street
Westborough, Massachusetts 01581
Telephone: 617-366-4335

*CP/M-86 is a trademark of Digital Research.

**MS-DOS is a trademark of Microsoft.

Lightning One is a trademark of Lomas Data Products.

Listing 1 continued:

RET *RETURN TO PROG THAT CALLED MENU

* CHECK FOR VALID CHANNEL NUMBER

* ENTRY A=CHANNEL NUMBER
* EXIT 'Z' CLEAR IF DISABLED
* 'Z' .SET IF ENABLED
* USES ALL

VALID CALL GETCHAN *GET CHANNEL ADDRESS BYTE
MOV A,M *LOAD THE CHARACTER
CPI '9' *ENABLED?
RET *AND RETURN

DISAB POP PSW *CLEAR STACK
CALL \$TYPTX
DB 0AH,0AH,07H,01BH
DB 'F THAT CHANNEL IS DISABLED - HIT RETURN'
DB ' TO CONTINUE',01BH,'a'+080H
JMP ERRIN *RETURN TO MAIN PROGRAM

*TITLE PRINT ROUTINE

TITLE CALL \$TYPTX
DB 01BH,045H+080H
LXI H,TITBUF *LOAD BUFFER ADDRESS
TITLOOP MOV A,M *FETCH BYTE
CPI 080H *END OF FILE?
RZ *DONE IF SO
CPI 'X' *X?
JZ REV *REVERSE VIDEO IF SO
SCALL .SCOUT *ELSE OUTPUT THE CHARACTER
JMP TITNXT *AND DO NEXT ONE
REV CALL \$TYPTX
DB 01BH,'F',01BH,'a'+080H
TITNXT INC H *INCREMENT POINTER
JMP TITLOOP *AND CONTINUE

TITBUF EQU *
DB 0AH
DB 0AH

Listing 1 continued on page 284

GET THE LATEST SOFTWARE PRODUCTS NOW...
...CHECK OUT OUR 2020 RANGE

THE FIRST IN A SERIES OF ADVANCED MICROCOMPUTER SOFTWARE PRODUCTS FROM OUR 2020 RANGE IS THE WP2020 WORD PROCESSOR SYSTEM.

DESIGNED FOR THE HEATH/ZENITH Z89 COMPUTER RUNNING UNDER CP/M* 2.2. IT OFFERS MORE FACILITIES THAN MOST OTHER MICROCOMPUTER WP SYSTEMS. CHECK THESE.

- ALL THE STANDARD FEATURES YOU WOULD EXPECT FROM AN ADVANCED WORD PROCESSOR SUCH AS MARGINS, TABS, PAGING, GLOBAL SEARCH AND REPLACE, PROPORTIONAL SPACING ETC.
EASY TO FOLLOW FIRST TIME USER DOCUMENTATION
SPELLING CHECKER AND MERGE DOCUMENT MODULES BUILT IN AS STANDARD NO ADDITIONAL PROGRAMS TO RUN
COMMUNICATIONS MODULE ALLOWS THE SYSTEM TO ACT AS A TERMINAL TO A MAIN FRAME OR LINK UP TO ANOTHER WP2020 SYSTEM
SPECIAL SET OF COLOURED FUNCTION KEYPADS SUPPLIED AS STANDARD
MENU DRIVEN SYSTEM DESIGNED FOR TYPISTS AND SECRETARIES - THERE ARE NO COMPLICATED CONTROL CODES TO REMEMBER
NO CONFIGURATION REQUIRED - PRINTERS DRIVERS ARE ALL BUILT IN - YOU CAN BE PRODUCING REPORTS AND LETTERS WITHIN MINUTES OF INSTALLATION.
SUPPORTS BACKGROUND PRINTING WHILST WORKING ON OTHER DOCUMENTS
HAS ITS OWN FILING SYSTEM WITH DOCUMENT NAMES UP TO 72 CHARACTERS LONG.

OTHER IN SERIES INCLUDE: FP2020 FINANCIAL PLANNER CM2020 CONFIGURABLE MANAGER SPECIFY 8" OR 5 1/4" S/S D 289 WHEN ORDERING. SYSTEM REQUIRES MINIMUM OF 2 DISKS AND 48K MEMORY

*CP/M REGISTERED TM DIGITAL RESEARCH WP2020 REGISTERED TM GRAFFCOM

PRICE: £320.00



CALL US TODAY FOR IMMEDIATE SHIPMENT DEALER ENQUIRIES WELCOME



GRAFFCOM GRAFFCOM SYSTEMS GROUP 102 PORTLAND ROAD LONDON W11 4LX TEL 01-727-5561

Computer Exchange

National Sales Dept. of CUSTOM COMPUTER
P.O. Box 1380, Jacksonville, OR 97530

926

FOR YOUR APPLE II

Apple II +

48K CALL
Disk II W/3.3 DOS CALL
All 48K's are 1981 models with Apple RAM.

APPLE III

Apple Monitor 12" Green \$249 25%

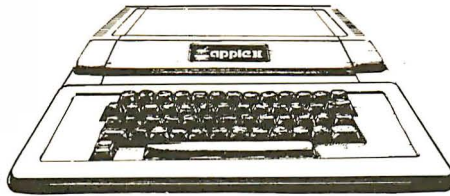

HARDWARE

Disk II and 3.3 Controller CALL SAVE
Disk II only CALL CALL

Direct Substitute for Apple Drives

A2 Drives from Micro-Sci --- Save \$300 on a dual disk system. The A2 does not include DOS software.

Micro-Sci 5" Drives for Apple II

A2, 143KK, 5" Drives \$395 18%
A2 Controller Card for A2 Drive \$85 15%
A 70, 286K, 5" Drive \$489 20%
A 40, 160K, 5" Drive \$369 18%
Controller Card for A70 or A40 \$79 21%

MONITORS:

ATI: 9" B&W \$119 30%
NEC 12" Color \$359 24%
12" Green \$169 22%
SANYO: 9" B&W \$159 32%
NEW 9" green CALL CALL
NEW 12" B&W CALL CALL
NEW 12" Green CALL CALL
13" Color \$399 38%
ZENITH 12" Green \$119 20%

DISKETTES, 5", box of 10:

Apple \$44 21%
Maxell \$39 33%
Memorex \$25 45%

80 COLUMN VIDEO CARDS:

Apple Smarterm \$289 20%
Videx Videoterm \$249 18%
M&R Sup R Term \$319 19%

MISCELLANEOUS:

Apple: Graphics Tablet \$695 13%
1 Yr Extended Warranty \$175 20%
IEEE-488 Card \$339 25%
CCS: Serial Interface Card \$139 22%
Parallel Interface Card \$99 20%
Hayes: Micromodem II \$299 26%
Smartmodem \$249 11%
Keyboard Company: Joystick II \$45 10%
Numeric Keypad \$119 21%
M&R: RF Modulator \$25 27%
SUPR FAN \$39 25%

Microsoft:

Z80 Softcard \$299 33%
16K RAM Card \$159 20%
Mountain: CPS Multifunction Card \$209 13%
Clock/Calendar \$239 15%
Orange Micro Grappler \$129 21%
SSM AIO Serial/Para. Interface \$159 20%

ALS:

Smarterm 80 Col Card \$289 20%
Z-Card (Z-80) \$209 22%
Addram 16K Card \$119 20%
Synergizer Package \$549 27%

PRINTERS:

Apple, Silentype w/Interface \$329 17%

SOFTWARE

Apple: \$149 25%

Apple Fortran \$119 27%
Apple Pilot \$49 30%
Apple Plot \$59 21%
Apple Writer \$49 20%
DOS 3.3 \$59 22%
DOS Tool Kit \$69 28%
Dow Jones News & Quotes \$45 10%
Dow Jones Portfolio Eval. \$379 25%
Language/Pascal System \$189 24%
Microcourier CALL CALL

Broderbund Software:

Central Point Software: \$35 10%
Copy II Plus \$35 10%

Will copy most copy protected software for your backup in 45 seconds! NEW!

Epson, MX 80 Graphics Dump \$7 30%

Hayden, Sargon II (chess) \$29 22%

Info. Unim. Easywriter (PRO) \$199 13%

Insolt:

ALD System II \$110 10%
TransFORTH II \$110 10%
Accounting Software \$365 66%

A full professional quality integrated GL, A/P, A/P, Payroll package. Hotline support available. Send for free sample printouts. Requires Z80 and 16K RAM card.

Micro Pro

Word Star \$239 36%
Super Sort \$129 36%
Mail Merger \$79 36%
Data Star \$189 36%
Spell Star \$159 36%

Microsoft (on disks)

A L D S \$110 10%
BASIC Compiler \$299 25%
Cobol 80 \$559 25%
Fortran 80 \$149 25%
Olympic Decathlon \$24 24%
TASC Compiler \$159 22%
Typing Tutor II \$19 30%
Muse, Super Text II \$109 27%
Peachtree Software CALL CALL

Personal Software:

Desktop Plan II \$159 21%
Visicalc 3.3 \$159 25%
Visiplot \$129 28%
Visitrend Visiplot \$199 31%
Visidex \$159 30%
Visiterm \$109 27%
Visifile \$199 30%

Software Publishing:

PFS Filing/Data Base \$69 28%
PFS Report \$69 28%
Stoneware, DB Master (new version) \$179 22%

Epson

MX80 \$495 36%
MX 80 F/T \$629 20%
MX100 F/T w/graphics \$779 22%
MX 80/100 Apple Interface and Cable \$95 15%
MX 80 Friction feed adapter \$59 22%
MX 80 Graftrax \$79 20%
MX 80/100 Atari Cable \$29 22%
MX 80/100 TRS 80 Cable \$29 22%

Corvus

5 Meg Hard Disk \$2995 21%
10 Meg Hard Disk \$4345 20%
20 Meg Hard Disk \$5245 20%
Omni-Net CALL CALL
Constellation CALL CALL
Mirror CALL CALL
Other Accessories CALL CALL

★ STAR INDICATES SPECIAL VALUE



We are an authorized dealer and repair center and will repair all Apple equipment regardless of where you purchased it, in or out of warranty. Normally our turn-around time on repairs is 24 hours. Call before sending equipment.

Repair Department
(503) 772-4401

NO SALES TAX

For specific software not listed, CALL

TOLL FREE
NATIONAL ORDER DESK
(800) 547-1289



★ Superbrain 64K Double Density

SAVE
60%
\$1995

Superbrain 64K Quad Density \$2895 28%

ATARI® 800 16K
\$759
SAVE 30%

Atari 820 Printer \$249 17%
Atari 810 Disk Drive \$425 29%
Atari 410 Program Recorder \$59 34%
Atari 16K RAM Module \$83 27%
Atari 850 Interface \$149 32%
Atari/Epson Cable \$29 22%
Atari Software CALL CALL



HP-85A Microcomputer with built-in printer and monitor \$2395 27%
HP-125 New! Microcomputer 64K CPU/Terminal/Keyboard/Monitor \$3095 18%

HP-41CV New! 2.2K Memory Calculator \$245 25%
HP-41C Calculator \$185 26%
Memory module for HP41C \$25 25%
Call for other HP equipment, software and accessories!

Above prices for mail orders only. Our store showroom is 126 NE "F" St., Grants Pass, OR. Store prices, which include software service, differ from mail order prices. No mail order sales at store. CALL ORDER DESK.

ORDERING INFORMATION:

Minimum order \$100. Money Orders, Cashier Checks or Bank Wire welcomed. Visa and MC orders add 3%. Personal or company checks are accepted (allow 20 days to clear). Add 3% for shipping, handling and insurance; UPS ground is standard. 6% total for UPS Blue or 10% total for foreign orders or US Parcel Post. Include your telephone number. No COD's. Prices are subject to change without notice. Order desk hours are 8 to 5 PST, 10 to 3 Saturdays.

REFERENCES:

Custom Computer has been an Apple dealer since 1978. Our bank reference is First Interstate Bank (503) 776-5620. We belong to the Chamber of Commerce. (503) 772-6293.

Technical Hotline
(503) 772-3803

(CUSTOMERS ONLY-PLEASE
HAVE INVOICE # OR
PACKING SLIP #)

Oregon Order Desk
(503) 772-3803



Listing 1 continued:

DB 0AH
 DB /
 DB /XXXX /XXXX /XXXXXXXXXXXX /XXXXXXXXXXXX, 0AH
 DB /XXXX /XXXX /XXXXXXXXXXXX /XXXXXXXXXXXX, 0AH
 DB /XXXX /XXXX /XXXX /XXXX /XXXX, 0AH
 DB /XXXX /XXXX /XXXX /XXXX /XXXX, 0AH
 DB /XXXXXXXXXXXXXXXXXXXX /XXXX /XXXXXXXXXXXX, 0AH
 DB /XXXXXXXXXXXXXXXXXXXX /XXXX /XXXXXXXXXXXX, 0AH
 DB /XXXX /XXXX /XXXX /XXXX, 0AH
 DB /XXXX /XXXX /XXXX /XXXX, 0AH
 DB /XXXX /XXXX /XXXXXXXXXXXX /XXXX, 0AH
 DB /XXXX /XXXX /XXXX /XXXX, 0AH
 DB /XXXX /XXXX /XXXXXXXXXXXX /XXXX, 0AH
 DB /XXXX /XXXX /XXXX /XXXX, 0AH
 DB 0AH
 DB 0AH
 DB 0AH
 DB /
 DB /
 DB BSR HOME CONTROL PACKAGE, 0AH
 DB 0AH

Listing 1 continued on page 286

NOW!

V.I.P.'s Call A.E.I.

V.I.P.'s call A.E.I. because A.E.I. tests before shipping, has expertise on all items offered, and is price competitive.



TELEVIDEO COMPUTER

	List	Sell
System 1 Computer	3995	2650
System 2 Computer	8995	CALL
System 3 Computer	19995	CALL
TS-80 user station	1795	1450



TELEVIDEO TERMINALS

	List	Sell
910 Terminal	699	575
912C Terminal	925	659
920C Terminal	995	725
950 Terminal	1195	900



NEC PRINTERS

	List	Sell
3510-1 30CPS Serial	2450	2050
7710-1 55CPS SERIAL	CALL	CALL
7720-1 KSR Serial	CALL	CALL
5510-1 55CPS Serial	3055	2495
5520-1 KSR Serial	3415	2895



NORTHSTAR HORIZON COMPUTERS

	List	Sell
HR2-2D-64K	4195	2849
HR2-2Q-64K	4495	3149
HR2-1Q-64K-HD5	6695	4999
HR2-1Q-64K-HD18	9270	6749
HDS-18 Hard Disc	5374	3690



NORTHSTAR SOFTWARE

	List	Sell
Northward D/O	399	295
Mailmanager D/O	299	235
Info manager D/O	499	365
General Ledger D/O	999	795
A/P D/O	599	475



TEXAS INSTRUMENTS PRINTERS

	List	Sell
TI-810 BASIC	1645	1398
TI-810 Full ASCII	1745	1479
TI-810 Package	1945	1649
TI-820 R/O BASIC	1995	1625
TI-820 KSR Package	2395	1950



NORTHSTAR ADVANTAGE COMPUTER

	List	Sell
ADV-2Q-64K	3995	CALL
SIO Board	175	CALL
PIO Board	200	CALL
FPB Board	399	CALL
Graphics Option	299	CALL



SYSTEMS GROUP

	List	Sell
2800 Computer	5035	3595
DM-6400 Memory	760	585
DMB-6400 Memory	995	735
CPC-2813 CPU-I/O	460	365
FDC-2801 Controller	465	370



QUME PRINTERS

	List	Sell
Sprint 9 35CPS R/O	1995	1700
Sprint 9 45CPS R/O	2300	2000
Sprint 9 55CPS R/O	2400	2050
Full Control Option	155	150
Memory Option	150	150



MORROW DECISION COMPUTER

	List	Sell
Decision 1 BASIC	1725	1350
Decision 2	CALL	CALL
65K Static Ram	1000	780
Switchboard I/O	259	210

Select drives from Morrow disc systems for desired configuration



MORROW DISC SYSTEMS

	List	Sell
Discus 2D 1 Drive	1095	849
Discus 2D 2 Drive	1875	1389
Discus 2 + 2 1 Drive	1395	1075
Discus 2 + 2 2 Drive	2495	1859
M26 Hard Disc	4495	3395

CP/M & Microsoft Basic Included



MODEMS

	List	Sell
Cat Modem	189	140
D-Cat	199	150
Auto-Cat	249	190
Apple-Cat	389	310
DC Hayes Micro-100	379	330



ZENITH DATA SYSTEMS

	List	Sell
VM-121 Green Monitor	160	CALL
Z-19 Terminal	995	CALL
Z-89 Computer	2895	CALL
Z-90 Computer	3195	CALL

—Call for Accessory Pricing—
Peachtree Software Available



MICROPRO SOFTWARE

	List	Sell
Wordstar	495	300
Apple Wordstar	375	275
Spellstar	250	190
Mailmerge	150	100
Datatar	350	250
Supersort	250	190



DISCS—CABLES

	List	Sell
Memorex 5" 1D	47	27
Memorex 5" 2D	55	36
Memorex 8" 1D	65	40
Memorex 8" 2D	70	45
RS-232 5' Cable	30	20
RS-232 10' Cable	40	25

—SEE THESE PRODUCTS AND MORE IN OUR SHOWROOM—
 PRICES CHANGE DAILY—CALL OR VISIT FOR CURRENT PRICING



AUTOMATED EQUIPMENT, INC.
 18430 WARD STREET, FOUNTAIN VALLEY, CALIFORNIA 92708

(714) 963-1414
 (800) 854-7635

DEALERS: By now you know that it takes

SOFTWARE TO SELL COMPUTERS

and International Micro Systems can provide you with the largest selection of quality business applications ever developed for the microcomputer industry.

If you are just looking for a G.L., A/P, and Payroll, you can find them in a dozen ads in this magazine. But there's a much bigger market for micros out there than that. Where can you find a fully interfaced Wholesale/Retail Distribution System? How about Manufacturing Inventory Control including Production Scheduling & Control. See that one anywhere else? Maybe your market is Medical/Dental and IMS has the full systems there too. You can't sell computers without software and IMS has the finest selection of software available for you. Each system has been developed by the IMS professional staff and we support what we sell.

But that's not all. International Micro Systems has the strongest dealer marketing plan in the industry. With our

\$295 Dealer Demo System.

we put all the software shown below in your office or store ready to demo to your prospects and we include the promotional material and our unique video sales presentation to help you move systems. Give us a call or drop us a card and let us show you what selling business systems should be all about.

Financial Systems

- GL, A/P, A/R
- Payroll
- Cash Receipts/Disb.
- Job Costing
- Mailing List Mgmt.

Medical/Dental

- Office Scheduler
- Patient Billing & A/R
- Insurance Forms

Governmental/Educational

- Student Record Keeping and Scheduling
- Fund Accounting

Wholesale Distribution System

- Purchasing & Receiving
- Inventory Control
- Invoicing & Receivables
- Salesman Comm. Reporting
- Backorder Management

Manufacturing Inventory Control

- Finished Goods Inventory Mgmt.
- Parts Inventory Mgmt.
- Parts Purchasing & Receiving
- Bill of Material
- Production Scheduling

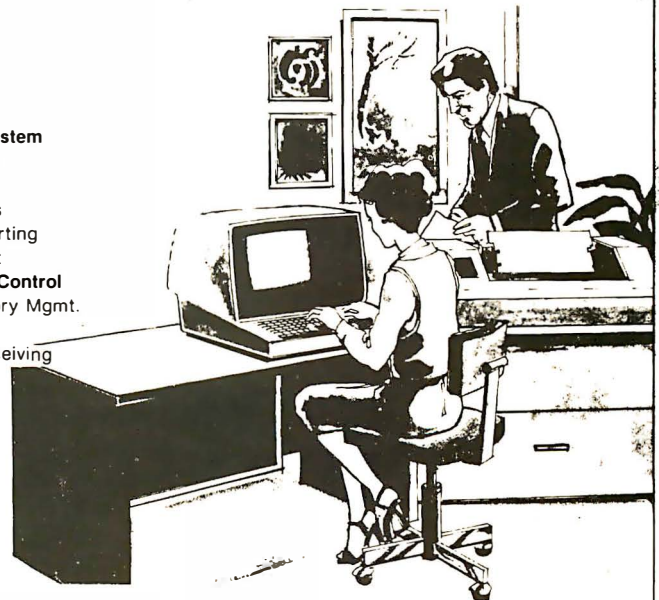

INTERNATIONAL
MICRO
SYSTEMS

For details on our Demo Special, contact us at:
6445 Metcalf, Shawnee Mission, KS 66202
Phone: (913) 677-1137

Listing 1 continued:

```
DB 0AH
DB /
DB /
DB /
DB /
DB /
DB /
DB /

DB 'Initializing Remote Control Units.....'
DB 000H
```

```
*****
*          DEFINE COMMAND CODES          *
*
*   CODES ARE SET UP SO THAT THE FIRST FIVE MOST SIGNIFICANT *
*   BITS REPRESENT THE BINARY CODE FOR THAT CHANNEL. REMEMBER *
*   THAT TO SEND A COMMAND FIRST SEND A LOGIC ONE, THEN THE *
*   FIVE BIT CHANNEL CODE, THE FIVE BIT CHANNEL CODE INVERTED, *
*   AND LASTLY, THE END OF MESSAGE SIGNAL FOR A TOTAL OF *
*   TWELVE BITS. *
*****
* CHANNEL NUMBER DEFINITIONS *
*
```

```
ONE      DB      01100000B
TWO      DB      11100000B
THREE    DB      00100000B
FOUR     DB      10100000B
FIVE     DB      00010000B
SIX      DB      10010000B
SEVEN    DB      01010000B
EIGHT    DB      11010000B
NINE     DB      01110000B
TEN      DB      11110000B
ELEVEN   DB      00110000B
TWELVE   DB      10110000B
THIRTY   DB      00000000B
FOURTY   DB      10000000B
FIFTY    DB      01000000B
SIXTY    DB      11000000B
```

```
*****
* FUNCTION CODES
```

```
ALLOFF   DB      00001000B
ALLON    DB      00011000B
ON       DB      00101000B
OFF      DB      00111000B
DIM      DB      01001000B
BRIGHT   DB      01011000B
```

```
*****
* STORAGE REGISTERS
```

```
COMMAND DS      2
```

Listing 1 continued on page 288

More performance than you ever imagined — for \$1995. If you're considering a DEC® terminal, C. Itoh now has two reliable alternatives that could easily change your mind.

Take our 132-column CIT 101, for example. Unlike DEC's VT100®, it includes full AVO performance — as standard equipment. You also get a 96 ASCII character set, plus 128 special characters. Characters may appear single-width and double-width, double-height. Reverse video, blinking, half-intensity and underscore may be used in up to 16 combinations. The cursor may be underline or block, blinking or non-blinking, or invisible to the viewer — all under computer control. There's

raster graphics too. And 19.2K Baud asynchronous communications. Human engineered features include a non-glare screen and detached selectric-type keyboard. Of course, if all you need is 80-column capability, have we got a terminal for you.

The \$1195 80-column terminal that performs like a 132. It's C. Itoh's CIT 80, the DEC VT52® emulator that's packed with features many big-ticket terminals don't offer. Things like smooth scrolling, soft setup mode, line drawing graphics and unidirectional RS 232-C printer port. A 19.2K Baud main port features X/ON-X/OFF protocol as well as full and half-duplex in conversation mode. Video attributes include

blinking, underline, half-intensity—even reverse video. You get CIT 101-type human engineered features too. Plus socketed firmware for maximum OEM flexibility.

Both terminals are backed by our 90-day warranty, fully field supported and ready for immediate shipment. So if you're thinking of getting a DEC terminal, consider the alternatives: CIT 80 and CIT 101.

For full details, contact our exclusive representative, ACRO Corporation, 18003-L Skypark South, Irvine, CA 92714. (714) 557-5118.

 **C. ITOH
ELECTRONICS, INC.**
One world of quality.

Before you order a VT100, think twice.

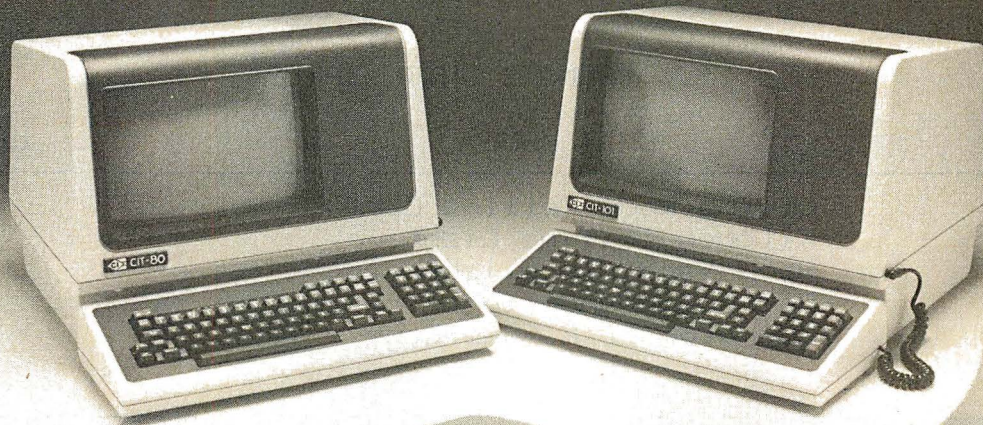

Listing 1 continued:

```
DEFLT   DB      'SY1ABS'  
UNITNAM DB      'SY1:UNITDEF.DAT'.B  
UNITEUF DS      1280  
UNITLOC DS      32
```

END BEGIN

```
00981 Statements Assembled  
8966 Bytes Free  
No Errors Detected
```

SAMPLE PROGRAM RUN

>RUN HCP

Initializing Remote Control Units.....

REMOTE UNIT STATUS

UNIT	UNIT NAME	LEVEL	STATUS
1	Living Room Ceiling Lamp	9	OFF
2	Kitchen Ceiling Light	9	OFF
3	Back Yard Floodlights	1	OFF
4	Bedroom Chandelier	4	ON
5	Computer Desk Swag Lamp	9	ON

Listing 1 continued on page 290

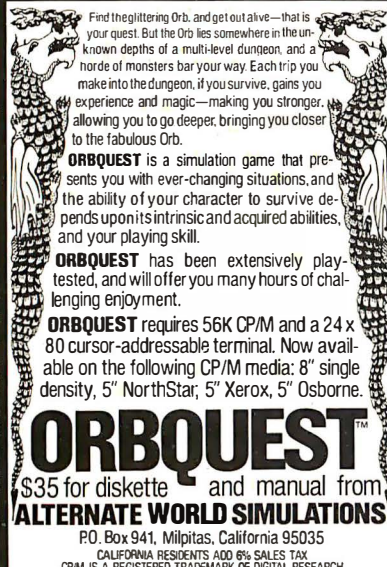

Find the glittering Orb, and get out alive—that is your quest. But the Orb lies somewhere in the unknown depths of a multi-level dungeon, and a horde of monsters bar your way. Each trip you make into the dungeon, if you survive, gains you experience and magic—making you stronger, allowing you to go deeper, bringing you closer to the fabulous Orb.

ORBQUEST is a simulation game that presents you with ever-changing situations, and the ability of your character to survive depends upon its intrinsic and acquired abilities, and your playing skill.

ORBQUEST has been extensively play-tested, and will offer you many hours of challenging enjoyment.

ORBQUEST requires 56K CP/M and a 24 x 80 cursor-addressable terminal. Now available on the following CP/M media: 8" single density, 5" NorthStar, 5" Xerox, 5" Osborne.

ORBQUEST™

\$35 for diskette and manual from
ALTERNATE WORLD SIMULATIONS
P.O. Box 941, Milpitas, California 95035
CALIFORNIA RESIDENTS ADD 6% SALES TAX
CP/M IS A REGISTERED TRADEMARK OF DIGITAL RESEARCH

COMPUTER CASSETTES

LENGTH	10 PACK	100 PACK
C-10	7.00	63.00
C-20	8.50	77.00
C-60	12.00	108.00
C-90	15.00	135.00

CASSETTE DUPLICATION

Software Duplication for TRS-80, Apple & Atari. Hayes Smart-Modem at \$249.00. Televideo Computers—call. For info call (305) 423-0338.

ACTS AUDIO, INC.
70 Illiana Ave
Orlando FL 32806

JOE COMPUTER PRESENTS WORD GRINDER

80,000 WORDS!

WORD GRINDER IS A DATA BASE OF OVER 80,000 ENGLISH WORDS IN ALPHABETICAL ORDER WITH SPACES DELIMITING EACH WORD. THE TRS-80† AND APPLE VERSIONS INCLUDE A BASIC EDITOR FOR DISPLAYING OR EDITING THE DATA FILES USING RANDOM ACCESS. WORD GRINDER IS AVAILABLE FOR TRS-80 MODEL I, II, OR III, APPLE CP/M, RT-11/HT-11 OR ANSI TAPES PRODUCED ON A PDP-11. PRICES START AT \$89.95 FOR MODEL I, III OR APPLE. \$124.95 FOR MODEL II, CP/M, RT-11 OR ANSI TAPES.

MAKE CHECKS PAYABLE TO:
JOE COMPUTER — PHONE ORDERS AND INFORMATION: (213) 992-0514 SEND TO: JOE COMPUTER, 22713 VENTURA BLVD., SUITE F, WOODLAND HILLS, CA. 91364

CALIF. RESIDENTS ADD 6% SALES TAX.
†TRS-80 IS A TRADEMARK OF TANDY CORP.

Circle 9 on inquiry card.

Circle 199 on inquiry card.

BETA COMPUTER DEVICES

AVAILABLE NOW ... SYSTEM 2800 FROM SYSTEMS GROUP

FEATURES

- IEEE S-100 Bus Compatible Systems, Z80A Based
- Two 8-Inch Drives: Single or Double Sided, Double Density Floppy Disk Drives or 10MB Winchester Hard Disk Drive
- 20MB Winchester and Tape Backup
- 8-Slot Shielded and Terminated Motherboard
- System Software Selection includes CP/M*, MP/M* or OASIS**
- Single-User or Multi-User Systems, Expandable to 6 Users
- Table Top or Rack Mountable
- Two Switched AC Outlets on Rear Panel
- One Year Warranty on Entire System

2812 CP/M, 2 Single Sided Floppies.....	\$3775.00
2814 CP/M, 2 Double Sided Floppies.....	4425.00
2819 CP/M, 1 10 MB Winchester & 1 Double Sided Floppy.....	6675.00
2824 MP/M, 2 Double Sided Floppies....	5235.00
2829 MP/M, 1 10 MB Winchester & 1 Doubled Sided Floppy.....	7500.00

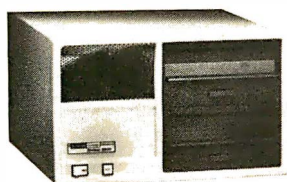

Model 2812/14/24



Model 2819/29

S-100 PRODUCTS

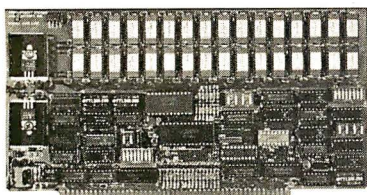

QUALITY RAM FROM SYSTEMS GROUP

- Z-80 4MHZ operation with no wait states
 - IEEE compatible timing - 200 NS 4116's
 - Factory assembled, tested & burned in
- | | |
|---------------------------------------|-----------|
| DMB6400 64K (Bank Select, shown)..... | \$ 740.00 |
| DM6400 64K..... | 540.00 |
| DM4800 48K..... | 510.00 |
| DM3200 32K..... | 475.00 |

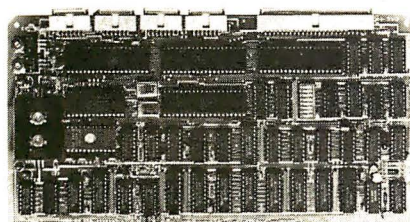

CONFIGURE A COMPLETE S-100 SYSTEM WITH 2nd GENERATION* PRODUCTS FROM SYSTEMS GROUP.

- CPC 2810 (shown) Z-80A processor board (4MHZ) with 4 serial & 2 parallel ports.....\$369.00
- CPC2813 - same as CPC2810 but 2 serial ports only.....\$345.00
- FDC2801/8 - 8" floppy disk controller board, up to 4 single/double sided drives, single or double density.....\$349.00
- INO-2804 - 4 channel serial I/O..... 329.00
- CRA-100 - Cromix* adaptor board.. \$55.00

CALL US FOR OUR MOST CURRENT PRICES!

*2nd Generation is a trademark of Measurement Systems and Controls, Inc. Cromix is a trademark of Cromemco, Inc. CP/M and MP/M are trademarks of Digital Research. OASIS is a trademark of Phase One Systems.

PAPER TIGER PRINTERS

IDS 460G 9x9 Dot Matrix Printer.....	\$890.00
IDS 560G Wide Carriage Printer.....	1099.00

TERMINALS

ADDS Viewpoint	\$569.00
TeleVideo 910	579.00
TeleVideo 912C	679.00
TeleVideo 920C	729.00
TeleVideo 950	929.00

8" DISK DRIVES

Shugart 801R.....	\$399.00
NEC FD1160 (double sided).....	525.00

DYNAMIC RAMS

4116 (200ns)	set of 8	\$24.00
4164 (64Kx1)		\$18.00

wabash[®]

8" or 5 1/4" flexible diskettes certified 100% error free with manufacturer's 5-year limited warranty on all 8" media. Soft-sectored in boxes of 10. 5 1/4" available in 10-sector.

(Add \$3.00 for plastic library cases)

8" single sided, single density.....	\$27.50
8" single sided, double density.....	35.50
8" double sided, double density.....	45.50
5 1/4" single sided, single density.....	27.50
5 1/4" single sided, double density.....	29.50

TERMS: Minimum order \$15.00. Minimum shipping and handling \$3.00. Calif. residents add 6% sales tax. Cash, checks, Mastercard, Visa and purchase orders from qualified firms are accepted. (Please allow two weeks for personal checks to clear before shipment.) Product availability and pricing subject to change without notice.

INTERNATIONAL ORDERS: Add 15% to purchase price for all orders. Minimum shipping charge is \$20.00. Orders with insufficient funds will be delayed. Excess funds will be returned with your order. All prices are U.S. only.

6502 PRODUCTS

6502DM

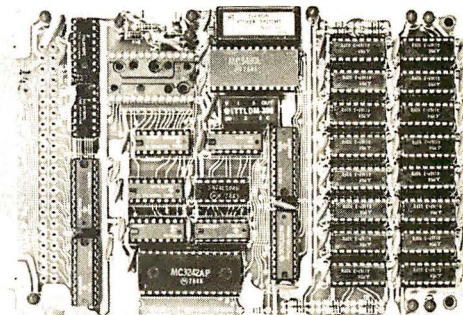

BETA 32K BYTE EXPANDABLE RAM FOR 6502 AND 6800 SYSTEMS

- AIM 65 KIM SYM PET S44-BUS
 - Plug compatible with the AIM-65/SYM expansion connector by using a right angle connector (supplied).
 - Memory board edge connector plugs into the 6800 S44 bus.
 - Connects to PET using an adaptor cable.
 - Uses +5V only, supplied from the host computer.
 - Full documentation. Assembled and tested boards are guaranteed for one full year. Purchase price is fully refundable if board is returned undamaged within 14 days.
- | | |
|-----------------------------|----------|
| Assembled with 32K RAM..... | \$349.00 |
| & Tested with 16K RAM..... | 329.00 |
- Bare board, manual & 6 hard-to-get parts. 99.00
PET interface kit. Connects the 32K RAM board to a 4K or 8K PET.....\$ 69.00

AIM Professional Enclosure...\$175.00

BETA COMPUTER DEVICES

1230 W. COLLINS AVE.
ORANGE, CA 92668
(714) 633-7280



Listing 1 continued:

Hit Return For Command Menu @

MANUAL CONTROL MENU

Commands Available:

- 0..... Exit Program
- 1..... All Units Off
- 2..... All Units On
- 3..... Single Unit Off
- 4..... Single Unit On
- 5..... Single Unit Brightness Adjust
- 6..... Return To Status Display

Enter Number of Choice 5

CHANNEL SELECTION MENU

- 1..... Living Room Ceiling Lamp
- 2..... Kitchen Ceiling Light
- 3..... Back Yard Floodlight
- 4..... Bedroom Chandelier
- 5..... Computer Desk Swag Lamp

Number of unit on which to adjust brightness? 5

Brightness Level (0=Dim, 9=Bright)? 5

REMOTE UNIT STATUS

UNIT	UNIT NAME	LEVEL	STATUS
1	Living Room Ceiling Lamp	9	OFF
2	Kitchen Ceiling Light	9	OFF
3	Back Yard Floodlights	1	OFF
4	Bedroom Chandelier	4	ON
5	Computer Desk Swag Lamp	5	ON

Hit Return For Command Menu @

Listing 1 continued on page 292

ALL YOU DO IS PLUG IT IN!

SYSTEMS FROM
\$3,775

A SIGMA SYSTEM is COMPLETE:

Computer, terminals, printers, interfaces, operating system, manuals and documentation, etc. *All you do is plug it in.*

A SIGMA SYSTEM WORKS:

It is assembled, tested, burned-in, tested, configured, tested, burned-in again, and retested. *All you do is plug it in.*

A SIGMA SYSTEM is FLEXIBLE:

Each system is configured for an exact need, be it a 64K stand-alone with a

small matrix printer or a 512K multi-user, multi-processor with several 600LPM line printers—or anything in between. *All you do is plug it in.*

A SIGMA SYSTEM is EXPANDABLE:

Each system is designed to grow with your customer's needs. Usually only an additional board is required for expansion. *All you do is plug it in.*

A SIGMA SYSTEM is SUPPORTED:

SIGMA's Engineering Depart-

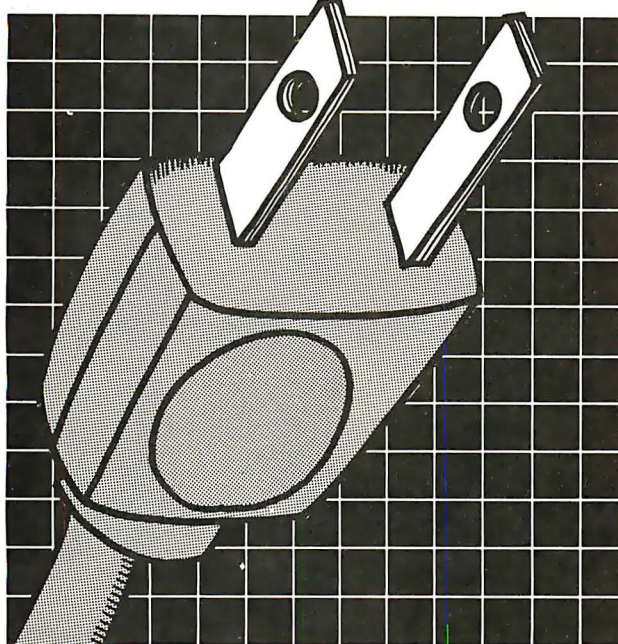

ment provides technical support, parts and training, while the SIGMA Marketing Department offers in-market sales and marketing support. We design our dealer/agency program to fit your needs.

Below are 4 of more than 80 fully integrated systems:

SIGMA SYSTEM I

A single user stand-alone system: • 64K RAM • 2 x 5¼" QD Floppy Drives (700KB) • 12" CRT with full ASCII Keyboard • Printer-100 cps (data processing) and 50 cps (letter quality) plus graphics capability • CP/M Operating System • Fully integrated and tested • Expandable
Total Price: \$3,775

SIGMA SYSTEM II

A multi-user (2) system: • 64K RAM per user • 5¼" Floppy Drive (500KB) • 5MB Hard Disk Drive • 2 CRT

Terminals with detachable keyboards • High speed 180 cps printer • MP/M Operating System • Fully integrated and tested • Expandable
Total Price: \$8,675

SIGMA SYSTEM III

A four user (4) system: • 64K RAM per user • 2 x 8" Floppy Disk Drives (1.2MB) • 11MB Hard Disk Drive • 4 CRT's with detachable keyboards • Printer—200 cps (data mode), 60 cps (letter quality mode) plus graphics • MP/M Operating System • Fully integrated and tested • Expandable
Total Price: \$14,459

SIGMA SYSTEM IV

An eight user (8) multi-processing system: • 512K RAM • 8" Floppy Disk Drive (1.2MB) • 18MB Hard Disk Drive • 8 CRT's with detachable keyboards • Printer—180 cps data printer • Printer—55 cps letter quality • CP/M compatible multi-user system • Data Base Management System • Fully integrated and tested • Expandable up to 16 users
Total Price: \$32,997

(The above systems include charge for integration. If integration is not desired, please inquire about additional discounts.)

U.S. Domestic/Canada
Sigma Digital Systems, Inc.
609 N. Scottsdale Road
Scottsdale, Arizona 85257
Telephone: (602) 941-4087

Sigma

SINTEL COMPANIES

DEALERSHIPS/AGENCIES AVAILABLE IN SELECTED AREAS
"PLUG INTO SIGMA'S DISTRIBUTION NETWORK"

Circle 335 on inquiry card.

International
Sigma International Trading Corp.
P.O. Box 1118
Scottsdale, Arizona 85252
Telephone: (602) 994-3435
Telex: 165-745 SIGMA

MANUAL CONTROL MENU

Commands Available:

- 0..... Exit Program
- 1..... All Units Off
- 2..... All Units On
- 3..... Single Unit Off
- 4..... Single Unit On
- 5..... Single Unit Brightness Adjust
- 6..... Return To Status Display

Enter Number of Choice 0

Listing 2: An example of the contents of UNITDEF.DAT. This file controls the status of the remote-control units and defines the remote names for the main program menu.routines. Note that all of the 16 channels must be defined even though 11 are disabled by setting the second and third columns to 99.

```

09 1Living Room Ceiling Lamp
09 2Kitchen Ceiling Light
01 3Back Yard Floodlights
14 4Bedroom Chandelier
19 5Computer Desk Swag Lamp
01 96
09 97
09 98
09 99
09 90
09 91
09 92
09 93
09 94
09 95
09 96
    
```

MULTIPLE FREQUENCY CLOCK GENERATOR MODEL II

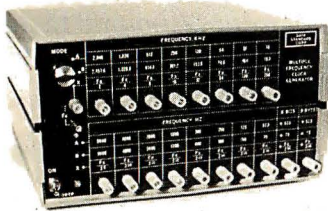

- Completely stand-alone operation or use with external synthesizer
- Internal crystal oscillator provides 16 clock frequencies simultaneously
- Single control selects data rate series
 - A. 75 x 2^N bps (North American)
 - B. 1000 x 2^N bps (European and Military)
- External mode provides 2^N division of any frequency up to 25 MHz. (For N = 0-16 and N = 19,22)
- Square wave output signals—TTL Levels (0,+5V)
- Simple to use! Turn it on and select: Mode A, Mode B or External.
- The only low cost multiple-frequency clock synthesizer available!

THE DATA STANDARD CORP
10000 WILSON AVENUE SEMINOLE, FLORIDA 33542
(813) 586-4827

Circle 115 on inquiry card.

SCR SUPER-BUYS

\$10.00 MIN. ORDER HANDLING/SHIPPING...\$5.00
UPS ANYWHERE IN CONTINENTAL U.S.

- ① UHF-VHF CONVERSION KIT. Complete with PC board; all required components; jumper wire; cabinet with speaker; and comprehensive brochure incl. schematic, board layout, mounting and hook-up diagrams, parts list, and assembly and set-up instructions. All parts are industrial prime quality. \$11995 ea.
- ② NEW ZENITH ZVM-121 HIGH-LEGIBILITY CRT MONITOR. Features 12" green phosphor CRT, with 15 MHz Bandwidth. 40 or 80 character widths are operator switch-selectable. Fully compatible with 80-column Apple cards, etc. \$11795 ea.
- ③ CROMEMCO COMPUTER CARDS "ACROSS-THE-BOARD." For better prices, quickest deliveries, and the most comprehensive follow-up support services — your best source is SCR, everytime!

SCR ELECTRONICS INC. (714) 527-2554 • (213) 598-7553
9533 Valley View Street, Cypress, CA 90630
Pay by CHECK, M.O., VISA, M/C, C.O.D.
For Free Buyers Guide Circle Number Shown Below

Circle 332 on inquiry card.

Verbatim®

Floppy Discs

SAVE 40% Write for our complete list.

	Price/10
5 1/4" Specify soft, 10 or 16 sector	
MD525 1 side/dbl dens	\$27.30
MD550 2 sides/dbl dens	44.20
MD577 1 side/77 track	32.50
MD557 2 sides/77 track	44.20
8" Critically Certified Soft sector	
FD34-9000 1 slide/sgl dens	33.80
FD34-8000 1 slide/dbl dens	39.00
FD34-4001 2 slide/dbl dens	46.20

CHECKS — VISA — MC — C.O.D.
(313) 777-7780 ADD \$2 SHIPPING

LYBEN COMPUTER SYSTEMS
27204 Harper Ave.
St. Clair Shores, MI 48081

Circle 216 on inquiry card.

BOY, IS THIS COSTING YOU.

It's really quite basic: time is money.

And BASIC takes a lot more time and costs a lot more money than it should every time you write a new business software package.

Especially when you could speed things up with dBASE II.

dBASE II is a complete applications development package.

Users tell us they've cut the amount of code they write by up to 80% with dBASE II.

Because dBASE II is the high performance relational database management system for micros.

Database and file handling operations are done automatically, so you don't get involved with sets, lists, pointers, or even opening and closing of files.

Instead, you write your code in concepts.

And solve your customers' problems faster and for a lot less than with BASIC (or FORTRAN, COBOL or PL/I).

dBASE II uses English-like commands.

dBASE II uses a structured language to put you in full control of your data handling operations.

It has screen handling facilities for setting up input and output forms.

It has a built-in query facility, including multi-key and sub-field searches, so you can DISPLAY some or all of the data for any conditions you want to apply.

You can UPDATE, MODIFY and REPLACE entire databases or individual characters.

CREATE new databases in minutes, or JOIN databases that already exist.

APPEND new data almost instantly, whether the file has 10 records or tens of thousands.

SORT the data on as many keys as you want. Or INDEX it instead, then FIND whatever you're looking for in seconds, even using floppies.

Organize months worth of data in minutes with the built-in REPORT. Or control every row and column on your CRT and your printer, to format input and output exactly the way you want it.

You can do automatic calculations on fields,

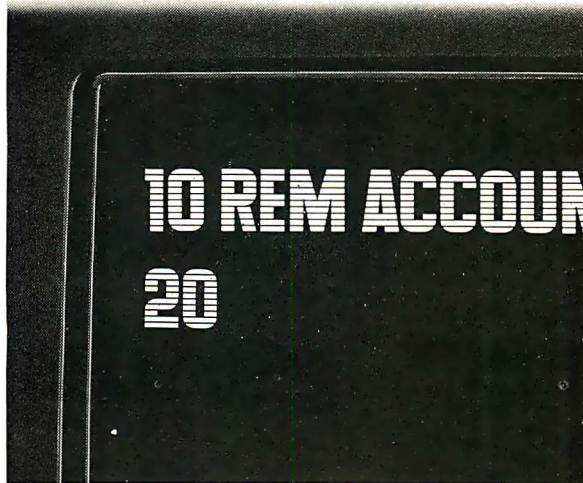

records and entire databases with a few keystrokes, with accuracy to 10 places.

Change your data or your entire database structure without re-entering all your data.

And after you're finished, you can protect all that elegant code with our run-time compiler.

Expand your clientbase with dBASE II.

With dBASE II, you'll write programs a lot faster and a lot more efficiently. You'll be able to write more programs for more clients. Even take on the smaller jobs that were out of the economic question before. Those nice little foot-in-the-database assignments that grow into bigger and better bottom lines.

Your competitors know of this offer.

The price of dBASE II is \$700 but you can try it free for 30 days.

Call for our Dealer Plan and OEM run-time package prices, then take us up on our money-back guarantee. Send us your check and we'll send you a copy of dBASE II that you can exercise on your CP/M system any way you want for 30 days.

Then send dBASE II back and we'll return all of your money, no questions asked.

During that 30 days, you can find out exactly how much dBASE II can save you, and how much more it lets you do.

But it's only fair to warn you: business programmers don't go back to BASIC's.

Ashton-Tate, 9929 Jefferson, Los Angeles, CA 90230. (213) 204-5570.

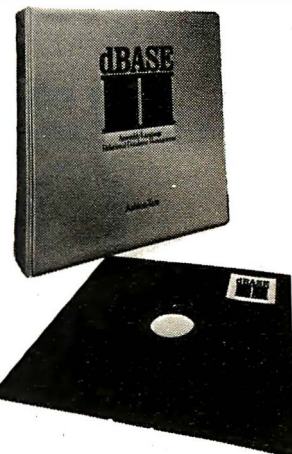

Ashton-Tate

©Ashton-Tate 1981



**BRING IN THE
NEW YEAR!**



**LOOK CLOSELY AT
THESE SUPER
SAVINGS!!**

**Ω OMEGA
SALES CO.**

• We
Accept
C.O.D.'s • Stock
Shipments Same Day
or Next • No Surcharge
For Credit Cards • All Equipment
Factory Fresh w/MFT Warranty • We
Carry the Complete Line of Personal
Software

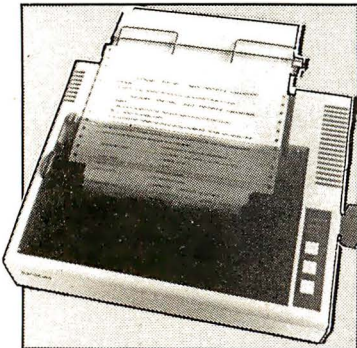

EPSON MX-80

\$ 469

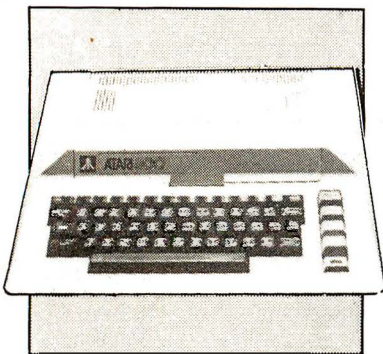

ATARI 800 16K

\$ 749

**EAST COAST
1-800-556-7586**



**WEST COAST
1-800-235-3581**

PRICES ARE SUBJECT TO CHANGE
W/O NOTICE.

SAVINGS!

**AMAZING
SPECIALS!**



**NEC Color Monitor
JC 1201 \$319**

INTERTEC SUPERBRAIN 64K RAM	\$2799
QD SUPERBRAIN	\$2999
NEC 5510 SPINWRITER (7710)	\$2345
NEC 5520 SPINWRITER (7720)	\$2695
NEC 5530 SPINWRITER (7730)	\$2345
NEC 12" MONITOR	\$ 189
NEC COLOR 12" MONITOR	\$ 339
NEC PC 8023 Printer	
100 CPS Tractor & Friction	\$ 639
OKIDATA MICROLINE-80	\$ 379
OKIDATA MICROLINE-82A	\$ 529
OKIDATA MICROLINE-83A	\$ 749
DIABLO 630	\$1995
APPLE II PLUS 48K	\$1139
APPLE DISK w/3.3 DOS Controller	\$ 525
APPLE DISK w/o Controller	\$ 449
EPSON MX-80	\$ 469
Interfaces:	
IEEE \$55, TRS-80 CABLE \$35,	
APPLE INTERFACE & CABLE \$90,	
RS-232 \$70	
HAZELTINE 1420	\$ 799
NORTHSTAR HORIZON II 32K QD	\$2925
ANADEX DP-9500/9501	\$1199
TELEVIDEO 912C	\$ 699
TELEVIDEO 920C	\$ 729
TELEVIDEO 950	\$ 929

**WE CARRY THE COMPLETE LINE OF ATARI SOFTWARE,
PERIPHERALS AND ACCESSORIES.**

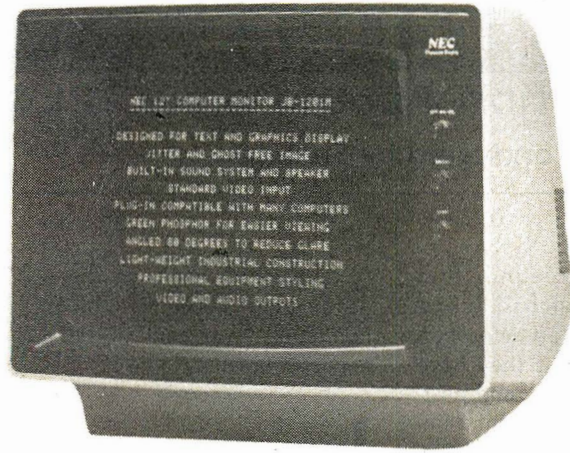

**NEC Green 12 Inch Monitor
JB 1201 \$179**

**NEC Friction Tractor Printer
100 CPS (Graphics, Bi-directional) \$635**

CBM 8032 COMPUTER	\$1149
CBM 8050 DISK DRIVE	\$1349
CBM 4032 COMPUTER	\$1029
CBM 4040 DISK DRIVE	\$1029
CBM 4022	\$ 649
CBM VIC-20	\$ 269
LEEDEX/AMDEK 100	\$ 139
LEEDEX/AMDEK 100G	\$ 169
LEEDEX/AMDEK COLOR-1 13" Color Monitor	\$ 329
MICROTEK 16K RAM BOARD for Atari	\$ 79
MICROTEK 32K	\$ 149
ATARI 800 16K	\$ 749
ATARI 400 16K	\$ 349
ATARI 810 DISK DRIVE	\$ 449
ATARI 820 40 Column Printer	\$ 299
ATARI 822 40 Column Thermal Printer	\$ 349
ATARI 825 80 Column Printer	\$ 599



**EAST COAST
1-800-556-7586**

OMEGA SALES CO.
12 Meeting St.
Cumberland, RI 02864
1-401-722-1027

**WEST COAST
1-800-235-3581**

OMEGA SALES CO.
3533 Old Conejo Rd. #102
Newbury Park, CA 91320
1-805-499-3678
CA. TOLL FREE 1-800-322-1873

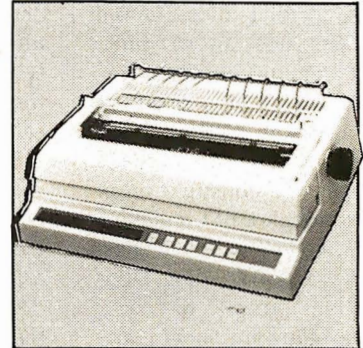

DIABLO 630

\$1995

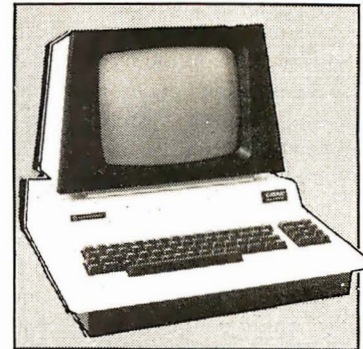

CBM 8032 COMPUTER

\$1149

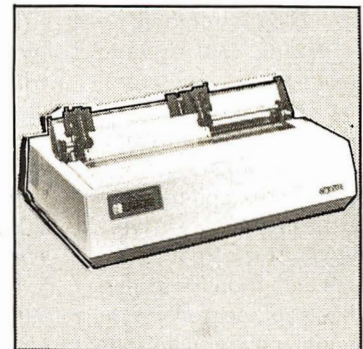

OKIDATA MICROLINE-83A

\$ 749

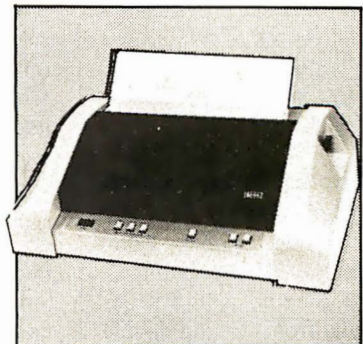

ANADEX DP-9500/9501

\$1199

BYTE LINES

News and Speculation About Personal Computing

Conducted by Sol Libes

Random Rumors: It's in the air that Intel is about to announce an IC (integrated circuit) designed specifically for database management (DBM) computers. This IC should make possible the construction of a relational DBM machine that works with a host processor, off-loading DBM functions from the host. Using hardware specifically designed for DBM applications should greatly improve DBM system performance over the current approach of using an existing general-purpose computer system for DBM applications.

Speculation has it that the chip itself will be a processor with an instruction set designed exclusively for database handling. As such, it could handle compression and decompression algorithms, among other tasks. . . . Zilog is rumored to be working with Seeq Technology on a microprocessor having on-board EPROM (erasable programmable read-only memory) for learn-and-remember *self-programming* ability. . . . IBM is expected to introduce an option for its personal computer for bisynchronous communications with 3270-compatible equipment, 3276 SDLC/SNA compatibility (fall of 1982), and X.25 communications support (spring of 1983).

Apple Drops Bomb On Mail Order: In a surprise move, Apple Computer, Inc. has unilaterally decided to prohibit its dealers from selling Apple computer products through mail or phone order sales. It

is Apple's feeling that "customers purchasing [Apple products] can be properly served only if they have the benefit of pre- and post-sale education, orientation, and support, specifically including in-person contact with the selling dealer." Dealers are required to sign a "modification" to their dealer sales agreement or their authorized dealership will be terminated. It is not clear just what previously educated customers, especially those not located close to an Apple dealer, are to do.

More rumors are surfacing regarding Apple's new computer offerings. The latest is that we'll see two new Apples: a low-cost system (\$500 and up) to use the Motorola 6809 microprocessor and a high-cost, business-oriented system that will use the Motorola 68000. The business-oriented system will be capable of addressing up to 760 K bytes of memory, will probably come with a hard disk, and will be compatible with the Xerox Star local networking system.

Apple has introduced a 5-megabyte, 5¼-inch Winchester Technology disk drive for the Apple III computer. Called the Profile Mass-Storage System, the unit is comprised of an intelligent controller, the drive itself, a power supply, an interface card, and driver software.

Pearcom, a European company, has started to market its Pear II computer (an Apple II work-alike). According to the grapevine, Apple is considering legal action. . . . Sears's computer

stores, already carrying the Atari and Vector Graphic computers, are said to be negotiating with Apple.

IBM Coming on Strong:

People who've been around the microcomputer industry awhile were surprised when IBM began shipping its new Personal Computer more than a month before the promised October delivery date and less than a month after announcing it. This is unheard of in the personal computer industry. Currently, distribution of the IBM Personal Computer is limited to ComputerLand shops, the few Sears computer stores, and IBM's sales force. ComputerLand and Sears appear to be handling single and limited-quantity sales, while the IBM salespeople seem to be pursuing large-quantity orders.

When IBM announced its Personal Computer, it reportedly received orders for 40,000 systems—that's worth about \$160 million. Sales of more than 150,000 systems are projected for 1982.

Early reports indicate that the Personal Computer has affected sales of other systems. Carrying the IBM computer apparently requires a large financial commitment from the stores. This, coupled with the current tight credit situation, is forcing the stores to cut other product lines to make room for IBM.

Several ComputerLand stores have already reported sales of the IBM computer equal to those of Apple. (Incidentally, ComputerLand accounts for 14 percent of

Apple's retail sales.)

IBM recently made another unprecedented move when it began offering its 8-inch Winchester disk drive as a separate OEM item to other manufacturers.

Tandy Happenings:

If you'd bought 1000 shares of Tandy stock in 1967 at \$15 a share, today it would be worth \$2,350,000. . . . Tandy owns 91 percent of its outlets. . . . Tandy employees own about 25 percent of the company. . . . Radio Shack has a mailing list of 25 million. . . . Radio Shack manufactures more than half the products it sells. . . . Earnings have doubled since 1978.

Tandy is pressing its copyright infringement suit against Personal Micro Computer Inc., of Mountain View, California, manufacturer of the PMC-80. A federal court has already dismissed PMC's claim that federal copyright laws do not pertain to ROM (read-only memory) based computer programs. Tandy is suing to stop sales of the PMC-80 and to obtain compensation for damages.

Tandy has also introduced Arcnet, a local network system to link up with 255 Model II computers. Arcnet is based on Datapoint's Attached Resource Computer (ARC). Arcnet operates at 21.5 megabytes per second and is reportedly similar to Ethernet.

Radio Shack and Interstate Bank of California have begun a pilot program for a home banking system. TRS-80 Videotex terminals and color computers are

THINK DIGITAL MARKETING. THINK AHEAD.



JANUARY

2670 Cherry Lane • Walnut Creek, CA 94596 (415) 938-2880

MILESTONE™—\$295. Manual alone—\$30. "Critical path" network analysis program for scheduling manpower, dollars and time to maximize productivity.
NEW IMPROVED. Interactive project management program that runs under CP/M. MILESTONE can be used to track paper flow, build a computer, check a department's performance, or build a bridge. MILESTONE can be used by executives, engineers, managers, and small businessmen.
 • Produce PERT chart in minutes.
 • Find critical tasks that can't be delayed.
 • Investigate tradeoffs between manpower, dollars and time.
 • Give plans to others using a printed project schedule.
 • Change details and immediately see the results on screen.
 • Balance time, manpower and costs.
 Requires 56K RAM and CP/M. Specify Z80 or 8080. Also available for UCSD Pascal or CP/M-86 operating systems. (Milestone-86 version - \$395.) Formats: 8. NS. MP. SB. TRS2. OB-1. XX. IPC. IOW

DATEBOOK II™ — \$295. Manual alone — \$30.
 Schedule appointments for up to 27 different doctors, lawyers, rooms, etc.
 Three appointment schedules are displayed on the screen at a time.
 File structure allows for appointments for up to one year in advance.
 Searches for openings that fit time of day, day of week and/or day of year constraints.
 Appointments made, modified or cancelled easily.
 Copies of day's appointments can be printed quickly.
 Requires 56K RAM and CP/M. Specify Z80 or 8080. Also available for Apple Pascal, UCSD Pascal or CP/M-86 operating systems. Formats: 8. NS. MP. SB. APPL. TRS2. OB-1. XX. IPC. IDW.

PERSONAL DATEBOOK™ — \$150. Manual alone — \$30.
 Time management and appointment scheduling calendar for an individual or small office with up to nine staff members. Displays one appointment schedule on screen at a time. Cancellations can be put into a hold file for easy rescheduling at your convenience. Menu driven commands do not require referral to manual.
 Requires CP/M 2.x and 56K RAM. Specify Z80 or 8080. Also available for Apple Pascal, UCSD Pascal or CP/M-86 operating systems. Formats: 8. NS. MP. SB. APPL. TRS2. XX. IPC. IDW.

TEXTWRITER III™ — \$125. Manual alone — \$30.
 A text formatting program with proportional spacing, footnoting, underscoring, boldface, double strike, strikeout, super and sub-script, dual pitch, reverse line feed, and color ribbon change for Diablo, Queme, and NEC printers. Requires CP/M. 32K RAM and any CP/M compatible editor. Formats: 8. NS. MP. SB. APPL. XX.

WHATSIT?™ — \$150. Manual alone — \$30.
 A data base/query/retrieval system that communicates conversationally, accepting questions and updates in simple sentences. Store, index and retrieve information about one or more aspects of related or unrelated subjects. Information is stored under you designated "subject" and "tag" headings, which can be added to, changed or deleted at any time.
 116 page manual assumes no programming knowledge.
 Requires CP/M. CBASIC2 and 24K RAM. Formats: 8. NS. MP. SB. APPL. OB-1. XX

SUPERCALC™—\$295.
 Allows a layman to manipulate business data in a variety of forecasting and accounting applications. Combines the interactive nature of an electronic spreadsheet with the power and convenience of a simple simulation language. Video display can be scrolled over entire worksheet using cursor controls. Symbolic vector references eliminate repetitive low-level data manipulation commands. Easy to use menu driven "Help" commands. Requires CP/M and 48K RAM. Formats: 8. NS. MP. SB. APPL. TRS2 Call for terminal formats.

ACT™
 CP/M compatible macro assembler family supporting all major 8 bit micros. ACT features include full macro capabilities, comprehensive pseudo-ops, link-file structures, cross reference map, and algebraic expression processor. Requires 32K RAM and CP/M.
 ACT I-6502 — \$175. ACT-86/88 — \$175.
 ACT I-6800 — \$175. ACT-6809 — \$175.
 ACT I-6800 — \$175. Manuals \$25. each.
 ACT I-8080/Z80 — \$175.

PASCAL/M™ — \$395. Manual alone — \$25.
 CP/M compatible language for 8080/Z80 CPUs, supports full Jensen & Wirth plus 45 extensions to Standard Pascal including Random access files, 40 segment procedures & 16 bit BCD real type. Also includes symbolic debugger which features trapping on stores, examining and changing variables and tracing of program execution.
 Requires CP/M 2.2 & 56K RAM. Formats: 8. NS. APPL. TRS2

PASCAL/M for 8086/88 — \$495. Manual alone — \$25.
 All the features of Pascal/M for the 8086 and 8088 processors running under CP/M-86.
 Requires CP/M-86 and 128 K RAM. Formats: 8. IPC. IDW.

Pascal:Sort™ — \$195. Manual alone — \$20.
 Fully commented source code into which the user simply places the particular file description and sequence requirements to obtain the desired sort. Can run stand-alone or as overlaid segment of larger program. Uses indirect Shell-Metzner in RAM, interleaved polyphase (Fibonacci) merge on disk, full sector buffering and shortest seek logic. Can match machine language sorts even under Pcode interpretation. Requires CP/M 2.x, and 56K RAM and CP/M-86 and 128K RAM. Pascal/M. UCSD Pascal or Pascal/MT+. Formats: 8. NS. APPL. XX. MP. TRS2. IPC. IOW.

THE FIELD COMPANION™ — \$295. Manual alone — \$30.
 Created for the needs of the traveling Salesman or Professional. Allows you to track the time spent with your clients, each client having up to four user-defined sub-fields. Expense accounting is provided and is itemized in a detailed journal for budgeting and tax reporting purposes. Maintains appointments, and current customer list including shipping and billing addresses, year-to-date sales and person to contact for follow up. Invoicing feature retrieves required data from both customer and product lists. Special instructions and discounts are supported. Invoice copies may be output to a printer or sent to the home office via modem, permitting electronic transfer of the contents of any report. Requires 56K RAM and CP/M or CP/M-86 and 128K RAM. Formats: 8. NS. MP. APPL. SB. XX. IPC. IOW

TRADEMARKS: Access/80-Friends Software. PEARL-CPU Int'l. Pascal/M. ACT. TRANS86. SuperCalc-Sorcim.CBASIC2. CBASIC/86. CP/M-80. CP/M-86-DigitalResearch. Milestone. Datebook II. Personal Datebook. Textwriter III- Organic Software. Spellguard - ISA. Spellbinder-Lexisoft. MCALL. AMCALL- Micro-Call Services. Selector IV. Selector V. Glector- Micro-AP. Field Companion. Pascal:Sort-Technical Software. Footnote-Pro/Tem Software. Whatsit?- Computer Headware. For shipping add \$7. per item. California residents add state sales tax. Terms: Pre-paid check. Am Exp. M/C. VISA or in US COD (UPS). Prices quoted do not include dealer installation & training. Prices and availability subject to change without notice.

ACCESS/80™
 A report generator and cross-tabulator. Virtually any report that can be described on paper can be generated by using your existing ASCII data files. Produces reports in minutes that would take hours to program in BASIC.

Level I—Report Generator and Cross-tabulator—\$295.
 Read ASCII files and create sorted reports with subtotalling capability. Provides multi-dimensional cross tabulation and computation. Includes operating system commands.
Level II—Output and Logic Processor—\$495.
 Everything in Level I plus, write out new files in any sorted order (including subtotalling). Load arrays from files. Performs binary search on sorted arrays in memory. Includes control language extensions for complex applications.
Level III—Information Management System—\$795.
 Available 1st Qtr '82
 Everything in Level I and II plus full screen data entry and updating, and Btree indexing.
 Requires CP/M and 48K RAM. Formats: 8. NS. MP. CDOS. SB. TRS2. APPL. XX.

FOOTNOTE™ — \$125.
 Automatically numbers and formats footnote calls, footnotes and text, placing footnotes on the bottom of the correct page. At the user's option, the footnotes can also be removed from the text file to a separate note file. Footnotes can be entered singly or in groups, in the middle or at the end of paragraphs. After running FOOTNOTE the user can re-edit the text, add or delete notes, and run FOOTNOTE again to re-number and re-format. Price include PAIR, a companion program that checks that underline and BOLDFACE commands are properly terminated. Requires CP/M. WordStar. 48K RAM. Formats: 8. NS. MP. SB. APPL. OB-1. XX.

SPELLBINDER™—\$495. Manual alone—\$50.
 Full feature word processing system with Office Management capabilities. Its special features include ease-of-use by office personnel, flexible print formatting & output, and a powerful macro capability which allows features to be added for the unique requirements of each user. Mail list macro is included for mail merge with form letters. Requires CP/M & 32K RAM. Formats: 8. NS. MP. CDOS. SB. APPL. XX

MORE SOFTWARE	PRODUCT/MANUAL ALONE	
SPELLGUARD	\$295.	\$20
MCALL	\$ 85.	n/a
AMCALL	\$ 95.	n/a
PEARL PERSONAL PROGRAMMER	\$295.	call
PEARL LEVEL 3	\$650.	\$50.
CBASIC2	\$150.	\$25.
SELECTOR IV	\$550.	\$35.
GLECTOR for SELECTOR IV	\$450.	\$35.
SELECTOR/86	\$650.	\$35.
SELECTOR V	\$495.	\$35.
S-BASIC	\$295.	\$35
bAZIC	\$250.	\$25.
dBASE II	\$695.	\$50.
MAGIC MENU	\$ 95	n/a
SPELL MENU	\$ 95.	n/a
SUPERDOS for SUPERBRAIN	\$129.	n/a
PROPERTY MANAGEMENT PROGRAM	\$995.	call
TRANS86	\$125.	\$25.
CBASIC/86	\$325.	\$25.

CODES: 8 (8" single density IBM soft-sectored) NS (NorthStar DD) MP (Micropolis Mod II/Vector MZ) SB (Superbrain 3.0) CDOS (Cromemco CDOS) TRS2 (TRS-80 Mod II) APPL (Apple II with CP/M) OB-1 (Osborne-1) XX (Xerox 820) IPC (IBM Personal Computer with CP/M-86) IDW (IBM Display Writer)

SOFTWARE
 SOFTWARE
DIGITAL MARKETING
 DIGITAL MARKETING

Tel: 17-1852 (DIGMKTG WNCK). DEALER INQUIRIES INVITED. OUTSIDE CALIFORNIA CALL (501) 442-0864. INSIDE CALIFORNIA CALL (415) 938-2883.

being used to handle standard customer transactions and electronic bill paying.

How Much Faster Are the 16-Bit Micros?: The introduction of several microcomputers based on the Intel 8086/8088 microprocessor has given computer users the chance to compare execution speeds of 16-bit and 8-bit micros.

Several vendors offer identical software—namely the CP/M operating system and Microsoft BASIC—for these machines. It's now possible to run identical BASIC programs and compare execution times. Tests have already shown that there is no significant difference between a microcomputer with an 8086 running at its standard speed (5 MHz) and one with a Z80 running at its standard speed (4 MHz). What must be considered is that CP/M-86 has many new features which may slow it down (compared with CP/M-80). Also, the 8086 version of Microsoft BASIC currently available is a translation of an 8080 version, one with minimal optimization for the 8086. I hope Microsoft will rework its BASIC interpreter to take advantage of the 8086's more powerful architecture. Presently, though, if you expect to get a significant improvement in execution time by moving up to a 16-bit micro, you may be sorely disappointed.

CDC Introduces Personal Computer: Amidst all the publicity given IBM and Xerox personal computers, Control Data Corporation, IBM's leading competitor, has introduced its own personal computer. The CDC-110 uses a Z80, has 64 K bytes of RAM (random-access read/write memory)

and a 1.2 megabyte 8-inch floppy-disk system. Prices start at just under \$5000. The system can be used as a work station with a timesharing or Plato system.

Pascal Standard Adopted: The IEEE has adopted a standard for the Pascal language, designated IEEE Standard 770-981. This culminates a 2½-year effort by a joint committee that included IBM, DEC, Honeywell, Burroughs, Intel, Motorola, Microsoft, Softech, and others, along with several universities. The base language has been standardized, but much remains undone in standardizing the extensions to Pascal. Standardization should pave the way toward making Pascal a more portable language. Significant differences currently exist among the various versions.

Random News Bits: OKI Electric is the first company to ship samples of a 256 K-bit RAM IC. Production quantities are expected late this year. . . Intel has announced development of a 4-megabit bubble memory IC. Sampling will start late this year. . . Shipments of computer equipment in 1981 have totaled about \$31.5 billion, a 17.6 percent increase over 1980. . . The NCC show, to be held in Houston in June, is expected to draw over 600 exhibitors. . . Shugart Associates recently shipped its one millionth 8-inch floppy-disk drive. . . Zilog and AMD have signed an agreement whereby AMD will make and sell a 32-bit microprocessor being developed by Zilog. . . Zilog has introduced the Z80L, a low-power version of the Z80. The Z80L draws only .15 mA instead of

100-150 mA for the standard Z80. . . Researchers at MIT are building robotic skin—thick sheets of rubber with wire lines imbedded in them to conduct a "sense" of touch.

Predictions, Predictions: Last January I made my customary predictions—eight in all—for 1981. How did I do? Let's check the results:

1. *The S-100 will become the de facto standard for bus interfacing, with the number of manufacturers supporting the bus to increase to more than 40 (and to include IBM).*

Score a *partially correct* on this. Close to 50 firms now make the S-100, and a like number supply peripheral boards. However, IBM chose to go with a new bus of its own design.

2. *Hardware will become more sophisticated and less expensive.*

Score a *correct* on this one. Personal computers have acquired features of their larger, more-expensive predecessors.

3. *The man/machine interface will be improved to accommodate the many users who have little or no knowledge of computers.*

Score a *correct* on this one too. New software packages (e.g., "The Last One") make software development for nonprogrammers possible (although I think we are far from the "last one"). The increasing use of "menu-driven" software (even menu enhancements for CP/M) has also made computers more accommodating.

4. *Cheap mass storage for personal computers will finally arrive via video cassette and optical-disk memories.*

Although two companies have introduced video-cassette interfaces, and others have demonstrated optical-

disk interfaces, acceptance has been cool. To make this hardware really useful, we need complementary software operating systems.

Let's score a *correct* on this one.

5. *Higher-quality displays using either liquid-crystal or semiconductor technology will be introduced.*

Epson did show prototypes of its 256-character/graphics liquid-crystal display, and a few semiconductor displays (typically one or two lines) were introduced, but a display suitable for general terminal use has not yet been shown. Therefore, score *partially correct* on this one.

6. *Personal computers will include self-testing capabilities and redundant circuits to improve reliability.*

Score a *correct* on this, as companies include self-test routines in their boot ROM (e.g., the new IBM and Osborne personal computers). Also, several companies have introduced an extra parity bit in RAM and provided circuitry to periodically test memory and correct faults.

7. *Expect BASIC to continue as the dominant language. . . Natural programming languages and automatic programming still appear to be many years away.*

Score another *correct*.

8. *Operating systems such as Unix, CP/M, MP/M, and more sophisticated systems will increase in popularity, and many manufacturers will design special hardware to support these operating systems.*

Check *correct* here also.

All predictions considered, I was about 90 percent accurate. Not bad!

Predictions for 1982:

1. *Who will dominate the microcomputer market? I expect 1982 will see continued*

Grow or die!

You are what you know. And if you don't know the ins and outs of microprocessor software, you aren't what you CAN be. We publish plain-talk, easy-to-understand books on all aspects of microcomputer software—to help you grow!

If you use or sell microprocessor systems, design with microprocessors, or train microcomputer users, you'll find our Advanced Technology Books well worth the small investment.

Fill out the order coupon or call us direct at (707) 422-1465 and use your credit card.

NEW! MICROPROCESSOR OPERATING SYSTEMS

Designed for microprocessor system users and anyone who must select, evaluate, or design operating systems to support applications software, this book contains descriptions of the most important systems currently available. Edited by John Zarrella, each chapter is written by an industry leader involved in the development or implementation of the operating system. This wealth of user-oriented technical details makes it easy for you to compare systems.

Contents: • The BLMX-80 Operating System, by Norm Rhodes. • The iRMX 80/88 Operating System, by Janice Cleary. • The iRMX 86 Operating System, by Bruce Schafer. • The MP/OS Operating System, by Jim Isaak. • The RIO/CP Operating System, by Eric Benhamou and Chris Riggins. • The Rx Operating System, by Rex Jackson. • The UNIX Operating System, by Bob Marsh, Grant Munsey, Kip Myers, and Craig Forney. • The VERSAdos Operating System, by Jay Glaser. • The ZRTS Operating System, by Stephen Savitzky.
Cat. # 033 166 pp. Price \$11.95

THE MICROPROCESSOR SOFTWARE ENGINEERING CONCEPTS SERIES

These easy-to-read books explain software concepts, techniques and terminology. Concise and up-to-the-minute, these books show you how to formulate software requirements, evaluate existing systems, and design new ones.

OPERATING SYSTEMS: Concepts and Principles

Used by Intel, Zilog, and Harris for software training. The most important component of system software is the operating system. This book provides an introduction to current operating systems technology. Operating systems concepts, capabilities, and terminology are explained.

Contents: • Real Time, Multitasking, and Multiuser systems. • The concept of a Process or Task. • How tasks communicate and synchronize. • Context switching, Swapping and Paging. • Priority scheduling. • Memory Management, File Systems and System Security
Cat. # 009 152 pp. Price \$8.95

WORD PROCESSING AND TEXT EDITING

Besides providing an introduction to word processing and text editing functions and features, this book offers an in-depth treatment of editing, printing and programming. Business managers will learn how to compare systems and select one which best fits their needs. Software and hardware designers will find the advanced topics invaluable in designing word processing and text-editing systems.

Contents: • The office of the future. • Information networks. • Proportional spacing. • Daisy wheel, thermal, and dot matrix printer selection. • Justified and flushed text. • Programming word processors. • CRT display techniques.
Cat. # 017 156 pp. Price \$8.95

SYSTEM ARCHITECTURE

This book presents the fundamental concepts on which modern 16- and 32-bit microprocessor architectures are based. A boon to anyone who must select or design a microprocessor or minicomputer system, the book also illustrates the impact of computer architecture on software efficiency and reliability.

Contents: • Object architecture and capability-based addressing. • Virtual memory, segmentation, and paging. • Data structures and representations. • Bus systems and communication protocols. • Microprogramming. • Addressing modes. • Software support.
Cat. # 025 240 pp. \$10.95

Buy these books at your technical bookstore or local computer store—or phone us your Visa/Master Card order—or mail this coupon today. Inquire about our quantity pricing.

Circle 244 on inquiry card.



MICROCOMPUTER APPLICATIONS

Dept. B9 P.O. Box E
Suisun City, CA 94585
(707) 422-1465

I want to grow with software know-how. Please send me:

QTY	TITLE	UNIT PRICE	TOTAL
	MICRO OP SYS	\$ 11.95	
	WORD PROC	\$ 8.95	
	OPER SYS	\$ 8.95	
	SYSTEM ARCH	\$ 10.95	
	SUBTOTAL		

Calif. residents add 6% sales tax

Add \$1.00/book—4th class book.
 \$1.75/book—UPS
 \$9.00/book—Overseas air.

Payment must accompany order

TOTAL ENCLOSED: _____

Please send free brochure.

Charge my MC Visa

CARD # _____ EXP. DATE _____

SIGNATURE _____

Or I'm enclosing a check or money order.
(Payment must be in U.S. funds drawn on a U.S. Bank.)

NAME _____

ADDRESS _____

CITY _____

STATE _____ ZIP _____

©1981 Microcomputer Applications

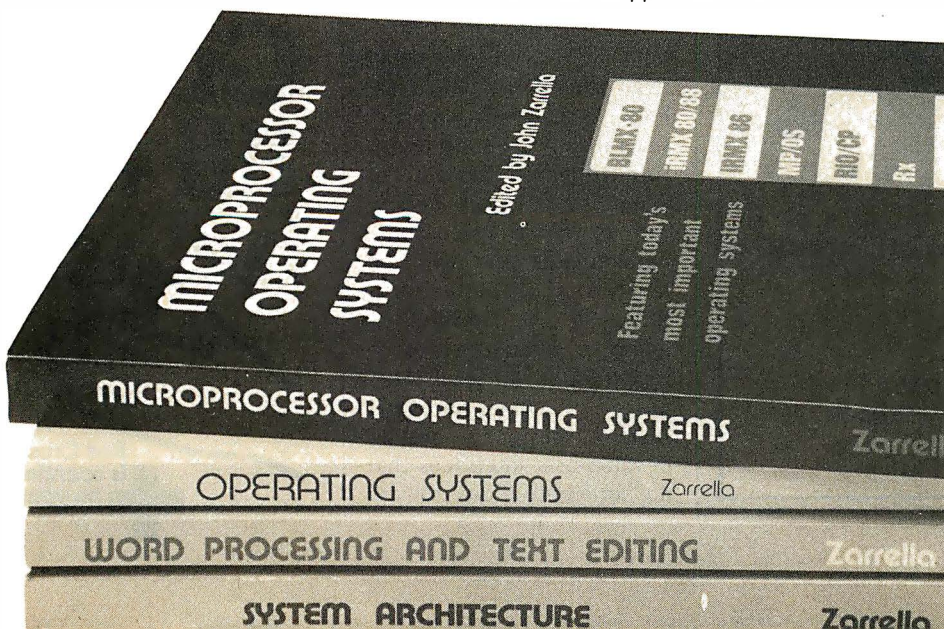

BYTE LINES

strong growth in the personal computing industry. I also foresee a year of great turmoil as competition heats up among three factions. They are traditional personal computing suppliers (e.g., Tandy, Apple, Heath, Commodore, and Atari), the biggies who have introduced personal computers (IBM, DEC, Xerox, etc.), and Japanese suppliers.

Eight-bit systems will probably retain their dominance in single-user systems, with CP/M reigning supreme among disk operating systems. I predict Apple, Tandy, and IBM will dominate this area.

However, absolute chaos will abound in local networking, as virtually every personal computer maker will have a separate system. Xerox should finally start shipping Ethernet systems, and nearly all personal com-

puter suppliers can be expected to supply Ethernet interfaces for their personal computers. Because of this, Ethernet (if its price is not a deterrent) stands a chance of becoming a local-networking standard. The Corvus Omninet system looks promising too.

Chaos is also expected in the multiuser personal computer area as the new 16-bit microprocessors fight it out. Although the 8086-based systems seem to have an early lead, the 68000-based systems may become dominant. I don't expect Digital Research to achieve the same success with its multiuser MP/M DOS that it has enjoyed with single-user CP/M.

2. *Some hardware predictions.* As memory prices drop, RAM ICs get larger and application software demands more memory. Sixty-

four K bytes should become the standard memory configuration for 8-bit, single-user, personal computers. . . . A new recording technology for floppy disks will increase storage for 5¼-inch disks to as much as 5 megabytes. . . . I expect more compact, portable personal computers (similar to the Osborne), with prices possibly dropping as low as \$1000 (disk drive, modem, and printer interfaces included). . . . DEC should finally introduce its personal computer, and I imagine it will be based on the LSI-11 architecture. . . . I expect both Xerox and IBM to market new personal computers with costs even lower than their current units. In fact, I anticipate the greatest competition will occur at the lower end of the personal computer market. . . . I foresee at least one S-100 supplier announcing a CPU that employs the Intel 432 32-bit processor. However, it will probably be 1983 before we see production units and software. . . . A low-cost, optically based memory system capable of storing a billion bytes may be introduced by year's end (sometime during 1983 is more likely). . . . Also by year's end or in 1983, we may see typewriters from IBM, Xerox, and Matsushita that feature voice input.

3. *Some software predictions.* BASIC will continue to reign supreme among high-level languages. I expect several software suppliers to furnish new versions of BASIC interpreters. These will eliminate line-number requirements and will use labels to allow better structuring of the BASIC programs. . . . I expect someone to introduce a Pascal interpreter. . . . Disk-operating-systems designers should develop user interfaces that are oriented more toward

users than programmers. Thus, DOS systems will all become menu driven, with elaborate prompts for the user. Utilities will increasingly become integral parts of the DOS. . . . Taking advantage of larger memory and storage capabilities, sophisticated business software packages will proliferate.

Commodore Happenings: Commodore is starting to promote Comal, a new structured language, as a substitute for PET BASIC. Developed in Denmark, Comal is supposedly easier to learn than PET BASIC; it uses Pascal-like structures. Also rumored is a version of the PET with Comal resident in ROM that will soon join the Commodore line. Commodore plans a sales promotion campaign for the new version and has signed William Shatner (*Star Trek's* Captain Kirk) to appear in its commercials.

MAIL: I receive a large number of letters each month as a result of this column. If you write to me and wish a response, please include a self-addressed, stamped envelope.

Sol Libes
POB 1192
Mountainside, NJ 07092

A Public Service of This Magazine
& The Advertising Council 

Give till it helps.



In Less Than 3 Minutes

Your IBM Model 50, 60, or 75
Electronic Typewriter
can be an RS232C PRINTER or TERMINAL



CALIFORNIA MICRO COMPUTER Models 5060 and 5061 can be installed easily and require NO modifications to the typewriter.

For additional information contact:

CALIFORNIA MICRO COMPUTER
9323 Warbler Ave., Fountain Valley, CA.
92708 (714) 968-0890

NEW PRINTERS. NEW PERIPHERALS. SAME OLD RELIABLE QUALITY AND VALUE.

1982 will find more OEM's, businesses, dealers and personal computer users turning to MICROTEK than ever before.

TekWriter-1



80 Column Dot Matrix Printer (Formerly BYTEWRITER-1)

The Tekwriter-1 printer is, dollar for dollar, the finest value in the industry. And we've proved it by comparing the Tekwriter-1 to the Epson MX-80. Our print speed is 14 lines per minute faster, our life expectancy is longer, the character sets are the same, and the interface, warranty and printhead replacement cost are all identical.* But the biggest difference is the price. The Tekwriter-1 is about \$300 less.

Our extensive testing has proved that the Tekwriter-1 interfaces problem-free to the TRS-80, the Apple II and the Atari 400 and 800.

The Tekwriter-1 is tough to beat for performance and quality.

*Data Source: Epson MX-80 Operation Manual

\$349

TekWriter-2

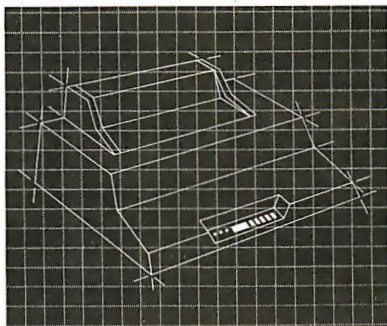

NEW! 80/132 Column Dot Matrix Printer

The Tekwriter-2 is perfectly suited to personal, business or OEM applications. Tekwriter-2 is designed to accept single sheet, roll or pin feed paper. It has a 9-wire dot matrix impact print head which produces crisp characters and has underlining capability. The printer is manufactured to run extremely quietly even while operating at peak output levels.

Tekwriter-2 is especially well suited to handle an abundance of text entry because of its data buffer expansion capability to 25K. This ability makes it an efficient graphics generator.

Parallel interface (Centronics type). Interfaces all models of TRS-80, Apple, and Atari 400/800, and most computers with Centronics printer interface.

\$695

Peripherals

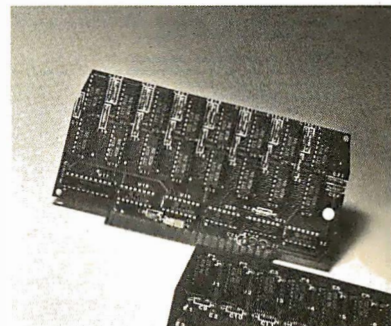

16K Memory Board, AMB-16

16K 4116 RAM (200NS)
• Assembled and tested • No modifications — hardware or software • Compatible with Atari 800

32K Memory Board, AMB-32

32K 4116 RAM (200NS) • Assembled and tested • No modifications — hardware or software • Compatible with Atari 400/800

Atari (RS-232) Serial Printer Cable

Pre-tested • 3' length • DB15 to DB25 connectors

Atari Parallel Printer Cable

Pre-tested • 3' length • Centronics compatible • DB15 to Amphenol 57-30360

16K Apple Memory Card

Expands Apple II to 64K RAM memory. Works with MICROSOFT Z-80 Softcard, Apple PASCAL and Visicalc software.

Quantity and OEM discounts available.

Continuing our quest for excellence.

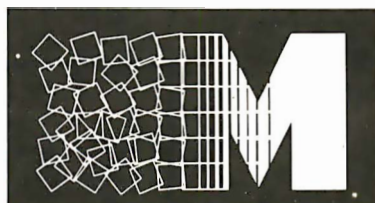

MICROTEKinc.

MICROTEK

9514 Chesapeake Drive
San Diego, CA 92123
(714) 278-0633
Outside CA call
Toll Free (800) 854-1081
TWX. 910-335-1269

TRS-80 is a trademark of Radio Shack, Inc.
Apple II is a trademark of Apple Computer, Inc.
Atari 400/800 are trademarks of Atari, Inc.
Microsoft is a trademark of Microsoft Consumer Products, Inc.
Z-80 is a trademark of Zilog, Inc.
Visicalc is a trademark of Personal Software, Inc.

DYNACOMP

Quality software for*:

ATARI
PET
APPLE II Plus

TRS-80 (Level II)**
NORTH STAR
CP/M Disks/Diskettes

CARD GAMES

BRIDGE 2.0 (Available for all computers) Price: \$17.95 Cassette/\$21.95 Diskette
An all-inclusive version of this most popular of card games. This program both BRIDGE and PLAYS either contract or duplicate bridge. Depending on the contract, your computer opponents will either play the offense OR defense. If you bid too high, the computer will double your contract! BRIDGE 2.0 provides challenging entertainment for advanced players and is an excellent learning tool for the bridge novice. See the software review in 80 Software Critique. Rated #1 by Creative Computing.

HEARTS 1.5 (Available for all computers) Price: \$15.95 Cassette/\$19.95 Diskette
An exciting and entertaining computer version of this popular card game. Hearts is a trick-oriented game in which the purpose is not to take any hearts or the queen of spades. Play against two computer opponents who are armed with hard-to-beat playing strategies. HEARTS 1.5 is an ideal game for introducing the uninitiated (your spouse) to computers. See the software review in 80 Software Critique.

STUD POKER (Atari only) Price: \$11.95 Cassette/\$15.95 Diskette
This is the classic gambler's card game. The computer deals the cards one at a time and you (and the computer) bet on what you see. The computer does not cheat and usually bets the odds. However, it sometimes bluffs! Also included is a five-card draw poker betting practice program. This package will run on a 16K ATARI. Color, graphics, sound. See review in COMPUTE.

POKER PARTY (Available for all computers) Price: \$17.95 Cassette/\$21.95 Diskette
POKER PARTY is a draw poker simulation based on the book, POKER, by Oswald Jacoby. This is the most comprehensive version available for microcomputers. The party consists of yourself and six other (computer) players. Each of these players (you will get to know them) has a different personality in the form of a varying propensity to bluff or fold under pressure. Practice with POKER PARTY before going to that expensive game tonight! Apple cassette and diskette versions require a 32 K (or larger) Apple II.

CRIBBAGE 2.0 (TRS-80 only) Price: \$14.95 Cassette/\$18.95 Diskette
This is simply the best cribbage game available. It is an excellent program for the cribbage player in search of a worthy opponent as well as for the novice wishing to improve his game. The graphics are superb and assembly language routines provide rapid execution. See the software review in 80 Software Critique.

THOUGHT PROVOKERS

MANAGEMENT SIMULATOR (Atari, North Star and CP/M only) Price: \$19.95 Cassette \$23.95 Diskette
This program is both an excellent teaching tool as well as a stimulating intellectual game. Based upon similar games played at graduate business schools, each player or team controls a company which manufactures three products. Each player attempts to outperform his competitors by setting selling prices, production volumes, marketing and design expenditures etc. The most successful firm is the one with the highest stock price when the simulation ends.

FLIGHT SIMULATOR (Available for all computers) Price: \$17.95 Cassette/\$21.95 Diskette
A realistic and extensive mathematical simulation of take-off, flight and landing. The program utilizes aerodynamic equations and the characteristics of a real airfoil. You can practice instrument approaches and navigation using radials and compass headings. The more advanced flyer can also perform loops, half-rolls and similar aerobically maneuvers. Although this program does not employ graphics, it is exciting and very addictive. See the software review in COMPUTRONICS. Runs in 16K Atari.

VALDEZ (Available for all computers) Price: \$15.95 Cassette/\$19.95 Diskette
VALDEZ is a computer simulation of super tanker navigation in the Prince William Sound/Valdez Narrows region of Alaska. Included in this simulation is a realistic and extensive 256 x 256 element map, portions of which may be viewed using the ship's alphanumeric radar display. The motion of the ship itself is accurately modeled mathematically. The simulation also contains a model for the tidal patterns in the region, as well as other traffic (outgoing tankers and drifting icebergs). Chart your course from the Gulf of Alaska to Valdez Harbor! See the software review in 80 Software Critique.

BACKGAMMON 2.0 (Atari, North Star and CP/M only) Price: \$14.95 Cassette/\$18.95 Diskette
This program tests your backgammon skills and will also improve your game. A human can compete against a computer or against another human. The computer can even play against itself. Either the human or the computer can double or generate dice rolls. Board positions can be created or saved for replay. BACKGAMMON 2.0 plays in accordance with the official rules of backgammon and is sure to provide many fascinating sessions of backgammon play.

CHECKERS 3.0 (PET only) Price: \$16.95 Cassette/\$20.95 Diskette
This is one of the most challenging checkers programs available. It has 10 levels of play and allows the user to change skill levels at any time. Although providing a very tough game at level 4-8, CHECKERS 3.0 is practically unbeatable at levels 9 and 10.

CHESS MASTER (North Star and TRS-80 only) Price: \$19.95 Cassette/\$23.95 Diskette
This complete and very powerful program provides five levels of play. It includes casting, en passant capture and the promotion of pawns. Additionally, the board may be preset before the start of play, permitting the examination of "book" plays. To maximize execution speed, the program is written in assembly language (by SOFTWARE SPECIALISTS of California). Full graphics are employed in the TRS-80 version, and two widths of alphanumeric display are provided to accommodate North Star users. See review in onComputing.

LEM LANDER (32K Apple Disk only) Price: \$16.95 Diskette
Pilot your LEM LANDER to a safe landing on any of nine different surfaces ranging from smooth to treacherous. The game paddles are used to control craft attitude and thrust. This is a real-time high res challenge!

FOREST FIRE! (Atari only) Price: \$16.95 Cassette/\$20.95 Diskette
Using excellent graphics and sound effects, this simulation puts you in the middle of a forest fire. Your job is to direct operations to put out the fire while compensating for changes in wind, weather and terrain. Not protecting valuable structures can result in startling penalties. Life-like variables are provided to make FOREST FIRE! very suspenseful and challenging. No two games have the same setting and there are 3 levels of difficulty.

NOMINOES JIGSAW (Atari, Apple and TRS-80 only) Price: \$16.95 Cassette/\$20.95 Diskette
A jigsaw puzzle on your computer! Complete the puzzle by selecting your pieces from a table consisting of 60 different shapes. NOMINOES JIGSAW is a virtuous programming effort. The graphics are superlative and the puzzle will challenge you with its three levels of difficulty. Scoring is based upon the number of guesses taken and by the difficulty of the board set-up. See review in ELECTRONIC GAMES.

MONARCH (Atari only) Price: \$11.95 Cassette/\$15.95 Diskette
MONARCH is a fascinating economic simulation requiring you to survive an 8-year term as your nation's leader. You determine the amount of acreage devoted to industrial and agricultural use, how much food to distribute to the populace and how much should be spent on pollution control. You will find that all decisions involve a compromise and that it is not easy to make everyone happy.

CHOMPELO (Atari only) Price: \$11.95 Cassette/\$15.95 Diskette
CHOMPELO is really two challenging games in one. One is similar to NIM; you must bite off part of a cookie, but avoid taking the poisoned portion. The other game is the popular board game REVERSI. It fully uses the Atari's graphics capability, and is hard to beat. This package will run on a 16K system.

SPACE LANES (Available for all computers) Price: \$14.95 Cassette
SPACE LANES is a simple but exciting space transportation game which involves up to four players (including the computer). The object is to form and expand space transportation companies in a competitive environment. The goal is to amass more net worth than your opponent. The economics include stock purchases and company mergers. Watch your wealth grow!

*ATARI, PET, TRS-80, NORTHSTAR, CP/M and IBM are registered trademarks and/or trademarks.

**Except where noted, all model software is available for the Model III. TRS-80 diskettes are not supplied with DOS or BASIC.

DYNACOMP OFFERS THE FOLLOWING

- Widest variety
- Guaranteed quality
- Fastest delivery
- Friendly customer service
- Free catalog
- 24 hour order phone

AND MORE...

STARTREK 3.2 (Available for all computers) Price: \$14.95 Cassette/\$15.95 Diskette
This is the classic Star Trek simulation, but with several new features. For example, the Klingons now shoot at the Enterprise without warning while also attacking starbases in other quadrants. The Klingons also attack with both light and heavy cruisers and move when hot! The situation is hectic when the Enterprise is besieged by three heavy cruisers and a starbase S.O.S. is received! The Klingons get even! See the software reviews in A.N.A.L.O.G., 80 Software Critique and Game Merchandising.

BLACK HOLE (Apple only) Price: \$14.95 Cassette/\$18.95 Diskette
This is an exciting graphical simulation of the problems involved in closely observing a black hole with a space probe. The object is to enter and maintain, for a prescribed time, an orbit close to a small black hole. This is to be achieved without coming so near the anomaly that the tidal stress destroys the probe. Control of the craft is realistically simulated using side jets for rotation and main thrusters for acceleration. This program employs Hi-Res graphics and is educational as well as challenging.

SPACE TILT (Apple and Atari only) Price: \$10.95 Cassette/\$14.95 Diskette
Use the game paddles to tilt the plane of the TV screen to "roll" a ball into a hole in the screen. Sound simple? Not when the hole gets smaller and smaller! A built-in timer allows you to measure your skill against others in this habit-forming action game.

MOVING MAZE (Apple and Atari only) Price: \$10.95 Cassette/\$14.95 Diskette
MOVING MAZE employs the game paddles to direct a puck from one side of a maze to the other. However, the maze is dynamically (and randomly) built and is continually being modified. The objective is to cross the maze without touching (or being hit by) a wall. Scoring is by an elapsed time indicator, and three levels of play are provided.

ALPHA FIGHTER (Atari only) Price: \$14.95 Cassette/\$18.95 Diskette
Two excellent graphics and action programs in one! ALPHA FIGHTER requires you to destroy the alien starships passing through your sector of the galaxy. ALPHA BASE is in the path of an alien UFO invasion; let five UFO's get by and the game ends. Both games require the joystick and get progressively more difficult the higher you score! ALPHA FIGHTER will run on 16K systems.

THE RINGS OF THE EMPIRE (Atari only) Price: \$16.95 Cassette/\$20.95 Diskette
The empire has developed a new battle station protected by rotating rings of energy. Each time you blast through the rings and destroy the station, the empire develops a new station with more protective rings. This exciting game runs on 16K systems, employs extensive graphics and sound and can be played by one or two players.

INTRUDER ALERT (Atari only) Price: \$16.95 Cassette/\$20.95 Diskette
This is a fast paced graphics game which places you in the middle of the "Dreadstar" having just stolen its plans. The droids have been alerted and are directed to destroy you at all costs. You must find and enter your ship to escape with the plans. Five levels of difficulty are provided. INTRUDER ALERT requires a joystick and will run on 16K systems.

GIANT SLALOM (Atari only) Price: \$14.95 Cassette/\$18.95 Diskette
This real-time action game is guaranteed addictive! Use the joystick to control your path through slalom courses consisting of both open and closed gates. Choose from different levels of difficulty, race against other players or simply take practice runs against the clock. GIANT SLALOM will run on 16K systems.

TRIPLE BLOCKADE (Atari only) Price: \$14.95 Cassette/\$18.95 Diskette
TRIPLE BLOCKADE is a two-to-three player graphics and sound action game. It is based on the classic video arcade game which millions have enjoyed. Using the Atari joystick, the object is to direct your blockading line around the screen without running into your opponent(s). Although the concept is simple, the combined graphics and sound effect lead to "high anxiety".

GAMES PACK I (Available for all computers) Price: \$10.95 Cassette/\$14.95 Diskette
GAMES PACK I contains the classic computer games of BLACKJACK, LUNAR LANDER, CRAPS, HORSESHOE, SWITCH and more. These games have been combined into one large program for ease in loading. They are individually accessed by a convenient menu. This collection is worth the price just for the DYNACOMP version of BLACKJACK.

GAMES PACK II (Available for all computers) Price: \$10.95 Cassette/\$14.95 Diskette
GAMES PACK II includes the games CRAZY EIGHTS, JOTTO, ACEY-DUCEY, LIFE, WUMPLUS and others. As with GAMES PACK I, all the games are loaded as one program and are called from a menu. You will particularly enjoy DYNACOMP's version of CRAZY EIGHTS.
Why pay \$7.95 or more per program when you can buy a DYNACOMP collection for just \$10.95?

MOON PROBE (Atari and North Star only) Price: \$11.95 Cassette/\$15.95 Diskette
This is an extremely challenging "lunar lander" program. The user must drop from orbit to land at a predetermined target on the moon's surface. You control the thrust and orientation of your craft plus direct the rate of descent and approach angle.

SPACE TRAP (Atari only, 16K) Price: \$14.95 Cassette/\$18.95 Diskette
This galactic "shoot 'em up" arcade game places you near a black hole. You control of your spacecraft using the joystick and attempt to blast as many of the alien ships as possible before the black hole closes about you.

ADVENTURE

CRANSTON MANOR ADVENTURE (North Star and CP/M only) Price: \$21.95 Diskette
At last! A comprehensive Adventure game for North Star and CP/M systems. CRANSTON MANOR ADVENTURE takes you into mysterious CRANSTON MANOR where you attempt to gather fabulous treasures. Lurking in the manor are wild animals and robots who will not give up the treasures without a fight. The number of rooms is greater and the associated descriptions are much more elaborate than the current popular series of Adventure programs, making this game the top in its class. Play can be stopped at any time and the status stored on diskette. Not available in 512K CP/M format.

GUMBALL RALLY ADVENTURE (North Star only, 48K) Price: \$21.95 Diskette
Take part in this outlaw race from the east coast to the west coast. The goal is to find your way to the finish line while maintaining the highest possible speed. You may choose one of five cars available at the garage. The choice will affect your speed and range. Remember to take spare parts and don't get caught speeding!

SPEECH SYNTHESIS

DYNACOMP is now distributing the new and revolutionary TYPE-N-TALK™ (TNT) speech synthesizer from Voytax. Simply connect TNT to your computer's serial interface, enter text from the keyboard and hear the words spoken. TNT is the easiest-to-program speech synthesizer on the market. It uses the least amount of memory and provides the most flexible vocabulary available anywhere.

Price: \$329.95 (Please add \$4.00 for shipping and handling)

TNT Software

The following DYNACOMP programs are available for use with TNT:

- STUD POKER (Atari, 24K)
- NOMINOES JIGSAW (Atari, 24K)
- TEACHER'S PET I (Atari and North Star)
- BRIDGE 2.0 (North Star)
- CHOMPELO (Atari, 24K)

TALK TO ME (TNT Atari only, 24K) Price: \$14.95 Cassette/\$18.95 Diskette
This program presents a superb tutorial on speech synthesis using the Atari 800 and TYPE-N-TALK™. TALK TO ME will illustrate normal word generation as well as phoneme generation. The documentation includes many helpful programming tips.

Please specify "TNT" versions when ordering.

ABOUT DYNACOMP

DYNACOMP is a leading distributor of small system software with sales spanning the world (currently in excess of 40 countries). During the past two years we have greatly enlarged the DYNACOMP product line, but have maintained and improved our high level of quality and customer support. The achievement in quality is apparent from our many repeat customers and the software reviews in such publications as COMPUTRONICS, 80 Software Critique and A.N.A.L.O.G. Our customer support is as close as your phone. It is always friendly. The staff is highly trained and always willing to discuss products or give advice.

BUSINESS and UTILITIES

SPELLGUARD™ (8" CP/M only) List Price: \$269, DYNACOMP Price: \$219.95 Diskette
SPELLGUARD is a revolutionary new product which increases the value of your current word processing system (WORDSTAR, MAGIC WAND, ELECTRIC PENCIL, TEXT EDITOR II and others). Written entirely in assembly language, SPELLGUARD™ rapidly assists the user in eliminating spelling and typographical errors by comparing each word of the text against a dictionary (expandable to over 20,000 of the most common English words. Words appearing in the text but not found in the dictionary are "flagged" for easy identification and correction. Most administrative staff familiar with word processing equipment will be able to use SPELLGUARD™ in only a few minutes.

MAIL LIST 2.2 (Apple, Atari and North Star diskette only) Price: \$34.95
This program is unique in its ability to maintain a maximum number of addresses on one diskette (minimum of 100 per diskette, more than 2200 for "double density" systems). Its many features include alphabetic and zip code sorting, label printing (1, 2, or 3 up), merging of files and a unique keyword seeking routine which retrieves entries by a virtually limitless selection of user defined codes. Mail List 2.2 will even link and delete duplicate entries. A very valuable program!

FORMLETTER SYSTEM rel. 2 (Atari, North Star and Apple Diskettes only) Price: \$34.95
FORM LETTER SYSTEM (FLS) is the ideal program for creating and editing form letters and address lists. It contains an easy-to-use text editor which produces fully justified text. Special codes are used in the address list to obtain personalized salutations. Form letters are produced by automatically inserting each address into a predetermined portion of your letter. FLS is completely compatible with MAIL LIST 2.2, which may be used to manage and sort your address files.
FLS and MAIL LIST 2.2 are available as a combined package for \$59.95.

SORTIT (North Star only) Price: \$29.95 Diskette
SORTIT is a general purpose sorting program written in 8080 assembly language. This program will sort sequential data files generated by NORTH STAR BASIC. Primary and optional secondary keys may be numeric or one to nine character strings. SORTIT is easily used with files generated by DYNACOMP'S MAIL LIST program and is very versatile in its capabilities for all other BASIC data file sorting.

PERSONAL FINANCE SYSTEM (Atari and North Star only) Price: \$34.95 Diskette
PFS is a single diskette, menu-oriented system composed of ten different programs. Besides recording your expenses and tax deductible items, PFS will sort and summarize expenses by month, and display information on expenditures by any of 26 user defined codes by month or by year. PFS will even produce monthly bar graphs of your expenses by category! This powerful package requires only one disk drive, minimal memory (24K Atari, 32K North Star) and will store up to 600 records per disk (and over 1000 records per disk by making a few simple changes to the program). You can record checks plus cash expenses so that you can finally see where your money goes and eliminate guesswork and tedious hand calculations.

FAMILY BUDGET (Apple only) Price: \$34.95 Diskette
FAMILY BUDGET is a very convenient financial record-keeping program. You will be able to keep track of cash and credit expenditures as well as income on a daily basis. You can record tax deductible items and charitable donations. FAMILY BUDGET also provides a continuous record of all credit transactions. You can make daily cash and charge entries to any of 21 different expense accounts as well as to 5 payroll and tax accounts. Data are easily retrieved giving the user complete control over an otherwise complicated (and unorganized!) subject.

INTELINK (Atari only) Price: \$49.95 Diskette
This software package contains a menu-driven collection of programs for facilitating efficient two-way communications through a full duplex modem (required for use). In one mode of operation you may connect to a data service (e.g., THE SOURCE or MicroNet) and quickly load data such as stock quotations onto your diskette for later viewing. This greatly reduces "connect time" and thus the service charge. You may also record the complete contents of a communications session. Additionally, programs written in BASIC, FORTRAN, etc. may be built off-line using the support text editor and later "uploaded" to another computer, making the Atari a very smart terminal. Even Atari BASIC programs may be uploaded. Further, a command file may be built off-line and used later as controlling input for a time-share system. That is, you can set up your sequence of time-share commands and programs, and the Atari will transmit them as needed; batch processing. All this adds up to saving both connect time and your time.

TEXT EDITOR II (CP/M) Price: \$29.95 Diskette/\$33.45 Disk
This is the second release version of DYNACOMP's popular TEXT EDITOR I and contains many new features. With TEXT EDITOR II you may build text files in chunks and assemble them for later display. Blocks of text may be appended, inserted or deleted. Files may be saved on disk/diskette in right justified/centered format or to be later printed by either TEXT EDITOR II or the CP/M ED facility. Further, ASCII CP/M files (including BASIC and assembly language programs) may be read by the editor and processed. In fact, text files can be built using ED and later formatted using TEXT EDITOR II. All in all, TEXT EDITOR II is an inexpensive, easy to use, but very flexible editing system.

DFILE (Atari and North Star diskettes only) Price: \$19.95
This handy program allows North Star and Atari disk users to maintain a specialized data base of all files and programs in the stack of disks which invariably accumulates. DFILE is easy to set up and use. It will organize your disks to provide efficient locating of the desired file or program.

FINDIT (North Star only) Price: \$19.95
This is a three-in-one program which maintains information accessible by keywords of three types: Personal (eg: last name), Commercial (eg: plumbers) and Reference (eg: magazine articles, record albums, etc.). In addition to keyword searches, there are birthday, anniversary and appointment searches for the personal records and appointment searches for the commercial records. Reference records are accessed by a single keyword or by cross-referencing two or three keywords.

SHOPPING LIST (Atari only) Price: \$12.95 Cassette/\$16.95 Diskette
SHOPPING LIST stores information on items you purchase at the supermarket. Before going shopping, it will remind you of all the things you might need, and then display (or optionally print) your shopping list and the total cost. Adding, deleting, changing and storing data is very easy. Runs with 16K.

TAX OPTIMIZER (North Star only) Price: \$59.95 Diskette
THE TAX OPTIMIZER is an easy-to-use, menu oriented software package which provides a convenient means for analyzing various income tax strategies. The program is designed to provide a quick and easy data entry. Income tax is computed by all tax methods (regular, income averaging, maximum and alternate minimum tax). The user may immediately observe the tax effect of critical financial decisions. TAX OPTIMIZER has been thoroughly field tested in CPA offices and comes complete with the current tax tables in its data files. TAX OPTIMIZER is his tax deductible!

EDUCATION

HODGE PODGE (Apple only, 48K Apple II or Integer BASIC) Price: \$19.95 Cassette/\$23.95 Diskette
Let HODGE PODGE be your child's babysitter. Pressing any key on your Apple will result in a different and intriguing "children's" related to the letter or number of the chosen key. The program's graphics, color and sound are a delight for children from ages 1 1/2 to 9. HODGE PODGE is a non-intimidating teaching device which brings a new dimension to the use of computers in education.

TEACHER'S PET I (Available for all computers) Price: \$11.95 Cassette/\$15.95 Diskette
This is the first of DYNACOMP's educational packages. Primarily intended for pre-school to grade 3, TEACHER'S PET provides the young student with counting practice, letter-word recognition and three levels of math skill exercises.

MISCELLANEOUS

CRYSTALS (Atari only) Price: \$ 9.95 Cassette/\$13.95 Diskette
A unique algorithm randomly produces fascinating graphics displays accompanied with tones which vary as the patterns are built. No two patterns are the same, and the combined effect of the sound and graphics are mesmerizing. CRYSTALS has been used in local stores to demonstrate the sound and color features of the Atari.

NORTH STAR SOFTWARE EXCHANGE (NSSE) LIBRARY
DYNACOMP now distributes the 23 volume NSSE Library. These diskettes each contain many programs and offer an outstanding value for the purchase price. They should be a part of every North Star user's collection. Call or write DYNACOMP for details regarding the contents of the NSSE collection.
Price: \$9.95 each/\$7.95 each (40r more)
The complete collection may be purchased for \$149.95

DYNACOMP CASSETTES

DYNACOMP now offers high quality DYNACOMP brand name C-20 cassettes for computer use. Each cassette is guaranteed to be defect-free.

Box of 10 cassettes: \$15.95 postpaid
Box of 20 cassettes: \$29.95 postpaid

AVAILABILITY

DYNACOMP software is supplied with complete documentation containing clear explanations and examples. Unless otherwise specified, all programs will run within 16K program memory space (ATARI requires 24K). Except where noted, programs are available on ATARI, PET, TRS-80 (Level II) and Apple (Apples II) cassette and diskette as well as North Star single density (double density compatible) diskette. Additionally, most programs can be obtained on standard (IBM format) 8" CP/M floppy disks for systems running under MBASIC. 5 1/4" CP/M diskettes are available for North Star and Osborne computer systems.

STATISTICS and ENGINEERING

DIGITAL FILTER (Available for all computers) Price: \$39.95 Cassette/\$43.95 Diskette
DIGITAL FILTER is a computer program which permits the user to design his own filter function or choose from a menu of filter forms. The filter forms are subsequently converted into non-recursive convolution coefficients which permit rapid data processing. In the explicit design mode the shape of the frequency transfer function is specified by directly entering points along the desired filter curve. In the menu mode, ideal low pass, high pass and bandpass filters may be approximated to varying degrees according to the number of points used in the calculation. These filters may optionally also be smoothed with a Hanning function. In addition, multi-stage Butterworth filters may be selected. Features of DIGITAL FILTER include plotting of the data before and after filtering, as well as display of the chosen filter functions. Also included are convenient data storage, retrieval and editing procedures.

DAT SMOOTHER (Not available for Atari) Price: \$19.95 Cassette/\$23.95 Diskette
This special data smoothing program may be used to rapidly derive useful information from noisy business and engineering data which are equally spaced. The software features choice in degree and range of fit, as well as smoothed first and second derivative calculation. Also included is automatic plotting of the input data and smoothed results.

FOURIER ANALYZER (Available for all computers) Price: \$39.95 Cassette/\$23.95 Diskette
Use this program to examine the frequency spectra of limited duration signals. The program features automatic scaling and plotting of the input data and results. Practical applications include the analysis of complicated patterns in such fields as electronics, communications and business.

TFA (Transfer Function Analyzer) Price: \$19.95 Cassette/\$23.95 Diskette
This is a special software package which may be used to evaluate the transfer functions of systems such as hi-fi amplifiers and filters by examining the response to pulsed input. TFA is a major modification of FOURIER ANALYZER and contains an engineering oriented decibel versus log-frequency plot as well as data editing features. Whereas FOURIER ANALYZER is designed for educational and scientific use, TFA is an engineering tool. Available for all computers.

HARMONIC ANALYZER (Available for all computers) Price: \$24.95 Cassette/\$28.95 Diskette
HARMONIC ANALYZER was designed for the spectrum analysis of repetitive waveforms. Features include data file generation, editing and storage/retrieval as well as data and spectrum plotting. One particularly unique facility that the input data need not be equally spaced or in order. The original data is sorted and a cubic spline interpolation is used to create the data file required by the FFT algorithm.

FOURIER ANALYZER, TFA and HARMONIC ANALYZER may be purchased together for a combined price of \$49.95 (three cassettes) and \$59.95 (three diskettes).

REGRESSION I (Available for all computers) Price: \$19.95 Cassette/\$23.95 Diskette
REGRESSION I is a unique and exceptionally versatile one-dimensional least squares "polynomial" curve fitting program. Features include very high accuracy; an automatic degree determination option; an extensive interlibrary of fitting functions; data editing; automatic data and curve plotting; a statistical analysis (eg: standard deviation, correlation coefficient, etc.) and much more. In addition, new fits may be tried without reentering the data. REGRESSION I is certainly the cornerstone program in any data analysis software library.

REGRESSION II (PARAFIT) (Available for all computers) Price: \$19.95 Cassette/\$23.95 Diskette
PARAFIT is designed to handle those cases in which the parameters are imbedded (possibly nonlinearly) in the fitting function. The user simply inserts the functional form, including the parameters (A(1), A(2), etc.) as one or more BASIC statement lines. Data and results may be manipulated and plotted as with REGRESSION I. Use REGRESSION I for polynomial fitting, and PARAFIT for those complicated functions.

MULTILINEAR REGRESSION (MLR) (Available for all computers) Price: \$24.95 Cassette/\$28.95 Diskette
MLR is a professional software package for analyzing data sets containing two or more linearly independent variables. Besides performing the basic regression calculation, this program also provides easy-to-use data entry, storage, retrieval and editing functions. In addition, the user may interrogate the solution by supplying values for the independent variables. The number of variables and data size is limited only by the available memory.

REGRESSION I, II and MULTILINEAR REGRESSION may be purchased together for \$51.95 (three cassettes) or \$63.95 (three diskettes).

ANOVA (Not available for PET/CBM) Price: \$39.95 Cassette/\$43.95 Diskette
In the past the ANOVA (analysis of variance) procedure has been limited to the large mainframe computers. Now DYNACOMP has brought the power of this method to small systems. For those conversant with ANOVA, the DYNACOMP software package includes the 1-way, 2-way and N-way procedures. Also provided are the Yates 2^k-P factorial designs. For those unfamiliar with ANOVA, do not worry! The accompanying documentation was written in a tutorial fashion by a professor in the subject and serves as an excellent introduction to the subject. Accompanying ANOVA is a support program for building the data base. Included are several convenient features including data editing, deleting and appending.

BASIC SCIENTIFIC SUBROUTINES, Volumes 1 and 2 (Not available for Atari)
DYNACOMP is the exclusive distributor for the software keyed to the popular texts BASIC SCIENTIFIC SUBROUTINES, Volumes 1 and 2 by F. Ruckdeschel (see advertisements in BYTE magazine). These subroutines have been assembled according to chapter. Included with each collection is a menu program which selects and demonstrates each subroutine.

Volume 1
Collection #1: Chapters 2 and 3 - Data and function plotting; complex variables and functions.
Collection #2: Chapter 4 - Extended matrix and vector operations.
Collection #3: Chapters 5 and 6 - Random number generators (Poisson, Gaussian, etc.); series approximations.
Price per collection: \$14.95 Cassette/\$18.95 Diskette
All three collections are available for \$39.95 (three cassettes) and \$49.95 (three diskettes).

Volume 2
Collection #1: Chapter 1 - Linear, polynomial, multidimensional, parametric least squares.
Collection #2: Chapter 2 - Series approximation techniques (economization, inversion, reversion, shifting, etc.).
Collection #3: Chapter 3 - Functional approximations by iteration and recursion.
Collection #4: Chapter 4 -CORDIC approximations to trigonometric, hyperbolic, exponential and logarithmic functions.
Collection #5: Chapter 5 - Table interpolation, differentiation and integration (Newton, LaGrange, splines).
Collection #6: Chapter 6 - Methods for finding the real roots of functions.
Collection #7: Chapter 7 - Methods for finding the complex roots of functions.
Collection #8: Chapter 8 - Optimization by steepest descent.
Price per collection: \$14.95 Cassette/\$18.95 Diskette

All eight collections are available for \$99.95 (eight cassettes) and \$129.95 (eight diskettes). Because the texts are a vital part of the documentation, BASIC SCIENTIFIC SUBROUTINES, Volumes 1 and 2 are available from DYNACOMP:

BASIC SCIENTIFIC SUBROUTINES, Vol 1 (339 pages): \$19.95 + 75c postage
BASIC SCIENTIFIC SUBROUTINES, Vol 2 (790 pages): \$23.95 + \$1.50 postage
See reviews in KILBAUD and Dr. Dobbs.

ROOTS (Available for all computers) Price: \$10.95 Cassette/\$14.95 Diskette
In a nutshell, ROOTS simultaneously determines all the zeroes of a polynomial having real coefficients. There is no limit on the degree of the polynomial, and because the procedure is iterative, the accuracy is generally very good. No initial guesses are required as input, and the calculated roots are substituted back into the polynomial and the residuals displayed.

ACTIVE CIRCUIT ANALYSIS (ACAP) (48K Apple only) Price: \$25.95 Cassette/\$29.95 Diskette
ACAP is the analog circuit designer's answer to LOGIC SIMULATOR. With ACAP you may analyze the response of an active or passive component circuit (e.g., a transistor amplifier, bandpass filter, etc.). The circuit may be probed at equal steps in frequency, and the resulting complex (i.e., real and imaginary) voltages at each component junction examined. By plotting the magnitude of these voltages, the frequency response of a filter or amplifier may be completely determined with respect to both amplitude and phase. In addition, ACAP prints a statistical analysis of the range of voltage responses which result from random variations in the components. ACAP is easy to learn and use. Simply describe the circuit in terms of the elements and their placement, and execute. Circuit descriptions may be saved onto cassette or diskette to be recalled at a later time for execution or editing. ACAP should be part of every circuit designer's program library.

LOGIC SIMULATOR (Apple only; 48K RAM) Price: \$24.95 Cassette/\$28.95 Diskette
With LOGIC SIMULATOR you may easily test your complicated digital logic design with respect to given set of inputs to determine how well the circuit will operate. The elements which may be simulated include multiple input AND, OR, NOR, EXOR, EXNOR and NAND gates, as well as the inverters, J-K, and D flip-flops, and one-shots. The response of the system is available every clock cycle. Inputs may be clocked in with varying clock cycle lengths/displacements and delays may be introduced to probe for glitches and race conditions. At the user's option, a timing diagram for any given set of nodes may be plotted using HIRSES graphics. Save your breadboarding until the circuit is checked by LOGIC SIMULATOR.

ORDERING INFORMATION

All orders are processed and shipped within 48 hours. Please enclose payment with order and include the appropriate computer information. If paying by VISA or MasterCard, include all numbers on card.

Shipping and Handling Charges
Within North America: Add \$1.50
Outside North America: Add 10% (Air Mail)

Delivery
All orders (excluding books) are sent First Class.

Quantity Discounts
Deduct 10% when ordering 3 or more programs. Dealer discount schedules are available upon request.

8" CP/M Disk
Add \$2.50 to the listed diskette price for each 8" floppy disk (IBM soft sector CP/M format). Programs run under MicroSoft MBASIC or BASIC-80.

5 1/4" CP/M Disk
All software available on 8" CP/M disks is also available on 5 1/4" disks, North Star format.

Ask for DYNACOMP programs at your local software dealer. Write for detailed descriptions of these and other programs from DYNACOMP.

DYNACOMP, Inc. (Dept. B)

1427 Monroe Avenue

Rochester, New York 14618

24 hour order phone: (716) 442-8731 recording
Office phone (9AM-5PM EST): (716) 442-8960

New York State residents please add 7% NYS sales tax.



Clocked Interrupts for the COSMAC Elf

Gary H. Price
733 Blue Sage Drive
Sunnyvale, CA 94086

Clocked (periodic) interrupts are useful in many microprocessor applications. My wish was to operate a data-logging system in the background while my COSMAC Elf was also executing other tasks. Clocked interrupts provide a relatively simple software-control method for the background task without burdening the system with software timing loops or flag checks.

Hardware

The 1802 microprocessor, around which the Elf is built, has a simple interrupt capability, which consists of a single hardware interrupt-request line that, when set, causes the pointers to the registers being used as stack pointer and program counter to be saved in register T, the assignment

of register 2 as stack pointer, the assignment of register 1 as program counter, and further interrupt requests to be ignored by the 1802 until the interrupt-request line is reenabled by the execution of the RET (Return) instruction.

The 1802 provides instruction for transferring T register contents to the stack; return from the interrupt-

Interlacing interrupt tasks can minimize interference.

service routine is accomplished by restoring the saved pointer values from the stack on execution of the RET instruction. The interrupt-request line can also be enabled and disabled under software control independently of the interrupt-service routine.

If the interrupt clock were to be the only source of interrupts in the system, the clock design would present few challenges. But, as do many 1802-based systems, my Elf includes an 1861 video-output processor. This device uses 1802 interrupt, direct memory access (DMA), and flag lines to produce low-resolution graphics

with partial software control of the output format. To use this capability concurrently with the clocked interrupts, some means for recognizing the source of an interrupt request must be provided.

An interrupt-priority structure is common to management of multiple-interrupt sources. Such a structure is, however, not necessarily the best choice when two interrupt sources are involved. If synchronizing the interrupt requests does not otherwise handicap performance, interlacing interrupt tasks will minimize their interference with each other; such is the case here, and the interrupt clock was therefore designed to synchronize with the 1861.

Additional hardware may not be needed in some instances. The interrupt clock could be fashioned in software by maintenance of a counter within the 1861 interrupt-service routine—a feasible alternative if the 1861 were never disabled and if its DMA-out requests could be accommodated even when no graphics output is intended. These constraints are sometimes awkward.

The clock circuit is diagrammed in figure 1 for the bus used in the

About the Author

Gary Price is a senior physicist in the Radio Physics Laboratory at SRI International, Menlo Park, California. His professional activities include scientific programming but little involvement with microprocessor hardware or software. He assembled the small Elf II system from kits to gain some understanding of the basic workings of microprocessor systems. His other hobbies include amateur radio (W6IRA) operation and letterpress printing.

Now NRI takes you inside the new TRS-80 Model III microcomputer to train you at home as the new breed of computer specialist!

NRI teams up with Radio Shack advanced technology to teach you how to use, program and service state-of-the-art microcomputers...

It's no longer enough to be just a programmer or a technician. With microcomputers moving into the fabric of our lives (over 250,000 of the TRS-80™ alone have been sold), interdisciplinary skills are demanded. And NRI can prepare you with the first course of its kind, covering the complete world of the microcomputer.

Learn At Home in Your Spare Time

With NRI training, the programmer gains practical knowledge of hardware, enabling him to design simpler,

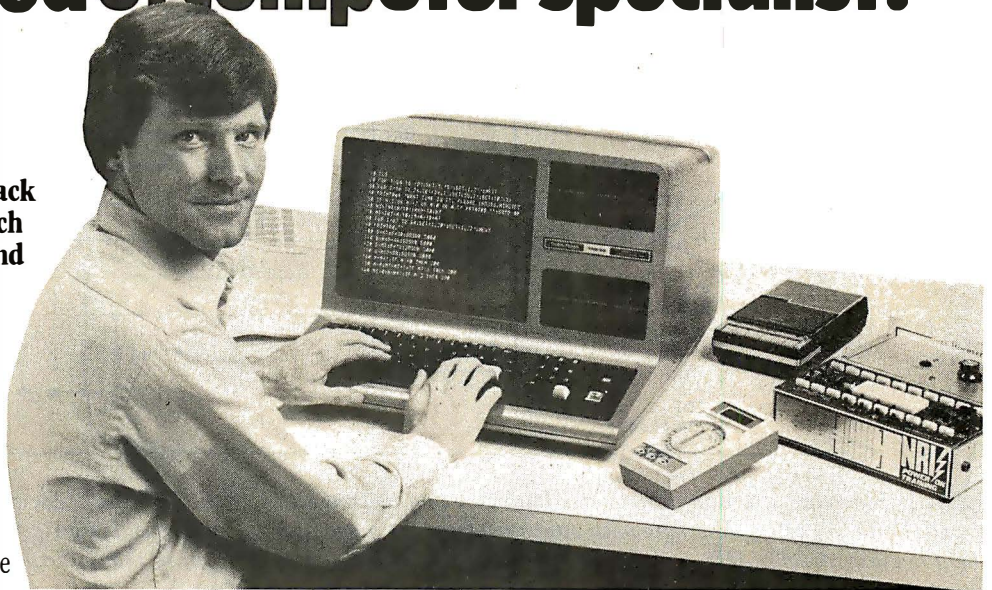

more effective programs. And, with advanced programming skills, the technician can test and debug systems quickly and easily.

Only NRI gives you both kinds of training with the convenience of home study. No classroom pressures, no night school, no gasoline wasted. You learn at your convenience, at your own pace. Yet you're always backed by the NRI staff and your instructor, answering questions, giving you guidance, and available for special help if you need it.

You Get Your Own Computer to Learn On and Keep

NRI training is hands-on training, with practical experiments and demonstrations as the very foundation of your knowledge. You don't just program your computer, you go inside it... watch how circuits interact... interface with other systems... gain a real insight into its nature.

You also work with an advanced liquid crystal display hand-held multimeter and the NRI Discovery Lab, performing over 60 separate experiments. You learn troubleshooting procedures

and gain greater understanding of the information. Both microcomputer and equipment come as part of your training for you to use and keep.

Send for Free Catalog... No Salesman Will Call

Get all the details on this exciting course in NRI's free, 100-page catalog. It shows all equipment, lesson outlines, and facts on other electronics courses such as Complete Communications with CB, TV/Audio and Video, Digital Electronics, and more. Send today, no salesman will ever bother you. Keep up with the latest technology as you learn on the latest model of the world's most popular computer. If card has been used, write to:

NRI NRI Schools
McGraw-Hill Continuing
Education Center
3939 Wisconsin Avenue
Washington, D.C. 20016

We'll train you for the good jobs!



Training includes new TRS-80 Model III microcomputer, 6-function LCD Beckman multimeter, and the NRI Discovery Lab with hundreds of tests and experiments.

(TRS-80 is a trademark of the Radio Shack division of Tandy Corp.)

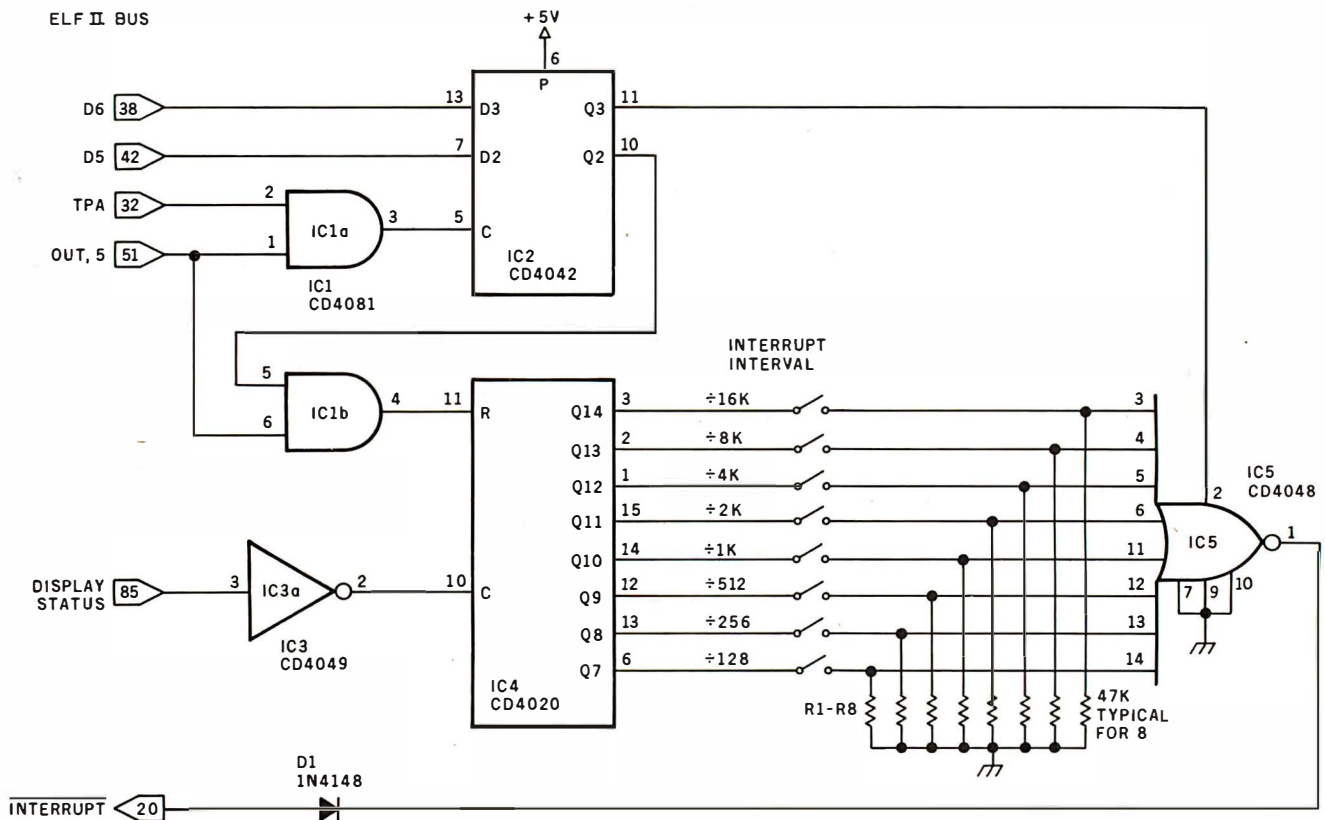

Figure 1: Schematic diagram of the clock hardware and its connection to the Elf II bus. The clocked interrupts are developed from system-timing signals to alternate with interrupts from the video display; neither will interrupt the other while it is being serviced by the processor. A set of DIP switches allows the user to select a division factor so that interrupts can occur at regular intervals from about two per second to one per minute.

Netronics Elf II; other Elf versions differ in their bus structures. Clock-interrupt requests are synchronized with those from the 1861 by driving the clock counter from the 1861 Display Status line, which remains active even when the 1861 is disabled. The line goes low twice during each 1861 video frame, or at about 122 Hz when the Elf is operated with a conventional 3.58-MHz crystal. The rate is divided by IC4, a 4020 CMOS 14-stage binary counter; the last eight stages provide interrupt-output rates ranging from about two requests per second to about one per minute.

The counter-output lines are fed through a set of switches to IC5, an eight-input programmable gate. The interrupt rate is determined by which switch is closed. You may use a control bit (D6) to disable the clock when desired; a second control bit (D5) resets the clock counter. With this arrangement, the clock-interrupt request remains present for up to one full clock interval when not immediately answered.

The interrupt source may be recognized by a Display Status signal test within the interrupt-service routine. In the Elf II, this 1861 output is fed to 1802 flag line 1, so it is readily accessible in software. Display Status is set low twice during each 1861 display frame: once during the last four horizontal video scans of the vertical-retrace time and again in the final four scans of the display frame. The 1861 interrupt-request signal is present only during the last half of the first of the two periods (when Display Status is low). Advancing the clock counter on the trailing (low-to-high) edge of the Display Status signal initiates the clock-interrupt requests while Display Status is high; those from the 1861 occur while Display Status is low. Thus a prompt test of flag line 1 within the interrupt-service routine can be used to distinguish between the two interrupt sources.

The clock-interrupt requests might occur at the end of the Display Status-low period just preceding the 1861 video-display time, rather than

Number	Type	+ 5 V	GND
IC1	CD4081	14	7
IC2	CD4042	16	8
IC3	CD4049	16	8
IC4	CD4020	16	8
IC5	CD4048	16	8

when Display Status goes high at the end of this time. If this happens, the clock-interrupt service activity and the 1861 display generation are overlaid rather than interlaced. This problem does not arise, however, if the 1802 interrupt line remains disabled from the beginning of the display generation until after termination of the second low period.

In this case response to the first mistimed clock-interrupt request is delayed until after passage of the proper Display Status-low signal. The consequent delay of the clock reset (initiated within the interrupt-service routine) insures correct timing for subsequent clock-interrupt requests. The interrupt-reenable delay needed for this adjustment is usually inher-

Qume® Data Trak™ Floppy Disk Drives

Distributed
by: **asap**
computer
products, inc.

The Data Trak™ 5 double-sided double-density drive uses state-of-the-art technology to give you superior data integrity through improved disk life, data reliability, and drive serviceability using 5¼" media.

Qume's independent head load yields wear characteristics far superior to competitive drives. This superior wear performance produces savings on both diskette usage and drive maintenance.

Improved data reliability, resulting from superior amplitude and bit shaft characteristics, optimizes operator efficiency and reduces processing time for end-users.

And Data Trak's unique modular design means simplified field servicing for you and your customers.

Design Features

Expanded storage capacity • Two-sided, double-density

Proven head carriage assembly • Ceramic head with tunnel erase • Dual-head flex mounting arrangement • Superior head load dynamics

Precise lead screw actuator • Fast access time — 12 ms track-to-track • Low friction and minimum wear • Low power dissipation

Additional features • Industry standard 5¼" media format • ISO standard write protect • Door lock out for media protection • Requires DC voltage only • Daisy Chain up to 4 drives • Heads load on command independent of loading media

Product Specifications

Performance Specifications • Capacity: Unformatted: 437.5K or 500K bytes; Qume Formatted: 286.7K or 327.7K bytes • Recording Density: 5456 BPI • Track Den-

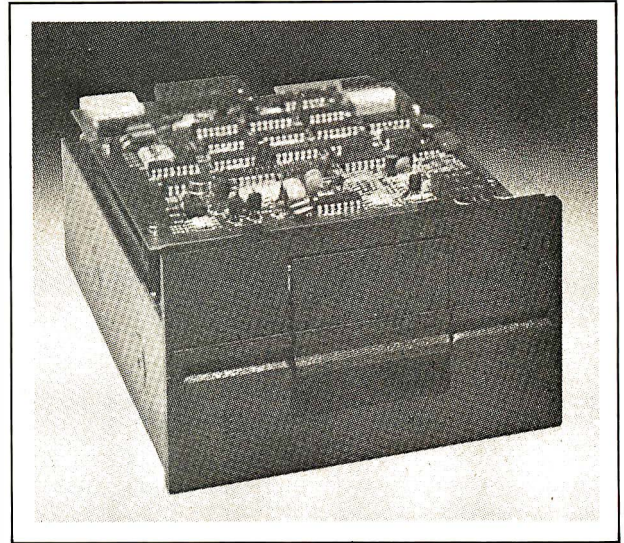

sity: 48 TPI • Cylinders: 35 or 40 • Tracks: 70 or 80 • Recording Method: FM or MFM • Rotational Speed: 300 RPM • Transfer Rate: 250K bits/second • Latency (avg.): 100 ms • Access Time: Track-to-track 12 ms; Settling 15 ms • Head Load Time: 50 ms

The Data Trak™ 8 double-sided double-density drive uses state-of-the-art technology to give you superior data integrity through improved disk life, data reliability, and drive serviceability.

Qume's innovative approach to controlling head load dynamics yields wear characteristics far superior to competitive drives. In independent evaluation, Data Trak 8 is setting industry standards for tap test performance. This superior wear performance produces savings on both diskette usage and drive maintenance.

Improved data reliability, resulting from superior amplitude and bit shift characteristics, optimizes operator efficiency and reduces processing time for end-users.

And Data Trak's unique modular design means simplified field servicing for you and your customers.

Design Features

Expanded storage capacity • Two-sided, double-density

Fully IBM compatible • IBM 3740 and System 32 drives • IBM 3600 and 4964 drives • IBM System 34 drives

Proven head carriage assembly • Ceramic head with tunnel erase • Dual-head flex mounting arrangement • Superior head load dynamics

Fast, precise steel belt drive • Fast access time — 3 ms track-to-track • Low friction and minimum wear • Low power dissipation

Additional features • ISO standard write protect • Programmable door lock • Negative DC voltage not required • Daisy Chain up to 4 drives • Side-by-side mounting in standard 19" RETMA rack • Compatible with Shugart SA850/SA851

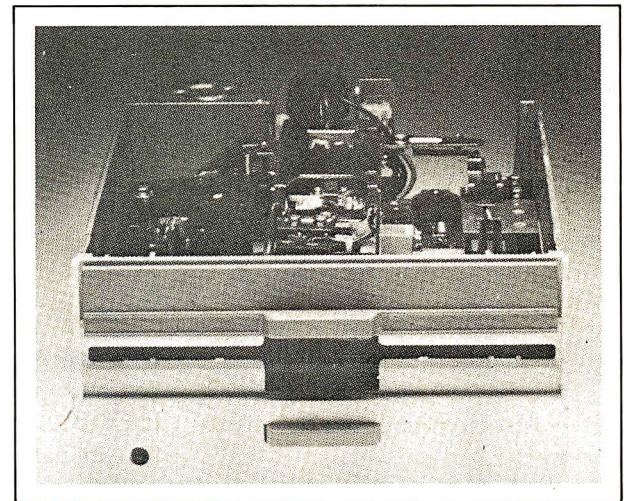

Product Specifications

Performance Specifications • Capacity: Unformatted: 1.6 Mbytes/disk; IBM Format: 1.2 Mbytes/disk • Recording Density: 6816 BPI • Track Density: 48 TPI • Cylinders: 77 • Tracks: 154 • Recording Method: MFM • Rotational Speed: 360 RPM • Transfer Rate: 500Kbits/second • Latency (avg.): 83 ms • Access Time: Track-to-track 3 ms; Settling 15 ms; Average 91 ms • Head Load Time: 35 ms • Disk: Diskette 2D or equivalent

asap
computer
products, inc.

1198 E. Willow, Signal Hill, CA 90806

Call Toll Free (800) 421-7701

AUTHORIZED DISTRIBUTOR FOR QUME
CALL FOR PRICE AND DELIVERY

(213) 595-6431 or (714) 891-2663 In California

Listing 1: A clock-test program illustrates interrupt-service techniques.

```

Label  Instr-  Argument  Comments
      uction
DIS    X=0,P=0  Disable 1802
              interrupt response
      LDI    PAGE
PHI,1  PHI,1
PHI,2  PHI,2
PHI,3  PHI,3
PHI,4  PHI,4
LDI    INT.0
PLO,1  PLO,1
LDI    STACK.0
PLO,2  PLO,2
LDI    MAIN.0
PLO,3  PLO,3
LDI    COUNT.0
PLO,4  PLO,4
LDI    ZERO      Initialize clock
              counter
STR,4  STR,4
OUT,4  ZERO      Display initial
              count
OUT,5  CLKSET    Start clock, with
              reset
RET    X=3,P=3  Jump to main, with
              interrupt enable
COUNT --
RETINT LDXA      interrupt-service
              return, restore
              registers
      PHI,4
LDXA   LDXA
PLO,4  PLO,4
LDXA   LDXA
SHL    SHL
LDXA   LDXA
RET    RET
INT    DEC,2      Entry, save register
              contents on stack
              T (old X,P)
      SAV
DEC,2  DEC,2
STXD   STXD
RSHR   RSHR
STXD   STXD
GLO,4  GLO,4
STXD   STXD
GHI,4  GHI,4
STXD   STXD
LDI    PAGE      Set up pointer
              to COUNT

```

```

PHI,4  PHI,4
LDI    COUNT.0
PLO,4  PLO,4
LDN,4  LDN,4      Increment count
ADI    ONE
STR,4  STR,4
STR,2  STR,2      Display count
OUT,4  OUT,4
DEC,2  DEC,2
LDI    CLKSET    Reset clock timer
STR,2  STR,2
OUT,5  OUT,5
BR     RETINT    Loop to return
MAIN  BN4      MAIN  Wait for interrupt
              or clock disable
OUT,5  CLKDIS    Disable clock
HOLD  B4      HOLD  hold disable
OUT,5  CLKENB    Reenable clock
BR     MAIN
--
--
--
STACK --

```

Register usage:
R1 Interrupt program counter
R2 Interrupt stack pointer
R3 Main program counter
R4 Storage pointer

Constants:
CLKENB 40*
CLKDIS 00
CLKSET 60*
ONE 01
PAGE 00
ZERO 00

Hex dump:
Location Contents
0000 71 00 F8 00 B1 B2 B3 B4 F8 26 A1 F8 FF A2 F8 43
10 A3 F8 1D A4 F8 00 54 64 00 65 60*70 33 00 72 B4
20 72 A4 72 FE 72 70 22 78 22 73 76 73 84 73 94 73
30 F8 00 B4 F8 1D A4 04 FC 01 54 52 64 22 F8 60*52
40 65 30 1E 3F 43 65 00 37 47 65 40*30 43

Notes:
*Hardware dependent, see text.

ently present in 1861 interrupt-service routines, so an additional software burden is seldom imposed by this requirement.

A stand-alone clock could be usefully improved if interrupt-rate selection was placed under software control. Replacement of the manual switches with logic gates achieves this. With two control bits performing the interrupt-disable and counter-reset functions, the remaining six can directly access six of the 4020 counter-output lines, or four can help a 4514 4-to-16 line decoder access all 14 counter-output lines. In the last instance, selecting one of the two unused decoder-output lines effectively disables the clock and no separate dis-

able bit is necessary. The decoder contains internal latches, so the 4042 latch (IC2) shown in figure 1 can also be eliminated.

Software

The interrupt clock's operation with your assembly-language programs presents few difficulties. Register 1 must be reserved as the program counter in the interrupt-service routine, and register 2's use as the stack pointer in this routine must also be anticipated. To assure that these registers are initialized before they are called upon by the interrupt-service routine, interrupts must be inhibited upon the 1802's initial entry into the run mode, following reset.

Because no provision is made for clock-hardware-interrupt requests to be disabled by 1802 reset, interrupt inhibition must be performed in software. The 1802 interrupt response is automatically disabled for one instruction following reset, providing sufficient time for this action to be accomplished by execution of a DIS (disable) instruction as the program's first instruction at location 0000.

Execution of the DIS instruction also reassigns the stack-pointer and program-counter registers, through replacement from the stack of the contents of registers X and P. Whenever the same register is being used as both program counter and stack

Text continued on page 312

Introducing The Grappler™:

The only interface that makes computer graphics easy as Apple pie.

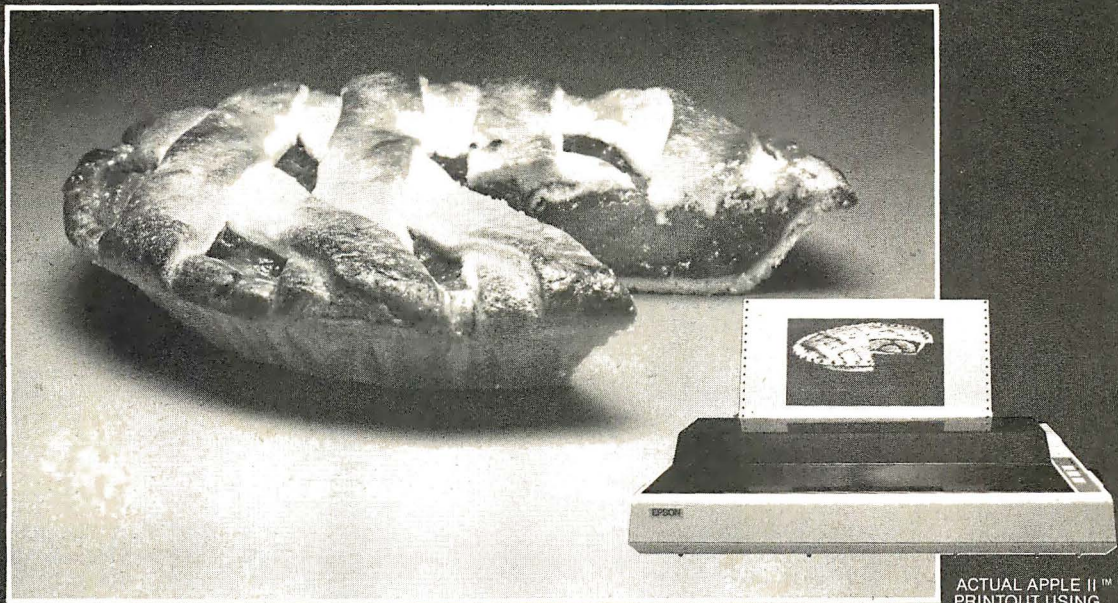

ACTUAL APPLE II™
PRINTOUT USING
GRAPPLER™ AND
EPSON MX-100.

Orange Micro offers the only universal parallel interface card that simplifies high resolution graphics for Apple™ computers. No longer does the user need to load clumsy software routines to dump screen graphics — it's all done by the Grappler's exclusive E-PROM chip. There are versions to accommodate the Anadex, Epson MX-100, MX-80* and MX-70, IDS Paper Tigers, Centronics 739, NEC 8023 and C. Itoh Prowriter, and future graphics printers. The Grappler™ accepts 18 simple software commands accessible through the keyboard or user program, making it the most intelligent Apple Interface available. Order The Grappler™ through Orange Micro direct, or authorized dealers.

*Requires Graftrax-80

FEATURES—User Benefits

GRAPHICS SCREEN DUMP—Choice of Hi-Resolution Graphics page 1 or page 2.

INVERSE GRAPHICS—Provides reverse graphics of black-on-white or white-on-black.

EMPHASIZED GRAPHICS—Allows high density graphics on certain printers.

DOUBLE SIZE PICTURE—Doubles the graphic screen representation vertically & horizontally.

90° ROTATION—Rotates the screen picture 90°.

CENTER GRAPHICS—Accomplished through setting left margin thereby centering the graph.

CHART RECORDER MODE—Successive horizontal pictures are combined continuously simulating a chart recorder.

BLOCK GRAPHICS—For printers with block graphics (e.g. Epson MX-80, Okidata M80), the high order bit can be controlled.

BELL—For printers with a bell, bell characters are deleted during user program listings.

MARGINS—Set left and right margins.

SKIP-OVER-PERF—Set page length; printer will automatically skip 6 lines between each page.

VARIABLE LINE LENGTH—For user program listings, sets line length and wraps around with breakpoint at nearest blank.

TEXT SCREEN DUMP—The text from a user report or page of program listing can be dumped directly from the screen.

WORKS WITH PASCAL & CPM

Dealer inquiries welcome to:

Waybern Corporation
(714) 554-4520

CompuCable Corporation
(714) 635-7330

Kal Tronics
(312) 291-1220



Orange Micro
inc.

3150 E. La Palma, Suite G, Anaheim, CA 92806

(800) 854-8275 TOLL FREE

(714) 630-3322 CA, AK, HI

The
Grappler™

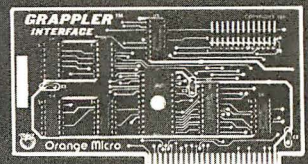

Listing 2: Coordination of clock and video display is tested by displaying clocked count on screen.

Label	Instr- uction	Argument	Comments			
	DIS	X=0,P=0	Disable 1802 interrupt response		SEX,2	
	GHI,0		Initialize registers		DEC,0	
	PHI,1				PLO,0	(DMA)
	PHI,2				SEX,2	
	LSKP		Reserve display space		DEC,0	
	IDL				PLO,0	(DMA)
	IDL				SEX,2	
	PHI,3				DEC,0	
	PHI,B				PLO,0	(DMA)
	PHI,C				BN1	REFR
	PHI,D				BR	RTN
	PLO,7		Initialize clock counter	HOLD	B4	HOLD
	LSKP			TVON	IN,1	Hold 1861 disable Enable 1861
	IDL				LDI	ZERO
	IDL				PLO,8	Start, translation of clock count to decimal, reset digit counters
	LDI	INT.0			PLO,9	Initialize digit pointer
	PLO,1				LDI	DGTSU.0
	LDI	STACK.0			PLO,D	Get count
	LSKP			LH	GLO,7	Extract hundreds digit
	IDL				SMI	HUND
	IDL				BM	TENS
	PLO,2				INC,8	
	LDI	MAIN.0			BR	LH
	PLO,3			TENS	ADI	HUND
	RET	X=2,P=3	Jump to main, with interrupt enable & R2 assigned as stack pointer	LT	SMI	TEN
					BM	UNITS
					INC,9	
					BR	LT
				UNITS	ADI	TEN
					STR,D	Store digits
MAIN	LDI	RESET	Activate clock		DEC,D	
	STR,2				GLO,9	
	OUT,5				STR,D	
	DEC,2				DEC,D	
	LSKP				GLO,8	
	IDL				STR,D	
	IDL				BNZ	DISPLY
LMAIN	BN4	TVON	Top of MAIN loop		ADI	TEN
	OUT,1		Disable 1861 video		STR,D	Test for nil hundreds digit
	DEC,2				INC,D	Blank if nil
	BR	HOLD			LDN,D	Test for nil tens digit
	IDL				BNZ	DISPLY
	IDL				ADI	TEN
RTNC	LDI	RESET	Interrupt-service routine		STR,D	Blank if nil
	STR,2		Reset clock	DISPLY	LDI	DGTSH.0
	OUT,5				PLO,D	Format decimal count for video display
	BR	SKIP			LDI	DSTRT
	IDL				PLO,B	Initialize display pointer
	IDL				LDI	MSKC1
SKIP	DEC,2		Increment clock count	LDSP	STR,2	Column mask to stack
	INC,7				LDN,2	Digit loop
	GLO,7				SHR	
	STR,2				STR,2	
	OUT,4				GLO,D	
RTN	LDXA		Restore registers		SHR	
	RET				BNF	ADV
INT	NOF		Entry to interrupt service routine		LDI	MSKC2
	DEC,2		Save register contents on stack		STR,2	Test for display byte hi/lo nibble
	SAV				INC,B	Reset column mask
	DEC,2					
	STXD					
	SEX,2		Timing			
	BN1	RTNC	Test for clock interrupt			
	INC,2					
	GHI,1		Set up DMA pointer for video output			
	PHI,0					
	LDI	DISP.0				
	PLO,0					
REFR	GLO,0		Display refresh loop			
	SEX,2		Timing			
	(DMA)					

Listing 2 continued on page 312

Microcomputer Workstations

from \$7,995.00

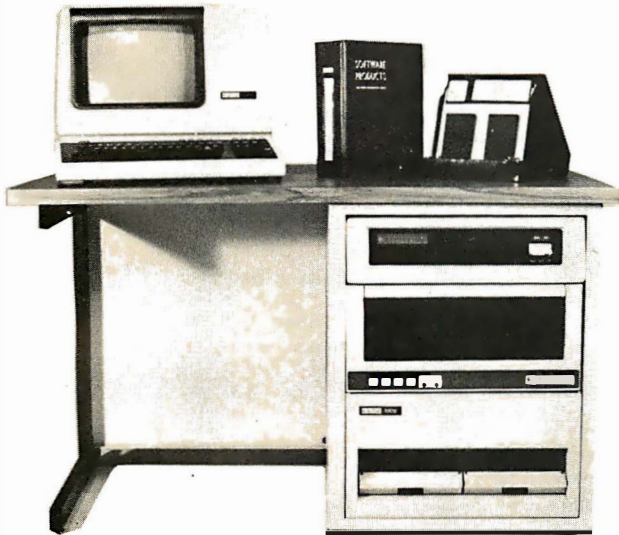

CI-MWS03-SB — LSI 11/2 computer workstation. LSI 11/2 CPU, 64KB Memory, power supply, KEV 11, in 16 slot rack mountable chassis. 2 port serial I/O. CRT terminal. 1 mega byte floppy disk system. Desktop workstation **\$7,995.00**

CI-MWS23-MB — LSI 11/23 computer workstation. LSI 11/23 CPU, MMU, 256KB Memory, power supply, in 16 slot rack mountable chassis. CRT terminal. 10 mega byte cartridge disk system. 4 port serial I/O. Desktop workstation **\$11,995.00**

CI-1103LK — LSI 11/2 CPU, 64KB Memory, power supply, KEV 11 in 16 slot rack mountable chassis **\$2,450.00**

PDP 1103SE — LSI 11/2 CPU, 64KB Memory, power supply, KEV 11 in 8 slot rack mountable chassis **\$2,695.00**

CI-11/23 AC — LSI 11/23 CPU, MMU, 256KB Memory, power supply, in 16 slot rack mountable chassis **\$4,995.00**

CI9448-96 — 96 mega byte cartridge disk system with controller. 80 mega bytes fixed and 16 mega bytes removable **\$10,500.00**



DON'T ASK WHY WE CHARGE SO LITTLE, ASK WHY THEY CHARGE SO MUCH.



Chrislin Industries, Inc.

31352 Via Colinas • Westlake Village, CA 91362 • 213-991-2254 • TWX 910-494-1253

LSI II is a trademark of Digital Equipment Corp.

Listing 2 continued:

```

SMI      DIGDEC      pointer
PLO,B
LDI      ROWCNT      Initialize row
PLO,9    counter
LROW     DEC,9       Row loop, decrement
          count
          DEC,A       Decrement bit count
          GLO,B       Advance display
          ADI      ROWADV      pointer
          PLO,B
          GHI,A       Extract character
          SHL          bits, to DF
          PHI,A
          LDN,B       Load display byte
          OR          Process bit, set
          BDF      PLOP      Test &
          XOR          reset if reset
          STR,B       Replace byte
          GLO,A       Check bit count
          BNZ      ENDROW
          LDN,C       Update character
          PHI,A       byte
          LDI      BITCNT
          PLO,A
          ENDROW     GLO,9    Check row count
          BNZ      LROW     Loop if not done
          LDN,2     Shift column mask
          SHR
          STR,2
          GLO,8     Check column count
          BNZ      LCOL     Loop if not done
          GLO,D     Check digits count
          SMI      CHARO.0
          BNZ      LDSP      Loop if not done
          BR      LMAIN     End main loop
          --        Stack space
          --
          --
          STACK
          DGTSH     --        Digits storage
          --
          DGTSU
          CHARO     --        74      Character table
          --        5C
          --        4F
          --        C2
          --        9D
          --        52
          --        8D
          --        54
          --        70
          --        BE
          --        ED
          --        64
          --        75
          --        64

```

Text continued from page 308:

pointer (as on entry into the run mode following reset), any instruction that references the stack actually accesses the byte immediately following the instruction in memory. Thus the initial DIS must precede an immediate data byte of value 00 to preserve register 0 as program counter and stack pointer until other registers are set up to perform these functions.

Several considerations must be kept in mind in the development of the interrupt-service routine. Basically, the contents of all registers outside the routine should be the same on

departure from the routine as at the time of the interrupt. Thus the contents of any register used by the interrupt-service routine and the external program should be saved—normally by storage on the stack—before the register is used within the routine. After the interrupt task is completed, contents are restored to their registers before returning to the interrupted program.

To illustrate the preceding points, listing 1 provides a program to verify the clock's basic operation. The interrupt-service routine is somewhat more complex than necessary to demonstrate the treatment of registers.

The contents of registers used by the routine—D, DF (in case of overflow on execution of the ADI at 0037), and 4—are all saved and restored, in addition to X and P. Also note the routine's loop structure, which causes register 1 to point to the routine entry upon exit from it.

The interrupt-service routine operation in listing 1 counts the interrupts serviced and shows this count on the Elf II's display, accessed in the Elf II via output port 4. Clock operation is inhibited by pressing the Elf I (input) key, which is connected to 1802 flag line 4 in the Elf II. The

Text continued on page 316

```

--      9D
--      30
--      55
--      54
--      45
--      5C
--      00
--      00

```

Register us age:

```

R0      DMA pointer
R1      Interrupt program counter
R2      Stack pointer
R3      Main program counter
R7.0    Clock count
R8.0    Hundreds digit, column counter
R9.0    Tens digit, row counter
RA.0    Bit counter
RA.1    Character byte, working storage
RB      Display pointer
RC      Character-table pointer
RD      Digit pointer/counter

```

Constants:

```

BITCNT  08
COLCNT  03
DIGDEC  28
DSTRT   26
HUND    64
MSKC1   10
MSKC2   80
RESET   60
ROWADV  08
ROWCNT  05
TEN     0A
ZERO    00

```

Hex dump:

Location	Contents
0000	71 00 90 B1 B2 C8 00 00 B3 BB BC BD A7 C8 00 00
10	F8 3F A1 F8 DF C8 00 00 A2 F8 20 A3 70 23 00 00
20	F8 60 52 65 22 C8 00 00 3F 5E 61 22 30 5C 00 00
30	F8 60 52 65 30 38 00 00 22 17 87 52 64 72 70 C4
40	22 78 22 73 E2 3C 30 12 91 B0 F8 00 A0 80 E2 E2
50	20 A0 E2 20 A0 E2 20 A0 3C 4D 30 3D 37 5C 69 F8
60	00 A8 A9 F8 E2 AD 87 FF 64 3B 6E 18 30 67 FC 64
70	FF 0A 3B 77 19 30 70 FC 0A 5D 2D 89 5D 2D 88 5D
80	3A 8C FC 0A 5D 1D 0D 3A 8C FC 0A 5D F8 E0 AD F8
90	26 AB F8 10 52 02 F6 52 8D F6 3B A0 F8 80 52 1B
A0	4D FE FC E3 AC 4C BA F8 08 AA F8 03 A8 28 8B FF
B0	28 AB F8 05 A9 29 2A 8B FC 08 AB 9A FE BA 0B F1
C0	33 C3 F3 5B 8A 3A CC 0C BA F8 08 AA 89 3A B5 02
D0	F6 52 88 3A AD 8D FF E3 3A 95 30 28 00 00 00 00
E0	00 00 00 74 5C 4F C2 9D 52 8D 54 70 BE ED 64 75
F0	64 9D 30 55 54 45 5C 00 00

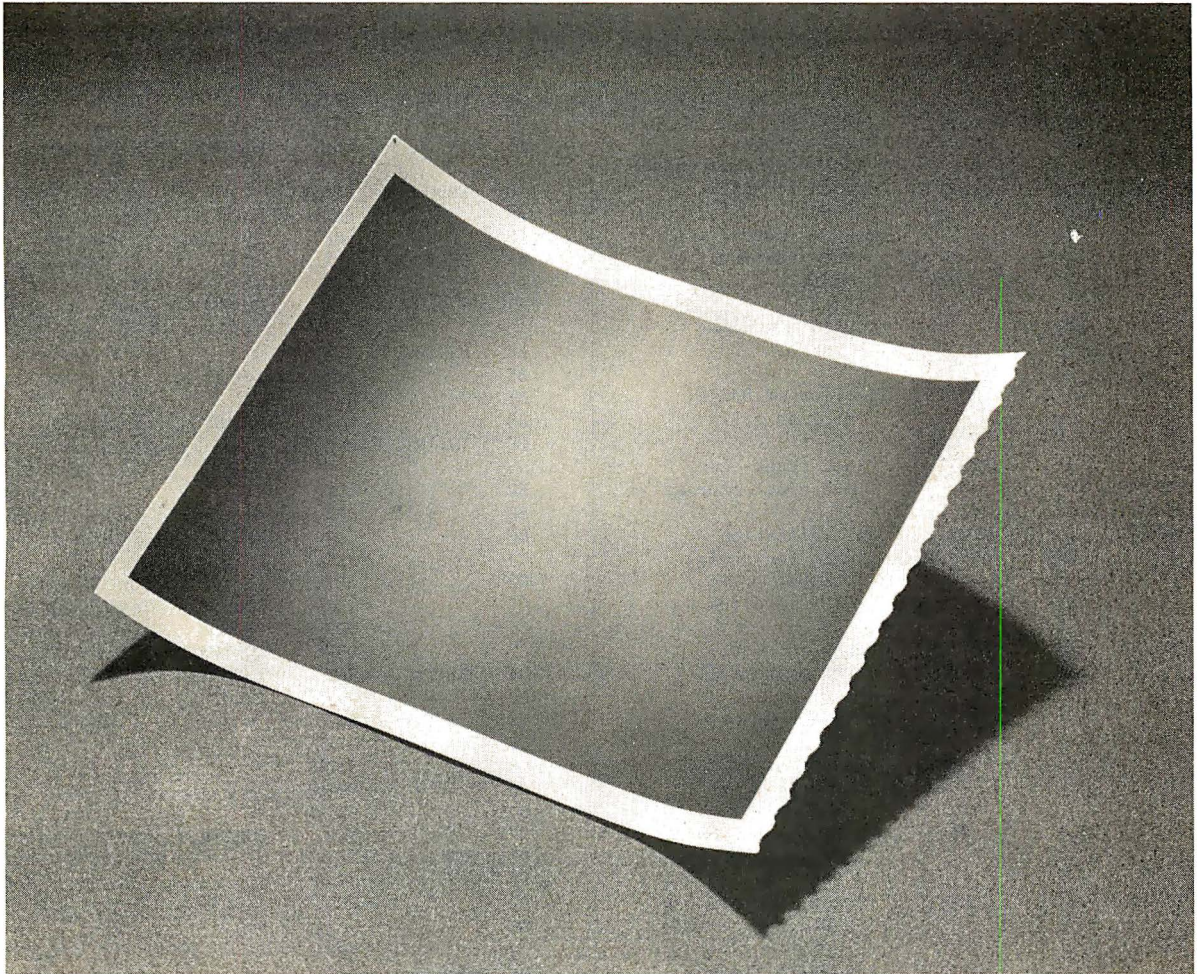

This is a picture
of all the printers in the world
that outsell the MX-80.

Epson.

The one thing you can't beat in the marketplace is value. And there simply isn't a better combination of reliability, print quality, features and price in an 80-column printer than the Epson MX-80. Anywhere on earth.

But while we're pleased to make the best-selling 80-column printer in the world, we're hardly surprised. Because we decided a long time ago that the way to succeed in this business is to build a good product, sell it at a fair price, and stand behind it.

So we built our MX-80 with features like a choice of 24 different type faces, graphics that rival plotters, logical seeking, bidirectional printing and the world's first disposable print head. We priced it at under \$650. And if it breaks, we'll be here to fix it.

That seems like a straightforward enough policy. But when we first introduced the MX-80, the competition

laughed. Now they're cutting prices, introducing "new" models, and running splashy color ads, all in an effort to catch up. And they're not laughing.

But you don't have to take our word for it. You've got a choice: you can buy the printer that's been embraced by several hundred thousand computer fanatics all over the world. Or you can buy something else. And take your chances.

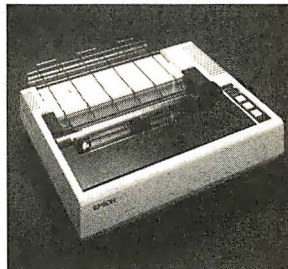

EPSON
EPSON AMERICA, INC.

3415 Kashiwa Street, Torrance, CA 90505 • (213) 539-9140

Listing 3: Tiny BASIC machine-language modifications to add clocked interrupts when using serial video terminal for I/O.

Location	Label	Instr- uction	Argument	Comments
0000		DIS	X=0,P=0	Disable 1802 interrupt response
02		LBR	BASIC	Branch to BASIC start
05		SEX,8		Monitor entry, with
06		DIS	X=0,P=0	1802 interrupt disable
--				
000F		SEP,8		Complete monitor link
--				
0020		--	PRGSTRT	Address of BASIC program start
--				
00B6		--	RESET	Clock reset code
B7	COUNTH	--		Clock count storage
B8	COUNTL	--		
B9	CONTINIT	B3	SKIP	Initialization
BB		BN4*	CONTINIT	Wait for serial input
BD		DIS	X=2,P=3	Disable clock
--				
0106	LCHARIN	LBR	CHARIN	Entry address
09		LBR	CHAROUT	Entry address
--				
0113		--	STKRES	ML stack reserve
--				
011C		--	PRGSTRT	Address of BASIC program start
--				
0182		--	CLKENB	IL jump table entry for clock enable
--				
01A2		--	CLKDIS	IL jump table entry for clock disable
--				
0202		--	INTINIT	Branch to finish interrupt setup
--				
0A7F		--	ENDCHIN	Branch to enable clock on exit from input routine
--				
0AA4		--	ENDCHOU	Branch to enable clock on exit from output routine
--				
0B13		--	LCHARIN	To funnel serial input through clock disable
--				
0B87	CLKENB	SEX,3		Clock enable routine
88		RET	X=D,P=5	by 1802 enable
8A	CLKDIS	SEX,3		Clock disable routine
8B		DIS	X=D,P=5	by 1802 disable
8D	CHARIN	GHI,E		Terminal input routine
8E		BNZ	CONT.A	
90		SEP,5		Return if cannot handle
91	CONT.A	SEX,3		Prepare to disable clock
92	WAIT	BN4*	WAIT	Wait for input
94		DIS	X=2,P=3	Disable clock
96		SHR		Adjust timing delay
97		SMI	ONE	for extra instructions
99		SEP,4	HALFTIME	
9C		B4*	CONT.B	
9E		SEX,3		False alarm,
9F		RET	X=2,P=3	enable clock
A1		BR	CHARIN	

A3	CONT.B	SEX,2		Timing
A4		SEX,2		
A5		LBR	STARTRD	Begin input processing
A8	ENDCHIN	SEX,3		Enable clock at end of input
A9		RET	X=2,P=3	of input
AB		LBR	FULLTIME	Finish up
AE	CHAROUT	SEX,3		Disable clock for character output
AF		DIS	X=2,P=3	
B1		LBR	STARTWR	Begin output processing
B4	ENDCHOU	SEX,3		Enable clock at end of output
B5		RET	X=2,P=3	
B7		GLO,C		
B8		LBR*	FINWR	Finish up
BB	INTINIT	PLO,7		Interrupt initialization
BC		LDI	INT.1	Set up R1 as interrupt program counter
BE		PHI,1		
BF		LDI	INT.0	
C1		PLO,1		
C2		SEX,3		For OUT byte
C3		BNF	CONT.C	Test cold/warm start
C5		OUT,5	ENABLE	Warm, enable clock
C7		LBR	CONTWARM	& continue
CA	CONT.C	RET	X=D,P=7	Cold, enable 1802
CC		--	COUNTH.0	& reset clock
CD		GHI,D		Zero count
CE		STXD		
CF		STXD		
D0		OUT,5		Reset
D1		SEX,3		
D2		LBR	CONTINIT	Back to mainstream
D5	RTN	SEX,2		Interrupt routine
D6		LDXA		Restore registers
D7		SHL		
D8		LDXA		
D9		RET		& return
DA	INT	DEC,2		Entry
DB		SAV		Save registers
DC		DEC,2		
DD		STXD		
DE		SHRC		
DF		STR,2		
E0		LDI	COUNTL.1	Set up R0 as pointer to clock count
E2		PHI,0		
E3		LDI	COUNTL.0	
E5		PLO,0		
E6		SEX,0		
E7		LDI	ONE	Increment count
E9		ADD		
EA		STXD		
EB		LDI	ZERO	
ED		ADC		
EE		STXD		
EF		OUT,5		Reset clock counter
F0		BR	RTN	

Addresses and constants:

BASIC	0100
CONTWARM	021A
ENABLE	40
FINWR	0ADE
FULLTIME	00F6
HALFTIME	00F9
ONE	01
PRGSTRT	0BF2
RESET	60
SKIP	E1
STARTRD	0A65
STARTWR	0A83
STKRES	1C
ZERO	00

Listing 3 continued on page 316

Double your disk storage capacity...



simply by switching to Omni's new reversible disk.

If you have an Apple, TRS-80, Zenith, North Star or any other single-sided 5¼" disk drive, you can double disk capacity by simply switching to the Flip/Floppy disk from Omni. It works just like your present disks, except you can flip it over and record on the reverse side. So you can consolidate programs and files that used to require two disks. You can halve your disk requirements. And save money.

Each disk comes with some impressive specifications: They're certified error-free at more than twice the error-threshold of your system. Rated for more than 12 million passes without disk-related errors or significant wear. And precision fabricated with such standard features as reinforced hub rings.

Call Omni toll-free today. Get premium disks. Twice the capacity. A full money-back guarantee. Unbeatable price. And if you order a ten pack now, a free \$5.00 storage case as well.

OMNI

Omni Resources Corporation

4 Oak Pond Avenue, Millbury, MA 01527
(800) 343-7620 In Mass. (617) 799-0197

Dealer inquiries invited.

Software Houses: We also offer duplicating and formatting services.

\$26.00-Five pack

(Equivalent to 10 single-sided disks)

\$50.00-Ten pack

(Equivalent to 20 single-sided disks)

Free

Protective plastic storage case with each 10 pack ordered by 3/1/81



Order toll-free (800) 343-7620.
In Mass. (617) 799-0197.

Send the following Flip/Floppy disks.

I understand they have a full 90 day money-back guarantee if I'm not completely satisfied.

System & model # _____

___ Five packs @ \$26.00 \$ _____

___ Ten packs @ \$50.00* \$ _____

* includes plastic case

Shipping and handling \$ 1.50 _____

5% sales tax (Mass. only) \$ _____

Total \$ _____

___ Check (to Omni Resources) ___ C.O.D.

___ Master Card ___ Visa

Card # _____ Exp. _____

Name _____

Address _____

Tel _____

Listing 3 continued:

Hex list:

Location	Contents
0000	7 00 C0 01 00 E8 71 00 D8
--	
0020	0B F2 . . .
--	
00B6	. . . 60 00 00 36 E1 3F*B9 71 23 .
--	
0106	. . . C0 0B 8D C0 0B AE . . .
--	
0113	. . . 1C 0B F2 . . .
--	
0182	. . 0B 87 . . .
--	
01A2	. . 0B 8A . . .
--	
0202	. . 0B BB . . .
--	
0A7F 0B
80	A8 . . .
--	
0AA3	. . . C0 0B B4 . . .
--	
0B13	. . . 01 06 . . .
--	
0B87 E3 70 D5 E3 71 D5 9E 3A 91
90	D5 E3 3F*92 71 23 F6 FF 01 D4 00 F9 37*A3 E3 70
A0	23 30 8D E2 E2 C0 0A 65 E3 70 23 C0 00 F6 E3 71
B0	23 C0 0A 83 E3 70 23 8C C0*0A DE A7 F8 0B B1 F8
C0	DA A1 E3 3B CA 65 40 C0 02 1A 70 D7 B7 9D 73 73
D0	65 E3 C0 00 B9 E2 72 FE 72 70 22 78 22 73 76 52
E0	F8 00 B0 F8 B8 A0 E0 F8 01 F4 73 F8 00 74 73 65
F0	30 D5
--	

Notes:

*For unmodified Netronics Tiny BASIC, change B4 (37) to BN4 (3F), BN4 (3F) to B4 (37), and the LBR (C0) at OBB8 to SEP,5 (D5).

Text continued from page 312:

clock-control byte is sent in this and other program listings to parallel port 5, with bits 6 and 7 (i.e., D5 and D6) used for clock reset and enable, respectively (see figure 1). These assignments should match the hardware implementation of the clock with which the program is run.

Listing 2 illustrates modification of a standard 1861 display routine to sort 1861 and clock interrupts. The clock portion of the interrupt-service routine again counts clock interrupts, and the count is sent to the Elf II's display and the 1861 video-display device. The video-displayed count is translated from hexadecimal to decimal before being formatted for storage in the display memory area. The I key disables the 1861 in this program, permitting independent clock operation to be checked.

The interrupt-service routine's particular placement within the overall program (see listing 2) is not critical; the arrangement shown is simply the first that gave a reasonably efficient procedure for allocating memory space to the display area. Allocation is normally straightforward, but the decision to confine the program (including display) entirely to a single page of memory makes it less so.

The possible disruption of 1861 timing, however, requires serious attention. A strict relationship must be preserved between the onset of 1861 interrupt and DMA requests and the 1802 instruction fetch/execute cycle, in order to maintain a jitter-free video display. To preserve this timing relationship, no three-cycle (fetch/execute/execute) instructions are included within the interrupted program; the one-cycle 1802 interrupt response is compensated by including an odd number of such instructions within the interrupt-service routine, preceding the first low SYNC pulse output by the 1861 subsequent to the 1802 interrupt response. For 1861 interrupts, the pulse normally occurs on the thirteenth 1802 machine cycle following the 1802 interrupt-request response.

The SYNC pulse location within the clock-interrupt-service sequence

Text continued on page 320

Need a Real-Time Multi-Tasking Executive for 8080 and Z80?



- Faultless operation proven in world wide use
- Truly hardware independent
- Optimized for fast interrupt response
- Minimal memory requirements
- ROMable for control applications
- Terminal Handler is CP/M BDOS compatible
- Console Driver supports Intel iSBC boards
- SYSGEN speeds user system configuring
- Program in PL/M, Fortran, Pascal or Assembler
- Source code included (Intel or Zilog mnemonics)
- Unlimited use licence agreement
- Complete documentation (available separately)
- Low cost



KADAK Products Ltd.

206-1847 West Broadway Avenue
Vancouver, B.C., Canada V6J 1Y5
Telephone (604) 734-2796

Dealer enquiries invited

CP/M is a trademark of Digital Research Corp.; RMX/80, iSBC are trademarks of Intel Corp.

MULTI-USER OASIS HAS THE FEATURES PROS DEMAND. READ WHY.

Computer experts (the pros) usually have big computer experience. That's why when they shop system software for Z80 micros, they look for the big system features they're used to. And that's why they like Multi-User OASIS. You will too.

DATA INTEGRITY: FILE & AUTOMATIC RECORD LOCKING

The biggest challenge for any multi-user system is co-ordinating requests from several users to change the same record at the same time.

Without proper co-ordination, the confusion and problems of inaccurate or even destroyed data can be staggering.

Our File and Automatic Record Locking features solve these problems.

For example: normally all users can view a particular record at the same time. But, if that record is being updated by one user, automatic record locking will deny all other users access to the record until the up-date is completed. So records are always accurate, up-to-date and integrity is assured.

Pros demand file & automatic record locking. OASIS has it.

SYSTEM SECURITY: LOGON, PASSWORD & USER ACCOUNTING

Controlling who gets on your system and what they do once they're on it is the essence of system security.

(THEN COMPARE.)

Without this control, unauthorized users could access your programs and data and do what they like. A frightening prospect isn't it?

And multi-users can multiply the problem.

But with the Logon, Password and Privilege Level features of Multi-User OASIS, a system manager can specify for each user which programs and files may be accessed—and for what purpose.

Security is further enhanced by User Accounting—a feature that lets you keep a history of which user has been logged on, when and for how long.

Pros insist on these security features. OASIS has them.

EFFICIENCY: RE-ENTRANT BASIC

A multi-user system is often not even practical on computers limited to 64K memory.

OASIS Re-entrant BASIC makes it practical.

How? Because all users use a single run-time BASIC module, to execute their compiled programs, less

memory is needed. Even if you have more than 64K, your pay-off is cost saving and more efficient use of all the memory you have available—because it services more users.

Sound like a pro feature? It is. And OASIS has it.

AND LOTS MORE...

Multi-User OASIS supports as many as 16 terminals and can run in as little as 56K memory. Or, with bank switching, as much as 784K.

Multi-Tasking lets each user run more than one job at the same time.

And there's our BASIC—a compiler, interpreter and debugger all in one. An OASIS exclusive.

Still more: Editor; Hard & Floppy Disk Support; Keyed (ISAM), Direct & Sequential Files; Mail-Box; Scheduler; Spooler; all from OASIS.

Our documentation is recognized as some of the best, most extensive, in the industry. And, of course, there's plenty of application software.

Put it all together and it's easy to see why the real pros like OASIS. Join them. Send your order today.

OASIS IS AVAILABLE FOR SYSTEMS: Altos; CompuCorp; Cromemco; Delta Products; Digital Group; Digital Microsystems; Dynabyte; Godbout; IBC; Index; Intersystems; North Star; Onyx; SD Systems; TRS 80 Mod II; Vector Graphic; Vorimex.

CONTROLLERS: Bell Controls; Cameo; Corvus; Konan; Micromation; Micropolis; Tarbell; Teletek; Thinkertoys; X Comp

Write for complete, free Application Software Directory

PLEASE SEND ME:

Product	Price with Manual	Manual Only
OPERATING SYSTEM (Includes: EXEC Language; File Management; User Accounting; Device Drivers; Print Spooler; General Text Editor; etc.) SINGLE-USER MULTI-USER	\$150 350	\$17.50 17.50
BASIC COMPILER/INTERPRETER/DEBUGGER	100	15.00
RE-ENTRANT BASIC COMPILER/INTERPRETER/DEBUGGER	150	15.00
DEVELOPMENT PACKAGE (Macro Assembler; Linkage Editor; Debugger)	150	25.00
TEXT EDITOR & SCRIPT PROCESSOR	150	15.00
DIAGNOSTIC & CONVERSION UTILITIES (Memory Test; Assembly Language; Converters; File Recovery; Disk Test; File Copy from other OS; etc.)	100	15.00
COMMUNICATIONS PACKAGE (Terminal Emulator; File Send & Receive)	100	15.00
PACKAGE PRICE (All of Above) SINGLE-USER MULTI-USER	500 850	60.00 60.00
FILE SORT	100	15.00
COBOL-ANSI '74	750	35.00

Order OASIS from:

Phase One Systems, Inc.
7700 Edgewater Drive, Suite 830
Oakland, CA 94621

Telephone (415) 562-8085
TWX 910-366-7139

NAME _____
STREET (NO BOX #) _____
CITY _____
STATE _____ ZIP _____

AMOUNT \$ _____
(Attach system description; add \$3 for shipping; California residents add sales tax)
 Check enclosed VISA
 UPS C.O.D. Mastercharge
Card Number _____
Expiration Date _____
Signature _____



MAKES MICROS RUN LIKE MINIS

Listing 4: Tiny BASIC machine-language modifications to add clocked interrupts when using parallel keyboard input and 1861 video device for output.

Location	Label	Instr- uction	Argument	Comments					
0000		DIS	X=0,P=0	Disable 1802 interrupt response	6B	STR,2			
					6C	SEX,0		For clock	
					6D	BN1	CLOCK	Test interrupt type	
02		LBR	BASIC	Branch to BASIC start	6F	LDI	DISP.1	Video branch	
05		SEX,3		Monitor entry, with	71	PHI,0			
06		DIS	X=0,P=0	1802 interrupt disable	72	LDI	DISP.0		
--					74	PLO,0			
00B6		--	RESET	Reset data byte	75	VIDLOOP	GLO,0		
B7	COUNTH	--	ZERO	Clock count storage			(DMA)		
B8	COUNTL	--	ZERO		76	DEC,0			
B9	CONTINIT	PLO,7		Continue initialization	77	PLO,0			
BA		SEX,3		Enable clock	78	PLO,C			
BB		OUT,5	ENABLE			(DMA)			
BD		LBDF	CONTWARM	Branch if warm start	79	DEC,0			
C0		OUT,5	RESET	Reset clock	7A	PLO,0			
C2		SEP,7	COUNTH.0	& zero count	7B	GHI,0			
C4		GHI,D				(DMA)			
C5		STXD			7C	XRI	ENDPAGE		
C6		STXD			7E	BNZ	VIDLOOP		
C7		PHI,E		Set I/O-type flag	80	PHI,C			
C8		LDI	.FF.	& continue	81	LDI	VIDCNT.0		
CA		SEP,4	LCHAROUT		83	PLO,C			
CD		LBR	CONTCOLD		84	LDX			
D0	CLKENB	SEX,3		IL Clock enable routine	85	ADI	ONE		
D1		OUT,5	ENABLE	Return	87	STR,C			
D3		SEP,5			88	SMI	MAXCNT		
D4	CLKDIS	SEX,3		IL Clock disable routine	8A	SEX,C		Timing for following clock interrupt	
D5		OUT,5	DISABLE	Return					
D7		SEP,5			8B	BNF	RTNINT		
--					8D	STXD			
0106		LBR	CHARIN	Entry to character input routine	8E	LDX			
					8F	ADI	ONE		
09	LCHAROUT	LBR	CHAROUT	Entry to character output routine	91	STR,C			
--					92	BR	RTNINT		
0113		--	STKRES	ML stack reserve	94	CLOCK	LDI	COUNTL.1	Clock service
--					96		PHI,0		Set up R0 as
0182		--	CLKENB	IL table entry, clock enable	97		LDI	COUNTL.0	pointer to
--					99		PLO,0		clock count
01A2		--	CLKDIS	IL table entry, clock disable	9A		LDI	ONE	Increment cour
--					9C		ADD		
0202		--	CONTINIT	Branch address to pick up clock initialization	9D		STXD		
09D9		--	INT.0	Lo byte, interrupt service entry	9E		LDI	ZERO	
--					A0		ADC		
09DC		--	INT.1	Hi byte	A1		STXD		
--					A2		OUT,5		Reset clock
0A5A	RTNINT	LDI	MON.1	Interrupt service routine	A3		BR	RTNINT	
					--				
5C		PHI,0		Set R0 up for monitor jump	0AD6		SEX,2		To delete 1802 interrupt disable on 1861 disable
5D		LDI	MON.0						
5F		PLO,0							
60		SEX,2		Restore saved register contents					
61		LDXA							
62		SHL							
63		LDXA							
64		RET							
65	INT	NOP		Entry, establish timing					
66		DEC,2		Save registers					
67		SAV							
68		DEC,2							
69		STXD							
6A		SHRC							

Addresses and constants:

BASIC	0100
CHARIN	0AB0
CHAROUT	0ABA
CONTCOLD	0204
CONTWARM	021A
DISABLE	00
DISP.0	80
DISP.1	0D
ENABLE	40
ENDPAGE	0F
MAXCNT	3D
MON.0	00
MON.1	F0
ONE	01
RESET	60
STKRES	1C
VIDCNT.0	0F
ZERO	00
.FF.	0C

A Database System that thinks like you do.

Sequitur. Its name suggests both its simplicity and its secret.

We linked a word processor and a relational database system together with a powerful minicomputer and produced one of the rarest forms of computer life: a system so sophisticated that a beginner can use it.

It helps you learn.

It's amazingly friendly. You can sit down in front of a terminal, pick up the Sequitur operating manual, and computerize your own data. So can anybody else, no matter how computer-shy. Even unassisted, it won't take more than a few hours of tinkering.

You can enter, edit, excerpt and report in a logical, orderly sequence. You just list the data you want to store. Sequitur organizes it into an easy-to-read table, which you can edit or call up at will, all or in part. Then you're ready to ask questions, make reports, print forms, write form letters or whatever.

It speaks your language.

You work with simple, clear commands. Sequitur avoids the arbitrary codes and rituals that

clutter up most systems.

To add a row to a table, you just type in the word "ADD," then fill in the blanks. In other systems, the same operation typically requires something like "INSERT INTO EMP (EMPNO, ENAME, JOB, SAL): <7989, 'CARTER', 'SALESMAN', 1500>:"

Its cost is friendly, too.

Today, Sequitur is ready to work with the multi-user Unix version 7 operating system or with most Unix look-alikes on any 16-bit machine.

You can install Sequitur on your computer for \$3495. If you investigate serious

Unix-compatible software, you'll know what a good price that is.

But you'll never appreciate Sequitur until you see it in action.

For a complete demonstration, get in touch with Pacific Software, 2608 Eighth Street, Berkeley, CA 94710. Phone (415) 540-0616.

Sequitur™

Pacific Software
Manufacturing Company

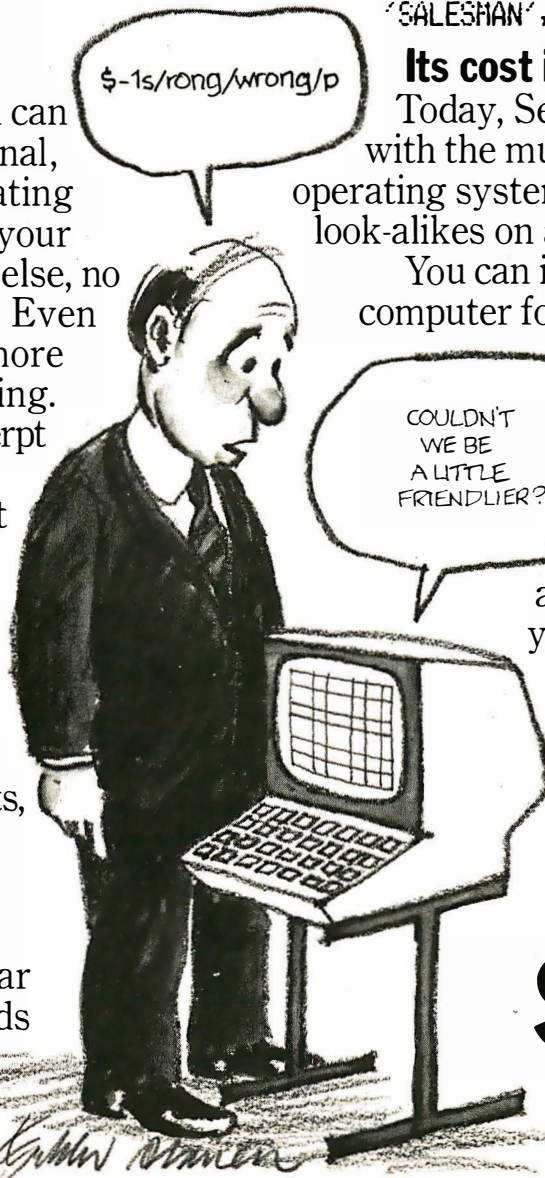

Unix is a trademark of Bell Laboratories.

Listing 4 continued:

Hex list:

Location	Contents
0000	71 00 C0 01 00 E3 71 00 . . .
00B6	. . . 60 00 00 A7 E3 65 40 C3 02 1A
CO	65 60 D7 B7 9D 73 73 BE F8 0C D4 01 09 C0 02 04
DO	E3 65 40 D5 E3 65 00 D5 . . .
0106	. . . C0 0A B0 C0 0A BA . . .
0113	. . . 1C . . .
0182	. . 00 D0 . . .
01A2	. . 00 D4 . . .
0202	. . 00 B9 . . .
09D9	. . . 65 . . 0A . . .
0A5A	. . . F8 F0 B0 F8 00 A0
60	E2 72 FE 72 70 C4 22 78 22 73 76 52 E0 3C 94 F8
70	0D B0 F8 B0 A0 80 20 A0 EC 20 A0 90 FB 0F 3A 75
80	BC F8 0F AC F0 FC 01 5C FF 3D EC 3B 5A 73 F0 FC
90	01 5C 30 5A F8 00 B0 F8 B8 A0 F8 01 F4 73 F8 00
A0	74 73 65 30 5A . . .
0AD6	. . . E2 . . .

Text continued from page 316:

depends, however, on the timing of the exit from the preceding 1861 interrupt service, near the end of which the clock-interrupt request is normally set. If unrecognized, the dependence can lead to difficulties. In particular, if the SYNC pulse immediately follows the 1802 response to a clock-interrupt request, the interrupt cycle cannot be compensated before timing is tested by the 1861; in this case some minor display jitter occurs with each clock interrupt regardless of where timing is adjusted within the clock-service routine. Timing adjustment of the return from the 1861 interrupt-service routine is necessary here to eliminate the problem (see listing 4).

Careless placement within the interrupt-service routine of the test to separate clock and 1861 interrupt requests may also produce surprises in the Elf II if the Netronics Giant board has been installed. One function performed by this board is to logically OR 1861 Display Status and SYNC to produce the input to the 1802's flag line 1. The flag is consequently reset during the SYNC-low intervals, even when Display Status is low. The flag test fails to distinguish between the two interrupt sources if it is executed at this time.

The interrupt clock can also be used while running Tiny BASIC on

the Elf, although not without some modification of the BASIC interpreter. The major difficulty to be overcome is interruption by the clock of serial I/O (input/output) transfers. In the Elf, the transfers are handled directly by the 1802 with software formatting and decoding of serial signals. Clock interrupts must therefore be inhibited during the transfers to avoid losing serial data. Interference with the clock unavoidably introduces minor variation to its rate; the variation, though undesirable, is probably less troublesome in many clock applications than are serial-data errors to BASIC use.

Two types of serial transfers are found in Tiny BASIC operation on the Elf: those to and from the terminal, and program SAVES and LOADS to and from cassette tape. Whether terminal I/O involves serial data transfer depends on the terminal hardware used. Both serial terminal and parallel keyboard input are supported by the Tiny BASIC used here, along with serial terminal and direct (1861) video output. The specific interpreter modifications required to implement the clock depend somewhat upon which hardware options are used and on the Tiny BASIC version being run.

Serial I/O is best dealt with by execution of a clock disable on entry

to the input or the output subroutine, followed by a reenable on exit. Clock operation does not affect parallel keyboard input, but the direct video output normally associated with such input in the Elf II involves 1861 interrupts. In this case the interrupt-service routine requires attention. An interrupt-service routine must be provided to perform the clock-initiated task, as well as code within the BASIC-initialization sequence to reset the clock. The interrupt pointer must also be defined preceding interrupt enable.

Protection of the SAVE and LOAD operations from clock interruption, though basically accomplished in the same manner as for terminal I/O, is most simply addressed in the context of the IL (intermediate language) through which BASIC instruction decoding is achieved. This is the approach adopted here, though it does not protect direct use of the tape read and write routines, through USR calls, from interruption by the clock. If such operation is contemplated, the routines should be protected at the machine-language level.

Stack use by the clock's interrupt-service routine must also be taken into account. This problem has been conservatively handled by addition to the stack reserve of the number of bytes used by the clock-service routine. Fewer bytes are probably necessary than are allocated, because the original stack reserve includes an allowance for its use by the 1861 interrupt-service routine. This last routine is denied free rein in Tiny BASIC, however; a prudent course is best in the absence of sure knowledge about the relevance of this restriction to the size of the original stack allocation.

Listings 3 through 5 detail patches developed to implement the clock—with storage in memory of its count—on my Elf II while running Netronics Tiny BASIC. Listing 3 describes changes and additions required by the clock when using serial terminal I/O. The modifications to Tiny BASIC recommended by Netronics for use with its video-terminal board are also assumed. If not, instructions marked with an asterisk should be changed as

Untype 60 words per minute.



The IBM Electronic 75 Typewriter can erase faster than some people can type.

At the touch of a button, it can automatically lift a character, a word, or an entire line clean off a page.

But not only does the IBM Electronic 75 offer you automatic erasing, it also offers you automatic indents, centering, underlining and column layout.

As well as a memory that can store up to 7,500 characters.



(With optional memory: 15,500.)

So if you're interested in saving time, consider the

IBM Electronic 75 Typewriter.

You'll be surprised how fast your typing gets done.

And undone.

To order call *IBM Direct* at the toll-free numbers below. Or, for a free demonstration call your local IBM Office Products Division Representative.

Free demonstration

For a free demonstration of the IBM Electronic 75 Typewriter, write today to: IBM Office Products Division, 400 Parson's Pond Drive/ Dept. 804 L. Franklin Lakes, N.J. 07417.

NAME _____

TITLE _____

COMPANY _____

STREET ADDRESS _____

CITY _____

STATE _____ ZIP _____

BUSINESS PHONE _____



128-12-81

Call *IBM Direct* 800-631-5582 Ext. 128. In New Jersey 800-352-4960 Ext. 128.

In Hawaii/Alaska 800-526-2484 Ext. 128.

indicated by the note at the listing's end.

Additional space for BASIC programs can be obtained, should the Netronics modifications not have been made, by moving the block of code located between hexadecimal addresses 0B87 and 0BD9 forward to start at 0AA6. This last change requires adjustment of many instructions to indicate new jump and entry-

point addresses in the relocated code. Remember to change the start address of the BASIC program area, stored at hexadecimal locations 0020 and 011C, if this modification is made; otherwise, the additional space is not actually allocated. Finally, note that monitor access is not provided in this case. The monitor call is also changed slightly, to USR(12,5,-4096), for the Netronics-modified BASIC version.

Listing 5: Tiny BASIC interpreter-language modifications to add clocked interrupts.

Location	IL Address	Instruction	Argument
0885	011F	BC	7, 'SAVE'
8A	24	BE	0
8B	25	J	0153
8D	27	BC	6, 'LOAD'
92	2C	BE	0
93	2D	BR	+2
94	2E	J	0185
96	30	LB	24
98	32	LN	09FA
9B	35	LN	0001
9E	38	LB	20
A0	3A	FV	
A1	3B	DC	
A2	3C	US	
A3	3D	BR	+7
A4	3E	EC	
A5	3F	LN	001B
A8	42	AD	
A9	43	SV	
AA	44	WS	
AB	45	EC	
AC	46	NL	
AD	47	PC	'TAPE ERROR'
B8	52	MT	
B9	53	PC	'START TAPE'
C4	5E	NL	
C5	5F	PC	'HIT KEY'
CD	67	LN	0106
D0	6A	DS	
D1	6B	DS	
D2	6C	US	
D3	6D	SP	
D4	6E	NL	
D5	6F	LN	09FD
D8	72	LB	24
DA	74	FV	
DB	75	LB	20
DD	77	FV	
DE	78	SU	
DF	79	LN	0100
E2	7C	AD	
E3	7D	LB	20
E5	7F	FV	
E6	80	DC	
E7	81	US	
E8	82	EC	
E9	83	SP	
EA	84	NX	

Hex dump:

Location	Contents
0885	. . . 87 53 41 56 C5 E0 39 53 86 4C 4F
90	41 C4 E0 62 39 85 09 24 0A 09 FA 0A 00 01 09 20
A0	12 0E 2E 67 1E 0A 00 1B 18 13 2D 1E 23 24 54 41
B0	50 45 20 45 52 52 4F D2 2B 24 53 54 41 52 54 20
C0	54 41 50 C5 23 24 48 49 54 20 4B 45 D9 0A 01 06
D0	0B 0B 2E 0C 23 0A 09 FD 09 24 12 09 20 12 19 0A
E0	01 00 18 09 20 12 0E 2E 1E 0C 1D . . .

Listing 4 describes patches needed to implement the clock when running with parallel keyboard input and 1861 video output. The interrupt-service routine is a modified version of that originally present to service the 1861 video interrupts, to which are added operations necessary to identify and service clock interrupts. The entire routine has been shifted to a location where it need not be split into two pieces to accommodate the additions. A more complex clock-interrupt task, requiring additional code, must be moved to the end of the interpreter (see listing 3) or split. Monitor entry is via a USR(5) function call.

The modified interpreter-language (intermediate-language) sequence for execution of BASIC SAVE and LOAD commands is the same for both hardware options (see code in listing 5). Interpreter-language instruction mnemonics used in listing 5 are those adopted by Pittman (see references), the author of this and other Tiny BASIC interpreters for various microprocessors. Two new instructions, Enable Clock (EC, 1E hexadecimal) and Disable Clock (DC, 0E hexadecimal), are added to the interpreter-language instruction set. The interpreter-language modification requires only minor changes to the original code, providing space for clock enable and disable instructions. The new instructions are implemented in machine language and their entry points added to the interpreter-language jump table.

The clock count, stored at locations 00B7 through 00B8, can be accessed from BASIC with the PEEK command. The clock can also be controlled directly from BASIC with OUT 5,x commands or through USR function calls to the clock enable and disable routines. ■

References

1. Pittman, T. *Tiny BASIC Experimenter's Kit*. Itty Bitty Computers (POB 23189, San Jose, CA 95153), 1977.
2. Price, G. "Clean Starts for Cosmac 1861 Video Output," *Dr. Dobb's Journal of Computer Calisthenics & Orthodontia*, Volume 5, Issue 7 (47), pp. 14-15 (August 1980).

Professional Quality 80 Column Dot Matrix Printers for Business or Personal Computers

MDT MICRO DATA TEK
 A Division of Electronic California, Inc.
 2630 California Street
 Mountain View, California 94040 (415) 941-7914
 Telex via TWX 910-373-8500 "INTERAX PTVY"

C. ITOH Model 8510 offers 8 character sizes, 5 different alphabets (upper and lower case descenders), character generator and high resolution graphics (144x144 dots per inch). The 9xN Matrix (9 pin printhead) produces exceptional quality printing combined with proportional spacing, if desired. Throughput can be more than 150 lpm and 100 CPS with logic seeking bidirectional and quick cancel printing technique. The printhead is designed with air cooled fins for a long useful life. Paper can be cut stock or punched and can be fed by built in Friction or Tractor. Cut off is within 1 inch of the print line. Vertical and horizontal tabbing is automatic. The manual functions included are Select, Line Feed, Top of Form and Power On, combined with Paper Empty LED indicator.

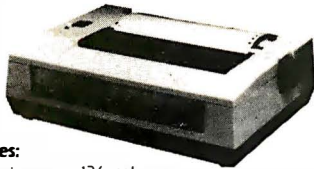

Print Features:

Number of Columns 136 col. max.
 Print Speed 100 CPS
 Print Direction Single-directional and Bidirectional.
 Switch Selectable
 Throughput Speed From 44 to 152 lpm
 Line Spacing Variable to 1/444"
 Print Width 203 mm (8") max.

Forms Type: Fan Fold Roll or Cut Sheet

Width 113 mm to 254 mm (4.5" to 10.0")
 Total Thickness 0.05 to 0.28 mm (0.002" to 0.011")
 Number of Copies Original + 3 copies nominal

Power:

115V ±10% 60 Hz Operating 180 Watts (max), Idle 16 Watts

Form Feed:

Method Tractor or Friction
 Form Loading Either rear or top

C. ITOH 8510 with (list price \$825.00)

Parallel interface **\$575.00** RS232-C interface **\$675.00** Apple II Computer interface **\$645.00**

Also in stock —

MX-80 80 Column Dot Matrix Printer **\$469.00**
 MX-80F/T 80 Column Dot Matrix Printer **\$60.00**
 MX-100 136 Column Dot Matrix Printer **\$750.00**

All standard Epson printers are equipped with parallel interface. However, the following options are available:

- RS-232 interface **65.00**
- RS-232 interface with 2K buffer **150.00**
- IEEE interface **70.00**
- Apple interface (card) **70.00**

ATARI/TRS-80/PET COMPUTERS

Interface for 8510/Epson Printers are available

Expansion Boards For Apple II (1)

• **MEM-1 (Memory Expansion Module)**

Expand your Apple II to a full 64K RAM system with highest quality 16K dynamic RAMs. Fully buffered to provide reliable operation — even fully loaded Apples. Total compatibility with Microsoft Softcard(2)/CP/M(3) and all Apple software. Supplied complete with installation instructions and test program.

• **VERSAcard**

A combination of:

- Serial input/output (RA-232C) interface
- Parallel output interface
- Precision quartz clock/calendar
- BSR control

All on one card, VERSAcards may be the only Apple peripheral card you will ever need.

• **ADS PRT-1 PARALLEL INTERFACE CARD**

PRT-1 is an inexpensive, simple interface card that allows you to interface your Apple computer to any printer that has Centronics compatible interface.

• **SMARTERM 80 Column Card**

Expand your Apple to a full 80 columns with the software commanded. The SMART TERM features:

1. Automatic 80 to 40 and 40 to 80 column switching.
2. Fully compatible with Apple, Pascal and CP/M
3. Lowest power consumption of all presently available 80 column cards on the market.
4. 9 extra characters included that are not provided on the Apple keyboard. Back Slash, Underline, Accent, Left/Right Brace, Logical OR, Tilde, Delete, Bracket, Carrot.

Software: MICROPRO

CP/M™ Version	Suggested Price	Our Price	APPLE Version	Suggested Price	Our Price
WordStar	\$495.00	\$297.00	WordStar	375.00	225.00
MailMerge	150.00	90.00	MailMerge	125.00	75.00
SpellStar	250.00	150.00	SpellStar	200.00	120.00
DataStar	350.00	210.00	DataStar	295.00	177.00
SuperSort I	250.00	150.00	SuperSort I	200.00	120.00
SuperSort II	200.00	120.00			
WordMaster	150.00	90.00			
CalcStar	295.00	177.00			
WordStar — Cust. Notes	150.00	90.00			
DataStar — Cust. Notes	100.00	60.00			

Also available: 1) Accounting Plus-CP/M Version 2) Apple Accounting Plus

Registered Trade Marks (1) Apple Computers, Inc. (2) Microsoft Consumer Products (3) Digital Research, Inc. (4) Micro Pro International Corporation.

ORDER NOW!

California residents, please add 6% sales tax. All unit prices are f.o.b. Mt. View, California.

Print Name _____ Signature _____
 Address _____ City _____
 State _____ Phone _____

Charge to my Mastercharge VISA Check enclosed.

Acct. No. _____ Exp. date _____

Add a Peripheral Interface Adapter to Your Apple II

Kenneth J. Ciszewski
1929 Hurstgreen
Overland, MO 63114

A couple of years ago the comment was made in BYTE that some experimenters had trouble interfacing a Motorola 6820 PIA (peripheral interface adapter) to the Apple II computer ("Cross-Pollinating the Apple II," April 1979 BYTE, page 20). I found this incomprehensible, since the 6820 is virtually identical to the 6520 PIA, which was designed to work with the 6502 microprocessor (used in the Apple II).

At the request of an associate who sought a parallel port for his Apple, I attempted to interface a 6520 PIA to his computer. The result is shown in figure 1.

In this interface, the active-low select line $\overline{CS2}$ of the PIA is always connected to ground and the active-high select lines CS0 and CS1 are connected to the active-low Device Select (generated by logic in the Apple II) via a logic inverter. The signal selects its particular expansion slot when the microprocessor is addressing a specified area of memory. The Device Select signal considerably simplifies interfacing.

The interface is easy to build. The original prototype was done on a solderless prototyping board with the peripheral slot-connector signals brought out on 16-pin DIP (dual inline package) connectors with ribbon cables. These were in turn plugged into an Apple II expansion-slot prototyping card (Vector 4609DP or equivalent) that had been wire-wrapped to connect the expansion-slot signals to 16-pin DIP sockets. A 25-pair cable (24 AWG twisted pair) was used to bring the PA0 through PA7 and PB0 through PB7 connections on the PIA to the "outside world." Interface layout does not appear critical.

To test the interface, a DIP switch assembly and pull-up resistors were connected to PA0 through PA7 of the PIA, while PB0 through PB7 were connected to LEDs with dropping resistors via 7404 inverting buffers (see figure 2). The program in listing 1 was entered using the Apple II's miniassembler (not found in the newer auto-start ROMs) and was then run starting at hexadecimal address 0300. The program sets up port A as inputs and port B as outputs, with PB0 through PB7 initially set to a logic 0 state.

The program then continuously reads port A and writes the contents to port B. This causes the logic state of each switch to be transferred to its respective LED (a lighted LED corresponds to a logic 1 state). Changing the setting of the DIP switches allows you to test each line as well as the interface to the Apple II. (My associate said the test procedure's overall effect was to replace straight wire between the switches and LEDs with a computer!)

One disadvantage of the interface (see figure 1) is that the PIA is not fully and uniquely decoded—that is, the PIA can also be addressed by other groups of addresses assigned to an expansion slot. Figure 3 shows one method of overcoming this problem. The 74LS42 decodes address lines A2 and A3, so the PIA occupies only four of the 16 addresses allocated to an Apple II expansion slot. This also allows the addition of a second PIA on the same prototyping card. ■

Listing 1: Program for testing the 6520 interface. Used in conjunction with the circuits in figure 2, it reads the value encoded on the switches through one port and then displays the same value on the LEDs through the other port.

(Reset the Apple II prior to running this program.)

(Reset the Apple II to exit this program)

(PIA register addresses for expansion slot #4 used in this program:

\$C0C0 = Data Direction Register A (DDRA)/Output Register A (ORA)

\$C0C1 = Control Register A (CRA)

\$C0C2 = Data Direction Register B (DDRB)/Output Register B (ORB)

\$C0C3 = Control Register B (CRB).)

```
$0300 LDA # $FF
$0302 STA $C0C2 Write to DDRB to set PB0-PB7 as outputs
$0305 LDA # $04
$0307 STA $C0C1 Write to CRA to enable ORA, disable DDRA
$030A STA $C0C3 Write to CRB to enable ORB, disable DDRB
$030D LDA $C0C0 Read PA0-PA7 into accumulator
$0310 STA $C0C2 Write accumulator into PB0-PB7
$0313 JMP $030D Repeat until reset
```

The Computer Headquarters

• Apple II plus 48K
• Apple Disc Drive II w/Interface DOS 3.3
• 12" Green high resolution monitor
• OKIDATA 80 Gr. Printer
• TYMAC cable and interface
• Magic window
Now Only \$2469⁰⁰

BUSINESSMAN'S SPECIAL

• Apple II plus 48K
• Apple Disc Drive II and Interface DOS 3.3.
• 12" Green High Resolution monitor.
• Visicalc 3.3 Software
\$2039⁰⁰

• Apple II plus 48K
• Apple Disc Drive II w/Interface DOS 3.3
• 12" Green High Resolution Monitor
• PFS System
Creates your own personal files easily!
\$1949⁰⁰

SOFTWARE

ARTSCI
Magic Window \$85
Magic Mailer \$60

BRODEBOND
Payroll \$309⁹⁵

HAYDEN
Apple Compiler \$159

HIGH TECH
Disc-O Check \$85
DB Management \$85
Client Billing \$250
Info Master (DOS 3.3) \$130

MICROSOFT
Cobol 80 \$595
Fortran-80 \$154.50

MICRO PRO
Word Star 3.0 \$269
Spell Star \$200
Data Star \$214

PEACH TREE II/APPLE
General Ledger \$274
Accounts Payable \$274
Accounts Receivable \$274
Magic Wand \$350

BPI
General Ledger \$315
Accounts Receivable \$315
Inventory Control \$315

THE SOURCE
Only \$89

PERSONAL SOFTWARE
Visicalc 3.3 \$159⁹⁵
Visiplot \$149⁹⁵
Visidex \$159⁹⁵

STONEWARE
DB Master Version 3 \$180

BEST SELLERS ON DISK Games

Temple of Apschai 37.50
Rescue at Rigel 37.50
Crush Crumble and Chomp 28.95
Cosmo Mission 23.95
Major League Baseball 29.00
Apple Panic 28.95
Allen Rain 23.95
Rastler Blaster 28.95
Saragon II 32.95
Zork 37.50
Robot War 37.50
Space Eggs 28.95
Gorgon 37.95
TG Joystick 49.95

MOUNTAIN COMPUTER

Expansion Chassis \$609⁹⁵
CPS Multi Function \$189⁹⁵
Music System \$475⁰⁰
100,000 Day Clock \$325⁰⁰
The Clock \$239⁹⁵
A/D + D/A W/O Cable \$309⁹⁵
Supertalker SD200 \$255⁰⁰
Introl/x-10 Controller \$170⁰⁰
Romwriter 154⁰⁰

5 1/4" DISKETTES FOR APPLE & OTHER MICROS

MEMOREX Box of 10 \$27.00
MAXELL Box of 10 \$37.00
BASAF Box of 10 \$35.00

Call for Diskette Quant. Price

CORVUS Hard Disc Systems for Personal Computers

A CORVUS personal computer disc system provides 5, 11, or 20 million bytes of unformatted storage. System includes a single enclosure with Winchester disc drive, a power supply, and an intelligent controller; an interface card with a 5 foot cable for the specified computer; system software. 110 or 220 volt model may be specified.

5xx 5 Mbytes (unformatted) disc system 3,450.00
11xx 11 Mbytes (unformatted) disc system 4,899.00
20xx 20 Mbytes (unformatted) disc system 5,950.00

CORVUS Mirror Backup System

M/xx MIRROR backup system hardware and software 750.00

APPLE II ACCESSORIES

DC Hayes Micro Model II \$299
Videx 80 Column Video Terminal \$289
Videx Keyboard Enhancer \$109
SUP'R Mod \$27
Microsoft Z80 \$289
Apple Silent Type Printer \$339
High Speed Serial Interface \$158
Micro Soft 16K Ramcard \$159
Language System w/Apple Pascal (contains Integer Basic & 16K Expansion Card) \$405
Integer BASIC Firmware Card \$159
ABT Keypad (Data Entry Pad for Apple) \$109.95

SOFTWARE

HOWARD SOFTWARE
Tax Preparer 80.00
Real Estate Analyzer 129.95
Creative Financing 130.00

LJK SOFTWARE
Letter Perfect 129.95

APPLE II SOFTWARE
Dow Jones Portfolio Evaluator 47.00
The Controller 1.1 (General Bus. System) 520.00
Apple Post 47.00
Dos Tool kit 67.50
Dow Jones News and Quotes Reporter 85.50
Apple FORTRAN 175.00
Apple Plot 64.00

Texas Instruments
New! 99/4A Computer



Orig. 950.00 Now \$369⁹⁵

Disc Drive Control 224.95
Disc Memory Drive 349.95
Solid State Printer 295.00
RF Modulator 39.95
TI 59 Program 179.95
Less Manuf. Rebate -20.00
YOUR COST 159.95
TI 58C Program 89.95
PC 100C Printer for 58/59 157.50
Solid State Speech Synthesizer 119.50
Telephone Coupler (modern) 174.50
RS-232 Accessories Interface 172.50
Memory Expansion by 32-K 295.00
10" Color Monitor 324.50

A limitless learning environment for children

NOW
IN STOCK

TI
LOGO

...from Texas Instruments.

hp HEWLETT
PACKARD

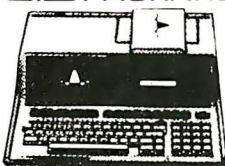

The HP-85 is a powerful BASIC language computer, w/keyboard, CRT display, printer & tape drive, 16K RAM, expandable to 32K
Reg. 3250.00 Now \$2595
HP-83 Reg. 2250 \$1750

NEW!
HP-125 CPU Terminal
Reg. 3750 Now \$2995
OPT. 885 Reg. 3950 \$2995
LTD. QTY.

7225B Graphics Plotter
OPT. 002 Reg. 2,200 \$1939
82901M 5 1/4" Dual Master Flex. Disc Drive
Reg. 2,500 \$1995
2631B Impact Printer
OPT. 885 Reg. 3,950 \$3,095

ATARI 800 with 16K
\$759⁹⁵



810
Disc Drive
\$449⁹⁵

ATARI 410
PROGRAMMABLE RECORDER
\$64⁹⁵

PRINTERS

QUME SPRINT
NEC Spinwriter 3500 Series CALL
CENTRONICS 739 \$699.00
DIABLO-XEROX
630 (RS-232) Daisywheel prntr \$2399
Forms Tractor Bi Direct \$250



5 1/4" Personal Computer
• 1 Monitor
• 1 Keyboard
• 2 Disc Drives
Only \$2895

OKIDATA

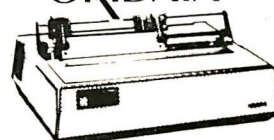

Microline-80 \$399.00
82A PRINTER: Graphics, 120 cps Bidirectional, Friction and Pin Feed, 80/132 Columns 539.95
Tractor Feed Optional 55.00
83A PRINTER: Graphics, 120 cps Bidirectional, Friction and Tractor, 136 Columns, Takes 15" Paper 815.00

EPSON

MX-80 Printer
Call or write for low price!
MX-80 FT Printer
Call or write for low price!
MX-100FT Printer
Call or write for low price!

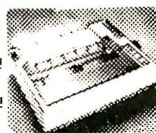

Sanyo Monitors

VM-4509 9" B&W 169.95
DM-5112CX 12" Green 269.95
DMC-6013 13" Color 449.95
Electro Home 9" Green 204.95



CORPORATE ACCOUNTS WELCOME

47st. photo
Cameras • Electronics • Audio • Video • Computers • Darkroom • Accessories

67 West 47th Street, New York, N.Y. 10036
115 West 45th Street, New York, N.Y. 10036
MAIL ORDER ADDRESS: 36 E. 19th St. New York, N.Y. 10003

Items on sale for limited time only, and are subject to limited availability. Not responsible for typographical errors. This ad supersedes all other ads prior to Jan. '82. All orders subject to verification and acceptance. Minimum shipping and handling \$4.95.



(212) 260-4410

TOLL FREE OUT OF STATE

800-221-7774
800-221-5858
800-223-5661

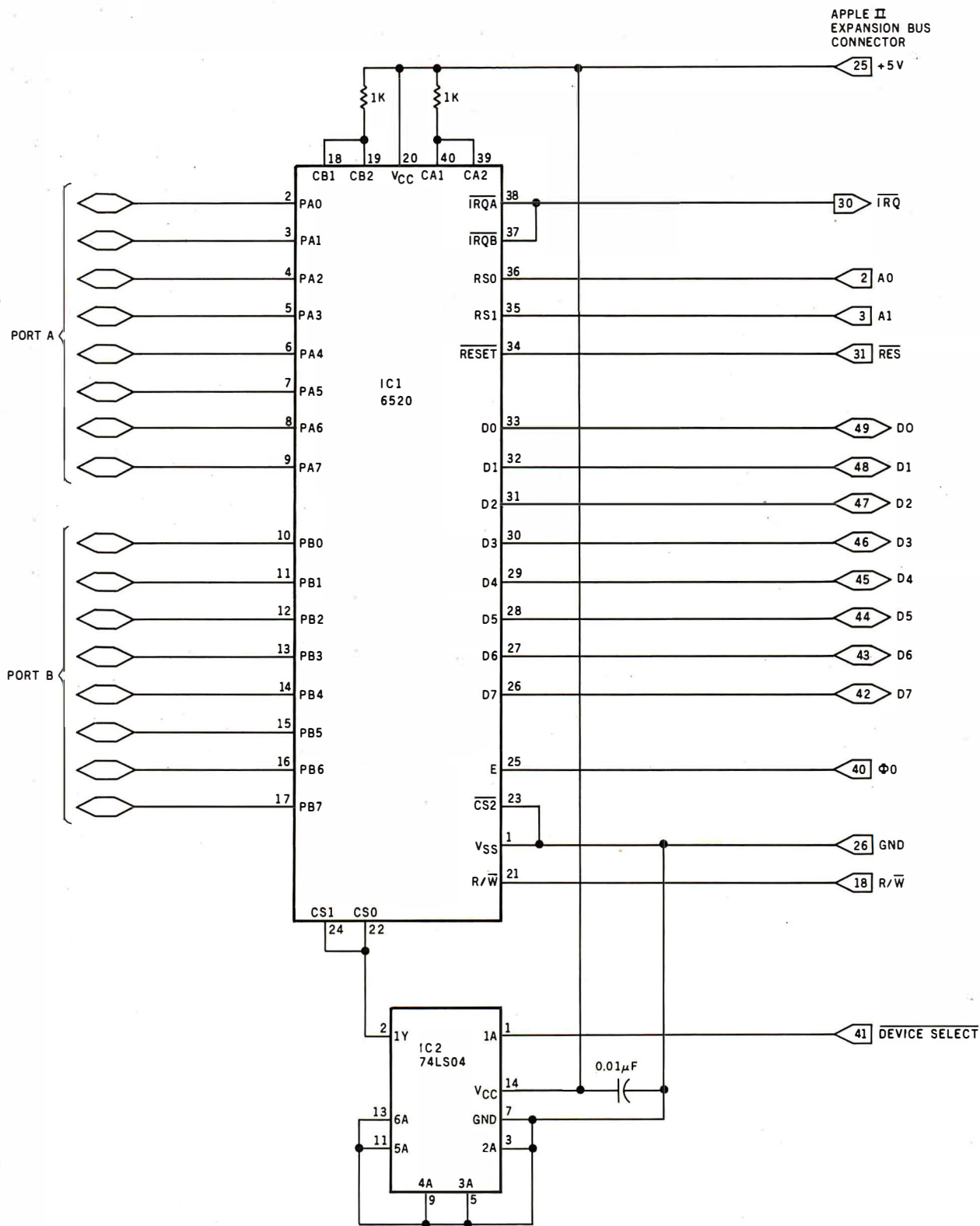

Figure 1: Interfacing an Apple II to a 6520 peripheral interface adapter. The active-low select line of the 6520 is tied to ground while both active-high select lines are connected via an inverter to $\overline{Device\ Select}$ (an active-low signal generated by the Apple II that enables one of its eight peripheral positions).

THE FORTH SOURCE™

Specializing in the FORTH Language.

- NEW** FORTH-79 Disks by MicroMotion
- APPLE II/II+ . \$180.00
Editor, assembler, graphics, virtual memory, floating point, turtle graphics, DBMS, file transfer, modem utilities.
 - Z-80 CP/M* Ver. 2.x & Northstar \$180.00
Editor, assembler, graphics, virtual memory, floating point, DBMS, modem utilities.
Other versions available.
 - "Starting FORTH" by Brodie. Best Explanation. Soft \$ 16.00
 Hard \$ 20.00

NEW FORTH based Games and Application Programs

- NEW** AIM65 FORTH Microcomputer by Rockwell \$530.00
plus \$20 shipping

The FORTH Source has books, manuals and disks for and about FORTH. Write, call or circle the reader service number for the latest list of FORTH materials. Over 30 books and manuals. Disk programs for: CP/M, APPLE, TRS-80, HP85, H89, 8080, Z-80, 6800, 6809, 8086 and more. Coming: IBM, Atari, Osborne. . . .

ORDERS ONLY (415) 961-4103

DEALER & AUTHOR INQUIRIES INVITED

Ordering Information: Check, Money Order (payable to MOUNTAIN VIEW PRESS), VISA or MasterCard accepted. No COD's or unpaid PO's. California residents add 6½% sales tax. Shipping costs in US included in price. Foreign orders, pay in US funds on US bank, include for handling and shipping by Air: \$5.00 for each item under \$25.00, \$10.00 for each item between \$25.00 and \$99.00, and \$20.00 for each item over \$100.00. Minimum order \$10.00. All prices and products subject to change or withdrawal without notice. Single system and/or single user license agreement required on some products. *REGISTERED TRADEMARKS

MOUNTAIN VIEW PRESS

PO BOX 4656

MOUNTAIN VIEW, CA 94040

(415) 961-4103

System Notes

2a

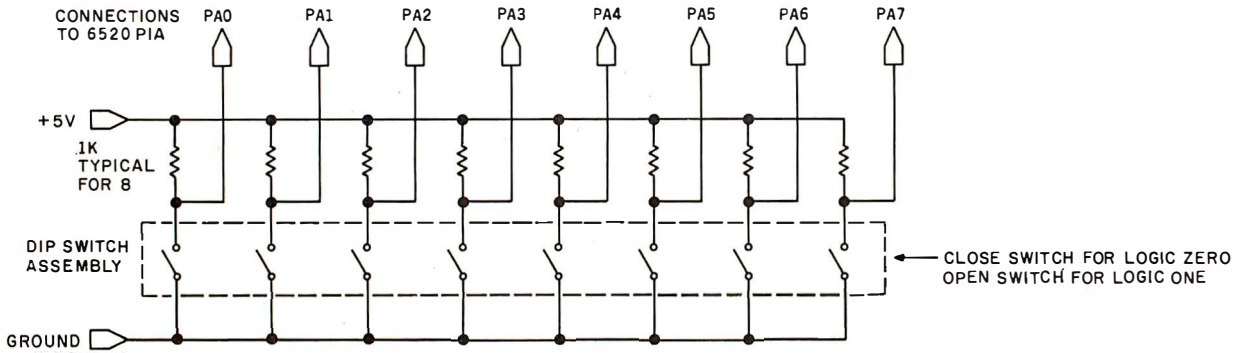

2b

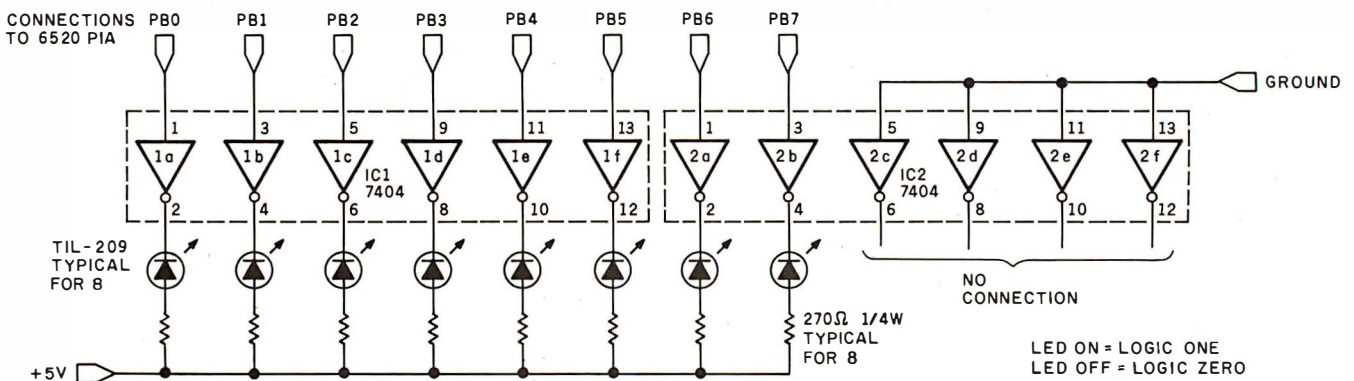

Figure 2: Controls and indicators for testing the circuit of figure 1. Figure 2a diagrams a method for manually setting the logic conditions on one port of the 6520. Figure 2b shows a circuit that indicates the logic state of each bit in one port of the 6520.

Number	Type	+ 5 V	GND
IC1	7404	14	7
IC2	7404	14	7

1802 fig-FORTH

high-level compiler language
10- 20X faster than BASIC
ELF II / SuperELF / Other
**w/editor, strings
macro-assembler
floating-point** **\$80**

plus tiny pascal **add \$35**
on cassette/requires 16k+RAM

P. O. Box 8403
Austin, Texas 78712

512-477-2207

Circle 157 on inquiry card.

AUDEX-1 the EAR & MOUTH for AIM-65

- Recognition and Response in One Unit
- Built-in Amplifier and Speaker
- Dynamic Microphone Included
- You can make your own vocabulary
- Good-Speech Quality
- Up to 98% Recognition Accuracy
- Easy-to-follow Users Manual
- In a 3 1/4" x 5 1/4" x 1 1/4" Box
- Assembled and Fully Tested

\$169.00 ea. plus shipping and handling charge: U.S. \$3.50 Overseas, 10%

NJ Residents, add 5% sales tax.

— VISA, Mastercharge Welcome —

AUDEC CORPORATION (Dept. L1)
728 Larch Avenue
Teaneck, NJ 07666 (201) 692-1729

Circle 42 on inquiry card.

APPLE JOY

At last, an inexpensive and viable alternative to the graphics tablet.

- For Apple II (DOS 3.3) users who presently own or are planning the purchase of an Apple II Joystick.
- Our software will enable you to easily interface your **Basic** or **Pascal** Programs to the Apple Joystick.
- Software will provide your programs with a "tracking" cursor either on High-Resolution Screen-1 or High-Resolution Screen-2. Coordinate input is activated via Joystick Button-1. "Fine" cursor movement is enabled via Joystick Button-2.
- Included is 5 1/4" Disk, User Manual, Object Code of Joystick Interface Routines and Source Code of Demo Programs.

\$24.95 ppd.
(California Residents add 6%)

PLEASE SPECIFY LANGUAGE REQUIRED (BASIC OR PASCAL)
Send Check or Money Order (Personal Checks Allow 3 Weeks)

To:

MICON

5851 Via Sonora / Yorba Linda, CA 92686
Telephone: (714) 970-1422

Circle 232 on inquiry card.

MORE BANG FOREVER

Forever is a long time and that's what Qantex Printers are designed to do, print for a long time. The new Qantex Impact Printers are perfect for applications where crisp copy is needed fast, reliably and at a modest cost.

The new feature packed Model 6010 incorporates a 2K or a 4K message buffer capable of accepting up to two full CRT screens of data. . . Switch selectable forms length from 3 to 22 inches in .5 inch increments. . . Switch selectable vertical tabbing, 4 or 6 lines. . . Horizontal tabs at columns 1, 9, 17, 25, etc. . . Adjustable tractors accept paper sizes from 3 to 15 inches, front or bottom feed. . . Multiple communications protocols accommodate parallel or up to 19,200 baud serial interfaces supporting RS-232, X-ON, X-OFF or current loop. . .

Other advanced features included at no additional cost include a sleek human factors engineered enclosure incorporating a low noise sound cover. . . Exceptionally high reliability resulting from simple mechanical and electronic design. . . 500 million character print head. . . High quality original plus up to five sharp copies. . . Beautiful 96 character set stored in the micro-processor in a 9 x 9 dot matrix. . . True lower case descenders and underlining. . . Bi-directional logic seeking. . . Built-in self test 150 characters per second. . . 80/136 columns per line. . . Available now!

For more information about the new Model 6010 contact your local distributor!

THE NEW MODEL 6010

Qantex*

Division of North Atlantic
60 Plant Avenue
Hauppauge, NY 11788
(800) 645-5292 (516) 582-6060
TWX (510) 227-9660

*Registered Trademark of North Atlantic Industries, Inc.

Circle 312 on inquiry card.

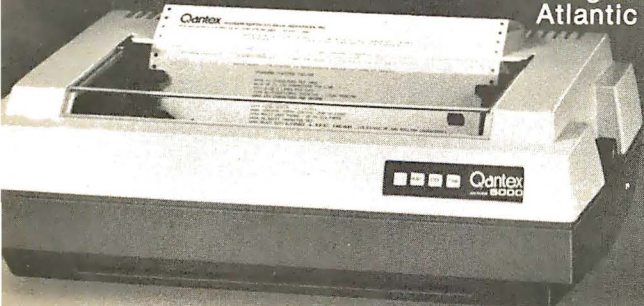

DISTRIBUTOR INQUIRIES WELCOME!

ARIZONA	
The Phoenix Group Inc.	(602) 967-1421
ARKANSAS	
Harvey Electronics	(501) 224-0899
CALIFORNIA	
Basic Systems Corp.	(213) 673-4300
Basic Systems Corp.	(714) 268-8000
Basic Systems Corp.	(408) 727-1800
ILLINOIS	
Electro Tech Marketing	(312) 588-4535
Engineered Sales	(312) 832-8425
LOUISIANA	
Micro Computer of New Orleans	(504) 885-5883
MARYLAND	
	(800) 645-5292
MASSACHUSETTS	
S & S Electronics, Inc.	(617) 458-4100
MINNESOTA	
Vikeland Sales	(612) 645-4647
MISSOURI	
ESC Sales & Leasing	(314) 997-1515
NEW YORK	
Daily Business Products, Inc.	(516) 543-6100 (800) 645-5556 (212) 594-8065
Straitline Marketing Inc.	(212) 445-4225
Synchro Sound Enterprises	(516) 484-1852
Washington Electric Co.	(212) 226-2121 (800) 221-5416
PENNSYLVANIA	
QED Electronics	(215) 674-9600
TEXAS	
Datanet Inc.	(214) 669-1758
VIRGINIA	
Nine Associates, Inc.	(703) 273-1803
AUSTRALIA	
Mitsui Computer Systems	02-9299921
CANADA	
Computer Markets	416-445-1978
DENMARK	
T.M.S. System I/S	(45) 02-840784
ENGLAND	
Northamber Limited	(44) 372-67646
FRANCE	
Gepsi	(33) 1-554-9742
GERMANY	
Technitron	49 (89) 692-4141
HONG KONG	
Hong Kong Equipment Computerworld Ltd.	3-444216-8 5-440033
ITALY	
Eltron	39 (30) 55026
NETHERLANDS	
Computata Benelux B.V.	31-73-422045
PORTUGAL	
Decada Equipamentos de Electronica Lda	351-19-558609
REPUBLIC OF CHINA	
Microcontrol Corp.	(02) 703-1842
SINGAPORE	
General Engineers Assoc. Pte. Ltd.	2729412
SPAIN	
2i Ingeniera Informatica	204-2099
VENEZUELA	
Sysgen Data	02-719455

System Notes

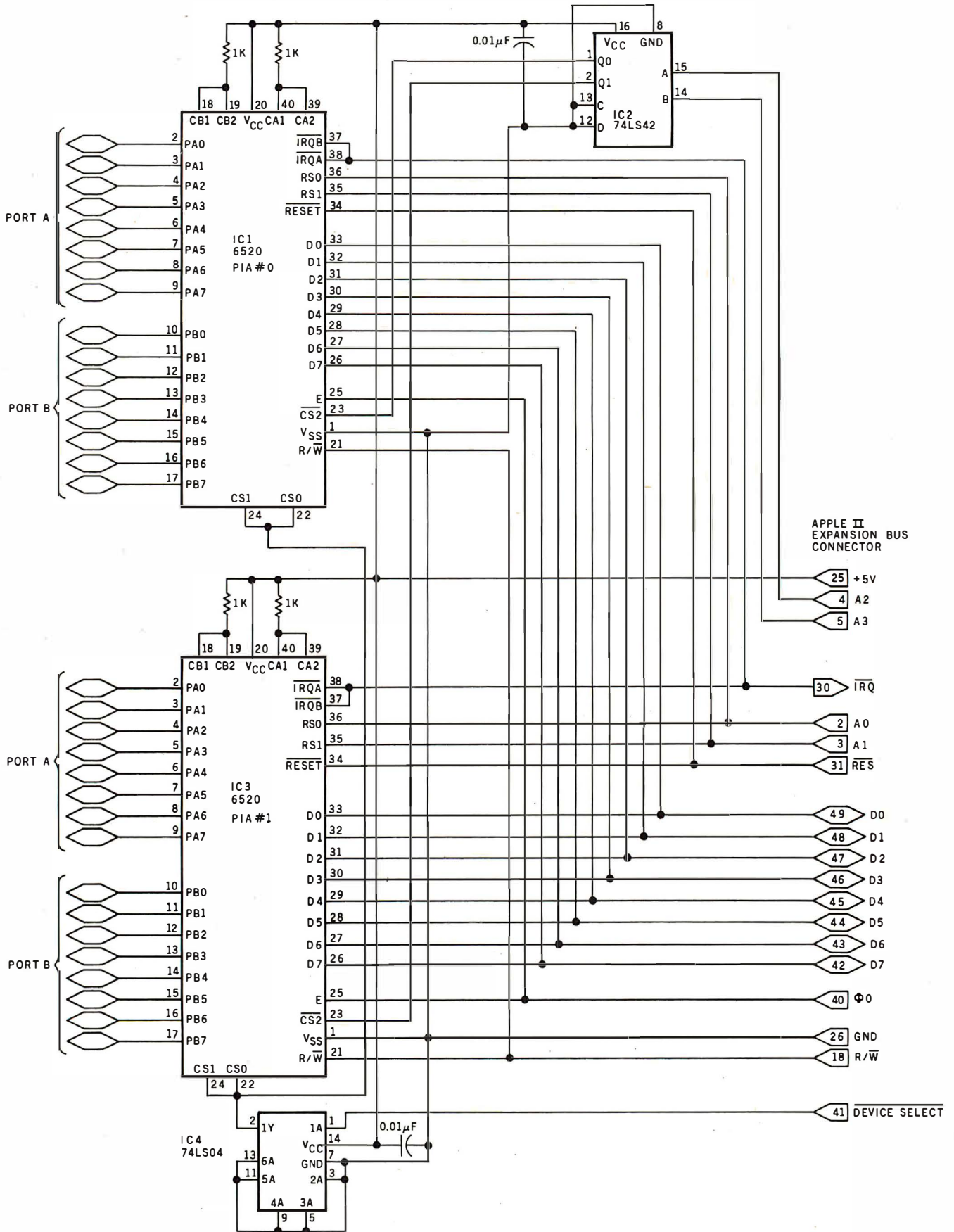
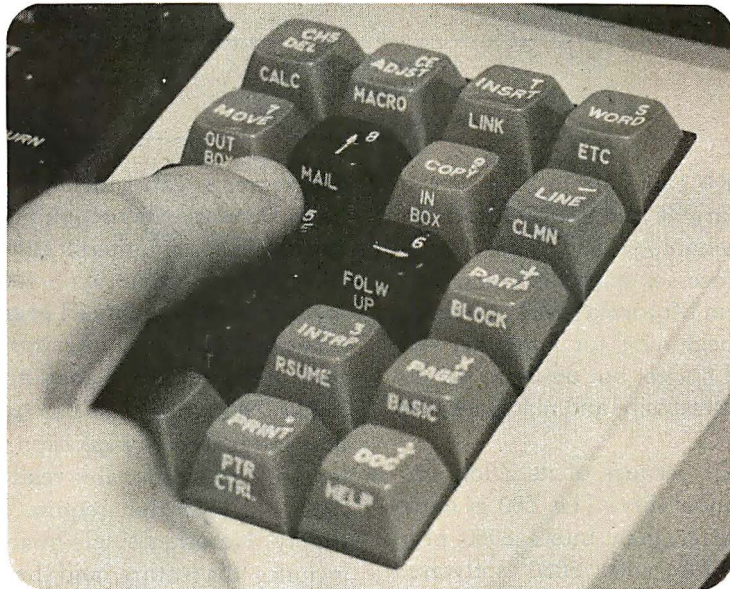

Figure 3: The addition of a 74LS42 allows more than one 6520 to be addressed by a single Apple II expansion port.

Today, executives push buttons, too.



Learn about your evolving office at



THE THIRD ANNUAL

OFFICE AUTOMATION CONFERENCE

Moscone Center • San Francisco • April 5-7, 1982

Everyone is affected by office automation. Directly or indirectly. The dramatic changes it carries with it touch all our lives. For some of us, how we manage these changes may even shape our professional futures.

That's why we urge you to attend the one conference that can provide you with the latest information about and insights into this exciting-but-sometimes-scary concept. We'll accomplish this through a

program of technical sessions spotlighting featured speakers. Through a series of innovative industry-related workshops. Through an exhibit floor packed with displays by some 200 companies.

If you're uncertain about any aspect of office automation, don't push the panic button! Instead, fill out and mail this coupon. Learn in more detail about the conference whose theme focuses on "The Human Connection." On you.

Sponsored by the American Federation of Information Processing Societies, Inc.

NAME _____ TITLE _____

COMPANY _____

ADDRESS _____

CITY _____ STATE _____ ZIP _____



Mail to:
AFIPS
1982 OAC
P.O. Box 9659
Arlington, VA. 22209

D

"THE INTERNATIONAL CONFERENCE FOR DECISION MAKERS"

SD Systems' Z80 Starter Kit

Wayne Angevine
1124 West 29 St. Apt. 4
Los Angeles, CA 90007

SD Systems' Z80 Starter Kit came out in 1979. It is a single-board computer comparable to the KIM-1 (formerly manufactured by MOS Technology) and to the evaluation kits offered by microprocessor manufacturers, particularly Intel's SDK series and Motorola's MEK systems. Such systems are a good beginning for computer enthusiasts who have a limited budget but desire to get involved with microcomputer hardware and machine-level software.

I chose the Z80 Starter Kit because of its Zilog Z80 microprocessor and its expandability. The Z80 is more powerful and potentially faster than Intel's 8080 processor and yet is compatible with 8080 software.

Therefore, it can run Digital Research's CP/M, the de facto standard microcomputer disk operating system. It can also be easily interfaced to the S-100 bus. The kit has space for mounting two S-100 circuit boards (connectors are not included). Since I eventually hope to put together a business-type computer system with disk mass storage, the kit seemed like a good place to start.

The Z80 Starter Kit has two other important features that influenced my decision. It can program EPROMS (erasable programmable read-only memories) such as the 2716 and 2758 that require only a single +5 V power supply. No other single-board computer that I know of includes this feature; and the Starter Kit includes enough blank area for prototyping circuitry.

At a Glance

Name

Z80 Starter Kit

Manufacturer

SD Systems
POB 28810
Dallas TX 75228
(214) 340-0303

Price

\$401, kit
\$531, assembled

Dimensions

12.9 by 32.2 cm
(8 $\frac{1}{4}$ by 12 $\frac{1}{16}$ inches)

Processor

Z80, 8-bit

System Clock Frequency

1.9968 MHz

Memory

1 K bytes supplied

Mass Storage

Interface for cassette-tape recorder

Features

S-100-like bus, custom wire-wrap area on circuit board, EPROM-programming circuitry

Software Included

ZBUG monitor

Hardware options

Requires external power supply

Audience

Persons interested in learning about small microcomputer systems, persons who need a dedicated controller for custom circuitry

Assembly

The Z80 Starter Kit is available either as a kit or assembled. I chose the kit version to save money and become more familiar with the design. The assembly was straightforward and took about six hours. The instructions provided were clear and concise; the only problem I had was in mounting the switches for the keyboard.

Each switch assembly consists of four switches in a row, with two pins per switch; two small threaded studs protrude from the bottom of each assembly. The pins are short and somewhat springy, and aligning eight of them with the appropriate holes in the printed-circuit board is a challenge indeed. To add to the difficulty, the studs for mounting the switch assemblies are barely long enough to be gripped by the nuts provided. Only after considerable effort did the assemblies finally end up in place.

A good section on how to solder is included in the back of the instruction manual, but this kit is not recommended for a person who has never constructed a kit before. Most of the soldering involves sockets for integrated circuits, but there are lots of sockets and plenty of chances to make solder bridges from one pin to another.

All the parts of the starter kit are high quality: the printed-circuit board is a very heavy, double-sided card with a green solder mask and clearly printed component locations and numbers. As previously noted, the keyboard is made up of blocks of real switches (as opposed to the membrane or calculator-type keyboards of other units). The keys are big enough to be easy to use.

The only modification that I made was the addition of

About the Author

Wayne Angevine graduated recently from the University of Colorado at Boulder and is an electronics engineer for Hughes Aircraft Company, where he works on research and development of infrared detector arrays. He is also pursuing a master's degree in electrical engineering at the University of Southern California. He became enthusiastic about personal computers while taking a course in microprocessors, but has been using computers since the seventh grade. His other interests include hiking and cross-country skiing.

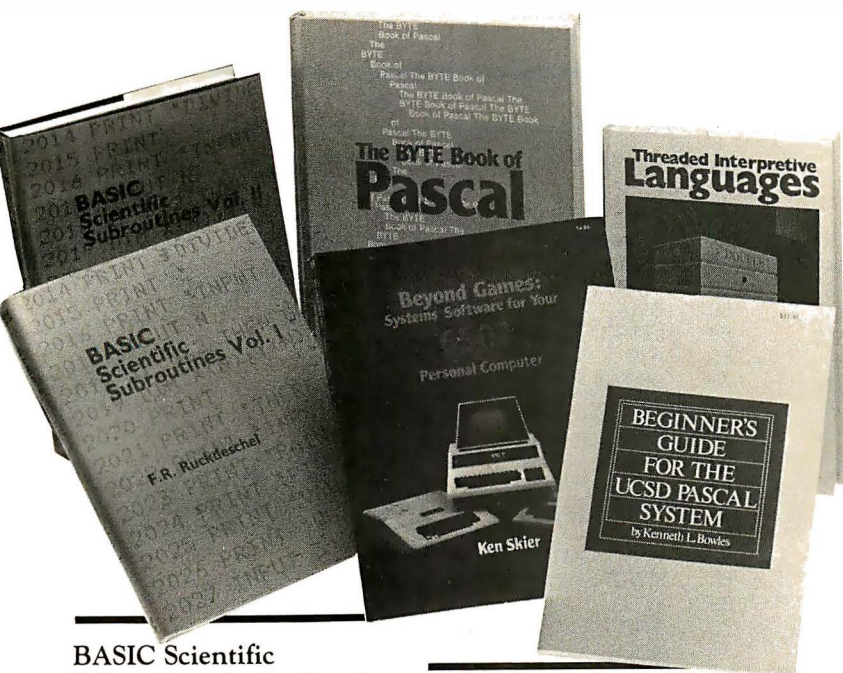

From BYTE Books

BASIC Scientific Subroutines, Vols. I and II

Valuable programs for professional and hobbyist

by Fred R. Ruckdeschel

Designed for the engineer, scientist, experimenter, and student, this series presents a complete scientific subroutine package featuring routines written in both standard Microsoft and North Star BASIC.

- Volume I covers plotting, complex variables, vector and matrix operation, random number generation, and series approximations.
- Volume II includes least-squares approximation, special polynomial functions, approximating techniques, optimization, roots of functions, interpolation, differentiation, and integration.

Volume I
ISBN 0-07-054201-5
336 pages; hardcover
19.95

Volume II
ISBN 0-07-054202-3
800 pages; hardcover
23.95

Threaded Interpretive Languages

How to implement FORTH on your Z80

by Ronald Loeliger

This book develops an interactive, extensible language with specific routines for the Zilog Z80 microprocessor. With the core interpreter, assembler, and data type defining words covered in the text, it is possible to design and implement programs for almost any application and equivalent routines for different processors.

ISBN 0-07-038360-X
272 pages; hardcover
18.95

Beginner's Guide for the UCSD Pascal System

The most popular Pascal version explained by its creator

by Kenneth L. Bowles

Written by the originator of the UCSD Pascal System, this informative book is an orientation guide to the System.

For the novice, this book steps through the System, bringing the user to a sophisticated level of expertise. Once familiar with the System, the reader will find the Guide an invaluable reference tool for creating advanced applications.

ISBN 0-07-006745-7
204 pages; softcover
11.95

in BASIC and the other in 8080 assembly language; a p-code interpreter written in both Pascal and 8080 assembly language; a chess-playing program; and an APL interpreter.

ISBN 0-07-037823-1
334 pages
hardcover
\$25.00

The BYTE Book of Pascal

A powerful, structured language
Blaise W. Liffick, Editor

Based on articles, language forums, and letters from BYTE magazine, this work is a valuable software resource. Pascal continues to be popular as a structured programming language. Written for both potential and established users, this book introduces the Pascal language and examines its merits and possible implementations. Featured are two versions of a Pascal compiler, one written

Beyond Games: Systems Software for Your 6502 Personal Computer

Creating programs for the Apple, Atari, Challenger and PET computers

by Kenneth Skier

At last, a complete programming guidebook. A self-contained course in structured programming and top-down design, this book presents a powerful set of tools for building an extended monitor, disassembler, hexadecimal dump routine and text editor programs.

ISBN 0-07-057860-5
440 pages; softcover
14.95

Name	Title	Price	Quantity	Amount
Address				
City	State	Zip		
Check Enclosed	Amount			
Bill Visa/Master Card Number				
Expiration Date				
Add 75c per book to cover shipping costs:				
Total				



BYTE Books 70 Main Street Peterborough, N.H. 03458

Circle 61 on inquiry card.

ORDER TOLL FREE 800/258-5420

Pin	Standard	Kit	Pin	Standard	Kit	Pin	Standard	Kit	Pin	Standard	Kit
1	+8 V	+8 V	26	pHLDA		51	+8 V	+8 V	76	pSYNC	
2	+16 V	+16 V	27	RFU		52	-16 V	-16 V	77	pWR*	
3	XRDY		28	RFU		53	GND		78	pDBIN	
4	VI0*		29	A5	A5	54	SLAVE CLR*		79	A0	A0
5	VI1*		30	A4	A4	55	DMA0*		80	A1	A1
6	VI2*		31	A3	A3	56	DMA1*		81	A2	A2
7	VI3*		32	A15	A15	57	DMA2*		82	A6	A6
8	VI4*		33	A12	A12	58	sXTRQ*		83	A7	A7
9	VI5*		34	A9	A9	59	A19		84	A8	A8
10	VI6*		35	DO1/DATA1	D1	60	SIXTN*		85	A13	A13
11	VI7*		36	DO0/DATA0	D0	61	A20		86	A14	A14
12	NMI*		37	A10	A10	62	A21		87	A11	A11
13	PWRFAIL*		38	DO4/DATA4	D4	63	A22		88	DO2/DATA2	D2
14	DMA3*	+5 V	39	DO5/DATA5	D5	64	A23		89	DO3/DATA3	D3
15	A18		40	DO6/DATA6	D6	65	NDEF		90	DO7/DATA7	D7
16	A16		41	DI2/DATA10	D2	66	NDEF		91	DI4/DATA12	D4
17	A17		42	DI3/DATA11	D3	67	PHANTOM*		92	DI5/DATA13	D5
18	SDSB*		43	DI7/DATA15	D7	68	MWRT	sMEMW	93	DI6/DATA14	D6
19	CDSB*		44	sM1		69	RFU		94	DI1/DATA9	D1
20	GND		45	sOUT	sOUT	70	GND		95	DI0/DATA8	D0
21	RFU		46	sINP	sINP	71	NDEF		96	sINTA	
22	ADSB*		47	sMEMR	sMEMR	72	RDY		97	sWO*	
23	DODSB*		48	sHLTA		73	INT*		98	ERROR*	
24	Φ		49	CLOCK	CLOCK	74	HOLD*		99	POC*	
25	pSTVAL*	φ	50	GND	GND	75	RESET*		100	GND	GND

Table 1: Signals of the IEEE S-100 standard (Task 696.1/D2) compared to the S-100 interface implemented in the SD Systems' Z80 Starter Kit. In the IEEE's nomenclature, an asterisk indicates a signal that is active in the low state.

binding posts at the power-supply terminals. The stock kit has holes only in the circuit board, to connect the power supply. I added binding posts from Radio Shack to be able to connect and disconnect the cord from my power supply easily. I recommend the type of binding posts in which the metal connector and mounting stud are one piece. The holes on the board must be enlarged slightly by careful use of a drill. After the posts are inserted, they must be soldered to the board on the top and bottom to insure a good connection.

Use and Features

The kit has the same basic configuration as most single-board systems. User input and output are accomplished by a hexadecimal keyboard plus 12 command keys and a 6-digit 7-segment LED (light-emitting diode) display. The display has large (0.6 inch), bright digits and is easy to

read under normal lighting.

An audio-cassette interface is supplied. I have used it with an inexpensive Superscope recorder and have found the combination to be highly reliable—I have had only one misload in three months' use. The volume-level indicator, which allows the recorder volume level to be set properly, helps ensure the reliability. The interface uses Kansas-City-Standard coding and the Intel hexadecimal format.

The kit comes with 1024 (1 K) bytes of programmable memory in the form of eight 2102 static memory devices. There is space on the board, and all decoding circuitry is in place, for adding another 1 K bytes of 2102s, but no sockets are provided. However, sockets and integrated circuits can be added for \$10 to \$15.

The system monitor uses the top 110 bytes of installed memory as a scratch pad, but the remaining memory is

PRINTERS Epson

EPSON MX-70	\$395
EPSON MX-80	495
EPSON MX-80FT	595
EPSON MX-100	795
EPSON INTERFACE & CABLE	100
C. ITOH STARWRITER 25 PARALLEL	1440
ANADEX DP9500	1350
IDS-560G PAPER TIGER	1475
QUME SPRINT 5/45	2499

MONITORS

AMDEX 12" B&W	139
AMDEX 13" COLOR	389
SANYO 9" B&W	185
ZENITH 12" GREEN	139
NEC 12" GREEN	169

APPLE II SOFTWARE & ACCESSORIES

VISICALC	\$159
VISITREND/VIPILOT	215
D.B. MASTER	169
PERSONAL FILING SYSTEM	85
BPI BUSINESS SOFTWARE	335
CONTINENTAL BUSINESS SOFTWARE	215
MAGIC WINDOR	85
SUPERTEXT II	125
EASYWRITER	219
WORDSTAR (CP/M)	299
REAL ESTATE ANALYZER	120
TAX PREPARER	85
MOUNTAIN COMPUTER CPS CARD	250
HAYES MICROMODEM II	299
NOVATION APPLE CAT II	349
MICROSOFT Z-80 SOFTCARD	299

MICROSOFT 16K RAM CARD	169
VIDEX 80 COLUMN CARD	269
VOTRAX TYPE'N TALK	340



ATARI 800W/16K	749
ATARI 400 W/16K	350
410 PROGRAM RECORDER	69
810 DISK DRIVE	499
16K MEMORY MODULE	89
850 INTERFACE	175
830 ACOUSTIC MODEM	159
825 LINE PRINTER (80 COL)	600
ATARI WORD PROCESSOR	125

TO ORDER: Please send cashier's check, money order or personal check (allow 10 business days to clear). VISA and Master Card credit card service add 3%. American Express credit card service add 5%. Shipping, handling and insurance in U.S. add 3% (minimum \$4). California residents add 6% sales tax. Foreign orders add 10% for shipping. Equipment is subject to price change and availability. All equipment carries factory warranty. Store prices differ from mail order prices.

(800) 854-1941 **computer age** (714) 565-4062

Outside Ca. Order Desk Technical & California
4688 CONVOY STREET, SAN DIEGO, CA 92111

TIRED OF KEYBOARDING?

**INPUT INFO THE EASY WAY!
OMR DATA ENTRY GOES DIRECT
FROM SCAN-TRON FORMS TO
YOUR COMPUTER.**

The new Scan-Tron Model 1200 OMR Data Entry Terminal offers a simple LOW COST solution for many applications in education, business and government.

Now at a price competitive with a small card reader, you have the flexibility of scanning documents of all sizes (up to 8½ x 14). In addition, Scan-Tron offers a wide variety of standard off the shelf forms. Scan-Tron Corporation also provides complete custom form design and printing services through a nationwide network of 43 branch offices.

The Model 1200 is designed to be flexible, accurate and reliable. Features include compact desk-top design, light weight, simple operation (for non-technical personnel).

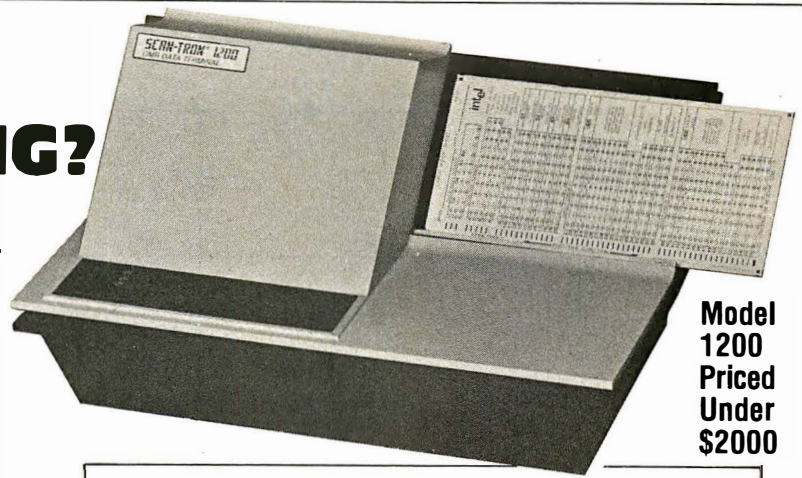

**Model
1200
Priced
Under
\$2000**

TYPICAL SCAN-TRON APPLICATIONS

EDUCATION

- * **ADMISSION REGISTRATION.** Provides a simple method of student enrollment class scheduling. Simplifies grade reporting and student record keeping.
- * **ATTENDANCE REPORTING.** Daily attendance on a period by period basis with absentee followup.
- * **TEST SCORING.** Teacher prepared tests, criterion referenced tests,

- or standardized tests.
- * **TEST ANALYSIS.** Detailed item analysis, descriptive statistics, question validity, and more.

BUSINESS AND MEDICAL

- * **INVENTORY ACCOUNTING**
- * **LABOR ACCOUNTING**
- * **QUALITY CONTROL**
- * **BILLING SYSTEMS**
- * **MEDICAL QUESTIONNAIRES**
- * **HOSPITAL PATIENT RECORDS**

OFFICES IN ALL PRINCIPAL CITIES

SCAN-TRON® CORPORATION

3398 E. 70th Street, Long Beach, CA 90805 • (213) 633-4051

READ AMERICA'S NUMBER 1 NON-SELLER.



Not for sale in any bookstore! Not available at any price! The new Consumer Information Catalog!

It's the free booklet that lists over 200 helpful Federal publications; more than half, free. On topics like home repairs. Money management. Nutrition. Informa-

tion that could help you to a better way of life.

To get your free copy, just write:

**CONSUMER INFORMATION
CENTER,
DEPT. E
PUEBLO, COLORADO
81009**

General Services Administration

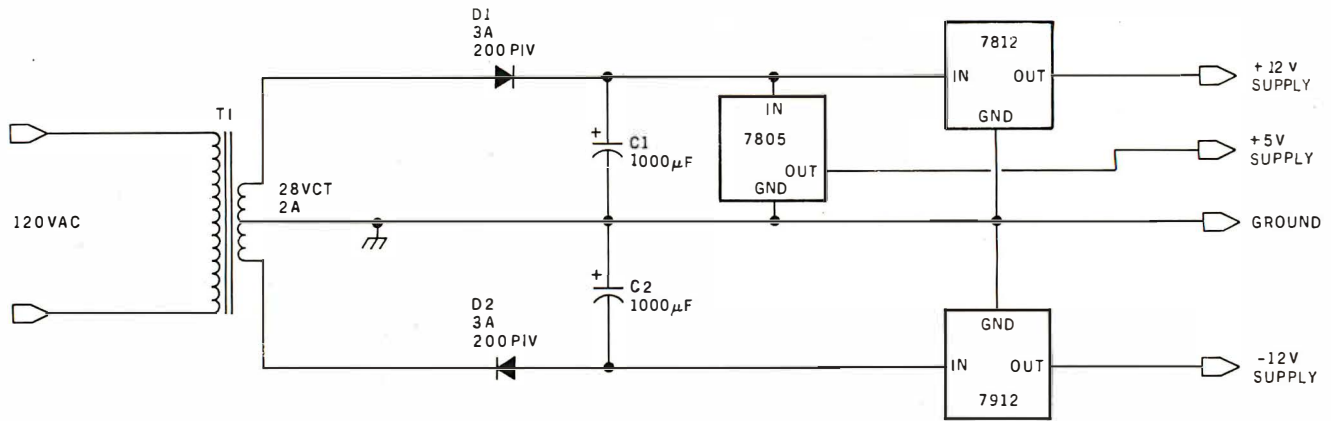

Figure 1: Simple and inexpensive power supply for the Z80 Starter Kit. It will provide +5 V at 1 A and ±12 V at 200 to 300 mA for the Z80 Starter Kit and user circuitry. Parts used include: T1: 120 VAC primary, 28 VAC center-tapped secondary, 2 A; D1, D2: 3 A, 200 V PIV silicon diodes; C1, C2: 1000 µF, 50 V electrolytic capacitors (note polarity carefully); 7805: +5 V, 1.5 A voltage regulator; 7812: +12 V, 1.0 A voltage regulator; 7912: -12 V, 1.0 A voltage regulator.

big enough for most uses. There are also three 22-pin sockets on the board for read-only or erasable read-only memory. One of these sockets is occupied by the system monitor. Of the remaining two, one is the programming socket, but it can also be used in a read-only mode. Each socket is selected by decoding circuitry to occupy 2 K bytes in memory-address space and wired for the pin arrangement of 2716-type devices.

One of the biggest selling points of the kit is the on-board S-100 interface. Space for two connectors is

provided, although the connectors themselves are not. Technically, however, the interface is not S-100 compatible. The manual says that it is "compatible with general static memory or I/O expansion cards" but "specifically...not with the Expandoram modules." Expandoram is SD Systems' series of dynamic-memory cards. A comparison with the IEEE (Institute of Electrical and Electronics Engineers) S-100 standard shows that only 45 of the Starter Kit's 100 pins carry the signals specified. Many of the unconnected pins are not vital, such as extended addressing and the 16-bit request and acknowledge lines. Others are of more interest, such as DMA (direct memory access) and interrupts. No DMA or interrupt lines are present in the interface as wired. The most significant of the missing signals, however, are the pSYNC, pDBIN, and sM1 timing signals, which are used to implement "invisible" refresh in dynamic-memory boards. It should also be noted that it is not possible to issue a RESET signal to any boards in the S-100 slots. Table 1 gives a comparison of the IEEE S-100 standard and the on-board signal lines.

Also, some confusion exists about clock signals, as pins 24 and 25 in table 1 show. The master bus-timing signal, which the board designers call Φ , is routed to pin 25 of the S-100 interface. The standard specifies pin 24 for Φ and pin 25 for pSTVAL* (the status-valid strobe). However, SD Systems' dynamic-memory boards require clock signal ϕ_1 on pin 25 and ϕ_2 on pin 24. I suggest that anyone who plans to use any boards requiring clocks be careful of this.

These difficulties may be overcome, however, if the user has the patience and skill to construct the needed signals from timing diagrams and design the logic to produce them. The logic can then be constructed in the wire-wrap area and the signals routed to the S-100 connectors.

Another problem with the S-100 interface on the starter kit is that the address and data-bus lines are unbuffered. The Z80 processor can safely drive four LS TTL (low-power Schottky transistor-transistor logic) inputs. Many of the address lines are already connected to a

You may be holding the most important Software you could ever own... in the Palm of Your Hands

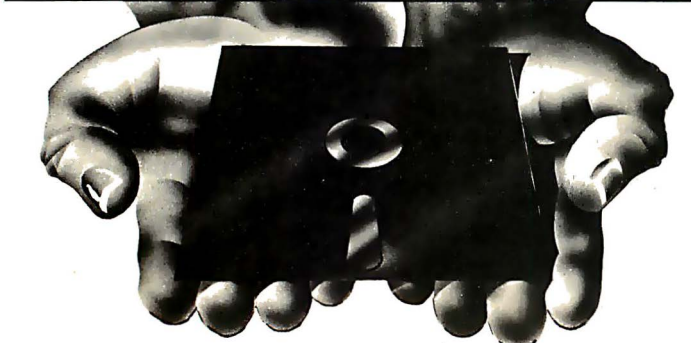

TITLE: "THE PROGRAM WRITER/REPORTER"

Enables ANYONE to write, compile, running, debugged BASIC LANGUAGE Programs in 30 to 40 minutes, with NO PRIOR PROGRAMMING KNOWLEDGE OR ABILITY.

If you are one of the many who bought a microcomputer in the belief that with just a little studying you could write your own programs, you now know that you can't.

If you, as a businessman, thought you could have stock software modified at a reasonable cost, with reasonable results, you know that's not possible either.

If you are a hobbyist getting tired of the untold hours it takes to write a program, only to find it takes more hours to debug than to write.

If you are a skilled programmer you don't have to be reminded of the repetitious time spent on each new application.

If you have "IT" in your vocabulary, sitting someplace gathering dust... meet THE PROGRAM WRITER/REPORTER!

THE PROGRAM WRITER/REPORTER is not just another data base generator. THE PROGRAM WRITER/REPORTER, at your direction, makes complete running programs that are thoroughly documented, easy to modify at any time by YOU! THE PROGRAM WRITER/REPORTER cuts programming time up to 90% for a skilled programmer.

THE PROGRAM WRITER/REPORTER will make anyone a skilled programmer in 30 to 35 minutes!

THE PROGRAM WRITER/REPORTER does the work YOU can't see, the simple direct questions and THE PROGRAM WRITER/REPORTER CREATES... AND ALL IN BASIC LANGUAGE.

Q. After THE PROGRAM WRITER/REPORTER has produced a program, can it be modified?

A. Yes, the resulting program is totally, fully documented and readily accessible for alterations or deletion.

Q. Does the program created use so much disc space that there is very little space left for other applications?

A. No, these programs are extremely compact despite complete documentation. If requested, THE PROGRAM WRITER/REPORTER will even "back" or compress information. You may even delete the "remains" making it even more space efficient.

Q. Must I be expert or even conversant with BASIC Language?

A. No, all questions to and answers from the operator require no computer language knowledge, simple everyday English will do.

Q. What is "human" ability?

A. You can count on fingers and toes, you'll have no problems.

Q. Will the programs which I produce with THE PROGRAM WRITER/REPORTER be bulky, slow or unreliable?

A. No, the resulting programs will be sophisticated and extremely fast operating. For example, should you create a mailing list or inventory program, the time for any record to be retrieved and displayed from a full disc would take a maximum of 1 second.

Q. Must the programs produced conform to a predetermined format and file length?

A. No, you determine format and file size to fit your requirements. You may have as many as 300 files or as few as 1.

Q. Can I develop my own business programs?

A. For them to start, yes.

Q. What are the limitations? What programs can I produce with THE PROGRAM WRITER/REPORTER?

A. Your own ingenuity and hardware limitations. 100's of different programs.

TECHNICAL ASPECTS

The Reporter Package, makes reports your way. Record access by a listing algorithm guaranteeing fast record retrieval. Duplicate keys permitted. Record deletion automatically supported. Record access and file maintenance is user transparent. Minimal disc overhead since there is no special assembly language routine called. No "Basic" overhead.

Programs produced can be transported between 8000, 8002, 8080, 286, 8085, 8086 and Z8000 based systems.

Can be used with Micro-Soft Basic and CP/M systems.

Complete file maintenance including update of any record in any field, delete and add new records even with duplicate key.



800-355-5119

Vital Information Inc. 7899 Main Dr. Overland Park KS 66204

BYTE'S Best Cellar List

BUILD YOUR OWN Z80 COMPUTER

This practical guide shows how to build a working computer based on the Zilog Z80 microprocessor. Each computer subsystem is fully explained and supported by proven design and testing information. The description focuses on a basic single-board microcomputer containing:

- easy expansion to include a video terminal
- a 1K-byte operating system
- serial and parallel ports
- hexadecimal display
- audio cassette mass storage

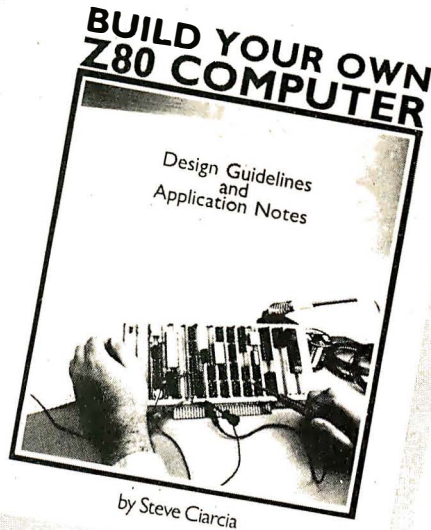

330 pp., softcover

\$15.95

STEVE CIARCIA is a Computer Consultant, Electrical Engineer, and author of "Ask Byte" and "Ciarcia's Circuit Cellar" columns in BYTE magazine.

CIARCIA'S CIRCUIT CELLAR — VOLUMES I & II

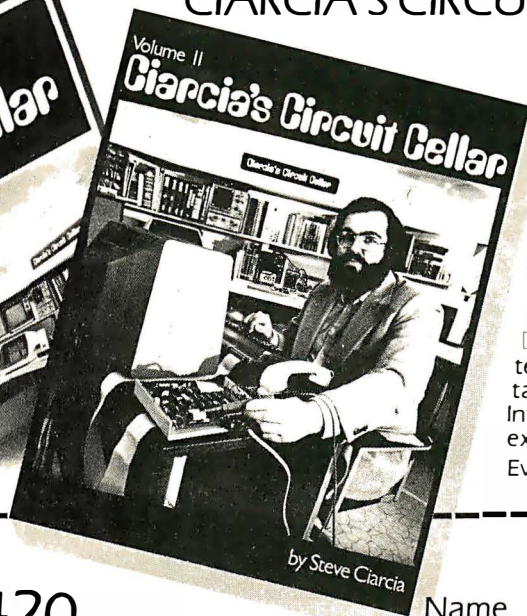
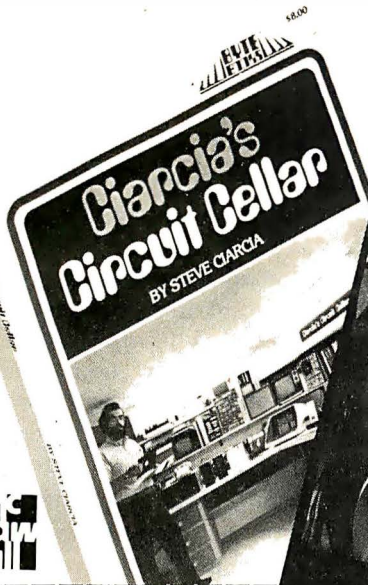

VOL. I details a variety of microcomputer projects. A collection of the best articles from the popular series in BYTE magazine, it includes:

- D/A conversion
 - programming EPROMS
 - AC remote-controlled appliances
 - digitized speech
 - touch input video display
- Complete instructions. 125 pp., softcover \$8.00

VOL. II tells how microcomputers can be interfaced to our environment and includes:

- building a computer controlled home-security system
- computerizing appliances
- transmitting digital information over a beam of light
- building the Intel 8086 microprocessor system design kit
- I/O expansion for the TRS-80

Every step spelled out. 330 pp., softcover. \$12.95

Order by phone
Call toll free

800-258-5420

Please send:

- _____ BUILD YOUR OWN Z80 COMPUTER \$15.95
- _____ CIARCIA'S CIRCUIT CELLAR, VOL. I \$8.00
- _____ CIARCIA'S CIRCUIT CELLAR, VOL. II \$12.95

Add 75¢ to cover postage and handling.

- Check enclosed in the amount of \$ _____
- VISA MasterCard Expires _____
- Card # _____

Name _____

Title _____

Company _____

Street _____

City _____ State _____ Zip _____

BYTE BOOKS 70 Main Street
Peterborough, NH 03458

B1



SB-80

Single Board Technology

- 4MHz Z80A CPU
- CP/M 2 operating system
- 64K 200ns main memory
- 8-inch dual floppy drives
- 50-pin expansion connector
- 2-serial ports
- 2-parallel ports
- 4-counter/timers
- Hard disk options available

Basic system with: 600K bytes

- 2.4 megabytes **\$3490**
- 1.2 megabytes **\$2990**

A Z80A CPU combined with the CP/M* operating system opens new vistas to software availability for eight-bit micros. FORTRAN, COBOL, BASIC, APL, PL/I and Pascal are available now to accommodate today's scientific, educational, sophisticated small business and personal system users.

* CP/M is a registered trademark of Digital Research, Inc.

The Price Is Nice.

\$2425

NORTHEAST COMPUTER SALES

563 South Main Street
Bradford, Massachusetts 01830
(617) 683-3024

decoder, so they can drive only three more input loads. A high-quality S-100 board will not present more than one load to the bus. If two such boards are present in the S-100 expansion slots, make sure that no more than one load for each line is present in circuitry in the wire-wrap area. The data bus is already driving two loads, so you must be very careful about loading it at all in the wrap area.

There are no restrictions on the number of MOS (metal-oxide semiconductor) loads, such as memory devices or LSI (large-scale integration) peripheral-interface integrated circuits, since such devices present negligible load to the signal buses.

Care must also be taken in using any old boards that have standard TTL, since the processor can drive only one such load. You may have to add supplementary buffering components.

The wire-wrap area is a fairly sizable section of the printed-circuit board, containing holes that mate with standard-pattern DIP (dual-inline packages). Each hole has a solder pad; power and ground buses are available on both sides of the board. The useful signals, 70 in all, are brought out to this area.

For my purposes, the wire-wrap area has two disadvantages. It is too small, and I dislike the idea of continually turning the board upside down to wire and check circuitry—both wiring mistakes and damage to the components already on the board are likely to result. I plan to use 44-pin connectors and standard circuit boards to alleviate these problems.

The on-board EPROM programmer is a strong feature of this system. It will program type-2716 and 2758 (which require other supply voltages). In stock trim, the system is capable of programming only 914 bytes, since that is all the user-programmable memory available. However, a program is provided to allow the data to be programmed to reside in any area of memory. This would allow programming from any user-installed memory, and copying read-only memories from the spare socket to the programming socket. One suggestion for those planning to use the starter kit for large-scale read-only memory programming would be to install a ZIF (zero-insertion-force) socket in place of the provided programming socket. This would prevent bent pins and other such damage incurred in prying the programmed device out of the socket.

Some interface capability is built into the Z80 Starter Kit, in the form of a Z80 PIO (parallel input/output) and Z80 CTC (counter/timer circuit) components. The Z80 PIO is a parallel interface circuit similar to the Intel 8255 and Motorola 6820. It has two 8-bit I/O ports with two handshake lines each, and it can be configured in several ways by the use of programmable registers.

The Z80 CTC is a counter and timer circuit (it also is programmable). It has four channels, three of which are used by the kit for timing functions in the read-only-memory programmer and cassette interface. One channel is available to the user. When properly programmed, the

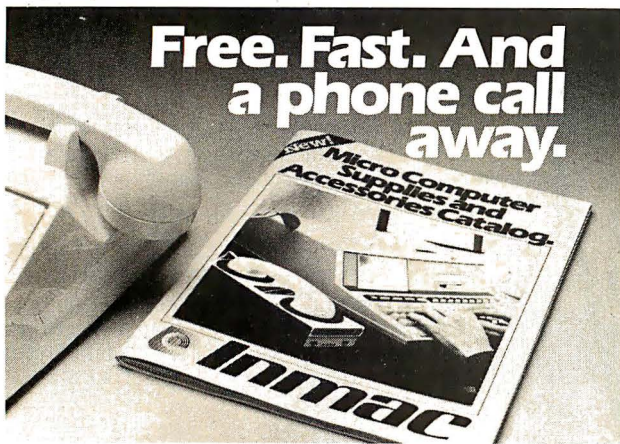

Free. Fast. And a phone call away.

INMAC INTRODUCES THE SOLUTION TO YOUR MICRO SUPPLY AND ACCESSORY NEEDS.

- One-Stop Shopping. This new catalog offers over 1,000 products specifically for Micro Computers. Compatible with Apple, Atari, Northstar, TRS-80s and many others.
- Convenient Ordering. By mail or phone, ordering supplies and accessories from this catalog will be quick and easy.
- Fast Delivery. We'll ship your order within 24 hours from our distribution centers in New Jersey, California, Illinois and Texas. Overnight delivery available.
- Top Quality Products. Virtually all our products are guaranteed for at least one year. Risk-free trial of any product for 45 days.

Send for your FREE Inmac Catalog or call (408) 727-1970.

 **Inmac**
Dept. Micro, 2465 Augustine Drive,
Santa Clara, CA 95051

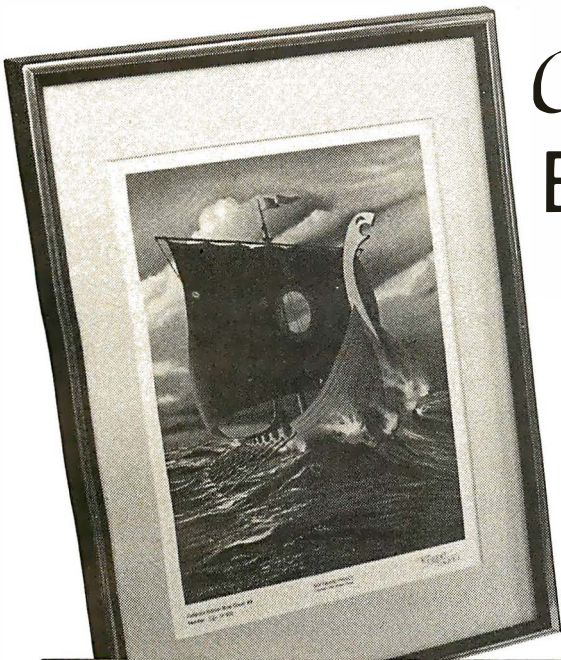

Collector Edition BYTE COVERS

The Byte covers shown below are available as beautiful Collector Edition Prints. Each full color print is 11" x 14", including 1 1/2" border, and is part of an edition strictly limited to 500 prints. The artist, Robert Tinney, has personally inspected, signed and numbered each print. A Certificate of Authenticity accompanies each print guaranteeing its quality and limited number.

The price of a Collector Edition Byte Cover is \$25, plus \$3 per shipment for postage and handling (\$8 for overseas airmail). Collector Prints 9, 10, 11 and 12 can be purchased as a set for \$80, as can Prints 13, 14, 15 and 16.

Collector Edition Byte Covers are also available in the beautiful mat and frame shown above for \$60 each (if Set 9-12 or Set 13-16 is ordered framed and matted, the price per set is \$200). The mat is a neutral gray which blends with most decors, and the black 12" x 16" frame is trimmed in silver. The print is mounted under non-glare glass.

Framed and matted prints are shipped UPS—no delivery to P.O. boxes. Because of expense and breakage, no framed prints are shipped overseas. Please allow 4-6 weeks delivery for framed prints.

To order use the coupon below; Visa and Master Charge orders may call Toll Free.

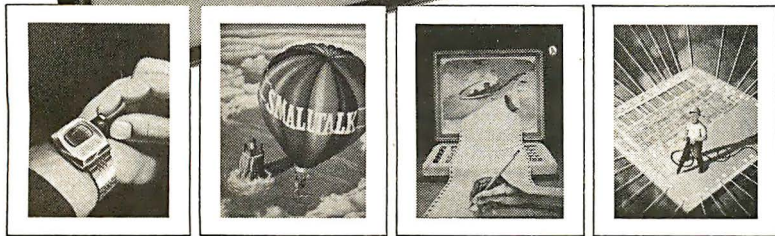

Set 13-16, \$80

FUTURE COMPUTERS
Print 13 - \$25

SMALLTALK
Print 14 - \$25

SOFTWARE
Print 15 - \$25

CHIP BUILDING
Print 16 - \$25

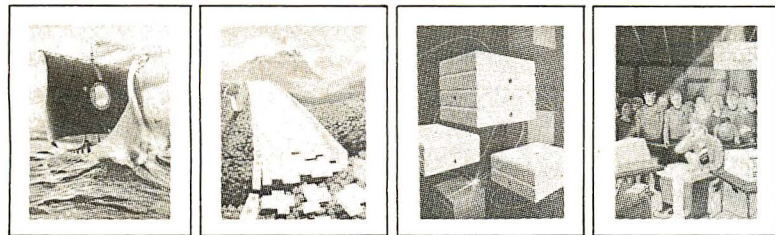

Set 9-12, \$80

SOFTWARE PIRACY
Print 9 - \$25

THE PROGRAMMING ROUTE
Print 10 - \$25

FORTH
Print 11 - \$25

FUTURE PAST
Print 12 - \$25

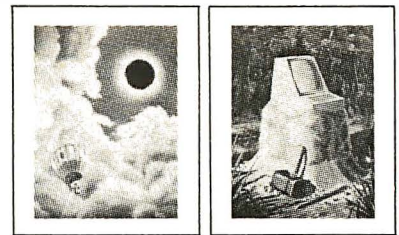

TOTAL ECLIPSE
Print 6 - \$25

COMPUTER HARDWARE
Print 7 - \$25



PERSPECTIVES
Print 8 - \$25

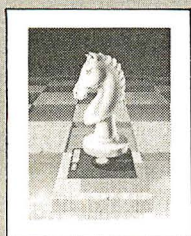

COMPUTER CHESS
Oct. 1978
\$7.95



THROUGH THE TRAP DOOR
Mar. 1979
\$35.00

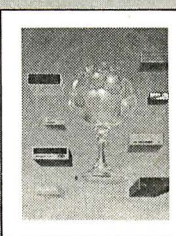

BREAKING THE SOUND BARRIER
Sept. 1977
\$35.00

ALSO AVAILABLE are the prints shown at left. "Computer Chess" is an 18" X 22" full color poster. "Through the Trap Door" and "Breaking the Sound Barrier" are limited editions of 750 prints each, signed and numbered by the artist. Each print is 18" X 22", and is accompanied by its own Certificate of Authenticity. If both "Door" and "Barrier" are ordered, a special price of \$55 applies.

All three prints shown at left are shipped first class in heavy duty mailing tubes.

QTY	TITLE	AMOUNT	
_____	_____	\$ _____	<input type="checkbox"/> I have enclosed check or money order. <input type="checkbox"/> Visa <input type="checkbox"/> MasterCard Card # _____ Expiration Date _____ SHIP MY PRINTS TO: Name _____ Address _____ City _____ State _____ Zip _____
_____	_____	\$ _____	
_____	_____	\$ _____	
_____	_____	\$ _____	
_____	_____	\$ _____	
_____	_____	\$ _____	
_____	_____	\$ _____	
_____	_____	\$ _____	
_____	_____	\$ _____	
_____	_____	\$ _____	
Frames — \$35 each		\$ _____	Mail this coupon to: robert tinney graphics 1864 N. Pamela Drive Baton Rouge, LA 70815
<input type="checkbox"/> Set 9-12 or <input type="checkbox"/> 13-16 — \$80.		\$ _____	
<input type="checkbox"/> Both "Trap Door" and "Barrier" — \$55.		\$ _____	
postage & handling \$3.00 (Overseas \$8.00)		\$ _____	For VISA OR MASTERCARD ORDERS CALL TOLL FREE! 1-800-854-0562 / Ext. 910 Calif: 1-800-432-7257 / Ext. 910 24 HOURS A DAY! 7 DAYS A WEEK!
TOTAL \$		\$ _____	

California:
213-970-1476

Apple II — 48K	\$1080
Apple Disk w/Controller	\$475
Apple Disk Add-on	\$375
5¼ Diskettes	\$25/10
Starwriter 45 cps	\$1750
Epson MX-80	\$465
Epson MX-100	\$750
NEC PC-8001A	\$1000
13" RGB Monitor	\$850
S-100 64K Static	\$550
Qume DT-8	\$510
ADDS Viewpoint	\$565

Discount on SD, CCS, AQ and more.
All items new, guaranteed.



Mail: P.O. Box Q, Sherman Oaks, CA 91423
Store: 15618 S. Inglewood Ave., Lawndale, CA 90260
213-970-1476

STATPRO: MAINFRAME STATISTICS ON AN APPLE

Statpro is a PASCAL software package designed for the professional researcher seeking solutions with a minimum of effort.

Statpro is grouped into a modular format for sales purposes yet which allows the user to transfer data between modules and other programs with easy to use prompts.

Statpro modules include:

- | | |
|-----------------------------------|------------------------------------|
| (1) Real number data base | (2) Data transformations |
| (3) Questionnaire database | (4) Mailing label database |
| (5) General category database | (6) Graphic printing & editing |
| (7) Corvus & profile compatible | (8) Sample data for first time use |
| (9) Does cross tabulation | (10) Descriptive statistics |
| (11) Scatter & Histogram plotting | (12) Regression analysis |
| (13) Analysis of variance | (14) Bibliographic analysis |

Statpro is an integrated database system designed for extensive number crunching, including linear and non-linear regression, step-wise and multiple regression, and analysis of variance.

Statpro, unique in being non-memory dependent allows databases to be limited in size only by disk space. Statpro can enter, receive, send, sort, and transform data.

Transformations include Arithmetic Logarithmic, Exponential, Trigonometric, Powers & Square Roots, Conversions, Random Numbers, Standardized Observations and over 40 English to Metric or Metric to English conversions. Statpro contains several statistical analysis programs, all interlinked and designed to analyze the database records.

Among other features, Statpro has extensive color graphic capabilities, a graphic screen editor, multiple plots per screen, user or computer defined access limits, and choice of symbols and lines. Printing a graph takes only 30 to 120 seconds depending on whether the printer is an Anadex, Epson, Paper Tiger or Silen-type.

Apple III version now available.
(send for brochure)



Blue Lakes Computer
3240 University Ave.
Madison, WI 53705
(608) 233-6502

counter will divide the system clock by a 16-bit value and produce a pulse train or interrupt signal.

I should also note that the processor is a 2 MHz Z80, not a 4 MHz Z80A. The precise clock rate is 1.9968 MHz.

The kit features a switch-selectable automatic restart for those interested in dedicating the unit to a particular application. After a system reset, the monitor examines a switch that chooses whether the normal monitor program or the program in the number-1 read-only-memory socket should be executed. This allows the system to run without operator intervention after reset.

System Monitor

The system monitor supplied with the Z80 Starter Kit is called ZBUG. It is a fairly sophisticated program residing in a 2 K-byte read-only memory. The monitor provides the following command functions:

- Return to Monitor
- Examine Memory
- Examine Port
- Examine Register
- Set Breakpoint
- Single-Step
- Execute
- Dump Memory Contents to Cassette
- Load Memory from Cassette
- Program EPROM
- Next (repeat last operation for next location)

Each function is activated by a single key on the keypad.

With one exception, the ideas behind each of these functions should be obvious. Return to Monitor causes the executing program or other monitor function to cease and allows a new monitor command to be entered. It is supposed to be able to recover the system when an executing program is in an infinite loop.

I found that this does not always work. If a jump is executed to an unused area of memory, the monitor will not recover it. Other mistakes are possible also. In a case like this the only alternative is to reset, which scrambles the contents of memory and is generally unproductive.

The monitor has several other capabilities. One of the most important is a subroutine that calculates the offset for a relative-jump instruction. This is very useful in hand-assembling programs. Other user-callable subroutines are available to provide a 20-ms delay and to convert ASCII (American Standard Code for Information Interchange) characters to and from binary.

One hard-to-find piece of information is the address to return control to the monitor from a program. The address of this reentry point is hexadecimal 00AE.

Documentation

The Z80 Starter Kit Operations Manual is the main system documentation. A Mostek Z80 Micro-Reference Manual is also provided. It is a small booklet that gives the Z80 instruction-set mnemonics, op codes, and timing

An Introduction to Digital Electronics, Logic Design, and Computer Architecture

Today, there is an increasing demand for computer users who are not only well versed in software, but who can also maintain, modify, and design their own hardware systems.

Microcomputer Structures by Henry D'Angelo

This text introduces computer users with little or no background in digital hardware to the basic computer structures used in microcomputer design and microcomputer interfacing. Helpful examples and end-of-chapter exercises further illustrate the various concepts presented, and a detailed bibliography provides additional reading opportunities. As a resource, it will assist:

- programmers and systems analysts
- engineers and scientists
- managers

As a textbook, it will thoroughly prepare students in the fundamentals of digital electronics. The author uniquely begins with Chapter 0, a section for those having no background in electronics. An *Instructor's Manual* accompanies the book, giving detailed explanations and solutions to the exercises at the end of each chapter.

Dr Henry D'Angelo is the Associate Dean of the College of Engineering and Professor of Manufacturing Engineering at Boston University.

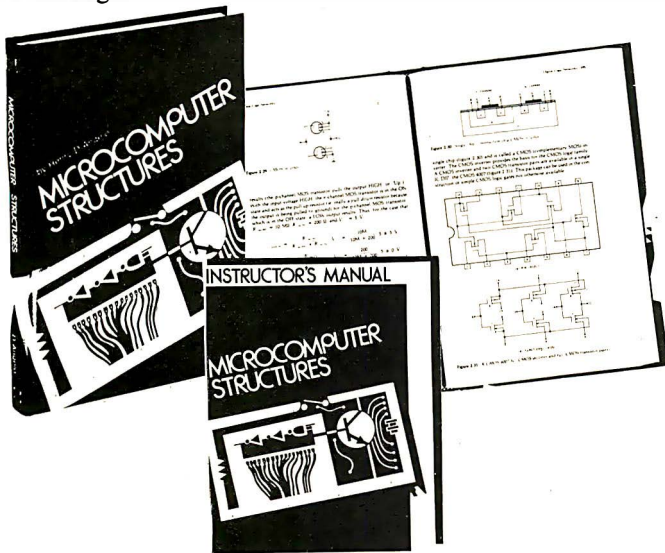

ISBN 0-07-015294-2
395 pages
hardcover
314 illustrations
18.95
Instructor's Manual
ISBN 0-07-015298-5
softcover
8.95

Circle 63 on inquiry card.

Name _____		Title _____	Price _____	Quantity _____	Amount _____
Address _____					
City _____	State _____	Zip _____			
Check _____	Amount _____	Add 75¢ per book to cover shipping costs: _____			
Enclosed _____					
Bill Visa/Master Card Number _____		Total _____			
Expiration Date _____		Call Toll-Free 800/258-5420			
		BYTE Books 70 Main Street, Peterborough, NH 03458			



information. It also gives a summary of Z80 PIO and Z80 CTC programming.

The *Operations Manual* is fairly well written: most of the information is presented clearly, although occasionally a useful item is buried. The best place to look for these is in the "Example Programs" section. Several programs are provided there that give an overview of the kit and help expand its usefulness. A complete schematic diagram and a complete source-code listing of the monitor are also included.

Power Supply

The manual states that the Z80 Starter Kit requires +5 V at 1 A for normal operation and an additional +25 V supply at 30 mA for read-only-memory programming. I designed the power supply shown in figure 1 to provide the +5 V, as well as power for linear semiconductor devices in the wire-wrap area at ± 12 V.

All parts but the voltage regulators are available from Radio Shack. The regulators can be acquired at most electronics supply houses or by mail from any of several BYTE advertisers. Be sure to mount the regulators on heat sinks, and don't be surprised if they become warm. The supply will put out 1 A at +5 V and 200 to 300 mA at ± 12 V. The +25 V supply for EPROM programming can be provided by three 9-V transistor-radio batteries in series, since the current requirement is so small and the duration of use is short.

Summary

If you are looking for a single-board computer that can be expanded and run 8080 or Z80 software, the Z80 Starter Kit is a good choice. You should also consider it for practical applications such as home security and small-scale industrial or laboratory control, and as an inexpensive stand-alone EPROM programmer. ■

The perfect marriage of Superbrain™ and Winchester.™

SUPERFIVE™

700K or 350K floppy storage

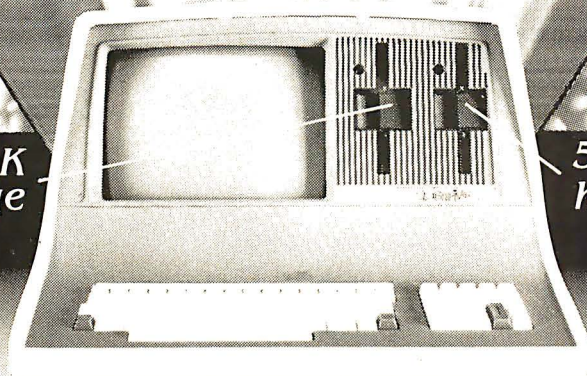

5 Megabytes hard disk storage

Finally, a price-performance breakthrough for mass storage in a one-piece, handsomely styled desk-top computer.

- 5 1/4" Micro-Winchester™ 5 Mbyte (formatted) hard disk.
- 700K or 350K floppy disk back up.
- Dual Z-80 processors with 64K RAM.
- Dual RS232 ports.
- Complete and ready to run with CP/M™ 2.2.

**DEALER & OEM
INQUIRIES INVITED**

TELEPHONE (206) 453-9777
TOLL FREE 1-800-426-2963



- Largest Intertec distributor in the United States.
- Distributor for C. Itoh, MPI, Epson.
- Seagate, Tandem drives.
- Corvus hard disks, multiplexers.
- Superbrain S-100 bus, graphics, and parallel port.
- Software: MicroPro, Accounting Plus, Peachtree, Condor, Benchmark.

SuperFive ALSO DISTRIBUTED BY:

Compu Data
1 Bala Cynwyd Plaza
Bala Cynwyd, Pennsylvania 19004
Telephone (215) 667-6843

Diversified Data
8045 W. 82nd
Indianapolis, Indiana 46278
Telephone (317) 299-0115

CMC International
A Division of Computer Marketing Corporation
11058 Main, Suite 125, Bellevue, WA 98004
(206) 453-9777

TERMINALSMITH™

THE FIRST BRILLIANT TERMINAL™

MORE FEATURES PER DOLLAR THAN ANY OTHER TERMINAL

- 3 Keyboard Layouts
- Multiple Emulations
- ADM-31, DEC VT-52 & VT-100
- Smooth Scrolling
- Full Editing Features
- Detachable Keyboard w/ Human Engineered Keys
- Inductive Key Switches (No contamination or cleaning)
- Easy to Program Function
- Keys with Battery Backup of Memory
- Split Screen
- Status Line with Real Time Clock

- Green Phosphor Std
- Full Screen Attributes
- Double High and Double Wide Characters
- All Terminal Functions Accessible through Software



FALCO
DATA PRODUCTS

\$1195* QTY.-1

OPTIONS: Multiple Page Memory
 Integral 300-1200 Baud Modem

Qume

QUMETRAK 8 & QUMETRAK 5 FLOPPY DISC DRIVES DUAL SIDED DUAL DENSITY

QT-8 **\$525.** QTY. 1
 QT-5 **\$310.** QTY. 1

THINLINE Tandon

8"

TM-848-1 \$475* QTY. 1 SINGLESIDED
 TM-848-2 \$550* QTY. 1 DUAL SIDED

FIT 2 DRIVES IN THE SPACE OF 1

QUME LETTER QUALITY PRINTERS

SPRINT 9/45 \$2245* QTY. 1

OTHER MODEL AND CONFIGURATIONS AVAILABLE AUTHORIZED QUME DISTRIBUTOR



744-O SSSD 5 1/2" 2.15 ea
 740-O SSSD 8" 2.20 ea
 741-O SSDD 8" 2.75 ea
 743-O DSDD 8" 3.35 ea

PRICE FOR QTY. 100

(408) 438-5454

4444 SCOTTS VALLEY DR., SCOTTS VALLEY, CA 95066

TERMS: Cashiers Check, VISA, M/C, COD
 Shipping charges added to all orders
 *Quantity Discounts Available



TERMINALS FROM TRANSNET

PURCHASE PLAN • 12-24 MONTH FULL OWNERSHIP PLAN • 36 MONTH LEASE PLAN

	DESCRIPTION	PURCHASE PRICE	PER MONTH			
			12 MOS.	24 MOS.	36 MOS.	
DEC	LA36 DECwriter II	\$1,095	\$105	\$58	\$40	
	LA34 DECwriter IV	995	95	53	36	
	LA34 DECwriter IV Forms Ctrl.	1,095	105	58	40	
	LA120 DECwriter III KSR	2,295	220	122	83	
	LA120 DECwriter III RO	2,095	200	112	75	
	VT100 CRT DECscope	1,695	162	90	61	
	VT101 CRT DECscope	1,195	115	67	43	
	VT125 CRT Graphics	3,295	315	185	119	
	VT131 CRT DECscope	1,745	167	98	63	
	VT132 CRT DECscope	1,995	190	106	72	
VT18XAC Personal Computer Option	2,495	240	140	90		
TEXAS INSTRUMENTS	T1745 Portable Terminal	1,595	153	85	58	
	T1765 Bubble Memory Terminal	2,595	249	138	93	
	T1 Insight 10 Terminal	695	67	37	25	
	T1785 Portable KSR, 120 CPS.	2,395	230	128	86	
	T1787 Portable KSR, 120 CPS.	2,845	273	152	102	
	T1810 RO Printer	1,695	162	90	61	
	T1820 KSR Printer	2,195	211	117	80	
	ADM3A CRT Terminal	595	57	34	22	
	ADM5 CRT Terminal	645	62	36	24	
	ADM32 CRT Terminal	1,165	112	65	42	
LEAR SIEGLER	ADM42 CRT Terminal	1,995	190	106	72	
	DT80/1 CRT Terminal	1,695	162	90	61	
	DT80/3 CRT Terminal	1,295	125	70	48	
	DT80/5L APL 15" CRT	2,295	220	122	83	
	920 CRT Terminal	895	86	48	32	
	950 CRT Terminal	1,075	103	57	39	
	TELEVIDEO	Letter Quality, 7715 RO	2,895	278	154	104
		Letter Quality, 7725 KSR	3,295	316	175	119
	NEC SPINWRITER	2030 KSR Printer 30 CPS	1,195	115	67	43
		2120 KSR Printer 120 CPS	2,195	211	117	80
GENERAL ELECTRIC	Executive 80/20	1,345	127	75	49	
	Executive 80/30	1,695	162	90	61	
HAZELTINE	MX-80 F/T Printer	745	71	42	27	
	MX-100 Printer	895	86	48	32	

FULL OWNERSHIP AFTER 12 OR 24 MONTHS • 10% PURCHASE OPTION AFTER 36 MONTHS

MICROCOMPUTERS

APPLE • COMMODORE • HP85 • DEC LSI 11

ACCESSORIES AND PERIPHERAL EQUIPMENT

ACOUSTIC COUPLERS • MODEMS • THERMAL PAPER • RIBBONS • INTERFACE MODULES • FLOPPY DISK UNITS



TRANSNET CORPORATION
 1945 ROUTE 22 • UNION, N.J. 07083 • (201) 688-7800
 TWX 710-985-5485

TRS-80™ DISCOUNT - BUY DIRECT

WE SELL THE FULL LINE OF TRS-80'S AT WHOLESALE PRICES

MODEL II

26-4002 64K I Drive. **\$3288**

Ask About Hard Drives

MODEL III

26-1062 16K. **\$849**

26-1066 48K with
2 Drives, RS232. **\$2069**

COLOR COMPUTER

26-3001 4K. **\$318**

26-3002 16K Ext. Basic. **\$488**

26-3003 32K Ext. Basic. **\$578**

POCKET COMPUTER

26-3501 Pocket Computer. **\$188**

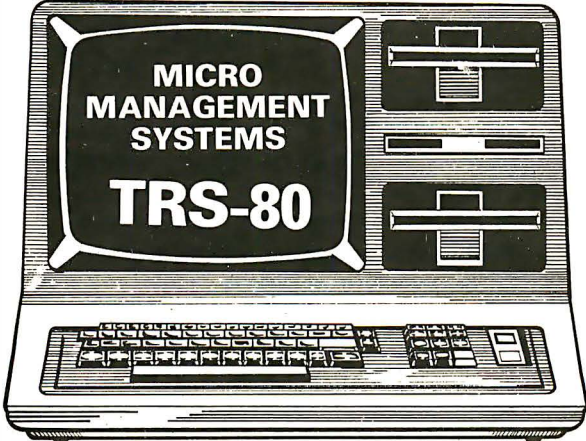

THOUSANDS OF SATISFIED CUSTOMERS

WRITE FOR YOUR FREE CATALOG

ORDER TOLL FREE

1-800-841-0860

- LARGE INVENTORY
- FAST DELIVERY

TM - TANDY CORPORATION
FREE COPY OF WARRANTY UPON REQUEST

MICRO MANAGEMENT SYSTEMS, INC.

DEPT. NO. 1
115C SECOND AVE. S.W.
CAIRO, GA. 31728
GA. 912-377-7120

CENTRONICS

739-1 PRINTER

\$699⁰⁰

COSMAC EPROM Programmer

Dan Rubis
POB 402
St. Clair Shores, MI 48080

Programming an EPROM (erasable programmable read-only memory) has become much easier in recent years. The old-style 2708 EPROMs (1 K by 8 bits) required +26 volts (V) to be turned on and off 100 times for each byte programmed—a total programming time of 100 milliseconds (ms) per byte. A 2708 programmer was a complex device that often relied on adherence to close timing specifications and used switching transistors. It was also necessary to program the whole device at once—unprogrammed addresses contained invalid data and could not be programmed until the entire device was erased.

The newer 2716 (2 K by 8 bits) and 2732 (4 K by 8 bits) EPROMs, on the other hand, use only +5 V on the programming pin (a +25 V supply is necessary, though). A single byte at any address can be programmed in 50 ms. Under certain circumstances, you can even program one bit of a byte.

These features make EPROM programming possible with a relatively simple circuit connected to a microprocessor. This article describes an EPROM programmer, based on the RCA COSMAC 1802 microprocessor, which is designed for the not-so-affluent computer enthusiast. (Projected cost for the programmer circuitry is about \$30, and single-board 1802 computers are available for about \$100. Considering that in-

dustrial programmers cost thousands of dollars, this is an outstanding value.) The approach I have taken should allow any 1802 computer to be used.

Design Basics

This is a "bare bones" design, without many protective hardware features, and so a certain amount of care and attention to detail is required: a goof-up could cost you the price of an EPROM. The key here is simplicity; hence the use of the 1802. The 1802 excels in control applications and will provide the address, data, and control signals, as well as perform all the timing functions of the programming process.

Programming a 2716 or a 2732 is quite similar to programming a 2708, the main difference being the storage size. If your computer has only 4 K bytes of programmable memory, any 2732s you program will have to be done in two 2 K-byte segments. The biggest advantage of the new-style EPROMs is the simpler programming process: all that is required to program a byte anywhere in the address space is one 50-ms pulse.

Figure 1 illustrates how the 1802 computer functions as the controller. The computer's programmable memory will hold the data to be programmed into the EPROM. With appropriate software, the computer will supply address and data to their

respective latches. Then the control lines of the computer will signal the latches to hold the address and data. The output of each latch is applied to the appropriate pin on the target EPROM.

The computer then applies a control signal (programming pulse) to the EPROM. This pulse signals that the data information is ready and that it should be programmed into the memory location as specified by the address. Three conditions are necessary to successfully program a byte of data into the EPROM:

1. The address location must be applied to the correct pins of the EPROM (A0 through A10).
2. The data byte must be applied to the output pins of the EPROM (O0 through O7).
3. A programming pulse of 50 ms must be applied to the programming pin of the EPROM (PGM).

Notice the two 24-pin integrated circuits (IC3 and IC4) marked CDP-1852 in the circuit diagram (figure 2a). These are RCA CMOS (complementary metal-oxide semiconductor) 8-bit I/O (input/output) ports, which will be used in their output mode as latches.

The memory locations of a 2716 are addressed in the range from 000 through 7FF hexadecimal and therefore require eleven address bits. One

Model 953A EPROM PROGRAMMER

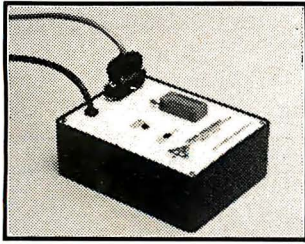

- Programs 2508, 2758, 2516, 2716, 2532 and 2732 five volt EPROMS.
- Complete - no personality modules to buy.
- Intelligent - microprocessor based, programs and verifies any or all bytes.
- RS-232 serial interface - use with computer or terminal.
- Verify erase command - verifies that EPROM is erased.
- Extended diagnostics - error output distinguishes between a bad EPROM and one which needs erasing.
- May be used for extremely reliable data or program storage.
- All power on programming socket under processor control. LED warning light indicates when power is applied.
- Complete with Textool zero insertion force socket.
- High performance/cost ratio.
- Standard DB-25 I/O connector.

PRICE \$289



BAY TECHNICAL ASSOCIATES, inc.

HWY. 603, P.O. BOX 387
BAY ST. LOUIS, MISSISSIPPI 39520
(601) 467-8231

BDOS ERROR ON B:BAD SECTOR



Before disk errors ruin your work again order BADLIM.

- BADLIM assures the reliability of your CP/M computer.
- You can use your disks 10 times longer without losing your data AND your time.
- BADLIM checks thoroughly your disk marking all the blocks which have defective sectors. The operating system will know that those sectors should be skipped.
- BADLIM is the only program that gives protection for soft and hard errors.
- The first time BADLIM will list which files in your disk are on bad sectors, so you can take action to correct it.
- But thereafter the bad areas in your disk will be automatically by-passed.
- For CP/M 1.4 single density and for CP/M 2.xx of any format and density. It is a must for Winchester as the media cannot be replaced.

BADLIM cost only \$73. Whatever the reason you have to use a computer you need BADLIM. Contact your dealer or call us today:

BLAT R&D Corp., 8016 188th. St SW, Edmonds WA 98020. Phone: [206] 771-1408

DEALER INQUIRIES INVITED.

BADLIM

COMPUTERS
ATARI 800™ COMPUTER SYSTEM

16k → \$750.00
48k → \$898.00

"APPLE II Plus"

48k → \$1199.00
64k → \$1399.00

ATARI Software

Missile Command
Asteroids
Star Raiders
Chess

All / \$3600/ea

CONCORD COMPUTER PRODUCTS

1971 SO. STATE COLLEGE
ANAHEIM, CALIF. 92806

(714) 937-0637
CHECK - M/O
NO COD

*\$10. MIN ORDER/ C.A. RES. ADD 6% FRT.
\$10-49 \$2.00 \$250-499 \$9.00
50-99 4.00 500-999 11.00
100-240 8.00 1000-UP CALL

send \$4.00 for '81 catalog

SPECIALS

- ZENITH ZVM-121 Video Monitor: Green Phosphor
12 inch. 15+Mhz. → \$134.00
- 3inch MUFFIN FAN w/cord → \$9.95
UPD 765: Floppy Disk Cont. → \$19.95
- 8155-RAM → \$11.50
8255-PPI → \$7.95
2111-Static RAM → \$1.75
8085A CPU → \$8.50
MC6800-CPU → \$7.75
ER 2501-EAROM → \$4.95
- AY3-8603 → \$4.95
LM300H → 45c
6802 → \$9.50
6502 → \$6.50
6821 → \$4.95

MONITORS

- AMDEK Corp.
- 12in. B/W → \$129.00
12in. Green → \$155.00
13in. Color → \$365.00

Tbar inc.

RS-232 COMPATIBLE DIGITAL TRANSFER SWITCH WILL SWITCH MODEMS BETWEEN PROCESSORS / PRINTERS. 24 PINS ARE SWITCHED. PIN 1 WIRED TO GROUND.

DESK TOP # 5722 \$149.00

AS SHOWN \$145.00

COMPONENTS

SN7400N .18	SN7482N .30	74500 .39	745138 .75
SN7402N .22	SN7492N .49	74502 .45	745140 1.00
SN7404N .21	SN7493N .45	74503 .38	745158 .75
SN7408N .22	SN7495N .50	74504 .39	745174 1.35
SN7410N .18	SN7496N .50	74505 .39	745175 1.35
SN7412N .20	SN74122N .39	74510 .39	745182 .75
SN7413N .22	SN74138N .36	74515 .45	745189 4.25
SN7414N .20	SN74141N .60	74520 .55	745201 8.75
SN7416N .27	SN74151N .65	74522 .55	745240 2.75
SN7417N .29	SN74153N .55	74530 .75	745244 2.56
SN7420N .17	SN74154A 1.25	74537 .65	745251 2.75
SN7425N .20	SN74155N .75	74540 .65	745287 2.95
SN7430N .17	SN74157N .55	74551 .49	745289 2.95
SN7438N .24	SN74161N .65	74564 .55	745298 5.75
SN7440N .18	SN74163N .85	74574 .65	745470 9.25
SN7442N .45	SN74164N .87	74586 .96	745471 9.50
SN7443N .42	SN74165N .58	745112 1.95	745473 9.50
SN7445N .04	SN74174N .88	745132 1.45	
SN7451N .19	SN74175N .78		
SN7454N .19	SN74180N .75		
SN7474N .27	SN74181N 1.15		
SN7475N .35	SN74933N 1.65		

EPROMS

2708	3.25ea	8 for 2.95ea
2716	5.50ea	8 for 5.00ea
2732	12.95ea	4 for 11.00ea
4116	300MS 2.00ea	8 for 14.00
	200MS 2.25ea	8 for 18.00
	200MS 2.45ea	4 for 2.00ea

MISC.

2111	450MS	2.50ea	10 for 2.00ea
------	-------	--------	---------------

CONT'D

1103A	.75
UPD785	19.85
controller	w/80
floppy disk	1.50
LANC001	1.95
LANC001	1.50
TMS4400	1.40
MC4008P	1.50
MH0026	1.55
D3824	1.95
D3001	1.95
D3002	1.95

I.C. SOCKETS

85	85	85	w	p	at
.85	1015.30	8	1011.90		
.85	1015.70	16	1011.40		
1.50	1018.70	18	1011.90		
1.15	1019.70	30	1012.70		
1.50	1012.70	22	1012.70		
1.50	1013.70	24	1012.70		
.85	1014.70	28	1013.00		
.25	1017.70	40	1013.90		
.55	wirewrap				
.30	solder				
1.30					

74LS00

74LS00 .28	74LS158 .60	2102	
74LS02 .28	74LS161 .83	450MS	
74LS03 .28	74LS162 .80	NE565	
74LS04 .28	74LS163 .88	AIS-1013A	
74LS05 .22	74LS164 .85	1488	
74LS08 .29	74LS165 .85	1489	
74LS10 .28	74LS169 .65	8212	
74LS12 .22	74LS171 .85	8216	
74LS16 .27	74LS172 .85	IS4KDCR	
74LS20 .40	74LS173 .85	7410TRIAC	
74LS24 .37	74LS240 1.65	7905	
74LS28 .31	74LS241 1.65	7906	
74LS30 .31	74LS242 1.65	7907	
74LS32 .30	74LS243 1.55	7908	
74LS36 .83	74LS244 1.55	7909	
74LS42 .77	74LS245 1.45	7915	
74LS48 .38	74LS246 1.25	7918	
74LS52 .35	74LS251 2.25	7919	
74LS56 .45	74LS252 .85	7906	
74LS60 .55	74LS253 .55	7908	
74LS69 .60	74LS259 1.95	7908	
74LS74 .80	74LS260 1.75	7912	
74LS107 .43	74LS273 1.55	7912	
74LS113 .45	74LS279 1.55	MC1330AIP	
74LS122 .45	74LS280 1.25	MC1350P	
74LS123 .90	74LS293 1.85	MC1358P	
74LS125 .80	74LS305 .85	LM380	
74LS126 .79	74LS307 .75	LM358N	
74LS138 .64	74LS373 1.45	LM741	
74LS139 .59	74LS374 1.45	MC1458P	
74LS151 .49	74LS377 1.25	LM723	
74LS153 .40	74LS380 1.55	LM358	
74LS157 .60	74LS387 1.85	LM389	

Bare Bones APPLE II

W/O Keyboard \$450.
W/O Pwr. Supply

CPU*	7.95
Z-80 CTC	10.50
Z-80A CPU	10.50
Z-80 002 16-64K	129.00
8085A	2.90
2901A	7.50
MC6800	9.50

POWER SUPPLY MODEL #CP198

INPUT: 110-125v
OUTPUT: 5-vdc
at 5amps

turns an ordinary outlet into a 5 amp rated power source

\$29.95
Qty price email

DISKETTE «SALE»

Wabash: 5 1/4 → 10¢ \$24.95
8inch → 10¢ \$27.95

Dysan & Spectrum also available!! call for price

APPLE CLOCK \$124.00

PROTO BOARD \$25.00

PRINTERS EPSON MX-80 \$535.00

FT-8645.00

Interface & cable \$78.90

WE CARRY COMPUTER BOOKS!!!

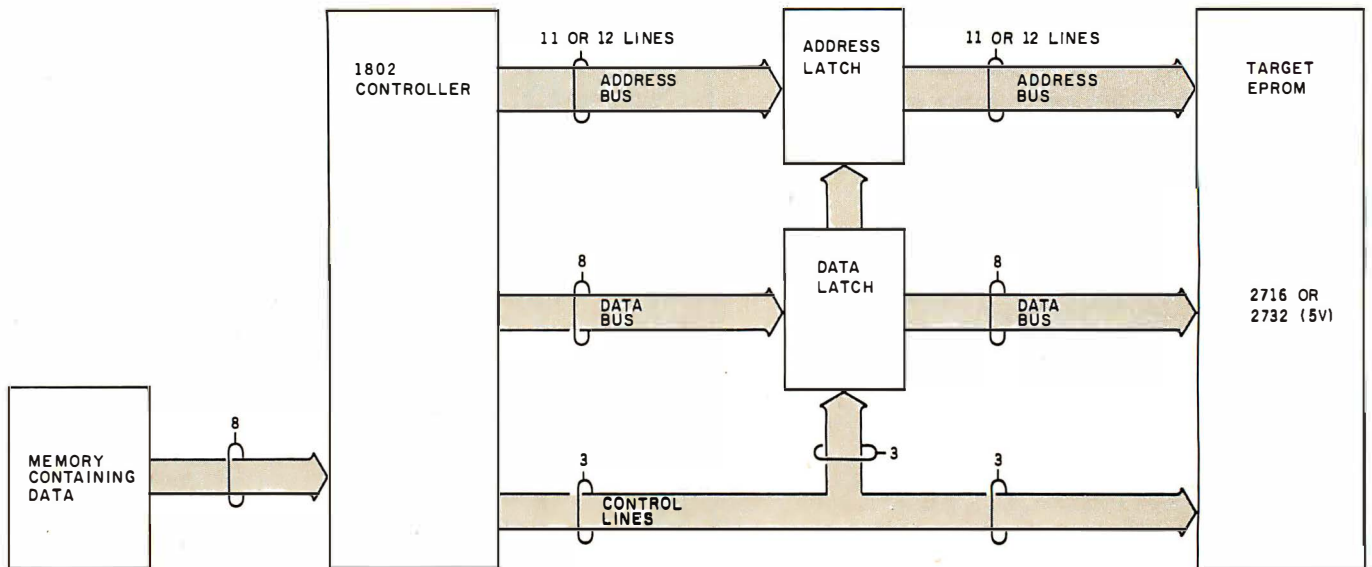

Figure 1: A block diagram of the EPROM-programmer system. The 1802 microprocessor provides address and data signals to latches, then, through the use of various control signals, releases the information from the latches at the proper time to program the EPROM.

1852 8-bit latch is not large enough; an additional CD-4042 4-bit latch (IC2) is needed. Also notice that the 1852 has two device-select pins, $\overline{CS1}$ and $CS2$, and a clock pin. These pins are used to latch the address at the appropriate time. The 4042 is a simple latch and does not have select pins; it is necessary to include a CD-4011 quad NAND gate to help select the latch. See figure 3 for the pin assignments of the CDP-1852, CD-4042, and CD-4011.

The programming data is only 8 bits wide, and, therefore, only one 1852 (IC4) is required for latching. Refer to figure 2a for information on how it is connected to the EPROM.

The 2732 has slightly different pin designations. The A11 address bit is assigned to pin 21, and V_{pp} now shares the output enable (OE) pin 20. A11 has to be accommodated in order for the EPROM to address 4 K bytes of memory. This is the dashed line in figure 2a.

If you plan on programming both 2716s and 2732s, a switch will have to be provided; otherwise jumper wires will do nicely.

Power Supply

The schematic for the 5-V power supply is shown in figure 2b. Its input comes from a well-filtered +8-V

source, such as a transformer/bridge-rectifier/capacitor combination. The +25-V programming power supply (figure 2c) is a full-wave rectified 24-V AC transformer, filtered by a 3500 μ F capacitor and regulated by an LM 340-24 positive voltage regulator. In order to meet the +25-V requirement using a +24-V regulator, a diode (1N914) is placed in series with the ground reference pin of the regulator. The diode represents about a 0.6-V drop and therefore brings the ground reference of the regulator up from 0 V to 0.6 V. The output of the regulator will therefore be 0.6 V closer to the required voltage. The manufacturer allows a tolerance of ± 1 V on the programming voltage, and the added diode puts the voltage within this tolerance.

Timing

The computer has eight clock cycles of period T for every machine cycle (see the timing diagram, figure 4). A machine cycle can be either a fetch or an execute cycle. I will discuss only the programming execute cycle, OUT7 (67). This instruction transfers data from the computer's programmable memory to the data bus.

An OUT7 instruction asserts a logic 1 level on each of the N2, N1, and N0 status lines. In this design, N2

is used to signal the latches when to hold the address and data.

N2 stays at logic 1 during the entire execute cycle. When N2, TPA (line 3), and \overline{MRD} (line 5) are logic true (1, 1, and 0, respectively), the high-order address byte A1 is on the bus and is ready to be latched (see line 2 at clock cycle 1.5).

Only bits A8 through A10 of the high-order address are needed for a 2716 EPROM. These three bits are latched by the 4042. In order to latch them at the correct time, TPA and N2 are ANDed together using the 4011 NAND gates. When both TPA and N2 are at logic 1, the \overline{STROBE} pin of the 4042 latch will be at logic 1. This allows the outputs of the latch to follow the inputs; what appears at the latch's inputs also appears at its outputs. When TPA goes from logic 1 to logic 0, this negative transition essentially freezes the outputs of the latch until a subsequent positive transition (0 to 1) occurs. Another positive transition of the \overline{STROBE} pin will not occur until after the 50-ms programming pulse has been completed (see lines 2, 3, 6, and 7 of the timing diagram, figure 4).

Further down the execute cycle, the low-order bits A0 through A7 are available on the address bus starting at 2.5 on the clock cycle (A0). TPB goes positive at clock cycle 6.5, and

Text continued on page 352

DISCOUNT PRICES

MICROCOMPUTERS
CRT TERMINALS
PRINTERS
DISKETTES
SOFTWARE

WE'RE ON THE
EAST COAST

DUPRÉ ENTERPRISES, INC. MICROCOMPUTER SALES DIVISION

SUITE 6 NELSON BLDG.
271 FORT LEE ROAD
LEONIA, NJ 07605

(201) 461-8086
9 AM-3 PM
MON.-FRI.

68000

ERG68-696 68000 CPU in production. Meets or exceeds IEEE696 S-100 standard.

\$1995

Available software: Z80 emulator, 68K FORTH systems language, Whitesmiths' UNIX-like IDRIS—O/S with C or Pascal compilers.

Integrated 68000 systems also available.

Special offer: 68K Mini-System \$7995 CPU, 4 port I/O, 64K static RAM, 68K FORTH systems language, 10 slot mainframe, (2) 8" D/D, D/S floppy drives or a 5 MB 5 1/4" hard disk drive.

Empirical Research Group, Inc.

PO Box 1176
Milton, WA 98354
206-631-4855

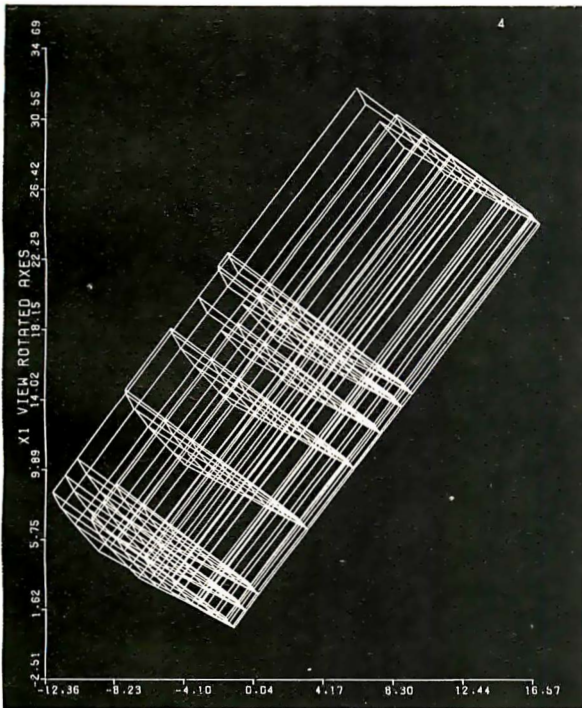

ENGINEERING SOFTWARE FOR MICRO'S

Graphic Software for Micro's - This self-teaching guide will show you how to write your own 2D and 3D graphics software. Contains 61 programs for elementary to advanced graphics operations - translation, rotation, scaling, clipping, stretching, hidden line removal, shading, perspective, intersections, animation and more. Also includes practice problems for classroom use. Program listings in BASIC fully explained and presented alongside theory. Perfect for students, professionals & software developers. "One of the most outstanding books on computer software"- Alan Grund, University of Illinois

"A magnificent book...a major contribution to the educational literature for computers" - Philip Becker, Christian Brothers College, Memphis

Book with listings-\$19.95, Disk(Apple II plus 48K DOS3.3)-\$18.95

Engineering Applications of Micro's - A collection of techniques and programs for applying micro's and computer graphics to engineering - structural mechanics, kinematics, heat transfer, systems analysis, Fourier analysis, optimization, CAD/CAM, and more. Theory with listings in BASIC fully documented. Book with listings-\$28.50, Disk(Apple II plus 48K DOS3.3)-\$19.95

Structural Analysis on Micro's - Theory and program listings in BASIC for matrix structural analysis of rigid frames. Graphical output shows displaced configuration. Member loads determined. Use software as is or modify for your special applications. Book with listings-\$39.95, Disk(Apple II Plus 48K DOS3.3)-\$24.95



call (617)934-0445
for faster delivery



Add \$2 per item shipping, \$3 UPS in US; \$3.50 Canada
\$12 air Europe & Central America; \$18 elsewhere.

KERN PUBLICATIONS • Duck Hill Rd • PO BOX 1029C • Duxbury, MA 02332

Number	Type	+5V	GND
IC1	CD4011	14	7
IC2	CD4042	16	8
IC3	CDP1852	24	12
IC4	CDP1852	24	12

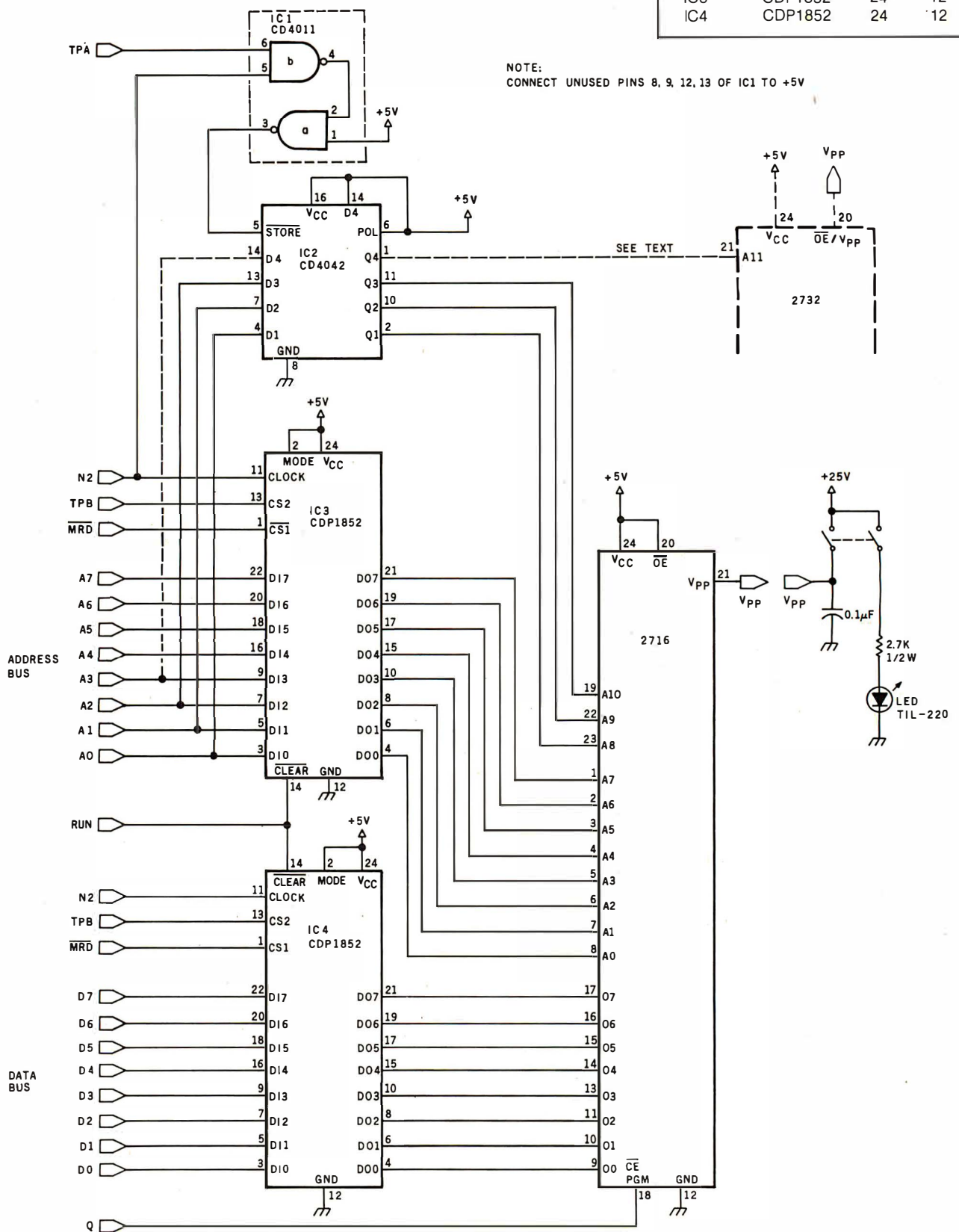

Figure 2a: A schematic diagram of the EPROM programmer, which illustrates the use of one 1852 8-bit latch (IC4) to hold the data that will be programmed into the EPROM. An 1852 and the combination of a 4042 latch and a 4011 NAND device are used to hold up to 12 address bits.

Expand Your

ZENITH

Computer System

with these Professional Quality CP/M™ Software Packages*

SPELLBINDER™ – the best word processing and office management system. All standard features plus horizontal scroll, boilerplating, mailmerge, sorting, 2 column printing, forms creation, and much more **\$395**
Law Office Management add on package **\$395**

ACCOUNTING PLUS™ – modular, true double entry bookkeeping system with audit trail; includes GL, AR, AP, payroll, inventory, point of sale, sales order entry, purchase order entry. Minimum 3 module system **\$1600-4000**

PLAN80™ – powerful multi-level financial modeling system to plan, analyze, and report; interactive and programmed modes **\$295**

*These and other powerful, professional and personal software packages are available for most computers running standard CP/M 2.2. For more details call or write today!

TARCO

DEVELOPMENT
CORPORATION

1445 Koll Circle, Suite 111, San Jose, CA 95112. (408) 947-1101
 (out of state, call toll free 800/538-7864)

Spellbinder is a TM of Lexisoft Inc.. Accounting Plus is a TM of Software Dimensions Inc.. PLAN80 is a TM of Business Planning Systems. CP/M is a TM of Digital Research.

Main/Frames from \$200

Main/Frames from \$200

- 14 Basic Models Available
- Assembled & Tested
- Power Supply:
8v@15A, ± 16v@3A
- 15 Slot Motherboard (connectors optional)
- Card cage & guides
- Fan, line cord, fuse, power & reset switches, EMI filter
- 8v@30A, ± 16v@10A option on some models

Rack mounted Main/Frame

8" Floppy Main/Frame (includes power for drives and main/frames)

Write or call for our brochure which includes our application note:
 'Building Cheap Computers'
INTEGRAND
 8474 Ave. 296 • Visalia, CA 93277 • (209) 733-9288
 We accept BankAmericard/Visa and MasterCharge

S-100 INNOVATORS:

S-C-I-T-R-O-N-I-C-S-I-N-C.

REMOTE CONTROLLER—Innovative Features:

- * Complete 256 address control—not just 16
- * No ultrasonic link—prevents erratic operation
- * 120,208,240 and 277VAC control—for single & 3 phase operation
- * Hardware driven—requires minimal software
- * Complete line of industrial switches available—to 5.5KW

REAL TIME CLOCK—Innovative Features:

- * First to use LSI OKI clock chip
- * Crystal controlled for .002% accuracy
- * 4 software selectable clock generated interrupts
- * Full clock and calendar data
- * Lithium battery backup good for 6000 hours!

ENERGY WATCHER™—Innovative Features:

- * First microcomputer based energy monitor
- * Clip on probes for easy installation
- * Monitors **Real Power**, not volt-amps
- * Peak Power and continuous power readings
- * Single and 3 phase operation

See your local computer dealer or contact SciTronics directly for more information. Watch for future innovative products from SciTronics Inc., 523 So. Clewell St., P.O. Box 5344, Bethlehem, PA 18015 (215) 868-7220

Circle 331 on inquiry card.

BYTE January 1982 349

MTI stocks 'em all for faster delivery.

Ask about our "QED" discounts.
VISA and MasterCard orders accepted.

VIDEO TERMINALS	MTI Price
VT100 DECscope	\$ 1595
VT101 DECscope	1215
VT131 DECscope	1785
VT132 DECscope	1395
ADM 3A (dumb terminal)	595
ADM 5 (dumb with visual attributes)	645
ADM 31 (two page buffer)	1095
ADM 32 (ergonomic ADM 31)	*
ADM 42 eight page buffer avail.	*
TI 940 (two page buffer)	1795
TI "Insight Series 10" personal term.	695
Hazeltine Executive 80 Model 20	1495
Hazeltine Executive 80 Model 30	1715
1410 (Hazeltine dumb terminal)	825
1421 (Corsul 580 & ADM 3A comp.)	850
1500 (dumb terminal)	1045
1510 (buffered)	1145
1520 (buffered, printer port)	1395
1552 (VT52 compatible)	1250
Hazeltine Esprit	645
GRAPHICS TERMINALS	
VT100 with graphics pkg.	3250
VT 125 (DEC graphics)	3280
ADM 3A with graphics pkg.	1795
ADM 5 with graphics pkg.	1845
300 BAUD TELEPRINTERS	
LA34-DA DECwriter IV	995
LA34-AA DECwriter IV	1095
LA36 DECwriter II	1095
Teletype 4310AAG	1045
Teletype 4320AAK	1195
Diablo 630 RO	2295
Diablo 1640 KSR	2775
Diablo 1650 KSR	2835
TI 743 (portable)	1190
TI 745 (port/built-in coupler)	1485
TI 763 (port/bubble memory)	2545
TI 765 (port/bubble/b.i. coupler)	2595
TI "Insight Series 10/1" pers. term.	695
600 BAUD TELEPRINTERS	
Epson MX-80	645
TI 825 KSR impact	1570
TI 825 KSR pkg.	1795
TI 840 RO impact	895
TI 840 KSR impact	1145
TI 840 KSR pkg.	1635
1200 BAUD TELEPRINTERS	
Epson MX-100	995
LA 120 RA (receive only)	2095
LA 120 AA (forms package)	2295
TI 783 (portable)	1645
TI 785 (port/built-in coupler)	2270
TI 787 (port/internal modem)	2595
TI 810 RO impact	1545
TI 810 RO pkg.	1795
TI 820 RO impact	1850
TI 820 RO pkg.	2025
TI 820 KSR impact	2025
TI 820 KSR pkg.	2195
Lear Siegler 310 ballistic	1945
2400 BAUD	
Dataproducts M200 (2400 baud)	2910
DATAPRODUCTS LINE PRINTERS	
8300 (300 LPM band)	5260
8600 (600 LPM band)	6776
8900 (900 LPM band)	10220
8P1500 (1500 LPM band)	19700
2230 (300 LPM drum)	8148
2260 (600 LPM drum)	9979
2290 (900 LPM drum)	13098
ACOUSTIC COUPLERS	
A/J A242-A (300 baud orig)	242
A/J 247 (300 baud orig)	315
A/J 1234 (Vadic compatible)	795
Vadic VA 3413 (300/1200 orig)	845
Vadic VA 3434 (1200 baud orig)	845
MODEMS	
GDC 103A3 (300 baud Bell)	395
GDC 202S/T (1200 baud Bell)	565
GDC 212-A (300/1200 baud Bell)	810
A/J 1256 (Vadic compatible)	825
VA 103 (300 baud modem/phone)	235
VA 3451 (orig/ans triple modem)	885
VA 3455 (1200 baud orig/ans)	770
CASSETTE STORAGE SYSTEMS	
Techtran 816 (store/forward)	1050
Techtran 817 (store/for/speed up)	1295
Techtran 818 (editing)	1795
Techtran 822 (dual)	2295
FLOPPY DISK SYSTEMS	
Techtran 950 (store/forward)	1395
Techtran 951 (editing)	1995

300 BAUD TELEPRINTERS	
LA34-DA DECwriter IV	995
LA34-AA DECwriter IV	1095
LA36 DECwriter II	1095
Teletype 4310AAG	1045
Teletype 4320AAK	1195
Diablo 630 RO	2295
Diablo 1640 KSR	2775
Diablo 1650 KSR	2835
TI 743 (portable)	1190
TI 745 (port/built-in coupler)	1485
TI 763 (port/bubble memory)	2545
TI 765 (port/bubble/b.i. coupler)	2595
TI "Insight Series 10/1" pers. term.	695
600 BAUD TELEPRINTERS	
Epson MX-80	645
TI 825 KSR impact	1570
TI 825 KSR pkg.	1795
TI 840 RO impact	895
TI 840 KSR impact	1145
TI 840 KSR pkg.	1635
1200 BAUD TELEPRINTERS	
Epson MX-100	995
LA 120 RA (receive only)	2095
LA 120 AA (forms package)	2295
TI 783 (portable)	1645
TI 785 (port/built-in coupler)	2270
TI 787 (port/internal modem)	2595
TI 810 RO impact	1545
TI 810 RO pkg.	1795
TI 820 RO impact	1850
TI 820 RO pkg.	2025
TI 820 KSR impact	2025
TI 820 KSR pkg.	2195
Lear Siegler 310 ballistic	1945
2400 BAUD	
Dataproducts M200 (2400 baud)	2910
DATAPRODUCTS LINE PRINTERS	
8300 (300 LPM band)	5260
8600 (600 LPM band)	6776
8900 (900 LPM band)	10220
8P1500 (1500 LPM band)	19700
2230 (300 LPM drum)	8148
2260 (600 LPM drum)	9979
2290 (900 LPM drum)	13098
ACOUSTIC COUPLERS	
A/J A242-A (300 baud orig)	242
A/J 247 (300 baud orig)	315
A/J 1234 (Vadic compatible)	795
Vadic VA 3413 (300/1200 orig)	845
Vadic VA 3434 (1200 baud orig)	845
MODEMS	
GDC 103A3 (300 baud Bell)	395
GDC 202S/T (1200 baud Bell)	565
GDC 212-A (300/1200 baud Bell)	810
A/J 1256 (Vadic compatible)	825
VA 103 (300 baud modem/phone)	235
VA 3451 (orig/ans triple modem)	885
VA 3455 (1200 baud orig/ans)	770
CASSETTE STORAGE SYSTEMS	
Techtran 816 (store/forward)	1050
Techtran 817 (store/for/speed up)	1295
Techtran 818 (editing)	1795
Techtran 822 (dual)	2295
FLOPPY DISK SYSTEMS	
Techtran 950 (store/forward)	1395
Techtran 951 (editing)	1995

*Please call for quote



Distributors, New York, New Jersey and Ohio.
New York:
516/482-3500, 212/895-7177, 518/449-5959
Outside N.Y.S.: 800/645-8016
New Jersey: 201/227-5552
Ohio: 216/464-6688

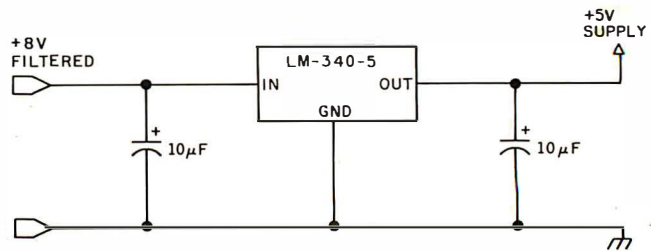

Figure 2b: A +5-V supply is developed from the computer's +8-V unregulated source.

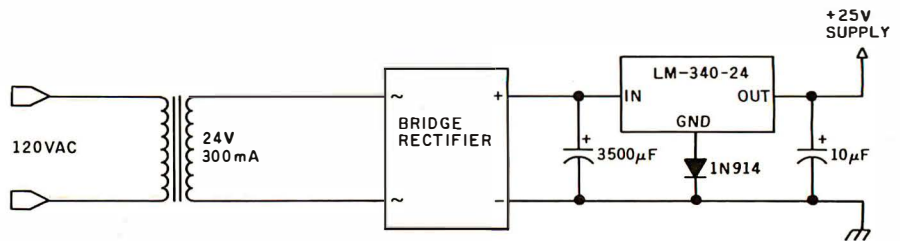

Figure 2c: A +25-V supply provides programming voltage. A +24-V regulator is used in conjunction with a diode to produce +24.6 V—well within the ±1-V tolerance specified by EPROM manufacturers.

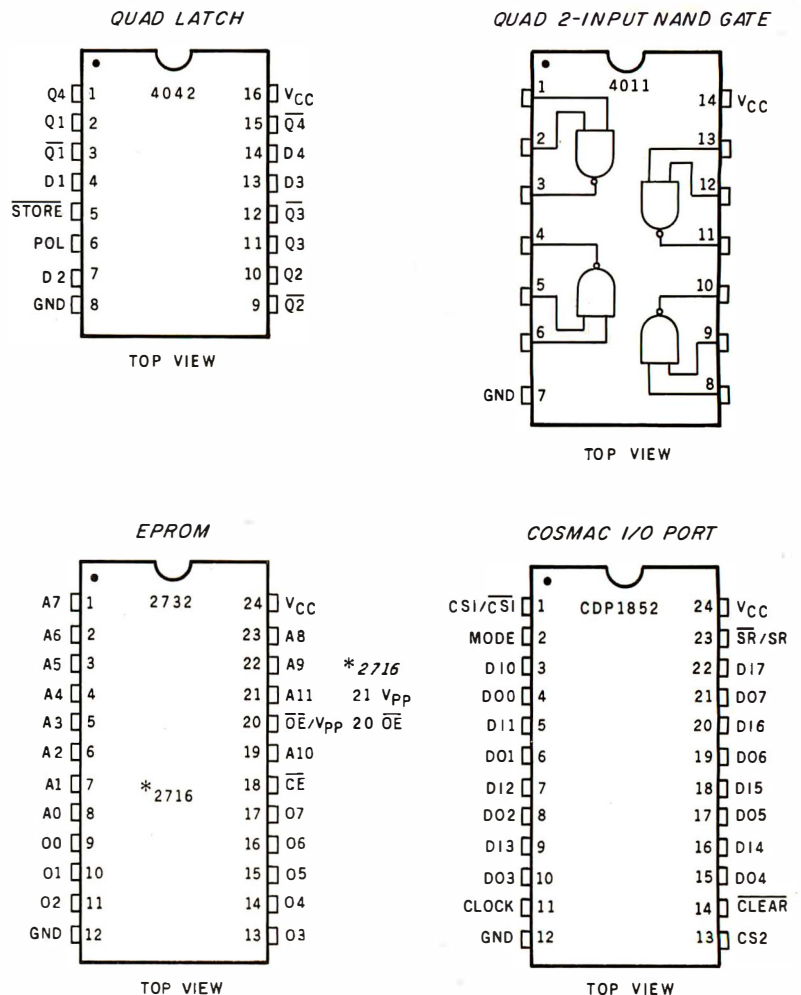

Figure 3: Pin assignments of the various integrated circuits used in the EPROM programmer.

START YOUR OWN COMPUTER CO.

HOW TO START YOUR OWN SYSTEMS HOUSE \$36.
7th edition, November 1981

Written by the founder of a successful systems house, this fact-filled 220-page manual covers virtually all aspects of starting and operating a small systems company. It is abundant with useful, real-life samples: contracts, proposals, agreements and a complete business plan are included in full, and may be used immediately by the reader. Proven, field-tested solutions to the many problems facing small turnkey vendors are presented.

HOW TO BECOME A SUCCESSFUL COMPUTER CONSULTANT \$28.
by Leslie Nelson, 4th revised edition, December 1981

Independent consultants are becoming a vitally important factor in the micro-computer field, filling the gap between the computer vendors and commercial/industrial users. The rewards of the consultant can be high: freedom, more satisfying work and doubled or tripled income. This manual provides comprehensive background information and step-by-step directions for those interested to explore this lucrative field.

FREE-LANCE SOFTWARE MARKETING \$30.
by B. J. Korites, 3rd edition, June 1980

Writing and selling computer programs as an independent is a business where • you can get started quickly, with little capital investment • you can do it full time or part time • the potential profits are almost limitless. This best-seller by Dr. Korites explains how to do it.

HOW TO START YOUR OWN WORD PROCESSING SERVICE \$39.50
by Leslie Nelson, February 1982

Turn a small investment into a steady, money making business that adds \$10,000, \$50,000 or \$100,000 to your income. Detailed start-up, marketing and operations plans are included.

Send check, money order, VISA, Master Charge or American Express # and exp. date. Publisher pays 4th class shipping. Add \$1.00 per book for UPS shipping (USA only). NJ residents add 5% sales tax. For faster shipment on credit card orders call (201) 684-6940.

ESSEX PUBLISHING CO. Dept. 2
285 Bloomfield Avenue • Caldwell, N.J. 07006

S-100 Modem

An Atlanta bulletin board system uses a Hayes S-100 modem around the clock. Since March 1979, it has logged over 21,500 calls and been down a mere 10 minutes. For performance like this, depend on the Hayes Micromodem 100™. Features include automatic dialing/answering, 45 to 300 baud operation, a built-in serial interface and direct connection to any modular phone jack.

The Micromodem 100—and Micromodem II™ for Apple II® computers—are now available nationwide. Call or write for the name of your nearest dealer.



Hayes Microcomputer Products Inc.
5835 Peachtree Corners East, Norcross, GA 30092 (404) 449-8791

Micromodem 100 & Micromodem II are trademarks of Hayes Microcomputer Products Inc. ® TM Apple Computer Inc.

SAVE \$600.00 On TRS-80® 48K Model III

**Limited Supply Now Available
For The Low-Low Price Of \$1895.00**

TRADEMARKS:
TRS-80 and TRSDOS/Radio Shack/Tandy Corp.
LDOS/Logical Systems Inc.
Kit III/Morgan Products Inc.

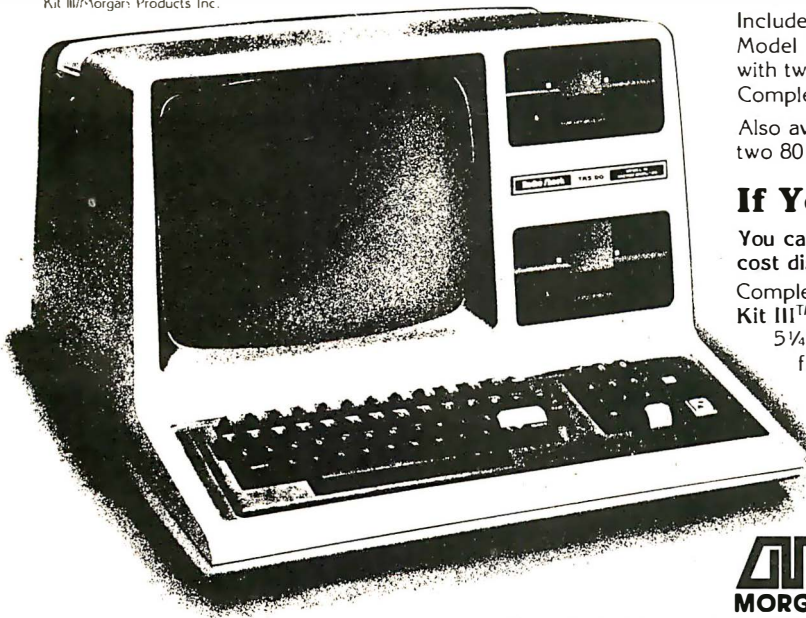

Includes all the standard basic features of the TRS-80® Model III with 48K of RAM and disk expansion Kit III™ with two 40 track double density Tandom disk drives. Completely compatible with TRSDOS™ and LDOS™.

Also available — TRS-80® Model III same as above with two 80 track Tandom disk drives for only \$2145.00

If You Own A 16K Model III.

You can easily expand your capabilities with our low cost disk expansion **Kit III™**

Completely compatible with TRSDOS™ and LDOS™ the **Kit III™** single drive assembly includes: One 40 track 5 1/4" double density Tandom disk drive, power supply, floppy disk control card, mounting hardware, applicable cables and instructions. **ONLY \$599.00**

Also available — Kit III™ same as above with one 80 track Tandom disk drive for only \$724.00

**Call TOLL FREE (800) 851-4614
In Illinois Call (618) 233-0018**

We accept: Visa, Master Charge, Certified Checks (Personal checks require three weeks clearance), Money Orders, and C.O.D.



Morgan Products Incorporated 104 Berkshire Drive Belleville, Illinois 62223

Text continued from page 346:

when TPB, $\overline{\text{MRD}}$, and N2 are logic true, the 1852 8-bit latch "knows" that the low-order address byte is on

the bus and is ready to be latched. Likewise, the 1852 will stay latched until TPB, $\overline{\text{MRD}}$, and N2 are logic true again.

Now that the complete address is latched, the same procedure is used for the data byte. The data is available on the data bus when N2 goes positive. By using TPB, $\overline{\text{MRD}}$, and N2, we can latch the data at the same time as the low-order address. Again, this data will be held until another logic-true condition appears on the device-select lines.

The outputs of these three latches are applied to the appropriate pins on the target EPROM. With +25 V applied to V_{pp} , it is only necessary to apply a 50-ms logic 1 pulse to the programming pin on the EPROM for a 2716 and a logic 0 pulse for a 2732.

The generation of the programming pulse will be accomplished by programming the 1802's 1-bit Q output port. The Q line can be set or reset with the SEQ and REQ instructions. The Q line will go to logic 1 or logic 0 respectively. By timing the Q line setting and resetting with a 50-ms delay loop, we can use the Q line to control the EPROM programming pulse.

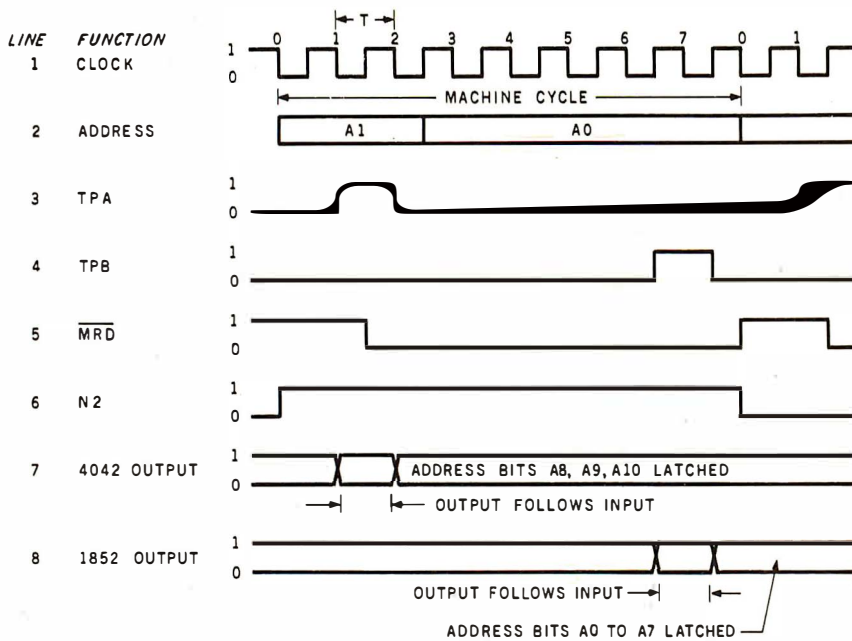

Figure 4: The 1802 timing diagram is broken into eight T-cycles. A machine cycle can be either a fetch or an execute cycle; the diagram here shows the execute phase and the timing relationship of the control signals.



96K CP/M®

(For your TRS-80* Model II)

Multiple Job Executive

Add a whole new dimension to your TRS-80 Model II. Let it work while you work!!

ATON's unique JobStream™ CP/M 2.2, along with additional RAM memory; allows you to **simultaneously** compile, assemble, or link in one 64K background partition (62K TPA) while you edit files, and spool to the printer, and communicate with another computer in up to four 32K foreground partitions (28K TPA).

As you expand memory beyond 64K, you also enter the amazing world of TrackMode BIOS™ which not only **multiplies diskette speed up to five times**, but also automatically performs read after write checks for the ultimate in data reliability.

- **Gain hard disk performance** for a fraction of the cost—and **no backup problems!!**
- **Works in 32K**, add RAM memory to 256K using standard Radio Shack memory boards.
- **Supports two sided expansion disk drives** (1.2 megabytes per diskette).
- Allows 6K-7K more space for user programs (62K TPA).

JobStream CP/M 2.2 (with Z-80** Debugger)	\$235
Omni Writer™ Video Text Editor	\$150
Z-80 Debugger Source Code	\$ 50
Package of above (a \$435 value)	\$295

"Software with Service"



Aton

International, Inc.

Prepaid, Visa, MasterCard or COD. Shipping and handling extra. California residents add 6% sales tax. Product price and availability subject to change without notice.

CP/M* Digital Research, Inc. **Zilog Corp.
JobStream, TrackMode BIOS™ ATON Intl.
Omni Writer™ Omnigraphics ***Tandy Corp.

260 Brooklyn Avenue, San Jose, CA 95128
(408) 286-4078

The Program

The program has to accomplish several objectives:

1. Supply the address and data to the bus.
2. Furnish control signals to the latches.
3. Perform address bookkeeping chores of start, current, and finish addresses.
4. Fulfill programming pulse timer requirements.

(See listing 1 for the program and figure 5 for a flowchart of the program. The flowchart is annotated with numbers that correspond to line numbers of the program listing.)

The delay constants in lines 25 and 27 of the program were calculated using the following formula:

$$\text{delay machine cycles} = \frac{DT \times f}{8}$$

where f = clock frequency = $\frac{1}{2}$ crystal frequency, DT = delay time, and 8 clock cycles = 1 machine



TAKE THE 3-VOLUME PERSONAL COMPUTING LIBRARY FOR ONLY \$2.95

when you join **THE LIBRARY OF COMPUTER AND INFORMATION SCIENCES**
You simply agree to buy 3 more books—at handsome discounts—within the next 12 months.

Enjoy the challenge and reap the benefits of microcomputing with the Personal Computing Library. This set of three carefully-selected books provides you with hours of thought-provoking computer projects. For only \$2.95—it's a value you can't afford to pass up.

Take a look at the books you'll get!

MICROPROCESSORS: From Chips to Systems.

Rodney Zaks' *Microprocessors: From Chips to Systems* brings the hobbyist and the computer professional a complete, progressive guide to microprocessors—the phenomena that is revolutionizing modern technology.

In over 400 fact-filled pages, *Microprocessors: From Chips to Systems* details the most up-to-date information. Topics include internal microprocessor operation, system components and their interconnection, basic interfacing techniques, principles of programming, a comparison of major microprocessors and much more. Detailed examples, photographs and diagrams supplement the ten extensive chapters. The book also describes a "standard" microprocessor system and is applicable to all microprocessors. A helpful index, appendix and bibliography make complete this excellent introduction to the exciting world of microprocessors. "... (A) thorough review of all the popular microprocessors..."—Interface Age
Publisher's Price \$25.00

CIARCIA'S CIRCUIT CELLAR: Volumes I and II.

Tinkering with microchip assemblies and personal computers is a hobby for many computer enthusiasts. It's a passion for Steve Ciarcia, personal computing specialist whose popular series in BYTE magazine has made him a "computer folkhero".

CIARCIA'S CIRCUIT CELLAR: Volumes I and II provides a complete tutorial to the construction of over 30 microcomputer projects.

Volume I includes:

- how to build a dual voltage converter, and various methods to help you achieve voltage multiplication
- classical I/O decoding and memory mapped methods
- how to construct an 8 channel 3½ digit DC digital voltmeter interface
- how to build an inexpensive address state analyzer which provides dynamic display of the microprocessor address bus during program execution

Volume II includes:

- how to build a computer controlled security system for your home
 - a design for a computer controlled wood stove
 - an introduction to 16-Bit Computing
 - how to add nonvolatile memory to your computer
- Publisher's Price \$20.95 (softcover).

What is The Library of Computer and Information Sciences?

It's the oldest and largest book club especially designed for the computer professional. In the incredibly fast-moving world of data processing, where up-to-date knowledge is essential, we make it easy for you to keep totally informed on all areas of the information sciences. In addition, books are offered at discounts up to 30% off publishers' prices.

Begin enjoying the club's benefits by accepting the **PERSONAL COMPUTING LIBRARY**. It's the perfect reference for computer professionals... and it's a great bargain, too.

If the reply card has been removed, please write to
The Library of Computer and Information Sciences
Dept. 7-AX9, Riverside, N.J. 08075
to obtain membership information and an application.

SORT EASIER QUICKER BETTER WITH MAGSORT

Now there is MAGSORT™, the first full featured Sort/Select/Merge program specifically designed to take the pain out of sorting.

EASIER

Interfacing MAGSORT to your CBASIC, Microsoft BASIC, Pascal/MT+, PL/I-80, or Fortran-80 programs is a snap. Two simple statements do it all. No dedicated memory, relocation, or special interfacing is required - not even in CBASIC.

And running MAGSORT stand alone is just as simple. The easy-to-use utility program asks all the questions so you don't have to remember a dictionary full of commands.

QUICKER

MAGSORT is written in 8080/Z80 assembler and uses a unique proprietary technique that allows the entire user memory space to be utilized for buffering. This provides the fastest possible sorting and optimizes MAGSORT for large files.

BETTER

MAGSORT is better than super! Its unmatched features make it the sort for today's sophisticated systems.

At \$250, MAGSORT may cost a little more than some other sorts, but it quickly pays for itself with convenience, speed and versatility. And, like all MAG software products, MAGSORT includes our free one year support service.



Micro Applications Group Dept. 101
20201 Sherman Way, Suite 205
Canoga Park, CA 91306

Please send more information about
MAGSORT today.

I would like to know more about your
other programs too.

Name _____ Title _____

Address _____

City _____ State _____ Zip _____

CBASIC is a trademark of Compiler Systems Pascal/MT+ is a trademark of MT Microsystems PL/I-80 is a trademark of Digital Research Fortran-80 is a trademark of Microsoft

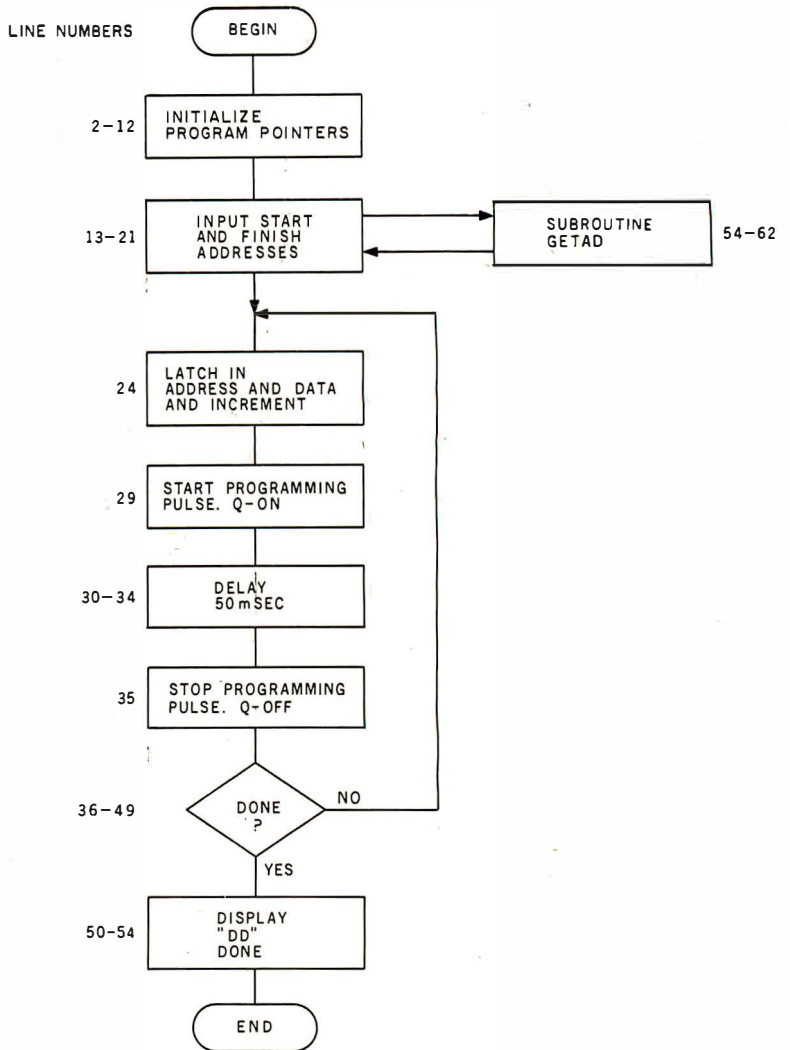

Figure 5: A flowchart of the program for controlling the 1802. The numbers to the left of the box symbols correspond to program line numbers.

cycle. In a common system, the system clock is developed from a video color-burst crystal (3.579545 MHz).

The inner delay loop consists of program lines 30, 31, and 32, for a total of six machine cycles for each time through the loop. The outer loop goes from line 30 to 34, for a total of ten machine cycles each time. The correct delay constants can be determined by the following formula:

$$\begin{aligned}
 & [6n + 6(m - 1)(256)] \\
 & + [10(256)] \\
 & = 11,186
 \end{aligned}$$

where $mn = 16$ -bit delay constant (m is the high-order byte, n is the low-order byte). The series of terms enclosed in the first set of brackets accounts for the inner loop, those in the second set for the outer loop. Solving

for mn gives hexadecimal 69E ($m = 6$, and $n = 157$).

Programming the EPROM

The following is the procedure for programming 2 K bytes of a 2716 EPROM:

1. Using an ultraviolet light source, erase the EPROM to set all bits equal to a logic 1. **Caution:** The ultraviolet rays seem harmless, but they are not. Do not expose your eyes to the rays, and keep others from inadvertently walking into the area while you are erasing.
2. Verify that each memory location of the EPROM is filled with FF hexadecimal. Use the program in listing 2.

Text continued on page 362

DEC LSI-11 Components

Dependable service at discount prices
Domestic and Export

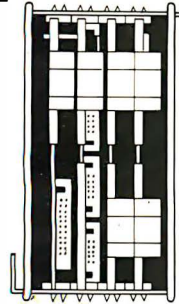

Mini Computer Suppliers, Inc.

25 Chatham Rd., Summit, N.J. 07901
Since 1973
(201) 277-6150 Telex 13-6476

©Mini Computer Suppliers, Inc. 1979

forth

for PET/CBM

FORTH is a new concept in programming, with the speed of compilers and interactive ease of BASIC. Programs become a part of FORTH extending the power of FORTH and your PET.

- 8050,4040 disk, cassette all PET-CBM's 16k+
- Starter fig-FORTH w editor assembler \$35
 - Personal floating point; strings; source \$75
 - Professional turnkey development/data base \$259

software for small computers
1983 Rio Grande Austin, Texas 78785
1-512-477-2207
P.O. Box 8483 Austin, Texas 78712



DEALERS INQUIRE



Olympic Sales Company

SERVING YOU SINCE 1947

Main Showroom & Offices:
216 South Oxford Avenue
Los Angeles, CA 90004

WE HONOR VISA and MASTERCARD



TELEX: 67 34 77

ORDER DESKS open 7 Days a Week!
7:00 AM to 7:00 PM Mon thru Sat
Sunday Noon to 5:00 PM

Order Desks: (213) 739-1130

TOLL-FREE (outside Calif.) TOLL-FREE (within Calif.)

800-421-8045 800-252-2153

NO ONE UNDERSELLS OLYMPIC SALES

Write & request our new 112 pg catalog—please include \$1.00 to defray postage & handling—includes many more items—from TV's to Watches!

All goods subject to availability; this ad supersedes all previous ads; we are not responsible for typographical errors; we will meet or beat any advertised prices if the competition has the goods on hand.
Minimum shipping and handling \$4.95.
All orders subject to verification and acceptance.

apple computer

We are an authorized servicing Apple dealer for Apple II & III. Immediate delivery on all models—we carry an enormous inventory of Apple products at all times!

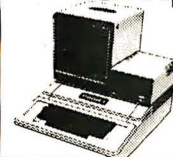

Large Inventory of:
Disk with controller DOS 3.3
Second Disk Drives
Pascal—Fortran—Cobol languages
Dow Jones & Quote reporter
Graphics Tablets
Visicalc for Apple II & III
Smarterm 80 column card
Micromodem II by DC Hayes and more...

Immediate delivery
NEW, IMPROVED APPLE III 128K VERSION

ATTENTION: Immediate delivery
WE ALSO CARRY SOFTWARE!
Microsoft
Pasch Tree Software
Micropro
Innovative
American System Plus and more...



hp HEWLETT PACKARD

2 NEW DELUXE CALCS FROM HP!
Slim, shirt-pocket styling

NEW! HP-11C Your Cost: \$114.95
Advanced Programmable Scientific LCD Retail: \$130.00

NEW! HP-12C Your Cost: \$129.95
Advanced Programmable Financial LCD Retail: \$150.00

HP-125 New Microcomputer Retail Your Cost
64K CPU/Terminal/Keyboard 375.00 3195.00

HP-85 Microcomputer—built-in printer/monitor 325.00 2499.00

HP-83 Microcomputer—built-in monitor 325.00 256.00
HP-2631B Printer, dot mtrix (ask for options) 395.00 3199.00
HP-82905A 80 col printer, dot matrix 945.00 755.00

HP-2601A Letter quality prter, daisy wheel 3495.00
HP-82901M Dual master (256KB disk drive) 2500.00 1999.00
Call us for the lowest prices on 7 disk drives. Call us Call us

HP-41CV New! 2.2K bytes of memory 325.00 256.00
Card Reader for 41CV 215.00 171.00
Printer for 41CV 395.00 294.00
Quad Ram 95.00 84.95
Optical Wand for 41CV 125.00 99.95
HP-41C Calculator 250.00 189.95
Memory mod. for 41C 25.00 26.95
HP-97 Programmable printer 750.00 579.95
HP-34C Programmable scientific 150.00 117.95
HP-38C Programmable business/R/E 150.00 119.95

We have the complete line of accessories, etc.

XEROX

Model 820-1 (5 1/4") 8" \$3750.00
64K COMPUTER & WORD PROCESSOR AS LOW AS \$2995.00
Special discount available to Schools & Institutions—Inquire! Required software add'l!

NEW—FAMOUS CORVUS DISK DRIVES—5, 10, 20 MEGABYTES with fantastic new DM/NINET Network
Call us for the best prices in the USA! System

Texas Instruments Home Computer

New—1982 Model with full typewriter style keyboard, U/L case & more!
New KEYBOARD \$369.95
Retail Your Cost \$950.00 \$369.95

18" color monitor for 99/4 650.00 319.95
32K Exp. mem. module 399.95 314.95
Extended Basic, a MUST for 32K module 100.00 75.00

Speech synthesizer 150.00 129.95
We carry a large inventory of software, & accessories

TI-30-2 LCS Stu Slide NEW 18.95
TI-35 SPL CD SCIENTIFIC 22.50
TI-40 LCD SCI/NEW 28.95
TI-57 Prog. Scientific 39.95
TI-58C 480 Step, Prog. 89.95
TI-59 960 Step, Prog. 179.95
PC-100C Print/Plot 149.95
LCD-Programmer/NEW 59.95

Large inventory of periphls, access. etc. & accessories

ATARI Computer Retail Your Cost
400 SPECIAL PRICE! 16K 595.00 339.95
No language inc., opt'l basic, 54.95

800 16K Computer 1080.00 759.95
SPECIAL! ATARI 800 48K Computer 1250.00 869.95

OHIO SCIENTIFIC

CBPDF—48K Retail: \$3495.00 Y/C: \$3195.00

• Dual 8" Drives • 64 col x 32 line/color
• 7 MIPS —FAST! • Many more stand features
Fortran & Pascal available

Many other OSI products—at discounted prices

NEW! From TI—Series 10 Personal Information Terminal Retail 995.00 Your Cost 795.00

PRINTERS

• DIABLO (Letter Quality) Retail Your Cost
630 R102 bi-directional/tractors 2965.00 2699.00
1640K109 keyboard, tractors 3072.00 2899.95
630 RO Receive only 2710.00 2499.95
1650K136 keyboard/tractors 3220.00 2999.95

• CENTRONICS dot matrix
700-9 Parallel, heavy duty 1460.00 1199.95
704-9 Serial, heavy duty 1795.00 1599.95
737-1 Parallel 995.00 799.95
737-3 Serial 1045.00 899.95
704-11 Parallel 1870.00 1695.00
P-1 Electrostatic 495.00 189.95

• PAPER TIGER
460 995.00 895.00
460G graphics 1094.00 969.95
560 1295.00 1099.00
560G graphics 1394.00 1195.00
445 795.00 695.00
445G 894.00 789.00

EPSON PRINTERS Retail: Your Cost
MX80 645.00 539.95
Optional Graftrax Chip 80 95.00
MX80 FT 745.00 659.95
MX80 + GRAFTRAX 80 695.00 579.95
MX80 FT + GRAFTRAX 80 795.00 689.95
MX100 995.00 789.95

WE ALSO HAVE...
• NOVIATION Modems Retail Your Cost
CAT 199.95 159.95
D-CAT 199.95 159.95
APPLE-CAT Direct connect 349.95 314.95

SANYO MONITORS High resolution

13" Color (new) high quality 550.00 419.95
12" Green phosphorous 360.00 295.95
12" Black & white 340.00 239.95
15" Black & white 370.00 259.95
9" Black & white (the best seller) 235.00 169.95

AMDEK(Leedex) High Quality Monitors

100 12" B/W, 12 MHz 179.00 139.95
100-G 12" Green, 12 MHz 199.00 174.95
300-G 12" Green, 18 MHz 249.00 199.95
Color I 13" Color, NTSC comp. input, 449.00 339.95
audio amp & speaker
Color II 13" Color, RGB input, hi res graphics, speaker 999.00 699.95

• HAZELTINE Video Display Terminals
• SHUGART Disk Drives
• DEC VT100 & VT103
Call us for your DISCOUNTED price TODAY!

Listing 1: Program instructions for controlling the COSMAC microprocessor to program a 2716 EPROM. To program a 2732 EPROM, the mnemonic REQ (7A) in lines 2 and 35 should be changed to SEQ (7B) and SEQ (7B) in line 29 should be changed to REQ (7A).

3/14/81 11.80 CROSS ASSEMBLER 1802 VER 1.1

ADD.	CODE	LINE NO.	LABEL	ASM	REGIS. OPERND	COMMENT
0100		1		ORG	0100	: ORIGIN
0100	7A	2		REQ		: INITIALIZE Q = 0
0101	F801	3		LDI	01	: INITIALIZE POINTERS
0103	B2	4		PHI	R2	: STACK HI
0104	B3	5		PHI	R3	: PROGRAM COUNTER HI
0105	B6	6		PHI	R6	: SUBROUTINE GETAD HI
0106	F8FF	7		LDI	FF	:
0108	A2	8		PLO	R2	: STACK LO
0109	F8A1	9		LDI	A1	:
010B	A6	10		PLO	R6	: GETAD LO
010C	F810	11		LDI	10	:
010E	A3	12		PLO	R3	: PRG COUNTER LO
010F	D3	13		SEP	R3	: PROGRAM COUNTER NOW R3
0110	D6	14		SEP	R6	: CALL GETAD
0111	B7	15		PHI	R7	: HI START ADDRESS
0112	D6	16		SEP	R6	: CALL GETAD
0113	A7	17		PLO	R7	: LO START ADDRESS
0114	D6	18		SEP	R6	: CALL GETAD
0115	B8	19		PHI	R8	: HI FINISH ADDRESS
0116	D6	20		SEP	R6	: CALL GETAD
0117	A8	21		PLO	R8	: LO FINISH ADD*PLUS ONE*
0118	D6	22		SEP	R6	: WAIT FOR INPUT PRESS
0119	E7	23	BEGIN	SEX	R7	: SET X TO START ADD
011A	67	24		OUT	#7	: LATCH ADD AND DATA
011B	F806	25		LDI	06	: LOAD DELAY CONSTANTS
011D	BD	26		PHI	RD	: " " "
011E	F89E	27		LDI	9E	: " " "
0120	AD	28		PLO	RD	: " " "
0121	7B	29		SEQ		: START PROGRAMMING PULSE
0122	2D	30	DELAY	DEC	RD	: DECREMENT DELAY COUNTER
0123	9D	31		GHI	RD	: CHECK TO SEE IF FINISHED
0124	3A22	32		BNZ	DELAY	: CONTINUE IF NOT FINISHED
0126	9D	33		GLO	RD	: CHECK TO SEE IF FINISHED
0127	3A22	34		BNZ	DELAY	: "
0129	7A	35		REQ		: STOP PULSE AFTER 50 MSEC
012A	E2	36		SEX	R2	
012B	97	37		GHI	R7	: FINISHED PROGRAMMING BYTE
012C	73	38		STXD		: HI BYTE POINTER ON STACK
012D	60	39		IRX		: REPOSITION STACK POINTER
012E	98	40		GHI	R8	: LOAD HI FINISH ADDRESS
012F	F3	41		XOR		: AND COMPARE
0130	3A19	42		BNZ	BEGIN	: CONTINUE IF NOT FINISHED
0132	87	43		GLO	R7	
0133	73	44		STXD		: LO BYTE POINTER ON STACK
0134	60	45		IRX		: REPOSITION STACK POINTER
0135	88	46		GLO	R8	: LOAD LO FINISH ADDRESS
0136	F3	47		XOR		: AND COMPARE
0137	3A19	48		BNZ	BEGIN	: NOT FINISHED THEN CONTINU
0139	F8DD	49		LDI	DD	: ELSE
013B	73	50		STXD		: LOAD (DD) ONE TO SIGNAL EN
013C	60	51		IRX		: REPRO. STACK POINTER
013D	64	52		OUT	#4	: OUTPUT TO HEX DISPLAY
013E	303E	53	STOP	BR	STOP	: "THE END"
01A0		54		ORG	01A0	: **SUBROUTINE GETAD**

Listing 1 continued on page 358

NEVADA COBOL



- Edition II of Nevada COBOL, a subset of ANSI-74, features:
- Copy statement for library handling.
 - CALL... USING... CANCEL.
 - PERFORM... THRU... TIMES... UNTIL... Paragraph or section names.
 - IF... NEXT SENTENCE... ELSE... NEXT SENTENCE AND/OR <=> NOT.
 - GO TO... DEPENDING ON.
 - Unique easily understood diagnostic error messages.
 - Interactive ACCEPT/DISPLAY...
 - RELATIVE (random) access files.
 - Sequential files both fixed and variable length.
 - DISPLAY, 16-bit binary or packed decimal (COMP-3) data types with up to 18-digit accuracy.
 - INSPECT... TALLYING... REPLACING.
 - ADD, SUBTRACT, MULTIPLY, DIVIDE, GIVING, ROUNDED, ON SIZE ERROR.
 - Generates optimized 8080 machine language at up to 500 statements per minute.

\$149⁹⁵
DISKETTE AND MANUAL

• Uses CP/M or MP/M operating system to work with TRS-80, Apple's with softcard, North Star, Superbrain, Micropolis, and many other microcomputers. Needs a minimum of 16K of RAM. Uses single density 8" or 5 1/4" diskette.



ELLIS COMPUTING
SOFTWARE TECHNOLOGY

600 41st Avenue
San Francisco, CA 94121

CP/M, MP/M and TRS-80 are registered TM's of Digital Research and Tandy Corporation.

WE WELCOME C.O.D.'s



(415) 751-1522.

WARNING! Electric Power Pollution. Spikes & Lightning HAZARDOUS to MICROCOMPUTERS!!

Patented ISOLATORS provide protection from ...

- Computer errors caused by power line interference
- Computer errors due to system equipment interaction
- Spike damage caused by copier/elevator/air conditioners
- Lightning caused damage



Pat. #4,259,705

- ** FULLY GUARANTEED ****
- ISOLATOR (ISO-1) 3 isolated 3-prong sockets; Spike Suppression; useful for small offices, laboratories, classrooms. \$69.95
 - ISOLATOR (ISO-2) 2 isolated 3-prong socket banks; (6 sockets total); Spike Suppression; useful for multiple equipment installations. \$69.95
 - SUPER ISOLATOR (ISO-3) similar to ISO-1 except double isolation & oversize Spike Suppression; widely used for severe electrical noise situations such as factories or large offices. \$104.95
 - SUPER ISOLATOR (ISO-11) similar to ISO-2 except double isolated socket banks & Oversize Spike Suppression; for the larger system in severe situations. \$104.95
 - MAGNUM ISOLATOR (ISO-17) 4 Quad Isolated Sockets; Multiple Spike Suppressors; For ULTRA-SENSITIVE Systems in extremely Harsh environments. \$181.95
 - CIRCUIT BREAKER, any model (Add-CB) Add \$9.00
 - CKT BRKR/SWITCH/PILOT (-CBS) Add \$17.00
- AT YOUR DEALERS MasterCard, Visa, American Express
ORDER TOLL FREE 1-800-225-4876 (except AK, HI, PR & Canada)

ESP Electronic Specialists, Inc.

171 South Main Street, Natick, Mass. 01760

Technical & Non-800: 1-617-655-1532

A REFURBISHED DAISY WHEEL TERMINAL
FOR PERSONAL COMPUTER USERS AND SMALL BUSINESSES.

Now you can have letter-quality printing and professional features for just \$1,495*

AJ daisy wheel printer terminals are renowned for exceptional performance, high reliability, and applications versatility. Now you can have all this for only \$1,495* in our special limited offer.

- 30 cps letter-quality printing
- Changeable type faces
- Full ASCII keyboard with numeric pad
- High resolution X-Y plotting
- Complete electronic forms control
- 128-character buffer
- Asynchronous RS-232 interface
- Printwheel, ribbon cartridge, and cable included
- 30-day parts/labor warranty

And you can choose from a list of options including forms tractor, pin-feed platen, paper trays, side shelves, extra printwheels, APL keyboard and 2K buffer.

Call your nearest AJ regional office for details: San Jose, CA (408) 946-2900; Rosemont, IL (312) 671-7155; Hackensack, NJ (201) 488-2525. Or check the phone book for the number of your local AJ sales/service office.



*Price excludes options and is subject to change without notice. Model shown includes certain options. Offer available only in the contiguous U.S.

**ANDERSON
JACOBSON**

Listing 1 continued:

```

01A0 D3      55  RETURN  SEP  R3      :TO MAIN
01A1 E2      56          SEX  R2      :ENTRY POINT OF SUBROUTINE
01A2 3FA2    57  WAIT1  BN4  WAIT1    :FOR INPUT PRESS
01A4 37A4    58  WAIT2  B4   WAIT2    :FOR RELEASE
01A6 6C      59          INP  #C      :LOAD INPUT INTO MX,D
01A7 64      60          OUT  #4      :DISPLAY BYTE
01A8 22      61          DEC  R2      :REPO. STACK POINTER
01A9 30A0    62          BR   RETURN :D HOLDS ADDRESS BYTE
    
```

TABLE OF LABELS USED

```

BEGIN      0119:DELAY      0122:STOP      013E:RETURN      01A0:WAIT1      01A2:
WAIT2      01A4:
:
    
```

Listing 2: A program to use the 1802 to check that an EPROM is completely erased.

3/14/81 11.90 CROSS ASSEMBLER 1802 VER 1.1

ADD.	CODE	LINE NO.	LABEL	ASM	REGIS. OPERND	COMMENT
0100		1		ORG	0100	: ORIGIN
0100	F801	2		LDI	01	: INITIALIZE POINTERS
0102	B2	3		PHI	R2	: WORK AREA HI
0103	B3	4		PHI	R3	: PROGRAM COUNTER HI
0104	B6	5		PHI	R6	: SUBROUTINE GETAD HI
0105	F8FF	6		LDI	FF	:
0107	A2	7		PLO	R2	: STACK LO
0108	F8A1	8		LDI	A1	:
010A	A6	9		PLO	R6	: GETAD LO
010B	F80E	10		LDI	0E	:
010D	A3	11		PLO	R3	: PROGRAM COUNTER LO
010E	D3	12		SEP	R3	: PROGRAM COUNTER NOW R3
010F	D6	13		SEP	R6	: CALL GETAD
0110	B7	14		PHI	R7	: HI START ADDRESS
0111	D6	15		SEP	R6	: CALL GETAD
0112	A7	16		PLO	R7	: LO START ADDRESS
0113	D6	17		SEP	R6	: CALL GETAD
0114	B8	18		PHI	R8	: HI FINISH ADDRESS
0115	D6	19		SEP	R6	: CALL GETAD
0116	A8	20		PLO	R8	: LO FIN ADDRESS*PLUS ONE*
0117	D6	21		SEP	R6	: WAIT FOR INPUT PRESS
0118	E7	22	BEGIN	SEX	R7	: START OF LOOP
0119	72	23		LDXA		: LOAD BYTE FROM EPROM
011A	FBFF	24		XRI	FF	: COMPARE WITH FF
011C	3A35	25		BNZ	BAD	: GOTO BAD BYTE D NOT 0
011E	E2	26		SEX	R2	
011F	97	27		GHI	R7	: COMPARE WITH FINISH POINT
0120	73	28		STXD		: DONE?
0121	60	29		IRX		: REPOSITION STACK POINTER
0122	98	30		GHI	R8	: LOAD HI FINISH ADDRESS
0123	F3	31		XOR		: AND COMPARE
0124	3A18	32		BNZ	BEGIN	: CONTINUE IF NOT FINISHED
0126	87	33		GLO	R7	
0127	73	34		STXD		: LO BYTE POINTER ON STACK
0128	60	35		IRX		: REPO. STACK POINTER
0129	88	36		GLO	R8	: LOAD LO FINISH ADDRESS
012A	F3	37		XOR		: AND COMPARE
012B	3A18	38		BNZ	BEGIN	: CONTINUE IF NOT FINISHED
012D	E2	39		SEX	R2	
012E	F8DD	40		LDI	DD	: DONE -- NO BAD BYTES

Listing 2 continued on page 360

HAVE YOUR CAKE AND EAT IT TOO



As Low As \$690⁺

IT'S A PIECE OF CAKE TO CONNECT AN **Actek** TRIX I INTERFACE TO YOUR OLIVETTI PRAXIS 30 OR 35 CORRECTING ELECTRONIC TYPEWRITER. DAISY WHEEL QUALITY AT DOT MATRIX PRICES!

- 10+ CPS
- 15 MINUTE INSTALLATION
- HALF SPACE JUSTIFICATION
- CABLE REMOVES IN SECONDS
- TYPEWRITER FUNCT. UNIMPAIRED
- AVAILABLE NOW: ATARI & APPLE
- OTHER DIRECT CONNECTIONS AND RS232 AVAILABLE SOON
- PRINT AND PRINT #N OPERATE
- NO INTERFACE NEEDED: USES FRONT CONNECTOR - ATARI USES CONTROLLER PLUG - APPLE
- PRICE: \$215 - APPLE ADD \$10
- †BASED ON WARDS PR30 PRICE
- TYPEWRITER AND SERVICE WIDELY AVAILABLE



12225 SW 2nd/SUITE 200-B
P.O.B. CCC
BEAVERTON, OR 97075

Model EP-2A-87

EPROM Programmer

The Model EP-2A-87 EPROM Programmer has an RS-232 compatible interface and includes a 2K, 4K or 8K buffer. Seventeen RS-232 commands allow another computer to download or remotely control the Programmer. INTEL, TEXTRONIX OR MOTOROLA formats are supported. The buffer may be edited directly from a CRT and EPROMS can be copied off-line. Power requirements are 115v 50/60 Hertz at 15 watts.

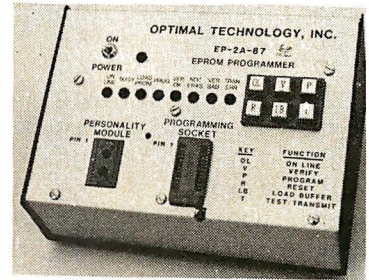

EP-2A-87-1	Programmer with 2K Buffer	\$575.00
EP-2A-87-2	Programmer with 4K Buffer	\$650.00
EP-2A-87-3	Programmer with 8K Buffer	\$725.00
	Non-Standard voltage (220v, 240v, or 100)	\$ 15.00

Personality Modules

PM-0	TMS 2708	\$18.00	PM-5E	2816	\$36.00
PM-1	2708	18.00	PM-6	2704	18.00
PM-2	2732	34.00	PM-7	2758	18.00
PM-2A	2732A	34.00	PM-8	MCM68764	36.00
PM-3	TMS 2716	26.00	PM-9	2764	36.00
PM-4	2532	34.00	PM-10	2564	36.00
PM-5	2716	18.00			
SA-64-2	2564	39.00	SA-64-3	2764	39.00

Optimal Technology, Inc.

Phone (804) 973-5482
Blue Wood 127 Earlysville, VA 22936

NOW!

NEW PRODUCTS! NOW AVAILABLE FROM AUTOMATED EQUIPMENT

TELEVIDEO SYSTEM I

The Televideo System I is a CP/M® based single-user computer system. State-of-the-art design and single board construction accounts for Televideo's reliability and exceptional price performance. Cobal, Basic, PL/1 and Fortran are just a few of the high level languages available. As your needs grow so can your Televideo computer system. The System I can be a satellite computer of a larger network of user stations using the multi-processor multi-tasking System II or System III. System I includes TS-81 computer, Televideo 910 terminal (950 terminal available at additional cost) and CP/M® 2.2. Nation wide on-site service is available through General Electric service company.

System I specifications: Z80A, 64K Ram, 4K diagnosticEprom, two 5" 360K drives, serial and parallel port.



CP/M® is a licensed product supplied by Digital Research, Inc.

See Televideo System Ad.



NORTHSTAR ADVANTAGE COMPUTER

The Northstar Advantage Computer is an integrated package including full graphics capability. Line charts, bar graphs, pie charts and 3 dimensional displays are all possible as part of Northstar's optional graphics/DOS operating system or CP/M® graphics package. All Northstar applications software is available for the Advantage Computer. Slots for 6 additional expansion cards are included.

Specifications: Z80A CPU, 64K Ram, Green screen 12" monitor, 240 x 640 pixel graphics resolution, sculptured typewriter-like keyboard, two 5" 360K drives.

V.I.P.'s call A.E.I.

Because A.E.I. tests before shipping, has expertise on all items offered, and is price competitive.



AUTOMATED EQUIPMENT, INC.

18430 WARD STREET, FOUNTAIN VALLEY, CALIFORNIA 92708

See these products and a full line of peripheral equipment in our showroom.

ZENITH

Zenith Data Systems with world famous quality and reliability are now available from A. E. I. The Z89 and Z90 are standalone micro computers with a one piece design that simplifies installation and operation. With the board line of PeachTree accounting software and Micro-Pro word processing software the Zenith computers are the ideal small business systems. Heathkit/Zenith educational courses are available making the Zenith computer an excellent choice for the first time buyer.

Zenith specifications:

Z89—48K ram standard, Z80 cpu, 2 serial ports, built in 12" terminal, one 5" 100K drive, expandable.

Z90—64K ram standard, Z80 cpu, 2 serial ports, built in 12" terminal, one 5" 200K drive, expandable.

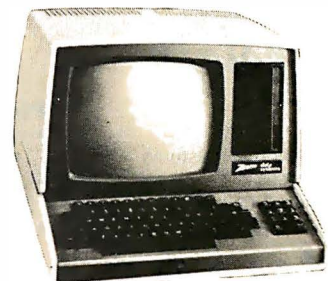

(714) 963-1414

(800) 854-7635

Listing 2 continued:

0130	73	41	STXD		:LOAD (DD)ONE TO SIG END
0131	60	42	IRX		:REPO. STACK POINTER
0132	64	43	OUT	#4	
0133	3033	44	BR	STOP	: "THE END"
0135	E2	45	BAD	SEX R2	:BAD BYTE
0136	27	46	DEC	R7	:POINT TO BAD BYTE
0137	87	47	GLO	R7	:LOAD LO ADDRESS
0138	73	48	STXD		:STORE ON STACK
0139	97	49	GHI	R7	:LOAD HI ADDRESS
013A	73	50	STXD		:STORE ON STACK
013B	F8EE	51	LDI	EE	: **ERROR**
013D	73	52	STXD		:LOAD (EE)RROR TO SIG ERR.
013E	60	53	IRX		:REPO. STACK POINTER
013F	64	54	OUT	#4	:OUTPUT TO HEX DISPLAY
0140	3033	55	BR	STOP	: "THE END"
0A00		56	ORG	0A00	:**SUBROUTINE GETAD**
0A00	D3	57	RETURN	SEP R3	
0A01	E2	58	SEX	R2	:ENTER SUBROUTINE HERE
0A02	3F02	59	WAIT2	BN4 WAIT2	:FOR INPUT PRESS
0A04	3704	60	WAIT3	B4 WAIT3	:FOR RELEASE
0A06	6C	61	INP	#C	:LOAD INPUT INTO MX,D
0A07	64	62	OUT	#4	:DISPLAY BYTE
0A08	22	63	DEC	R2	:REPO. STACK POINTER
0A09	3000	64	BR	RETURN	: D HOLDS ADDRESS BYTE

TABLE OF LABELS USED

BEGIN 0118:STOP 0133:BAD 0135:RETURN 0A00:WAIT2 0A02:
 WAIT3 0A04:
 :

DYMARC
INDUSTRIES, INC.



LINE VOLTAGE TRANSIENT SUPPRESSORS
 Features Parallel Operation 5000 Hits/Second

Clipstrip™ AND Clipper™

PROTECTS:

- Computers
- Micro-Computer Systems
- Word Processors
- Cash Registers
- Power Supplies

PROTECTS AGAINST:

- High Energy Voltage Transients
- On-Off Switching
- Lightning Induced Transients
- Inrush of On/Off Power

DYMARC
INDUSTRIES, INC.
DEALER INQUIRIES INVITED

7133 Rutherford Rd. Baltimore, Md. 21207
(301) 298-3130

Clipstrip 977E LISTED
 Clipper 678F LISTED

800-638-9098

S&M
SYSTEMS, INC



The Price Is Nice.

SB-80

Single Board Technology

- CP/M is a registered trademark of Digital Research, Inc.
- A Z80A CPU combined with the CP/M operating system opens new vistas to software availability for eight-bit micros.
- FORTRAN, COBOL, BASIC, APL, PL/I and Pascal are available now to accommodate today's scientific, educational, sophisticated small business and personal system users.

Basic system with: 600K bytes **\$2995**

- 1.2 megabytes **\$3995**
- 2.4 megabytes **\$4995**
- 4MHz Z80A CPU
- CP/M 2 operating system
- 64K 200ns main memory
- 8-inch dual floppy drives
- 50-pin expansion connector
- 2-serial ports
- 2-parallel ports
- 4-counter/timers
- Hard disk options available

S&M SYSTEMS, INC (617) 373-1599
 P.O. Box 1225,2 Washington Street, Haverhill, Ma. 01830

P&T CP/M[®]2 Supports Hard Disk Storage for the TRS-80 Model II

P&T CP/M 2 now supports two popular hard disk subsystems for the Mod II; thus you can combine all the features of the best CP/M for the Mod II with the speed and capacity of the hard disk drives.

Cameo Electronics

- uses mature cartridge disk technology for maximum reliability
- supports up to 4 drives
- removable cartridges make backup and data transfer fast and easy

Corvus System

- support for 10 and 20 Mbyte drives
- special mirror utility allows backup by logical drive
- supports up to 4 drives



Price: \$250 (FOB Goleta) for P&T CP/M2-hard disk version (CA residents add 6% sales tax)

PICKLES & TROUT
P. O. BOX 1206, GOLETA, CA 93116, (805) 685-4641

CP/M is a registered trademark of Digital Research. TRS-80 is a trademark of Tandy Corp.

MICROSTAT[™] Release 2.0

NEW RELEASE!

Just some of the new features of Microstat Rel. 2.0 include: new programs for moments about the mean, skewness, kurtosis and stepwise multiple regression, longer file names, faster sort routine, the ability to declare each data file's numeric precision and drive location plus an expanded user's manual with new appendices for the equations and file structures used in Microstat. Also included is a Data Management Subsystem for file maintenance (edit, list, destroy, augment, sort, rank-order, move and merge) plus transformations (add, subtract, multiply, divide, reciprocal, log, natural log and antilog, exponentiation and linear) that allow you to create new variables from existing variables.

After file creation with OMS, programs for analysis include: Descriptive statistics, Hypothesis testing (mean and proportion), ANOVA (one-way, two-way, and random blocks), Scatterplots, Frequency distributions, Correlation analysis, Simple, Multiple and Stepwise Multiple Regression (including files larger than available memory), Time series, 11 Nonparametric tests, 8 Probability distributions, Crosstabs and Chi-square, Combinations, Permutations and Factorials (up to one million factorial). All program output is neatly formatted for easy use.

The price for Microstat Rel. 2.0 is \$295.00 and the user's manual is available for \$25.00 (credited towards purchase) and includes sample printouts with file labels that reference standard statistical texts and journals so you can compare the results from Microstat to those produced on much larger systems. Compare Microstat to any other package on the market and we think you'll agree that Microstat is the best at any price.

ECOSOFT, INC.

P. O. BOX 68602
INDIANAPOLIS, IN 46268-0602
(317) 283-8883



PRODUCTS FOR YOUR RADIO SHACK

COLOR COMPUTER

MICROTEXT COMMUNICATIONS VIA YOUR MODEM!

NEW!

Now you can use your printer with your modem! Your computer can be an intelligent printing terminal. Talk to timeshare services or to other personal computers; print simultaneously through a second printer port; and re-display text stored in memory. Download text to Basic programs; dump to a cassette tape, or printer, or both. Microtext can be used with any printer or no printer at all. It features user-configurable duplex/parity for special applications, and can send any ASCII character. You'll find many uses for this general purpose module! Available in ROMPACK, ready-to-use, for \$59.95.

SOFTWARE DEVELOPMENT SYSTEM

The Micro Works Software Development System (SDS80C) is a complete 6809 editor, assembler and monitor package contained in one Color Computer program pack! Vastly superior to RAM-based assemblers/editors, the SDS80C is non-volatile, meaning that if your application program bombs, it can't destroy your editor/assembler. Plus it leaves almost all of 16K or 32K RAM free for your program. Since all three programs, editor, assembler and monitor are co-resident, we eliminate tedious program loading when going back and forth from editing to assembly and debugging!

The powerful screen-oriented Editor features finds, changes, moves, copies and much more. All keys have convenient auto repeat (typamatic), and since no line numbers are required, the full width of the screen may be used to generate well commented code.

The Assembler features all of the following: complete 6809 instruction set; complete 6800 set supported for cross-assembly; conditional assembly; local labels; assembly to cassette tape or to memory; listing to screen or printer; and mnemonic error codes instead of numbers.

The versatile ABUG monitor is a compact version of CBUG, tailored for debugging programs generated by the Assembler and Editor. It features examine/change of memory or registers, cassette load and save, breakpoints and more. SDS80C Price: \$89.95

GAMES



- Star Blaster** — Blast your way through an asteroid field in this action-packed Hi-Res graphics game! Available in ROMPACK; requires 16K. Price: \$39.95
- Pac Attack** — Try your hand at this challenging game by Computerware, with fantastic graphics, sound and action! Cassette requires 16K. Price: \$24.95
- Berserk** — Have fun zapping robots with this Hi-Res game by Mark Data Products. Cassette requires 16K. Price: \$24.95
- Adventure** — *Black Sanctum* and *Calixto Island* by Mark Data Products. Each cassette requires 16K. Price: \$19.95 each.

ROMLESS PAK I — is an empty program pack capable of holding two 2716 or 2732 EPROMs, allowing you up to 8K of program! The PC board inside comes with sockets installed, ready to go with the addition of your custom EPROMs. Price: \$24.95

2-PASS DISASSEMBLER — with documentation package. 16K; cassette. 80C Disassembler Price: \$49.95

CBUG — Machine language monitor. CBUG Cassette Price: \$29.95
CBUG ON 2716 EPROM: Can plug into Romless Pak I. CBUG ROM Price: \$39.95

PARALLEL PRINTER INTERFACE — serial to parallel converter allows use of all standard parallel printers. P180C Price: \$69.95

Assembly Language Programming, by Lance Leventhal. Price: \$16.95
MEMORY UPGRADE KITS: 4-16K Kit Price \$39.95. 16-32K (requires soldering experience) Price: \$39.95

PARTS & SERVICES: SAMs, 6809Es, RAMs, PIAs. Call for prices.

WE SHIP FROM STOCK!

Master Charge/Visa and COD Accepted

THE **MICRO WORKS**



GOOD STUFF!

P.O. BOX 1110 DEL MAR, CA 92014 714-942-2400

THINK BIG. BUY SMART.

You can save buying wholesale with our buying service. As your agent we will buy computer equipment on the wholesale market for you. Our fee is one fourth of what we save you off the list price. We have access to over 500 manufacturers. Call for present wholesale market conditions. Examples of total prices being paid by our clients (including our fee) are:

COMPUTERS

Alpha Micro 1030	\$12,047.00	Dynabyte 5200-B2	4,896.00
Alpha Micro 1051	17,634.00	Dynabyte 5615-A1	8,396.00
Alpha Micro AM-1011	9,313.00	Ithaca C.B. 128KSS/OD	5,421.00
Altos 8000-10	6,397.00	Ithaca Sys. 2A W/Panel	2,941.00
Altos 8000-15	3,585.00	NEC 8001A	1,014.00
Altos 8000-2	2,629.00	NEC 8012A	600.00
Apple 2 + 48K	1,208.00	NEC 8031A	1,014.00
Archives Model I	4,794.00	North Star 64K DD	3,073.00
Archives Model II	5,532.00	North Star Advantage	2995.00
Archives Model III	6,269.00	Televideo System I	2,380.00
CCS Series 300-1A	4,414.00	Televideo System II	5,311.00
CCS Series 400-1A	6,374.00	Televideo TS-800 Term.	1,324.00
Cromemco System 3	5,650.00	Vector 2600	4,221.00
Cromemco Z-2H	7,521.00	Vector 3005	6,458.00
Dynabyte 5200-A2	3,216.00	Vector 5005	7,308.00

SOFTWARE

Dbase II	500.00	Wordstar	305.00
Spellguard	200.00	Basic Compiler	277.00
Datastar	230.00	Fortran 80-CPM	375.00
Spell Star	180.00	Visi Calc	160.00

PRINTERS

Anadex 9000	1,100.00	NEC 5510	2,345.00
Anadex 9501	1,278.00	NEC 5520 KSR	2,645.00
C. Itoh 25 P	1,325.00	NEC 5530	2,345.00
C. Itoh 45 P	1,700.00	NEC 7710	2,345.00
Diablo 1640	2,444.00	Epson MX80 in stock	468.00
Malibu 1650	1,796.00	Qume Sprint 9-35	1,738.00
Malibu 200	2,320.00	Qume Sprint 9-45	1,996.00
NEC 3510	1,980.00	Qume Sprint 9-55	2,085.00

CRT, DISK DRIVE, MODEMS

Alpha Micro AM-600	8,075.00	Houston Instrument DMP-7	1,528.00
Anderson Jacobsen 1256	641.25	Lobo Dual 8" DS/DD	2,234.00
DEC VT 100	1,495.00	Lobo Dual Mini Drives	855.00
Hayes Micromodem Apple	250.00	Morrow 10MEG	2,750.00
Hayes Micromodem S-100	319.00	Morrow 20 MEG	3,550.00
Houston Instrument DMP-2	819.00	Morrow 26 MEG	3,375.00
Houston Instrument DMP-4	1,063.00		

For latest wholesale prices and to order Call Toll Free 800-227-2288. In California call 415-376-9020.

Assembly, integration and testing also available from our service department.

ASK ABOUT OUR LEASING PROGRAM.

Mastercharge at 3% handling fee. Prices subject to change without notice. Minimum fee \$100. 15% cancellation fee.



We are buying agents for overseas computer dealers. Export services available. International Telex 470851

THE PURCHASING AGENT

1635 School St., Suite 101, Moraga, CA 94556

Text continued from page 354:

- Load the EPROM program at 0100 to 01FF hexadecimal.
- Load the data at 0800 to 0FFF hexadecimal.
- Insure that the +25-V power supply is off before installing the EPROM.
- Install the EPROM to be programmed.
- Insure that the +5-V power supply is applied to the EPROM. Then turn on the +25-V supply.
- Run the program loaded at 0100 hexadecimal.
- Enter the high and low parts of the starting address of the data to be programmed.
- Enter the high and low parts of the finish address, plus one.
- Press input again to start programming. The program is finished when "DD" is displayed.
- Turn off the +25-V power supply; then remove the EPROM.
- Verify that the data was stored correctly.

The data may be loaded only from hexadecimal 0800 to 0FFF. The EPROM's memory is addressed from X000 to X7FF (or 000 0000 0000 to 1111 1111 in binary). Only the least-significant 11 bits are required. The only address space in a 4 K-byte system that meets this requirement is from 0800 to 0FFF (or 1000 0000 0000 to 1111 1111 1111). The 1802's address space from 0000 to 07FF is where its own program is stored in memory.

If you like, you can program just one bit of a byte. When you are programming a byte of data into the EPROM, you are actually programming zeros into the required bit positions of the byte. For example, take the data value 4F hexadecimal (0100 1111 in binary). A zero is programmed into bit positions 7, 5, and 4, while bits 6, 3, 2, 1, and 0 remain at logic 1. Any of the logic 1 bits can be programmed to logic 0. The byte 4F can be changed to 42 (or 0100 0010) because the only bits changed were the logic 1 bits. The only way to change a logic 0 bit to a

REPAIR PCB'S ANYWHERE.

With the NEW Pace Micro!

Perform power desoldering and soldering anywhere. Depot. Service center. Mobile van. On-site. Anywhere! Operates on AC or 12 VDC.

Write or call today for a FREE brochure.

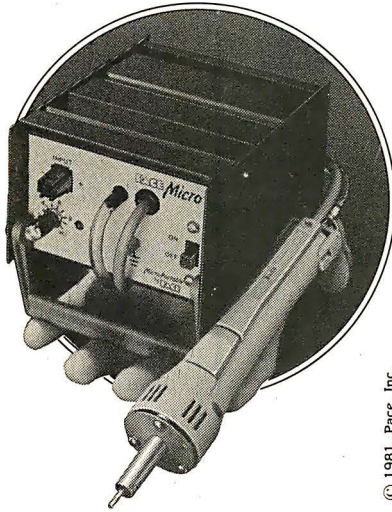

© 1981, Pace, Inc.

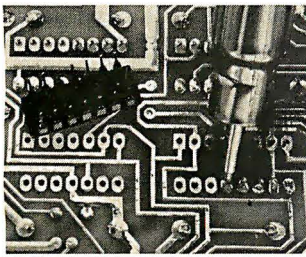

PAGE

Micro Portable
Systems for PCB Repair Anywhere™

9893 Brewers Court
Laurel, Md. 20707, U.S.A.
(301) 490-9860.
Telex 87446.

DUAL THERMOMETER

For Apple II*
COMPLETE with SOFTWARE



- Display temperature, maximum, minimum and difference.
- Sound alarm for over/under temperature.
- Store data on disk or printer automatically.
- Display time with on-

- board timer.
- Up to 7 boards with 14 probes in one Apple*.
- -55°C to 125°C range, 0.4° accuracy over most of range.
- Requires 48K Apple* with Applesoft* and disk.

Strawberry Tree Computers

949 Cascade Drive
Sunnyvale, Ca. 94087
(408) 736-3083

\$260.00

If your dealer doesn't have it, call or write us at dept. A

*TM of Apple Computer, Inc.

ORDER: 1-800-547-2492

IN OREGON CALL

SERVICE: 503-479-4150

SPECIAL ON APPLE REPAIRS

ATARI® 400 (16K) \$325
800 (16K) \$739

I.D.S. EPSON

445G Printer	\$689	MX-70	\$369
460G Printer	\$799	MX-80	\$459
560G Printer	\$999	MX-80FT	\$559
		MX-100	\$739

TERMS:
SHIPPING: Add 3% of total transaction for UPS brown (ground) or 5% for UPS blue (air), Parcel Post, or any special arrangements.
PAYMENT: Cashier's checks, certified checks, money orders, and bank wires honored immediately. Wire transfer funds to U.S. National Bank of Oregon, South Grants Pass Branch. Credit RCE, account number 501-981, to the attention of Rose. Add 2% for Visa and Master Charge. Allow 20 days for personal checks to clear.
REFUNDS: 10% restocking charge on all returns or exchanges. No refunds on opened software. Call first.
GUARANTEE: All products with full manufacturer's warranty. Sanyo and Apple warranty available. We have full repair and service facilities for all electronic repairs with HP, Dynascan, Pioneer, Sanyo and Apple trained and certified technicians. For any technical service call them for instant advice or questions right on their benches at (503) 479-4150.
REPAIRS: Out of warranty guarantee: Labor 30 days from date of your receipt, 90 days on parts. Call for details on quality guaranteed discount repair and reconditioning service.
We have been repairing electronic equipment for 12 years and love it!

"A Unique Combination of Quality Products, Competitive Prices, and Service"

APPLE HARDWARE

CCS 7710A	\$109
7720A	\$95
7740A	\$95
7470A	\$95
VIDEX 80 COLUMN	\$269
CORVIS 5 MEG DRIVE	\$3049
LOWER CASE ADAPTOR	\$39
16K RAM CARD (MICROSOFT)	\$149
Z-80 CARD (MICROSOFT)	\$329
MICROMODEM (HAYES)	\$289
SMART MODEM (HAYES)	\$229
NOVATION MODEMS	
APPLE CAT	\$309
AUTO CAT	\$209
CAT	\$139
D CAT	\$149
MOUNTAIN CLOCK	\$239
MOUNTAIN MUSIC SYSTEM	\$469
MOUNTAIN A/D CONVERTER	\$299
MOUNTAIN INTROL/X-10 CARD	\$169
MOUNTAIN C.P.S.	\$189
10 KEYPAD (A.B.T.)	\$99
SUP-R-TERM (80 COLUMN)	\$299
SUP-R-MOD R.F. MODULATOR	\$24
16K MEMORY EXPANSION	\$39
JOYSTICK (T.G.)	\$39
9" B&W MONITOR (SANYO)	\$145
9" B&W MONITOR (N.E.C.)	\$149
12" B&W MONITOR (SANYO)	\$189
12" GREEN MONITOR (SANYO)	\$229
12" GREEN MONITOR (ZENITH)	\$114
12" GREEN MONITOR (BMC)	\$255
13" COLOR MONITOR (SANYO)	\$385
EPSON CABLE & INTERFACE	\$79
EPSON GRAFTRAX	\$70
SANYO SLIM II CASS DECK	\$29

ATARI HARDWARE

CX-2600 VIDEO GAME	\$139
410 PROGRAM RECORDER	\$39
810 DISK DRIVE	\$429
820 PRINTER	\$249
822 PRINTER	\$339
825 PRINTER	\$579
830 MODEM	\$149
850 INTERFACE MODULE	\$135
853 16K MEMORY EXPANSION	\$79
RAM CRAM	\$185

SOFTWARE

VISICALC (ATARI)	\$189
BASIC (ATARI)	\$49
VISICALC	\$189
VISIDEX	\$139
VISIPLOT	\$129
VISITERM	\$109
VISITREND/PLOT	\$179
MICROLAB DATA FACTORY	\$129
D 8 MASTER (STONEWARE)	\$109
SUP-R-TEXT II	\$179
WORDSTAR	\$259
B.P.I. SOFTWARE (each)	\$319
SOFT-TECH PAYROLL	\$179
STOCKFILE INVENTORY	\$369
ADVENTURE	\$29
ZORK	\$29
SARGON CHESS	\$29
GALAXIAN	\$22
FUJII CASS TAPE/10	\$19
VERBATIM	\$25
MAXELL	\$38

WRITE FOR CATALOG



RALSTON-CLEARWATERS ELECTRONICS

530 N.E. 'E' Street • Grants Pass, Ore. 97526
ALL BRAND NAMES ARE REGISTERED TRADE MARKS

FREE
with software purchase—
One CPM Handbook

DISCOUNT Ad #21 SOFTWARE ULTIMATE SOFTWARE PLAN

We'll match any advertised price on any item that we carry. And if you find a lower price on what you bought within 30 days of buying it, just show us the ad and we'll refund the difference. It's that simple.

Combine our price protection with the availability of full professional support and our automatic update service and you have the Ultimate Software Plan.

It's a convenient, uncomplicated, logical way to get your software.

✓ (New items or new prices)

CP/M users:
specify disk systems and formats. Most formats available.

CP/M®	DISK WITH MANUAL ONLY	MANUAL ONLY
ARTIFICIAL INTELLIGENCE		
Medical(PAS-3)	\$849/\$40
Dental (PAS-3)	\$849/\$40
ASYST DESIGN		
Prof Time Accounting	\$549/\$40
General Subroutine	\$269/\$40
Application Utilities	\$439/\$40
COMPLETE BUS SYSTEMS		
Creator	\$269/\$25
Reporter	\$169/\$20
Both	\$399/\$45
COMPUTER CONTROL		
Fabs (B-tree)	\$159/\$20
UltraSort II	\$159/\$25
COMPUTER PATHWAYS		
Pearl (level 1)	\$ 99/\$25
Pearl (level 2)	\$299/\$40
Pearl (level 3)	\$549/\$50
DIGITAL RESEARCH		
CP/M 2.2	
NorthStar	\$149/\$25
TRS-80 Model II (P+T)	\$159/\$35
Micropolis	\$169/\$25
Cromemco	\$189/\$25
PL/I-80	\$459/\$35
BT-80	\$179/\$30
Mac	\$ 85/\$15
Sid	\$ 85/\$15
Z-Sid	\$ 90/\$15
Tex	\$ 90/\$15
DeSpool	\$ 50/\$10
CB-80	\$459/\$35
CBasic-2	\$ 98/\$20
D.M.A.		
Ascom	\$149/\$15
Formula	\$539/\$45
GRAHAM-DORIAN		
General Ledger	\$729/\$40
Acct Receivable	\$729/\$40
Acct Payable	\$729/\$40
Job Costing	\$729/\$40
Payroll II	\$729/\$40
Inventory II	\$729/\$40
Payroll	\$493/\$40
Inventory	\$493/\$40
Cash Register	\$493/\$40
Apartment Mgt	\$493/\$40
MICRO-AP		
S-Basic	\$269/\$25
Selector IV	\$269/\$35
Selector V	\$469/\$50
MICRO DATA BASE SYSTEMS		
HDBS	\$269/\$35
MDBS	\$795/\$40
DRS or QRS or RTL	\$269/\$10
MDBS PKG	\$1295/\$60
MICROPRO®		
WordStar	\$319/\$60
Customization Notes	\$429/\$na
Mail-Merge	\$109/\$25
WordStar/Mail-Merge	\$419/\$85
DataStar	\$249/\$60
WordMaster	\$119/\$40
SuperSort I	\$199/\$40
Spell Star	\$175/\$40
CatcStar	\$259/\$na
MICROSOFT		
Basic-80	\$298
Basic Compiler	\$329
Fortran-80	\$349
Cobol-80	\$629
M-Sort	\$124
Macro-80	\$144
Edit-80	\$ 84
MuSimp/MuMath	\$224
MuLisp-80	\$174

MICROTAG		
Individual	\$250/na
Professional	\$1000/na
Partnership	\$750/na
Package	\$1500/na

ORGANIC SOFTWARE		
TextWriter III	\$111/\$25
DateBook II	\$269/\$25
Milestone	\$269/\$30

OSBORNE		
General Ledger	\$ 59/\$20
Acct Rec/Acct Pay	\$ 59/\$20
Payroll w/Cost	\$ 59/\$20
All 3	\$129/\$60
All 3 + CBASIC-2	\$199/\$75
Enhanced Osborne	\$269/\$60
With "C" Basic	\$349/\$75

PEACHTREE*		
General Ledger	\$399/\$40
Acct Receivable	\$399/\$40
Acct Payable	\$399/\$40
Payroll	\$399/\$40
Inventory	\$399/\$40
Surveyor	\$399/\$40
Property Mgt	\$799/\$40
CPA Client Write-up	\$799/\$40
P5 Version	Add \$129

SOFTWARE WORKS		
Adapt(CDOS to CP/M)	\$ 69/\$na
Ratfor	\$ 86/\$na

SOHO GROUP		
MatchMaker	\$ 97/\$20
WorkSheet	\$177/\$20

STRUCTURED SYSTEMS		
GL or AR or AP or PayCall	Call
Inventory Control	Call
Analyst	Call
Letterright	Call
QSort	Call
NAD	Call
Order Entry	Call

SUPERSOFT		
Diagnostic I	\$ 49/\$20
Diagnostic II	\$ 84/\$20
Disk Doctor	\$ 84/\$20
Forth (8080 or Z80)	\$149/\$30
Fortran	\$219/\$30
Fortran w/Ratfor	\$289/\$35
C Compiler	\$174/\$20
Star Edit	\$189/\$30
Other	less 10%

TCS		
GL or AR or AP or Pay\$	\$79/\$25
All 4	\$269/\$99
Compiled each	\$ 99/\$25
Inventory	\$ 99/\$25

UNICORN		
Mince	\$149/\$25
Scribble	\$149/\$25
Both	\$249/\$50

WHITESMITHS		
"C" Compiler	\$600/\$30
Pascal (incl "C")	\$850/\$45

"DATA BASE"		
FMS-80	\$649/\$45
dbASE II	\$595/\$50
Condor II	\$899/\$50
Access 80 Level 1	\$249
Access 80 Level 2	\$429
Access 80 Level 3	\$679
Optimum	\$749/\$50

"PASCAL"		
Pascal/MT+	\$429/\$30
Pascal/Z	\$349/\$30
Pascal/UCSD 4.0	\$429/\$50
Pascal/M	\$189/\$20

"WORD PROCESSING"		
WordSearch	\$179/\$50
SpellGuard	\$229/\$25
VTS/80	\$259/\$65
Magic Wand	\$289/\$45
Spell Binder	\$349/\$45
Select	\$495/\$na

"OTHER GOODIES"		
Forecaster	\$199/\$na
Micro Plan	\$419/\$na
Plan 80	\$269/\$30
SuperCalc	\$269/\$na
Target	\$189/\$30
BSTAM	\$149/\$15
BSTMS	\$149/\$15
Tiny "C"	\$ 89/\$50
Tiny "C" Compiler	\$229/\$50
Nevada Cobol	\$129/\$25
MicroStat	\$224/\$25
Vedit	\$105/\$15
MiniModel	\$449/\$50
StatPak	\$449/\$40
Micro B+	\$229/\$20
Raid	\$224/\$35
String 80	\$ 84/\$20
String/80 (source)	\$279/\$na
ISIS CP/M Utility	\$199/\$50
Lynx	\$199/\$20

APPLE II®		
INFO UNLIMITED		
EasyWriter	\$199
Datadex	\$249
EasyMailer	\$128
Other	less 15%

MICROSOFT		
Softcard (Z-80 CP/M)	\$298
Fortran	\$179
Cobol	\$499
Tasc	\$139

MICROPRO		
Wordstar	\$269
MailMerge	\$ 99
WordStar/MailMerge	\$349
SuperSort I	\$159
Spellstar	\$129

PERSONAL SOFTWARE		
Visicalc 3.3	\$159
Desktop/Plan II	\$159
Visitem	\$129
Visidex	\$159
Visiplot	\$149
Visitrend/Visiplot	\$229
Visifile	\$199

PEACHTREE®		
General Ledger	\$224/\$40
Acct Receivable	\$224/\$40
Acct Payable	\$224/\$40
Payroll	\$224/\$40
Inventory	\$224/\$40

"OTHER GOODIES"		
dbASE II	\$595/\$50
VU #3R	
(usew/Visicalc)	\$ 79
Context Connector	\$129
(usew/Visicalc)	\$129
Micro Courier	\$219
TCS Apple	
(complete business)	\$269/\$99
Super-Text II	\$127
Data Factory	\$134
DB Master	\$184
Charles Mann	less 15%
STC	less 15%

ORDERS ONLY—CALL TOLL FREE VISA • MASTERCARD

1-800-854-2003 ext. 823 • Calif. 1-800-522-1500 ext. 823

Outside of Continental U.S.—add \$10 plus additional postage • Add \$3.50 postage and handling per each item • California residents add 6% sales tax • Allow 2 weeks on checks, C.O.D. ok • Prices subject to change without notice. All items subject to availability • ®—Mfgs. Trademark.

THE DISCOUNT SOFTWARE GROUP

6520 Selma Ave. Suite 309 • Los Angeles, Ca. 90028 • (213) 837-5141
Int'l TELEX 499-0032 BVHL Attn: DiscSoft • USA TELEX 194-634 BVHL Attn: DiscSoft •
TWX 910-321-3597 BVHL Attn: DiscSoft

logic 1 is by ultraviolet erasing, and this necessarily means erasing the entire EPROM.

The manufacturer recommends that V_{pp} (+25 V) should always be applied to the EPROM after V_{cc} (+5 V) has been applied. If you adhere to the instructions numbered 5, 6, 7, and 13 closely, there should be no problems.

Construction

Construction of the programmer can be accomplished in several ways but a single-sided printed-circuit board is probably the easiest. The positive photographic system for etching your own boards is recommended because one of the photographic steps is eliminated.

Those who do not have access to an industrial EPROM eraser can make their own. An ultraviolet tube can be purchased at just about any barber-shop supply house. The General Electric number G15T8 is a 15-inch tube that fits nicely into a fluorescent desk-lamp fixture. Place the EPROM about an inch or two away from the tube, and expose it for about one half an hour. Again, be sure to avoid exposing your eyes to ultraviolet rays.

Owners of ELF II computers should be aware that the monitor included with the Giant Board uses the highest two bytes of programmable memory for its own work space. Anyone with only 4 K bytes of memory located at 0000 to 0FFF should take care not to jump to the monitor after loading the EPROM data at 0800 to 0FFF, because bytes OFFD and OFFE will be overwritten by the ELF II monitor.

ELF II owners can use the output port that is on the Giant Board, but they will have to cut two traces on the board. It is really very simple and is worth the effort. The objective is to get the clock, CS2, and CS1 pins of the 1852 connected to the N2, TPB and MRD lines, respectively.

That is all there is to it. Now that you have your EPROM programmer running successfully, you have another valuable tool for your hardware and software development system. ■

S-100 USERS

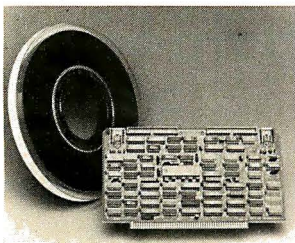

INTERFACE 9-TRACK TAPE DRIVES

With the DTI - DMA Tape-Unit Interface

- Transfers data via DMA up to 200K bytes per second
- Allows full control over all tape-drive functions

SPEED NUMBER-CRUNCHING SOFTWARE 5-10 X's AND MORE

With the FMP - Fast Math Processor

- Kit or assembled
- 32-bit floating point operations for arith., trig., exponential, etc. functions
- Or 64-bit floating point operations for arithmetic functions

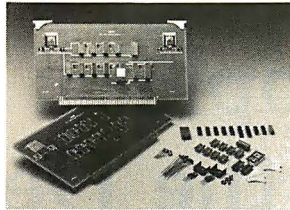

Both the DTI and FMP meet the IEEE S-100 standard. Software is available.

For further information contact:



A MEMBER OF THE SPC GROUP
SPC TECHNOLOGIES, INC.

P.O. Box 248, Arlington, VA 22210
(703) 841-3632

OVER 8 MBytes OF SOFTWARE AT \$8* PER DISKETTE FULL

The exchange library of The CP/M® Users Group has nearly 50 volumes of software available. Everything from editors, assemblers, languages, games, tools and more—and almost everything in full source code.

Send \$6** for full library catalog.

THE CP/M USERS GROUP

1651 Third Avenue, New York, N.Y. 10028.

*Domestic price. Inquire for overseas price.
**The complete catalog of CPMUG is available for \$6 prepaid to the U.S., Canada and Mexico. \$11 prepaid to all other countries.

© CP/M is a registered trademark of Digital Research. The CP/M Users Group is not affiliated with Digital Research.

ECT™

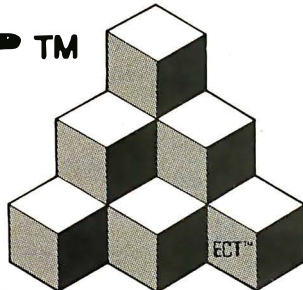

Building Blocks for Microcomputer Systems, Dedicated Controllers and Test Equipment.

R²I/O S-100 ROM, RAM & I/O BOARD

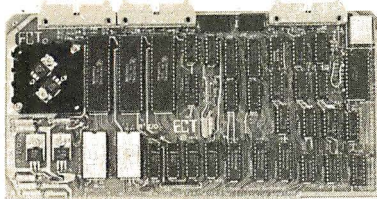

ECT's R²I/O is an S-100 Bus I/O Board with 3 Serial I/O Ports (UART's), 1 Parallel I/O Port, 4 Status Ports, 2K of ROM with the 8080 Apple Monitor Program and 2K of Static RAM.

\$295.00

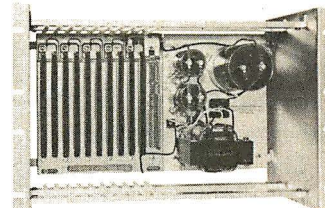

RM-10 S-100 RACK MOUNT CARD CAGE

ECT's RM-10 is a rack mount 10 slot Card Cage with Power Supply, consisting of an ECT-100 rack mount Card Cage (19"W x 12.25"H x 8"D), the MB-10 Mother Board (with ground plane and termination) all 10 connectors and guides and the PS-15A Power Supply (15A @ 8V, 1.5A @ ± 16V).

\$295.00

Specializing in Quality Microcomputer Hardware
Industrial • Educational • Small Business • Personal

Card Cages, Power Supplies, Mainframes, CPU's, Memory, I/O, OEM Variations

ECT™ ELECTRONIC CONTROL TECHNOLOGY (201) 686-8080

763 Ramsey Ave., Hillside, NJ 07205

An Apple Talks with the Deaf

Ned W. Rhodes
2001 North Kenilworth St.
Arlington, VA 22205

When a deaf woman came to work in my office last summer, I realized I had been taking for granted the ability to hear. She read lips and I learned some sign language, so we were able to "talk," and we corresponded by letter when she returned home to St. Louis at the end of the summer. But I was frustrated that I couldn't pick up the phone and wish her a Merry Christmas or happy birthday. This article describes how I overcame that frustration by turning my Apple into a communications device that helps me talk to my friend and other hearing-impaired people.

Devices called TTYs (teletypewriters) allow the deaf and hearing-impaired to communicate with one another over the phone. The two parties type their messages on keyboards and receive a response either as a printout or video display. The process resembles the way microcomputers communicate with a remote

computer by using a modem, except that the communications frequencies used by TTYs are not compatible with standard computer-modem frequencies. Phone-TTY Inc. of Fair Lawn, New Jersey (see box on page 377) makes an acoustic coupler with a 60 milliampere (mA) interface that allows communication between TTYs. I bought the M-1 coupler

thinking I could easily interface it to my Apple, but I was wrong. The coupler was shipped with very clear instructions on how to connect it to a 60-mA teletypewriter interface, but there were no instructions or schematics to help with my Apple interfacing project. The manufacturer was unwilling to send me a schematic but did give me the name of a local

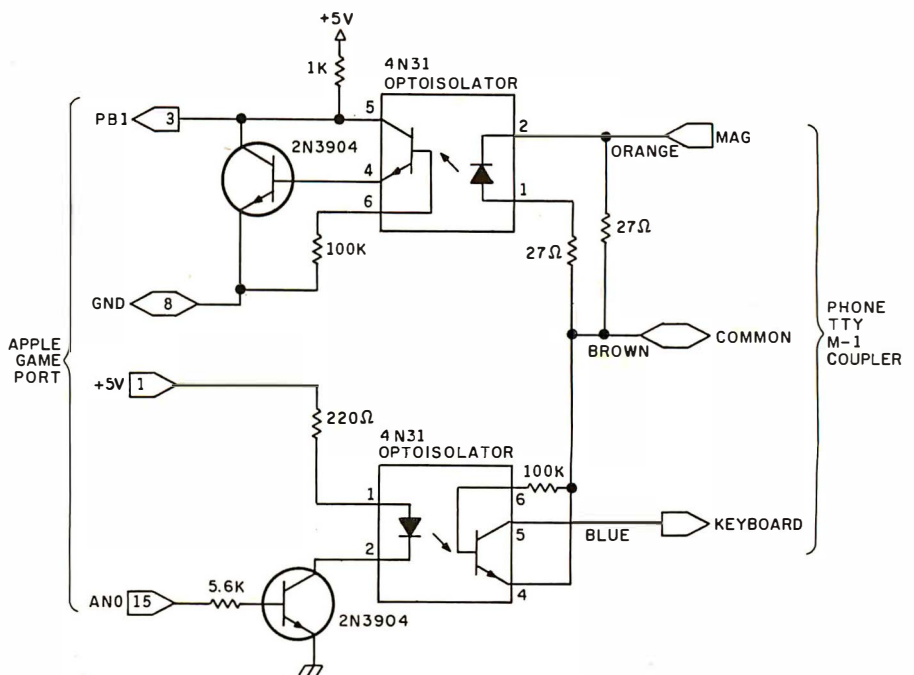

Figure 1: A schematic diagram of the Apple/M-1 coupler interface. The circuit uses optical isolators to convert the coupler's 60-mA current loop to the TTL levels required by the Apple game-paddle interface.

About the Author

Ned Rhodes has an electrical engineering degree from the University of Minnesota and a master's degree in computer science from George Washington University. He is employed by the Melpar Division of E-Systems Inc. in Falls Church, Virginia, where he develops minicomputer-based data-acquisition systems.

MITSUBISHI FLEXIBLE DISK DRIVE

SETTING NEW STANDARDS FOR RELIABILITY AND DURABILITY

- FULLY IBM AND SHUGART SA850R COMPATIBLE
- DOUBLE-SIDED, DOUBLE-DENSITY
- 1.6 MBYTE/DISK
- SOFTOUCH™ PROPRIETARY HEAD LOAD MECHANISM
- 3 MS TRACK-TO-TRACK ACCESS TIME
- HIGH QUALITY, ALL FERRITE MnZn HEADS
- PRECISION BUILT/MODULAR CONSTRUCTION
- 6 MONTH WARRANTY

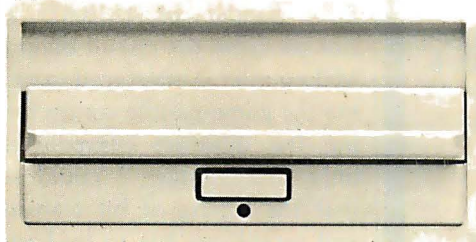

***\$525.00** Available from stock. Terms: cash, check, money orders, VISA, MasterCharge. Tax: 6% if California resident. *Price subject to change without notice.

NCL DATA

1333 Lawrence Expressway, Suite 408
 Santa Clara, California 95051
 (408) 247-3450/TWX 910-338-7442
 AUTHORIZED SALES AND SERVICE AGENT
 FOR INFORMATION CONTACT HOLLY SAUER
 OEM INQUIRIES INVITED

MEMOREX FLEXIBLE DISCS

BUY THE BEST FOR LESS. Lowest prices. **WE WILL NOT BE UNDERSOLD!!** Buy any quantity. Call free (800) 235-4137 for prices and information. Dealer inquiries invited. C.O.D.'s accepted.

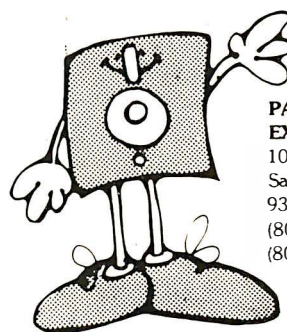

PACIFIC EXCHANGES
 100 Foothill Blvd.
 San Luis Obispo, CA 93401. In Cal. call (800)592-5935 or (805)543-1037

COMPUTERWORLD DOES IT AGAIN! ABSOLUTELY THE LOWEST PRICES EVER SEEN IN THE U.S.!

EPSON — The World's Best Printer At The World's Lowest Price

LOBO

WE SELL THE ENTIRE LINE OF EPSON PRINTERS AND ACCESSORIES

MX-80FT SERIAL IMPACT DOT MATRIX PRINTER
 80 CPS BIDIRECTIONAL/9 x 9 MATRIX
 FRICTION FEED AND ADJUSTABLE
 TRACTOR FEED/STANDARD
 PARALLEL INTERFACE \$CALL

MX-100 SERIAL IMPACT DOT MATRIX PRINTER
 SIMILAR MX-80
 WITH 136 CHARACTERS
 NORMAL AND 233 COMPRESSED/
 ALSO WITH DOT RESOLUTION
 GRAPHICS \$CALL

VERBATIM DISKETTES

MD525-01 SOFT SECTORED (10) \$26.95
 FD34-4001 DSDD (10) \$47.95

VISTA COMPUTER COMPANY

FOR APPLE:
 150 40 CHARACTER
 TYPE AHEAD BUFFER \$ 39.95
 VISTA MUSIC MACHINE \$ 99.00
 VISION 80 COLUMN CARD \$ 299.00

PRINTERS:

V300-25P 25CPS
 Daisy Wheel Printer/Parallel
 with uni. P/S and
 Paper/Ribbon Out switches \$1655.00
 V300-25R 25CPS
 with RS232C Interface \$1725.00
 V300-45P 45CPS
 Daisy Wheel Printer/Parallel
 Forms Tractor \$1999.00
 \$275.00

APPLE IS A TRADEMARK OF APPLE COMPUTER, INC.

CALIFORNIA COMPUTER SYSTEMS

7424-01 CALENDAR CLOCK \$ 97
 7440-01 PROGRAMMABLE TIMER BOARD \$ 95
 7710-01 SERIAL ASYNCHRONOUS BOARD \$ 135
 7712-01 SERIAL SYNCHRONOUS BOARD \$ 145
 7720-01 PARALLEL INTERFACE \$ 109
 7720-02 PARALLEL CENTRONICS BOARD \$ 109
 7811-01 ARITHMETIC PROCESSOR BOARD
 WITH DISKETTE (OR WITH ROM) \$ 375
 CALL FOR PRICES ON OTHER CCS PRODUCTS

LOBO MANUFACTURE A COMPREHENSIVE RANGE OF DISK DRIVES AND ACCESSORIES FOR THE APPLE, TRS-80 AND S-100 SYSTEMS. ALL LOBO DRIVES PRODUCTS HAVE A ONE YEAR PARTS AND LABOR WARRANTY.

MINIFLOPPY WITH CONTROLLER
 FOR APPLE \$459
 ADD-ON DRIVE FOR APPLE \$389
 DUAL 8" DOUBLE-SIDED, DOUBLE DENSITY
 DRIVES FOR APPLE WITH CONTROLLER
 2.2 MEGABYTES DOS 3.3 COMPATIBLE \$2299
 5 MB and 10 MB HARD DISK SYSTEMS
 WITH FLOPPY BACK-UP AND
 CONTROLLER \$CALL
 APPLE 16 K RAMCARD \$109
 APPLE II \$CALL

"QUALITY, SERVICE AND SATISFACTION!"
 ORDER LINE OPEN 7 DAYS A WEEK



(303) 279-2727

COMPUTERWORLD INTERNATIONAL, INC.
 SUITE 133, P.O. BOX 81, WHEAT RIDGE
 COLORADO, U.S.A. 80034-0081

TERMS:
 MAIL ORDER/VISIT BY APPOINTMENT
 WE WILL SHIP UPS FREIGHT COLLECT
 OR ADD 3% FOR SHIPPING.

COLORADO RESIDENTS
 ADD APPROPRIATE SALES TAX.
 MASTERCHARGE/VISA ACCEPTED

ATTENTION DEALERS

TOSHIBA SUPERFIVE SUPERBRAIN & COMPUSTAR

We're selling dealers some of the best products in the industry. Like Toshiba computers and word processors,

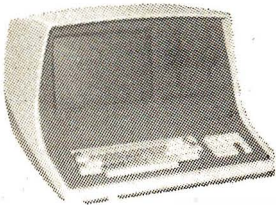
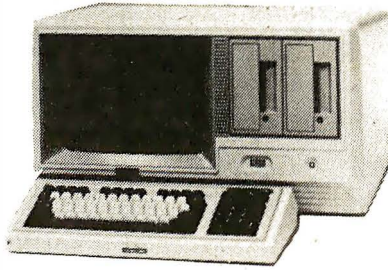

Intertec's Superbrain and CompuStar systems, and CMC's own SuperFive and SuperTen. We offer hardware and software support and our own version of Intertec's CARE® program called Compex. We sell worldwide. Our prices are the best! And you'll like Toshiba's great price-performance ratio, with software ready to go.

PRODUCTS

- TOSHIBA**
5 1/2", 8" Models
- CMC SUPERTEN**
10mb Computer
- CMC SUPERFIVE**
5mb Computer
- SUPERBRAIN**
64k, QD Models
- COMPUSTAR**
Models 10, 15, 20, 30, 40
- HARD DISCS**
5, 10, 32 & 96 mb
- CORVUS**
- DYSAN**
- C.I.TOH**
- EPSON**

Plus a full line of printers and peripheral equipment, including MPI, NEC, Mailbu, C.Itoh, Anadex, TI and others, including Seagate, Tandon and CDC drives. Diskettes from Dysan and Verbatim.

SERVICE

Rapid turnaround on parts and module replacement, and repair in our factory-trained service department.

SOFTWARE

We're more than order-takers. Our software specialists stand ready to give our dealer network the support you want and need to make you successful. Our software is the best and you'll like our prices.

•ACCOUNTING PLUS
G/L, A/R, A/P, P/R, Inventory,
Purchase Order Entry, Sales Order Entry,
Point of Sale.

- d Base II**
- M Basic 80**
- Micro Plan**
- MT Pascal**
- Condor**
- CBasic**
- Super Calc**
- Fortran**
- Micro Pro**
- Cobol**
- Calc Star**
- Peachtree**

INTERNATIONAL CUSTOMERS

Exclusive distributors for SuperFive and SuperTen needed in Germany, Spain, France, Belgium, Scandinavia, Italy, Saudi Arabia, Egypt, Hong Kong, Singapore, Taiwan, Venezuela, Brazil and Mexico.

FOR ORDERING CALL

TOLL FREE 1-800-426-2963

PHONE (206)453-9777 TELEX 152 556 SEATAC



A Division of Computer Marketing Corporation

CMC

INTERNATIONAL

11058 Main, Suite 125

Bellevue, WA 98004

computer club that had already interfaced the M-1 coupler to the Apple.

Apple/M-1 Interface

A call to Paul Rinaldo of AMRAD (Amateur Radio Research and Development Corporation) in Vienna, Virginia, brought the offer of a schematic and software to drive the hardware. I had expected the schematic, but getting a software package was almost too good to be true. Figure 1 shows the schematic of the Apple/M-1 interface, based on a design by Elton Sanders of AMRAD. As you can see from the circuit diagram, the M-1 coupler is interfaced to the Apple via the game-paddle connector, making the interface inexpensive. The only disadvantage I could see was that the timing of bit transmissions and receptions has to be handled in software. As it turned out, however, this was really an advantage.

The circuit in figure 1 uses optical isolators to convert the 60-mA current loop used by the M-1 coupler to the TTL (transistor-transistor logic) levels used by the Apple game-paddle interface. You can use almost any optical isolator in the circuit as long as the isolator's LED (light-emitting diode) can handle 20 mA or more. The output side of the optical isolator must be able to handle collector-to-emitter voltages of about 15 V. The switching time of the optical isolator doesn't need to be very fast; switching times in the tens of milliseconds can keep up with TTY devices.

Finally, the forward or turn-on voltage of the LED must be 1.5 V or less because the input of the 60-mA interface of the M-1 coupler operates from -1.5 V to 0 V. I had a problem with one brand of optical isolator that had a turn-on voltage greater than 1.5 V. The circuit wouldn't work because the optical isolator was never turning on. I switched to a different brand of isolator (4N31 or Radio Shack 276-133), with a lower turn-on voltage, and then the circuit worked fine.

Communications Software

As I mentioned before, AMRAD gave me a software routine that allowed the Apple to communicate

Complete AIM 65 Expansion

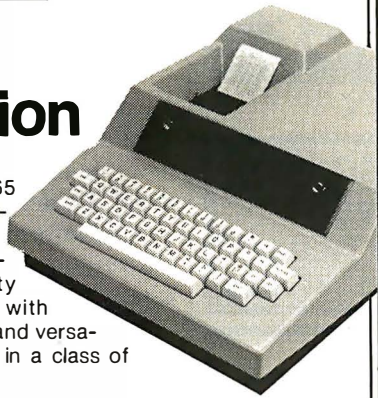

For complete AIM 65 expansion, Forethought Products brings you the AIM-Mate Series, quality expansion products with price, performance and versatility that puts them in a class of their own.

AIM-Mate Series expansion, including RAM (to 48K), PROM, I/O, video and floppy disk interface, STD BUS interface, parity protection and more, lets you configure the kind of system *you* need.

The compact AIM-Mate case puts it all together in a sturdy, portable, desk top unit.

Write today for complete details on the AIM-Mate System- AIM 65 expansion products for the professional.

**FORETHOUGHT
PRODUCTS**

87070 Dukhobar Road, Eugene, Oregon 97402 (503) 485-8575

CATCH THE S-100 INC. BUS!



January Specials

	LIST PRICE	OUR SPECIAL CASH PRICE
S.D. Systems 80x24 Video Board	556.00	420.00
VFI Double Density Disk Controller	507.00	382.00
PROM 100 Programmer	311.00	237.00
All of the above factory assembled and tested. We also stock S.D. kits		
North Star's Advantage Computer	3,999.00	3,199

Subject to Available Quantities • Prices Quoted Include Cash Discounts. Shipping & Insurance Extra.

We carry all major lines such as S.O. Systems, Cromemco, Ithaca Intersystems, North Star, Sanyo, ECT, TEI, Godbout, Thinker Toys, SSM. For a special cash price, telephone us.

We are pleased to announce our appointment as a TEI distributor. Dealer inquiries invited.

S-100, inc.

14425 North 79th Street, Suite B
Scottsdale, Arizona 85260

Order Number 800-528-3138
Technical 602-991-7870

Now available from your computer store- the whole line of AJ couplers and modems.



Starting now you can buy AJ acoustic data couplers and modems directly from your local computer store.

Not just selected models. *Any* models. Ranging from the 0-450 bps A 242A, the world's most widely used acoustic data coupler, to the revolutionary AJ 1259 *triple modem* that handles 300 bps Bell 103, 1200 bps Bell 212A, and 1200 bps VA 3400 protocols.

Whether you need full or half duplex or both in one; originate or answer, auto answer; acoustic coupling, or direct-connect—there's a model for you in the AJ line.

Starting now you don't have to settle for second best.

For the location of your local computer store handling the AJ line, call toll-free:

800/538-9721

California residents call 408/263-8520, Ext. 307.

**ANDERSON
JACOBSON**

MICROMAIL HAS THE RIGHT TERMINAL AT THE RIGHT PRICE.

• CRT'S • PRINTERS • TELEPRINTERS •

* SPECIAL	C.ITOH	TELEVIDEO
	8510	.910 .950
	• PARALLEL..... \$595.00	\$569.00 \$939.00
	• SERIAL..... \$695.00	.912.. \$689.00 .920.. \$725.00

SPECIAL	TEC 511	SPECIAL	TELETYPE 43
	CRT \$499.00		PF(TTL) \$899.00

LETTER QUALITY PRINTERS

QUME	NEC	DIABLO
• SPRINT 9/45	• 7700 SERIES	• 630 RO
\$1849.00	• 3500 SERIES	\$1949.00
• SPRINT 9/35	CALL FOR OUR	• 630 KSR... CALL
CALL FOR PRICE	LOW PRICES	• 1640 CALL

ANADEX	TEXAS INSTRUMENTS
DP 9500 \$1199.00	810/2 \$1399.00
DP 9501 \$1199.00	<small>(Includes upper/lower case option)</small>
DP 8000 AP \$749.00	810/2 VFC/CP \$1549.00
SPECIAL	<small>(includes u/l case, forms control & compressed print)</small>

SOROC	DEC
IQ 120 \$689.00	LA 34 DA
IQ 135 \$849.00	\$849.00
IQ 140 \$1075.00	DEC LA 34AA \$999.00
C. ITOH	VT 100 \$1399.00
CIT 101 \$1399.00	
Special!	

CALL TOLL FREE (800) 854-6028

To Order: Send check to MICROMAIL, P.O. Box 3297, Santa Ana, CA 92703. Personal or company checks require two weeks to clear. Visa/MasterCard accepted. C.O.D. requires a 15% deposit. **Handling:** Add 3% to orders less than \$750.00, and 2% for orders \$751.00 or over. **NOTE:** Handling charges are waived on orders pre-paid in advance by check. **Shipping:** We ship FREIGHT COLLECT via UPS or Motor Freight. Air and Express delivery is available. Prices subject to change without notice.

OVERSEAS ORDERS WELCOME



P.O. Box 3297
Santa Ana, CA 92703
Phone: 714/731-4338
TWX: 910 595 1146

over the phone with other TTY devices using the M-1 coupler. The routine, written by AMRAD member Nancy Sanders, worked fairly well, but I wanted more. So I sat down and wrote the software in listing 1. When I was finished, my routine was the same size as the original but had some new features. Before explaining those, I'll describe some of the background information I needed to write the routine, as well as some of the software techniques I used.

TTY devices for the deaf use a five-level code called Baudot that differs greatly from ASCII (American Standard Code for Information Interchange). A five-level code like Baudot uses 5 bits to represent each character. At most, 5 bits can represent 32 unique characters (because $2^5 = 32$). In order to represent 26 letters, 10 numbers, and a host of special alphanumeric characters, some sort of encode/decode scheme must be used with Baudot code. Table 1 shows the code for TTY communications. You can see in the table that the Baudot code is defined as having a letters and a figures case. The default case setting is letters; in order to shift to figures case, you must send the figures-case character (11011). Then the figures case is selected until the letters-case character (11111) is sent again. By using these "shift-case" characters, the Baudot code makes 5 bits represent 56 characters (not counting the shift-case characters themselves, and counting only once the four characters that are the same in both cases).

TTY Data Rates

Because the M-1 coupler is interfaced to the Apple via the game I/O (input/output) port, software must handle the timing of all bits both transmitted and received. The transmission rate (bits per second) is obviously an important consideration. For TTY communications, the transmission rate is 60 words per minute or 6 characters per second, allowing 166 ms for transmitting one Baudot character. When each Baudot character is transmitted, 7 bits are sent. First comes a start bit, then the 5 data bits, and finally a stop bit. The time be-

FORTH

FOR/MAT™

SCREEN EDITOR

A MUST FOR THE SERIOUS FORTH PROGRAMMER

- All code is Forth-79 standard. Each line of code is fully explained and flow-charted (Forth style) for easy modification.
- This editor works just like the popular word processors on the market except it is written in high level forth and is confined to the 1024 byte boundary of a forth screen.
- There are over 20 different commands for cursor positioning, text modification, tabs, relocating lines, spreading lines, and moving lines to other screens.
- Insert mode is toggled on and off for midstream insertions and deletions. Text ahead of CP is moved right during insertion and left during deletion if insert mode is on.
- Column position is displayed at all times.
- Bomb proof—all unused control codes are trapped.
- Must be used with a CRT that has cursor addressing or with a memory mapped video.
- Send check or money order in the amount of \$50.00 and receive complete source code, flowcharts, documentation, and instructions for bringing up on your system.
- Versions for the Apple, Radio Shack, Commodore, Atari and other small systems will be available soon. For immediate notification of availability, please send name, address and description of system.

See full page ad in December issue (Page 61) of BYTE.

KV33 CORPORATION
 P.O. BOX 27246
 TUCSON, AZ 85726
(602) 889-5722



RAM

For ATARI

48K RAM BOARD FOR THE 400

- Increases memory capacity
- Reduces power consumption
- Reduces heat

48K Board (400) \$299

32K Board (800) \$150

INTEC PERIPHERALS CORP

3389 Del. Rosa Avenue
 San Bernardino, CA 92404

(714) 864-5269

ATARI, 400, 800 are Trademarks of ATARI, Inc.

Marymae INDUSTRIES, INC.

In Texas Orders
Questions & Answers
1-713-392-0747

21969 Katy Freeway
Katy (Houston) Texas 77450

To Order
1-800-231-3680
800-231-3681

SAVE BIG DOLLARS ON ALL TRS-80® HARDWARE & SOFTWARE

TRS-80® BY RADIO SHACK. Brand new in cartons delivered. Save state sales tax. Texas residents add only 5% sales tax. Open Mon.-Fri. 9-6, Sat. 9-5. We pay freight and insurance. Come by and see us. Call us for a reference in or near your city. Ref: Farmers State Bank, Brookshire, Texas.

WE OFFER ON REQUEST

- Federal Express (Overnight Delivery)
- Houston Intercontinental Airport Delivery (Same Day)
- U.P.S. BLUE (Every Day)
- References from people who have bought computers from us probably in your city

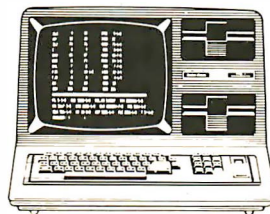

In stock TRS-80 Model II and III

No Tax on Out of Texas Shipments!

Save
10% 15%

OR MORE

We Specialize In Overseas Shipments

Telex 77-4132 (Fleks Hou)

WE ALWAYS OFFER

- NO extra charge for Master Card or Visa.
- We use Direct Freight Lines. No long waits.
- We always pay the freight and insurance
- Toll free order number
- Our capability to go to the giant TRS-80® Computer warehouse 5 hours away, in Ft. Worth, Texas, to keep you in stock.

JOE McMANUS

® TRS-80 is a Registered Trademark of Tandy Corp

ED McMANUS



MMSFORTH VERSION 2.0: MORE FOR YOUR RADIO SHACK TRS-80 MODEL I OR MODEL III !

- ★ **MORE SPEED**
10-20 times faster than Level II BASIC.
- ★ **MORE ROOM**
Very compact compiled code plus VIRTUAL MEMORY makes your RAM act larger. Variable number of block buffers, 31-char.-unique word-names use only 4 bytes in header!
- ★ **MORE INSTRUCTIONS**
Add YOUR commands to its 79-STANDARD-plus Instruction set!
Far more complete than most Forths: single & double precision, arrays, string-handling, clock, more.
- ★ **MORE EASE**
Excellent full-screen Editor, structured & modular programming
Word search utility
THE NOTEPAD letter writer
Optimized for your TRS-80 with keyboard repeats, upper/lower case display driver, full ASCII, single- & double-width graphics, etc.
- ★ **MORE POWER**
Forth operating system
Interpreter AND compiler
8080 Assembler
(280 Assembler also available)
Intermix 35- to 80-track disk drives
Model III System can read, write & run Model I diskettes!
VIRTUAL I/O for video and printer, disk and tape (10-Megabyte hard disk available)



THE PROFESSIONAL FORTH FOR TRS-80

(Over 2,000 systems in use)

MMSFORTH Disk System V2.0 (requires 1 disk drive & 16K RAM, 32K for Model III) \$129.95*

AND MMS GIVES IT PROFESSIONAL SUPPORT

Source code provided
MMSFORTH Newsletter
Many demo programs aboard
MMSFORTH User Groups
Inexpensive upgrades to latest version
Programming staff can provide advice, modifications and custom programs to fit YOUR needs.

MMSFORTH UTILITIES DISKETTE: includes FLOATING POINT MATH (L2 BASIC ROM routines plus Complex numbers, Rectangular-Polar coordinate conversions, Degrees mode, more), plus a full Forth-style 280 ASSEMBLER; plus a powerful CROSS-REFERENCER to list Forth words by block and line. All on one diskette (requires MMSFORTH V2.0, 1 drive & 32K RAM) \$39.95*

FORTHCOM: communications package provides RS-232 driver, dumb terminal mode, transfer of FORTH blocks, and host mode to operate a remote TRS-80 (requires MMSFORTH V2.0, 1 drive & 32K RAM) \$39.95*

THE DATAHANDLER V1.2: a very sophisticated database management system operable by non-programmers (requires MMSFORTH V2.0, 1 drive & 32K RAM) \$59.95*

MMSFORTH GAMES DISKETTE: real-time graphics & board games w/source code. Includes BREAKFORTH, CRASHFORTH, CRYPTOQUOTE, FREEWAY, OTHELLO & TICTACFORTH (requires MMSFORTH V2.0, 1 drive & 32K RAM) \$39.95*

Other MMSFORTH products under development

FORTH BOOKS AVAILABLE

MMSFORTH USERS MANUAL - without Appendices, for non-owners \$17.50*

STARTING FORTH - best companion to our manual \$15.95*

INVITATION TO FORTH - detailed beginner book on figFORTH \$17.50*

THREADED INTERPRETIVE LANGUAGES - advanced, excellent analysis of MMSFORTH-like language, \$18.95*

PROGRAM DESIGN & CONSTRUCTION - intro. to structured programming, good for Forth \$13.95*

FORTH '79 STANDARD MANUAL - official reference to 79-STANDARD word set, etc \$13.95*

FORTH SPECIAL ISSUE, BYTE Magazine (Aug. 1980) - we stock this collector's item for Forth users and beginners \$4.00*

* ORDERING INFORMATION: Software prices include manuals and require signing of a single-system, single-user license. SPECIFY for Model I or Model III. Add \$2.00/S/H plus \$3.00 per MMSFORTH and \$1.00 per additional book; Mass. orders add 5% tax. Foreign orders add 20%. UPS COD, VISA & M/C accepted; no unpaid purchase orders, please.

Send SASE for free MMSFORTH information.
Good dealers sought

Get MMSFORTH products from your
computer dealer or

**MILLER MICROCOMPUTER
SERVICES (B1)**

61 Lake Shore Road, Natick, MA 01760
(617) 653-6136

tween bits is constant except for the stop bit. The stop bit time is 1.5 times longer than the times for the other bits. If you choose a bit-delay of 22 ms, the total transmission time for the 7 bits is 165 ms (16 × 22 + 1 × 33). The difference of 1 ms from the ideal time corresponds to an error of about 0.6 percent, which is

acceptable. So the pattern of transmission is: first a start bit, then a 22-ms delay; next the 5 data bits, delaying 22 ms between each pair; finally, the stop bit and a delay of 33 ms.

The 22-ms and 33-ms delays are important for proper reception and transmission of Baudot code, but a

Bit Numbers	Letters Case	Figures Case
4 3 2 1 0		
0 0 0 0 0	rubout	rubout
0 0 0 0 1	E	3
0 0 0 1 0	line feed	line feed
0 0 0 1 1	A	-
0 0 1 0 0	space	space
0 0 1 0 1	S	,
0 0 1 1 0	I	8
0 0 1 1 1	U	7
0 1 0 0 0	carriage return	carriage return
0 1 0 0 1	D	\$
0 1 0 1 0	R	4
0 1 0 1 1	J	,
0 1 1 0 0	N	,
0 1 1 0 1	F	!
0 1 1 1 0	C	:
0 1 1 1 1	K	(
1 0 0 0 0	T	5
1 0 0 0 1	Z	"
1 0 0 1 0	L)
1 0 0 1 1	W	2
1 0 1 0 0	H	=
1 0 1 0 1	Y	6
1 0 1 1 0	P	0
1 0 1 1 1	Q	1
1 1 0 0 0	O	9
1 1 0 0 1	B	?
1 1 0 1 0	G	+
1 1 0 1 1	figures	figures
1 1 1 0 0	M	.
1 1 1 0 1	X	/
1 1 1 1 0	V	;
1 1 1 1 1	letters	letters

Table 1: The Baudot code for TTY communications. By using two cases—figures case and letters case—the Baudot code makes 5-bit numbers represent 56 unique characters. The shift-case characters, as well as rubout, line feed, space, and carriage return, are the same in the two cases.

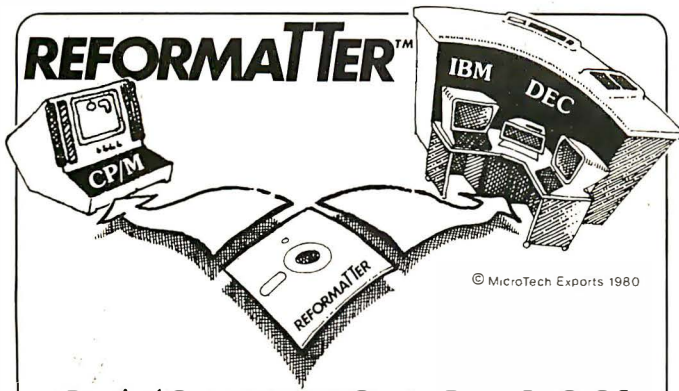

GETS FILES ACROSS!

With **REFORMATTER** disk utilities you can read and write IBM 3740 and DEC RT-11 single density formatted diskettes on your CP/M® system.

REFORMATTER enables you to access large system databases, improve data exchange with other organizations, increase program development capabilities, and use your micro in distributed processing.

REFORMATTER programs feature bi-directional data transfer and full directory manipulation. ASCII/EBCDIC conversion provided with CP/M ↔ IBM. *MP/M is now fully supported.*

Program Data Sheets, Application Guides, and Machine Compatibility Guides available.

Each program \$195.00 from stock. Specify CP/M ↔ IBM or CP/M ↔ DEC. Order from MicroTech Exports, Inc., 467 Hamilton Ave., Suite 2, Palo Alto, CA 94301 □ Tel: 415/324-9114 □ TWX: 910-370-7457 MUH-AITOS □ Dealer and OEM discounts available.

CP/M® is a registered trademark of Digital Research.

RETURNS ARE IN

CPA's Celebrate CPAids 1040 Federal Tax Software

Our Master Tax program for your microcomputer features a year-round fixed-asset program and a proforma tax organizer. Choice of 4 print routines, 12 different schedules and 17 forms.

CPAids

1640 Franklin Ave., Kent, OH 44240 (216) 678-9015

A Message to our Subscribers

From time to time we make the BYTE subscriber list available to other companies who wish to send our subscribers promotional material about their products. We take great care to screen these companies, choosing only those who are reputable, and whose products, services, or information we feel would be of interest to you. Direct mail is an efficient medium for presenting the latest personal computer goods and services to our subscribers.

Many BYTE subscribers appreciate this controlled use of our mailing list, and look forward to finding

information of interest to them in the mail. Used are our subscribers' names and addresses only (no other information we may have is ever given).

While we believe the distribution of this information is of benefit to our subscribers, we firmly respect the wishes of any subscriber who does not want to receive such promotional literature. Should you wish to restrict the use of your name, simply send your request to BYTE Publications Inc, Attn: Circulation Department, 70 Main St, Peterborough NH 03458. Thank you.

<h3>TANTALUM CAPACITORS</h3> <p>470F35V \$1.00 100F 35V \$1.40 60F 35V 51.00 220F 10V \$1.30 1uF 35V 51.00 300F 6V 51.00 2.2uF 20V 51.00 330F 20V \$1.60 3.3uF 20V 41.00 470F 20V \$1.85 4.7uF 35V 41.00 60uF 10V \$1.00 6.0uF 35V 31.00 120uF 6V \$1.75 200uF 20V 31.00</p> <p>14PIN HEADERS 31.00 16PIN HEADERS 40 24PIN HEADERS 75 40PIN HEADERS 1.10 50PIN EDGEBOARD CONN. 3.95 80PIN EDGEBOARD CONN. 2.50 50PIN RIGHT ANGLE CONN. 3.95 20PIN RIGHT ANGLE CONN. 2.25</p>	<h3>LINEAR CIRCUITS</h3> <p>LM201 - 75 LM348 - 90 709 - 25 LM310/748 - 30 LM358 - 50 710 - 45 741CV - 25 LM361 - 1.75 711C - 40 747 - 50 LM377 - 1.00 LM1838 - 1.75 1456 - 80 LM382 - 90 LM1839 - 1.35 1458 - 50 LM393 - 2.50 CAV58 - 1.75 LM386 - 80 LM388 - 80 CA3018 - 1.95 2000 - 45 LM397 - 1.25 CA3078 - 1.50 LM307 - 30 LM393 - 1.00 CA3080 - .95 LM308 - 75 LM555 - 2.25 CA3086 - .95 LM324 - 65 LM565 - 1.00 CA3094 - 2.25 LM338 - 65 LM568 - .85 CA3094 - 2.25 LF351 - 75 564B - .95 LM2001 - .95 LF353 - 1.25 565 - .95 8038CC - 3.90 LF355 - 1.25 566 - 1.40 NE536A - 1.50 LF366 - 1.35 567 - .85 TL064C P - .45 LM311 - 50 567 - .85 TL064CN - 1.50 LM318 - 1.00</p> <p>NEO - SPDT - 1.10 2060 - DPDT - 1.50 206P - DPDT - CENTER SWITCHES - OFF-5175</p>	<h3>CRYSTALS \$3.45 ea.</h3> <p>2,000 MHz 6,144 MHz 3,000 MHz 8,000 MHz 3.57 MHz 10,000 MHz 4,000 MHz 18,000 MHz 5,000 MHz 18,432 MHz 6,000 MHz 20,000 MHz</p> <h3>REGULATORS \$1.50</h3> <p>LM317T \$1.50 LM337 \$2.50 79HC05CV at 5A \$8.95 723 \$.50 320T 5, 12 or 15V \$.90 78M05 \$.35 78L05 \$.45 LM305G \$.75 340K 12, 15 or 24V \$1.50 340T 5, 6, 8, 9, 12, 15, 18 or 24V \$.85 LAS1412 - 12V3A \$3.95</p>
<h3>RS232 CONNEX</h3> <p>DB 25P male \$2.75 DB 25S female 3.75</p> <h3>HOODS 1.25</h3> <h3>C/MOS</h3> <p>4001 - 20 4077 - 35 4002 - 20 4082 - 20 4003 - 20 4083 - 60 4088 - 65 4089 - 1.75 4009 - 45 4901 - .95 4010 - 45 4910 - 1.25 4011 - 20 4511 - .65 4012 - 20 4514 - 1.40 4013 - 30 4515 - 1.50 4014 - 55 4518 - .75 4015 - 55 4918 - 1.25 4016 - 30 4520 - .70 4017 - 50 4621 - 2.75 4018 - 50 74C00 - 27 4019 - 45 74C02 - 27 4020 - 70 74C08 - 30 4021 - 55 74C10 - 27 4022 - 80 74C14 - 1.20 4023 - 20 74C20 - 27 4024 - 45 74C24 - 95 4025 - 75 74C23 - 75 4026 - 40 74C24 - 50 4028 - 25 74C83 - 1.30 4029 - 75 74C83 - 1.30 4030 - 75 74C83 - 1.30 4034 - 2.25 74C86 - 50 4035 - 75 74C90 - 90 4036 - 65 74C96 - 95 4037 - 55 74C151 - 1.75 4038 - 65 74C157 - 1.75 4039 - 55 74C160 - 1.70 4040 - 30 74C161 - 1.15 4041 - 30 74C161 - 1.15 4049 - 40 74C165 - 1.25 4050 - 40 74C171 - 1.20 4051 - 80 74C174 - 1.30 4052 - 75 74C175 - 1.20 4053 - 75 74C192 - 1.30 4066 - 50 74C901 - 50 4069 - 30 74C914 - 1.75 4071 - 25 74C926 - 5.50 4072 - 60 74C926 - 5.50 4076 - 65</p>	<h3>RAM's</h3> <p>2141-3 - 2.75 4116-2 - 3.50 2716 5v - 3.25 2102-4 - 80 2532 - 16.95 2102-4 - 80 2532 - 16.95 4118-4 - 4.95 82S23 - 1.95 MK6207-3 - 3.50 82S112 - 4.95 MK6208-11 - 1.95 1702A - 4.95 TMS4915-25 - 4.90 82S123 - 2.25 MS62050NL - 3.95 82S126 - 1.95 2101-1 - 2.45 82S129 - 1.95 MM5270 - 3.45 82S130 - 1.95 MK6208-11 - 1.95 82S131 - 2.25 IM7001 - 4.95 82S181 - 6.95 MS6205 - 3.95 3625A-3 - 6.95 2111AL - 2.45 AM9218C - 2.95 UART's R256-5174188A - 1.75 AY5-1013 - 3.75 COM2017 - 3.75 TR1620B - 3.25 AY3-8700 - 2.25</p> <h3>INTERFACE SHIFTS & DRIVERS REGISTERS</h3> <p>1771 - 19.95 1489 - 1.10 MM1402 - 1.75 8130 - 2.50 MM1403 - 1.75 8030 - 2.50 MM1404 - 1.75 8833 - 2.50 MM5013 - 2.50 8834 - 2.00 MM5016 - 2.50 8837 - 2.00 MM5055 - 2.50 8838 - 2.00 MM5056 - 2.50 81380 - 2.50 MM5057 - 2.50 MM5321 - 9.50 MM5058 - 2.50 MM53-9 - 2.50 MM5060 - 2.50</p>	<h3>74LS SERIES</h3> <p>74LS00 - 17 74LS93 - 39 74LS196 - 85 74LS01 - 18 74LS96 - 55 74LS197 - 85 74LS02 - 22 74LS109 - 38 74LS221 - 80 6.95 74LS112 - 38 74LS240 - 85 74LS04 - 22 74LS113 - 45 74LS241 - 89 74LS05 - 22 74LS114 - 55 74LS242 - 89 74LS08 - 20 74LS124 - 1.25 74LS244 - 1.50 74LS09 - 22 74LS123 - 58 74LS248 - 89 74LS10 - 22 74LS125 - 45 74LS248 - 89 74LS11 - 22 74LS126 - 45 74LS247 - 75 74LS12 - 22 74LS132 - 50 74LS248 - 1.10 74LS13 - 40 74LS136 - 45 74LS251 - 55 74LS15 - 35 74LS138 - 48 74LS252 - 55 74LS20 - 18 74LS139 - 48 74LS257 - 55 74LS21 - 18 74LS151 - 40 74LS258 - 55 74LS22 - 25 74LS153 - 1.15 74LS26 - 35 74LS156 - 70 74LS273 - 48 74LS27 - 28 74LS159 - 70 74LS280 - 1.80 74LS28 - 45 74LS157 - 48 74LS283 - 75 74LS30 - 18 74LS158 - 48 74LS290 - 72 74LS32 - 35 74LS161 - 58 74LS293 - 38 74LS34 - 35 74LS162 - 70 74LS296 - 52 74LS38 - 30 74LS163 - 58 74LS396 - 52 74LS40 - 40 74LS164 - 58 74LS397 - 52 74LS42 - 44 74LS168 - 1.25 74LS398 - 52 74LS43 - 65 74LS169 - 1.75 74LS399 - 1.28 74LS51 - 20 74LS170 - 1.50 74LS399 - 1.25 74LS54 - 20 74LS173 - 59 74LS399 - 1.25 74LS73 - 35 74LS174 - 45 74LS399 - 98 74LS74 - 35 74LS175 - 40 74LS399 - 98 74LS75 - 35 74LS181 - 1.95 74LS399 - 98 74LS76 - 45 74LS190 - 72 74LS570 - 1.60 74LS83 - 75 74LS191 - 72 81S98 - 1.10 74LS86 - 65 74LS192 - 65 81S98 - 1.10 74LS88 - 40 74LS193 - 60 74LS90 - 38 74LS194 - 1.10 74LS92 - 45 74LS195 - 90</p>
<p>POSTAGE RATES: ADD 10% FOR ORDERS UNDER \$20.00 ADD 5% FOR ORDERS BETWEEN \$20.00 AND \$50.00 ADD 3% FOR ORDERS ABOVE \$50.00</p> <p>TERMS: FOB CAMBRIDGE, MASS. SEND CHECK OR MONEY ORDER. MINIMUM TELEPHONE, C.O.D. PURCHASE ORDER OR CHARGE \$20.00 MINIMUM MAIL ORDER \$5.00.</p> <p>SEND \$25 FOR OUR CATALOG FEATURING TRANSISTORS & RECTIFIERS. 145 HAMPSHIRE ST., CAMBRIDGE, MASS. 02138</p>		
<h2>SOLID STATE SALES</h2> <p>P.O. BOX 74B SOMERVILLE, MASS. 02143</p> <p>TEL. (617) 547-7053 TOLL FREE 1-800-343-5230 FOR ORDERS ONLY</p>		

stock Apple lacks a precision interval-timer for timing these delays. You can code a software-delay loop to do the job, but you'll run into a few problems. Because the Apple does not use interrupts for any of its normal processing, it must do everything in a serial fashion. In other words, the Apple can be reading the keyboard or executing a delay loop or sending characters to the M-1 coupler, but it can't do more than one of those things at the same time. In this application, the Apple will usually be executing the delay loop, during which time the processor is doing nothing more than timing 22-ms or 33-ms intervals.

Remember that for every character sent, the Apple is in a delay loop totaling 165 ms. Because of the use of the figure and letter shift characters, however, any key pressed may actually result in the transmission of *two* characters, keeping the Apple busy in delay loops for as long as 330 ms. An average typist, who can easily type faster than the Apple can accept input, ends up having to con-

centrate more on the process of typing than on the message being typed.

Because most TTY devices are hard-copy terminals with line widths of 64 characters, the software has to send a carriage return/line feed combination after each group of 64 characters in order to prevent characters from being lost at the end of the line. As a result, the Apple stays busy sending the carriage return/line feed and can't read keyboard input in time. The software supplied by AMRAD did in fact lose characters; clearly something was required to remedy the situation.

A "Do Something" Delay Loop

With the processor spending a lot of time in the delay loop, why not make checking the keyboard for input an integral part of that loop? In other words, why not turn the "do nothing" delay loop into a "do something" delay loop? That's exactly what I did. I chose to use an 11-ms delay loop so that I could easily build 22-ms and 33-ms delays. I then constructed an 11-ms delay loop that

checks the keyboard for input and does nothing if input is not available. If input is available, it is read and stored (more about that later). This delay loop is the most important part of the communications software. No matter what happens, it must always execute in the same amount of time. The delay loop can follow one of two execution paths depending on whether or not keyboard input is available. As you can see in listing 1, both paths take 47 cycles of the Apple clock. The delay loop is executed 239 times for a total of 11,233 clock cycles. The Apple is running at 1.023 MHz so that each clock cycle is 0.9775 μ s. The total time of the delay loop is therefore $11,233 \times 0.9775 \mu$ s, or about 10.98 ms, which is within 0.2 percent of the desired 11 ms. But these figures don't take into account the time required to enter the subroutine and then return to the mainline code. The effect of these transitions is to lengthen the delay loop slightly and bring it even closer to the desired 11 ms.

The Input Ring Buffer

Now that you have a routine to read input data from the keyboard, you need a place to put the data. Because you may be reading ahead of the transmission routine, the character currently being read will not necessarily be the next character transmitted. My solution to this problem was to use a ring buffer for the storage of characters awaiting transmission. A ring buffer is conceptually an array in which the last element is followed by the first. That is, when you are reading characters from the buffer and come to the last item in the buffer, the next item to be selected is the item that is now first in the buffer. A ring has no actual start or end but uses position pointers to indicate the next character.

This application requires three position pointers. The first, FILL, indicates the next empty position in the ring buffer. The pointer EMTY indicates the next character to be displayed on the Apple screen. Finally, TOUT points to the next character to be sent to the M-1 coupler. When TOUT or EMTY is equal to FILL, you



EMPLOYMENT OPPORTUNITIES

DP OPPORTUNITIES

Martin Marietta Aerospace, NASA's designated Contractor for the Space Shuttle External Tank Program has the following immediate opportunities at their Michoud Assembly Facility in suburban East New Orleans:

Business Applications Programmers/ Project Lead Experienced In:

- Engineering
- Manufacturing
- Shop Floor Control
- Scheduling
- Inventory
- Purchasing

**UNIVAC DMS 1100 Data Base Or Other CODASYL Data Base
Experience Utilizing The Data Manipulation Language With
COBOL Knowledge Of:**

- DDL
- SDDL
- TIP/CMS
- DPS 1100
- DDS 1100

Specialist

- Network Controllers
- Operations Research

All interested and qualified candidates are urged to send their resume, complete with salary history and background to: Martin Marietta Aerospace, Dept. B, P.O. Box 29304, New Orleans, Louisiana 70189, Attn: Personnel Department. We are an equal opportunity employer, m/f/h.

MARTIN MARIETTA

know all available characters have been sent or displayed. I didn't worry about buffer overflow because I had allocated a 256-character ring buffer and I can't type much faster than the 60-word-a-minute rate used by Baudot. Under normal circumstances, I have only one or two characters in the ring buffer at one time.

The ring buffer is easy to implement in assembly language because of a handy property of integer addition. The largest number that can be represented by 8 bits is 255. When 1 is added to 255, the result is zero, with the carry bit set; that is exactly what is required for a ring buffer. Using an 8-bit pointer as an index into a 256-byte buffer, start the index at 0 and continue to 255. Then, when 1 is added to 255, ignore the carry and use the result of zero as the index into the buffer for the next element—a painless method of implementing a ring buffer. If you needed ring buffers of other sizes, you would need additional software to check the index pointer for values greater than the size of the buffer. If the index exceeded the end of the buffer, you would have to force the index's value to zero and continue.

Program Initialization

The program begins by clearing the Apple screen, displaying a blinking cursor, and then initializing some of the variables used in the program. Then the program enters its main loop, which checks for keyboard input, displays a character from the input ring buffer, sends a character to the coupler, displays a character from the input ring buffer, checks for incoming data, and again displays a character from the input ring buffer.

Here I should mention the repeated calls to the display routine. As stated previously, the delay loop checks for keyboard input and reads in any it finds. The data is stored in the input ring buffer and is not displayed when read. A call to the display routine is necessary in order to "echo" the typed characters to the screen. I had to use this method because I was using the display routine in the Apple monitor and could not be certain of the time required to display one character.

PFAS

The portable ISAM for the UCSD p-System™, Pascal MT +™, and the HP-1000 Pascal

PFAS is the professional, easy to use program development tool with advanced features such as:

- Variable length records
- Alternate and partial key access
- Unlimited number of records in a file.
- A B + tree index.

PFAS is a set of modules which link to your PASCAL program making powerful ISAM functions part of Pascal.

Programs using PFAS are not limited to a single machine or operating system. Since PFAS is written in Pascal it is truly machine independent, from Apple to Zenith, from HP-125 to HP-1000. Only PFAS is this portable.

Now available for the p-System is PHOSFORM, our formatted screen input system. PHOSFORM allows you to quickly create and customize fill-in-the-form type input for your programs. PHOSFORM configures itself to run on any terminal making your software portable.

When you use PFAS and PHOSFORM to input, organize, and maintain your data, your time can be more effectively spent dealing with the creative facets of your software.

- * PFAS with Manual from \$200
- * PHOSFORM with Manual (Introductory Price) . . . \$ 95
- * Manual only \$ 15

C.J. Wigglesworth Software / Gryphon Systems

P.O. Box 755, Cardiff-by-the-Sea, CA 92007 (714) 436-1455

• UCSD Pascal and p-System are trademarks of the Regents of the University of California.
 • Pascal MT+ is a trademark of MT MicroSYSTEMS.

UNLIMITED.

Exploration of the arts through computer technology.

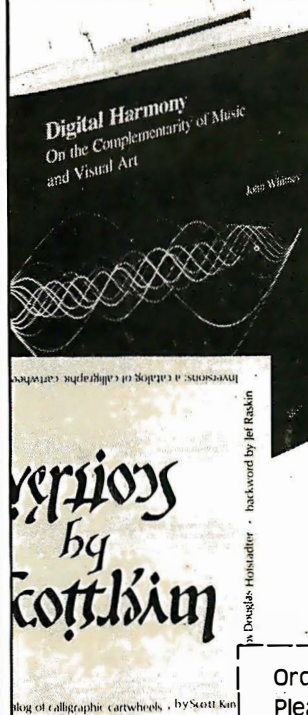

DIGITAL HARMONY by John Whitney

Lays the foundation for the whole new field of audio-visual art made possible by microcomputers. Whitney, a pioneer of the special effects technology used in STAR WARS and 2001: A SPACE ODYSSEY, explains the special union of computer graphics and music. Illustrations and descriptions of Whitney's computer, peripherals, and film techniques.
 ISBN 07-070015-X, 240 pp., hardcover \$21.95

INVERSIONS: A Catalogue of Calligraphic Cartwheels by Scott Kim

Filled with intriguing designs, words that read the same right-side up and upside down, words within words, and unexpected symmetries, these compositions create a fresh way to look at the alphabet. Invertible writing appeals to everyone who loves beauty in mathematics and design.
 ISBN 0-07-034546-5, 128 pp., softcover \$8.95

Order by mail or phone. Call toll free 800-258-5420.

Please send: _____ **DIGITAL HARMONY \$21.95**
 _____ **INVERSIONS \$8.95**

Add 75c per book to cover postage and handling.

Check enclosed in the amount of \$ _____
 VISA MasterCard

Card # _____ Expires _____

Name _____

Street _____

City _____ State _____ Zip _____

BYTE BOOKS

70 Main St.
 Peterborough, NH
 03458

The execution time of the monitor's display routine varies, depending on which character is being displayed and whether a screen scroll is required. Because I needed a delay loop that was constant and precise, I couldn't use the monitor's character-display routine.

Five Program Sections

I will now briefly describe the five major sections of the communications program shown in listing 1: the keyboard-read routine; the character-display routine; the Baudot-send routine; the serial-output routine; and the serial-input routine. I will then describe the program's memory use.

The keyboard-read routine is a straightforward routine that first checks for input and, if any is available, reads it in. Next this routine checks the case of the character and converts any lowercase characters to uppercase. Finally, the keyboard-read routine stores the character in the ring buffer. Just before this final step, you can check for buffer over-

flow. Note that the character is simply read here, not displayed.

The character-display routine displays characters stored in the ring buffer. For most characters, this means simply reading the character from the ring buffer, displaying it, and then displaying the screen cursor. When a character is displayed, it overwrites the blinking cursor. The blinking cursor must be displayed again and backed over, so that the next character displayed will also overwrite the cursor. When you backspace over the cursor, you change only a pointer, leaving the cursor displayed and blinking.

The characters "carriage return" and "line feed" require special handling. When either of these characters is detected, the character-display routine first clears the screen from the current cursor position to the end of the line. This action erases the cursor and clears off any garbage that may have been displayed on the line. Then the routine displays the character and the cursor.

The "rubout" or "back space" character is also handled in a special fashion. When the "rubout" (or "left arrow" on the Apple) is detected, the routine displays a space to erase the cursor, then backspaces two characters, displays the cursor again, and backspaces over it. This effectively erases the previously typed character by moving the cursor back one character position.

The Baudot-send routine is responsible for sending characters out to the M-1 coupler. As mentioned before, this routine also keeps track of the number of characters on one line. When 64 characters have been sent, a carriage return/line feed combination must follow. The problem with this rule is that, on the receiving end, it may break a word at the end of a line. To solve that problem, the send routine begins looking for a space character after 51 characters have been sent. If a space is found, the carriage return/line feed is inserted, and the next word appears on the following line. If no spaces are encountered before the 65th character, a carriage return/line feed is inserted after the 64th character typed, and a word is broken. This code makes the output easier to read.

Before the characters are sent to the M-1 coupler, they have to be converted from ASCII to Baudot. The conversion is performed by isolating the 7 low-order ASCII bits and subtracting hexadecimal 20. The result is then used as an index into the conversion table, and the equivalent Baudot character is "looked up." Before the character is sent, the routine determines whether the character is of the current shift case, or whether a new character indicating one of three possible shift cases must be sent first. In addition to the letters and figures shifts, certain bit patterns mean the same thing in either shift case. These characters (the "space" character is one example) require no shift change and may be sent in the current shift case. Because Baudot characters use only 5 bits, the 3 remaining bits (out of 8) in the lookup table are used to code the shift case. When the character itself is sent, it consists only of the low-order 5 bits.

CompuServe: Update 1982

The CompuServe Information Service is the largest and fastest growing videotex system in North America. Our customer base increased a dramatic 300% in 1981. And there's a reason:

- our broad base means more communications between users
- a wide variety of high-value data bases
- games to excite any aficionado
- up-to-date financial information to give you a competitive edge on the market
- new services like electronic shopping
- free subscription to our informative TODAY magazine
- easy-to-follow instructions for the novice and powerful services for the experienced user

Ask for a demonstration at a Radio Shack® Computer Center. Videotex software is available for various brands of personal computers. CompuServe Information Service, 5000 Arlington Centre Blvd., Columbus, Ohio 43220. (614) 457-8600.

CompuServe

The lookup table is constructed so that entries with the seventh bit set require no change in mode or shift case. Entries with the sixth bit set are figures-shift characters, and entries with the sixth bit reset are letters-shift characters. The current shift case is always stored in a temporary location; before a character is sent, its case is compared with the current shift case. If the two cases differ, the appropriate shift case is sent before the character. When the current case is the same as the case of the character to be sent, no case change is required, and the character is dispatched immediately. The Baudot character is sent in a serial fashion to the M-1 coupler, and then to the TTY device on the other end of the line.

The serial-output routine transmits the 5-bit Baudot character to the coupler. First the routine sends the start bit, followed by a 22-ms delay. The 5 data bits are sent next with a 22-ms delay between each pair. Finally, the serial-output routine sends the stop bit, following it with a 33-ms delay.

The serial-input routine handles character input from the M-1 coupler. First the routine brings in a start bit, followed by 5 data bits and a stop bit. The bits are read in a serial fashion into a memory location that retains only the 5 data bits. Next, the routine checks to see if the character read was either a letters or a figures character.

If so, the shift case is stored in a memory location. If the character is not a shift character, the value of the current shift case is added to the character that was read, and this value becomes the index into the Baudot-to-ASCII lookup table. The appropriate character is retrieved from the lookup table and displayed immediately. The character is not placed in the ring buffer, which is reserved for outgoing characters.

Memory Usage

The TTY program uses page zero locations 0 through 9 hexadecimal for internal housekeeping. Memory locations 800 through 8FF hexadecimal are reserved for the input ring buffer. The program itself is located from hexadecimal 900 to B5E and may be relocated to another memory location by reassembly. I relocated my routine to the D800 address space and burned the routine into a PROM so that I could turn on my Apple and begin execution of the TTY program without loading it from disk or cassette.

I chose the Apple as my home computer because it can wear many hats. I am glad to have played a part in adding another hat to the Apple wardrobe. With the addition of the M-1 coupler and a little bit of software, the Apple makes an excellent communication device for the deaf, the hearing-impaired, and their friends. ■ *Listing 1 is on pages 377-386*

Telephone Communications Products for the Deaf and Hearing-Impaired

Phone-TTY Inc of Fair Lawn, New Jersey, offers five products to help the deaf and hearing-impaired with telephone communication. The M-1 acoustic-coupler modem described in the accompanying article costs \$164.50. Another acoustic-coupler modem, the M-1W, is priced at \$174.50 and will send signals through home power lines to a Phone-TTY remote-control receiver (\$27.50) plugged into any outlet. A light connected to the receiver will flash when the telephone is ringing. The M-2W direct-connect modem costs \$182.50; like the M-1W, the M-2W will send signals to an electrical outlet to trigger an indicator light when the telephone

rings. The AM modem is an auto-memory device that can answer the telephone and transmit to the caller a previously programmed message up to 2 K bytes in length. The AM can also convert a KSR (Keyboard Send Receive) teletypewriter to an ASR (Automatic Send Receive) teletypewriter. An ASR teletypewriter normally reads paper tape and sends the data read; the Phone-TTY AM coupler enables a KSR teletypewriter to send data stored in the AM's 2-K-byte buffer. The AM is priced at \$545. Phone-TTY Inc is located at 14-25 Plaza Rd., Fair Lawn, NJ 07410, telephone (201) 796-5414 (voice or TTY).

LEO ELECTRONICS, INC.



8921 S. Sepulveda, Ste #208
Los Angeles, Calif. 90045
(213) 641-3101
(800) 421-2418

**BEGIN YOUR 82 —
LET LEO
WORK FOR YOU**

MEMORY

1702A	1-49
2708	4.25
TMS2716	2.75
2716 (5V)	6.00
2716-1 (350NS)	5.50
2532	6.50
2732 (450NS)	14.00
2732A-4 (390NS)	14.00
2732A-3 (300NS)	14.50
2732A (250NS)	15.00
2732A-2 (200NS)	16.00
2758	17.00
2764	7.00
2114 (450NS)	40.00
2114 (300NS)	2.20
2114 (200NS)	2.55
TMS4027-30	2.60
TMS4060-2	1.65
4116 (200NS)	2.10
4116 (150NS)	1.85
4164 (200NS)	2.25
5203Q	19.35
6800	12.00
6802	6.00
6810	10.00
6821	3.50
6850	3.50
8080A	4.40
8085A	2.30
8212	8.25
8214	1.60
8216	3.50
8224	1.70
8748	2.50
Z80 CPU	28.00
Z80A CPU	6.00
	7.00

LS PRODUCT

L800	.25	L845	.50	L8157	.75	L8244	.95
L802	.25	L846	.40	L8158	.78	L8245	1.00
L804	.25	L890	.40	L8161	.75	L8259	1.00
L806	.25	L893	.50	L8162	.85	L8273	1.00
L810	.25	L895	.70	L8163	.75	L8279	.80
L812	.25	L8107	.38	L8164	.75	L8283	.85
L814	.30	L8109	.45	L8165	.75	L8387	.85
L820	.25	L8112	.38	L8166	1.50	L8368	.85
L822	.25	L8113	.38	L8173	.80	L8373	1.00
L832	.30	L8123	.75	L8174	.80	L8374	1.00
L833	.35	L8126	.80	L8175	.80	L8377	1.00
L837	.55	L8132	.74	L8191	.80	L8390	1.25
L838	.35	L8138	.65	L8193	.80	L8393	1.25
L842	.75	L8139	.85	L8195	.80	L8395	1.25
L851	.30	L8151	.75	L8221	1.00	L8668	1.25
L854	.30	L8153	.75	L8240	.95	L8669	1.25
L873	.40	L8155	.85	L8241	.95	L8670	1.25
L874	.30						

S PRODUCT

S188	2.75	7805	.85
S189	2.75	7812	.85
S287	2.75	7815	.85
S288	2.25	7905	.95
S387	2.75	7912	.95
S471	7.00	7915	.95
S472	7.00	309K	1.45
		323K	2.50
MISC		555	.35
6T26	1.50	TLO-72	1.25
8T97	.85	TLO-84	1.55
6T96	.85		
1468	.60		
1468	.60		

I.C. SOCKETS

8	.12	8	.52
14	.14	14	.54
16	.16	16	.58
18	.19	18	.80
20	.27	20	.82
22	.28	22	.88
24	.28	24	.88
28	.37	28	1.40
40	.45	40	1.60

RESISTORS
1/4 Watt 5%
100ea - Anyone value .02/ea

WE CAN ALSO SUPPLY THE HARD TO FIND SEMICONDUCTOR

TTL - CMOS
CONNECTORS
CAPACITORS
DIP SWITCHES
DIODES
TRANSISTORS

TERMS: Check, Money Order, Visa, Master Card. Call for C.O.D. U.S. Funds only. P.O.'s accepted from qualified firms and institutions. California residents add 6% sales tax or resale card.
SHIPPING: Add \$2.00 ground or \$5.00 air for UPS.

CALL FOR VOLUME PRICING

PRICING SUBJECT TO CHANGE WITHOUT NOTICE.
ALL PARTS 100% GUARANTEED. MINIMUM ORDER \$15.00

Listing 1: An assembly-language program that enables the Apple to function as a TTY device for telephone communications with the deaf and the hearing-impaired. The program has five major sections: the keyboard-read routine, the character-display routine, the Baudot-send routine, the serial-output routine, and the serial-input routine. The main program loop starts at line 091D.

: ASM

```

1000 *
1010 *
1020 *   COMMUNICATIONS PACKAGE TO ALLOW THE APPLE TO FUNCTION
1030 *   AS A TTY DEVICE FOR USE BY THE DEAF AND HEARING
1040 *   IMPAIRED. THE APPLE IS INTERFACED TO AN M1 COUPLER
1050 *   MANUFACTURED BY PHONE-TTY OF NEW JERSEY.
1060 *   THE HARDWARE WAS DESIGNED BY ELTON A SANDERS, MEMBER
1070 *   OF AMRAD IN VIENNA, VIRGINIA, AND USES PUSHBUTTON 1
1080 *   AND ANNUNCIATOR 1 OF THE APPLE GAME I/O CONNECTOR.
1090 *   THIS SOFTWARE ROUTINE IS BASED LOOSELY ON ONE
1100 *   DEVELOPED BY NANCY SANDERS, ALSO A MEMBER OF AMRAD.
1110 *   I HAVE ADDED SOME SPECIAL FEATURES SUCH AS A HIGH
1120 *   SPEED RING BUFFER THAT ALLOWS THE OPERATOR TO TYPE
1130 *   CHARACTERS FASTER THAN THE INTERFACE CAN SEND THEM.
1140 *
1150 *   WRITTEN BY NED W. RHODES
1160 *   DECEMBER 1980
1170 *
1180 *
1190 *   MEMORY USAGE
1200 *
1210 *   BASE PAGE : 0 - 9 -- HOUSEKEEPING VARIABLES
1220 *   $800-$8FF : RING BUFFER FOR INPUT
1230 *   $900-$B5E : PROGRAM ITSELF (IT IS RELOCATABLE)
1240 *
1250 *
1260 *   VARIABLE DEFINITIONS
1270 *
1280 *
FBE2- 1290 BELL .EQ $FBE2   MONITOR BELL ROUTINE.
0044- 1300 BSPC .EQ $44    BAUDOT SPACE +NO MODE CHANGE
0032- 1310 MAXC .EQ 50    START WITH 50 CHARACTERS PER LINE
C058- 1320 STRB .EQ $C058 SEND SPACE
C059- 1330 MRK .EQ $C059  SEND MARK
0040- 1340 RUBO .EQ $40    RUBOUT CHARACTER + NO MODE CHANGE
0042- 1350 LINF .EQ $42    LINE FEED IN BAUDOT + NOMO
0048- 1360 CRC .EQ $48    CARRIAGE RETURN IN BAUDOT
C000- 1370 KEYB .EQ $C000  KEYBOARD
C010- 1380 STRB .EQ $C010  KEYBOARD STROBE
FDF0- 1390 DISP .EQ $FDF0  MONITOR OUTPUT
0000- 1400 NULL .EQ $00    NULL CHARACTER
FC58- 1410 HOME .EQ $FC58 HOME SCREEN
0024- 1420 CHAR .EQ $24    MONITOR CHARACTER COUNT
0025- 1430 CV .EQ $25     MONITOR VERTICAL COUNTER
FC9C- 1440 CEOL .EQ $FC9C CLEAR TO EOL
FC10- 1450 BS .EQ $FC10   MONITOR BACKSPACE
0020- 1460 FIG .EQ $20    INDICATE FIGURES SHIFT
0080- 1470 ILLG .EQ $80    ILLEGAL BAUDOT CHARACTER
0040- 1480 NOMO .EQ $40    NO MODE CHANGE REQUIRED
0800- 1490 RING .EQ $800   RING BUFFER IS ON PAGE EIGHT
0000- 1500 SHIFT .EQ $00   SHIFT STATUS
0001- 1510 EMTY .EQ $01    DISPLAY POSITION IN RING BUFFER
0002- 1520 TOUT .EQ $02    TTY OUT POSITION IN RING BUFFER
0000- 1530 LET .EQ $00     LETTERS SHIFT
001B- 1540 FIGS .EQ $1B    FIGURES SHIFT
0003- 1550 CNT .EQ $03     BIT COUNTER
0004- 1560 FILL .EQ $04    RING BUFFER FILL POSITION
0005- 1570 HOLD .EQ $05    CHARACTER HOLD AREA
0006- 1580 CNUM .EQ $06    CHARACTER PER LINE COUNTER
0007- 1590 RSFT .EQ $07    RECEIVE SHIFT LOCATION
FFF2- 1600 REM .EQ MAXC-64 - NUMBER OF CHARACTERS BEFORE 64
C062- 1610 TINP .EQ $C062 TTY BIT INPUT
001F- 1620 LSHF .EQ $1F    LETTERS SHIFT
000B- 1630 CHR .EQ $0B    RECEIVED ASSEMBLED CHARACTER

```

Listing 1 continued:

```

0009-      1640 VALUE .EQ $09      BIT VALUE OF RECEIVED CHARACTER
008A-      1650 LF .EQ $8A        LINE FEED
008D-      1660 CR .EQ $8D        CARRIAGE RETURN
0088-      1670 ROUT .EQ $88      RUBOUT
0060-      1680 CURS .EQ $60      CURSOR
00A0-      1690 SPAC .EQ $A0      SPACE
          1700 .OR $900          ORG IT HERE, ABOVE THE RING BUFFER
          1710 *
          1720 *
          1730 *      INITIALIZATION -- CLEAR SCREEN AND LOAD VARIABLES
          1740 *
          1750 *
0900- 20 58 FC 1760 VINT JSR HOME      CLEAR SCREEN
0903-  A9 60      1770      LDA #CURS      GET CURSOR CHARACTER
0905-  85 00      1780      STA SHIFT      SET SHIFT UP TO FORCE A MODE TRANSMIT
0907-  20 F0 FD 1790      JSR DISP      DISPLAY IT
090A-  C6 24      1800      DEC CHAR      BACK UP OVER CURSOR
090C-  A9 00      1810      LDA #0        GET A ZERO
090E-  85 04      1820      STA FILL      STARTING POSITION
0910-  85 01      1830      STA EMTY      STARTING POSITION
0912-  85 02      1840      STA TOUT      STARTING POSITION
0914-  8D 59 CO 1850      STA MRK      SET COUPLER TO IDLE MODE
0917-  85 07      1860      STA RSFT      DEFAULT RECIEVER SHIFT TO LETTERS
0919-  A9 32      1870      LDA #MAXC      GET CHARACTER COUNT
091B-  85 06      1880      STA CNUM      SAVE AWAY
          1890 *
          1900 *
          1910 *      MAIN PROGRAM LOOP
          1920 *
          1930 *
091D-  20 32 09 1940 LOOP JSR KEYS      READ THE KEYBOARD IF CHARACTER IS PRESENT
0920-  20 51 09 1950      JSR SHOW      DISPLAY CHARACTER FROM RING BUFFER
0923-  20 88 09 1960      JSR SEND      SEND A CHARACTER IF PRESENT
0926-  20 51 09 1970      JSR SHOW      DISPLAY CHARACTER FROM RING BUFFER
0929-  20 3C 0A 1980      JSR INPT      RECEIVE A CHARACTER IF PRESENT
092C-  20 51 09 1990      JSR SHOW      DISPLAY CHARACTER FROM RING BUFFER
092F-  4C 1D 09 2000      JMP LOOP      TRY AGAIN
          2010 *
          2020 *
          2030 *      KEYBOARD ENTRY
          2040 *
          2050 *
0932-  2C 00 CO 2060 KEYS BIT KEYB      CHECK THE KEYBOARD
0935-  10 19      2070      BPL KRTS      NO CHARACTER
0937-  AD 00 CO 2080      LDA KEYB      GET CHARACTER
093A-  2C 10 CO 2090      BIT STRB      RESET STROBE
093D-  AA          2100      TAX          SAVE A COPY
          2110 *
          2120 *
          2130 *      CHECK HERE FOR LOWER CASE LETTERS
          2140 *      CONVERT TO UPPER CASE IF FOUND
          2150 *
          2160 *
093E-  29 60      2170      AND #$60      MASK OUT LOWER CASE
0940-  C9 60      2180      CMP #$60      IS IT LOWER CASE
0942-  D0 04      2190      BNE CAP      NO--CAPITAL
0944-  8A          2200      TXA          GET CHARACTER
0945-  29 DF      2210      AND #$DF      MAKE UPPER CASE
0947-  AA          2220      TAX          SAVE CHARACTER AGAIN
0948-  8A          2230 CAP TXA          GET CHARACTER
0949-  A6 04      2240      LDX FILL      GET POSITION IN BUFFER
094B-  9D 00 08 2250      STA RING,X  SAVE IT
094E-  E6 04      2260      INC FILL      BUMP POINTER
0950-  60          2270 KRTS RTS      RETURN
          2280 *
          2290 *
          2300 *      SHOW ROUTINE -- DISPLAY A CHARACTER IN
          2310 *      THE RING BUFFER IF THERE IS ONE AVAILABLE
          2320 *
          2330 *

```

Listing 1 continued on page 380

Listing 1 continued:

```

0951- A6 01      2340 SHOW LDX EMTY      GET POINTER
0953- E4 04      2350      CFX FILL      HAVE WE CAUGHT UP??
0955- F0 30      2360      BEQ SRTS      YES--EXIT
0957- BD 00 0B   2370      LDA RING,X    GET CHARACTER
095A- E6 01      2380      INC EMTY      BUMP POINTER
095C- 4B         2390 SHW2 PHA      SAVE CHARACTER
                2400 *
                2410 *
                2420 *      HANDLE LINE FEED AND CARRIAGE RETURN IN A SPECIAL WAY
                2430 *
                2440 *
095D- C9 8A      2450      CMP #LF        IS IT A LINE FEED??
095F- D0 05      2460      BNE NOLF      NOPE
0961- 20 9C FC   2470      JSR CEOL      CLEAR TO END OF LINE
0964- B0 15      2480      BCS NBS      CONTINUE ONWARD
0966- C9 8D      2490 NOLF CMP #CR      IS IT A CARRIAGE RETURN??
0968- D0 05      2500      BNE CRN      NOPE
096A- 20 9C FC   2510      JSR CEOL      CLEAR TO END OF LINE
096D- B0 0C      2520      BCS NBS      CONTINUE ON
                2530
                2540 *
                2550 *
                2560 *      RUBOUT OR BACKSPACE IS SPECIAL CASE
                2570 *
                2580 *
096F- C9 8B      2590 CRN  CMP #ROUT     IS IT A BACKSPACE
0971- D0 0B      2600      BNE NBS      NOPE
0973- A9 A0      2610      LDA #SPAC    GET A SPACE
0975- 20 F0 FD   2620      JSR DISP     ERASE CURSOR
0978- 20 10 FC   2630      JSR BS       BACK SPACE ONE
097B- 6B         2640 NBS  FLA       GET CHARACTER
097C- 20 F0 FD   2650      JSR DISP     DISPLAY CHARACTER
097F- A9 60      2660      LDA #CURS    GET CURSOR
0981- 20 F0 FD   2670      JSR DISP     SHOW IT
0984- 20 10 FC   2680      JSR BS       BACK UP OVER IT
0987- 60         2690 SRTS RTS      RETURN
                2700 *
                2710 *
                2720 *      SEND ROUTINE -- SEND CHARACTER TO MODEM
                2730 *
                2740 *
0988- A6 02      2750 SEND LDX TOUT    GET POINTER
098A- E4 04      2760      CFX FILL      HAVE WE CAUGHT UP??
098C- F0 3B      2770      BEQ NSND     YES--EXIT
098E- BD 00 0B   2780      LDA RING,X    GET CHARACTER
0991- E6 02      2790      INC TOUT     INCREMENT POINTER
                2800 *
                2810 *
                2820 *      CHECK FOR SPECIAL CHARACTERS
                2830 *
                2840 *      LINE FEED DOESN'T BUMP CNUM
                2850 *      CARRIAGE RETURN RESETS CNUM
                2860 *      RUB OUT BUMPS CNUM DUE TO USE WITH HARDCOPY TERMINALS
                2870 *
                2880 *
0993- C9 8A      2890      CMP #LF        IS IT A LINE FEED
0995- D0 06      2900      BNE NLF      NOPE
0997- A9 42      2910      LDA #LINF     GET LINE FEED IN BAUDOT
0999- 20 0A 0A   2920      JSR TTYO     SEND IT
099C- 60         2930      RTS         RETURN
099D- C9 8D      2940 NLF  CMP #CR      IS IT A CARRIAGE RETURN??
099F- D0 0F      2950      BNE NCR      NOPE
09A1- A9 4B      2960      LDA #CRC      GET A CARRIAGE RETURN IN BAUDOT
09A3- 20 0A 0A   2970      JSR TTYO     SEND IT
09A6- A9 42      2980      LDA #LINF     GET A LINE FEED ALSO
09A8- 20 0A 0A   2990      JSR TTYO     SEND IT
09AB- A9 32      3000      LDA #MAXC     CHARACTERS PER LINE
09AD- B5 06      3010      STA CNUM     RESET IT
09AF- 60         3020      RTS         RETURN
09B0- C9 8B      3030 NCR  CMP #ROUT     HOW ABOUT A RUBOUT??

```

Listing 1 continued:

```

09B2- D0 06      3040      BNE NROU      NOPE
09B4- A9 40      3050      LDA #RUBO     GET A RUBOUT
09B6- 20 C7 09   3060      JSR COLUT     DO A RUBOUT
09B9- 60          3070      RTS           RETURN
09BA- 29 7F      3080 NROU AND ##7F     GET ONLY 7 BITS
09BC- 38          3090      SEC           SET CARRY
09BD- E9 20      3100      SBC ##20     BIAS FOR LOOKUP TABLE
09BF- AA          3110      TAX           SEND TO X
09C0- BD E3 0A   3120      LDA BAUD,X   GET BAUDOT CHARACTER
09C3- 20 C7 09   3130      JSR COUT     SHIP IT OUT
09C6- 60          3140 NSND RTS           RETURN
          3150 *
          3160 *
          3170 *      TTY OUTPUT ROUTINE
          3180 *
          3190 *      RING THE BELL IF AN ILLEGAL CHARACTER
          3200 *
          3210 *
09C7- C9 80      3220 COUT CMP #ILLG     IS CHARACTER LEGAL BAUDOT??
09C9- 90 04      3230      BCC CON      YES -- CONTINUE
09CB- 20 E2 FB   3240      JSR BELL     RING - RING
09CE- 60          3250      RTS           RETURN
09CF- C9 40      3260 CON CMP #NOMO     CHECK MODE
09D1- B0 14      3270      BCS OUT     NO CHANGE
09D3- 48          3280      PHA         SAVE CHARACTER
09D4- 29 20      3290      AND #FIG     LOOK AT MODE BIT
09D6- C5 00      3300      CMP SHIFT    COMPARE WITH CURRENT MODE
09D8- F0 0C      3310      BEQ NCHN    NO CHANGE
09DA- 85 00      3320      STA SHIFT    CHANGE MODE FLAG
09DC- 49 20      3330      EOR #FIG     COMPLEMENT BIT
09DE- 4A          3340      LSR         MOVE BIT TO
09DF- 4A          3350      LSR         CORRECT
09E0- 4A          3360      LSR         POSITION
09E1- 09 1B      3370      ORA #FIGS    CONVERT TO MODE CHARACTER
09E3- 20 0A 0A   3380      JSR TTYO     SEND PROPER MODE
09E6- 68          3390 NCHN PLA         GET CHARACTER
09E7- 48          3400 OUT  PHA         SAVE CHARACTER
09E8- 20 0A 0A   3410      JSR TTYO     REALLY SEND CHARACTER
09EB- 68          3420      PLA         GET CHARACTER
09EC- C6 06      3430      DEC CNUM     HAVE WE PRINTED MAXC+1 CHARACTERS??
09EE- 10 19      3440      BPL CRTS    NO, WE'RE OK
          3450 *
          3460 *
          3470 *      NOW WE TRY SOME INTELLIGENCE. IF WE HAVE SENT
          3480 *      > MAXC+1 CHARACTERS. WE BEGIN TO LOOK FOR A BAUDOT
          3490 *      SPACE SO THAT WE CAN BREAK WORDS AT A SPACE INSTEAD
          3500 *      OF RIGHT IN THE MIDDLE.
          3510 *
          3520 *
09F0- C9 44      3530      CMP #BSPC    IS IT A BAUDOT SPACE??
09F2- D0 0F      3540      BNE TEST    NO, CHECK FOR > 64 CHARACTERS ANYWAY
09F4- A9 42      3550 MAXL LDA #LINF    GET LINE FEED
09F6- 20 0A 0A   3560      JSR TTYO     SEND IT
09F9- A9 48      3570      LDA #CRC     GET CARRIAGE RETURN
09FB- 20 0A 0A   3580      JSR TTYO     SEND IT
09FE- A9 32      3590      LDA #MAXC    GET CHARACTER COUNT
0A00- 85 06      3600      STA CNUM     SAVE IT
0A02- 60          3610      RTS           RETURN
0A03- A9 F2      3620 TEST LDA #REM    COUNT OF 64 CHARACTERS WHEN ALL IS SAID A
ND DONE
0A05- C5 06      3630      CMP CNUM     HAVE WE PRINTED 64 PER LINE??
0A07- B0 EB      3640      BCS MAXL    YES, SEND CARRIAGE RETURN
0A09- 60          3650 CRTS RTS           RETURN
          3660 *
          3670 *
          3680 *      SERIAL OUTPUT ROUTINE
          3690 *
          3700 *
0A0A- A0 05      3710 TTYO LDY #5     5 BITS TO SEND
0A0C- B4 03      3720      STY CNT     BIT COUNTER

```

Listing 1 continued on page 382

Listing 1 continued:

```

0A0E- 85 05      3730      STA HOLD      SAVE CHARACTER
0A10- 8D 58 C0 3740      STA SFA      SEND START BIT
0A13- 20 B2 0A 3750 CLOP JSR MS11      11 MSEC DELAY
0A16- 20 B2 0A 3760      JSR MS11      11 MSEC DELAY
0A19- 66 05      3770      ROR HOLD      RIGHT SHIFT
0A1B- 90 05      3780      BCC ZERO      BIT IS 0
0A1D- 8D 59 C0 3790      STA MRK      SEND MARK
0A20- B0 03      3800      BCS OVER      CONTINUE
0A22- 8D 58 C0 3810 ZERO STA SFA      SEND A SPACE
0A25- C6 03      3820 OVER DEC CNT  DEC COUNTER
0A27- D0 EA      3830      BNE CLOP      LOOP FOR ALL CHARACTERS
0A29- 20 B2 0A 3840      JSR MS11      11 MSEC DELAY
0A2C- 20 B2 0A 3850      JSR MS11      11 MSEC DELAY
0A2F- 8D 59 C0 3860      STA MRK      SEND STOP BIT
0A32- 20 B2 0A 3870      JSR MS11      11 MSEC DELAY
0A35- 20 B2 0A 3880      JSR MS11      11 MSEC DELAY
0A38- 20 B2 0A 3890      JSR MS11      11 MSEC DELAY
0A3B- 60          3900      RTS          RETURN
          3910 *
          3920 *
          3930 *      TTY INPUT ROUTINE
          3940 *
          3950 *
0A3C- 20 62 C0 3960 INPT BIT TINP      ANY DATA??
0A3F- 10 44      3970      BPL IRTS      NO--EXIT
0A41- 20 B2 0A 3980      JSR MS11      DELAY 11 MSEC.
0A44- 20 B6 0A 3990      JSR TTYI      READ DATA IN
0A47- C9 1F      4000      CMP #LSHF      LETTERS SHIFT??
0A49- D0 05      4010      BNE CF1G      NO--CHECK FOR FIGURES SHIFT
0A4B- A9 00      4020      LDA #LET      GET LETTERS SHIFT
0A4D- 85 07      4030      STA RSFT      STORE IT
0A4F- 60          4040      RTS          RETURN
0A50- C9 1B      4050 CF1G CMP #FIGS      FIGURES SHIFT??
0A52- D0 05      4060      BNE NSH      NO SHIFT
0A54- A9 20      4070      LDA #FIG      GET SHIFTER
0A56- 85 07      4080      STA RSFT      SAVE IT
0A58- 60          4090      RTS          RETURN
0A59- 1B          4100 NSH CLC          CLEAR CARRY
0A5A- 65 07      4110      ADC RSFT      BIAS POINTER
0A5C- AA          4120      TAX          SEND TO INDEX REGISTER
0A5D- BD 1E 0B 4130      LDA ASCI,X    GET ASCII CHARACTER
          4140 *
          4150 *
          4160 *      HERE WE TWIDDLE CNUM SO THAT WE WILL BE
          4170 *      OK WHEN IT IS OUR TURN TO SEND
          4180 *
          4190 *
0A60- C9 8D      4200      CMP #CR      IS IT A CARRIAGE RETURN??
0A62- D0 0A      4210      BNE NRST      NO, NO NEED TO RESET
0A64- A9 32      4220      LDA #MAXC     GET CHARACTERS PER LIN
0A66- 85 06      4230      STA CNUM      SAVE IT
0A68- A9 8D      4240      LDA #CR      GET A CARRIAGE RETURN
0A6A- 20 5C 09 4250      JSR SHW2     DISPLAY IT
0A6D- 60          4260      RTS          RETURN
0A6E- C9 BA      4270 NRST CMP #LF      HOW ABOUT A LINE FEED??
0A70- D0 06      4280      BNE RUB      NO, CHECK FOR A RUBOUT
0A72- A4 24      4290      LDY CHAR     CHECK CHARACTER POSITION
0A74- F0 0F      4300      BEQ IRTS     WE ARE AT BEGINNING OF LINE--NO LINE FEED
0A76- D0 0A      4310      BNE PRN2     PRINT IT
0A78- C9 88      4320 RUB CMP #ROUT    AND A RUBOUT??
0A7A- D0 04      4330      BNE PRNT     NOFE, PRINT AWAY
0A7C- E6 06      4340      INC CNUM     ADD ONE FOR DELETION
0A7E- 50 02      4350      BVC PRN2     AND PRINT
0A80- C6 06      4360 PRNT DEC CNUM  FIDDLE WITH COUNTER
0A82- 20 5C 09 4370 PRN2 JSR SHW2     DISPLAY IT
0A85- 60          4380 IRTS RTS     AND RETURN
          4390 *
          4400 *
          4410 *      SERIAL INPUT ROUTINE
          4420 *

```

Listing 1 continued:

```

4430 *
0A86- A9 01 4440 TTYI LDA #1      A ONE
0A88- 85 09 4450      STA VALUE  BIT VALUE OF INPUT
0A8A- A9 05 4460      LDA #5    5 BITS
0A8C- 85 03 4470      STA CNT   TO INPUT
0A8E- A9 00 4480      LDA #00   ZERO OUT
0A90- 85 08 4490      STA CHR   RECEIVED CHARACTER VALUE
0A92- 20 B2 0A 4500 ILOP JSR MS11  DELAY 11 MSEC.
0A95- 20 B2 0A 4510      JSR MS11  DELAY 11 MSEC.
0A98- 2C 62 C0 4520      BIT TINF  LOOK FOR A BIT
0A9B- 30 06 4530      BMI SPACE WE READ A SPACE
0A9D- A5 08 4540      LDA CHR   GET CHARACTER BUFFER
0A9F- 05 09 4550      ORA VALUE  GET THE PROPER BIT VALUE
0AA1- 85 08 4560      STA CHR   RE-SAVE CHARACTER
0AA3- 06 09 4570 SPACE ASL VALUE  SHIFT RIGHT ONCE
0AA5- C6 03 4580      DEC CNT   ARE WE DONE??
0AA7- D0 E9 4590      BNE ILOP NO--GET MORE BITTS
0AA9- 20 B2 0A 4600      JSR MS11  DELAY 11 MSEC
0AAC- 20 B2 0A 4610      JSR MS11  DELAY 11 MSEC
0AAF- A5 08 4620      LDA CHR   GET THE CHARACTER
0AB1- 60      4630      RTS      AND RETURN
4640 *
4650 *
4660 *      11 MILLISECOND DELAY LOOP
4670 *
4680 *      THE DELAY LOOP IS LONG BECAUSE WE
4690 *      ARE CHECKING FOR KEYBOARD INPUT DURING
4700 *      THE DELAY TIME SO THAT WE CAN ACTUALLY
4710 *      TYPE FASTER THAN THE 6 CHARACTERS PER
4720 *      SECOND THAT THE BAUD RATE LIMITS US TO.
4730 *      THE DELAY LOOP HAS BEEN DESIGNED SO THAT
4740 *      IT TAKES THE SAME AMOUNT OF TIME WHETHER
4750 *      OR NOT THE BRANCHES ARE TAKEN.
4760 *
4770 *
0AB2- A0 EF 4780 MS11 LDY #239    239 * 47 = 11233 CLOCK CYCLES
0AB4- 2C 00 C0 4790 TOP  BIT KEYB  TEST KEYBOARD [4] [4]
0AB7- 10 18 4800      BPL NOT   NO DATA [4] [3]
0AB9- A6 04 4810      LDX FILL  GET POINTER [3]
0ABB- AD 00 C0 4820      LDA KEYB  READ THE DATA [4]
0ABE- 2C 10 C0 4830      BIT STRB  RESET STROBE [4]
0AC1- 9D 00 08 4840      STA RING,X SAVE IN BUFFER[5]
0AC4- E6 04 4850      INC FILL  BUMP POINTER [5]
0AC6- EA      4860      NOP      [2]
0AC7- 48      4870      PHA      PUSH [3]
0AC8- 68      4880      PLA      POP [4]
0AC9- EA      4890      NOP      [2]
0ACA- 88      4900      DFY      DEC COUNTER [2]
0ACB- F0 15 4910      BEQ EXIT  RETURN [2]
0ACD- EA      4920      NOP      [2]
0ACE- 4C B4 0A 4930      JMP TOP   TRY AGAIN [3]
4940 *      47 CLOCK CYCLES
4950 *
4960 *
4970 *      NO DATA
4980 *
4990 *
0AD1- A5 00 5000 NOT  LDA #0    ACCESS BASE PG [3]
0AD3- 48      5010      PHA      PUSH [3]
0AD4- 68      5020      PLA      POP [4]
0AD5- 48      5030      PHA      PUSH [3]
0AD6- 68      5040      PLA      POP [4]
0AD7- 48      5050      PHA      PUSH [3]
0AD8- 68      5060      PLA      POP [4]
0AD9- 48      5070      PHA      PUSH [3]
0ADA- 68      5080      PLA      POP [4]
0ADB- EA      5090      NOP      [2]
0ADC- 88      5100      DEY      DEC COUNTER [2]
0ADD- F0 03 5110      BEQ EXIT  RETURN [2]
0ADF- 4C B4 0A 5120      JMP TOP   TRY AGAIN [3]

```

Listing 1 continued on page 384

```

5130 *
OAE2- 60 5140 EXIT RTS          EXIT          47 CLOCK CYCLES
5150 *
5160 *
5170 *   LOOK-UP TABLES
5180 *
5190 *   ASCII-TO-BAUDOT
5200 *
5210 *
5220 *   THE TABLE IS CODED AS FOLLOWS:
5230 *   BIT 6 LIT = NO MODE CHANGE REQUIRED
5240 *   BIT 5 LIT = FIGURES SHIFT
5250 *   BIT 5 OFF = LETTERS SHIFT
5260 *   BIT 7 LIT = ILLEGAL BAUDOT CHARACTER
5270 *           DO NOT SEND
5280 *
5290 *
5300 *   FIGURES SHIFT
5310 *
5320 *
OAE3- 44 5330 BAUD .DA ##04+NOMO SPACE
OAE4- 2D 5340      .DA ##0D+FIG !
OAE5- 31 5350      .DA ##11+FIG "
OAE6- 80 5360      .DA #ILLG  # IS ILLEGAL
OAE7- 29 5370      .DA ##09+FIG $
OAE8- 80 5380      .DA #ILLG  % IS ILLEGAL
OAE9- 80 5390      .DA #ILLG  & IS ILLEGAL
OAEA- 2B 5400      .DA ##0B+FIG '
OAEB- 2F 5410      .DA ##0F+FIG (
Oaec- 32 5420      .DA ##12+FIG )
Oaed- 80 5430      .DA #ILLG  * IS ILLEGAL
Oaee- 3A 5440      .DA ##1A+FIG +
Oaef- 2C 5450      .DA ##0C+FIG ,
Oaf0- 23 5460      .DA ##03+FIG -
Oaf1- 3C 5470      .DA ##1C+FIG .
Oaf2- 3D 5480      .DA ##1D+FIG /
Oaf3- 36 5490      .DA ##16+FIG 0
Oaf4- 37 5500      .DA ##17+FIG 1
Oaf5- 33 5510      .DA ##13+FIG 2
Oaf6- 21 5520      .DA ##01+FIG 3
Oaf7- 2A 5530      .DA ##0A+FIG 4
Oaf8- 30 5540      .DA ##10+FIG 5
Oaf9- 35 5550      .DA ##15+FIG 6
Oafa- 27 5560      .DA ##07+FIG 7
Oafb- 26 5570      .DA ##06+FIG 8
Oafc- 38 5580      .DA ##18+FIG 9
Oafd- 2E 5590      .DA ##0E+FIG :
Oafe- 3E 5600      .DA ##1E+FIG ;
Oaff- 80 5610      .DA #ILLG  < IS ILLEGAL
Ob00- 34 5620      .DA ##14+FIG =
Ob01- 80 5630      .DA #ILLG  > IS ILLEGAL
Ob02- 39 5640      .DA ##19+FIG ?
5650 *
5660 *
5670 *   LETTERS SHIFT
5680 *
5690 *
Ob03- 80 5700      .DA #ILLG  @ IS ILLEGAL
Ob04- 03 5710      .DA ##03      A
Ob05- 19 5720      .DA ##19      B
Ob06- 0E 5730      .DA ##0E      C
Ob07- 09 5740      .DA ##09      D
Ob08- 01 5750      .DA ##01      E
Ob09- 0D 5760      .DA ##0D      F
Ob0A- 1A 5770      .DA ##1A      G
Ob0B- 14 5780      .DA ##14      H
Ob0C- 06 5790      .DA ##06      I
Ob0D- 0B 5800      .DA ##0B      J
Ob0E- 0F 5810      .DA ##0F      K
Ob0F- 12 5820      .DA ##12      L

```

Listing 1 continued:

OB10- 1C	5830	.DA ##1C	M
OB11- 0C	5840	.DA ##0C	N
OB12- 18	5850	.DA ##18	O
OB13- 16	5860	.DA ##16	P
OB14- 17	5870	.DA ##17	Q
OB15- 0A	5880	.DA ##0A	R
OB16- 05	5890	.DA ##05	S
OB17- 10	5900	.DA ##10	T
OB18- 07	5910	.DA ##07	U
OB19- 1E	5920	.DA ##1E	V
OB1A- 13	5930	.DA ##13	W
OB1B- 1D	5940	.DA ##1D	X
OB1C- 15	5950	.DA ##15	Y
OB1D- 11	5960	.DA ##11	Z
	5970 *		
	5980 *		
	5990 *	ASCII-TO-BAUDOT TABLE	
	6000 *		
	6010 *		
OB1E- 88	6020	ASCII .DA #ROUT	RUBOUT
OB1F- C5	6030	.DA ##C5	E
OB20- 8A	6040	.DA ##8A	LINE FEED
OB21- C1	6050	.DA ##C1	A
OB22- A0	6060	.DA ##A0	SPACE
OB23- D3	6070	.DA ##D3	S
OB24- C9	6080	.DA ##C9	I
OB25- D5	6090	.DA ##D5	U
OB26- 8D	6100	.DA ##8D	CARRIAGE RETURN
OB27- C4	6110	.DA ##C4	D
OB28- D2	6120	.DA ##D2	R
OB29- CA	6130	.DA ##CA	J
OB2A- CE	6140	.DA ##CE	N
OB2B- C6	6150	.DA ##C6	F
OB2C- C3	6160	.DA ##C3	C
OB2D- CB	6170	.DA ##CB	K
OB2E- D4	6180	.DA ##D4	T
OB2F- DA	6190	.DA ##DA	Z
OB30- CC	6200	.DA ##CC	L
OB31- D7	6210	.DA ##D7	W
OB32- C8	6220	.DA ##C8	H
OB33- D9	6230	.DA ##D9	Y
OB34- D0	6240	.DA ##D0	F
OB35- D1	6250	.DA ##D1	Q
OB36- CF	6260	.DA ##CF	O
OB37- C2	6270	.DA ##C2	B
OB38- C7	6280	.DA ##C7	G
OB39- 1B	6290	.DA ##1B	FIGURES
OB3A- CD	6300	.DA ##CD	M
OB3B- D8	6310	.DA ##D8	X
OB3C- D6	6320	.DA ##D6	V
OB3D- 1F	6330	.DA ##1F	LETTERS
	6340 *		
	6350 *		
	6360 *	FIGURES SHIFT	
	6370 *		
	6380 *		
OB3E- 88	6390	.DA #ROUT	RUBOUT
OB3F- B3	6400	.DA ##B3	3
OB40- 8A	6410	.DA ##8A	LINE FEED
OB41- AD	6420	.DA ##AD	-
OB42- A0	6430	.DA ##A0	SPACE
OB43- A7	6440	.DA ##A7	7
OB44- B8	6450	.DA ##B8	8
OB45- B7	6460	.DA ##B7	7
OB46- BD	6470	.DA ##BD	CARRIAGE RETURN
OB47- A4	6480	.DA ##A4	\$
OB48- B4	6490	.DA ##B4	4
OB49- A7	6500	.DA ##A7	7
OB4A- AC	6510	.DA ##AC	,
OB4B- A1	6520	.DA ##A1	!

Listing 1 continued on page 386

SOFTWARE DEVELOPMENT TOOLS FOR INDUSTRY

CP/M CROSS-ASSEMBLERS

Fast, comprehensive cross-assemblers to run under CP/M.* Extensive pseudo-ops include full listing control, nested conditionals, mnemonic synonyms, and inclusion of external source files. Generate object file, assembly listing, and symbol table from source code for nine popular microprocessor families.

XASM05..... 6805
 XASM09..... 6809
 XASM18..... 1802
 XASM48..... 8048/8041
 XASM51..... 8051
 XASM65..... 6502
 XASM68..... 6800/6801
 XASMF8..... F8/3870
 XASM400..... COP400

Assemblers... \$200.00 each
 Manual only... \$ 25.00

8048 DEVELOPMENT PACKAGE

Now you can use the 8048 family of single-chip microcomputers without buying expensive equipment. Develop 8048 software with the XASM48 cross-assembler. Then plug our EPR-48 board into your S-100 system to program the 8748 EPROM version.

8048 Development Package... \$574.00
 EPR-48 alone \$449.00

EPROM SIMULATOR BOARD

Debug dedicated systems quickly. Our PSB-100 PROM Emulator is an S-100 board with up to 8K of RAM. Cable with 24-pin plug replaces 2708 or 2716 EPROM(s) in your target system for instant program testing

PSB-100 EPROM Simulator... \$445.00
 w/2K RAM

*Trademark of Digital Research

avocet 
systems inc.

804 SOUTH STATE ST.
 DOVER, DEL. 19901
 302-734-0151

Visa and Mastercharge accepted. We ship 8" single-density and Softcard+ 5.25" diskettes. Ask us about other formats. OEM AND DEALER INQUIRES INVITED.

+ Trademark of Microsoft

**Hello.
This is the APPLE
talking. The message
is: Don't byte your
APPLE. Use COGNIVOX
to speak to it!**

**I am now listening
for your reply . . .**

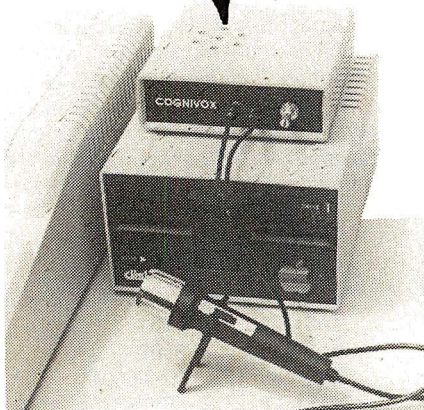

Let's face it. Voice I/O is a fascinating and efficient way to communicate with computers. And now, thanks to VOICETEK, Voice I/O peripherals are easily available, easy to use and very affordable.

If you own an APPLE II computer, COGNIVOX model VI0-1003 will enable your computer to understand your spoken commands and talk back with clear, natural sounding voice.

COGNIVOX can be trained to recognize up to 32 words or short phrases chosen by the user. To train COGNIVOX to recognize a new word, you simply repeat the word three times under the prompting of the system.

COGNIVOX will also talk with a vocabulary of 32 words or phrases chosen by the user. This vocabulary is independent of the recognition vocabulary, so a dialog with the computer is possible. The speech output is natural sounding since it is a digital recording of the user voice using a data compression algorithm.

For applications requiring more than 32 words, you can have two or more vocabularies of 32 words and switch back and forth between them. Vocabularies can also be stored on disk.

COGNIVOX VI0-1003 comes complete with microphone, power supply, software on cassette and extensive manual, ready to plug in and use. It plugs into the paddle connector and thus it leaves the valuable expansion slots free for other peripherals.

Software provided with the unit includes demonstration programs and two voice operated, talking video games! It is also very easy to incorporate voice in your own programs. A single statement from BASIC is all that is needed to either recognize or say a word.

COGNIVOX can be used as an educational tool, a data entry device when hands and/or eyes are busy, an aid to the handicapped, a foreign language translator, a sound effects generator, an intelligent telephone answering machine, a talking calculator. Using an IEEE 488 interface card you can control by voice instruments, plotters, test systems. And all these devices can talk back to you, telling you their readings, alarm conditions, even their name.

COGNIVOX VI0-1003 costs \$249 plus \$5 shipping (CA res. add 6% tax). Software on diskette (DOS 3.3) with extra features to save vocabularies on disk, \$19. Order by mail or call us at (805) 685-1854, 9AM to 5PM PST, M-F and charge it on your MASTERCARD or VISA. Foreign orders welcome, add 10% for air mail shipping and handling. COGNIVOX is backed by a 120 day limited warranty against manufacturing defects.

VOICETEK
Dept. B, Box 388
Goleta, CA 93116

Listing 1 continued:

0B4C- BA	6530	.DA	##BA	:
0B4D- AB	6540	.DA	##AB	(
0B4E- B5	6550	.DA	##B5	5
0B4F- A2	6560	.DA	##A2	"
0B50- A9	6570	.DA	##A9)
0B51- B2	6580	.DA	##B2	2
0B52- BD	6590	.DA	##BD	=
0B53- B6	6600	.DA	##B6	6
0B54- B0	6610	.DA	##B0	0
0B55- B1	6620	.DA	##B1	1
0B56- B9	6630	.DA	##B9	9
0B57- BF	6640	.DA	##BF	?
0B58- AB	6650	.DA	##AB	+
0B59- 1B	6660	.DA	##1B	FIGURES
0B5A- AE	6670	.DA	##AE	.
0B5B- AF	6680	.DA	##AF	/
0B5C- BB	6690	.DA	##BB	:
0B5D- 1F	6700	.DA	##1F	LETTERS
0B5E-	6710	END	.EQ	*
	6720	.EN		

SYMBOL TABLE

0B1E- ASCI	097B- NBS
0AE3- BAUD	09E6- NCHN
FBE2- BELL	09B0- NCR
FC10- BS	099D- NLF
0044- BSFC	0966- NOLF
0948- CAP	0040- NOMO
FC9C- CEOL	0AD1- NOT
0A50- CFGI	09BA- NROU
0024- CHAR	0A6E- NRST
0008- CHR	0A59- NSH
0A13- CLOP	09C6- NSND
0003- CNT	0000- NULL
0006- CNUM	09E7- OUT
09CF- CON	0A25- OVER
09C7- COUT	0AB2- PRN2
008D- CR	0AB0- FRNT
0048- CRC	FFF2- REM
096F- CRN	0800- RING
0A09- CRTS	0088- ROUT
0060- CURS	0007- RSFT
0025- CV	0A78- RUB
FDF0- DISF	0040- RUBO
0001- EMTY	0988- SEND
0B5E- END	0000- SHIFT
0AE2- EXIT	0951- SHOW
0020- FIG	095C- SHW2
001B- FIGS	C058- SPA
0004- FILL	00A0- SPAC
0005- HOLD	0AA3- SPACE
FC58- HOME	0987- SRT\$
0080- ILLG	C010- STRB
0A92- ILOP	0A03- TEST
0A3C- INPT	C062- TINF
0AB5- IRTS	0AB4- TOP
C000- KEYB	0002- TOUT
0932- KEYS	0AB6- TTYI
0950- KRTS	0A0A- TTYO
0000- LET	0009- VALUE
008A- LF	0900- VINT
0042- LINF	0A22- ZERO
091D- LOOP	
001F- LSHF	
0032- MAXC	
09F4- MAXL	
C059- MRK	
0AB2- MS11	

Books Received

Computers and the Radio Amateur, Phil Anderson. Englewood Cliffs, NJ: Prentice-Hall, 1982; 23.5 by 17.5 cm, 208 pages, hardcover, ISBN 0-13-166306-2, \$18.95.

Computer Performance Evaluation: Tools and Techniques for Effective Analysis, Michael F. Morris and Paul F. Roth. New York: Van Nostrand Reinhold, 1981; 23 by 15.5 cm, 260 pages, hardcover, ISBN 0-442-80325-7, \$24.95.

Denotational Semantics: The Scott-Strachey Approach to Programming Language Theory, Joseph E. Stoy. Cambridge, MA: The MIT Press, 1981; 14.5 by 22.5 cm, 414 pages, softcover, ISBN 0-262-69076-4, \$12.50.

Developing Structured Systems, A Methodology Us-

ing Structured Techniques, Brian Dickinson. New York: Yourdon Press, 1981; 24.5 by 17.5 cm, 344 pages, softcover, ISBN 0-917072-23-5, \$40.

International Microcomputer Software Directory, John Graham and Roy Wyand, eds. Los Angeles, CA: Imprint Software, 1981; 27.5 by 21 cm, 400 pages, softcover, ISBN 0-907352-03-0, \$29.95.

Laboratory Minicomputing, John R. Bourne. New York: Academic Press, 1981; 15.5 by 23 cm, 297 pages, hardcover, ISBN 0-12-119080-3, \$27.

Operational Amplifiers and Linear Integrated Circuits, 2nd edition, Robert F. Coughlin and Frederick F. Driscoll. Englewood Cliffs, NJ: Prentice-Hall, 1982; 15

by 23 cm, 376 pages, hardcover, ISBN 0-13-637785-8, \$21.95.

Operating System Elements: A User Perspective, Peter Calingaert, Englewood Cliffs, NJ: Prentice-Hall, 1982; 15 by 23 cm, 240 pages, hardcover, ISBN 0-13-637421-2, \$23.95.

Starting FORTH, Leo Brodie. Englewood Cliffs, NJ: Prentice-Hall, 1981; 23 by 16.5 cm, 348 pages, softcover, ISBN 0-13-842922-7, \$15.95.

Structured Programming Using PL/C, Joan K. Hughes and Barbara J. La Pearl. New York: John Wiley & Sons, 1981; 27 by 21 cm, 414 pages, softcover, ISBN 0-471-04969-7, \$17.95.

Word Processing, 2nd edition, Arnold Rosen and Rosemary Fielden. Englewood Cliffs, NJ: Prentice-Hall, 1981; 23 by 15.5 cm, 430 pages, hardcover, ISBN 0-13-963488-6, \$18.95. ■

This is a list of books received at BYTE Publications during this past month. Although the list is not meant to be exhaustive, its purpose is to acquaint BYTE readers with recently published titles in computer science and related fields. We regret that we cannot review or comment on all the books we receive; instead, this list is meant to be a monthly acknowledgment of these books and the publishers who sent them.

QUALITY parts at DISCOUNT PRICES

RFI LINE FILTER for line to line & line to ground noise suppression CORCOM # 10K6 Rated: 10 amp 115/250 v 50-400 hz \$ 3.75 ea. 10 for \$35.00	750 MFD 330 V PHOTO FLASH 2" HIGH X 1 1/4" DIA. \$1.25 EACH 10 FOR \$11.00	MINI SIZE BUZZERS 1 1/2 to 3 volts WITH WIRE LEADS 75¢ each 1 1/2 to 3 volts WITH PIN TERMINALS 75¢ each 3 to 7 volts WITH PIN TERMINALS 75¢ each
4PDT PRINTED CIRCUIT 12 VDC 14 pin style 3 amp contacts BRAND NEW P.C. Mount \$ 2.75 EA.	TYPE N CONNECTOR KINGS UG 526 B-U FITS RG55, RG58, RG141 RG142, RG223 SOLDER TYPE \$1.75 each 10 for \$16.00	MRF 901 MICROWAVE TRANSISTOR \$ 3.00 EA.
COMPUTER GRADE CAPACITOR 3,600 mfd. 40VDC \$1.00 1 3/8" DIA. X 2 3/4" HI 6,400 mfd. 60VDC \$2.50 1 3/8" DIA X 4 1/4" 20,000 mfd. 25VDC 2" DIA. X 2 1/2" HIGH \$2.00 22,000 mfd. 25VDC 2" DIA X 2 1/2" HIGH \$2.50 22,000 mfd. 40VDC 2" DIA. X 5" HIGH \$3.00 45,000 mfd. 25VDC 2" DIA. X 4" HIGH \$3.50 52,000 mfd. 15VDC 2" DIA X 4 1/2" HIGH \$3.00 72,000 mfd. 15VDC 2" DIA. X 4" HIGH \$3.50 CLAMPS TO FIT CAPACITORS 50¢ ea.	L.E.D.'s STANDARD JUMBO DIFFUSED RED 10 FOR \$1.50 GREEN 10 FOR \$2.00 YELLOW 10 FOR \$2.00 FLASHER LED 5 VOLT OPERATION JUMBO SIZE 2 FOR \$1.70 BI POLAR LED 2 FOR \$1.70 SUB MINI LED .079" X .098" 20mA at 1.75v 10 FOR \$1.00 200 FOR \$18.00 QUANTITY PRICES AVAILABLE	14 CONDUCTOR RIBBON CABLE SCOTCHFLEX #3365 28 AWG STRANDED GRAY WITH RED MARKER 10 FEET for \$2.50 100 FOOT ROLL \$12.00
ALL ELECTRONICS CORP. 905 S. Vermont Ave. P.O. BOX 20406 Los Angeles, Calif. 90006 (213) 380-8000 Mon. - Fri. Saturday 9 AM - 5 PM 10 AM - 3 PM	TERMS • Quantities Limited • Min. Order \$10.00 • Add \$2.50 Shipping USA • Calif. Res. Add 6% • Prompt Shipping	TRANSFORMERS 120 volt primaries 6 VOLTS at 150 mA \$1.25 12 V.C.T. at 500mA \$2.50 16.5 V. at 3 AMPS \$6.50 18 VOLTS at 1 AMP \$4.50 25.2 VCT at 2.8 AMP \$5.50
		2" ALLIGATOR CLIPS 7 clips for \$1.00 100 clips for \$12.00 500 clips for \$50.00

TRS-80 MODEL I 64K CP/M



MM-16K \$200
 CP/M 2.2 \$125

with BIOS
 special BOOT - ROM
 \$25.00 extra on request
 specify 16K, 32K or 48K
 Minimum 16K & 1 Disk Drive

Now enjoy the portability of CP/M, combined with the power of a full 64K of RAM with the **MM-16K memory management unit** which includes 16K of on board RAM. The **MM-16K** will work with 16K of TRS-80 RAM, and one disk but we suggest 48K and two disk drives.

Model III version soon available

Dealer inquiries invited

Martin Data Systems

3010 Santa Monica Blvd. Suite 193
 Santa Monica, Ca. 90404 (213) 828-8985 EXT. 929

\$3.50 shipping and handling charge (UPS) check or money order. Calif. residents add 6% sales tax
 CP/M Trademark Digital Research TRS-80 Trademark Tandy Corp.

Event Queue

January 1982

January-February

Intel Microcomputer Workshops, various sites throughout the U.S. Intel's hands-on workshops cover a wide selection of Intel's microcomputer components, boards, software, operating systems,

and design tools. The workshops can be held at your company's facility. For information, contact Intel Corp., Customer Training, 27 Industrial Ave., Chelmsford, MA 01824, (617) 256-1374.

January-March

Hands-On Local Network Workshops, various sites

throughout the U.S. This series of four-day workshops provides hands-on experience with a local computer network. File, printer, and electronic-mail servers, and various software and hardware components of a local-network computer system will be provided. The local network used as the example

will consist of at least a Nestar Cluster One/Model A. Write to Architecture Technology Corp., POB 24344, Minneapolis, MN 55424.

January-April

Computer Network Design and Protocols, various sites throughout the U.S. Participants in this workshop will learn to determine network-system requirements and perform design trade-offs, implement network-communication and control protocols, use packet- and message-switching techniques, evaluate network hardware and software components, interface local systems to networks, and design and build private networks. The course fee is \$845. Contact Ruth Dordick, c/o Integrated Computer Systems, 3304 Pico Blvd., POB 5339, Santa Monica, CA 90405, (800) 421-8166; in California (800) 352-8251.

January-April

Fundamentals of Data Processing for Administrative Assistants and Office Support Staff, various sites throughout the U.S. The American Management Associations (AMA) has designed this three-day course for secretaries, assistants, supervisors, and other personnel desiring to learn the fundamentals of data processing and its use in offices. Computer hardware and software, programming languages, and technology will all be covered. The team fee for AMA members is \$470 per individual and \$550 for non-members. Individual fees are \$550 for AMA members and \$630 for nonmembers. For a schedule of dates and locations, contact the AMA, 135 West 50th St., New York, NY 10020, (212) 586-8100. To register by phone, call (212) 246-0800.

★★★ VALUABLE FREE GIFT TO SYSTEM PURCHASERS ★★★

Free subscription to THE SOURCE, extensive data base, 600 subjects, via telephone link to micros. Offer is applicable for any system in our product line. We offer a wide range of CRTs, printers, graphics equipment & software for these systems. Each system is completely tested, integrated and ready for plug-in operation when you receive it. We tailor and configure systems to meet your needs and budget.

CROMEMCO: We proudly announce the inclusion of CROMEMCO in our product line. **INTRO SALE:** 25% off systems/software. 15% off boards/components.

CALIFORNIA COMPUTER SYSTEMS 2210A: High Quality, Low Price Z80 CPU, 1 serial port, 12 slot S-100, disk controller w/CPM 2.2, 64K RAM...\$1,750. Add our MAX BOX w/dual Shugarts or Qumes and SSM I/O 4 or IMS I/O for additional ports.

IMS 5000 and 8000 SYSTEMS 2 year warranty on boards!
Z80A, S-100, double density drives (single or double sided) plus optional built in Winchester from 5.5 to 40 MB, DMA disk controller, 64K RAM. Single or double user.

MULTI-USER SYSTEMS FEATURING TURBODOS
TURBODOS: Spectacular CP/M® compatible operating system. Z80 code, interrupt driven. Up to 6X faster than CP/M®; up to 35% increased disk capacity. Now available for IMS, TRS-80 Model II, CCS and Tarbell controllers.

SYSTEMS GROUP (Measurement Systems & Control). CP/M® and MP/M® Systems with dual floppies or one floppy + one 10MB Winchester...10% off list price.

TECMAR 16bit 8086 IEEE S-100 system w/8 MHZ option...5% off list price.
Z80 Video Digitization systems...5% off list price.

SD Systems: Boards, kits and systems...10% off list price.

GRAPHIC SYSTEMS: Advertising, Architects, Designers. Complete package including powerful interactive graphics software plus MicroAngelo Graphics Subsystem w/22 MHZ high resolution green phosphor screen; M9900 16 bit, IEEE S-100 computer w/dual 8" floppies, 64K RAM, Multi user capability, Houston Instruments HIPAD Digitizer, Mauro Plotter...\$10,200. 10MB Hard Disk Subsystem option...\$3,400.

CENTRAL DATA, GODBOUT, SEATTLE COMPUTER: Complete product lines now available.

MAX BOX Mfg by John D. Owens Assoc. 8" dual drive cabinet w/regulated power supply, fan, complete internal cabling. Will hold Qumes, Shugarts or remove "Siemens" & change to Winchester, horizontally mounted. Excellent design & engineering. 17½" X 5½" X 22...\$325.
With 2 Shugart 801 R...\$1,275. With 2 Qume double sided drives...\$1,680.

PER SCI—THE KING AND QUEEN OF DRIVES
Model 299B...\$2,300. Model 277...\$1,245. Slim line cabinet...\$325.

MICROANGELO GRAPHICS SUBSYSTEM from Scion...\$2,295.
Screenware Pak II...\$350. S-100 Graphics card...\$985.
Color systems now available...5% off list price.

WE EXPORT: Overseas Callers: TWX 710 588 2844
Phone 212 448-6298 or Cable: OWENSASSOC

JOHN D. OWENS Associates, Inc.
12 Schubert Street, Staten Island, New York 10305
212 448-6283 212 448-2913 212 448-6298

January-June

Datamation Institute Seminars on Information Management, various sites throughout the U.S. Databases and communications, systems performance, data-processing management, word processing and office automation, computer graphics, and topics of general interest are among the areas to be covered by these two-day seminars. Fees range from \$495 to \$595. For schedules of times and places, contact Karen Smolens, c/o the Center for Management Research, Datamation Institute Seminar Coordination Office, 850 Boylston St., Chestnut Hill, MA 02167, (617) 738-5020.

January 7-10

The 1982 Winter Consumer Electronics Show (CES), Las Vegas Convention Center, Hilton Hotel, and the Jockey Club, Las Vegas, NV. Conferences, workshops, seminars, sales meetings, press events, and exhibits of audio and video equipment, computers, telephones, and other consumer items highlight this show. For details, contact Consumer Electronics Shows, Suite 1607, Two Illinois Center, 233 North Michigan, Chicago, IL 60601, (312) 861-1040.

January 11-13

Unix and C Conference, San Francisco, CA. This conference is sponsored by Uni-Ops, a Unix users group. Tutorials on the Unix operating system and the C language and sessions for beginners to advanced users will be held. Bulletins of information are available from Uni-Ops, POB 5182, Walnut Creek, CA 94596, (415) 933-8564.

January 11-15

Applied Interactive Computer Graphics, University of Tennessee Space Institute, Tullahoma, TN. Lectures by Sylvan Chasen, Bertrand

Herzog, and Carl Machover are the main features of this conference. For technical information, call Dr. F. W. Donaldson (615) 455-0631. For general information, contact Jules Bernard at (615) 455-0631.

January 12-15

Communication Networks Conference and Exposition, Georgia World Congress

Center, Atlanta, GA. The Communication Networks Conference is designed to bring users and the telecommunication industry together. The Conference features sessions, panel discussions, and tutorials on voice, data, and electronic-mail communications. For information, contact Communication Networks, 375 Cochituate Rd., POB 880, Framingham, MA 01701, (617) 879-0700.

January 15-16

Microcomputers in Education, Uses for the 80s, Arizona State University, Tempe, AZ. The Tenth Annual Math/Science Conference will emphasize the microcomputer as a medium for instruction, as a tool for research, and as an information manager. Workshops, demonstrations, panel discussions, and problem-solving groups will be offered. Contact Nancy Watson, 203

★★★ GREETINGS TO OUR FRIENDS IN SWITZERLAND ★★★

<p>3M SCOTCH® Diskettes In storage box 5 box minimum, price per box. 740, 8" ss/sd\$29.00 741, 8" ss/dd\$35.50 743, 8" dd/dd\$45.50 744-0, 5¼" soft sector or 744-10, hard sector, single sided\$28.50</p>	<p>MORROW & QUANTUM HARD DISK DRIVES at discount prices</p> <p>THE MARSHALL: Complete hardware/software protection device for hard disk subsystem. Intelligent tape subsystems using ¼" tape cartridge w/file oriented software. Can save & restore files by individual names.</p>
<p>TEI MAINFRAMES, S-100 MCS 112...\$ 620. MCS 122...\$ 745. RM 12\$ 655. RM 22\$ 790. OEM & Qty. discounts offered</p>	<p>WHITESMITH: The Complete C-compiler produces optimized native code for Z80. PASCAL from Whitesmith allows intermixing of C & PASCAL. Full PASCAL as defined by Jensen & Werth, discounted price.</p>
<p>HOUSTON INSTRUMENTS PLOTTERS Standard & Intelligent models w/surface areas of 8½" X 11" to 11" X 17". Front panel electronic controls. DMP-2....\$ 935. DMP-3....\$1,195. DMP-4....\$1,295. DMP-5....\$1,455. DMP-6....\$1,685. DMP-7....\$1,865.</p>	<p>dBASE II Brings power of mainframe database software to a microcomputer. Manual and demo software:\$ 50. Complete package with money back guarantee:\$595.</p>
<p>TARBELL Double density controller\$435. Z80 CPU395.</p>	<p>COMMUNICATIONS SOFTWARE Enables communications from a micro to a terminal or to another micro, mini or maxi computer. Source code: ..\$250.</p>
<p>OLIVETTI DAISY WHEEL PRINTERS Letter quality print. Quiet performance; ideal for office environment. Model 211 (20CPS)\$1,660. Model 311 (34CPS)2,150. Model 811 (80CPS)3,795. Bidirectional tractor:\$150.</p>	<p>MICROSOFT BASIC-80 (interpreter)\$270. BASIC COMPILER:\$305. COBOL-80\$560. FORTRAN-80\$380. X-MACRO-86:\$275. muLISP/muSIMP:\$190.</p>
<p>PMMI S-1000 Modem\$385. Compatible w/telex & Twx. 51 to 600 baud. On board pulse dialer.</p>	<p>MICROPRO WORDSTAR:\$320. MAIL MERGE:\$110.</p>
<p>HAZELTINE 1500\$ 885. 1510\$ 980. 1520\$1,210. 220 volt models, add \$100.</p>	<p>TWX (TELEX II) SOFTWARE \$350. Send/receive with a microcomputer connected directly to WU line. Eliminate paper tape. Messages can be formatted w/text editor.</p>
<p>EPSON MX80\$475. MX100\$725. RS 232 Interface\$ 70.</p>	<p>TEXAS INSTRUMENTS Printers TI810 Basic\$1480.</p>
<p>TELETYPE Model 4320 AAK\$1,140. Model 43ASR, 8 level, 1" tape..\$2,595.</p>	<p><i>Prices subject to change without notice</i></p>

JOHN D. OWENS Associates, Inc.
 SEE OUR AD ON FACING PAGE

Event Queue

Payne Hall, Arizona State University, Tempe, AZ 85287. Vendors interested in exhibiting may contact Dr. Gary Bitter, 203 Payne Hall, Arizona State University, Tempe, AZ 85287, (602) 965-3322.

January 19-22

Hands-on Pascal Workshop, Washington, D.C. The Hands-on Pascal Workshop is a four-day course designed by Integrated Computer Systems (ICS). Teams of three will be provided with an Apple Pascal system for use throughout the course. Some of the skills to be taught will

be coding in Pascal, using structured programming techniques, and controlling real-time devices. For more details, contact ICS, 3304 Pico Blvd., POB 5339, Santa Monica, CA 90405, (800) 421-8166; in California (800) 352-8251.

January 19-22

Peripheral Array Processors for Signal Processing and Simulation, Sheraton National Hotel, Washington, D.C. The fee for this course is \$795. For complete details, contact the Continuing Education Institute, Suite 1030, 10889 Wilshire Blvd., Los

Angeles, CA 90024, (213) 824-9545.

January 19-22

The Which Computer? Show, National Exhibition Centre, Birmingham, England. Information about this show can be obtained from Clapp & Poliak, Inc., 245 Park Ave., New York, NY 10167, (800) 223-1956; in New York (212) 661-8410.

January 20-22

Texas Computer Show, Dallas Convention Center, Dallas, TX. Conferences, panel discussions, and seminars will be featured at this show. The exhibition will include word- and data-processing equipment plus peripherals. Contact the Texas Computer Show, POB 214035, Dallas, TX 75221, (214) 761-9108; in Georgia (404) 452-0114; in Canada (416) 252-7791.

January 21-23

The First Annual Pacific Computer Exposition, San Diego Convention and Performing Arts Center, San Diego, CA. This computer show will feature approximately 200 exhibitions of software and hardware of interest to business, industry, education, and homeowners. Contact Gloria Williams, c/o Williams Professionals, Suite 150, 2333 Camino Del Rio S., San Diego, CA 92108, (714) 296-4025.

January 26-29

Computer Graphics, San Francisco, CA. Computer Graphics is a four-day course designed by Integrated Computer Systems (ICS). The course provides an overview of the state of the art in computer-graphics hardware, software, and applications. Topics include fundamentals,

In order to gain optimal coverage of your organization's computer conferences, seminars, workshops, courses, etc, notice should reach our office at least three months in advance of the date of the event. Entries should be sent to: Event Queue, BYTE Publications, POB 372, Hancock NH 03449. Each month we publish the current contents of the queue for the month of the cover date and the two following calendar months. Thus a given event may appear as many as three times in this section if it is sent to us far enough in advance.

SENIOR SOFTWARE ENGINEERS

Start with unlimited technical resources. Add a top-caliber team of professionals well-known for developing some of the most powerful and reliable products on the market. Then top it all off with the opportunity to work in an environment where you can fully demonstrate your creative talents.

You'll find all this with Digital's Language Development Department in New Hampshire—an organization that provides software tools, languages, and high-technology support services for new products and existing products such as the PDP-11 and VAX systems.

You should have at least 5-10 years of language processor or operating systems development experience.

We'll provide a fully competitive salary/benefits package and relocation assistance to a tax-free New England that's near a wide variety of cultural and recreational attractions. Apply by sending your resume and salary history to: Hank Vezina, Digital Equipment Corporation, Dept. AO1 3817, Continental Blvd., Merrimack, NH 03054.

We are an affirmative action employer.

digital

We change the way
the world thinks.

THE BIGGEST NAME IN LITTLE COMPUTERS[®]

TRS-80[™] Model II—Your Best Buy
in a Business Microcomputer

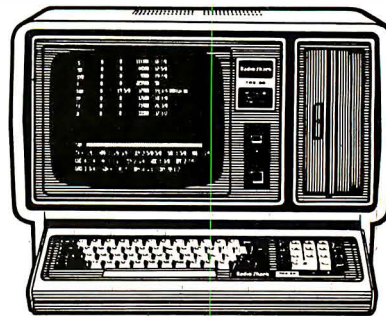

UP
TO
15%
OFF!

TRS-80[™] computers, on
software and peripherals

Similar values on all merchandise

CALL TOLL FREE:

800-351-1580

In Texas 915-283-2920

Van Horn Office Supply

701 W. Broadway—PO Box 1060

Van Horn, Texas 79855

DEALER G055

Form F48 Provided

Standard Warranty on Merchandise

THE NATIONWIDE SUPERMARKET OF SOUND[®]



color techniques, and how to select and implement equipment in graphics applications. Contact ICS, 3304 Pico Blvd., POB 5339, Santa Monica, CA 90405, (800) 421-8166; in California (800) 352-8251.

January 28-30

Conference on Modeling and Simulation on Microcomputers, Bahia Hotel, San Diego, CA. The Society for Computer Simulation (SCS) is presenting this conference, which features papers, panel discussions, and tutorials on discrete and continuous simulation on microcomputers. Contact SCS, POB 2228, La Jolla, CA 92038, (714) 459-3888.

February 1982

February 1-3

The 1982 Instructional Computing Conference, Orlando, FL. The objectives of the conference are to provide insights into the use of computers in education, provide information on hardware and courseware for instructional computing, provide contact with persons now using instructional computing in Florida, and to cover trends in educational technology. Contact J. Warren Binns, State of Florida Dept. of Education, Tallahassee, FL 32301.

February 14-18

The Kuwait Information Management Exhibition: INFO Kuwait, Kuwait International Exhibition Center, Kuwait. Industrial executives from the Middle East are among those expected to attend this conference. Exhibits and speakers will be featured. Contact Clapp & Poliak International, 7315 Wisconsin Ave., Washington, D.C. 20014, (301) 657-3090.

February 18-19

Computer/Micrographics Interface, Stouffer's Greenway Plaza, Houston, TX. The Computer/Micrographics Interface is designed for information managers, systems analysts, micrographics systems analysts, records managers, and others who need information on computer and micrographic technologies. The course is presented by the Battelle Research Institute. Contact Battelle Seminars and Studies Program, 4000 Northeast 41st St., Seattle, WA 98105, (800) 426-6762; in Washington (206) 527-0542.

February 18-19

The Second Annual Talmis Conference and Exhibit, Chicago, IL. The Talmis Conference will focus on educational and reference media for the institutional, training, home-computer, and video markets. Local computer networks in education, the market for electronic educational and reference media in the home, software piracy, and other topics will be discussed. Exhibits of products and services will be featured. The registration fee is \$450. For more information, contact Talmis, 115 North Oak Park Ave., Oak Park, IL 60301, (312) 848-4001.

February 22-24

The Eighth Federal DP Expo, Sheraton Washington Hotel, Washington, D.C. More than 150 computer companies will display and demonstrate hardware and software systems and services at the Federal DP Expo. Conferences on data processing and office automation will be held. Approximately 120 computer-industry experts will speak. Contact The Interface Group, 160 Speen St., Framingham, MA 01701,

(800) 225-4620; in Massachusetts (617) 879-4502.

February 23-25

Computers and Automated Office Systems Exhibit for Caribbean Markets, Holiday Inn, Paradise Island, Nassau, Bahamas. This show is intended to bring together buyers and distributors with the industry. Exhibits of equipment for businesses in the Caribbean will be featured. For more details, contact Ormand Vee Co., 8852 Leslie Ln., Desplaines, IL 60016, (312) 635-7347.

February 26-28

Computer Expo '82, Tupperware Convention Center, Orlando, FL. Focusing on computers in education, business, industry, professional trades, and the home, the Computer Expo '82 will feature exhibits

of computers and peripherals. It is sponsored by Adventure International. General admission is \$5. For details, contact Computer Expo '82, 377 East Highway 434, POB 1185, Longwood, FL 32750, (305) 339-1731.

March 1982

March 1-4

Robots VI Conference and Exposition, Cobo Hall, Detroit, MI. An estimated 6000 manufacturing executives and engineers are expected to attend the Robots VI Conference, which features the latest in robotics technology and equipment. Among the topics to be addressed are assembly, foundry operations, aerospace applications, vision and handling, research

16 PLUS MEMORY EXPANSION FROM 16K TO 32K FOR THE COLOR COMPUTER

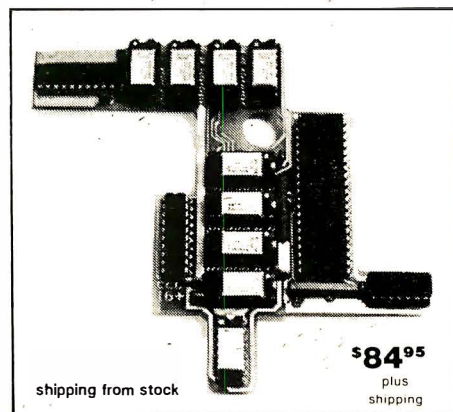

shipping from stock

\$84⁹⁵
plus
shipping

- No soldering! Easy to plug in!
- Fits under RF shield — complete instructions included
- Allows video display (graphics) to reside anywhere in the 32K memory
- Call or write for our complete catalog of Color Computer products!

COMPUTERWARE®

6809 Specialists

Box 668 • Encinitas, CA 92024
(714) 436-3512

Computerware is a trademark of Computerware.

Event Queue

and development, and sessions on human factors associated with robotics. Cincinnati Milacron, Unimation, and Hitachi America are a few of the companies that will be exhibiting at this show. The show is being sponsored by Robotics International of the Society of Manufacturing Engineers (RI/SME). Contact the RI/SME, One SME Dr., POB 930, Dearborn, MI 48128, (313) 271-1500, ext. 416.

March 2-4

The 1982 Vancouver Island Business Show, Empress Hotel, Victoria, British Columbia, Canada. The Vancouver Island Business Show features word-processing, communications, and office systems. The show provides the Vancouver Island business community with the opportunity to meet face-to-face with many Canadian suppliers of computer equipment. For information, contact Southex

Exhibitions, 202-2695 Granville St., Vancouver, British Columbia, V6H 3H4, Canada, (604) 736-3331. In eastern Canada, contact Judy Hurd, 1450 Don Mills Rd., Don Mills, Ontario, M3B 2X7, Canada, (416) 445-6641.

March 7-10

The Eleventh Annual TI-MIX Symposium, Las Vegas Hilton, Las Vegas, NV. TI-MIX is an organization for Texas Instruments computer users.

Its annual symposium features exhibits, a business meeting, and a new products workshop. Individual presentations, panel discussions, and workshops are planned. Contact TI-MIX, M/S 2200, POB 2909, Austin, TX 78769, (512) 250-7151.

March 9-11

The 1982 International Zurich Seminar on Digital Communications, Zurich, Switzerland. The theme of this seminar is "Man-Machine Interaction." Its aim is to present recent advances in theory and applications of digital-communication systems. Services, facilities, ergonomics, and their impact on peripheral equipment, systems architecture and design, as well as I/O (input/output) concepts and principles, will be covered. For details, contact Secretariat '82 IZS, M. Frey, EAE, Siemens-Albis AG, POB CH-8047, Zurich, Switzerland.

March 10-12

Cincinnati Business Show, Cincinnati Convention Center, Cincinnati, OH. The Cincinnati Business show features the latest in business technology, office systems, and products. Seminars will also be presented. For information, contact Ray G. Nemo, 5679 Creek Rd., Cincinnati, OH 45242, (513) 531-5959.

March 19-21

The Seventh West Coast Computer Faire, Civic Auditorium and Brooks Hall, San Francisco, CA. Attendance this year is expected to reach 35,000. More than 300 exhibitors and a wide assortment of seminars make this one of this largest annual computer shows. For more information, contact The Computer Faire, 333 Swett Rd., Woodside, CA 94062, (415) 851-7075. ■



The DS120 Terminal Controller makes your LA36 perform like a DECwriter® III.

The Datasouth DS120 gives your DECwriter® II the high speed printing and versatile performance features of the DECwriter® III at only a fraction of the cost. The DS120 is a plug compatible replacement for your LA36 logic board which can be installed in minutes. Standard features include:

- 165 cps bidirectional printing
- Horizontal & Vertical Tabs
- Page Length Selection
- 110-4800 baud operation
- 1000 character print buffer
- X-on, X-off protocol
- Self Test
- RS232 interface
- 20 mA Current Loop interface
- Top of Form
- Adjustable Margins
- Double wide characters
- Parity selection
- Optional APL character set

Over 5,000 DS120 units are now being used by customers ranging from the Fortune 500 to personal computing enthusiasts. In numerous installations, entire networks of terminals have been upgraded to take advantage of today's higher speed data communications services. LSI microprocessor electronics and strict quality control ensure dependable performance for years to come. When service is required, we will respond promptly and effectively. Best of all, we can deliver immediately through our nationwide network of distributors. Just give us a call for all the details.

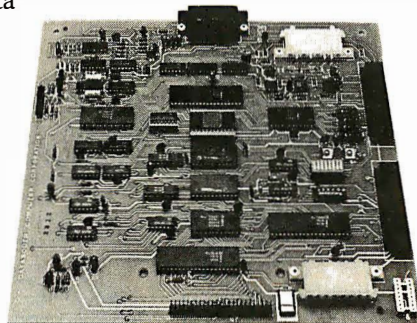

datasouth computer corporation

4740 Dwight Evans Road • Charlotte, North Carolina 28210 • 704/523-8500

Clubs and Newsletters

Program Innovators

Program Innovators is a new club for Texas Instruments TI-99/4 programmers and enthusiasts. For information, contact Gene Hitz, 2007 North 71st, Wauwautosa, WI 53213, (414) 453-0499.

Intel Has Solutions

Articles on single-board computers, notes on how to use Intel programmable-memory integrated circuits, new Intel products, new literature, and microcomputer workshops are included in *Solutions*, a bimonthly publication available free from Intel Corp., 3065 Bowers Ave., Santa Clara, CA 95051, (408) 987-8080.

Computers In Education

The New Hampshire Association for Computer Education Statewide (NHACES) has evolved to serve in an advisory capacity to public school educators regarding computer education and the use of computers in public schools in New Hampshire. NHACES is working to increase computer literacy and the use of computers in schools, improve the quality of computer education, and coordinate the dissemination of information regarding computer education, hardware, and software. Directories of products and services will be developed, maintained, and distributed to all members of NHACES. For complete details, contact NHACES, c/o Richard F. Antonak, Department of Education, University of New Hampshire, Durham, NH 03824.

VoiceNews Reports on Speech Technology

VoiceNews is a new publication devoted to speech-synthesis and speech-recognition technology. Published ten times a year, *VoiceNews* describes speech products such as integrated circuits, boards, peripherals, and systems. The newsletter also reports on applications for speech I/O (input/output), exhibitions, companies, courses, conferences, and other events in the voice-technology field. Subscriptions to *VoiceNews* are \$95 per year. Contact Stoneridge Technical Services, POB 1891, Rockville, MD 20850, (301) 424-0114.

Apples In North Carolina

TAC (Triad Apple Core) is made up of Apple users interested in home and business applications for the Apple. *TAC Notes* is the club's monthly newsletter. For information, contact Mitzi T. Grey, Triad Apple Core, POB 1624, Lexington, NC 27292, (704) 352-7126.

FORTRUG

FORTRUG is interested in popular computers for personal, hobby, and business uses. The club meets monthly on the third Tuesday at 7 p.m. at the Corsair Computer Corporation, 7952 Highway 80, West Fort Worth, TX 76116. Meetings cover applications, programming, problem solving, and idea exchange. A majority of members use TRS-80 computers.

No dues or fees are collected. FORTRUG can be contacted at the above address or by calling Linda Gill, (817) 731-8439, or Patrick Coyne, (817) 429-7055.

TRS-80 Color Computer Newsletter

The Rainbow is a monthly newsletter dedicated to Radio Shack's TRS-80 Color Computer. A typical issue contains feature stories, hints and tips on operation, sample programs, and reviews of new products. Annual subscriptions are \$12. Contact *Rainbow*, 5803 Timber Ridge Dr., Prospect, KY 40059, (502) 588-6171.

South Florida Computer Group

SFCG (South Florida Computer Group) has user groups for 6800, 8080, Z80, TRS-80, PET, Apple, Digital Group, and other microcomputer systems. The Miami and Fort Lauderdale areas are covered by SFCG's two sections. They publish the *I/O Newsletter*.

The SFCG Fort Lauderdale Section meets on the second Monday of each month at 8 p.m. Membership and newsletter are \$8 per year. Contact SFCG, Fort Lauderdale Section, POB 698, Hollywood, FL 33022, (305) 922-0935.

The Miami Section of the SFCG meets on the third Tuesday of each month at 8 p.m. Membership and newsletter are \$5 per year. For information, contact SFCG, Miami Section, 240 Northwest 203 Terrace, Miami, FL 33169, (305) 653-0669.

IBM Personal Computer Group

The Philadelphia Area IBM Personal Computer User Group has been formed. Group activities are sponsored, and a monthly newsletter is planned. Members of other IBM Personal Computer groups are invited to submit articles and ideas to the newsletter and the group. For information, contact Craig W. Uthe, 4101 Spruce St., Apt. 311, Philadelphia, PA 19104, (215) 387-8208.

Osborne Software Users

The Osborne Business Software Users Group promotes the use of Osborne/McGraw-Hill software. A newsletter is planned, and assistance to new users on implementation of the software will be provided. Membership fees are \$10, which entitles you to a newsletter subscription, bug reports and fixes, and access to compatible business software on 8-inch disks. Contact the Osborne Business Software Users Group, Suite 11, 2256 Main St., Otay, CA 92011, (714) 423-0538.

Computer Telephone Directory

The On-Line Computer Telephone Directory is a quarterly publication that provides information on computer bulletin-board systems and software, terminal equipment and software, and telephone numbers of free-access bulletin-board systems across North America. Contact *The On-Line Computer Telephone Directory*, POB 10005, Kansas City, MO 64111. ■

Software Received

Apple

Ampergraph, a graphics utility program for the Apple II. Floppy disk, \$25. Midwest Software, POB 9822, Madison, WI 53715.

Cribbage, a board game for the Apple II. Floppy disk, \$24.95. On-Line Systems, 36575 Mudge Ranch Rd., Coarsegold, CA 93614.

Discounted Cash Flow/Manufacturing Costs Estimator, a business package for manufacturing and engineering applications for the Apple II. Floppy disk, \$149. Centec, Inc., 11260 Roger Bacon Dr., Reston, VA 22090.

Disk Prep, a disk-testing and formatting program for the Apple II. Floppy disk,

\$25. Sympathetic Software, 9531 Telhan Dr., Huntington Beach, CA 92646.

Event Cruncher, critical-path-method analysis program for the Apple II. Floppy disk, \$85. Nottforhire Software, 1671B River Village, Fort Belvoir, VA 22060.

Fender Bender, an arcade game for the Apple II. Floppy

disk, \$24.95. California Pacific Computer, 1623 Fifth St., Davis, CA 95616.

Genetic Drift, a graphics arcade game for the Apple II. Floppy disk, \$29.95. Broderbund Software, 2 Vista Way, San Rafael, CA 94901.

The Graphics Printing System, screen-graphics printing system for the Apple II. Floppy disk, \$109.95. Progressive Software, Suite 323, Blue Bell West, Blue Bell, PA 19422.

Handicapped Typewriter, Version 2, a "non-keyboard typewriter" program for the physically disabled for the Apple II. Floppy disk, \$99. Rocky Mountain Software, 214-131 Water St., Vancouver, British Columbia, V6B 4M3, Canada.

Orbitron, an arcade game for the Apple II. Floppy disk, \$29.95. Sirius Software, 2011 Arden Way #225A, Sacramento, CA 95825.

Painter Power, a high-resolution-graphics development system for the Apple II. Floppy disk, \$39.95. Micro Lab, Inc., 2310 Skokie Valley Rd., Highland Park, IL 60035.

Print II, a print-formatting utility for the Apple II. Floppy disk, \$24.95. Computer Systems Design, 2139 Jackson Blvd., Rapid City, SD 57701.

SAT English 1, a tutorial program for the Apple II. Floppy disk, \$25. Micro Lab, Inc. (see address above).

Shuffleboard, a graphics arcade game for the Apple II. Floppy disk, \$29.95. Innovative Software Design, Inc., POB 1658, Las Cruces, NM 88004.

Space Quarks, a graphics arcade game for the Apple II. Floppy disk, \$29.95. Broderbund Software (see address above).

Star Thief, a graphics arcade game for the Apple II. Floppy disk, \$29.95. Cavalier

**This ad is aimed
at people with
PDP/LSI-11, 8080/Z80
and 68000 computers.**

**Don't be trapped into
a single-user operating system.**



Consider Idris.

Idris is multiuser. It uses memory management when available... and can run multiuser when memory management is not available.

Since Idris is available NOW on all these machines and we're moving it to the other 16 and 32 bit computers, you won't be locked-in to any one hardware vendor. Idris assures you the freedom to choose.

We wrote Idris, we maintain it. We'll train you—and we stand behind it. Write or call.

Protect your software investment.
Whitesmiths, Ltd.

P.O. Box 1132 Ansonia Station
New York, N.Y. 10023
(212) 799-1200 Telex 645 592

Idris is a trademark of Whitesmiths, Ltd.

Computer, POB 2032, Del Mar, CA 92014.

Stock Forecasting System, a program for stock investors for the Apple II. Floppy disk, \$175. Urban Aggregates, Inc., 6431 Brass Knob, Columbia, MD 21044.

Universal Graphics, high-resolution graphics development package for the Apple II. Floppy disk, \$39.95. Sympathetic Software (see address above).

Atari

Forest Fire, a fire-fighting simulation for the Atari 800. Floppy disk, \$20.95. Dynacomp, Inc., 1427 Monroe Ave., Rochester, NY 14618.

Galactic Chase, a graphics arcade game for the Atari 400/800. Cassette, \$24.95; floppy disk, \$29.95. Spectrum Computers, 26618 Southfield, Lathrup Village, MI 48076.

Stud Poker, a card-game program for the Atari 800. Floppy disk, \$15.95. Dynacomp, Inc. (see address above).

Supergraphics, a three-dimensional graphics and color game development system for the Atari 800. Floppy disk, \$39.95. United Software of America, 750 Third Ave., New York, NY 10017.

North Star

Cranston Manor Adventure, an adventure game for the North Star. Floppy disk, \$21.95. Dynacomp, Inc., 1427 Monroe Ave., Rochester, NY 14618.

Renumber, a utility program for the North Star. Floppy disk, \$39.50. Electronic Technicians Software Services, 1072 Casitas Pass Rd., Carpinteria, CA 93013.

Scan, a utility program for the North Star. Floppy disk, \$29.50. Electronic Technicians Software Services (see address above).

TRS-80

Asylum, a graphics adventure for the TRS-80 Model I or III. Floppy disk, \$19.95. Med Systems Software, POB 2674, Chapel Hill, NC 27514.

Atlantean Odyssey, a graphics adventure for the TRS-80 Model I. Floppy disk, \$29.95. Interpro, POB 4211, Manchester, NH 03108.

Blockade, a graphics arcade game for the TRS-80 Color Computer. Cassette,

\$14.95. Interpro (see address above).

Color Computer Disassembler, a utility program for the TRS-80 Color Computer. Cassette, \$19.95. Interpro (see address above).

Domes of Kilgari, an adventure game for the TRS-80 Model I and III. Cassette, \$19.95. The Programmer's Guild, POB 66, Peterborough, NH 03458.

Invasion Force, a strategy

game for the TRS-80 Model I. Cassette, \$14.95. Radio Shack, One 1800 Tandy Center, Fort Worth, TX 76102.

Package #1, five graphics arcade games for the TRS-80 Model I Level II. Cassette, \$7. Programmable Software, 508 Margin Rd., Lebanon, PA 17042.

Raaka-Tu, an adventure game for the TRS-80 Level II, Models I and III. Cassette,

This ad is aimed at people who know about UNIX

Consider Idris instead.

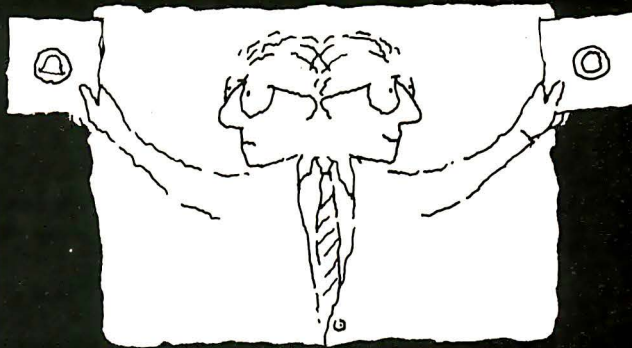

Idris is pin for pin compatible with Unix/V6. Same system calls. Same file system. The same software tools, too. So why Idris, you ask? First, it is available NOW on PDP/LSI-11, 8080/Z80, and 68000. Second, Idris costs less. And the license restrictions are much less cumbersome. Also, we support it. We maintain it. And we stand behind it. If you need more reasons to buy Idris, just ask. We have plenty.

Protect your software investment.
Whitesmiths, Ltd.

P.O. Box 1132 Ansonia Station
New York, N.Y. 10023
(212) 799-1200 Telex 645 592

Idris is a trademark of Whitesmiths, Ltd.

Unix is a trademark of Bell Labs.

Software Received

\$14.95. Radio Shack (see address above).

Space Warp, a strategy game for the TRS-80 Level II, Models I and II. Cassette, \$14.95. Radio Shack (see address above).

Ultra-Mon, a utility pro-

gram for the TRS-80 Model I. Cassette, \$24.95. Interpro (see address above).

Wordsmith, a word-processor program for the TRS-80 Model I Level II. Cassette, \$14.95. ABS Suppliers, Suite 4A, 3003 Washtenaw,

Ann Arbor, MI 48104.

ZX-80

Super Z, extended BASIC commands for the Sinclair ZX-80. Cassette, \$9.95. Lamo-Lem Laboratories, POB 2382, La Jolla, CA 92038.

ZX-80 Home Computer Package, utility and graphics programs for the Sinclair ZX-80. Cassette, \$9.95. Lamo-Lem Laboratories (see address above).

Other Computers

IBMPAK, a program to convert Flex files to IBM format for 6809-based Flex systems. Floppy disk, \$125. Helix Enterprises, 504 Fort Drum Dr., Austin, TX 78745.

Magic Typewriter Ver 3.0, a word-processing system for CP/M. Floppy disk, \$350. California Digital Engineer-

ing, POB 526, Hollywood, CA 90028.

Management Simulator, a business simulation for CP/M. 8-inch disk, \$26.45. Dynacomp, Inc., 1427 Monroe Ave., Rochester, NY 14618.

Rubik Cube Unscrambler Program. BASIC program listing, \$12. Wray, 31 Church Green, Totternhoe, Dunstable, Bedfordshire, LU6 1RF, England.

Unica and XM-80, a Unix-like operating system for CP/M and a macroassembler for the Z80. Floppy disk, \$195. Knowlogy, POB 283, Wilsonville, OR 97070.

Valdez, a maritime simulation for CP/M. 8-inch disk, \$22.45. Dynacomp, Inc. (see address above). ■

This is a list of software packages that have been received by BYTE Publications during the past month. The list is correct to the best of our knowledge, but it is not meant to be a full description of the product or the forms in which the product is available. In particular, some packages may be sold for several machines or in both cassette and floppy-disk format; the product listed here is the version received by BYTE Publications.

This is an all-inclusive list that makes no comment on the quality or usefulness of the software listed. We regret that we cannot review every software package we receive. Instead, this list is meant to be a monthly acknowledgment of these packages and the companies that sent them. All software received is considered to be on loan to BYTE and is returned to the manufacturer after a set period of time. Companies sending software packages should be sure to include the list price of the packages and (where appropriate) the alternate forms in which they are available.

PIXELCASTER

INTELLIGENT VISUAL PREPROCESSOR

RS-232
RS170
S100™
TRS-80™

Don't waste samples on input which contains no added information.

The two-card **PIXELCASTER®** (S100 size) allows powerful image processing via RS-232. Using a map, it samples a group of Pixels, and returns them to the host in ASCII. Application programs can be written in any language. System \$1485

DIGITAL CONTROLLER PDC-8106 \$790

- 256 x 256 x 4 Sample Resolution per Field
- 1024 Sample Points independently positioned anywhere on the screen
- Programmable Sample Output Order
- Z80A CPU Intelligent Image Preprocessor
- RS-232 300 — 19.2 K BAUD, 2 CH. Modem Control
- 2716/2732 Prom-based Monitor
- ASCII Command Protocol Load, Dump, Sample, Reset, Load, Offset
- 1K BYTE Ram Buffer for Code and Data, memory expandable via card connector
- Real Time Interrupts: Horiz. and Vert. Sync
- Pixel Positions base register addressed
- NMI Switch for program development

VIDEO INTERFACE PVD-8000 \$790

- NTSC Video Input — RS170
- Precision Window Digitizer — dual threshold
- Sample Clock 3.58 MHz locked to color carrier
- 32 Sample Modes — 32 Output Display Modes
- Intelligent Sync Extraction
- Auto/Computer Frame Control

Video Expansion Card — Available Soon

- 14 MHz Sample Clock — resolves 70 ns
- 4-Bit Video Digitizer — resolves 16 levels
- Dual 8-Bit DACS — set digitizer window

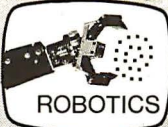

ROBOTICS



SECURITY



TEXT RECOGNITION

WRITE FOR INFORMATION

LogiGate

P.O. BOX 308
TILLAMOOK, OR. 97141
ORDER: (503) 842-6471

BYTE

Back Issues For Sale

The following issues are available:

\$2.00 ea.	\$2.75 ea.	\$2.75 ea.	\$3.25 ea.
July 76	May 78	Oct. 79	Feb. 81
Apr. 77	June 78	\$3.25 ea.	Mar. 81
May 77	July 78	Nov. 79	Apr. 81
June 77	Aug. 78	Dec. 79	May 81
July 77	Sept. 78	Jan. 80	July 81
Aug. 77	Oct. 78	Mar. 80	Aug. 81
\$2.75 ea.	Dec. 78	Apr. 80	Oct. 81
Sept. 77	Jan. 79	May 80	Nov. 81
Nov. 77	May 79	June 80	Dec. 81
Dec. 77	June 79	July 80	
Feb. 78	July 79	Aug. 80	
Mar. 78	Aug. 79	Oct. 80	
Apr. 78	Sept. 79	Dec. 80	

The above prices include postage in the US. Please add \$.50 per copy for Canada and Mexico; and \$2.00 per copy to foreign countries (surface delivery).

Send requests with payment to:

BYTE Magazine
70 Main St, Peterborough NH 03458
Attn: Back Issues

* Payments from foreign countries must be made in US funds payable at a US bank.
* Please allow 4 weeks for domestic delivery and 8 weeks for foreign delivery.

An Effective Text-Compression Algorithm

David Cortesi
2340 Tasso St.
Palo Alto, CA 94301

It is often desirable to be able to *compress* data: to encode it in a shorter form than normal so that it takes up less storage space. In a recent case, I found it essential. I was constructing a word-processing system based on a computer that had only 4096 bytes of memory. Into that tiny space, I had to cram the program as well as words for it to process.

Choice of compression algorithm is dictated by the data characteristics and the amount of space and running time tolerable in the compressing and decompressing routines. In this case, the data was general English text, which is probably the least compressible of any. The compression routines had to be small and simple, but not necessarily fast.

After some figuring, I came up with an algorithm that was fairly simple to implement, quick in execution, and effective. It can usually squeeze text to 75% of its original size. While it may have been written before, the algorithm was new to me. Anyone who needs to compress general text may find it useful, too.

The branch of mathematics called information theory says that data is compressible in so far as it is predictable. That is, the minimum number of bits needed to convey a particular message (using message to mean a piece of information) depends on how

many unique messages might be sent. At one limit, if only two messages are sent or stored, then only one bit is needed to encode them. Paul Revere's warning signal in the tower of the Old North Church could have been such a system: "0 = land, 1 = sea." (Historically, the famous signal was, of course, "one if by land, two if by sea.") At the other extreme, if absolutely any message at all might be sent, then an infinite number of bits would be needed to encode any single message uniquely.

Ordinary data falls somewhere between those theoretical limits, usually much closer to the one-bit end than to the other. For any list of practical messages, a theoretical minimum number of bits is needed to represent any one message. Often, the number of bits actually used to store information is larger than the theoretical minimum. The excess bits are *redundant*. The aim of data compression is to remove as much redundancy as possible.

Character data encoded in the ASCII (American Standard Code for Information Interchange) format constitutes a set of 128 possible messages. Any of the 128 pieces of information can be encoded in 7 bits, as a binary number between 0 and 127. Microprocessors designed around an 8-bit word store ASCII characters one per word, for convenience. The inconvenient alternative is to store one and one-seventh characters per word, which would complicate programs considerably. This convenience is bought at a cost of 12% redundancy (1 redundant bit in 8).

Any one collection of data may have even more redundancy. A pro-

gram in BASIC uses only the upper-case letters, digits, and limited punctuation; fewer than 64 unique characters. The BASIC vocabulary of possible messages could be represented in a code of just 6 bits per character. It's feasible to write a program that would compress a BASIC source file so that every 3-byte group expresses four 6-bit letters. This compression is achieved by predicting and encoding for a smaller vocabulary of messages in the data.

Another type of compression requires knowledge of another kind of predictable characteristic: the statistical distribution of messages in the data. If you could confidently predict that, for example, 50% of all the characters in a file were the letter Z, you could arrange an encoding based on these rules:

- a 1 bit stands for Z
- a 0 bit says "take the next 7 bits as an ASCII character other than Z"

This would produce a nice compression. Fifty percent of the letters in the file (the Zs) would be stored as single bits; the other 50% as groups of 8 bits. The average number of bits used to store a character would be 4.5. This scheme can be generalized by adding more rules, until every *n*th-commonest letter is encoded in exactly by *n* bits (i.e., the most common character is encoded in 1 bit, the second most common is encoded in 2 bits, and so on).

Two things are wrong with this scheme and its generalized variations. It isn't effective unless each character is stored as a variable number of bits,

About the Author

David Cortesi has had extensive experience in the computing world, including work in the fields of machine repair and marketing and as a developer of interactive software. He recently dropped out of the mainframe computer business to write about, and experiment with, personal computers.

Listing 1: Text-compression algorithms as described in the text, written in a loosely structured pseudocode based on Pascal. The notation @pointer means "the byte addressed by pointer."

```

procedure COMPRESS( ADIN: points to the input;
                   ADOUT: points to the output)

  local bytes THIS, THAT,
  local numbers FIRST, SECOND.

  REPEAT
    BEGIN
      THIS := @ADIN                                (pick up next character)
      FIRST := MEMBER(THIS,13)
      IF ( FIRST ≠ 13 ) THEN                        (THIS is in the long list)
        BEGIN
          THAT := @(ADIN+1)                        (check the next byte)
          SECOND := MEMBER(THAT,8)
          IF ( SECOND ≠ 8) THEN                    (THAT is in short list)
            BEGIN                                  (build a digraph)
              THIS := a digraph made from FIRST & SECOND
              ADIN := ADIN+1
            END
          ENDIF
        END
      ENDIF
      @ADOUT := THIS                                (store byte or digraph)
      ADOUT := ADOUT+1                              (and bump the pointers)
      ADIN := ADIN+1
    END
  UNTIL ( THIS = string-end-marker byte)
END COMPRESS

```

```

function MEMBER( LETTER: a byte; LISTSIZE: a number)
  RETURNS a number

```

(this function returns the origin-zero index of LETTER in TABLE if it is there, or a failure signal if it is not. For clarity the signal is shown as a too-high index, but it could be anything, e.g. setting the carry flag.)

local pointer P, local number T.

```

P := address of TABLE (point to " etaoinshrdlu")
T := LISTSIZE

```

```

REPEAT
  BEGIN
    IF ( LETTER = @P ) THEN GOTO FOUND
    P := P+1
    T := T-1
  END
UNTIL ( T=0 )
RETURN LISTSIZE (indicate failure)

```

```

FOUND: (LETTER is in the first LISTSIZE elements of TABLE;
       at this point T is in the range LISTSIZE..1)
RETURN LISTSIZE-T (..origin-zero index)
END MEMBER

```

Listing 1 continued:

```

procedure DECOMPRESS( ADCOMP: points to the compressed input;
                     ADNORM: points to the output)

local bytes THIS, THAT,
local number T.

REPEAT
  BEGIN
    THIS := @ADCOMP
    IF ( Bit 7 of THIS is a 1 ) THEN
      BEGIN
        T := extracted bits "aaaa" of THIS
        @ADNORM := TABLE[T]
        ADNORM := ADNORM+1
        T := extracted bits "bbb" of THIS
        THIS := TABLE[T]
      END
    ENDIF
    @ADNORM := THIS (store 2nd or only character)
    ADNORM := ADNORM+1
    ADCOMP := ADCOMP+1
  END
UNTIL ( THIS = string-end-marker byte )
END DECOMPRESS

```

without regard to the word size of the processor. This usually makes the compression and decompression processes complex and slow. Second, it won't work at all if the prediction of letter frequencies is wrong. If the two rules above are applied to a file that contains no Zs, then all letters will fall under the second rule and be stored as 8 bits, one more than necessary. In general, if the data is not as predicted, this algorithm will expand it instead of compressing it. The more rules in the algorithm, the more predictions the computer makes about the data, and the greater the error when the predictions are wrong.

Let's try another approach to compression and accept that it's a practical necessity to respect the machine's 8-bit word boundaries. Each word can represent any one of 256 messages. Is there a way to make full use of all 256 messages? If so, we would eliminate at least the basic 12% redundancy. If some of the new messages can be made to stand for groups of the old ones (the ASCII characters) then even more redundancy would be eliminated.

A word of caution. The computer makers already may have made

WHY SHOULD YOU PAY FOR THEIR AD SPACE ? ?

You'll see many large mail order ads, all with the lowest price. We think that's funny because we know what those large ads cost and who has to pay for them - YOU! At Futra Company, we try to provide our customers with true value. True value to the customer is not in larger ads but in better service. Futra has sold through mail order for the past four years. Our reputation for fast delivery and courteous service has flourished. Most of our sales are repeat customers or referrals. We're proud of that. So, why pay for their ad space? Look over the list of product lines we carry and call us when you need a quote on a specific product. Stop paying for ad space and consider true value.



FUTRA "Star Values"			
Microsoft Z-80 Softcard	\$269.00	Xerox 820	CALL
Microsoft 16K Ramcard	129.00	Vector Graphics	CALL
Videx Videoterm	265.00	Altos 8000 series	CALL
Epson MX-100 & MX-80/ft.	CALL	SUPPLIES:	
Zenith 12" Green Monitor	119.00	Scotch Diskettes	
Novation Apple-Cat-Modem	319.00	744-0, 10, 16 RH 5"	\$27.00
SOFTWARE:		745-0 RH DS/DD 5"	39.00
Wordstar 3.0 (Apple)	229.00	741-0 RH SS/DD 8"	37.00
Peachtree/40 (Apple)	195.00	743-0 RH DS/DD 8"	44.00
Peachtree/5 (8" CP/M)	350.00		

ABT	ADDS	ALDOS	ANALOX	ASBORNIE (BOOKS)	ASTON TATE	BFI	CCS	COMMODORE	CORVUS	DYSON	EPSON	HATES	HAZELTINE	HEWLETT PACKARD	HOWARDGOTT	KIMAN	M & R	MICRO FOCUS	MICRO PRO	MICROMOM	MICROSOFT	MITSUBISHI (VCR)	MORROW DESIGNS	MOUNTAIN COMPUTER	NEC	NOVATION	PANASONIC	PEACHTREE	RCA (VCR)	SANTO	SCOTCH	SHARP	SOFTWARE PUBLISHING	SONY (VCR & PRINTER)	SPRIM	SSW	STONEWARE	STRUCTURED SYSTEMS	SUPPLIES	SYSTEM PLUS	TOK	TELEVIDEO	TEXAS INSTRUMENTS	TNC	TWC	VISTA	XEROX	ZENITH DATA SYSTEMS
-----	------	-------	--------	------------------	------------	-----	-----	-----------	--------	-------	-------	-------	-----------	-----------------	------------	-------	-------	-------------	-----------	----------	-----------	------------------	----------------	-------------------	-----	----------	-----------	-----------	-----------	-------	--------	-------	---------------------	----------------------	-------	-----	-----------	--------------------	----------	-------------	-----	-----------	-------------------	-----	-----	-------	-------	---------------------

(213) 328-8951 - (800) 421-5006
 TWX 910-349-6211
 Cable AGENFTRA

FUTRA COMPANY

Mail Order to: P.O. Box 4380, Torrance, CA 90510-4380
 Retail: 20695 S. Western Ave., Suite 124, Torrance, CA 90501

TERMS: Shipping add 3% for product shipped within continental USA via UPS surface (minimum \$3.00). If the order is placed prepaid with U.S. funds in the form of check or money order, a Total Charge of \$3.00 for shipping is all you pay within the continental USA via UPS surface. Allow 14 working days for personal and company checks to clear. Credit card charges limited to \$1000. No COD's, P.O. APO or orders outside continental USA call or write for shipping charges or add 10% to purchase price (any difference will be refunded). California residents add 6% sales tax. All offers subject to change or withdrawal without notice.



Make Your Dreams Come True With Computer Shopper

Now you can expand your system or get a new one at prices you had never dreamed possible by taking advantage of the thousands of bargains each month in COMPUTER SHOPPER.

COMPUTER SHOPPER is THE publication for buying, selling and trading new and used micro and mini-computer equipment, accessories and software.

- Buy, Sell or Trade
- Over 60 Big (11" x 14") pages
- Over 20,000 readers nationwide
- Classified ad only 12¢ a word
- Hundreds of ads from individuals
- Money back guarantee

New subscribers are entitled to a FREE 50 word classified ad to use for software or used equipment plus a FREE ISSUE all for the low subscription price of ONLY \$10.00.

SAVE OVER 50% OFF the single copy price of \$1.50. Add it up:

- 12 issues @ \$1.50.....\$18.00
- One free issue.....\$1.50
- Free 50 word classified ad\$5.00

TOTAL VALUE.....\$24.50

NOW ONLY \$10.00. You save \$14.50.

MasterCard or VISA subscription orders only
Call TOLL FREE 1-800-327-9920



Yes, I want to save money with Computer Shopper. If I'm not 100% satisfied with my first issue my money will be refunded in full and I get to keep the first issue FREE.

- 1 yr. (3rd class) \$10.00
- I am a new subscriber - send me a certificate for a free classified ad.

NAME _____

ADDRESS _____

CITY _____

ST _____

ZIP _____

OFFER EXPIRES 4/30/82

assumptions about that "unused" eighth bit in a character byte (the most significant bit, usually designated as bit 7). For example, most firmware monitors assume it is a parity bit and clear it to zero when exchanging a byte with a terminal (thus defeating any value it may have had as a parity check, but never mind). Some video boards use the bit to distinguish the normal character set from a set of 128 graphics symbols. Still, if the compressed data is kept only in storage or in a file and is always decompressed for transmission to a peripheral, it's probably safe to use the eighth bit. That gives us an expanded alphabet of 256 characters to play with, 128 of them new and uncommitted.

One common use of these byte values is the implementation of *run-length encoding*. Each of the 128 new characters is interpreted by these rules:

- set bit 7 to 0, then
- take the resulting integer and replicate the byte that follows it that many times

With this algorithm any string of 3 to 130 identical characters can be expressed in just two bytes. The first byte is one of the new characters; it signals a run of identical characters and tells its length. The second byte indicates the repeated character. When the data predictably contains runs of like characters, then run-length encoding compresses very well. Unfortunately, the general English text with which a word processor must deal contains almost no runs of characters.

I hit upon the idea of using the extra 128 byte values to represent pairs of letters, or *digraphs*. Putting a pair of letters in a single byte will certainly result in compression, but the expanded alphabet will only accommodate 128 unique pairs over and above the standard ASCII characters. To result in compression, the pairs that are encoded must be the pairs that can be predicted to occur the most frequently. Another requirement is that it must be very easy to identify a compressible pair, so that the compression code can be simple.

Cryptographers have compiled lists of the frequency of use of digraphs in English. It would be possible to include a table of the 128 most frequent digraphs in the compression routine. But that would require 256 bytes of precious space and entail a lengthy search over the list for every pair of candidate letters.

Cryptographers and printers have long known the sequence "etaoinshrdlu" as the frequency order of the twelve most common letters in English. The same letters are the most common in all the Romance languages, although the order varies. Here is one prediction that can be made with confidence about any sample of text. Inside a computer, the blank space is a letter on par with the others, probably the most frequent one of all, so it should be added to the head of the list.

I reasoned that if these are the most common individual letters, then pairs of letters from that list will be common; not necessarily the most common, but frequent enough to result in compression. That has proved to be the case. The basic notion of the algorithm is to find adjacent pairs of letters in which both letters are on the list of the most frequently occurring letters and make digraph bytes of those pairs.

I chose the following organization for a digraph byte: 1aaaabbb. Bit 7 is set to 1 to signal a digraph. The next four bits, aaaa, represent a binary number in the range 0..12 and stand for the first letter of the pair. The least significant three bits, bbb, are a number in the range 0..7 and stand for the second letter of the pair. This sort of bit manipulation is usually difficult and always obscure in a high-level language. In machine language, it is easy to partition a single byte into two or more groups. Notice that it isn't possible to include two 4-bit numbers plus a flag bit in 1 byte. The digraphs that can be encoded in this way are the 104 pairs whose first character is one of the thirteen letters "(space)etaoinshrdlu" and whose second member is one of the shorter list of eight letters "(space)etaoins." A side benefit of this encoding is that, because the bits marked "aaaa" won't

Into Computers? Robotics? Want to get started?



The Computer Book Club keeps you on top of the dynamic, fast-paced world of computers . . . all the latest info on hardware, software, applications, and theory *plus substantial savings!*

Select 6 fact-filled, money-saving books for only \$2.95

(total value up to \$106.70)

1982 Computer Calendar FREE!

1299 List \$16.95
1333 List \$16.95

101 MICROPROCESSOR SOFTWARE AND HARDWARE PROJECTS
1187 List \$15.95

1203 List \$14.95
1195 List \$12.95

1276 List \$15.95
1241 List \$12.95

1000 List \$10.95
1160 List \$12.95

1205 List \$15.95
1062 List \$12.95

1228 List \$12.95
1295 List \$16.95

1053 List \$12.95
1369 List \$21.95

1111 List \$14.95

1055 List \$8.95

1332 List \$16.95

1191 List \$16.95

1200 List \$16.95

1053 List \$12.95

1330 List \$15.95

1003 List \$10.95

1275 List \$14.95

1005 List \$10.95

1251 List \$16.95

1275 List \$14.95

1330 List \$15.95

1982 Computer Calendar FREE when you join!

Publisher's List \$5.95

7 very good reasons to try The Computer Book Club Blue Ridge Summit, PA 17214

- **Reduced Member Prices.** Save up to 75% on books sure to increase your know-how
- **Satisfaction Guaranteed.** All books returnable within 10 days without obligation
- **Club News Bulletins.** All about current selections—mains, alternates, extras—plus bonus offers. Comes 10 times a year with dozens of up-to-the-minute titles you can pick from • "Automatic Order". Do nothing, and the Main selection will be shipped automatically! But . . . if you want an Alternate—or no books at all—we'll follow the instructions you give on the reply form provided with every News Bulletin
- **Continuing Benefits.** Get a Dividend Certificate with every book purchased after fulfilling membership obligation, and qualify for discounts on many other volumes
- **Extra Bonuses.** Take advantage of added-value promotions, plus special discounts of software, games, and more
- **Exceptional Quality.** All books are first-rate publisher's editions, filled with up-to-the-minute info

THE COMPUTER BOOK CLUB Blue Ridge Summit, PA 17214

Please accept my membership in The Computer Book Club and send the 6 volumes circled below, plus a free copy of the 1982 Computer Calendar. I understand the cost of the books selected is \$2.95 (plus shipping/handling). If not satisfied, I may return the books within ten days without obligation and have my membership cancelled. I agree to purchase 4 or more books at reduced Club prices during the next 12 months, and may resign any time thereafter.

1000 1045 1053 1055 1062 1111 1160 1187
1191 1195 1200 1203 1205 1228 1241 1251 1271
1275 1276 1295 1299 1330 1332 1333 1369

Name _____ Phone _____
Address _____
City _____
State _____ Zip _____

(Valid for new members only. Foreign and Canada add 20%. Orders outside U.S. or Canada must be prepaid with international money orders in U.S. dollars) BY-182

MULTIPROGRAMMER

KITS AVAILABLE

SYSTEM-10

**PROGRAMS
OVER 100
POPULAR
PROMS &
EPROMS**



Standard Features:

- RS232 Serial Port - Standard Formats
- 4.75 K RAM (Expandable)
- Device Read, Compare & Verify
- Editing & Special Functions
- Less Than \$1,500 for Programmer, Module and Adapter
- Attractive OEM Prices



COMPUTER SYSTEMS CORPORATION

100 E. Linton Blvd
Delray Beach, Fla 33444

Phone (305) 272-2051

REP AREAS AVAILABLE

be used for a number larger than 12, it will never form a byte of the binary form "1111xxxx." The 16 byte values of this form could be used to implement run-length encoding for runs of 3 to 18 characters if that were desired.

I had to implement the algorithm in a tedious manner: by hand-assembling the machine-language instructions and typing them as hexadecimal numbers. This process is likely to produce both typographical and logic errors. To minimize the chance of logic errors, I first wrote the algorithm in a pseudocode, which is a program written in a precise way but not necessarily in any real programming language. Since the pseudocode program will never be read by a machine, one is free to use any kind of notation that will make the meaning clear.

For this project, I carried the pseudocode to a very fine level of detail so that I could translate it directly into machine instructions (see listing 1). Most of its conventions are those of Pascal, loosened and simplified. The notation *@pointer* is a concession to the needs of machine-language programming; it means "the byte addressed by *pointer*."

Procedure COMPRESS is called to compress a single line of characters; the line is terminated by some special character such as a carriage-return. It inspects the line from left to right. If a character is not in the list of thirteen common letters, it is simply copied to the output string; if the copied byte is the end-marker, then the procedure is completed.

When a specific letter is found in the list of thirteen common letters, the next character is tested against the first eight letters of the same list. If it, too, is found, the indices corresponding to the two letters are combined into a single byte and the combined byte is stored.

Function MEMBER tests a character for membership in the list of frequent letters. When it finds the letter in the list, it returns the letter's index in the list, counting from zero. Such origin-zero indices are more convenient to use at the level of machine language. If the character does not

Choice

GNT Makes a Tape Punch Station and a Tape Reader/Punch Combination.

Both are small, quiet, and economical. One of them will fit your needs exactly.



The 4601 Combo

- Punching speed: 75 Cps
Reading speed: up to 150 Cps
- RS-232-C serial interface
- Utilizes all types of Mylar® and paper tape
- Reliability: MTBF 100 million characters

The 3601 Punch

- Punching speed: 50 or 75 Cps
- RS-232-C serial interface
- Utilizes all types of Mylar® and paper tape
- Reliability: MTBF 100 million characters

Serviced nationally by **Carterfone**

GNT AUTOMATIC INC.

1560 Trapelo Road, Waltham, MA 02154 (617) 890-3305 Telex: 923318

Make me a willow cabin at your gate,
 And call upon my soul within the house;
 Write loyal cantons of contemned love
 And sing them loud even in the dead of night;
 Halloo your name to the reverberate hills,
 And make the babbling gossip of the air
 Cry out "Olivia!" O, you should not rest
 Between the elements of air and earth,
 But you should pity me!

Mak(e)m(e) (a)wil(lo)w cab(in) (a) (t)you(r)g(at)e,
 An(d)cal(l)up(on) my(s)ou(l)w(it)(hi)(n)t(he) (ho)(us)e;
 W(ri)(te) (lo)ya(l)c(an)(to)(ns) (o)f c(on)(te)m(ne)d) (lo)ve
 An(d) (si)ng(t)(he)m (lo)u(d)ev(en)
 (i)n)t(he) (de)a(d)of(n)ig(ht);
 Hal(lo) (o)you(r) (na)m(e) (to) (t) (he)
 (re)verbe(ra) (te) (hi)l(ls),
 An(d)mak(e)t(he) babb(li)ng g(os)(si)p(o)f(t)(he) (a)ir
 Cry(o)(ut) "O(li)v(ia)!" O, yo(u)s(ho)ul(d) (no) (t) (re) (st)
 B(et)w(ee) (n)t(he) (e) (le)m(en) (ts) (o)f
 (a)i(r) (an) (d) (ea) (rt)h,
 B(ut) yo(u)s(ho)ul(d)p(it)y me!

Figure 1: Effect of compression on a sample text, from Twelfth Night. Each parenthesized pair of characters would be stored as a single byte. There are 339 characters in the sample; 100 pairs are formed for a space saving of 29%.

appear in the list, MEMBER returns a failure signal.

Procedure DECOMPRESS expands a line that had been processed by COMPRESS. Ordinary characters are just copied to its output. Digraph bytes are split up and the indices they contain are used to find the letters of the pair in the list of common letters.

Figure 1 illustrates the effect of the compression algorithm on a sample of data. The algorithm has proven quite effective. In fact, it is part of the micro word processor used to type this article. Of its 4096 bytes, about 2700 are available for data storage. Compression makes this the equivalent of about 3300 bytes,

which is ample room for a typical letter or manuscript page.

The compression code itself occupies fewer than 150 bytes, and the processing overhead it adds is not perceptible in the program's response. I hope the algorithm will work as well in someone else's program as it worked in mine. ■

Ask BYTE

Conducted by Steve Clarcia

Differing Views on Mail Order

There has been a lot of controversy lately concerning mail-order versus retail purchase of computer hardware. The following letters might help shed some more light on the issues. . . . Steve

Dear Steve,

Two recent letters in your column have really upset me. I am a computer-marketing representative for Radio Shack. I would like to address the letters from Jeff Goodling and Dave Storti. (See "Mail-Order Forum" in the October 1981 BYTE, page 316.) Mr. Goodling asks if Radio Shack is dumping defective products through mail order. All mail-order outlets are independent dealers. Some of these outlets openly advertise that they have modified the computer. Why, then, would someone take a chance on getting a modified or damaged piece of equipment when they could test it out locally? A great number of people have already learned that the few dollars saved through mail order isn't such a bargain.

Mr. Storti's case is one most computer representatives see nearly every week: the businessman who wants all that terrific local support and service but doesn't want to pay for it. There is no free lunch, Mr. Storti. That price difference represents the important hand-holding time I'm going to give you. That's something the mail-order folks don't care about. Radio Shack has a leasing plan through A & A Leasing (our own leasing company). I don't know where Mr. Storti came up with his maintenance costs, but it wasn't from a Computer center.

Anyone who services an IBM, Wang, or Lanier for \$400 to \$800 a year less than the cost of service on a Model II is doing it for free, as the service on a Model II is \$476 a year. Mr. Storti kept dwelling on a five-year life for his computer system. Four years from now, Mr. Storti will be trying to figure a way out of his lease because the system will be outdated.

Radio Shack is after the business market, and it's getting it. I can't get Model IIs fast enough. I was offered jobs with Apple, Digital Equipment Corporation, and Data General but chose Radio Shack because I feel it has the best product for the money. Mr. Goodling and Mr. Storti both have the same problem. They expect Radio Shack to be all things to all people and do it for free. The "big guys" don't do it, and I don't think we should either. If either of these gentlemen wants to honestly and intelligently discuss the benefits of a TRS-80 versus any other system, he can call me at (304) 296-5492. Thank you.

Donald C. Kirkendall, Jr.
Morgantown, WV

Dear Steve,

About those mail-order TRS-80s . . .

I was recently involved in the purchase of a TRS-80 Model III through the mail-order firm Marymac Industries, Inc., operating out of the Houston area. We checked out Marymac's offer of local references and found out they included a nationally known, locally based electronics firm that had good things to say about Marymac.

On the strength of that, other references, and telephone conversations with various mail-order firms, we

decided to buy from Marymac. It shipped exactly what we ordered on the day we ordered it, and our Model III arrived in six days (two of those were the weekend).

In short, Marymac did what it said it would do. (Incidentally, Marymac picked up the shipping charges.)

But, like many others, our Model III arrived with one of the drives out of commission. However, our encounter with the local Radio Shack Computer Center in Tempe, Arizona, and our request for repair service couldn't have been handled more professionally had we bought directly from the local store.

Store manager David Kelly and salesman Joe Rubey grimaced only slightly when we told them where we bought our "lame" Model III and then took us under their wing. They kept us informed as to how repair work was coming and called when it was ready to be picked up. And, of course, there was no charge.

In short, our mail-order purchase was very satisfactory. Our Model III is now in daily use, and we have been back to the local store for programs and supplies.

My only complaint is that with its Scripsit program up and running the Model III has become too popular in our office, so popular I couldn't get to it to write this letter.

Burton C. Kennedy
Phoenix, AZ 85003

A Loaded Question Answered

I have an answer to Dave Bower's letter, "A Loaded Question." (See the July 1981 "Ask BYTE," page 218.) The solution to the same problem appeared in the July 1978 issue of Radio Shack's *Micro-*

computer Newsletter. The article, called "How to Merge Two Programs Using CLOAD Command," suggested this:

1. Make sure that the program to be merged (the one on cassette) has line numbers that are larger than the line numbers of the program located in memory.
2. Look at the contents of locations 16633 and 16634 using PRINT PEEK (16633), PEEK (16634). Write down the numbers.
3. If the contents of 16633 are 2 or greater, execute the following statements:

```
POKE 16548, PEEK  
(16633)-2:  
POKE 16549, PEEK (16634)
```

Then go to step 5.

4. If the contents of 16633 are 0 or 1, execute the following statements:

```
POKE 16548, PEEK (16633)  
+254:  
POKE 16549, PEEK  
(16634)-1
```

5. CLOAD the program from cassette. Then execute the statements:

```
POKE 16548, 233:  
POKE 16549, 66
```

6. LIST, RUN, or CSAVE the merged program.

Mr. Bower also asks if there is a system tape to do this. The answer is yes. It is called Remodel & Proload and is manufactured by Racet Computes, Suite M, 1330 North Glassell, Orange, CA 92667, (714) 997-4950. It costs \$35, and you must specify whether you have a 16 K-, 32 K-, or 48 K-byte machine. The Remodel & Proload can renumber any

"THE BETTER BOARD"

SB-80 Single Board Computer

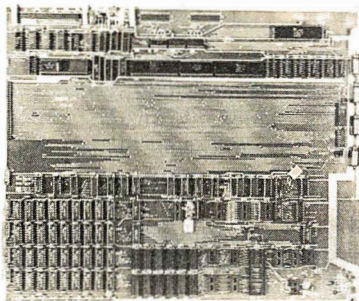

**Z-80-A
64K RAM**

Fully Assembled and Tested

Size: 16" x 13"
Same as 2 8" floppy drives. Requires:
+5V 1.5 Amp
-5V 1.0 Amp
+12V 1.5 Amp

\$825.00

The SB-80 single computer board along with for 2 8 inch disk drives, a power supply, an enclosure, and a CRT give you a complete computer system that can be used for either business or personal use and will still allow for upgrade options (up to 4 floppy drives, 5 to 40 megahard disk, or 24 x 80 character video).

CONSTRUCTION

- Computer is fabricated on a single printed circuit board.
- Sockets for all integrated circuits.
- 50 pin connector allows access to system for future expansion.

PROCESSOR

- Z80A with 4 MHz system clock with no wait states.

MEMORY

- 64K of 200ns dynamic RAM is standard. 4116 IC's.
- Parity protection is standard. A memory error places the system in a permanent wait state and lights on LED indicator.

ROM

- 256 bytes bootstrap ROM.

2 SERIAL I/O's

- Z80A-SIO/O dual channel chip.
- Two complete bidirectional serial ports with RS232 buffering. Fully programmable for Asynch, Bi-synch, and SDLc.
- Programmable dual baud rate generator on board. Selectable baud rates up to 19.2kb. Provisions for modem supplied clocks.
- Interrupts or polling under program control.

2 PARALLEL I/O's

- Z80A-PIO chip.
- Two complete TTL eight-bit bidirectional ports with extra handshake lines. Interrupts or polling under program control.
- Printer support through one parallel port.

COUNTER/TIMERS

- Z80A-CTC chip.
- Four separate counter/timers under program control. Counters can count external events and can interrupt or be polled. Timers are programmed to interrupt or signal an external device after a desired time interval.

FLOPPY DISK CONTROLLER

- Uses Western Digital 1793 controller chip which supports soft-sectored formats under program control.
- Standard IBM - CP/M single density formats or double density for 600K bytes per side. Density is selected by way of software control runs CP/M 2.2*

EXPANSION

50 pin connector bus allows for future expansion capabilities.

OPTIONAL

Character video board 80 x 24 for use with black and white monitor using a stand-alone keyboard. \$215.00

OPTIONAL

Winchester Host Adaptor board for Shugart SA-1000 or Corvus Hard Disk. Includes cables. \$315.00.

OPTIONAL

Stand-alone keyboard and cable plugs into computer board for 80 x 24 video option. \$190.00.

CP/M* 2.2 & BIOS

CP/M* 2.2 & BIOS modified by S & M systems to run on single board is available for **\$200.00**

HOW TO ORDER

Phone orders using American Express, Visa, MasterCard, Bank wire transfer, Cashier's or Certified check, Money Order, or Personal check (allow 10 days to clear). Please add 5% for shipping, handling and insurance minimum \$500.00. Conn. residents add 7.5% sales tax. All equipment is subject to price changes and availability without notice. All equipment is new and comes complete with manufacturers warranty. Showroom prices may differ from mail-order advertisement.

* CP/M is a trademark of Digital Research Corp.
** 1 to 4 piece domestic U.S. price.

SB-80

The Price Is Nice.



Introductory offer... \$2425.

Basic system with: 600K bytes

- 1.2 megabytes \$2990.
- 2.4 megabytes \$3490.

Single Board Technology

A Z80A CPU combined with the CP/M® operating system opens new vistas to software availability for eight-bit micros. FORTRAN, COBOL, BASIC, APL, PL/1 and Pascal are available now to accommodate today's scientific, educational, sophisticated small business and personal system users.

- 4 MHz Z80A CPU
- CP/M 2 operating system
- 64K 200ns main memory
- 8-inch dual floppy drives
- 50-pin expansion connector
- 2-serial ports
- 2-parallel ports
- 4-counter/timers
- Hard disk options available

CPU — DISK DRIVE CABINET

Metal cabinet with proportionately balanced air flow-convection cooling, AC power cord connector, lighted power switch, Fuse assembly, 0L65 Dual drive power supply (Will also power single board CPU). All hardware included to mount 2 8" disk drives. Includes space area to mount any single board computer. Fully assembled and tested.

SB-..... Cabinet Kit \$445.00
SB-..... Bare Cabinet \$135.00

SS/DD DISK DRIVE SYSTEM

SB Assembled tested with 2 8" drives... \$1185.00

DD/DD DISK DRIVE SYSTEM

SB Assembled tested with 2 8" drives... \$1650.00

8" FLOPPY DISK DRIVES:

Single Sided/Double Density Double Sided/Double Density

Shugart 800/801R \$395.00 2/\$770.00
Shugart 850/851R \$590.00 2/\$1140.00

PRINTERS

Okidata Microline 82A Bidirectional Friction/Pin Feed 9 x 9 Pin Head \$595.00

Okidata Microline 83A 120 cps: Bidirectional 19 x 9 Pin Head \$795.00

82A Tractor \$75.00

C. Itoh Starwriter (Parallel) 25 cps: Daisywheel \$1550.00

C. Itoh Starwriter (Parallel) 45 cps: Daisywheel \$1850.00

C. Itoh Starwriter Tractor \$190.00

TERMINALS

Televideo 910 \$625.00
912C \$725.00
920C \$770.00

ADDS Viewpoint \$620.00

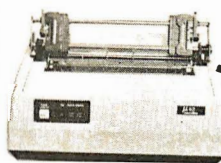
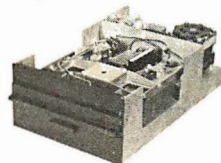
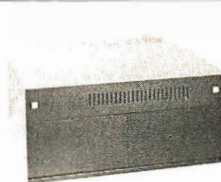

IC's

16K Static RAM 4116 200ns \$2.30 ea. 16/\$32.00
Z80A CPU \$6.00
Z80A CTC \$6.00
Z80A PIO \$6.00
Z80A SIO/O \$19.00



Colonial Data Services Corp.

105 Sanford Street Hamden, Conn. 06514

(203) 288-2524 • Telex: 956014

Circle 401 on inquiry card.

portion or all of a BASIC program, move any portion of a BASIC program, delete lines or range of lines, merge all or any portion of a BASIC program from tape with renumbering on the way in, save combined and merged program or any portion of a program to tape, and verify the contents of the saved program bit-for-bit. Also, it allows you to selectively save and load a library of data statements, which is a more effective method of retrieving and loading data than using data-tape facilities.

A. C. Posada
Richmond, VA

Just like "Dear Abby," sometimes my readers provide advice that's more up-to-date. A case in point is my answer to Dave Bowers. I've received 20 letters that corrected me on this point. Thank you. . . . Steve

Small System Monitor

I have been looking for a Z80 system monitor that can fit into 1 K bytes of space, i.e., a 2708 EPROM (erasable programmable read-only memory). The functions I want are:

- dump memory content to console
- input data to memory through console keyboard
- execute program at user-specified address
- modify and display registers of the Z80 processor
- single-step of absolute program
- breakpoint of user program
- fill memory with user-specified data
- move memory contents from one place to another

Can you provide me with any such program, including source listings? I can do some

patching to suit my system.
Albert K. Lee
Scarborough, Ontario, Canada

My latest book, Build Your Own Z80 Computer, published by BYTE/McGraw-Hill, contains a rather complete 1 K-byte EPROM-resident monitor that does much of what you're looking for. It allows you to display and replace memory, display and replace registers, execute a program in a specified address, and it facilitates serial I/O (input/output). The complete source code is included with the book and can be easily modified to accommodate some of the breakpoint and single-step functions you would like. Contact BYTE Books, 70 Main St., Peterborough, NH 03458, (800) 258-5420; in New Hampshire (603) 924-9281.

Also, the MicroWorks, POB 44248, Cincinnati, OH 45244, has a small monitor, which I've been using for a number of years, that has all of these features. (I cannot recall whether it's 1 K, it may be more.) MicroWorks' program Stepper is everything you could want. It was designed to run on a Digital Group Z80 computer, but I'm sure it can be modified for your system. The source code, however, may not be available. . . . Steve

Color-Monitor Bandwidths

Dear Steve,

What color monitor and what combination monitor/receiver would you recommend for 640 by 200 pixel graphics? What information should I look for when evaluating monitors? My local TV store is of no help at all on these questions. Also, can you recommend a reference to read on this subject?

Ronald I. Frank
Framingham, MA

I can't go into all of the details and theory, but I will try to answer your question. The bandwidth needed is calculated by dividing the active-trace time by the number of horizontal dots. In other words, 48 microseconds divided by 640 dots is 74 nanoseconds per dot, or 13.4 MHz.

These numbers are for a standard monitor. To get the value for the active-trace time for any other monitor, subtract from the reciprocal of the horizontal rate the percentage of time taken by the retrace and blanking intervals.

In modified television sets, the bandwidth is limited to about 8 MHz. For a good, inexpensive black-and-white monitor, the bandwidth usually ranges from 15 to 25 MHz. For color monitors that accept composite video, the bandwidth is about 3.5 MHz for the color information and 6 MHz for the luminance (brightness).

The only color monitors that have more than 3.5 MHz bandwidth are the kind that accept separate inputs for red, green, and blue (commonly called RGB monitors).

By the way, the monitor types I've listed above are also in order of increasing cost.

If you're looking for a good source for monitors, you might check the ads in BYTE. For information on video graphics, BYTE/McGraw-Hill (70 Main St., Peterborough, NH 03458, (800) 258-5420; in New Hampshire (603) 924-9281) has published a number of books on the subject. I would also recommend that you look up the NTSC (National Television Standards Committee) Television Standards Reference at your library. . . . Steve

Source Code!

The Q/C compiler includes the full source code for a major extension to Ron Cain's Small-C:

- For, switch/case, do-while, goto
- Assignment operators
- Improved code generation
- Command line arguments (argv and argc)
- Conditional and comma operators
- I/O redirection
- I/O library written in C
- Generates code for M80 (or ASM or MAC)

Q/C does not include float, double, long, unsigned or short; static externals; sizeof; typedef; casts; structures and unions; multidimensional arrays; #ifdef, #if, #undef, #line.

For only \$95 (including shipping in the US and Canada) you get the full source code and a running compiler with sample programs on disk, along with a well-written user manual. (Requires 48K CP/M system.)

We also sell CW/C, a C compiler which runs on a 56K CP/M system. It supports structures, unions, multidimensional arrays, #ifdef, and will selectively search "source library" files for functions used by your program. The I/O library for CW/C is written almost entirely in assembler. CW/C costs \$75, and does not include source code for the compiler.

CW/C and Q/C both grew out of Small-C, but were developed independently. Jim Colvin of Quality Computer Systems implemented Q/C. We are offering Q/C for the many Small-C fans that want the source code to an extended compiler. (We still distribute the original Small-C source code on disk for only \$17).

CA residents add 6% tax. Visa and MasterCard welcome.

The Code Works Box 550, Goleta, CA 93116 805-683-1585

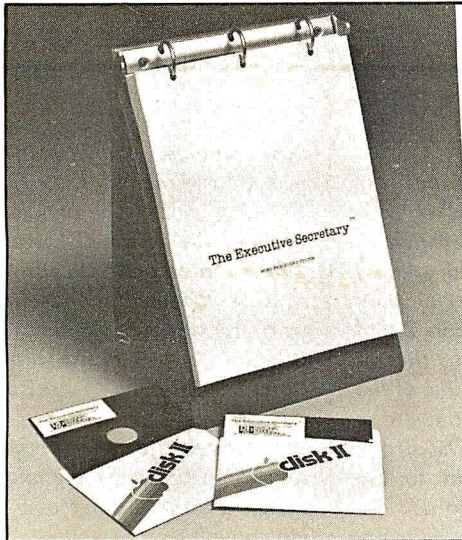

We'd like your apple[®] to meet The **Executive Secretary[™]**

The professional
 word processing system
 for the Apple[™] computer

GENERAL Editing, printing, form letters, mail-merge, and electronic mail all in one package at one price?	✓		check this chart:		
User's manual designed for the user?	✓				
User-controlled configuration of printers, slots, drives, and 40/80 column editing?	✓		INTEGRATED CARD FILE FEATURES		
THE MANUAL Complete index included?	✓		Allows multiple card files per disk?	✓	
Organized as a set of lessons?	✓		Allows user to define size and content of 'cards' in each file?	✓	
Easel-bound for ease of use?	✓		Generates new subset card files based on search or sort criteria for an existing file?	✓	
THE DOCUMENT PRINTER Integrates files from DB MASTER's Utility Pack [™] , The Data Factory [™] , Visicalc [™] , Information Master [™] , and most DIF [™] files.	✓		Incorporates one/multiple line report printer for card files?	✓	
Accepts keyboard input at print time?	✓		Allows totals and subtotals during report printing?	✓	
Supports all major printers, including Centronics 737 and IBM ET- series?	✓		THE DOCUMENT EDITOR		
Has IF and related commands to allow conditional printing of information based on the contents of a database or on keyboard input?	✓		Keeps up with professional typing speeds?	✓	
Prints page headers of arbitrary complexity?	✓		User-defined phrase abbreviations?	✓	
Prints page numbers wherever you want them?	✓		40 or 80 character edit modes user-selectable?	✓	
Automatically generates alphabetical index for words you specify?	✓		Supports Smarterm [™] , Superterm [™] , Videoterm [™] and Full View 80 [™] .	✓	
Supports file chaining and file nesting?	✓		Uses real shift key?	✓	
Has multi-level outline indenting?	✓		Supports file merge and unmerge?	✓	
Has left- and right-justified tab stops?	✓		Global search and replace?	✓	
Gives full control of all margins, dynamic text reformatting, centering, and justification?	✓		Block operations: move, transfer, delete?	✓	
Supports Thunderclock [™] and the CCS clockcard for automatic dating?	✓		Character/word/line: insert/replace/delete?	✓	
			Allows embedded commands to control special printer functions?	✓	
			ELECTRONIC MAIL SYSTEM		
			Menu driven?	✓	
			Multiple document queuing?	✓	
			Fully automatic with Hayes modem?	✓	

Published by:



4306 Upton Avenue South
 Minneapolis, Minnesota 55410
 Phone (612) 929-7104

Distributed
 by:

Aurora Systems
 2040 East Washington Ave.
 Madison, WI 53704
 (608) 249-5875

Eastern Software
 17 Commerce Street
 Baltimore, MD 21012
 (301) 539-5022

Software Express
 2615 Miller Avenue
 Mountain View, CA 94041
 (415) 949-1118

Sweet Talk

Dear Steve,

I read your September 1981 "Circuit Cellar" about the Votrax SC-01 speech synthesizer with great interest. (See "Build an Unlimited-Vocabulary Speech Synthesizer," page 38.) When it came to the parts list for the Sweet Talker, I noticed that the Micromint was offering an Apple II-compatible board as well. Your article said nothing about such a board. Is it different? Would you provide a schematic?

Harvey Kaye
Fort Wayne, IN

The article was written and submitted when I decided to design an Apple II version of the Sweet Talker. Initially I

had designed a parallel version as a demonstration board for the SC-01. In the interim, however, I had a chance to review the response to the Digi-Talker-based Micromouth synthesizer presented in the June 1981 BYTE. (See "Build a Low-Cost Speech-Synthesizer Interface," page 46.) It was overwhelmingly Apple II owners!

In an effort not to ignore a substantial portion of the audience, I quickly designed an Apple II Sweet Talker and slipped it into the parts list.

The Apple II Sweet Talker plugs into any Apple II slot and interacts with the computer as a single I/O (input/output) port. Functionally, the operation of the SC-01 is exactly the same as the

parallel version. Only the timing is different.

As figure 1 illustrates, the Apple II Sweet Talker contains an 8-bit parallel latch. A POKe to the board address will latch the phoneme data into integrated circuits 2 and 3. To accommodate the required data set-up time of the SC-01, IC6 delays the strobe 10 microseconds. The strobe delay is transparent to the computer and words are spoken simply by POKing the phoneme code to the

board. Doing a PEEK at the board address examines the SC-01 busy line.

Finally, unlike the parallel version, the Apple II Sweet Talker is provided with a cassette of demonstration software written in Applesoft BASIC. A disk-based dictionary program is also available.

I apologize for the confusion. Sometimes writing and design leadtimes don't overlap enough. . . . Steve

Number	Type	+5 V	GND	+12 V
IC1	SC-01		18	1
IC2	74LS75	5	12	
IC3	74LS75	5	12	
IC4	7416	14	7	
IC5	74LS02	14	7	
IC6	74LS123	16	8	
IC7	74LS367	16	8	
IC8	LM386		4	6

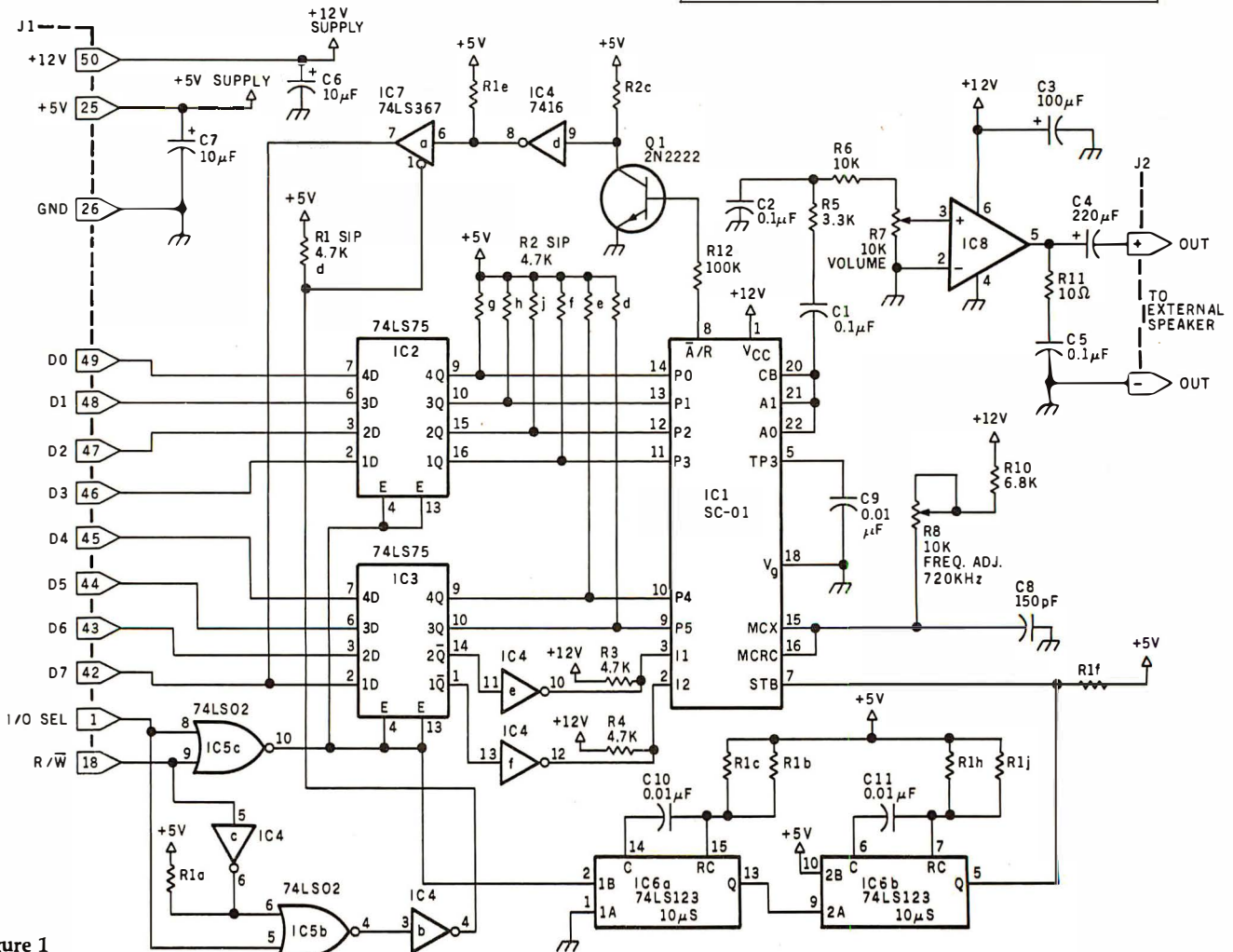

Figure 1

Low-Cost Monitor

Dear Steve,

Do you know where I can get a board that contains a microprocessor, a UART (universal asynchronous receiver/transmitter), and a television interface so that the board could be programmed to let a cheap (\$80) television set be used as a data-line monitor (RS-232C asynchronous data)? I would like to be able to display data in both directions at all baud rates, with and without parity, and at different word lengths. I would also like to be able to recognize control codes and display them in some special format.

Single-board computer systems are now available that could be programmed to do this, but I would like to keep the cost below \$300.

Edward L. Pavia
Webster, NY

Your best approach would be to use the Z8 BASIC computer-controller board presented in my July and August 1981 "Circuit Cellar" articles (see pages 38 and 50, respectively) and a low-priced terminal such as the ASCII Keyboard/Computer Terminal Kit offered by Netronics Research and Development, Ltd., 333 Litchfield Rd., New Milford, CT 06776, (800) 243-7428; in Connecticut (203) 354-9375. Netronics' 16-line by 64-character terminal (\$149.95) plus the Z8 board (\$195) is slightly more expensive than you requested, but it appears to me that it will meet your requirements. You would simply program your application in a 2716 EPROM (erasable programmable read-only memory) and set it to run on the BASIC computer-controller board. The only problem that I can see is at extremely high data rates you may be forced to use ma-

chine-language coding rather than BASIC.

I hope this helps. . . . Steve

More to Draw on

Dear Steve,

I own a Radio Shack TRS-80 Model I and am just beginning to realize its graphics potential.

I am now getting into three-dimensional animated work. Someday I may market a game using the techniques I've learned.

Although the TRS-80 has good graphics potential, I've decided it's not good enough. I don't think any computer currently on the personal-computer market today can satisfy my ever-growing imagination.

I have decided to try to build a vector-graphics display to be TRS-80-controlled and I am looking for information or ideas on low-cost, do-it-yourself systems. Can you help?

Arthur A. Gleckler
Baltimore, MD

It so happens that the first article I ever wrote for BYTE, way back in 1976, was on making a vector-graphics display. The title of the article was "Make Your Next Peripheral a Real Eye-Opener." (See the November 1976 BYTE, page 78. Reprints of BYTE articles are available from University Microfilm, 300 North Zeeb Rd., Ann Arbor, MI 48106.) It was reprinted in the Scelbi-BYTE primer edited by Nat Wadsworth and Carl Helmers (now out of print). The vector-graphics display used two 8-bit D/A (digital-to-analog) converters to create a 256 by 256 resolution display. I used a converted Sanders Associates 720 video terminal that operated on a vector (rather than raster-scan) principle. It was very easy to convert. If you do not

have such a display available, a standard 5-inch oscilloscope will also work. The circuit is relatively simple and will probably cost you less than \$30 in components.

Over the years, many experimenters have written to me about these articles. At this point, I no longer have any information on the Sanders unit, nor do I even have the prototype that I made. Both have been given away to people who have written to me.

After looking over the article again, the only item that I noticed missing in the reprint was the fact that the power-supply pins for the MC1408L8 D/A converter were not provided. Pin 13 should be connected to +5 V and pin 3 should be connected to -15 V.

Not too many people think about vector-graphics dis-

plays anymore because raster scan has become so inexpensive, but I found that I had a lot of fun using it and would still have it if I didn't have so much time tied up making other projects. . . . Steve ■

In "Ask BYTE," Steve Ciarcia answers questions on any area of microcomputing. The most representative questions received each month will be answered and published. Do you have a nagging problem? Send your inquiry to:

Ask BYTE

c/o Steve Ciarcia

POB 582

Glastonbury CT 06033

If you are a subscriber to The Source, send your questions by electronic mail or chat with Steve (TCE317) directly. Due to the high volume of inquiries, personal replies cannot be given. Be sure to include "Ask BYTE" in the address.



GEORGIA
EXECUTIVE
MICRO
SYSTEMS INC.

SOUTHEASTERN DISTRIBUTORS FOR:

Ithaca Inter Systems:

PDP-80 / CACHE BIOS / CPM System 80

DPS-8000-16 Bit Multi-user

Unix-Type OS Coherent

ADES:

10-154 MByte HD-w/wo tape back-up

Controllers/Interfaces for Most Systems

2885 Kellogg Creek Rd., Acworth, GA 30101

(404) 974-4430

DEALER AND OEM INQUIRIES INVITED

Structured Programming in BASIC

Mark Sobell
Cromemco, Inc.
280 Bernardo Ave.
Mountain View, CA 94043

"Why study structured programming?" Structured programming pays off in increased software reliability, as well as greater ease in debugging and maintenance.

This article will introduce the basic concepts and techniques of structured programming. I'll concentrate on the implementation of modular programs through the use of procedures, as well as discuss control structures and their relationship to program flow. I've also included a Morse-code-generator program so that you can put the elements of this discussion to practical use.

Cromemco 32 K Structured BASIC is the language I have chosen for this discussion. Its interactive nature is well suited to develop structured programming skills. Since BASIC is a "friendly," widely used language, it is possible to concentrate on the details of structured programming rather than the details of the language.

Modules and Procedures

The essence of structured programming is *simplicity*. Since a structured program is broken down into small logical modules, called *procedures*, each of the modules can be independently tested, and the program is easier to debug than the large, tangled

mess of a conventional program. When the entire program is finally run, the only untested part is the interaction *between* the modules, and the program is much more likely to execute correctly than an equivalent program that is not built from modules.

Cromemco 32 K Structured BASIC gives you the option of dividing the user memory in the computer into as many as eight partitions. Each partition can contain either a single procedure or a group of related procedures and has its own set of variables, statement labels, and line numbers. When a procedure in a given partition is called from another partition, values and variables may be passed to it as calling parameters and returned as return parameters.

The example in listing 1 is the skeleton of a routine designed to read input from the console terminal. It illustrates the concept of simplifying a program through the use of procedures. In order to further simplify things, I've omitted some important details such as the statements within the procedures, error checking, and parameter passing.

Here we assume that each procedure has access to a common variable (called Buffer\$) which acts as a storage buffer for the input string being read. When the topmost procedure (.Read'console'no'blanks'-no'null) is called, a sequence of calls to other procedures is executed, dur-

ing which the variable Buffer\$ is filled with a line of characters from the input terminal. As you can see from the name of this procedure, there will be no leading or trailing blanks placed in Buffer\$, and a null string will be suppressed. (If the user types only a carriage return in response to an input prompt on the terminal, the input prompt will be repeated.)

When reducing any task to its smallest logical pieces, you should write the primitive procedures first. (Primitive procedures are those which do not call any other procedures.) These can then be tested and debugged independently of the other primitive procedures. In listing 1, the primitive procedures are:

- .Read'console
- .Strip'leading'blanks
- .Strip'trailing'blanks
- .No'null

After you have broken the task into its most basic pieces and have written primitive procedures to perform each, it's a relatively simple matter to write other, higher layers of procedures (which simply call the primitive procedures).

In the example, the next higher procedure is called .No'blanks, which calls .Strip'leading'blanks and .Strip'trailing'blanks. Higher than .No'blanks is the procedure .Read'console'no'blanks, which calls both .No'blanks and the primitive

Acknowledgments

The author wishes to thank Laura King, Roger Melen, and Roger Sippl for their contributions to this article.

Listing 1: The skeleton of a structured BASIC routine that reads input from the console terminal. For simplicity, most details have been omitted.

```

Procedure .Read'console'no'blanks'no>null
  Call .Read'console'no'blanks
  Call .No>null
Endproc

  Procedure .Read'console'no'blanks
    Call .Read'console
    Call .No'blanks
  Endproc

    Procedure .No'blanks
      Call .Strip'leading'blanks
      Call .Strip'trailing'blanks
    Endproc

      Procedure .Read'console
        Rem This procedure accepts a
        Rem string Buffer$ from the
        Rem console.
      Endproc

        Procedure .Strip'leading'blanks
          Rem This procedure shifts the
          Rem characters in Buffer$ to
          Rem the left so that the first
          Rem non-blank character is in
          Rem the first position of the
          Rem string.
        Endproc

          Procedure .Strip'trailing'blanks
            Rem This procedure changes
            Rem all trailing blanks in
            Rem Buffer$ to null characters.
          Endproc

            Procedure .No>null
              Rem This procedure will reject
              Rem Buffer$ if it contains
              Rem nothing but null characters.
              Rem Note: the user will have to
              Rem be re-prompted.
            Endproc
  
```

procedure .Read'console. The top-most procedure in listing 1 is .Read'console'no'blanks'no>null, which we find appropriately placed at the top of the listing. (Writing the lowest-level procedures first and then proceeding upward is referred to as "bottom-up coding.")

Because this console-reading routine has been written in modular form, it can be entered at several points. For instance, if you want null input accepted from the user and returned in Buffer\$, you can call the second procedure (.Read'console'no'blanks). In a similar manner, you can call the primitive procedure .Read'console if the program needs *all* the input from the console terminal.

By combining the four primitive procedures in various ways, you can create a series of more complex and useful routines. The list of primitive procedures can be expanded to include error checking and other operations. When all the necessary primitive procedures are completed,

the skeleton routine can be fleshed out into a working program.

Control Structures and Linear Flow

In structured programming, control should flow in a linear or sequential manner. A *control structure* is a means by which the order of execution is changed from the sequential line-number order. In BASIC, the simplest control structure is the GOTO statement. (In nonstructured programming, the flow tends to jump around through the use of multiple GOTO statements.)

Although the GOTO statement is available in Cromemco 32 K Structured BASIC, its use in structured programming is strongly discouraged. Overuse of GOTO statements tends to make programs more difficult to debug and maintain. Structured languages use conditional loops and branches that allow the program to flow in as linear a fashion as possible.

CHOOSE...

Choose an Apple Desk



A compact Bi-Level desk ideal for the Apple computer system. This 42" x 29½" desk comes with a shelf to hold two Apple disk drives. The top shelf for your TV or monitor and manuals can also have an optional paper slot to accommodate a printer. It is shown here with the optional Corvis shelf which will hold one Corvis disk drive. The Corvis shelf is available on the 52" x 29½" version of the Apple desk.

Choose a Micro Desk



The Universal Micro desk accommodates the S-100 type microcomputers. The desk is available in four sizes: 17.75 inch, 19.06 inch, and 20.75 inch wide openings with 24 inch front-to-rear mounting space. The fourth size is a 20.75 inch wide opening with a 26.50 inch front-to-rear mounting space.

Choose a Mini Rack

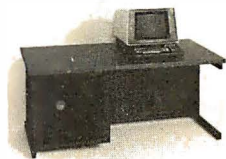

Mini racks and mini micro racks have standard venting, cable cut outs and adjustable RETMA rails. Choose a stand alone bay or a 48", 60", or 72" desk model in a variety of colors and wood tones. A custom rack is available for the Cromemco.

Choose a Printer Stand

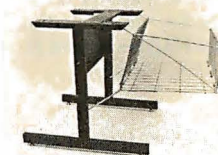

The Universal printer stand fits the:

Centronics 700's	Diablo 1600's & 2300's
Dec LA 34	T.I. 810 & 820
NEC Spinwriter	Okidata Slimline
Lear Siegler 300's	Anadex 9500's

Delivery in days on over 200 styles and colors in stock. Dealer inquiries invited.

**ELECTRONIC SYSTEMS
FURNITURE
COMPANY**

17129 S. Kingsview Avenue
Carson, California 90746
Telephone: (213)538-9601

CP/M DATA ENTRY "RADAR"

RADAR is a high speed data entry system that will run on any CP/M system providing a "3741" style key-to-disk environment. RADAR is ideal for replacing KEYPUNCH machines and older, slower key-to-disk systems like the 3741's and 42's.

Features:

- Verify Mode
- Check Digit Processor
- Auto Dup/Manual Dup
- 16 Accumulators
- Parameter Driven (No Programming)
- "Virtual" File Access
- Add or Delete Records
- Record Retrieval By Number Or Content
- Full Editing Capability
- Operator Prompts
- Extremely Fast (Written In Assembly Language)

In addition to "heavy-duty" data entry, RADAR is also the ideal "front-end" for many applications programs, providing aquisition and retrieval of keyed data with a degree of reliability simply not possible with any other technique. RADAR can cut programming time by more than 30%, simply because there is no longer any need to write the "input" portion of a program, just let RADAR handle it!

Write or call for free brochure. The RADAR manual is also available separately for \$25.00.



**SOUTHERN
COMPUTER
SYSTEMS,
Inc.**
P.O. Box 3373A
Birmingham, AL 35255
Phone: 205-933-1659

```
IF CONDITION THEN DO
  STATEMENTS 1
ELSE
  STATEMENTS 2
ENDDO
```

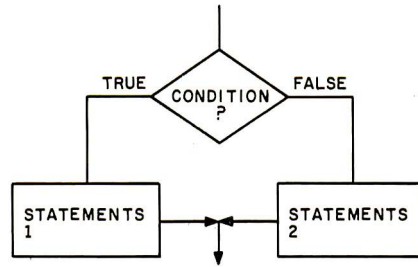

Figure 1: Flowchart symbols used to represent the IF...THEN...ELSE...ENDDO programming construct that is important to structured programming.

Cromemco 32 K Structured BASIC provides a number of control structures, including conditional loops and branches, which allow you to write clear, concise, and readable programs that flow in a linear fashion.

The IF...THEN...ELSE...ENDDO structure, shown in flowchart form in figure 1, provides a conditional branch followed by two independent sections of code. Execution of the program can follow either (but not both) of the paths. IF a condition is true (such as a variable having a certain value), THEN certain statements are executed. If the condition is not true, the statements after the ELSE are performed. Each path can contain as many BASIC statements as needed.

The WHILE...ENDWHILE and REPEAT...UNTIL structures (shown in figure 2) are conditional loops.

UNTIL or WHILE a condition is true, they cause a set of BASIC instructions to be executed over and over again. But there is one important difference between the two: WHILE tests the condition *before* executing the instructions; REPEAT tests the condition *after* executing the instructions. The REPEAT structure will always execute at least once. The WHILE structure, depending upon the tested condition, may not execute at all.

An Example

The Morse-code generator (shown in listing 2) demonstrates some of the structured-programming concepts I've been discussing. While the program doesn't incorporate some Structured BASIC features, such as the procedure library, memory partitions, common storage area, and parameter passing, it is designed to show a linear and well-documented structured program. (Note that when you call a procedure, use of the keyword CALL is optional. You can call a procedure simply by referencing its name, which always begins with a period in Structured BASIC.)

The procedure that generates the actual Morse-code dits and dahs is called .Tone (see listing 2). To produce audible tones you'll need the Cromemco D+7A I/O (input/output) interface board as well as a pair of Cromemco joystick consoles, which produce the audio output. If you don't have the consoles, the Morse code will be displayed as a

(2a)

```
WHILE CONDITION
  STATEMENTS
ENDWHILE
```

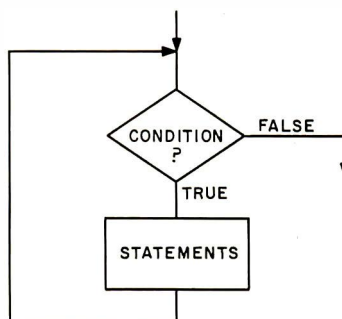

(2b)

```
REPEAT
  STATEMENTS
UNTIL CONDITION
```

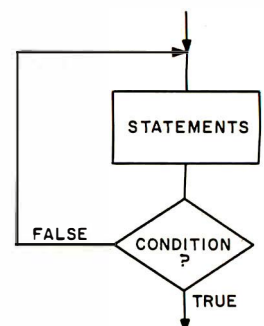

Figure 2: Flowchart symbols used to represent the WHILE...ENDWHILE (figure 2a) and REPEAT...UNTIL (figure 2b) programming constructs.

Listing 2: A Morse-code generator program written in Cromemco 32 K Structured BASIC that illustrates some of the concepts of structured programming. Text for translation to Morse code is read from a disk file. Here the BASIC keywords use only an initial capital letter, instead of the usual all-capital style. Long variable names are used, and names of procedures begin with periods. Arguments enclosed in backslashes refer to disk-file operations.

```

1000 Rem PROGRAM MORSE
1010 Rem date 9.79
1020 Rem
1030 Rem Program to convert a text file
1040 Rem to its Morse code equivalent.
1050 Rem
1060 Call .Initialize
1070 Call .Set'up
1080 Call .Read'and'process
1090 Call .Finish
1100 Stop
1110 Rem- - - - - *
1120 Rem- - - - - *
1130 Procedure .Initialize
1140 Integer Dash'to'dot'ratio,Ies,Ils,Iws,Max'line'length
1150 Rem
1160 Rem The four following parameters control the characteristics
1170 Rem of the code generated and the console display. They may
1180 Rem be changed by the user.
1190 Rem
1200 Max'line'length=75 : Rem Maximum line length on console.
1210 Ies=1 : Rem Inter-element spacing ratio.
1220 Ils=5 : Rem Inter-letter spacing ratio.
1230 Iws=7 : Rem Inter-word spacing ratio.
1240 Dash'to'dot'ratio=3 : Rem This is the standard.
1250 Rem
1260 Rem
1270 Dim Filename$(13),Character$(0),Null$(0)
1280 Dim Valid'characters$(64)
1290 Integer True,False,Error'number,End'of'file'flag
1300 Integer Wpm,Delay,Index,End'of'file'error'number
1310 Integer Num,Low'case,Up'case,P'duration,T'duration
1320 Integer Line'length,Max'line'length
1330 Valid'characters$="aAbBcCdDeEfFgGhHiIjJkKlLmMnNoOpPqQrRsStTuUvV"
1340 Valid'characters$(44)="wWxXyYzZ0123456789 .?"
1350 True=1 : False=0
1360 End'of'file'error'number=138
1370 Null$=""
1380 Line'length=0
1390 Rem Correct inter-word spacing ratio to follow
1400 Rem inter-letter space.
1410 Iws=Iws-Ils
1420 Rem Correct inter-letter spacing ratio to follow
1430 Rem inter-element space.
1440 Ils=Ils-Ies
1450 Rem Correct maximum line length to allow another character
1460 Rem to be displayed.
1470 Max'line'length=Max'line'length-10
1480 Endproc
1490 Rem- - - - - *
1500 Rem- - - - - *
1510 Procedure .Set'up
1520 Print : Print
1530 Rem Prompt user for speed and file name.
1540 Input"Morse code speed (WPM)=",Wpm
1550 If Wpm<1 Then 1540
1560 If Wpm>100 Then @"Cannot be greater than 100" : Goto 1540
1570 Delay=250/Wpm
1580 Input"Filename (XXXXX.XXX)=",Filename$
1590 Open\l\Filename$
1600 Endproc
1610 Rem- - - - - *
1620 Rem- - - - - *
1630 Procedure .Read'and'process
1640 On Error Gosub Error'trap
1650 On Esc Gosub Escape
1660 End'of'file'flag=False
1670 Get\l\Character$
1680 While End'of'file'flag=False
1690 .Filter
1700 .Decode'and'output
1720 Get\l\Character$
1730 Endwhile
1740 On Error Stop
1750 Endproc
1760 *Error'trap : Error'number=Sys(3)
1770 End'of'file'flag=True

```

series of dots and dashes on the video screen.

The program is made up of four major procedures:

- .Initialize
- .Set'up
- .Read'and'process
- .Finish

By simply reading the series of CALL statements at the beginning of the program, you can easily discern the basic flow of control.

The first procedure (.Initialize) initializes the value, type, and dimension of all of the program variables. Note that even though the variable-type-declaration statements are not required, using them results in faster execution and more memory-efficient code.

Four parameters that you can change are identified at the beginning of the initialization procedure. Although the spacing ratios assume that the length of a dot is equal to one unit, the actual dot length generated is dependent on the speed in words per minute that you select when the program is run.

The default values I've selected are a silent pause equal to one dot after each element (dot or dash), a five-dot pause after each complete letter, and a seven-dot pause after each word.

After variable initialization, the procedure .Set'up sets the parameters for program execution by prompting you for the information and then setting up a data file on a peripheral device.

Next, the file must be read and the information processed, by using the procedure .Read'and'process. The first matters of business for .Read'and'process are the setting up of error and escape traps. As program execution comes to an end or is interrupted, the input data file must be closed before control is returned to the user. If it isn't, a file might be left open after an aborted run, resulting in incorrect execution the next time the program is used. The error trap is also used to set the logical value of the end-of-file flag to true when the end of the file is reached.

Listing 2 continued on page 414

Listing 2 continued:

```

1780      If Error'number#End'of'file'error'number Then Do
1790      Rem Print error message, reset error trap,
1800      Rem and abort program execution.
1810      Print
1820      Print"System Error ";Error'number
1830      On Error Stop
1840      .Finish
1850      Stop
1860      Enddo
1870      Return
1880 *Escape
1890      On Error Stop
1900      .Finish
1910      Stop
1920      Return
1930      Rem- - - - - *
1940      Rem- - - - - *
1950 Procedure .Finish
1960      .Break
1970      Close\l\
1980      Print : Print
1990      Endproc
2000      Rem- - - - - *
2010      Rem- - - - - *
2020 Procedure .Filter
2030      Rem
2040      Rem The following instructions locate the character
2050      Rem in a string of valid characters. If it is not
2060      Rem found a -1 is returned indicating that it is an
2070      Rem invalid character. If the character is valid
2080      Rem it is displayed else the character buffer is set
2090      Rem equal to the value of a null character.
2100      Rem
2110      If Pos(Valid'characters$,Character$,0)=-1 Then Do
2120      Rem If it is a carriage return, display a space.
2130      If Character$=Chr$(13) Then Call .Space
2140      Character$=Null$
2150      Else
2160      Print Character$;
2170      Line'length=Line'length+1
2180      Enddo
2190      Endproc
2200      Rem- - - - - *
2210      Rem- - - - - *
2220 Procedure .Dot
2230      .Tone (1)
2240      Print".";
2250      Line'length=Line'length+1
2260      .Pause (Ies)
2270      Endproc
2280      Rem- - - - - *
2290      Rem- - - - - *
2300 Procedure .Dash
2310      .Tone (Dash'to'dot'ratio)
2320      Print"-";
2330      Line'length=Line'length+1
2340      .Pause (Ies)
2350      Endproc
2360      Rem- - - - - *
2370      Rem- - - - - *
2380 Procedure .Space
2390      Rem Call Pause with inter-word pause value (Iws).
2400      Rem Display a space on the console.
2410      .Pause (Iws)
2420      Print" ";
2430      Line'length=Line'length+1
2440      Endproc
2450      Rem- - - - - *
2460      Rem- - - - - *
2470 Procedure .Pause (P'duration)
2480      Rem Pause for P'duration times dot value.
2490      For Index=1 To Delay*P'duration
2500      Next Index
2510      Endproc
2520      Rem- - - - - *
2530      Rem- - - - - *
2540 Procedure .Tone (T'duration)
2550      Rem Generate tone for T'duration times dot value.
2560      Rem Joystick speakers must be connected to output ports 25 and 27.
2570      Rem Noesc, Esc sequence allows for faster execution so that
2580      Rem a higher frequency tone is generated.
2590      Noesc
2600      For Index=1 To Delay*T'duration
2610      Out 27,0 : Out 27,128
2620      Out 25,0 : Out 25,128
2630      Next Index
2640      Esc
2650      Endproc
2660      Rem- - - - - *
2670      Rem- - - - - *

```

Listing 2 continued on page 415

The WHILE loop is the heart of the program. It is preceded by a file access to determine whether or not the file is empty. If the file is not empty, the character buffer (Character\$) is initialized.

If the end-of-file flag is true, the WHILE loop will not execute and the procedure terminates. If the end-of-file flag is false, the characters continue to be processed. When the end of the file is encountered during a file access, the run-time error is trapped by the ON ERROR instruction and control is transferred to the subroutine at the location denoted by the logical identifier Error'trap.

If the Error'trap subroutine is called and the error number and end-of-file error number are found equal, the end-of-file flag is set to true and the RETURN instruction causes program control to be passed to the instruction following the one that generated the error. In this case, the GET instruction would generate the error, and control would return to the ENDWHILE instruction. ENDWHILE causes control to be returned to the WHILE statement. Because the end-of-file flag has been set to true, the condition for the execution of the WHILE loop is not satisfied and control is passed to the instruction following the ENDWHILE instruction.

If the error number is not equal to the end-of-file error number, execution of the program is aborted. The procedure .Read'and'process calls two other procedures, .Filter and .Decode'and'output. Invalid characters are eliminated by .Filter. The string function POS is used to determine whether or not the character in the character buffer, Character\$, is valid. This is done by finding the position of the character within the string Valid'characters\$, which contains all of the valid characters. If the character cannot be found in the string, the POS function returns a -1. This occurs if Character\$ contains an invalid character.

Although the carriage return is an invalid character, it is trapped in this routine and causes a pause to be output. This is done because it is com-

mon to terminate words in a file of ASCII (American Standard Code for Information Interchange) characters with a carriage return (new line) and no space.

Valid characters are displayed on the console terminal. If an invalid character is detected in the file, Character\$ is assigned a null value. Valid characters are decoded and output by the procedure .Decode'and' output, which contains thirty-eight subroutines, each named for the character it generates. For example, consider the letter "d." Its value is not within the range of the numeric characters. Therefore, no numeric-character subroutine is called. During the check for a lowercase letter, the variable Low'case is assigned a value of 4. The ON...GOSUB instruction transfers control to the fourth subroutine in the list, D.

Subroutine D calls the procedures .Dash, .Dot, .Dot, and .Pause, and then control is returned to the calling routine. Both .Dot and .Dash display characters on the console terminal and call the procedure .Tone to generate the appropriate Morse-code sequence. The duration of the pause generated by .Pause is specified by its argument. In this case, the length of the pause is determined by the value of the variable Ils (inter-letter spacing) multiplied by the length of a dot.

If the displayed output line becomes too long, the .Output'and'decode procedure generates a new line on the console. If the program reaches a normal or abnormal termination, the statement ON ERROR STOP restores the standard system error-handling routines. Then, the next procedure (.Finish) sends a Morse-code "break" character (S and K sent as one character), which indicates the end of the transmission. At the same time, the input file is closed.

A Few Final Thoughts

The following are important points to remember when writing structured programs:

1. Break the program up into logical tasks. Break each task into subtasks. Continue to simplify until each

Listing 2 continued:

```

2680 Procedure .Break
2690   Print : Print"Break";
2700   .Pause (Ies+Ils+Iws)
2710   .Dash : .Dot : .Dot : .Dash : .Dot : .Dash
2720   Endproc
2730   Rem- - - - -
2740   Rem- - - - -
2750 Procedure .Decode'and'output
2760   Rem
2770   Rem Check for number.
2780   Num=Asc(Character$)-Asc("0")+1
2790   On Num Gosub Zero,One,Two,Three,Four,Five,Six,Seven,Eight,Nine
2800   Rem
2810   Rem Check for lower case letter.
2820   Low'case=Asc(Character$)-Asc("a")+1
2830   On Low'case Gosub A,B,C,D,E,F,G,H,I,J,K,L,M,N,O,P,Q,R,S,T,U,V,W,X,Y,Z
2840   Rem
2850   Rem Check for upper case letter.
2860   Up'case=Asc(Character$)-Asc("A")+1
2870   On Up'case Gosub A,B,C,D,E,F,G,H,I,J,K,L,M,N,O,P,Q,R,S,T,U,V,W,X,Y,Z
2880   Rem
2890   Rem Check for punctuation.
2900   If Character$=" " Then .Space
2910   If Character$="?" Then Gosub Questionmark
2920   If Character$="." Then Gosub Period
2930   Rem
2940   Rem Check line length and issue a new line if required.
2950   If Line'length>=Max'line'length Then Do
2960     Print
2970     Line'length=0
2980   Enddo
2990   Endproc
10000 *Zero : .Dash : .Dash : .Dash : .Dash : .Dash : .Pause (Ils) : Return
10001 *One : .Dot : .Dot : .Dash : .Dash : .Dash : .Pause (Ils) : Return
10002 *Two : .Dot : .Dot : .Dash : .Dash : .Dash : .Pause (Ils) : Return
10003 *Three : .Dot : .Dot : .Dot : .Dash : .Dash : .Pause (Ils) : Return
10004 *Four : .Dot : .Dot : .Dot : .Dot : .Dot : .Pause (Ils) : Return
10005 *Five : .Dot : .Dot : .Dot : .Dot : .Dot : .Pause (Ils) : Return
10006 *Six : .Dash : .Dot : .Dot : .Dot : .Dot : .Pause (Ils) : Return
10007 *Seven : .Dash : .Dash : .Dot : .Dot : .Dot : .Pause (Ils) : Return
10008 *Eight : .Dash : .Dash : .Dash : .Dot : .Dot : .Pause (Ils) : Return
10009 *Nine : .Dash : .Dash : .Dash : .Dash : .Dot : .Pause (Ils) : Return
10010 *A : .Dot : .Dash : .Pause (Ils) : Return
10011 *B : .Dash : .Dot : .Dot : .Dot : .Pause (Ils) : Return
10012 *C : .Dash : .Dot : .Dash : .Dot : .Pause (Ils) : Return
10013 *D : .Dash : .Dot : .Dot : .Pause (Ils) : Return
10014 *E : .Dot : .Pause (Ils) : Return
10015 *F : .Dot : .Dot : .Dash : .Dot : .Pause (Ils) : Return
10016 *G : .Dash : .Dash : .Dot : .Pause (Ils) : Return
10017 *H : .Dot : .Dot : .Dot : .Dot : .Pause (Ils) : Return
10018 *I : .Dot : .Dot : .Pause (Ils) : Return
10019 *J : .Dot : .Dash : .Dash : .Dash : .Pause (Ils) : Return
10020 *K : .Dash : .Dot : .Dash : .Pause (Ils) : Return
10021 *L : .Dot : .Dash : .Dot : .Dot : .Pause (Ils) : Return
10022 *M : .Dash : .Dash : .Pause (Ils) : Return
10023 *N : .Dash : .Dot : .Pause (Ils) : Return
10024 *O : .Dash : .Dash : .Dash : .Pause (Ils) : Return
10025 *P : .Dot : .Dash : .Dash : .Dot : .Pause (Ils) : Return
10026 *Q : .Dash : .Dash : .Dot : .Dash : .Pause (Ils) : Return
10027 *R : .Dot : .Dash : .Dot : .Pause (Ils) : Return
10028 *S : .Dot : .Dot : .Dot : .Pause (Ils) : Return
10029 *T : .Dash : .Pause (Ils) : Return
10030 *U : .Dot : .Dot : .Dash : .Pause (Ils) : Return
10031 *V : .Dot : .Dot : .Dot : .Dash : .Pause (Ils) : Return
10032 *W : .Dot : .Dash : .Dash : .Pause (Ils) : Return
10033 *X : .Dash : .Dot : .Dot : .Dash : .Pause (Ils) : Return
10034 *Y : .Dash : .Dot : .Dash : .Dash : .Pause (Ils) : Return
10035 *Z : .Dash : .Dash : .Dot : .Dot : .Pause (Ils) : Return
10036 *Period : .Dash : .Dot : .Dot : .Dot : .Dash : .Pause (Ils) : Return
10037 *Questionmark : .Dot : .Dot : .Dot : .Dash : .Dot : .Dot
10038   .Pause (Ils) : Return
10039   End

```

primitive procedure performs a single clear and simple task.

2. Use meaningful names for procedures, variables, and line labels, when possible.

3. Use the preferred control structures, i.e., IF...THEN...ELSE, WHILE...ENDWHILE, and REPEAT...UNTIL. Avoid using the GOTO instruction.

4. Use remarks in the source code. They will help clarify the purpose of a program section.

Try to keep these suggestions in mind when you design and code programs. They are not hard-and-fast rules, but they will allow you to create programs that are more efficient and easier to maintain. ■

CMOS: Memory with a Future

Ideas Behind CompuPro's RAM 17

Craig Anderton
c/o BYTE Publications Inc.
POB 372
Hancock, NH 03449

The world of personal computers has evolved into two major categories. The all-in-one computer has most of the machine's intelligence residing in one major module produced by a single manufacturer. On the other hand, the bus-oriented computer can accept boards from numerous manufacturers. The major advantage of the bus-oriented computer is flexibility—modules performing distinct functions are available from a variety of vendors operating in a competitive marketplace. Therefore, systems integrators (people who put systems together by selecting boards from a variety of sources) can choose modules best-suited to perform a specific function (i.e., data acquisition, software development, word processing, etc.) from a wide variety of available boards. Furthermore, a bus-oriented computer allows relatively inexpensive upgrading when the requirements of the user either expand or change altogether.

The most popular bus-oriented small computers are based on the S-100 bus, developed by MITS for its Altair computer in the mid-1970s and proposed in 1979 as a standard by the Institute of Electrical and Electronics Engineers (IEEE specification 696). Unfortunately, the publication of specification 696 has not made integrating S-100 systems as simple as one might like. In fact, integrating boards from a variety of manufacturers, while resulting in a more flexible system, can also cause headaches for the integrator—particularly when choosing memory.

First, the strengths and limitations of currently available memory boards must be thoroughly understood in order to predict their effect on system performance. It is by no means certain that a given S-100 memory board—even one designed to meet the IEEE-696 specifications for S-100 bus performance—will function reliably in a given system simply because that system contains only boards that claim to meet these specifications. Claiming to meet specifications is easy; actually

meeting those specifications is somewhat more difficult.

Second, since a major attraction of the S-100 bus to the end user is the ease with which these systems can be upgraded, future hardware and software developments must be anticipated so that upgrading the system will be as inexpensive as possible. Unlike an automobile or stereo, an S-100 machine does not have to be replaced in order to make room for next year's higher-performance model; instead, older boards may be replaced and newer boards added in order to achieve the current state of the art.

For example, when a system is upgraded from single-user to multi-user, or is modified for DMA (direct memory access) disk operation, all other aspects of the computer—memory, power supply, motherboard, etc.—may be preserved as is (protecting the initial investment) if the systems integrator had the foresight to choose the modules with future compatibility in mind. Since programmable memory is a high-cost item, it is especially important at the outset to choose a memory board with a future. The advantage of easy upgrading disappears if the system boards lack compatibility or if they are not designed to accommodate future improvements in technology.

Dynamic Versus Static Memory

The controversy over the respective merits of dynamic and static memory in S-100 computers goes back almost as far as the S-100 bus itself, and much ink has been spilled praising one and condemning the other. Many early dynamic-memory boards simply did not work, mostly due to poor design and inadequate (or sometimes nonexistent) quality control. This situation produced an unfair prejudice against the very principle of dynamic memory. Nevertheless, dynamic memory's high density, low power, and low cost, combined with improved design and manufacturing techniques, gradually restored

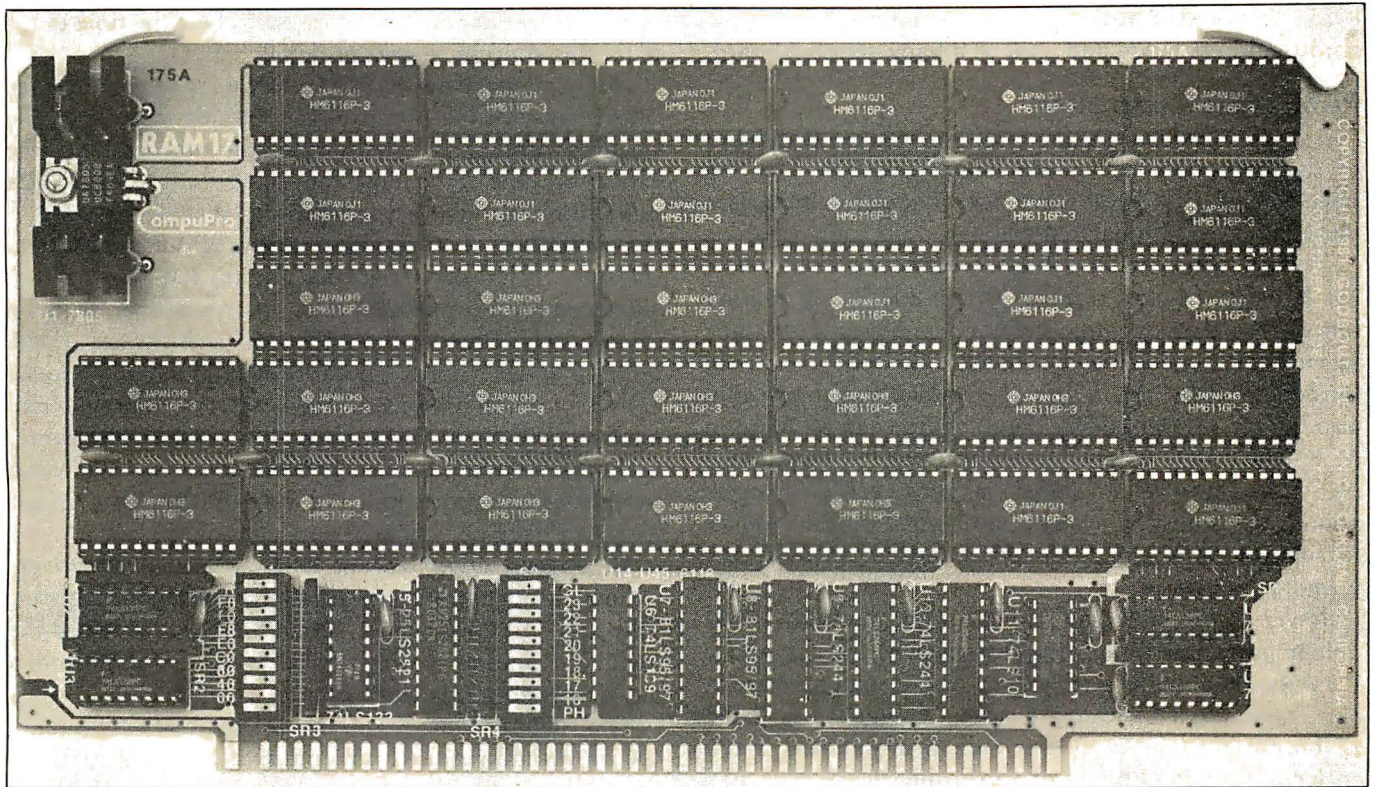

Photo 1: CompuPro's RAM 17, the first commercially available 64 K-byte static-memory board for the S-100 bus.

it to respectability and established it as the prime choice in many applications.

Static memory, while consuming more power and costing more than dynamic, offers the advantage of requiring no refresh signals. It is therefore the choice in systems using DMA devices. Until recently, putting a system together involved a necessary compromise; neither form of memory offered the ideal combination of low cost, high density, low power consumption, and the ability to execute DMA flawlessly.

Enter CMOS Memory

CMOS (complementary metal-oxide semiconductor) memory seemed to hold the best hope for being the ideal memory except for one major problem: cost. Until recently, CMOS memory was prohibitively expensive, restricting its use to all but the most expensive computing systems. However, a new generation of CMOS random-access memory has evolved that delivers all the qualities associated with an "ideal" memory at a reasonable price. The first commercially available 64 K-byte static-memory board for the S-100 bus, CompuPro's RAM 17, could not have existed without CMOS memory.

The introduction of low-cost CMOS memory has obsoleted some of the most forceful arguments formerly made in favor of dynamic memory. Five categories of performance have been greatly affected: density, power, speed, compatibility, and reliability/ease of maintenance.

CMOS memory is still more expensive than dynamic memory, although future price decreases are expected to lessen this cost difference. Nonetheless, the true cost of a memory board goes beyond the list price. If a board causes problems due to erratic or unpredictable operation, or needs to be replaced when a system is upgraded, an attractive initial savings may turn into an ugly added expense.

Before comparing the performance of dynamic versus CMOS memory, a brief functional description of CompuPro's RAM 17 is in order. RAM 17 is a 64 K-byte static-memory board using Hitachi's 6116 CMOS "byte-wide" memory integrated circuits (2 K by 8 bits) and is designed to meet all IEEE-696 specifications. The board can be used as *global* or *extended address* memory (global memory decodes only address lines A0-A15 and ignores address lines A16-A23; extended address memory decodes all 24 available address lines). The maximum amount of global memory possible in a system is 64 K bytes; the maximum extended address memory is 16 megabytes.

CompuPro's RAM 17 can be addressed to occupy any 64 K-byte page of memory. Four 16 K-byte "windows" can be switch disabled, and the upper 8 K bytes of the board can be disabled in four individual 2 K-byte increments (this makes room for popular memory-mapped devices such as disk controllers or video interfaces). When used with a CompuPro Memory Manager (available as a separate board or as part of CompuPro's Z80 or

Product Description

8085/88 processor boards), RAM 17 can be placed in extended address mode and used as a bank-selected board.

Performance Comparison

As mentioned earlier, many of the arguments in favor of dynamic memory are no longer relevant since the development of CMOS memory. The most important differences are summarized below.

Density: Since 32 of Hitachi's 6116 memory devices (64 K bytes) fit on a standard-size S-100 board, it is no longer true that dynamic memory is denser than static memory at the board level. (In fact, CompuPro recently introduced RAM 21, a 128 K-byte static memory that also fits on a standard-size S-100 board, and RAM 16, a 64 K-byte board designed for either 8- or 16-bit systems.) At the systems level, an additional bonus of CMOS operation is the ability of systems with small power supplies to support more static-memory boards than dynamic-memory boards.

Power: CompuPro's RAM 17 typically draws 150 milliamperes (mA) from the +8-volt (V) line, or about 1.2 watts (W). At the sixth West Coast Computer Faire in San Francisco, a 1-megabyte system comprised of RAM 17 boards (16 of them) was run in a standard S-100 enclosure. After 12 hours of work, the system remained cool—the entire megabyte drew only about 3 amperes (A)!

Speed: The Hitachi 6116 has a worst-case access time of 150 nanoseconds (ns), compared with about 250 ns for conventional dynamic-memory devices. This means that a static-memory board can run without wait states with a 6-megahertz (MHz) Z80 microprocessor, while no currently available dynamic-memory board is fast enough to do this. Because there is no need for refresh on a static-memory board, the possibility for real-time applications is limited only by access time.

While dynamic-memory boards may *seem* to have a respectable access time, they cannot be run at their fastest access time because dynamic memory must be refreshed every few milliseconds. This can introduce sporadic delays in system operation in the form of refresh wait states, thereby slowing down the entire system and degrading real-time operation.

Compatibility: Current dynamic-memory-board designs all have serious weaknesses when used in DMA environments, particularly in environments supporting multiple DMA devices. For a fine description of the problems encountered when interfacing dynamic memories with DMA devices, refer to Larry Malakoff's excellent article "Dynamic Memory: Making an Intelligent Decision" (February 1981 BYTE, page 142).

The subject of reliability/ease of maintenance will be covered later in this article.

Static Memory and DMA

Probably the most important aspect of static memory in general, and CMOS memory in particular, is the ability

to perform DMA. Therefore, we'll take the time to explain this concept in greater detail.

Direct memory access is a technique whereby a device other than the processor can read into, or write from, the system's memory directly, without the intervention of the processor. One of the most important results of the IEEE's publication of the 696 specifications for the S-100 bus is the definition of a standard protocol for DMA data transfer, including a rigorous arbitration scheme that allows multiple (up to 16) DMA devices to operate in the same system. Prior to the IEEE-696 specifications, DMA on the S-100 bus had a reputation so bad that it made the early reputation of dynamic memory look good. No two implementations of DMA were alike, and, in any event, no implementation seemed to work reliably. This was a terribly serious shortcoming of the S-100 bus that limited its use in truly professional applications.

The biggest advantage of DMA is that it allows extremely fast data transfer, thereby increasing throughput. This is due to the fact that within the S-100 standard the minimum amount of time needed to transfer data from a bus master to a bus slave is three clock cycles. Thus, a system running at 10 MHz, where each clock cycle takes 100 ns, would require a minimum of 300 ns to perform one data transfer. A system using processor-directed transfer would require from 30 to 40 clock cycles (3000 to 4000 ns) to make the same transfer.

A Static CMOS Memory Application

The versatility of the CMOS memory/DMA marriage allows for some novel applications. G & G Engineering markets a system, based on CompuPro hardware, that will run Digital Research's CP/M 2.2 or CP/M-86 on the same system (CompuPro has a dual processor board with an 8085 microprocessor and an 8088 microprocessor that makes this possible). When running CP/M-86, as much as 1 megabyte can be directly addressed by the 8088 (which is simply an 8086 that fetches data one byte at a time). When running CP/M 2.2, the 8085 has control, which means that only 64 K bytes can be directly addressed; but rather than wasting the remaining amount of memory, it is treated as if it were a disk drive. Thus, this vast storage area becomes a pseudo disk drive (which G & G calls Warp Drive), but one that operates at extremely high speed because there are none of the mechanical restraints associated with a traditional disk drive. This configuration allows users to run standard, unmodified CP/M 2.2 programs on the Warp Drive and achieve speed increases of up to 20 times over a standard floppy-disk system. Add to this the advantage of running all CP/M 2.2 programs on a 6-MHz 8085 without wait states, and the increase in performance over conventional 8-bit systems is enormous.

G & G Engineering's technique for implementing its Warp Drive is entirely dependent upon a DMA controller capable of transferring data to *any* location within the entire 16 megabytes of S-100 address space. While this

technique could theoretically work with conventional static memory, the excessive power dissipation, power supply requirements, and the shortage of card slots would make the concept of Warp Drive highly impractical. Also, dynamic memory could not handle this type of application at all. As a result, this concept of a "solid-state disk drive" had to wait until the advent of a relatively inexpensive CMOS memory board such as RAM 17.

A future application of high-density, low-power CMOS memory combined with DMA devices involves multi-user systems. Before too long, it will be possible to upgrade single-user systems to powerful 16-bit multi-user systems, such as Digital Research's MP/M-86, Phase One's Oasis 86, and Microsoft's Xenix.

Thanks to the present availability of high-density, low-power CMOS memory, these future upgrades hold the promise of developing super systems without the loss of a single piece of existing computer hardware, except perhaps a processor board. What's more, the new operating systems will be greatly enhanced thanks to the addition of extra DMA devices (e.g., hard-disk controllers, direct I/O channel controllers, etc.). These hardware and software enhancements will produce faster and more efficient systems, making it more and more difficult for dynamic memory to find a niche in tomorrow's high-performance computers.

Reliability and Maintainability

It is important to address the question of reliability when dealing with high-density memories. The all-CMOS memory board has four distinct advantages over dynamic memory:

1. It consumes less power and, therefore, produces less heat and stresses the system power supply less than dynamic memory. (RAM 17 typically draws 150 mA from the +8-V power supply, which is the *only* power source required by this board. This represents a total power dissipation of about 1.2 W per board, compared with about 8 W total power dissipation for the better 64 K-byte dynamic-memory boards.) As Larry Malakoff points out in the article cited earlier, "(a) decrease in power dissipation of more than sixfold can make a big difference in the reliability of the entire system. This is especially true when the system contains more than 64 K bytes of memory, as in a multi-user application. Since the reliability factor for electronic equipment decreases exponentially as the operating temperature increases, the mean time between failures can be drastically improved by using dynamic memories in the larger memory-intensive systems." If, in the last sentence of this excerpt, the word "dynamic" is replaced by "static CMOS," the quotation may be upgraded to remain true in light of today's technology.

2. Static-memory boards have a dramatically lower parts count than equivalent dynamic-memory boards

since there is no need for complicated refresh circuitry. Dynamic memories also require about three times more support ICs (about 30 versus 10); the more parts, the more chances for failure.

3. The Hitachi 6116 CMOS memory device used in the RAM 17, in addition to having more power-line noise immunity than a 4116-type dynamic memory, is also less sensitive to so-called soft-errors caused by alpha particle radiation. This means that even without parity checking RAM 17 is still more reliable than a 64 K-byte dynamic-memory board that does include parity checking.

4. The extremely fast, high-current switching occurring in dynamic-memory devices places a stress on these chips that is more severe than any stresses placed on CMOS memories. These stresses can cause dynamic memories to simply "wear out" after long-term operation. Though this wearing-out process may take several years on the average, the more dynamic memory there is in a system, the higher the probability that some devices will fail after only a few months or years.

Serviceability

Basically, any static-memory board is easier to repair than a dynamic-memory board. The near total absence of complex analog circuitry is mostly responsible for this. However, a special feature of CompuPro's RAM 17 makes maintenance even simpler. Though most S-100 memory devices using a bidirectional internal data bus (which includes conventional dynamic-memory boards, as well as RAM 17) may not be read or written from an IMSAI-type (switches and indicators for address and data lines) front panel, a special switch on the RAM 17 board allows these two operations. Therefore, 90 percent of the problems that may develop with the board can be quickly isolated by a technician using only a front panel and a logic probe.

Summing Up

Thanks to their low cost, dynamic memories may still find a home in dedicated, single-board small business/personal computers or even in some S-100 machines whose application is "frozen solid" (i.e., not subject to future upgrades). But the handwriting is on the wall; as CMOS technology becomes more refined and more publicized, the price advantage of dynamic memory will dissipate. In fact, for larger, high-performance systems, any potential economic advantages of dynamic memory are already outweighed by the lower power dissipation, higher speed, and greater reliability of the new generation of CMOS static memories. Of course, incremental improvements in dynamic memory are bound to occur—but it would take quite a breakthrough for dynamic memory to maintain its current share of the S-100 market, especially when you consider the many advantages offered by its CMOS competition. ■

The GEOSAT Program

Steve Emmett
12816 Tewksbury Dr.
Herndon, VA 22071

Scan the night sky on a clear evening and you might see some "stars" ancient astronomers never saw. These new heavenly bodies are communications satellites that relay voice, data, and television signals around the world.

"Parked" at various positions around the equator, these satellites appear to remain stationary above certain points on the earth's surface. Actually, they're orbiting the earth once every 24 hours. Because they maintain their positions relative to a point on earth, they are called *geostationary* or *geosynchronous* satellites.

The idea of geosynchronous communications satellites was first brought to public attention by a young British mathematician in a paper entitled "Extra-Terrestrial Relays." It was initially published in the October 1945 issue of *Wireless World*. In later years, Arthur C. Clarke has speculated on how wealthy he might've become if he'd had the foresight to patent the idea.

Commercial possibilities of these satellites were tapped by Western Union when it launched the first commercial geosynchronous communications satellite in 1974. Since then, nations have joined private corpora-

tions in the ever-increasing launching of geosynchronous satellites.

While the legality of transmission reception by nonsubscribing individuals is still being argued, financial and technical problems associated with signal reception are diminishing. If you had a satellite-receiving station (a television-receive-only or TVRO terminal), you could watch news events from around the world, first-run movies, unique sports events, and superstations like Ted Turner's WTBS—all free of charge.

The price for a TVRO terminal can range from \$4000 to over \$15,000.

Well, *almost* free of charge. The price for a TVRO terminal ranges from \$4000 to more than \$15,000 (see table 1 for a list of TVRO equipment suppliers).

All you need is a dish antenna, a low-noise amplifier, and a receiver/downconverter to change the satellite signal to a frequency usable by your home television. Before you purchase and install the receiving equipment, it's necessary to know the satellites'

locations relative to your site. Frequencies used by the satellites to transmit the television signals (2-4 GHz) require an unobstructed path or *line of sight* (LOS) between the satellite and the receiving antenna. It would be extremely annoying to dish out money for the equipment and whatever zoning permits might be necessary only to learn that the LOS of interest is blocked by a highrise building or lies below the horizon!

The GEOSAT program presented here will calculate the azimuth and elevation angle on which a TVRO antenna must be placed to receive signals from a specified geosynchronous satellite. (Note: while this article discusses TVRO sites in the United States, the program will calculate the antenna look angle for any site in the world.)

For precise designation of any point on or above its surface, the earth is divided into an imaginary grid. Grid lines circling the earth parallel to the equator indicate *latitude*; those extending from pole to pole indicate *longitude* (see figure 1).

Latitude is measured from the equator, which equals 0 degrees latitude. North or south from the

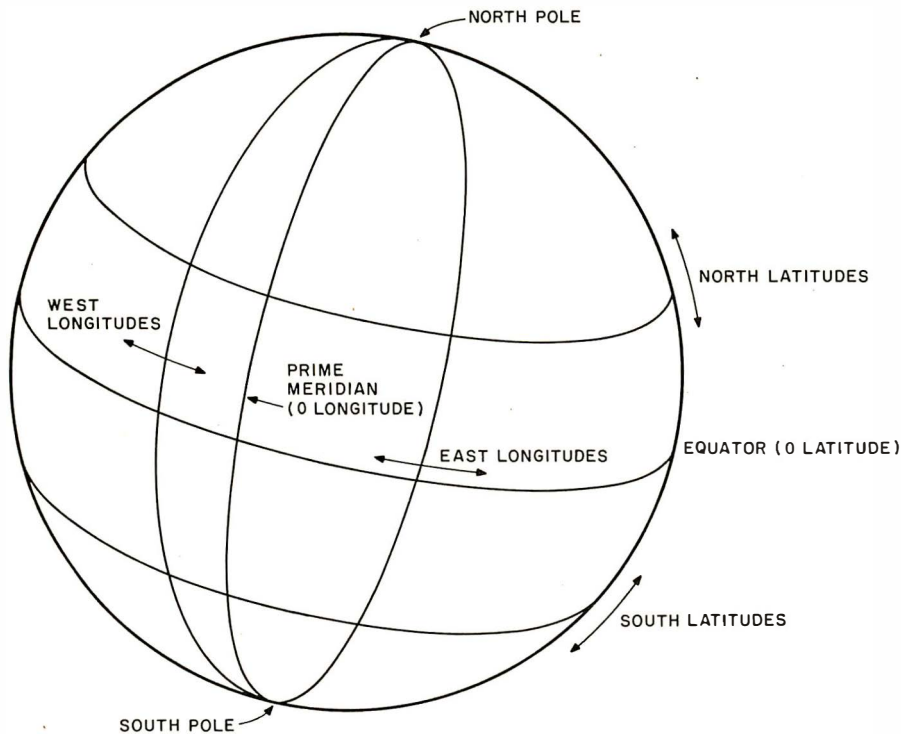
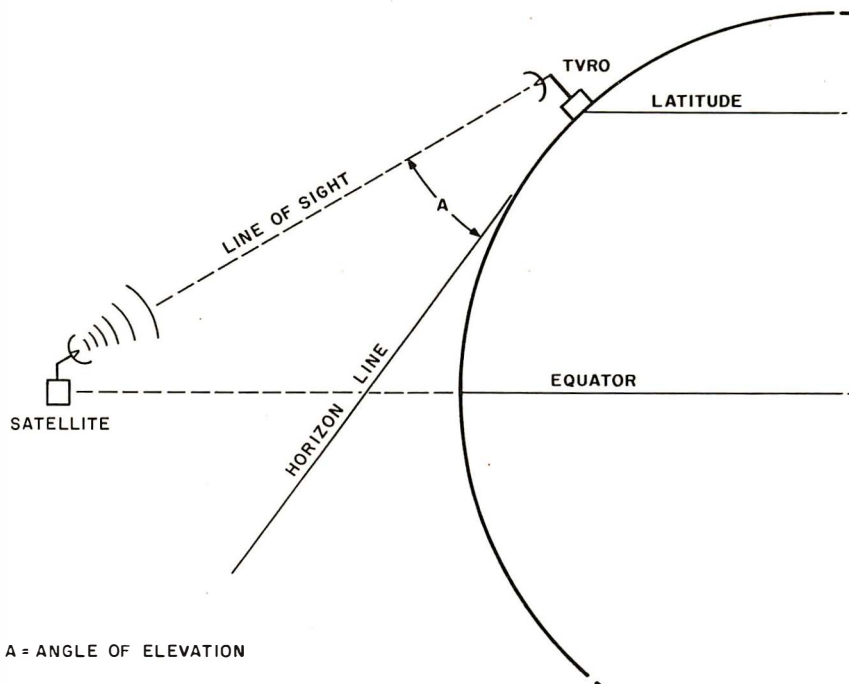

Figure 1: Longitude is measured from the prime meridian (0 degrees), which passes through Greenwich, England. Latitude is measured from the equator (0 degrees) to the poles.



A = ANGLE OF ELEVATION

Figure 2: Elevation angle for the antenna is measured from the horizon (0 degrees) to straight up (90 degrees).

equator, latitude increases to 90 degrees at the poles. Lines going toward the north pole are called north latitudes; those going toward the south pole are called south latitudes. The United States lies between about 25 and 50 degrees north latitude.

The reference for 0 degrees longitude is a line that extends between the poles and passes through Greenwich, England. Moving away from Greenwich, longitude increases to 180 degrees at the International Date Line (IDL), which is halfway around the world from Greenwich. Imagine yourself standing on the 0-degree longitude line and facing west. Longitudinal lines going west toward the IDL are termed west longitudes, while those going east from 0 degrees are termed east longitudes. The United States lies between about 70 and 125 degrees west longitude.

Since geosynchronous satellites are in orbit around the earth's equator (with an orbital inclination of 0 degrees), the satellites' latitude equals that of the equator: 0 degrees. A satellite's longitude is the point on the equator directly beneath it (the satellite subvehicular or *nadir* point). For communication satellites of interest to continental United States TVRO sites, longitudes range from about 85 to 180 degrees west (see table 3).

The direction in which the TVRO antenna must point for signal reception is given in terms of *azimuth* and *elevation*. To determine the azimuth, draw a circle whose center is the proposed antenna site. Draw a line from the center of the circle toward the north pole; this line has an azimuth of 0 degrees. Now move this line clockwise around the circle. When the line is pointing east, it has an azimuth of 90 degrees. At the half-circle or 180-degree mark, the line is pointing south. Thus, when an azimuth from a TVRO location to a satellite is given as, say, 190 degrees, the antenna is facing a little west of due south.

The *elevation angle* (how high the antenna has to be pointed) is measured with an imaginary line that extends from the TVRO site toward the horizon and ranges from 0 to 90

degrees (see figure 2). An elevation angle of 0 degrees means the antenna is pointing directly at the horizon; at 90 degrees, the antenna is pointing straight up.

Thus, given the satellite longitude and the receiving site latitude and longitude, it's possible to determine where the antenna must be pointed to receive signals. Since the satellite is geostationary, the antenna doesn't need to "track" the satellite. Only when reception from another satellite is desired is it necessary to move the antenna. (In the strictest sense, a geostationary satellite *does* move. But movement in latitude and longitude is small compared to the beam width of both the satellite transmitting antenna and the TVRO antenna. Consequently, it can be ignored).

The GEOSAT program (see listing 1, page 424) is written in Applesoft

BASIC and composed of nine modules:

INITIAL (6000-6600) sets up data arrays containing satellite and city names and defines several constants.

HEADER (4000-5060) consists of the greeting message and provides operating instructions as needed.

LISTCITY (7000-7460) provides a list of cities whose latitude and longitude data are stored in the program. Option to use one of the cities already stored or to enter a new city is offered (see table 2).

CITYLATLONG (1000-2380) is entered from LISTCITY if a city not in LISTCITY is desired. This module prompts for the city name, latitude, and longitude; it also does some input error checking.

LISTSATELLITE (8000-8460) provides a list of satellites whose longitude data are stored in the program. The option to use one, all, or to enter a new satellite is offered (see table 3).

SATLONG (3000-3700) is entered from LISTSATELLITE if a satellite not in LISTSATELLITE is desired. This module prompts for the satellite name and longitude and does some input error checking.

CALLSETUP (9000-9400) is used to set up some temporary arrays and to initialize some temporary variables prior to performing the actual look-angle calculations.

COMPUTE.LOOK (100-590) performs the look-angle calculation from a given city to the satellite(s) of choice. This module is called once for each satellite of interest.

SCREEN.DISPLAY (10000-10520) displays azimuth and elevation from the chosen city to the satellite(s) of interest and permits printing of results if desired (see table 4).

The overall flow of the program, which is fairly straightforward, is shown in figure 3. Three of the modules, COMPUTE.LOOK, CITYLATLONG, SATLONG, are called as subroutines. Taking advantage of how Applesoft processes a subroutine call, the three subroutines are placed at the beginning of the program. This

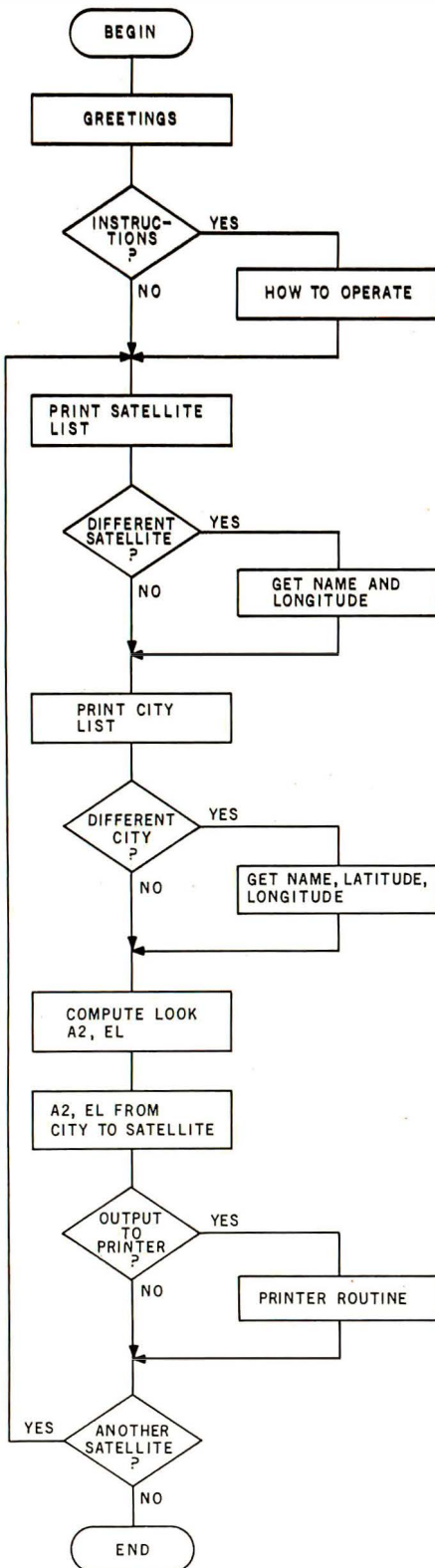

Figure 3: A flowchart showing organization and operation of the GEOSAT program.

- Antenna Development & Manufacturing, Inc.
POB 1178
Poplar Bluff, MO 63901
(314) 785-5988
- Antenna Engineering, Inc.
POB 1676
El Cajon, CA 92022
(714) 280-3443
- Heath Company
Benton Harbor, MI 49022
(800) 253-0570
- Interstar Satellite Systems, Inc.
21708 Marilla St.
Chatsworth, CA 91311
(213) 882-6770
- Microwave General
2680 Bayshore Frontage Rd.
Mountain View, CA 94043
(415) 969-3355
- Mid-America Video Corporation
POB 511
North Little Rock, AR 72115
(501) 753-3555
- NEC
Broadcast Equipment Division
130 Martin Lane
Elk Grove Village, IL 60007
(312) 640-3750
- Satellite International
3107 Eagle Rock Rd.
Augusta, GA 30903
(404) 738-5101
- Satellite Systems Science
POB 7213
Ocala, FL 32672
(904) 687-4633

Table 1: Some distributors of TVRO terminal equipment.

makes for poor program readability but does help increase its responsiveness.

To make the GEOSAT program as generally useful as possible, both satellite and city data are in the pro-

gram (see tables 2 and 3). If the data do not suit a particular need, the option is given during program operation to enter other data. In addition, it's simple to change the data lists in the program to permanently reflect

particular preferences. To accomplish this, just follow these steps:

1. List lines 20030 through 20270.
2. The first DATA statement (20030) contains the number of satellites presently stored in the program (maximum of 30).
3. The following DATA statements (20040-20150) contain the satellite names and their longitudes.
4. To add, delete, or change a satellite entry, simply enter the changes, following the format of the present entries and remembering to use a minus sign for west longitudes.
5. Be certain the number of satellites is correctly reflected in the DATA statement that precedes the list.
6. Immediately following the last satellite name is a DATA statement (20160) that contains the number of cities stored in the program (maximum of 30). Follow steps 4 and 5 to make any changes to the city list. South latitudes must be entered with a minus sign.
7. Save the revised version of the program.

Now whenever the program is run, the new data will be displayed (see table 4). After the azimuth and elevation calculations have been done, go to the potential TVRO site and look in the directions indicated by the program to see if there are any LOS obstructions.

A word of caution: if the elevation angle is low (0-10 degrees) or there's doubt about missing an obstruction, it's worthwhile to conduct a site survey. This survey would include taking into account the beam-width effects of the TVRO antenna and a precise determination of the angular separation of obstructions from the LOS. The larger the TVRO antenna, the narrower its beam width and the less effect obstructions and proximity to the horizon will have on its ability to receive signals from a particular satellite. When in doubt, do the survey. The amount you'll pay to determine whether or not the TVRO site is properly located is minuscule compared to the outlay for a system that can't be used! ■

Name	Latitude (N)	Longitude (W)
Washington, DC	39	77
Los Angeles	34	118
New York	40.5	74
Atlanta	33.5	84.5
Miami	25.75	80.25
Jacksonville	30.5	81.5
Tampa	28	82.75
Anchorage	60.8	147
Nome	65	165
Phoenix	33.5	112
Little Rock	34.75	92.25

Table 2: Latitude and longitude for these cities have been entered as data statements in the GEOSAT program. Other city locations can be included.

Name	Longitude (W)
COMSTAR 3	87
WESTAR 3	91
COMSTAR 2	95
WESTAR 1	99
ANIK 1	104
ANIK 2	109
ANIK 3	114
SATCOM 2	119
WESTAR 2	123.5
COMSTAR 1	128
SATCOM 3	132
SATCOM 1	135

Table 3: These satellites can be "seen" from the United States and are included in the program.

From: Washington, DC		
To	Antenna	
	Azimuth	Elevation
COMSTAR 3	195	49
WESTAR 3	201	48
COMSTAR 2	207	46
WESTAR 1	212	44
ANIK 1	219	41
ANIK 2	224	38
ANIK 3	230	35
SATCOM 2	235	31
WESTAR 2	239	27
COMSTAR 1	243	23
SATCOM 3	246	20
SATCOM 1	248	17

Table 4: Sample output of the GEOSAT program for a TVRO terminal located in Washington, D.C. Azimuth and elevation angles for each of the satellites in the program are shown.

Listing 1: Using a modular approach, the GEOSAT program has nine major subroutines. DATA statements containing positions for satellites and cities, plus tab positioning and printer routines, are located at the end of the program.

```

10 FG = 0
20 GOTO 4070
100 REM ****
110 REM
120 REM THIS MODULE COMPUTES THE LOOK AZIMUTH AND ELEVATION FROM A SPECIFIED POSITION ON THE EARTH TO A SYNCHRONOUS SATELLITE
130 REM
140 REM ****
150 REM
160 REM AZIMUTH IS IN Y
170 REM ELEVATION IS IN EL
180 REM
190 REM FIRST COMPUTE THE PROPER LONGITUDE DIFFERENCE
200 REM
210 T = M2 - M1
220 TA = ABS (T)
230 IF TA <= 180 THEN GOTO 260
240 TS = SGN (T)
250 T = - 1 * ((TS * 360) - T)
260 EP = T
270 REM
280 REM NOW CONVERT ANGLES INTO RADIANS
290 REM
300 T = T / RD:L1 = L1 / RD:EP = EP / RD
310 REM
320 REM NOW COMPUTE "MODIFIED" RECEIVER LATITUDE
330 X = SQR (1 - .5 * (COS (L1) + COS (EP)))
340 ML = 2 * FN ARCSYN(X)
350 REM
360 REM NOW COMPUTE ELEVATION LOOK ANGLE
370 REM
380 EL = (PI / 2) - (ML + ATN (R * SIN (ML) / (R * (1 - COS (ML) * H))))
390 REM
400 REM NOW COMPUTE LOOK AZIMUTH
410 REM
420 IF EP = 0 THEN YA = PI: GOTO 490
430 ZA = 1 / TAN (EP / 2)
440 ZB = TAN (L1 / 2)
450 YA = ATN (ZA * ZB) + ATN (ZA * (1 / ZB))

```

```

460 REM
470 REM NOW CONVERT ANGLES BACK TO DEGREES
480 REM
490 YA = YA * RD:EL = INT (EL * RD):L1 = L1 * RD
500 REM
510 REM CORRECT LOOK AZIMUTH FOR NORTH/SOUTH HEMISPHERE
520 REM
530 ZF = 360
540 IF L1 < 0 THEN GOTO 580
550 YA = 360 + YA
560 Y = FN MOD(YA)
570 RETURN
580 Y = INT (180 + YA)
590 RETURN
1000 REM ****
1010 REM
1020 REM MODULE TO GET CITY NAME, LATITUDE AND LONGITUDE.
1030 REM
1040 REM ****
1050 HOME
1060 PRINT "WHAT IS THE NAME OF THE CITY? ": INPUT NC$
1070 PRINT : PRINT
1080 PRINT "ENTER THE CITY LATITUDE USING SPACES TO SEPARATE DEGREES MINUTES AND NORTH OR SOUTH. ": INPUT DL$
1090 REM
1100 REM NOW DECOMPOSE DL$ INTO DEGREES, MINUTES AND NORTH OR SOUTH
1110 REM DO DEGREES FIRST
1120 REM
1130 LE = LEN (DL$)
1140 I = 1
1150 IF MID$ (DL$, I, 1) = CHR$ (32) THEN GOTO 1270
1160 IF (I = LE) THEN GOTO 1220
1170 I = I + 1: GOTO 1150
1180 REM
1190 REM DATA IS NOT IN PROPER FORMAT
1200 REM GIVE ERROR MESSAGE AND DO AGAIN
1210 REM
1220 UTAB 20: HTAB 1: PRINT "WHEN YOU ENTER THE LATITUDE, BE SURE TO USE SPACES TO SEPARATE THE ENTRIES. ": PRINT "ANY KEY TO CONTINUE ": GET K$: PRINT K$
1230 UTAB 5: HTAB 1: CALL - 958: GOTO 1080

```

Listing 1 continued:

```

1240 REM
1250 REM GET DEGREES
1260 REM
1270 J = I - 1
1280 DG = VAL ( MID$ (DL$,1,J))
1290 REM
1300 REM NOW LOOK FOR MINUTES
1310 REM
1320 MN = 0:KK = 0
1330 I = I + 1
1340 IF MID$ (DL$,1,1) = CHR$
(32) THEN GOTO 1400
1350 IF (I = LE) THEN GOTO 1220

1360 I = I + 1:KK = 1: GOTO 1340
1370 REM
1380 REM GET MINUTES
1390 REM
1400 JK = I - 1
1410 IF KK < > 0 THEN MN = VAL
( MID$ (DL$,J + 1,JK))
1420 REM
1430 REM DEGREES BETWEEN 0-90 A
ND MINUTES BETWEEN 0-60?
1440 REM
1450 IF NOT (DG > 90 OR DG < 0 OR
MN > 60 OR MN < 0) THEN GOTO
1540
1460 REM
1470 REM DEG,MIN BETWEEN CORREC
T LIMITS
1480 REM
1490 UTAB 20: HTAB 1: PRINT "DEG
REES ARE BETWEEN 0 AND 90 AN
D MINUTES ARE BETWEEN 0 AND 6
0.": PRINT "ANY KEY TO CONTI
NUE "': GET K$: PRINT K$
1500 UTAB 5: HTAB 1: CALL - 958
: GOTO 1080
1510 REM
1520 REM CONVERT TO DECIMAL
1530 REM
1540 L1 = DG + (MN / 60)
1550 REM
1560 REM N OR S?
1570 REM
1580 I = I + 1
1590 NS$ = MID$ (DL$,I,1)
1600 IF NS$ = "N" OR NS$ = "S"
THEN GOTO 1690
1610 REM
1620 REM MUST BE NORTH OR SOUTH

1630 REM
1640 UTAB 20: HTAB 1: PRINT "ENT
ER EITHER N FOR NORTH OR S F
OR SOUTH.ANY KEY TO CONTINUE

. "': GET K$: PRINT K$
1650 UTAB 5: HTAB 1: CALL - 958
: GOTO 1080
1660 REM
1670 REM PUT IN CORRECT SIGN FO
R LATITUDE
1680 REM
1690 IF NS$ = "S" THEN L1 = - L
1
1700 REM
1710 REM
1720 REM NOW GET CITY LONGITUDE

1730 REM
1740 REM
1750 UTAB 11: HTAB 1
1760 PRINT "ENTER THE CITY LONGI
TUDE USING SPACES TOSEPARATE
DEGREES MINUTES AND (EAST)
OR W(EST).": INPUT DL$
1770 REM
1780 REM NOW DECOMPOSE DL$ IN
TO DEGREES,MINUTES AND E OR
W
1790 REM DO DEGREES FIRST
1800 REM
1810 LE = LEN (DL$)
1820 I = 1
1830 IF MID$ (DL$,I,1) = CHR$
(32) THEN GOTO 1950
1840 IF (I = LE) THEN GOTO 1900

1850 I = I + 1: GOTO 1830
1860 REM
1870 REM DATA IS NOT IN PROPER
FORMAT
1880 REM GIVE ERROR MESSAGE AND
DO AGAIN
1890 REM
1900 UTAB 20: HTAB 1: PRINT "WHE
N YOU ENTER THE LONGITUDE, B
E SURE TOUSE SPACES TO SEPAR
ATE THE ENTRIES. "': PRINT "A
NY KEY TO CONTINUE "': GET K
$: PRINT K$
1910 UTAB 11: HTAB 1: CALL - 95
8: GOTO 1750
1920 REM
1930 REM GET DEGREES
1940 REM
1950 J = I - 1
1960 DG = VAL ( MID$ (DL$,1,J))
1970 REM
1980 REM NOW LOOK FOR MINUTES
1990 REM
2000 MN = 0:KK = 0
2010 I = I + 1

```

Listing 1 continued on page 426

Listing 1 continued:

```

2020 IF MID$(DL$,I,1) = CHR$(
      (32) THEN GOTO 2080
2030 IF (I = LE) THEN GOTO 1900

2040 I = I + 1:KK = 1: GOTO 2020
2050 REM
2060 REM GET MINUTES
2070 REM
2080 JK = I - 1
2090 IF KK < > 0 THEN MN = VAL
      ( MID$(DL$,J + 1,JK) )
2100 REM
2110 REM DEGREES BETWEEN 0-180
      AND MINUTES BETWEEN 0-60?
2120 REM
2130 IF NOT (DG > 180 OR DG < 0
      OR MN > 60 OR MN < 0) THEN
      GOTO 2220
2140 REM
2150 REM DEG,MIN BETWEEN CORREC
      T LIMITS
2160 REM
2170 UTAB 20: HTAB 1: PRINT "DEG
      REES ARE BETWEEN 0 AND 180 A
      ND MINUTES ARE BETWEEN
      0 AND 60.": PRINT "ANY KEY
      TO CONTINUE "": GET K$: PRINT
      K$
2180 UTAB 11: HTAB 1: CALL - 95
      8: GOTO 1750
2190 REM
2200 REM CONVERT TO DECIMAL
2210 REM
2220 M1 = DG + (MN / 60)
2230 REM
2240 REM E OR W
2250 REM
2260 I = I + 1
2270 EW$ = MID$(DL$,I,1)
2280 IF EW$ = "E" OR EW$ = "W"
      THEN GOTO 2370
2290 REM
2300 REM MUST BE EAST OR WEST
2310 REM
2320 UTAB 20: HTAB 1: PRINT "ENT
      ER EITHER E FOR EAST OR W FO
      R WEST. ANY KEY TO CONTINUE
      . "": GET K$: PRINT K$
2330 UTAB 11: HTAB 1: CALL - 95
      8: GOTO 1750
2340 REM
2350 REM PUT IN CORRECT SIGN F
      OR LONGITUDE
2360 REM
2370 IF EW$ = "W" THEN M1 = - M
      1
2380 RETURN

```

```

3000 REM ****
3010 REM
3020 REM MODULE TO GET SATELLI
      TE NAME AND LONGITUDE.
3030 REM
3040 REM ****
3050 HOME
3060 PRINT "WHAT IS THE NAME OF
      THE SATELLITE? ": INPUT NS$
3070 PRINT : PRINT
3080 PRINT "ENTER THE SATELLITE
      LONGITUDE USING SPACES T
      O SEPARATE DEGREES MINUTES A
      ND E(AST) OR W(EST).": INPUT
      SL$
3090 REM
3100 REM NOW DECOMPOSE SL$ IN
      TO DEGREES,MINUTES AND E OR
      W
3110 REM DO DEGREES FIRST
3120 REM
3130 LE = LEN (SL$)
3140 I = 1
3150 IF MID$(SL$,I,1) = CHR$(
      (32) THEN GOTO 3270
3160 IF (I = LE) THEN GOTO 3220

3170 I = I + 1: GOTO 3150
3180 REM
3190 REM DATA IS NOT IN PROPER
      FORMAT
3200 REM GIVE ERROR MESSAGE AND
      DO AGAIN
3210 REM
3220 UTAB 20: HTAB 1: PRINT "WHE
      N YOU ENTER THE LONGITUDE, B
      E SURE TO USE SPACES TO SEPA
      RATE THE ENTRIES. ": PRINT "
      ANY KEY TO CONTINUE "": GET
      K$: PRINT K$
3230 UTAB 11: HTAB 1: CALL - 95
      8: GOTO 1750
3240 REM
3250 REM GET DEGREES
3260 REM
3270 J = I - 1
3280 DG = VAL ( MID$(SL$,1,J) )
3290 REM
3300 REM NOW LOOK FOR MINUTES
3310 REM
3320 MN = 0:KK = 0
3330 I = I + 1
3340 IF MID$(SL$,I,1) = CHR$(
      (32) THEN GOTO 3400
3350 IF (I = LE) THEN GOTO 3090
3360 I = I + 1:KK = 1: GOTO 3340

```

Listing 1 continued:

```
3370 REM
3380 REM GET MINUTES
3390 REM
3400 JK = I - 1
3410 IF KK < > 0 THEN MN = VAL
< MID$ (SL$,J + 1,JK)>
3420 REM
3430 REM DEGREES BETWEEN 0-180
AND MINUTES BETWEEN 0-60?
3440 REM
3450 IF NOT (DG > 180 OR DG < 0
OR MN > 60 OR MN < 0) THEN
GOTO 3540
3460 REM
3470 REM DEG. MIN BETWEEN CORREC
T LIMITS
3480 REM
3490 UTAB 20: HTAB 1: PRINT "DEG
REES ARE BETWEEN 0 AND 180 A
ND MINUTES ARE BETWEEN
0 AND 60.": PRINT "ANY KEY
TO CONTINUE ";; GET K#: PRINT
K#
3500 UTAB 5: HTAB 1: CALL - 958
: GOTO 3080
3510 REM
3520 REM CONVERT TO DECIMAL
3530 REM
3540 M2 = DG + (MN / 60)
3550 REM
3560 REM E OR W
3570 REM
3580 I = I + 1
3590 EW$ = MID$ (SL$,I,1)
3600 IF EW$ = "E" OR EW$ = "W"
THEN GOTO 3690
3610 REM
3620 REM MUST BE EAST OR WEST
3630 REM
3640 UTAB 20: HTAB 1: PRINT "ENT
ER EITHER E FOR EAST OR W FO
R WEST.": PRINT "ANY KEY TO
CONTINUE. ";; GET K#: PRINT
K#
3650 UTAB 11: HTAB 1: CALL - 95
8: GOTO 1750
3660 REM
3670 REM PUT IN CORRECT SIGN F
OR LONGITUDE
3680 REM
3690 IF EW$ = "W" THEN M2 = - M
2
3700 RETURN
4000 REM ****
4010 REM
4020 REM HEADER MODULE
4030 REM
4040 REM ****
4050 REM THIS MODULE DOES THE H
EADER AND GIVE INSTRUCTIONS
AS NEEDED
4060 REM
4070 TEXT : HOME
4080 UTAB 10: HTAB 14: PRINT "G
E O S A T"
4090 UTAB 13: HTAB 9: PRINT "LOO
K ANGLE CALCULATOR"
4100 FOR I = 1 TO 2000: NEXT I
4110 HOME
4120 UTAB 4: HTAB 1
4130 PRINT " THIS PROGRAM WILL A
LLOW YOU TO"
4140 PRINT " DETERMINE WHERE YOU
HAVE TO POINT"
4150 PRINT " AN ANTENNA TO PERMI
T RECEPTION OF"
4160 PRINT " SIGNALS TRANSMITTED
FROM A
4170 PRINT " GEOSYNCHRONOUS SATE
LLITE."
4180 PRINT : PRINT
4190 PRINT " IF YOU NEED INSTRUCC
IONS ON THE"
4200 PRINT " OPERATION OF THIS P
ROGRAM. PRESS"
4210 PRINT " THE <ESC> KEY. OTH
ERWISE ANY"
4220 PRINT " OTHER KEY WILL STAR
T THE PROGRAM."
4230 PRINT
4240 PRINT " THE INSTRUCTIONS AR
E CONTAINED ON"
4250 PRINT " SEVERAL PAGES. TO
SEE THE VARIOUS"
4260 PRINT " PAGES, USE ANY KEY
TO CHANGE THE"
4270 PRINT " DISPLAY."
4280 UTAB 22: HTAB 2: PRINT "<ES
C> TO GET INSTRUCTIONS"
4290 PRINT " ANY OTHER KEY TO ST
ART ";; GET KB#: PRINT KB#
4300 REM
4310 REM WHAT IS KB#?
4320 REM
4330 IF KB# < > CHR$ (27) THEN
GOTO 6080
4340 REM
4350 REM GIVE INSTRUCTIONS
4360 REM
4370 HOME
4380 PRINT : PRINT
4390 PRINT "WHENEVER THERE ARE P
ARENTHESSES AROUND "
4400 PRINT "WORDS OR GROUPS OF L
```

Listing 1 continued on page 428

Listing 1 continued:

```

    ETERS IN THE"
4410 PRINT "INSTRUCTIONS, THIS M
    EANS THAT THE"
4420 PRINT "THINGS INSIDE THE PA
    RENTHESES ARE"
4430 PRINT "OPTIONAL."
4440 PRINT
4450 PRINT "ITEMS INSIDE THE SYM
    BOLS < > ARE"
4460 PRINT "REQUIRED OPERATIONS
    OR ENTRIES."
4470 PRINT
4480 PRINT " <SP> IS THE SPACE
    KEY."
4490 PRINT " <RTN> IS THE RETUR
    N KEY."
4500 PRINT " <ESC> IS THE ESCAP
    E KEY."
4510 UTAB 24: HTAB 39: GET KB#:
    PRINT KB#
4520 HOME
4530 PRINT
4540 PRINT "AS A PART OF THIS PR
    OGRAM, THERE ARE 2"
4550 PRINT "DATA SETS. ONE CONSI
    STS OF A NUMBER OF"
4560 PRINT "SATELLITES AND THEIR
    LONGITUDES. THE"
4570 PRINT "OTHER IS A NUMBER OF
    CITIES AND THEIR"
4580 PRINT "LATITUDES AND LONGIT
    UDES."
4590 PRINT
4600 PRINT "FOR EACH DATA SET, Y
    OU WILL BE ASKED"
4610 PRINT "WHETHER YOU WISH TO
    USE THE INFORMATION"
4620 PRINT "ALREADY IN THE PROGR
    AM OR WISH TO ENTER"
4630 PRINT "NEW INFORMATION."
4640 PRINT
4650 PRINT "IF YOU CHOOSE TO USE
    THE INFORMATION"
4660 PRINT "ALREADY IN THE PROGR
    AM, SIMPLY ENTER"
4670 PRINT "THE NUMBER THAT CORR
    ESPONDS TO THE CITY"
4680 PRINT "OR SATELLITE YOU DES
    IRE AND PRESS"
4690 PRINT "THE <RTN> KEY."
4700 PRINT
4710 PRINT "IF YOU WISH TO ENTER
    YOUR OWN CITY OR"
4720 PRINT "SATELLITE, PRESS ANY
    KEY THAT DOES NOT"
4730 PRINT "CORRESPOND TO A CITY
    OR SATELLITE AND"
4740 PRINT "PRESS <RTN>."
4750 UTAB 24: HTAB 39: GET KB#:
    PRINT KB#
4760 HOME
4770 PRINT
4780 PRINT "YOU WILL THEN BE ASK
    ED SEVERAL"
4790 PRINT "QUESTIONS."
4800 PRINT
4810 PRINT "FOR NAMES OF CITIES
    OR SATELLITES ENTER"
4820 PRINT "WHATEVER YOU WISH.
    USE SPACES AND NOT"
4830 PRINT "COMMAS AS SEPARATORS
    IF NEEDED."
4840 PRINT
4850 PRINT "WHEN LATITUDE INFORM
    ATION IS REQUESTED,"
4860 PRINT "ENTER THE DATA IN TH
    E FORMAT:"
4870 PRINT
4880 PRINT "DEGREES <SP> MINUTES
    <SP> N OR S <RTN>"
4890 PRINT
4900 PRINT "N(NORTH) OR S(SOUTH) M
    UST BE ENTERED, BUT"
4910 PRINT "IF YOU WISH TO SKIP
    THE DEGREE OR"
4920 PRINT "MINUTE ENTRY JUST EN
    TER A SPACE INSTEAD"
4930 PRINT "OF THE NUMBER. COMPL
    ETE THE ENTRY BY"
4940 PRINT "PRESSING THE RETURN
    KEY."
4950 PRINT
4960 PRINT "THE IDENTICAL FORMAT
    IS USED FOR"
4970 PRINT "LONGITUDE DATA. JUST
    REPLACE N OR S BY"
4980 PRINT "E(EAST) OR W(WEST)."
```

```

4990 UTAB 24: HTAB 39: GET KB#:
    PRINT KB#
5000 HOME
5010 PRINT : PRINT : PRINT
5020 PRINT "IF YOU NEED TO SEE T
    HE INSTRUCTIONS"
5030 PRINT "AGAIN, PRESS <ESC>.
    OTHERWISE, USE ANY"
5040 PRINT "OTHER KEY TO START T
    HE PROGRAM."
5050 UTAB 24: HTAB 39: GET KB#:
    PRINT KB#
5060 IF KB# = CHR# (27) THEN
    GOTO 4370
6000 REM ****
6010 REM
6020 REM INITIALIZATION MODULE
```

Listing 1 continued:

```
6030 REM
6040 REM ****
6050 REM
6060 REM SOME CONSTANTS
6070 REM
6080 HOME :R = 6378:H = 35500:PI
      = 3.14159
6090 RD = 360 / (2 * PI)
6100 REM
6110 REM ARCSIN DEFINATION
6120 REM
6130 DEF FN ARCSYN(X) = ATN (X
      / SQR (- X * X + 1))
6140 REM
6150 REM MODULUS DEFINITION
6160 REM
6170 DEF FN MOD(Z) = INT ((Z /
      ZF - INT (Z / ZF)) * ZF + .
      05) * SGN (Z / ZF)
6180 REM
6190 REM READ IN THE SATELLITE
      PARAMETERS
6200 REM
6210 RESTORE
6220 REM
6230 REM N IS THE NUMBER OR SAT
      ELLITES IN THE LIST
6240 REM
6250 READ N
6260 REM
6270 REM SN#( IS NAME ARRAY AND
      SN( IS LONGITUDE ARRAY
6280 REM
6290 IF FG = 1 THEN GOTO 6340
6300 DIM SN#(N),SN(N),DS#(N),DS(
      N),P#(24)
6310 REM
6320 REM P#( IS PRINTER BUFFER
6330 REM
6340 FOR I = 1 TO N
6350 READ SN#(I)
6360 READ SN(I)
6370 NEXT I
6380 SN(0) = N
6390 REM
6400 REM A( IS LOOK AZIMUTH ARR
      AY AND E( IS LOOK ELEVATION
      ARRAY
6410 REM
6420 IF FG = 1 THEN GOTO 6490
6430 DIM A(N),E(N)
6440 REM
6450 REM READ IN CITY PARAMETER
      S
6460 REM
6470 REM
6480 REM M IS NUMBER OF CITIES
6490 READ M
6500 REM
6510 REM CN#( IS CITY NAME ARR
      Y:CL( IS CITY LATITUDE ARRAY
      : CM( IS CITY LONGITUDE ARR
      Y
6520 REM
6530 IF FG = 1 THEN GOTO 6550
6540 DIM CN#(M),CL(M),CM(M)
6550 FOR I = 1 TO M
6560 READ CN#(I)
6570 READ CL(I)
6580 READ CM(I)
6590 NEXT I
6600 CL(0) = M
7000 REM ****
7010 REM
7020 REM THIS MODULE GIVES THE
      CITY LIST ALONG WITH THE OPT
      ION OF CHOOSING ONE OF THE S
      TORED CITIES OR ENTERING A N
      EW ONE
7030 REM
7040 REM ****
7050 HOME
7060 UTAB 2: HTAB 1: PRINT "THESE
      CITIES ARE AVAILABLE:": UTAB
      5: HTAB 1
7070 REM
7080 REM GET NUMBER OF CITIES.
      IF >30 THEN TRUNCATE.
7090 REM
7100 M = CL(0)
7110 IF M > 30 THEN M = 30
7120 REM
7130 REM DETERMINE NUMBER OF RO
      WS OF DUAL COLUMN PRINTING N
      EEEDED
7140 REM
7150 M1 = M / 2:M2 = INT (M1):MP
      = M1 - M2
7160 REM
7170 REM DEFAULT TAB OFFSET POS
      IITIONS
7180 REM
7190 HL = 3:HR = 23
7200 FOR I = 1 TO M2
7210 J = I + M2
7220 REM
7230 REM IF MP=0 THERE WILL BE
      2 COLUMNS ON EACH ROW. OTHE
      RWISE THERE WILL BE AN EXTRA
      ROW.
7240 REM
7250 IF MP < > 0 THEN J = J + 1
7260 REM
```

Listing 1 continued on page 430

Listing 1 continued:

```
7270 REM GOSUB DETERMINES THE
      NUMBER OF DIGITS IN I,J
7280 REM
7290 GOSUB 30000
7300 PRINT TAB( HL - H1);I; TAB(
      HL + 2);CN$(I); TAB( HR - H2
      );J; TAB( HR + 2);CN$(J)
7310 NEXT I
7320 IF NP < > 0 THEN GOSUB 30
      000: PRINT TAB( HL - H1);I;
      TAB( HL + 2);CN$(I)
7330 REM
7340 REM GET CHOICE OF CITY. O
      NLY ONE AT A TIME!!!
7350 REM
7360 UTAB 21: HTAB 1: PRINT "ENT
      ER YOUR CHOICE BY INDICATING
      : "
7370 PRINT TAB( 2);"A NUMBER BE
      TWEEN 1 AND ";M;" OR USING "
7380 PRINT TAB( 2);"ANY OTHER K
      EY FOR A NEW CITY ";; INPUT
      KB#
7390 REM
7400 REM WHAT IS KB#
7410 REM
7420 CK = VAL (KB#)
7430 IF CK < 1 OR CK > M THEN
      GOSUB 1050:CK = M + 1
7440 REM
7450 REM NOW DO SATELLITE
7460 REM
8000 REM ****
8010 REM
8020 REM THIS MODULE GIVES THE
      SATELLITE LIST ALONG WITH
      THE OPTION OF USING ALL THE
      STORED NAMES OR ENTERING A N
      EW ONE
8030 REM
8040 REM ****
8050 HOME
8060 UTAB 2: HTAB 1: PRINT "THESE
      SATELLITES ARE AVAILABLE:"
      : UTAB 5: HTAB 1
8070 REM
8080 REM GET NUMBER OF SATELLIT
      ES. IF >30 TRUNCATE
8090 REM
8100 N = SN(0)
8110 IF N > 30 THEN N = 30
8120 REM
8130 REM DETERMINE NUMBER OF DU
      AL COLUMN PRINTINGS NEEDED
8140 REM
8150 N1 = N / 2:N2 = INT (N1):NP
      = N1 - N2
8160 REM
8170 REM DEFAULT TAB OFFSET POS
      ITIONS
8180 REM
8190 HL = 3:HR = 23
8200 FOR I = 1 TO N2
8210 J = I + N2
8220 REM
8230 REM IF NP=0 THEN THERE WI
      LL BE 2 COLUMNS FOR EACH ROW
      . OTHERWISE, AN EXTRA ROW I
      S NEEDED.
8240 REM
8250 IF NP < > 0 THEN J = J + 1
8260 REM
8270 REM GOSUB DETERMINES THE N
      UMBER OF DIGITS IN I,J
8280 REM
8290 GOSUB 30000
8300 PRINT TAB( HL - H1);I; TAB(
      HL + 2);SN$(I); TAB( HR - H2
      );J; TAB( HR + 2);SN$(J)
8310 NEXT I
8320 IF NP < > 0 THEN GOSUB 30
      000: PRINT (HL - H1);I; TAB(
      HL + 2);SN$(I)
8330 REM
8340 REM NOW GET CHOICE OF WHIC
      H SATELLITE(S) TO USE
8350 REM
8360 UTAB 20: HTAB 1: PRINT "ENT
      ER YOUR CHOICE:"
8370 PRINT TAB( 2);"ZERO(0) TO
      USE ALL OR": PRINT TAB( 2);
      "ANY NUMBER BETWEEN 1 AND ";
      N;" OR": PRINT TAB( 2);"ANY
      OTHER KEY FOR A NEW SATELLI
      TE ";; INPUT KB#
8380 REM
8390 REM WHAT IS KB#
8400 REM
8410 SQ = ASC (KB#)
8420 SK = VAL (KB#)
8430 REM
8440 REM GO GET A NEW SATELLITE
      ?
8450 REM
8460 IF SK = 0 AND (SQ < 48 OR S
      Q > 57) THEN GOSUB 3050:SK =
      N + 1
9000 REM ****
9010 REM
9020 REM SETUP CITY,SATELLITE P
      ARAMETERS PRIOR TO AZ,EL CAL
      CULATION
9030 REM
```

Listing 1 continued:

```
9040 REM ****
9050 REM
9060 REM DO CITY FIRST
9070 REM
9080 IF CK > M THEN DC# = NC#
9090 IF CK < = M THEN DC# = CN#
      (CK):L1 = CL(CK):M1 = CM(CK)

9100 REM
9110 REM DO SATELLITE. FIRST S
      ETUP DEFAULT NAME ARRAY
9120 REM
9130 N = SN(0)
9140 FOR I = 0 TO N
9150 DS#(I) = SN#(I)
9160 DS(I) = SN(I)
9170 NEXT I
9180 REM
9190 REM IF SK=0 USE ALL
9200 REM
9210 IF SK = 0 THEN GOTO 9350
9220 REM
9230 REM DISTINGUISH BETWEEN SK
      =1,N AND SK>N
9240 REM
9250 DS(0) = 1
9260 IF SK > N THEN GOTO 9300
9270 DS#(1) = DS#(SK)
9280 DS(1) = DS(SK)
9290 GOTO 9350
9300 DS#(1) = NS#
9310 DS(1) = M2
9320 REM
9330 REM NOW DO AZ,EL CALCULATI
      ON
9340 REM
9350 MX = DS(0)
9360 FOR I = 1 TO MX
9370 M2 = DS(I)
9380 GOSUB 210
9390 A(I) = Y:E(I) = EL
9400 NEXT I
10000 REM ****
10010 REM
10020 REM THIS MODULE DOES THE
      SCREEN DISPLAY OF THE CALCU
      LATION RESULTS
10030 REM
10040 REM ****
10050 HOME
10060 UTAB 2: HTAB 4: PRINT "FRO
      M: ";DC#
10070 UTAB 5: HTAB 29: PRINT "AN
      TENNA"
10080 PRINT TAB( 4):"T0": TAB(
      26):"AZIMUTH": TAB( 35):"ELE
      U."
```

```
10090 REM
10100 REM SETUP TEXT WINDOW TO
      PROTECT LABELS
10110 REM
10120 POKE 34,7
10130 REM
10140 REM SOME DEFAULTS: LINES/
      PAGE:START LINE:STOP LINE:AZ
      ,EL TABS
10150 REM
10160 LP = 15:ST = 1:SP = LP:HL =
      31:HR = 38
10170 REM
10180 REM DETERMINE NUMBER OF D
      ISPLAY PAGES
10190 REM
10200 Z1 = INT (N / 15)
10210 ZP = Z1 + 1
10220 REM
10230 REM DISPLAY PAGE LOOP
10240 REM
10250 FOR ZQ = 1 TO ZP
10260 UTAB 8
10270 IF DS(0) < SP THEN SP = DS
      (0)
10280 FOR ZR = ST TO SP
10290 I = A(ZR):J = E(ZR)
10300 GOSUB 30000
10310 PRINT TAB( 2):DS#(ZR): TAB(
      HL - H1):I: TAB( HR - H2):J
10320 NEXT ZR
10330 UTAB 24
10340 PRINT "<ESC> TO PRINT/ANY
      KEY TO CONTINUE ";; GET KB#
10350 REM
10360 REM IF KB#=CHR$(27) THEN
      GOTO PRINT ROUTINE
10370 REM
10380 IF KB# = CHR# (27) THEN
      GOSUB 50000
10390 ST = SP + 1:SP = SP + LP: HOME
10400 NEXT ZQ
10410 REM
10420 REM DO ANOTHER SET?
10430 REM
10440 TEXT : HOME
10450 PRINT : PRINT
10460 PRINT "USE <ESC> TO USE TH
      E PROGRAM AGAIN."
10470 PRINT "USE <RTN> TO LEAVE
      THE PROGRAM."
10480 GET KB#: PRINT KB#
10490 IF KB# = CHR# (27) THEN F
      G = 1: GOTO 6080
10500 IF KB# = CHR# (13) THEN
      GOTO 10520
```

Listing 1 continued on page 432

Listing 1 continued:

```
10510  GOTO 10440
10520  TEXT : HOME : END
20000  REM
20010  REM  DATA STATEMENTS
20020  REM
20030  DATA  12
20040  DATA  COMSTAR 3,-87
20050  DATA  WESTAR 3,-91
20060  DATA  COMSTAR 2,-95
20070  DATA  WESTAR 1,-99
20080  DATA  ANIK 1,-104
20090  DATA  ANIK 2,-109
20100  DATA  ANIK 3,-114
20110  DATA  SATCOM 2,-119
20120  DATA  WESTAR 2,-123.5
20130  DATA  COMSTAR 1,-128
20140  DATA  SATCOM 3,-132
20150  DATA  SATCOM 1,-135
20160  DATA  11
20170  DATA  WASHINGTON D.C.,39,-
      77
20180  DATA  LOS ANGELES,34,-118
20190  DATA  NEW YORK,40.5,-74
20200  DATA  ATLANTA,33.5,-84.5
20210  DATA  MIAMI,25.75,-80.25
20220  DATA  JACKSONVILLE,30.5,-8
      1.5
20230  DATA  TAMPA,28,-82.75
20240  DATA  ANCHORAGE,60.8,-147
20250  DATA  NOME,65,-165
20260  DATA  PHOENIX,33.5,-112
20270  DATA  LITTLE ROCK,34.75,-9
      2.25
```

```
29970  REM
29980  REM  TAB POSITIONING ROUTI
      ME
29990  REM
30000  H1 = 3:H2 = 3
30010  IF I < 100 THEN H1 = 2
30020  IF I < 10 THEN H1 = 1
30030  IF J < 100 THEN H2 = 2
30040  IF J < 10 THEN H2 = 1
30050  RETURN
49950  REM
49960  REM  PRINTER ROUTINE
49970  REM
49980  REM  FOLLOWS SCREEN FORMAT
      SHOWN ON PAGE 16 OF APPLE R
      EFERENCE MANUAL
49990  REM
50000  FOR I = 1 TO 3
50010  LN = 1024 + (I - 1) * 40
50020  FOR J = 1 TO 8
50030  LM = LN + (J - 1) * 128
50040  A# = "      "
50050  FOR K = 0 TO 39
50060  A# = A# + CHR# ( PEEK (LM +
      K))
50070  NEXT K
50080  P#(8 * (I - 1) + J) = A#
50090  NEXT J: NEXT I
50100  PR# 2
50110  FOR J = 1 TO 23
50120  PRINT P#(J): NEXT J
50130  PR# 0
50140  RETURN
```



Z80 Starting Address One Jump Further

Steven Lemmen
2034 Kings Road
Victoria BC
Canada V8R 2P7

While designing my homebrew Z80-based computer system, I realized it would be a great advantage to have programmable memory in the first page of memory space. If I could reach that goal, I could make full use of the Z80's restart locations for more flexible programming. But I needed a way to pass control to a memory page other than page 0, where a program in EPROM (erasable programmable read-only memory) would be located. Because experience has taught me to rank flexibility in microprocessor systems as a high priority, I wanted to be able to start at any page.

My approach is similar to the one proposed by Randy Soderstrom in "Forcing the Z80 Starting Address" (February 1981 BYTE, page 288), but mine provides flexibility and the lower device count desirable in a microprocessor system. Program execution can be directed to any of the Z80's 256 memory pages by setting an 8-bit DIP (dual-inline package) switch to the appropriate setting to indicate the desired page, using four integrated circuits.

As shown in figure 1, two SN74LS257 multiplexers drive the switch-settings onto the data bus at the appropriate time. These devices have three-state outputs allowing them to be connected directly to the data bus.

Figure 2 shows the timing sequence associated with the circuit operation. The timing of the forced-jump instruction is controlled by the dual D flip-flop circuit made of IC3. When $\overline{\text{RESET}}$ occurs, these two flip-flops are set, causing the $\overline{\text{JUMP ENABLE}}$ signal to go low. This, in turn, prevents any $\overline{\text{RD}}$ pulses from enabling the bus receivers, and also enables IC1 and IC2 to drive the Z80 data lines.

After a reset, the first address the Z80 places on the address bus is 0000 hexadecimal. The byte it fetches from this address will be interpreted as an operation code, making $\overline{\text{M1}}$ go low and causing $\overline{\text{IC3}}$ to reset. This action stores the first occurrence of $\overline{\text{M1}}$. With address lines A0 and A1 low, the value placed on the data bus will be C3 hexadecimal—the operation code for a jump instruction. When the address lines go to 0001 hexadecimal to fetch the low byte of the jump address, the multiplexers will place 00 on the data bus. When the address lines go to 0002 to fetch the high byte of the jump address, the value of the 8-bit DIP switch is placed on the data bus. The characteristics of TTL (transistor-transistor logic) mean pullup resistors are not needed on the DIP switch. An open switch will assume a logic 1 state and a closed switch will assume a logic 0 state.

The cursor in figure 2 marks the first $\overline{\text{RD}}$ cycle in the previous sequence. The Z80 will now execute a jump to location xxxxxxxx00000000 binary, where xxxxxxxx represents the value set by the DIP switch. At this location an operation-code fetch cycle is executed. When $\overline{\text{M1}}$ goes low after this cycle, IC2b is reset, marking the second occurrence of $\overline{\text{M1}}$. The $\overline{\text{JUMP ENABLE}}$ signal is then disabled and the bus-receiver $\overline{\text{RD}}$ signal re-enabled. The E marker in figure 2 indicates this point in the timing. The Z80 is now executing program code starting at the page specified by the DIP switch setting.

On my processor card, I connected the data lines of this circuit directly to the Z80 data lines. I connected the $\overline{\text{BUFFER RD}}$ signal to the bus receivers that buffer the backplane to the Z80 data bus. In this way, memory that would normally be read at memory address 0000 would

Number	Type	+ 5 V	GND
IC1	74LS257	16	8
IC2	74LS257	16	8
IC3	74LS74	14	7
IC4	74LS00	14	7

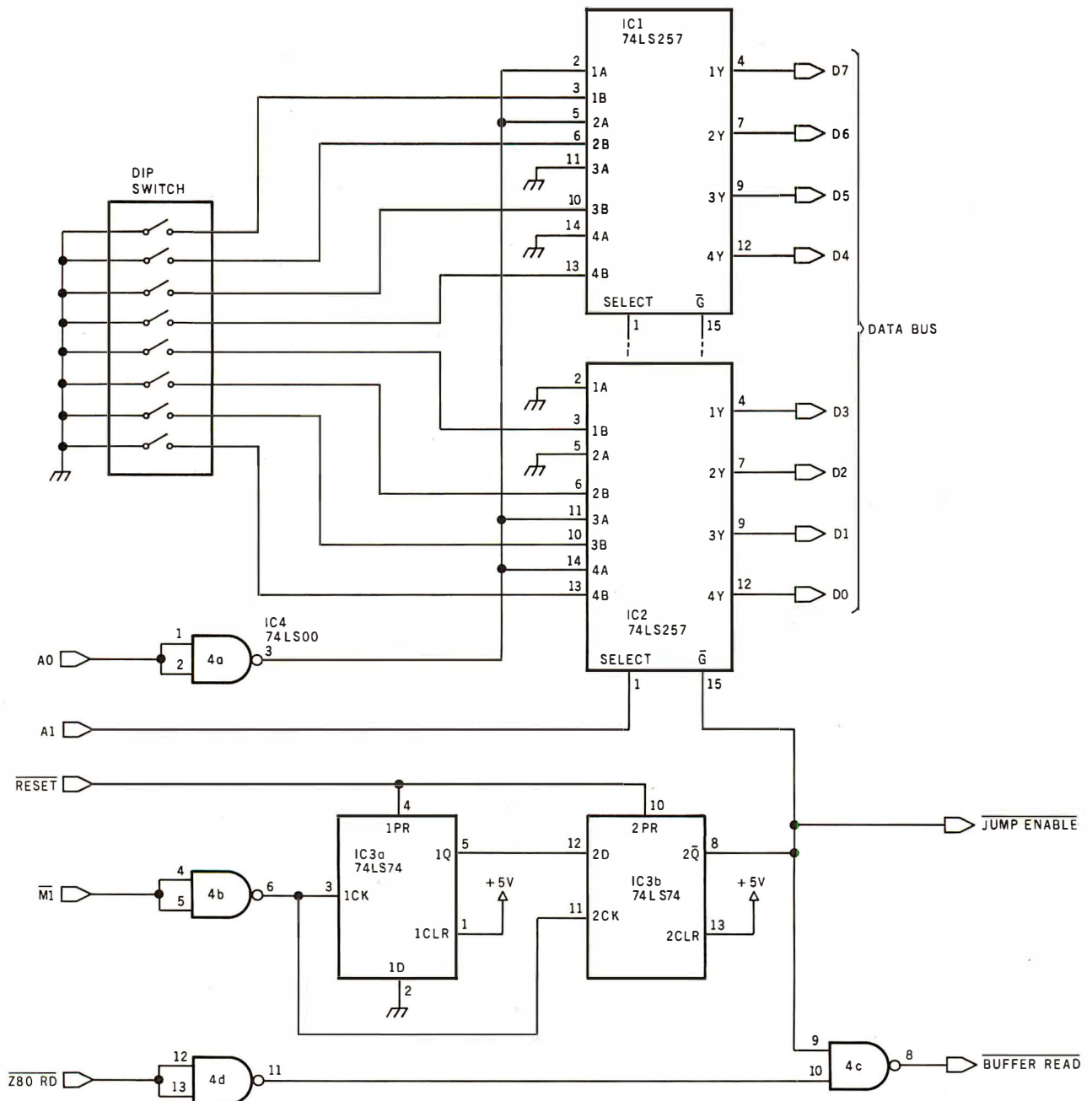

Figure 1: Schematic diagram of the circuit used to force Z80 starting addresses to any of 256 memory pages. IC1 and IC2 are three-state multiplexers that pass the address set by the switches when the proper combination of reset signals occurs.

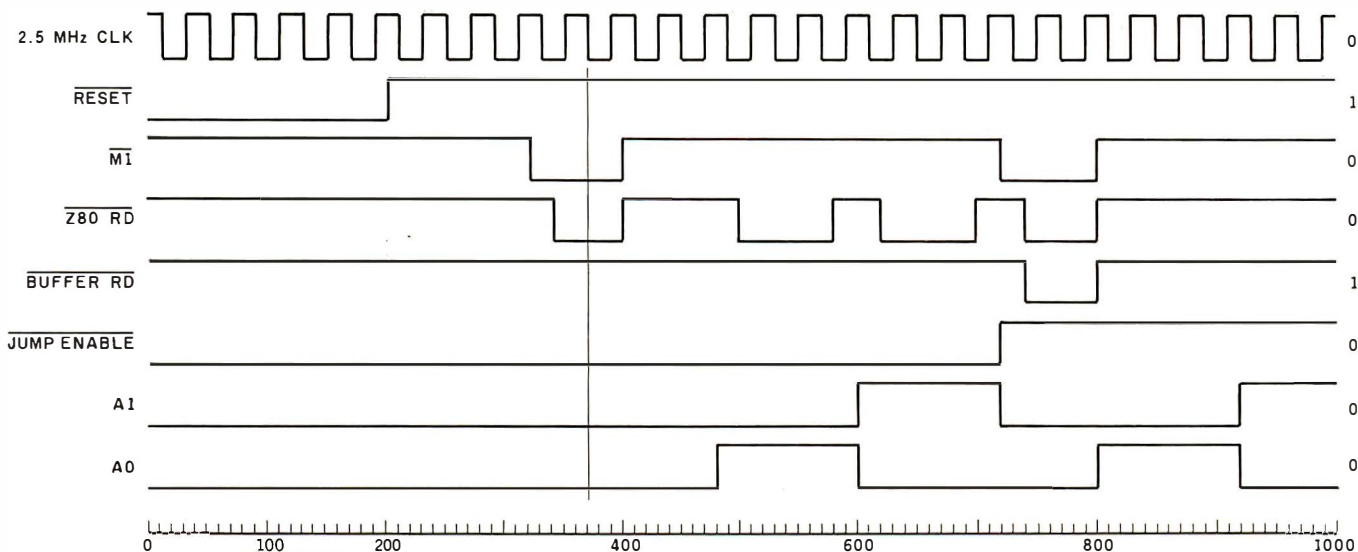

Figure 2: Timing relationships of the forced jump.

not affect program flow during the forced-jump sequence. But the circuit could be connected to directly disable memory as suggested by Soderstrom.

If your system has a negative-true bus, you can use an

SN74LS258 in place of the SN74LS257. And if you need more current-driving capability, you can use regular TTL in place of the LS TTL in the multiplexer chips. ■

Increase Memory **4X** on the **IBM** Personal Computer

Datamac Peripheral Products offer the perfect solution to the major limitation of the IBM Personal Computer - only a 32K or 64K byte memory. The Datamac Memory Expansion Board - The First & the Only Available - contains 4 TIMES the amount of memory offered by the IBM Personal Computer. The 64K byte board is currently priced at about 20% below IBM's suggested retail price. Configurations can be set at 64K, 128K, 192K and 256K bytes.

The Datamac Memory Expansion Board is AVAILABLE NOW for immediate delivery.

Call or write for more information - Dealer inquiries welcomed.

data
mac

Peripheral Products Division
680 Almanor Avenue
Sunnyvale, CA 94086
(408) 735-0323

SOFTIM A Software Timer

Dan Terpstra, Dittmer Laboratory of Chemistry, POB 254,
Florida State University, Tallahassee FL 32306

I recently found myself in a situation where I had to use a Z80-based microcomputer to collect data as a function of time, then average that data over an extended period of time and subject it to a Fourier transformation to analyze its frequency dependence. This meant that I needed several highly accurate timers that I could set very precisely over a wide range of different time periods.

When precision and accuracy are required (as with computer-synthesized music), a timing job is often assigned to interrupt-driven hardware timer circuits, such as the Zilog CTC (counter/timer circuit) or the Intel 8253 programmable timer. These circuits base their timing intervals on crystal oscillators and can fulfill a wide range of timing functions if they are available in a system.

If the timing requirements are not very rigid (as with games or video animation), simple software loops are usually adequate. These loops can be "tweaked" empirically to provide the aesthetically appropriate amount of delay.

But what do you do if you need precise, accurate time delays and you don't have the hardware to do it? Could I satisfy all those requirements with software?

I wrote a few simple timer routines, just to identify the problems that I had to solve. (I will classify the routines according to the number of bytes used to count repetitions of a timing loop.) My 1-byte timer was the simplest to code, but it was deficient in both resolution and dynamic range; the 2-byte timer was better in both respects but still not substantial enough for my purposes; the 3-byte timer had an adequate dynamic range, but the internal branching of the routine resulted in timing jitter that depended on the relative number of times each branch was executed. In addition, all of these routines had a finite amount of overhead as they entered and exited the timing loop, which lead to a constant error

that was increasingly significant for shorter and shorter time delays.

As a result of these simple routines, I made a list of the characteristics for my ideal software timer:

- at least 3 counter bytes to allow an adequate dynamic range (ratio of longest time to shortest time)
- rapid execution for high resolution (brief timing loop)
- internal branches of identical length to eliminate branching jitter
- subroutine structure to avoid excessive code duplication
- setup and calling sequences within the timing loop to prevent constant timing errors
- capability of generating several different intervals or repeating the same interval in any given program
- time delays that can be defined at run-time from keyboard input or other sources
- if possible, a loop-execution time in even units to eliminate the need for a clumsy conversion routine that shifts from a human time frame to a software time frame

By carefully counting the T-states (external clock cycles) for each instruction (as given in the *Z80-CPU Technical Manual*), and after several false starts, I finally arrived at a deceptively simple program that I call SOFTIM, shown in listing 1. The time-delay count is stored as a 3-byte (24-bit) positive integer that can take on hexadecimal values from 1 to FFFFFF. It is located in memory with the bytes arranged in a low, middle, high format, and it is not modified by the timing loop (which allows the same time delay to be generated repeatedly). The necessary registers are loaded outside the subroutine so that several different time delays can be maintained

Listing 1: The high-precision timing program, SOFTIM, written for the Zilog Z80 microprocessor. Careful attention to T-states (microprocessor clock cycles) allows high-resolution timing of a broad range of intervals in standard time units.

```

;          **** SOFTIM:  Z80 SOFTWARE TIMER ****
;          **** WRITTEN BY:  DAN TERPSTRA ****
;          ***** CHEMISTRY DEPARTMENT *****
;          ** FLORIDA STATE UNIVERISTY **
;          *****
;
;          The execution time of this routine is given by:
;          T = (N+2)*40
;          where T is the time in t-states, and N is the 3 byte
;          (positive integer) delay quantity obtained from memory
;          locations LODELA, HIDE LA. To calculate the time in
;          seconds, multiply the number of t-states by the time of
;          one clock cycle (e.g. 4 MHz = 250 ns/cycle). This
;          timing assumes memory that operates with no wait
;          states. The minimum time of execution for a 4 MHz Z80
;          is 30 usec for N = 1 (including the CALL and RET
;          sequence), increasing in steps of 10 usec to a maximum
;          of over 160 sec. N = 0 is undefined, and N =
;          FFFFFFFF(HEX) is the maximum time period. There is NO
;          software jitter in this timing loop.
;
;
;          MAIN:          ;CALLING SEQUENCE (INCLUDED IN TIMING)
0100  2A1E01          LD      HL,(LODELA)          ;LOW ORDER COUNT WORD
0103  3A2001          LD      A,(HIDE LA)          ;HIGH ORDER COUNT BYTE
0106  CD0A01          CALL    SOFTIM          ;TIME IT
;          ...CONTINUE WITH PROGRAM...
0109  C9              RET
;
;          SOFTIM SUBROUTINE
;
;          ENTRY CONDITIONS:
;          A, HL = 24 BIT POSITIVE COUNT
;          EXIT CONDITIONS:
;          A = B = HL = 0
;          MODIFIES:
;          A, B, HL
;
010A  3C              SOFTIM:  INC      A          ;AT LEAST ONE PASS
010B  47              LD      B,A          ;THROUGH OUTER LOOP
010C  3E00            LD      A,0          ;DUMMY INSTRUCTIONS
010E  C31301          JP      SOFTM2          ;TO KILL TIME
0111  1800            SOFTM1:  JR      SOFTM2          ;DELAY 16 T STATES
0113  00              SOFTM2:  NOP
0114  2B              SOFTM3:  DEC      HL          ;DECREMENT LOW ORDER
0115  7D              LD      A,L
0116  B4              OR      H          ;HL = 0?
0117  C21101          JP      NZ,SOFTM1          ;NO, LOOK AGAIN
011A  05              DEC      B          ;B = ZERO?
011B  20F7            JR      NZ,SOFTM3          ;NO, REPEAT OUTER LOOP
011D  C9              RET          ;YES, RETURN
;
;          STORAGE LOCATION FOR 24-BIT TIME DELAY WORD
011E  (0002)          LODELA:  DS      2          ;LOW ORDER 16 BITS
0120  (0001)          HIDE LA:  DS      1          ;HIGH ORDER 8 BITS

```

System Notes

Listing 2: Version of SOFTIM modified for use with an Intel 8080 processor. This version provides resolution and range similar to the version shown in listing 1, but measurements are not provided in standard units of time.

```

;          ***** SOFTIM: SOFTWARE TIMER *****
;          *** MODIFIED FOR 8080 FAMILY ***
;          *****
;
;          The execution time of this routine is given by:
;          T = (N+2)*38
;          This is 2 t-states shorter than the equivalent Z80
;          routine, resulting in a slightly less manageable minimum
;          time of 28.5 usec and a step size of 9.5 usec, again
;          assuming a 4 MHz clock. All other features of the
;          timer remain identical to the Z80 version of this
;          program.
;
;
;          MAIN:          ;CALLING SEQUENCE (INCLUDED IN TIMING)
0100 2A2001             LHL  LODELA  ;LOW ORDER COUNT WORD
0103 3A2201             LDA  HIDEA   ;HIGH ORDER COUNT BYTE
0106 CD0A01             CALL SOFTIM ;TIME IT
;
;          ...CONTINUE WITH PROGRAM...
0109 C9                RET
;
;          SOFTIM SUBROUTINE FOR 8080
;
;          *****
;          CODE THAT DIFFERS FROM Z80 VERSION
;          IS MARKED OFF BY ASTERISKS
;          *****
;
010A 3C                SOFTIM: INR   A          ;AT LEAST ONE PASS
010B 47                MOV    B,A         ;THROUGH OUTER LOOP
010C 3E00              MVI    A,0        ;DUMMY INSTRUCTIONS
;*****
010E C31501            JMP    SOFTM3   ;TO KILL TIME
0111 C31401            SOFTM1: JMP   SOFTM2   ;DELAY 14 T STATES
;*****
0114 00                SOFTM2: NOP
0115 2B                SOFTM3: DCX   H          ;DECREMENT LOW ORDER
0116 7D                MOV    A,L
0117 B4                ORA    H          ;HL = 0?
0118 C21101            JNZ   SOFTM1   ;NO, LOOK AGAIN
011B 05                DCR    B          ;B = ZERO?
;*****
011C C21501            JNZ   SOFTM3   ;NO, REPEAT OUTER LOOP
;*****
011F C9                RET              ;YES, RETURN
;
;          STORAGE LOCATION FOR 24-BIT TIME DELAY WORD
0120                LODELA: DS    2          ;LOW ORDER 16 BITS
0122                HIDEA: DS    1          ;HIGH ORDER 8 BITS
```

simultaneously in different memory locations.

The calling sequence shown in the three lines following MAIN is part of the timing calculation and should not be modified. The SOFTIM subroutine modifies several registers, as indicated in the listing, so the prior contents of these registers should be saved if they will be needed later. Both branches of the timing loop contain exactly forty T-states, eliminating branch jitter and resulting in an execution time of 10 μ s (microseconds) for a 4 MHz Z80. The CALL and RET (return) sequence is eighty T-states, exactly twice as long as the timing loop. This means that all setup error is eliminated by specifying the delay count as 2 less than the number of counts actually required.

SOFTIM can, of course, be modified to run on Intel's 8080 microprocessor, as well as on a Z80 (as shown in listing 2). The only essential changes involve the conversion of two relative jumps to absolute jumps. This has the effect of shortening both branches of the timer loop by two T-states, which requires further modification to the setup portion of the program.

By vectoring the first jump instruction to SOFTM3 rather than SOFTM2, a NOP (no operation) instruction is avoided during setup, and four T-states are eliminated. This restores a 2:1 balance between the setup sequence and the timer loop. (These changes are highlighted with asterisks in listing 2.) Shortening the 8080 version of SOFTIM yields a timing loop of thirty-eight T-states. This results in a somewhat ungainly loop execution time of 9.5 μ s at 4 MHz (7.6 μ s at 5 MHz), which makes time conversions unavoidably clumsy in this version of SOFTIM.

To the best of my knowledge, SOFTIM overcomes most of the serious drawbacks commonly associated with software-based timing functions. The major remaining disadvantage of this or any other software timer when compared to hardware is that it requires the microprocessor's complete attention while it is timing and prevents the computer from performing any other functions.

A few words of warning are in order at this point: SOFTIM was designed to be run at full speed. If it is burned into EPROM (erasable programmable read-only memory) or used from slow user-programmable memory, wait states can be introduced that affect its timing characteristics. In specific environments, you can probably compensate for this result as long as the wait states are introduced in a consistent manner. Finally, if your computer uses interrupt-driven or DMA (direct memory access) peripherals, be careful not to call SOFTIM while they are active, since timing errors will result if a DMA access or an interrupt service occurs while the timer is busy.

In spite of its shortcomings, SOFTIM provides an accurate and precise alternative to hardware timers—and at a much lower cost. In addition, it gives your microcomputer a chance to have the (software) time of its life. ■

Pascal -X

MICROPROCESSOR
CROSS PASCAL RUN-
NING ON ALL PDP-11/
LSI-11 SYSTEMS

WRITTEN IN MACRO-
II SYMBOLIC P-CODE
OUTPUT . . . USER-
MODIFIABLE AND . . .

LOW COST !!!

TARGET MICROPROCESSORS

8085	6809
8048	68000
Z80	Z8000
9900	8086
6500	PDP-11
6800	

OPERATING SYSTEMS

UNIX
RT-11
RSTS
RSX-11D
RSX-11M
RSX-11M-PLUS
IAS

**ALSO FROM
SYSTEM-KONTAKT**

- DOWN LOADERS
- SIMULATORS
- CROSS ASSEMBLERS

SYSTEM-KONTAKT, Inc.

6 Preston Court • Bedford, MA 01730 U.S.A.
(617) 275-2333

Circle 418 on inquiry card.

What's New?

PUBLICATIONS



Information-Processing Industry Guide

Data Sources is a 1460-page guide to nearly 7000 software products and more than 6000 systems and peripherals. Product locators and cross-indexes help you find your way to company profiles of 1200 hardware manufacturers, 300 software com-

panies, and 3900 service industries. A single issue of Data Sources costs \$20. Charter subscriptions cost \$60 per year for four issues. For details, contact Data Sources, 20 Brace Rd., Cherry Hill, NJ 08034, (609) 429-2100. Circle 550 on inquiry card.

Columbia Products Catalog

Columbia Data Products has a free catalog featuring its data-communication-storage equipment, single- and multiuser distributed-processing systems, and custom-designed microcomputers. Contact Columbia Data Products, 8990 Rte. 108, Columbia, MD 21045, (301) 992-3400. Circle 551 on inquiry card.

Intronics Catalog

Modules for analog-function computation, power supplies, data-display modules, operational and isolation amplifiers, and nonlinear-function modules are among the products described in a catalog from Intronics, 57 Chapel St., Newton, MA 02158, (617) 964-4000. Circle 552 on inquiry card.

Computerist's Directory

The Community Computerist's Directory (CCD) is a semiannual national database in telephone-book format for computer users. The "White Pages" contain hundreds of non-commercial listings submitted by individuals and organizations wishing to share interests, information, skills, and resources, including hardware and software. Many list Source and Compuserve numbers.

CCD's "Yellow Pages" also have hundreds of entries, subdivided in 72 categories, including listings and display ads covering hardware, software, databases, consultants, systems houses, publications, and services. A glossary of computer terms, a bulletin board section, and clubs and newsletters listings are also included.

A one-year subscription to the CCD costs \$10, which includes a free "White Page" listing, two issues, and quarterly updates. The Community Computerist's Directory is published by Altnet, Inc., POB 405, Forestville, CA 95436, (707) 887-1857. Circle 553 on inquiry card.

How to Copyright Your Software

Sofprotex has released the report **How to Copyright Computer Software**. The report costs \$20 and is available from Sofprotex, POB 271, Belmont, CA 94002. Circle 554 on inquiry card.

Microcomputers and Farmers

The Farm Computer News is filled with programming help, news of software and hardware, and reviews of computer products concerned with agriculture. The News is published monthly by Successful Farming Magazine, 1716 Locust, Des Moines, IA 50336. Subscriptions are \$40 per year. Circle 555 on inquiry card.

16-Bit Microprocessor Handbook

The 16-Bit Microprocessor Handbook examines the 8086, Z8000 series, 68000, 9900, LSI-11, and 16032 microprocessors. Software benchmarks that can be used for comparisons are provided, and hardware and software support available for the devices is discussed. Registers available, addressing capability, data types processible, clock speed, configurations, and instruction sets are covered. Pinouts, power-supply voltages, and system timing and operation are given. A simple example with I/O (input/output) ports is used to illustrate the interfacing process. Interrupts are covered and complementary circuits and devices are detailed. The 16-Bit Microprocessor Handbook costs \$14.95, plus \$1 for shipping and handling, and is available from Group Technology, Ltd., POB 87, Check, VA 24072, (703) 651-3153. Circle 556 on inquiry card.

What's New?

SYSTEMS

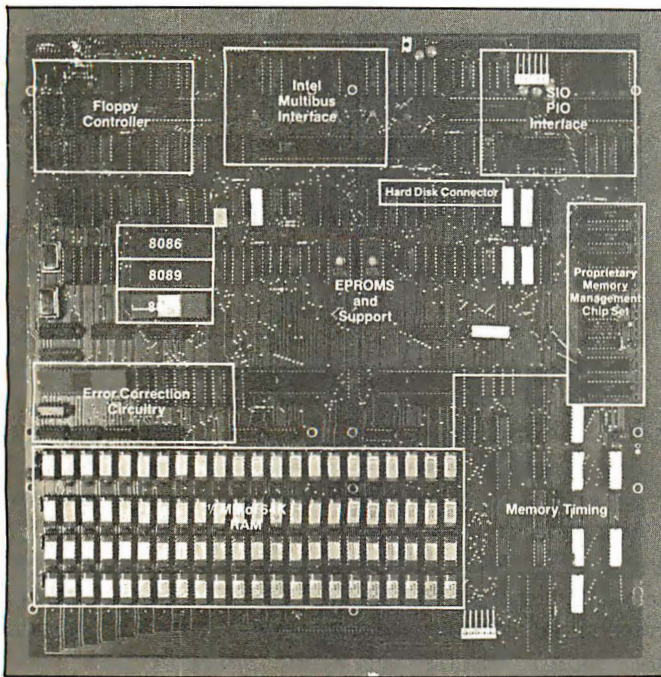

16-Bit Microcomputers

The ACS8600 family of 16-bit microcomputers is based on the Intel 8086 microprocessor. The systems provide up to 1 million bytes of main memory, plus online floppy- and Winchester hard-disk storage from 1 to 80 megabytes. Up to 1 megabyte of memory can be addressed directly in blocks of 64 K bytes.

The ACS8600 family is organized around three processors: the 8086 for systems and applications control, the 8089 for DMA (direct-memory access) and I/O (input/output) processing, and the 8087 (optional) for floating-point arithmetic.

Up to eight terminals and peripherals can be supported. Expansion is possible through a Multibus port, and the systems accept both synchronous and asynchronous com-

munications protocols. Data rates of up to 800 kbps (thousand bits per second) can be handled. The floppy-disk system can be upgraded to any of the hard-disk systems, and each hard-disk system can be upgraded to twice its original capacity.

The systems feature error detection and correction and a memory-management system. Each data word is accompanied by 6 bits of error-correction code, which allows the ACS8600 to perform 2-bit error detection and single-bit error detection and correction. Memory management is organized as 256 pages of 4 K bytes and provides both position independence and protection for the memory's contents.

Four operating systems are supported: Xenix, CP/M-86, MP/M-86, and Oasis-16. Languages sup-

porting end-user applications are Microsoft's BASIC, Pascal, COBOL, and FORTRAN, as well as CIS-COBOL, Pascal/M-86, RM-COBOL, and C-BASIC-86.

The basic ACS8600 system has 512 K bytes of programmable memory, a 10-megabyte hard-disk drive and floppy-disk backup, and costs \$12,990. Without the Winchester hard-disk backup, the same system, with dual floppy-disk storage of 1 megabyte and 128 K bytes of programmable memory, costs \$8990. There are six hard-disk configurations available, and prices range from \$12,990 to \$18,980, which includes 40 megabytes of memory and magnetic-tape backup. For complete details on the ACS8600 microcomputer family, contact Altos Computer Systems, 2360 Bering Dr., San Jose, CA 95131, (408) 946-6700.

Circle 557 on inquiry card.

Z8000 Processor

Computex Microcomputer Systems' Multibus-compatible processor board features a 16-bit Z8001 microprocessor and sockets for two 2716 EPROMs (erasable programmable read-only memories). The board has eight vectored-interrupt levels plus a nonmaskable-interrupt input, two programmable timers, and a socket for a 9511 arithmetic processor. The board incorporates a memory-management circuit that divides memory into 2 K-byte pages, which are

then mapped into addresses by the onboard circuitry. This allows a total system-wide memory of 16 megabytes. The 2 K-byte pages do not have to be contiguous in memory.

The Multibus-compatible board costs \$998 and is available from Computex Microcomputer Systems, 5710 Drexel Ave., Chicago, IL 60637, (312) 684-3183.

Circle 558 on inquiry card.

Host of New Telesoft Products

The portable Telesoft-Ada compiler is the key part of the Telesoft-PSE family, which includes a Telesoft-Pascal multitasking compiler, a multitasking operating system, a screen-oriented editor, a 68000 macroassembler, a 68000 native-code translator and object-code linker, and general-purpose utilities. The Ada compiler performs full Ada syntax checking and supports packages, tasks, exceptions, identifier overloading, and separate compilation (with limitations).

Another new Telesoft product is its fully integrated, desktop Workstation computer system. The Workstation features the new Telesoft T68KQ 68000 processor board, which can run on the DEC (Digital Equipment Corporation) Q-bus. The Workstation features an intelligent terminal, floppy-disk or Winchester-disk drives, 256 K bytes of programmable memory, and four serial ports. Telesoft-

What's New?

PSE for the 68000 is available now and systems are being prepared for the 8086, VAX, and IBM 370 series.

The Telesoft-Ada compiler costs \$2400, the screen-oriented editor is \$125, the link editor is \$275, the 68000 macroassembler and the native-code translator cost \$400 each, and the Pascal compiler is available for \$425. The T68KQ board is priced at \$2995. The Telesoft-Workstation ranges between \$10,000 and \$20,000, depending on disk configuration. For details, contact Telesoft, 10639 Roselle St., San Diego, CA 92121, (714) 457-2700.
Circle 559 on inquiry card.

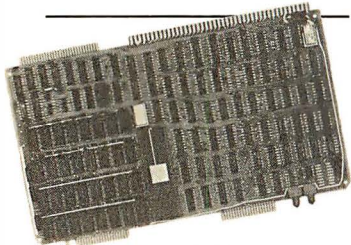

68000 Board

TSD Display Products' 68000-based processor board for the Multibus system has 256 K bytes of memory and the ability to work at 8 MHz with no wait states. Edge connectors for a logic analyzer are provided for easy debugging. Bus timeout protection, simple memory protection, and interrupt-type selection are also provided. The TSD Multibus-compatible 68000 board costs \$3000 and is available from TSD Display Products, Inc., 35 Orville Dr., Bohemia, NY 11716, (516) 589-6800.

Circle 560 on inquiry card.

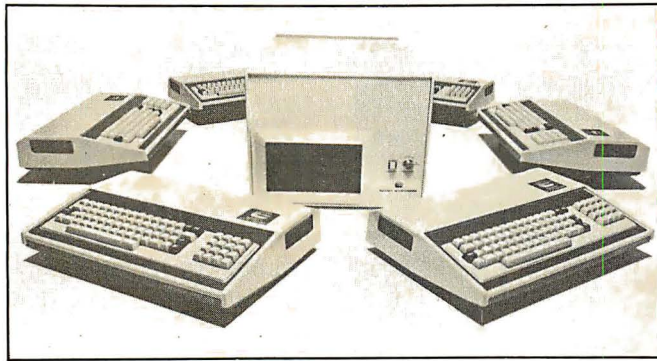

Sorcerers Net

The Multi-Net 80 network system consists of an Exidy Sorcerer microcomputer with peripherals that can transfer CP/M files and a timeshared global processor that can handle up to 16 Sorcerers with 64 K bytes of memory in each unit. Each Sorcerer is connected to a serial port on the user module and not through the system bus, which reduces bus contention and operator waiting time. The Multi-Net 80 Global Processor supports 8-inch IBM-compatible Winchester hard-disk drives and 8-inch floppy-disk drives, or cartridge tapes can be configured for backup.

Multi-Net 80 operating-system software consists of CP/NET, CP/NOS, and MP/M, which controls the global processor. The user operating system is CP/NOS, which looks to the user like CP/M 2.2. Network communications between user modules and the global module are under the control of CP/NET.

A single-user Multi-Net 80 system costs approximately \$6000 and a 16-user system is about \$34,100. Contact Exidy Systems, Inc., 1234 Elko Dr., Sunnyvale, CA 94086, (408) 734-9831.

Circle 561 on inquiry card.

Low-Cost Development Systems

The CDP18S693 1802 microprocessor-development system comes with a floating-point BASIC interpreter and system utility software. It includes a CMOS (complementary metal-oxide semiconductor) single-board computer, memory/cassette-controller board, a cassette-tape drive, a five-card chassis and case, and a 5 V DC power supply. The CDP18S693 costs \$499.

The CDP18S694 has all the features of the

CDP18S693 plus an 1802 assembler/editor PROM (programmable read-only memory) board and a second cassette drive. Both development systems can be memory expanded up to 64 K bytes and I/O (input/output) capacity can be increased. Further information can be obtained from RCA Solid State Div., POB 3200, Somerville, NJ 08876, (800) 526-3862; in New Jersey (201) 685-6423.

Circle 562 on inquiry card.

SOFTWARE

Supercalc for CP/M

Sorcim Corporation has announced the availability of its Supercalc program for the CP/M operating system. Both 5- and 8-inch drives are supported, including Apple CP/M, Xerox 820, North Star, Superbrain, Micropolis, Zenith, Osborne, and Vector Graphic. Supercalc features automatic formatting of printed reports and the ability to examine all formulas contained in a worksheet on an interactive basis. Other features include the ability to merge several sheets into one and an extensive help command that guides you through all the levels and options in the program.

The Supercalc program costs \$295, which includes user guide and tutorial, reference card, and an installation program for use with more than 25 terminals. For details, contact Sorcim Corp., 405 Aldo Ave., Santa Clara, CA 95050, (408) 727-7634.
Circle 563 on inquiry card.

1981 Tax Planning Models

Pansophics 1981 Tax Planning Models incorporate the changes in the federal income tax laws governing the year 1981. The 1981 tax reduction has been incorporated into the tax planning models, along with the combined dividend and interest exclusion, automatic calculation of the 20% capital-gains maximum tax, and the

What's New?

new FICA and self-employment tax rates. Pansophics' tax models can print directly on IRS Form 1040 and your tax is calculated using either the tax tables or the tax-rate schedules automatically, whichever is appropriate.

The 1981 Tax Planning Models are fully supported and will run on 48 K- or 64 K-byte Apple IIs, running either DOS 3.2 or 3.3. There are two versions from which to choose: a personal model for \$100 or a professional version for \$150, which includes corporate and partnership tax-return models. For details, contact Pansophics, Ltd., Whistlestop Mall, POB 59, Rockport, MA 01966. Circle 564 on inquiry card.

6800 Pascal Compiler

Technical Systems Consultants has released a 6809 native-code Pascal compiler for operation under 6809 Flex and Uniflex operating systems. The compiler produces 6809 assembly-language source mnemonics that are assembled into object code. The compiler supports integer and floating-point math with up to 16.8 digits of accuracy, scientific functions, variable names unique to 160 characters, sets of up to 128 elements, dynamic-storage allocation and deallocation, parameter passing from the command line to the Pascal program, and the ability to call other Pascal programs. The Uniflex version supports random-access files.

The compiler includes a

manual, a copy of the **Pascal User Manual and Report** by Jensen and Wirth, the compiler and run-time object-code programs. The Flex version sells for \$200 and a single-processor license for the Uniflex version costs \$300. Both versions are provided with one year of maintenance. Contact Technical Systems Consultants, Inc., 1208 Kent Ave., POB 2570, West Lafayette, IN 47906, (317) 463-2502. Circle 565 on inquiry card.

High-Quality Apple Graphics

The Graphics Printing System program for the Apple II prints high-resolution images on Diablo-formatted daisy-wheel printers and thimble printers, such as NEC (Nippon Electric Company) 5510s and 5620s, and is stingy with your printer's expensive ribbons. A typical chart or graph takes 3-4 minutes to output to the printer. Images can be selected from any rectangular area of the screen and printed in different sizes and formats.

The Graphics Printing System features an on-screen software device, called the Magicframe, that can output any object down to one pixel in size and surround it with a border. The Graphics Printing System program costs \$109.95. Contact Progressive Software, Suite 323, Blue Bell West, Blue Bell, PA 19422, (215) 628-2383.

Circle 566 on inquiry card.

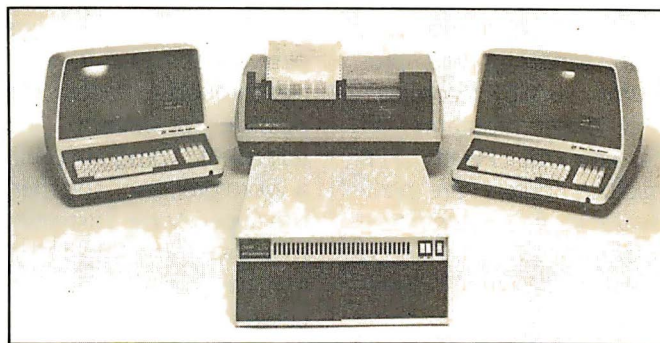

HiNet Networking Software

Digital Mirosystems' HiNet-2 networking software is designed for HiNet local computer networks. HiNet's 500-k-bits-per-second data cable can address up to 255 users. HiNet-2 allows the use of CP/M 2.2 software on the network. Another feature converts CP/M software for multi-user networking. SDLC (synchronous data-link control) protocols are standard with automatic error

detection, correction, and resend. The networking software also features a print-spooling utility and a utility that provides single-sector tracks on floppy disk to back up hard disks. The transfer rate to the drives is 14 K bytes per second. For details on the HiNet-2 software, contact Digital Mirosystems, 1840 Embarcadero, Oakland, CA 94606, (415) 532-3686. Circle 567 on inquiry card.

Tax Help for TRS-80 Users

The Tax/Forecaster and Tax/Saver programs are designed to help TRS-80 users do their tax work. Tax/Saver features special screen formatting for data input, displaying to a video screen, two types of print-out, and disk storage of data files. Tax/Saver compares all possible filing statuses, compares itemized deductions to national averages, computes certain limitations, checks for excess FICA, and helps determine dependents. The Tax/Forecaster turns the Tax/Saver into a tax forecaster. Both programs are tax deductible and run on TRS-80 Models I and III with

32 K bytes of memory and two disk drives. Including a user manual, Tax/Saver I costs \$79.95, Tax/Saver II (an enhanced version) is \$119.95, and Tax/Forecaster is \$29.95. The manual is available separately for \$19.95. For details, contact Micromatic Programming Co., POB 158, Georgetown, CT 06829, (203) 544-8777. Circle 568 on inquiry card.

BASEX Compiler for the Heath H-8

The BASEX language combines the features of BASIC with executable machine-language code. BASEX programs typically

What's New?

run up to 10 times faster than similar BASIC programs. BASEX compiler and loader programs on cassette for Heath H-8 microcomputers are now available from Interactive Microware. This enhanced revision of BASEX includes a console driver, commands to save and load programs on tape, and a manual, which has listings of the compiler and execution routines. The manual, a Heath H-8 addendum, and cassette are offered for \$33. The BASEX manual can be purchased separately for \$8 from BYTE Books, 70 Main St., Peterborough, NH 03458, (800) 258-5420; in New Hampshire (603) 924-9281.

BASEX cassettes are also offered for TRS-80 Level II, Sorcerer, Sol, and Poly-88 systems, and disk versions are available for 5-inch North Star and 8-inch single-density CP/M systems. For additional information, contact Interactive Microware Inc., POB 771, State College, PA 16801, (814) 238-8294. Circle 569 on inquiry card.

Convert Apple to Apple

The Super Apple Textwriter allows you to convert a file generated by Applewriter, Supertext, and Superscribe word processors into a file accessible by the other two. It can convert standard text files into files accessible by either Supertext or Applewriter and it converts Applewriter or Supertext files into standard text files. It lets you edit information obtained

from a communications network as well as transmit files through a modem. It is possible to develop and edit a BASIC program using a word processor and then use Super Apple Textwriter to convert the file into a text file that can be executed into memory. Super Apple Textwriter retails for \$49.95 and is available from Mint Software, 6422 Peggy St., Baton Rouge, LA 70808, (504) 766-2318. Circle 570 on inquiry card.

Overlay Linker

The Overlay Linker can link files produced by Cromemco's Macro Assembler and by the FORTRAN, C, and COBOL compilers to produce executable object files. The Linker permits the construction and execution of programs that are too large to fit into available memory. Any standard Cromemco relocatable file that does not include absolute loading can be loaded by the Linker. It can also manage an arbitrary number of common blocks and create an arbitrary number of overlays, each in a separate file on disk. Commands can be given to the Linker as a part of the command line. A relocatable library-file manager is also included.

The Overlay Linker operates under CDOS or Cromemco operating systems. It's available on 5- or 8-inch disks for \$395. For additional information, contact Cromemco, Inc., 280 Bernardo Ave., Mountain View, CA 94043, (415) 964-7400. Circle 571 on inquiry card.

TRS-80 BASIC Compiler

RSBASIC is a business-oriented BASIC compiler for the TRS-80 Models I and III that compiles programs and allows interactive debugging in a run mode prior to compilation. Among its features are sequential, random, and single-key ISAM (indexed sequential-access method) file access; direct calls to machine-language programs; program-chaining capabilities with common variable storage; numeric accuracy to 14 digits; step and trace debugging; printer and disk utilities; strings, arithmetic, trigonometric, and bit operations; and conversions between data types.

RSBASIC is equipped with BEDIT, an editor for source programs, and RUNBASIC, which executes compiled programs. RSBASIC will not convert programs written for BASIC interpreters. RSBASIC requires a TRS-80 Model I or III, 48 K bytes of memory, and two floppy-disk drives. It is available for \$149 from Radio Shack, 1800 One Tandy Center, Fort Worth, TX 76102, (817) 390-3272. Circle 572 on inquiry card.

Supervyz Your CP/M

Supervyz allows non-technical users an easier way of dealing with CP/M. Communication with CP/M for many users has been abbreviated, impolite, and not helpful when a mistake is made. The symbols can be cryptic and frustrating for many users. Aided by error messages

and computer-assisted tutoring, Supervyz helps the operator avoid mistakes and advises the next step in a polite manner. It serves as a mediator between the user and CP/M, requesting information in plain English and translating the response into a form CP/M understands.

Supervyz is an enhanced CP/M with a number of new intrinsic (built-in) commands, such as GET, which loads a program, GO, which executes the loaded program, and WAIT, which requests keyboard input before proceeding with the program. Supervyz costs \$95 and is manufactured by Epic Computer Corp., 9181 Chesapeake Dr., San Diego, CA 92123, (714) 569-0440. Circle 573 on inquiry card.

Spellguard 2.0

Spellguard 2.0 proofreads text 1.5 times faster than its predecessor, Spellguard 1.0, and occupies 1/3 less space (54 K bytes). It can proofread up to 60 double-spaced pages (15,000 words) per minute, using double-density 8-inch disk drives. Deletions from and additions to the Spellguard's 20,000-word dictionary present no problem.

Spellguard 2.0 is available on 5- or 8-inch disks for the Apple and other microcomputers with 32 K bytes of memory, one disk drive, and the CP/M operating system. It costs \$295. For \$35, owners of Spellguard 1.0 can upgrade to version 2.0 by returning

What's New?

their disk to the company. Contact Innovative Software Applications, Suite 300, 260 Sheridan Ave., Palo Alto, CA 94306, (415) 326-0805.

Circle 574 on inquiry card.

Crank Up UCSD Pascal

Using Professional Business Software's Crank utility, you can convert CP/M BIOS to UCSD Pascal BIOS, which will allow UCSD Pascal to run on any 48 K-byte computer that runs CP/M. The Crank works with floppy- and hard-disk drive systems. A UCSD p-system for CP/M-based machines is available for \$450. Run-time-only systems are available for \$150 from Professional Business Software, 119 Fremont St., San Francisco, CA 94105, (415) 546-1596. Circle 575 on inquiry card.

MISCELLANEOUS

RS-232C Cable Designer

The RS-232C DB25 Pin Reconfiguration Adapter (PRA) lets you mate almost any serial I/O (input/output) device to any computer by rerouting RS-232C signals. The PRA eliminates the task of making special cables or resoldering existing cable wiring to achieve proper interfaces. A flat cable with DB25 connectors and the PRA adapter will tie proper signal lines together. All you do is position the slide switches for proper signal routing through the adapter.

The PRA package is made up of a printed-circuit card with one male and one female DB25 connector mounted on it and a matrix switch. It has a suggested retail price of \$59.95 and is available from Mountain Computer, Inc., 300 El Pueblo Rd., Scotts Valley, CA 95066, (408) 436-6650.

Circle 576 on inquiry card.

68000 Memory-Management Unit

The MC68451 memory-management unit provides address translation and protection of the 16-megabyte addressing space of the 16-bit 68000 processor. It also provides address-space separation of system user resources and write-protection. The MC68451 costs \$215 and is available from Motorola, Inc., MOS Integrated Circuits Div., 3501 Ed Bluestein Blvd., Austin, TX 78721, (512) 928-6369.

Circle 579 on inquiry card.

Lowercase for the Apple II

The McLaren LCG (lowercase generator) for the Apple II generates the full 96-character ASCII (American Standard Code for Information Interchange) set with true descenders. Installation is simple and requires no soldering. The McLaren LCG costs \$49.95 and is distributed by Great Lakes Digital Resources, POB 32133, Detroit, MI 48232, (313) 538-7963.

Circle 580 on inquiry card.

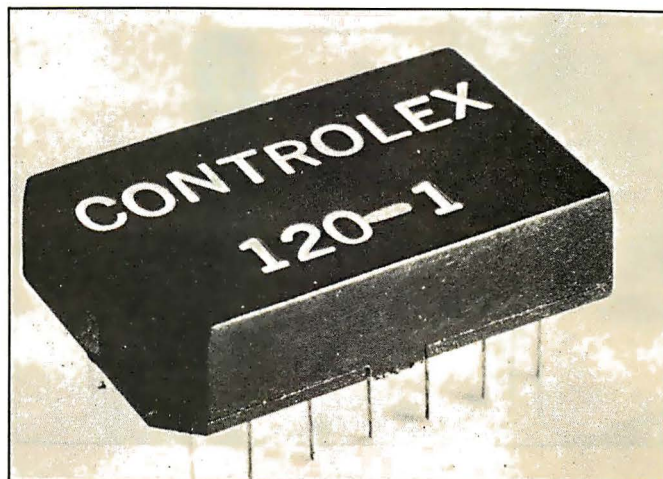

Tiny Core Memory

The Controlex Model 120 is a tiny core-memory module for use as a non-volatile store of microprocessor data. Its 4-bit array can store a status word upon power shutdown or loss and retain it indefinitely. In a typical application, the 120 would be accessed by a microprocessor I/O (input/output) port in response to power shutdown. Data are sequentially loaded in four cycles and retained. When power is returned, the data are sequentially loaded back to return to the status word.

The Model 120 comes in a 14-pin DIP (dual inline package). Variations, including longer word lengths (i.e., 8 bits), parallel access, and custom-support circuitry are available. The Model 120 operates on +5 V and uses low-cost, common TTL (transistor-transistor logic) devices as support circuits. It costs \$6.90 in OEM (original equipment manufacturer) quantities. Contact Controlex Corp., 16005 Sherman Way, Van Nuys, CA 91406, (213) 780-8877.

Circle 581 on inquiry card.

Convert Signals

The Mint-01 interface board converts TTL (transistor-transistor logic) levels to RS-232C or 20 mA current-loop signals in a 5 V DC environment. The board will convert TTL voltages to a single 20 mA current-loop input and output, or to RS-232C inputs and four RS-232C outputs, selectable with on-board jumpers. A DC-to-DC converter provides

± 12 V DC for the conversion circuitry, while requiring a +5 V DC input at 400 mA. The Mint-01 can be attached to any TTL-level logic through a 14-pin cable connector. The price is \$105 from Miller Technology, 647 North Santa Cruz Ave., Los Gatos, CA 95030, (408) 395-2032.

Circle 582 on inquiry card.

What's New?

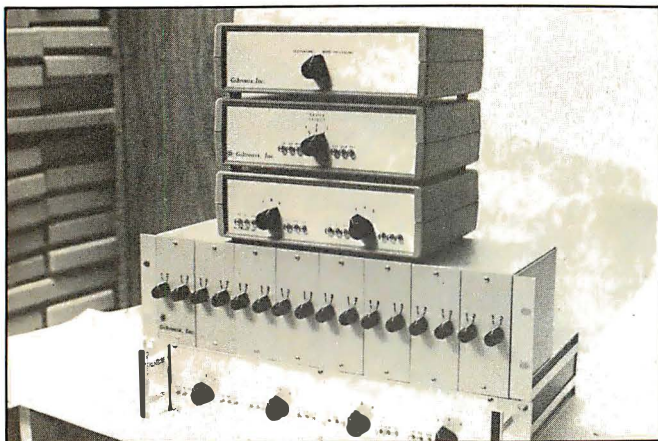

Share Up to Six Peripherals

Giltronix Inc.'s position-switching and port-sharing units allow several computers to share a common device, such as a printer or terminal, or allow a single computer to use several devices from one microprocessor port. The Models GRS 232-S8AD, -S8AE, and -S8AF switching units have four, five, and six positions and can connect up to six devices to a common I/O

(input/output) device. All units can switch eight lines of an RS-232C interface.

Options for the series include monitoring capabilities and a rack-mountable enclosure. Prices are \$249, \$299, and \$339, respectively. For more information, contact Giltronix, Inc., 450 San Antonio Ave., Palo Alto, CA 94306, (415) 493-1300. Circle 583 on inquiry card.

Fast CMOS Microprocessor

The CDP1802A CMOS (complementary metal-oxide semiconductor) microprocessor offers a clock frequency of 3.2 MHz at 5 V DC and 6.4 MHz at 10 V DC, guaranteed over a range of -40°C to +85°C. It also features an internal Schmitt-trigger buffer on the CLEAR input, which eliminates the need for ex-

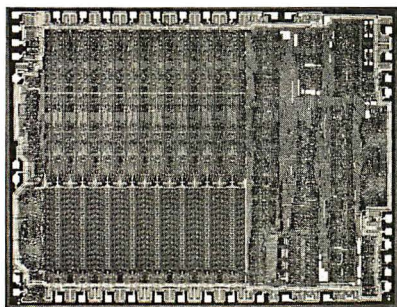

ternal logic devices for power-on reset.

The CDP1802A is pin-for-pin compatible with the CDP1802 and is priced at \$3.98 in OEM (original equipment manufacturer) quantities. Contact RCA Solid State Div., Rte. 202, Box 3200, Somerville, NJ 08876.

Circle 584 on inquiry card.

The Speaker's Voice

The Speaker is a voice synthesizer for SS-50, SS-50C, and TRS-80 Color Computers. Typically, 1 or 2 bytes are required to represent the phonetic-speech codes. The board can be used from any BASIC by using PEEK and POKE commands. Data statements are used for speech storage. The Speaker for the SS-50/50C costs \$189.95. It's available with demonstration software for Technical Systems Consultants and Smoke Signal Broadcasting disk operating systems. The TRS-80 Color Computer version comes with demonstration and utility programs operating in machine language and Color BASIC. It costs \$179.95. For more information, contact Alford & Associates, POB 6745, Richmond, VA 25250, (804) 320-6722. Circle 585 on inquiry card.

Digital Timer Circuit

Slow operate and release, intervals, and flashings from 6 microseconds to infinity can be programmed with the LS7210 digital-timer circuit. The device can be driven by an on-circuit oscillator set by an external remote-control network, or by an external clock. Delays of 36 days are obtainable. Circuits can be cascaded for sequential events. The LS7210 can be operated in four modes: delayed operate, delayed release, dual delay, and one-shot modes. All inputs on the

device are CMOS- (complementary metal-oxide semiconductor), PMOS- (p-type MOS), and TTL- (transistor-transistor logic) compatible. The cost is \$3.70 in 1- to 24-unit quantities. Contact LSI Computer Systems, Inc., 1235 Walt Whitman Rd., Melville, NY 11747, (516) 271-0400. Circle 586 on inquiry card.

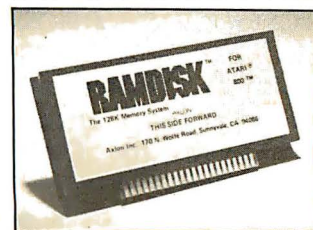

Boost the Atari 800's Memory

The RAMdisk is a 128 K-byte programmable memory system for the Atari 800. RAMdisk has software that makes the system appear to the computer to be a disk drive. RAMdisk is compatible with existing software written for the Atari 800 and is up to 20 times faster than the Atari 810. RAMdisk can also be programmed as bank-selectable memory in eight 16 K-byte pages. No modifications to the 800 are required.

The complete RAMdisk memory system includes the 128 K module, operating manual, DOS (disk operating system) memory-management software, and utility software. The suggested retail price is \$699 from Axlon, Inc., 170 North Wolfe Rd., Sunnyvale, CA 94086, (408) 730-0216. Circle 587 on inquiry card.

HUNTINGTON COMPUTING

ONE OF THE WORLD'S LARGEST INVENTORIES

Softlights

By Fred Huntington

More and more fantastic things are becoming available for the Apple®. We just received one of my favorites – the Passport Designs **SOUNDCHASER Computer Music System**. It's easy to set up and an absolute blast to play with.

Price is \$650 for the keyboard and \$350 for each synthesizer board.

We recommend two boards. When you buy the complete system, we will give you \$100 worth of free software (your choice from our current catalog).

Having worked my way through college playing in a small band, I keep thinking how great my group would have sounded if we had had the Passport Designs setup.

You can actually record a song and then play it back and even play along with it – no tapes or accessing the disk. You have to see it (and hear it) to believe it. Five stars!

HARD DISK

We're now official dealers for Nestar. We think the Nestar system is so great, we've adopted it for in-house use. We have four Apples hooked up to a 16 Megabyte disk. This allows us to have several people processing orders at the same time, all working off the same inventory disk.

Our system has the capability of expanding to 64 Apples hooked up together.

And, by the time you read this, CP/M® (a registered trade mark of Digital Research) should be available for the system.

Call for more information.

COMING SOON!

California Toll-Free Number

800-692-4143

GAMES

Golden Mountain	\$19.95 now	\$16.89
Space Eggs	\$29.95 now	\$19.99
Apple - Panic	\$29.95 now	\$19.99
Thief	\$29.95 now	\$25.39
Snack Attack	\$29.95 now	\$25.39
Med Fly Mania	\$29.95 now	\$24.59
The Book	\$19.95 now	\$17.99
Hi-Res Soccer	\$29.95 now	\$25.39
Apple - Oids	\$29.95 now	\$25.39
Wurst of Huntington Computing		\$19.99
Ultima	\$39.95 now	\$33.89
Autobahn	\$29.95 now	\$25.39
Battle Cruiser Action	\$44.95 now	\$38.89
Gorgon	\$39.95 now	\$33.89
Super Stellar Trek	\$39.95 now	\$33.89
Hellfire Warrior	\$39.95 now	\$33.99
Gamma Goblins	\$29.95 now	\$25.39
Mission Asteroid	\$19.95 now	\$17.99
Wizardry	\$49.95 now	\$42.49
Warp Factor	\$39.95 now	\$33.99
Microsoft Adventure	\$29.95 now	\$25.39
Wizard and the Princess	\$32.95 now	\$28.99
Flight Simulator	\$34.95 now	\$29.49
Odyssey	\$29.95 now	\$25.39
Sargon II	\$34.95 now	\$29.69
Space Eggs	\$29.95 now	\$25.39
Hi-Res Cribbage	\$24.95 now	\$21.19
Lords of Karma (cass.)	\$20.00 now	\$16.99
Oh Shoot		\$199.99
ABM	\$24.95 now	\$21.19
Computer Conflict	\$39.95 now	\$35.99
Computer Air Combat	\$59.95 now	\$52.99
Temple of Apshai	\$39.95 now	\$33.89
Zork	\$39.95 now	\$33.99
All Nibble Software		15% off list
Robot Wars	\$39.95 now	\$33.99
Cranston Manor	\$34.95 now	\$29.69
Dragon's Eye	\$24.95 now	\$21.19
Twala's Last Redoubt	\$29.95 now	\$25.39
Snoggle	\$24.95 now	\$21.19
Aen Hain	\$24.95 now	\$21.19
Alien Typhoon	\$24.95 now	\$21.19
Raster Blaster	\$29.95 now	\$25.39
Creature Venture	\$24.95 now	\$21.19
Hodge Podge	\$23.95 now	\$21.29
Meteoroids in Space	\$19.95 now	\$16.99
Dragon Fire	\$49.95 now	\$42.49

MISCELLANEOUS

Escape from Acturus	\$29.95 now	\$25.39
Basic Mailer	\$69.95 now	\$59.49
Memory Management II	\$49.95 now	\$42.89
Castle Wolfenstein	\$29.95 now	\$25.39
Upper Reaches of Apshai	\$19.95 now	\$16.89
Bridge Tutor	\$39.95 now	\$35.19
PASCAL Animation Tools		\$65.99
Hand Holding BASIC		\$84.99
Crossfire	\$29.95 now	\$26.29
Epoch	\$29.95 now	\$25.39
Outpost	\$29.95 now	\$26.29
Ulysses	\$34.95 now	\$29.69
Space Quark	\$29.95 now	\$25.39
Beneath Apple DOS (book)	\$19.95 now	\$16.89
Birth of the Phoenix	\$14.95 now	\$12.69
Goblins	\$27.50 now	\$23.29
Painter Power	\$39.95 now	\$33.89
U.S. Constitution	\$29.95 now	\$25.39
Merger	\$49.95 now	\$42.49
Super Stellar Trek	\$39.95 now	\$33.89
LISA	\$79.95 now	\$67.89
V-Plot (Yuccipa)	\$29.95 now	\$25.39
V-Stat	\$29.95 now	\$25.39
V-Print	\$29.95 now	\$25.39
Brain Surgeon	\$49.95 now	\$42.49
Info Master	\$150.00 now	\$127.49
Waterloo II	\$49.95 now	\$42.39
Speedstar	\$139.95 now	\$114.69
Kaves of Karkhan	\$49.95 now	\$42.39
Dos Boss	\$24.00 now	\$20.39

WORD PROCESSORS

Apple Writer		\$65.99
Magic Window	\$100.00 now	\$84.99
Easy Writer Professional	\$250.00 now	\$219.00
Letter Perfect	\$150.00 now	\$127.49
Super Text	\$150.00 now	\$127.49
Superscribe	\$129.95 now	\$110.39
Executive Secretary	\$250.00 now	\$212.49
Apple - Wordstar	\$375.00 now	\$284.00
Hebrew II	\$60.00 now	\$50.99
Apple - Writer Extended	\$29.95 now	\$25.39

STOCK PROGRAMS

Portfolio Master	\$75.00 now	\$63.69
Market Charter	\$129.95 now	\$110.39
Dowlog for Market Charter	\$99.95 now	\$80.99
Investment Decisions	\$99.95 now	\$84.99
Stock Tracker	\$190.00 now	\$161.49
Stock Tracker (Auto Ver.)	\$300.00 now	\$254.99

BUSINESS APPLICATIONS

Invoice Factory (Special)	\$200.00 now	\$149.00
Regression Trend Analysis	\$26.95 now	\$22.89
Multiple Regression	\$29.95 now	\$25.39
Microsoft Fortran	\$200.00 now	\$165.69
Microsoft Cobol-80	\$750.00 now	\$637.49
Business Pac 100	\$99.95 now	\$84.99
Desktop Plan II	\$200.00 now	\$169.99
Visicalc 3.3 Special	\$200.00 now	\$149.00
Visiplot	\$179.95 now	\$152.89
Visitrend/Visiplot	\$259.95 now	\$220.89
Visiterm	\$149.95 now	\$127.39
Complete Mailing (Avant-Garde)	\$59.95 now	\$50.89
DB Master	\$229.95 now	\$194.59
PFS	\$95.00 now	\$80.69
PFS Report	\$95.00 now	\$80.69
Data Factory	\$150.00 now	\$124.00
Thinker	\$495.00 now	\$420.69
Request	\$225.00 now	\$191.19
Super Kram	\$175.00 now	\$148.69
ASCII Express	\$99.95 now	\$84.99
BPI Accounts Receivable	\$395.00 now	\$335.69
BPI General Ledger	\$395.00 now	\$335.69
The Mail Room	\$29.95 now	\$25.39
Continental General Ledger	\$250.00 now	\$212.49
Cont. Accounts Receivable	\$250.00 now	\$212.49
Cont. Accounts Payable	\$250.00 now	\$212.49
Continental Payroll	\$250.00 now	\$212.49
Broderbund Payroll	\$395.00 now	\$335.69
Inform II	\$49.95 now	\$42.49
Creative Financing	\$150.00 now	\$127.49
Real Estate Analyzer	\$150.00 now	\$127.49
Accounting Assistant (cass.)	\$7.95 now	\$6.89
Spell Star	\$250.00 now	\$212.49
Muse Form Letter	\$100.00 now	\$84.99
Property Management System	\$225.00 now	\$191.19

PERSONAL/HOME

Interlude (disk)	\$19.95 now	\$16.99
Handwriting Analysis	\$19.95 now	\$16.89
Decision Master	\$29.95 now	\$25.39
The Correspondent	\$44.95 now	\$38.19
Diet Planning	\$24.95 now	\$21.19
Win at the Races	\$39.95 now	\$33.89
Pro Football (SDL)	\$26.95 now	\$22.89
College Football (SDL)	\$26.95 now	\$22.89
Grocery List	\$19.95 now	\$16.89
Financial Management System II	\$39.95 now	\$33.89
Home Money Minder	\$34.95 now	\$29.69

MISCELLANEOUS

D.C. Hayes Micromodem	\$375.00 now	\$299.00
D.C. Hayes Smart Modem	\$279.00 now	\$249.00
460G Paper Tiger	\$1094.00 now	\$961.99
560G Paper Tiger	\$1394.00 now	\$1225.00
Tiger Trax	\$16.95 now	\$15.25
Z-80 Softcard	\$395.00 now	\$299.00
NEC 12. Green on Black	\$260.00 now	\$209.00
Videx 80-col.	\$350.00 now	\$299.00
TG Joystick	\$59.95 now	\$50.89
TG Game Paddles	\$39.95 now	\$33.89
Paymar LCA Rev. 7		\$29.69
Don't Book	\$8.95 now	\$8.05
Dragon Fire	\$49.95 now	\$42.49
Hungry Boy	\$24.95 now	\$21.19
Ring of Saturn	\$39.00 now	\$33.89
Streets of the City & Trucker	\$24.95 now	\$21.19
Race for Midnight	\$29.95 now	\$25.39
Galactic Empire	\$24.95 now	\$22.99
Space Warrior	\$24.95 now	\$21.19
Pulsar II	\$29.95 now	\$25.39
Star Cruiser	\$24.95 now	\$20.99
Both Barrels	\$24.95 now	\$21.89
Cyber Strike	\$39.95 now	\$36.99
Phantom 5	\$29.95 now	\$25.39
Memorex Diskette		10 for \$24.99
Verbatim Diskette-plain w/hubs		10 for \$27.99
Dysans		10 for \$49.99
Flipsort Box		\$29.80
Scotch Disk Cleaner	\$29.95 now	\$26.99
E-Z Port	\$24.94 now	\$21.19
Atari - TRS-80 - Pet		Write for information

HUNTINGTON COMPUTING

Post Office Box 1235
Corcoran, California 93212

Order by Phone 800-344-4111
In California (209) 992-5411

Apple® is a registered trademark of Apple Computer, Inc.
Pet® is a registered trademark of Commodore.
TRS-80® is a registered trademark of Tandy Corp.
Atari® is a registered trademark of Atari, Inc.
Circle 175 on inquiry card.

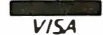

We take MasterCard or VISA (Include card # and expiration date) California residents add 6% tax. Include \$2.00 for postage. Foreign and hardware extra. Send for free catalog. Prices subject to change.

Call Toll-Free 800-344-4111 (Outside California)

What's New?

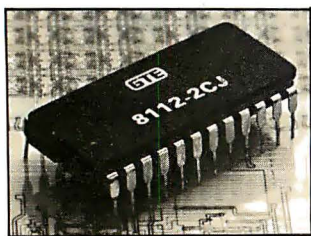

New Circuits from GTE

The 8112 static programmable-memory integrated circuit is pin-for-pin-compatible with the 2716 EPROM (erasable programmable read-only memory). A detached write function allows data to be controlled by the write-enable function, making a delayed write possible. The 8112 operates in the enabled and the disabled modes. In the enabled mode, the device typically uses 135 mW of power and in the disabled mode it uses 30 mW. Organized as a 1 K by 8-bit circuit, the 8112 is available in 200, 300, and 400 ns versions. It requires a single +5 V DC power supply. Depending on speed, the 8112's price ranges from \$10.10 to \$13.05. Contact GTE Microcircuits, 2000 West 14th St., Tempe, AZ 85281, (602) 968-4431. Circle 588 on inquiry card.

5 V DC, 10 A Switching Power Supply

Suitable for 90 V to 135 V AC or 180 V to 270 V AC, the Model USB 5-10, a 5 V DC 10 A open-frame switching power supply, can handle a line frequency of between 47 and 440 Hz. Efficiency is

more than 72% at full load, 115 or 230 V AC and 25°C. The supply can compensate for up to 0.5 V line drop and has crowbar overvoltage protection. The price for the USB 5-10 switching supply is \$99. Contact Adtech Power, Inc., 1621 South Sinclair, Anaheim, CA 92806, (714) 634-9211. Circle 589 on inquiry card.

BitSwitch

BitSwitch is a manually activated device that allows one of two RS-232C interfaces to be switched to a common port. With BitSwitch, printers, modems, and terminals can be shared. The Model 117 BitSwitch can be placed under modems or telephones and is priced at \$124 from Development Associates, 1520 South Lyon St., Santa Ana, CA 92705, (714) 835-9512. Circle 590 on inquiry card.

TRS-80 Control Keys

Clockwork Software's Control Key system is a hardware and software combination that lets you control your TRS-80 Model I's 32 K- or 48 K-byte floppy-disk system with single keystrokes. The hardware converts the TRS-80's numeric keypad into a set of 12 programmable-function keys accessible by BASIC or machine-language commands.

Four Control Key programs are available: Doskey, Baskey Scripkey, and Numkey. Doskey

allows execution of the most frequently used DOS (disk operating system) functions with a single key. Baskey aids the entering and debugging of BASIC programs by configuring the keypad to accommodate BASIC commands. Scripkey works in conjunction with the Scripsit word-processing program and allows 24 Scripsit commands to be entered with single keystrokes. Numkey converts the Control Key hardware back into a numeric pad for data entry. A total of 24 functions/com-

mands are available from the Control Key keyboard during the execution of each Control Key program.

The Control Key hardware costs \$150 assembled, \$70 partially assembled, or \$20 for the bare board, including documentation. Doskey and Numkey come with the assembled and partially assembled versions. Baskey and Scripkey cost \$20 each. For details, contact Clockwork Software, POB 704, Colorado Springs, CO 80901. Circle 591 on inquiry card.



RS-232C Cable Assemblies

Belden Corp.'s shielded interface-cable assemblies comply with the EIA's (Electronics Industries Association's) RS-232C standards. Belden's molded cable assemblies feature a 25-conductor shielded cable with subminiature male or female D connectors. This design protects signals from external interference. Connector pins

and sockets feature gold over copper-flashed beryllium copper. Prices range from \$21.06 for a 5-foot length to \$56.82 for a 70-foot piece. Contact Joe Prechodnik, Belden Corp., Interconnect Systems Operation, 105 Wolfpack Rd., Gastonia, NC 28052, (704) 865-4513.

Circle 592 on inquiry card.

Why use their flexible discs:

Athana, BASF, Control Data, Dysan, IBM, Maxell, Nashua, Scotch, Shugart, Syncom, 3M, Verbatim or Wabash

when you could be using

MEMOREX

for as low as \$1.94 each?

Find the flexible disc you're now using on our cross reference list... then write down the equivalent Memorex part number you should be ordering.

Product Family	Product Description	Memorex Part Number (1270-1)	CE quant. 100 price per disc(s)	Athana	BASF	Dysan	IBM	Maxell	Nashua	Scotch 3M	Shugart	Syncom	Verbatim	Wabash	Control Date
Flexible Disc 1s Single Headed Drives Single Density Media	IBM Compatible 1128 B/S, 26 Sectors	3000	1.99	473071	53428	800506	2305830	FD1-128	FD-1	740-D	S/A 100	15002	FD34-9000	F111111X	421602
	IBM Compatible 1128 B/S, 26 Sectors w/ W.P.N.	3004	2.04	--	--	--	--	--	--	740-D	--	--	FD34-9000	--	--
	IBM Compatible 1128 B/S, 26 Sectors w/ W.P.N. & Hub Ring	3064	2.39	--	--	--	--	--	--	--	--	--	FD34-9000	--	--
	IBM Compatible 1128 B/S, 26 Sectors REVERSE SIDE	1729	3.19	473072	54311	--	--	--	FD-2	740/2-D	--	15150	FF34-8000	F171111X	--
	IBM System 6 Compatible	3066	2.04	473077	54561	800509	1669559	--	--	740-D 0556	--	15003	FD60-9000	F116111X	--
	IBM Compatible 1256 B/S, 15 Sectors	3109	1.99	473073	--	800584	2305845	--	--	740-3600	--	15005	FD36-9000	F112111X	--
	IBM Compatible 1512 B/S, 8 Sectors	3110	1.99	473074	--	800585	1669554	--	--	15004	--	15004	FD60-9000	F113111X	--
	Shugart Compatible 32 Head Sector	3015	1.99	470901	53802	10111	--	FH1-32	FD-132	740-32	S/A-101	15025	FD32-9000	--	421322
	Wang Compatible 32 Head Sector w/Hub Ring	3087	2.49	--	54491	--	--	--	--	740-32RH	--	--	--	F37A411X	--
	CPT 8000 Compatible	3045	2.89	--	--	--	--	--	--	--	--	15276	--	--	--
Flexible Disc 1d Single Headed Drives Double Density Media	IBM Compatible 1128 B/S, 26 Sectors	3090	2.69	474011	54568	37401-D	--	FD1-128/M2100	FD-10	741-0	--	--	FD34-8000	F131111X	423002
	Soft Sector 1128 B/S, 26 Sectors REVERSE SIDE	3093	3.89	--	--	--	--	--	--	--	--	--	FD32-8000	F33A411X	423322
	Shugart Compatible 32 Head Sector	3091	2.69	470801	54596	1011-D	--	FH1-32D	--	741-32	S/A-103	15075	--	--	--
	Wang Compatible 32 Head Sector w/Hub Ring	3088	3.09	--	--	--	--	--	--	--	--	--	--	--	--
Flexible Disc 2s Double Headed Drives Single Density Media	IBM Compatible 1128 B/S, 26 Sectors	3113	3.09	--	54428	800814	1766870	--	--	--	S/A-150	15153	FD10-4026	F121111X	--
	Soft Sector 1256 B/S, 15 Sectors	3106	3.09	473477	54276	800815	2736700	FD2-256D	--	742-0	--	15154	FD10-4015	F122111X	424612
Flexible Disc 2d Double Headed Drives Double Density Media	Soft Sector (Unformatted)	3102	3.09	473485	--	DY150	--	FD2-XDM	FD-2D	743-0	--	15103	DD34-4001	--	425002
	Soft Sector (128 B/S, 26 Sectors)	3115	3.09	--	--	--	--	--	--	--	S/A-150	--	DD34-4028	F144111X	425602
	Soft Sector (256 B/S, 26 Sectors)	3103	3.09	473471	54325	800817	1766872	FD2-256D	--	743-0256	--	15101	DD34-4018	F145111X	425612
	Soft Sector (512 B/S, 15 Sectors)	3114	3.09	473472	54476	800818	1669554	--	--	743-0512	--	15100	DD34-4015	F146111X	425612
	Soft Sector 1024 B/S, 8 Sectors	3104	3.09	473473	54405	800819	1669045	--	--	743-01024	--	15102	DD34-4008	F147111X	425622
	32 Head Sector	3105	3.09	470851	--	1012D	--	--	FH2-32D	743-32	S/A-151	15125	DD32-4000	F34A411X	425322
	Burroughs 8-80 Compatible 32 Head Sector	3092	3.09	--	--	--	--	--	--	--	--	--	--	F34A611X	--
	Soft Sector 1024 B/S, 8 Sectors w/ Hub Ring	3116	3.49	--	--	--	--	--	--	--	--	--	--	--	--
	Shugart Compatible 32 Head Sector	3181	3.39	--	--	--	--	--	--	--	--	--	--	DD32-4000	--
	Flexible Disc FD Memorex 851 or Ex-Dur Drive Compatible	FD VI (Navy) Jacket	3071003	2.69	470551	--	FDIV	--	--	FD-165	511-0	--	15026	FD65-1000	F61A111X
Mini Flexible Disc 1s 5 1/4" Single Headed Drives Single Density Media	Soft Sector (Unformatted)	3401	1.94	475001	54256	10411	--	MD1	MD 1	744-0	S/A-104	15320	MD25-01	M11A211X	441002
	10 Head Sector	3403	1.94	475010	54257	10711	--	--	MD 110	744-10	S/A-107	15325	MD25-10	M41A211X	441102
	16 Head Sector	3405	1.94	475016	54258	10511	--	MH1	MD 116	744-16	S/A-105	15326	MD25-16	M51A211X	441162
	Soft Sector (Unformatted) w/Hub Ring	3431	2.14	--	--	--	--	--	--	--	--	--	MD25-10	--	--
	10 Head Sector w/Hub Ring	3433	2.14	--	--	--	--	--	--	--	--	--	MD25-10	--	--
16 Head Sector w/Hub Ring	3435	2.14	--	--	--	--	--	--	--	--	--	MD25-16	--	--	
Mini Flexible Disc 1d 5 1/4" Single Headed Drives Double Density Media	Soft Sector (Unformatted)	3417	2.14	--	54646	1041-D	--	--	--	--	--	--	MD25-01	--	--
	10 Head Sector	3418	2.14	--	54649	1071-D	--	--	--	--	--	--	MD25-10	--	--
	16 Head Sector	3419	2.14	--	54652	1051-D	--	--	--	--	--	--	MD25-16	--	--
	Soft Sector (Unformatted) w/Hub Ring	3481	2.34	--	--	--	--	--	--	--	--	--	MD25-01	--	--
	10 Head Sector w/Hub Ring	3483	2.34	--	--	--	--	--	--	--	--	--	MD25-10	--	--
	16 Head Sector w/Hub Ring	3485	2.34	--	--	--	--	--	--	--	--	--	MD25-16	--	--
Mini Flexible Disc 2d 5 1/4" Double Headed Drives Double Density Media	Soft Sector (Unformatted)	3421	2.59	--	54624	1041-2D	--	--	--	--	S/A-154	--	MD55-01	--	--
	10 Head Sector	3423	2.59	--	54627	1071-2D	--	--	--	--	S/A-157	--	MD55-10	--	--
	16 Head Sector	3425	2.59	--	54630	1051-2D	--	--	--	--	S/A-155	--	MD55-16	--	--
	Soft Sector (Unformatted) w/Hub Ring	3491	2.79	--	--	--	--	--	--	--	--	--	MD55-01	--	--
	10 Head Sector w/Hub Ring	3493	2.79	--	--	--	--	--	--	--	--	--	MD55-10	--	--
	16 Head Sector w/Hub Ring	3495	2.79	--	--	--	--	--	--	--	--	--	MD55-16	--	--

Memorex Flexible Discs...The Ultimate in Memory Excellence

Quality
Memorex means quality products that you can depend on. Quality control at Memorex means starting with the best materials available. Continual surveillance throughout the entire manufacturing process. The benefit of Memorex's years of experience in magnetic media production, resulting, for instance, in proprietary coating formulations. The most sophisticated testing procedures you'll find anywhere in the business.

100 Percent Error Free
Each and every Memorex Flexible Disc is certified to be 100 percent error free. Each track of each flexible disc is tested, individually, to Memorex's stringent standards of excellence. They test signal amplitude, resolution, low-pass modulation, overwrite, missing pulse error and extra pulse error. They are torque-tested, and competitively tested on drives available from almost every major drive manufacturer in the industry including drives that Memorex manufactures. Rigid quality audits are built into every step of the manufacturing process and stringent testing result in a standard of excellence that assures you, our customer, of a quality product designed for increased data reliability and consistent top performance.

Customer-Oriented Packaging
Memorex's commitment to excellence does not stop with a quality product. They are proud of their flexible discs and they package them with pride. Both their packaging and their labeling have been designed with your ease of identification and use in mind. The desk-top box containing ten discs is convenient for filing and storage. Both box labels and jacket labels provide full information on compatibility, density, sectoring, and record length. Envelopes with multi-language care and handling instructions and color-coded removable labels are included. A write-protect feature is available to provide data security.

Full One Year Warranty—Your Assurance of Quality
Memorex Flexible Discs will be replaced by Memorex if they are found to be defective in materials or workmanship within one year of the date of purchase. Other than replacement, Memorex will not be responsible for any damages or losses (including consequential damages) caused by the use of Memorex Flexible Discs.

Quantity Discounts Available

Memorex Flexible Discs are packed 10 discs to a carton and 10 cartons to a case. Please order only in increments of 100 units for quantity 100 pricing. We are also willing to accommodate your smaller orders. Quantities less than 100 units are available in increments of 10 units at a 10% surcharge. Quantity discounts are also available. Order 500 or more discs at the same time and deduct 1%; 1,000 or more saves you 2%; 2,000 or more saves you 3%; 5,000 or more saves you 4%; 10,000 or more saves you 5%; 25,000 or more saves you 6%; 50,000 or more saves you 7% and 100,000 or more discs earns you an 8% discount off our super low quantity 100 price. Almost all Memorex Flexible Discs are immediately available from CE. Our warehouse facilities are equipped to help us get you the quality product you need, when you need it. If you need further assistance to find the flexible disc that's right for you, call the Memorex compatibility hotline. Dial 800-538-8080 and ask for the flexible disc hotline extension 0997. In California dial 800-672-3525 extension 0997.

Buy with Confidence

Get the fastest delivery from CE of your Memorex Flexible Discs, send or phone your order directly to our Computer Products Division. Be sure to calculate your price using the CE prices in this ad. Michigan residents please add 4% sales tax. Written purchase orders are accepted from approved government agencies and most well rated firms at a 10% surcharge for net 10 billing. All sales are subject to availability, acceptance and verification. All sales are final. Prices, terms and specifications are subject to change without notice. Out of stock items will be placed on backorder automatically unless CE is instructed differently. Minimum order \$50.00. International orders are invited with a \$20.00 surcharge for special handling in addition to shipping charges. All shipments are F.O.B. Ann Arbor, Michigan. No COD's please. Non-certified and foreign checks require bank clearance.

Mail orders to: Communications Electronics, Box 1002, Ann Arbor, Michigan 48106 U.S.A. Add \$8.00 per case or partial case of 100 8-inch discs or \$6.00 per case of 100 5 1/4-inch mini-discs for U.P.S. ground shipping and handling in the continental U.S.A. If you have a Master Card or Visa card, you may call anytime and place a credit card order. Order toll-free in the United States. Call anytime 800-521-4414. If you are outside the U.S. or in Michigan, dial 313-994-4444. Dealer inquiries invited. All order lines at Communications Electronics are staffed 24 hours.
Copyright ©1981 Communications Electronics™



Order Toll-Free!
(800) 521-4414
In Michigan (313) 994-4444

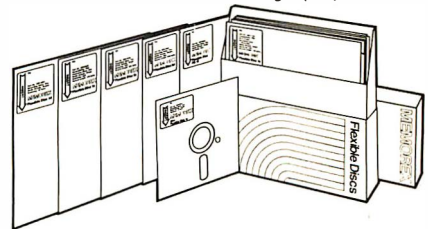

For Data Reliability—Memorex Flexible Discs

COMMUNICATIONS ELECTRONICS™

Computer Products Division

854 Phoenix □ Box 1002 □ Ann Arbor, Michigan 48106 U.S.A.
Call TOLL-FREE (800) 521-4414 or outside U.S.A. (313) 994-4444

What's New?

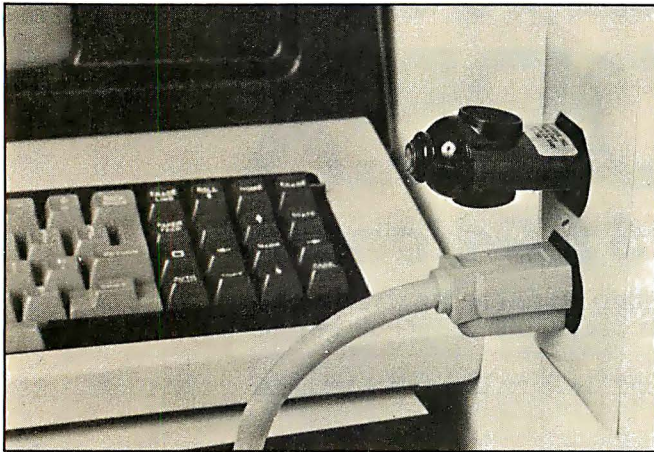

Voltage Suppressor

The Voltage Surge and Transient Suppressor electronically removes or reduces sudden voltage changes that can affect electronic equipment. The Suppressor is plugged into an AC-line power receptacle on the same 15 A breaker circuit as the electronic equipment being protected. Overvoltage surges beyond 132 V AC are clipped and high-frequency

transients are cut off. A 2 A internal fuse provides overload protection. A power indicator lets you know whether your AC-input voltages are normal or poor. For information on the suppressor, contact Cuesta Systems, Inc., 3440 Roberto Court, San Luis Obispo, CA 93401, (805) 541-4160. Circle 593 on inquiry card.

North Star-Compatible Disk Controller

The Phase Lock II North Star-compatible disk controller can handle double- and quad-density floppy-disk drives. The Phase Lock II runs programs made for the North Star controller and supports four extra disk drives. The controller is capable of supporting a mixed configuration of 48- and 96-track-per-inch drives.

Optionally, the Phase Lock II can allow boot-up at a user-selectable address. Available with the selectable-address option is

Super DOS-96 & Boot PROM (programmable read-only memory), which automatically tracks the controller-board address and continues to function at different addresses. The Super DOS-96 & Boot PROM permits users to boot up on a drive other than number 1. Additionally, Super DOS-96 does not require a GO command: the user merely types in the file name followed by a RETURN and Super DOS-96 will automatically load and execute a file. A file program provided on a disk lets users merge files from a single- or double-density

disk to another single- or double-density disk.

The Phase Lock II costs \$450 or \$500 with the multi-address option. Contact HSC Computer Services, Ltd., POB 43, Brooklyn, NY 11236, (212) 780-0022. Circle 594 on inquiry card.

Controller for 5-Inch Seagate Drives

Xebec Corporation's S1410 controller is designed specifically for Seagate 5-inch-compatible drives. The S1410 is compatible with DTC (Data Technology Corp.) 510 and SA1400 interfaces, which allows the controller to operate with host adapters supplied by DTC and Shugart, such as those for the Apple, Q-Bus, Multibus, and S-100 computers. The microprocessor-controlled S1410 combines an on-board data separator with a Shugart Associates SA1400 series host interface. It can handle two drives simultaneously and it features a control that can configure the size of the drive through software commands. The S1410's power requirements are +5 V at 2.5 A and +12 V at 50 mA.

Other features include automatic seek and verify, automatic head and cylinder switching, a full-sector buffer, variable-sector size, automatic retries, and user-programmable drive characteristics. The host system initializes the drive size by sending the controller the maximum number of cylinders and heads. The S1410

controller costs \$295. Contact Xebec Corp., 432 Lakeside Dr., Sunnyvale, CA 94086, (408) 733-1340. Circle 595 on inquiry card.

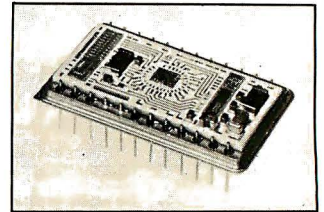

12-Bit 35 ns D/A Converter

Designed as a pin-for-pin replacement for the earlier ADH-030, the ADH-030 II D/A (digital-to-analog) converter provides 12-bit linearity, settling in 35 ns to within 0.01%. The device is useful for applications in video displays, including television and radar video reconstruction, x-y deflection positioning, and digitally controlled frequency agile oscillators. The ADH-030 II comes in two temperature grades: 0° to 70°C and -55° to +105°C. Prices begin at \$139, for single pieces. For more information, contact ILC Data Device Corp., 105 Wilbur Pl., Bohemia, NY 11716, (516) 567-5600.

Circle 596 on inquiry card.

Dot-Matrix Printers

Printek's Models 910 and 920 dot-matrix printers share many features: a 9 by 9 format, graphics density of 144 by 144 dots per inch, and a 96-character ASCII (American Standard Code for Information Interchange) set with optional

HANLEY ENGINEERING CORP.

We Will Beat All Competitor's Prices!!!

Guaranteed to ship within 24 hours on all telephone orders or YOUR ORDER FREE!!

800-426-2668
206-643-0792

4 K STATIC RAM
8/\$20.00

16K Memory
8/\$16.00

74LS00

4000CMOS

74LS00	25	74LS123	90	74LS259	2.80	4000	.35	4040	95	4501	.50
74LS01	25	74LS124	2.95	74LS260	.60	4001	.35	4041	95	4502	.95
74LS02	25	74LS125	3.00	74LS261	2.45	4002	.35	4042	75	4503	.65
74LS03	25	74LS126	.80	74LS266	.50	4006	.95	4043	85	4506	8.95
74LS04	25	74LS132	.75	74LS273	1.60	4007	.35	4044	.85	4506	1.25
74LS05	25	74LS136	.50	74LS275	3.30	4008	.95	4046	95	4507	.95
74LS08	30	74LS138	.75	74LS279	.50	4009	.45	4047	95	4508	1.95
74LS09	25	74LS139	.75	74LS280	1.95	4010	.45	4048	75	4510	.95
74LS10	25	74LS145	1.10	74LS283	.95	4011	.35	4049	55	4511	.95
74LS11	30	74LS147	2.25	74LS290	1.20	4012	.35	4050	55	4512	.95
74LS12	.30	74LS148	1.25	74LS293	1.80	4013	.45	4051	95	4514	2.25
74LS13	.40	74LS151	.75	74LS296	1.00	4014	.95	4052	95	4515	2.25
74LS14	.75	74LS153	.75	74LS298	.95	4015	.95	4053	95	4516	1.50
74LS15	.30	74LS159	.90	74LS309	2.50	4016	.45	4055	2.75	4518	1.25
74LS20	25	74LS156	.90	74LS323	3.95	4017	.95	4056	2.75	4519	1.25
74LS21	30	74LS157	.75	74LS324	1.75	4018	.95	4059	9.95	4520	1.25
74LS22	25	74LS158	.75	74LS347	1.95	4019	.45	4060	1.25	4522	1.25
74LS26	30	74LS160	.90	74LS348	1.95	4020	.95	4066	.75	4526	1.25
74LS27	.35	74LS161	.90	74LS352	1.50	4021	.95	4068	.40	4527	1.75
74LS28	.35	74LS162	.90	74LS353	1.50	4022	.95	4069	.40	4528	1.25
74LS30	25	74LS163	.90	74LS363	1.35	4023	.35	4070	.40	4531	.95
74LS32	.35	74LS164	.90	74LS365	.90	4024	.75	4071	.30	4532	1.75
74LS35	.55	74LS165	.90	74LS366	.90	4025	.35	4072	.30	4539	1.75
74LS37	.50	74LS166	2.00	74LS367	.65	4026	1.95	4073	.30	4543	1.95
74LS38	.35	74LS168	1.70	74LS368	.65	4027	.65	4075	.30	4553	4.95
74LS40	25	74LS169	1.70	74LS373	1.15	4028	.80	4076	.95	4555	.95
74LS42	.50	74LS170	1.70	74LS374	1.75	4029	.95	4078	.50	4556	.95
74LS47	.75	74LS173	.75	74LS375	.65	4030	.45	4081	.40	4558	2.25
74LS48	.75	74LS174	.80	74LS377	1.40	4031	1.50	4082	.40	4566	5.50
74LS49	.70	74LS175	.90	74LS385	1.85	4032	2.75	4085	.95	4581	1.95
74LS51	.25	74LS181	2.10	74LS386	.60	4033	2.75	4086	.95	4582	1.95
74LS54	.35	74LS189	9.95	74LS390	1.65	4034	2.75	4093	95	4584	.95
74LS56	.35	74LS190	.95	74LS393	1.85	4035	.85	4094	3.95	4585	.95
74LS53	1.20	74LS191	.95	74LS395	1.60	4036	2.50	4099	1.75	4072	9.95
74LS55	.35	74LS192	.90	74LS399	1.65						
74LS74	.40	74LS193	.90	74LS424	2.95						
74LS75	.50	74LS194	.95	74LS447	.35						
74LS76	.40	74LS195	.90	74LS490	1.90						
74LS78	.50	74LS196	.80	74LS530	75.00						
74LS83	.75	74LS197	.80	74LS540	3.00	7805CT	.85	LM301V	.75	LM567V	1.25
74LS85	1.10	74LS221	1.15	74LS541	3.00	7812CT	.85	LM308V	.75	LM723	.50
74LS86	.40	74LS240	1.15	74LS542	3.00	7815CT	.95	LM311V	.60	LM741V	.30
74LS90	.60	74LS241	1.15	74LS545	3.00			LM317T	1.90	LM747	.75
74LS91	.80	74LS242	1.85	74LS568	1.65	7805KT	1.40	LM317K	3.75	LM748V	.60
74LS98	.65	74LS243	1.85	74LS569	1.40	7812KT	1.40	LM318N	1.50	LM1414	1.50
74LS93	.60	74LS244	1.00	74LS570	2.15	7815KT	1.40	LM323K	3.75	LM1458V	.65
74LS96	.60	74LS245	1.95	74LS674	9.60	7810S	.65	LM324N	.60	DS1488N	1.00
74LS96	.80	74LS247	.75	74LS622	3.15	7812L	.65	LM337K	3.95	DS1483D	1.00
74LS107	.40	74LS248	1.20	74LS683	2.25	7805CT	.75	LM359	.75	LM1893	2.45
74LS109	.40	74LS249	.95	74LS684	2.35	7912CT	.95	LM377	2.25	LM3900	.60
74LS112	.40	74LS251	1.25	74LS685	2.35	7915CT	1.15	LM380	1.25	LM3909	.90
74LS113	.40	74LS252	.80	74LS688	2.35			LM386V	1.25	LM3914	3.75
74LS114	.50	74LS257	.80	74LS689	2.35	7905K	1.50	LM3915	3.75	LM3916	3.75
74LS122	.45	74LS258	.80	74LS622	1.25	7912K	1.50	LM555V	.40	LM5916	3.75
						7915K	.75	LM566	.70	DS1542	.40
						79L12	.75	LM565	.95	DS75452	.40
						79L15	.75	LM566V	1.50	DS75453	.40

LINEAR

74C00 CMOS

74C00	.40	74S132	1.20	74S201	14.90	74C00	.35	74C161	1.95	74C908	2.00
74C02	.45	74S133	.95	74S225	8.90	74C02	.35	74C162	1.95	74C909	2.20
74C03	.45	74S134	.85	74S240	3.95	74C04	.35	74C163	1.95	74C910	9.90
74C04	.75	74S135	1.45	74S241	3.70	74C08	.35	74C164	1.95	74C911	9.90
74C05	.75	74S138	1.05	74S251	1.85	74C10	.35	74C165	1.95	74C912	9.90
74C08	.45	74S139	1.20	74S253	7.40	74C14	1.45	74C176	1.95	74C914	1.90
74C09	.75	74S140	1.40	74S257	1.35	74C16	.35	74C177	2.20	74C915	1.90
74S10	.65	74S151	1.15	74S268	1.45	74C20	.35	74C178	2.20	74C917	2.70
74S11	.80	74S153	1.15	74S260	1.80	74C30	.35	74C175	2.20	74C917	2.70
74S15	.65	74S157	1.15	74S274	19.90	74C32	.50	74C192	2.20	74C918	1.90
74S20	.65	74S158	1.40	74S275	19.90	74C42	1.70	74C193	2.20	74C920	16.00
74S22	.75	74S161	2.80	74S280	2.85	74C48	2.05	80C97	.60	74C922	5.90
74S30	.45	74S162	3.70	74S287	4.70	74C53	.65	80C19	4.95	74C926	5.90
74S32	.95	74S163	3.70	74S288	4.40	74C74	.85	74C195	2.20	74C925	6.70
74S37	1.85	74S168	4.60	74S289	6.95	74C76	1.90	74C221	2.20	74C926	7.90
74S38	1.65	74S169	5.40	74S301	6.90	74C83	1.90	74C240	2.20	74C927	7.90
74S40	.40	74S174	1.05	74S373	3.40	74C86	.90	74C244	2.20	74C928	7.90
74S51	.75	74S175	1.95	74S374	3.40	74C89	4.50	74C373	2.70	74C929	7.90
74S54	.75	74S177	4.45	74S381	7.90	74C90	1.70	74C374	2.70	74C930	7.90
74S65	1.20	74S182	2.90	74S387	5.70	74C93	1.70	74C901	.80	74C932	1.95
74S74	.65	74S188	3.90	74S412	2.95	74C95	1.70	74C902	.80	74C941	2.75
74S85	2.35	74S189	14.90	74S471	9.90	74C107	.95	74C903	.80	74C989	9.90
74S86	1.40	74S194	2.90	74S472	16.80	74C150	5.70	74C904	.80	80C95	.85
74S112	1.55	74S196	1.85	74S474	17.80	74C151	2.20	74C905	10.90	80C96	.90
74S113	1.95	74S196	4.85	74S482	15.50	74C154	3.20	74C906	.90	80C90	3.95
74S114	1.45	74S197	4.20	74S570	7.75	74C157	1.75	74C907	.90	88C29	3.95
74S124	2.75			74S572	7.75	74C160	1.95				

HITACHI

2K x 8 CMOS RAM 150NS
Pin Compatible with 2716

HM6116P-3
\$13.00

8200

8 For \$88.00

8080A	3.95
8085A	8.95
8085A-2	11.95
8088	99.95
8088	39.95
8155	11.25
8185	29.95
8202	45.00
8205	3.95
8212	1.90
8214	3.85
8216	1.80
8224	2.50
8228	1.80
8238	4.90
8238	4.90
8243	4.50
8251A	5.45
8253	9.80
8255A-5	5.20
8257-5	8.95
8259A	6.95
8271	60.00
8272	39.95
8275	29.95
8275-9	10.00
8282	6.60
8283	6.60
8284A	5.75
8285	6.60
8287	6.60
8288	25.00
8289	49.95
8755A	45.00
8748	30.00

4118
STATIC RAM
1K x 8
\$15.00

6800

3242 8.00
3480 9.00
6800 5.75
6802 11.00
6809 25.00
6832E 36.00
6835 3.50
6821 3.50
6840 9.00
6843 41.00
6845 22.00
6847 12.25
6850 3.50
6852 3.50
6875 7.00
6880 1.80
6882 4.70
6885 1.80
6888 1.80
6889 1.80
6890 1.80
6898 12.50

AUGAT LOW PROFILE SOCKETS

These Are High Reliability Industry Standard Sockets

8PIN	208-AG29D	.10
14PIN	214-AG29D	.16
16PIN	216-AG29D	.18
18PIN	218-AG29D	.20
20PIN	220-AG29D	.22
22PIN	222-AG29D	.24
24PIN	224-AG29D	.26
28PIN	228-AG29D	.28
40PIN	240-AG29D	.42

4164

64K Dynamic Ram
200 NS pin
\$15.00

Z80

Z6

Z80A

Z80B

Z80C

Z80D

Z80E

Z80F

Z80G

Z80H

</

What's New?

fonts, underlining, super- and subscript, lowercase descenders, double-width characters, and downloadable character set. Both printers have a 1.8 K-byte character buffer. The Models 910 and 920 differ only in their bidirectional print speed and throughput. The 910 can print up to 170 cps (characters per second); the 920 up to 340 cps. The Model 910 has a maximum throughput of 140 lpm (lines per minute); the 920 can do 270 lpm. In graphics, the 910 prints 2000 dots per second, while the 920 prints 4000 dots per second.

The Model 910 has a suggested list price of approximately \$1695; the Model 920 is \$2345. Complete details are available from Printek, Inc., 1517 Townline Rd., Benton Harbor, MI 49022, (616) 925-3200.

Circle 597 on inquiry card.

Alps Printers

Using a special ballpoint pen, the Alps Electric Model 1200 color printer prints four-color graphic symbols, letters, numbers, Chinese ideograms, and drawings and graphs. During color printing, the printer selects the appropriate pen through software routines. Another printer, the Model 1100, uses a single pen and can write 12 cps (characters per second) in its smallest column size.

Alps printers are available as stand-alone units or as the printing mechanism alone. The price for the one-color printer is \$325,

the mechanism alone is \$140. The four-color Model 1200 is \$450; the mechanism alone is \$180. For details, contact Alps Electric, Inc., 100 North Centre Ave., Rockville Centre, NY 11570, (516) 766-3636.

Circle 598 on inquiry card.

Desktop Digitizer

Summagraphics Corporation has introduced a new version of its Bit Pad digitizer: the Bit Pad 10. The device is useful for cursor control, business-data entry, and graphics-information entry. RS-232C, IEEE (Institute of Electrical and Electronics Engineers), and 8-bit parallel interfaces are available for the 11-inch square digitizer

The Bit Pad 10 costs between \$895 and \$990, depending upon accessories. For complete details, contact Summagraphics Corp., 35 Brentwood Ave., Fairfield, CT 06430, (203) 384-1344.

Circle 599 on inquiry card.

Tabletop Drum Plotter

Houston Instrument's CPS-16, a four-pen, tabletop drum plotter, is micro-processor-based. The CPS-16 can produce four-color drawings on paper, mylar, or vellum. It accepts data from RS-232C or 20 mA current-loop sources and can operate in an on-line or remote time-share environment. It features up to 172 characters containing upper- and lowercase letters, positive paper feed, buffer memory,

and protocol for detection and correction of data-transmission errors. Writing speeds of 10 or 15 inches per second with a 0.05 mm (0.002 inches) resolution are touch-selectable. For additional information, contact Houston Instrument, One Houston Sq., Austin, TX 78753, (512) 837-2820.

Circle 600 on inquiry card.



Smart Logic Probe

The SP-1 Smart Probe is a logic probe with four address lines that can connect to TTL- (transistor-transistor logic) level circuitry. When the logic levels of the address lines match the parameters that the user has set into the switches, the TTL-logic level present at the probe tip is latched and displayed on an LED (light-emitting diode). This gives the user the ability to latch and display the logic level of a circuit at any specific instant. The SP-1 costs \$55 and is available from New Technologies Co., POB 32, Streamwood, IL 60103, (312) 289-4410.

Circle 601 on inquiry card.

Auto-Cat

The Auto-Cat is an auto answer, FCC- (Federal Communications Commission) approved, direct-connect 300-bit-per-second modem that can automatically answer calls at any time. Auto-Cat has three data modes: automatic answer, manual answer, and manual originate. It can operate in full- or half-duplex and features local and remote loopback test functions. The interface is RS-232C.

The Auto-Cat costs \$249. For complete details, contact Novation, Inc., 18664 Oxnard St., Tazana, CA 91356, (213) 996-5060.

Circle 602 on inquiry card.

Where Do New Products Items Come From?

The information printed in the new products pages of BYTE is obtained from "new product" or "press release" copy sent by the promoters of new products. If in our judgment the information might be of interest to the personal computing experimenters and homebrewers who read BYTE, we print it in some form. We openly solicit releases and photos from manufacturers and suppliers to this marketplace. The information is printed more or less as a first-in first-out queue, subject to occasional priority modifications. While we would not knowingly print untrue or inaccurate data; or data from unreliable companies, our capacity to evaluate the products and companies appearing in the "What's New?" feature is necessarily limited. We therefore cannot be responsible for product quality or company performance.

INCREDIBLE? BELIEVE IT!

PRINTERS



150 cps bidirectional-9x9 dot matrix, quietized case, 136 col, vertical form control and many other functions.
\$1195
 We feel this printer offers the best price/performance ratio available. RS-232 serial to 19,200 baud x-on, x-off add \$40

Teletype 40, 300 LPM-typewriter quality, RS-232 interface. This quality printer is available in many configurations including forms access, quietized case, etc. **from Only \$2928**

Teletype 43 **from \$995**

Teletype AP-200, 340 cps dot matrix (similar to Data Prod. M-200) **\$2799**

NEC Spinwriter-55 cps, bidirectional, letter quality R.O. 7710 KSR 7720 **\$2799**

DIABLO 630-40 cps, bidirectional, daisy wheel, plot/graph **\$2449**

QUME Sprint 9/45 cps, daisy wheel **\$2228**

C. ITOH Starwriter, 25 cps, daisy wheel **\$1575**

C. ITOH Starwriter, 45 cps, daisy wheel **\$1849**

EPSON MX-80, 100, 80 cps, 9x9 dot matrix **\$CALL**

ANADEX 9500/9501, up to 200 cps, high resolution dot **\$1325**

OKIDATA Microline 80, 80 cps, 9x7 dot matrix **\$399**

Microline 82A, bidirectional, friction/pin feed **\$525**

Microline 83A, bidirectional, 120 cps, uses 15" paper **\$799**

TI-810, 150 cps, Basic **\$1449**

Package-Compressed print, vertical form control **\$1630**

MANNESMANN MT 1705 200 cps, 7x7, 132 col **\$1425**

TALLY MT 1805 200 cps, + NLQ 40 x 18 matrix **\$1675**

CENTRONICS 704-9, 180 cps, 9x9 dot matrix, 132 col **\$CALL**

739 100 cps, nx9 dot matrix, FULL GRAPHICS **\$700**

DEC LA-34 **\$1085**

IDS 460G **\$892**

S-100 SPECIALTIES



DP/Z-80A, CPU, 64K ram, floppy cont., RS-232 port, S-100 IEEE, 8 slot in Adds terminal, inc. CP/M 2.2 **\$CALL**



Delta has Winchester based networks of up to 16 users available.

Systems Group Call us for best prices on these high quality 2nd generation boards and systems.

California Computer Systems These high quality, reliable products have made CCS defacto industry standard for S-100 products Assembled and tested: list only

2200 H.D. Mainframe, 20 a. P.S., 12 slot MB **\$434 \$359**

2065C 64K dynamic RAM/Bank Select **\$720 \$580**

2810A Z-80 CPU, serial port, ROM monitor **\$310 \$259**

2422A Floppy Cont, CP/M 2.2, ROM monitor **\$425 \$345**

IMS 8000 DT w/64k, 1.2 MB 8" floppies, 2 serial, 3 par. CPM 2.2 **\$CALL**

FULL 2 YEAR WARRANTY!

GODBOUT ELECTRONICS WE OFFER GENEROUS DISCOUNTS ON THE COMPUPRO LINE OF FAST, QUALITY 8 AND 16 BIT BOARDS

NorthStar ADVANTAGE & HORIZON **\$CALL**

Similar savings on the full lines of CCS, SSM, NNC, MORROW, DELTA, NORTHSTAR, ITHACA INTERSYSTEMS, GODBOUT, NEC, TELEVIDEO, IMS ZENITH, ADDS, DEC, DATA GEN., ATARI, DYNABYTE, TECMAR, DUAL

8" DISK DRIVE SALE

8" SHUGART SA801R \$450 **8" SHUGART SA 851R \$669** 2 for \$1289

QUME DATATRACK 8 \$589, 2 for \$1110

Enclosure, power supply for 2 8" drives A&T \$299

VISTA industrial grade enclosure for 2 drives with P.S. \$420

MORROW Discus 2D + CP/M[®], MICROSOFT BASIC \$950

Discus 2+2 + CP/M[®], MICROSOFT BASIC \$1195

HARD DISK SPECIALS

CORVUS 10MB and controller \$5350 **List only \$6450** **20MB and controller \$6450** **Scall**

Constellation Network Multiplexer and Mirror Video Tape Disk Backup

MORROW 26MB + controller + CP/M 2.2[®], M basic \$4495 **\$3821**

controller, CDC Hawk Drive (5 fix, 5 rem) \$7995 **\$6795**

controller, Western Dynex (5 fix, 5 rem) \$5995 **\$5099**

Winchester 5 1/4 drives complete with case, cable, software, S-100 controller. Adapter avail. for use with

any Z-80 system. Cartridge drive controllers avail.

5MB \$2899 **APPLE XEROX ALTOS OEM discounts available!** **Z-89 R.S. MOD. II \$3398**

10MB \$3398

ADDES \$33-33MB Drive and Controller \$4468

\$66-66 MB Drive and Controller \$5925

PRIAM 8" and 14" Winchester/tape subsystems avail.

We carry the full line of ADDES disk and tape controllers and subsystems.

FULLY CONFIGURED BUSINESS SYSTEMS

The following are some examples of the fully assembled and tested business and scientific computer systems which we offer. All include 64K bytes

RAM, Z-80A 4mh CPU. We offer a full line of quality, tested software.

Delta TVD w/ 1.2 Mb floppy drives, 2 serial, 3 parallel ports \$CALL

Delta S-4500 10 USER, MULTI-PROCESSOR, 40 MB HARD 17MB TAPE \$CALL

CCS 2210A w/floppy controller, 1 serial port \$1849

CCS 300-1A w/1.2MB floppy drives, 2 serial, 2 parallel ports \$4849

CCS 400-1A w/10MB hard disc, 2 serial, 2 parallel ports \$6999

NNC 80W w/.5MB floppy, 8.4MB hard disc, (OASIS optional) \$6693

ALTOS single and multi-user systems \$CALL

MORROW DESIGNS, MICROSOFT basic, UNIX \$CALL

XEROX 820 Desktop computer-64K, 2 floppys, (CP/M AVAIL.) List \$2995 \$CALL

We offer multi-user networks by DELTA PRODUCTS, DISCOVERY, TELEVIDEO, MUSYS, IMS, DIGITAL MICROSYSTEMS

TERMINALS PMMI MODEM \$359

AMPEX DIALOGUE 30, 80 \$CALL

TELEVIDEO 910 C (multi-terminal) \$699 \$610

920 C \$1030 \$775

950C \$1195 \$950

SOROC IQ 120 \$995 \$729

HAZELTINE ESPRIT \$745 \$669

DEC VT-100 \$2050 \$1575

Similar savings for our HAZELTINE and LEAR SIEGLER lines

LOOK HERE! **AMPEX Dialogue 80™**

Call us for ALL your software needs

SYSTEMS HOUSES & EDUCATIONAL INSTITUTIONS, & GOVERNMENT AGENCIES GIVEN SPECIAL CONSIDERATION.



ALL OF OUR PERIPHERALS CAN BE CONFIGURED FOR RADIO SHACK® MODEL II

DEALER and INTERNATIONAL INQUIRIES WELCOME

WASHINGTON COMPUTER SERVICES

an affiliate of **WASHINGTON ELECTRIC COMPANY** est. 1912

CUSTOM COMPUTER ROOM WIRING SINCE 1960

97 Spring Street

New York, N.Y. 10012

Hours: 9 AM-5:30 PM (EST) Mon.-Fri.

TO ORDER: CALL OUR TOLL-FREE NUMBER:

★(800) 221-5416★ In N.Y. State and for technical information call 1-(212) 226-2121

For fast delivery, send certified checks, money order or call to arrange direct bank wire transfers. Personal or company checks require two to three weeks to clear. All prices are mail order only. Prices subject to change without notice; call for latest prices. Prices include 3% cash discount. N.Y. residents add sales tax. Quantex is a trademark of North Atlantic Industries, Inc. Radio Shack® is a trademark of the Tandy Corp. CP/M® is a trademark of Digital Research. All sales subject to our standard sale conditions (available on request).



Z8 BASIC COMPUTER/CONTROLLER

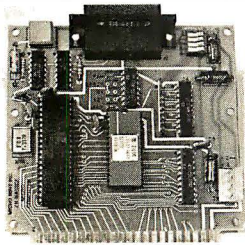

As featured in
Byte Magazine, July and August 1981

- On board tiny BASIC Interpreter.
 - 2 on board parallel ports.
 - Serial I/O port
 - 6 interrupts.
 - Just attach a CRT terminal and immediately write control programs in BASIC.
 - BAUD RATES 110-9600 BPS.
 - Data and address buses available for 124K memory and I/O expansion.
 - 4K RAM, 2716 or 2732 EPROM operation.
 - Consumes only 1 1/2 WATTS
- Z8 Basic Microcomputer/Controller Assembled & Tested.....\$195.00**
Complete Kit\$165.00
Universal Power Supply (+5, +12, & -12v)\$ 35.00

Z8 is a trademark of Zilog Inc.

SWEET-TALKER, IT GIVES YOUR COMPUTER AN UNLIMITED VOCABULARY.

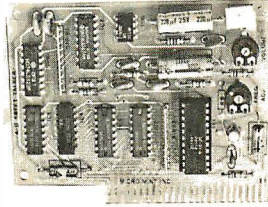

As Featured In
Byte Magazine, September 1981

- Utilizes VORTRAX SC-01A speech synthesizer chip.
 - Unlimited vocabulary.
 - Contains 64 different phonemes which are accessed by an 8-bit code.
 - Text is automatically translated into electrically synthesized speech.
 - Parallel port driven or Plug-in compatible with APPLE II.
 - On board audio amplifier.
 - Sample Program for APPLE II on cassette
- SWEET-TALKER Assembled and Tested**
Parallel Port Circuit Card.....\$139
APPLE II Plug-in Card\$149

VORTRAX is a trademark of Federal Screw Works

DISK-80 EXPANSION INTERFACE FOR THE TRS-80 MODEL I



As Featured In
Byte Magazine, March 1981

- Disk controller (4 drives)
- Hardware data separator
- Buffered TRS-bus connector
- Real-time clock
- Printer port (optional)

- DISK 80-ASSEMBLED & TESTED with 32K RAM\$329.95**
Centronics Printer Port add\$ 50.00
DISK-80 pc board\$ 48.00
Printer/Power Supply pc board\$ 16.00
Complete Kit with 32K RAM and Printer Port\$275.00

TRS-80 is trademark of Tandy Corp.



To Order: Call Toll Free - 1-800-645-3479
 (In N.Y. State Call: 1-516-374-6793)
 For Information Call: 1-516-374-6793

MICROMINT INC.
 917 Midway
 Woodmere, N.Y. 11598

TERMINAL

- Feather Touch Capacitance Keyboard
- 60 Key Standard ASCII PLUS + Hex Keypad PLUS + 8 Special Function Keys PLUS + 20 Screen Editing Keys
- SOROC Type Screen Attribute Set
- Half Intensity

COMPUTER

- 8 Slot S-100
- 64K Dynamic Ram
- 4MHZ Z-80
- Serial Printer Port (150-19.2K)
- Double Density Disk Controller
- Programmable Baud Rate
- Programmable Keyboard Set

S-100-8



INCLUDING CP/M2.2®

WITH: 8" SS/DD Drives Only \$2850.00
5 1/4" SS/DD Drives Only \$2700.00

CALL FOR QUOTE ON DIFFERENT DRIVE OPTIONS

CP/M2.2 is a TM of Digital Research Inc.

California Computer Systems



- 2810 CPU Only — \$250.00
- 2422 Dsk Cont Only — \$300.00
- 2065C 64K Only — \$425.00
- 2032C 32K Only — \$620.00
- 2710 4 Serial Port Only — \$245.00
- 2200A Mainframe Only — \$349.00
- 2501 Mother Board Only — \$106.00
- 2116C 16K Static Ram 200ns Only — \$309.00
- 2520K Extender Board Only — \$52.00
- 2200 System Tested and Assembled Only — \$1,600.00
- Software AP/PR/AR/GL Only — \$450.00
- Mail List Only — \$69.95
- Calendar Only — \$44.50

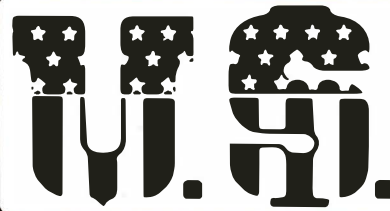

MICRO SALES

11 EDISON DRIVE ★ NEW LENOX ★ ILLINOIS 60451
 CALL TOLL FREE: 1-800-435-9357 ★ MONDAY thru SATURDAY
 (ILLINOIS RESIDENTS CALL: 815-485-4002) ★ 8:00 a.m. to 6:30 p.m.

TERMS: Prepayment — C.O.D. up to \$100.00 — M/C Visa
 \$5.00 Processing and Handling added to each order PLUS
 Shipping Charges.

Please allow personal check to clear before shipment.

★ SPECIAL ★ SPECIAL ★ SPECIAL ★

DUAL DRIVE SUBSYSTEM



- \$1,045.00
- \$995.00-3 or More
- \$245.00 w/no Drives Tested and Assembled
- \$1,295.00 2-QUME DT 8 Power Supply and Cabinet Tested and Assembled

2 SHUGART 801R POWER SUPPLY

IN STOCK!!!



- CPU Serial Cable — \$30.00
- Z80 CPU — \$250.00
- DP Dsk Cont - \$275.00
- DP 64K — \$400.00
- 32K (Kit) — \$250.00

TERMINALS

- Televideo 910 — \$575.00
- Televideo 912C — \$665.00
- Televideo 920C — \$740.00
- Televideo 950 — \$950.00
- Ampex Dialog 80 — \$895.00
- Zenith Z19 — \$745.00

PRINTERS

- C-ITOH Comet I 9 x 7 Dot Matrix . . . \$450.00
- C-ITOH Comet II . . . \$810.00 132 Column Printer 9 x 7 Dot Matrix
- MPI-886 \$725.00
- EPSON MX 80 \$470.00
- EPSON MX 100 CALL
- Anadex 9501 \$1,235.00 Graphic Printer

S1 — MOD (KIT) \$199.00

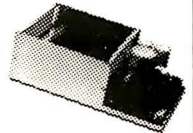

Complete S-100 12 Slot Main Frame. Ample system power with regulated power for drives. Excellent for Subsystem or Hobby use. Four hours to build. (6 conn., incl., less fans)
 POWER RATING — 30AOF ± 8V
 6AOF ± 16V

DISK DRIVES

- Shugart 801's — \$395.00
- Shugart 851's — \$585.00
- Qume DT-8's — \$540.00
- Shugart 400's — \$255.00
- Tandom 5 1/4 — \$255.00

LEXICON LX-11, acoustic — \$145.00

S-100 CARD EXTENDER (Gold Contacts) \$12.50

Zenith

data systems
Quality Affordable Microcomputers

CALL FOR PRICES

Circle 369 on inquiry card.

SPECIAL

 340 POWER SUPPLY FOR 1 MINI DRIVE \$21.00

 DMA/A CHIPS \$15.00

TWIN VERTICAL DRIVES

5" \$550.00 — 8" \$980.00



- 2716—\$6.75
- 2708—\$3.95
- 4116—\$2.50
- 2114—\$2.75

- Z-80A — \$6.95
- Z-80A SUPPORT
- CTC — \$6.55
- SIO — \$25.50
- PIO — \$6.50

XEROX MICRO COMPUTERS

(Options)

- 2 5 1/4" Disc Drives
- 2 8" Disc Drives
- Letter Quality Printer (Call for Prices)

★ CABLES ★

- R3232 made to order
- 50 Pin Ribbon cable w/connectors
- 34 Pin Ribbon cable w/connectors
- Call for Prices

★ ★ ★ ★ ★ THE MICRO BILLBOARD ★ ★ ★ ★ ★

★ U.S. Micro Sales now open 7 days a week — 24 hours a day.
 ★ Now you can simply dial up your computer and get into our
 ★ specially priced merchandise. CALL TOLL-FREE 800—435-9357
 ★ BILLBOARD OPEN FROM 6:30 P.M. TIL 8:00 A.M.

Novation



- CAT \$150.00
- D-CAT \$165.00
- AUTOCAT \$235.00
- APPLECAT \$350.00
- SUPERMIKE \$11.50

FLOPPY DISK DRIVES

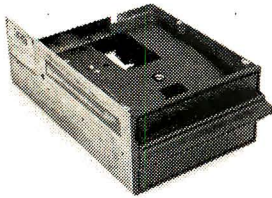

SPECIAL!!!!!!! QUME DATATRAK 8
 Virtually the industry standard. High quality/
 reliability. Full featured, double sided, double
 density.

1-5	\$499
6-9	\$485
10	\$475

TANDON DOUBLE SIDED, DOUBLE DENSITY MINIS

TM100-2 48 TPI (500 KBYTES)	\$325
Compatible with Northstar, Cromemco, TRS-80	
TM100-4 96 TPI (1000 KBYTES)	\$425
Compatible with Zenith, Heath, etc.	
SA850 1-5	\$499
6-9	\$485
10	\$475

Qume Datatrak 5	\$345
SA 400	\$299

CONTROLLERS

Tarbell single density kit	\$195
Tarbell single density A & T	\$310
Tarbell double density A & T	\$425
CCS 2422 w/CPM 2.2	\$350
Godbout Disk 1	\$450
MDA MXV-21 LSI-11 controller (RX-01, RX-02 compatible)	\$1050

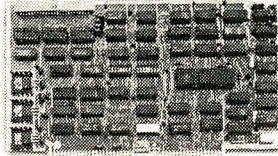

MISCELLANEOUS

2 Disk drive enclosure	\$ 95	Cable Kits 2 drives	\$ 35
(fits Siemens, Shugart, Qume)		3 drives	\$ 40
CP-206 power supply	\$110	4 drives	\$ 45
(powers two floppies)		Diskettes ss \$39/10 — ds \$59/10	
Mini-Enclosure with power supply			
1 drive	\$ 85		
2 drives	\$120		

Electrolabs

POB 1608, Palo Alto, CA 94302 (415) 321-5601

CPU

CCS 2810	\$ 275
Godbout Z-80A	\$ 275
Godbout 8085A	\$ 295

MEMORY

CCS 2065 64K dynamic	\$ 625
CCS 2116 32K static	\$ 675
Godbout RAM 17 64K	\$ 995

I/O

CCS 2710 4 SIO	\$ 325
Godbout Interfacer 1	\$ 225
Godbout Interfacer 2	\$ 225

NEW !!!!

Qume Sprint 9
DAISY WHEEL PRINTER . . \$2395
 45 CPS, RO. Available in KSR version.
 Call for further particulars.
 Ribbons: \$125/case
 Bidirectional tractor feed \$225

NEW !!!!

ABM 85 Video Terminal . . \$ 895
 — Detachable keyboard
 — Televideo 920, ADM 3A compatible
 — High resolution green phosphor (23 MHZ)
 — Extra multi-bus or S-100 slot for stand-alone capability

Terms of sale: cash or checks, MC/
 VISA. Min. order \$25. CA residents
 add 6% tax. Prices subject to change
 without notice. All goods subject to
 prior sale.

SAVE UP TO \$600.00 NOW on TRS-80™ Computers & Accessories With This Coupon*

Now you can own a great little computer at a great big discount off the manufacturer's list price. For home or office use, the Radio Shack® line of computers is first in quality, performance and price.

- **FREE SHIPPING** in the 48 continental contiguous states on prepaid orders of \$100 or more.
- **NO SALES TAX** collected on out-of-state orders.
- **CONVENIENT ORDERING** — Call us **TOLL FREE** — 1—800/531-7466
- **FREE COMPLETE PRICE LIST** available upon request.

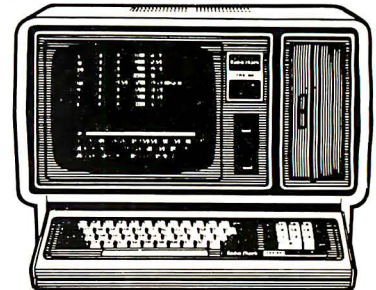

Model II

Catalog Number	Description	List Price	Cashier's Check	Cash Price You Save
Radio Shack® TRS-80 Model II				
26-4002	64K 1-Disk Model II	3,899.00	3,299.00	600.00
26-4150	Model II Hard Disk System (Installation Not Included).	4,495.00	4,045.50	449.50
Radio Shack® TRS-80 Model III				
26-1062	Model III 16K	999.00	859.00	140.00
26-1065	Model III 48K — 1 Disk	1,995.00	1,795.50	199.50
26-1066	Model III 48K — 2 Disk	2,495.00	2,099.00	396.00
Radio Shack® TRS-80 Color Computer				
26-3001	4K Color Computer	399.00	315.00	84.00
26-3002	16K Color Computer	599.00	475.00	124.00
26-3003	32K Color Computer	699.00	585.00	114.00
Epson® MX-80 Printer				
		645.00	499.00	146.00
Hewlett-Packard® HP-85 Personal Computer				
		3,250.00	2,499.00	751.00
Hewlett-Packard® HP-125				
		3,750.00	Call for Price	

Pan American Electronics

CALL TOLL FREE 800/531-7466 • (Operator 13) • Texas & Principal Number 512/581-2766 • Telex 767339
 Dept. 13 • 1117 Conway Avenue • Mission, Texas 78572
FORT WORTH BRANCH:
 2912 N. Main, Fort Worth, Texas 76106 • Phone Number 817/625-6333 • Telex 794836

TRS-80 is a Trademark of Tandy Corp. *With This Coupon Only! — Offer expires 2/27/82 Prices subject to change without notice — Slightly higher for Credit Card Orders.

SPECIALS on INTEGRATED CIRCUITS

6502	7.45	10/6.95	50/6.55	100/6.15
6502A/6512A	8.40	10/7.95	50/7.35	100/6.90
6520 PIA	5.15	10/4.90	50/4.45	100/4.15
6522 VIA	6.45	10/6.10	50/5.75	100/5.45
6532	7.90	10/7.40	50/7.00	100/6.60
2114-L200	3.75	25/3.50	100/3.25	
2114-L300	3.15	25/2.90	100/2.65	
2716 EPROM	7.00	5/6.45	10/5.90	
2532 EPROM			14.50	
6118 Hitachi 2K x 8 CMOS RAM			14.50	
4116			8 for 17	
Zero Insertion Force 24 pin Socket			2.00	
6550 RAM (PET 8K)			12.70	
S-100 Wire Wrap Socket			2.40	

A P Products 15% OFF
A P Hobby-Blox 15% OFF



THE STAR MODEM

From Practica/Liveware Data Systems

RS232 MODEM	SALE \$128
IEEE 488 MODEM	SALE \$199
RS232 CCITT	\$170
IEEE 488 CCITT	\$270

We carry Apple II+ from Bell & Howell

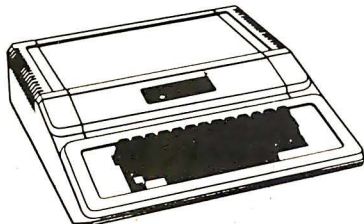

fullFORTH+ for Apple II	\$75
A full-featured FORTH with enhancements. Conforms to FORTH Interest Group standards.	
FORTH for PET by Cargile/Riley	\$50
Full FIG model with all 79 Standard extensions.	
Metacompiler for FORTH for independent object code	30
KMMM PASCAL for PET/CBM	\$85
Includes translator for true machine language object code.	
EARL for PET/CBM	65
Editor, Assembler, Relocator, Linkeditor.	
SuperGraphics - BASIC Language Extensions	30
Fast Machine Language Graphics routines for PET/CBM.	
SM-KIT - Super PET/CBM ROM based Utilities	40
SubSORT for PET/CBM by James Strasma	35
Flexible general purpose machine language sort routine.	
PaperMate 60 Command Word Processor (Riley)	40
Full-featured CBM/PET version with tape or disk text files.	
FLEX-FILE Data Base/Report Writer/Mail List	60
Versatile PET/CBM data handling system by Michael Riley.	
4 Part Music System for PET/CBM	\$60
Includes Visible Music Monitor and D/A Converter.	

commodore

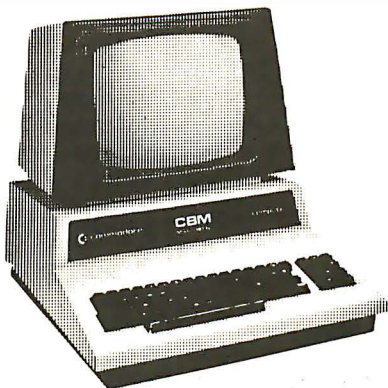

CBM-PET SPECIALS

	list	SALE
8023 Printer - 136 col, 150 cps bi-directional	(995)	775
8300 (Diablo 630) Daisy Wheel - 40 cps bi-directional	(2250)	1725
8032 80 x 25 CRT, business keyboard	(1495)	1100
Micro Mainframe	(1995)	1600
8096 Board (extra 64K RAM for 8032)	(500)	400
8050 Dual Disk Drive - 1 megabyte	(1795)	1345
8250 Dual Disk Drive - 2 megabyte	(2195)	1760
CBM IEEE Modem	(395)	199
4016 full size graphics keyboard	(995)	795
4032 full size graphics keyboard	(1295)	999
4040 Dual Disk Drive - 330,000 bytes	(1295)	999
2031 Single Disk Drive - 165,000 bytes	(695)	560
4022 Tractor Feed Printer	(795)	630
C2N External Cassette Deck	(75)	65
VIC 20 Color Computer	(299)	259
VIC 1515 Graphic Printer	(395)	315
Used CBM/PET Computers		CALL
8024-7 High Speed Printer	(1995)	1345

WE WILL MATCH ANY ADVERTISED PRICE

***** EDUCATIONAL DISCOUNTS *****
 Buy 2 PET/CBM Computers, receive 1 FREE

WordPro 3 Plus - 32K CBM, disk, printer	200
WordPro 4 Plus - 8032, disk, printer	300
OZZ Data Base System for CBM 8032	335
VISICALC for PET, ATARI, or APPLE	155
SM-KIT - Super PET ROM Utilities	40
Programmers Toolkit - PET ROM Utilities	35
PET Spacemaker II ROM Switch	36
2 Meter PET to IEEE or IEEE to IEEE Cable	40
Dust Cover for PET	7
IEEE-Parallel Printer Interface for PET	110
IEEE-RS232 Printer Interface for PET	120
The PET Revealed	17
Library of PET Subroutines	17

RAM/ROM for PET/CBM

4K or 8K bytes of soft ROM with optional Battery Backup.
 Adds extra RAM which can be write protected like ROM.
4K Version - \$80 8K Version - \$120 Battery Backup - \$30

EPROM Programmer for CBM/PET 79
 Branding Iron with software/hardware for 2716 and 2532.

Watanabe Intelligent Plotter

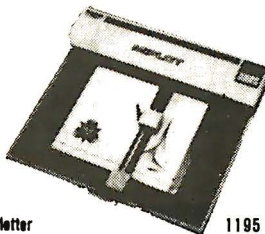

WATANABE WX4671 Plotter 1195
WATANABE WX4675 8-pin Plotter 1445

DISK SPECIALS



SCOTCH (3M) 5"	10/2.75	50/2.65	100/2.60
SCOTCH (3M) 8"	10/2.80	50/2.70	100/2.65
Verbatim 8" Double Dens.	10/3.45	50/3.35	100/3.20
Verbatim 5" Datalife	10/2.45	50/2.40	100/2.35
(add 1.00 for Verbatim 5" plastic storage box)			
BASF 5" soft	10/2.40	20/2.35	100/2.30
Wabash 5" in Plastic Box	10/2.70	50/2.60	100/2.50
Wabash 8" in Plastic Box	10/2.75	50/2.65	100/2.55

WE STOCK MAXELL DISKS

Diskette Storage Pages		10 for 3.95
Disk Library Cases	8" - 2.85	5" - 2.15
Disk Hub Rings	8" - 50 for 7.50	5" - 50 for 6.00

CASSETTES - AGFA PE-611 PREMIUM

High output, low noise, 5 screw housings.

C-10	10/56	50/50	100/48
C-30	10/73	50/68	100/66

All other lengths available. Write for price list.

SPECIALS

EPSON MX-80 Printer	
EPSON MX-80 F/T Printer	
EPSON MX-70 Printer	
EPSON MX-100 Printer	
Centronics 739 Printer with dot graphics	675
STARWRITER Daisy Wheel Printer	1445
Zenith ZVM-121 Green Phosphor Monitor	115
Amdek Color Monitor	355

ALL BOOK and SOFTWARE PRICES DISCOUNTED
 OSBORNE/McGraw-Hill, HAYDEN, SYBEX, etc.

Synertek Systems

SYM-1 Microcomputer	SALE 199
SYM BAS-1 BASIC or RAE 1/2 Assembler	85
KTM-2/80 Synertek Video and Keyboard	349
KTM-3/80 Synertek Tubeless Terminal	385

ZENITH data systems

Z90-80 64 K	2170
Z90-82 64K, 1 double dens. drive	2395
Z89-0 48K	1950
Z89-1 48K, 1 drive	2150
Z67 10 Megabyte + Floppy Drive	4495
Z37 1.3 Megabyte Dual Floppy	1495
Z25 High Speed Printer	1195
Z19 Video Terminal (VT-52 compatible)	665
ZVM-121 Green Phosphor Monitor	115

All Zenith Software discounted



ATARI SPECIALS

800 Computer	749	DOS 2	21
400 - 16K	329	Pilot	68
810 Disk Drive	449	Microsoft BASIC	68
825 Printer	629	Educ. Series	20% off
850 Interface	139	MISSILE COMMAND	32
822 Printer	359	ASTEROIDS	32
Paddle Pair	17	STAR RAIDERS	32
Joystick Pair	17	Space Invaders	17
16K RAM	85	Music Composer	45
Assembler/Editor	46	Chess	30
TeleLink	20	Super Breakout	30

Write for prices on other Atari items.

WRITE FOR CATALOG

Add \$1.25 per order for shipping. We pay balance of UPS surface charges on all prepaid orders. Prices listed are on cash discount basis. Regular prices slightly higher. Prices subject to change.

252 Bethlehem Pike Colmar, PA 18915 215-822-7727

A B Computers

MULTIBUS

BLC 80/11	\$150	DATA CUBE RM-119 64K Dynamic
SBC 80/30	\$450	RAM, with memory refresh + more.
SBC 204	\$450 \$595.
SBC 534	\$500	
SBC 556	\$200	CENTRAL DATA 128K Dynamic
SBC 711	\$500	RAM, featuring 8/16 bit addressing,
SBC 614	\$100	more \$1399.

NEW YEAR'S SPECIALS

- 1) 80/11, 204, 556 \$695
- 2) 80/30, 204, 556 \$995
- 3) 80/30, 204, Datacube RM-119 \$1400
- 4) 80/30, 204, Central Data 128K \$1999
- 5) Create your own combo. Call & we will be happy to price it for you. Many more multibus boards in stock to choose from. (This offer good only while supply lasts, so hurry, folks)

DEVELOPMENT SYSTEM CORNER

MDS 230, Complete, factory fresh \$9999
 Note: We usually have other development systems in stock, like MDS 800, 235, etc., so give a jingle to see what Oracle's elves have cooking.

ENDS & ODDS

Miscellaneous goodies have been accumulating at Oracle. Here's a chance to pick up some terrific buys. Please act quickly, as many of these won't last long.
 Memorex 660 50 Mby hard disk drive \$1000.
 Versatec 110 Electrostatic printer \$6999.
 General Automation 16/440 with a multitude of peripherals. . \$14,000.
 PDP 11/34A with 32K memory, operator's console, and much much more. A veritable steal at \$7500.

Terms of sale: MC/VISA O.K. COD shipments with 25% deposit. Purchase orders accepted from qualified firms and institutions. All goods subject to prior sale, and prices subject to change without notice. Shipping/handling extra. CA residents add sales tax.

IC RAMAGANZA PARTSALANCHE

RAM	1-49	50-99	100+up	CPU	1-49	50-99	100+up
2104	\$1.00	\$.75	\$.65	Z80	\$8.95	\$8.75	\$8.50
4116	2.25	2.15	2.00	Z80A	9.95	9.75	9.50
4164	17.00	15.00	13.00	6502	6.95	6.85	6.75
2114 (450)	2.25	2.25	2.00	8085A	10.00	9.00	8.75
2114 (300)	2.50	2.25	2.00	9900	25.00	23.00	20.00
4044-25NL	3.25	3.00	2.75				
6104-3	2.00	1.75	1.50				
5101L	3.00	2.85	2.75				
2147	3.50	3.25	3.15				
EPROM	1-49	50-99	100+up	MISC	1-49	50-99	100+up
5203Q	\$7.50	\$6.50	\$5.50	3242	\$9.00	\$8.00	\$7.00
5204Q	7.50	6.50	5.50	8202A	45.00	43.00	40.00
2708	3.25	2.75	2.50	8255A	5.75	5.65	5.50
2716	5.00	4.50	4.00	MM5303/			
2732	12.00	11.00	9.00	TR1602B	4.00	3.85	3.75
68764	30.00	25.00	20.00	9901	4.00	3.75	3.65

Complete listing of Oracle's inventory available for the asking. Please write/call to be placed on our mailing list, and thus receive the latest & greatest from Oracle.

Oracle is interested in buying/swapping/selling any/all makes & breeds of computers, peripherals, and related subjects. If you wish to trade your micro for a mini, mini for a micro, both for a player to be named later, and everything up, down, and in between, we may be able to assist. We accept virtually any type of gear as trade-ins when purchasing from us. Call us for the fullest of particulars. Intel, National, DEC, HP, DG, & Motorola our specialties.

If you are interested in products by: MICROBAR, DISTRIBUTED COMPUTER SYSTEMS, ETI MICRO, VOTRAX, HEURIKON, INTERPHASE, ELECTRONIC SOLUTIONS, TODD PRODUCTS, DIGITAL PATHWAYS, ETC., give us a shout. We are not formal distributors of same, but frequently have their MULTIBUS goods in stock, or at our fingertips. Call/write for details.

Oracle Electronics & Trading Co., Inc.
 P.O. Box 921 Palo Alto, CA 94302 (415) 961-4920

SUNNY LOW LOW COST POWER SUPPLIES FOR S-100, FLOPPY DISKS.

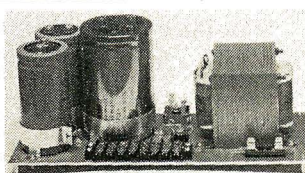

KIT 1, 2 & 3 For S-100

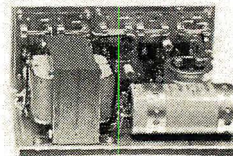

R3 For Three 8" or 5 1/4" Disk Drives

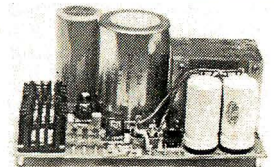

S3 2 in 1 Unit for S-100 and two 8" or 5 1/4" Disk Drives. It fits most Disk System Mainframes.

S-100 POWER SUPPLY KITS (OPEN FRAME WITH BASE PLATE, 3 HRS. ASSY. TIME)

ITEM	USED FOR	@ + 8 Vdc	@ - 9 Vdc	@ + 16 Vdc	@ - 16 Vdc	@ + 28 Vdc	SIZE W x D x H	PRICE
KIT 1	15 CARDS SOURCE	15A	_____	2.5A	2.5A	_____	12" x 5" x 4 7/8"	54.95
KIT 2	SYSTEM SOURCE	25A	_____	3A	3A	_____	12" x 5" x 4 7/8"	61.95
KIT 3	DISK SYSTEM	15A	1A	2A	2A	4A	14" x 6" x 4 7/8"	69.95

DISK DRIVE POWER SUPPLY "R3" REGULATED, OPEN FRAME, ASSY. & TESTED 69.95

SPECS: + 5V @ 5A OVP, -5V @ 1A + 24V @ 5A. SHORTS PROTECT. 2 SIZES AVAIL. 1) 9" (W) x 6 1/4" (D) x 4 3/8" (H), 2) 9" (W) x 4 7/8" (D) x 5 1/4" (H) OPTION: 1.) REPLACE + 24V BY + 12V. 2.) FOR SIZE 1 ONLY. ADD + 12V @ 1A. AT AN ADDITIONAL \$12.00 IDEAL FOR THREE 8" or 5 1/4" FLOPPY DISK DRIVES. SUCH AS SHUGART 801/851, SIEMANS FDD 100-8/200-8 OR 100-5 ETC

DISK SYSTEM PWR SUPPLY "S3" OPEN FRAME, ASSY. & TESTED. COMPACT SIZE: 10" (W) x 6" (D) x 5" (H) 97.95

REGULATED OUTPUTS FOR DISK DRIVES +5V @ 4A, -5V @ 1A, +24V @ 4A (OR + 12V @ 4A). SHORTS PROTECT UNREGULATED OUTPUTS FOR S-100 +8V @ 14A, + 16V @ 3A (OPTION. ADD OVP FOR +5V. ADD \$5.00) A COMPLETE UNIT FOR DISK SYSTEM WITH THE MAINFRAME CONTAINING 12 SLOTS & TWO 8" or 5 1/4" DISK DRIVES

POWER TRANSFORMERS (WITH MOUNTING BRACKETS)

ITEM	PRIMARY	SECONDARY #1	SECONDARY #2	SECONDARY #3	SIZE W x D x H	PRICE
T1	110/120	2 x 8 Vac, 15A	28 Vac, CT, 2.5A	_____	3 3/4" x 3 5/8" x 3 1/8"	22.95
T2	110/120	2 x 8 Vac, 25A	28 Vac, CT, 3.5A	_____	3 3/4" x 4 3/8" x 3 1/8"	28.95
T3	110/120	2 x 8 Vac, 15A	28 Vac, CT, 2.5A	48 Vac, CT, 2A	3 3/4" x 4 3/8" x 3 1/8"	30.95
T4	110/120	2 x 8 Vac, 6A	28 Vac, CT, 1.5A	48 Vac, CT, 3A	3 3/4" x 3 3/8" x 3 1/8"	23.95
T5	110/120	2 x 8 Vac, 6A	28 Vac, CT, 2A	_____	3" x 3" x 2 1/2"	15.95

SHIPPING For each power supply \$5.50 in Calif., \$8.00 in other states, \$18.00 in Canada. For each Transformer \$5.00 in all States, \$12.00 in Canada. Calif. Residents add 6% Sales Tax.

MAILING ADDRESS:
 P.O. BOX 4296
 TORRANCE, CA 90510
 TELEX: 830-5010
 ANSWER BACK FOR TELEX SUNYCO TRUC

SUNNY INTERNATIONAL
 (TRANSFORMERS MANUFACTURER)
 (213) 328-2425 MON-SAT 9-6

SHIPPING ADDRESS:
 22129 1/2 S. VERMONT AVE
 TORRANCE, CA 90502



You'll like our service. You'll love our price!

Ohio Scientific Superboard II \$329.



WHAT A BUY

- 4K static RAM on board, expandable to 8K
- Full 53-key keyboard, with upper and lower case. Plus user expandability.
- Video interface and audio cassette interface.

The Ohio Scientific Superboard II at \$329 — in today's economy — has got to be the best buy by far. It will entertain you with spectacular graphics made possible by its ultra high resolution graphics and super fast BASIC. It will help you in school or industry, as an ultra powerful scientific calculator. Advanced scientific functions and a built-in "immediate" mode allow you to solve complex problems without programming.

The Superboard II can be expanded economically, for business uses, or to remotely control your home appliances and security. Even communicate with other computers.

Read what's been written about Superboard II:

"We heartily recommend Superboard II for the beginner who wants to get into microcomputers with a minimum cost. A real computer with full expandability."

—POPULAR ELECTRONICS, MARCH 1979

"The Superboard II is an excellent choice for the personal computer enthusiast on a budget."

—BYTE, MAY 1979

- It's the first complete computer system on a board.
- Superboard II uses the ultra powerful 6502 Microprocessor
- 8K Microsoft BASIC-in-ROM

Buy Now. Quantities Limited!

610 Board For use with Superboard II and Challenger 1P. 8K static RAM. Expandable to 24K or 32K system total. Accepts up to two mini-floppy disk drives. Requires +5V @4.5 amps.

Mini-Floppy Disk Drive Includes Ohio Scientific's PICO DOS software and connector cable. Compatible with 610 expander board. Requires +12V @1.5 amps and +5V @0.7 amps. (Power supply & cabinet not included.)

4KP 4K RAM chip set.

PS-005 5V 4.5 amp power supply for Superboard II.

PS-003 12V power supply for mini-floppies.

RF Modulator Battery powered UHF Unit.

C1P Sams C1P Service manual

C4P Sams C4P Service manual

Ohio Scientific and independent suppliers offer hundreds of programs for the Superboard II, in cassette and mini-floppy form.

\$ 298

311

79

45

45

35

8

16

OS-65D V3.3 Operating System

Supports a command "KERNEL", Microsoft 9-digit BASIC, a 6502 Assembler Editor and debugger utility. Available for C1P, C4P and C8P floppy disk computers.

- Expanded to a self-teaching operating system. V3.3 comes in a 6 disk set with an easy-to-follow manual which leads the first time user from the operation of simple menuized programs through programming in BASIC and storing data on disk to a complete program development system with advanced capabilities.

- BASIC feature expansions including a full feature screen editor, full upper/lower case compatibility with "Normal" typewriter operation, PRINT USING, and screen formatting capability.

- Improved graphics support including direct X, Y plotting and the ability to dump medium resolution (64 x 128) graphics directly to the AC-19A low cost printer.

- Enhanced utilities including great! simplified Create, Initialize and Delete functions, new Single Disk Copier, a communications support utility for the optional modem and Resequencer.

- Compatible with OS-65D V3.2 files and programs but has greatly improved disk I/O throughput.

24K Ram Required **Only \$79**

Freight Policies All orders of \$100 or more are shipped freight prepaid. Orders of less than \$100 please add \$4.00 to cover shipping costs. Ohio residents add Ohio Sales Tax.



Hours: Call Monday thru Friday, 8:00 AM to 5:00 PM Eastern Time
TOLL FREE: 1-800-321-5805

Guaranteed Shipment

Cleveland Consumer Computers & Components guarantees shipment of computer systems within 48 hours upon receipt of your order. Our failure to ship within 48 hours entitles you to \$35 of software, FREE.

To Order: Or to get our free catalog **CALL 1-800-321-5805 TOLL FREE.** Charge your order to your **VISA** or **MASTER CHARGE** account. Ohio residents call: (216) 464-8047. Or write, including your check or money order, to the address listed below.



CLEVELAND CONSUMER COMPUTERS & COMPONENTS

**P.O. Box 46627
Cleveland, Ohio 44146**

Order Form:

CLEVELAND CONSUMER COMPUTERS & COMPONENTS
P.O. Box 46627 Cleveland, Ohio 44146

- Superboard II \$329.
 - 610 Board \$298.
 - Mini-Floppy Disk Drive \$311.
 - RF Modulator \$35.
 - OS-65D V3.3 [Specify System] \$79.
 - C1P Sams Service Manual \$8.
- [Attach separate sheet for other items.]

NAME: _____

ADDRESS: _____

CITY: _____ STATE: _____ ZIP: _____

PHONE: _____

Payment by: VISA _____ MASTER CHARGE _____ MONEY ORDER _____

Credit Card Account # _____

Expires _____ Interbank # (Master Charge) _____

TOTAL CHARGED OR ENCLOSED \$ _____ (Ohio Residents add Ohio Sales Tax)

Orders of less than \$100, please add \$4.00 to cover shipping costs. Orders will be accepted from U.S. and Canada only. All prices quoted are U.S., date of publication, standard UPS shipping FOB the factory.

PRICES SUBJECT TO CHANGE WITHOUT NOTICE

BASF Flexy-Disks®

SAVE 40% Write for our complete list.

5 1/4" Specify soft, 10 or 16 sector	Price/10
1 side/single density	\$26.70
1 side/double density	31.90
2 sides/double density	37.10

8" Specify soft or 32 sector	
1 side/single density	26.70
1 side/double density	31.90
2 sides/double density	41.60

CHECKS — VISA — MC — C.O.D.
(313) 777-7780 ADD \$2 SHIPPING

LYBEN COMPUTER SYSTEMS
27204 Harper Ave.
St. Clair Shores, MI 48081

Circle 217 on inquiry card.

64K-200ns RAM (Japanese) 8/\$79.95
16K-250ns RAM (NEC) 8/\$9.95

Color R.F. Modulator Kit: (5V) \$14.95
14 Amp S-100 Power Supply Kit \$29.95

50-60Hz, 100-240 VAC includes R.F.I. filter and aux. 110V winding for fans and/or floppies

SEAGATE 506 5MBy hard disk with S-100 controller, cables & full hardware and software documentation. \$2195
(add \$100.00 for CP/M)

Please include cost of shipping, handling and insurance. We are philosophically against VISA & M.C. (for 5% who wouldn't be?)

Dealin' Electronics
735 Loma Verde, Palo Alto, CA 94303
415-493-5930
Send 36 *SASE for our 16 page flyer.

Circle 119 on inquiry card.

PLUG INTO ACCESS
The Journal of Microcomputer Applications At last!

A journal for engineering and scientific applications of microcomputers. ACCESS covers: numerical analysis, economics, project planning & management, personal finance & other topics of interest to engineers & scientists. Charter subscriber rate 6 issues for \$16. Sample issue \$3.00. Send check, money order or purchase order to ACCESS, PO Box 12847, Research Triangle Park, NC 27709.

Circle 5 on Inquiry card.

We're it!

We're it for your hardware and software needs.

- EPSON
- ZENITH
- MAGNOLIA MICROSYSTEMS
- CP/M-COMPATIBLE SOFTWARE

THE APPLICATIONS GROUP

TAG

(214) 749-5513

CP/M is a trademark of Digital Research.

Circle 32 on inquiry card.

THE MISSING LINK

\$249*

Adapt IBM ET50, 60, or 75 to Apple II or III with our Missing Link for word processing quality output.

- Does not affect normal typewriter operation
- Typewriter still qualified for IBM maintenance contract
- Interface isolates the Apple from the typewriter

See our full page ad in May 1980 BYTE
Check with your local Apple dealer or to order call: 1-800-845-2712 (In S.C., call 1-800-922-5528)

If you need word processing software, we offer Manuscripter in two versions: Beginner \$95, Advanced \$195

*S.C. residents add 4% sales tax

CompuSystems

Circle 87 on inquiry card.

ANALOG ↔ DIGITAL
DIGITAL ↔ ANALOG

CONVERSION MODULES
SOFTWARE
GAIN CONTROL

high accuracy — programmable gain instrumentation amplifier — custom board test — \$100 — 2 to 15 kHz conversion time — 12-bit — sample and hold amplifier — gain from 1 to 1024 — 8-bit — sample and hold amplifier — 8-channel differential — 16-channel — analog to digital high accuracy — programmable gain instrumentation amplifier — custom board test — \$100 — 2 to 15 kHz conversion time — mixable high and low inputs — gain from 1 to 1024 — 12-bit — sample and hold amplifier — 8-channel differential — 16-channel — analog to digital high accuracy — programmable gain instrumentation amplifier — custom board test — \$100 — 2 to 15 kHz

For additional details about the AD-100-4 and other fine California Data Corporation 100% individually tested, high reliability products, circle the reader service card number below or for faster response write or call us.

CALIFORNIA DATA CORPORATION
3475 Old Conejo Road, Suite C-10
Newbury Park, CA 91320
(805) 498-3651

Circle 67 on Inquiry card.

The 7th System

- FORTH-like direct threaded interpretive system with structured assembly language (8080 mnemonics).
- Application development can utilize all CP/M (tm) capabilities (editor, file system, etc.).
- Includes re-entrant multi-task executive with counting semaphores for TASK/MSG synchronization.
- Supports strings, single and double precision integers.
- Capable of generating ROM-based stand-alone systems for dedicated applications.
- All source code supplied. No royalties on derivative software.
- Fully documented with 200 page reference manual including glossary and index of all standard words.
- Training seminar available on request.
- Send check or money order for \$495.00 to receive manual and system (8" single sided single density diskette). Demo system with manual \$75.00. Manual only \$45.00. Alabama residents add 6% sales tax.

UC UNITED CONTROLS CORPORATION
P.O. Box 4620 Huntsville, Alabama 35802
(205) 837-6144

Circle 371 on inquiry card.

ATARI

GRAPHICS HARDCOPY

ON: EPSON PRINTERS
CENTRONICS 739
IDS 445G
TRENDCOM

Dumps anything on the screen to the printer
To Order Toll Free
1-800-344-7493

In CA. & for Service (209) 667-2888

MACROTRONICS, inc.
1125 N. Golden State Blvd.
Turlock, California 95380

Circle 219 on inquiry card.

Convert your TRS-80 into a
DEVELOPMENT SYSTEM

Z-80 In-Circuit emulation and EPROM/EEPROM programming in a single compact unit.

Debug stand-alone systems with program in TRS-80 RAM, then copy working program into PROM.

Only \$329 including personality module for 2716, 2516, 2758, 2508, 2532, 2816, 2808, 48016.

ORION INSTRUMENTS
172 Otis Ave, Woodside, CA 94062
(415) 851-1172

Circle 288 on inquiry card.

TTL

7400	2/.85	7490	.85
7402	2/.85	7493	.85
7404	2/.85	74100	2.25
7406	2/1.19	74109	2/1.19
7407	2/1.19	74121	.69
7408	2/.89	74123	.99
7410	2/.85	74150	1.95
7414	.99	74154	1.95
7417	2/1.19	74157	.99
7420	2/.85	74161	1.19
7447	1.19	74164	1.59
7474	.69	74174	1.59
7475	.79	74175	1.49
7476	.69	74192	1.19
7485	1.19	74193	1.19
748	2/1.19	74367	.99
7489	2.99	74393	1.95

Phone Tunes

REPLACES THE TELEPHONE RINGER BELL WITH A SELECTION OF 30 FAMILIAR TUNES

Telephone PT030 Wall Jack

FEATURES

Replaces monotonous telephone ringer bell. Easily connects to any standard phone. Use alongside regular phone or replace remote ringer elsewhere in building or outside. FCC approved. Use on any phone system — worldwide. Use different tune to identify extension phones. Microprocessor controlled. Adjust. vol. control and variable tune speed control. Operates on 2-9V batteries or AC Adapter (not incl.).

PT030 Phone Tunes . . . \$49.95
AD30 AC Adapter . . . \$8.95

LS Schottky

74LS00	.55	74LS109	.75
74LS02	.55	74LS123	1.49
74LS04	.69	74LS138	1.29
74LS05	.55	74LS139	1.29
74LS10	.55	74LS154	1.95
74LS14	1	74LS157	1
74LS30	.55	74LS161	1.29
74LS32	.69	74LS174	1.19
74LS38	.69	74LS175	1.19
74LS42	1.2	74LS192	1.49
74LS47	1.29	74LS193	1.49
74LS48	1.79	74LS221	1.49
74LS73	.75	74LS241	1.89
74LS74	.69	74LS245	3.49
74LS75	.75	74LS367	.89
74LS85	1.49	74LS374	1.95
74LS90	.89	81LS97	2.29

POTENTIOMETERS

2 Watt @ 70°C
7/8" Slotted Shaft
Linear Taper
1K, 5K, 10K, 25K, 50K, 100K, 1 Meg
CMU . . . \$2.95

3/4 Watt @ 70°C
15 Turn Pot.
Linear Taper
100 Ohm, 500 Ohm, 1K, 5K, 10K, 60K, 100K, 500K, 1Meg
830P . . . \$1.79

PT030 Phone Tunes . . . \$49.95
AD30 AC Adapter . . . \$8.95

SOCKETS

Low Profile Wire Wrap

8 pin LP	2/.59	14 pin WW tin	.75
14 pin LP	2/.69	14 pin WW gold	1.09
16 pin LP	2/.79	16 pin WW tin	.79
18 pin LP	2/.89	16 pin WW gold	1.19
20 pin LP	2/.99	24 pin WW gold	1.69
22 pin LP	2/1.09	40 pin WW gold	2.75
24 pin LP	.79	14 p. plug; cover	1.29
28 pin LP	.82	16 p. plug; cover	1.39
36 pin LP	.99	24 p. plug; cover	1.95
40 pin LP	1.19	A 150, The Molex Line	

5-WAY DC VOLTAGE ADAPTER

With Universal Plug & 9V Battery Snap
Selective voltage: 6.9, 12VDC.
Pol. selection (+/-). 6' line — adapter to plugs. 6" line — adapter to batt. snap.
120V/60Hz. 300mA.
DC6912 . . . \$9.95

JE215 Adjustable Dual Power Supply

General Description: The JE215 is a Dual Power Supply with independent adjustable positive and negative output voltages. A separate adjustment for each of the supplies provides the user unlimited applications for IC current voltage requirements. The supply can also be used as a general all-purpose variable power supply.

FEATURES:

- Adjustable regulated power supplies, pos. and neg. 1.2VDC to 15VDC.
- Power Output (each supply): 5VDC @ 500mA, 10VDC @ 750mA, 12VDC @ 500mA, and 15VDC @ 175mA.
- Two, 3-terminal adj. IC regulators with thermal overload protection.
- Heat sink regulator cooling
- LED "on" indicator
- Printed Board Construction
- 120VAC input
- Size: 3-1/2" w x 5-1/16" L x 2" H

JE215 Adj. Dual Power Supply Kit (as shown) . . \$24.95

DIODES & TRANSISTORS

IN 751	2/.59	2N2219A	2/1.19
IN 757	2/.59	2N2222A	2/.89
IN 1188	2.69	2N2907A	2/.89
IN 3600	5/.99	2N3055	.99
IN 4001	4/.59	2N3772	2.25
IN 400	4/.69	2N3904	2/.69
IN 4007	4/.79	2N390	2/.69
IN 4148	10/.99	2N4401	2/.79
IN 4733	2/.69	2N4403	2/.79
IN 4734	2/.69	2N5129	2/.69
IN 4735	2/.69	2N5139	2/.69
IN4742	2/.69	2N5210	2/.79
IN4744	2/.69	2N5951	2/1.29

CMOS

4000	.55	4030	.75
4001	.55	4040	1.79
4002	.59	4044	1.39
4006	1.49	4046	1.95
40 9	.79	4047	2.75
4010	.79	4049	.79
4011	.55	4050	.89
4013	.79	4051	1.59
4016	.79	4066	.95
4017	1.39	4069	.69
4018	1.39	4060	.75
4020	1.39	4071	.69
4023	.49	4081	.59
4024	1.19	4093	1.19
4027	.79	4511	1.95

DESK TOP ENCLOSURES

DTE-8 (Pictured) . . . \$31.95
DTE-11 (Pictured) . . . \$34.95
DTE-14 (Pictured) . . . \$36.95
DTE-HK (Case for JE600) . . . \$47.95
DTE-AK (Case for JE610) . . . \$52.95

CAPACITORS

Dipped Tantalum	ELECTROLYTIC		
.1mfd @ 35V	Jmfd @ 50V	3/.69	
.47mfd @ 35V	4.7mfd @ 50V	2/.59	
1mfd @ 35V	10mfd @ 50V	2/.69	
2.2mfd @ 25V	22mfd @ 50V	2/.79	
3.3mfd @ 25V	47mfd @ 50V	2/.89	
4.7mfd @ 25V	100mfd @ 50V	.59	
10mfd @ 25V	220mfd @ 50V	.69	
33mfd @ 25V	330mfd @ 50V	1.19	
100V MYLAR	2200mfd @ 16V	1.39	
.001-.01mfd	50V CERAMIC		
.022mfd	4/.89	10pf. 022mfd	4/.59
.047mfd	4/.99	.047mfd	4/.69
.1mfd	4/1.19	.1mfd	4/.79
.2 mfd	4/1.29		

CONNECTORS

DB 25P	D-Subminiature Plug	3.95
DB25S	D-Subminiature Socket	4.95
DB51226	Cover for DB25P/S	2.25
2 / 44SE	P.C. Edge	2.95
UGB / U	BNC Plug	2.19
UG 89/U	BNC Jack	3.95
UG-175/U	UHF Adapter	.59
SO239	UHF Panel recp.	1.49
PL258	UHF Adapter	1.95
PL259	UHF Plug	1.95
UG260/U	BNC Plug	2.39
UG1094/U	BNC Bulkhead recp.	1.49

Sun Power Your Electronics!

SOLAR CELL PANEL KIT

- Output: 10VDC, to 100mA in Series 5VDC, to 200mA in Parallel
- Panel may be easily connected for Series or Parallel out
- Over 11 square inches of active cell surface
- Voltage line tap @ 0.5V Increments
- Provision for charging batteries
- Overall panel size: 4 3/4" L x 1 1/2" D

The JE305 Solar Cell Panel Kit contains 20 ea. solar cells. On the panel board are power line taps which allow the user to select voltages (1 voltage at a time) from 0.5VDC to 10VDC. The applications of each panel can be further expanded by coupling additional panels in series for more voltage or in parallel for more current. The premium grade solar cells provide the current necessary for the operation of most portable transistors radios, small battery powered cassette tape players & unlimited experimental solar projects.

JE305 . . . \$39.95

MICROPROCESSORS

Z80A	CPU (4MHz)	13.95
MC 6800	8 Bit MPU	8.95
8080A	CPU	6.95
8212	8 Bit I/O Port	3.95
8216	BI-Directional Bus Driver	4.49
2513/2140	Character Generator	12.95
8T97	Tri-State He B ffer	2.25
AY-5-1013	30K Baud U B	6.95
Av-s-2376	88-Key Keyboard Encoder	11.95
2114-2	4K Static RAM (20 ns)	3.95
MK4116	16K Dynamic RAM (250ns)	3.95
2708	8K EPROM	5.95
2716	16K EPROM (+5V)	9.95

Function Generator Kit

Provides 3 basic waveforms: sine, triangle and square wave. Freq. range from 1 Hz to 100K Hz. Output amplitude from 0 volts to over 6 volts (peak to peak). Uses a 12V supply or a ±6V split supply. Includes chip, P.C. Board, components & instructions.

JE2206B . . . \$19.95

Z-80 and 8086 FORTH

Z80* FORTH—a complete program development system. Uses standard CP/M* compatible random access disk files for screen storage. Package includes: interpreter/compiler with virtual memory management, line editor, screen editor, Z80 Assembler, de-compiler, utilities, demonstration programs, and 80 page user manual. System requirements: Z-80 microcomputer, 48 kbytes RAM, CP/M 2.2 or MP/M* 1.1. \$50.00

Z-80 FORTH WITH NAUTILUS SYSTEMS CROSS-COMPILER. Extend/modify the FORTH runtime system, recompile on a host computer for a different target computer, generate headerless code, generate ROMable code with initialized variables. Supports forward referencing to any word or label. Produces load map and list of unresolved symbols. 107 page manual. System requirements as for Z-80 FORTH above. \$200.00

8086 FORTH with line editor, screen editor, assembler, and utilities. Uses standard CP/M compatible random access files for screen storage. Requires 8086 or 8088 microcomputer, 64 kbytes RAM, and CP/M-86 operating system. \$100.00

MACHINE TEST PROGRAM PACKAGE for Z-80 systems. Includes memory, floppy disk, printer, and terminal tests with all source code. Requires CP/M 2.2. \$50.00

All software distributed on eight-inch soft sector single density diskettes. Prices include shipping by first class air or UPS within USA or Canada. COD charges extra. Purchase orders accepted at our discretion [CP/M and MP/M are registered trademarks of Digital Research, Inc. Z-80 is a registered trademark of Zilog, Inc.]

Laboratory Microsystems
4147 Beethoven Street
Los Angeles, CA 90066
(213) 390-9292

Circle 206 on inquiry card.

LABELS

299

perM

15/16" x 3 1/2" white pressure
1 up - pin feed sensitive

PRICE INCLUDES SHIPPING
Packed 5M per box - Min. order 1 box - \$14.95
Check with order - Mass Residents add 5% Sales Tax



CHECK-MATE

P.O. Box 103, Randolph, MA 02368
Telephone: 617-963-7694

Circle 71 on inquiry card.



NEW! for
the 'B9 from

MAGNOLIA
MICROSYSTEMS

DOUBLE DENSITY DISK CONTROLLER

for both 5 1/4" & B" drives
only **\$595** complete

including CP/M™ 2.2

MAGNOLIA MICROSYSTEMS, INC.
2812 Thornndyke W., Seattle 98199
(206) 285-7266 (800) 426-2841

CP/M is a trademark of Digital Research.

Circle 220 on inquiry card.

STATISTICAL SOFTWARE

ELF — Stepwise regression, factor analysis, correlation coefficients, crosstabs, simple statistics, t-tests, ANOVA, stepwise discriminant analysis, all BASIC transformations and more. \$200.00

TWG/ARIMA — Box-Jenkins for seasonal and non-seasonal models, identification, estimation and forecasting. Introductory Price: \$250.00.

Each includes a database manager, numeric software keypad, and is menu-driven. Each requires an Apple II with Applesoft, 48K, and DOS 3.3.

For further information, write

The Winchendon Group
3907 Lakota Road
P.O. Box 10114
Alexandria, VA 22310

*Apple II and Applesoft are trademarks of the Apple Computer Company

Circle 387 on inquiry card.

68K FORTH

New SYSTEMS LANGUAGE for ERG 68-696 CPU and Motorola's KDM board. O/S, Compiler, Monitor, MACRO Assembler, Interpreter, Virtual Memory, Screen Editor, DBL Precision Arithmetic and more. Enhanced FIG-FORTH Vocabulary. Environment: stand alone, Bell Lab's UNIX, or Whitesmiths' IDRIS, etc.

\$795

EMPIRICAL RESEARCH
GROUP, INC.
PO Box 1176
Milton, WA 98354
206-631-4855

Circle 146 on inquiry card.

SOFTWARE PROFESSIONALS

CONSIDER CALIFORNIA!

SYSTEMS DEVELOPMENT
MICROCOMPUTER/BAY AREA TO \$40K

DIAGNOSTICS/SOFTWARE DEVELOPMENT
SAN DIEGO TO \$32K

SOFTWARE ENGINEER
SIGNAL PROCESSING/BAY AREA . . TO \$42K

LOCAL NETWORKING ANALYST
ORANGE COUNTY TO \$40K

SOFTWARE ENGINEER/UNIX, C
BAY AREA TO \$45K

FOR MORE INFORMATION ABOUT THESE AND
OTHER OPPORTUNITIES, CALL:

(714) 565-4331

WESTBROOKE SEARCH, INC.
9320 CHESAPEAKE DRIVE, SUITE 202
SAN DIEGO, CALIFORNIA 92123

Circle 383 on inquiry card.

QUARTZ CRYSTALS

3219-B	5.2428-B	9.9336-B	20.000-B	36.2886-B	42.8518-B	46.8128-B
5390-B	5.610-B	9.96408-B	20.4988-B	36.3538-B	42.8768-B	47.3768-B
1.000-A	5.7143-A	9.98960-A	22.1184-A	37.9528-A	42.9258-A	47.8838-A
18435-A	5.9555-A	10.000-A	22.0258-A	38.3768-A	42.9628-A	48.000-A
1.9437-B	5.982-B	10.2458-B	25.3558-B	38.4448-B	43.0008-B	48.3008-B
2.000-A	6.000-A	10.4958-A	26.5008-A	38.6258-A	43.0378-A	48.5568-A
2.0971-A	6.144-A	10.7758-A	26.6708-A	38.9258-A	43.0748-A	48.7008-A
2.4576-A	6.15030-A	10.8258-A	27.000-A	39.3128-A	43.1858-A	48.8768-A
2.500-A	6.29780-A	10.8386-A	27.0008-A	39.5008-A	43.2588-A	49.7008-A
2.9537-B	6.400-B	11.138-B	27.5538-B	39.6568-B	43.3238-B	49.7538-B
2.9550-A	6.5538-A	11.155-A	28.4008-A	39.7538-A	43.3708-A	49.8128-A
3.000-A	6.72538-A	11.2186-A	28.6278-A	39.8768-A	43.4078-A	50.2505-A
3.067-B	6.75640-B	11.2890-B	28.7538-B	39.9528-B	43.4378-B	51.0556-B
3.200-A	6.9003-A	11.4776-A	29.8758-A	40.4448-A	43.4448-A	51.3128-A
3.2768-A	7.0063-A	11.6568-A	29.9378-A	40.5928-A	43.5558-A	51.7718-A
3.500-B	7.0336-B	11.6816-B	30.0648-B	40.8128-B	43.6258-B	51.8506-B
3.5719-B	7.0918-B	12.440-B	30.3008-B	40.8338-B	43.6668-B	52.8128-B
4.000-B	7.1636-B	14.382-B	30.6258-B	40.8758-B	43.7778-B	56.7506-B
4.1943-B	7.2588-B	14.4338-B	30.8768-B	40.8868-B	43.8128-B	60.5006-B
4.2425-B	8.000-B	15.300-B	31.4378-B	40.9258-B	43.9148-B	60.7506-B
4.4903-B	8.0556-B	15.4408-B	31.7538-B	41.0008-B	43.8518-B	66.7506-B
4.6103-B	8.1416-B	15.5065-B	31.9008-B	41.1668-B	43.8868-B	70.4006-B
4.6503-B	8.1818-B	16.000-B	32.000-B	41.3768-B	43.9258-B	75.0006-B
4.8308-B	8.3003-B	16.3868-B	33.2008-B	41.9378-B	44.0008-B	90.8338-B
4.9157-B	8.4988-B	17.2248-B	33.5258-B	42.0008-B	44.0378-B	99.9568-B
5.000-A	8.5766-A	17.2422-A	34.5558-A	42.5838-A	44.3766-A	100.9568-A
5.0668-B	8.6056-B	18.000-B	34.7538-B	42.6268-B	44.7718-B	101.4668-B
5.1203-B	8.9608-B	18.4320-B	34.9778-B	42.7008-B	45.1256-B	103.0668-B
5.1850-B	8.9908-B	19.4950-B	35.9258-B	42.7538-B	45.3008-B	103.4668-B
5.1856-B	9.47208-B	19.7508-B	36.000-B	42.8148-B	45.7006-B	104.9918-B

ALL A - \$2.99

ALL B - \$1.99

100% MORE DEDUCTIBLE*

ADD \$1.00 SHIPPING
CAL. RES. ADD 6% SALES TAX
FREE OSCILLATOR SCHEMATICS
WITH ANY ORDER

QUALITY COMPUTER PARTS
P.O. BOX 743 / CHATSWORTH, CA 91311

Circle 313 on inquiry card.

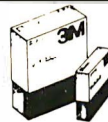

Scotch

DISKETTES

SAVE 40% Write for our
complete list.

5 1/4" Specify soft, Price/10
or 16 sector

#744 1 side/sgl dens. \$26.70

#744D 1 side/dbl dens. 33.20

#745 2 sides/dbl dens. 40.30

8" Specify soft
or 32 sector

#740 1 side/sgl dens. 27.30

#741 1 side/dbl dens. 35.80

#743 2 sides/dbl dens. 43.60

CHECKS - VISA - MC - C.O.D.
(313) 777-7780 ADD \$2 SHIPPING

LYBEN COMPUTER SYSTEMS
27204 Harper Ave.
St. Clair Shores, MI 48081

Authorized Distributor
Information Processing Products



Circle 218 on inquiry card.

RS-232 PROBLEMS?

Need to keep a hard copy of the data on a RS-232 line? Need to look at the data for trouble shooting? Use the DATA TAP to tap a CRT or printer into any RS-232 line.

DATA TAP \$34.95 postpaid

Do you have a set of Modems that may not be working? Bypass them with the NULL MODEM adapter and find out.

NULL MODEM \$24.95 postpaid

Send for literature on these and other RS-232 problem solvers.

Pay by: VISA, M/C, Check, P.O.

B & B ELECTRONICS
BOX 475 / MENDOTA, IL 61342
IL Residents add 5% Tax.

Circle 48 on inquiry card.

CRT CONTROLLER



This intelligent CRT Controller uses an 8085A CPU & an 8275 integrated CRT Controller. It features:

- 25 lines (80 char./line)
- 5x7 dot matrix
- Upper & lowercase
- Two 2716's (controller & char. generator)
- Serial interface RS232 & TTL
- Baud rates of 110, 150, 300, 600, 1200, 2400, 4800 and 9600
- Keyboard scanning system
- Unencoded keyboard required
- Uses +5V & ±12V Power Supplies
- Does not have graphic capabilities.

Documentation includes program listing and composite video circuit.

Bare Board only (with doc) **\$39.95**
 2716 Char. Gen. A7 **\$19.95**
 2716 Program A12 **\$19.95**

6522 APPLE II INTERFACE



The JBE 6522 Parallel Interface for the Apple II Computer, plugs directly into any slot 1 through 7 in the Apple. This card has 2 6522 VIA's that provide:

- Four 8 bit bi-directional I/O ports
 - Four 16 bit programmable timer/counters
 - Serial shift registers
 - Handshaking
- A 74LS05 is for timing. Four 16 pin sockets provide easy connections to other peripheral devices. (Dip Jumpers with ribbon cables are also available from JBE) The 6522 Parallel I/O card interfaces to the JBE EPROM programmer.

Understanding of machine language required to use this board. Inputs and outputs are TTL compatible.

79-295A **\$69.95** Assembled
 79-295K **\$59.95** Kit
 79-295B **\$19.95** Bareboard

81-260 "SLIM"

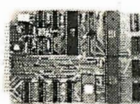

Single board large scale Integration Microcomputer. This 4.5 x 6.5 board uses the 6502 Microprocessor, two 6522 VIA's, four 2114 RAM's, 2516, 2716 or 2532 EPROM. The fully buffered 22/44 pin bus is similar to the KIM[®], SYM[®], and AIM[®] expansion connector. The four 8 bit I/O ports connect through 16 pin dip sockets. This board was designed for control and is ideal for Personal and OEM use.

- 6502 MPU
- Two 6522 VIA's
- Four 2114 RAM's (2K bytes)
- One EPROM 2516 or 2532
- Crystal clock 1 Mhz
- Requires 5V 1AMP Power
- 4.5 x 6.5 card
- Power on reset
- Fully buffered-expandable
- Solder mask-both sides

Use your Apple II Computer, JBE 6522 Parallel Interface card and EPROM Programmer as a development system for SLIM.

Prices:
 81-260A **\$199.95** Assembled
 81-260K **\$149.95** Kit
 81-260B **\$ 39.95** Bare Board

JBE I MICROCOMPUTER

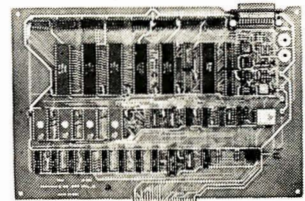

JBE's 7.75 x 11.75 6502 base Microcomputer has the capacity for 16K of EPROM, 4K of RAM, 8 Parallel Ports and 1 Serial Port. Monitor and Tiny Basic are also available. The fully populated version includes:

- 1 6502 CPU
- 4 6522 VIA (8 Parallel I/O Ports)
- 1 AY5-1013 (Serial I/O Ports)
- 8 2114 RAM (4K)
- 2 2716 EPROM (Monitor & Tiny Basic)

The partially populated version includes:

- 1 6502 CPU
- 1 6522 VIA (2 Parallel I/O Ports)
- 1 AY5-1013 (Serial I/O Port)
- 2 2114 RAM (1K)
- 1 2716 EPROM (with Monitor)

Both versions include sockets for 2716s or 2532s, 8 16 pin sockets for I/O interfacing and a DB25 connector for RS232.

All address and data lines are brought off the board to the 50 pin edge connector. (similar to the Apple II bus)

This board also features power on reset and cassette interface.

81-030 C Fully Populated **\$349.95**
 81-030M Partially Populated **\$249.95**
 81-030B Bare Board **\$ 89.95**
 2716 EPROM (with Monitor) **\$ 19.95**
 2715 EPROM (with Tiny Basic) **\$ 19.95**

A-D CONVERTER



JBE's 16 channel A-D Converter plugs into your Apple II computer. It uses an ADC0817 which incorporates a 16 channel multiplexer and an 8 bit A-D Converter. The 16 inputs are high impedance and the voltage range is 0 to 5.12 volts. Conversion time is <100µsec. The resolution is 8 bits or 256 steps. Linearity is ± 1/2 step. Two 16 pin DIP sockets are used for input, GND & reference voltage connections. There are 3 single bit TTL inputs. Doc. includes sample program.

81-132A Assm. **\$89.95**
 81-132K Kit **\$69.95**
 81-132B Bare Board **\$29.95**

SPEECH SYNTHESIZERS



JBE's Speech Synthesizers use the Votrax SC-01 Phoneme Synthesizer chip. The SC-01 phonetically synthesizes continuous speech of unlimited vocabulary. The SC-01 contains 64 different phonemes and 4 levels of inflection accessed by an 8 bit code. It requires 10 Bytes per second for continuous speech. Both boards have an audio amp for direct connection to an 8 ohm speaker.

Documentation Includes basic user programs, a phoneme chart and listing of coded words to help you get started. Documentation for the Apple II[®] Speech Synthesizer includes a disk with many user programs.

81-088 Apple II Speech Synthesizer **\$139.95**
 81-120 Parallel Input Speech Synthesizer **\$149.95**
 Prices include the SC-01 Chip
 SC-01 sold separately for **\$ 75.95**

6502 MICROCOMPUTER

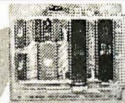

6502 MPU, 6522 VIA, 2716 EPROM, 2114 RAM single board computer. Single 5 volt power supply at 400 Ma. Two independent 8 bit I/O ports with hand-shake lines. RC controlled 1 Mhz clock.

Complete documentation. I/O lines use 50 pin edge connector. Data and address lines are not accessible. Mod. for 2532 is included. EPROM is not included. 1K RAM, 2K EPROM, 2 I/O ports.

80-153 Assm. **\$110.95**
 80-153 Kit **\$ 89.95**
 80-153 Bare Board **\$ 19.95**

EPROM PROGRAMMER



JBE's EPROM Programmer is designed to program 5V 2516's, 2532's & 2716's. It interfaces to the JBE Parallel I/O card using four ribbon cables. An LED indicates when the EPROM is being programmed. A textool zero insertion force socket is used for the EPROM. Comes with complete documentation for writing and reading EPROM's in the Apple II or Apple II Plus. Cables available separately.

80-244A Assm. **\$49.95**
 80-244K Kit **\$39.95**
 80-244B Bare Board **\$24.95**

EPROM EXPANSION CARD



JBE EPROM Expander for the Apple II holds six 5V 2716s for a total of 12K bytes of EPROM. This board takes the place of the on board ROM in the Apple. It is software switchable by the same technique used by the Apple II firmware card. Solder jumpers are for reset to the Apple ROM or EPROM Expansion Card. Use JBE EPROM Programmer and Parallel I/O to program your EPROMs. EPROMs sold separately.

81-085A Assm. **\$59.95**
 81-085K Kit **\$49.95**
 81-085B Bare Board **\$39.95**

Z-80 MICROCOMPUTER



Z-80 MPU, Z-80 PIO, 2716 EPROM, 2114 RAM single board computer. Single 5 volt power supply at 300 Ma. Two independent 8 bit I/O ports with hand-shake lines. RC controlled 2Mhz clock.

Complete documentation. I/O lines use 50 pin edge connector. Data and address lines are not accessible. Mod. for 2532 is included. EPROM is not included. 1K RAM, 2K EPROM, 2 I/O ports.

80-280 Assm. **\$129.95**
 80-280 Kit **\$119.95**
 80-280 Bare Board **\$ 19.95**

PARTS

6502 MPU **\$9.95**
 6522 VIA **\$9.95**
 Z-80 MPU **\$9.95**
 Z-80 PIO **\$9.95**
 TWO 2114 RAM **\$9.95**
 2716 **\$14.95**
 50 pin conn. **\$5.95**
 Dip Jumper 2 ft. **\$4.95**



JOHN BELL ENGINEERING, INC.

ALL PRODUCTS ARE AVAILABLE FROM JOHN BELL ENGINEERING • P.O. BOX 338 • REDWOOD CITY, CA 94064
 ADD SALES TAX IN CALIFORNIA • ADD 5% SHIPPING & HANDLING 3% FOR ORDERS OVER \$100
 SEND FOR CATALOG **(415) 367-1137** 10% OUTSIDE U.S.A.





Free

Microprocessor Catalog
40 page catalog of 6800 single board computers, interface modules, SPRINT 68 control computer/development system, WIZRD multitasking DOS, assemblers, compilers, BASIC, cross assemblers, cross compilers, custom engineering, OEM applications software.

WINTEK
Wintek Corp.
1801 South Street
Lafayette, IN 47904
317-742-8428

Circle 388 on inquiry card.



**"ELF" Interface
Converts Your
Typewriter into Printer**



- Finest print quality
- Low cost
- Easy installation
- Quick delivery
- Fits IBM Selectric® and Electronic Typewriters
- Models for all popular computers
- Call or write for more information, today!

- We export to all countries -

IPEX INTERNATIONAL INC.
5115 Douglas Fir Rd.
Calabasas, CA 91302 U.S.A.
Tel: (213) 710-1444 TLX/TWX: 910 494 2100

Circle 191 on inquiry card.

cc6502

C cross compiler for the 6502. With the exception of three minor features, all facilities of the complete C language are supported. Output is symbolic assembly language and is easily customized to existing assemblers. This cross compiler has been in use for over one year.

Host System: PDP-11 running RT-11, RSX-11M, UNIX/V6, UNIX/V7; or VAX-11 running VMS, UNIX/32V.

For additional information, contact

Advanced Digital Products, Inc.

1701 21st Ave. S., Suite 222 • Nashville, TN 37212
Phone (615) 383-7520

UNIX and UNIX/32V are trademarks of Bell Laboratories; RT-11, RSX-11M, PDP-11, VMS, and VAX-11 are trademarks of Digital Equipment Corporation.

Circle 11 on inquiry card.

ZENITH/Heath Users

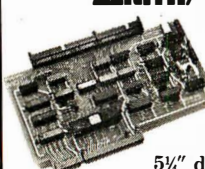

Double Your 5 1/4" disk storage capacity without adding a drive.

Get twice as much from your H88 or H89 microcomputer. Our FDC-880H floppy disk controller, in conjunction with your 5 1/4" drives, for example, expands memory capacity from 256 bytes to 512 bytes per sector.

And it handles single and double-sided, single and double-density, 8" and 5 1/4" drives — simultaneously.

Call 714/275-1272 today or write for details.

C.D.R. Systems Inc.
Controlled Data Recording Systems, Inc.
7667 Vickers St., San Diego, CA 92111

Circle 70 on inquiry card.

ONE BOARD CP/M SYSTEM!



**only \$750
Assm., Tested & Burned-In
for one week**

Features:

- 8 1/2" by 12 inches
- 10 MHz 8085 CPU
- 64K RAM
- 3 RS-232 channels
- 8272 Floppy Disk Controller
- Handles Single/Double Density
- One to Four Drives. 801R or 850R.

Documentation \$15.
CP/M Floppy Disk Operating System \$150
Check or Money Order

autocontrol INCORPORATED

11744 Westline Industrial Drive
St. Louis, MO 63141
(314) 432-1313

Circle 43 on inquiry card.

CHIPS & DALE

**THE INFLATION FIGHTERS!
— RAM —**

- 4116 200ns 8/\$13.00
- 4116 150ns 8/\$16.00
- 2114L 300ns 8/\$16.95
- 2114L 200ns 8/\$18.00
- 4164 200ns \$13.00

— EPROM —

- 2716 (5V)450ns 8/\$3.90 ea. \$4.15 ea.
- 2732 (5V)450ns 8/\$10.50 ea. \$10.75 ea.
- 2532 (5V)450ns 8/\$12.00 ea. \$12.50 ea.

Please allow up to 3 wks. for personal checks to clear.

Add \$2.50 Shipping & Handling
C.O.D. \$3.00. Wash. residents add 5.4% Sales Tax

CHIPS & DALE
P.O. Box 31607
Seattle, Wash. Zip 98103 **Master Charge**
1-206-524-9126 VISA accepted.

Circle 74 on inquiry card.

SPECIALS of the MONTH

- ATARI 800 Computers \$ 750.00
- ATARI 810 Disc Drives \$ 450.00
- ATARI Software 25% off
- APPLE II G 48 K Computers . . . \$1,150.00
- LOBO Disc Drive for APPLE II . . \$ 395.00
- 8" Dual Drive Subsystems 2.4Mb DS-DD complete. \$1,795.00
- CDC LARK Subsystems 16Mb with 1 cartridge-power supply-cables. \$5,200.00
- Complete Word Processing System with DIABLO Printer. \$4,200.00
- CALIFORNIA Computer Systems 300 Dual 8" Drive Computer, 64K RAM, OASIS-2.4 Mb Disc memory, 25 serial ports, 1 Centronics compatible parallel port, a televideo 910 CRT-COMLETE! \$5,800.00
- EPSON MX-70 Printers \$ 385.00
- EPSON MX-80-F/T Printers \$ 685.00
- IDS 460G Printers \$ 800.00
- IDS 560G Printers \$1,150.00
- CITOH STARWRITER 25 Printers . . \$1,380.00
- DIABLO 630 RD Printers \$2,240.00
- NEC SPINWRITERS Call for price
- APPLE Peripherals Call for price
- MOUNTAIN HARDWARE CPS Multifunction Cards \$ 180.00

219/836-5350

Meade's DATA SYSTEMS
"THE COMPLETE SYSTEMS AND SUPPORT TEAM"
MARKET SQUARE SHOPPING CENTER, RIDGE RD. & CALUMET AVE., MUNSTER, IN 46321

Circle 226 on inquiry card.

TRY! OUR \$99 PORT SELECTOR

Good for APPLE, ATARI, PET, TRS80, ALTOS. . as well as IBM, DEC, H/P, WANG, UNIVAC etc. .



Our \$99 switch will save you money and aggravation. Share your printer, modem etc. The selection is made by turning the front panel knob. Our 2 Pos. "SBAB" can connect one printer to two CPU's. It can also be used to connect one CPU to either a printer or a modem. We also have 3 Pos. units. In fact we have about 30 models to satisfy all the common applications. We offer a 5 year Warranty, and our units have a unique monitoring capability. Call us for a FREE colorful catalog.

DEALER INQUIRIES INVITED!
Call (415) 493-1300

GILTRONIX, INC
UNIVERSAL INTERFACE PRODUCTS

450 San Antonio Ave., Palo Alto, CA 94306

Circle 160 on inquiry card.

GRADEKEEPER
Computerize your gradebook! Record class lists and grades with weighted categories — ranks by grades or averages over students or classes. \$19.95

SPELLING-BINDER
Learn to find and fix 75 frequently misspelled or misused words or easily create content for your own individualized drills. \$39.95

PROPORTIONAL TEXT FORMATER
Get the full capability of your CENTRONICS 737 or 739 printer. Utilize proportional, condensed and elongated fonts with half line faces, underlining & more. This assembly language software interfaces with APPLE WRITER and an Apple, John Bell, Mountain CPS, Grapple or CCS parallel, and most serial cards. Proportional Formater for NEC 8023A — Write for details. \$39.95

GENERIC-RATE 2.0
Calculate the Mean-Time-Between-Failure of electronic equipment according to the MIL-HDBK-217C generic part failure rates. Over 4000 generic parts to choose from. \$34.95

Signature Software

Software requires 48K Apple with disk drive — Dealer inquiries invited — Write for more information. Apple & APPLE WRITER are trademarks of Apple Computer, Inc.
P.O. Box 453 • Arlington Heights, IL 60006

Circle 390 on inquiry card.

Printers Plus

...computers, peripherals,
accessories and supplies!

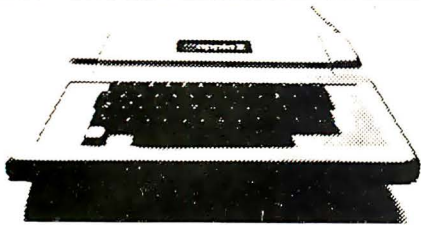

APPLE ACCESSORIES

Apple II & 48K	CALL
Disk II w/controller DOS 3.3	CALL
Disk II Add-On	CALL
Microsoft Z80 Softcard	319.
16K Ram Card	159.
CCS Parallel Card	109.
Async Serial Card	139.
Clock/Calendar Card	109.
IEEE Card	239.
A-D Card	99.
Mountain Comp. Romplus	139.
KB Filter ROM	49.
CPS Multifunction Card	199.
Supertalker	259.
Paymar L/C Adapter - New	49.
— Old	39.
M&R Super Mod	25.
Superterm	319.
Videx Video Term	309.

APPLE SOFTWARE

Personal S/W Desktop Plan II	\$169.
CCA Data Mgmt	85.
Visicalc	169.
Visiplot	159.
Visitrend/Visiplot	219.
Visidex	169.
Visiterm	129.
Micropro Wordstar	299.
Super-Sort	159.
Mail-Merge	99.
Data Star	239.
Spell Star	199.
Muse Super Text II	129.
Address Book	44.
Form Letter Module	79.
Stoneware-DB Master II	199.
Microcom-MicroCourier	239.
Infotory	199.

RIBBONS

NEC	\$77.00/Doz.
Qume	45.00/Doz.
Diablo	66.00/Doz.
Anadex	135.00/6 ea.
Tritel	95.00/Doz.
TI/DEC/TTY	45.00/Doz.
Epson	13.95/ea.
MPI/Axiom/Base 2	12.50/ea.

MAGNETIC MEDIA

Premium Quality At Bargain Prices
5 1/4" Diskettes, all Formats

100% Certified with hub rings, box of 10

Single sided, single density	26.95
Single sided, double density	29.95
Double side, double density	38.95
8" Diskettes, All Formats, 100% Certified	
Single sided, single density	29.95
SSSD Error Free	32.95
Single sided, double density	39.95
Double sided, double density	49.95

EPSONS

Complete Stock of MX-80, MX-80 F/T
MX-100 Printers, Graphics Chip Sets
Cards and Cables



NEC-8023 A, 100 cps Matrix Printer

Hi-Res dot graphics, proportional spacing, correspondent quality printing, bi-directional tractor and friction feed. 80, 132 col. Greek & Math symbols. Everything you need in a small printer.
List \$840 \$699.



MODEMS

UDS 103 LP, direct	\$169.
103 JLP Auto Answer	219.
202 LP 1200 BAUD	259.
NOVATION CAT, acoustic	159.
D-CAT, direct	169.
Auto Cat	219.
Apple Cat	339.
HAYES S100 Micromodem	\$349.
Apple Micromodem	329.
Smart Modem	249.

VIDEO MONITORS

Zenith 12" Green	\$139.
NEC 12" Green	\$239.
Amdex 12" B/W (Leedex)	\$139.
Amdex 13" Color Lo-Res	\$439.

VIDEO TERMINALS

Ampex Dialog 80	\$995.
Ampex Dialog 30	795.
Televideo 920C	845.
Televideo 950	995.



● Z-80A CPU 4 Mhz
● 5 user programmable function keys ● 82 Keys with numeric keypad ● 160 x 100 resolution ● 80 character screen

PC-8001A Microcomputer w/32K RAM	1099.
PC-8012A I/O Unit w/32K RAM	
Expansion slots	699.
PC-8031A Dual Mini-Disk Drive Unit	1099.
PC-8032A Add-On Dual Mini Disk Drive Unit	949.

INTRO
PRICING
\$1099.00

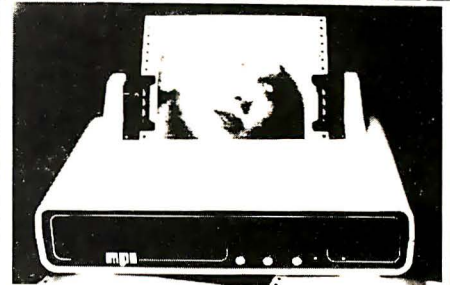

MPI 88G / 99G MATRIX

High resolution dot-addressable graphics for Apple Enhanced "correspondence quality" printing. Tractor and friction feed. Serial and Parallel Input. 100 cps Bidirectional printing. 80, 96 and 132 column widths!

88 G List	\$749	\$589.
99 G List	\$849	\$660.
Apple Parallel I/O Card/Cable/Disk	\$110.	
with Graphics Prom (Ap-Pak)	\$145.	
IEEE I/O Card	\$55.	
Single Sheet Feeder	\$25.	
QT Cover	\$25.	

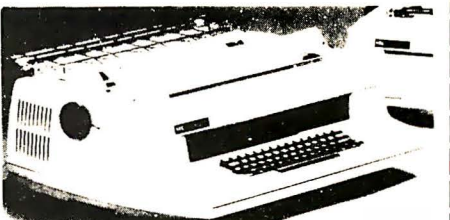

NEC SPINWRITERS

5510/5530 RO w/tractor	\$2,550.
7710/7730 RO w/tractor	\$2,595.
5520 KSR w/tractor	\$2,850.
7720 KSR w/tractor	\$2,895.
3510/3530 RO	\$1,895.
Bi-directional tractor	\$225.
Pusher tractor	\$350.

NEW!

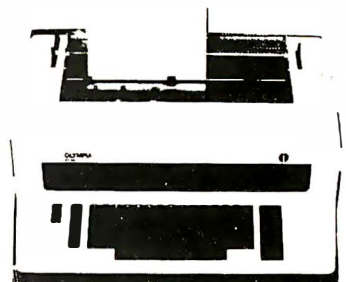

OLYMPIA

Letter quality. Daisy wheel printer/typewriter interfaces to Apple, Atari, NEC, TRS80 and RS232 Serial ports. A truly cost effective letter quality printer that functions as a typewriter.

ES100 RO Computer printer	
List \$1690	CALL
ES100 Typewriter only	"
Interface Card Only	"
(specify serial or parallel)	"
I/O Cable (specify serial or parallel)	"
Apple Serial Card	"
Print Wheels & Ribbons	"

TO PLACE YOUR ORDER CALL:

TELEPHONE (714) 744-7314 TELEX 697120

or write to:

PALOMAR

Computer Products

910-105 W. San Marcos Blvd., San Marcos, CA 92069

TERMS OF SALE: Cash, check, money order bank wire transfer credit card or purchase orders from qualified firms and institutions. Please include telephone number with order and expiration date on credit card orders. California residents add 6% sales tax. Advertised prices are for prepaid orders F.O.B. shipping point. Add 3% for shipping in U.S. Pricing and availability subject to change without notice.



NEW IFR FLIGHT SIMULATOR
RUNS ON
Apple II 48K Applesoft DOS 3.3

Puts you behind a set of instruments so real you could actually fly an airplane with them.

No toy this. It includes all primary Instruments, ADF, ILS, and VOR approaches, and, even an XY plot after each flight.

\$25.00 at your Computer Store.

Or direct from
PROGRAMMERS SOFTWARE
 Box 199
 Cabot ARK 72023
 (501) 843-2988

Circle 309 on inquiry card.

IEEE-696 S-100

32K STATIC RAM
 IEEE-696 S-100, 8/16 bit data.
 Extended Addressing 24 bits,
 bank select, 2716 EPROM Mix,
 battery backup option.
 150 nsec CMOS, A&T \$385

NEC 12" green phosphor
 monitor \$210

WORDSTAR for APPLE \$250
 WORDSTAR for CP/M \$315
 SPELLSTAR (requires Wordstar) ... \$175
 MAILMERGE (requires Wordstar) ... \$100

8" Disk Drive Subsystem
 Cover, power supply, fan
 2 GUME DT-8 for 2.4 MB \$1600

15-Slot S100 Mainframe
 280 CPU 4Mhz
 2 parallel, 2 serial interfaces
 64K Fast Static RAM
 CP/M 2.2 \$2000

1 YEAR GUARANTEE ON ALL BOARDS
 Outside California CALL TOLL FREE
800-854-6413
 In California Call 714-497-5777

COTTON ASSOCIATES
 1278 Glennyre, Suite 505
 Laguna Beach, California 92651

LETTER QUALITY PRINTER



...and a
**TYPEWRITER too. All
 Internal and all
 NEW... \$795**

BYTEWRITER
 125 NORTHVIEW RD.
 ITHACA, N.Y. 14850
 (607) 272-1132

Circle 65 on inquiry card.

CP/M® Compatible \$GOLD DISKS Z-80 Software

Z-80 Disassembler **\$175.**
 ppd
 creates assembly language source files

E-Z Text **\$75.**
 ppd
 unique text file word processor

**Bower-Stewart
 & Associates**
 POST OFFICE BOX 1389
 HAWTHORNE, CALIFORNIA 90250
 213 / 676-5055

 
 Trademark
 Digital Research

Circle 57 on inquiry card.

OMEGA

**The Last Disassembler
 You Will Ever Need!**

Mnemonics Externally Defined

Zilog, Intel, PASM Supplied

ASCII/HEX Preconditioner

Can Externally Def. Equates

Optional Address Listing

ASM/PASM/M80 Compatible

DB statements forcible over user
 specified range

\$150. complete/\$25. manual only
 for further information contact

COMPUTER TOOLBOX, INC.
 1325 East Main St.
 Waterbury, Ct. 06705
 Phone (203) 754-4197

Circle 97 on inquiry card.

JANUARY SPECIAL
 Charge cards, C.O.D. or P.O. not available

WAMECO, MEM-3 (Less RAM), A & T	\$129.95
WAMECO, EPM-2 (Less ROM), A & T	\$89.95
SSM, PB-1, A & T	\$179.95
SSM, IO-4, A & T	\$189.95

Complete Line of SSM, CCS and WAMECO PCBO kits
 and assembled units

CCS, 2065, 65K, DYNAMIC, A & T	\$548.95
CCS, 2422, FLOPPY CONTROLLER, A & T	\$329.95
CCS, 2810, Z80, CPU, A & T	\$249.95
SSM, PB-1, kit	\$135.95
SSM, IO-4, kit	\$155.95
SSM, VB-3, kit	\$345.95
WAMECO, MEM-3, PCBO	\$36.95
WAMECO, EPM-2, PCBO	\$32.95
WAMECO, FPB-1, PCBO	\$48.95

MIKOS

415-728-9121 • P.O. BOX 955 • EL GRANAADA CA 94018

\$20.00 MIN. ORDER. NO SHIPPING CHARGES ADDED
 WHEN ORDER IS PREPAID BY CHECK OR MONEY ORDER
 (U.S. ONLY). TAX ON CALIF. RESIDENTS. PRICES SUB-
 JECT TO CHANGE WITHOUT NOTICE.

Circle 255 on inquiry card.



FREE!

1982
 DISCOUNT-
 ELECTRONICS
 CATALOG

JOIN THE PAK!

Send for our Free catalog and become a member of our exclusive Pak. Our members receive Poly Paks' exciting catalog several times a year. We offer:

- Penny Sales, Free Premiums and Low, Low Prices on a wide variety of Electronic Products such as Computer Peripherals, Integrated Circuits, Speakers, Audio Equipment, Rechargeable Batteries, Solar Products, Semiconductors, and much, much more!

Take advantage of our 25 years as America's foremost Supplier of discount electronics.

POLY PAKS, INC.
 P.O. BOX 942, BT1
 S. LYNNFIELD, MA. 01940

(617) 245-3828

**Over
 4.5 Million
 Satisfied
 Customers**

Circle 304 on inquiry card.

ELIZA IS HERE!

AT LAST! A FULL IMPLEMENTATION of the original ELIZA program is now available to run on your microcomputer!

Created at MIT in 1966, ELIZA has become the world's most celebrated artificial intelligence demonstration program. ELIZA is a non-directive psychotherapist who analyzes each statement as you type it and then responds with her own comment or question — and her remarks are often startlingly appropriate!

Designed to run on a large mainframe, ELIZA has hitherto been unavailable to personal computer users except in greatly stripped down versions lacking the sophistication which made the original program so fascinating.



Now, our new microcomputer version possessing the FULL power and range of expression of the original is being offered at the introductory price of only \$25. And if you want to find out how she does it (or teach her to do more) we will include the complete Source Program for only \$20 additional.

Order your copy of ELIZA today and you'll never again wonder how to respond when you hear someone say "Okay, let's see what this computer of yours can actually do!"

ELIZA IS AVAILABLE IN THE FOLLOWING DISK FORMATS:

- 1 Standard 8 inch single density for all CP/M based computers \$25 for ELIZA COM - add \$20 for Microsoft BASIC-80 Source
- 2 5 1/4 inch CP/M for Apple II equipped with Z-80 SoftCard \$25 for ELIZA COM - add \$20 for Microsoft BASIC-80 Source
- 3 5 1/4 inch for 48K Apple II with Applesoft ROM and DOS 3.3 \$25 for Protected File - add \$20 for Unprotected Source

ARTIFICIAL INTELLIGENCE RESEARCH GROUP
 921 NORTH LA JOLLA AVENUE
 LOS ANGELES, CALIFORNIA 90046
 (213) 656-7368 (213) 654-2214

 
 MC, VISA and CHECKS ACCEPTED

Circle 37 on inquiry card.

FREE SOFTWARE CATALOG

CP/M APPLE

Business and Educational

XPS, Inc.

323 York Road
 Carlisle, PA 17013

Circle 389 on inquiry card.

QUEST FULL LINE ALL PARTS & COMPUTER PRODUCTS



P.O. Box 4430X
 Santa Clara, CA 95054
 Will call: 2322 Walsh Ave.
 (408) 988-1640

Same day shipment. First line parts only. Factory tested. Guaranteed money back. Quality IC's and other components at factory prices.

INTEGRATED CIRCUITS

7400TTL	LM1317	1.65	CD4017	1.05	8126	1.69	UART-FIFO	DESS	1.95
7400N	LM1317K	3.75	CD4018	94	8728	1.95	AYS-1013	DAISP	2.10
7402N	LM1318	1.40	CD4019	45	8797	1.95	AYS-1014	DAISS	3.10
7402N	LM320K-5	1.35	CD4020	95	8798	1.65	3241	ComData Srt	5.50
7409N	LM320K-12	1.33	CD4021	95					
7410N	LM320L-5	1.35	CD4022	1.10					
7414N	LM320L-5	95	CD4023	29					
7420N	LM320L-9	95	CD4024	75	2101-1	1.95	2532	Auto Clock Kit	17.95
7420N	LM320L-12	95	CD4025	23	2102-1	85	7088	Digital Clock Kit	19.75
7424N	LM320L-15	95	CD4026	1.63	2102A-4	1.45	271611		8.50
7445N	LM323K-5	4.95	CD4027	65	2102AN-2L	1.65	2716 S Split		7.25
7447N	LM323N	4.95	CD4028	80	2104A-4	4.95	2716 S WDR	39.00	
7448N	LM323N	99	CD4029	95	2107B-4	3.75	2132		16.50
7474N	LM324K-5	1.33	CD4030	45	2111-1	2.99	8741A		39.95
7475N	LM324K-9	1.33	CD4031	65	111-2	2.99	8741A		39.95
7485N	LM324K-12	1.33	CD4032	95	2114	2.24	8748		5.00
7489N	LM324K-15	1.35	CD4033	75	2114L 320h1	2.50	8748B		5.50
7490N	LM324K-24	1.33	CD4034	75	2114L 550h1	2.37	8755A		49.95
7495N	LM340T-5	89	CD4034A	46	4116 200ms	2.50	NE8223		2.95
7495N	LM340T-9	89	CD4035	95	84114L 200h1	15.40	NE8223		3.95
7497N	LM340T-12	89	CD4036	95	MM5280	3.00	NE82126		5.75
7497N	LM340T-15	89	CD4037	95	MM5320	9.95	NE82129		4.75
7497N	LM340T-18	89	CD4038	95	MM5330	5.55	NE82331		4.85
74145N	LM340T-24	89	CD4039	1.42	PS101L	8.95	NE82136		8.75
74150N	LM350	5.00	CD4066	71	4200A	11.50	NE82137		8.75
74150N	LM350	5.00	CD4067	31	4200B	3.50	NE82138		3.50
74151N	LM359N	1.80	CD4069	35	4100	10.00			
74161N	LM381	1.60	CD4070	35	416	2.50			
74162N	LM387	1.60	CD4071	30	CLOCKS				
74162N	LM387	1.60	CD4072	30	MM5311	4.95			
74174N	LM393N	95	CD4073	35	MM5312	3.90			
74175N	LM393N	95	CD4074	35	MM5313	3.90			
74175N	LM393N	95	CD4075	35	MM5314	3.90			
74175N	LM393N	95	CD4076	35	MM5319	14.95			
74190N	LM397H	75	CD4081	30	MM5369	14.95			
74190N	LM397H	75	CD4082	30	MM5369	14.95			
74190N	LM397H	75	CD4083	30	MM5369	14.95			
74221N	LM397H	75	CD4084	30	MM5369	14.95			
74221N	LM397H	75	CD4085	30	MM5369	14.95			
74228N	LM397H	75	CD4086	30	MM5369	14.95			
74285N	LM397H	75	CD4087	30	MM5369	14.95			
74366N	LM397H	75	CD4088	30	MM5369	14.95			
74366N	LM397H	75	CD4089	30	MM5369	14.95			
74366N	LM397H	75	CD4090	30	MM5369	14.95			
74366N	LM397H	75	CD4091	30	MM5369	14.95			
74366N	LM397H	75	CD4092	30	MM5369	14.95			
74366N	LM397H	75	CD4093	30	MM5369	14.95			
74366N	LM397H	75	CD4094	30	MM5369	14.95			
74366N	LM397H	75	CD4095	30	MM5369	14.95			
74366N	LM397H	75	CD4096	30	MM5369	14.95			
74366N	LM397H	75	CD4097	30	MM5369	14.95			
74366N	LM397H	75	CD4098	30	MM5369	14.95			
74366N	LM397H	75	CD4099	30	MM5369	14.95			
74366N	LM397H	75	CD4100	30	MM5369	14.95			
74366N	LM397H	75	CD4101	30	MM5369	14.95			
74366N	LM397H	75	CD4102	30	MM5369	14.95			
74366N	LM397H	75	CD4103	30	MM5369	14.95			
74366N	LM397H	75	CD4104	30	MM5369	14.95			
74366N	LM397H	75	CD4105	30	MM5369	14.95			
74366N	LM397H	75	CD4106	30	MM5369	14.95			
74366N	LM397H	75	CD4107	30	MM5369	14.95			
74366N	LM397H	75	CD4108	30	MM5369	14.95			
74366N	LM397H	75	CD4109	30	MM5369	14.95			
74366N	LM397H	75	CD4110	30	MM5369	14.95			
74366N	LM397H	75	CD4111	30	MM5369	14.95			
74366N	LM397H	75	CD4112	30	MM5369	14.95			
74366N	LM397H	75	CD4113	30	MM5369	14.95			
74366N	LM397H	75	CD4114	30	MM5369	14.95			
74366N	LM397H	75	CD4115	30	MM5369	14.95			
74366N	LM397H	75	CD4116	30	MM5369	14.95			
74366N	LM397H	75	CD4117	30	MM5369	14.95			
74366N	LM397H	75	CD4118	30	MM5369	14.95			
74366N	LM397H	75	CD4119	30	MM5369	14.95			
74366N	LM397H	75	CD4120	30	MM5369	14.95			
74366N	LM397H	75	CD4121	30	MM5369	14.95			
74366N	LM397H	75	CD4122	30	MM5369	14.95			
74366N	LM397H	75	CD4123	30	MM5369	14.95			
74366N	LM397H	75	CD4124	30	MM5369	14.95			
74366N	LM397H	75	CD4125	30	MM5369	14.95			
74366N	LM397H	75	CD4126	30	MM5369	14.95			
74366N	LM397H	75	CD4127	30	MM5369	14.95			
74366N	LM397H	75	CD4128	30	MM5369	14.95			
74366N	LM397H	75	CD4129	30	MM5369	14.95			
74366N	LM397H	75	CD4130	30	MM5369	14.95			
74366N	LM397H	75	CD4131	30	MM5369	14.95			
74366N	LM397H	75	CD4132	30	MM5369	14.95			
74366N	LM397H	75	CD4133	30	MM5369	14.95			
74366N	LM397H	75	CD4134	30	MM5369	14.95			
74366N	LM397H	75	CD4135	30	MM5369	14.95			
74366N	LM397H	75	CD4136	30	MM5369	14.95			
74366N	LM397H	75	CD4137	30	MM5369	14.95			
74366N	LM397H	75	CD4138	30	MM5369	14.95			
74366N	LM397H	75	CD4139	30	MM5369	14.95			
74366N	LM397H	75	CD4140	30	MM5369	14.95			
74366N	LM397H	75	CD4141	30	MM5369	14.95			
74366N	LM397H	75	CD4142	30	MM5369	14.95			
74366N	LM397H	75	CD4143	30	MM5369	14.95			
74366N	LM397H	75	CD4144	30	MM5369	14.95			
74366N	LM397H	75	CD4145	30	MM5369	14.95			
74366N	LM397H	75	CD4146	30	MM5369	14.95			
74366N	LM397H	75	CD4147	30	MM5369	14.95			
74366N	LM397H	75	CD4148	30	MM5369	14.95			
74366N	LM397H	75	CD4149	30	MM5369	14.95			
74366N	LM397H	75	CD4150	30	MM5369	14.95			
74366N	LM397H	75	CD4151	30	MM5369	14.95			
74366N	LM397H	75	CD4152	30	MM5369	14.95			
74366N	LM397H	75	CD4153	30	MM5369	14.95			
74366N	LM397H	75	CD4154	30	MM5369	14.95			
74366N	LM397H	75	CD4155	30	MM5369	14.95			
74366N	LM397H	75	CD4156	30	MM5369	14.95			
74366N	LM397H	75	CD4157	30	MM5369	14.95			
74366N	LM397H	75	CD4158	30	MM5369	14.95			
74366N	LM397H	75	CD4159	30	MM5369	14.95			
74366N	LM397H	75	CD4160	30	MM5369	14.95			
74366N	LM397H	75	CD4161	30	MM5369	14.95			
74366N	LM397H	75	CD4162	30	MM5369	14.95			
74366N	LM397H	75	CD4163	30	MM5369	14.95			
74366N	LM397H	75	CD4164	30	MM5369	14.95			
74366N	LM397H	75	CD4165	30	MM5369	14.95			
74366N	LM397H	75	CD4166	30	MM5369	14.95			
74366N	LM397H	75	CD4167	30	MM5369	14.95			
74366N	LM397H	75	CD4168	30	MM5369	14.95			
74366N	LM397H	75	CD4169	30	MM5369	14.95			
74366N	LM397H	75	CD4170	30	MM5369	14.95			
74366N	LM397H	75	CD4171	30	MM5369	14.95			

MAJOR CORPORATION SEEKING TO ACQUIRE CONTROLLING INTEREST IN ELECTRONIC HIGH TECHNOLOGY COMPANIES (OR START UP VENTURES) WITH PRODUCTS COMPATIBLE WITH ITS EXISTING INVESTMENTS IN OFFICE OF THE FUTURE TECHNOLOGY. ALL REPLIES SHALL BE TREATED WITH THE STRICTEST CONFIDENTIALITY.

READER SERVICE NO.: 16

Circle 16 on inquiry card.

FIRE

HALON 1211
FIRE EXTINGUISHER

- RECOMMENDED BY THE NATIONAL FIRE PROTECTION ASSOCIATION FOR PROTECTION OF ELECTRONIC COMPUTER/EDP EQUIPMENT
- NO DAMAGE TO MEDIA
- NO STATIC
- NO POWDERY RESIDUE
- WIDE RANGE OF UL LISTED EXTINGUISHERS

GUARD EVERY
COMPUTER
WITH A HALON 1211
FIRE EXTINGUISHER

R.C. INDUSTRIES
Home of Quality FIRE EXTINGUISHERS

1320 W. Blancke St.
Linden, N.J. 07036

Wholesale Distributor Inquiries
Given Immediate Attention.
Call (800) 631-7377



275HAL

Circle 317 on inquiry card.

WHO
has the
LOWEST
ADVERTISED PRICES
on any item over \$500
in this magazine?

THE PURCHASING AGENT
will tell you for
FREE
800-227-2288
(415) 376-9020 (In Calif.)

Circle 311 on inquiry card.

RS-232 PROBLEMS?



LET THE RS-232 TESTER HELP YOU SOLVE YOUR COMPUTER INTERFACE PROBLEMS. DESIGNED TO CONNECT IN SERIES WITH ANY RS-232 INTERFACE, IT DISPLAYS THE STATUS OF SEVEN OF THE MOST IMPORTANT LINES: TRANSMIT DATA, RECEIVE DATA, REQUEST TO SEND, CLEAR TO SEND, DATA SET READY, CARRIER DETECT, AND DATA TERMINAL READY. THE RS-232 TESTER REQUIRES NO POWER AND MAY BE LEFT IN THE LINE PERMANENTLY.

\$39.95 POST PAID
B & B ELECTRONICS
BOX 475/MENDOTA, IL 61342

Circle 47 on inquiry card.

FLEX* UniFLEX*

Linked Business
Software that works!

- Accounts Receivable
- Accounts Payable
- General Ledger
- DBMS for Inventory Control
- Word Processing

Software Development Tools!

Call or Write for Information

(208) 529-3210

GREAT PLAINS

COMPUTER COMPANY, INC.

P.O. Box 916, Idaho Falls, ID 83402

*Trademark of Technical
Systems Consultants

Circle 163 on inquiry card.

ALL ATARI® HARDWARE

15%-25%
OFF LIST PRICE



	OUR PRICE	SAVE
Atari 400 w/16K	\$320	20%
Atari 800 w/16K	\$810	25%
Atari 410 cassette	\$ 67	25%
Atari 810 disk drive	\$480	20%

ALL ATARI® ACCESSORIES
10%-20% OFF LIST PRICE

8K Memory Board	\$45	10%
16K Memory Board	\$80	20%
Joysticks (pair)	\$17	15%
Paddles (pair)	\$17	15%

PLUS 10%-20% OFF
ALL ATARI® SOFTWARE



To order: Call 617-964-3080
Ask for mail order, or write.

The Bit Bucket

1355 Washington Street (Rt. 16)
West Newton, MA 02165
617-964-3080

Circle 54 on inquiry card.

SLIDER QUALITY
CompuPro™ from COMBOUR TELEVIDEO SYSTEM I
ZENITH NORTHSTAR

8MHz 8200,8086, MPM II & 86 Disk 2	CALL
8MHz 8085/88 CSC	399 6MHz CPU Z CSC 308
6MHz 8085/88 A&T	319 4MHz CPU Z A&T 221
DISK I A&T	371 MPX A&T 371
INTERFACER I, II	187 INTERFACER 3 (5) 465
RAM 20 A&T 32K	319 RAM 17 A&T 64K 597
RAM 16 A&T 64K	699 RAM 21 A&T 128K 1356
SYSTEM SUPPORT I	297 4MHz 9511 (INTEL) 175
ENCLOSURE 2 DESK	619 ENCLOSURE 2 RACK 671
8MHz 8085/88 SYSTEM DUAL 8" DRS 64K CPM*	3695
6MHz CPU Z SYSTEM DUAL 8" DRS 64K CPM*	3595
SYSTEMS HAVE 48 HOUR CSC BOARD EXCHANGE	
ALL TELEVIDEO & ZENITH ITEMS AT LOWEST PRICES	
VISTA V1000 DR CAB 375 dBASE II	CALL
SPELLBINDER	275 WORD STAR 290
SEATTLE COMPUTER SYS I \$2549	SYSTEM II \$3325
ALL PRICES & SPECS SUBJECT TO CHANGE SHIPPING	
MIN \$3. CPM, MPM, MPX Trade Marks of Digital Research. ALL PRICES CASH PRICES	
PO 951 WESTMINSTER CA 92583-0951	
74 895-1746	

Circle 337 on inquiry card.

OVERSTOCK

SURPLUS 5 1/4" SINGLE SIDED FLOPPY
DISC DRIVES, WHILE THEY LAST!!!

TEAC 96 TPI (NEW)

\$245⁰⁰

MICROPOLIS 100 TPI (GOOD AS NEW)

\$145⁰⁰

CONTACT: JOHN OR HAL
AT 319-386-9737



archives incorporated
404 West 35th Street
Davenport, Iowa 52806

Circle 35 on inquiry card.



5110-5120 PROGRAMMERS:
WORKER IV MENU
Associate Programmer

ENTER OPTION NUMBER	
1	LIST PROGRAM(S) WITH OR W/O CROSS REFERENCE
2	FIND LITERAL REFERENCES IN PROGRAM(S)
3	SWAP (REPLACE) LITERALS IN PROGRAM(S)
4	LENGTH TEST FOR PROGRAM LINES OVER 64 CHAR
5	CREATE / EDIT / LIST A PROGRAM FILE
6	COMPARE TWO PROGRAMS LINE BY LINE
7	TEXT READER / WRITER / PRINTOUT
10	INSTRUCTIONS FOR WORKER IV USAGE
99	RETURN TO SYSTEM

Key in OPTION NUMBER and Press the EXECUTE key

As a companion to the serious programmer, "WORKER IV" will eliminate weeks of tedium that normally accompany the writing, debugging and conversion of programs.

Price: \$275. Includes postage, 32 page manual on disk. Full refund within 90 days, if not completely satisfied with the performance of the WORKER IV: Associate Programmer.



To order, write or call:
DIVERSIFIED COMPUTING
BOX 95
EAST GLACIER PARK
MONTANA 59434
(406) 226-9346

*Trademark: International Business Machines Corp.

Circle 129 on inquiry card.

**ORDER
TOLL-FREE**

consumer computers

Mail Order

DISCOUNTS

**FREE
SHIPPING***
on all pre-paid cash orders

SEE OUR ADS ON PAGES 165 AND 271 FOR MORE EXCITING DISCOUNTS

NEC Microcomputer



- PC-8001A 32K Computer.....CALL
 - PC-8012A I/O Unit w/32K RAM.....CALL
 - PC-8013A Dual Mini-Disk Drive Unit.....CALL
 - PC-8001 Multi Cardware (FDI/O & 32K).....CALL
 - CP/M 2.2 Operating System for NEC.....129
 - WordStar configured for NEC.....299
 - SuperCalc configured for NEC.....279
 - NEC Wordprocessor & Accounting Software.....CALL
- Many more software packages and languages: (Pascal, Fortran, Cobol, etc) are available configured for the NEC 8001A Computer.
Please call or write for a product price list.

ATARI



ATARI 800 16K

CALL FOR BEST PRICE

- Atari 400 w/16K.....349
- 410 Program Recorder.....65
- 810 Disk Drive.....449
- 825 80 col. 7x8 Dot matrix impact printer.....699
- 822 40 col. Quiet Thermal Printer.....349
- 850 Interface Module.....159
- Atari 16K Ram Module.....69
- Axlon Ramcrum 32K Module.....189
- Asteroids, Missile Command and Star Raiders.....35 ea.

SPECIAL ATARI CATALOG AVAILABLE

Video Monitors

- Amdek/Leedex Video 100 12" B&W.....149
- Amdek/Leedex Video 100G 12" Green Phosphor.....179
- Amdek (Hitachi) 13" Color w/audio output.....389
- NEC 12" Green Phosphor Display JB-1201M.....CALL
- NEC 12" Lo-Res Color Display.....CALL
- NEC 12" Hi-Res RGB Color Display.....CALL
- Sanyo 9" B&W Display.....185
- Sanyo 9" Green Phosphor Display.....CALL
- Sanyo 12" B&W Display.....269
- Sanyo 12" Green Phosphor Display.....285
- Sanyo 13" Color Display.....449
- Zenith 12" Green Phosphor Display ZVM-121.....149



**ZENITH
12"
GREEN**

\$149

S-100

California Computer
Systems

- Floppy Disk Controller.....\$369
- 64K Dynamic Ram Board, 200ns.....\$499
- Z-80 CPU board w/ monitor ROM.....\$269
- 16K Static memory board, 200ns.....369
- 32K Static memory board, 200ns.....599
- S-100 12 Slot Mainframe.....475
- 4-Port Serial Interface.....299
- 2-Port Serial/2-Port Parallel Interface.....299
- 4-Port Parallel Interface.....229

Commodore

VIC20™

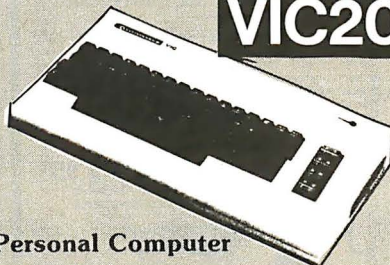

Personal Computer

Color * Sound * Graphics
Call or write for more info. **\$259**
Disk drives available soon!

Printers

Silentyne
w/Apple II interface

\$349

Epson
MX-80 or
MX-80 FT
CALL



- Anadex 9501 w/2K Buffer.....1349
- C. Itoh Starwriter 25 CPS daisywheel.....1449
- C. Itoh Starwriter 45 CPS daisywheel.....1649
- Epson MX-70.....CALL
- Epson MX-80 & MX-80 F/T.....CALL
- Epson MX-100.....CALL
- NEC 8023 Impact Dot Matrix.....695
- NEC Spinwriters (Latest models).....CALL
- Paper Tiger IDS-445G w/graphics.....699
- Paper Tiger IDS-460G w/graphics.....949
- Paper Tiger IDS-560G w/graphics.....1249
- Silentyne Printer w/Apple interface.....349
- Qume Sprint Daisywheels (Latest models).....CALL

**ORDER TOLL FREE
800-854-6654**

In California and
outside continental U.S.
(714) 698-8088
Telex 695-000 Beta CCMO

Apple Computer
Authorized Dealer

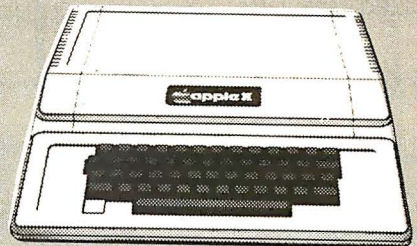

APPLE II PLUS

16K's, 48K's, 64k's*

*48K Apple with 16K RamBoard

**CALL FOR
BEST PRICES**

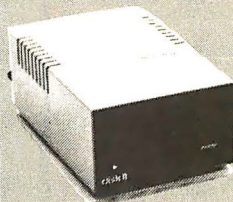

**APPLE
DISK
DRIVES**

DRIVE ONLY OR
W/CONT
& DOS 3.3

CALL FOR PRICES

SPECIAL APPLE CATALOG AVAILABLE

16K RAMBOARD by ConComp
for Apple II Computers

FOR ONLY \$129.95

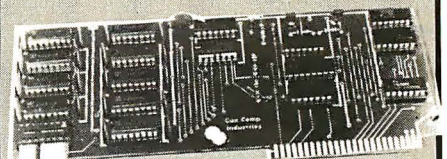

AVAILABLE NOW

Ordering information: Phone orders using VISA, MASTERCARD, AMERICAN EXPRESS, DINER'S CLUB, CARTE BLANCHE, bank wire transfer, cashier's or certified check, money order, or personal check follow ten days to clear. Unless prepaid with cash, please add 5% for shipping, handling and insurance. (minimum 5.00) California residents add 6% sales tax. We accept CODs. OEM's, Institutions and corporations please send for a written quotation. All equipment is subject to price change and availability without notice. All equipment is new and complete with manufacturer's warranty (usually 90 days). Showroom prices may differ from mail order prices.

Send Orders To:

**consumer
computers** Mail Order

**8314 Parkway Drive
La Mesa, Calif. 92041**

PRINTERS PRICED TO GO



OKIDATA 82A \$545.
83A \$770.
TI 810 BASIC \$1,395.
810 PACKAGED \$1,695.
PRINTRONIX P-300 \$4,995.

XEROX 820 with 10MB Hard Disk \$CALL

SOUTHWEST COMPUTERS
714-571-5916

Circle 341 on inquiry card.

PERSONAL COMPUTER SOFTWARE for EXECUTIVES and MANAGERS

- Name/Address/Key Information
- Personal Schedule
- Corporate Schedule
- Document Tracking
- File Indexing Schema
- Tickler File
- Questionnaire Tabulating

Any three for \$150 - All seven for \$250.
Functional, well engineered software in the Pascal programming language for Apple II and TRS-80 Model II computers.

SOFTWARE CONSULTING SERVICES

901 Whittier Drive, Allentown, Pa. 18103
(215) 797-9690
ATT. Martha Cichelli

*TMI Apple Computer Co. **TMI Tandy Corp.

Circle 338 on inquiry card.

8048 IN-CIRCUIT EMULATOR

- IEEE-696 (S-100), CP/M compatible
 - Emulates 8035, 8039, 8048, 8049, 8748, 8040, 8050, and 80C48 CMOS.
 - Hardware Breakpoints allow Real Time Emulation up to 11 MHz
 - Trace includes disassembled code
 - Display/Modify Program & Data Memory, Registers, I/O Ports & Flags
 - Disassembler
 - Scope trigger from breakpoint locations
- MICE-48 comes on one S-100 board with a 3 ft. cable and buffer assy. that plugs into the user's µP socket. The board with all supporting software is \$995. For 8048 MACRO Assembler add \$150. (213) 451-5382

SIGNUM SYSTEMS
726 Santa Monica Blvd.
SANTA MONICA, CA. 90401

Circle 336 on inquiry card.

18086/8087/8088 CROSS SOFTWARE PACKAGES

1 C cross compiler for the 8086. All facilities of the complete C language, including floating point for the 8087, are supported. Optionally, memory can be allocated for use with the 8088. Output is symbolic assembly language. The compiler is suitable for use in porting UNIX to the 8086.

2 Cross assembler/linker/librarian/downline loader for the 8086. Assembler input is an extension to that used by Intel. Loader output is a file in standard Intel hex format.

3 Simulator/debugger for the 8086. Capabilities include display, breakpoints, interpretive execution, as well as many others.

Host System: PDP-11 running RT-11, RSX-11M, UNIX/V6, UNIX/V7; or VAX-11 running VMS, UNIX/32V.

For additional information:

Advanced Digital Products, Inc.

1701 21st Ave. S., Suite 222 • Nashville, TN 37212
Phone (615) 383-7520

Intel is a trademark of Intel Corporation; UNIX and UNIX/32V are trademarks of Bell Laboratories; RT-11, RSX-11M, PDP-11, VMS, and VAX-11 are trademarks of Digital Equipment Corporation.

Circle 12 on inquiry card.

BLACKJACK FOR WINNERS

FINALLY, A PROGRAM THAT'S NOT ONLY FUN BUT ONE THAT COULD PAY FOR ITSELF.

BLACKJACK, VEGAS STYLE will help you learn to count cards. This program allows the user to assign plus or minus values to each card, to assign a POINT COUNT. Once entered the machine automatically keeps a running count as it deals from the deck. When there is less than 12 cards left the deck is shuffled and the count is returned to zero. Runs on an Apple II+, 48K DOS 3.3. Featuring QUALITY COLOR GRAPHICS.

See your local dealer or send check or money order to:

BULLSEYE SOFTWARE \$23.95
P.O. Drawer 7900 Incline Village, NV 89450



Circle 58 on inquiry card.

Screens in seconds QUICKSCREEN™

Screen Builder

• ABC CORPORATION •	
• INVENTORY DISPLAY •	

• ITEM ID: 12345 •	

FINANCIAL	QUANTITIES
PRICE \$8	ON HAND 193
COST \$4	ON ORDER 50

SALES:	ALLOCATED 6

MTD \$200	MTD SOLD 25
YTD \$800	YTD SOLD 100

Microsoft BASIC, CBASIC, dBASEII, or FMS80 (four separate versions) 56K CP/M

\$149 (user manual: \$20) plus shipping -
Fox & Geller Associates, Inc. (201) 837-0142
P.O. Box 1053 Credit Cards
Teaneck, N.J. 07668 Accepted

MS80 is a trademark of DJR Associates
dBASE II is a trademark of Ashton-Tate
CBASIC, CP/M, are trademarks of Digital Research

Circle 155 on inquiry card.

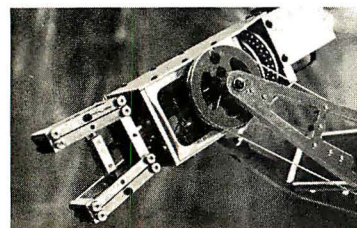

RHINO® XR-1 ROBOT

Versatile, rugged 32" high robotic arm for education, research and industry. Compatible with all computers having RS232C interface. Immediate delivery. \$2,400 F.O.B. Champaign, Ill. (In Ill., add 5% tax). Price includes 150 pg. operations manual... an excellent introduction to robotics. Manuals can be purchased separately @ \$35.00 ea. Inquiries invited.

SANDHU MACHINE DESIGN INC. Sales Dept.
308 S. State
Champaign, IL 61820
(217) 352-8485

Circle 328 on inquiry card.

TEXT EDITOR NORTH STAR COMPUTER

A PROFESSIONAL EDITOR, USER-TESTED IN BUSINESS FOR OVER TWO YEARS.

- * WRITTEN IN BASIC -- EASY TO MODIFY.
- * CRITICAL FUNCTIONS IN 2-80 ASSEMBLY LANGUAGE FOR HIGH PERFORMANCE.
- * EXCELLENT DOCUMENTATION -- ANNOTATED LISTINGS, 29-PAGE USERS GUIDE, INSTALLATION GUIDE, MORE.
- * REQUIRES NORTH STAR DOS 5.1 OR 5.2, MINIMUM 48K MEMORY.
- * RECLAIMS OLD DISK SPACE FOR FILES -- NO MORE COMPACTIONS.
- * PRINTER OUTPUT FEATURES: AUTO PAGING, INDENTING, CENTERING, ESCAPE SEQUENCES, MORE.

\$75 COMPLETE, \$25 USER MANUAL (CAN BE CREDITED TO COMPLETE PACKAGE). FOR SPEC SHEETS, SEND STAMPED, SELF-ADDRESSED ENVELOPE TO: PAUL T. BRADY, 91 MARSHIRE DRIVE, MIDDLETOWN, NEW JERSEY, 07748.

Scotch® Diskettes

Rely on Scotch® diskettes to keep your valuable data safe. Dependable Scotch diskettes are tested and guaranteed error-free. The low abrasivity saves your read/write heads. They're compatible with most diskette drives.



(800)235-4137

VISA

Dealer inquiries invited

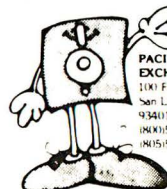

PACIFIC EXCHANGES
100 Foothill Blvd.
San Luis Obispo, CA
93401 In Cal. call
(800)542-5435 or
(805)544-1047

Circle 293 on inquiry card.

DIGITAL RESEARCH COMPUTERS

(214) 271-3538

32K S-100 EPROM CARD

NEW!

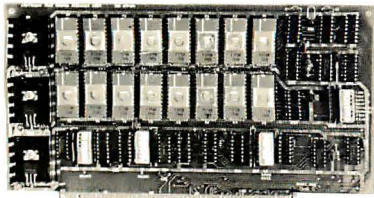

\$79.95
KIT

USES 2716's

Blank PC Board - \$34
ASSEMBLED & TESTED
ADD \$30

SPECIAL: 2716 EPROM's (450 NS) Are \$9.95 Ea. With Above Kit.

KIT FEATURES:

1. Uses +5V only 2716 (2Kx8) EPROM's.
2. Allows up to 32K of software on line!
3. IEEE S-100 Compatible.
4. Addressable as two independent 16K blocks.
5. Cromemco extended or Northstar bank select.
6. On board wait state circuitry if needed.
7. Any or all EPROM locations can be disabled.
8. Double sided PC board, solder-masked, silk-screened.
9. Gold plated contact fingers.
10. Unselected EPROM's automatically powered down for low power.
11. Fully buffered and bypassed.
12. Easy and quick to assemble.

32K SS-50 RAM

\$299⁰⁰ KIT

For 2MHZ
Add \$10

Blank PC Board
\$50

For SWTPC
6800 - 6809 Buss

Support IC's
and Caps
\$19.95

Complete Socket Set
\$21.00

Fully Assembled,
Tested, Burned In
Add \$30

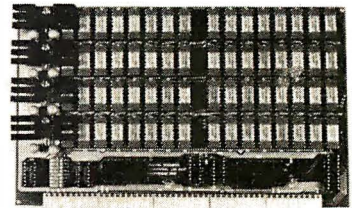

At Last! An affordable 32K Static RAM with full 6809 Capability.

FEATURES:

1. Uses proven low power 2114 Static RAMS.
2. Supports SS50C - EXTENDED ADDRESSING.
3. All parts and sockets included.
4. Dip Switch address select as a 32K block.
5. Extended addressing can be disabled.
6. Works with all existing 6800 SS50 systems.
7. Fully bypassed. PC Board is double sided, plated thru, with silk screen.

16K STATIC RAM KIT-S 100 BUSS

PRICE CUT!

\$169⁹⁵ KIT

FOR 4MHZ
ADD \$10

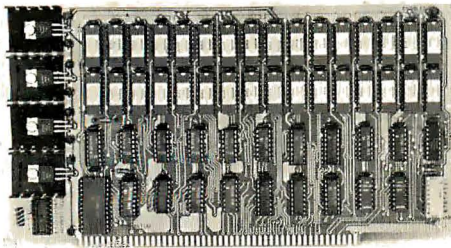

KIT FEATURES:

1. Addressable as four separate 4K Blocks.
2. ON BOARD BANK SELECT circuitry. (Cromemco Standard!). Allows up to 512K on line!
3. Uses 2114 (450NS) 4K Static Rams.
4. ON BOARD SELECTABLE WAIT STATES.
5. Double sided PC Board, with solder mask and silk screened layout. Gold plated contact fingers.
6. All address and data lines fully buffered.
7. Kit includes ALL parts and sockets.
8. PHANTOM is jumpered to PIN 67.
9. LOW POWER: under 1.5 amps TYPICAL from the +8 Volt Buss.
10. Blank PC Board can be populated as any multiple of 4K.

BLANK PC BOARD W/DATA-\$33

LOW PROFILE SOCKET SET-\$12

SUPPORT IC'S & CAPS-\$19.95

ASSEMBLED & TESTED-ADD \$35

**OUR #1 SELLING
RAM BOARD!**

16K STATIC RAM SS-50 BUSS

PRICE CUT!

\$159 KIT

FULLY STATIC!

FOR 2MHZ
ADD \$10

FOR SWTPC
6800 BUSS!

ASSEMBLED AND
TESTED - \$35

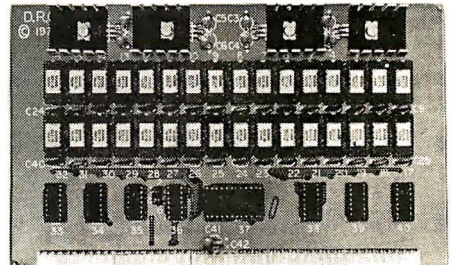

KIT FEATURES:

1. Addressable on 16K Boundaries
2. Uses 2114 Static Ram
3. Fully Bypassed
4. Double sided PC Board. Solder mask and silk screened layout
5. A/I Parts and Sockets included
6. Low Power: Under 1.5 Amps Typical

BLANK PC BOARD-\$35

COMPLETE SOCKET SET-\$12

SUPPORT IC'S AND CAPS-\$19.95

NEW! STEREO! S-100 SOUND COMPUTER BOARD NEW!

At last, an S-100 Board that unleashes the full power of two unbelievable General Instruments AY3-8910 NMOS computer sound IC's. Allows you under total computer control to generate an infinite number of special sound effects for games or any other program. Sounds can be called in BASIC, ASSEMBLY LANGUAGE, etc.

KIT FEATURES:

- * TWO GI SOUND COMPUTER IC'S.
- * FOUR PARALLEL I/O PORTS ON BOARD.
- * USES ON BOARD AUDIO AMPS OR YOUR STEREO.
- * ON BOARD PROTO TYPING AREA.
- * ALL SOCKETS, PARTS AND HARDWARE ARE INCLUDED.
- * PC BOARD IS SOLDERMASKED, SILK SCREENED, WITH GOLD CONTACTS.
- * EASY, QUICK, AND FUN TO BUILD, WITH FULL INSTRUCTIONS.
- * USES PROGRAMMED I/O FOR MAXIMUM SYSTEM FLEXIBILITY.

Both Basic and Assembly Language Programming examples are included.

SOFTWARE:

SCL™ is now available! Our Sound Command Language makes writing Sound Effects programs a SNAP! SCL™ also includes routines for Register-Examine-Modify, Memory-Examine-Modify, and Play-Memory. SCL™ is available on CP/M™ compatible diskette or 2708 or 2716. Diskette-\$24.95 2708 - \$19.95 2716 - \$29.95. Diskette includes the source. EPROM's are ORG at E000H. (Diskette is 8 Inch Soft Sector)

COMPLETE KIT!

\$84⁹⁵

(WITH DATA MANUAL)

BLANK PC
BOARD W/DATA
\$31

SPECIAL PURCHASE!

UART SALE!

TR1602B - SAME AS TMS6011,
AY5-1013, ETC. 40 PIN DIP

TR1602B

\$2⁹⁵ EACH

4 For \$10⁰⁰

CRT CONTROLLER CHIP

SMC #CRT 5037. PROGRAMMABLE FOR 80 x 24, ETC. VERY RARE SURPLUS FIND. WITH PIN OUT. \$12.95 EACH.

NEW! G.I. COMPUTER SOUND CHIP

AY3-8910. As featured in July, 1979 BYTE! A fantastically powerful Sound & Music Generator. Perfect for use with any 8 Bit Microprocessor. Contains: 3 Tone Channels. Noise Generator, 3 Channels of Amplitude Control. 16 bit Envelope Period Control, 2-8 Bit Parallel I/O. 3 D to A Converters, plus much more! All in one 40 Pin DIP. Super easy interface to the S-100 or other busses. \$11.95 PRICE CUT!

SPECIAL OFFER: \$14.95 each Add \$3 for 60 page Data Manual.

TERMS: Add \$2.00 postage. We pay balance. Orders under \$15 add 75¢ handling. No C.O.D. We accept Visa and MasterCard. Tex. Res. add 5% Tax. Foreign orders (except Canada) add 20% P & H. Orders over \$50, add 85¢ for insurance.

Digital Research Computers
(OF TEXAS)

P.O. BOX 401565 • GARLAND, TEXAS 75040 • (214) 271-3538

ALL SALES ARE MADE SUBJECT TO THE TERMS OF OUR 90 DAY LIMITED WARRANTY. A COPY OF THIS WARRANTY IS AVAILABLE FREE, ON REQUEST.

**ADVANCED PRODUCTIVITY SYSTEM
FOR TRS-80 • MODEL II**

Finally a general purpose, high performance productivity system. APS is functionally comparable to the widely acclaimed SPF productivity system used on most large-scale computers. It is fully menu driven and provides Browse, Edit, Utility and Word Processing subsystems as well as split screen support. It is a powerful tool for quickly and efficiently creating, manipulating and revising programs, text files and data files of any size.

The full-screen, general purpose Edit Subsystem supports function keys as well as primary and line commands. A unique dataset isolation feature guarantees dataset integrity while editing.

The Utility Subsystem allows dataset allocation, record format conversion, dataset recovery and more.

Registered users receive full maintenance support. For more information contact:

Arrix Logic Systems Inc.
P.O. Box 142
Don Mills, Ontario
Canada M3C 2R6

* Registered Trademark of Tandy Corporation

Circle 36 on inquiry card.

**MEMOREX
FLEXIBLE DISCS**

**WE WILL NOT BE UNDER-
SOLD!** Call Free (800)235-4137
for prices and information. Dealer
inquiries invited and C.O.D.'s
accepted.

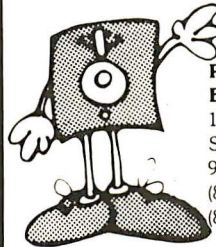

**PACIFIC
EXCHANGES**
100 Foothill Blvd.
San Luis Obispo, CA
93401. In Cal. call
(800)592-5935 or
(805)543-1037

Circle 293 on inquiry card.

ANADEX
DP9500/9501 - 1195⁰⁰
DP9000/9001 - 1135⁰⁰
200 CPS - GRAPHICS

**AMPEX DIALOG 80
W/DETACHABLE KEYBOARD
SALE - 920⁰⁰**

BASF
5.25" SINGLE SIDE/DENSITY
IN BOX OF 10 DISKS - 2.25ea

KNE RESOURCES
415 W. GOLF ROAD
ARLINGTON HTS, IL 60005
(312) 228-5850

Circle 203 on inquiry card.

STARSWEEP

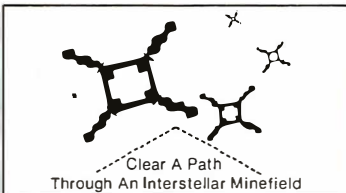

**EXCITING HIGH SPEED GRAPHICS
RUNS ON TRS-80™
MODEL I, LEVEL II 16 K**

Watch Space Mines Loom On
Your Screen As You Zip
Through Space. Align Your
Spacecraft, Then Blast Them
With Your Lasers. It Takes Skill
And Dexterity To Score High.

**TAPE
\$15**

Send Check Or Money Order To:

PENDRAGON SOFTWARE
P.O. BOX 230
LITTLE NECK, NY 11363
(NY State residents add appropriate sales tax)

Circle 298 on inquiry card.

**EXEK 86
8086/8088 EXECUTIVE**

- EPROM based real-time multi-tasking executive proven in industrial process control applications since 1980.
- Position independent assembly language for maximum speed, configuration flexibility, and minimum size. Task scheduling nucleus is less than 4 Kbytes.
- Modular code is user extensible and configurable for any 8086/8088 system with a real-time clock interrupt (1 msec maximum).
- Dynamic memory manager for the full 1 Mbyte address range.
- Run time binding to application tasks provides the ability to add/delete application tasks without changing existing firmware. Extensions to the executive can be made without changing existing applications firmware.
- Device independent I/O system with general CRT driver. Fortran like format interpreters, command line parser, general purpose queue utilities are provided with the I/O system. Complete I/O system adds less than 8 Kbytes.
- System services are available to assembly language and high level language programmers. Extensive macro and subroutine libraries are supplied.
- \$1250 complete price for source code with no usage fees for resale of object code in other products. Source code is supplied on single or dual density diskettes for use on Intel microprocessor development systems.

MODULAR INTERGRATION, INC.
P.O. Box 1079 • Issaquah, WA 98027 • (206) 392-8085

Circle 258 on inquiry card.

HY-TYPE I • HY-TYPE II

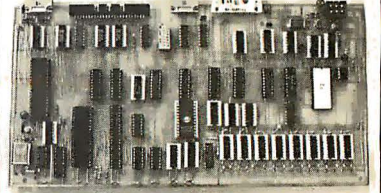

INTELLIGENT PRINTER INTERFACE

16,000 BYTE BUFFER / STAND ALONE
PARALLEL / SERIAL INPUT (BAUD RATES - 50 to 19,200)

OPTIONS INCLUDE: GRAPHICS • REVERSE PRINT • BOLD PRINT
UNDER-SCORE • REPRINT OF BUFFER
ADJUSTMENT OF LINES PER-INCH
CHARACTERS PER-INCH SELECTION
DOUBLE LINE

CUSTOM OPTIONS ALSO AVAILABLE

A & T FROM \$450.00 BARE BOARD \$80.00

MASTER CARD & VISA ACCEPTED

WARN ELECTRONICS, LTD.

PO BOX 526 KNIGHTDALE, NC 27545 (919) 266-9411

Circle 379 on inquiry card.

**WANTED:
APPLE, IBM, TRS-80, CP/M
SOFTWARE**

Westico is a publisher and distributor of professional software for microcomputers. If you have a new program ready for distribution or want your existing programs to reach a larger market, contact:

Phillip Woellhof, V.P. Mktg.
Westico, Inc.
25 Van Zant Street
Norwalk, CT 06855
(203) 853-6880

To increase your profits, take advantage of Westico's worldwide promotion and distribution.

WESTICO
The Software Express Service

maxell®

DISKETTES - SOLD IN BOXES OF 10
5" 1 side... 330 8" 1 side... 390
5" 2 side... 425 8" 2 side... 560

ALL MAXELL DISKETTES ARE DOUBLE DENSITY
QUANTITY PRICES AVAILABLE

SAME DAY SHIPMENT. Order via Master Charge -
Visa - Money Order - Personal Checks (allow 2 weeks)
- C.O.D. requires 10% deposit. Call! Res. add 6%
sales tax

SATISFACTION OR FULL REFUND

FSI

6901 Canby Avenue
Reseda, CA 91335
(213) 705-4202

Circle 153 on inquiry card.

For Your

ATARI®
Commercial Quality

JOYSTICK

**FINALLY! A HIGH QUALITY, PLUG-
COMPATIBLE JOYSTICK FOR THE
ATARI VIDEO-GAME AND 400/800
COMPUTER SYSTEMS. GAME-TECH'S
SERIES B PRO-STICK. METAL CON-
STRUCTION. SELF-CENTERING,
GOLD-PLATED CONTACTS. ARCADE
STYLE. FULL 6 MONTH WARRANTY.**

Send \$39.95 per joystick
(mass. res. add 5%)

Plus \$2.00 ea. shipping & handling to:

GAME-TECH

283 BROADWAY
ARLINGTON, MASS. 02174
1-(617)-774-8819

ATARI is a trademark of ATARI, Inc.

Circle 153 on inquiry card.

WE WILL NOT BE UNDERSOLD

DISK DRIVES

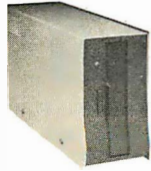

FOR TRS-80* Model I
CCI-100 5 1/4", 40 Track (102K) \$299

ADD-ON DRIVES FOR ZENITH Z-89
CCI-189 5 1/4", 40 Track (102K) \$389
Z-87 Dual 5 1/4" system \$995

External card edge and power supply included. 90 day warranty/one year on power supply.

CORVUS 5 mg \$3089 10mg \$4489 Mirror \$699
RAW DRIVES 8" SHUGART 801R \$399
5 1/4" TANDON \$ CALL POWER SUPPLIES \$ CALL

DISKETTES

— Box of 10
5 1/4" Maxell \$40 BASF/Verbatm \$26.95
8" Maxell \$45 BASF/Verbatm \$36.00
PLASTIC FILE BOX—Holds 50 5 1/4" diskettes \$19.00
PLASTIC LIBRARY CASE 5 1/4" \$3.00 8" \$ 4.00
HEAD CLEANING DISKETTE \$25.00
FLOPPY SAVER \$10.95 RINGS \$ 6.95

16K RAM KITS

200ns for TRS-80*, Apple II, (specify): 2 for \$37 \$19
Jumpers \$2.50

COMPUTERS/SYSTEMS

ALTOS ACS8000 Series \$CALL
ZENITH 48K, all-in-one computer \$2149
ATARI 400 \$ 359
800 \$ 789
APPLE PERIPHERALS \$CALL

TERMINALS

ADDS Viewpoint \$CALL
ZENITH Z-19 \$ 719
TELEVIDEO 910 \$559
920C \$729
950 \$929



S-100 CALIFORNIA COMPUTER SYSTEMS

MAINFRAME \$349 Z80 CPU \$ 239
64K RAM \$569 FLOPPY DISC CNTRL \$ 339
INTEGRATED SYSTEM W/INTERNAL CABLES, TESTED \$1975

2P + 2S I/O \$ 269
4 PORT SERIAL I/O \$ 249
4 PORT PARALLEL I/O \$ 179
CABLES \$CALL

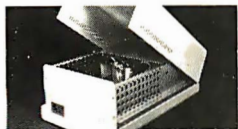

CASIO CALCULATORS

POCKET COMPUTER FX702 \$199.00
DESK PRINTER/CALCULATOR FR100 \$ 79.95
SCIENTIFIC CALCULATOR FX8100 \$ 49.95
GAME WATCH CA90 Plastic \$ 49.95
GAME WATCH CA901 Steel \$ 69.95
SPORT WATCH AX210 Calendar \$ 59.95

BUSINESS SOFTWARE

WORDSTAR for Apple II \$ 329
WORDSTAR for Zenith Z89 \$ 329

For fast delivery, send certified checks, money orders or call to arrange direct bank wire transfers. Personal or company checks require two to three weeks to clear. All prices are mail order only and are subject to change without notice. Call for shipping charges.

PRINTERS

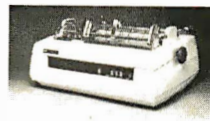

NEC SPINWRITER
7710 R.O. Par \$2395
7710 R.O. Par w/tractor \$2595
7720 KSR w/tractor \$2795
7730 R.O. Ser \$2395
7730 R.O. Ser w/tractor \$2595
NEW 3500 Series \$CALL
MX-70 MX-80 MX-80FT MX100 \$CALL

EPSON PAPER TIGER
IDS 445 Graphics & 2K buffer \$CALL
IDS 460 Graphics & 2K buffer \$CALL
IDS 560 Graphics \$CALL

ACCESSORIES
ANADIX DP-8000 \$849 DP-9500/01 \$1389
OKIDATA

Microline 80 Friction & pin feed \$CALL
Microline 82A Friction & pin feed \$CALL
Microline 83A 120 cps, uses up to 15" paper \$CALL
Call for new Microline series!

CENTRONICS 739, new model with graphics \$ 739
C. ITOH

Starwriter I 25 cps, parallel interface \$1525
Starwriter I 25 cps, serial interface \$1620
Starwriter II 45 cps, parallel interface \$1950
Starwriter II 45 cps, serial interface \$2075

AXIOM GP-80M \$ 319
DATA SOUTH 180 cps \$CALL
OLIVETTI DY 211 Daisy Wheel \$CALL

MONITORS

BELL & HOWELL 9" B & W BHD911 \$125
LEEDEX 12" B & W \$129 12" Green Screen \$155
13" Color \$329
SANYO 9" B & W \$149 12" Green Screen \$238
12" B & W \$219 13" Color \$399
13" Color \$349 12" Green Screen \$129

TELECOMMUNICATIONS

PRENTICE STAR MODEM 1-year guarantee \$125
UNIVERSAL DATA SYSTEMS UDS103LP \$149 UDS103JP \$215
NOVATION CAT \$139 D-CAT \$149
AUTO-CAT \$199 APPLE CAT II \$339
D.C. HAYES SMART/STACK MODEM \$249
MICRO-MODEM II \$295
CCI Telnet Communications Package \$135

APPLE ACCESSORIES AND SOFTWARE

Mfr. by: Microsoft - Mountain Computers - Videx - CCS - Personal Software
VISICALC \$159.00 VISIDEX \$159.00
VISITERM \$119.00 VISIPILOT \$139.00
Z-80 SOFTCARD \$259.00 VIDEX BOARD \$249.00
KEYBOARD ENHANCER \$110.00 16K CARD \$159.00
APPLE JOYSTICK \$ 49.00 SUP-R FAN \$ 39.00
SUP-R MOD \$ 25.00 CCS CARDS \$ CALL
APPLE CARDS \$ CALL ASCII EXPRESS \$ 59.00
SUPERCALC \$199.00 ALF9 VOICE BOARD \$149.00
CPS MULTIFUNCTION CARD \$199.00
METACARD 8088 MICROPROCESSOR FOR APPLE \$CALL

ENTERTAINMENT

Mfr. by: On Line - Broderbund - Sirius - California Pacific
FLIGHT SIMULATOR \$29.00 SARGON II \$29.00
WIZARD & PRINCESS \$28.00 ABM \$21.95
MYSTERY HOUSE \$24.00 GORGON \$34.95
HI-RES FOOTBALL \$35.00 MICROPainter \$29.00
RASTER BLASTER \$25.95 APPLE PANIC \$27.95
SPACE EGGS \$17.95 POOL 1.5 \$25.95

DEALER (NATIONAL/INTERNATIONAL) INQUIRIES INVITED

Send for FREE Catalogue

The CPU SHOP

TO ORDER CALL TOLL FREE 1-800-343-6522

TWX: 710-348-1796 Massachusetts Residents call 617/242-3361

420-438 Rutherford Ave., Dept. B01M
Charlestown, Massachusetts 02129
Hours 10AM-6PM (EST) Mon.-Fri. (Sat. till 5)

Technical Information call 617/242-3361
Massachusetts Residents add 5% Sales Tax
Tandy Corporation Trademark® Digital Research
Circle 110 on inquiry card.

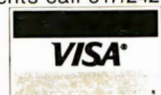

We're wizards at giving you mysterious mystifying low prices, amazing selections, instant delivery and in-a-flash service



SALE

EPSON PRINTERS		OKIDATA PRINTERS	
MX70	389.00	MK80	485.00
MX80	485.00	MK90	485.00
MK80PT	450.00	MK90PT	450.00
MK100	749.00	MK100	749.00

RS232C COMPUTER CABLES			
DESC	LEN	MAF	EST. COST
4 LINE 10' C0475M	C0475M	C0475M	19.95
12.3.7 25' C0475M	C0475M	C0475M	25.95
9 LINE 10' C0910M	C0910M	C0910M	24.95
14.20 25' C0910M	C0910M	C0910M	33.95
25 LINE 10' C2350M	C2350M	C2350M	37.95
1.25 25' C2350M	C2350M	C2350M	49.95

AVAILABILITY & PRICES SUBJECT TO CHANGE WITHOUT NOTICE. FEDERAL CHECKS WILL DELAY SHIPMENT 2 WEEKS. PRICES REFLECT 3% CASH DISCOUNT. PRINTER PRODUCTS SHIPPED IN FACTORY SEALED CARTONS WITH WARRANTY. ADD 2% A MINIMUM OF \$5.00 FOR SHIPPING & HANDLING.

TRIANGLE COMPUTERS
P.O. Box 172 Dillard Go 30537
404 746 5395

Circle 367 on inquiry card.

S-100

INDUSTRY STANDARD THROUGHOUT (IEEE 696)

- Z80 processor-4Mhz • 10 slot motherboard
- Enhanced CP/M • On board monitor
- Complete manuals • Line filters • 2-8" Shugart-801R-drives • 64K RAM-expandable to 256 • 2 serial/parallel ports • EPROM programmer, 6K EPROM • 2 Filtered receptacles • Heavy duty power supply.

COMPARE

WE SUPPORT OUR PRODUCTS
Assembled, burned-in, 1 FULL YEAR warranty. Technical hotline, newsletter, upgrades. ALSO - Discount software, Zenith, Epson.

\$2995 PLUS SHIPPING

COMPUTERIZED MANAGEMENT SYSTEMS
310 1st Ave. S., Seattle, WA 98104
Phone (206) 624-9499/598-4274

*CP/M is a trademark of Digital Research

Circle 98 on inquiry card.

S-100 Boards from S. C. Digital

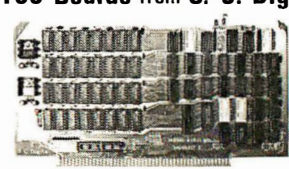

64K DYNAMIC RAM 'Uniselect: 2'

features: **Model 64KUS \$485, A&T**

- 16 or 24 bit addressing. • 8 bit data. • Bank Select by SW settable Port, Bits in Two blocks. • Two 32K (or 128KB) addressing. • Transparent refresh with delay lines, giving unlimited DMA, immune to Wait States, halts, resets.
- Fast access time - 220nsec from Smemr or Psync high, will run with Z80, Z8000 to 4mhz, 8080, 8085, 8088, 8086 to 5mhz without wait states. • Provision to expand to 256KB using 64K by 1 chips. • Conforms to IEEE 696-S100 specs.

Guaranteed one full year. Shipping is in 3 days. MC, Visa, or COD orders accepted. Add \$5.00 for COD orders. Illinois residents-add 5 1/4% sales tax.

O.E.M. & DEALER PRICING AVAILABLE

S.C. DIGITAL
P.O. Box 906, Aurora, Illinois 60507
Phone: (312) 897-7749

Circle 324 on inquiry card.

SUPER E-Z80 KIT
64K-Z80A-CP/M™ Compatible Micro-Computer

Features: Z80A CPU-CTC and PIO • 64K Dynamic Ram • 4K Monitor EProm • 54 Key Keyboard (Detachable) • 3 Fully Buffered S-100 Spaces • Integrated Circuit Sockets • RS232-C Asynch. Modem Control (Programmable Baud Rate) • Composite Video • CP/M™ Operating System Compatible • Epson or Centronics Printer Compatible Parallel Port • 8272 Floppy Controller Device - 3740 and 3741 Comp. - 8" & 5 1/4" Drives - up to 4 Drives • Z80 Programming Card • Assembly Instructions • Monitor Listing • Block Diagram.

PRICE: \$1195.00
TERMS: Certified check or money order
(Texas Res. Add Sales Tax)

HIT-80 INC.
18601 LBJ Fwy. • Mesquite, Texas 75150
• 800-527-1593
A Subsidiary of Patrick Computer Systems, Inc.
Manufacturer of the ic436 integrated business computer

™ Trademark of Digital Research

Circle 423 on inquiry card.

Smartmodem



- Auto-Answer • Auto-Dial • Repeat
- Programmable - Use Any Language
- Touch-Tone and Pulse Dialing
- Audio Monitor - Listen to Connection
- FCC-Approved Direct-Connect
- Full or Half Duplex. 0-300 Baud
- RS-232C Interface • 7 Status LED's
- Two Year Limited Warranty

\$249

Send certified check or money order
Allow two weeks for personal check
Florida residents add 4% sales tax

RCE COMPUTER PRODUCTS of Florida Inc.
1640 N.W. 3rd STREET
DEERFIELD BEACH, FLA. 33441
VOICE: 305-427-1257/DATA: 305-427-6300

Circle 6 on inquiry card.

"C" COMPILERS FOR MC6809

- Generates re-entrant/relocatable, efficient, 'rom'able assembly language
- Supports full "C" except: long, floats, doubles, initializers, and bit fields
- Includes object code linker, library manager, and 6809 assembler
- All user program I/O easily configured to target hardware environment
- Available as flex-compatible, resident compiler or CP/M-compatible, cross-compiler

FC 6809 FLEX VERSION \$300.00
CC 6809 CP/M VERSION \$350.00

CP/M - 68XX CROSS-ASSEMBLERS
(INCLUDING SOURCE CODE IN "C")

A6800	... MC 6800, MC 6802, MC 6808	... \$100.00
A 6801	... MC 6801, MC 6803	... \$100.00
A 6809	... MC 6809	... \$100.00

CP/M FORMATS: 8" SOFT SECTORED, 5" NORTHSTAR
FLEX FORMATS: 8" SOFT SECTORED

*Flex Trademark of Technical Systems Consultants, Inc.
*CP/M Trademark of Digital Research

INTROL CORP.
647 W. Virginia St.
Milwaukee, WI. 53204
(414) 276-2937

Circle 293 on inquiry card.

All over the world there are people thinking about interfacing the APPLE

Also in Germany—with german precision

We present:

DSI 16K
Made in Western Germany

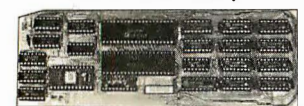

PRINTER-BUFFER INTERFACE

So you can keep on working with your APPLE, when the printer is busy!!!

- 16k RAM Buffer on board
- On board Z80 CPU
- Full APPLE Software compatible
- Full CP/M + PASCAL compatible
- Full Centronics compatible

SOLE DISTRIBUTION: **\$310**

Kleinfen Computer
Koelnerstr. 49
D 4000 DUESSELDORF 1 WEST GERMANY
Phone 211 369191 Tlx. 8582848

Write or call for more informations!!
Let us know your VISA or AE number.
Add 7 \$ for overseas shipping.
We accept American Express and VISA

Circle 246 on inquiry card.

\$ INCOME TAX PREPARATION \$

- \$600 MILLION SPENT BY TAXPAYERS
- EARN EXTRA \$\$\$\$ BY PREPARING TAXES
- NO ACCOUNTING DEGREE REQUIRED
- DESIGNED AND TESTED BY A CPA
- PROGRAMMED BY PROFESSIONALS
- WILL MAKE \$\$\$\$ FOR YOU THIS YEAR
- EARN YOUR SHARE NOW!!!
- LATEST TAX CHANGES, FORMS & SCHEDULES 1040 long/short
- A&B itemized deductions & interest income averaging
- IT-201 for New York residents
- ALL TAX TABLES INCLUDED FOR AUTOMATIC TAX AND SALES TAX COMPUTATION (A,B,C,D,X,Y,Z,EIC,all state sales)

- Interactive data entry and edits
- Client history file created
- Reprint and restart from client file
- Prints on 8 1/2" x 11 IRS supplied forms or on blank stock for use with overlay
- Printer & video configurator program

AVAILABLE FOR CP/M™ FORMATS ONLY:

8" SD CP/M™	DD ITHACA™	1202 Troy Road	PRICE: \$100
5 1/4" DD NorthStar™	5 1/4" DD Superbrain™	Latham, NY 12110	complete with documentation

requires CP/M™ 2.2
64-KB Z80 cpu
two disk drives

SEND CHECK or MONEY ORDER, name, address, telephone #, system model and desired disk format or call us at 518-783-8605.

Circle 246 on inquiry card.

Dysan CORPORATION

Solve your disc problems, buy 100% surface tested Dysan diskettes. All orders shipped from stock, within 24 hours. Call toll FREE (800) 235-4137 for prices and information. Visa and Master Card accepted.



PACIFIC EXCHANGES
100 Foothill Blvd.
San Luis Obispo, CA
93401. (In Cal. call (805) 543-1037.)

Circle 293 on inquiry card.

The MICROMINT Z8 BASIC COMPUTER/CONTROLLER board represents a milestone in microcomputer price-performance. It is cheap enough to be programmed directly in a high level language, and efficient enough to be battery operated if required. The entire computer is 4" by 4½" and includes a tiny BASIC interpreter, 4K bytes of program memory, one RS-232 serial port and two parallel ports, plus a variety of other features. Using a powerful Z8 microcomputer chip and Z6132 4K X 8 RAM, the Z8 BASIC COMPUTER/CONTROLLER board is completely self-contained and optimized for use as a dedicated controller. The unit is assembled and tested and comes with over 200 pages of documentation.

The price, in single quantity, a tiny \$195.*

Optional power supply (+5, +12 and -12V) \$35.

Please include \$4 for shipping and handling.

*Call Micromint for quantity pricing

Z8 MICROCOMPUTER

- On board tiny BASIC interpreter.
- Parallel and serial I/O ports.
- 6 interrupts.

RS-232 CONNECTOR

- Just attach a CRT terminal and immediately write control programs in BASIC.

4K BYTES OF RAM

- Z6132 4K X 8 low power quasi-static RAM. EPROM pin compatible.

SWITCH SELECTABLE BAUD RATES

- 110-9600 BPS.

FULLY EXPANDABLE

- Data and address buses available for 124K memory and I/O expansion.
- 2 onboard parallel ports.
- 7.3728MHZ crystal for fast control operations.

JUMPER SELECTABLE MEMORY OPTIONS

- 4K RAM, 2716 or 2732 EPROM operation.

LOW POWER

- Consumes only 1½ WATTS at +5, +12 and -12V (optional power supply available).

To Order:

Call Toll Free

1-800-645-3479

For Information Call

1-516-374-6793

MICROMINT INC.

917 Midway

Woodmere, N.Y. 11598

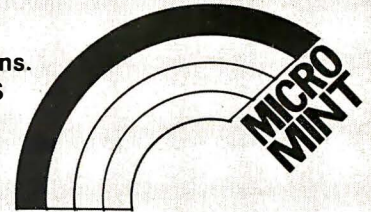

Micromint will put both a computer development system and an OEM dedicated controller in the palm of your hand for only \$195.

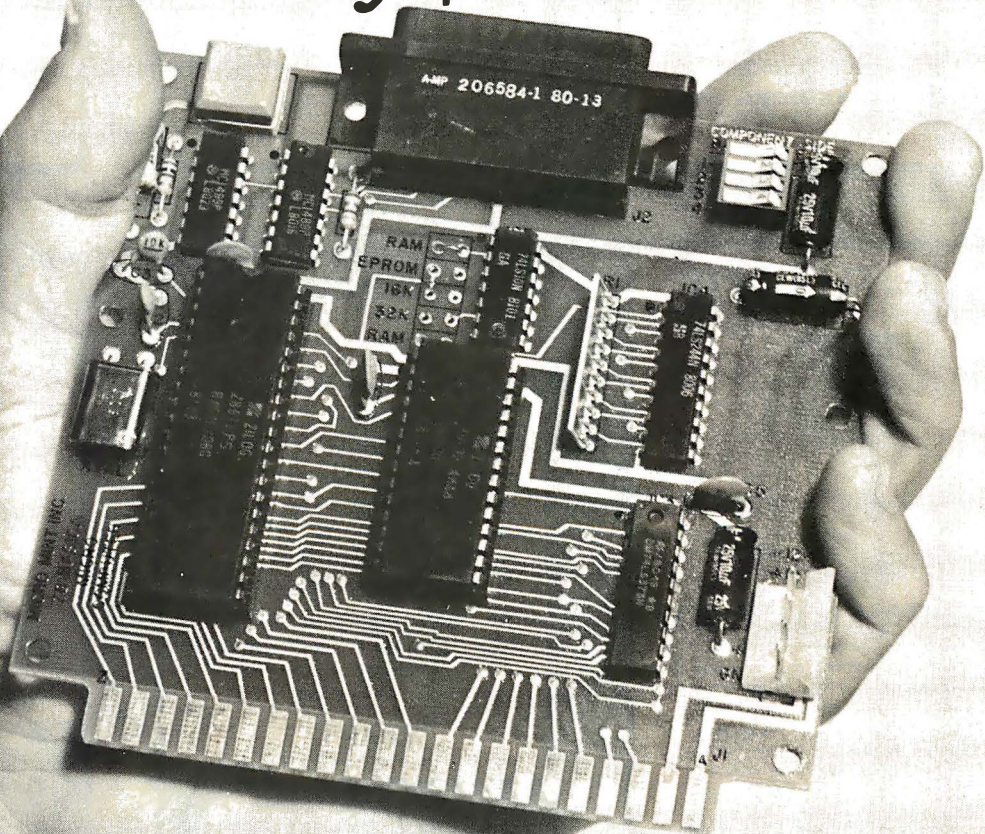

Circle 419 on inquiry card.

As featured in Byte Magazine, July, August, 1981.

Z8 is a trademark of Zilog Inc.

Verbatim flexible disks

Call Free (800) 235-4137 for prices and information. Dealer inquiries invited. C.O.D. and charge cards accepted.

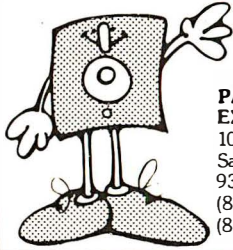

VISA

PACIFIC EXCHANGES
100 Foothill Blvd.
San Luis Obispo, CA
93401. In Cal. call
(800) 592-5935 or
(805) 543-1037.

Circle 293 on inquiry card.

YOU CAN SAVE \$\$\$ ON RIBBONS FOR

Anadex DP 9500	\$14.00
Centronics 700 Series		
Zip Pack (Box of 3)	\$ 8.25
Cartridge	\$ 8.50
D.E.C. LA-34	\$ 6.90
Diablo 630	\$ 6.00
Epson MX 70-80	\$12.95
NEC Spinwriter (Box of 3)	\$14.25
Okidata Microline 80 (Box of 3)	\$ 8.90
Radio Shack LP II - IV	\$ 8.50
Teletype 33 (Box of 3)	\$ 6.00
Teletype 43	\$ 7.50
TI Silent 700 Thermal Paper (Case)	\$48.00

Plus Many Others - Call for Information on Ribbons, Thermal Paper and Diskettes.

Add \$3.00 for Shipping & Handling
Illinois Res. Add 6% Sales Tax

ILLINOIS COMPUTER PRODUCTS CO.

P.O. Box 112
Mt. Prospect, IL 60056 (312) 228-5590

Circle 416 on inquiry card.

SOFTWARE AUTHORS

micro's-mini's-main frames

Take advantage of our exciting development program for new software in all fields!

20% Royalty!

For that professional push contact: Michael L. Dean, V.P. Research & Development.

InfoSoft Computer Systems
P.O. Box 562, Concord, CA 94522
(415) 680-0202

Innovative



Solutions™

Circle 183 on inquiry card.

UV EPROM ERASER



\$49.95

- * ERASES ALL UV ERASABLE EPROMS (2708, 2716, 2564, etc.)
- * QUICK FIFTEEN MINUTES ERASE TIME
- * ERASES OVER FIFTEEN EPROMS AT A TIME
- * LAMP LIFE, 7000 HOURS
- * INDUSTRIAL MODEL \$68.50
- * INDUSTRIAL MODEL WITH TIMER & SAFETY INTERLOCK SWITCH \$97.50 (Plugged in free enclosure with bottom drawer)

THE BEST 6809 SINGLE BOARD COMPUTER AVAILABLE

- Relay Controller
- Printer Port
- RS-232 Port
- SWTPC compatible
- Built in SFR's
- Full Documentation

PRICE: \$389.00

FOR THE SS-50 AND S-100 BUS
ASSEMBLED, TESTED, 48 HOUR BURN IN, 90 DAY WARRANTY

2114 RAM 300 ns	\$2.95	STRAIGHT FROM THE FACTORY & GUARANTEED.
2716 EPROM 550ns	\$4.50	
EPROM PROGRAMMER for 2716, 2732	\$99.50	
In Circuit Emulator for 68xx, 8085, 280	\$99.95	

WE ACCEPT VISA, MASTERCARD, C.O.D., CHECKS

PHONE ORDERS (305) 974-0967

LOGICAL DEVICES INC.

781 W OAKLAND PARK BLVD. • FT. LAUDERDALE, FLORIDA 33311

ADD: \$1.95 SHIPPING, \$2.00 C.O.D. CHARGES

Circle 214 on inquiry card.

You can pay more — But you can't get more!

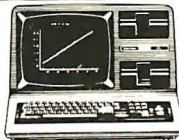

Model III 16K

\$839

Model III 48K
2 disc & RS232C

\$2100



Color Computer 4K

\$310

w/16K Ext. Basic

\$459

BUY DIRECT. These are just a few of our great offers which include Printers, Modems, Computers, Peripherals, Disc Drives, Software and more. call TOLL FREE 1-800-343-8124

We have the lowest possible fully warranted prices and a full complement of Radio Shack Software.

computer plus
Write for your free catalog.
245A Great Road
Littleton, MA 01460
617 • 486 • 3193

Circle 93 on inquiry card.

PLOTTING SOFTWARE

Calcomp compatible, for

EPSON and HILOT with CPM, FORTRAN, and BASIC

PLOTWARE-z 8" ssd 399
Manuals - only 95
PLOTWARE-z samples 8
* Refundable on order

ENERCOMP
P.O. BOX 28014
Lakewood, Colo.
80228
303-988-1848

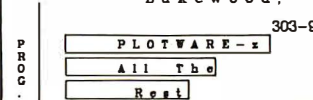

VALUE & EASE



OPTIONS:
Maps, Charts,
Drafting
Scientific
Characters,
Terminal
Emulation

PLOTWARE-z drew this ad

Circle 147 on inquiry card.

HIT-80 INC.

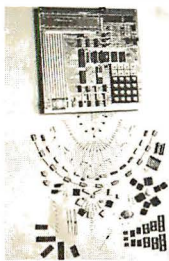

E-Z-80 ENTRY KIT

A Z-80 Micro Computer with CPU: CTC: PIO: Prom Programmer: Read Outs: Key Pad: Onboard ROM & RAM: Wire Wrap: DC Regulator: Manual & Instructions.

Kit Price \$390.00

P.O. BOX 501—KAUFMAN, TEXAS (USA)—75142
A Subsidiary of Patrick Computer Systems, Inc., manufacturer of the ic436 integrated business computer.

Circle 415 on inquiry card.

'UCSD p-System *Pascal'

*Trademark of The Regents of The State of California

Most commonly re-invented PROCEDURES

For business application programmers:

- User friendly
- Bomb proof
- Access methods
- Screen input
- Printed report formatting
- Text formatting
- Data type conversions
- Sample shell programs

Source provided to allow creation of units, segments, or in-line code

We have invested hundreds of hours. If you save one hour of coding, it's worth the price.

\$19.95

1372 East 52nd. St., Chicago, IL 60615

Users Pascal Procedures Exchange Register

MICROSETTE CASSETTES

Length	Qty 10	Qty 50
C-10	\$ 7.50	\$32.50
C-20	9.00	39.00
C-60	13.50	57.00
C-90	17.50	77.50

5-screw shell, boxes, labels, product warranty, UPS shipping included. Please no P.O. box.

CA Customers add taxes.

MICROSETTE CO.

475 Ellis St., Mt. View,
CA 94043 (415) 968-1604

Circle 247 on inquiry card.

Circle 194 on inquiry card. →

The Best Boards SD Prices Slashed !!!

Single User System

SBC-200, 64K ExpandoRAM II, Versafloppy II, CP/M 2.2

\$995.00

4 MHz Z-80A CPU, 64K RAM, serial I/O port, parallel I/O port, double-density disk controller, CP/M 2.2 disk and manuals, system monitor, control and diagnostic software.

-All boards are assembled and tested-

ExpandoRAM III

64K to 256K expandable RAM board

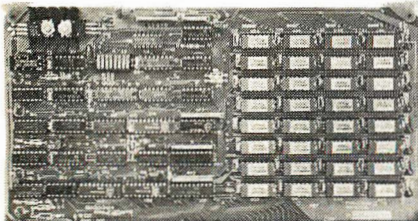

SD Systems has duplicated the famous reliability of their ExpandoRAM I and II boards in the new ExpandoRAM III, a board capable of containing 256K of high speed RAM. Utilizing the new 64K x 1 dynamic RAM chips, you can configure a memory of 64K, 128K, 192K, or 256K, all on one S-100 board. Memory address decoding is done by a programmed bipolar ROM so that the memory map may be dip-switch configured to work with either COSMOS/MPM-type systems or with OASIS-type systems.

Extensive application notes concerning how to operate the ExpandoRAM III with Cromemco, Intersystems, and other popular 4 MHz Z-80 systems are contained in the manual.

MEM-65064A	64K A & T	\$495.00
MEM-65128A	128K A & T	\$639.95
MEM-65192A	192K A & T	\$769.95
MEM-65256A	256K A & T	\$879.95

Versafloppy II

Double density controller with CP/M 2.2

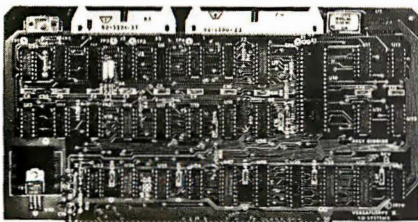

- S-100 bus compatible • IBM 3740 compatible soft sector format • Controls single and double-sided drives, single or double density, 5 1/4" and 8" drives in any combination of four simultaneously
- Drive select and side select circuitry • Analog phase-locked loop data separator • Vectored interrupt operation optional • CP/M 2.2 disk and manual set included • Control/diagnostic software PROM included

The Versafloppy II is faster, more stable and more tolerant of bit shift and "jitter" than most controllers. CP/M 2.2 and all necessary control and diagnostic software are included.

IOD-1160A A & T with CP/M 2.2 .. \$370.00

SBC-200

2 or 4 MHz single board computer

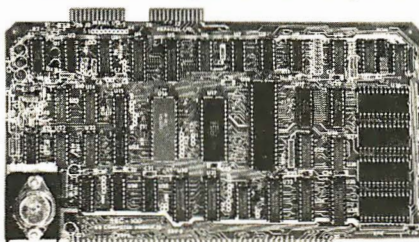

- S-100 bus compatible • Powerful 4MHz Z-80A CPU • Synchronous/asynchronous serial I/O port with RS-232 interface and software programmable baud rates up to 9600 baud • Parallel input and parallel output port • Four channel counter/timer • Four maskable, vectored interrupt inputs and a non-maskable interrupt • 1K of on-board RAM • Up to 32K of on-board ROM • System monitor PROM included

The SBC-200 is an excellent CPU board to base a microcomputer system around. With on-board RAM, ROM, and I/O, the SBC-200 allows you to build a powerful three-board system that has the same features found in most five-board microcomputers. The SBC-200 is compatible with both single-user and multi-user systems.

CPU-30200A A & T with monitor . \$299.95

ExpandoRAM II

16K to 64K expandable RAM board

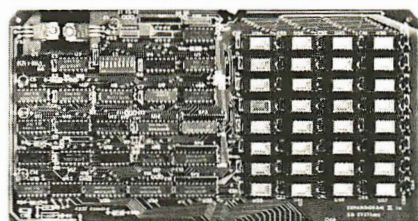

- S-100 bus compatible • Up to 4MHz operation • Expandable from 16K to 64K • Uses 16 x 1 4116 memory chips • Page mode operation allows up to 8 memory boards on the bus • Phantom output disable • Invisible on-board refresh

The ExpandoRAM II is compatible with most S-100 CPUs. When other SD System' series II boards are combined with the ExpandoRAM II, they create a microcomputer system with exceptional capabilities and features.

MEM-16630A	16K A & T	\$325.00
MEM-32631A	32K A & T	\$345.00
MEM-48632A	48K A & T	\$365.00
MEM-64633A	64K A & T	\$385.00

COSMOS

Multi-user operating system

- Multi-user disk operating system • Allows up to 8 users to run independent jobs concurrently • Each user has a separate file directory

COSMOS supports all the file structures of CP/M 2.2, and is compatible at the applications program level with CP/M 2.2, so that most programs written to run under CP/M 2.2 or SDOS will also run under COSMOS.

SFC-55009039F COSMOS on 8" disk \$395.00

Multi-User System

SBC-200, 256K ExpandoRAM III, Versafloppy II, MPC-4 COSMOS Multi-User Operating System, C BASIC II

\$1995.00

Two Z-80A CPUs (4 MHz), 256K RAM, 5 serial I/O ports with independently programmable baud rates and vectored interrupts, parallel input port, parallel output port, 8 counter/timer channels, real time clock, single and double sided/single or double density disk controller for 5 1/4" and 8" drives, up to 36K of on-board ROM, CP/M 2.2 compatible COSMOS interrupt driven multi-user disk operating system, allows up to 8 users to run independent jobs concurrently, C BASIC II, control and diagnostic software in PROM included.

-All boards are assembled and tested-

MPC-4

Intelligent communications interface

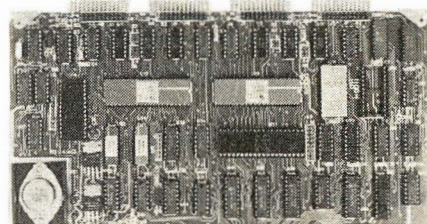

- Four buffered serial I/O ports • On-board Z-80A processor • Four CTC channels • Independently programmable baud rates • Vectored interrupt capability • Up to 4K of on-board PROM • Up to 2K of on-board RAM • On-board firmware

This is not just another four-port serial I/O board! The on-board processor and firmware provide sufficient intelligence to allow the MPC-4 to handle time consuming I/O tasks, rather than loading down your CPU. To increase overall efficiency, each serial channel has an 80 character input buffer and a 128 character output buffer. The on-board firmware can be modified to make the board SDLC or BISYNC compatible. In combination with SD's COSMOS operating system (which is included with the MPC-4), this board makes a perfect building block for a multi-user system.

IOI-1504A A & T with COSMOS .. \$495.00

Place Orders Toll Free

Continental U.S. Inside California
800-421-5500 800-262-1710

For Technical Inquiries or Customer Service call:

213-973-7707

JADE

Computer Products

4901 W. Rosecrans, Hawthorne, Ca 90250

TERMS OF SALE: Cash, checks, credit cards, or Purchase Orders from qualified firms and institutions. Minimum Order \$15.00. California residents add 6% tax. Minimum shipping & handling charge \$3.00. Pricing & availability subject to change

JADIE

Computer Products

Printers

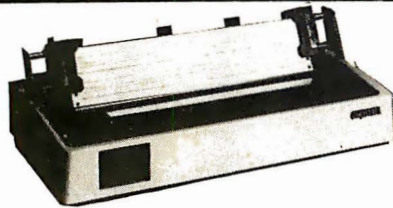

BETTER THAN EPSON! - Okidata

Microline 82A 80/132 column, 120 CPS, 9 x 9 dot matrix, friction feed, pin feed, adjustable tractor feed (removable), handles 4 part forms up to 9.5" wide, rear & bottom feed, paper tear bar, 100% duty cycle/200,000,000 character print head, bi-directional/logic seeking, both serial & parallel interfaces included, front panel switch & program control of 10 different form lengths, uses inexpensive spool type ribbons, double width & condensed characters, true lower case descenders & graphics
PRM-43082 with FREE tractor \$539.95

Microline 83A 132/232 column, 120 CPS, handles forms up to 15" wide, plus all the features of the 82A.
PRM-43083 with FREE tractor \$749.95

PRA-27081A Apple card \$39.95
PRA-27082A Apple cable \$19.95
PRA-27087A TRS-80 cable \$24.95
PRA-43080 Extra ribbons pkg. of 2 ... \$9.95

INEXPENSIVE PRINTERS - Epson

MX-70 80 column, 80 CPS, 5 x 7 dot matrix, adjustable tractor feed, & graphics
PRM-27070 List \$459 \$399.95

MX-80 80 column, 80 CPS, bi-directional/logic seeking printing, 9 x 9 dot matrix, adjustable tractor feed, & 64 graphics characters
PRM-27080 List \$645 \$469.95

MX-80FT same as MX-80 with friction feed added.
PRM-27082 List \$745 \$559.95

MX-100 132 column, correspondence quality, graphics, up to 15" paper, friction feed & adjustable tractor feed, 9x9 dot matrix, 80 CPS.
PRM-27100 List \$945 \$759.95

PRA-27084 Serial interface \$69.95
PRA-27088 Serial intf & 2K buffer .. \$144.95
PRA-27081 Apple card \$74.95
PRA-27082 Apple cable \$22.95
PRA-27086 IEEE 488 card \$52.95
PRA-27087 TRS-80 cable \$32.95
PRA-27085 Graftrax II \$95.00
PRA-27083 Extra ribbon \$14.95

NEC 7700 & 3500

NEC Spinwriter w/Intelligent Controller

Standard serial, Centronics parallel, and current loop interfaces • Selectable baud rates 50 to 19,200 • Automatic bidirectional printing • Logic seeking • 650 character buffer with optional 16K buffer • 55 characters per second print speed • Comes with vertical forms tractor, ribbon, thimble and cable • Diabolo compatible software • Available with or without optional front panel

PRD-55511 1K no front panel \$2795.00
PRD-55512 16K no front panel .. \$2895.00
PRD-55515 1K w/front panel \$2995.00
PRD-55516 16K w/front panel \$3095.00

Intersell NEC 3500Q

New from NEC in the 3500 series Spinwriters. Incorporates all the features and reliability of the 5500 and 7700 series Spinwriters into an inexpensive 30 CPS letter quality printer with an optional bi-directional tractor assembly.

PRD-55351 3500Q 1K \$1995.00
PRD-55352 3500Q 16K \$2095.00
PRA-55100 Deluxe tractor option .. \$300.00

Accessories for Apple

16K MEMORY UPGRADE

Add 16K of RAM to your TRS-80, Apple, or Exidy in just minutes. We've sold thousands of these 16K RAM upgrades which include the appropriate memory chips (as specified by the manufacturer), all necessary jumper blocks, fool-proof instructions, and our 1 year guarantee.
MEX-16100K TRS-80 kit \$25.00
MEX-16101K Apple kit \$25.00
MEX-16102K Exidy kit \$25.00

16K RAM CARD - for Apple II

Expand your Apple to 64K. 1 year warranty
MEX-16500A Save \$70.00 !!! \$129.95

Z-80* CARD for APPLE

Two computers in one, Z-80 & 6502, more than doubles the power & potential of your Apple, includes Z-80* CPU card, CP/M 2.2, & BASIC-80
CPX-30800A A & T \$299.95

8" DISK CONTROLLER

New from Vista Computer, single or double sided, single or double density, compatible with DOS3.2/3.3, Pascal, & CPM 2.2, Shugart & Qume compatible
IOD-2700A A & T \$499.95

2 MEGABYTES for Apple II

Complete package includes: Two 8" double-density disk drives, Vista double-density 8" disk controller, cabinet, power supply, & cables, DOS 3.2/3.3, CP/M 2.2, & Pascal compatible.

1 MegaByte Package (Kit) \$1495.00
1 MegaByte Package (A & T) \$1695.00
2 MegaByte Package (Kit) \$1795.00
2 MegaByte Package (A & T) \$19.95

CPS MULTICARD - Mtn. Computer

Three cards in one! Real time clock/calendar, serial interface, & parallel interface - all on one card.
IOX-2300A A & T \$199.95

AIO, ASIO, APIO - S.S.M.

Parallel & serial interface for your Apple (see Byte pg 11)
IOI-2050K Par & Ser kit \$139.95
IOI-2050A Par & Ser A & T \$169.95
IOI-2052K Serial kit \$89.95
IOI-2052A Serial A & T \$99.95
IOI-2054K Parallel kit \$69.95
IOI-2054A Parallel A & T \$89.95

A488 - S.S.M.

IEEE 488 controller, uses simple basic commands, includes firmware and cable, 1 year guarantee, (see April Byte pg 11)
IOX-7488A A & T \$399.95

Modems

CAT MODEMS - Novation

CAT 300 baud, acoustic, answer/originate
IOI-5200A List \$189.95 \$149.95
D-CAT 300 baud direct connect, answer/originate
IOI-5201A List \$199.95 \$169.95
AUTO-CAT Auto answer/originate, direct connect
IOI-5230A List \$299.95 \$239.95

Apple-CAT - Novation

Software selectable 1200 or 300 baud, direct connect, auto-answer/auto-dial, auxiliary 3-wire RS232C serial port for printer.
IOI-5232A Save \$50.00!!! \$325.00

SMARTMODEM - Hayes

Sophisticated direct-connect auto-answer/auto-dial modem, touch-tone or pulse dialing, RS232C interface, programmable
IOI-5400A Smartmodem \$269.95

Single Board Computer

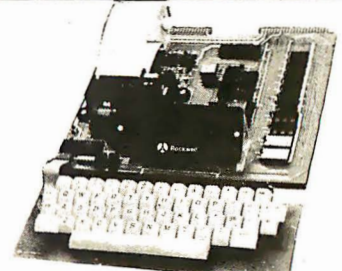

AIM-65 - Rockwell

6502 computer with alphanumeric display, printer, & keyboard, and complete instructional manuals

CPK-50165 1K AIM \$424.95
CPK-50465 4K AIM \$474.95
SFK-74600008E 8K BASIC ROM .. \$64.95
SFK-64600004E 4K assembler ROM \$43.95
PSX-030A Power supply \$64.95
ENX-000002 Enclosure \$54.95

4K AIM, 8K BASIC, power supply, & enclosure
Special package price \$649.95

Z-80 STARTER KIT - SD Systems

Complete Z-80 microcomputer with RAM, ROM, I/O, keyboard, display, kludge area, manual, & workbook
CPS-30100K KIT \$299.95
CPS-30100A A & T \$469.95

SYM-1 - Synertek Systems

Single board computer with 1K of RAM, 4K of ROM, key-pad, LED display, 20ma & cassette interface on board.
CPK-50020A A & T \$249.95

Video Monitors

HI-RES 12" GREEN - Zenith

15 MHz bandwidth, 700 lines/inch, P31 green phosphor, switchable 40 or 80 columns, small, light-weight & portable.
VDM-201201 List price \$150.00 \$118.95

Leedex / Amdek

Reasonably priced video monitors
VDM-801210 Video 100 12" B&W .. \$139.95
VDM-801230 Video 100-80 12" B & W \$179.95
VDM-801250 12" Green Phosphor \$169.95
VDC-801310 13" Color I \$379.95

12" COLOR MONITOR - NEC

Hi-res monitor with audio & sculptured case
VDC-651212 Color Monitor \$479.95

12" GREEN SCREEN - NEC

20 MHz, P31 phosphor video monitor with audio, exceptionally high resolution - A fantastic monitor at a very reasonable price
VDM-651200 Special Sale Price \$199.95

Video Terminals

AMBER SCREEN - Volker Craig

Detachable keyboard, amber on black display, 7 x 9 dot matrix, 10 program function keys, 14 key numeric pad, 12" non-glare screen, 50 to 19,200 baud, direct cursor control, auxiliary bi-directional serial port
VDT-351200 List \$795.00 \$645.00

VIEWPIONT - ADDS

Detachable keyboard, serial RS232C interface, baud rates from 110 to 19,200, auxiliary serial output port, 24x80 display.
VDT-501210 Sale Priced \$639.95

TELEVIDEO 950

VDT-901250 List \$1195.00 \$995.00

DIALOGUE 80 - Ampex

VDT-230080 List \$1195.00 \$895.00

JADIE

Computer Products

S-100 CPU Boards

THE BIG Z* - Jade

2 or 4 MHz switchable Z-80* CPU with serial I/O, accommodates 2708, 2716, or 2732 EPROM, baud rates from 75 to 9600

CPU-30201K Kit	\$139.95
CPU-30201A A & T	\$189.95
CPU-30200B Bare board	\$35.00

2810 Z-80* CPU - Cal Comp Sys

2/4 MHz Z-80A* CPU with RS-232C serial I/O port and on-board MOSS 2.2 monitor PROM, front panel compatible.

CPU-30400A A & T	\$269.95
------------------------	----------

CB-2 Z-80 CPU - S.S.M.

2 or 4 MHz Z-80 CPU board with provision for up to 8K of ROM or 4K of RAM on board, extended addressing, IEEE S-100, front panel compatible.

CPU-30300K Kit	\$239.95
CPU-30300A A & T	\$299.95

S-100 PROM Boards

PROM-100 - SD Systems

2708, 2716, 2732 EPROM programmer w/software

MEM-99520K Kit	\$189.95
MEM-99520A A & T	\$249.95

PB-1 - S.S.M.

2708, 2716 EPROM board with built-in programmer

MEM-99510K Kit	\$154.95
MEM-99510A A & T	\$219.95

EPROM BOARD - Jade

16K or 32K uses 2708's or 2716's, 1K boundary

MEM-16230K Kit	\$79.95
MEM-16230A A & T	\$119.95

S-100 Video Boards

VB-3 - S.S.M.

80 characters x 24 lines expandable to 80 x 48 for a full page of text, upper & lower case, 256 user defined symbols, 160 x 192 graphics matrix, memory mapped, has key board input.

IOV-1095K 4 MHz kit	\$349.95
IOV-1095A 4 MHz A & T	\$439.95
IOV-1096K 80 x 48 upgrade	\$39.95

VDB-8024 - SD Systems

80 x 24 I/O mapped video board with keyboard I/O, and on-board Z-80A*.

IOV-1020A A & T	\$459.95
-----------------------	----------

VIDEO BOARD - S.S.M.

64 characters x 16 lines, 128 x 48 matrix for graphics, full upper/lower case ASCII character set, numbers, symbols, and Greek letters, normal/reverse/blinking video, S-100.

IOV-1051K Kit	\$149.95
IOV-1051A A & T	\$219.95
IOV-1051B Bare board	\$34.95

S-100 Motherboards

ISO-BUS - Jade

Silent, simple, and on sale - a better motherboard
6 Slot (5 1/4" x 8 3/4")

MBS-061B Bare board	\$19.95
MBS-061K Kit	\$39.95
MBS-061A A & T	\$49.95
12 Slot (9 3/4" x 8 3/4")	
MBS-121B Bare board	\$29.95
MBS-121K Kit	\$69.95
MBS-121A A & T	\$89.95
18 Slot (14 1/2" x 8 3/4")	
MBS-181B Bare board	\$49.95
MBS-181K Kit	\$99.95
MBS-181A A & T	\$139.95

S-100 RAM Boards

MEMORY BANK - Jade

4 MHz, S-100, bank selectable, expandable from 16K to 64K

MEM-99730B Bare Board	\$49.95
MEM-99730K Kit no RAM	\$199.95
MEM-32731K 32K Kit	\$239.95
MEM-64733K 64K Kit	\$279.95
Assembled & Tested	add \$50.00

64K RAM - Calif Computer Sys

4 MHz bank port / bank byte selectable, extended addressing, 16K bank selectable, PHANTOM line allows memory overlay, 8080 / Z-80 / front panel compatible.

MEM-64565A A & T	\$575.00
------------------------	----------

64K STATIC RAM - Mem Merchant

64K static S-100 RAM card, 4-16K banks, up to 8MHz

MEM-64400A A & T	\$789.95
------------------------	----------

32K STATIC RAM - Jade

2 or 4 MHz expandable static RAM board uses 2114L's

MEM-16151K 16K 4 MHz kit	\$169.95
MEM-32151K 32K 4 MHz kit	\$299.95
Assembled & tested	add \$50.00

16K STATIC RAM - Mem Merchant

4 MHz 16K static RAM board, IEEE S-100, bank selectable, Phantom capability, addressable in 4K blocks, "disable-able" in 1K segments, extended addressing, low power

MEM-16171A A & T	\$164.95
------------------------	----------

S-100 Disk Controllers

DOUBLE-D - Jade

Double density controller with the inside track, on-board Z-80A*, printer port, IEEE S-100, can function on an interrupt driven buss

IOD-1200K Kit	\$299.95
IOD-1200A A & T	\$375.00
IOD-1200B Bare board	\$59.95

DOUBLE DENSITY - Cal Comp Sys

5 1/4" and 8" disk controller, single or double density, with on-board boot loader ROM, and free CP/M 2.2* and manual set.

IOD-1300A A & T	\$374.95
-----------------------	----------

S-100 I/O Boards

S.P.I.C. - Jade

Our new I/O card with 2 SIO's, 4 CTC's, and 1 PIO

IOI-1045K 2 CTC's, 1 SIO, 1 PIO ..	\$179.95
IOI-1045A A & T	\$239.95
IOI-1046K 4 CTC's, 2 SIO's, 1 PIO ..	\$219.95
IOI-1046A A & T	\$299.95
IOI-1045B Bare board w/ manual ..	\$49.95

I/O-4 - S.S.M.

2 serial I/O ports plus 2 parallel I/O ports

IOI-1010K Kit	\$179.95
IOI-1010A A & T	\$249.95
IOI-1010B Bare board	\$35.00

S-100 Mainframes

MAINFRAME - Cal Comp Sys

12 slot S-100 mainframe with 20 amp power supply

ENC-112105 Kit	\$329.95
ENC-112106 A & T	\$399.95

DISK MAINFRAME - N.N.C.

Holds 2 8" drives and a 12 slot S-100 system. Attractive metal cabinet with 12 slot motherboard & card cage, power supply, dual fans, lighted switch, and other professional features

ENS-112325 with 25 amp p.s.	\$799.95
----------------------------------	----------

Disk Drives

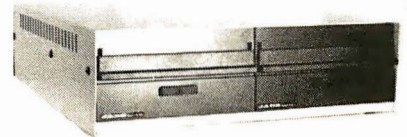

Handsome metal cabinet with proportionally balanced air flow system • Rugged dual drive power supply • Power cable kit • Power switch, line cord, fuse holder, cooling fan • Never-Mar rubber feet • All necessary hardware to mount 2-8" disk drives, power supply, and fan • Does not include signal cable

Dual 8" Subassembly Cabinet

END-000420 Bare cabinet	\$59.95
END-000421 Cabinet kit	\$225.00
END-000431 A & T	\$359.95

8" Disk Drive Subsystems

Single Sided, Double Density

END-000423 Kit w/2 FD100-8Ds ..	\$924.95
END-000424 A & T w/2 FD100-8Ds ..	\$1124.95
END-000433 Kit w/2 SA-801Rs ..	\$999.95
END-000434 A & T w/2 SA-801Rs ..	\$1195.00

8" Disk Drive Subsystems

Double Sided, Double Density

END-000426 Kit w/2 DT-8s	\$1224.95
END-000427 A & T w/2 DT-8s ..	\$1424.95
END-000436 Kit w/2 SA-851Rs ..	\$1495.00
END-000437 A & T w/2 SA-851Rs ..	\$1695.00

QUME DT-8

8" Double-Sided, Double-Density Disk Drive

1 Drive ...	\$524.95 each
2 Drives ..	\$499.95 each
10 Drives	\$479.95 each

Jade Part Number MSF-750080

Shugart 801R

8" Single-Sided, Double-Density Disk Drive

1 Drive ...	\$394.95 each
2 Drives ..	\$389.95 each

Jade Part Number MSF-10801R

SIEMENS 8"

8" Single-Sided, Double-Density Disk Drive

1 Drive ...	\$384.95 each
2 Drives ..	\$349.95 each
10 Drives	\$324.95 each

Jade Part Number MSF-201120

Shugart 400

5 1/4" Single-Sided, Double-Density Disk Drive

1 Drive ...	\$234.95 each
2 Drives ..	\$224.95 each
10 Drives	\$219.95 each

Jade Part Number MSM-104000

END-000213 Case & power supply	\$74.95
--------------------------------------	---------

7400

SN7400N	.20	SN74126N	.29
SN7401N	.20	SN74127N	.29
SN7402N	.25	SN74128N	.29
SN7403N	.25	SN74129N	.29
SN7404N	.25	SN74130N	.29
SN7405N	.29	SN74131N	.29
SN7406N	.35	SN74132N	.29
SN7407N	.35	SN74133N	.29
SN7408N	.29	SN74134N	.29
SN7409N	.29	SN74135N	.29
SN7410N	.25	SN74136N	.29
SN7411N	.29	SN74137N	.29
SN7412N	.35	SN74138N	.29
SN7413N	.40	SN74139N	.29
SN7414N	.40	SN74140N	.29
SN7415N	.29	SN74141N	.29
SN7416N	.29	SN74142N	.29
SN7417N	.29	SN74143N	.29
SN7420N	.25	SN74144N	.29
SN7421N	.29	SN74145N	.29
SN7422N	.45	SN74146N	.29
SN7423N	.29	SN74147N	.29
SN7424N	.29	SN74148N	.29
SN7425N	.29	SN74149N	.29
SN7426N	.29	SN74150N	.29
SN7427N	.25	SN74151N	.29
SN7428N	.40	SN74152N	.29
SN7429N	.29	SN74153N	.29
SN7430N	.25	SN74154N	.29
SN7431N	.29	SN74155N	.29

74LS

74LS00	.29	74LS192	1.15
74LS01	.20	74LS193	1.15
74LS02	.20	74LS194	1.15
74LS03	.20	74LS195	1.15
74LS04	.35	74LS196	1.15
74LS05	.35	74LS197	1.15
74LS06	.35	74LS198	1.15
74LS07	.35	74LS199	1.15
74LS08	.35	74LS200	1.15
74LS09	.35	74LS201	1.15
74LS10	.35	74LS202	1.15
74LS11	.35	74LS203	1.15
74LS12	.35	74LS204	1.15
74LS13	.35	74LS205	1.15
74LS14	.35	74LS206	1.15
74LS15	.35	74LS207	1.15
74LS16	.35	74LS208	1.15
74LS17	.35	74LS209	1.15
74LS18	.35	74LS210	1.15
74LS19	.35	74LS211	1.15
74LS20	.35	74LS212	1.15
74LS21	.35	74LS213	1.15
74LS22	.35	74LS214	1.15
74LS23	.35	74LS215	1.15
74LS24	.35	74LS216	1.15
74LS25	.35	74LS217	1.15
74LS26	.35	74LS218	1.15
74LS27	.35	74LS219	1.15
74LS28	.35	74LS220	1.15
74LS29	.35	74LS221	1.15
74LS30	.35	74LS222	1.15
74LS31	.35	74LS223	1.15
74LS32	.35	74LS224	1.15
74LS33	.35	74LS225	1.15
74LS34	.35	74LS226	1.15
74LS35	.35	74LS227	1.15
74LS36	.35	74LS228	1.15
74LS37	.35	74LS229	1.15
74LS38	.35	74LS230	1.15
74LS39	.35	74LS231	1.15
74LS40	.35	74LS232	1.15
74LS41	.35	74LS233	1.15
74LS42	.35	74LS234	1.15
74LS43	.35	74LS235	1.15
74LS44	.35	74LS236	1.15
74LS45	.35	74LS237	1.15
74LS46	.35	74LS238	1.15
74LS47	.35	74LS239	1.15
74LS48	.35	74LS240	1.15
74LS49	.35	74LS241	1.15
74LS50	.35	74LS242	1.15

74S

74S00	.45	74S243	3.25
74S01	.45	74S244	3.25
74S02	.45	74S245	3.25
74S03	.45	74S246	3.25
74S04	.45	74S247	3.25
74S05	.45	74S248	3.25
74S06	.45	74S249	3.25
74S07	.45	74S250	3.25
74S08	.45	74S251	3.25
74S09	.45	74S252	3.25
74S10	.45	74S253	3.25
74S11	.45	74S254	3.25
74S12	.45	74S255	3.25
74S13	.45	74S256	3.25
74S14	.45	74S257	3.25
74S15	.45	74S258	3.25
74S16	.45	74S259	3.25
74S17	.45	74S260	3.25
74S18	.45	74S261	3.25
74S19	.45	74S262	3.25
74S20	.45	74S263	3.25
74S21	.45	74S264	3.25
74S22	.45	74S265	3.25
74S23	.45	74S266	3.25
74S24	.45	74S267	3.25
74S25	.45	74S268	3.25
74S26	.45	74S269	3.25
74S27	.45	74S270	3.25
74S28	.45	74S271	3.25
74S29	.45	74S272	3.25
74S30	.45	74S273	3.25
74S31	.45	74S274	3.25
74S32	.45	74S275	3.25
74S33	.45	74S276	3.25
74S34	.45	74S277	3.25
74S35	.45	74S278	3.25
74S36	.45	74S279	3.25
74S37	.45	74S280	3.25
74S38	.45	74S281	3.25
74S39	.45	74S282	3.25
74S40	.45	74S283	3.25
74S41	.45	74S284	3.25
74S42	.45	74S285	3.25
74S43	.45	74S286	3.25
74S44	.45	74S287	3.25
74S45	.45	74S288	3.25
74S46	.45	74S289	3.25
74S47	.45	74S290	3.25
74S48	.45	74S291	3.25
74S49	.45	74S292	3.25
74S50	.45	74S293	3.25

CA-LINEAR

CA3010H	.45	CA3089N	3.75
CA3013H	2.15	CA3096N	3.75
CA3023H	3.25	CA3100H	1.25
CA3035H	2.49	CA3101H	1.25
CA3038H	1.35	CA3106H	1.25
CA3046N	1.30	CA3401N	.50
CA3059N	3.25	CA3600N	3.50

CD-CMOS

CD4000	.39	CD4098	2.49
CD4001	.39	CD4506	.75
CD4002	.39	CD4507	.75
CD4006	1.19	CD4510	1.39
CD4007	.39	CD4511	1.29
CD4009	.49	CD4512	1.29
CD4010	.49	CD4513	1.29
CD4011	.39	CD4514	1.39
CD4012	.39	CD4515	2.95
CD4013	.49	CD4516	1.49
CD4014	1.39	CD4518	.79
CD4015	1.19	CD4519	1.89
CD4016	.59	CD4520	1.29
CD4017	.59	CD4521	1.29
CD4018	.99	CD4522	1.29
CD4019	.49	CD4523	1.29
CD4020	1.19	CD4524	2.79
CD4021	1.39	CD4525	11.95
CD4022	1.19	CD4526	2.79
CD4023	.29	CD4527	2.49
CD4024	.29	CD4528	.75
CD4025	.29	CD4529	.75
CD4026	.29	CD4530	.75
CD4027	.69	CD4531	.75
CD4028	.89	CD4532	.75
CD4029	1.49	CD4533	.75
CD4030	1.49	CD4534	.75
CD4031	3.49	CD4535	.75
CD4032	.49	CD4536	.75
CD4033	.49	CD4537	.75
CD4034	.49	CD4538	.75
CD4035	.49	CD4539	.75
CD4036	.49	CD4540	.75

Phone Tunes

As Seen on "Good Morning America" Replaces the Telephone Ringer Bell with a Selection of 30 Familiar Tunes



Each Unit will play any of the following tunes:

- Close Encounters
- Happy Birthday
- Wedding March
- Jingle Bells
- Mexican Hat Dance
- Twinkle, Twinkle Little Star
- Deutschlandlied
- God Save the Queen
- Greensleeves
- William Tell Overture
- Eyes of Texas
- Star Spangled Banner
- Orange and Lemons
- Soldiers Chorus
- Sailor's Hornpipe
- Charge!
- Pomp & Circumstance
- Bach Toccata in D Minor
- Shave and a Haircut
- Blue Danube Waltz
- Beechoven's 5th
- La Marseillaise

Replaces monotonous telephone ringer bell. EASY connects to any standard telephone. Can be used alongside regular phone or replace a remote ringer elsewhere in building or outdoors. FCC approved. Can be used on any telephone system - worldwide. Use a different tune to identify extension phones. Microprocessor controlled. Adjustable volume control and variable tune speed control. Operates on two 1/2 volt batteries or AC Adapter (not included).

PT030 Phone Tunes \$49.95
AD30 AC Adapter \$8.95

DISCRETE LEADS

XC556R .200" red	5/51	MV50 .085" red	6/51
XC556G .200" green	4/51	XC209R .125" red	5/51
XC556Y .200" yellow	4/51	XC209G .125" green	4/51
XC556C .200" clear	4/51	XC209Y .125" yellow	4/51
XC222R .200" red	5/51	XC252R .185" red	5/51
XC222G .200" green	4/51	XC252G .185" green	4/51
XC222Y .200" yellow	4/51	XC252Y .185" yellow	4/51
MV10B .170" red	4/51	XC252C .185" clear	4/51

Diffused Bi-Color LED
Part No. 1-99 100+
XC5491 .79 .69

CS536 Red LED, METAL MFG. HOW. 2+4
RL-2 .\$.39 ea. or 3/\$1.00

DISPLAY LEADS

C.A. - Common Anode D.D. - Double Digit
R.C.D. - Common Cathode R.H.D. - Right Hand Decimal

Type	Polarity	Ht	Price	Type	Polarity	Ht	Price
MAN 1	C.A.-red	.270	2.95	DLG507	C.A.-green	.500	1.25
MAN 2	S.D.T.M.-red	.300	4.95	DL704	C.C.-red	.300	1.25
MAN 3	C.C.-red	.125	.25	DL708	C.C.-red	.300	1.25
MAN 52	C.A.-green	.300	.99	DL728	C.C.-orange	.300	1.49
MAN 54	C.C.-green	.300	.99	DL741	C.A.-red	.600	1.25
MAN 71	C.A.-red	.300	.75	DL747	C.A.-red	.600	1.49
MAN 72	C.A.-red	.300	.75	DL750	C.C.-orange	.800	1.49
MAN 74	C.C.-red	.300	1.25	DL850	C.C.-orange	.800	1.49
MAN 82	C.A.-yellow	.300	.49	DL338	C.C.-red	.110	.35
MAN 84	C.C.-yellow	.300	.99	FND33B	C.C. ± 1	.357	.99
MAN 3620	C.A.-orange	.300	.49	FND357	C.C. (FND503)	.357	.75
MAN 3630	C.A.-orange ± 1	.300	.99	FND500	C.A. (FND510)	.500	.99
MAN 3640	C.C.-orange	.300	.99	FND507	C.A. (FND510)	.500	.99
MAN 4610	C.C.-orange	.400	.99	HDS-P3401	C.C.-red	.800	1.50
MAN 6610	C.A.-orange-DD	.560	.99	HDS-P3403	C.C.-red ± 1	.800	1.50
MAN 6630	C.A.-orange ± 1	.560	.99	HDS-P3406	C.C.-red ± 1	.800	1.50
MAN 6640	C.C.-orange-DD	.560	.99	C.A.R.H.D.-red	430	1.25	
MAN 6650	C.C.-orange ± 1	.560	.99	5082-7760	C.C.R.-R.H.D.	430	1.25
MAN 6660	C.A.-orange	.560	.99	5082-7300	4x7Numeric (RHD)	600	22.00
MAN 6710	C.A.-red-DD	.560	.99	5082-7302	4x7Numeric (LHD)	600	22.00
MAN 6740	C.C.-red-DD	.560	.99	5302-7340	4x7Hexd. (0-9/A-F)	600	22.50
MAN 6750	C.C.-red ± 1	.560	.99	4N28	Photo Xisistor Opto-Isol.	.69	
DLO304	C.C.-orange	.300	1.25	L1-1	Photo Xisistor Opto-Isol.	.69	
DLO307	C.A.-orange	.300	1.25	MOC310	Optically Isol. Triac Driver	1.25	
DLG500	C.C.-green	.500	1.25				

COMPUTER GRADE CAPACITORS

MFD	WVDC	PRICE	MFD	WVDC	PRICE	MFD	WVDC	PRICE
250	150	1.95	10,000	15	2.95	24,000	70	2.95
500	150	2.49	10,000	15	3.49	24,000	70	2.95
1,000	150	3.99	10,000	15	4.99	33,000	25	4.95
1,500	25	1.95	11,000	30	5.49	40,000	25	5.95
2,000	25	2.49	11,000	30	5.99	40,000	25	5.95
2,500	10	1.95	13,000	16	2.95	50,000	20	7.95
3,000	10	2.49	13,000	16	3.49	50,000	20	7.95
3,500	10	2.99	14,000	35	3.95	55,000	15	3.95
4,000	10	3.49	15,000	20	4.95	60,000	10	7.95
4,500	25	4.49	20,000	20	2.95	65,000	10	7.95
5,000	25	4.99	20,000	20	3.45	70,000	5	7.95
5,500	25	5.49	23,000	7	1.95	90,000	10	8.95
6,000	40	4.95	23,000	20	3.95	200,000	3	12.95

OVER 200 OTHER VALUES AVAILABLE - CALL OR WRITE FOR YOUR REQUIREMENT

LOW PROFILE (TIN) SOCKETS

Pin	1-24	25-49	50-100
8 pin LP	.17	.16	.15
14 pin LP	.20	.19	.18
16 pin LP	.22	.21	.20
18 pin LP	.29	.28	.27
20 pin LP	.34	.32	.30
22 pin LP	.37	.36	.35
24 pin LP	.38	.37	.36
28 pin LP	.45	.44	.43
36 pin LP	.60	.59	.58
40 pin LP	.63	.62	.61

SOLDERTAIL STANDARD (TIN)

Pin	1-24	25-49	50-100
8 pin ST	.27	.25	.24
14 pin ST	.30	.27	.25
16 pin ST</			

7400

SN7400N	.19	SN74123N	.59
SN7401N	.22	SN74125N	.39
SN7402N	.22	SN74126N	.44
SN7403N	.22	SN74127N	.59
SN7404N	.22	SN74132N	.69
SN7405N	.23	SN74136N	.75
SN7406N	.23	SN74139N	.95
SN7407N	.23	SN74141N	.79
SN7408N	.26	SN74142N	.29
SN7409N	.22	SN74143N	2.18
SN7410N	.22	SN74144N	.62
SN7411N	.29	SN74145N	.95
SN7412N	.29	SN74147N	1.95
SN7413N	.39	SN74148N	1.20
SN7414N	.59	SN74150N	1.09
SN7416N	.29	SN74151N	.67
SN7417N	.29	SN74152N	.67
SN7420N	.22	SN74153N	.67
SN7421N	.35	SN74154N	1.19
SN7422N	.29	SN74155N	.78
SN7423N	.29	SN74156N	.78
SN7425N	.29	SN74157N	.69
SN7426N	.29	SN74158N	1.65
SN7427N	.25	SN74160N	.88
SN7429N	.45	SN74161N	.88
SN7430N	.23	SN74162N	.89
SN7432N	.29	SN74163N	.87
SN7437N	.25	SN74164N	.87
SN7438N	.29	SN74165N	.87
SN7439N	.19	SN74166N	1.20
SN7440N	.19	SN74167N	1.95
SN7441N	.79	SN74170N	1.69
SN7442N	.39	SN74172N	4.75
SN7443N	.95	SN74173N	1.19
SN7444N	.95	SN74174N	.89
SN7445N	.79	SN74175N	.85
SN7446N	.79	SN74176N	.75
SN7447N	.65	SN74177N	.75
SN7448N	.79	SN74178N	1.34
SN7450N	.19	SN74180N	1.75
SN7451N	.19	SN74181N	.75
SN7453N	.19	SN74182N	.75
SN7454N	.19	SN74184N	2.25
SN7459N	.25	SN74185N	2.25
SN7460N	.29	SN74186N	9.95
SN7462N	.29	SN74188N	9.95
SN7463N	.29	SN74190N	1.15
SN7473N	.34	SN74191N	1.15
SN7474N	.34	SN74192N	.85
SN7475N	.38	SN74193N	.85
SN7476N	.34	SN74194N	.85
SN7479N	4.60	SN74195N	.68
SN7480N	.49	SN74196N	.85
SN7482N	.55	SN74197N	.85
SN7483N	.55	SN74198N	1.39
SN7485N	.65	SN74199N	1.39
SN7486N	.65	SN74200N	1.19
SN7489N	1.75	SN74201N	.95
SN7490N	.39	SN74202N	1.05
SN7491N	.57	SN74203N	1.75
SN7492N	.45	SN74204N	1.40
SN7493N	.45	SN74205N	3.90
SN7494N	.69	SN74206N	1.19
SN7495N	.65	SN74207N	1.25
SN7496N	.69	SN74208N	.95
SN7497N	2.90	SN74209N	.68
SN7498N	1.20	SN74210N	.68
SN7499N	.32	SN74211N	.68
SN74100N	2.90	SN74212N	1.90
SN74101N	.32	SN74213N	1.90
SN74102N	.32	SN74214N	1.90
SN74103N	.32	SN74215N	1.90
SN74104N	.32	SN74216N	1.90
SN74105N	.32	SN74217N	1.90
SN74106N	.32	SN74218N	1.90
SN74107N	.32	SN74219N	1.90
SN74108N	.32	SN74220N	1.90
SN74109N	.32	SN74221N	1.90
SN74110N	.32	SN74222N	1.90
SN74111N	.32	SN74223N	1.90
SN74112N	.32	SN74224N	1.90

74LS00

74LS00N	.26	74LS164N	1.19
74LS01N	.28	74LS165N	.89
74LS02N	.28	74LS166N	2.48
74LS03N	.28	74LS168N	1.15
74LS04N	.28	74LS169N	1.15
74LS05N	.28	74LS170N	1.99
74LS08N	.28	74LS173N	.89
74LS09N	.35	74LS174N	.89
74LS10N	.28	74LS175N	.89
74LS11N	.39	74LS181N	2.20
74LS12N	.75	74LS190N	7.15
74LS13N	.47	74LS191N	1.15
74LS14N	.95	74LS192N	.98
74LS15N	.33	74LS193N	.98
74LS20N	.36	74LS194N	1.15
74LS21N	.33	74LS195N	.95
74LS22N	.33	74LS196N	.95
74LS26N	.33	74LS197N	.89
74LS27N	.33	74LS221N	1.15
74LS28N	.33	74LS240N	1.69
74LS30N	.26	74LS241N	1.69
74LS32N	.33	74LS242N	1.69
74LS33N	.33	74LS243N	1.69
74LS37N	.45	74LS244N	1.49
74LS38N	.39	74LS245N	2.20
74LS40N	.26	74LS247N	1.10
74LS42N	.79	74LS248N	1.10
74LS47N	.79	74LS249N	1.10
74LS48N	.79	74LS250N	1.40
74LS51N	.26	74LS253N	.98
74LS54N	.29	74LS257N	.85
74LS55N	.29	74LS258N	.98
74LS57N	.45	74LS259N	2.95
74LS58N	.42	74LS260N	.65
74LS59N	.42	74LS261N	.65
74LS62N	.59	74LS266N	.59
74LS67N	.45	74LS273N	1.75
74LS68N	.79	74LS275N	4.40
74LS69N	1.19	74LS279N	.99
74LS73N	.45	74LS283N	.99
74LS74N	.42	74LS290N	.59
74LS76N	.42	74LS292N	.99
74LS78N	.45	74LS293N	.99
74LS79N	.79	74LS295N	1.10
74LS82N	.99	74LS298N	1.19
74LS83N	.99	74LS324N	1.75
74LS85N	1.19	74LS327N	1.95
74LS86N	.45	74LS343N	1.95
74LS87N	.45	74LS344N	1.95
74LS89N	.75	74LS352N	1.19
74LS92N	.75	74LS353N	1.19
74LS95N	.88	74LS363N	1.49
74LS96N	.88	74LS365N	.69
74LS98N	.88	74LS367N	.69
74LS107N	.45	74LS368N	.69
74LS112N	.43	74LS373N	1.89
74LS113N	.43	74LS374N	1.89
74LS114N	.43	74LS375N	1.89
74LS122N	.55	74LS376N	1.89
74LS123N	.119	74LS377N	1.89
74LS124N	.69	74LS385N	1.95
74LS125N	.89	74LS386N	1.95
74LS126N	.52	74LS389N	1.95
74LS132N	.79	74LS390N	1.95
74LS136N	.49	74LS393N	1.95
74LS139N	.65	74LS395N	1.95
74LS145N	1.25	74LS396N	1.95
74LS148N	1.49	74LS399N	1.95
74LS151N	.79	74LS399N	1.95
74LS153N	.79	74LS399N	1.95
74LS154N	1.70	74LS399N	1.95
74LS155N	2.35	74LS424N	2.95
74LS156N	.99	74LS568N	1.75
74LS157N	.85	74LS670N	2.29
74LS158N	.75	81LS95N	1.69
74LS160N	1.05	81LS95N	1.69
74LS161N	1.05	81LS97N	1.69
74LS162N	1.05	81LS98N	1.69
74LS163N	1.05	81LS98N	1.69

16K UPGRADE ONLY \$24.95 SPECIFY COMPUTER

hp HEWLETT PACKARD

HP-95 \$2695.00

HP 7225 Graphics Plotter 1795.00
 HP 16K Memory Module 2650.00
 HP 5 1/4" Dual Master Flex. Disk Drive 2100.00
 HP 5 1/4" Single Master Flex. Disk Drive 1285.00
 HP Personality Module 700.00
 HP ROM Drawer 400.00
 HP Plotter/Printer ROM 130.00
 HP Input/Output ROM 260.00
 HP Matrix ROM 130.00
 HP Serial Interface (RS-232C) 350.00

HP-83 \$1895.00

HP-41: Powerful, Yet Easy to Use

- The HP-41 communicates with you in words as well as numbers
- You can customize the HP-41 to your own design.
- Programming is fast and easy
- Continuous Memory saves everything!
- Optional Peripherals allow you to expand capabilities

HP-41-CV 398.00
 HP-41 System II 675.00
 HP-41 Card Reader 178.00
 HP-41 Optical Wand 105.00
 HP-41C HP-Plotter/Printer 315.00
 HP-Quad RAM 85.00

Microbot MINIMOVER-5 ROBOTIC ARM

Completely Assembled w/Applications Manual

- Automation or Robotic Assembly
- Education in Robotic Principles
- Artificial Intelligence Experiments
- Computer Art and Games

\$1695.00

Armbasic Software for TRS-80 w/Applications Manual \$399
 Applications/Reference Manual \$169

California Computer Systems 2200

SUPER S-100 BUY!

- 12 Slot Mainframe
- 64 Dynamic RAM
- CP/M™ 2.2
- 2-80 CPU @ 4MHz w/Serial ID
- Double Density Disk Controller
- Interface to Vista V-1000 Chassis

SPECIAL PACKAGE PRICE FOR COMPLETE SYSTEM 1899.00

with (2) Shugart Double Density Floppys mounted. add **1495.00**

Proto Clips

14-Pin Clip	PC-14	\$ 4.25
16-Pin Clip	PC-16	\$ 4.50
18-Pin Clip	PC-18	\$ 9.50
40-Pin Clip	PC-40	\$14.95

Proto Boards

PB-6	16.95	PB-104	54.00
PB-10	11.00	PB-203	37.00
PB-11	21.00	PB-203A	14.90
PB-12	12.00	PB-203A-KIT	129.00
PB-13	43.00		

Novation AUTO-CAT™

Automatic Answer Direct Connect 0-300 Band

List 279.95 **ACP 245.95**

CAT™ List 198.00 **ACP 169.00**

Answer Originate

D-CAT™ direct Connect 0-300 Band. List 249.95 **ACP 189.00**

Rockwell Single Board Computers

AIM 65 w/1K	435.00
AIM65 w/4K	475.00
8K BASIC ROM	93.00
4K ASSEMBLER ROM	84.00
POWER SUPPLY	64.95
ENCLOSURE	49.95
TOTAL SYSTEM w/Kit	669.00
SYNERTEC SYM-1	239.00
SD 2-80 STARTER KIT	367.00
SD 2-80 STARTER KIT A.T.	450.00
SD SBC 100 2-80 A.T.	367.00
SD SBC 200 2-80 A.T.	399.00
RCA COSMAC VIP	193.00
CHROMEMO 2-80 SBC	449.00

ADVANCED COMPUTER PRODUCTS

Apple Computer Sales and Service

Apple II® 64K

- Z-80 Softcard Maxi-System
- 16K Ram Card
- Disk II w/controller
- Apple II w/48K

Call for more pricing!

Total Value \$2719.00 your price \$2229.00 save! For Pascal System add \$251.00

Apple II hardware clearance up to 25% off

VISTA COMPUTER				
Datascraper™ Interchangeable P.S.	395.00	New	CCS Parallel Card#720A	155.00
Vocalizer™ Voice Card	225.00	New	Apple Computer	
Vision 80™ 80x2 Card	325.00	New	Apple Hi-Speed Serial I/O	174.95
Vision 60™ Video Enhancement	172.00	New	Centronics Printer I/O	179.95
A 800 Quad Density 8" Controller	5500.00	New	Appsoft II Firmware	159.95
Microsoft Z80 Softcard	259.00		Apple Graphics Tablet	599.95
Microsoft 16K Ram Card	169.00		Apple II w/48K	244.95
SSM A/D Serial/Parallel I/O	185.00		Apple Prototyping Card	21.95
CCS Asynchronous TTY & Serial	139.00		Apple Disk II w/48K	459.95
Apple Jostic™ GDSU	54.95		Apple Disk II	459.95
Mountain Computer			Pascal Language Card	425.95
ROMax™	169.00		Parallel Printer Card	159.95
ROM Writer	159.00		Communication Card	169.00
Intro/IO Remote Cont. Sys.	249.00		Imaging ROM Card	159.95
Super Talker	275.00		Call. Prod. Viscasic Keyboard	169.95
Music System	499.00		M & R Super Mod.	49.95
CP/M Multifunction	228.00	New	Corvus 575 Hard Disk	369.00
Expansion Chassis	699.00	New	Corvus 10MB Hard Disk	Call
DC Hayes Smart Modem	349.95	New	Corvus 20MB Hard Disk	Call
Transcommunications	49.00	New	Corvus Contention Kit	Call
X-1010™ Option	49.00	New	ADP 115 Upgrade Kit	24.95
Pascal For Above™	29.00	New	Scott Voice Recognition VET-2	695.00

Apple Triple Play!

- Apple III 128K RAM Information Analysis Pkg 12" Green Phosphor Monitor Disk II for Apple III Silent-type Printer**
4200.00
- Apple III 128K RAM Information Analysis Pkg 12" Green Phosphor Monitor Disk II for Apple III Silent-type Printer**
5100.00
- Apple III 128K RAM Information Analysis Pkg 12" Green Phosphor Monitor Disk II for Apple III Silent-type Printer**
5500.00

Buy a System and Save

New Apple software

Visicalc—Now Better Than Ever 169.00
 Visicalc—Grand 229.00
 Visicalc Worksheets 149.00
 Visi-Trend/Visiplot—Visiplot w/Trend Analysis 239.00
 VisiCalc—The Ultimate DBMS Visicalc Compatible 219.00
 Visiterm—Communicate w/other Systems 299.00
 BPI General Ledger 209.00
 BPI Accounts Receivable 299.00
 BPI Inventory 299.00
 Stockfile Inventory System 349.00
 Inventory Inventory System 289.00
 Microcom Microcomputer 229.00
 Microcom Micrograph 229.00
 Accounting Plus II Btz Pkg. 1250.00
 Stoneware DB Master 189.00
 Stoneware Utility Pkg (For above) 89.00

WORDSTAR—The Benchmark of Word processing software requires Z-80 & 80x24 349.00

VTS-80 CP/M-Wordprocessor has no screen menu uses new keycaps (supplied) to display Key functions 319.00 New

MAIL-MERGE-A Wordstar Enhancement Pkg. allows form-letter generation & chained printing 169.00

SPELL-GUARD-Vill proofread Wordstar & VTS-80 Text files against an expandable 20,000 word dictionary 169.00

SUPER SORT-Vill sort, merge & perform record selection on your CP/M Data Files 169.00

FORTRA 80-By Microsoft 195.00

COLBOL 80-By Microsoft 749.00

ACS BASIC ACCOUNTING SYSTEM. Total accounting system includes G/L, AIR, A/P, PAYROLL 699.00 New

Breakthru in Apple II® Mass Storage!

Vista A800 Quad Density DMA 8" Disk Controller

Model A800... only \$595.00

Special Complete Subsystem Offer

- V1000 w/Two Qume Datatrack 8" Cable, ready to run
- A800 Apple II 8" Disk Controller

Total Value \$2939.00 your price \$2495.00

ATARI 800 & 400 Personal Computer System

ATARI 800 \$799.00
ATARI 400 \$375.00

ATARI 800 Includes: Computer Console, BASIC Lang. Cartridge, BASIC Language Programming Manual, 800 Operator's Manual w/Notebook, 16K RAM Module, Power Supply, TV Switch Box.

PowerSoft					
810 Disk Drive	499.00	Home Finance	550.00	Basic Electricity	35.00
800 Print-Air Kit	225.00	Basic Astronomy	35.00	Basic Anatomy	35.00
800 Power-800 Kit	295.00	U.S. Government	35.00	Basic Bank and Program Calculators	15.00
8K Print-Air	49.95	Supervisor Skills	35.00	Guide to BASIC Programming	19.00
800 Interface	189.95	World History—Western	35.00	BASIC Game Programs	19.00
Program Recorder	69.00	Basic Science	35.00	8K RAM Memory Module	175.00
Solution—IBM Cartridges		Basic Sociology	35.00	16K RAM Memory Module	210.00
Business Communications	280.00	Principles of Accounting	35.00	8K Disk Drives	
Atari BASIC	55.				

California Digital

Post Office Box 3097 B • Torrance, California 90503



DISKETTES

FREE PLASTIC LIBRARY CASE INCLUDED WITH THE PURCHASE OF EVERY BOX OF DISKETTES

Private labeled for California Digital by one of the most respected producers of magnetic media. Each diskette is certified double density at 40 tracks. To insure extended media life each diskette is manufactured with a reinforced hub-hole. And of course, a plastic library case is included with every box of diskettes. **MMB-CDS(01K10)** Please specify country or required sectors.

\$24.95
BOX

Ten boxes \$22.75 One hundred boxes \$21.50

MINDISKETTES	Box	10 boxes	Box	10 boxes
Memorex 3401	\$27.00	\$25.00	Scotch 74-10(10)(16)	\$31.00
Verbatim 525(01K10)	28.00	27.00	Dynas	43.00

EIGHT INCH	Scotch	box	10 bx.	Dynas	box	10 bx.	MRN	box	10 bx.
Single side/single den.	740-0	35.	33.	37-10(1)	84.	37.	300	8.	8.
Single side/double den.	741-0	45.	43.	37-10(1)	75.	33.	300	37.	35.
Double side/double den.	742-0	55.	53.	na.	na.	na.	na.	na.	na.
Double side/double den.	743-0	65.	63.	na.	na.	na.	na.	na.	na.

SCOTCH brand head cleaning kit. \$24.95 MMB-CMS(8) please specify 3 1/4" 8" Prices available on request for: tape, cartridges, diskpacks, volum diskettes.

MEMORY

64K DYNAMIC \$11.95	16K STATIC \$13.95
4164 100-19.75	2167 200ns.
16K DYNAMIC \$2.10	2716 EPROM \$4.95
4116 100-11.85	100-14.50 1K-44.00



2732 EPROM SALE \$8.95

STATIC

	ca.	32+	100+	1K+
211.02	450ns.	1.19	1.05	.99
211.02	250ns.	1.49	1.45	1.39
211.14	450ns.	3.95	2.95	2.75
211.14L3	300ns.	4.25	3.75	3.00
40-14-4	450ns.	4.95	4.50	4.25
40-14-2	250ns.	5.50	4.95	4.50
5257-3	300ns.	4.47	4.25	4.05

EPROM

2708	450ns	4.95	4.50	3.75	3.25
2716	5V.	4.95	4.50	4.00	
2716	tri-volt	9.95	9.00	8.25	7.50
2732	Intel	9.00	8.50	8.00	
2532	1T	21.50	19.00		
2764		*			



direct connect MODEM Your Choice **\$169**

Direct connect modems eliminate loss of information due to the carbon compression associated with acoustic modems. Choose either of these two great units.

The Universal Data Systems DMLP is switch selectable between answer and originate modes. 1416 16-11 PPI compatible. Directly connects to the new modular telephone with 100% protection from the telephone line. No need to locate modem in proximity to A.C. power receptacle. **MOB-10-211** 2 pounds.

Novation "DF" Cat connects to most of the new "Bell" modular handsets. Ideal for multiple line office telephones. Requires external A.C. power. **MOB-DUAT 2 LB.**

Universal Data Auto Answer 103LPJ \$219
Novation Auto Cat RS232 \$239

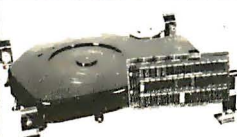

26 Megabyte Hard Disk Drive from GEORGE MORROW'S Thinker Toys \$3495

Other Morgan Products.	Price	Disc Access 2B controller	Price
Additional hard disk	280.00	Disc Access 1 Controller	195
Discus 2B 1 drive	350	3756 hard disk Controller	625
Discus 2B 2 drives	625	Switchboard Interface	230
Discus 2B 1 drive	32.00	New Multibyte	275
Discus 2B 2 drives	22.75	M-10 Ten Megabyte hard	2500

POWER STATION \$99

Two Stage Noise Filter Surge Suppressor Line Voltage Meter

The Power House eliminates interference caused by noise generating motors and office machines. This product is a must for anyone who has experienced a power fault while operating a computer. Double filtering circuitry eliminates both high and low frequency line noise. Suppression devices clip voltage spikes above 120VAC. Volt meter monitors RMS line voltage. Switch power receptacle three circuit. Constructed in water resistant NEMA-4 industrial enclosure. CAL-PH6 12 lbs.



The new BSR timer runs your home just like clockwork. Turns on lamps and appliances while you're away from home. Completely compatible with your existing System X-10 devices. BSR Timer eight channel \$65.00 Appliance Module 500 W. \$13.95 Master control console \$4.95 Lamp Module 300 Watts \$3.95 Ultrasonic Controller \$11.95 New full control wall switch \$4.50

S-100 Mother Board \$35

Quiet Buss

IMSAI 18 Slot CAL-M18

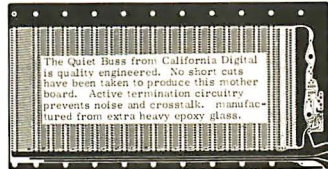

The Quiet Buss from California Digital is quality engineered. No short cuts have been taken to produce this mother board. Active termination circuitry prevents noise and cross-talk. Manufactured from extra heavy epoxy glass.

SWITCHES

DIP SWITCHES		FOGALL	
pos.	ca.	100+	1K+
1	1.88	.75	.49
2	1.89	1.84	.79
3	1.95	.91	.67
12	1.19	.92	.81

CONNECTORS

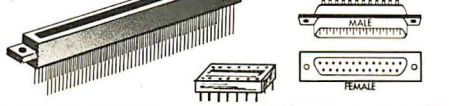

GOLD EDGE CONNECTORS		INTEGRATED CIRCUIT SOCKETS	
Low Profile	Wire Wrap	Low Profile	Wire Wrap
S-100 125" centers	each 100	8 pin 300	each 1000
Insul solder .250" row	\$2.55	8 pin 300	\$16 8.11
Insul wire wrap 47D	3.95	14 pin 300	23 .41
Sullins In-Rel. .250"	8.50	16 pin 300	25 .45
Sullins In-Rel. WW	5.35	24 pin 300	34 .87
Sullins /Altair .140"	4.95	40 pin 300	1.60 1.17

CENTRONICS		RIBBON CABLE CONNECTORS	
1714 2" disk	4.15	20/40 FRS-50	5.95
1717 2" disk	4.15	20/40 FRS-50	5.95
1718 2" disk	4.15	20/40 FRS-50	5.95
1719 2" disk	4.15	20/40 FRS-50	5.95
1720 2" disk	4.15	20/40 FRS-50	5.95



ZENITH GREEN PHOSPHOR MONITOR

The new Zenith ZVM-121 features a P31 green phosphor tube along with 15 MHz bandwidth. Switch selectable for 40/80 character screen. Fully compatible with 80 column Apple cards. **\$119**

VDM-Z131 20 lbs. **10 + '109 100 + '99**

Shugart Associates



\$395
801/ R Disk Drive 15 lbs. Shugart 801R with CP 206 power supply, muffin exhaust fan, complete in dual enclosure with all the necessary harnessing cables. Documentation included. 36 pounds. MSD-1801 Same as above but with two Shugart 801R disk drives. \$1195 50 pounds. MSD-2801 Disk drive cable, 6 feet 50 conductor with edge card connector at both ends. WCA-650S \$25.00 Export Disk drives. 220V. 50MHz add \$50.00 per disk drive.

SHUGART 801R \$395

Shugart 851R Double Sided ... \$525
Qume D78 Double Sided ... \$495



NEW from Shugart Technology 5 Megabyte Hard Disk Drive
Packaged in the same physical size as the industry standard 5 1/4" minifloppy disk drive. The micro-Winchester stores thirty times as much data (6.38 megabytes unformatted), accesses data twice as fast (170 milliseconds) and transfers data twenty times faster (5.0 megabits per second.)

The ST506 is factory sealed to protect the media from environmental contaminants. Requires only DC voltage. Dual California Digital 5 1/4" enclosure, \$1500 ST506 drive and power supply.

Shugart Associates SA400 removable media disk drive for above package. add: **\$300**

Regulated Power Supply 5VOLT 5AMP \$1195

This USED surplus power supply was removed from working equipment. Pass transistor regulation outputs five volts at a conservative five amps suitable for TTL logic applications. SPS-181 3 pounds.

TOLL FREE ORDER LINE (800) 421-5041 TECHNICAL & CALIFORNIA (213) 679-9001 TWX 910 325-6212



All merchandise sold by California Digital is premium grade. Shipping: First five pounds \$2.00; each additional add \$4.00 Foreign orders 10% shipping. Excess will be refunded. California residents add 8% sales tax. COD's discouraged. Open accounts extended to state supported educational institutions and companies with a "Strong Dun & Bradstreet." Warehouse: 15608 Inglewood Blvd. Visitors by appointment.

California Digital

Post Office Box 3097 B • Torrance, California 90503



BRUCE SEALS
Designer of the Static • 64

Those of us who remember back to 1974 when S-100 was in its infancy and assembling from kit your own Altair Computer will recall that the only working and in memory was the 8K static IC rd manufactured by Seals Electronics out of Knoxville Tennessee.

Ed Roberts and William Gates are credited for the design of the Altair computer. But Bruce Seals had the only working memory board.

By the time Mr. Seals' company was dissolved in 1979, Seals Electronics had sold over 47,000 of their 8K memory board.

Since the liquidation of Seals Electronics, Bruce has been hiding from the excavators and ramming moonshiners in the hills of Tennessee. After extensive negotiations California Digital has convinced Mr. Seals to come out of hiding and design the next generation of static memory boards.

The product that he has engineered is destined to become the next milestone in S-100 memory products.

In the next several months we expect to release a full line of computer products designed by Bruce Seals.

California Digital STATIC • 64

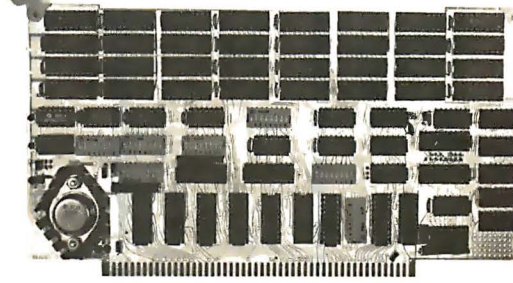

Utilizing the new "2167" ram chip, the Static 64 is the most current technology available in S-100 memory.

24 bit extended addressing, 8 or 15 bit data paths along with 16 bit request and acknowledge make this unique board completely compatible with the IEEE 696 bus standard.

The Static 64 has been engineered to allow each 18K circuit board specifications. IC sockets utilize ultra-reliable machine screw contacts are used to increase the total integrity of the product. Each board before leaving our facility is subjected to extensive high temperature testing and test procedures.

Unconditional one-year warranty with 24 hour repair or replacement of all boards purchased from California Digital. CEM sold dealer pricing upon request. CAL-6400.

\$850



EPSON MX80
\$475

Epson MX80FT friction/tr 559.00
Epson MX100 132 column 825.00
Ct-82trx 80 option 70.00
Apple I/O & cable (8131) 129.00
Serial Interface (81-41) 79.00
Cable for TRS-80 145.00
IEEE 488 interface (8161) 65.00
Replacement head 45.00
Replacement Ribbon 14.00
Paper 3500 sheets 9 1/2" 35.00



NEC PC-8023A
\$635

Dot-matrix, bi-directional, logic-seeking, friction or tractor feed, impact printer. Complete graphics, upper and lower case ASCII, Greek, mathematics along with the ability to print dot graphic screen images directly onto paper.

Proportional spacing and 132 column compressed print make this low cost machine the best value in today's printer market.



3101
Display Terminal

IBM Direct Price \$1395

California Digital
discount \$1295
price



AMPEX
DIALOGUE 80
CRT TERMINAL
\$995

New from the Ampex Corporation. The Dialogue 80 features removable keyboard, displayable two pages (four optional) dual program keys, half intensity protected fields and status line. Transmits data either block, line or character mode. Excellent value. VDT-D80 shipping 47 lbs.

VIDEO TERMINALS

ADDS Viewpoint	VDT-RVP	595
ADDS Regent 25 numeric cluster	VDT-R25	850
ADDS Regent 50 25th status line	VDT-R50	950
ADDS Regent 40 limited graphics	VDT-R40	1195
ADDS Regent 50 Block mode	VDT-R60	1495
Ampex Dialogue 80 two page detach	VDT-D80	995
Digital Equipment VT-100	VDT-V100	1595
Digital Equipment VT-132	VDT-V132	1895
Direct VP-800A emulator	VDT-P800	call
Hazeltine 1410	VDT-H1110	750
Hazeltine 1420	VDT-H11420	795
Hazeltine 1500	VDT-H1500	
Hazeltine 1510	VDT-H1510	
Hazeltine 1520	VDT-H1520	
Hewlett Packard 2621A	VDT-HP21A	
Hewlett Packard 3231P	VDT-HP21P	
IBM 3101-10 character mode green	VDT-3101	1195
IBM 3101-20 block mode	VDT-31012	1395
Lear Scitiger 3A upper case only	VDT-L3A	850
Lear Scitiger ADM5	VDT-L5	945
Lear Scitiger ADM31	VDT-L31	1365
Lear Scitiger ADM42	VDT-L42	1995
Visual 300	VDT-V200	995
Televideo 310C (new)	VDT-T910	595
Televideo 912C	VDT-T912	665
Televideo 920C	VDT-T920	745
Televideo 950C detachable keybd.	VDT-T950	985
Zenith Z-19	VDT-Z-19	735

VIDEO MONITORS

BMC KG12C 18MHz	\$259
P-31 gm phosphor	129
Leaflex/Amdek 12" 100	169
Leaflex 100 green	197
Leaflex 100-80	197
Hitachi color 13"	389
Zenith color 13"	379
NEC green phosphor	219
Panasonic color 10"	
Sanyo 9" BW	149
Sanyo 12" green phos.	235
Sanyo 15" BW	259
Sanyo 13" color	419

ACCESSORIES FOR THE APPLE COMPUTER

CALIFORNIA COMPUTER SYSTEMS	
Arithmetic Processor 7811 B/C	\$319
Asynchronous serial interface 7710	129
Centronics interface card 7728	95
12K PROM Module 7114	89
Calendar/Clock, Bat. back-up 7424	99
Parallel Interface 7720A	99
Programmable Timer 7740A	99
Analog/Digital converter 7470A	99
MICROSOFT PRODUCTS	
Apple to Z-80 CPU card	379
D. C. HAYES PRODUCTS	
MicroModem for Apple II	319
COMPUTER STOP PRODUCTS	
Double Vision / 80 Column Video	250
INTERACTIVE STRUCTURES	
16 Channel A/D card 3107/2	275
MOUNTAIN COMPUTER PRODUCTS	
Intro X-10 system for BSR	\$239
Intro X-10 card only	165
16 channel A/D 8 bit	319
Apple Clock battery back-up	225
Supertalker SD200	245
ROM Plus with filter	165
ROM Writer / Programmer	149
APPLE BRAND PRODUCTS	
Apple Language card	450
Floppy disk with controller	560
Floppy disk without controller	495
Apple parallel interface	175
SSI MICROCMPUTER	
Dual serial bus interface AIO	500
SORRENTO VALLEY ASSOCIATES	
8" floppy controller (Pascal)	360

S-100 BOARDS

Assembled • Tested • Burned-in

CPU BOARDS	
Calif. Computer 2810A Z-80	\$260
IBM 438L IBC-C7E10	
Goldstat Z-80 24 bit bus	239
Goldstat 8085/8088 dual 16 bit processor	375
Measurement Systems Z-100	
4 serial 2 parallel real time clock, 8 vector IBC-3120	365
SD Systems SMC-200 Z-80 with serial & parallel I/O ports	386
Teltek HMC-111 single board CPU & floppy disk controller plus I/O	695
MAIN FRAMES	
Calif. Computer 2200A 12 slot & power supply	349
E11 12 slot table ENM-112	
E11 22 slot table ENM-122	
Goldstat mainframe ENM-63M	
MEMORY BOARDS	
Calif. Computer 2065A 8K & static memory IBM-C7995	542
Calif. Computer 2065 16K static memory IBM-C2095	250
Calif. Computer 2032 45K static memory IBM-C2032	385
Goldstat Ram 17 64K static memory IBM-C417	1025
SD Systems Extranet 801	
IBM monome IBM-EX15	295
IBM monome IBM-EX95	375
Measurement Systems DMS450 for Alpha Altero IBM-AL6100	665
EPROM BOARDS	
Digital Research 32K 2716 prom's card IBM-EP32	89
SD Systems Prom-100 programmer IBM-100	250
FLOPPY DISK CONTROLLER	
Calif. Computer 2423A with 2 x CP/M 16 bit controller	329
Goldstat "Disk One" features the NEC 765 controller, DMA arbitration IBM-411	395
Measurement Systems 765 chip, single & double density, Error recovery IBM-411	419
SD Systems Versafloppy II double density IBM-VI2	419
Farwell D/D IBM-112	419
Marrow Design disk Jockey II Single density IBM-JI1	195
Marrow Design disk Jockey II double density IBM-JI2	345
INTERFACE BOARDS	
Calif. Computer 2718 I/O	
2 serial/2 par IBM-C2718	
Marrow Design Switchboard 2 serial/4 par IBM-MSB	219
Marrow Design MultiBoard 2 serial/4 par IBM-MMB	275
Goldstat Interface One 2 serial/2 par IBM-GI1	199
Goldstat Interface Two 1 serial/2 par IBM-GI2	199
SPECIALTY BOARDS	
CP Computer real time clock/calendar IBM-CC1	115
Artec Elec. Wire wrap prototype board IBM-WW	25
Artec Elec. Control Purpose proto board IBM-AGP	25
Goldstat Spectrum color board IBM-USC	295
D. C. Hayes S-100 Micro-modem IBM-1M	350
Multi-Products extension board & logic probe IBM-EP1	49
Multi-Products Auto-center board kit IBM-MOC	135

PRINTRONIX

P-300	\$4500
P-600	\$6150

Epson MX80	PRE-MX80	\$475
Epson MX80FT	PRE-MX80F	595
Epson MX100	PRE-MX100	825
Amdek 5500	PR-A500	1295
Anacom 150	PR-A150	1075
IDS Paper Tr.	PR-C460G	1095
IDS Tiger 560	PR-C560G	1350
Diablo 530	PR-D530	2150
Diablo 1550	PR-D1550	2850
Diablo 1640	PR-D1640	2496
Datasouth 180	PR-J180	1350
Printronic 300	PR-P300	4500
Printronic 600	PR-P600	6150
NEC/Sellum 1	PR-N5510ps	2695
NEC/Sm 16K	PR-N516ps	2795
TEC Starlit.	PR-V300	1395
Okiwada 80	PRO80	419
Okiwada 82	PRO82	619
Okiwada 83	PRO83	805
Teletype 43K	PT-1320K	1095
Texas Ins. 810	PRT810B	1450
Tex. Ins 810C	PRT810C	1795
Centronics 730	PR-C730P	529
Centronics 737	PR-C737P	695
Centronics 749	PR-C749P	795
Centrix 704-9	PR-C704-9	
Centrix 704-11	PR-C704-11	

SYSTEMS

APPLE III \$1150
48K MEMORY

\$2450 **HP** **HEWLETT PACKARD**
HP85

Hew/Pack 85	SY-SHP85	2650	Super-brain 64K SY-SNH64K	\$3650	
Hew/Pack 83	SY-SHP83	1895	Super-brain 64K SY-SNH64K	2950	
Altos ACS8000	SY-ACS8000	3795	Northstar 64 K SY-SNH64K	3295	
Osborn 1	SY-SOB1	1795	Northstar 64K SY-SNH64K	2895	
Commodore	SY-SC8032	1485	NEC/PC8000	SY-PC8000	call
Commodore	SY-SC8095	1795	Apple II Plus	SY-SAP	1170



All merchandise sold by California Digital is premium grade. Shipping: First five pounds \$2.00; each additional add \$4.00 Foreign orders 10% shipping. Excess will be refunded. California residents add 6% sales tax. COD's discouraged. Open accounts extended to state supported educational institutions and companies with a "Strong Dun & Bradstreet." Warehouse: 15608 Inglewood Blvd. Visitors by appointment. Circle 68 on inquiry card.

Rotron Muffin Fan
\$1477 \$12.00 @ 100
10.50 @ 1000

115 VAC. 7 Watts WR2AU
Factory fresh Muffin fans
NOT pull-outs. EMF-4M

TOLL FREE ORDER LINE
(800) 421-5041
TECHNICAL & CALIFORNIA
(213) 679-9001
TWX 910 325-6212

16K Memory

4116-200ns **8/15.95**

ALL MERCHANDISE 100% GUARANTEED!

CALL US FOR VOLUME QUOTES

EPROMS

			Each	8 pcs
1702	256 x 8	(1 ns)	4.95	4.50
2708	1024 x 8	(450ns)	2.99	2.75
2758	1024 x 8	(5V) (450ns)	9.95	8.95
TMS2516	2048 x 8	(5V) (450ns)	6.95	5.95
2716	2048 x 8	(5V) (450ns)	5.50	4.95
2716-1	2048 x 8	(5V) (350ns)	9.00	8.50
TMS2716	2048 x 8	(450ns)	9.95	8.95
TMS2532	4096 x 8	(5V) (450ns)	12.95	11.95
2732	4096 x 8	(5V) (450ns) (200ns)	CALL	CALL
2764	8192 x 8	(5V) (450ns)	CALL	CALL

DYNAMIC RAMS

				100 pcs
4027	4096 x 1	(250ns)	2.50	2.00
4116-120	16,384 x 1	(120ns)	8/29.95	CALL
4116-150	16,384 x 1	(150ns)	8/18.95	1.95
4116-200	16,384 x 1	(200ns)	8/15.95	1.80
4116-300	16,384 x 1	(300ns)	8/14.95	1.75
4164	64,536 x 1	(200ns)	CALL	CALL

STATIC RAMS

				100 pcs
2101	256 x 4	(450ns)	1.95	1.85
2102-1	1024 x 1	(450ns)	.89	.85
21L02-4	1024 x 1	(LP) (450ns)	1.29	1.15
21L02-2	1024 x 1	(LP) (250ns)	1.69	1.55
2111	256 x 4	(450ns)	2.99	2.49
2112	256 x 4	(450ns)	2.99	2.79
2114	1024 x 4	(450ns)	8/16.95	1.95
2114L-2	1024 x 4	(LP) (200ns)	8/19.95	2.35
2114L-3	1024 x 4	(LP) (300ns)	8/18.95	2.25
2114L-4	1024 x 4	(LP) (450ns)	8/17.95	2.10
2147	4096 x 1	(55ns)	9.95	CALL
TMS4044-4	4096 x 1	(450ns)	3.49	3.25
TMS4044-3	4096 x 1	(300ns)	3.99	3.75
TMS40L44-2	4096 x 1	(LP) (200ns)	4.49	4.25
TMM2016	2048 x 8	(200ns) (150ns)	CALL	CALL
HM6116	2048 x 8	(200ns) (150ns) (120ns)	CALL	CALL

LP = LOW POWER

CRYSTALS

32.768 KHZ	3.95
1.0 MHZ	4.95
1.8432	4.95
2.0	3.95
2.097152	3.95
2.4576	3.95
3.2768	3.95
3.579545	3.95
4.0	3.95
5.0	3.95
5.0688	3.95
5.185	3.95
5.7143	3.95
6.5536	3.95
8.0	3.95
10.0	3.95
14.31818	3.95
18.0	3.95
18.432	3.95
20.0	3.95
22.1184	3.95
32.0	3.95

MISC.

AY5-2376	12.50
11C90	13.95
XR2206	4.95
3242	7.95
3480	9.00
MC4024	3.95
MC4044	4.50
7103	9.50
7106	9.95
7107	12.95
76477	3.95
8038	3.95
95H90	7.99
9602	1.50

DISC CONTROLLERS

1771	24.95
1791	36.95
1793	44.95
1797	54.95

UARTS

AY3-1014	6.95
AY5-1013	3.95
TR1602	4.95
IM6402	7.95

INTERFACE

8T26	1.69
8T28	2.49
8T95	.99
8T96	.99
8T97	.99
8T98	.99
DM8131	2.95
DS8836	1.29

CLOCK CIRCUITS

MMS369	3.95
MMS375	3.95
MSM5832	7.45
7207	7.50
7208	15.95

CONVERTERS

MC1408 L8	4.95
DAC-0800	4.95
ADC-0804	4.95

January Specials

Z-80A-CPU	6.00
Z-80A-PIO	6.00
8214	2.95
8216	1.50
6800	4.95
6810	3.95

TMS 40L44-20

4096 x 1 low power 200ns RAMS

By Texas Instruments - not equivalent part number made by another manufacturer as sold by others:

4.49 each 125.00/32 pcs.
Specials end January 31, 1982

Please state "January Specials" when ordering

800-538-5000
800-662-6279
(CALIFORNIA RESIDENTS)

CALL JDR BEFORE YOU BUY!
WE WILL BEAT ANY COMPETITORS' PRICES

6502

6502	6.95
6502-A	12.95
6504	6.95
6505	8.95
6507	9.95
6520	4.35
6522	9.95
6532	14.95
6551	11.85

Z80

Z80-CPU	8.95
Z80A-CPU	6.00
Z80-PIO	6.50
Z80A-PIO	6.00
Z80-CTC	5.95
Z80A-CTC	8.65
Z80-DART	15.25
Z80A-DART	18.75
Z80-DMA	17.50
Z80A-DMA	27.50
Z80-S100	23.95
Z80A-S100	28.95
Z80-S101	23.95
Z80A-S101	28.95
Z80-S102	23.95
Z80A-S102	28.95
Z80-S100/9	17.95
Z80A-S10/9	22.95

Z80B-CPU	18.95
Z80B-CTC	17.95
Z80B-PIO	17.95

Z8671	39.95
Z6132	34.95

CMOS

74C00	.35	74C374	2.75	4019	.45	4098	2.49
74C02	.35	74C901	.80	4020	.95	4099	1.95
74C04	.35	74C902	.85	4021	.95	14409	12.95
74C08	.35	74C903	.85	4022	1.15	14410	12.95
74C10	.35	74C905	10.95	4023	.35	14411	11.95
74C14	1.50	74C906	.95	4024	.75	14412	12.95
74C20	.35	74C907	1.00	4025	.35	14419	4.95
74C30	.35	74C908	2.00	4026	1.65	4502	.95
74C32	.50	74C909	2.75	4027	.65	4503	.65
74C42	1.75	74C910	9.95	4028	.80	4508	1.95
74C48	2.10	74C911	10.00	4029	.95	4510	.95
74C73	.65	74C912	10.00	4030	.45	4511	.95
74C74	.85	74C914	1.95	4034	2.95	4512	.95
74C76	.80	74C915	2.00	4035	.85	4514	1.25
74C83	1.95	74C918	2.75	4040	.95	4515	2.25
74C85	1.95	74C920	17.95	4041	1.25	4516	1.55
74C86	.95	74C921	15.95	4042	.75	4518	1.25
74C89	4.50	74C922	5.95	4043	.85	4519	1.25
74C90	1.75	74C923	5.95	4044	.85	4520	1.25
74C93	1.75	74C925	6.75	4046	.95	4522	1.25
74C95	1.75	74C926	7.95	4047	.95	4526	1.25
74C107	1.00	74C927	7.95	4049	.55	4527	1.95
74C150	5.75	74C928	7.95	4050	.55	4528	1.25
74C151	2.25	74C929	19.95	4051	.95	4531	.95
74C154	3.25	74C930	19.95	4053	.95	4532	1.95
74C157	1.75	4000	.35	4060	1.45	4538	1.95
74C160	2.00	4001	.35	4066	.75	4539	1.95
74C161	2.00	4002	.25	4068	.40	4543	2.70
74C162	2.00	4006	.95	4069	.35	4555	.95
76C163	2.00	4007	.29	4070	.35	4556	.95
74C164	2.00	4008	.95	4071	.30	4581	1.95
74C165	2.00	4009	.45	4072	.30	4582	1.95
74C173	2.00	4010	.45	4073	.30	4584	.95
74C174	2.25	4011	.35	4075	.30	4585	.95
74C175	2.25	4012	.25	4076	.95	4702	12.95
74C192	2.25	4013	.45	4078	.30	4724	1.50
74C193	2.25	4014	.95	4081	.30	80C07	.95
74C195	2.25	4015	.95	4082	.30	80C95	.85
74C200	5.75	4016	.45	4085	.95	80C96	.95
74C221	2.25	4017	1.15	4086	.95	80C97	.95
74C373	2.75	4018	.95	4093	.95	80C98	1.20

HOURS: Mon. - Fri., 9 to 5; Sat., 11 to 3

VISIT OUR RETAIL STORE!



JDR MICRODEVICES, INC.

1224 So. Bascom Ave.

San Jose, CA 95128

800-538-5000 • 800-662-6279 (CA)

(408) 995-5430 • Telex 171-110

TERMS: For shipping include \$2.00 for UPS ground, \$3.00 for UPS Blue Label air. \$10.00 minimum order. Bay Area residents add 6 1/2 % sales tax. California residents add 6 % sales tax. We reserve the right to limit quantities and substitute manufacturer. Prices subject to change without notice. Send SASE for complete list.

2716 EPROMS 450NS (5V)

8/4.95 ea.

ALL MERCHANDISE 100% GUARANTEED!

CALL US FOR VOLUME QUOTES

8000

8035	16.95
8039	19.95
8080A	3.95
8085	12.95
8085A-2	16.95
8086	99.95
8088	39.95
8155	11.95
8156	11.95
8185	29.95
8185-2	39.95
8741	39.95
8748	29.95
8755	44.95

8200

8202	45.00
8205	3.50
8212	1.85
8214	3.85
8216	1.80
8224	2.50
8226	1.80
8228	4.90
8237	19.95
8238	4.95
8239	4.85
8243	4.45
8250	14.95
8251	4.75
8253	9.25
8253-5	9.85
8255	4.75
8255-5	5.25
8257	8.75
8259	6.90
8272	39.95
8275	29.95
8279	9.50
8279-5	10.50
8282	6.65
8283	6.65
8284	5.70
8286	6.65
8287	6.50
8288	25.00
8289	49.95

TV CIRCUITS

MC1330	1.89
MC1350	1.29
MC1358	1.79
LM380	1.29
LM386	1.50
LM565	.99
LM741	.29
LM1310	2.90
LM1800	2.99
LM1889	1.49



APPLE FAN \$69.00

- EXTRA PLUG-IN CARDS CAN CAUSE YOUR APPLE TO OVERHEAT
- ULTRA-QUIET APPLE FAN DRAWS COOL AIR THROUGH YOUR COMPUTER
- ELIMINATES DOWN TIME
- SAVES REPAIR CHARGES
- INCREASES RELIABILITY
- CLIPS ON - NO HOLES OR SCREWS
- COLOR MATCHES APPLE
- LONG LIFE, LOW NOISE MOTOR



*APPLE IS A TRADEMARK OF APPLE COMPUTER INC.

IC SOCKETS

1-99		
8 pin ST	.13	.11
14 pin ST	.15	.12
16 pin ST	.17	.13
18 pin ST	.20	.18
20 pin ST	.29	.27
22 pin ST	.30	.27
24 pin ST	.30	.27
28 pin ST	.40	.32
40 pin ST	.49	.39

ST = SOLDER TAIL		
8 pin WW	.59	.49
14 pin WW	.69	.52
16 pin WW	.69	.58
18 pin WW	.99	.90
20 pin WW	1.09	.98
22 pin WW	1.39	1.28
24 pin WW	1.49	1.35
28 pin WW	1.69	1.49
40 pin WW	1.99	1.80

CONNECTORS

RS232 MALE	3.25
RS232 FEMALE	3.75
RS232 HOOD	1.25
S-100 ST	3.95
S-100 WW	4.95

DIP SWITCHES

4 POSITION	.85
5 POSITION	.90
6 POSITION	.90
7 POSITION	.95
8 POSITION	.95

6800

6800	5.70
6802	10.95
6808	9.95
6809	24.95
6809E	29.95
6810	4.60
6820	4.95
6821	4.95
6828	9.95
6834	16.95
6840	14.95
6843	42.95
6844	44.95
6845	16.95
6847	15.95
6850	4.75
6852	5.75
6860	10.95
6862	11.95
6875	6.95
6880	2.95

68B00	10.95
68B21	12.95
68B50	12.95

LEDS

Jumbo Red	10/1.00
Jumbo Green	6/1.00
Jumbo Yellow	6/1.00
5082-7760 .43"CC	.79
MAN74 .3"CC	.99
MAN72 .3"CA	.99

EPROM ERASERS

PE-14	78.50
PE-14T (with timer)	108.50
PE-24T (with timer)	154.50

ALL ARE HIGH QUALITY UNITS ENCLOSED IN A BLACK ANODIZED ALUMINUM ENCLOSURE.

OUR AD MAY BE IMITATED BUT OUR SERVICE CAN NEVER BE DUPLICATED.

VOLTAGE REG's

7805T	.79	7905T	.89
7808T	.99	7912T	.89
7812T	.79	7915T	1.19
7815T	.99	7924T	1.19
7824T	.99		

7805K	1.39	7905K	1.49
7812K	1.39	7912K	1.49
7815K	1.39	7915K	.79
78L05	.69	79L12	.79
78L12	.69	79L15	.79
78L15	.69		

LM309K	1.49	LM317K	3.95
LM317T	1.95	LM323K	4.95
		LM337K	3.95

T = TO-220 K = TO-3 L = TO-92

LINEAR

LM301V	.34
LM308V	.98
LM309K	1.49
LM311	.64
LM317T	1.95
LM317K	3.95
LM318	1.49
LM323K	4.95
LM324	.59
LM337K	3.95
LM339	.99
LM377	2.29
LM380	1.29
LM386V	1.50
LM555V	.39
LM556	.69
LM565	.99
LM566V	1.49
LM567V	1.29
LM723	.49
LM733	.98
LM741V	.29
LM747	.79
LM748V	.59
LM1310	2.90
LM1414	1.59
MC1330V	1.89
MC1350V	1.29
MC1358	1.79
LM1414	1.59
LM1458V	.69
LM1488	.99
LM1489	.99
LM1800	2.99
LM1889	2.49
LM3900	.59
LM3909V	.98
LM3914	3.95
LM3915	3.95
LM3916	3.95
75451V	.39
75452V	.39
75453V	.39

7400 SERIES

7400	.19	7451	.23	74136	.50	74186	18.50
7401	.19	7453	.23	74141	.65	74190	1.15
7402	.19	7454	.23	74142	2.95	74191	1.15
7403	.19	7460	.23	74143	2.95	74192	.79
7404	.19	7470	.35	74144	2.95	74193	.79
7405	.22	7472	.29	74145	.60	74194	.85
7406	.22	7473	.34	74147	1.75	74195	.85
7407	.22	7474	.35	74148	1.20	74196	.79
7408	.24	7475	.49	74150	1.35	74197	.75
7409	.19	7476	.35	74151	.65	74198	1.35
7410	.19	7480	.59	74152	.65	74199	1.35
7411	.25	7481	1.10	74153	.55	74221	1.35
7412	.30	7482	.95	74154	1.40	74246	1.35
7413	.35	7483	.50	74155	.75	74247	1.25
7414	.55	7485	.65	74156	.65	74248	1.85
7416	.25	7486	.35	74157	.55	74249	1.95
7417	.25	7489	4.95	74159	1.65	74251	.75
7420	.19	7490	.35	74160	.85	74259	2.25
7421	.35	7491	.40	74161	.70	74265	1.35
7422	.29	7492	.50	74162	.85	74273	1.95
7423	.29	7493	.49	74163	.85	74276	1.25
7425	.29	7494	.65	74164	.85	74279	.75
7426	.29	7495	.55	74165	.85	74283	2.00
7427	.29	7496	.70	74166	1.00	74284	3.75
7428	.45	7497	2.75	74167	2.95	74285	3.75
7430	.19	74100	1.00	74170	1.65	74290	.95
7432	.29	74107	.30	74172	5.95	74293	.75
7433	.45	74109	.45	74173	.75	74298	.85
7437	.29	74110	.45	74174	.89	74351	2.25
7438	.29	74111	.55	74175	.89	74365	.65
7440	.19	74116	1.55	74176	.89	74366	.65
7442	.49	74120	1.20	74177	.75	74367	.65
7443	.65	74121	.29	74178	1.15	74368	.65
7444	.69	74122	.45	74179	1.75	74376	2.20
7445	.69	74123	.55	74180	.75	74390	1.75
7446	.59	74125	.45	74181	2.25	74393	1.35
7447	.69	74126	.45	74182	.75	74425	3.15
7448	.69	74128	.55	74184	2.00	74426	.85
7450	.19	74132	.45	74185	2.00	74490	2.55

HOURS: Mon. - Fri., 9 to 5; Sat. 11 to 3

VISIT OUR RETAIL STORE!



JDR MICRODEVICES, INC.

1224 S. Bascom Ave.

San Jose, CA 95128

800-538-5000 • 800-662-6279 (CA)

(408) 995-5430 • Telex 171-110

TERMS: For shipping include \$2.00 for UPS Ground, \$3.00 for UPS Blue Label Air. \$10.00 minimum order. Bay Area residents add 6 1/2% sales tax. California residents add 6% sales tax. We reserve the right to limit quantities and substitute manufacturer. Prices subject to change without notice. Send SASE for complete list.

PRIORITY ONE ELECTRONICS

**1
ONE**

S-100 CPU

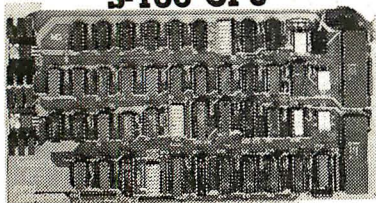

CPU-Z - GODBOUT

2/4 MHz Z80 CPU 24 Bit Addressing

GBT 160A	A&T	\$199.00
GBT 160C	CSC 3-6 MHz	\$375.00

DUAL PROCESSOR 8085-8088 - GODBOUT

6 or 8 MHz Provides true 16 Bit Power with a standard 8 bit S-100 bus.

GBT 1612A	A&T...6 MHz	\$399.00
GBT 1612C	CSC... 8 MHz	\$496.00

SOLID STATE DISK DRIVE, 3500% FASTER!

Not Really, But the Next Best Thing For Godbout 8085/88 Users. Call For Details on M-Drive. See Page 340 of November BYTE

GBT MD 128K		\$1550.00
GBT MD 256K		\$3,000.00

2810 Z80 CPU-CA. COMP. SYST.

2/4 MHz Z80A CPU with RS232C Serial I/O Port complete with Monitor PROM for 2422 Disk Controller

CCS 2810A	A&T	\$280.00
-----------	-----	----------

CB2 Z80 CPU - S.S.M.

2/4 MHz will accept 2716, or 2732, or RAM RUN/STOP and single step switches

SSMCB2K	Kit	\$260.00
SSMCB2A	A&T	\$310.00
SSMZ80M	SSMZ80 Monitor	\$89.00

CBIA 8080 CPU - S.S.M.

8080 CPU, 1K RAM, Holds 1 2708, 1 8 Bit parallel input port.

SSMCB1K	Kit	\$183.00
SSMCB1A	A&T	\$225.00
SSM8080M	SM 8080 Monitor	\$59.00

S-100 I/O BOARDS

SYSTEM SUPPORT 1 - GODBOUT

Serial port (software prog baud), 4K EPROM OR RAM provision, 15 levels of interrupt, real time clock, optional math processor

PART NO.	DESCRIPTION	LIST PRICE	OUR PRICE
GBT162A	Assembled & Tested	\$39.00	\$360.00
GBT162C	CSC	\$495.00	\$460.00
GBT8231	Math Chip	\$195.00	\$195.00
GBT8232	Math Chip	\$195.00	\$195.00
GBT162AM1	A&T with 8231 Math Chip	\$555.00	\$555.00
GBT162CM1	CSC with 8231 Math Chip	\$655.00	\$655.00
GBT162AM2	A&T with 8232 Math Chip	\$555.00	\$555.00
GBT162CM2	CSC with 8232 Math Chip	\$655.00	\$655.00

MPX CHANNEL BOARD - GODBOUT

I/O Multiplexer, using 8085a-2 cpu on board

GBT186A	Assembled & Tested	\$495.00	\$450.00
GBT166C	CSC	\$595.00	\$550.00

INTERFACER I - GODBOUT

Two Serial I/O

GBT133A	A&T	\$249.00	\$219.00
GBT133C	CSC	\$324.00	\$298.00

INTERFACER II - GODBOUT

Three parallel, one serial I/O board

GBT150A	A&T	\$249.00	\$219.00
GBT150C	CSC	\$324.00	\$289.00

INTERFACER III - GODBOUT

Eight channel multi-use serial I/O board

GBT1748A	Assembled & Tested	\$699.00	\$629.00
GBT1748C	CSC 200 hr. Burn In Test	\$849.00	\$629.00

INTERFACER 3 WITH 5 SERIAL PORTS

GBT1745A	Assembled & Tested	\$599.00	\$530.00
GBT1745C	CSC 200 hr. Burn In	\$699.00 Test	\$629.00

MULTI I/O - MORROW DESIGNS

Three Serial, Two parallel

MOSM83200	A&T	\$329.00	\$309.00
-----------	-----	----------	----------

SWITCHBOARD-MORROW DESIGNS

Two serial I/O, four parallel I/O, one status port, one strobe port

MOSS82411		\$259.00	\$239.00
-----------	--	----------	----------

I/O4 - SSM

Two serial I/O, two parallel I/O

SSM104K Kit		\$290.00	\$210.00
SSM104A A&T		\$290.00	\$260.00

2710 4 PORT SERIAL - CCS

4 Full handshaking RS232 ports and optional 2K ROM

CCS271001	A & T	\$340.00	\$310.00
-----------	-------	----------	----------

2718 2 SERIAL & 2 PARALLEL - CCS

2 RS232 C ports, 2 8 bit parallel ports, & optional 2K ROM

CCS271801	A & T	\$360.00	\$325.00
-----------	-------	----------	----------

2720 4 PORT PARALLEL - CCS

4 8 bit parallel ports and optional 2K ROM

CCS272001	A & T	\$250.00	\$225.00
-----------	-------	----------	----------

S-100 10 MHZ STATIC RAM

NEW LOW PRICES!

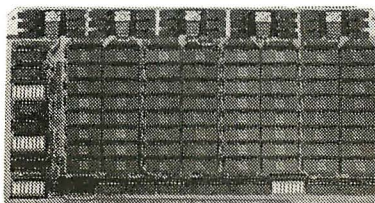

32K STATIC RAM - GODBOUT

RAM 20 10 MHZ, 4Kbyte block disable, bank or 24 bit addressings available 8, 16, 24 or 32K

PART NO.	DESCRIPTION	LIST PRICE	OUR PRICE
GBT164AA8	8K A&T	\$210.00	\$190.00
GBT164AC8	8K CSC	\$280.00	\$260.00
GBT164AA16	16KA&T	\$285.00	\$260.00
GBT164AC16	16K CSC	\$355.00	\$325.00
GBT164AA24	24K A&T	\$355.00	\$325.00
GBT164AC24	24K CSC	\$425.00	\$385.00
GBT164AA32	32K A&T	\$425.00	\$385.00
GBT164AC32	32K CSC	\$495.00	\$450.00

64K STATIC RAM - GODBOUT

RAM 17, 10 MHZ, 2 Watt, DMA Compatible 24 Bit Addressing

GBT175A48	48K A&T	\$650.00	\$619.00
GBT175C48	48K CSC 200hr.	\$750.00	\$710.00
GBT175A64	64K A&T	\$795.00	\$755.00
GBT175C64	64K CSC 200hr.	\$895.00	\$850.00

NEW! 32K x 16 BIT STATIC RAM - GODBOUT

RAM 16 10 MHZ, 32K x 16 or 64K x 8 IEEE/696 16 BIT 2 Watt, 24 Bit Addressing

GBT180A	64K A&T	\$895.00	\$850.00
GBT180C	64K CSC	\$995.00	\$945.00

NEW! 128K STATIC RAM - GODBOUT

RAM 21 10MHZ 128K x 8 or 64K x 16 IEEE/696 8 or 16 Bit 1.2 Amps 24 Bit Addressing

GBT167A	128K A&T	\$1695.00	\$1610.00
GBT167C	128K CSC	\$1895.00	\$1795.00

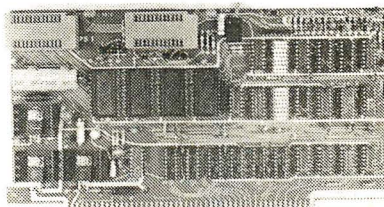

S-100 ROM

PBI PROM PROGRAMMER - SSM

Programs 2708 or 2716's, operates as a 4K/8K EPROM BOARD AS WELL.

SSMPB1K	Kit	\$179.00
SSMPB1A	Assembled & Tested	\$265.00

ECONOROM 2708 - GODBOUT

16K x 8eprom Board using 2708, Power on jump to any 256 byte

GBT125A	Assembled & Tested	\$135.00	\$120.00
GBT125C	CSC	\$195.00	\$175.00

S-100 VIDEO BOARDS

SPECTRUM - GODBOUT

Color Graphics board with Parallel I/O

GBT144A	Assembled & Tested	\$399.00	\$349.00
GBT144C	CSC	\$449.00	\$399.00
GBT20	Sublogic Universal Graphics Interpreter Software		\$35.00

VB - 3 S.S.M.

80 x 25 or 50 character video display Memory Mapped, Parallel Keyboard port

SSMVB3K24	80x24 Kit	\$425.00
SSMVB3A24	80x24 A&T	\$499.00
SSMVB3UP	80x50 Line Upgrade	\$39.00

VB2-S.S.M.

I/O Mapped Video Board, with Parallel Keyboard port 64 x 16

SSMVB2K	Kit	\$199.00
SSMVB2A	Assembled & Tested	\$269.00

VBIC - S.S.M.

Memory Mapped Video Board 64x16 character display or 64x16 graphics display

SSMVB1K	Kit	\$179.00
SSMVB1A	Assembled & Tested	\$242.00

S-100 DYNAMIC RAM

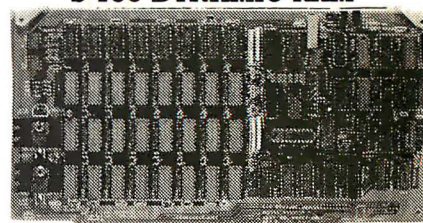

THE EXPANDABLE I PRIORITY 1 ELECTRONICS

THE EXPANDABLE 1" 64 K Dynamic Ram board provides your S-100 system with 64K of reliable, high-speed dynamic RAM. Compatible with most of the major S-100 systems on the market, including those with front panels, it supports DMA operations and requires no Wait states with current microprocessors.

- User expandable from 16 to 64K
- Supports DMA
- Designed to IEEE proposed S-100 bus standards • 2 or 4 MHz operation
- Operates with either an 8080 or Z-80 based S-100 system, providing processor-transparent refreshes with both
- Supports IMSAI-type front panels
- Jumper-selectable Phantom input
- Uses Popular 4116 RAMS
- All ICs in sockets
- Any 16K block can be made bank-independent
- Fully buffered address and data lines
- Fail-safe refresh circuitry for extended Wait states
- Board configuration with reliable, easy-to-configure Berg jumpers

PRIEXP116	16K Assembled & Tested	\$299.00
PRIEXP132	32K Assembled & Tested	\$339.00
PRIEXP148	48K Assembled & Tested	\$379.00
PRIEXP164	64K Assembled & Tested	\$409.00

S-100 DISK CONTROLLERS



DISK I - GODBOUT

FAST DMA. Soft Sector. Controls 8" or 5 1/4", single or double density OUR BEST!

PART NO.	DESCRIPTION	LIST PRICE	OUR PRICE
GBT171A	Assembled & Tested	\$495.00	\$450.00
GBT171C	CSC	\$595.00	\$555.00
GBTCPM80*	CP/M 2.2 for Z80/8085 with manuals & BIOS 8" S/D disk		\$175.00
GBT0AS8S	Oasis 8 bit single user 8" S/D disk		\$500.00
GBT0AS8M	Oasis 8 bit multi-user. 8" S/D disk		\$850.00

2422A - CA. COMP. SYST.

I/O Mapped, controls 8" or 5 1/4" single or double density A&T with CPM 2.2 8" S.D.

CCS2422A		\$475.00	\$375.00
----------	--	----------	----------

DISK JOCKEY 2D - MORROW

I/O Mapped, controls 8", single or double density, serial I/O

MOS0J2208	A&T with CP/M 2.2	\$399.00	\$375.00
-----------	-------------------	----------	----------

S-100 DISK SUBSYSTEMS

DISCUS SINGLE SIDED MORROW

8" DBL Density drives with cabinet, power supply controller, with CP/M 2.2 and Microsoft Basic

MOSF1218	Single Drive System	\$1095.00	\$950.00
MOSF1228	Dual Drive System	\$1875.00	\$1598.00

DISCUS DOUBLE SIDED - MORROW

8" DBL Density/sided drives with cabinet Power supply controller, with CP/M 2.2 and Microsoft Basic

MOSF2218	Single Drive System	\$1395.00	\$1250.00
MOSF2228	Dual Drive System	\$2495.00	\$2050.00

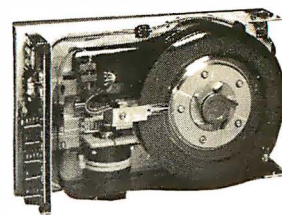

S-100 HARD DISK - MORROW

8" 10 & 20MB. 14" - 26MB formatted hard disk complete with cabinet, P.S., Controller. CPM 2.2 and Microsoft Basic

PART NO.	DESCRIPTION	LIST PRICE	SALE PRICE
MOSM10S	10 MB	\$3695.00	\$2950.00
MOSM20S	20 MB	\$4795.00	\$3825.00
MOSM26S	26 MB	\$4495.00	\$3495.00

PRIORITY ONE ELECTRONICS

S-100 SYSTEMS

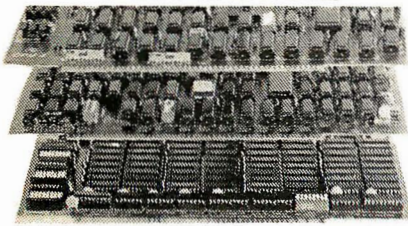

"LITTLE 8" Z80 SYSTEM STARTER SET GODBOUT

CPU 2: A 4MHz Z80 A-based 8-bit workhorse CPU board that includes all the standard features plus many of the convenience options. Meets all IEEE 696/S-100 specifications, including timing.

DISK 1: DMA High Performance Disk Controller. disk controllers don't have to be your system's bottleneck! The DISK 1 is lightning fast thanks to properly implemented DMA (with arbitration) and transfer that is independent of CPU speed.

RAM 20 32K High Speed Static RAM. This board has it all Operates at speeds up to 10MHz, ultra-low power consumption, IEEE 696/S-100 extended addressing protocol, bank select and flawless DMA.

CP/M 2.2: The de facto standard of 8-bit operating systems ready to load and go!

ANOTHER PRIORITY 1 EXCLUSIVE!

We went to GODBOUT and made a special buy on the nucleus of the best S-100 Z80A systems ever.

LOOK AT WHAT YOU GET:

1 GBT180A 2/4 MHz Z80 CPU	\$295.00
1 GBT19A32 32K 10MHz Static Ram	\$425.00
1 GBT171A DMA Disk Controllers	\$495.00
1 GBTCPMB0 CP/M 2.2	\$175.00
IT ALL ADDS UP TO... \$1039.00	

TOTAL PACKAGE PRICE ONLY \$1095.00
ORDER NO. PDBGBTSG

SUPERSIXTEEN - GODBOUT

LOOK WHAT \$3495.00 WILL BUY!

WHY WAIT ANY LONGER?

HERE IS WHAT EACH PACKAGE INCLUDES:

- GBT1812A 6 MHz 8085/8088 Dual Processor Board
- GBT171A High Speed DMA Disk Controller
- GBT182A System Support 1 Multi Function Board
- GBT133A Interfacer 1 Dual Serial I/O
- 128K 10MHz Low Power Static Ram
- CP/M 86 16 Bit Operating System Ready to Load & Go
- Cables and Documentation Three interfacer cables one disk I/O cable, complete documentation for all hardware, and manuals for both CP/M operating systems.
- Compu Pro's famous 1 Year limited warranty.

Now to the best part of all. If purchased separately, these quality components would list for \$4,344.00. BUT SuperSixteen's low package price is an amazing \$3,495.00. To save \$849.00! For boards qualified under the Certified System Component high-reliability program - with extended 2 year warranty, 200 hour burn-in and 8MHz processors - add \$600 to the package price.

Sh. Wt. 15 lbs.

PDBGBTJS	SuperSixteen A&T	\$3495.00
PDBGBTSC	SuperSixteen CSC	\$4095.00

S-100 SOFTWARE

PRIORITY 1 is pleased to offer the finest in industry standard software. All software is supplied on 8" Single Density IBM 3740 CP/M compatible diskettes. All software is sold "AS IS" and is non-returnable. If you have questions about the software for your application, order the manual first.

CCS803 CP/M Version 2.2 Microcomputer Control Program	\$150.00
CCS2301 MAC-CP/M Macro Assembler	\$90.00
CCS2401 SID-CP/M Symbolic Instruction Debugger	\$75.00
CCS2501 TEX-CP/M Text Formatter	\$75.00
CCS2601 DESPOOL-CP/M Background Print Utility	\$50.00

CP/M, MAC, SID, TEX, and DESPOOL are registered trademarks of Digital Research

PART NO.	DESCRIPTION	LIST PRICE	OUR PRICE
CCS401	C-BASIC-2 Interp	\$150.00	\$139.00
CCS401M	Manual	\$ 32.00	\$ 32.00
CCS1101	FMS-80 by Systems Plus	\$995.00	\$895.00
CCS1101M	Manual	\$ 70.00	\$ 70.00

GRAHAM-DORIAN ACCOUNTING

CCS1301	General Ledger	\$820.00	\$750.00
CCS1301M	Manual	\$ 50.00	\$ 50.00
CCS1501	Accounts Receivable	\$820.00	\$750.00
CCS151M	Manual	\$ 50.00	\$ 50.00
CCS1401	Accounts Payable	\$820.00	\$750.00
CCS1401M	Manual	\$ 50.00	\$ 50.00
CCS1701	Inventory II	\$820.00	\$750.00
CCS1701M	Manual	\$ 50.00	\$ 50.00
CCS1801	Payroll II	\$555.00	\$495.00
CCS1801M	Manual	\$ 50.00	\$ 50.00
CCS20001	Job Costing	\$820.00	\$750.00
CCS2001M	Manual	\$ 50.00	\$ 50.00
CCS2701	Order Entry/Invoice	\$820.00	\$750.00
CCS2701M	Manual	\$ 50.00	\$ 50.00

MEDICAL PRACTICE PATIENT BILLING

CCS1801	15 Programs	\$820.00	\$750.00
CCS1801M	Manual	\$ 50.00	\$ 50.00
CCS1901	14 Programs	\$820.00	\$750.00
CCS1901M	Manual	\$ 50.00	\$ 50.00

S-100 MAINFRAMES



S-100 MICROFRAME - TEI

1 10V 60HZ CVT Mainframes, the best money can buy!
12 Slot ±8V 17A ±16V @ 2A
22 Slot ±8v @ 30A ±16V @ 4A

TEI has announced a 5 - 8% Price Increase Feb 1 - Hurry!

		OUR PRICE	1-9	10-24
TEIMCS 112	12 Slot Desk	\$685.00	\$615.00	\$570.00
TEIMCS 122	22 Slot Desk	\$825.00	\$760.00	\$705.00
TEIRM 12	12 Slot Rackmnt	\$725.00	\$720.00	\$819.00
TEIRM 22	22 Slot Rackmnt	\$875.00	\$850.00	\$750.00

Shipping Weight: On 12 Slot Mainframes 45 lbs.
On 22 Slot Mainframes 55 lbs.

S-100 FRAMES 2 - 5" DISK CUTOUTS - TEI

±8V @ 17±16V @ 2A +12V @ 1.2A. Internal Cables
1-9 10-24

TEIF12	12 Slot desk	\$675.00	\$825.00	\$580.00
TEIR012	12 Slot Rackmnt	\$795.00	\$715.00	\$865.00

Shipping Weight: On 12 Slot Desk 40 lbs.
On 12 Slot Rackmount 45 lbs.

DUAL 8" DISK DRIVE CHASSIS - TEI

For Shugart 800/801R or 850/851R with internal power cables provided
+24V @ 1.5A +5V @ 1.0A - 5V @ 25A

		1-9	10-24
TEIF00	Desk Top	\$535	\$485
TEIR00	Rack Mount	\$720	\$870
PB0F00S1	DFDO with 1 Shugart 801R	\$970.00	\$970.00
PB0F00S2	DFDO with 2 Shugart 801Rs	\$1375.00	\$1375.00
PB0F00S1	RFDO with 1 Shugart 801R	\$1095.00	\$1095.00
PB0F00S2	RFDO with 2 Shugart 801Rs	\$1495.00	\$1495.00
PRIS0P6C2	Internal Data Cable .50 pin plug connector to 2 Card Edge.	\$34.95	\$34.95

Due to UPS shipping regulations, disk drives will be shipped separately from the cabinet. Don't forget to include shipping for each drive. (Shipping Wt. 16 lbs., each)

CALL FOR NEW TEI PRICES FEBRUARY 1st.

S-100 MAINFRAME - GODBOUT

110V 60HZ CVT Mainframe uses famous 20 slot GODBOUT Motherboard. 55 lbs.
GBTENC20RM 20 Slot Rack Mount \$895.00 \$825.00
GBTENC20DK 20 Slot Desk Top \$825.00 \$780.00

GODBOUT Mainframe, Less Motherboard & Power Supply - Kit. 23 lbs

GBTBOX DESK	Desk Top Main Frame	\$289.00
GBTBOX RACK	Rack Mount Main Frame	\$329.00

S-100 MAINFRAME - CCS

12-slot motherboard with removable termination card.
CCS2200-01 Office Cream 35 lbs \$575.00 \$535.00
CCS2200-02 Blue 35 lbs \$575.00 \$535.00

S-100 MOTHERBOARDS

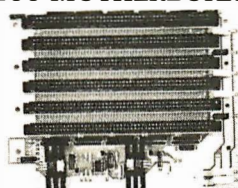

MOTHERBOARD - GODBOUT

Active termination, 6-12-20 slot

GBT153A	A&T 6 slot, 2 lbs	\$140.00	\$128.00
GBT153C	CSC 6 slot, 2 lbs	\$190.00	\$175.00
GBT154A	A&T 12 slot, 2 lbs.	\$175.00	\$155.00
GBT154C	CSC 12 slot, 2 lbs.	\$240.00	\$220.00
GBT155A	A&T 20 slot, 4 lbs.	\$265.00	\$235.00
GBT155C	CSC 20 slot, 4 lbs.	\$340.00	\$310.00

FLOPPY DISC DRIVES

Tandon TM-800 Thinline is exactly half the size of conventional 8" floppy disk drives

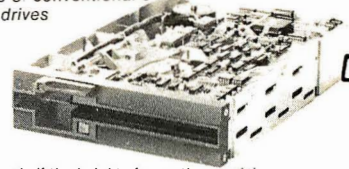

Exactly one-half the height of any other model. Proprietary, high-resolution, read-write heads patented by Tandon. D.C. only operation - no A.C. required. Industry standard interface. Three millisecond track-to-track access time 9 lbs.

TNDTMB481	Single Sided \$495.00 2 or more	\$470.00
TNDTMB482	Double Sided \$825.00 2 or more	\$600.00
TNDTMB8M	Manual not included with drive	\$10.00

801R - SHUGART

Single sided doubledensity most popular 8" drive
SHU801R \$425.00 ea. or 2 or more (16 lbs.) \$395.00
SHUS801RM Manual for 801R drives \$10.00

DT-8 - QUME

Data track 8 double sided, double density 8" QMEDT8 \$575.00 ea or 2 or more (16 lbs.) \$540.00
QMEDT8M Manual for DT-8 \$10.00

5 1/4" DRIVES - TANDON

TN0TMI001	Single Sided, 250KB (5 lbs)	\$310.00
TN0TMI002	Double Sided, 500KB	\$370.00
TN0TMI003	Single Sided, 500KB	\$375.00
TN0TMI004	Double Sided, 1000KB	\$495.00
TN0TMI5M	Manual not included with drive	\$10.00

DISK CABINETS



V-100 - VISTA

- Desk or rack mountable • Internal power and data cables
- Drives pull out for easy service and maintenance

VIS100 Disk Drive Cabinet (35 lbs) \$495.00 \$449.00

SINGLE 8" - Q.T.

Single 8" cabinet with power supply
QTCCDC8 . (2 lbs) \$195.00

DUAL 8" - Q.T.

Dual 8" cabinet with power supply
QTCCDC88 . (25 lbs) \$349.00

5" CABINETS - VISTA

VIS-9801 Single 5" with P.S. \$75.00
VIS-9802 Dual 5" with P.S. \$95.00



5 1/4" MINIFLOPPY - VISTA

Totally compatible with several microcomputers including TRS-80/Notistar, Exidy, Texas Instruments, Heath/Zenith and others.

PART NO.	CAPACITY	NO. DRN TRAC	SIDE	LIST PRICE	OUR PRICE
VISV80	10SK	1	40	1	395.00
VISV80	204K	1	40	2	595.00
VISV81	204K	1	80	1	595.00
VISV8000	408K	1	80	2	775.00
VISV802	204K/408K	2	40	1	775.00
VISV8002	408K/816K	2	40	2	1095.00
VISV8012	408K/816K	2	80	1	1095.00
VISV8002	816K/16M	2	80	2	1495.00

S-100 MOTHERBOARDS - Q.T

QTCMB6BB	6 Slot Bare Board	\$ 25.00
QTCMB6K	6 Slot Kit	\$ 40.00
QTCMB6A	6 Slot A&T	\$ 50.00
QTCMB8BB	8 Slot Bare Board	\$ 27.00
QTCMB8K	8 Slot Kit	\$ 55.00
QTCMB8A	8 Slot A&T	\$ 70.00
QTCMB12BB	12 Slot Bare Board	\$ 30.00
QTCMB12K	12 Slot Kit	\$ 70.00
QTCMB12A	12 Slot A&T	\$ 90.00
QTCMB18BB	18 Slot Bare Board	\$ 50.00
QTCMB18K	18 Slot Kit	\$100.00
QTCMB18A	18 Slot A&T	\$140.00



PRIORITY ONE ELECTRONICS

9161-B DEERING AVE • CHATSWORTH, CA 91311

ORDER TOLL FREE (800) 423-5922 CA, AK, HI CALL (213) 709-5464

Terms U.S. VISA, MC, BAC, Check/Money Order, U.S. Funds Only. CA residents add 6% Sales Tax. MINIMUM PREPAID ORDER \$15.00. Include MINIMUM SHIPPING & HANDLING of \$2.50 for the first 3 lbs. plus 25¢ for each additional pound. Orders over 50 lbs. sent freight collect. Just in case, please include your phone no. Prices subject to change without notice. We will do our best to maintain prices through January, 1982. Credit Card orders will be charged appropriate freight. See November BYTE for 60 page Catalog or send \$1.00 for your copy today. Sale prices are for prepaid orders only.



OKIDATA MICROLINE PRINTERS

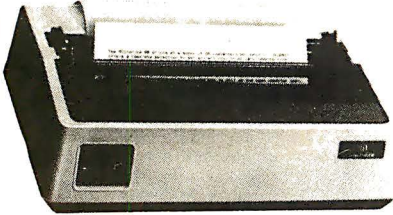

WITH FRICTION AND TRACTOR FEED

- Bi-DIRECTIONAL - 120 CPS
- 9x9 Matrix (Alphanumeric)
- 6x9 or 12 Matrix for Graphics
- 5, 8.3, 10, 16 Characters Per Inch
- 6 or 8 Lines Per Inch
- 80 CPL @ 10 CPI for 82A
- 132 CPL @ 10 CPI for 83A
- Parallel and Serial I/O
- 110 Through 1200 Baud
- Sell Test
- Out of Paper Switch
- Friction or Tractor Feed
- 3" to 14" Top of Form (Switch Selectable)
- 10 Different Character Sets

Part No.	Description	List Price	Sale Price
OKIDAT82AT	80CPL@10CPI	\$ 799.00	\$539.00
OKIDAT83AT	132CPL@10CPI	\$ 1195.00	\$750.00

EPSON MX-80

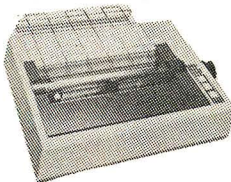

The **EPSON MX-80** Dot Matrix Printer is a highly versatile, general-purpose and computer-grade printer featuring 80 CPS bi-directional printing with logical seeking capability and 9x9 dot-matrix character formation. The MX-80 accepts the ASCII 96 codes and codes for special characters/symbols. It also accepts codes for 64 graphic patterns. Characters can be printed in any desired size — enlarged, condensed, emphasized, normal, etc. The one-chip microprocessor is engaged in performing all functions of the Printer and the two built-in stepper motors of the MX-80 control the carriage and paper feeding functions respectively. Therefore, versatile software controls, such as horizontal and vertical tabs, and form feed are at your disposal. In addition, various interface options are available to permit handshaking with most personal computers. Centronics type 8 bit parallel interface standard.

EPN MX80 Tractor Feed ... List \$645.00 **Sale \$450.00**

PRINTER INTERFACES

RS232 Serial Interface Conversion for EPSON MX-80	
MBSSEII Assembled & Tested.....	\$55.00
Apple 8 bit Centronics Parallel Interface for OKIDATA, EPSON, and CENTRONICS printers	
MBSAEII Assembled & Tested.....	\$55.00
MBSAECI Cable for above.....	\$14.95



THE STAR MODEM from PRENTICE FEATURE FITS GTE HANDSETS! 1 YEAR WARRANTY EXCLUSIVE ACOUSTIC CHAMBERS:

The exclusive triple seal of Prentice's new flat mounted cups locks the handset into the acoustic chamber yielding superior acoustic isolation and mechanical cushioning. Designed to adapt to most common handsets used throughout the world.

SELF TEST: The self test feature on the STAR allows the user to verify total operation of the acoustic modem by using the terminal in the full duplex mode. No need for remote assistance in diagnosing terminal or modem problems.

PART NO.	DESCRIPTION	LIST PRICE	OUR PRICE
PRNSTAR	RS232, TTL 200 Ma \$199.00		\$129.00
PRNSTAR-V21	Current Loop RS232, TTL 200 Ma \$229.00		\$209.00
	Standard		

PART NO.	CABLES DESCRIPTION	PRICE
CNDRS2328F	RS232 8 Cond 8 Ft	\$19.95
IDCCABLE12	RS232 25 Cond 3 Ft	\$14.95

MICROPOLIS™

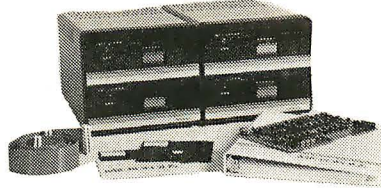

- Dual 5 1/4" S-100 Floppy Disk Subsystem
- 315K Per Drive, 630K Total — Single Sided
- 630K Per Drive, 1.2 MB Total — Double Sided
- S-100 Controller (8080, 8085, Z80 Compatible)
- Handles Up to 4 Heads
- Comes Complete With MDOS, Basic and Text Editor
- Built-in LED Indicates Drive Select, Drive Address and File Protect

Model	Configuration	List Price	Our Price
MCPI053M2	Single Sided, 630K	\$1534.00	\$995.00
MCPI053M4	Double Sided 1.2MB	\$1888.00	\$1395.00

See page 10 of our ENGINEERING SELECTION GUIDE in the November, 1981 **BYTE** for more details

ANCHOR MODEM AUTOMATION

PRICE BREAKTHROUGH!!



\$129.00

THE SIGNALMAN MK 1

Meet the direct-connect SIGNALMAN MK1... the smallest, lightest, most compact modem available today. Its long life 9 volt self-contained battery and exclusive audible Carrier Detect Signal allows you to install the SIGNALMAN anywhere... out of the way, and out of sight. Now, there is no need for messy cables, and no need to look at an LED to verify carrier.

Anchor's SIGNALMAN has been designed for transmitting both voice and data signals over all common telephone lines. And when you're in the data position, your SIGNALMAN automatically changes from ORIGINATE to ANSWER and back again as the need arises — ending all that confusion. Your SIGNALMAN is fully compatible with all BELL 103 modems — putting your computer in instant communications with thousands of other computers.

Anchor Automation has taken the FUSS out of communications. For business or fun, SIGNALMAN is the ideal modem.

PRODUCT FEATURES

- Direct Connect Modem
- Built-in RS232C Cable and Connector
- Self-contained 9V Battery — Wall plug transformer available.
- Audible carrier detect signal.
- Automatic mode selection.
- Talk/Data switch.
- CONNECTS IN SERIES WITH MODULAR HANDSET JACK ON TELEPHONE
- Complete with RS232C and Modular Handset Cables, eliminates need to buy cables — save \$200-\$300, assures correct fit.
- Uses low cost 9V battery. Eliminates unsightly cords and need for "another" AC outlet. Optional plug-in transformer available.
- Audio Transducer eliminates need to view LED to confirm connection — can be placed anywhere (velcro tape provided).
- Advanced IC Circuitry eliminates confusion of who is originator — ends need to manually switch from Originate to Answer and Vice-Versa.
- Permits you to listen/talk on phone or switch to data communications mode.
- Permits you to communicate with most other computer networks.
- Small size, light weight permits you to install the SIGNALMAN anywhere.
- Lowest priced modem available.

RS232C SPECIFICATIONS

Data Format: Serial, binary, asynchronous **Operate Mode:** Manual dial, Automatic ANSW/ ORIG selection **Data Rate:** 0 to 300 bps, full duplex **Modulation:** Frequency shift keyed (FSK) **Line Interface:** Direct Connect. **Data Interface:** RS232C, Cable to Computer Built-In.

Transmit Frequency	ORIG		ANSW	
	MARK	SPACE	1270 Hz	2025 Hz
Transmit Frequency Accuracy: 0.1%	ORIG		ANSW	
	MARK	SPACE	2225 Hz	1270 Hz
Receive Frequency	ORIG		ANSW	
	MARK	SPACE	2225 Hz	1270 Hz

Carrier Detect Threshold: -44 dbm, plus or minus 2 dbm (ORIG) / -46 dbm, plus or minus 2 dbm (ANSW). **Carrier Detect Indicator:** Audible Tone. **Power Requirement:** Self-Contained — 9V Transistor Battery / 110V AC Through Adapter. **Mechanical:** 8" x 4" x 1"

ANCMK1 \$129.00

LOGIC PROBES



LP-1 LOGIC PROBE - Hand-held logic probe provides instant reading of logic levels for TTL, DTL, HTL, or CMOS. **INPUT IMPEDANCE:** 100,000 Ohms. **Min. Detectable Pulse:** 50 ns. **Max Input Signal (Frequency):** 10 MHz. **Pulse Detector (LED):** High speed train or single event. **Pulse Memory:** Pulse or level transition detected and stores.

GSCLP1 List \$50.00 **Our Price \$45.00**

LP-2 LOGIC PROBE - Economy version of Model LP-1. Safer than a voltmeter - ore accurate than a scope. **Input Impedance:** 300,000 Ohms. **Min Detectable Pulse:** 300 ns. **Max Input Signal (Frequency):** 1.5 MHz. **Pulse Detector (LED):** High speed train or single event. **Pulse Memory:** none.

GSCLP2 List \$32.00 **Our Price \$30.00**

LP-3 LOGIC PROBE - High speed logic probe. Captures pulses as short as 10 ns. **Input Impedance:** 500,000 Ohms. **Minimum Detectable Pulse:** 6 ns. **Max Input Signal (Frequency):** 60 MHz. **Pulse Detector (LED):** High speed train or single event. **Pulse Memory:** Pulse or level transition detected and stored.

GSCLP3 List \$77.00 **Our Price \$69.00**

DIGITAL PULSER

GSCLP1 List \$83.00 **\$76.00**

GSCLTC-1 Logical Analysis Kit - Complete with LP-1 logic Probe, DP-1 Logic Pulser, LM-1 Logic Monitor wiring accessories, manuals and molded case. **Our Price \$220.00**

GSCLTC-2 Logical Analysis Kit - For high-speed and memory analysis. Same as Model LTC-1, except substitutes LP-3 High-Speed Logic Probe. **Our Price \$245.00**

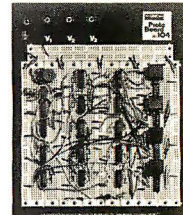

PROTO-BOARD UNITS

All the speed and convenience of QT sockets and Bus Strips plus backplanes and binding posts in both kits and pre-assembled units. Assemble, test and modify circuits as fast as you can think.

Part No.	Dip Capacity	Board Size Inches	Price
GSCPB6	Kil 10(14's)	6 x 4 x 1/4	\$19.95
GSCPB100	Kil 10(14's)	4 1/2 x 6 x 1/4	\$21.95
GSCPB101	ASM 10(14's)	6 x 4 1/2 x 1/4	\$28.95
GSCPB102	ASM 12(14's)	7 1/4 x 4 1/2 x 1/4	\$34.95
GSCPB103	ASM 24(14's)	9 x 6 x 1/4	\$59.95
GSCPB104	ASM 32(14's)	9 1/2 x 8 x 1/4	\$77.00

PROTO-BOARD PB-203 - HOLDS 24 14-PIN IC's

Fully assembled breadboard contains built-in, short-proof, fused, 5VDC at 1 amp, regulated power supply, in addition to three QT-59S sockets, four QT-59B bus strips, one QT-47B bus strip and four binding posts. Capacity for most digital and many analog projects. **SIZE:** 9.75" Lg, 6.6" w, 3.25" h. **WEIGHT:** 5 lbs.

GSCPB203 List Price \$133.00

OUR PRICE \$125.00

GSCPB203A ... All features plus ±15VDC @ 500mA... \$174.00

OUR PRICE \$160.00

GSCPB203AK Kit version of the 203A \$149.95

Our Price \$138.00

ALL-CIRCUIT EVALUATORS

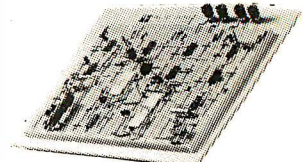

Ace for fast, solderless, plug in circuit building and testing. Plug in any components with leads up to 0.032" diameter. Interconnect with solid wire up to 20 gauge. Gold-anodized aluminum base/ground. Non corrosive nickel silver terminals. 4 rubber feet.

PART NO.	ACE MODEL NO.	DIP TIE	BUSES	NO. POSTS	NO. EACH	PRICE
923333	200-K (kit)	8	728	2	2	\$22.75
923332	208 (assem)	8	872	8	2	\$30.70
923334	201-K (kit)	12	1032	2	2	\$29.95
923331	212 (assem)	12	1224	8	2	\$37.05
923326	218 (assem)	18	1760	10	2	\$49.80
923325	227 (assem)	27	2712	28	4	\$63.55
923324	236 (assem)	36	3648	36	4	\$84.75

PRIORITY ONE ELECTRONICS

BUY WITH CONFIDENCE
From the Nation's Largest

HITACHI Distributor
Hitachi Denshi, Ltd.

Single and dual trace. 15 thru 100 MHz. All high sensitivity Hitachi oscilloscopes are built to demanding Hitachi quality standards and are backed by a 2-year warranty. They're able to measure signals as low as 1mV/division (with X5 vertical magnifier). It's a specification you won't find on any other 15 or 30 MHz scopes. Plus: Z-axis modulation, trace rotation, front panel X-Y operation for all scopemodels, and X10 sweep magnification. And, 30 thru 100 MHz oscilloscopes offer internal signal delay lines. For ease of operation, functionally related controls are grouped into three blocks on the color coded front panel. Now here's the clincher: For what you'd expect to pay more, you actually pay less. Check our scopes before you decide. All scopes complete with probes.

HITV302B List \$995.00

30 MHz DUAL TRACE OSCILLOSCOPE
Our Price: \$859.00

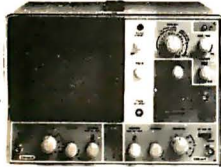

TV sync-separator circuit
High-sensitivity 1mV/div (3MHz)
Sweep-time magnifier (10 times)
Z-axis input (intensity modulation)
Signal delay line
Complete with 2 probes
CH1, CH2, DUAL, ADD
DIFF, Vertical
Deflection Modes
X-Y operation
Trace Rotation

Hitachi... The measure of quality.
HITV152B DUAL TRACE 15MHz (no delay)
LIST \$735.00 OUR PRICE \$650.00

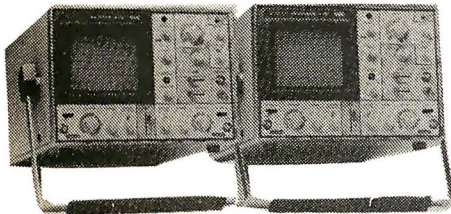

HIT-V352
35MHz DUAL TRACE WITH DELAY
LIST PRICE: \$1150.00
OUR PRICE: \$998.00

HIT-V202
20MHz DUAL TRACE
LIST PRICE: \$850
OUR PRICE: \$765

Economically priced dual trace oscilloscope. Square CRT with internal graticule (illuminated scale). High-accuracy voltage axis & time axis set at #3% (certified at 10° to 35° C). High-sensitivity 1mV/div. Low drift 2 Year Warranty.

Dynamic range 8 div. TV sync separator circuit. Built-in signal delay line (V-352). X-Y operation. Sweep-time magnifier (10 times). Trace rotation system. Fine adjusting, click-positioning function.

50 MHz & 100 MHz DUAL TRACE WITH CALIBRATED TIME DELAY
HIT V550B 50MHz with 3rd TRACE TRIGGER VIEW LIST \$1745.00 SALE \$1495.00
HIT V1050 100MHz with 3rd & 4th TRACE TRIGGER VIEW LIST \$2390.00 SALE \$1995.00

MICROCOMPUTER PRODUCTS

MEMORY		8080 SERIES	
PART NO.	PRICE	PART NO.	PRICE
4116AC20	8/\$20.00	INS 8080A	\$5.50
2016P3	8/\$100.00	INS 8085A	\$19.95
2114N3L	8/\$28.00	DP8212N	\$2.95
5257N3L	8/\$50.00	DP8214N	\$5.25
2732	8/\$120.00	DP8216N	\$2.95
2716	8/\$50.00	DP8224N	\$3.25
2708	8/\$20.00	DP8224-4N	\$9.95
Z80 SERIES		DP8226N	\$3.50
Z80A	\$14.95	DP8228N	\$5.55
Z80AP10	\$14.95	DP8238N	\$5.55
Z80ACTC	\$13.95	INS8250N	\$15.00
Z80ADMA	\$45.00	INS8251N	\$7.50
Z80AS100	\$59.95	INS8253N	\$17.95
Z80AS101	\$59.95	INS8255N	\$6.80
Z80AS102	\$59.95	INS8257N	\$16.45
UARTS		INS8259N	\$18.00
AY51013A	\$5.95	INS8275N	\$59.95
TR1602B	\$5.95	INS8279N	\$49.95
TR1863	\$6.95	FLOPPY DISC CONTROLLER	
DM6402	\$7.95	FD1771B-01	\$24.95
		FD1791B-01	\$44.95

KEITHLEY

Handheld DMMs For Every Application and Budget

Easy-to-use Rotary Switches
Large 0.6" LCD displays
dc Voltage
ac Voltage
dc Current
ac Current
Resistance
Diode Test
3/2 or 4 1/2 Digit Accuracy
Overload Protection
Externally Accessible Battery & Fuse
Rugged 0.1" ABS Plastic Case
Shock-Mounted PC Board

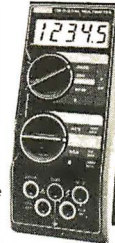

KTH130	± 0.5% DCV accuracy, 10M Ω impedance auto polarity and current measurement through 10A	\$124.00
KTH131	Same as KTH130 except 0.25% accuracy and enhanced bandwidth on top ACV ranges	\$139.00
KTH128	See/hear display includes both over/under threshold indicator arrows, audible tone that operates on all ranges & functions, and adjustable threshold	\$139.00
KTH135	4 1/2 digit, 0.05% accuracy	\$235.00
KTH870	Thermocouple (TC) based thermometer	\$199.00
KTH1304	Soft Carrying Case & Stand (handhelds)	\$ 10.00
KTH1306	Deluxe Carrying Case (handhelds)	\$ 25.00

LCD & LED Bench DMMs

KTH169	3 1/2 Digit, LCD Display	\$189.00
KTH176	4 1/2 Digit, LCD Display	\$269.00
KTH179-20A	4 1/2 Digit, LED Display, TRMS	\$439.00
KTH1793	IEEE-488 Interface (Model 179-20A)	\$325.00

See pp 42-43 of our Engineering Selection Guide in the November BYTE for a complete list of specifications and accessories

LEDU

IM-10A List \$104.95
SPECIAL \$69.95 with tube

Perfectly balanced fluorescent lighting with precision magnifier lens. Tough thermoplastic shade. Easy lens removal. New wire clip design permits easy installation and removal of fluorescent tube. Comes with plastic shield to protect tube from soiling and damage. Colors: Gray, Black and Chocolate Brown. Comes with one 22 watt T-9 Curline fluorescent tube, 3 diopler lens, 10 lbs.



\$69.95

LDUIM10GY Gray
LDUIM10BK Black
LDUIM10CB Brown

PRIORITY ONE ELECTRONICS

9161-B DEERING AVE • CHATSWORTH, CA 91311

ORDER TOLL FREE (800) 423-5922 CA, AK, HI CALL (213) 709-5464

Terms U.S. VISA, MC, BAC, Check Money Order, U.S. Funds Only. CA Residents add 6% Sales Tax. MINIMUM PREPAID ORDER \$15.00. Include MINIMUM SHIPPING & HANDLING of \$2.50 for the first 3 lbs. plus 25¢ for each additional pound. Orders over 50 lbs. sent freight collect. Just in case, please include your phone no. Prices subject to change without notice. We will do our best to maintain prices through January, 1982. Credit Card orders will be charged appropriate freight. See November BYTE for 60 page Catalog or send \$1.00 for your copy today. Sale prices are for prepaid orders only.

GSC ISOBAR 1 ONE

With Built-In Noise Filters and Surge Suppressors

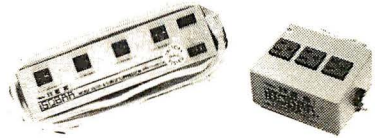

ISOLATES SENSITIVE AND VALUABLE EQUIPMENT FROM: Equipment interaction - Damaging High Voltage Spikes - AC line noise and hash.

PROTECTS AGAINST: Voltage transients caused by lightning, contact switching, turn-off of inductive components, noise due to electromagnetic coupling.

USE THE GSC ISOBAR TO ISOLATE: Microprocessor from peripherals - Lab instruments from noisy equipment - Sensitive pre-amp or tape deck from power amplifier.

THE GSC ISOBAR ELIMINATES: Equipment interaction - Equipment damage from power line spikes and surges - Errors - False printouts - Disk Skips - Audio or video hash.

FEATURES: Inactive isolated ground - Sockets individually filter isolated - Circuit breaker protected at 15A.

VOLTAGE TRANSIENT SPIKE PROTECTION: 2000 A peak for up to 6 Sec duration spikes. 1000A, 8/20 Sec protection from repeated spikes.

LOAD HANDLING: 1875 W max. total load; 15A per socket.

INPUT: 125 VAC, 15 amps; standard 3-prong plug.

Three common outlets built-in circuit breaker, pilot light, hang-up bracket and a 6 foot cord.

MODEL	SH. WT.	LIST PRICE	OUR PRICE
GOFBAR3	3 lbs.	\$59.95	\$39.95
IBAR 46	4 lbs.	\$79.95	\$49.95
IBAR 86	8 lbs.	\$84.95	\$54.95
IBAR 9RM	6 lbs.	\$99.95	\$74.95

GSC POWERMATE

LINE STABILIZERS
FULLY AUTOMATIC LINE REGULATION OVER AN 85V AC TO 125V AC INPUT RANGE, 15 AMP LOAD CAPACITY

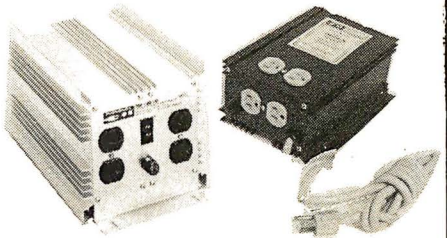

TRA SERIES SPECIFICATIONS

- Constant 115V AC output.
- 4% output regulation for all combined effects of line and load.
- 4 or 6 ground 3 prong outlets
- 6 ft. 14 gauge - 3 conductor power cord.
- Fully protected against overload.
- Rugged anodized aluminum case.
- Designed for direct wall or floor mounting, or bench top use.

MODEL	SH. WT.	LIST PRICE	OUR PRICE
GOFTRA650	10 lbs.	\$79.95	\$69.95
GOFTRA1150	20 lbs.	\$159.95	\$139.95
GOFTRA1650	20 lbs.	\$239.95	\$210.00



1 ONE

WIRE WRAPPING TOOLS AND WIRE

"HOBBY" WIRE WRAPPING TOOL BATTERY POWERED

For .025" (0.63mm) sq post "MODIFIED" wrap, positive indexing anti-overwrapping device.

OKMBW2630 Tool \$21.95
OKMBC1 Batteries and Charger \$14.95
OKMBT30 Bit for AWG 30 \$ 4.19
OKMBT2628 Bit for AWG 26-28 \$ 8.49

Use "C" size NICAD Batteries, not included



HOBBY WRAP TOOLS

MODIFIED WRAP

OKMWSU30M Modified Wrap \$8.49

BW928 INDUSTRIAL WRAPPING TOOL GREAT FOR PRODUCTION!

- Accepts Industrial Bits & Sleeves (Gardner Denver or equivalent)
- Auto-indexing
- Modified Wrap
- Back-Force available (Recommended for #30)



PART NO.	DESCRIPTION	PRICE:
OKMBW928	Tool	\$64.95
OKMBW928BF	Tool (with Backforce)	\$69.95
OKMBT30I	#30 Bit and Sleeve	\$34.95
OKMBC1	Batteries & Charger	\$14.95

TRI-COLOR DISPENSER

- 3 Rolls of Wire in one dispenser
- 3 Colors Blue, White, Red 50 ft. of each color
- AWG 30 (0.25mm) KYNAR Insulated Wire
- Built-in Plunger cuts wire to desired length
- Built-in Stripper strips 1" of insulation
- Refillable (for refills, see below)

OKMWD30TRI Tri-Color Dispenser \$8.49
OKMR30TRI Replacement Rolls \$8.49



WK-7 IC INSERTION

OKMWK 7 Complete IC Inserter/Extractor Kit \$34.95

INDIVIDUAL COMPONENTS

OKMMS1418	14-16 Pin MOS CMOS Safe Inserter	\$ 8.95
OKMMS2428	24-28 Pin MOS CMOS Safe Inserter	\$ 8.95
OKMMS40	36-40 Pin MOS CMOS Safe Inserter	\$ 9.95
OKMEX1	14-16 Pin Extractor Tool	\$ 1.95
OKMEX2	24-40 Pin CMOS Safe Extractor Tool	\$ 9.95
OKMINS1416	14-16 Pin Dip/IC Inserter	\$ 3.95

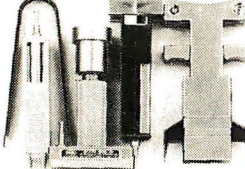

TERMINALS

- .025" (0.63mm) Square Post
- 3 Level Wire-Wrapping
- Gold Plated 25 per Pkg.

OKMWW1 Slotted Terminal \$6.29
OKMWW2 Single Sided Term. \$3.79
OKMWW3 IC Socket Terminal \$6.29
OKMWW4 OBL Sided Terminal \$2.19

TERMINAL INSERTING TOOL FOR ABOVE: OKMINS1 \$2.99

P.C.B. TERMINAL STRIPS

The TS Strips provide positive screw activated clamping action, accommodate wire sizes 14-30 AWG (1.8-0.24mm) Pins are solder plated copper. .042 inch (1mm) diameter on 200 inch (5mm) centers.

OKMTS4 4-Pole \$1.98
OKMTS8 8-Pole \$2.98
OKMTS12 12-Pole \$3.98

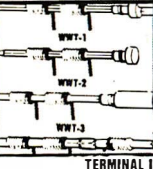

MODULAR TERMINAL STRIPS

The space-saving terminals take conductors from 26 through 16 AWG conforming to 20 inch (5.08mm) hole spacing on board up to 126 inch (3.20mm) thick.

OKMTSGMD 2-Pole \$2.19

PC BOARD

The 4 x 45 x 1/16 inch board is made of glass coated EPOXY Laminated and features solder coated 1 oz copper pads. The board has provision for a 22/44 two sided edge connector with contacts on standard 156 spacing.

OKMHPCB1 Hobby Board \$5.49



VACUUM VISE

Unique vacuum based light duty vise for precision handling of small components and assemblies. Rugged ABS construction 1 1/2" (38mm) wide jaws 1 1/2" (32mm) travel for maximum versatility. Also features crew lugs for permanent installation. (mounting screws included)

OKMNV1 Vacuum Vise \$3.79

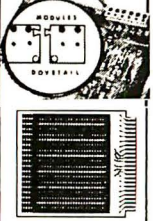

WHY CUT? WHY STRIP? WHY SLIT? WHY NOT... JUST WRAP

JUST WRAP TOOL WITH One 50 Ft. Roll of Wire

COLOR	PART NO.	LIST
Blue	OKMJWB	\$15.95
White	OKMJWW	\$15.95
Yellow	OKMJWY	\$15.95
Red	OKMJWR	\$15.95

- AWG 30 Wire
- .025" Square Posts
- Daisy Chain or Point to Point
- No Stripping or Sifting Required
- JUST WRAP
- Built in Cut Off
- Easy Loading of Wire
- Available Wire Colors Blue, White, Red & Yellow



JUST WRAP KIT CONTAINS

- JUST WRAP Tool
- Roll of Blue Wire, 50 ft.
- Roll of White Wire, 50 ft.
- Roll of Yellow Wire, 50 ft.
- Roll of Red Wire, 50 ft.
- Unwrapping Tool

OKMJWK6 JUST WRAP Kit \$26.95



JUST WRAP REPLACEMENT ROLLS

OKMRJW8	Blue Wire	50 ft. roll	3.49
OKMRJWW	White Wire	50 ft. roll	3.49
OKMRJWY	Yellow Wire	50 ft. roll	3.49
OKMRJWR	Red Wire	50 ft. roll	3.49



UNWRAP TOOL FOR JUST WRAP

OKMJWU1 Unwrapping Tool \$3.79



WIRE DISPENSER

- With 50 ft. Roll of AWG 30 KYNAR® wire-wrapping wire
- Built-in Plunger cuts wire to desired length
- Built-in Stripper strips 1" of insulation
- Refillable (For refills, see below)

OKMWD30B Blue Wire \$5.49
OKMWD30Y Yellow Wire \$5.49
OKMWD30W White Wire \$5.49
OKMWD30R Red Wire \$5.49



DISPENSER REPLACEMENT ROLLS

Wire for wire-wrapping AWG-30 (0.25mm) KYNAR® wire 50 ft. roll, silver plated, solid conductor, easy stripping.

PGS050U	30-AWG Blue 50 ft. roll	\$3.49
PGS050Y	30-AWG Yellow 50 ft. roll	3.49
PGS050W	30-AWG White 50 ft. roll	3.49
PGS050R	30-AWG Red 50 ft. roll	3.49



Wrap-ID

Pat. Pend.

12 11 10 9 8 7 6 5 4 3 2 1

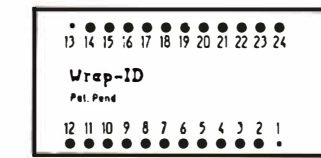

SOCKET WRAP - ID

Slipped onto socket, before wrapping to identify pins

PART NO.	PKG.	QTY.	PRICE	PART NO.	PKG.	QTY.	PRICE
OKM1410	10	\$1.89	OKM1410100	100	\$8.95		
OKM1610	10	1.69	OKM1610100	100	8.95		
OKM1810	10	1.89	OKM181050	50	8.95		
OKM2010	5	1.69	OKM201050	50	8.95		
OKM2410	5	1.69	OKM241050	50	9.95		
OKM2810	5	1.69	OKM2850	50	9.95		
OKM4010	5	1.89	OKM4025	25	8.95		

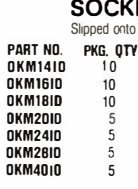

PRB-1 DIGITAL LOGIC PROBE

Compatible with all logic families using a 4 to 15V power supply. Thresholds automatically programmed. Visual indication of logic levels to show high, low, bad level or open circuit logic outputs.

- 10 msec. pulse responses
- 120K input impedance
- Automatic resetting memory.
- Includes tip with protective cap & coiled cord



PSL-1 LOGIC PULSAR

Superimposes a pulse train (20pps) or a single pulse onto the circuit node under test without unbalancing IC's

- Automatic polarity sensing
- 2 us pulse width
- Finger tip push button actuated
- Includes tip with protective cap & coiled cord

OKMPRB1 Digital Logic Probe \$39.95
OKMPLS1 Logic Pulsar \$54.95



PI DESOLDERING PUMP

Easy one hand operation. Rugged all metal construction. Replaceable TEFLOON Tip. Self Cleaning on each stroke. Suction precisely regulated for reliable desoldering without damage to delicate circuitry.

PART NO. **DESCRIPTION** **PRICE**
OKMPI Desoldering Pump \$11.95



page ASSEMBLED AND TESTED CABLES

- Fully Assembled & Tested
- Robinson-Nugent IDC Connectors
- Many Standard Configurations
- Custom lengths and combinations available

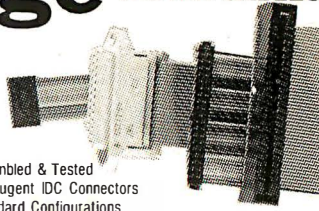

DIP JUMPERS

Available with 14, 16, 24 and 40 contacts. Mates with standard IC socket.

PGC 14P36	14 PIN DIP JUMPER 36" SGL	\$ 4.00
PGC 14P06P	14 PIN DIP JUMPER 06" DBL	\$ 4.60
PGC 14P12P	14 PIN DIP JUMPER 12" DBL	\$ 4.75
PGC 14P18P	14 PIN DIP JUMPER 18" DBL	\$ 4.95
PGC 14P24P	14 PIN DIP JUMPER 24" DBL	\$ 5.10
PGC 14P36P	14 PIN DIP JUMPER 36" DBL	\$ 5.50
PGC 16P36	16 PIN DIP JUMPER 36" SGL	\$ 4.50
PGC 16P06P	16 PIN DIP JUMPER 06" DBL	\$ 4.90
PGC 16P12P	16 PIN DIP JUMPER 12" DBL	\$ 5.20
PGC 16P18P	16 PIN DIP JUMPER 18" DBL	\$ 5.40
PGC 16P24P	16 PIN DIP JUMPER 24" DBL	\$ 5.65
PGC 16P36P	16 PIN DIP JUMPER 36" DBL	\$ 6.05
PGC 24P36	24 PIN DIP JUMPER 36" SGL	\$ 6.50
PGC 24P06P	24 PIN DIP JUMPER 06" DBL	\$ 7.50
PGC 24P12P	24 PIN DIP JUMPER 12" DBL	\$ 7.75
PGC 24P18P	24 PIN DIP JUMPER 18" DBL	\$ 8.05
PGC 24P24P	24 PIN DIP JUMPER 24" DBL	\$ 8.35
PGC 24P36P	24 PIN DIP JUMPER 36" DBL	\$ 8.95
PGC 40P36	40 PIN DIP JUMPER 36" SGL	\$10.50
PGC 40P06P	40 PIN DIP JUMPER 06" DBL	\$11.35
PGC 40P12P	40 PIN DIP JUMPER 12" DBL	\$11.85
PGC 40P18P	40 PIN DIP JUMPER 18" DBL	\$12.35
PGC 40P24P	40 PIN DIP JUMPER 24" DBL	\$12.80
PGC 40P36P	40 PIN DIP JUMPER 36" DBL	\$13.75

CARD EDGE JUMPERS

Mate with standard 0.62" PC boards

PGC 20E36	20 PIN CARD EDGE 36" SGL	\$ 7.25
PGC 20E36E	20 PIN CARD EDGE 36" DBL	\$10.95
PGC 28E36	26 PIN CARD EDGE 36" SGL	\$ 8.50
PGC 28E36E	26 PIN CARD EDGE 36" DBL	\$12.40
PGC 34E36	34 PIN CARD EDGE 36" SGL	\$10.50
PGC 34E36E	34 PIN CARD EDGE 36" DBL	\$15.15
PGC 40E36	40 PIN CARD EDGE 36" SGL	\$12.25
PGC 40E36E	40 PIN CARD EDGE 36" DBL	\$17.50
PGC 50E36	50 PIN CARD EDGE 36" SGL	\$15.00
PGC 50E36E	50 PIN CARD EDGE 36" DBL	\$21.65

SOCKET JUMPERS

Mates with two rows of posts on .100" centers

PGC 20S36	20 PIN SOCKET 36" SGL	\$ 5.50
PGC 20S36S	20 PIN SOCKET 36" DBL	\$ 7.50
PGC 26S36	26 PIN SOCKET 36" SGL	\$ 6.95
PGC 26S36S	26 PIN SOCKET 36" DBL	\$ 9.40
PGC 34S36	34 PIN SOCKET 36" SGL	\$ 8.85
PGC 34S36S	34 PIN SOCKET 36" DBL	\$11.90
PGC 40S36	40 PIN SOCKET 36" SGL	\$10.35
PGC 40S36S	40 PIN SOCKET 36" DBL	\$13.40
PGC 50S36	50 PIN SOCKET 36" SGL	\$12.75
PGC 50S36S	50 PIN SOCKET 36" DBL	\$17.05

"D" CONNECTORS

Mates with any standard female DB25 "D" Subminiature Connector

PGC 25DP38	25 PIN IDB25P 36" SGL	\$12.00
PGC 25DP06DP	25 PIN IDB25P 06" DBL	\$17.95
PGC 25DP12DP	25 PIN IDB25P 12" DBL	\$18.25
PGC 25DP18DP	25 PIN IDB25P 18" DBL	\$18.55
PGC 25DP24DP	25 PIN IDB25P 24" DBL	\$18.85
PGC 25DP30DP	25 PIN IDB25P 36" DBL	\$19.45
PGC 25DP06DP	25 PIN IDB25P 06" DBL	\$20.85

SPECIAL COMBINATIONS

Designed to meet the needs of computer I/O and Floppy Disk interfacing.

PGC 26SD06DS	26 PIN SOCKET/25 PIN IDB25S 06"	\$13.70
PGC 28SI2DS	26 PIN SOCKET/25 PIN IDB25S 12"	\$14.05
PGC 28SI8DS	26 PIN SOCKET/25 PIN IDB25S 18"	\$14.35
PGC 28S24DS	26 PIN SOCKET/25 PIN IDB25S 24"	\$14.65
PGC 28S38DS	26 PIN SOCKET/25 PIN IDB25S 36"	\$15.30
PGC 25S06DS	26 PIN SOCKET/25 PIN IDB25S 06"	\$16.55
PGC 25DP06DS	25 PIN IDB25P/IDB25S 06"	\$18.80
PGC 25DP12DS	25 PIN IDB25P/IDB25S 12"	\$19.10
PGC 25DP18DS	25 PIN IDB25P/IDB25S 18"	\$19.40
PGC 25DP24DS	25 PIN IDB25P/IDB25S 24"	\$19.75
PGC 25DP36DS	25 PIN IDB25P/IDB25S 36"	\$20.35
PGC 25DP06DS	25 PIN IDB25P/IDB25S 06"	\$21.80
PGC 50E06S	50 PIN CARD EDGE/SOCKET 06"	\$18.35
PGC 50E12S	50 PIN CARD EDGE/SOCKET 12"	\$18.95
PGC 50E18S	50 PIN CARD EDGE/SOCKET 18"	\$17.55
PGC 50E24S	50 PIN CARD EDGE/SOCKET 24"	\$18.15
PGC 50E38S	50 PIN CARD EDGE/SOCKET 36"	\$19.35
PGC 50E06S	50 PIN CARD EDGE/SOCKET 06"	\$21.75
PGC 34S48E30E	34 PIN SOCKET/CARD EDGE 48"/30"	\$22.95
PGC 34S60E30E	34 PIN SOCKET/CARD EDGE 60"/30"	\$23.95
PGC 50S48E30E	50 PIN SOCKET/CARD EDGE 48"/30"	\$31.95
PGC 50S60E30E	50 PIN SOCKET/CARD EDGE 60"/30"	\$32.95
PGC 34S60EX4	34 PIN SOCKET/EDGE CARD X 4	\$34.95
PGC 34S60EX4	34 PIN SOCKET/EDGE CARD X 4	\$35.95
PGC 50S48EX4	50 PIN SOCKET/EDGE CARD X 4	\$51.95
PGC 50S60EX4	50 PIN SOCKET/EDGE CARD X 4	\$52.95

PRIORITY ONE ELECTRONICS

RN ROBINSON NUGENT, INC.

EDGE CARD CONNECTOR



1" Spacing. Crimps onto cable with ordinary vise & mates with standard .062" Card Edge.

PART NO.	NO. OF PINS	1-9	10-24	25-99	100-249
RNIDE20	10/20	4.35	4.00	3.30	3.00
RNIDE26	13/26	5.00	4.50	3.75	3.25
RNIDE34	17/34	6.00	5.40	4.50	4.00
RNIDE40	20/40	6.90	6.20	5.30	4.80
RNIDE50	25/50	7.25	6.60	5.90	5.30

SOCKET CONNECTOR



1" Spacing. Crimps onto cable with ordinary vise & mounts to header sold

PART NO.	NO. OF PINS	1-9	10-24	25-99	100-249
RNIDS20	10/20	2.75	2.50	1.85	1.70
RNIDS26	13/26	3.50	3.20	2.40	2.20
RNIDS34	17/34	4.50	4.20	3.10	2.90
RNIDS40	20/40	5.40	5.00	3.65	3.30
RNIDS50	25/50	6.50	6.00	4.60	4.20

HEADER CONNECTOR



1" Spacing. Mounts on PC Board & Mates with IDS Socket above.

RIGHT ANGLE SOLOERTAL GOLD HEADER

PART NO.	NO. OF PINS	1-9	10-24	25-99	100-249
RNSIDH25R	1.90	1.60	1.20	1.00	
RNSIDH26SR	2.25	2.00	1.55	1.30	
RNSIDH34SR	2.95	2.60	2.05	1.70	
RNSIDH40SR	3.60	3.00	2.40	2.10	
RNSIDH50SR	4.30	3.60	3.00	2.55	

RIGHT ANGLE WIRE WRAP GOLD HEADER

PART NO.	NO. OF PINS	1-9	10-24	25-99	100-249
RNIH20WR	4.15	3.60	2.75	2.40	
RNIH26WR	5.30	4.30	3.60	3.10	
RNIH34WR	5.95	5.00	4.15	3.70	
RNIH40WR	7.00	6.00	4.90	4.30	
RNIH50WR	7.95	6.80	6.15	5.20	

Straight headers are also available at the above prices. Drop the R from the end of the part number to specify Straight. RNIJ24 Header Ejector Bars (Package of 4) \$1.00



RIBBON CABLE

COLOR CODED LAMINATED CABLE FOR INSULATION DISPLACEMENT 28 GAUGE, 7 STRAND

PART NO.	NO. OF CONDUCTORS	10 FT.	100 FT.
IDC09CC*	9	3.80	30.00
IDC14CC*	14	4.75	40.00
IDC16CC*	16	5.50	45.00
IDC20CC*	20	7.00	60.00
IDC25CC*	25	8.50	72.00
IDC26CC*	26	8.50	72.00
IDC34CC*	34	11.00	100.00
IDC40CC*	40	13.00	115.00
IDC50CC*	50	16.00	145.00

GRAY LAMINATED CABLE FOR INSULATION DISPLACEMENT 28 Gauge 7 Strand

PART NO.	NO. OF CONDUCTORS	10 FT.	100 FT.
IDC09GY*	9	2.50	18.05
IDC14GY*	14	3.50	28.00
IDC16GY*	16	4.00	32.00
IDC20GY*	20	4.80	40.00
IDC25GY*	25	6.00	50.00
IDC26GY*	26	6.00	50.00
IDC34GY*	34	8.30	66.00
IDC40GY*	40	10.00	77.00
IDC50GY*	50	12.00	95.00

*Add "Y" to Part No. for 100 Ft. Spool

Connectors, Plugs, and Sockets

D-SUBMINIATURE CONNECTORS

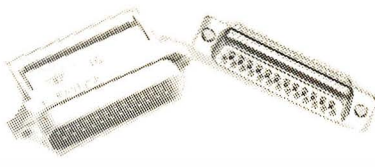

Solder Style solders onto cable, IDC Style crimps onto cable with vise.

INSULATION DISPLACEMENT TYPE

P = Plug, Male Type - S = Socket, Female Type - C = Cover Hood

PART NO.	NO. OF PINS	1-9	10-24	25-99	100-249
IDCDE9P	9	4.20	4.00	3.60	3.20
IDCDE9S	9	4.50	4.20	3.80	3.40
IDCDE9C	9	1.25	1.10	1.00	.95
IDCDA15P	15	4.35	4.20	3.75	3.40
IDCDA15S	15	5.00	4.85	4.35	3.90
IDCDA15C	15	1.40	1.25	1.10	.95
IDCDB25P	25	6.25	6.00	5.20	4.70
IDCDB25S	25	6.60	6.35	5.60	5.00
IDCDB25C	25	1.60	1.50	1.35	1.20
IDCC37P	37	8.80	8.00	7.20	6.40
IDCC37S	37	11.00	10.25	9.20	8.20
IDCC37C	37	2.25	2.20	1.80	1.60

SOLDER TYPE

PART NO.	DESCRIPTION	1-9	10-24	25-99
CNDE9P	9 Pin Male	\$2.10	\$1.90	\$1.70
CNDE9S	9 Pin Female	\$2.70	\$2.40	\$2.10
CNDE9C	9 Pin Cover	\$1.50	\$1.25	\$1.10
CNDA15P	15 Pin Male	\$2.75	\$2.45	\$2.15
CNDA15S	15 Pin Female	\$3.95	\$3.60	\$3.20
CNDA15C	15 Pin Cover	\$1.50	\$1.30	\$1.10
CNDB25P	25 Pin Male	\$3.00	\$2.75	\$2.25

★ **CNDB25P 100 pcs at \$1.95 ea.** ★

★ **CNDB25S 100 pcs at \$2.95 ea.** ★

★ **CNDB51226 2 Pc. Black Hood \$1.90 \$1.65 \$1.45**

★ **CNDB51226 100 pcs at \$1.00 ea** ★

CNDB51212	1 Pc. Grey Hood	\$1.60	\$1.45	\$1.30
CNDP25H	2 Pc. Grey Hood	\$1.50	\$1.25	\$1.10
CNDDC37P	37 Pin Male	\$5.80	\$5.10	\$4.45
CNDDC37S	37 Pin Female	\$8.70	\$7.70	\$6.70
CNDDC37C	37 Pin Cover	\$1.80	\$1.55	\$1.30
CNDD50P	50 Pin Male	\$8.75	\$7.75	\$6.70
CNDD50S	50 Pin Female	\$11.65	\$10.25	\$8.90
CNDD50C	50 Pin Cover	\$2.00	\$1.80	\$1.60
CNDD05A18	Hardware Set 2 Pr. RS232, DB25P, EIA Class 1 Cable 8 Con. 8 Ft.	\$19.95	\$17.95	\$15.95
CNDRS232BF	Cent. 700 Series/Epson Printer Conn.	\$9.00	\$7.50	\$6.00
CND573036D	IDC Version of Above	\$9.95	\$9.00	\$6.00

DIP PLUGS

1" Spacing. Crimps onto cable with ordinary vise & plugs into standard IC Socket.

PART NO.	NO. OF PINS	1-9	10-24	25-99	100-249
RNIOP14	14	1.50	1.40	1.25	1.10
RNIOP16	16	1.70	1.60	1.45	1.30
RNIOP24	24	2.50	2.20	2.00	1.80
RNIOP40	40	4.15	3.65	3.30	3.00

RN ICU Series Solder Tail Sockets

End side stackable. Low profile Closed Entry. Lead Entry has RN "EZ" Entry feature to guide IC leads into socket. Standoff to facilitate board cleaning. Self lock leads hold socket firmly in place while soldering. Contact's long movement arm provides low insertion force. Normal force of contact combined with uncoiling force provide high retention (making socket vibration resistant). Gas tight. Tin Plated.

PART NO.	PINS	1-9	10-49	50-99	100-499	1,000+
RNS08LP	08	N/A	.15	.10	.08	.07
RNS14LP	14	N/A	.18	.15	.14	.12
RNS16LP	16	N/A	.20	.18	.16	.13
RNS18LP	18	.30	.25	.22	.18	.15
RNS20LP	20	.30	.25	.23	.20	.17
RNS22LP	22	.35	.30	.25	.22	.19
RNS24LP	24	.40	.35	.30	.24	.20
RNS28LP	28	.45	.40	.35	.28	.24
RNS40LP	40	.50	.45	.42	.40	.35

*MINIMUM ORDER \$1.00 Per Line Item
Call for RN High Reliability Solder Sockets

ICN SERIES GOLD 3 LEVEL WIRE WRAP SOCKETS

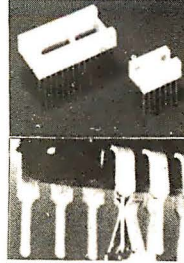

- 10 in. GOLD Plated Pins
- Deep Chamfered Closed Entry Contacts
- RN Side Wipe Contact Design
- Phosphor Bronze Contact Material
- Terminal Barbs Allow Self-lock into PC Board
- Rugged Socket Body Design
- Deep Chamfered Closed Entry Contacts

PRICE

PART NO.	PINS	1-9	10-24	25-99	100-249	250-999
RNS08WWG	8	.60	.55	.49	.45	.41
RNS14WWG	14	.75	.70	.65	.55	.48
RNS16WWG	16	.85	.75	.70	.60	.52
RNS18WWG	18	1.00	.90	.80	.75	.71
RNS20WWG	20	1.20	1.05	.96	.91	.87
RNS22WWG	22	1.35	1.25	1.15	1.05	.99
RNS24WWG	24	1.35	1.25	1.15	1.05	.99
RNS28WWG	28	1.70	1.55	1.40	1.34	1.25
RNS40WWG	40	2.20	2.05	1.85	1.60	1.50

GOLD PLATED CONTACTS

NEW! SELECTIVE PLATED PINS THAT WILL SAVE YOU MONEY BY HAVING GOLD ONLY WHERE IT COUNTS! Same as above except pins are selectively plated.

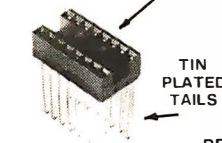

TIN PLATED TAILS

PART NO.	PINS	1-9	10-24	25-99	100-24	250-99
RNS08TWW	8	.55	.50	.45	.41	.37
RNS14TWW	14	.65	.55	.50	.47	.44
RNS16TWW	16	.75	.65	.52	.51	.46
RNS18TWW	18	.90	.79	.75	.70	.65
RNS20TWW	20	1.10	.95	.91	.87	.82
RNS22TWW	22	1.25	1.15	1.05	.94	.89
RNS24TWW	24	1.25	1.15	1.05	.96	.89
RNS28TWW	28	1.50	1.45	1.35	1.25	1.15
RNS40TWW	40	2.00	1.80	1.60	1.40	1.30

Call for RN High Reliability Wire Wrap Sockets

page

PRECUT WIRE WRAP WIRE
Precut Wire Save Time and
Costs Less Than Wire on Spools



Kynar pre-cut wire. All lengths are overall, including 1" strip on each end. Colors and lengths cannot be mixed for quantity pricing. Choose from colors Red (R), Blue (B), Black (BK), and Yellow (Y).

PART NO.	LENGTH	/C	/D	/M
PGP025+	2.5"	\$1.38	\$3.94	\$6.19
PGP030+	3.0"	1.43	4.25	6.78
PGP035+	3.5"	1.51	4.57	7.37
PGP040+	4.0"	1.56	4.68	7.94
PGP045+	4.5"	1.63	5.21	8.54
PGP050+	5.0"	1.69	5.54	9.13
PGP055+	5.5"	1.74	5.92	9.72
PGP060+	6.0"	1.82	6.23	10.31
PGP070+	7.0"	2.19	7.44	12.44
PGP080+	8.0"	2.35	8.12	13.79
PGP090+	9.0"	2.46	8.92	15.01
PGP100+	10.0"	2.63	9.56	16.28

† Specify package size when ordering: 100 (C), 500 (D), 1000 (M).
* Specify color when ordering. RED (R), BLUE (B), BLACK (BK), & YELLOW (Y). Example: If you wish to order (2) pkg. 1000 4" Red

2		PGP040MR	T94	\$15.88			
BUY PRECUT WIRE IN KITS AND SAVE							
PGPWK1*	\$9.95	PGPWK3*	\$34.95				
CONTAINS		CONTAINS					
200	3"	100	4 1/2"	250	2 1/2"	500	4 1/2"
200	3 1/2"	100	5"	500	3"	500	5"
100	4"	100	6"	500	3 1/2"	500	5 1/2"
PGPWK2*	\$24.95	500	6"	500	4"	500	6"
CONTAINS		CONTAINS					
250	2 1/2"	250	5"	500	2 1/2"	1000	4 1/2"
500	3"	100	5 1/2"	1000	3"	1000	5"
500	4"	100	6 1/2"	1000	3 1/2"	1000	5"
250	4 1/2"	100	7"	1000	4"	1000	6"
* Wire kit assortments are available in the 4 colors mentioned above along with a rainbow assortment. Use color code (A) for the rainbow assortment. Example: If you wish to order (2) wire kit 3 in blue							
2	PGPWK3U	\$34.95	\$69.90				



PRIORITY ONE ELECTRONICS

9161-B DEERING AVE. • CHATSWORTH, CA 91311



Unclassified Ads

FOR SALE: AIM-65 with 4 K, assembler, BASIC, and new enclosure. In excellent working condition; \$450. Assembled and working Video-1 with 4 K, D/A, and A/D (A/D module needs work); \$300. Both for \$700. Also, video terminal; negotiable. Dave Trout, 3261 Michigan Ave., Costa Mesa, CA 92626. (714) 546-7481.

FOR SALE: Amateur radio transceiver: 5B0-Delta, 9-band, TENTEC, solid state; \$690. Power supply; \$90. Will consider trade for computer equipment. H.D. Chapin, POB 1918, Fort Collins, CO 80522. (303) 484-4121.

FOR SALE OR SWAP: H-P microprocessor training course. Complete in brand-new condition. Contains 5036A lab, 5004A signature analyzer, and 5024A logic probe kit. \$2270 or swap for Tektronix 5658 oscilloscope. Walter Lindell, 757 Columbus Ave., San Francisco, CA 94133.

FOR SALE: OSI Challenger IP, Series I (metal case), upgraded to 8 K, switch-selectable 1 or 2 MHz clock, tape read/write, print at 300, 600 and 1200 bps, and CEGMON PROM expanded monitor; \$350. Variety of tape software, including OSI assembler/editor and extended monitor; \$50. Mike Fichtelman, 72-61 113 St., Forest Hills, NY 11375. (212) 263-1221 evenings.

WANTED: TRS-80 Level II programs to swap: games, home, and business programs. Send tape, disk, or listing with your name and address. George Vandervort, POB 199, San Marcos, TX 78666.

FOR SALE: IBM Selectric I/O printer, correspondence code. With parallel interface (8 bits out, 1 bit in) and driver software for a 6502. Also, manuals and spare parts. \$450 plus shipping. Al Thomason, 2544 Union #27, Klamath Falls, OR 97601. (503) 883-3278.

FOR SALE: Sinclair ZX80 personal computer in perfect condition. 16 K programmable memory, 8 K floating-point BASIC, and Z80A processor. Manual included, plus subscription to *Synk*, and all back issues. Clock speed is 3.25 MHz. \$240 or best offer. Cost \$350 new. Brad Konia, Spring Hill Farm, Easton, PA 18042. (215) 252-7134.

FOR SALE: CIP in good condition. With 8 K, case, power supply, manuals, BASIC instruction book, R/F modulator, cables, and demonstration tapes. Best offer takes all. Mike Kirk, 1205 Washington, Friona, TX 79035. (806) 247-3767 weekends.

FOR SALE: ADDS Regent 100 video terminal, like new; \$600. US Robotics auto-answer/originate terminal Model USR 320; \$100. InterTec InterTube 3 video terminal, one-month old; \$600. Jack Hardman, 600 Cortlandt St., Belleville, NJ 07109. (201) 751-3005.

WANTED: Nonprofit microcomputer club in France requests contacts with similar organizations in the United States and Great Britain, with special regard to software. We also seek reprint rights of magazines and benchmarks, and software for our organization's two radio stations. AMIF, 6 rue des Ormes, 94120 Fontenay-Sous-Bois, France.

FOR SALE: LSI-11/2 complete system. WH-11A with 64 K, three WH-11-5 serial cards, WH-27 dual 8-inch floppies, WH-14 printer, Hazeltine 1510 terminal, and AJ acoustic coupler. Runs UCSD Pascal or DEC PDP-11/03 software. Best offer. F. Monaco, 570 C. Connor Rd., West Point, NY 10996. (914) 446-4217.

WANTED: Hewlett-Packard HP-19 calculator in good condition. John Dilday, 621 Vickers Ave., Durham, NC 27701. (919) 682-1121.

FOR SALE: Commodore PET computer. 8 K upgraded to 32 K, with tape drive, keyboard, and screen; \$950. DeLinn Shields, 903 Enterprise Dr., Suite 1, Sacramento, CA 95825. (916) 929-7670.

FOR SALE: H-8 64 K Trionyx board, H-8-5 interface, H-17 disk controller only, and H-P terminal (unmodified); \$1200. Joe Cross, 8010 East Zimmerly, Wichita, KS 67207. (316) 685-8673.

FOR SALE: Heath H-8 computer, 8 K programmable memory, I/O interface board, H-9 video terminal, BASIC. Extended BASIC, editor, games, and documentation; \$500. Al Meyer, 28 Skipper Dr., West Islip, NY 11795. (516) 422-0891.

FOR SALE: HP-2621A video-display terminal in original box with all manuals. This is a professional unit with two pages of memory, scroll up/down, previous/next page, addressing, editing, N-key rollover, auto repeat any key, and detached keyboard. It is capable of displaying control characters as a selectable mode. In mint condition. I pay shipping. \$1095 takes it. Three Heath 8 K programmable-memory boards with DIP switches for address and one Heath WH-8-16 16 K programmable-memory board. All manuals, etc., included. Seven TMS 4044-4 4 K programmable-memory chips. I pay shipping. \$419 takes it all. Brian Branson, 2255 Cahuilla Rd. #10B, Colton, CA 92324. (714) 824-0144.

FOR SALE: Commodore PET Model 2001 with 8 K programmable memory, a self-contained cassette recorder, original documentation, Hayden's Basic BASIC book, and a cassette with many programs. \$450, you pay shipping. Expand this PET with BETSI PET to S-100 interface with an Expand-Ram with 24 K of additional programmable memory. Also contains four 2 K PROM sockets. Includes power supply and documentation. An additional \$300. John Lemkelde, 5980 Bull Rd., Dover, PA 17315. (717) 292-4933.

FOR SALE: ADDS Regent 200 editing terminal with protected fields, half-intensity, blinking, and reverse video. Like new; \$750. North Star single-density disk controller and SA-400 minifloppy drive; \$350. IMSAI PIC-8 priority interrupt controller and programmable clock. New; \$75. IMSAI MPU-A 2.0 MHz processor card; \$50. D. Sellar, 616 North Delaware Ave., Lindenhurst, NY 11757.

WANTED: Nonfunctional Hazeltine 1500 CRT, with or without tube, to be used as spare parts for my own flaky Hazeltine 1500. James Vliet, 32 Wesley St., Monmouth Beach, NJ 07750. (201) 222-4313 evenings.

FOR SALE: CompuColor Model 4, 16 K microcomputer with 101-key keyboard, eight-color display, Disk BASIC language, software, and manuals. Hardly used; \$1000/offer. Kathy Siiva, 2954 Kilkare Rd., Sunol, CA 94586. (415) 862-2146, 792-9800.

FOR SALE: Lear-Siegler ADM3A terminal with uppercase/lowercase read-only memories, 80 columns, 24 rows, absolute and indirect cursor addressing. Includes operator's manual. Excellent condition; \$650. Shugart SA-801 8-inch floppy-disk drive with power supply and cabinet with fan. Includes manuals. Good condition; \$550. Dave Gewirtz. (201) 796-3140.

FOR SALE: Drum memory, military airborne type. Over 100 RAW heads (no drive electronics), includes 110 VAC drive motor, \$100 plus shipping. Also, Processor Technology programs on cassette (CUTS format), never used: Trek-80 (Star Trek with sound), Software #1 (8080 assembler), and FOCAL language; \$10 each. George Bonicatto, 5 Southview Dr., Apt. #D, Hibbing, MN 55746. (218) 263-5306 after 4 p.m.

FOR SALE: Digital Group Z80 computer (26 K) with dual Phi-Decks (extra controller board), printer B, full-function ASCII keyboard, video modulator, 32 K static (TMS-4044, etc.) bare board, and lots of software (including Sargon, Business BASIC, MaxiBASIC, Mini and Tiny BASIC, and games). Complete with full documentation, but no covers. Includes the Audio ROM and Phi ROM; \$1500. D.M. Lazok, 1161 North Cherywood Dr., East Layton, UT 84041. (801) 766-0885.

WANTED: S-100 adapter board, any type. Also, schematic and parts list for Processor Technology CUTS. I have some PT boards and want to interface with a single-board computer. Larry Bates, 39 Hanover St., Asheville, NC 28806.

FOR SALE: Complete S-100 video subsystem. Includes Polymorphic video terminal interface card, Sanyo 9-inch video monitor, Microage keyboard with 10-key pad, all cables and connectors, and complete documentation. Upgraded my system to VDT after 18 months of no-problem use. \$350 takes it all. Joe Rothstein, 3529 Kaau St., Honolulu, HI 96816.

FOR SALE: TRS-80 Model I with expansion interface, 48 K, RS-232C, LNW double density, 80-Graphix, and Archbold speedup. Running over 6 months. Includes DOS plus 3.3D operating system. \$1500 or best offer. IthacaIntersystems S-100 2708/2716 EPROM board. Factory sealed with 16 K of 2708 EPROMs. Must sell. \$150 or best offer. Mike Okrent, 11 Prince Dr., Bethany, CT 06525. (203) 393-2662.

FOR SALE: PET and Apple software by Soft Sector. Includes: 1. electrical engineering—ladder network analysis, active filter design (lowpass, highpass, bandpass, allpass), attenuator design, and Butterworth and Chebyshev filter design; 2. audio engineering—passive crossover and inductor design, acoustic speaker design, and exponential horn design. For PET and Apple on disk and tape. Must sell. Send for complete program descriptions and sample printouts. R. Majef, 534 Apollo, Richardson, TX 75081.

FOR SALE: Back issues of *BYTE* from September 1975 through June 1980. Highest reasonable bid. Gary Dawkins, 3523 Bunyan, San Antonio, TX 78247. (512) 494-5995.

FOR SALE: First 60 issues of *BYTE* (issue #1) through vol. 5, no. 8) in excellent condition. \$120 plus shipping. Shipped only to areas served by UPS (shipping charges COD). Send name, address (no POB numbers), certified check or postal money order, and SASE for return of check. Sorry, will not sell partial set or return checks without SASE. David B. Lamkins, 56 Lakeshore Dr., Marlboro, MA 01752. (617) 481-6192 6 to 9 p.m. ET.

FOR SALE: H-17 floppy bare board (Heathkit) with all components, including read-only memory, hardware, and instruction manuals. No cable, disks, or cabinet. \$95. Anthony J. Gasbarre. (603) 847-9797.

FOR SALE: H-11 32 K-byte memory board; \$320. Two DLV11 serial interface; \$85 each. H-11 complete with 40 K-byte memory, DLV11, boot and memory test board, and LTC option; \$1450. Mike Kennedy, 3630 South Kenwood Lane, Phoenix, AZ 85282. (602) 978-0748.

FOR SALE: Computer ideal for personal finances, beginners, and bright youngsters. Complete with video monitor, keyboard, multipurpose cassette recorder, blank cassettes, prerecorded game cassettes, comprehensive how-to manuals, creative graphics book, eight-lesson cassette instruction course, and all necessary connection cables. Assembles in 15 minutes. Lots of software available. Complete package for \$400 or best offer. Mike Sutherland, 419 East Pershing St., Appleton, WI 54911.

FOR SALE: Scantron optical mark reader Model 509B-2. Good for reading test answer sheets, other data records, etc. Three years old; factory reconditioned. Excellent operating condition. \$1200 or best offer. Municipal Personnel Service, 1675 Green Rd., Ann Arbor, MI 48105. (313) 662-3246.

UNCLASSIFIED POLICY: Readers who are soliciting or giving advice, or who have equipment to buy, sell or swap should send in a clearly typed notice to that effect. To be considered for publication, an advertisement must be clearly noncommercial, typed double spaced on plain white paper, contain 75 words or less, and include complete name and address information.

These notices are free of charge and will be printed one time only on a space available basis. Notices can be accepted from individuals or bona fide computer users clubs only. We can engage in no correspondence on these and your confirmation of placement is appearance in an issue of *BYTE*.

Please note that it may take three or four months for an ad to appear in the magazine.

Reader Service

Inquiry No.	Page No.	Inquiry No.	Page No.	Inquiry No.	Page No.	Inquiry No.	Page No.
1	47th STREET PHOTO 325	86	COMPUSERVE 376	171	HEWLETT-PACKARD 151	256	MILLER MICROCOMP.SERV. 372
2	A.S.T. RESEARCH 238	87	COMPU SYSTEMS INC. 460	172	HEWLETT-PACKARD 225	257	MINI COMP SUPPLIERS 355
3	AB COMPUTERS 457	88	COMPUTER AGE 334	173	HOUSTON INSTRUMENTS 135	258	MODULAR INTEGRATION 472
4	ABM PRODUCTS 194	89	COMPUTER DISC.OF AM. 224	174	HOUSTON INSTRUMENTS 135	406	MORGAN PRODUCTS 351
5	ACCESS 460	90	COMPUTER EXCHANGE 283	175	HUNTINGTON COMPUTING 447	259	MORROW DESIGNS 24, 25
6	ACE COMP. PROD. 474	91	COMPUTER FURN.& ACCSS. 240			260	MORROW DESIGNS 175
7	ACTEK 359	92	COMPUTER MAIL ORDER 211			261	MOUNTAIN VIEW PRESS 327
8	ACTION COMPUTER 89	93	COMPUTER PLUS 476	176	IBM 61	262	MSD 214
9	ACTS AUDIO INC 288		COMPUTER PROFESSIONAL 256, 257	416	ILLINOIS COMPUTER PROD. 476	263	MTI MICROSYSTEMS 12, 13
10	ADV.COMP.PROD. 482, 483	94	COMPUTER SHOPPER 400	177	IMS INTERNATIONAL 185	264	MTI, INC. 350
11	ADV. DIGITAL PROD. 464	95	COMPUTER SPLCTIES. 200, 201	179	INDNPT BUS.SYS.INC 152, 153	265	MULTI BUSN.COMP.INC. 192
12	ADV. DIGITAL PROD. 470	97	COMPUTER TOOLBOX, INC. 466	183	INFOSOFT 476	266	NATIONAL DATA PROD. 148
13	ADV.MICRO DIGITAL CORP. 167		COMPUTER WRHSE. 247	181	INMAC 338	267	NAVTEL, LTD. 20
15	ADVENT PRODUCTS 232	98	COMPUTERIZED MNGMNT.SYS 474	182	INNOVATIVE SFTW.APPL. 126		NCC/AFIPS 205
17	ALL ELECTRONICS CORP 387	99	COMPUTERWARE 391	184	INTEC 371	268	NCL DATA INC. 367
19	ALPHA BYTE STORAGE 124, 125	403	COMPUTERWORLD INT'L. 367	185	INTEGRAL DATA SYS. 82, 83	269	NEBS 144
20	ALPHA BYTE STORAGE 139	101	COMPUTEX CORP 78	186	INTEGRAND 349	270	NEC HOME ELECTR.USA 55
21	ALPHA BYTE STORAGE 155	102	COMPUVIEW PROD.INC. 66, 67	187	INTELLIGENT SYS. CORP. 93	271	NEECO 133
22	ALSPA COMP.SYS. 73	103	CONCOMP IND. 271	188	INTERACTIVE MICROWRE 96	272	NET PROFIT COMP. 102
*	ALTERNATE WORLD SIMU. 288	104	CONCORD COMP.PROD. 345	189	INTERACTIVE STRUCT. 150		NETRONICS 228, 229
23	ALTOS COMP.SYS. 168, 169	106	CONSUMER COMP. 165	190	INTERTEC DATA SYS. 137	273	NEW GENERATION SYS. 210
24	AMDEK CORP. 85	107	CONSUMER COMP. 469	178	INT'L.MICRO SYS. 285	384	NORPAK LTD. 79
25	AMER.SQUARE COMP. 180, 181	108	CONTEXT MANGMNT.SYS. 23		INTROL CORP 474	274	NORTH STAR COMPUTERS 97
27	ANCRONA 276, 277	*	COTTON ASSOC. 466	191	IPEX INT'L. 464	275	NORTHEAST COMP.SALES 338
28	ANDERSON JACOBSON 357		CP AIDS 373	192	ITHACA INTERSYSTEMS 8		NRI SCHOOLS ELECTR.DIV. 305
29	ANDERSON JACOBSON 369	110	CPJ SHOP, THE 473	193	ITHACA INTERSYSTEMS 9		OASIS SYSTEMS 242
30	APPARAT INC 213	*	CROMEMCO CII	194	JADE COMP.PROD. 477		OFFICE AUTOMATION CONF. 331
32	APPLICATIONS GROUP 460	112	CROMEMCO 1	195	JADE COMP.PROD. 478, 479	277	OHIO SCIENTIFIC INSTR. CIV.
33	APPLIED ANALYTICS 222	113	CROMEMCO 2	196	JAMECO ELECTR. 480, 481	278	OLYMPIAN SALES 355
34	APPLIED MICRO TECHN. 18	*	CYBERNETICS INC 157	197	JDR MICRODEVICES 486, 487	279	OMEGA SALES 294, 295
35	ARCHIVES, INC. 468	*	DATA DISCOUNT CTR 254	198	JIM-PAK 461	280	OMIKRON 235
36	ARRIX LOGIC SYS.INC. 472	115	DATA STANDARD 292	199	JOE COMPUTER 288	281	OMNI RESOURCES 315
37	ARTIFICIAL INT'L.RESRCH 466	116	DATAFACE 184	200	KADAK PRODUCTS 316	283	OPTIMAL TECHNOLOGY 359
38	ASAP COMP.PROD.INC 236, 237	404	DATAMAC 435	201	KERN PUBLISHING 347	284	ORACLE ELECTR. 458
39	ASAP COMP.PROD.INC. 307	117	DATASOUTH COMP.CORP. 145	423	KIT-80 INC. 474	285	ORANGE MICRO 244, 245
40	ASHTON-TATE 293	118	DATASOUTH COMP.CORP. 392	415	KIT-80 INC. 476	286	ORANGE MICRO 309
41	ATON INT'L. 352	119	DEALIN ELECTRONICS 460		KLEINOFEN COMPUTERS 474		OREGON SOFTWARE 130
42	AUDEC CORP. 328	121	DESIGNER SOFTWARE 129	203	KNE RESOURCES 472	287	OREGON SOFTWARE 131
43	AUTOCONTROL INC 464	*	DIGITAL EQUIPMENT 390	204	KONAN CORP. 77	288	ORION INSTRUMENTS 460
44	AUTOMATED EQUIP. 284	122	DIGITAL GRAPHIC SYS 226	205	KV 33 371	289	OSBORNE COMPUTERS 33
45	AUTOMATED EQUIP. 359	123	DIGITAL MARKETING 6	206	LABORATORY MICROSYS. 462	290	OSBORNE/MCGRAW-HILL 159
*	AVOCET 385	124	DIGITAL MARKETING 297	208	LEO ELECTRONICS 377	291	OSM COMPUTER 161
46	AXIOM CORP 267	125	DIGITAL RESEARCH 50, 51	211	LIFEBOAT ASSOC. 279		OWENS ASSOC. 388, 389
48	B&B ELECTR. 462	*	DIGITAL RESEARCH COMP. 471	212	LIFEBOAT ASSOC. 365	282	PACE ELECTRONCS 363
47	B&B ELECTR. 468	*	DISCOUNT SOFTWARE 218	213	LJK ENTERPRISES INC. 187	292	PACIFIC COMP BRK. 98
49	BARRETO & ASSOC. 17	127	DISCOUNT SOFTWARE 219	214	LOGICAL DEVICES 476	293	PAC.EXCHNGS. 367, 470, 472, 474, 476
50	BASF SYSTEMS 265	128	DISCOUNT SOFTWARE 364	73	LOGIGATE 396	294	PACIFIC SOFTWARE 319
51	BAY TECHNICAL ASSOC. 345	129	DIVERSIFIED COMPUTING 468	215	LOMAS DATA PRODUCTS 281	295	PALOMAR COMP.EQUIP. 465
*	BEECH AIRCRAFT CORP. 217	130	DMA 275	216	LYBEN COMP.SYS. 292	296	PAN AMERICAN ELEC INC. 456
*	BELL JOHN ENGR. 463	131	DUAL SYS.CONTROL CORP. 60, 62, 64	217	LYBEN COMP.SYS. 460	297	PEACHTREE SOFTWARE 140
*	BETA COMP DEVICES 289	134	DUPRE ENTERPR. 347	218	LYBEN COMP.SYS. 462	298	PENDRAGON SFTW. 472
53	BISON PRODUCTS 340	135	DYMARC IND. 360	219	MACROTRONICS 460	299	PERCOM DATA 7
54	BIT BUCKET, THE 468	136	DYNACOMP 302, 303	220	MAGNOLIA MICROSYS. 462	300	PERCOM DATA 7
55	BLAT RESRCH & DEVELP. 345	137	DYSAN CORP. 94, 95	222	MARTIN DATA SYSTEMS 387	301	PERCOM DATA 7
56	BLUE LAKES COMPUTING 340	138	ELECTRIC SYSTEMS 114		MARTIN MARIETTA 374	*	PERCOM DATA 87
57	BOWER-STEWART 466	139	ECOSOFT 361	223	MARYMAC INDUSTRIES 371	302	PHASE ONE SYS.INC. 317
*	BRADY, PAUL T. 470	140	ELECTROLABS 456	*	MCGRAW-HILL MAGAZINES 179	321	PHONE 1 INC. 107
58	BULLSEYE SOFTWARE 470	141	ELECTRONIC CONTROL 365	*	MCMILLAN BOOK CLUBS 353	303	PICKLES & TROUT 361
59	BYTE BOOKS 199	142	ELECTRONIC SPLCLISTS 357	225	MIC 16	304	POLY PAKS 466
60	BYTE BOOKS 231	143	ELECTRONIC SYS.FURN 411	226	MEADE'S DATA SYS. 464		POPULAR COMPUTING 193
61	BYTE BOOKS 333	144	ELLIS COMPUTING 357	227	MEDIA DISTRIBUTING 343	*	POTOMAC MICRO-MAGIC 136
62	BYTE BOOKS 337	145	EMPIRICAL RESRCH GRP. 347		MEDIAMIX 32	305	POWER ONE INC. 110
63	BYTE BOOKS 341	146	EMPIRICAL RESRCH GRP. 462	228	MEMORY MERCHANT 143	18	PRACTICAL PERIPHERALS 15
64	BYTE BOOKS 375	147	ENERCOMP 476	229	META COMPANIES, THE 27	306	PRIORITY ONE 488, 489
*	BYTE SUBSCRIBER 373	148	EPIC COMPUTER CORP. 214	230	METAMORPHIC SYS.INC. 223	307	PRIORITY ONE 490, 491
*	BYTE BACK ISSUE 396	149	EPIC COMPUTER CORP. 249	231	MFJ ENTERPRISES INC 268	308	PRIORITY ONE 492, 493
64	BYTEK COMP.SYS. 402	150	EPSON AMERICA 313	232	MICON 328	309	PROGRAMMERS SFTW 466
65	BYTEWRITER 466	151	ESSEX PUBLISHING 351	233	MICRO AGE COMP.STORE 127	310	PURCHASING AGENT, THE 362
421	C. ITOH 287	152	EXPOTEK 156	234	MICRO APPL.GROUP 354	311	PURCHASING AGENT, THE 468
66	CALICO SYSTEMS 146	363	EYRING RESEARCH 91	235	MICRO BUSINESS WORLD 173	312	QUANTEC DIV. 329
67	CALIF DATA CORP 460	153	F.S.I. 472	411	MICRO CRAFT SYS. 66	313	QUALITY COMP.PARTS 462
68	CALIF. DIGITAL 484, 485	*	FAIRCOM 108	*	MICRO DATA BASE SYS 208	314	QUALITY SOFTWARE 203
*	CALIF.MICRO COMP. 300	154	FORETHOUGHT PRODUCTS 369	236	MICRO DATA BASE SYS 209	315	QUASAR DATA PROD.INC. 117
70	CDR SYSTEMS 464	155	FOX & GELLER ASSOC 470	237	MICRO DATA-TEK 323	316	QUEST ELECTR. 467
71	CHECK-MATE 462	156	FSS 328	238	MICRO HOUSE 19	317	R.C. INDUSTRIES 468
72	CHECKS-TO-GO 34	157	FSS 355	402	MICRO MAGAZINE 154	318	RADIO SHACK 49
74	CHIPS & DALE 464	158	FUTRA CO. 399	239	MICRO MANAGEMENT SYS. 343	319	RCA 68
75	CHRISLIN INDUSTRIES 311	*	GAME-TECH 472	419	MICRO MINT 475	320	RCE 363
76	CLEV.CONS.COMP. 459	159	GEORGIA EXEC.MICRO 409	420	MICRO MINT 454	322	ROBOTICS AGE 116
77	CMC,INT'L. 149	160	GILTRONIX,INC. 464	240	MICRO PRO INT'L. 109	323	ROCKWELL INT'L. 221
78	CMC,INT'L. 158	161	GNT AUTOMATIC INC 402	241	MICRO WORKS, THE 361	324	S C DIGITAL 474
80	CMC,INT'L. 342	162	GRAFFCOM SYS. 282	243	MICROCOMP.TECH.INC. 195	325	S&M SYSTEMS 360
79	CMC,INT'L. 368	163	GREAT PLAINS COMP.CO. 468	244	MICROCOMPUTER APP. 299	*	S-100 INC 369
81	CODEWORKS, THE 406	164	H&E COMPUTRONICS 259	245	MICROMAIL 370	327	S.P.C. TECH.INC. 365
401	COLONIAL DATA 405	165	H&E COMPUTRONICS 261	246	MICRONET SYSTEMS 474	328	SANDHU MACHINE DESN. 470
407	COLUMBIA DATA PROD. 241	166	H.E.I., INC. 58	247	MICROSETTE INC. 476	329	SANTA CRUZ SFTW.SERV. 230
408	COMMODORE BUSN.MACH. 75	167	HANLEY ENGRNGR 451	248	MICROSOFT (CPD) 59	422	SCAN-TRON CORP. 335
82	COMMUNICATIONS ELECTR. 449	168	HAYES MICROCOMP.PROD. 111	249	MICROSOFT (CPD) 273	330	SCION CORP 5
83	COMPONENTS EXPRESS 262	169	HAYES MICROCOMP.PROD. 351	250	MICROTAX 198	331	SCITRONICS 349
*	COMPUDIAL, INC. 196	*	HEATH COMPANY 65	251	MICROTECH EXPORTS 373	*	SCOTTSDALE SYSTEMS 128
84	COMPUMART 70, 71	*	HEMENWAY ASSOC. 269	252	MICROTEK INC. 301	332	SCR ELECTR. 292
*	COMPUPRO/GODBOUNT 104, 105	*	HERTZ.THE CORP. 101	253	MID AMER.MICRO MART 227	333	SEATTLE COMP PRODS 115
85	COMPUPRO/GODBOUNT 106			255	MIKOS 466	335	SIGMA INT'L.TRADING 291
						336	SIGNUM SYSTEMS 470
						337	SLUDER 468
						400	SOFYS 407
						338	SOFTWARE CONSLTG.SERV. 470
						*	SOLID STATE SALES 373
						339	SORCIM 141
						340	SORRENTO VALLEY ASSOC 134
						413	SOUTHERN COMP.SYS. 412
						341	SOUTHWEST COMP. 470
						342	SSM MICRO COMP PROD 11
						343	STANDARD MICROSYS.INC. 122
						*	STATCOM CORP. 35

To get further information on the products advertising in BYTE, fill out the reader service card with your name and address. Then circle the appropriate numbers for the advertisers you select from the list. Add an 18-cent stamp to the card, then drop it in the mail. Not only do you gain information, but our advertisers are encouraged to use the marketplace provided by BYTE. This helps us bring you a bigger BYTE. The index is provided as an additional service by the publisher, who assumes no liability for errors or omissions. *Correspond directly with company.

Reader Service

Inquiry No.	Page No.	Inquiry No.	Page No.	Inquiry No.	Page No.	Inquiry No.	Page No.	
344	STATIC MEMORY SYS 251	356	TARCO DEVELPMT. CORP 349	371	UNITED CONTROLS 460			
345	STRAWBERRY TREE COMP. 363	*	TECHNICAL SYS CONS 69	*	UNITED SFTW OF AMER. 188, 189	412	WESTICO INC. 472	
346	SUBLOGIC 274	357	TECMAR INC 63	*	USERS PASCAL PROCDRSEX. 476		WESTWARE 233	
347	SUNNY INT'L. 458	358	TECMAR INC 243	372	VAN HORN OFFICE SUPP. 390		WHITESMITHS LTD 99	
348	SUPERSOFT 119	359	TELERAM COMMUNIC. 142	373	VECTOR GRAPHICS 183		WHITESMITHS LTD 394	
349	SUPERSOFT 197	360	TELEVIDEO INC 112, 113	374	VERBATIM CORP 177		WHITESMITHS LTD 395	
350	SUPERSOFT 255	361	TELEVIDEO INC 215	375	VIDEX 21		385	WIGGLESWORTH, C.J. 375
202	SYBEX 191	362	TEXAS COMP.SYS. 138	376	VISTA COMPUTER CO 207		386	WILD HARE COMP.SYS. 171
351	SYSTEMS GROUP, THE 29	*	TINNEY,RBT.GRAPHICS 339	377	VITAL INFORMATION 336		387	WINCHENDON GRP,THE 462
352	SYSTEMS GROUP, THE 29	364	TRACE SYSTEMS 53	*	VOICETEK 386		388	WINTEK CORP. 464
409	SYSTEMS GROUP, THE 31	365	TRANSNET CORP. 343	*	VR DATA 263		389	XPS INC 466
410	SYSTEMS GROUP, THE 31	366	TRANSWAVE CORP 103	379	WARN ELECTRONICS 472		390	ZIGGURAT SOFTWARE 464
418	SYSTEMS KONTAKT 439	*	TRAXX COMPUTER CORP. 57	380	WASHINGTON COMP.SERV. 453		*	ZOBEX 81
353	SYSTEMS PLUS INC. 253	367	TRIANGLE COMPUTER 474	381	WESPER MICRO SYSTEMS 120			
*	SYSTEMS SUPPORT INC. 204	368	U.S. MICRO SALES 454	382	WESPER MICRO SYSTEMS 121			
354	TAB BOOKS 401	369	U.S. MICRO SALES 455	383	WESTBROOK SEARCH INC. 462			
355	TARBELL ELECTR. 147	370	U.S. ROBOTICS 10	*	WESTICO INC. 163			

*Correspond directly with company.

BOMB

BYTE's Ongoing Monitor Box

Article #	Page	Article	Author(s)
1	26	The Atari Tutorial, Part 5: Scrolling	Crawford
2	36	A Closer Look at the IBM Personal Computer	Williams
3	72	Analog Interfacing in the Real World	Ciarcia
4	100	MIKBUG and the TRS-80, Part 2: A File Transfer and Debugging Package	
5	122	The RCA VP-3301 Data Terminal	Labenski
6	132	Operating Systems, Languages, Statistics, Pirates, and the Lone Wolf	Daneliuk
7	160	Build a Joystick A-to-D Converter for the TRS-80 Model I or III	Pournelle
8	190	Troubleshooting with Electronic Signatures	Barden
9	216	Memory Expansion for the ZX-80	Piggott
10	239	An 8080-Based Remote Appliance Controller	Ernde
11	304	Clocked Interrupts for the COSMAC Elf	Staeihin
12	332	SD Systems' Z80 Starter Kit	Price
13	344	COSMAC EPROM Programmer	Angevine
14	366	An Apple Talks with the Deaf	Rubis
15	397	An Effective Text-Compression Algorithm	Rhodes
16	410	Structured Programming in BASIC	Cortesi
17	420	The GEOSAT Program	Sobell
			Emmett

Readers Vote IBM Number One

It looks like our article on the IBM Personal Computer really hit the spot. Philip Lemmons' report, "The IBM Personal Computer: First Impressions," was voted number one by our readers. Phil will receive the \$100 kitty. Steve Ciarcia placed second with his article, "Build an Intelligent EPROM Programmer." He'll receive \$50. As Steve put it, it's not so bad taking second place to IBM. A close third place goes to Ken Clements and Dave Daugherty for "Ultra-Low-Cost Network for Personal Computers." Evidently our readers found the authors' low-cost approach to networking intriguing in its simplicity.

European Advertisers Please Contact:

A. Fabio Guarnieri
Via Baracchini 1
20123 Milan, Italy

Fritz Krusebecker
Liebigstrasse 27c
D-6000 Frankfurt/Main 1
West Germany

Michael Sales
17 rue Georges Bizet
F 75116 Paris, France

Simon Smith
34 Dover Street
London W1X 3RA, England

Andrew Karnig
Andrew Karnig & Associates
Kungsholmsgatan 10
112 27 Stockholm, Sweden

Mrs. Gurit Gepner
115 Yosephal Street
Bat Yam, Israel

Mr. Hans Csokor
Publimedia
Veithgasse 6/3
A-1037 Vienna, Austria

BYTE READER SERVICE

January 1982
4112

For fastest service transfer mailer label from wrapper to coupon provided at the right. Requests cannot be honored unless zip code is given. This card valid for 90 days only.

NOTE—If label is missing or defaced fill out coupon carefully—**PLEASE PRINT**—this is the only way to get requested material to you.

Name _____

(Title) _____ (Company) _____

Address _____

City _____ State _____ Zip _____

1 21 41 61 81	101 121 141 161 181	201 221 241 261 281	301 321 341 361 381	401 421 441 461 481	501 521 541 561 581	601 621 641 661 681
2 22 42 62 82	102 122 142 162 182	202 222 242 262 282	302 322 342 362 382	402 422 442 462 482	502 522 542 562 582	602 622 642 662 682
3 23 43 63 83	103 123 143 163 183	203 223 243 263 283	303 323 343 363 383	403 423 443 463 483	503 523 543 563 583	603 623 643 663 683
4 24 44 64 84	104 124 144 164 184	204 224 244 264 284	304 324 344 364 384	404 424 444 464 484	504 524 544 564 584	604 624 644 664 684
5 25 45 65 85	105 125 145 165 185	205 225 245 265 285	305 325 345 365 385	405 425 445 465 485	505 525 545 565 585	605 625 645 665 685
6 26 46 66 86	106 126 146 166 186	206 226 246 266 286	306 326 346 366 386	406 426 446 466 486	506 526 546 566 586	606 626 646 666 686
7 27 47 67 87	107 127 147 167 187	207 227 247 267 287	307 327 347 367 387	407 427 447 467 487	507 527 547 567 587	607 627 647 667 687
8 28 48 68 88	108 128 148 168 188	208 228 248 268 288	308 328 348 368 388	408 428 448 468 488	508 528 548 568 588	608 628 648 668 688
9 29 49 69 89	109 129 149 169 189	209 229 249 269 289	309 329 349 369 389	409 429 449 469 489	509 529 549 569 589	609 629 649 669 689
10 30 50 70 90	110 130 150 170 190	210 230 250 270 290	310 330 350 370 390	410 430 450 470 490	510 530 550 570 590	610 630 650 670 690
11 31 51 71 91	111 131 151 171 191	211 231 251 271 291	311 331 351 371 391	411 431 451 471 491	511 531 551 571 591	611 631 651 671 691
12 32 52 72 92	112 132 152 172 192	212 232 252 272 292	312 332 352 372 392	412 432 452 472 492	512 532 552 572 592	612 632 652 672 692
13 33 53 73 93	113 133 153 173 193	213 233 253 273 293	313 333 353 373 393	413 433 453 473 493	513 533 553 573 593	613 633 653 673 693
14 34 54 74 94	114 134 154 174 194	214 234 254 274 294	314 334 354 374 394	414 434 454 474 494	514 534 554 574 594	614 634 654 674 694
15 35 55 75 95	115 135 155 175 195	215 235 255 275 295	315 335 355 375 395	415 435 455 475 495	515 535 555 575 595	615 635 655 675 695
16 36 56 76 96	116 136 156 176 196	216 236 256 276 296	316 336 356 376 396	416 436 456 476 496	516 536 556 576 596	616 636 656 676 696
17 37 57 77 97	117 137 157 177 197	217 237 257 277 297	317 337 357 377 397	417 437 457 477 497	517 537 557 577 597	617 637 657 677 697
18 38 58 78 98	118 138 158 178 198	218 238 258 278 298	318 338 358 378 398	418 438 458 478 498	518 538 558 578 598	618 638 658 678 698
19 39 59 79 99	119 139 159 179 199	219 239 259 279 299	319 339 359 379 399	419 439 459 479 499	519 539 559 579 599	619 639 659 679 699
20 40 60 80 100	120 140 160 180 200	220 240 260 280 300	320 340 360 380 400	420 440 460 480 500	520 540 560 580 600	620 640 660 680 700

BYTE'S BOMB is your direct line to the editor's desk. Each month, the two top-rated authors receive bonuses based on your votes. To cast your vote, first look at the list of this month's articles and corresponding article numbers (located in the unclassified ads section on the page preceding the Reader Service list), then rate each article as **Excellent**, **Good**, **Fair**, or **Poor** by circling the appropriate number in each column below. Your feedback helps to produce the best possible magazine each month.

Article No.	1	2	3	4	5	6	7	8	9	10	11	12	13	14	15	16	17	18	19	20	21	22	23	24	25
Excellent	801	805	809	813	817	821	825	829	833	837	841	845	849	853	857	861	865	869	873	877	881	885	889	893	897
Good	802	806	810	814	818	822	826	830	834	838	842	846	850	854	858	862	866	870	874	878	882	886	890	894	898
Fair	803	807	811	815	819	823	827	831	835	839	843	847	851	855	859	863	867	871	875	879	883	887	891	895	899
Poor	804	808	812	816	820	824	828	832	836	840	844	848	852	856	860	864	868	872	876	880	884	888	892	896	900

Comments _____

BYTE READER SERVICE

January 1982
4112

For fastest service transfer mailer label from wrapper to coupon provided at the right. Requests cannot be honored unless zip code is given. This card valid for 90 days only.

NOTE—If label is missing or defaced fill out coupon carefully—**PLEASE PRINT**—this is the only way to get requested material to you.

Name _____

(Title) _____ (Company) _____

Address _____

City _____ State _____ Zip _____

1 21 41 61 81	101 121 141 161 181	201 221 241 261 281	301 321 341 361 381	401 421 441 461 481	501 521 541 561 581	601 621 641 661 681
2 22 42 62 82	102 122 142 162 182	202 222 242 262 282	302 322 342 362 382	402 422 442 462 482	502 522 542 562 582	602 622 642 662 682
3 23 43 63 83	103 123 143 163 183	203 223 243 263 283	303 323 343 363 383	403 423 443 463 483	503 523 543 563 583	603 623 643 663 683
4 24 44 64 84	104 124 144 164 184	204 224 244 264 284	304 324 344 364 384	404 424 444 464 484	504 524 544 564 584	604 624 644 664 684
5 25 45 65 85	105 125 145 165 185	205 225 245 265 285	305 325 345 365 385	405 425 445 465 485	505 525 545 565 585	605 625 645 665 685
6 26 46 66 86	106 126 146 166 186	206 226 246 266 286	306 326 346 366 386	406 426 446 466 486	506 526 546 566 586	606 626 646 666 686
7 27 47 67 87	107 127 147 167 187	207 227 247 267 287	307 327 347 367 387	407 427 447 467 487	507 527 547 567 587	607 627 647 667 687
8 28 48 68 88	108 128 148 168 188	208 228 248 268 288	308 328 348 368 388	408 428 448 468 488	508 528 548 568 588	608 628 648 668 688
9 29 49 69 89	109 129 149 169 189	209 229 249 269 289	309 329 349 369 389	409 429 449 469 489	509 529 549 569 589	609 629 649 669 689
10 30 50 70 90	110 130 150 170 190	210 230 250 270 290	310 330 350 370 390	410 430 450 470 490	510 530 550 570 590	610 630 650 670 690
11 31 51 71 91	111 131 151 171 191	211 231 251 271 291	311 331 351 371 391	411 431 451 471 491	511 531 551 571 591	611 631 651 671 691
12 32 52 72 92	112 132 152 172 192	212 232 252 272 292	312 332 352 372 392	412 432 452 472 492	512 532 552 572 592	612 632 652 672 692
13 33 53 73 93	113 133 153 173 193	213 233 253 273 293	313 333 353 373 393	413 433 453 473 493	513 533 553 573 593	613 633 653 673 693
14 34 54 74 94	114 134 154 174 194	214 234 254 274 294	314 334 354 374 394	414 434 454 474 494	514 534 554 574 594	614 634 654 674 694
15 35 55 75 95	115 135 155 175 195	215 235 255 275 295	315 335 355 375 395	415 435 455 475 495	515 535 555 575 595	615 635 655 675 695
16 36 56 76 96	116 136 156 176 196	216 236 256 276 296	316 336 356 376 396	416 436 456 476 496	516 536 556 576 596	616 636 656 676 696
17 37 57 77 97	117 137 157 177 197	217 237 257 277 297	317 337 357 377 397	417 437 457 477 497	517 537 557 577 597	617 637 657 677 697
18 38 58 78 98	118 138 158 178 198	218 238 258 278 298	318 338 358 378 398	418 438 458 478 498	518 538 558 578 598	618 638 658 678 698
19 39 59 79 99	119 139 159 179 199	219 239 259 279 299	319 339 359 379 399	419 439 459 479 499	519 539 559 579 599	619 639 659 679 699
20 40 60 80 100	120 140 160 180 200	220 240 260 280 300	320 340 360 380 400	420 440 460 480 500	520 540 560 580 600	620 640 660 680 700

To get further information on the products advertised in BYTE, fill out the reader service card with your name and address. Then circle the appropriate numbers for the advertisers you select from the list. Add a 12-cent stamp to the card, then drop it in the mail. Not only do you gain information, but our advertisers are encouraged to use the marketplace provided by BYTE. This helps us bring you a bigger BYTE. The index is provided as an additional service by the publisher, who assumes no liability for errors or omissions. *Correspond directly with company.

PLACE
STAMP
HERE

BYTE

READER SERVICE
PO BOX 2114 GPO
NEW YORK NY 10116
USA

PLACE
STAMP
HERE

BYTE

READER SERVICE
PO BOX 2114 GPO
NEW YORK NY 10116
USA

BYTE

SUBSCRIPTIONS

For a subscription to BYTE, please complete this card.

Name _____

Address _____

City _____

State _____ Zip _____ Country _____

Card No. _____

Expiration date _____

Four digits above name—Master Charge only _____

Signature _____ Date _____

Please allow eight weeks for processing. Thank you.

- | | USA | Canada
Mexico |
|----------------------------------|-------------------------------|-------------------------------|
| <input type="checkbox"/> 1 year | <input type="checkbox"/> \$19 | <input type="checkbox"/> \$21 |
| <input type="checkbox"/> 2 years | <input type="checkbox"/> \$34 | <input type="checkbox"/> \$38 |
| <input type="checkbox"/> 3 years | <input type="checkbox"/> \$49 | <input type="checkbox"/> \$55 |

- \$43 Europe (air delivery) payment enclosed
 \$35 Elsewhere (surface mail) payment enclosed
 (Air mail rates available upon request)

Please remit in US funds drawn on a US bank. Thank you.

- Check enclosed (**Bonus:** [North America only] one EXTRA issue—receive 13 issues for the price of 12)



- Bill me (North America only)

4112

BYTE

SUBSCRIPTIONS

For a subscription to BYTE, please complete this card.

Name _____

Address _____

City _____

State _____ Zip _____ Country _____

Card No. _____

Expiration date _____

Four digits above name—Master Charge only _____

Signature _____ Date _____

Please allow eight weeks for processing. Thank you.

- | | USA | Canada
Mexico |
|----------------------------------|-------------------------------|-------------------------------|
| <input type="checkbox"/> 1 year | <input type="checkbox"/> \$19 | <input type="checkbox"/> \$21 |
| <input type="checkbox"/> 2 years | <input type="checkbox"/> \$34 | <input type="checkbox"/> \$38 |
| <input type="checkbox"/> 3 years | <input type="checkbox"/> \$49 | <input type="checkbox"/> \$55 |

- \$43 Europe (air delivery) payment enclosed
 \$35 Elsewhere (surface mail) payment enclosed
 (Air mail rates available upon request)

Please remit in US funds drawn on a US bank. Thank you.

- Check enclosed (**Bonus:** [North America only] one EXTRA issue—receive 13 issues for the price of 12)



- Bill me (North America only)

4112

Don't Miss An Issue!

Have BYTE delivered to your door.

Each month BYTE will bring you the latest in microcomputer technology.

DISCOVER and IMPLEMENT new ideas. Don't miss the original information presented in the pages of BYTE.

With BYTE you'll always be among the first to know about the important breakthroughs, worthwhile new equipment, and innovative projects in the world of computing.

CHALLENGE US to deliver the very best ideas in microcomputers and advanced technology to you. Return the attached card today!

Subscribe to BYTE—the world's leading computer magazine.

*Note our special offer!
 Send cash with your order
 and receive 13 issues
 for the price of 12 for
 each year you subscribe.
 (North America only, please.)*

PLACE
STAMP
HERE

BYTE SUBSCRIPTIONS
PO Box 590
Martinsville NJ 08836
USA

PLACE
STAMP
HERE

BYTE SUBSCRIPTIONS
PO Box 590
Martinsville NJ 08836
USA

REMEMBER.

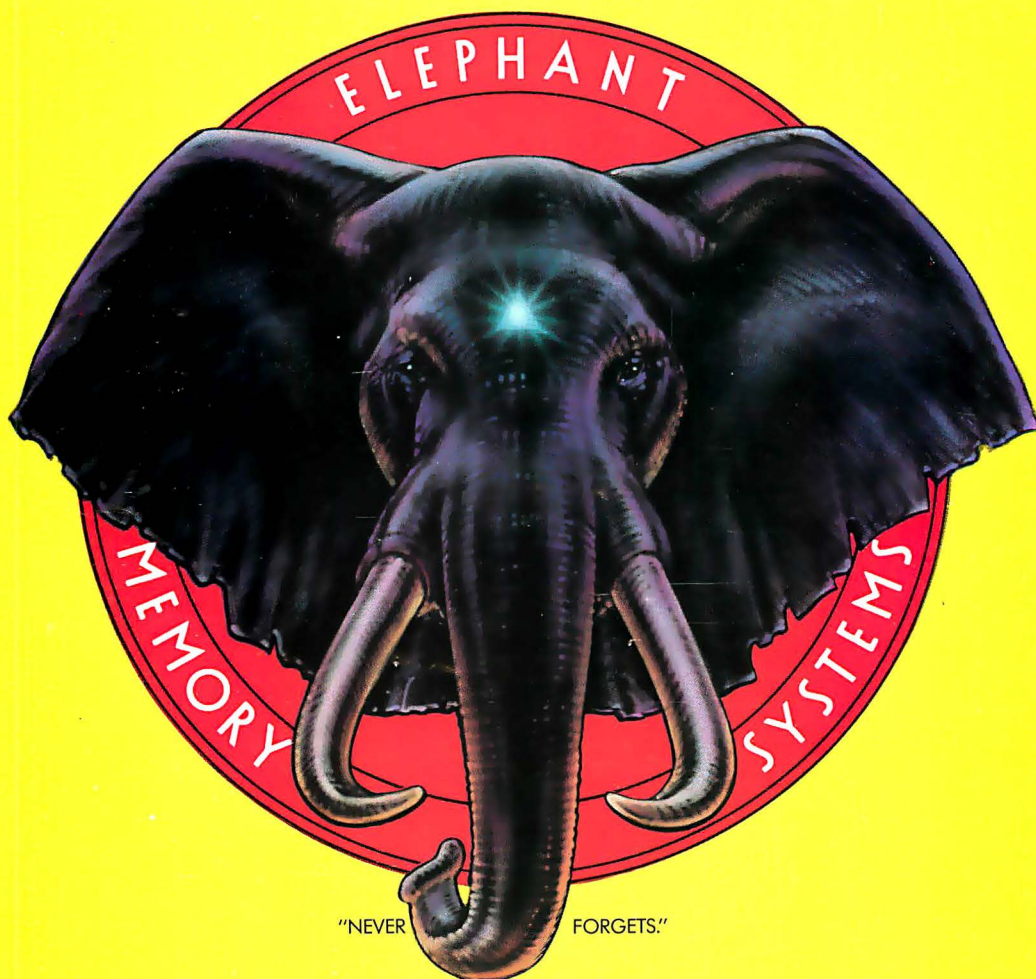

Elephant™ floppies. They're guaranteed to meet or beat every industry standard for quality. They come standard with reinforced hub rings at no extra cost. They come in every popular 5¼" model, in both hard and

soft sector. And they sell at some of the lowest prices in the business. Elephant Flexible Disks. They're heavy duty. They work for peanuts. They never forget. Get yourself a trunkful.

HEAVY DUTY DISKS.

Distributed Exclusively by Leading Edge Products, Inc., 225 Turnpike Street, Canton, Massachusetts 02021
Call: toll-free 1-800-343-6833; or in Massachusetts call collect (617) 828-8150. Telex 951-624.

**"I SHOULD
HAVE BOUGHT
OHIO SCIENTIFIC..."**

**... SEEMS THE ONLY
THING EXPANDABLE
ABOUT MY COMPUTER
IS THE LINE OF
EMPLOYEES WAITING
TO USE IT."**

All too often, a small business will make a major investment in a computer system only to find out, a year or so later, that they have outgrown it. The computer can't keep up with the need for more work stations, for more job functions, for more multi-user operations, and your initial investment is jeopardized.

If you're a first time computer buyer, you should know that **system expandability is a big advantage of Ohio Scientific computer systems.**

A business can start with a modestly priced floppy disk based computer to handle many office functions. Later, as your business needs grow, you can easily and economically expand upward to our series of hard disk based computers, adding more users for accounts receivable, general ledger, payroll, inventory, word processing and much more.

Don't catch yourself second guessing the computer you buy. We're convinced that the more you compare, the better we look.

Ohio Scientific computer systems are sold by more than 400 dealers nationwide. For the one near you, **call 1-800-321-6850 toll free.**



OHIO SCIENTIFIC

a **MACOM** Company

1333 SOUTH CHILLICOTHE ROAD
AURORA, OH 44202 • (216) 831-5600

The **expandable** small business computer

Circle 277 on inquiry card.