

NEW ZEALAND'S PERSONAL COMPUTER MAGAZINE

BITS & BYTES

Jan. — Feb. 1986: \$2.00

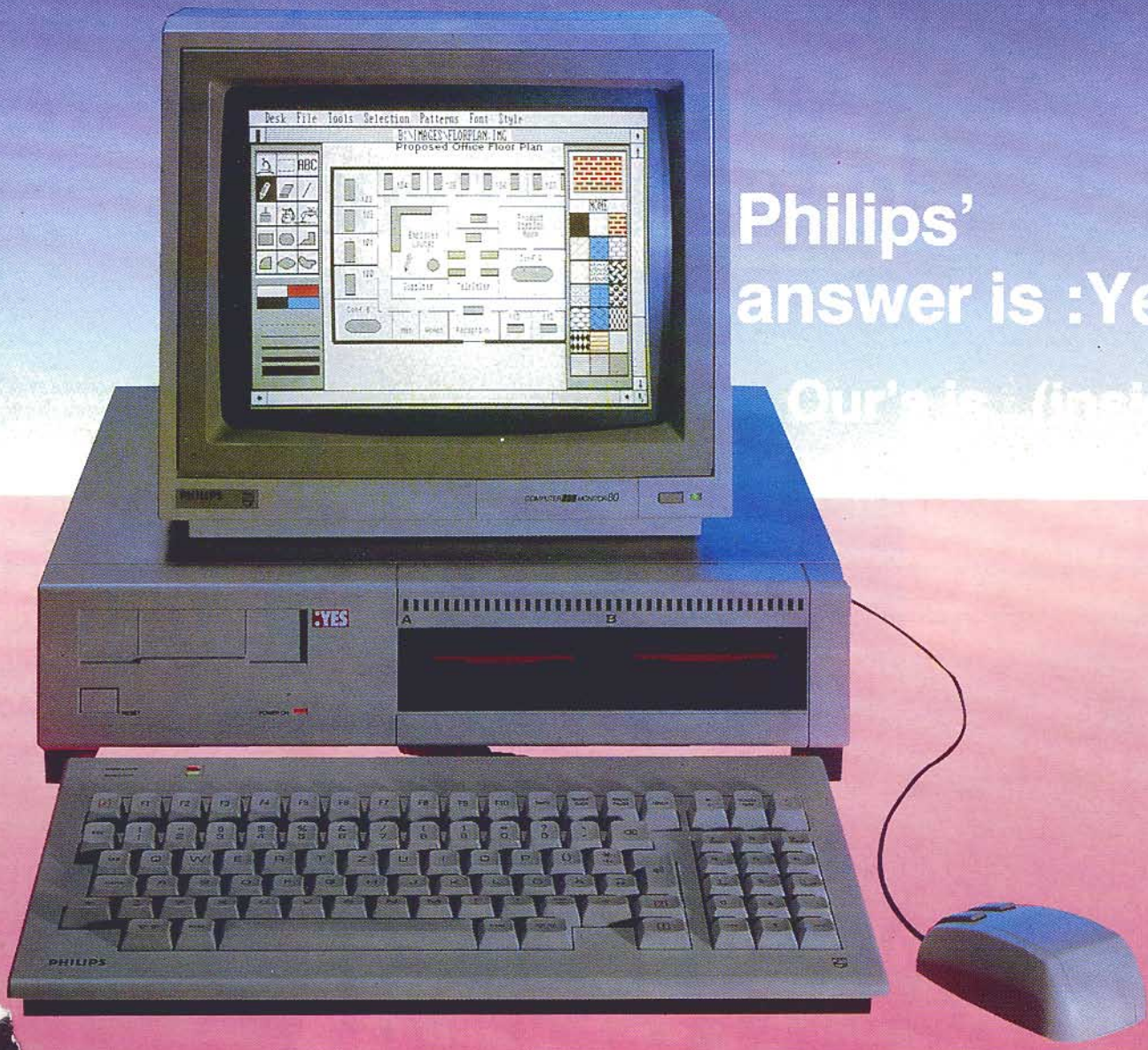

Philips' answer is :Yes
Our's is... (inside)

Find also, inside data on:

Panasonic's Executive Partner.
Under \$4000 hardware survey.

The next wave of computing?
Teachers' advice to PC buyers.
B & B Volume 3 INDEX

NEW

When you've
already made the
best home computer,
what do you
do for an encore?



\$1995
with Colour Monitor
\$1595
with Green Screen



Amstrad CPC 6128
with Colour Monitor or Green Screen

The Businesslike CPC6128

By including a disc drive and 128K or RAM with the CPC6128, Amstrad has elevated the budget price computer beyond being primarily a games console into the realm where serious business applications may be tackled with ease.

Digital Research's famous CP/M Plus operating system keeps your CPC6128 disc filing in order while programs like Microscript and Amsoft Business Control system (dual disc systems) keeps your business affairs in order.

The Amstrad CPC6128 is the ideal computer for the small business, and what with rates, mortgages, HP, income tax, insurance etc just about everyone can benefit from running their personal affairs with the aid of a low cost computer.

Give all your correspondence the professional touch. Plan your domestic budget, file names and addresses, organise your time more effectively. Amsoft has programmes already available to do all these tasks and many more.

The Entertaining CPC6128

With over 300 colourful games already available covering everything from advanced flight and combat simulation to slick examples of all the arcade classics, the CPC6128 has an unfair advantage over its competitors.

There's shoot-outs, adventures, brain teasers, card games, 'simulations' — enough to keep the most agile and inquisitive minds busy indefinitely. As part of the CPC6128 package you will also receive CPM plus, GSX and Dr Logo, the world famous teaching and graphics language that introduces the concepts and ideas behind writing computer programs.

High Performance-Low Cost

The one thing you won't need a computer to work out is that the Amstrad CPC6128 represents outstanding value for money. You only have to check the cost of buying all the elements separately, 128K RAM computer, disc drive and monitor to realise that the Amstrad package is very hard to beat.



Wordprocessing and Amsword can improve the productivity of everyone from unskilled typist to trained secretary.

An Expanding System

There is a complete range of peripherals available to CPC6128 which plug into built in interfaces. These include a joystick and printers. The Centronics compatible parallel printer interface connects to a vast range of printers, from low cost dot matrix through to daisywheel printers giving superb print quality.

The expansion connector at the rear of the CPC6128 contains all the signals necessary to implement a wide range of add-on peripherals. Modems, light pens, speech synthesizers and serial interfaces are amongst products already available or in development by either Amstrad or independent vendors.

Compatibility

The Amstrad Serial Interface (RS232C) is much more than just a complete means of connecting serial printers and modems. It's a complete extension and expansion system that incorporates its own ROM software to emulate terminals so that your CPC system can work in conjunction with mini and microframe computer systems.

There's a full PRESTEL mode with graphics and colour.

The built in ROM BASIC for the CPC6128 is in the tradition of excellence established by the CPC464 and CPC664. Programs written using the CPC464/CPC664 BASIC will run on the CPC6128.

Amstrad Join The Club

As a member you will enjoy regular magazines, competitions for valuable prizes and contact with other Amstrad users.

Whether you're a games fanatic or interested in serious business applications, you'll want to join the club.

Figure analysis made easy with Microspread.



YES

I'd like to know more about the totally professional CPC6128 Complete Computer System

NAME: _____

ADDRESS: _____

POST TO: Grandstand Computers Ltd, CPO Box 2353, Auckland
21 Great South Road, Newmarket, Auckland. Phone: 504-033

GRANDSTAND AMSTRAD

RES 729

FINALLY, A MODEM YOU CAN COMMUNICATE WITH.

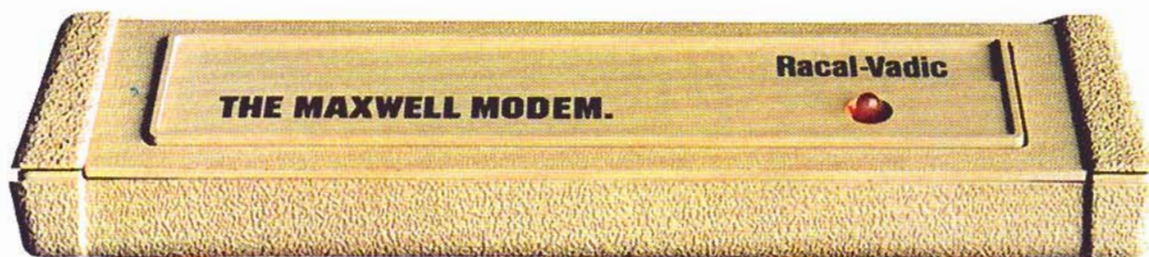

Any modem can send and receive information. But what good is a modem if you can't communicate with it?

In plain English.

The Maxwell Modems and George,[™] our communications software, let you do just that. In fact, learning to use them is as easy as reading a menu. Instead of a manual.

All the features make sense. Like auto-dialing directories. Automatic log-on. Auto-answer.

Automatic error-checking. And complete unattended operation.

Which means you can send and receive files late at night when the phone rates are lower. And you're asleep.

Plus, with single keystroke dialing, you can call a database faster than you can say *Racal-Vadic*. While the handy message editor makes jotting a quick message just that. Quick.

The Maxwell Modems are available in two versions, internal* or desktop. And, now, in three different speeds. 300, 1200 or 2400 bits-per-second. So there's bound to be one just right for you. And your personal computer.

Best of all, they're from Racal-Vadic - the world's leading supplier of switched-network modems. The kind of modems data networks use to take calls from modems like yours.

Just as soon as you get one.

And the easiest way to do that is to call 800-4-VADICS for the name of the Maxwell Modem dealer nearest you.

Racal-Milgo New Zealand Limited
PO Box 26-143, Auckland
Phone 504-309, Auckland; Phone 730-313, Wellington



THE MAXWELL MODEM.

From Racal-Vadic

RACAL

*The Maxwell Modem and George are trademarks of Racal-Vadic. *Internal modems for IBM PC, XT and compatibles. IBM is a registered trademark of International Business Machines Corp. © 1984, Racal-Vadic.

BURNETT 7852

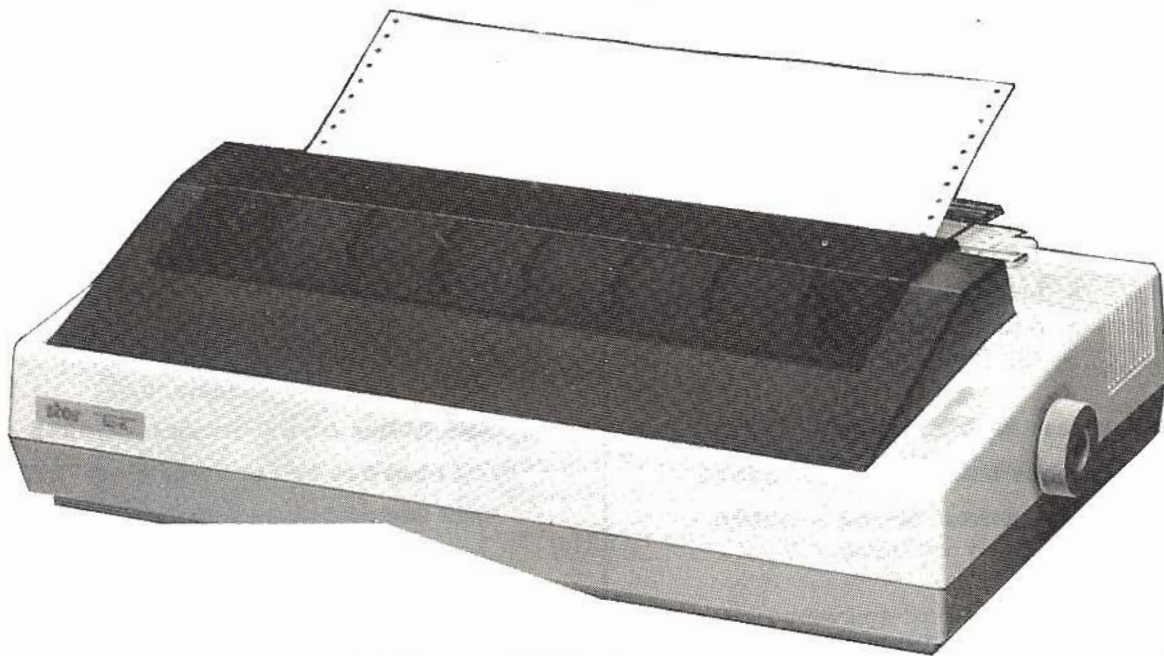

'The Star S.D. 15 is a good example of what any printer ought to be:

fast, reliable, easy to set up and use and able to pretty much take care of itself' — M. David Stone

P.C. Magazine, Sept. '85

In their September 1985 issue, P.C. Magazine put the Star S.D. 15 through their printer 'torture test'. It came through with flying colours. In addition to M. David Stone's comments, the magazine awarded the S.D. 15 with its 'Editors Choice' seal.

So whatever your personal computer, Star's proven S.D. dot matrix printers provide reliable performance with a variety of choices — to be sure your exact needs will be met today . . . and tomorrow.

Check out the Star printer range — you won't be sorry

CLIP AND MAIL THE COUPON — TODAY

Yes, I would like more information on the S.D. 15. Please send me the name of the nearest S.D. 15 dealer.

Name

Address

Phone

High 160 c.p.s. printing speed for draft mode plus N.L.Q. (Near Letter Quality)

Distributed by:

Genesis Systems Ltd.

star printer distributors for N.Z.

47 Station Road Otahuhu, Auckland, New Zealand
P.O. Box 6255, Auckland 1, New Zealand
Phone 27-67349 Telex 2814 (Rocket)

VALUE FOR MONEY

REMARKABLE PC - \$3395

- Features Include**
- ★ MS Dos Compatibility
 - ★ XT Power Supply
 - ★ 256K Bytes RAM
 - ★ 2 x 360K 5¼" Drives
 - ★ 1 Parallel Port
 - ★ Med-Res Amber Screen
 - ★ 8 Expansion Slots
 - ★ 180 Day Guarantee

With Hi-Res Amber Screen - \$3595

With Med-Res Colour Screen - \$4595

With Hi-Res Colour Screen - \$5095

(Delivery costs extra)

REMARKABLE XT - \$6095

- Features Include**
- ★ MS Dos Compatibility
 - ★ 20MB Hard Disk
 - ★ 2 x 360K 5¼" Drives
 - ★ 8 Expansion Slots
 - ★ XT Power Supply
 - ★ 256K Ram
 - ★ 1 Parallel Port
 - ★ Med-Res Amber Screen
 - ★ 180 Day Guarantee

With Hi-Res Amber Screen - \$6295

With Med-Res Colour Screen - \$7295

With Hi-Res Colour Screen - \$7795

(Delivery Costs Extra)

SAVE ON HARD DISKS

20MB Half-Height Disks - \$2250

External 20MB Half Heights - \$2525

Hard Disk Controllers - \$475

SAVE ON TAPE UNITS

10MB Tape Drives - \$2250

External 10MB Tape Drives - \$2525

10MB Tapes - \$65

* Units plug straight into floppy controllers
(No controller card required)

SAVE ON PERIPHERALS

360K Half Height Floppy Drives - \$350

Floppy Controller Cards - \$250

4.77MHz Multifunction Boards (Unpop) - \$595

8.00MHz Multifunction Boards (Unpop) - \$595

64K Ram Upgrades - \$50

220V 135 Watt Power Supplies - \$535

8087 Co-Processors - \$545

Hercules Compatible Graphics Cards - \$363

RS232 Cards - \$145

Parallel Cards - \$72

Panasonic KXP Series Printers - CALL !!

NDK 5025 Printers - CALL !!

C ITOH Printers - CALL !!

Data Products Printers - CALL !!

Colour/Monochrome Monitors - CALL !!

(All prices subject to change without notice)

SAVE ON SANYO UPGRADES

20MB Ext. Hard Disk Plus Controller - \$3000

8MHz Multifunction Board - \$595

Additional 384K Ram - \$300

- ★ Gives your MBC-775 the Power of an XT-20
- ★ Components come with 180 Day Guarantee
- ★ Compare Prices with Competing Upgrades or the cost of a New Machine, then Call Us

SAVE ON DISKS ONLY \$4.50 EACH

- ★ Premium Quality DSDD 5¼" Diskettes
- ★ Replacement Guarantee ★ ANSI Spec.
- ★ To Order Send Cheque or Money Order To:

Remarkable Enterprises Ltd (Software Division)

Freeport 191, P.O. Box 1415, Dunedin.

(Please add \$3.00 per Order for P. & P.)

or

Telephone Dunedin (024) 774-464

(We accept Bankcard, Visa, Amex, Diners)

DEALER ENQUIRIES WELCOME

Call (024) 774-464 Today

For Our Latest Prices

REMARKABLE ENTERPRISES LTD

(Software Division)

7 Crawford Street, Dunedin

FAX: (024) 772-948, Tel: 774-464, Telex: NZ5406 REMPAP



BITS & BYTES

January/February 1986. Vol 4, no. 5

NEWS

Duty cuts, Price cuts. Shaky store. Big store. New machines. Dropped machines. And other manoeuvres. 8-12

HARDWARE REVIEWS

Philips' :Yes gets a qualified nod from Peter Ensor. 13
Panasonic's Executive Partner is a slick one, says Bevan Clarke 17

SOFTWARE REVIEWS

Perfect Series software has a few flaws that irk Peter Biggs. 67
JET is test flown by IBM columnist Richard Gorham. 65

HARDWARE SURVEY

A round-up of under-\$4000 micros (next month's pricier). 29-49

BITS & BYTES VOL 3 INDEX 39-43

FEATURES

Multi-user systems may be the next wave, says Mark James. 21
School teachers share their computer buying wisdom with Colin Marshall. 25
Micros-at-work is another new column 66
Do-it-yourself Basic is commenced by machine linguist Joe Colquitt. 70

COLUMNS

Amstrad	50	IBM	65
BBC	52	Micros-at-work	66
Apple	54	Machine language	70
Sega	55	Letters	71
Commodore	57	Bookclub	72
Spectravideo	59	Classifieds	76
Spectrum	61	Advertisers Index	76
Atari	63		

NZ Micro No. 42 Jan—Feb. '86

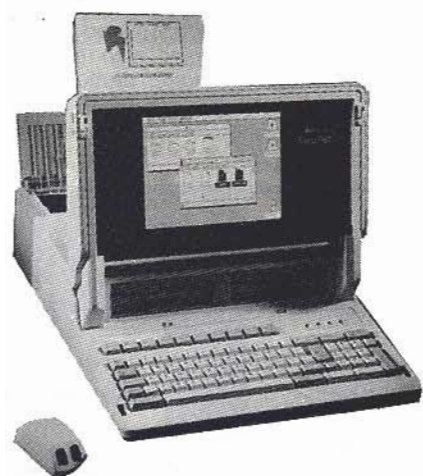
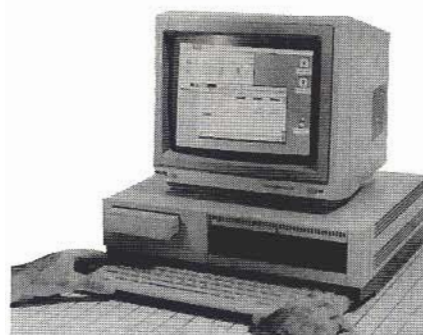

BITS AND BYTES magazine is published monthly (excepting January) by Bits and Bytes Ltd, Denby House, third floor, 156 Parnell Road, PO Box 9870, Auckland 1. Phone 796-776, 796-775. **EDITORIAL:** managing editor, Gaie Ellis; editor, Steven Searle; Wellington reporter, Pat Churchill, 5 Lucknow Tce, 797-193; Christchurch reporter, Dion Crooks, 66-566. **ADVERTISING:** Auckland - Paul Harris, PO Box 9870, 796-776; Wellington - Marc Heymann, PO Box 27-205, 844-985; Christchurch - Jocelyn Howard, PO Box 827, 66-566. **SUBSCRIPTIONS:** First floor, Oxford Court, 222 Oxford Tce, Christchurch, PO Box 827, Phone 66-566. Manager, Mavis Shirtcliffe. **SUBSCRIPTION RATE:** \$16 for 11 issues, school pupils rate \$14. Overseas subs are \$27/year surface mail, and airmail rates of \$59 (Australia, South Pacific), \$86 (North America and Asia), and \$108 (Europe, South America, Middle East). **BOOK CLUB:** manager, Dion Crooks, at above Christchurch address, 66-566. **DISTRIBUTION INQUIRIES:** bookshops to Gordon and Gotch Ltd, computer stores to publisher. **PRODUCTION:** graphic designer, Shona Willis; typesetter, Monoset; printer, Rodney and Waitemata Times. **DISCLAIMERS:** The published views of contributors are not necessarily shared by the publisher. Although all material in Bits and Bytes is checked for accuracy, no liability is assumed by the publisher for any losses due to use of material in this magazine. **COPYRIGHT:** All articles and programmes published herein are copyright and are not to be sold or distributed in any format to non-subscribers of Bits and Bytes.

Now shaky

Computer Now Ltd was in receivership just prior to the Christmas retail rush, but according to the company's appointed receiver only the Ponsonby Raod store was being cleared of stock.

The South Auckland and Browns Bay branches were then unaffected by the disposal of Computer Now assets.

Laurie Chilcott, of the Smith, Chilcott and Co accountancy, said those other branch stores were held by subsidiaries of Computer Now Ltd.

Similarly the management consultancy, Consulting International, was outside the action as an associate company.

On the bright side, the Ponsonby store's stock clearance was well-timed for the Christmas spend-up.

Coco down

The Tandy home colour computer, the Coco, has been reduced by \$240, to \$555.

Computer Advances in Auckland has also announced two new Tandy models: another lap-top with built-in 3 1/2-inch disc drive, and its version of an enhanced PC-AT.

Big sales

Farmers Trading Company had a merry Christmas with its computer sales.

The main line was Amstrad — Farmers Trading Co having withdrawn as a Commodore vendor since the early December retirement of Fountain Marketing as a Commodore sub-distributor.

Farmers' home entertainment merchandise manager, Dick Barter, says another line withdrawn was the Amstrad 664, the early disc drive "tester" machine.

Its main computer sales were of the tape-driven 464 unit.

The retail chain's handling of the word-processor 8256 was limited, he said, but the newer Amstrad disc-driven 6128 was selling strongly.

Meanwhile Farmers' Sega price, at \$199, had successfully positioned this home computer as a games machine, said Barter.

Effect of duty cuts

There was no customs duty on computers and therefore computer prices were not dramatically affected by the government's December 19 cuts in duty.

Expectations of shoppers however

were otherwise, and prices of some brands were to further drop early in the new year to effect "duty cuts" in line with other electronic appliance discounts.

Bits and Bytes' view is that the duty cuts heralded an opportune time for some distributors to reduce further their own margins on computers in order to be more competitive.

IBM manoeuvres

IBM PCs and peripherals were discounted 15 percent by IBM NZ Ltd in early December — apparently in response to the increasing market prominence of its emulators like Sigma, Multitech (Dick Smith) and others offering significant price incentives.

The compatibles were selling for less than \$2000.

Meanwhile IBM's problems with unreliable hard discs packed with its AT model have been overcome — most customers who had purchased the faulty line having since been offered free replacement discs.

IBM NZ's PC distribution and retail manager, Murray Jurgeleit, also reports JX sales being encouraging, particularly in the small-business sector. Larger businesses, he said, tended instead to remain loyal to the 5 1/4-inch disc format.



ANNOUNCE TIME-SHARING

This unique low-cost product turns a single-user PC into a high-performance multi-user system. Simply add on "dumb" terminals and you can run the full range of **MLS** multi-user software

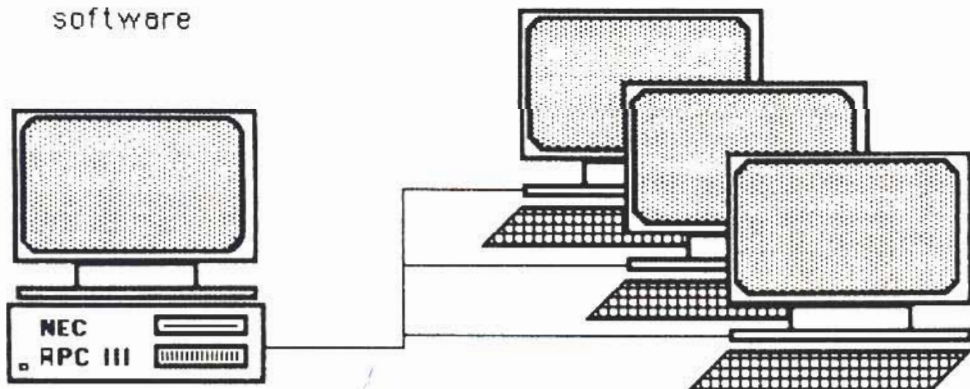

MLS Time-sharing will be supplied only on selected machines and is initially available on NEC's APC III.

For more information phone M L Systems on Ak 836-0558

MULTI-USER

Aggressive

After a year of heavy advertising expenditure, Amstrad distributor Grandstand Leisure was planning another marketing tack — discounting.

Price drops in February were planned. At time of writing (December) actual discounts were not definite, but managing director Bill Fenton was considering slashing \$400 off the 6128 single drive/screen/128K ram unit, to \$1295, and \$600 off the 8256 word processor, to \$1895.

In its first month here, less than 200 8256 w/ps sold but Fenton attributed this slow buying to pre-Christmas uncertainties.

Memotech dropped

John Gilbert Electronics Ltd is dropping the Memotech home micro distributorship — its remaining stock being almost halved in price at \$500 per unit.

The reason is claimed a lack of support from Memotech in the UK for both parts and software.

Regarding this micro's refined market image, one Gilbert staffer said the Memotechs were still not beyond the odd breakdown, but unlike Rolls Royce had non-existent servicing support.

Sharp tactics

Beechey and Underwood Ltd is enticing custom for its Sharp business micros by throwing in with each computer three modules of The Financial controller, accounting software written locally by Intersoft Systems Ltd.

The software, initially covering debtors, stock control and credit/debit analysis, is described as "fun, fast and accurate".

Fastest Sord

Mitsui Computer Systems has released the Sord M68MX, a 16-bit desk-top micro, costing \$7,500, which runs at 10 Mhz.

Its 512K ram is expandable to 3.5 Mb ram, and it can support 1.2 Mb floppies and 20 Mb hard discs.

Compaq arrives

In February Paxus Commercial Systems is scheduled to launch the complete range of Compaq micros.

The 14 models will be priced between \$5000 and \$15,000, the top-line model being an IBM-AT matcher.

The US-sourced portables and desktops are built around the same processor chips as in IBM PCs.

Colour upgrade

The 180 cps dot matrix Juki 5510 printer, costing \$1100, is being released with a colour kit upgrade option, costing an extra \$200.

The colour kit avails seven colours and extra buffer memory.

"THE HACKERS HANDBOOK"

A complete manual on all aspects of the popular sport of hacking into computers. Takes you through each step.

Banned in the U.K. after a recent controversial court case.

Limited number of copies available, for \$24.50, from:
Hugo Cornwall, P.O. Box 794, Napier

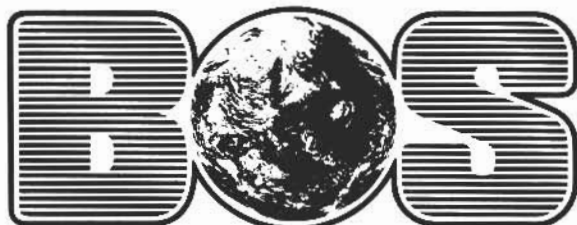

BUSINESS OPERATING SOFTWARE

Now in New Zealand

BUSINESS SOFTWARE



OFFICE SOFTWARE

BOS software gives you true multi-user function even on single user PCs

(e.g. SANYO • WANG • PC • CANON • IBM • PC/XT)

- ★ BOS has 30% of multi user micro sites in the U.K.
- ★ 10,000 sites in 30 countries
- ★ Ease of use, an untrained person can install a complete system in minutes
- ★ Transportable on over 100 computers, guarantees future expansion

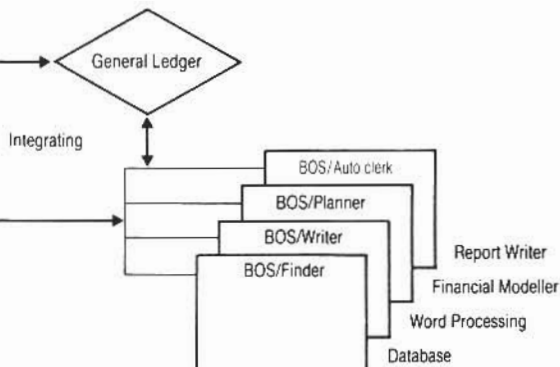

Software (NZ) Ltd, P.O. Box 221, Auckland. Phone (09) 798-178



The New Zealand
**Personal
Computer
Exhibition**

Overseas Terminal
Princes Wharf Auckland
8-9-10 May 1986

**NEW ZEALAND'S
LARGEST
&
MOST SUCCESSFUL
COMPUTER
EXHIBITION**

**The showcase
of computing in
New Zealand**



PC 86
P.O. Box 9870,
Newmarket
AUCKLAND
Ph. (09) 796-775

THE EVENT

The second annual personal computer exhibition.

Building on the extremely successful PC85 exhibition. P C 86 will be the focal point for the New Zealand Personal Computer industry in 1986.

In addition to the three day exhibition at which exhibitors will sell and demonstrate products and services while gaining valuable contacts, there will be:

- (1) *Seminars, for both the public and industry, led by industry experts.*
- (2) *The second annual Software Awards.*
- (3) *The second annual software awards and computer dinner with an international keynote speaker.*
- (4) *An exhibitor's night out.*

**For your PRIORITY booking form
(including floor plan) and more detailed information
CLIP THE COUPON BELOW**

Company:

Name:

Address:

POST TO:

PC 86, P.O. Box 9870, Newmarket, AUCKLAND.

Sanyo reshape

Autocrat Sanyo Ltd, the NZ parent of Sanyo Business Systems, has announced a major restructuring effort "to bring it back into profitability".

Sanyo Business Systems' general manager Bill Wouters said the move into larger premises early in the new year heralds a busy schedule of product launches over the next eight months.

The business systems company continued to be a profitable division for Autocrat Sanyo, he said.

There would be a major push of Sanyo-Icon's Supermicro, and Sanyo's matcher for the IBM-AT.

The Attache range of accounting software is also added to the line-up.

Commodore release

Commodore Computer NZ Ltd is extending its business range of micros with a 256K, single floppy PC-WS (work station) and PC-PLUS, which has 512K ram, dual floppies and a 10 Mb hard disc. They are for networking.

Digital's hottest micro

DEC's 15-year-old PDP micro range is extended with the release of the PDP-11/83, a 16-bit micro which can support up to 33 users and be configured to more

than 1 Gb of storage.

Complete PDP-11/83 systems are priced from a mere \$99,336 for the desk-side version.

Screen-sharing

ML Systems in Auckland recently demonstrated to a Bondwell dealers conference the logic of installing multi-user screen-sharing systems for running on one keyboard, and one screen.

The concept is to enable various computing functions to run concurrently without need for the expense of linking several terminals and screens.

The base price for the software is \$1,600, and ML Systems sees the product being pitched at the small business market.

Sinclair hopeful

Sinclair Research Ltd in the UK has announced a 30 percent increase in sales, due to its slashing of home computer prices, but a loss for its '85 year of almost \$30 million.

Sir Clive gave the hopeful news of plans in '86 to introduce two new pieces of Sinclair proprietary technology: flat screen displays, and wafer scale integration.

Any volunteers?

Massey University's department of production technology is seeking two volunteer businesses to run its prototype software called Progress Control System.

It is aimed at job-tracking and late-job detection rather than job-costing or work-in-progress valuation, and runs on IBM or compatible micros.

The system is a stand-alone, and does not require pre-stored operations routing details for each made-in part says the project leader, H.J. Baracough.

Stock clearance

Software importer/wholesaler Imagineering held a "garage sale" to clear its stock of old software, like Visi-On, prior to Christmas.

The company said the sale was not establishing a precedent and featured only the software that dealers had difficulty in shifting.

LOAD UP FOR LESS

HARDWARE:

TURBO BOARDS

8086 10 Mhz Turbo \$2900
ORCHID PC Turbo incl. 256K RAM & daughter board — gives 640K in one slot \$1850

CO-PROCESSORS

8087-3 5 Mhz \$434
8087-2 8 Mhz \$595
80-287 for AT \$725

MEMORY UPGRADES

64K Memory Upgrades (9 chips) \$ 49
256K Memory Upgrades (9 chips) \$ 165

MEMORY EXPANSION CARDS

512K Memory Card — no other features \$215
AST 6PakPlus Multifunction card \$895
ORCHID Conquest Multifunction, 2Mb capacity \$895
ORCHID ECCELL AT Multifunction, 3Mb capacity \$1255
AST Advantage for AT 128K RAM 3Mb capacity \$1250

UPGRADE CARDS

Serial Port \$130
Parallel Port \$76
Clock \$130
Clock and Serial Port \$270
Clock and Serial and Parallel Ports \$320

GRAPHICS

Hercules Monographics card \$ 900
Comway Monographics card \$ 875
Hercules Short Colour card \$ 595
Sigma (Hercules Mono compatible) \$ 445
Sigma Colour graphics \$ 330

DISK DRIVES

½ height Disk Drive 360K \$460
Tallgrass 25Mb Internal hard disk# \$2860
Tallgrass 25Mb/60Mb Tape External hard disk# (#includes controller & software) \$7500
10Mb External Tape back-up unit \$2850

KEYBOARDS

Professional separate cursor/numeric pad \$295
Key Tronics 5151 for PC/XT or AT \$555

COMMUNICATIONS

AST communications products
IRMA communications products
IBM communications products

CALL FOR BEST PRICES

TERMINAL EMULATION

Crosstalk XVI \$ 395

NETWORKING

ORCHID PCNet \$2045
Additional station \$940
Novell Netware \$1795

SOFTWARE:

SPREADSHEETS

Framework II \$1425
Open Access \$1245
Lotus 1-2-3 \$995
Symphony \$1362

DATABASES

dbase II \$870
dBase III \$1235
Revelation \$1600

WORD PROCESSORS

Wordstar \$450
Microsoft Word \$900
MultiMate \$995
DisplayWrite 3 \$995

UTILITY

HardRunner — Copy-protected version \$125
Peter Norton Utility \$280
Sidekick \$189
Sideways \$189

PROGRAMMING

Turbo Pascal 3.0, Turbo Tutor, Toolbox and Graphix \$565

PLEASE CALL FOR BEST POSSIBLE PRICES:

IBM PCG, PC-XT, PC-AT, PPC, JX
IBM compatible PC's and software

CONTACT: Charles Battley • Cara Kemp • Vanessa Healey

C.J. Battley & Associates Ltd

AT: 1st Floor, 10 O'Connell Street, Auckland 1 Telephone: (09) 34-545/34-546

TERMS: Nett cash 7 days from receipt of goods

AMSTRAD and SEGA

from

The Home Mail Shop

PO Box 134, 40 Harris Street, Waimate.

Send three 25cent stamps for catalogue.

Philips' :Yes

Will you say ":Yes, please"?

by Peter Ensor

Ever wanted to use those Macintosh style pull-down windows on your MS-DOS machine? The Philips :YES computer lets you have the best of both worlds.

Philips released late last year a machine which is an integration of several machines into a single package. The machine is aimed at the professional-small business-hobbyist market as a decent quality product at low cost.

A dealer network has been set up to distribute the computer but with education buyers Philips prefers to deal direct: with presumably bulk buying privileges and lack of a dealer markup this seems a sensible strategy.

The system runs the DOS-PLUS operating system, a sub-set of Digital Research's Concurrent Dos, which supports simultaneously the MS-DOS and the CP/M 86 operating systems.

Both operating systems are supported simultaneously through the use of different file extension names for the different operating system programs. Switching between the two operating systems is entirely transparent to the user.

The operating system also features simple multitasking with foreground and background processing capabilities. DR NET and GSX graphics are also supported.

The network abilities will be especially important to the success of the machine as a classroom tool.

By using the network, diskless machines can be used and at a retail price of approximately \$3000 per machine (less for schools) this will make a low cost network.

Four windows

Concurrent DOS is available for purchase separately, and this will enable users to run up to four separate programs simultaneously and in real time. Each of the programs can have their own window on the screen or one program can fill the full screen, as the user desires.

The purchase of Concurrent DOS also includes the DR NET network program. To run the network successfully 640K of RAM is required by the file server computer.

With two operating systems being combined some of the commands have been altered.

Floating disc drives are a feature on this machine. Any directory path such as \APPS\WP\DATA\ can be assigned to one of two drive letters O: or N:. Specify-

ing the appropriate drive letter will default a path to the subdirectory DATA on the current drive.

If an old friend of an operating system is what you desire then MS-DOS version 2.11 and GW BASIC can be purchased to replace the DOS-PLUS operating system supplied.

However, the power of the system does not lie in the operating system alone. With the machine comes a selection of software.

Front-end help

For the first time user of a computer, there is a menu-driven front end program. This starts up when the computer is booted or by command and allows the user to issue commands via the menus.

While this program will always be used by some users, others will soon disable the package and key in the command straight to the DOS.

This option includes configuring the machine for the various system options and the disk maintenance tools.

While this is a good package it is slowed down by the disc drives each time it is reloaded after completing a function.

Open Access is an integrated package of six different programs which is bundled with :Yes "professional board" pack (\$700 — \$1400).

Word processing, a database, a spreadsheet, a graphics program, a time management program and a data communication package are included.

Info Management, as the database program is called, forms the basis of all the other programs. It has a versatile query type language with a menu driven database handler and report generator.

Supporting this is a spreadsheet package. This performs all the standard spreadsheet functions and passes information to other packages for graphic display.

Three-dimensional

The graphics display package creates

not only the standard histograms and line graphs, it will also draw three-dimensional high resolution graphs from data supplied.

The word processor provides a good range of the basic functions. These are enough to produce reasonable documents.

Time Management consists of an electronic calendar for appointment keeping and address card keeping. But no matter how "good" this type of program is, I am always sceptical about how often it would be usefully employed. A notebook diary seems to be far more convenient to use, and much more portable.

The last major section of the package is the communication section.

This enables files to be sent from one computer to another via the serial link.

For a system with two computers running Open Access, one computer may become the master and have access to the other computer's files.

A cut-down Open Access is initially supplied with :Yes as standard. But this initial package only has the spreadsheet and some operating utilities. When the professional board is purchased the full version is supplied.

Logistix is also offered for this machine. This is a spreadsheet with "the fourth dimension of time".

It has the functions of a database and graphing like many other spreadsheets on the market, but it also has functions for manipulating timesheets and critical path analysis.

With options to vary the days worked (i.e. omit Sundays or other days from the analysis) and the hours worked it is able to show critical paths through a project.

I can see this feature becoming a useful addition to other spreadsheets.

The colour presentation of the display makes it very easy to use and I would use it in preference to some of the several other spreadsheets supplied.

Mac-like

A Macintosh look-a-like package is also available.

This is the GEM package written by Digital Research for PC DOS machines. It consists of a desktop — which is the same theme as for the operating system command processors — and the application programs.

(Continued on page 15)

The confusion is over.
You've made the
'right computer decision'
Right?



Now, don't get confused
all over again
about the
right computer
supplies...



CALL COMPUMEDIA

Welcome to Compumedia, a company set up to take the hassles out of choosing computer supplies.

We source quality products from Japan, U.S.A., U.K., Germany, Australia and New Zealand ... products to help you maximise the potential of your computer ... products to help you take good care of your total computer investment.

- FLOPPY DISKS • DISK MINDERS • COMPUTER TAPE
- PRINTER RIBBONS • CLEANING PRODUCTS • COMPUTER PAPER • ACOUSTIC PRINTER HOODS • VDU ANTI GLARE FILTERS • ATTRACTIVE, PRACTICAL COMPUTER FURNITURE.

CALL AUCKLAND: 444-6085, P.O. Box 3273 Tlx. Ak 60835
CALL WELLINGTON: 851-548, P.O. Box 11091 Tlx. Wgtn 31415 or send this coupon for our product brochure and price list

**Compumedia
Systems**

*We're No.1.
in Computer
Supplies!*

To Compumedia Systems Ltd, Freepost 1167, P.O. Box 3273 Auckland.
Please send me your free product brochure and price list.
Name:
Company:
Address:

(Continued from page 13)

The desktop is retailed for \$195, if purchased separately, but will normally be included with the first application program purchased. At the time of writing (December) the only package that was available in production quantities was the GEM DRAW package at \$700, including the desktop.

Other packages to become available are GEM WRITE and GEM PAINT. Also supplied with the review machine but purchased separately was a thick GEM programmer's manual for writing application programs.

Other packages that are available for demonstration are the Wordstar word processing package, DBase II, Turbo Pascal and the Multiplan spreadsheet.

The screen emulates a subset of the VT52 or VT100 commands with additional commands to make use of the extra features available.

The machine hardware is neatly presented. The basic machine comes with 640 by 350 bit resolution colour graphics as standard along with 128K bytes of RAM. The choice of a screen is up to the user.

New interface

The number of disc drives can vary from none, if the network or a ROM key is being used, to two drives fitted as standard. Each of these drives are 3.5 1/4-inch microfloppies holding 720K of data.

For applications where either a disc drive is not desirable or in addition to the disk drives, a ROM key can be inserted into the cartridge slot in the front of the machine. This holds a maximum of 128K of code.

Hard disk drives can be added using the SASI port as well as 5-inch disk drives. The latter drives are supplied in their own cases, complete with power supply, and are intended for use mainly by dealers copying data from the standard 360K disks on to the microfloppies. They are available to the public, for \$1000 each.

The keyboard is slim with tilting legs. LEDs are supplied for the Caps Lock and Num Lock keys. When the machine is not in use the keyboard can be slid under the machine into a carry slot.

The key layout is similar to the IBM PC layout but with the function keys along the top rather than down the lefthand side.

Faster, bigger

The processor is the 80186 running at 8MHz and supported by 64Kb of ROM. This processor uses a true 16-bit wide data bus rather than the 8-bit wide multiplexed bus of the 8088. This results in a faster throughput of data and hence a

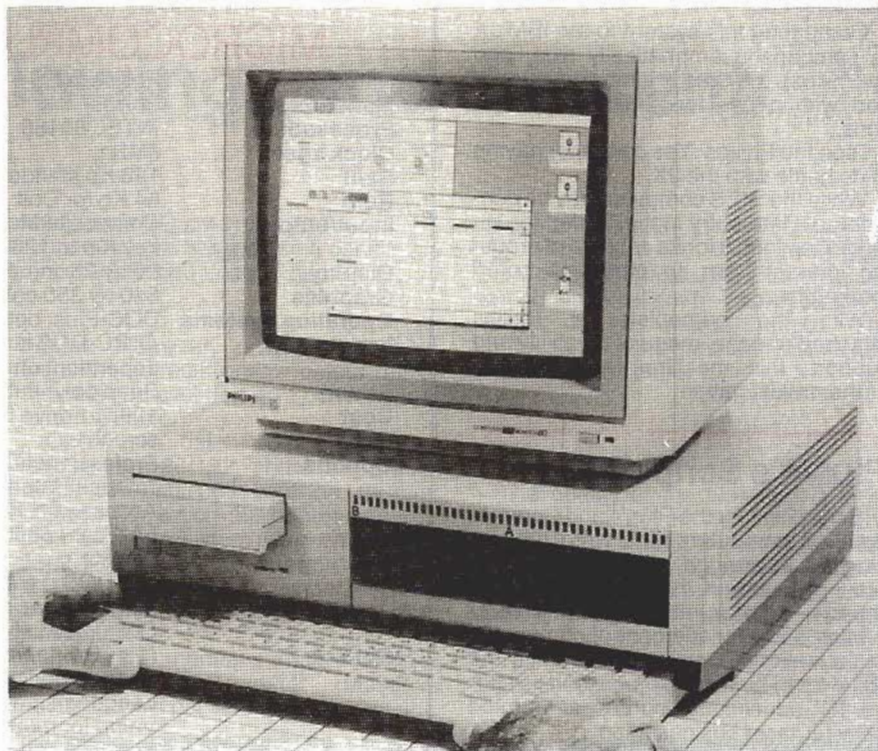

faster speed.

The ROM is bank-switched to allow more of the system RAM to be available to the program. This has the advantage that programs that are too big to run on other machines have a better chance of running on this machine.

Other interfaces provided as standard are outputs for a composite monitor, RGB-TTC video, and five-inch disk drives, as well as a serial and a Centronics port.

The only hardware upgrades that are presently being offered are the Professional board and a Local Area Network (LAN) card.

The Professional board contains either 128K or 512K bytes of RAM and a battery-backed clock and calendar.

There are interfaces for a "mouse" and a SASI interface for the hard disk. As mentioned before, the full version of Open Access will also be supplied.

The LAN card, when fitted with the Professional board, uses up the two available expansion slots. To add more expansion cards to the system requires an extender card (not supplied here).

Great manuals

The manuals that come with the machine are impressive. While only the machine and DOS user guides will come gratis, there are full software and hardware reference manuals available.

The Open Access manuals are substantial and a pocket reference guide is

supplied.

It is interesting to note that two big names, IBM and now Philips, have both produced machines that are not copies of machines that have gone before.

IBM brought out a machine running the unique PC-DOS, which a large number of manufacturers have since followed.

Now Philips has produced a machine against the popular tide of PC compatibles.

Official PC DOS calls to the :YES DOS are supported but any machine specific requirements such as access straight to the screen will not work.

Overall the machine is impressive and well-priced but with what does it tempt prospective buyers?

An investment in :Yes is cost effective, the machine is well designed, but what else can it offer?

The plastic finish is attractive, but the holes for inserting "things" are prolific on three of the four sides.

The quiet fanless operation and the higher speed are certainly advantageous.

On the software side it has the DOS-PLUS operating system going for it with the abridged Open Access package and the menu-driven file manager.

The Concurrent DOS and the GEM series packages are good additions to the system and will appeal to many people.

And for those looking for a cost effective LAN system then this one is a serious contender.

(Continued on page 16)

Hardware review

(Continued from page 15)

Comparing this system to the IBM JX (a comparison emphatically side-lined by Philips), the :Yes is almost level-pegged with prices for similar configurations.

I see the Philips :Yes computer having to do battle with the JX.

While the :YES computer may be considered a late entry in the market for 16-bit processors, it looks capable of arousing interest from an otherwise bored marketplace.

With the nameplate of Philips attached and the image of reliability and support, this machine is well worth further investigation.

Plus/4's Script Plus

Script Plus for the Plus/4 and Commodore 16 computers puts word processing into a cartridge, costing \$90, to enable preparation of comprehensive reports, administration of small companies and management of community organisations. Commodore admits the Plus/4's in-built word processor "is useful for educational purposes, but too slow for most businessmen".

Features of Script Plus include a wide screen of between 40 and 240 columns, but still only a "window" of 40 columns.

MICROCOMPUTER SUMMARY

Name	Philips :YES
Manufacturer	Philips
Processor	INTEL 80186
Clock speed	8MHz
Ram	128 Kb standard, up to 640 Kb
Rom	64 Kb for Dos. Optional 128k Rom key.
Input/output	Composite Monitor, external floppy disk drives, ROM key (up to 128 Kb), serial, Centronics
Display	80 by 25 lines
Graphics	640 by 350 colour
Operating systems	DOS-Plus; optional is MS-DOS, Concurrent DOS
Languages	All PC-DOS languages, e.g. GW Basic, Turbo Pascal; dependent on compiler.
Sound	Beep only; audio output port
Cost	128K, 1 drive \$3250; 128K, 2 drive \$3900 — without screen
Options	Professional Board (512 Kb, battery backed up clock, "mouse" interface, SASI (hard disk) interface Open Access with 128K \$700, with 512K \$1400 LAN card \$850 Logistix p.o.a. MS-DOS p.o.a. Monochrome monitor less than \$400 typical Colour IBM style less than \$1000 typical
Ratings	(1 — 5, 5 the best) Documentation 5, ease of use 5, Language n/a, expansion 5, Value for money 4, support 5.

Review unit from Philips New Zealand Ltd, Auckland.

AFFORDABLE ERGONOMIC FURNITURE

SET YOUR TERMINAL OR COMPUTER ON SILKWOOD FURNITURE TO MINIMISE RISK OF RSI, INCREASE COMFORT AND EFFICIENCY!



\$ 135.00

(in Auckland - Sept. 85) puts your computer on a Silkwood Copy Stand ECS2 (illustrated) on your present desk.

Surprisingly little more buys a full work station proved to be EFFICIENT and ERGONOMIC by thousands of Companies countrywide.



Silkwood copy stand ECS2

SILKWOOD COMPUTER FURNITURE MODULES ARE AVAILABLE FROM GOOD RETAILERS. BROCHURES. DATA SHEETS. OUTLET ADDRESSES AND FREE CONSULTANCY ADVICE FROM -

Silkwood Manufacturing Limited
8 TIRONUI ROAD, PAPA KURA. PH. (09) 298 7089

SEE
the complete SILKWOOD range



SILKWOOD
WORK STATION



Silkwood
DATA CENTRE



SILKWOOD 'MULTI'

...and MORE

PANASONIC'S EXECUTIVE PARTNER

Sleek, fast, glowing...and different

By Bevan J. Clarke

Be the first kid in your street to own a computer that glows red in the dark! The new flat flat-screen Panasonic Executive Partner has a plasma panel display with 640 x 400 pixels. Its crisp, high-definition images glow in a restful neon red.

The importers, MEC Ltd of Auckland, say that the Executive Partner is not intended to crowd its older sister, (still called the 'Senior partner' in the USA, but labelled here as the 'Panasonic Portable') out of the market but is meant to meet the needs of a subtly different market. For example, it can run at twice the usual speed!

We shall try to define its market role at the end of this review.

First let us meet and test the new member of the family.

The Executive Partner follows the former machine's tradition in being a 'luggable computer'! Its svelte portable-typewriter looks make the Senior Partner look dumpy — all-rounded like an early model Holden.

Although at 11kg it weighs only 4kg less, it seems to be lighter.

A slim profile (when closed) and a better carry handle make it easy to tote.

It needs no carry case (unless you're the sort to put loose covers over new sofas).

Across the back we find the power input and outputs for a parallel printer port, a serial RS-232 connector (with D-shell connectors) and a 60-pin bus expansion connector. The ports are covered individually with snap covers.

Option board

Inset into the right side of the machine is a hatch where one small 5 1/4" option board may be installed. This is the size of the 'short slot' of the PC-XT.

The manual's line drawing seems to show a modem but I found it ideal for my Microsoft Mouse's bus board. As with the older machine the power cord is not retractable.

To their credit the NZ agents have furnished the power cord with a tap-on plug. It is little attentions like this which eliminate constant irritations.

Executive takes up only a small footprint on your desk. A space 410mm wide by 540 deep is all that is needed. (A true PC with its keyboard in a comfortable place eats up 510 by 660.) Its cooling fan is audible but now totally inoffensive.

Also in the 'Partner' tradition is the built-in printer. When you turn the power on output will normally be directed to this

printer. However, pressing Alt/PrtSc instantly redirects printer output out of the other parallel port, to a conventional external printer.

Opening a hatch across the back reveals an 80/132 character printer which can print both with the 'thermal process' (in which the printhead's column of tiny resistors blacken thermal paper) and with the 'thermal transfer process' (in which the same resistors blast ink off a special carbon ribbon onto plain paper).

Ignore the manual's implication that special 'thermal transfer' paper is needed. Any paper will work, but the

smoother the better.

If you run the MS-DOS GRAPHICS.COM program first then you can obtain excellent bit-mapped screen dumps on the internal printer. The printer clatters, the printhead clunks as it loads on to the paper for each line.

Basic print

The quality of the type-face and its variations is better than that of the Senior Partner but it is only 'basic dot-matrix' quality. This is a shame — I have a tiny typewriter which uses the same printing processes but with a 25-pin printhead to produce true letter quality.

The NZ cost for either process comes to about 20c per densely-typed A4 page.

(Continued 19)

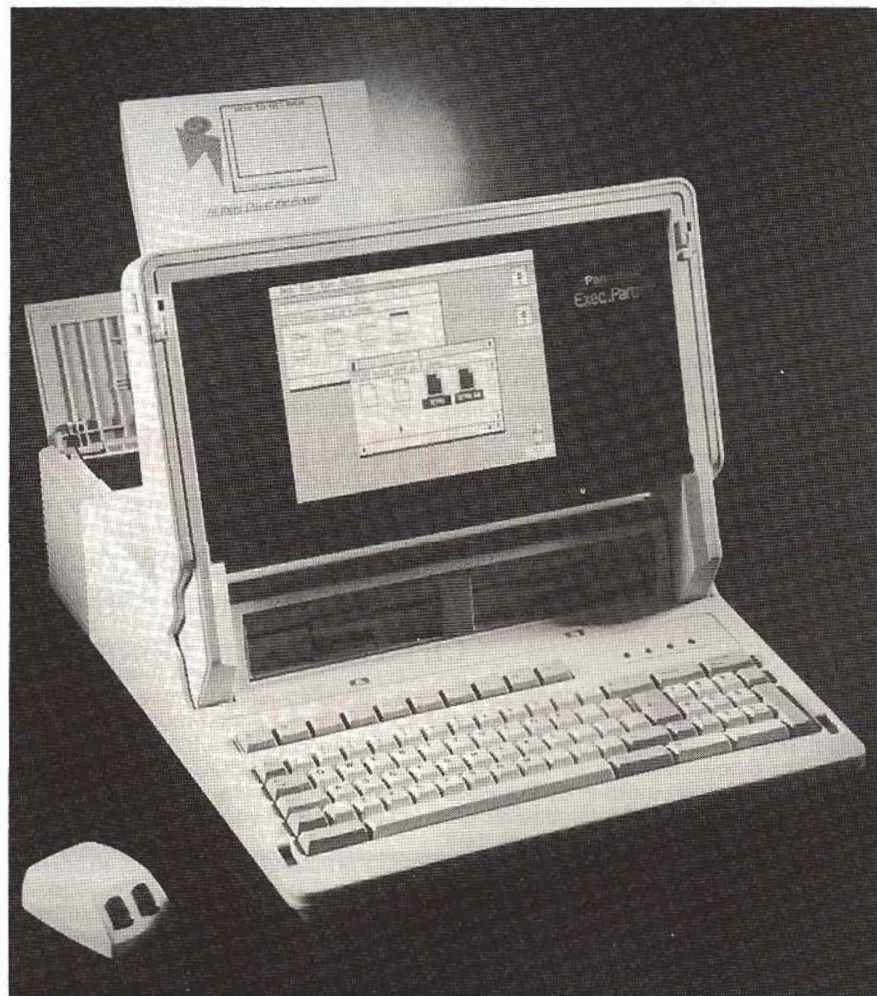

FOR THE VERY BEST IN FLOPPY DISKS



THINK Verbatim®

WORD PERFECT FOR LIFE

Contact: Verbatim New Zealand Limited
Wellington 858-615

Or: Your Local Computer Store

THE WORLD'S BIGGEST SELLING FLOPPY DISK

Verbatim. 

(Continued from page 17)

Although this is a distinct improvement on the previous machine's printer it is no substitute for an external printer for serious work.

What use is it then? I have found that one does not use it often, but when you need it you really appreciate it.

There are times when the need for hardcopy is urgent; at a conference, in a hotel room, in the field on the client's desk — if you ever have the need for immediate printout of a file then the Executive will be a godsend. The simple printer mechanism adds very little to the cost.

But it does add 100 mm to the length of the machine. Despite appearances this is not a lap-top, unless you have a lap like a Japanese wrestler and an a.c. power socket in your navel.

Although it is portable, you have to feed it 240 volts. A deeply recessed switch by the small option-board slot allows a globetrotting user to flip over to 120v a.c. with a nail-file or swizzle-stick.

It takes 12 seconds to heave the Executive on to a desk, release and lift the plasma panel display from over the keyboard and turn the power on.

Since this is an IBM PC compatible the ROM boot routines then take 33 more seconds to run a diagnostic check on all the memory chips. A count-up in 32 Kb increments appears on the screen and once the memory is checked (256 or 640 Kb) then MS-DOS 2.11 is in control with all that that implies.

Superb keyboard

The keyboard is not detachable, but Panasonic know how to make superb keyboards. This one is IBM-standard except that the function keys have been moved back to their obvious place, a straight row above the number row.

To their right a row of four LEDs tell you of the status of your world. Two report on Numlock and Capslock. The third tells you which printer port is active — the external printer or the internal printer.

But the fourth — wonder of wonders — reports on the FAST mode.

Pressing Ctrl,Alt and Gray-Plus at once toggles this neat machine out of the 4.77 Mhz speed which is standard for a PC or clone, into the 7.16 Mhz speed rightly called FAST mode.

I used to think Turbo Pascal 3.0 was unbeatable value; my program to compute all the primes below 4000 took only 29.6 seconds. But toggle FAST on and the same program exactly takes only 13.0 seconds.

You may wonder why anyone would want to use the slow mode (which can also be triggered by a DOS call from within a program).

Certainly I have found no program

which fails when run in FAST mode.

Perhaps Space Invaders suggests one answer. If you, too, are constantly beaten by your children at computer games, don't tell them about FAST mode. But if you have serious computations to make then the Executive Partner with its 8086-2 processor must be considered.

As a closet WordStar user I dream of using this machine in FAST mode and with my files in a RAM-drive. Oh that I could word-think as fast as this combination can word-process!

And putting an 8087-2 maths co-processor into the socket provided then should produce great results if you have the software to drive it (Turbo Pascal again?).

IBM-compatible?

Is this a true IBM-compatible? Of course, it cannot legally have the IBM copyright notice burned into its ROM, but software is the test.

The Norton Utility called 'SI' (system information) rates this machine a 1.00 relative to a true PC (and incidentally declares the computer to be a 'Panasonic Senior Partner'. Is the ROM largely the same?).

Like all clones BASIC is not in a ROM so programs in BASIC or BASICA will fail unless you first load BASIC off disk.

Within a wide range of software I have found the Executive Partner to run: PC-DOS 2.0 straight from an IBM PC, Lotus 1-2-3 (in FAST mode it's a real Lotus-eater!), Sidekick, Turbo Pascal (including programs which make machine language calls on the ROM and one which copies the ROM's bit-patterns for the character set and modifies it to produce italics & BIG letters), LPA Professional Micro-PROLOG with pull-down menus everywhere, Framework, and, of course, dear old Flight Simulator, the reviewer's standard test.

The most impressive and successful software test was running the new GEM package — Graphics Environment Manager — from Digital Research. Load this program and plug in your mouse and your PC-clone becomes a Macintosh work-alike with icons, menus, variable fonts and font-sizes and a MacDraw copy called GEM Draw.

It runs without any hitch.

Hardware compatibility calls for a more cautious comment.

The disks are in the totally compatible 360Kb 5¼" MS-DOS standard. No problem with your existing software base and no need to copy files across to 3½" rigid floppies.

On the other hand, no increase in storage capacity either!

I would have installed Panasonic's 5¼" drives with at least 720Kb, made the machine boot up in 360Kb mode and provided yet another mode-displaying

LED — "VAST".

The only provision for installing an internal option board is the slot in the side where I installed my mouse board. Not much else is tiny enough to go in there.

There are not very many small modem or network cards presently on the market. So one may be limited to Panasonic's offerings.

To my knowledge they have not yet produced anything except a memory card for the Senior Partner.

The expansion slot at the back is not for direct plug-ins but is intended for connecting the expansion box (RD-9655) when it is released.

Easy expansion

The review machine came with 256Kb of RAM.

We are used to adding memory via a tedious process of populating an expansion board, opening the machine (put all those Philips-head screws down carefully!), slotting in the board, setting inaccessible DIP-switches to an obscure pattern with a knitting needle and a flashlight, then re-assembling the machine.

I have good news for you: the Executive can have only 256Kb or 640Kb and you upgrade it simply by opening a hatch in its base and replacing the 64Kbit RAM chips with 256Kbit chips. Then reset a one-bit switch.

Put the old chips in a handipack; keep them for one year, then post to MOTAT's computer museum.

The machine reviewed was the FT-70 with twin, quiet floppies. The FT-80 model has an in-built 10Mb hard disk. Since there appears to be just enough room internally for a small controller board, one could consider replacing one of the FT-70 drives with a do-it-yourself hard disk, such as that from Qubie (\$US595 for 20Mb).

On the other hand, what do you need to plug into this machine? It already has built-in graphics, a real-time clock, printer and serial ports and can have a mouse added easily. If you need more perhaps this is not the machine for you.

Plasma screen

And what about the great innovation: the plasma-panel screen?

It is flat, flip-up and convenient. It tilts and holds its position over a range of angles. This is more useful for minimizing reflections off the un-etched glass than anything else.

So far eight users have joined me in testing the machine and without exception they have praised the clarity of the screen. Not one objected to the orange/amber colour but two secretaries found

(Continued on page 20)

(Continued from page 19)

that they wished to have the screen further from their eyes — an impossibility with the integral keyboard.

The plasma screen is MUCH easier to view than an LCD screen. Three people side by side can view it comfortably.

The manual's hype describes it as "equivalent to a 12" CRT". Its diagonal is only 9 1/4! But if they really mean "As clear as..." they are making a fair claim.

On the test machine the background shade was not pure black but a faint glow. Whether this was a fault, an unavoidable current-leakage or a design choice is not known. When the screen lights the level of radio interference rises — it is already higher with this machine than with its predecessor.

Unlike the Senior Partner there is no RGB port on the back. The documentation refers to installing alternative graphics cards to provide full colour graphics. It states that the Executive will automatically recognize the presence of such a card and redirect output to the attached monitor. But such a monitor could not be perched on top of the computer.

But although the plasma screen is very readable it does bring us to the Executive's oddest features. For reasons of plasma technology (one presumes) each of the 640 x 400 tiny square pixels is either fully on or fully off. Neither the screen as a whole nor a pixel can be varied in intensity.

Making a virtue of necessity the manual claims that the "display has been set for optimal viewing under various lighting conditions and cannot be adjusted." This is a surprisingly fair claim, but nevertheless I would like a brightness control.

When I put a mesh screen up to cut out window reflections then I need to turn up the overall brightness to compensate.

With no polarizer over the screen (small wonder at today's prices) the only solution is to lower the venetians.

Donations to Sallies

CCL Business Systems has given the Salvation Army a cash donation of \$5000 and a Texas Instruments computer worth more than \$10,000 to help the Army recover from the tragedy involving their motor launch Kaheno.

The Kaheno was swamped and badly damaged with the loss of four lives in September.

The computer will enable the Army to upgrade its record keeping, which has been on a manual card index system since its rehabilitation programme started in 1907.

Auckland software importer Micro Source Ltd has donated Open Access.

No shades

But other effects are odder: for PAINTing areas of colour the 8 or 16 standard colours (which usually map into 8 shades of green) are mapped into only 4 textures of orange. And for writing text in colour the same 8 shades are mapped onto 4 different type styles. Clever and effective, but odd.

The documentation is adequate: an A5 softbound BASIC book and an A5 plastic-covered ring-binder, all about everything else, which is mainly DOS. The contents of the standard DOS documentation have been adapted where necessary to the new machine but all the old dross is there as well, including how to use Edlin, the world's most horrible, obsolete editor.

Vendors like Panasonic should lean on MicroSoft, who should have tarted up this rubbish years ago!

Panasonic's documentation has improved. It's now up to the industry average, which is not saying much.

Where, oh where, are the tutorial disks, video tapes or audio cassettes for rank beginners?

The best way to learn is still to have an experienced friend nearby.

So who is this machine for?

It is not for use on a sun-drenched desk. It is not for someone who wants to add full-length expansion cards. It is not

for those who must have their graphics in colour or want to feed video output into a video-projector (a great option with the Senior Partner for meetings and staff training).

But it is a high-resolution machine which is very easy to view. It would suit anyone whose tired eyes cannot read a fuzzy 320 x 200 screen.

As a much smarter-looking machine than the Senior Partner it is for the fashionable.

It is for anyone whose need for a printer is occasional but urgent.

It would be fine for the accountant, surveyor or field engineer who wants to take his power-tool to the (240-volt) work-site.

It is for the travelling journalist or conference-goer who needs the whole power of MS-DOS and 640Kb on the road.

It is for anybody who wants portability and number-crunching with it. This includes everyone whose spreadsheets have grown to take more than 2 minutes to re-compute: the FAST mode is marvellous. Can anyone lend me an 8087-2 math co-processor?



Microcomputer summary

Name:	Panasonic Executive Partner.
Manufacturer:	Matsushita.
Processor:	8/16 bit Intel 8086-2.
Clock speed:	4.77Mhz or 7.16Mhz at user or program option.
RAM:	256 or 640Kb.
ROM:	16Kb.
Input/output:	Standard keyboard, serial port, parallel (Centronics) port, rear and side bus expansion slot, can take mouse.
Display:	Neon gas plasma panel standard (monochrome orange/amber). Conventional CRT graphics monitor connectable via bus expansion port.
Operating systems:	MS-DOS 2.1 supplied. Will take anything IBM PC can take.
Languages:	All MS-DOS and 8088/8086 family languages. BASICA supplied.
Graphics:	640 x 400 pixels resolution. Usual BASICA graphics. Only 4 'colours' available on the plasma panel & those are textures of orange.
Sound:	Internal speaker's beeps and tones.
Options:	10Mb internal hard disk. One internal slot for a small card. One slot for connection to an expansion box.
Cost:	FT-70 \$5,995; FT-80 to be announced.
Reviewer's ratings	(5 the highest): Documentation 4; ease of use 5; language 5; speed 5; support 4; value for money 3.

(Review machine supplied by M.E.C. Ltd, Auckland)



Multi-user micros: The Next Wave

by Mark James

When 16-bit microprocessors first hit the market in the late 1970s, their makers bragged that each one of them held the computing power of a 1960s mainframe computer. While technically true, the chips have been used in ways very different from those of their room-sized ancestors.

Most microcomputers have been built for single-user, heavily computational operations such as colour graphics, spreadsheets and fancy word processing; few have thought of microcomputers as multi-user, time-sharing systems.

That is now changing. Multi-user micros may well be the next wave, and the reason for the change is, of course, falling costs.

Hardware

In terms of hardware, a computer needs four items in order to support each extra user: a terminal, a serial port to attach it to, extra memory, and extra disk space.

The price for each of these ingredients has plummeted in the last few years, along with the cost of the micro itself, to the point where the price of a multi-user system today is less than that of a single-user system a few years ago.

Terminals: Very large scale integrated circuits and cheap labour in Taiwan and Korea have brought the prices of video terminals down to less than half of what they were in 1982, and

the trend continues.

Even the cheapest "dumb" terminals now have microprocessors that control character fonts, video attributes such as bright and dim, programmable function keys, and often even special editing modes.

At the time of writing, list price for such terminals in New Zealand starts at \$1500; various discounts can be had, and used terminals are much cheaper. Graphics and colour, however, are still expensive options.

Serial ports: Most 16-bit computers today are sold with at least one serial port inbuilt, for use with modems, serial printers or communication with larger computers.

While some companies still charge



\$100 or more for add-on serial-port controllers, an article in the March 1985 issue of Byte magazine showed how to build your own for US\$15; and component prices have come down since then.

For the IBM PC and compatibles, boards are available with four and even eight serial ports.

In general, both the serial port and the terminal must support the RS-232C communications standard.

However, a note of caution: this "standard" leaves plenty of room for variation in terms of the cables required to connect the terminal to the port. Connectors may have 25, thirteen or nine pins; may be male or female; and may require varying numbers of the pins to be wired in various ways.

If you don't understand these issues, it would pay to consult someone who does.

(Continued on page 22)

(Continued from page 21)

Memory: With the price of RAM chips dropping, there are now few 16-bit computers sold with less than 256K bytes of main memory; and the chips for an upgrade to 512K cost well under \$100, if you install them yourself.

Most multi-user operating systems will function in 256K, although some not very efficiently. In general, since memory is cheap, a multi-user computer should have as much of it as is practical.

Disks: A recent price war in California saw the price of a five-megabyte hard disk drop to US\$89 (without controller). The IBM PC/AT has popularised high-density floppy disks and caused their prices to fall as well.

Increasing competition between American and Japanese manufacturers, and between 5 1/4-inch and 3 1/2-inch formats, will guarantee that the bargains continue.

All of the multi-user operating systems

to be listed in next month's Bits and Bytes recommend hard disks, for the good reason that they are much faster than floppies; with several people making demands on them, floppy drives can be a real bottleneck.

In addition, disk-hungry operating systems like UNIX will not even fit on any but the densest floppy disks, although the leaner ones like AMPS will fit on dual 360K diskettes.

Networking

There are two other approaches to multi-user micros that require further hardware and have some advantages, but also some drawbacks.

The first is networking.

In a network, every user actually has his/her own PC, and these are linked by high-capacity communications cables through which they share expensive peripherals such as hard disks and printers.

The advantage here is flexibility: If part of the network goes down, the rest of it can continue to work.

The disadvantage is cost, since each user must have a full computer plus a network controller board; networks are not really multi-user systems, except from the point of view of the shared peripherals.

The cable does not come cheap either (there are some exceptions to this), nor does the software (disk servers, print servers and the like) that shares the peripherals.

The other approach is the multi-processor PC.

This involves adding boards to an ordinary microcomputer, each of which contains, in effect, another PC minus the peripherals. Ordinary monitors and

keyboards may then be attached to each card, and software in the "master" PC governs the sharing of the disks, printer and other peripherals.

The advantage to this method is that each user may run his/her own copy of MS-DOS programs, with minimal effect on other users; also, without the necessity for cables, the total cost per user is generally less than that of a network, although still higher than that of a true multi-user computer.

We shall limit ourselves here to the consideration of true multi-user systems — that is, several users sharing one processor, one chunk of memory, and one set of peripherals.

Judging systems

There are several multi-user operating systems for microcomputers on the market now, and more are likely to appear.

Each has strengths and weaknesses, and none stands out as the best for all applications; some, for example, are fine-tuned for business-oriented database operations, but would be painfully slow at scientific number crunching.

Some support glittering graphics and elaborate word-processing functions, but slow to a crawl once the second user tries to start working.

Functionality and efficiency, of course, are issues for any operating system, whether multi-user or not.

One consideration that is particularly relevant to multi-user systems is security.

In any multi-user arrangement, two important security issues must be dealt with: co-ordination between users of the same equipment, and the protection of each user's programs and data against



**COMPUTERS
FOR PEOPLE**



SANYO MBC
SALES AND SUPPORT

35 Taranaki St, Wellington
Phone (04) 859-675

407 Queen St, Auckland
Phone (09) 393-408

Choosing a Payroll System

*Read this
before you decide*

- The T.C.S. PAYROLL provides detailed reporting on each employee, detailed reports for each pay run, detailed reports for employers for M.T.D. and Y.T.D. totals.
- The T.C.S. PAYROLL is extremely flexible providing for multiple hourly rates, unit rates, extras and deductions.
- The T.C.S. PAYROLL calculates all tax deductions and retains totals for quick, accurate printing of IR12 tax forms.
- The T.C.S. PAYROLL provides for both active and non-active employees.

- The T.C.S. PAYROLL allows for a mixture of different pay frequencies between employees.
- The T.C.S. PAYROLL calculates cash breakdown and banking splits.
- The T.C.S. PAYROLL provides for rounding of pay if required.
- The T.C.S. PAYROLL was completely written in N.Z. and is fully supported in N.Z.
- The purpose of this payroll system is to provide quick, accurate Payroll calculations, keep accurate records of employee totals and retain employer totals for necessary tax returns.

what you've been looking for ?

TCS
PAYROLL

at only
\$499
there really
is no choice!

SPECIFICATIONS

- Runs under MS-DOS 2. Available for IBM PC and compatibles also Sanyo 550 series (Commodore versions available)
- 128k memory for 200 employees
- 256k memory for 320 employees
- Hardware requirements
 - Minimum 128k RAM Micro Computer (MS-DOS 2)
 - One 360k Disk Drive
 - 80 column printer

THAMES COMPUTER SERVICES
P.O. BOX 527 THAMES N.Z.
PH (0843) 86 893

A Division of James Electronics Ltd

DEALER ENQUIRIES
WELCOME

accidental or willful damage by other users.

Mainframe computer systems have long had to face these problems, but their solutions are not always appropriate for small computers.

Furthermore, not all multi-user micros available today provide even the most fundamental security measures.

Program-locking

Any multi-user system should have some form of record or program locking.

This means that only one user should be able to make changes to shared data at one time; otherwise, inconsistencies could develop.

Imagine, for example, a simple banking system in which a client has an account balance of \$1000. One teller wishes to process a deposit of \$200, while another has a check for \$50 to record. Each reads the current balance, \$1000; the first teller adds \$200 to it and stores the new balance of \$1200 onto the disk, while the other subtracts \$50 and stores \$950 — overwriting the first teller's work. Result: \$200 is "misplaced", and the bank loses one irate customer.

At the simplest level, a multi-user operating system could merely prohibit more than one user from running the accounts program at one time; this is called program locking.

A more sophisticated approach is record or file locking, in which the accounts program would simply lock the file or the individual record that it is using, allowing other users to run the same program on other data.

This is especially useful when someone has to process a long series of transactions in its entirety before allowing anyone else access to that information.

Unfortunately, this means that at every transaction, the system must check the status of the records in question; such complexities are open invitation to waste time, and some badly-written operating systems take full advantage of the opportunity.

Queuing

There are other system resources apart from the data that need sharing.

If two people want to use the printer, there must be some kind of queuing mechanism, and it should not freeze out the user while printing or waiting to print.

Ideally, the system should be multi-tasking as well as multi-user.

That means that one user should be able to run more than one task at a time; if a job does not require continuous human intervention (generating a report, for example), there should be some way

to shove it into the background and let it churn away unattended, while the user moves on to other tasks.

The other security issue is that of data integrity. Data can be damaged either by accident or by malice.

While the press gives much attention to the problem of "hackers", much more time and money are lost through inadvertent data loss, as anyone knows who has left a floppy disk to melt on the dashboard.

Safeguards

It may be true that no one can stop a determined "inside hacker" — a vengeful former employee, for example, who knows the system well. But most intruders do not fall into this category.

A simple password system will keep most of them out, and an equally simple count of unsuccessful attempts to log on will take care of nearly all the rest. It is surprising, however, how many multi-user systems lack even these elementary safeguards.

The most fundamental protection against accidental data loss is the ability to take back-up copies of both programs and data, and any decent computer system must provide a back-up utility.

If a problem occurs, the system can be restored to its status at the time that the back-up copy was taken; however, all work since then is lost. This is an important consideration for multi-user systems, especially those with sophisticated database operations with indices at several levels.

A power failure, a scratch on the disk or a bug in the database software could render huge swaths of data inaccessible.

In this case, the ability to restore only selected parts of a back-up would be useful, instead of forcing all users to surrender all work done since the last back-up.

Log file

In a multi-user environment, simple back-up copies are sometimes not enough.

Even if the entire system is backed up once a day, there is still the danger of several people losing as much as a full day's work, and particularly for businesses, this might not be acceptable.

A further refinement to the idea of back-up security is "transaction logging", where all transactions are written twice, once to their proper files and once to a special log file.

If even the data are destroyed and a back-up needs to be implemented, the log file can then be applied to the backup copy, and all of the day's work can thereby be recovered.



Transaction logging works, of course, only when the log file has not been destroyed along with the main body of data.

There is also the problem of efficiency. With logging, the computer must perform two operations instead of one, every time it wants to write something to disk.

The less efficiently-designed microcomputer operating systems cannot handle this extra load.

Popular systems

Until recently, to have more than one user on a computer you needed to purchase at least a "supermicro", a computer whose price tag made it resemble more a minicomputer than a micro.

But this is no longer true.

There are several operating systems now available that can support three or more users on a simple IBM PC/XT or compatible, and some can go even smaller than that.

In next month's Bits and Bytes we will consider the various operating systems as they would function on a simple, Intel 8088-based MS-DOS machine. They are judged accordingly to multi-user functionality, efficiency, ease of use, and the security issues outlined above.

Each will be evaluated both as an environment for writing programs and as a system for the end user who might not be very comfortable with computers.

Commodore gives you facts at your fingertips.

Easy to use and affordable, Commodore business systems are designed to handle information quickly, giving you, at the touch of a key, the facts you need to make sound business decisions.

Keep track of accounts . . .
analyse your sales
progress . . . monitor
stock levels . . .
predict cash flows
and costs.

Your information
under your
control, instantly.

Introduce yourself
to Commodore.

In a very
short time you'll
discover your Commodore
is one of the best business
friends you ever had.

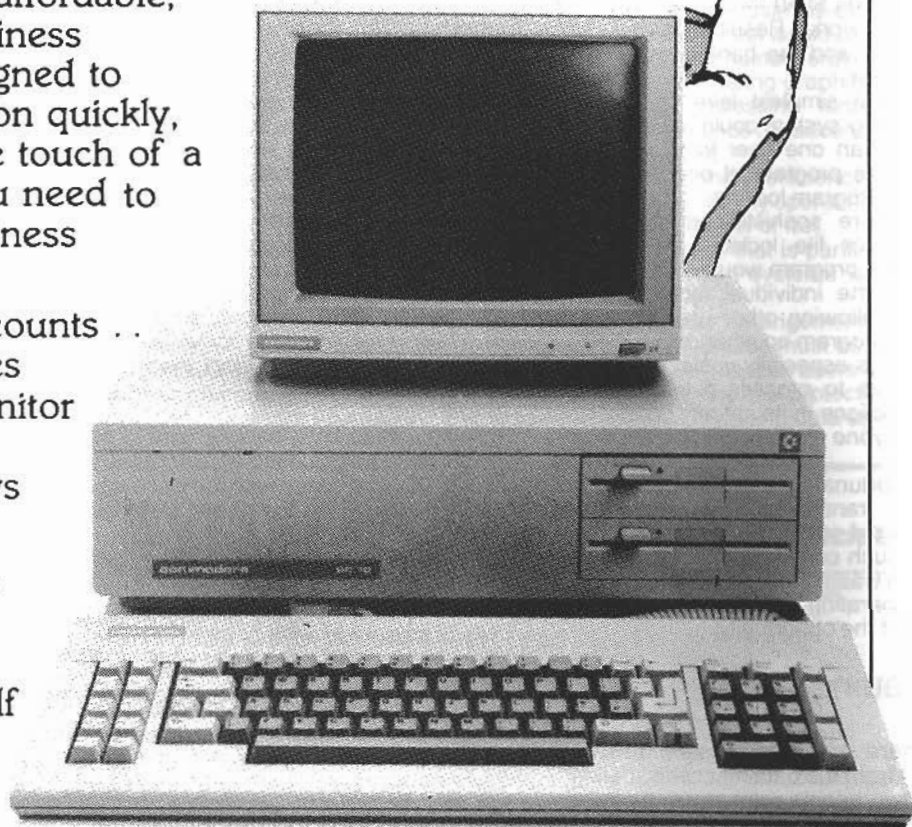

commodore PC
Businessman's best friend.

Teachers advise on computer buys

by Colin Marshall

Mid-1985 saw a group of 22 Auckland and Hamilton school teachers meet to discuss guidelines for schools' computer hardware purchases. They aimed to provide primary and intermediate schools with informed guidelines when making decisions on hardware purchases.

The result was a booklet entitled "Computers in Primary Schools", which was distributed to schools late last year.

It aimed to assist schools in the following considerations:

- 1) Why buy a computer for your school?
- 2) How to select software and hardware.
- 3) Organisation of equipment and programmes.
- 4) Ways to introduce equipment into schools.

The booklet was intended to be used in conjunction with the Department of Education's Computer Courseware Development Unit's "Newsletters".

Rather than recommending a particular computer or listing a recommended range of brands the focus was on the roles of computers in schools.

Why buy a computer?

In the school situation there is a wide range of situations in which computers are being used, for example: in administration, information management, computer assisted learning (CAL), simulations, word processing, remedial and extension exercises.

The intent of this section of the booklet was to help the individual focus on the objective of having school computers.

The overriding consideration is software availability.

There are some "beautiful" machines out there, but they are useless unless they have suitable programmes to run.

Selecting hardware, software

The booklet advises to look for software addressing specific needs. You should seek the advice of others using similar software.

View the software working, before purchase. In practical terms this means hiring programmes from dealers, for hands-on experience.

Every user should at least look at the "essential" option of word processing.

Most important is to disregard dealers' promises of certain programmes being available at a given time — especially if the programmes have not yet been released in New Zealand. Here we

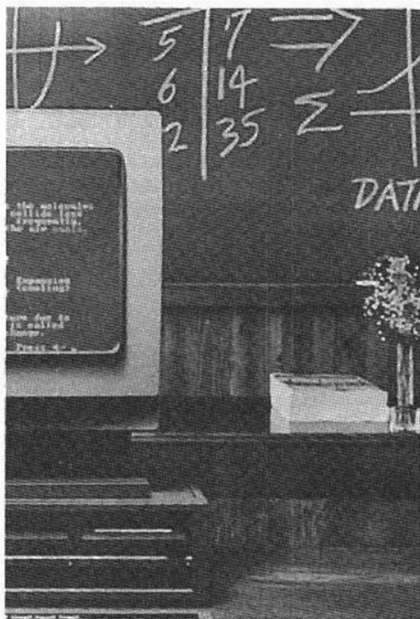

are subject to various delays in getting material from overseas, and often do not see locally the software advertised in overseas magazines.

The wide availability of software is the most important decision in purchasing a machine.

The one exception to this, mainly applicable to business users, is when a programme is required to be industry

specific.

Custom programming is not cheap, therefore teachers/parents should view software written for similar users, and talk to clients of the programmer involved.

Hardware.

"Computers in Primary Schools" suggests that schools look at the following as reasonable bases for buying a computer:

- 64K minimum memory,
- Quality colour monitor,
- Disk drive,
- Typewriter keyboard,
- Upper/lower case with descenders,
- Rugged, durable construction,
- Connectable to a printer,
- Good dealer service and support,
- Available software,
- Manuals with clear instructions,
- Colour and sound capability.

Software

Next the booklet suggests a series of questions that schools should ask suppliers of hardware — and to expect affirmative (yes) responses.

- Is there an established software base for the machine?
- Are you prepared to demonstrate your

(Continued on page 27)

OFFICE ELECTRONICS LTD

Your West Auckland agents for



SANYO

BUSINESS COMPUTERS

NEW PREMISES
4 Waipareira Ave
Henderson

NEW PHONES
837-1362
837-1363

Thanks for the memory!

The Commodore 128 It's here . . .



. . . and it's going to make a lot of people happy. A personal computer with a 128K memory and 80-column capability that's still compatible with all the peripherals and over 3000 programs designed for the Commodore 64.

In fact, the new C128 is three computers in one. That's because it can run as a C64, a C128 and in CP/M mode. Or it can even be expanded to a full 512K memory. And that's about as "personalised" as a personal computer can get.

"The company (Commodore) has gone to great lengths to produce a new, 'State of the Art' look while preserving compatibility with 64 software and hardware: a smart move since it provides the 128 with an instant base of thousands of software packages."

Personal Computing

"The 80-column display, 2 MHz microprocessor, 128K of memory (theoretically expandable to a megabyte), CP/M plus, and fast double-sided disk drive make the 128 a capable business machine, competitive with the much more expensive IBM and Apple computers."

Computer's Gazette

"Commodore deserves applause from all quarters of the industry for at last establishing compatibility within their range, yet producing a really exciting machine . . . It is also capable of running CP/M and well warrants the description of both home and small business computers."

Your Computer

"When you look at the C128, consider these factors: The wealth of existing software that is compatible with the C128 system in the areas of business, education and entertainment; The amount of that software taking full advantage of the sound and graphics features; The quality and extensiveness of its built-in BASIC; The cost of peripherals and hardware. Considering all it has to offer, the C128 is a personal computer that should make Apple cringe and IBM raise its eyebrows."

Run Magazine

Go to your nearest specialist Commodore dealer for information about the all new Commodore 128.

Commodore Computer (NZ) Ltd, P.O. Box 33-847, Takapuna, Auckland 9

(Continued from page 25)

hardware running the type of software that I am interested in?

- Who else have you sold this type of system to and can I contact them?
- What personnel have you that understand and can identify my specific needs?
- Is the computer able to use other languages?
- Is it also a word processor?
- Are the hardware manuals written in easy to read, everyday terms?

Personally I cannot stress enough the importance of having an informed dealer, whose interest goes beyond merely selling, and who is technically knowledgeable.

Dealer support

Good dealer support is more valuable than any 10% discount on machinery.

A second set of questions to ask dealers is as follows:

- Can he provide software for evaluation? (Some dealers will have demonstration packs that you can take home and try.)

- Does the computer brand have a history of maintaining software compatibility with machines to be built in the future?
- Who are the dealers that can support me near where I live?
- Is the hardware expandable?
- Are hardware prices stable or do they reduce as the hardware ages?
- How portable is the hardware?
- How easy is the system to set up?
- Can you plug the computer into other peripherals or specialist machinery?
- Do you have a trade policy if and when we wish to upgrade?

Other options

There are a number of other helpful hints:

- Consider renting a computer first.
- A second-hand system or an old computer lying around may be sufficient to do a specific job. (At Kohimarama Primary we have an old Commodore Pet used simply for keeping track of pupils' personal record cards.)
- Consider a printer a high priority purchase. The options with a printer are endless.
- Realise and recognise that computers are an on-going cost. The cost

does not stop with purchase. Once you have a computer you will think up new things for the computer to do...and the costs mount up — ask my school committee.

Security

There are two other considerations that are really self explanatory — security and protection of programmes and hardware.

These may seem obvious but a lot of people only plan for these problems after purchase.

The booklet contains other information, mainly specific to the education system, as well as a number of case studies of schools that have acquired computer systems.

This information was collated under the auspices of the Auckland Education Board and I feel the board has taken a worthy initiative in freely providing suggestions, advice and recommendations on computers for schools.

Advice like this, in such clear, direct and unbiased form, has been hard to come by.

PITMAN NEW ZEALAND

SAMS

THE BEST BOOK OF: FRAMEWORK



otherwise require significant time at the keyboard. For anyone who writes, works with numbers, or needs rapid access to store information. Allan Simpson.

\$45.00

BEST BOOK OF: SYMPHONY®

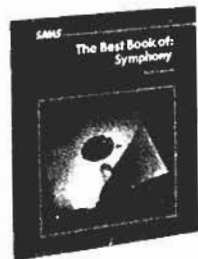

Symphony is a complete set of integrated application programs and therefore can be overwhelming to the first-time user. This book takes a feature-by-feature approach to explaining and demonstrating the full capabilities of the package. Alan Simpson. 256 pages

\$59.95

THE BEST BOOK OF: dBASE II/III



dBase II® and dBase III® have long been recognized as comprehensive data base management packages. But, they have also gained a reputation for being difficult to use. This book simplifies a very complicated product and allows you to get greater utility from this software. Ken Knecht. \$49.95

PITMAN PUBLISHING NEW ZEALAND
PO BOX 38-688
PETONE

SAVE THOUSANDS

olivetti
M24
BUSINESS PACKAGE

OPEN ACCESS
 software
 package
FREE



Look at what you get . . .

- 256K RAM
- 8086 CPU
- 8MHz clock
- IBM style keyboard
- Hi-Res green monitor
- Single 360K disk drive
- Parallel port
- Serial port

PLUS → **10 MEGABYTE HARD DISK DRIVE**

With the sheer speed of the Olivetti M24 and the power and performance of Open Access you'll make child's play of:

- **Spreadsheets** — 300 rows × 216 columns. 648,000 cell entries!
- **Information management** — relational database
- **Wordprocessing** — with graphics in text
- **Communications** — talk to the world or the computer on the next desk
- **Time management** — appointments, reminders, phone nos, note pad.
- **3-D graphics**

SUGGESTED RETAIL ~~\$12,595~~

\$9995

Cat X-5219

SAVE \$2600

NZ195/4

Dick Smith Electronics

COMPUTER CITY



- **AUCKLAND**
 Downtown
 Newmarket
 Papatoetoe
 Avondale
- **HAMILTON**
- **WELLINGTON**
- **LOWER HUTT**
- **CHRISTCHURCH**
- **DUNEDIN**

Cnr Fort & Commerce Sts, Ph: 38 9974
 98 Carlton Gore Rd, Ph: 54 7744
 26 East Tamaki Rd, Ph: 278 2355
 1795 Great North Rd, Ph: 88 6696
 450 Anglesea St, Ph: 39 4490
 154 Featherstone St, Ph: 73 9858
 440 Cuba St, Alicetown Ph: 66 2022
 Cnr Victoria St & Bealey Ave., Ph: 50 405
 Cnr Manse & Stafford Sts, Ph: 74 1096

DSXpress Mailorders -
 Dick Smith Electronics
 Private Bag, Newmarket.

(09) 54 9924

Terms available to approved personal applicants through



Want to know more about the Olivetti M24?
 Send for your **FREE** information pack. It's obligation free: no salesman will call.

Name:

Address:

..... phone

Drop into any Dick Smith Electronics store or send to DSXpress, Private Bag Newmarket, Auckland.

Hardware survey

Under-\$4000 microcomputers



This month our annual hardware survey commences with a line-up of computers retailing for less than \$4000.

Next month we look at the \$4000-and-over machines.

If the odd machine is missing from the ranks it's because its main distributor, despite repeated promptings, neglected to respond to the survey.

Others could be missing because their more workable configurations place them in the \$4000-and-over category.

The survey compilation was during December.



Acorn Electron

Processor: 6502, 2Mhz
 RAM: 32K
 ROM: 32K for OS, BASIC; 128K with Plus 1.
 Video RAM: No
 Keyboard: Full travel, 56 keys, no numeric. 10 programmable function keys.
 Video: RGB Colour, Video, VHF; 80 x 25 characters.
 Resolution: 640 x 256, 8 colours.
 Interfaces: Cassette
 Disk drives: —
 Other components: —
 Operating systems: Proprietary
 Languages: BBC BASIC
 Optional: Pascal, COMAL, Lisp, Forth
 Bundled software: Welcome Pack
 Prices: \$695.00
 Expansions: ROM/printer intfc \$249, disk unit 315K, 3.5" \$890
 Applications: Home/education

Interfaces: 2nd drive/printer/joystick/ stereo sound/data bus/centronics
 Disk drives: 1 x 3" fd inclusive, 380 Kb.
 Other components: Monitor/3" disc drive/1 system disc.
 Operating systems: Amsdos/CPM 2.2
 Languages: Basic and Logo
 Optional: Pascal/Fortran/Forth/C/ Cobol/CBASIC/Micro-Prolog...
 Bundled software: Dr Logo/CPM2.2 with utilities (ASM/ED/DDT, etc.)
 Prices: \$1495 (green screen), \$1895 (colour)
 Expansions: Printer \$695, 2nd drive \$595, RS 232 + software \$199.
 Applications: Games/educational/ programming/small business.

port/joystick/stereo sound.
 Disk drives: 2 optional drives, 3" fds of 380K each.
 Other components: Datacorder and monitor inclusive.
 Operating systems: Amsdos and CPM 2.2 with disc drive.
 Languages: Locomotive Basic
 Optional: Pascal/Forth/C/Logo/ Fortran/Cobol/CBASIC/ etc.
 Bundled software: Starter kit
 Prices: \$695 with green monitor, \$1095 with colour.
 Expansions: Speech synth/light pen/RS 232/printer.
 Applications: Games/educational/ small business.

Amstrad 664

Processor: Z80A, 4 Mhz.
 RAM: 64K
 ROM: 48K for OS, expandable to 8 Meg.
 Video RAM: Inclusive 16K
 Keyboard: Full travel, 77 keys, numeric and cursor pads, 10 function keys.
 Video: Monochrome or colour. 20/40 or 80 columns x 25 lines.
 Resolution: 160 x 200/320 x 200/640 x 200; 20 colours.

Amstrad CPC 464

Processor: Z80A, 4Mhz
 RAM: 64K
 ROM: 48K for OS, expandable to 8 Mb.
 Video RAM: Inclusive 16K
 Keyboard: Full travel, 77 keys, numeric pad, 10 function keys, cursor pad.
 Video: Colour or monochrome, 20/40 or 80 columns x 25 lines.
 Resolution: 160 x 200/320 x 200/640 x 200; 27 colours.
 Interfaces: Disc drive/centronics

Amstrad CPC 6128

Processor: Z80A, 4 Mhz
 RAM: 128Kb
 ROM: 48K for DOS, OS & Basic. Expandable to 8 Megs.
 Video RAM: 16K inclusive.
 Keyboard: Full travel, 77 keys, numeric and cursor pads, 10 function keys.
 Video: Colour or monochrome screen inclusive. 20/40 or 80 columns x 25 lines.
 Resolution: 160 x 200/320 x 200/640 x 200; 27 colours.
 Interfaces: Extra drive/centronics/ joystick/stereo/data bus.

(Continued 31)

(Continued from 29)

Disk drives: 1, optional 2nd drive, 3" fds of 380Kb.

Other components: Monitor and disc drive.

Operating systems: Amsdos/CP/M 2.2/CP/M Plus.

Languages: Basic and Logo

Optional: Pascal/Forth/c/Fortran/Cobol/C BASIC/Micro-PROLOG...

Bundled software: Dr Logo/CP/M2.2, CP/M Plus. All utilities (ASM/ED/DDT, ...)

Prices: \$1595 (green screen), \$1995 (colour)

Expansions: ALQ printer \$695, second drive \$595, RS 232 + Light Pen \$69, software \$199.

Applications: Business/games/education/programming.



Amstrad PCW 8256

Processor: Z80A, 4 Mhz

RAM: 256Kb

ROM: Kernal as boot loader.

Video RAM: 24K inclusive.

Keyboard: Full travel, 88 keys, numeric and cursor pads, 30 function keys.

Video: Monochrome, 90 characters x 32 lines.

Resolution: 720 x 256. Colours 27, if linked with separate colour monitor.

Interfaces: Centronics/bus.

Disk drives: 1 x 3" 380K fd.

Other components: Printer/monitor/disk drive all inclusive.

Operating systems: CP/M Plus/2.2 Mallard Basic/Locoscript.

Languages: Mallard Basic.

Optional: Forth/Pascal/c/Lisp/Prolog/Fortran/Cobol/CBasic/PL-2.

Bundled software: Loco Script, CP/M Plus + Mallard Basic/Locoscript

Prices: Keyboard/disc drive/NLQ printer/monitor \$2495.

Expansions: 1 Mb hard disc, RS 232, Serial Interface..

Applications: Business — typewriter alternative



Apple IIc

Processor: 65C02, 1 Mhz.

RAM: 128 Kb.

ROM: 16K for Basic Interpreter and System software.

Video RAM: Inclusive 1-8K in main RAM.

Keyboard: Full travel, 63 keys, no numeric pad, cursor

control keys.

Video: Colour, 80 columns x 24 lines.

Resolution: 192V x 560H, 16 colours.

Interfaces: RS 232 serial, centronics parallel.

Disk drives: 1-4, 5 1/4" or 3 1/2" fds, 140K or 800 Kb.

Other components: Optional printer.

Operating systems: ProDOS or UCSD P system or DOS 3.3.

Languages: Applesoft Basic.

Optional: Pascal, Logo, ProLog, Forth, Modula-2, Fortran.

Bundled software: Introductory software (self-paced instruction).

Prices: \$2923: CPU, monitor, monitor stand, single 5 1/4" disk drive.

Expansions: —

Applications: Business, education.

Apple IIe

Processor: 65C02, 1 Mhz.

RAM: 64 Kb, 1128 Kb max.(1.125 Mb).

ROM: 16 Kb for Basic Interpreter and System software.

Video RAM: 1 — 8K included in main RAM.

Keyboard: Full travel, 63 keys, no numeric pad, cursor control keys.

Video: Colour, 80 columns x 24 lines.

Resolution: 192V x 560H, 16 colours.

Interfaces: RS 232, serial, centronics parallel.

Disk drives: 1 to 8 5 1/4" or 3 1/2" fds, 140 Kb or 800 Kb.

Other components: Optional printer.

Operating systems: ProDOS or UCSD P system or DOS 3.3.

Languages: Applesoft Basic.

Optional: Pascal, Logo, ProLog, Forth, Modula-2, Fortran.

Bundled software: AppleWorks (word processor, spreadsheet, database) + Introductory (self-paced instruction).

Prices: \$3995: CPU, monitor, duo disk drive, 80 column card, AppleWorks software.

Expansions: —

Applications: Business, education.

Apple Macintosh

Processor: 32/16 bit Motorola 68000, 7.8336 Mhz.

RAM: 512K max.

ROM: 64K for device handling, standard user interface, operating system. Max. 128K.

Video RAM: 22K included in main RAM

Keyboard: Full travel, standard layout, 58 keys, optional numeric pad, software mapped.

Video: Monochrome. 3 to 42 lines, various columns, depending on font size selected.

Resolution: 512H x 342V. Black/white.

Interfaces: 2 x RS 232/RS 422, mouse port, sound (4 voices), disk port.

Disk drives: Up to 6. 3 1/2" floppy or fixed disk.

Other components: 9" & 15" dot-matrix printer, 300 DPI laser printer.

Operating systems: Proprietary, based on mouse-user interface, including graphics, fonts.

Languages: —

Optional: Pascal, Basic, Modula-2, C, Cobol, Neon, Forth, Prolog.

Bundled software: MacWrite Word Processor, MacPaint Graphics, Self-paced instruction tutorials.

Prices: \$6,735: CPU, monitor, 1 x 400K disk drive, keyboard, mouse, MacWrite/MacPaint software.

Expansions: Additional 20 MByte fixed disk, 400K floppy disk, 9" or 15" dot-matrix graphic printers, 300 DPI laser graphic printer.

Applications: Business.

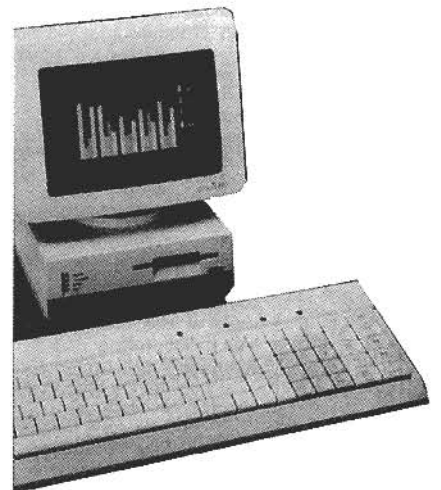

Apricot F1

Processor: 8086. 4.77 Mhz

RAM: 256K, 768 K max.

ROM: 32K for BIOS.

(Continued on page 33)



The new Amstrad Word processor-Typewriter appears to have upset our rivals.

Why spend huge amounts for an electric typewriter when for a third of the price, you can enjoy the unique advantages of a serious business word processor, typewriter and computer combination complete in one unit.

The sensational new Amstrad PCW8256. With 256K RAM, built-in disc drive, monitor, Locoscript word processing software, and complete CP/M Plus computer power, Amstrad will speed up the way in which the microcomputer takes away the drudgery of office routine. Simply, efficiently, completely.

(And the price will amaze you!)

The 82 key keyboard is specifically designed for wordprocessing. Its special function keys allow you to refer to "pull down" menus as you work, so you don't have to memorise complicated codes.

This simply means it's easy to use. And the PCW8256 has an integrated printer, with compatible software that gives you a choice of letter quality and high speed drafting capabilities.

(All for the price of an electric typewriter!)

With the 'user friendly' software of the PCW8256, word processing need be no more complicated than an

electric typewriter — although as you absorb more of the fundamentals and skills, then you can progress further to take advantage of some of the most powerful word processing software available anywhere.

And the price will amaze you — just \$2,495 complete. Nothing else comes near it.

From finger to keyboard to screen to disc and printer. One simple process, one plug, one amazing price.

Amstrad makes the rest obsolete. See it now at Amstrad stockists or clip the coupon for the full story.



**More than a wordprocessor
for less than a typewriter.**

I'd like to know more about the totally professional PCW8256 Word Processing Typewriter.

NAME: _____

ADDRESS: _____

POST TO: Grandstand Computers Ltd, CPO Box 2353 Auckland,
21 Great South Road, Newmarket, Auckland. Phone: 504-033

**PCW
8256 \$2,495**

**GRANDSTAND
AMSTRAD**

(Continued from page 31)

Video RAM: Inclusive.
 Keyboard: Full travel, 92 keys, numeric pad, 8 function keys.
 Video: Mono or colour. 80 characters x 25 lines.
 Resolution: 640 x 256, 320 x 256. 4 or 16 colours.
 Interfaces: Serial RS 232, centronics parallel.
 Disk drives: one fd, 3.5", 720Kb.
 Other components: —.
 Operating systems: MSDOS.
 Languages: GWBasic.
 Optional: All MSDOS.
 Bundled software: ASYNC Comms, Acitivity, Utilities
 Prices: \$3895 for processor, keyboard, software.
 Expansions: —.
 Applications: Business/education.



Aquarius

Processor: 280A, 3.579 Mhz
 RAM: 4K, 34K max.
 ROM: 10K for Basic, OS & character set.
 Video RAM: Inclusive 2K.
 Keyboard: Rubber, 49 keys, no numeric pad. Single key function entry.
 Video: Colour RF output. 40 characters x 24 lines.
 Resolution: 80 x 72. 16 colours.
 Interfaces: Cassette port, printer/serial port, cartridge slot.
 Disk drives: —
 Other components: Printer, cassette recorder, ROM cartridges optional.
 Operating systems: Basic
 Languages: Basic
 Optional: Logo
 Bundled software: None
 Prices: \$99, including power supply and manuals.
 Expansions: ROM cartridge slots and paddles.
 Applications: Home.

Atari 130 XE

Processor: 6502, 2 Mhz.
 RAM: 128K.
 ROM: 24K for Basic & OS.
 Video RAM: Inclusive.



Keyboard: Full travel, 62 keys. Numeric pad optional. 6 function keys.
 Video: Mono or colour. 40 character x 24 lines.
 Resolution: 320 x 192; 256 colours.
 Interfaces: Atari serial. TV RF. 2 joystick ports.
 Disk drives: Fd 5 1/4", 127 Kb. Optional.
 Other components: Optional.
 Operating systems: Atari.
 Languages: Basic.
 Optional: See 800 XL.
 Bundled software: —
 Prices: \$659.
 Expansions: —
 Applications: —

Atari 800 XL

Processor: 6502. 2 Mhz.
 RAM: 64K.
 ROM: 24K for Basic & OS.
 Video RAM: Inclusive.
 Keyboard: Full travel, 62 keys. No numeric pad. 6 function keys.
 Video: Mono and colour. 40 characters x 24 lines.
 Resolution: 320 x 192. 256 colours.
 Interfaces: Atari serial, TV RF, 2 joystick ports. ROM cartridge slot.
 Disk drives: Optional. 5 1/4" fd, 127 Kb.
 Other components: Printer, plotter, touch tablet, datasette, lightpen. All optional.
 Operating systems: Atari.
 Languages: Basic.
 Optional: Logo, Pilot, C Forth, Action, Assembler, Pascal, Lisp, Microsoft Basic.
 Bundled software: —
 Prices: \$439.
 Expansions: Disc drives.
 Applications: Home.

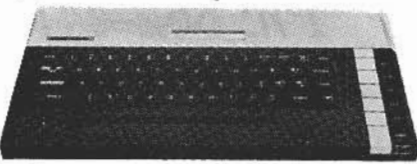

BBC Micro. Model B

Processor: 6502. 2 Mhz.
 RAM: 32K. B-Plus has 128K board.
 ROM: 32K for Basic & OS. Maximum 16 x 16K ROMs.
 Video RAM: Inclusive.
 Keyboard: Full travel, 73 keys, no numeric pad. 10 function keys plus four cursor controls.
 Video: RGB, PAL & RF. 80 or 40 columns x 24 or 32 lines.
 Resolution: 640 x 256. To 16 colours.
 Interfaces: Parallel printer, user port, 1 Mhz bus, Tube, RS 423, cassette, video.
 Disk drives: Up to 4 fds plus hd. 3 1/2" or 5 1/4". Max. fd is 800K. Hd is 96 Mb.
 Other components: Optional.
 Operating systems: Acorn.
 Languages: Basic.
 Optional: Lisp, Forth, Logo, Pascal, BCPL, Cobol, Fortran, Microprolog, C.

Bundled software: Welcome disc — 3 programmes.
 Prices: \$1295.
 Expansions: \$1495 with disc drive interface. BBC-Plus (64K) \$1939.
 Applications: Home, education, business.

Cat Computer

Processor: 6502A. 2 Mhz.
 RAM: 64 K.
 ROM: 32K for OS, language & inbuilt terminal s'ware.
 Video RAM: Inclusive.
 Keyboard: Full travel, 81 keys, 8 (x3) function keys, numeric pad, cursors, rubout etc.
 Video: RGB (with colour defeat) and optional RF adaptor. 40 or 80 columns x 24 lines.
 Resolution: 560 x 192 (6 colours), 280 x 192 bit image graphics (8 colours).
 Interfaces: Cassette, joysticks, printer, RS 232, disc drive, video, RGB.
 Disk drives: Optional 5 1/4" fds of 140Kb.
 Other components: Optional.
 Operating systems: Apple DOS 3.3.
 Languages: Microsoft Basic Extended.
 Optional: Apple Basic, Pascal, Logo.
 Bundled software: None.

(Continued 35)

Pacific Computers

(Retail Division of Parsonage Electronics)

16 bit IBM PC/XT COMPATIBLE COMPUTER

ONLY \$2,400⁰⁰

Including:

- ★ High Resolution Green or Amber Monitor
- ★ Two 360K disk drives 256K Ram fitted
- ★ Parallel Printer Port
- ★ Graphics Display board
- ★ 12 months warranty (parts & labour)
- ★ We can supply many add-on cards

Full customer support:

Sales: Printers, Software and Expansion cards

Service: All I.B.M. compatibles serviced

Training: A range of seminars will be advertised

RETAIL SHOWROOM: *60 Ti Rakau Drive,
Pakuranga
Ph: 562-441*

MAIL ENQUIRIES: *P.O. Box 54-069, Bucklands Beach
Auckland*

(Continued from page 33)

Prices: Cat, single drive, green screen plus software \$1995.

Expansions: Optional.

Applications: Business, education, home.

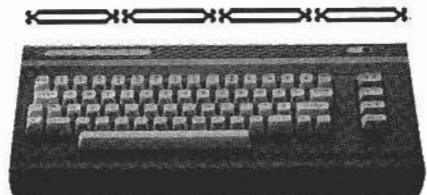
**Commodore C16**

Processor: 7501, .89 - 1.76 Mhz.

RAM: 16K, to 64K max.

ROM: 32K for Operating system and Basic interpreter.

Video RAM: Inclusive.

Keyboard: Full travel, 66 keys, no numeric pad, 8 function keys plus Help, Escape.

Video: None standard. Display is 40 columns, x 25 lines.

Resolution: 320 x 200, 160 x 200. 121 colours.

Interfaces: Serial, 2 joysticks, cartridge, monitor o/p, RF, cassette.

Disk drives: Optional. 5 1/4". 170 Kb.

Other components: Optional.

Operating systems: CBM Kernal.

Languages: BASIC 3.5.

Optional: —

Bundled software: —

Prices: \$295.

Expansions: Optional.

Applications: Games, education.

Commodore C64

Processor: 6510. 0.89 to 1.76 Mhz.

RAM: 64K, 38K random.

ROM: 20K, for Operating systems and Basic interpreter.

Video RAM: Inclusive.

Keyboard: Full travel, 66 keys, numeric pad optional. 8 function keys.

Video: None standard. Displays 40 columns x 25 lines.

Resolution: 320 x 200, 160 x 200. 16 colours.

Interfaces: RS232C, serial, cartridge, 2 joysticks, datasette, monitor, RF.

Disk drives: Optional, 5 1/4" fds, 170Kb.

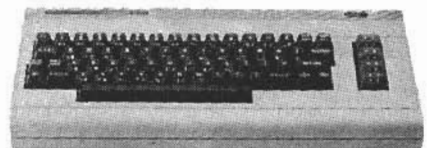

Other components: Optional printers, datasette, joystick, modem, lightpen.

Operating systems: CBM.

Languages: BASIC.

Optional: Pascal, Logo, Assembler, Cp/m.

Bundled software: —

Prices: \$495.

Expansions: —

Applications: Games/education/small business.

**Commodore C128**

Processor: 8502, 6510, 280A. 1 — 4 Mhz.

RAM: 128K. 512K max.

ROM: 48K for OS, character sets, language.

Video RAM: Inclusive.

Keyboard: Full travel, 92 keys, numeric pad, 8 function keys and 6 cursor keys. Help key, 40/80 column key, no scroll and more.

Video: None standard. 128 mode — 40 or 80 columns.

Resolution: 160 x 200 min, 640 x 200 max.

Interfaces: User cassette, RF, audio, monitor, RGB Serial, 2 joystick, cartridge.

Disk drives: Optional, up to five 5 1/4" fds, 360 Kbs.

Other components: Printers, datasette, joystick, modem optional.

Operating systems: CBM & CP/M.

Languages: BASIC 7.0, BASIC 2.0, Machine Code Monitor.

Optional: —

Bundled software: —

Prices: \$995.

Expansions: —

Applications: Business/games/education.

Commodore Plus 4

Processor: 7501, 0.89 - 1.76 Mhz.

RAM: 64K.

ROM: 32K for OS and Basic interpreter.

Video RAM: Inclusive.

Keyboard: Full travel, 66 keys, no numeric pad, 8 function

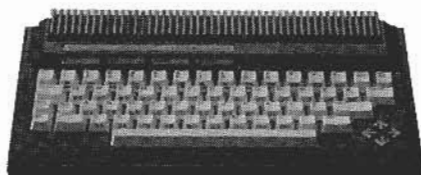

keys and Help, Escape, separate cursors.

Video: None standard. 40 columns, x 25 lines.

Resolution: 320 x 200, 160 x 200. 121 colours.

Interfaces: Serial, User Port, 2 x joystick, cartridge, monitor, RF, cassette.

Disk drives: Optional. 5 1/4". 170 Kb.

Other components: Printers, datasette, joysticks optional.

Operating systems: CBM.

Languages: BASIC 3.5.

Optional: —

Bundled software: —

Graphics, spreadsheet, word processing, file management.

Prices: \$495.

Expansions: —

Applications: Business, education.

**Commodore SX64**

Processor: 6510. 0.89 to 1.76.

RAM: 64K, 38K random.

ROM: 20K for OS and BASIC interpreter.

Video RAM: Inclusive.

Keyboard: Full travel, 66 keys, no numeric pad, 4 (x2) function keys.

Video: Colour. 40 columns x 25 lines.

Resolution: 320 x 200, 160 x 200. 16 colours.

Interfaces: RS 232, serial, cartridge, joysticks.

Disk drives: Standard 1 x 5 1/4" fd of 170 Kb.

Other components: Printers, joysticks, modems optional.

Operating systems: CBM.

Languages: BASIC.

Optional: Pascal, Logo, Assembler, CP/M.

Bundled software: —

The Manager, Easy Script, Easy Mail, Disk Bonus Pack. No charge — W/P, Database.

Prices: \$2295.

Expansions: —

Applications: Education, small business.

(Continued on page 37)

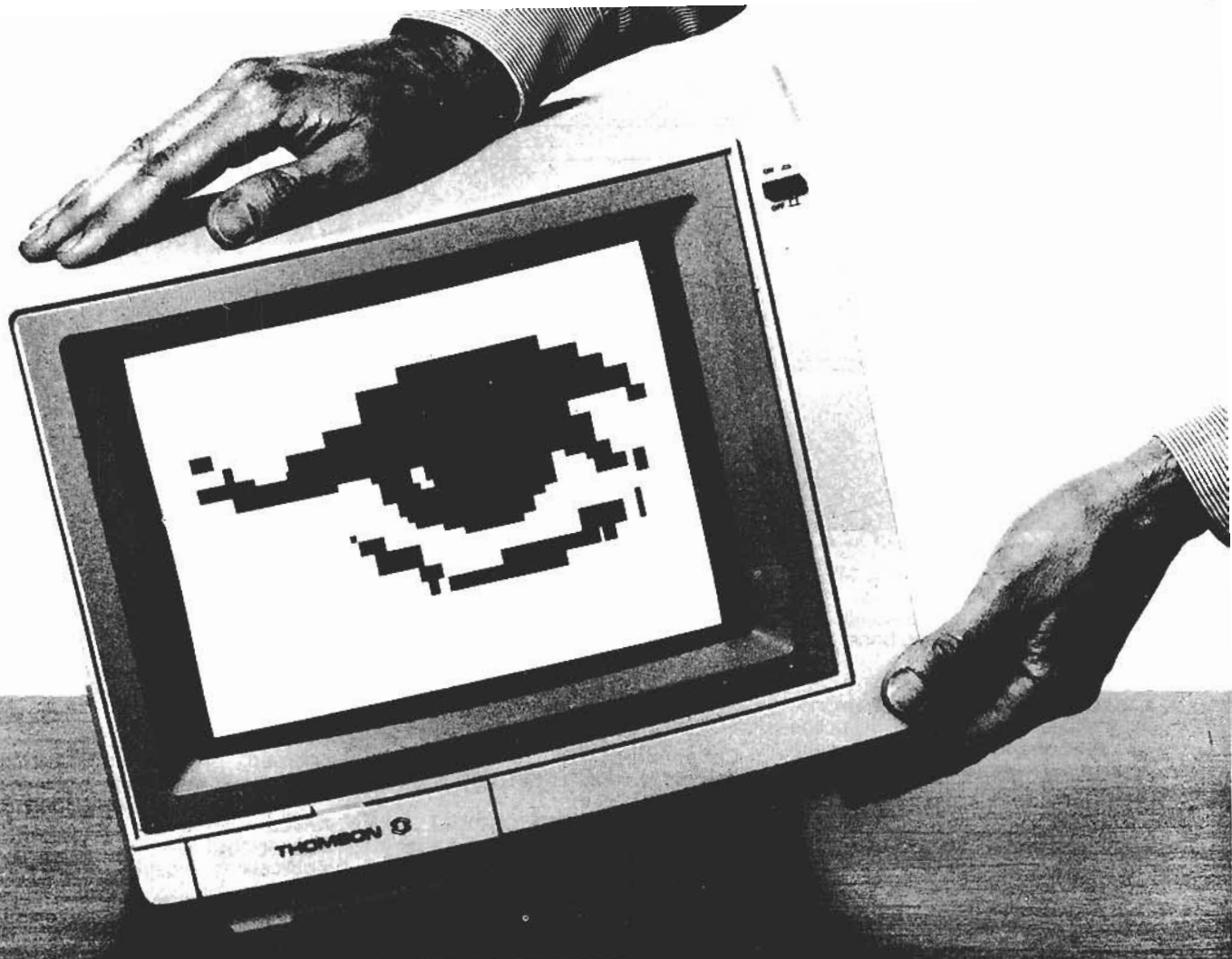

A sight for sore eyes.

THOMSON

For all of us who stare at PC monitors, blessed relief has arrived. From the \$6 billion corporation that is changing the way the world looks at computers, comes the European-designed Thomson range of monitors. Designed for IBM, Commodore, Apple . . .

Thomson flat-faced monochrome monitors are based on exciting new technology. The unequalled 35MHz bandwidth gives sharp, crisp characters across the entire display. And the price won't make your eyes water either.

Thomson RGB colour monitors feature a finer dot pitch to ensure clear characters.

Without blurring. Without shadows.

Without coloured edges. And a switch to select full colour, green or amber display.

Thomson picture quality reduces eye fatigue, makes your computer hours easier, more productive. Make the comparison now.

The full family of Thomson monitors are available through the Commodore dealer network, Powercorp, Businessworld . . . Indeed, any dealer with an eye to the finer points.

New Zealand Distributor and Service Centre:

CONTROL

P.O. Box 68-474, AUCKLAND, N.Z. TELEX NZ 61102 'DATASYS'
45 NORMANBY ROAD, MT EDEN, AUCKLAND 3. PH (09) 600-687.

(Continued from page 35)

DSE-Multitech

Processor: 8088. 4.77 Mhz.
 RAM: 128 K and 256K versions. Max. 512K.
 ROM: 8K for Bios and diagnostics. Optional max. 32K..
 Video RAM: Inclusive.
 Keyboard: Full travel, 84 keys, 12 key numeric pad, 10 function keys.
 Video: Mono, colour, RGB. 80 or 40 columns x 25 lines.
 Resolution: 640 x 200, 320 x 200. 16 colours.
 Interfaces: Parallel, centronics, RS 232 serial, joystick port, clock.
 Disk drives: One or dual fds of 360Kb, 5 1/4". Hard disc 10Mb.
 Other components: Optional
 Operating systems: MS-DOS 2.11.
 Languages: As for IBM.
 Optional: —
 Bundled software: Easyword.
 Prices: \$1995 for 128K ram, single disc; \$2495 — 256K ram dual fd; \$3995 — 512K ram 10Mb hd version.
 Expansions: As above.
 Applications: Home, education, business.



Epson PX8

Processor: Z80
 RAM: 64 Kb. Extra 120K as Ram disk.
 ROM: Max. 64Kb for extra software..
 Video RAM: 6Kb.
 Keyboard: Full travel, 72 keys, numeric pad, 5 function keys and extra edit keys.
 Video: Flip-up LCD. 80 columns x 8.
 Resolution: 480 x 64.
 Interfaces: RS 232, Serial (2 interfaces).
 Disk drives: Optional dual 5 1/4" 320K each, mains; or 1 x 3 1/2" 320K, battery..
 Other components: Real time clock, microcassette incl.

Operating systems: CP/M.
 Languages: Microsoft Basic.
 Optional: —
 Bundled software: CP/M, Basic, Wordstar, Portable calc, Scheduler, CP/M utilities.
 Prices: \$2377 + \$238 for above software.
 Expansions: Printer \$900; disc unit (120K) \$1000.
 Applications: Business-in-field.

HCP 1000 (IBM clone by TSE, Taiwan)

Processor: 8088, 4.77 Mhz.
 RAM: 256K; max. 640K.
 ROM: 8K for Bios; max. 128K.
 Video RAM: Inclusive.
 Keyboard: Full travel, 86 keys, numeric pad, 10 function keys, edit keys.
 Video: Monochrome (standard) or colour, 80 columns x 25 lines.
 Resolution: 16 colours, 600 x 300; mono 720 x 346.
 Interfaces: Parallel port std, optional serial ports.
 Disk drives: 2 x 5 1/4" fds, 360K each.
 Other components: None standard, printer optional.
 Operating systems: MS-DOS, PC-DOS.
 Languages: As for IBM.
 Optional: —
 Bundled software: None.
 Prices: 256K RAM computer, 2 fds, mono screen, keyboard \$2400. 10Mb hard disc \$2500.
 Expansions: —
 Applications: Business.

Kaypro 2X

Processor: Z80, 4 Mhz.
 RAM: 64K.
 ROM: 2K, bootstrap.
 Video RAM: Inclusive.
 Keyboard: Full travel, 72 keys, numeric pad, 18 function keys, cursor keys.
 Video: Monochrome (green) built-in, 80 columns x 25 lines.
 Resolution: 100 x 160. Monochrome.
 Interfaces: Serial, parallel.
 Disk drives: Two 5 1/4", 400K each, fds..
 Other components: Optional.
 Operating systems: CP/M 2.2.
 Languages: MBasic.
 Optional: Most CP/M languages.
 Bundled software: Wordstar, Mailmerge, Calcstar, Infostar,

MBasic.
 Prices: \$3995.00 for all above.
 Expansions: —
 Applications: Business & word processing.

Microbee

Processor: Z80A, 3.375 Mhz.
 RAM: 64K; max. 128K.
 ROM: Up to 80K on PC85 firmware. 4K character set.
 Video RAM: 4K.
 Keyboard: 60 key full travel. No function keys or numeric pad. Edit keys.
 Video: Amber mono, TV. 64 to 80 columns x 16 to 24 lines.
 Resolution: 512 x 526. Colour option.
 Interfaces: Programmable 8-bit I/O, parallel, RS 232, cassette, video.
 Disk drives: 3 1/2", 400K single/dual fds. 10 Mg hd option.
 Other components: Optional.
 Operating systems: CP/M 2.2.
 Languages: CP/M options; Microsoft Basic, Turbo Pascal...
 Optional: As above.
 Bundled software: None.
 Prices: 64K 1-drive \$1750.
 Expansions: As above.
 Applications: Australian-sourced educational programmes, and small business.



Poly 2 Learning System

Processor: 6809/Z80A dual. 4 Mhz.
 RAM: 128 Kbyte.
 ROM: 20 Kbyte for Basic O system..
 Video RAM: Inclusive.
 Keyboard: Full travel, 72 keys, numeric pad, editing keys.
 Video: Colour. 40, 60 and 80 columns x 24 lines.
 Resolution: 240 x 204, 480 x 204.
 Interfaces: Centronics standard, RS 232 C optional.

(Continued 44)

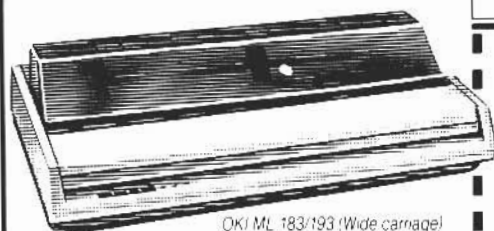
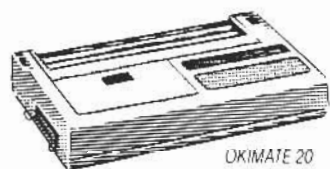

OKI provides a complete range of printers.
Compact, lightweight and exceptionally quiet.

A colour printing option.
Apple, IBM and Commodore compatibility.
Optional cut-sheet feeders for word-processing.
Not suitable for graffiti.

AWA New Zealand Limited

Data Systems Division
Head Office P.O. Box 50-248 Porirua

AUCKLAND
P.O. Box 1363
(09)760-129

WELLINGTON
P.O. Box 830
(04)851-279

CHRISTCHURCH
P.O. Box 32054
(03)890-449

New Zealand's Most Switched-On Company.

I'm interested. My requirements are as follows: (please tick)

	Yes	No
Word processing	<input type="checkbox"/>	<input type="checkbox"/>
Colour	<input type="checkbox"/>	<input type="checkbox"/>
Hi speed	<input type="checkbox"/>	<input type="checkbox"/>
Low speed	<input type="checkbox"/>	<input type="checkbox"/>
Wide carriage	<input type="checkbox"/>	<input type="checkbox"/>
Narrow carriage	<input type="checkbox"/>	<input type="checkbox"/>

Name: _____

Address: _____

phone: _____



PROMOTUS 3352-2

INDEX TO BITS & BYTES

Volume Three: Sept. '84 — Aug. '85

The following index to the third volume of Bits and Bytes alphabetically lists topics with their issue number first and then the page number.

For example, accounting packages are in issue number 8, beginning on page 31.

The key to Volume Three issue numbers is as follows:

1984: September's issue is No. 1, October #2, November #3, December #4.

1985: January/February #5, March #6, April #7, May #8, June #9, July #10, August #11.

Back issues are still available — simply send an order to the publisher with enclosed payment of \$2.00 per issue.

Our thanks to Gerald Fowler, a long-time subscriber to Bits and Bytes and professional indexer, who prepared this index.

Previous indexes are in earlier February issues.

a

accounting, packages, 8:31
small business, 11:29

Acorn Electron, 3:17
LOGO, 5:67
Olivetti and, 7:73
Pascal, 5:67
spreadsheet, 5:67
viewsheet, 5:67

ACT Apricot, 4:16; 7:42

Actrix Portable, 4:16

addressing, indexed, 11:47

ADFS, 6:63

adventure story, Twist-a-Plot, 11:33

Aeroplane, drawing grid, 4:60

Alphabet, Elephant, 1:42

alphabetical arrangement, program, 8:47

amateur radio, contest log keeping, 11:36

Amstrad CPC464/664, 7:32; 11:21

anagrams, 4:57

Andas, 2:20

Apple, ASCII organ, 10:48
biorhythm program, 6:46
drawing with, 4:67
Easy LOGO, 11:33
LOGO, Easy, 11:33
Macintosh, 5:16
ProDOS, 11:67
products, 5:66
profile, 10mgB, 8:40
Sandy, 6:54
Scribe, 7:70
10mgB profile, 8:40
IIC, 4:41; 5:66
2e, 2:20
Video Viper, 5:65
Writer II, word processing, 1:57

AppleWorks, 2:44; 8:40

Apricot, 4:16; 5:25; 7:42

ASCII organ, 10:48

assemblers, 1:70

Atari, clubs, 4:82
DOS, 11:43
400, 3:17
games, 1:60; 3:61

products, 7:81
1027 printer, 2:57
XL series, 3:20

Atariwriter, 7:81

Atmos, 3:20

authoring language, 7:73

auto-run routines, 4:70

b

banking systems, 2:19

BASIC, BBC, 4:77
calculating and, 11:46
Commodore and, 11:62
GRAPHICS, 3:62
IBM PC and, 5:61
indirection operators and, 1:61
machine language and, 9:50
programs, protection of, 11:55
ROM, Spectrum ZX, 2:61
Spectravideo, 7:76
Spectrum and, 6:64
VIC and, 1:53

BBC, authoring language and, 7:73
BASIC, 4:77
Beta-Base, 7:75
CAI languages, 8:49
Christmas carol, 4:62
graphics, 3:62
indirection operators, 1:61
keys for keywords, 6:50
languages and, 4:77; 5:67
mice and, 9:55
networks, 5:67
options, 6:63
Oxford Pascal, 8:50
products, 5:67
vision and, 11:57

BC Micro, Speech Synth, 11:24

Beeb, *see* BBC

benchmarks, 5:62; 6:56

Beta-Base, 7:75

Beta Basic, program, 3:66

biorhythms, Apple program, 6:46

BMC 800 Model 10, 4:20

boards, single, 6:29

Bondwell, 5:25; 11:18

book reviews, Acorn guide to Electron, 3:71
animation and art, 6:70
Apple II program, 3:71
Logo
programming, 8:53;
11:69
art and animation, 6:70
BASIC 3:72; 5:72; 6:69;
9:68; 10:61
BBC disk systems, 3:71
color, TRS-80, 7:83
colour Logo, 6:70
Commodore 64 BASIC, 5:72
computers, without
jargon, 1:72
data processing, 8:54
disk systems, for BBC, 3:71
educational games, 3:71
Electron, 3:71
games, 3:71, 4:85
graphics, 2:71; 4:85;
10:61
interfacing, 6:69
Logo colour, 6:70
programming,
8:53; 11:69
Lotus 1-2-3, 4:87
microcomputers, 5:71
microelectronics, 11:68
programming, 2:72;
3:71, 72; 8:53
Radio Shack colour
Logo, 6:70
RS-232, 7:82
Sinclair Spectrum, 4:85
Spectravideo and
BASIC, 10:61
technicians, 11:68
TRS-80, 1:71; 2:72; 7:83
VIC-20, 1:71; 2:71, 72;
4:88; 5:72
VisiCalc, 5:71
word processing on
TRS-80, 1:71

(Continued on page 40)

Z80, 2:71; 8:82
 books, reference, for teachers, 1:32
 VIC user, 3:60
 bridge deal, 9:47
 Brother HR-5 printer, 1:66
 bulletin boards, 7:28
 business, buying for, 4:16
 programs, 7:65
 small, accounting, 11:29
 software, 1:45
 buyer's guide, 3:14-33; 4:16-35; 5:15-28

C

CAI, languages, 8:49
 tutorial, 7:73
 calculating, BASIC and, 11:46
 Canon AS-100, 5:16
 capital, information and, 8:38
 carols, BBC, 4:62
 Cartesian graphics, 1:34
 CashLink, 11:29
 Casio, FP 1000, 4:20
 FP 6000S, 5:16
 FP 6016S, 9:24
 cassettes, liners, 6:38
 software magazine, 9:65
 CBS software, Muppet Learning Keys, 11:59
 Centronics, H136/H80, 10:17
 351/354/357/358, 10:23-24
 Challenger, Dick Smith, 4:22
 characters, enlarged, 4:64
 single keyboard in programs, 2:50
 children, Elephant Alphabet for, 1:42
 handicapped, 1:28
 programs for, 8:46
 Children's Television Workshop, Muppet Learning Keys, 11:59
 Chinese word processor, 7:54
 Christmas carol, 4:62
 C.ltoh, A 10 Series, 10:26
 C1300, 9:26
 C1350 Series, 10:23
 C1600, 9:26
 F10, 10:28
 M8510B Series, 10:17
 Y10 Series, 10:26
 1550B Series, 10:17
 1550S/SC Series, 10:22
 1570SC Series, 10:22
 7500 Series, 10:14
 8510S/SC Series, 10:17
 clocks, digital, Spectravideo, 4:66
 Clubfile, 1:64
 clubs, Atari, 4:82
 codes, machine, 5:68; 8:50
 colour, Commodore 64 and, 4:64
 Moire pattern and, 1:35
 Commodore, BASIC and, 1:53; 11:62
 CBM, 4:20
 Compuserve database, 11:60
 C16, 5:33; 7:67
 DPS1101, 10:26
 Manager, 7:67
 MPS-802/803, 9:16
 Muppet Learning Keys,

11:59
 PC 10, 10:35
 Plus 4, 7:67; 8:18
 products, 6:58
 SX-64, 4:22
 tricks, 8:45
 VIC-20, 3:30
 64, colours with, 4:64
 C128, 10:60
 data statement and machine language, 7:68
 drawing sprites, 9:61
 games with, 4:69
 Handic, 5:56
 machine language and data statement, 7:68
 1985 developments, 5:54
 pictures, moving, 10:56
 sprites, 8:42; 9:61; 10:56
 Star load, 6:48
 user groups, 3:55
 word processing on, 1:52
 6400, 10:28
 8023P, 9:20
 8024, 9:24

compatibles, *see* IBM
 Compuserve, database, 11:60
 Computer Education Society, NZ, 2:42
 computers, buying, 7:57
 changing, 9:51
 conversion, decimal, 4:63
 programs, 1:33
 copying, programs, 1:50
 Corona, 5:17
 C programming language, 7:77
 Cromemco C-10, 4:22
 crossword puzzles, 4:57
 C 64, *see* Commodore 64
 C-16, VIC-20 and, 3:56
 CTI CPA80, 9:16
 cursor, movement, 2:51
 C128, Commodore 64, 10:60

d

data, communications, 9:41
 files, Microsoft BASIC, 5:61
 sorting out, 3:54
 statement, machine language and, 7:68
 Databank, Delphi and, 6:29
 databases, 2:44; 9:42
 Compuserve, 11:60
 ENBase, 3:69
 management, 3:50; 4:50
 manager, Beta-Base, 7:75
 relational, 3:69
 Dataproducts DP20/35Q/55SQ, 10:28-29
 DP8020/8050/8070, 9:24, 26, 28
 dBASE II, 1:18
 decimal conversions, 4:63
 Delphi, single board, 6:29

DFC FOLIO, 2:19
 Dick Smith Challenger, 4:22
 VZ200, 3:21
 Digital, 5:17
 digitising, images, 5:65
 disks, driving, 10:53
 games from tape, 1:70
 information and, 6:66
 training and video, 6:63
 trouble with, 6:53
 video and training, 6:63
 word usage, 6:51
 DOS, 1:70; 5:53; 7:80
 Apple ProDOS, 11:67
 Atari, 11:43
 TRS 80, 11:65
 drawing, aeroplane grid, 4:60
 Apple, 4:67
 see also images
 joystick and, 4:56
 pattern, 4:56
 see also pictures
 program, 11:42
 programs, 4:56
 Sega Aeroplane, 4:60
 Sega, 4:56
 Sega, patterns, 4:63
 Spectravideo and, 4:79
 sprites, 9:61
 tapes and, 4:56
 drives, micro-, 10:37
 driving disks, 10:53

e

Eaca Colour Genie, 3:22
 Eagle, 5:17
 Eaglet EP, 10:14, 18
 Easy LOGO, 11:33
 education, 7:60
 computer, 1:30
 Otakou Software package, 11:32
 programs, 8:46
 software for, 8:35
 EFT-POS, 8:16
 Electron, languages and, 4:77
 options, 6:63
 Elephant Alphabet, 1:42
 ENBase, 3:69
 environment, windowing, 1:12; 2:15
 Epson, FX100, 9:25
 FX80+, 9:20
 HX-20, 3:22
 JX80, 9:25
 LO1500, 9:28
 PX-8, 4:24
 QX-10, 4:24
 RX100, 9:20
 RX80, 9:16, 20
 expansion options, hardware, 1:54

f

farmers, Farmfax system for, 1:56
 FileVision, 8:28
 filing systems, 1:64; 6:60, 63
 FOLIO, DFC, 2:19

Forge, Progeni, 3:49
 Fourier analysis, 1:41
 Fourth Generation learning, 3:49
 frames, word, 6:32
 Framework, 6:31; 7:53
 Franklin Ace 1000, 4:26
 Fujitsu DPL24, 10:22
 SP320, 10:28,29

g

games, Actavision, 3:62; 4:82
 anagrams, 4:57
 Apple, 4:59
 Apple Panic, 4:73
 arcade, 5:64
 Artillery, 6:43
 Asteroid Field, 4:55
 Astroblitz, 4:37
 Atari, 1:60; 3:61,62; 4:55,82;
 5:64; 6:67; 9:66; 10:47
 Atic Atac, 2:59
 BBC, 4:54
 BC's Quest for Tires, 3:61
 Bear Bovver, 1:64
 Blue Max, 9:66
 bridge, 9:47
 Bruce Lee, 9:60
 Buck Rogers, 10:47
 car race, 3:56
 CAT, 6:34
 cheaper, 5:56
 Chiller, 9:60
 Choplifter, 4:73
 Commodore, 4:58,60,63,69;
 9:58-60; 11:44
 crossword puzzles, 4:57
 Cuddly Cubert, 4:70
 Death Duel, 4:59
 Death Maze, 1:33
 Dice, 1:35
 Dig Dug, 2:48
 Dodge, 4:62
 Donkey Kong, 2:48
 Evolution, 4:70
 Four in a Row, 11:42
 Hand-held, 6:43
 Horse Race, 4:63
 Jetpac, 2:58
 Joust, 5:64
 Jungle Hunt, 2:57
 Kaboom, 4:82
 Killer Watt, 4:69
 King Solomon's Mines, 4:69
 Life Saver, 6:34
 Lineblaster, 1:44
 Loco, 4:69
 Lunar entry module, 4:57
 Lunar Jetman, 2:58
 Machine Gun, 4:60
 machine language, 2:56
 Mastermind, 1:36
 Meteor Smash, 1:42
 Microsoft, 10:58
 Minotaur's Maze, 7:64
 Monaco, 3:62; 4:82; 5:64
 Moon Patrol, 11:41
 Mystery of Munroe Manor, 4:69
 NATO Command, 6:67

Ninja, 4:79
 number guessing, 6:42
 Pengo, 7:81
 Pie Man, 11:44
 Pieman, 4:82
 Pit Stop, 3:56
 Planet Zoom, 10:47
 Pole Position, 1:60; 2:48
 Pool, 1:64
 programs for, 9:58-60
 race, car, 3:56
 Racer, 7:69
 Rat Hotel, 4:73
 Sanyo MBC 555, 11:36
 SASA, 2:56
 Sector Alpha, 6:57
 Serpentine, 4:73
 Shark Attack, 2:52
 Sharp MZ700, 4:57
 shooting, 3:54
 Simon, 4:54,62,66
 Skramble, 2:52
 Slot Game, 11:36
 Snake, 6:38
 Son of Blagger, 4:69
 Space Attack, 2:52
 Space Ranger, 11:43
 Space Shoot, 3:65
 Space War, 4:58
 Spectrafrog, 8:46
 Spectravideo, 3:65; 4:79; 6:57;
 8:46
 Spectrum, 1:64; 4:62,65; 6:38;
 11:42
 Spider, 4:58
 Spitfire 40, 10:58
 sprites and, 3:54
 Stargate Enterprises, 10:47
 Summer Games, 1:50
 Swingman, 3:65
 Synapse, 1:51; 9:66
 Tales of the Arabian Nights,
 9:60
 tape on to disk, 1:70
 tapes and, 1:70; 2:52
 Tapper, 4:70
 Tetra Horror, 7:76
 Time Tube, 11:36
 UFO, 11:45
 Ultimate, 2:59
 VIC, 4:58,73; 11:43
 Vz-200, 4:62
 Water Fight, 4:65
 Wheelie, 1:66
 Zaxxon, 1:51
 Zeppelin, 1:51
 ZX81, 6:42; 7:64; 11:41

generator, sound, 1:69
 graphics, BASIC, 3:62
 BBC, 3:63
 Cartesian, 1:34
 Spectravideo and, 4:79; 8:46
 Tablet, 4:80
 graphs, Sharp MZ 700, 6:44
 ZX81, 6:42
 groups, user, 3:55

h

hand-helds, 3:17

Handic, 5:56
 hardware, expansion options, 1:54
 Hewlett Packard, Laserjet, 9:28
 Thinkjet, 9:20
 110, 5:20
 150, 5:17
 hexadecimal conversions, 4:63
 Hi-Res CLS, 4:64
 Hitachi MB-6890, 3:22
 home computers, 2:49; 3:14
 HP, Integral PC, 11:16
 Touchscreen PC, 5:36
 110, 3:34

i

IBM, 5:20
 compatibles, 5:35,49; 10:35
 PC BASIC and, 5:61
 compatible, 4:36
 Junior, 8:37
 keyboard status, 2:66
 networks, 3:53
 Portable, 2:30
 TopView, 5:36
 word processing and, 1:59
 32016, 5:36
 PPC, PC, PC-XT, PC-AT, 2:67
 programs, 4:74
 service economy, 8:38
 ICL, 4:26
 IFPS, new version, 8:37
 images, digitised, 5:65
see also drawings, pictures
 indexed addressing, 11:47
 indirection operators, 1:61
 information, capital and, 8:38
 disks and, 6:66
 systems, 2:19
 Innove-Drive, 10:37
 input routines, 2:49; 3:57
 integrated systems, *see under*
 packages *and under* software
 Interactive Financial Planning
 System/Personal, *see* IFPS
 Intertec Headstart, 5:20

j

Jalpainter, 4:67
 joysticks, drawing and, 4:56
 sprites and, 3:64
 Juki Model 6100/6300, 10:27-28
 Juki 2200 Electronic, 10:26

k

Kaypro, 3:42; 4:26
 keyboards, characters, single in
 programmes, 2:50
 IBM PC, 2:66

(Continued 42)

purpose-built, 3:68
Spectrum, 3:68
keywords, keys for, 6:50
Kimi Ora School, 1:28

L

languages, authoring, 7:73
BBC, 5:67
CAI, 8:49
LOGO, 1:51
machine, *see* machine language
music macro, 9:57
PILOT, 1:51
programming, 7:77
Lear Siegler Versaprint 500, 9:25
learning, Fourth Generation, 3:49
letters, VIC writer and, 1:43
Line Design, 1:41
liners, cassette, 6:38
Lion New Zealand, 5:44
loading, programs, 2:64; 4:86; 6:48
logical operators, Sega, 3:70
Logitech, FT 5002, 10:14
WP-550/770, 10:26,28
LOGO, 6:35
Acorn, 5:67
BBC and, 4:77; 6:63
Easy, 11:33
language, 1:51
Lotus, 1-2-3, 1:14
Symphony, 3:48

M

machine code, routines, 5:68
Spectrum, 8:50
machine language, 4:77; 7:68; 8:36
BASIC and, 9:50
data statement and, 7:68
indexed addressing, 11:47
Macintosh, software, 1:58; 8:28
MacPaint, 8:28
Macproject, 8:38
MacWrite, 8:28
magazines, computer, 3:58
management, database, 3:50; 4:50
manager, Commodore, 7:67
database, Beta-Base, 7:75
maps, making on micros, 11:26
margins, VZ200, 1:63
markets, micro, 6:41
Mega, modem, 5:46
memory, 2:43; 4:83
Memotech, 3:24
merging, programs and strings, 5:50
messages, programs for, 6:40
MIC-504, 2:33
mice, BBC and, 9:55
micro-drive, 10:37
micro market, 5:41
Microsoft BASIC, 5:61
Microtext, 8:49
Mitsui 2200/4200, 10:18
modems, 5:46; 7:24
Modula-2, 5:66

Moire pattern, 1:35
Morrow, 4:28
MD II, 4:39; 5:20
MTX-500, 2:27
Multitech, MIC 500, 4:28
MIC-504, 2:33
Muppet Learning Keys, 11:59
music, Apple organ, 10:48
language, 9:57
organ, 10:48
sound of, Spectravideo, 11:51
Music Mentor, cartridge, 11:52

N

NCR PC 4i, 9:35
NDK Printstar 5025, 9:28
NEC APC II/III, 5:22; 8:13
Pinwriter P1 printer, 1:22
Pinwriter P2/P3, 9:25
Spinwriter 2000/3500/8800, 10:22,24
networks, 9:41; 10:44
BBC, 5:67
IBM PC, 3:53
NEWDOS80, 7:80
notice board, characters, enlarged, 4:64
1985 developments, 5:54
NZ Computer Education Society, 2:42

O

OKI Microline 82A/83A/84/92A/93A, 9:18,20,22,25
OKI 2350/2410, 9:28
Olivetti, 5:22
PR 2300, 2:35
Olympia Electronic NP, 9:22
RO, 10:27
ESW3000, 10:29
Open Access, 7:53
operations, parallel, 6:51
single, 6:51
operators, indirection, 1:61
organ, Apple ASCII, 10:48
Oric, 3:24
Osborne, 4:28
4 (Vixen), 7:36
Oxford Pascal, 8:50

P

packages, accounting, 8:31
integrated, 1:12-16; 2:14;
3:48-52; 6:31; 7:53
painting, program, 11:42
Panasonic JR100, 3:24
KXP 1090/1091/1092, 9:18,22
Panasonic, 4:29
Senior Partner, 5:22; 8:6
parallel operations, 6:51
Pascal, Acorn, 5:67

BBC and, 4:77
controversy, 5:66
Oxford, 8:50
pattern drawing, Sega, 4:56,63
ZX81 and, 6:40
PC Junior, 8:37
peripherals, 4:68
Philips 2010, 4:29
phreakers, bulletin boards and, 7:28
pictures, drawing program, 11:42
sprites, 10:56
see also drawing, images
PILOT language, 1:51
planets, Saturn, 1:44
PLAY, Spectravideo sound, 10:55
Poly 2, 3:49
portables, 3:34
Powergroup, 2:20
preschoolers, programs for, 8:46
prices, 5:15
software, 1:50
PRINT-A-PLOT, 4:52
printers, 1:22,24; 2:35,57
Apple Scribe, 7:70
Atariwriter, 7:81
Brother HR-5, 1:66
daisy wheel, 10:26-30
dot matrix, 10:14-24
dot matrix, 9:16-30
Scribe, 7:70
Star SG10, 10:31
processors, BBC second, 2:62
ProDOS, Apple, 11:67
Proforma, 8:49
Progeni Poly 2, 3:49
programming, learning, 1:48

programs, alphabetical arrangement, 8:47
BASIC, protection of, 11:55
benchmark, 5:62; 6:56
Beta Basic, 3:66
biorhythm, 6:46
business, 7:65
commercial, 1:50
conversion, 1:33
copying of, 1:50
drawing, 4:56; 11:42
educational, 8:46
games, 9:58-60
graph, 6:42,44
IBM, 4:74
keyword, 6:50
loading, 4:86; 6:48
merging, 5:50
message, 6:40
painting, 11:42
picture drawing, 11:42
public domain, 2:49; 4:74
readable, 11:34
renumbering, 4:60
SHIFT and, 5:56
sound generator and, 9:57
Spectrum, 3:66; 7:77; 10:49
speeding up, 2:68
Supertext, 10:49
tape loading aid, ZX81, 2:64
writing, 2:50; 9:47
protection, BASIC programs, 11:55
schemes, 1:50
Proteus, 4:30
PSION, 7:78
public domains programs, 2:49; 4:74

puzzles, crossword, 4:57

q

Qantex, 7065, 9:30
 QL v. BBC, 6:22
 Qume Letterpro 20, 10:27
 Sprint 11, various, 10:29,30

r

radio, amateur, contest log keeping, 11:36
 RAM/ROM cards, 6:63
 renumbering, programs, 4:60
 Ricoh RP1200/RP1300/RP1600, 10:27,30
 Riteman Blue Plus/C+F+/II/Plus/15, 10:14,16
 ROM, BASIC, Spectrum ZX, 2:61
 RS232, usage of, 6:51

s

Sandy, 6:54
 word processor, 3:52
 Sanyo, 4:30
 MBC 775 PC, 5:35
 MS-DOS, 11:54
 Saturn (planet), 1:44
 schools, 7:60
 Muppet Learning Keys, 11:59
 Otakou Software, 11:32
 software for, 8:35
 screen merge, 4:72
 Scribe, 7:70
 scrollers, side, 6:47
 Seaside, 11:36
 Second Opinion, spelling checker, 11:32
 Sega, Aeroplane, 4:60
 business programs, 7:65
 cassette liners, 6:38
 disks, driving, 10:53
 drawing, patterns, 4:63
 driving disks, 10:53
 filing systems, 6:60
 logical operator, 3:70
 memory scanning, 4:83
 merging programs, 5:50
 pattern drawing, 4:56
 program, alphabetical arrangement, 8:47
 SF 7000, 11:63
 3000H, 3:24
 Seikosha, BP5200I, 10:22
 BP5420, 10:23
 GP50/GP700A/, 10:16,18
 SP800, 10:16
 Senior Partner, Panasonic, 8:6
 serial operations, 6:51
 service economy, 8:38
 shapes, sprites for, 1:68
 Sharp, 5:22
 MZ 700, graphs with, 6:44
 MZ-721, 3:26
 SHIFT, press, 5:56

sidescrollers, ZX81, 6:47
 Signwriter, 6:40
 SIMPLOT, 4:52
 Sinclair QL, 1:66; 2:21; 4:30; 6:20; 7:78
 ZX, 3:26,38
 software, accounting, 8:31
 Activision, 3:62
 American, 2:54
 Apple Writer II, 1:57
 Atari, 3:62
 business, 1:45
 cassette magazine, 9:65
 database, 4:50
 educational, 2:61; 8:35
 integrated, 1:12; 2:14,44;
 3:48; 7:49
 learning, 3:49
 Macintosh, 1:58; 8:28
 Monaco, 3:62
 plotting, 4:52
 prices, 1:50
 Sandys, 3:52
 schools, 8:35
 thinkware, 2:61
 Turbo Pascal, 4:44
 windowing, 1:12
 word processing, Apple
 Writer II, 1:57

Sord, IS-11, 4:30
 M23/M68, 5:24
 M5, 3:28
 243, 5:24
 SORT command, 1:18
 sorting, program, alphabetical, 8:47
 sound, generator, 1:69; 9:57
 music, Spectravideo, 11:51
 Seaside, 11:36
 Spectravideo PLAY, 10:55
 UFO landing, 11:45
 waves crashing on shore, 11:36
 Spectra File Cabinet, 5:63
 Spectravideo, BASIC, 7:76
 benchmarks, 5:62; 6:56
 clocks, digital, 4:66
 drawing with, 4:79
 games, 3:65
 graphics, 8:46
 Music Mentor, 11:52
 PLAY, 10:55
 sound, 9:57; 10:55;
 11:51
 sprites, 3:54
 Tablet, 4:80
 318/328, 1:68; 3:30
 728, 9:32
 Spectrum, BASIC and, 2:61; 6:64
 games on, 1:64
 keyboards, 3:68
 machine code, 5:68; 8:50
 programming language C,
 7:77
 programs, 3:66; 7:77
 protection of BASIC
 programs, 11:55
 Supertext program, 10:49
 Ultimom, 9:65
 see also ZX
 Speech Synth, 11:24
 spelling checker, Second Opinion,
 11:32
 Sperry PC, 5:24; 7:40
 spreadsheets, 1:14; 2:44; 5:67

sprites, 1:68; 2:53; 3:64; 8:42; 9:61;
 10:56
 SRA thinkware, 2:61
 Star, Load, 6:48
 Powertype, 10:27
 SD10/SD15, 9:22,26
 SG10, 9:22,24; 10:31
 SR15, 9:26
 storage, Spectra File Cabinet, 5:63
 variables and, 10:46
 stories, adventure, Twist-a-Plot, 11:33
 storing, variables, 5:50
 strings, merging, 5:50
 students, handicapped, 1:28
 study guide for teachers, 1:30
 Super 5-CP80 printer, 1:24
 Superbase 64, 4:50
 Supersketch, drawing with, 4:56
 Supertext, Spectrum program, 10:49
 SVI 728, 9:32
 SV3000/3100/3200/3300, 9:18, 24
 SV3400/3500, 10:26,27
 switching, windows and, 3:52
 Symphony, 3:50; 7:53
 system variables, 2:60

t

Tablet, 4:80
 Tandy, Radio Shack Model, 1:70
 System 80, DOS, 7:80; 11:65
 4, 4:31
 100, 4:31
 1000, 3:30; 6:25
 2000, 5:24
 tapes, drawing and, 4:56
 games to disks, 1:70
 loading aid programs, ZX81,
 2:64
 tips, 1:55
 Tasword Two, 7:77
 TAS80/System 80, 1:70; 3:69
 TCM, 6:29
 teachers, reference books for, 1:32
 study guide for, 1:30
 Televideo, 4:31; 5:25
 thinkware, classroom, 2:61
 Topview, 5:36
 Torch, 5:25
 Toshiba P1351, 9:30
 training, disks for, 6:63
 tricks, 8:45
 TRS 80, DOS, 5:53; 7:80; 11:65
 information on disk, 6:66
 loading, 4:86
 Model 4P, 2:22
 Turbo Pascal, 4:44
 tutorial CAI, 7:73
 Twist-a-Plot, adventure story, 11:33

u

Ultimom, Spectrum, 9:65
 user groups, 3:55

(Continued on page 44)

(Continued from page 43)

V

variables, 2:60; 5:50; 10:46
see also Commodore

VIC, 3:30; 4:73
 Basic and, 1:53
 C-16 and, 3:56
see also Commodore games, 4:73
 signwriter, 6:40
 users, books for, 3:60
 writer, 1:43

video, disks for, 6:63
 Videotex, 7:22
 Video Viper, 5:65
 viewsheets, Acorn, 5:67
 Visi On, 2:15
 Vision, 7:53
 BBC and, 11:57
 Vixen (Osborne 4), 7:36
 VZ-200, characters, enlarged, 4:64
 margins on, 1:63

W

Wang PC, 5:29
 waveforms, standard, 1:41
 Wellington Crippled Children Society, 1:28
 Whitbread race, 5:44
 windows, 1:12; 2:15; 3:38,52; 4:70
 word processing, Apple Writer II, 1:57
 IBM PC and, 1:59
 on 64, 1:52
 word frame, 6:32

word processors, 3:52
 Chinese, 7:54
 Tasword Two, 7:77

words, disks, RS232, 6:51
 Wozniak interview, 6:4; 4:46
 writer, VIC, 1:43

xyz

Zenith Z150 PC, 4:36; 5:25
 ZX Spectrum, BASIC ROM, 2:61
 keyboard, 3:68

ZX81, decimal conversions, 4:63
 drawing with, 4:56
 graphs with, 6:42
 pattern maker, 6:40
 side scroller, 6:47
 tape loading aid programs, 2:64



(Continued from page 37)

Disk drives: Optional one, two or four: 600 Kb per 8" drive.

Other components: Optional

Operating systems: Polysystem — alternatively CP/M.

Languages: Basic.

Optional: Pascal, Logo, Pilot, Assembler.

Bundled software: Operating system, basic interpreter, 42 utilities.

Prices: \$2950 Poly 2.

Expansions: —

Applications: Education.



President Jr

Processor: 8088, 4.77 Mhz.

RAM: 256K; max. 640K.

ROM: 8K for bootstrap. Max. 32K.

Video RAM: Inclusive.

Keyboard: Full travel, 83 keys, numeric pad, 10 function keys, cursor keys.

Video: Optional RGB colour, composite & monochrome. 40 or 80 columns x 25 lines.

Resolution: 320 x 200, 640 x 200. 16 colours.

Interfaces: Parallel, RS 232, disk controller, game I/O.

Disk drives: One built-in, 5 1/4", 360K formatted.

Other components: Optional.

Operating systems: MS-DOS 2.11.

Languages: GW Basic.

Optional: All MS-DOS languages.

Bundled software: Open Access.

Prices: \$2750.00 for above.

Expansions: —

Applications: Small business, home.



Proteus

Processor: 6809/Z80A, 4 Mhz

RAM: 64 Kbyte.

ROM: 4 Kbytes for bootstrap.

Video RAM: Inclusive.

Keyboard: Uses Learseagler ADMII terminal.

Video: Mono. 80 columns x 24lines.

Resolution: —

Interfaces: —

Disk drives: 8", 630Kb per disc.

Other components: —

Operating systems: Flex, CP/M, Polysystem.

Languages: —

Optional: Basic Cobol/Fortran/c/PLI/Pascal/Assembler (6809-280).

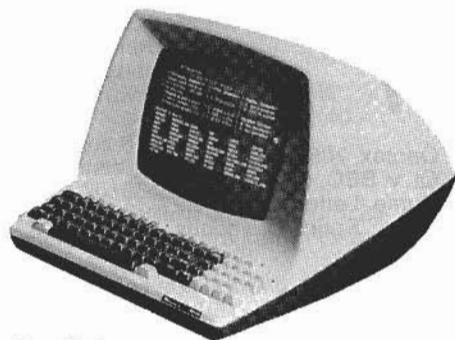

Bundled software: No

Prices: \$2500 (+ tax) single drive, \$3500 (+ tax) dual drive.

Expansions: —

Applications: Business.



Remarkable PC and XT

Processor: 8086, 8087 (optional). 4.77 Mhz.

RAM: 256K, max 640K.

ROM: IBM compatible.

Video RAM: —

Keyboard: Full travel, 83 keys, numeric pad, 10 function keys, 9 editing keys.

Video: Choice, 80 x 25.

Resolution: Medium — standard, high — optional, 16 colours.

Interfaces: Parallel port, 8 expansion slots.

Disk drives: 2 x 5 1/4" fds of 360K each.

Other components: 130 watt power supply.

Operating systems: MS-DOS.

Languages: —

Optional: —

Bundled software: —

Prices: \$2995, with 2 fds (screen extra). XT with 20Mb hard disc, \$5695.

Expansions: —

Applications: Business.



Sanyo MBC 550, 555-2, 555-T

Processor: 8088, 3.6 Mhz

RAM: 128K. Max 512K

ROM: 8K (IPL/CG)

Video RAM: 48K, including 16K of main RAM

Keyboard: Full travel, 84 keys, numeric pad, 10 function & 3 edit keys

Video: Optional mono and colour. 80 columns x 25 lines.

Resolution: 640 x 200x

Interfaces: Centronics parallel printer interface; RGB & video composite port.

Disk drives: 5 1/4". 550 has 1 fd x

160K; 555-2 has 2 fds x 360K; 555-T has 2 x 720K.

Other components: Optional.

Operating systems: MS-DOS 2.57
Languages: Basic (Sanyo)
Optional: Most others.

Bundled software: Wordstar, Calcstar, Mailmerge, Spelstar, Infostar.

Prices: 550 (incl. monitor) \$2290; 555-2 \$2995; 555-T \$3795.

Expansions: Optional.
Applications: Home, education, small business.

Sanyo MBC 885

Processor: 8088-2. 8.00/4.77 Mhz (switchable).

RAM: 256Kb RAM. Max. is 640K RAM.

ROM: 8K for character generator.

Video RAM: Inclusive.
Keyboard: Sculpture/type, 84 keys, 10 function keys, 5 editing keys.

Video: None. 80 columns x 25 lines.

Resolution: —
Interfaces: Parallel printer port, RGB monitor connector.

Disk drives: Dual 360 K, 5 1/4" fds.

Other components: —

Operating systems: MS-DOS.
Languages: GWBasic.
Optional: Most others.

Bundled software: Wordstar 2000.
Prices: \$3995 as above.

Expansions: —
Applications: Business/education.

Sega SC3000-H

Processor: Z80A 3.8 Mhz.

RAM: 64K.

ROM: 32K for OS.

Video RAM: 16K video ROM inclusive.

Keyboard: Full travel, 64 keys, cursor pad.

Video: Tv or monochrome/colour monitor. 38 characters x 24 lines.

Resolution: 256 x 192, 16 colours.

Interfaces: Video port, plotter/printer port, tape in/out.

Disk drives: 1 optional 3", 380 Kb.

Other components: Printer, tape, disc drive.

Operating systems: Basic.
Languages: Basic.
Optional: Logo.

Bundled software: —

Prices: \$199.

Expansions: ROM cartridges.

Applications: Games, education, small business, programming.

Sharp MZ 800

Processor: Z80A, 3.5 Mhz.

RAM: 80K.

ROM: 16K for boot monitor & character generator.

Video RAM: 16K from main RAM; extra 16K optional.

Keyboard: Full travel, 5 function keys (shiftable), cursor pad, no numeric pad, edit keys.

Video: Separate, RGB & composite video interface, colour or mono, 40-80 columns.

Resolution: 16 colours.

Interfaces: Video, bus for disc drive and RS232C, printer, 2 joystick ports, tape.

Disk drives: Optional, 3 1/2" or 5 1/4", 120K or 320K.

Other components: Room for cassette & plotter.

Operating systems: CP/M 80 card option; plus Sharp OS.

Languages: Basic (will run MZ700 software).

Optional: Pascal, Logo, and others.

Bundled software: —

Prices: February release.

Expansions: No RAM upgrade, otherwise as above.

Applications: Home.

Sigma PC

Processor: Intel 8086, 4.77 Mhz.

RAM: 128K — 512K. Upgradable to 640K RAM.

ROM: 16K.

Video RAM: —
Keyboard: IBM-like, separate keyboard, 10 function keys, numeric pad.

Video: 80 x 25 lines, colour or mono.

Resolution: —
Interfaces: RS 232, centronics / standard.

Disk drives: 360 Kb, 5 1/4" fds. Hd options.

Other components: Optional.

Operating systems: MS-DOS.

Languages: Basic.

Optional: IBM abilities.

Bundled software: —

Prices: \$2490 for single fd and

mono screen. \$2990 for 2 fds.

Expansions: To hard disc.

Applications: Business.

Sinclair QL

Processor: Motorola 68008, 8049 co-processor; 7.5 Mhz.

RAM: 128K; max. 1 Mgb.

ROM: 128K.

Video RAM: Inclusive.

Keyboard: Full travel, over membrane, 65 keys, 5(x2) function keys, no numeric pad, edit keys. Modes selectable up to 85 columns x 25 lines. Colour or mono.

Resolution: 512 x 256, 4 colours; 256 x 256, 8 colours.

Interfaces: 2 RS 232C, RGB monitor, UHF TV, ROM cartridge, 2 network, RAM expansion,

microdrive expansion, power input, 2 joystick ports.

Disk drives: 2 built-in 100K microdrives (continuous tape).

Other components: Optional.

Operating systems: Sinclair QDOS (multi-tasking).

Languages: Super Basic & Turtle Graphics.

Optional: C, 68000 assembler, BCPL, APL, Pascal, Fortran, Logo, Prolog.

Bundled software: Psion's Quill W/P, Abacus s'sheet, Archive database, Easel graphics.

Prices: \$995 for 128K RAM version above.

Expansions: External disc drives promised.

Applications: Home, business (incorporated in Computer Phone) and education.

Sinclair Spectrum & Spectrum Plus

Processor: Z80A, 3.25 Mhz.

RAM: 16 - 48K.

ROM: 16K.

Video RAM: Inclusive.

Keyboard: Spectrum — rubber; S.Plus — full travel, 50 keys, no numeric pad or function keys, has edit and cursor keys.

Video: Mono/colour, 32 columns x 24 lines.
Resolution: 256 x 190, 6 colours plus b/w, and shades programmable.

(Continued on page 46)

Hardware survey

(Continued from page 45)

Interfaces: Interface 2 (\$96) joysticks, ROM cartridge slots; Interface 1 (\$249) RS 232C, network, microdrives; memory upgrades, parallel printer, videotex adapter, I/O boards...

Disk drives: 100K microdrives optional.

Other components: Above options.

Operating systems: Proprietary.

Languages: Basic.

Optional: Forth, Microprolog, Logo, assemblers.

Bundled software: 'Special price' packs, including Interface 1 or 2, offered.

Prices: 16K version \$299, 48K version \$480, S.Plus \$599.

Expansions: See 'Interfaces'.

Applications: Home, education.

Disk drives: Standard 2 x 320 Kb, 5 1/4"; optional 1 x 10 Mb.

Other components: Optional.

Operating systems: CP/M.

Languages: Extended Microsoft Basic.

Optional: Pascal etc Under CP/M.

Bundled software: Small business accounts, invoicing, quotations, debtors, inventory, Wordstar, Mailmerge, Calcstar, Datastar, Reportstar.

Prices: \$3995. Computer, disk drives, bundled software, 80 cps dot matrix printer, monochrome monitor.

Expansions: —

Applications: Small business.

Resolution: 256 x 192, 16 colours.

Interfaces: For disk drive, datasette, 2 joysticks, parallel printer, expansion slot.

Disk drives: None standard. Optional 5 1/4", 320 Kb formatted.

Other components: Optional.

Operating systems: MSX-DOS, CP/M with disk drive.

Languages: MSX, extended Microsoft Basic.

Optional: Pascal etc Under CP/M.

Bundled software: None.

Prices: \$695. Computer, power supply, instruction manual, Tv cable.

Expansions: —

Applications: Home, education.



Spectravideo SV 738 X'Press

Processor: Z80A, 3.6 Mhz.

RAM: 64 Kb. 128K max.

ROM: 56 Kb of which 32 Kb = MSX Basic, 8 Kb = RS232, 16K = disk drive.

Video RAM: 16 Kb.

Keyboard: Full travel, 73 keys, 5x2 function keys, no numeric pad, edit keys.

Video: Monochrome, colour, Tv. 40/80 columns.

Resolution: 256 x 192, 16 colours.

Interfaces: Datasette, parallel printer, external disk, expansion slot, 2 x joysticks, RS232.

Disk drives: 1 x 3 1/2", 360 Kb standard. 2nd fd optional, as is 5 1/4" 320K fd.



Spectravideo SV 328 Business Pack

Processor: Z80A, 3.6 Mhz.

RAM: 64 Kb. 128K max.

ROM: 32 Kb, for extended Microsoft Basic.

Video RAM: 16 Kb.

Keyboard: Full travel, 89 keys, numeric pad, 5(x2) function keys, plus edit keys.

Video: Monochrome, colour, Tv. 40/80 columns.

Resolution: 256 x 192, 16 colours.

Interfaces: Parallel printer.

Spectravideo SV 728

Processor: Z80A, 3.6 Mhz.

RAM: 64 Kb. 128K max.

ROM: 32 Kb for MSX, Microsoft Basic.

Video RAM: 16 Kb.

Keyboard: Full travel, 90 keys, 5(x2) function keys, numeric pad, & edit keys.

Video: Monochrome, colour or Tv. 40 columns (80 optional).

HIRE PURCHASE The Bookkeeping Nightmare

Finance company accounting, in the area of hire purchase contracts, has been the cause of many sleepless nights to those involved in H.P. transactions. The burden of tedious and problem filled H.P. record keeping has been lifted...

TCS
HIRE PURCHASE SYSTEM

NOW! Rest easy with the
TCS Hire Purchase System
at only **\$499**
AN AMAZINGLY FAIR PRICE FOR A GOOD NIGHTS SLEEP

SPECIFICATIONS

• Runs under MS-DOS 2 Available for IBM PC and compatibles, also Sanoyo 550 series Commodore versions available)

• Hardware requirements.

— Minimum 256k RAM Micro Computer (MS-DOS 2) IBM or compatible
— Two 360k Disk drives — 80 column printer

TCS Hire Purchase System Overview...

- The T.C.S. HIRE PURCHASE system provides complete Finance Company Accounting.
- The T.C.S. HIRE PURCHASE system allows multiple vendor analysis.
- The T.C.S. HIRE PURCHASE system provides calculation of Penalty Interest.
- The T.C.S. HIRE PURCHASE system provides calculation of rebatable interest by rule 78.
- The T.C.S. HIRE PURCHASE system provides individual reports on each contract.
- The T.C.S. HIRE PURCHASE system gives full analysis by vendor.
- The T.C.S. HIRE PURCHASE system reports on each contract — current debt — paid to date — balance owing — rebatable interest — last pay date — overdue amount — days overdue — overdue date.
- The T.C.S. HIRE PURCHASE system provides a full trial balance reporting — split by vendor — total contracts — total paid — total new loans for month — total amount financed — total interest — total booking fees — total transactions, receipts/rebates/journal*/journal/penalty

THAMES COMPUTER SERVICES
P.O. BOX 527 THAMES N.Z
PH (0843) 86 893

A division of James Electronics Ltd

TCS
DEALER ENQUIRIES
WELCOME

Other components: Carry case included.
 Operating systems: MSX-DOS, CP/M.
 Languages: MSX, extended Microsoft Basic.
 Optional: Pascal etc under CP/M.
 Bundled software: Simple spreadsheet, memo writer, simple database, scheduler.
 Prices: \$1195. Computer, 360 Kb disk drive, carry case, bundled software, built-in 80 col, printer interface, RS232 interface.
 Expansions: —
 Applications: Home, education, small business.

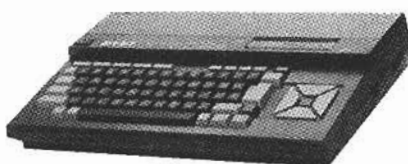

Sony Hit-bit MSX (75P)
 Processor: Z80A, 3.579 Mhz.
 RAM: 64K.
 ROM: 32K for MSX Basic.
 Video RAM: 16K separate.
 Keyboard: 74 full travel keys, 5(x2) function keys, 8 edit keys, cursor pad, no numeric pad.
 Video: Any TV, text up to 40 columns x 24 lines.
 Resolution: 256 x 192, 16 colours.
 Interfaces: Built-in for any TV, cassette recorder, printer.
 Disk drives: Optional 3 1/2" single fd of 500K.
 Other components: Supplied are TV cable, cassette cable, selector switch, and 2 manuals. Colour plotter optional.
 Operating systems: Proprietary.
 Languages: MSX Basic.
 Optional: —
 Bundled software: —
 Prices: \$895.
 Expansions: —
 Applications: Home



Sord IS-IIc
 Processor: Z80A, 3.6 Mhz.
 RAM: 80K, max. 112K.
 ROM: 72K for system software: W/p, comms, diary etc. Max. ROM 104K.
 Video RAM: Inclusive.
 Keyboard: Full travel, 70 keys, numeric pad optional

(with extra function keys), six function keys.
 Video: LCD. 80 columns x 25 lines.
 Resolution: 640 x 200. One colour.
 Interfaces: Standard I/O x 3, RS 232, Centr. port, ROM-RAM I/O, micro-disc drive, modem port.
 Disk drives: Optional external 3 1/2", 132K drive.
 Other components: Optional 40 col. thermal printer.
 Operating systems: Sord.
 Languages: Basic.
 Optional: —
 Bundled software: W/p, Comms, Calc, Diary & notebook.
 Prices: \$2800.
 Expansions: Fully expanded (with fd drive) \$4200.
 Applications: Business portable.



Tandy Colour Computer 2
 Processor: 5809E, 0.894 Mhz.
 RAM: 64K.
 ROM: 16K, for boot, extended colour Basic.

Video RAM: Inclusive.
 Keyboard: Full travel, 53 keys. No numeric pad or dedicated function keys.
 Video: None standard; mono and colour options. 32 columns x 16 lines.
 Resolution: 256 x 192, 8 colours.
 Interfaces: For cassettes 2 joysticks, RS 232C, TV.
 Disk drives: Optional, up to 2 x 5 1/4" fd, 153K each.
 Other components: Optional.
 Operating systems: Basic; CP/M optional.
 Languages: Basic.
 Optional: Logo, Pascal, C, Basic-09.
 Bundled software: None.
 Prices: \$795.
 Expansions: Numerous options.
 Applications: Home, education.



Tandy 100
 Processor: 80C85, 2.4 Mhz.
 RAM: 24K; max. 32K.
 ROM: 32K, for boot, Basic, W/p, database, communications.

(Continued on page 48)

**THE N.Z.
COMPUTER
GAMES CLUB**

CALLING ALL HOME COMPUTER and HOME VIDEO GAMES SYSTEM OWNERS

MEMBERSHIP OF THE N.Z. COMPUTER GAMES CLUB MEANS YOU CAN:

- 1. Hire Tapes, disks, cartridges and books, and evaluate in your own home before purchasing.**
- 2. Hire on a weekly basis at a fraction of the purchase price and exchange for different choices when you wish.**
- 3. Purchase by mail from the largest selection in N.Z. at discount prices. Also Direct ordering service from overseas.**

Fill In The Form Below For Details Of Cost, Titles Available Etc.

**Post to: THE N.Z. COMPUTER GAMES CLUB,
P.O. Box 18, Nelson. Phone 89-100 Nelson.**

Name

Address

ATARI 400/600/800
APPLE 11+/e
VIC 20
C64
BBC

ATARI 130XE
SYS 80
ZX81
SPECTRUM
ELECTRON

TRS 80
AMSTRAD
C16/PLUS 4

SEGA 3000

Hardware survey

(Continued from page 47)

Video RAM: Inclusive.
Keyboard: Full travel, 56 keys, numeric pad, 8 function keys and 4 command keys.
Video: LCD. 40 characters x 8 lines.
Resolution: 240 x 64.
Interfaces: RS 232, centronics, BCR, 6v DC, phone, cassette, bus.
Disk drives: 3 1/2", 100K fd optional.
Other components: Optional.
Operating systems: Transparent.
Languages: Basic.
Optional: —
Bundled software: As for ROM.
Prices: \$1965 for 24K version.
Expansions: Disc drives.
Applications: Business.

spreadsheet, database, telecom. Max. 104K.
Video RAM: Inclusive.
Keyboard: Full travel, 56 keys, numeric pad, 8 function keys, 4 command keys.
Video: LCD. 40 columns x 16 lines.
Resolution: 240 x 128. 1 colour.
Interfaces: RS 232, parallel, phone, cassette, BCR, 6v DC, Bus.
Disk drives: Optional 3 1/2", 100K.
Other components: Optional.
Operating systems: Transparent.
Languages: Basic.
Optional: —
Bundled software: As for ROM.
Prices: \$2810 for 24K version.
Expansions: Available.
Applications: Business.



Keyboard: Full travel, 46 keys, single key function entry, 4 edit keys and cursor keys.
Video: Mono & colour RF additional. 32 columns x 16 lines.
Resolution: 128 x 64 (8 colours), 64 x 32 (9 colours).
Interfaces: For video, cassette, printer, I/O port.
Disk drives: Optional 5 1/4" fds, 80K. Two.
Other components: Optional, incl. RAM, light pen.
Operating systems: Disc Basic.
Languages: Microsoft Basic.
Optional: —
Bundled software: None.
Prices: \$299 for VZ-300.

Tandy 200
Processor: 80C85, 2.4 Mhz.
RAM: 24K; max. 72K.
ROM: 72K for boot, Basic, W/p,

VZ-300
Processor: Z80A, 3.579 Mhz.
RAM: 18K; max. 68K.
ROM: 16K for Microsoft Basic.
Video RAM: 2K of standard RAM.

BREAKING BARRIERS

POLY 2 LEARNING SYSTEM



BREAKING THE LEARNING BARRIERS— Across all levels of Education and Training
BREAKING THE TECHNOLOGY BARRIERS— Being able to create your own courseware without specific computing skills
BREAKING THE COST BARRIERS— The combination of technical superiority and cost efficiency, delivering maximum return to its Users

Manufactured in New Zealand and guaranteed by POLYCORP New Zealand Limited, a division of PROGENI.

For further information Write or Call - Katharine Moody
 PO Box 30243
 Lower Hutt
 Ph 666014

Alan Depree
 PO Box 5420
 Auckland
 Ph 796377

John Gale
 PO Box 13027
 Christchurch
 Ph 795453

Expansions: \$799 for VZ-300 and one disc drive.
Applications: Home.

Yamaha CX5M Music Computer

Processor: Z80A, 3.579 Mhz.
RAM: 32K.
ROM: 32K.
Video RAM: Inclusive 4K.
Keyboard: Typewriter style, 73 keys, also piano style 49 keys. 5 (x2) function keys, 5 edit keys.
Video: 40 x 24 character/lines.
Resolution: 256 x 192, 16 colours.
Interfaces: TV, cassette, digital drum machine and synthesisers port, sequencers, tone generators, MSX printer port, sound and video.

Disk drives: —
Other components: Optional.
Operating systems: Proprietary.
Languages: MSX-Basic.
Optional: Music peripherals. DX7 Voicing programme.

Bundled software: The Music Composer package.
Prices: \$1995.
Expansions: See interfaces.
Applications: Music composition, MSX entertainment.

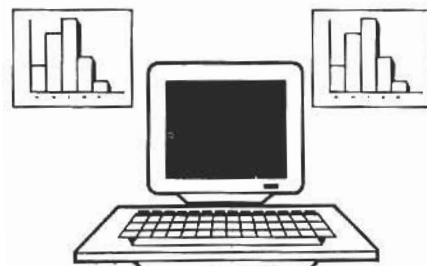

COMPUTERS FOR PEOPLE

AUTOCAD CAD/CAM SALES AND SUPPORT

35 Taranaki St, Wellington
Phone (04) 859-675
407 Queen St, Auckland
Phone (09) 393-408

Printer Utility

By William Mackay

This machine code program will allow listings to be made on any printer connected to the Commodore with a Centronics interface on the user port. The program turns all control characters into their hexadecimal number surrounded by brackets (see the listing demo), allowing listings to be made which don't confuse the printer or the reader.

Enter the program, making extra sure you don't make mistakes in the REM statements, and save it. Then run it and follow the instructions. When you use SYS to activate it, you will be given an open and CMD statement, to which the computer will react as normal. Programs will be listed in upper and lower case, with all control characters (except CR) converted.

If you have a Commodore printer, these POKES will allow you to print listings with control characters converted to character strings:

POKE 53039,0: POKE 53013,76: POKE 53014,202: POKE 53016,241: SYS 52730

However, upper case will be converted to lower case and vice versa.

Once you have the program in memory, you should make a copy with a monitor. The program occupies memory locations CDFO to CFFF. If you would like the program on tape, send \$4 and a blank cassette to: William Mackay, 91 Songer St, Stoke, Nelson.

You can also write to William at that address if you have any queries.

```

5 rem listing demo
10 print:"(F01) (F02) (F03) (F04) (WHT) (F06)
(BEL) (DIS) (ENS) (LF) (VT) (FF)
(LWR) (SI) "
20 print:"(F10) (DWN) (RON) (HOM) (DEL) (F15) (
F16) (F17) (CAN) (F1A) (F1B) (ESC) (RED) (F1G) (
GRN) (BLU) "
30 print:"(F80) (ORN) (F82) (F83) (F84) (F1) (F
3) (F5) (F7) (F2) (F4) (F6) (F8) (CR) (UPR) (F8F
7) "
40 print:"(BLK) (UP) (RDF) (CLS) (INS) (BRN) (L
RD) (GV1) (GV2) (LGN) (LBL) (GV3) (PUR) (LEF) (V
EL) (CYN) "
50 print:"(CLS) (LDWN) (LRTG) message! (HOM)
(2DWN) "
60 print:"commodore graphics(next line)"
70 print"a(#B0)b(#BF)c(#BC)d(#AC)e(#B1)f
(#BB)g(#A5)h(#B4)i(#A2)j(#B5)k(#A1)l(#B6)
m(#A7)n(#AA)o(#B9)p(#AF)q(#AB)r(#B2)s(#
AE)t(#A3)u(#BB)v(#BE)w(#B3)x(#BD)y(#B7)z
(#AD)+(#A6)-(#DC) *(#AB)^(#A4) *(#DF) "
80 print"shift graphics: +(#DB)-(#DD)\(#
A9)@(#BA)^(#FF)*#E > "
    
```

```

0 goto120
10 *****
20 *
30 * basic loader to accompany *
40 *
50 * basic lister program *
60 *
70 * for centronics printer *
80 *
90 * written by *
100 *
110 * william mackay *
120 *
130 * june 1985 *
140 *
150 *
160 *
170 *
180 *
190 *
200 *
210 *
220 *
230 *
240 *
250 *
260 *
270 *
280 *
290 *
300 *
310 *
320 *
330 *
340 *
350 *
360 *
370 *
380 *
390 *
400 *
410 *
420 *
430 *
440 *
450 *
460 *
470 *
480 *
490 *
500 *
510 *
520 *
530 *
540 *
550 *
560 *
570 *
580 *
590 *
600 *
610 *
620 *
630 *
640 *
650 *
660 *
670 *
680 *
690 *
700 *
710 *
720 *
730 *
740 *
750 *
760 *
770 *
780 *
790 *
800 *
810 *
820 *
830 *
840 *
850 *
860 *
870 *
880 *
890 *
900 *
910 *
920 *
930 *
940 *
950 *****
    
```

```

110 rem read mc,poke into memory
120 base=124096+13*256+15*16:bytesdiv16
=33
122 rem base=start address for routine
126 rem bytesdiv16=no of full data lines
130 by=by-1:s=0:print"please wait while
mc. loaded"
140 for j=ba to ba + by*16 step 16
150 for i=j to j + 15
160 read a:poke i,a:s=s+1:next
170 read a:s=s-int(s/65536)*65536
180 ifa<0>=int(s/256)*256:then print"erro
r in"int((i-ba)/16)"th data line":stop
190 next
200 read a,b:a=256*a+b:rem mod 64 k chec
ksum
210 ifa<0>then print"total checksum in e
rror":stop
220 print"data ok":print"(LWR)":rem"CTRL
n"
230 print:print"sys52720 to activate"
240 print:print"Then list program in usu
al way"
250 print:print"Once activated, more tha
n one program may be loaded and listed"
260 print:print"To load with basic progr
am in memory,add these lines"
270 print"0 stop"
280 print"1 load"chr$(34)"basic lister"ch
r$(34)",1,1"
290 print:print"Then type goto!"
999 end
1000 data169,26,141,32,03,169,206,141,33
,03,169,50,141,38,03,169,213
1010 data206,141,39,03,169,00,141,254,20
7,141,255,207,162,10,134,198,176
1020 data189,242,207,157,118,02,202,208,
247,96,32,15,243,240,03,76,149
1030 data01,247,32,31,243,165,186,41,04,
208,03,76,91,242,133,154,214
1040 data24,96,72,167,04,37,154,208,04,1
04,76,202,241,104,141,253,55
1050 data207,138,72,152,72,173,254,207,2
40,24,205,253,207,208,16,141,64
1060 data254,207,169,01,248,24,109,255,2
07,141,255,207,216,208,50,32,87
1070 data154,206,173,253,207,201,13,208,
09,32,21,207,173,47,207,24,174
1080 data144,28,201,32,144,217,201,65,14
4,20,201,91,176,02,09,32,89
1090 data201,128,144,10,201,192,144,199,
201,217,176,195,41,127,32,21,16
1100 data207,104,168,104,170,173,253,207
,24,76,169,173,32,21,207,173,199
1110 data255,207,201,01,240,21,74,74,74
,74,240,05,09,48,32,21,239
1120 data207,173,255,207,41,15,09,48,32,
21,207,173,254,207,201,160,145
1130 data144,24,72,74,74,74,74,32,11,207
,141,241,207,104,41,15,144
1140 data32,11,207,141,242,207,162,192,2
08,14,201,128,144,02,233,96,60
1150 data141,255,207,10,109,255,207,170,
232,232,232,142,255,207,202,202,46
1160 data202,189,48,207,32,21,207,232,23
6,255,207,208,244,169,125,32,100
1170 data21,207,169,00,141,254,207,141,2
55,207,96,24,105,246,144,02,15
1180 data105,06,105,58,96,72,169,255,141
,03,221,169,251,45,02,221,142
1190 data141,02,221,169,04,45,00,221,208
,251,104,141,01,221,96,10,185
if75 rem auto if flag **
1200 data78,85,76,36,48,49,36,48,50,36,4
8,51,36,48,52,87,25
1210 data72,84,36,48,54,66,69,76,68,73,8
3,69,78,83,09,76,36
1220 data70,00,86,84,00,70,70,00,67,82,7
6,87,82,00,83,73,198
1230 data36,49,48,68,87,78,82,79,78,72,7
9,77,68,69,76,36,00
1240 data49,53,36,49,54,36,49,55,67,65,7
8,36,49,65,36,49,58
1250 data66,69,83,67,82,69,68,82,73,71,7
1,82,78,66,76,85,222
1260 data36,56,48,79,82,78,36,56,50,36,5
6,51,36,56,52,00,06
1270 data70,49,00,70,51,00,70,53,00,70,5
5,00,70,50,00,70,172
1280 data52,00,70,54,00,70,56,94,67,82,8
5,80,82,36,56,70,102
1290 data66,76,75,00,85,80,82,79,70,67,7
6,83,73,78,83,66,217
1300 data82,78,76,82,68,71,89,49,71,89,5
0,76,71,78,76,66,109
1310 data76,71,89,51,80,85,82,76,69,70,8
9,69,76,67,89,78,46
1320 data36,66,68,79,208,49,44,52,58,67,
77,68,49,13,00,00,212
1330 data215,212
    
```

In the import game

by Craig Beaumont

What would the cost be to import a green screen 6128?

I was interested in finding this out so I wrote to MICRO-X Limited in the U.K. and asked for a quote.

This is what came back a few weeks later:—

CPC 6128 (green)	£245
Post, Packaging & Insurance	£50
Total	£295

Note that the 6128 price is discounted and carries no VAT so it is less than the U.K. retail price.

To find the final cost of having the beastly taking up space on my disk it was necessary to convert the quote to \$NZ, add the appropriate sales tax and the cost of a banker's draft for the foreign exchange.

The sales tax rate on both the monitor and computer are the same at 10% and a banker's draft from the BNZ costs \$2.55.

Assuming an exchange rate of 0.3500 or \$2.86 to £1 then:—

CPC 6128 (green)	\$700.00
Sales Tax	\$70.00

Post, Packing & Insurance	\$142.86
Cost of Banker's Draft	\$2.55

Total **\$915.41**

You will need to adjust these figures to account for the exchange rate at the time of purchasing the banker's draft.

The easiest way to do this is to divide the quoted price by the exchange rate in the paper — e.g. £245/0.3500 = \$700.

So there is a large cost advantage in importing direct — the NZ retail price for the 6128 is \$1595.

There are other considerations like possible difficulties in having the warranty acted on, but given the comparative reliability of Amstrads this is a minor concern.

There should be little chance of the price in the U.K. rising — it is far more likely to have fallen.

Editor's note:— This was a theoretical import exercise. Craig did not actually follow through with the import of an Amstrad.

Therefore he could not report on the predictable problems like: delays, loss of consignment, damage in

transit, insurance claims, exporter's liabilities (for inoperative equipment) or of Micro-X's reliability.

Such risks would also have to be part of anyone's import calculations.

Thanks to Microstyle Computers Ltd in Lower Hutt I can review two animated adventures by Gargoyle Games.

They are Dun Darach and Marsport. While based on the same animation technique they are from completely different worlds.

You are Cuchulainn the Great returning from battle. Your comrade Loeg is captured and imprisoned by Skar, a strikingly beautiful Sorceress. You make a mighty vow to rescue Loeg and after an arduous journey you come to the city of Dun Darach...

The city is outwardly normal with named streets and numbered houses. This makes mapping simple — a necessary exercise to really master the game.

It is populated by a variety of characters with whom you can interact. Some types of interaction are — buying and selling objects for iridi (the unit of currency), working, banking, bribery and crime. All help you to your ultimate aim — rescuing Loeg.

Throughout your explorations of the

SEKONIC SPL-400 X-Y PLOTTER

- 6 colour automatic pen change
- On board Centronics interface
- 200mm/sec axial pen speed
- 0.1 mm step size
- 8 directional position keys
- 24 stored plotting commands
- RS 232C & IEEE 488 interface adaptors available

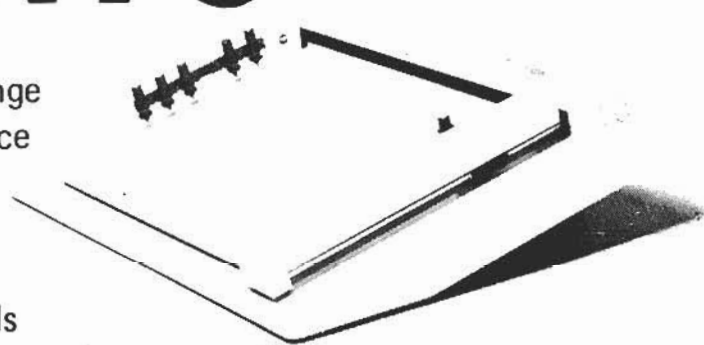

SPL-400: an extremely competitively priced digital X-Y plotter for the home enthusiast, draughtsperson or the latest in C.A.D. systems.

SOLE NEW ZEALAND AGENT

DEALER ENQUIRIES WELCOME



E C GOUGH

ELECTRONICS & INSTRUMENTATION DIVISION

E.C. Gough Ltd

Auckland: Phone 763-174
Wellington: Phone 686-675
Christchurch: Phone 798-740
Dunedin: Phone 775-823

city you will come across sub-quests; one of these where iridi can be quickly gained or lost in a gambling den.

This game is definitely non-violent as you can't "die", even after committing the most diabolical crime.

In contrast Marsport is the first of the "Siege of the Earth" trilogy. As in all good sieges there is a fair amount of confrontation — in this one it's you against Wardons, Sept Warriors and others.

Marsport is organised into lettered levels and sectors with numbered corridors. You move between levels by means of lifts. These stop only at the top or bottom of their shaft, to get to other levels you must find another lift — this feature builds up a sometimes confusing 3-D labyrinth.

Each level presents its own challenge to overcome. The corridors have wall cabinets of various types that allow you to manipulate objects. For example by collecting flour, water and a baking tin from supply cabinets you can assemble a cake (however tasteless) that helps with one of these challenges.

Marsport also has a games section. With the help of Infomat to tell you what keys to use, you can keep yourself amused for a while playing cat & mouse and connect 3.

Those are the differences in the games. What they have in common are their smoothly animated characters, their lack of sound, their menu options and their key layout.

The effort required for animation probably explains the lack of sound.

Apart from some comments about flat-footedness it is brilliant — especially when you drop to your knee to blast away a Sept Warrior in Marsport.

The menu options include saving and restoring the game status as they may take a number of sessions to complete. The key layout is comfortable and is based on the idea of controlling a camera watching your own character.

Altogether these two adventures are just as intriguing as the "normal" text/graphic types — with the atmosphere and special possibilities given by animation.

While at Microstyle I asked for a demonstration of the 8256 and its word processor program Loco Script. The main aim of this was really to test the little printer (it's about half the depth of the DMP-1) that comes with the machine. It performed well — the letter quality mode being the best I've seen in that range of printers and it was quiet too.

The machine itself is not software compatible with the other Amstrads so it won't form part of this column.

Now Amstrad have put out four computers within 18 months — that must be some sort of record!



To go with last issue's character set program I have found a little piece of machine code to help print double height characters.

The m/c routine slices a character in half horizontally then spreads the halves over the characters with ASCII values 254 and 255.

In its present form the attached program containing the routine puts a space between each double height character — if you want them next to each other just delete "CHR\$(9);" in line 210.

Line 80 illustrates a way to avoid typing "&" for each piece of HEX data and line 180 shows how to move through each character of a string.

The characters with ASCII values 8 to 11 printed in lines 200 and 210 move the cursor to the desired location to print the next visible character.

The program contains an example of the routine in action that should also show how to use it.

```
10 REM Double Height Characters
20 GOSUB 50:REM Set up m/c
30 TEXT$="HELLO":LOCATE 10,10:GOSUB 160
40 LOCATE 20,10:END
50 REM Double Height Char m/c
60 MEMORY HIMEM-50:ad=HIMEM+1
70 FOR I=ad TO ad+49
80 READ a$:POKE i,VAL("&"a$)
90 NEXT
100 DATA CD,06,B9,F5,3E,00,CD,A5,BB,DD
110 DATA 21,32,90,06,08,7E,DD,77,00,DD
120 DATA 77,01,23,DD,23,DD,23,10,F2,F1
130 DATA CD,0C,B9,3E,FE,21,32,90,CD,A8
140 DATA BB,3E,FF,21,3A,90,CD,A8,BB,C9
150 RETURN
160 REM Print Double Height Char
170 FOR I=1 TO LEN(text$)
180 POKE ad+5,ASC(MID$(text$,I,1))
190 CALL ad
200 PRINT CHR$(254);CHR$(10);CHR$(8);
210 PRINT CHR$(255);CHR$(11);CHR$(9);
220 NEXT:RETURN
```



MICRO SOFTWARE HIRE CLUB

OPEN WEEKDAYS & SATURDAY MORNINGS

Commodore VIC20 & 64 – AMSTRAD

ATARI – BBC – SPECTRUM – ELECTRON

☆☆ BRANCHES ☆☆

<p>AUCKLAND C B CENTRE PH 444-8063 15A Porana Rd Takapuna THE COMPUTER TERMINAL PH 419-0543 257 Hinemoa St Birkenhead ABACUS VIDEO CENTRE PH 864-151 16 New Bond St Kingsland K ROAD COMPUTERS PH 399-655 65 Pitt Street MANUKAU COMPUTERS (NZ) LTD PH 656-002 Greenwoods Corner, Epsom SOUTH AUCKLAND COMPUTERS PH 299-6030 214 Gl South Rd Papakura</p> <p>ROTORUA CHANNEL FIVE PH 89-164 87 Fenton Street</p> <p>NORTHLAND GARNET KEENE PH 84-999 36-40 Rainbone St Whangarei</p> <p>TAUPO Kiwi Computer Services Ph (074) 83-028 C/- Terrys Tyre Services Runanga Street</p>	<p>WAIKATO COMPUTER ROOM LTD PH 437-876 177 Ward St Hamilton</p> <p>GISBORNE PERSONAL & BUSINESS COMPUTERS LTD PH 88-256 115 Gladstone Road</p> <p>NEW PLYMOUTH TRIO BUSINESS CENTRE LTD PH 85-226 635 Devon Road</p> <p>TOKOROA AUDIO HI-FI SERVICES LTD PH 68-922 Dreghorn Place</p> <p>HAWKES BAY COMPUTER CONNECTION PH 51-965 18 Dutton St Napier</p> <p>GREYMOUTH Centrepoint Records Mackay Street Greymouth Ph 5956</p>
--	--

Mail Order other than through Clubs –

<p>NORTH ISLAND Kiwi Computer Services P O Box 822 Taupo Ph (074) 83-028</p>	<p>SOUTH ISLAND Centrepoint Records Mackay Street Greymouth Ph 5956</p>
--	---

☆☆ Trade enquiries welcome ☆☆

A Branch Franchise may be available in your area.
Please Contact Phone 444-8063 or write
Box 33-196 Takapuna, Auckland.

The Puzzle of Panos

by Pip Forer

Last month we began to review the 32016 second processor and discussed its capabilities as a super BASIC machine. We complete that task now with a look at its heavier side: its ability to run C, LISP, Fortran and Pascal. The processor comes as a system bundled with these options, which can be installed on NFS, DFS or ADFS. All four run under PANOS, the proprietary operating system of Acorn. Unlike Pandora, which is ROM-based and makes the 32016 virtually transparent to an established BBC user, PANOS is disk based and operates very differently from the normal environment.

My comments must be circumscribed by the provisional nature of the PANOS documentation that I had to hand but PANOS is best described as a sophisticated, text-orientated, disk-based operating system.

It includes a powerful text editor, which is common to all languages supported, and a variety of other utilities including support of time and date stamping of files.

It embraces environments for compiling and linking programs and is procedurally structured to allow execution of one program from another with eventual return to the initiating program for completion of processing.

Compiled code is completely relocatable and one job can use and integrate modules from another language.

The languages are all supersets of ISO standards and come from UK software houses in Edinburgh and Cambridge. At present their built-in extension to handle BBC graphics or I/O system calls have not been fully described (this is not to say there are problems in handling graphics via VDU commands suitably accessed) but quite clearly the implementation can both generate and accept code for or from other systems as well as produce impressive software for the BBC.

The compatibility of the compilers and

Are Beeb users to get 16/32 bits?

their range offers a good environment for developers. One might construct an intelligent front end with Lisp (the favoured American AI language), numeric processing with Fortran or Pascal and perhaps some bit-map graphics utilities with C, all for a specific application package.

Two drives

Unlike Pandora, with BBC BASIC it took me a little while to get PANOS operating. Things improved dramatically when I read the documentation however.

For a start it became clear that you must have two disk drives to make it work at all.

Once over that hurdle we got into gear quite quickly.

PANOS at present is in a youthful stage, which is to say that not everything is in place and at times one volume of documentation contradicts another.

To be fair the documentation stresses that this is a trial release and it should be judged as such. By the time you read this I would expect these (very minor) quibbles to be completely corrected.

Setting PANOS up with a language requires a little disk copying to get PANOS on one disk side, its utilities and some program library routines on a second and the language on a third. This leaves one side free for programs.

My testing ran to using PANOS under DFS only: the install options for NFS caused me some trouble and to meet the deadline I passed over an NFS test. However since the 32016 runs flawlessly on the network under Pandora, I would expect no problems.

Fluency

For this review I experimented with the Fortran and C compilers as well as running some of the demonstration programs (one of which makes the interesting claim that the NS32016 can run the SPICE utility 40% faster than a VAX 750).

Language documentation varies greatly in quantity, and for most languages simply covers differences from established standards, i.e. you need to buy a tutor/reference text unless you are fully at home with a language of your choice. The 32016 assembler and instruction set are heavily documented, the C least so.

Loading PANOS takes about 12 sec-

GANNET SOFTWARE

PRESENTS

SERIOUS SOFTWARE FOR ATARI COMPUTERS

GANNET Software has developed a series of BUSINESS programs for the Small to Medium New Zealand Business.

With an ATARI Computer, 1C50 Disk Drive, 1029 Printer and one or more Programs from the Gannet Series you can get SERIOUS about Business.

NOW AVAILABLE

DEBTORS : CREDITORS : STOCK (\$135.00 each)
GENERAL LEDGER (\$160.00)

Prices include MANUAL and Postage.

Enquiries and Orders to:

GANNET SOFTWARE

251 CLIFTON ROAD,

TE AWANGA,

HAWKES BAY.

TELEPHONE (070) 750-203

onds. From there you can create programs through a full-screen edit utility that is simple to use and is designed to allow multiple window editing.

The editor takes about 15 seconds to load.

Create your Fortran program here and save it.

It is then necessary to compile the program and, if successful, link it. When completed successfully you are left with relocatable code that can be actioned by just typing the file's name.

I produced a brief program for 10000 square roots as per last week's benchmark. In Fortran the compilation took about 25 seconds, the linking perhaps 15.

The actual calculations took approximately 5 seconds. This is 5 times faster than the 32016 BASIC (and hence 20 times the speed of BBC BASIC).

High speed

It is clearly a powerful processor. Although I had no time to try the square root comparison under C the demonstrations include a Sieve of Eratosthenes benchmark which executes in 2.5 seconds.

This compares with timings reported by Webster's column in Byte for IBM PC (Turbo Pascal) and Macintosh (compiled C and Pascal p-code) of 25.9, 6.5 and 104.1 seconds respectively.

Crude benchmarks may only approximate the truth but the general comparisons give some feel for where the 32016 stands.

Working with PANOS is not unlike working with your own private mainframe or mini: it has sophisticated but complex language options, editors and commands; very powerful but not especially friendly; many error messages, but few self-explanatory to the learner.

Like any such system it is best suited to large (i.e. hard disk) storage media.

At present floppies restrict space and slow the speed.

This latter is significant because even with a large RAM, PANOS does not at present swap utilities permanently into memory (for instance the editor has to re-load each time it is used).

All in all the PANOS/32016 combination offers a good, traditional programmer's development environment but is not yet set up to provide a more appealing user interface for us in education in general.

No doubt this will change and for the present an advanced programming class would certainly revel in the facilities it offers.

Beeb's successor?

One might second-guess a little as to where PANOS may go.

One puzzle is why Acorn chose to design an operating system of their own.

Part of the answer to this may be that Acorn will eventually look for a 16/32 bit successor to the Beeb, and one compatible with Econet conventions.

We have seen that the 32016 can run a lot of standard BBC BASIC programs with little or no change. And with a WIMPs front-end the power is there also to allow the transition across to 16/32 bit computing.

A front end like GEM might run quite smoothly on such a powerful chip.

PANOS may be developing with this sort of progress in mind.

Acorn have a very attractive scientific workstation: in terms of bangs for bucks it is quite outstanding. They are within reach of their aim of an upgrade path from the 6502 to a 16/32 bit chip with minimal user disruption.

It will be interesting to see how they

progress from here to a mainstream educational workstation.

The forthcoming Cambridge Workstation specs are not modest, starting at 1 megabyte of RAM as minimum and the release of this may offer some pointers. More on that in June 1986.

Network Software

This column has several times referred to the potential for software that uses the network to the full.

Don Austin in Tokoroa writes with news of just such software developed by him that uses many of the network's good features.

French Suite and German Suite permit a class to run a series of tutorial units on Econet with the teacher being able to monitor progress on a control machine.

This machine can check progress, halt lessons, send messages and, most impressively, modify the progress of any individual's tuition path as they progress through a unit.

Some of you may have seen this demonstrated at the NZCES National Conference.

It is a rather different mode of teaching than the simulations we have discussed before but another illustration of the strength of communication between users.

Any other initiatives happening out there?

Meanwhile, in the glitches department, the listing of the network logger had a procedure omitted (as several readers have let me know). Anyone wanting a full and proper copy just drop a line.



SEE THINGS MORE CLEARLY WITH ROLAND

HI-RES MONITORS

In RGB colour:

740 x 400 line 12-inch, 15-inch

640 x 240 line 12-inch, 14-inch

In Monochrome:

12-inch 80-char green or amber composite

12-inch 80-char green or amber IBM type

12-inch black-on-white IBM-compatible

14-inch black/white reversible IBM-compat.

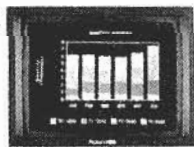

INTELLIGENT X-Y PLOTTERS

From the precision A2-size 8-pen (Resolution 0.0125mm) for CAD and camera-ready PCB art, to entry-level 1-pen and 8-pen there are 5 Roland models, all with parallel AND serial, wide range of commands, extensive software support and proven reliability.

ROLAND — the preferred monitor for IBM & all compatibles, BBC, Apple, Apricot.

GRAPHICS CARDS FOR IBM, ETC.

FROM STB (USA) all programmable

- ★ Graphics in color and mono with automatic switching, spool, Ramdisks, port, accelerator, etc.
- ★ Mono graphics with grey-scale resolution of color
- ★ Super Hi-res 400-line color

FROM ARIES (Taiwan) all programmable

- ★ Mono graphics & port with utilities, suits CAD
- ★ Color Graphics adaptor
- ★ Mono Display of Text

SUPPLIERS FOR ALL PLOTTERS

Glossy and Matt papers in A2 and A3. Pens in fibre, ceramic, oil OHP, ball-point, liquid ink.

NZ Distributors for Roland DG Corporation:

Concord Communications Ltd. Box 36-045 Auckland, 9.
Phone (09) 504-046

Roland DG

Hyper-Tunnel

By S. Shearman

This is a hi-res game for any Apple. The object is to rescue men trapped at the bottom of a pit. You must fly a craft down a twisting tunnel, pick up the men, and fly back to the surface. Your ship sinks straight down until it reaches the tunnel entrance, when you gain control of it with the left and right arrow keys.

```

5 REM BY S.SHEARMAN
6 REM DEDICATED TO R.BRUCE
10 HCOLOR= 3
20 CLEAR
30 SCALE= 1: ROT= 0
40 POKE 232,0: POKE 233,96
50 GOTO 390
60 FOR I = 24576 TO 24576 + 37: READ A: POKE I,A: NEXT
70 RETURN
80 RESTORE : FOR I = 768 TO 776
90 READ X: POKE I,X
100 NEXT
110 DATA 169,0,162,0,160,0,76,17,244
120 DATA 200,192,40,240,3,76
130 N = 2:L = 4 * (16 ^ 3):I = DD:L1 = L: POKE 230,32:Z = 2
140 X = 160: GOSUB 340:X = 0: GOSUB 340
150 FOR Y = 191 * (I = -1) + N * I TO 191 * (I = 1) STEP I * Z
160 X = 185: GOSUB 340
170 GOSUB 350
180 X = 153: GOSUB 340
190 Y = Y - N * I
200 GOSUB 350
210 Y = Y + N * I
220 NEXT
230 X = 169: GOSUB 340:X = 0: GOSUB 340
240 FOR Y = (192 - N) * (I = 1) TO 191 * (I = 1) + (N - 1) * (I = -1)
250 X = 153: GOSUB 340
260 GOSUB 350
270 NEXT
280 FOR I = 1 TO 6: READ X: GOSUB 340
290 NEXT
300 Y = L1 + 2: POKE L,Y - INT (Y / 256) + 256:L = L + 1
310 POKE L, INT (Y / 256):L = L + 1
320 X = 96: GOSUB 340
330 RETURN
340 POKE L,X:L = L + 1: RETURN
350 POKE 769,Y: CALL 768
360 POKE L, PEEK (38):L = L + 1
370 POKE L, PEEK (39):L = L + 1
380 RETURN
390 HOME :SR = 16384:DD = - 1
400 VTAB 12: HTAB 15: INVERSE: PRINT "HYPER-TUNNEL": NORMAL: GOSUB 102
410 GOSUB 60
420 GOSUB 1600
430 GOSUB 1640
440 DP = 1:M = 150:N = 121:Y = 180:F = 0:G = 279
450 GOSUB 1680
460 POKE 16385,10
470 GOSUB 620
480 GOSUB 750
490 GOSUB 1050
500 IF DP = 150 THEN GOSUB 620:F = 70:G = 289
510 IF DP = FD - 100 THEN HCOLOR= 0: GOSUB 620
520 IF DP = FD THEN GOTO 550
530 GOSUB 1070
540 GOTO 490
550 GOSUB 1090: REM TOUCH DOWN LIFT OFF
555 HPLLOT 0,0 TO 0,191: HPLLOT 279,0 TO 279,191
560 GOSUB 1050
570 IF DP = FD - 130 THEN GOSUB 620:F = 70:G = 289
580 IF DP = 250 THEN GOSUB 640: GOTO 600
590 GOSUB 1070: GOTO 560
600 GOSUB 1210
610 GOTO 440
620 IF PEEK (16385) = 0 THEN POKE 16385,10: POKE 16966,36: RETURN
630 POKE 16385,0: POKE 16966,40: RETURN
640 XDRAW 1 AT M,N: XDRAW 2 AT M,N + 1: XDRAW 2 AT M - 7,N + 1: RETURN
650 XDRAW 1 AT M,N: XDRAW 2 AT M,N + 1: IF PEEK (234) = 0 THEN GOTO 14
20
660 XDRAW 2 AT M - 7,N + 1: IF PEEK (234) = 0 THEN GOTO 1420
670 RETURN
680 HOME : VTAB 21: PRINT "SCORE":SC: HTAB 30: PRINT "DEPTH":DP
690 VTAB 22: PRINT "HI-SCORE":HS: HTAB 30: PRINT "ROUND":RD
700 VTAB 23: PRINT "LEVEL":LV: HTAB 30: PRINT "MEN":MN
710 RETURN
720 : VTAB 21: HTAB 7: PRINT SC: RETURN
730 VTAB 21: HTAB 36: PRINT DP: CALL - 868
740 RETURN
750 HDR
755 HPLLOT 0,0 TO 0,191: HPLLOT 279,0 TO 279,191
760 X = 0
770 FOR I = 1 TO 190 STEP 2
780 GOSUB 1010
790 HPLLOT 0,190 TO 0 + X,190: HPLLOT 279,190 TO 279 - X,190
800 X = X + 2: IF X = 120 THEN X = 120
810 CALL SR
820 NEXT

```



```

830 X = 120 + INT ((40 - W) / 2)
840 RETURN
850 C = INT (RND (5) * 2) + 1
860 IF C = 1 THEN X = X + 0
870 IF C = 2 THEN X = X - 0
880 IF X < 70 THEN X = 70
890 IF X > 209 THEN X = 209
900 RETURN
910 A = PEEK (49152)
920 IF A < 128 THEN NM = N: GOTO 940
930 POKE 49168,0
940 IF A = 149 THEN NM = M + R
950 IF A = 136 THEN NM = M - R
960 RETURN
970 FOR I = 1 TO 5
980 FOR S = UA TO UB STEP UC
990 XDRAW 3 AT S,UD:K = PEEK (- 16336): XDRAW 3 AT S,UD: NEXT
1000 SC = SC + 500: GOSUB 720: PRINT CHR$ (7): NEXT : RETURN
1010 GOSUB 650: GOSUB 640:DP = DP + J: GOSUB 730:K = PEEK (- 16336): RETURN
1020 VTAB 23: FLASH : HTAB 16: PRINT "REFUELING"
1030 NORMAL
1040 DD = - DD: GOSUB 96: RETURN
1050 GOSUB 910: GOSUB 1080: GOSUB 850:M = NM: GOSUB 650:DP = DP + J: GOSUB
730: RETURN
1060 GOSUB 910: GOSUB 1080:M = NM: GOSUB 650:DP = DP + J: GOSUB 730: RETURN
1070 GOSUB 640: CALL SR: RETURN
1080 HPLLOT F,Y TO X,Y: HPLLOT 6,Y TO X + W,Y: RETURN
1090 HCOLOR= 3: HPLLOT 0,159 TO 279,159
1100 GOSUB 640
1110 FOR N = M TO 157: GOSUB 1010: NEXT
1120 N = N - 1: GOSUB 640
1130 UA = 275:UB = M + 2:UC = - 1:UD = 152: GOSUB 970
1140 GOSUB 1020
1150 J = - J
1160 GOSUB 680
1170 F = 0:G = 279
1180 N = 157: GOSUB 640
1190 Y = 1: FOR N = 157 TO 101 STEP - 1: GOSUB 1010: NEXT
1200 RETURN
1210 GOSUB 1060: IF X > 120 THEN B = - 1
1220 IF X < 120 THEN B = 1
1230 IF X = 120 THEN GOSUB 1070: GOTO 1270
1240 X = X + B
1250 GOSUB 1070
1260 GOTO 1210
1270 X = 120: FOR S = 1 TO 20: GOSUB 1060: GOSUB 1070: NEXT
1280 X = 120: GOSUB 620:F = 0:G = 279
1290 X = X - 2:W = W + 4: GOSUB 1060: IF X = < 0 THEN GOSUB 1070: GOTO
1310
1300 GOSUB 1070: GOTO 1290
1310 FOR N = N TO 10 STEP - 1
1320 GOSUB 1010: NEXT
1330 GOSUB 640
1340 HPLLOT 279,10 TO M + 5,10
1350 UA = M + 3:UB = 269:UC = 1:UD = 3: GOSUB 970
1360 GOSUB 1550
1370 CALL - 3086
1380 J = - J
1390 GOSUB 680
1400 RETURN
1410 END
1420 SCALE= 100
1430 FOR I = 0 TO 64: ROT= 1: XDRAW 2 AT 140,96:K = PEEK (- 16336)
1440 NEXT
1450 FOR I = 1 TO 5: PRINT CHR$ (7): NEXT : SCALE= 1
1460 MN = MN - 1: IF MN = 0 THEN GOTO 1480
1470 CALL - 3086:J = 1: GOTO 440
1480 HOME : VTAB 12: HTAB 16: PRINT "GAME OVER"
1490 FOR I = 1 TO 100
1500 POKE 49232,0:K = PEEK (- 16336): POKE 49233,0: NEXT
1510 VTAB 1: HTAB 5: PRINT "YOUR SCORE WAS ";SC
1520 IF SC ) HS THEN HS = SC
1530 VTAB 22: HTAB 7: PRINT "HIT ANY KEY TO CONTINUE": GET A#: GOTO 390
1540 END
1550 TEXT : HOME : VTAB 12: HTAB 5: PRINT "CONGRATULATIONS YOU COMPLETED
ROUND ";RD
1560 PRINT 1RD = RD + 1: HTAB 12: PRINT "PREPARE FOR ROUND ";RD
1570 GOSUB 1020
1580 HOME
1590 RETURN
1600 SC = 0:DP = 0:M = 150:N = 121:D = 2:W = 70:Y = 180:F = 0:G = 279
1610 J = 1
1620 RD = 1:MN = 3:LV = 1
1630 RETURN
1640 REM INPUT LEVEL
1650 LV = 1: GOSUB 680: VTAB 23: HTAB 7: INPUT "LEVEL:LV":LV = VAL (LV)
1660 IF LV < 1 OR LV > 5 THEN GOTO 1650
1670 GOSUB 680: RETURN
1680 IF LV = 1 THEN W = 30:R = 2:0 = 2:FD = 500
1690 IF LV = 2 THEN W = 25:R = 3:0 = 3:FD = 700
1700 IF LV = 3 THEN W = 20:R = 4:0 = 4:FD = 900
1710 IF LV = 4 THEN W = 15:R = 2:0 = 2:FD = 1200
1720 IF LV = 5 THEN W = 15:R = 4:0 = 4:FD = 1500
1730 GOSUB 680: RETURN
1740 DATA 3,0,8,0,21,0,23,0,63,63,63,39,37,45,53,37,193,219,63,0,5,0
,55,45,188,50,63,77,253,50,55,111,1,193,46,7,0

```

Strings to enable searches

by Dick Williams

This month's article is about strings. Strings of characters, strings of numbers, adding strings and searching through strings for selected characters, taking the left, right, or middle of strings and counting the number of characters in a string.

As this subject can get a bit complicated for the typesetter, I have provided most of the examples as short programs at the end of this article, and each one will relate to a particular aspect of string handling.

There is no need to type in the rem comments in the programs as these are just to describe what the program is doing.

There are ten short programs in all.

The first shows the basic idea of a string of characters stored in A\$, B\$ and C\$ and then these three strings added together (concatenated) to produce a result on the screen.

Some of you may not realise that the computer stores strings in two places in its memory.

The first place is in the line numbers and the second place is in a part of memory reserved for the storage of strings.

It's easy to prove this, just type in program one and press reset. Note down the bytes free and then run the program.

If you now press reset the bytes free will have dropped, indicating that further memory has been used up.

If you now delete the program lines, using delete 10-80 +CR, and once again press reset, the bytes free will have increased, but not up to the normal memory capacity.

The reason is that even though you have deleted the program that created the strings, they are still in the memory and can be called up by print A\$, or print B\$ or print A\$+B\$.

These strings will stay in the computer memory until you cancel them by run, load, new, power off, or by setting them to a null string by this: A\$="":B\$="":C\$="" +CR.

Two problems

This aspect of strings, that they are stored in a separate part of the computer memory, leads to two different problems with the Sega.

The first is that there is a problem with saving them to tape. There is no facility in the Sega to save strings (or variables) to tape although it can be done relatively easily by modifying the end of program pointers. I have covered this point in a previous article (Feb 1985).

In these simple learning programs the lack of tape string storage will not be a problem. However, if you want to go further and really get into string storage then a disc drive would be necessary.

The second problem with strings stored in the computer string storage area is that you can't see them. How is this a problem?

Well, you have to imagine that your strings are stored in a part of the memory that you can't see and while it is a safe place, a mistake on your part can easily wipe them out in a fraction of a second.

For example, say you type in program one and after running it a few times decide to delete 10-80 as I suggested above, then you will still have the strings in the unseen string storage area and can still call them up with print A\$ etc.

But if you run and then try to call up A\$ you will find that it's gone.

Three into one

Program one is to introduce strings and is a very simple creation of three strings A\$ B\$ and C\$, and then the addition of these three strings to produce a longer one. The point being that D\$ is a brand new string created by the addition of A\$ B\$ and C\$.

The new string, D\$, shows the three words joined up together and as such don't make sense. This is to illustrate that strings add without a space.

The last part of program one shows a space being inserted between the words

(Continued on page 56)

Low-cost colour print

A printer costing less than \$700, that offers colour printing and can prepare acetate transparencies, has been announced by AWA New Zealand Ltd.

The Okimate 20's 24-element print head produces more than 100 shades. It can also print a colour transparency and reprint in black with grey tones for photocopies and can be used with thermal paper and no cartridge for black printing.

It offers 80 c.p.s. utility and 40 c.p.s. letter-quality printing for word proces-

sing, and is Oki's first printer which is Commodore-compatible. Other versions are for IBM, Apple, standard, serial and parallel connections.

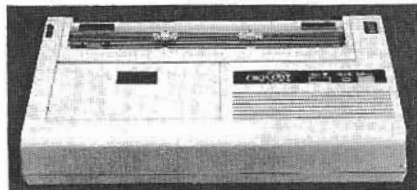

The PC Plotter:

An extraordinary graphics value!

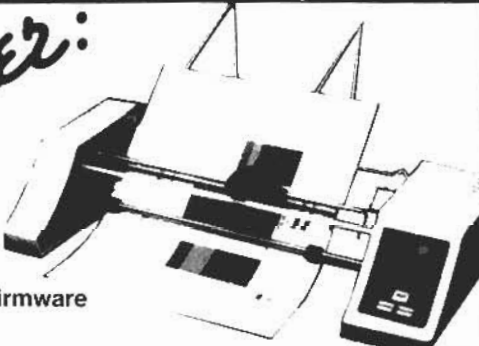

DM/PL firmware

<p>Model 595 — A4 size plots</p> <p>Model 695 — A4 & A3 plots</p> <p>4 pens — 4 colours</p> <p>Type: A synchronous serial RS232C</p> <p>Buffer: 256 bytes</p> <p>Byte format: 7 data bits, 1 parity bit (selectable), 2 stop bits</p>	<p>Baud rate: 300, 1200, 2400, 9600</p> <p>Speed: 3 ips. axial</p> <p>Resolution: .001", .005", .1mm, .025mm</p> <p>Software Smart</p> <p>Easy to use, operate, install</p>
---	---

houston instrument

"the recorder company"

FOR COST
EFFECTIVE

Recording Plotting:

N.Z. REPRESENTATIVE

S.D. MANDENO ELECTRONIC EQUIPMENT CO.

10 WOODHALL ROAD, EPSOM, AK 3. PH 600-008. TELGRMS "NUCLEONIC"

(Continued from page 55)

so that it looks right when we read it.

The maximum number of characters in a string in the Sega is limited to about 240, so it follows that adding three strings each having 100 characters would not work since the total is 300. You get a "string too long" error message.

Programs 3, 4, 5, 6 and 7 show the various ways of taking the left, right or middle of a string and placing the selected portions into D\$.

Programs 8-10 show how to search a string for selected characters.

Code similar to these last three programs make it very easy to obtain data from them. For example, I use program 9 to search 1000 strings to find how many items have been sold at the shop.

All customers have a code such as A1, A2, B1 etc where the alpha character is the first letter of their surname and the number is their code number in that alpha group.

By searching all sales strings (stored on disc) we can quickly count up how many of an item have been sold and also to whom.

Using program 10, we can also find for our video tape library who was the last person to rent a tape. All very easy and quick.

Take the trouble to type each of these programs in and get to know exactly how each one works, because this will help you build up your knowledge of strings on the Sega.

```
10 REM program one odd strings
15 A$="THIS PROGRAM"
20 B$="IS TO SHOW"
25 C$="MOVING STRINGS"
30 REM ---print strings
35 PRINT A$
40 PRINT B$+B$
45 PRINT A$+B$+C$
50 REM ---add spaces
55 D$=A$+" "+B$+" "+C$
60 PRINT
70 PRINT D$
```

```
80 REM delete 10-80 and the program
will delete but the strings are
still in the computer memory,try
print D$
```

```
10 REM program two adding strings
20 A$(1)="adding"
30 A$(2)="strings"
40 A$(3)="together"
50 FOR P=1 TO 3
60 D$=D$+A$(P)+""
70 NEXT
80 PRINT D$
90 D$=D$+" "
95 PRINT D$
98 REM this program adds subscripted
strings in a for next loop
```

```
10 REM program three LEFT$( )
20 A$="TAKING THE LEFT OF A STRING"
30 D$=LEFT$(A$,6)
40 PRINT D$
50 REM this program takes the left of
A$ for 6 positions starting from
the left,after 6 to get more or
less characters.
```

```
10 REM program four RIGHT$( )
20 A$="TAKING THE RIGHT OF A STRING"
30 D$=RIGHT$(A$,6)
40 PRINT D$
50 REM this program takes the right of
A$ for 6 positions starting from
the right,after 6 to get more or
less characters.
```

```
10 REM program five RIGHT$( )
20 A$="TAKING THE RIGHT OF A STRING"
25 FOR P=1 TO 6
30 D$=RIGHT$(A$,P)
40 PRINT D$
45 NEXT
50 REM this program takes the right of
A$ for 6 positions starting from
position 1 up to position 6
```

```
10 REM program six MID$( )
20 A$="123456789"
```

```
30 D$=MID$(A$,2,2)
40 PRINT D$
50 REM this takes the middle part of
A$ starting at position 2 for 2
more characters
```

```
10 REM program seven MID$( )
20 A$="123456789"
25 FOR P=1 TO 9
30 D$=MID$(A$,P,1)
40 PRINT D$
42 IF D$="5" THEN PRINT "FOUND 5":BEEP
45 NEXT
50 REM this takes the middle part of
A$ starting at position P for 1
character,this can find a searched
for character in a string
```

```
10 REM program eight MID$( )
20 A$="A20L12AB9P4118K9A43"
30 INPUT "TYPE CHARACTER ";K$
40 FOR P=1 TO LEN(A$)
50 D$=MID$(A$,P,1)
60 IF D$=K$ THEN PRINT D$;" POSITION";P:
A$=A$+1
70 NEXT
80 PRINT A
90 REM this takes the middle part of
A$ starting at position P for 1
character,this can count the
occurrence of a given character in a
string.
```

```
10 REM program nine count alpha
20 A$="W3H1K5A15G3F6U5E1K26F4"
30 X=0:FOR P=1 TO LEN(A$)
40 D$=MID$(A$,P,1)
50 IF ASC(D$) > 64 THEN PRINT D$;" ";X=X+1
60 NEXT
70 PRINT:PRINT X
80 REM this counts the alphabetical
characters only
```

```
10 REM program ten get last group
20 A$="WWWWWWBBBBBBBBBBBBBBBBB2?"
30 FOR P=1 TO LEN(A$)
40 D$=RIGHT$(A$,P)
50 IF ASC(D$) > 64 THEN 20
60 NEXT
70 PRINT D$
80 REM searches A$ from right to left
looking for rightmost alpha
character,stops and prints RIGHT$( )
from that point to end of string
```

COMPUTERS AND SOFTWARE

for
BUSINESS AND HOME



We stock the following models!
**BONDWELL — COMMODORE — SPECTRAVIDEO
AMSTRAD — ATARI**

- Many specialised software applications available
- Many other products — games, computer furniture, joysticks.

COMPUTERS LTD.
29 High Street, Lower Hutt Ph: (04) 693-313
OPEN SATURDAYS.

Notes on making notes

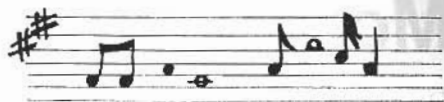

Commodore Music Maker

This is a plastic keyboard which fits right over the keys of your C64.

It turns your computer into a two octave instrument — what type is up to you.

All the variables of the SID chip are programmable from the programme, using the function keys.

Options are:

Change Octave — this allows for the selection of six different octaves for the keyboard.

Rhythm Select — select combinations of drum and bass to add depth to your music.

Poly Play — press three keys at the same time and they all sound. This means you can play chords, something I haven't seen on other keyboards.

Modify Voice — change the variables to make the sound into whatever you want. A chart of 9 different instruments is supplied and this is just the start. I managed to 'discover' an organ combination which I really liked.

Sequencer — this is the pearl. You can copy from sheet music the notes of a song without worrying about their length and then tap out the beat of the tune on one of the keys. The programme combines the notes with the beat and out comes the music with notes of the right length.

I was very impressed with this package. The programme is first class with plenty of on-screen help, and the keyboard fitted well and appeared to be made strong enough to take all but the harshest of treatment. Cost is \$79.95, available as disc or tape.

Micro Illustrator

This has to be the best drawing programme around. It is for use with either the joystick or a light-pen.

It's hard to know where to start as there really isn't much this programme can't do.

You can draw free-hand lines, points, straight lines, rays (ie several lines all starting in the same spot), boxes (filled or unfilled), circles (filled or unfilled), and also fill any area on the screen.

You can draw something in one quarter of the screen and mirror it in the other three.

You can magnify one part so that you can work on the fine details.

You can select an area of drawing and then reproduce anywhere else on the screen as many times as you like.

The disc comes with several sample pictures which certainly give you an idea of what can be achieved.

Also supplied is a very comprehensive manual of the various functions.

Once loaded all that is required is control of the joystick and hitting space bar to switch between drawing screen and command screen.

An excellent programme well worth the price for anyone interested in using the C64 or Plus 4 for drawing. Cost is \$59.95, on disc only.

Reviewed by
Andrew Mitchell

Bondwell



First for Quality

We can offer an excellent price with the back up and service required for the serious businessman.

Why place your business on the line by buying cheap IBM Compatibles.

Compare this list before you buy:

Software & Hardware

- ★ 100% IBM Compatible
- ★ Debtors package
- ★ Invoicing package
- ★ Stock control
- ★ 256K Ram
- ★ 2 x 360K disk drives
- ★ Word Processor
- ★ Spread sheet
- ★ Expandable to 526K Ram
- ★ 5 expansion slots
- ★ Portable or Desk top version

From \$2995.00 (\$800.00 Deposit)

Get in before the end of the financial year.

Your tax saving can pay the deposit.

SUPATECH ELECTRONICS

430 MT. EDEN ROAD PHONE 605-216 Late nights: Thursday & Friday
OPEN ALL DAY SATURDAY

More ways to make noise

by Joe Colquitt

Last issue, I presented a program which used an interrupt to time notes and repeat a sequence, independent of a Basic program.

I hope that you've done some experimenting with it, and probably those who know a bit of machine-code have pulled it apart.

This month, I'll give you a disassembly of the routines and a couple of ideas for modifications.

The routines for SYSNOISE and SYSOFF are the same except for the address that is put into \$0314/\$0315. SYSOFF restores EA31, and does POKE54296,0. Prog. follows:

These sorts of routines can be equally effective when setting up sprite registers, (colour, position etc), graphics screens, or indeed any program that uses an array of fixed or bank-switchable variables, (eg from a menu).

The JMP at \$C090 can be replaced with a JMP to a sub-routine, which could, for example, link up another register.

The JMP could even have its own table of addresses, so that you could implement a menu of different effects by using JMP\$table.

You may get away with changing the address by Basic POKES. I say 'may' because the POKES would have to be executed in the same interrupt cycle, otherwise you'd have only half the address changed, and the computer would find the wrong address on the next cycle.

It would be safer to pass the new address to an ML routine, which will do it

heaps faster:—

C090 JMP\$C142;(replaces EA31)

C142 LDA\$C970; put note timer

C145 STASD417; into filter

C148 JMP\$EA31; continue

1) setting the interrupt (SYSNO)

```
C000 SEI ;disable interrupt register
C001 LOAN$24 ;
C003 STAN$0314 ;poke789,36
C006 LOAN$3C ;
C008 STAN$0315 ;poke789,192
C00B LOAN$3F ;
C00D STAN$0418 ;poke54296,15
C010 CLI ;enable interrupt register
C011 RTS ;return
```

2) playing the notes

```
C024 PHA ;Push Acc onto the stack
C025 TXA ;transfer X contents to A
C026 PHA ;push it onto stack
C027 TYA ;transfer Y contents to A
C028 PHA ;push it onto stack
C029 DEC$C970 ;decrement note counter
C02C LDAN$970 ;
C02F CMP#000 ;if < 0
C031 BNE$C0B8 ;then don't change note
C033 LDY#00FF ;get the new note number
C036 LDAN#00 ;return previous notes off
C038 STAN$0404 ;
C03E STAN$040B ;
C041 LDAN$0000,Y ;get new voiced note LOW
C044 STAN$0400 ;POKE54272,LOW
C047 LDAN$1000,Y ;get new voiced note HI
C04A STAN$0401 ;POKE54273,HI
C04D LDAN$2000,Y ;ditto voices2,3
C050 STAN$0407 ;
C053 LDAN$3000,Y ;
C056 STAN$0408 ;
C059 LDAN$4000,Y ;
C05C STAN$040E ;
C05F LDAN$5000,Y ;
C062 STAN$040F ;
C065 LDAN$6000,Y ;get the new duration value
C068 STAN$C970 ;store it
C06B INY ;Y+1, ready for new note
C06C STY#00FF ;store it
C06F LDAN$C968 ;get wave-form voice1
C072 STAN$0404 ;POKE54275,wave
C075 LDAN$C961 ;ditto voice2,3
C078 STAN$0408 ;
C07B LDAN$C962 ;
C07E STAN$0412 ;
C081 CPY#00FF ;compare index with seq length
C084 BNE$C0B8 ;if < then don't reset index
C086 LDY#00 ;if it is, then set index to 0
C088 STY#00FF ;store it
C08B PLA ;get register values off stack
C08C TAY ;
C08D PLA ;
C08E TAX ;
C08F PLA ;
C090 JMP$EA31 ;and jump to housekeeping
```



3) raise an octave (SYSUx)

```
C0DC TXA ;save X on the stack
C0DD PHA ;
C0DE LDN#00B ;set index to B
C0E0 ASL#0000,X ;double the low byte
C0E3 ROL#0100,X ;double the high byte, (carry)
C0E6 INX ;
C0E7 BNE$C0E8 ;loop if X<256
C0E9 PLA ;restore original X value
C0EA TAX ;
C0EB RTS ;return to BASIC
```

4) lower an octave (SYSOx)

```
C10C TXA ;save X
C10D PHA ;
C10E LDN#00B ;set index
C110 LSR#0100,X ;halve high byte
C113 ROR#0000,X ;halve low, (+128 +low high)
C116 INX ;
C117 BNE$C118 ;
C118 PLA ;
C11A TAX ;
C11B RTS ;
```

5) double note length (SYS00)

```
C0C1 LDN#00B ;set index
C0C3 ASL#0000,X ;double byte value
C0C6 INX ;
C0C7 BNE$C0C3 ;
C0C9 RTS ;
```

6) halve note length (SYS0A)

```
C0CA LDN#00B ;
C0CC LSR#0000,X ;halve byte value
C0CF INX ;
C0D0 BNE$C0CC ;
C0D2 RTS ;
```

7) reset index (SYSR5)

```
C13C LDN#00B ;
C13E STAN$00FF ;
C141 RTS ;
```

8) same value (SYS5A)

```
C0D3 LDN#00B ;Acc set before call
C0D5 STAN$6000,X ;store in duration array
C0D8 INX ;
C0D9 BNE$C0D5 ;
C0DB RTS ;
```

9) transfer a block (SYSR3)

```
C0AD LDY#00 ;get 255 values
C0AF LDA($FB),Y ;from RAM and
C0B1 STAN($FD),Y ;store in play area
C0B3 INY ;
C0B4 BNE$00AF ;
C0B6 INC$FC ;repeat until
C0B8 INC$FE ;play area limit
C0BA LDA$FF ;is reached
C0BC CMP#00 ;
C0BE BNE$C0AD ;
C0BF RTS ;
```

10) move register values (SYSR6)

```
C09F LDY#00 ;move 19 values
C0A1 LDA($FC),Y ;from RAM into
C0A3 STAN$0400,Y ;SID registers
C0A6 INY ;
C0A7 CPY#19 ;
C0A9 BNE$C0A1 ;
C0AB RTS ;
```

COMPUTER GAMES FOR HIRE

Games available for weekly hire for the following computers:

★ AMSTRAD ★ APPLE
★ COM 64 ★ VIC 20 ★ BBC
★ ATARI ★ TRS 80/SYS 80

Send for catalogue and membership details to:

COMPUTER GAME RENTALS LTD
P.O. BOX 30947, LOWER HUTT.

Name.....

Address.....

Type of Computer.....



"among the best Apple software available" — *Bits and Bytes*

— Graphics Editor — Spelling Checker

— Twister Plot Story Teller — and more (for 64K Apple). See reviews in August and September issues of *Bits and Bytes*. Get an order form from your Apple dealer or write to Box 6186, Dunedin.

otakou software



Exploring ON commands

By Don Stanley

This and the next article will explore the ON statement and its various adaptations for SVI/MSX Basic.

ON <condition> GOTO/SUB

Under SVI/MSX Basic there are a number of ways these commands can be used. Here is a comprehensive list for SVI. This excludes the ON MDM .. command which is essentially superfluous to SVI users here.

```
ON <expression>      GOTO
ON <expression>      GOSUB
ON ERROR             GOTO *
ON STRIG             GOSUB *
ON INTERVAL=n       GOSUB *
ON KEY               GOSUB *
ON SPRITE            GOSUB *
ON STOP              GOSUB *
```

The starred (*) statements are global interrupt statements. These are set up somewhere in the program and while set up cause Basic to check whether the condition has been satisfied at the end of every line.

In this issue I'll deal with the first three commands in the list and explore the other interrupt commands next time.

Transfer line

ON <expression> GOTO is used when you want to transfer to a certain line of your program, but where you are doing the transfer on the basis of some other variables value. Suppose you have a variable called X1. If X1 is 1 you want to GOTO 1000, if X1 is 2 you want to go to line 2000, if X1 is 3 you want to go to line 3000. You could do it like this, using the IF statement.

```
IF X1=1 THEN 1000 ELSE IF X1=2
THEN 2000 ELSE IF X1=3 THEN 3000.
```

(By the way, just a byline note that you do not need to use the word GOTO in an IF statement like the above.)

Basic provides an alternative to this method which avoids using the IF. In case you are wondering why an alternative should be necessary, it's to do with a number of factors:— IF .. THEN .. ELSE statements are hard to follow as the number of options increases, and more importantly, Basic's internal stack can be overflowed with a large number of IF .. THEN .. ELSE's.

The alternative is the ON .. GOTO statement.

To use the ON xx GOTO statement requires the variable or expression xx to have values ranging from 1 up to maximum of 255. They need not be integers, but fractional numbers are truncated to integers first (not permanently, only for the ON .. GOTO).

The above IF statement is written as follows using ON .. GOTO.

```
ON X1 GOTO 1000,2000,3000
```

This means that line 1000 will be transferred if X1 is 1, line 2000 if X1 is 2, and line 3000 if X1 is 3. If X1 is 0 or X1 is above 3, then Basic will just carry on to the next line.

You do not need to specify a line number to go to for each possible value of X1. Maybe you only want to jump if X1 is 2 or 4; you would then code the line like this:

```
ON X1 GOTO ,2000,,4000
```

The first comma means that Basic will treat the line numbers as if a number was before it, the two commas after line 2000 are treated as if a value was between them.

There is a problem here though, namely what happens if X1 is 1 or 3?

It would be logical to expect that Basic would just go to the next line.

In SVI/MSX Basic a syntax error is generated under this condition.

You need to be careful about how you use this when omitting line numbers, and one way around this problem is indicated further on with the ON ERROR statement.

(The use of commas like this is possible since Basic only counts commas when looking for a line number, it does not consider any preceding line numbers.)

Variable

X1 above is a variable. That is not a necessary condition for this statement. Any expression which has a value between 0 and 255 can be used there.

To illustrate, suppose you want to jump to a certain line depending on whether a string variable has the value "A" "B" or "C"?

Obviously A, B and C are not numbers. You use the INSTR function to give a numeric value, and jump to that value. With INSTR you give a string which will

be searched for a second specified string.

The point in the first string where the second string begins is what INSTR returns, (0 if the second string is not found). Here's how it's done:

```
ON INSTR("ABC",X1$) GOTO
1000,2000,3000.
```

Now if X1\$ is "A" then INSTR("ABC",X1\$) returns 1 so the jump is to line 1000, and similarly for "B" and "C". If X1\$ were "D" no jump would be made and thus the program would just carry on after the ON .. GOTO statement.

A frequent question I get asked is:

"In a program where I want a single character from A to Z input, how can I check for lower case characters and jump to the correct line as if they were uppercase?"

One solution (among many) is to use INSTR. Suppose the letter entered should be A, B or C. You use the following:

```
ON INSTR("AaBbCc",X1$) GOTO
1000,1000,2000,2000,3000,3000
or
```

```
ON INT((INSTR("AaBbCc",X1$)+1)/
2) GOTO 1000,2000,3000
```

When using ON ... GOTO it is worth having some sort of check on the line following the ON ... GOTO. Then if a 0 or value outside the range for which there are line numbers occurs some action can be taken. For the previous example you may have:

```
100 X1$ = INPUT$(1)
110 ON INSTR("AaBbCc",X1$) GOTO
1000,1000,2000,2000,3000,3000
120 PRINT "You MUST Enter one of A B
or C"
130 GOTO 100
```

The above example illustrates that the line-numbers to jump to need not be unique.

Subroutines

ON <value> GOSUB is a further ability.

All the above statements about ON ...

(Continued on page 60)

VALUE FOR MONEY

If that's what you're after (and who isn't?), then call us — ANYTIME! (24hr phone)
We only stock those computers which offer you the best value your dollars can buy,
backed up by many years of experience in this specialised market.

OUR RANGE CURRENTLY INCLUDES:

AMSTRAD

ATARI

CAT

CORONA

KANE AGENCIES LTD

304A HARDY ST.
Ph (054) 84-066
P.O. BOX 710 NELSON

Orders supplied nationwide — FREIGHT FREE. Visa, Bankcard Accepted.

(Continued from page 59)

GOTO apply here. The only difference is that you are sending Basic to a subroutine, which means that you should have provision to send it back.

A subroutine is a section of code which is jumped to and then returned from. Usually it is some code that you use over and over in your program, coding it as a subroutine means you only code it once instead of coding it each time you want to use it. For instance:—

```
10 INPUT X
20 IF X > 100 THEN GOSUB 100 :
GOTO 10
30 INPUT Y
40 IF Y > 100 THEN GOSUB 100 :
GOTO 30
50 INPUT Z
60 IF Z > 100 THEN GOSUB 100 :
GOTO 50
..
..
100 CLS
110 PRINT "Error In Input — Must Be
Less Than 100"
120 FOR I = 1 TO 500
130 NEXT
140 RETURN
```

The subroutine begins at line 100. It could have been coded each time you wanted to use it, which would have meant more typing, more chance of errors entering it, and more memory used.

ON ... GOSUB requires that the word RETURN be entered at the end of the subroutine. If you omit it, several things could occur. One is that Basic runs out of lines, in which case a GOSUB WITH-OUT RETURN error will occur.

Another is somewhat more subtle.

Basic could get back to the code which called the subroutine (especially if you have GOTO's in the subroutine or maybe an ERROR trap which RESUMES somewhere before the subroutine was called) and call the subroutine again. If this happens you are likely to run out of memory — fast.

The reason is that Basic needs to keep track of where it returns to when a GOSUB is used, so it puts 2 bytes on the stack. If you don't go back with a RETURN those two bytes stay there, to be followed by two more the next time you go to the routine without a RETURN, and so on until you fill up all the available user RAM.

Basic all this time thinks you are still executing the first subroutine, after all it hasn't found a RETURN so it's just one big subroutine to Basic.

You can have more than one RETURN in a subroutine. Perhaps your subroutine asks for some input from the user, you can RETURN if this is a certain value or carry on if not.

But do ensure that all subroutines have a RETURN in there somewhere, and that Basic can access it.

Error control

The ON ERROR GOTO command gives you control over any errors which may occur. If an ERROR of any sort is encountered while running your program and the statement ON ERROR GOTO 5000 has been included at the start, then Basic will goto line 5000.

You would have some error checking and possibly correcting routine at line 5000.

There are two extra variables used with ON ERROR GOTO. These are created by BASIC and are called ERR (Error number) and ERL (Error Line). Your error handling routine can check the values of these variables and use them to take some corrective action.

Suppose you use the ON <value> GOTO statement as I used it above with the commas replacing numbers. If X1 was 1 or 3 Basic will crash with a syntax error. You can avoid this as follows:

```
100 ON ERROR GOTO 5000
200 ON X1 GOTO ,1000,,4000
300 IF X1=1 OR X1=3 THEN PRINT
"ERROR IN X1"
400 ...
...
5000 IF ERR=2 AND ERL=200 THEN
RESUME 300
5010 PRINT "ERROR",ERR,"OC-
CURRED AT LINE",ERL
5020 ON ERROR GOTO 0
5030 END
```

ON ERROR GOTO is a global interrupt.

When an error occurs Basic checks the contents of memory locations F7E5/F7E6 (SVI). If this is 0 then Basic prints the error message and line then stops. Otherwise Basic jumps to the location which is the contents of those two locations.

These two memory locations are 0 unless you set them using ON ERROR GOTO.

But at the end of a program Basic does not reset them back to 0.

This means that any subsequent statements that cause an error will restart the program at the error line. Thus when ENDING a program, use ON ERROR GOTO 0 to ensure that you don't suddenly get thrown back into the program if you misspell a command.

The extra to use with ON ERROR GOTO is the RESUME. This tells Basic to restart from somewhere.

In the above example, if the error was just an X1= or 3 error the program carries on from line 300. You can use RESUME with no line number to send BASIC back to where the ERROR occurred (which would cause an infinite loop in the above example as the ERROR would immediately reoccur and thus reinvokethe ERROR routine), with a line number as above, or with the word NEXT (RESUME NEXT) to go to the line

after that where the error occurred.

Advancements

Advanced programmers can manipulate certain high memory locations to advantage when doing error checking.

For instance F7E3/E4 contain the memory location which is the end of the line before the one where the error occurred, F7E5/E6 contain the line number to jump to on an error condition, F7E7 is FF if Basic is in an error trapping routine, and zero if Basic is not in an error trapping routine.

F53F contains the last error number (ERR) set by Basic or by your program.

Locations F7DF/E0 will contain the line number where the last error occurred.

All these values are for SVI, not MSX.

The corresponding MSX locations are F6B7/B8 (end of last line); F6B9/F6BA (line #); F6BB is the trap indicator; F414 (ERR); F6B3/B4 (ERL).

Finally you can add to Basic's error list by using the ERROR command, for instance, in the above program chunk:

```
150 IF X=1 THEN ERROR 99
```

will cause an ERROR and jump to the error routine from line 150.

The error message printed will be UNPRINTABLE ERROR IN 150 — you can only set up an error number, not an error message. However the DISK error messages are in RAM, so you could POKE your own error message over the top of a disk error message then use the error number corresponding to that message in your ERROR statement (thus producing your own error if you have a disk system).

The disk messages are in RAM at location EB22 and go through to location EC01. Each message ends with a zero byte.

Next month I will continue the ON theme with the interrupt commands.

To finish off this article, I have received many requests from people wanting to learn how to use CPM. Any CPM-80 books on the market are applicable to CPM on the SVI/MSX machine.

In particular Soul Of CPM, by Mitchell Waite & Robert Lafore is very good both to learn from and to get more advanced knowledge. It gets a bit technical since its overriding aim is to teach 8080 machine code programming, but is quite readable if you have a little computer expertise. I would not recommend it for absolute beginners.

Also for advanced users is Mastering CPM by Alan R Miller.

If anyone can recommend a good book for beginners please let me know via P.O. Box 7057, Wellington South.



Spectrum's future is cloudy

by Gary Parker



The Spectrum is probably the oldest of the current popular home computers, and despite its popularity it cannot last forever. What lies ahead?

The Spectrum really consists of three computers — the original model, the Spectrum Plus, and now the 128K model.

First there was the rubber-keyboard model, of which over a million were sold. This model was the first cheap colour home computer.

I remember the first Spectrums to arrive on our shore. At that time 48K seemed an incredible amount of memory, and considering the price, people were prepared to put up with the poor keyboard and suchlike.

At that time most people buying a home computer tended to be quite highly 'computer literate'. They didn't expect the Spectrum to be like the computers they used at work. They were amazed that they could buy a computer so cheaply at all.

For the masses

But as the home computer became a mass-market product, people who knew little about computers were in the market for one.

As one retailer told me: "These days, people walk into the shop, and ask to see one of these Spectrum things their little Johnny is telling them about.

"I show them one, and I can tell from the look on their faces that they are not going to spend that amount of money on such a small black box.

"So I lead them over to another computer which, although less powerful, comes in a bigger case..."

The problem is that to the public at large, looks are the most important part of a home computer.

A computer science major knows that RAM is RAM whatever package it sits in, but to the person on the street, the bells and whistles are what impress.

As technology advances and people begin to expect more of a home computer, the Spectrum is slipping behind its competitors in terms of sales.

Actually, it still contains quite a competitive amount of memory, but it is sadly lacking in the bells and whistles department.

Towards this end, Sinclair had produced the Spectrum Plus. It considerably improved the Spectrum's public appeal, but did nothing to internally improve the machine.

New home computers are released all the time, and many are starting to approach the Spectrum's price.

When I bought a Spectrum, the Commodore 64 was out of reach. But now

that every computer is cheap, Sinclair computers have less to offer over the competition.

This has been reflected by a slump in sales.

What appeal?

So what can Sinclair offer the modern public?

Now that computers are cheap, Sinclair machines cannot sell by price alone.

When most simple home computers cost in the region of \$1000, a Sinclair computer costing about \$300 or less did offer the sort of saving that tempted buyers.

And people were prepared to tolerate the Spectrum's evident shortcomings.

But nowadays, even though Sinclair computers may still be cheaper than most other brands, the overall low prices in the home computer market has resulted in buyers being willing to pay that little bit extra for a cosmetically superior computer.

Will Sinclair produce more technically superior computers?

In today's highly competitive market, that seems unlikely.

The QL was the first of its kind, but the fact of its hasty design showed. Accordingly, the QL gained a bad name.

Despite the fact that later versions have had the bugs ironed out, sales are reported to be slow.

Perhaps the road to success lies in producing a technically advanced computer at a cheap price?

Sinclair recently halved the price of the QL in Britain to £199 (NZ\$500). A friend of mine saw QLs selling in Britain for £130 (NZ\$320). This is at the same price the Spectrum was selling just a few months ago!

I might have a few reservations about the QL, but at half the price I originally paid for my Spectrum, I'd snap one up!

Pocket money

Where does this leave the Spectrum?

Frankly, with the QL selling at that price, and other advanced computers such as the Atari ST on the horizon, I see little future for the Spectrum.

Perhaps it will follow the path of the ZX81, selling for little more than a few weeks' pocket money, so that it will appeal to children.

Sinclair have released a 128K Spectrum in Spain. At the time of writing

(Dec), it had not been released in Britain, probably because the QL is now selling in the price bracket intended for the 128K Spectrum.

The 128K Spectrum has a few improvements over the Plus, such as three-channel sound, but it's doubtful whether it could be produced cheaply enough to be significantly cheaper than the QL.

Also, a computer with poorer specifications is not always cheaper to produce.

For example, the 512K Atari ST is actually cheaper to produce than the 128K model. This is because the 128K model was designed to use many small-capacity chips, whereas the 512K model was designed to use only a few large chips.

By the time the Atari computer was nearing production, the price of the large chips had fallen so dramatically that the 128K model cost more to produce. Not surprisingly, the 128K model was dropped.

Not compatible

Why would anybody want a 128K Spectrum?

Well, the Spectrum has a huge software base supporting it.

This might be reason enough to buy a 128K Spectrum, except the new model's ROM has been slightly altered to incorporate the new routines controlling memory paging, so it is not 100% compatible.

A friend of mine has a Spectrum with a customised ROM which uses the 1K of spare memory which exists in the Spectrum's 16K ROM, to control his printer.

Since this memory was spare in the original model, you'd think it would still work with all software. But it doesn't — some games don't work.

The games designers have made the game programs check that memory, possibly so that any alterations designed to aid piracy can be detected.

The 128K model undoubtedly also makes use of that spare 1K, and so is not completely compatible.

The 128K Spectrum loses its main raison d'être — the software base.

So the future of the Spectrum would seem to be grim.

Possibly it will continue to sell as a kid's computer, as has been the case with the ZX81.

Whatever happens, those million-plus Spectrums will remain, ensuring continued demand for associated products, and so continued support for the machine.

Morse Code

By Peter Smith

This entertaining program will convert any message you type into the computer to morse code.

It will draw the message as dots and dashes, and accurately beep out the message using the Spectrum's internal loudspeaker.

```

5 POKE 23658,8
10 INPUT "TYPE IN MESSAGE:"; L
INE a$
20 IF a$="" THEN LET A$="BITS
AND BYTES"
30 FOR N=1 TO LEN A$
31 IF A$(N)="." OR A$(N)="? " T
HEN GO TO 60
32 IF A$(N)=" " THEN FOR X=1
TO 52: NEXT X: PRINT ': GO TO 11
2
33 IF CODE A$(N)<48 OR CODE A$(
N)>90 THEN GO TO 115
35 IF CODE A$(N)>57 AND CODE A
$(N)<65 THEN GO TO 115
60 LET b$=a$(n)
70 RESTORE 1000+(CODE b$-48)

```

```

80 READ c$
85 PRINT 'A$(N);TAB 10;
87 POKE 23692,0
90 FOR m=1 TO LEN c$
100 BEEP (VAL c$(M))/15,0
105 IF C$(M)="2" THEN PRINT "-
";
106 IF C$(M)="1" THEN PRINT ".
";
110 NEXT m
115 FOR X=1 TO 5: NEXT X
120 NEXT n
125 FOR X=1 TO 100: NEXT X
130 CLS : GO TO 10
998 DATA "121212"
1000 DATA "22222"
1001 DATA "12222"
1002 DATA "11222"
1003 DATA "11122"
1004 DATA "11112"
1005 DATA "11111"
1006 DATA "21111"
1007 DATA "22111"
1008 DATA "22211"
1009 DATA "22221"
1015 DATA "112211"
1017 DATA "12"
1018 DATA "2111"
1019 DATA "2121"
1020 DATA "211"
1021 DATA "1"

```

```

1022 DATA "1121"
1023 DATA "221"
1024 DATA "1111"
1025 DATA "11"
1026 DATA "1222"
1027 DATA "212"
1028 DATA "1211"
1029 DATA "22"
1030 DATA "21"
1031 DATA "222"
1032 DATA "1221"
1033 DATA "2212"
1034 DATA "121"
1035 DATA "111"
1036 DATA "2"
1037 DATA "112"
1038 DATA "1112"
1039 DATA "122"
1040 DATA "2112"
1041 DATA "2122"
1042 DATA "2211"

```



A128 Accounting

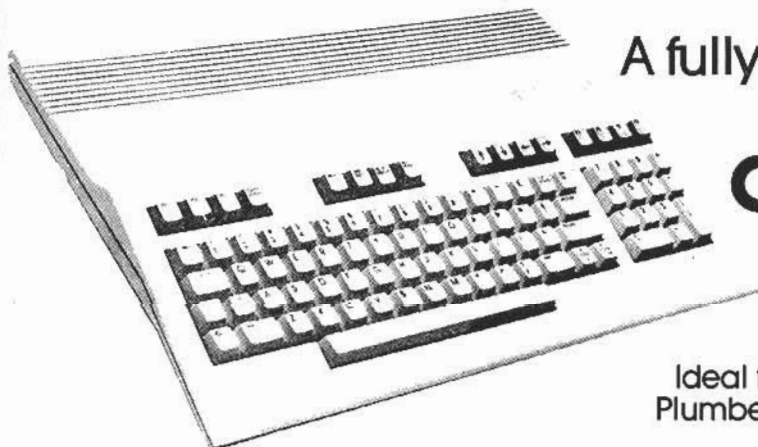

A fully integrated accounting package for the
Commodore 128.

**Handles Invoicing,
Statements, & Stock.**

Ideal for small business applications.
Plumbers, Electricians, Panelbeaters etc.

The A128 suite allows for GST (and sales tax) Configurations available to run on Commodore 1541, 1570, 1001, 4040, & 8250 drives. A128 runs in superbase 128 and can be used in conjunction with superscripts

128 to provide the complete office range. A128 is only \$500.00 for the 3 modules. Available now at Commodore dealers. Send SAE for details and your nearest dealer.

**Available now at Commodore dealers
send S.A.E. for details of
your nearest dealer to:**

Ashby Computer Centre Ltd

93 Ashby Ave, St Heliers, Auckland. Ph (09) 588-301

Trademark for Precision Software Ltd. UK.

Videoconferencing

The NZ Post Office is evaluating both the technology and market for videoconferencing, it was announced at a recent joint NZPO/GEC presentation on videoconferencing.

Telecom marketing manager Norm Nicholls said the present high cost of video circuits and videoconferencing equipment meant that travel was still a cheaper option for most companies.

However several factors could increase the appeal of videoconferencing, including:

- increasing costs of business travel,
- increasing emphasis on face-to-face negotiations rather than letter writing and phone calls,
- increasing importance of international communications,
- increasing capabilities in videoconferencing technology.

The Solar System

By Stephen Botha

This program provides a demonstration about the nine main planets of our solar system. It displays each planet in turn and facts about it. Full instructions are contained in the program.

Note that the right-hand brace character in line 9005 stands for the clear screen character (obtained by pressing ESC then CTRL-CLEAR).

```

0 REM *****THE SOLAR SYSTEM*****
1 REM *****BY STEPHEN BOTHA*****
2 REM *****
3 REM *****
4 REM *****
5 REM *****
6 REM *****
7 REM *****
8 REM *****
9 REM *****
10 REM *****
11 REM *****
12 REM *****
13 REM *****
14 REM *****
15 REM *****
16 REM *****
17 REM *****
18 REM *****
19 REM *****
20 REM *****
21 REM *****
22 REM *****
23 REM *****
24 REM *****
25 REM *****
26 REM *****
27 REM *****
28 REM *****
29 REM *****
30 REM *****
31 REM *****
32 REM *****
33 REM *****
34 REM *****
35 REM *****
36 REM *****
37 REM *****
38 REM *****
39 REM *****
40 REM *****
41 REM *****
42 REM *****
43 REM *****
44 REM *****
45 REM *****
46 REM *****
47 REM *****
48 REM *****
49 REM *****
50 REM *****
51 REM *****
52 REM *****
53 REM *****
54 REM *****
55 REM *****
56 REM *****
57 REM *****
58 REM *****
59 REM *****
60 REM *****
61 REM *****
62 REM *****
63 REM *****
64 REM *****
65 REM *****
66 REM *****
67 REM *****
68 REM *****
69 REM *****
70 REM *****
71 REM *****
72 REM *****
73 REM *****
74 REM *****
75 REM *****
76 REM *****
77 REM *****
78 REM *****
79 REM *****
80 REM *****
81 REM *****
82 REM *****
83 REM *****
84 REM *****
85 REM *****
86 REM *****
87 REM *****
88 REM *****
89 REM *****
90 REM *****
91 REM *****
92 REM *****
93 REM *****
94 REM *****
95 REM *****
96 REM *****
97 REM *****
98 REM *****
99 REM *****
100 REM *****
101 REM *****
102 REM *****
103 REM *****
104 REM *****
105 REM *****
106 REM *****
107 REM *****
108 REM *****
109 REM *****
110 REM *****
111 REM *****
112 REM *****
113 REM *****
114 REM *****
115 REM *****
116 REM *****
117 REM *****
118 REM *****
119 REM *****
120 REM *****
121 REM *****
122 REM *****
123 REM *****
124 REM *****
125 REM *****
126 REM *****
127 REM *****
128 REM *****
129 REM *****
130 REM *****
131 REM *****
132 REM *****
133 REM *****
134 REM *****
135 REM *****
136 REM *****
137 REM *****
138 REM *****
139 REM *****
140 REM *****
141 REM *****
142 REM *****
143 REM *****
144 REM *****
145 REM *****
146 REM *****
147 REM *****
148 REM *****
149 REM *****
150 REM *****
151 REM *****
152 REM *****
153 REM *****
154 REM *****
155 REM *****
156 REM *****
157 REM *****
158 REM *****
159 REM *****
160 REM *****
161 REM *****
162 REM *****
163 REM *****
164 REM *****
165 REM *****
166 REM *****
167 REM *****
168 REM *****
169 REM *****
170 REM *****
171 REM *****
172 REM *****
173 REM *****
174 REM *****
175 REM *****
176 REM *****
177 REM *****
178 REM *****
179 REM *****
180 REM *****
181 REM *****
182 REM *****
183 REM *****
184 REM *****
185 REM *****
186 REM *****
187 REM *****
188 REM *****
189 REM *****
190 REM *****
191 REM *****
192 REM *****
193 REM *****
194 REM *****
195 REM *****
196 REM *****
197 REM *****
198 REM *****
199 REM *****
200 REM *****
201 REM *****
202 REM *****
203 REM *****
204 REM *****
205 REM *****
206 REM *****
207 REM *****
208 REM *****
209 REM *****
210 REM *****
211 REM *****
212 REM *****
213 REM *****
214 REM *****
215 REM *****
216 REM *****
217 REM *****
218 REM *****
219 REM *****
220 REM *****
221 REM *****
222 REM *****
223 REM *****
224 REM *****
225 REM *****
226 REM *****
227 REM *****
228 REM *****
229 REM *****
230 REM *****
231 REM *****
232 REM *****
233 REM *****
234 REM *****
235 REM *****
236 REM *****
237 REM *****
238 REM *****
239 REM *****
240 REM *****
241 REM *****
242 REM *****
243 REM *****
244 REM *****
245 REM *****
246 REM *****
247 REM *****
248 REM *****
249 REM *****
250 REM *****
251 REM *****
252 REM *****
253 REM *****
254 REM *****
255 REM *****
256 REM *****
257 REM *****
258 REM *****
259 REM *****
260 REM *****
261 REM *****
262 REM *****
263 REM *****
264 REM *****
265 REM *****
266 REM *****
267 REM *****
268 REM *****
269 REM *****
270 REM *****
271 REM *****
272 REM *****
273 REM *****
274 REM *****
275 REM *****
276 REM *****
277 REM *****
278 REM *****
279 REM *****
280 REM *****
281 REM *****
282 REM *****
283 REM *****
284 REM *****
285 REM *****
286 REM *****
287 REM *****
288 REM *****
289 REM *****
290 REM *****
291 REM *****
292 REM *****
293 REM *****
294 REM *****
295 REM *****
296 REM *****
297 REM *****
298 REM *****
299 REM *****
300 REM *****
301 REM *****
302 REM *****
303 REM *****
304 REM *****
305 REM *****
306 REM *****
307 REM *****
308 REM *****
309 REM *****
310 REM *****
311 REM *****
312 REM *****
313 REM *****
314 REM *****
315 REM *****
316 REM *****
317 REM *****
318 REM *****
319 REM *****
320 REM *****
321 REM *****
322 REM *****
323 REM *****
324 REM *****
325 REM *****
326 REM *****
327 REM *****
328 REM *****
329 REM *****
330 REM *****
331 REM *****
332 REM *****
333 REM *****
334 REM *****
335 REM *****
336 REM *****
337 REM *****
338 REM *****
339 REM *****
340 REM *****
341 REM *****
342 REM *****
343 REM *****
344 REM *****
345 REM *****
346 REM *****
347 REM *****
348 REM *****
349 REM *****
350 REM *****
351 REM *****
352 REM *****
353 REM *****
354 REM *****
355 REM *****
356 REM *****
357 REM *****
358 REM *****
359 REM *****
360 REM *****
361 REM *****
362 REM *****
363 REM *****
364 REM *****
365 REM *****
366 REM *****
367 REM *****
368 REM *****
369 REM *****
370 REM *****
371 REM *****
372 REM *****
373 REM *****
374 REM *****
375 REM *****
376 REM *****
377 REM *****
378 REM *****
379 REM *****
380 REM *****
381 REM *****
382 REM *****
383 REM *****
384 REM *****
385 REM *****
386 REM *****
387 REM *****
388 REM *****
389 REM *****
390 REM *****
391 REM *****
392 REM *****
393 REM *****
394 REM *****
395 REM *****
396 REM *****
397 REM *****
398 REM *****
399 REM *****
400 REM *****
401 REM *****
402 REM *****
403 REM *****
404 REM *****
405 REM *****
406 REM *****
407 REM *****
408 REM *****
409 REM *****
410 REM *****
411 REM *****
412 REM *****
413 REM *****
414 REM *****
415 REM *****
416 REM *****
417 REM *****
418 REM *****
419 REM *****
420 REM *****
421 REM *****
422 REM *****
423 REM *****
424 REM *****
425 REM *****
426 REM *****
427 REM *****
428 REM *****
429 REM *****
430 REM *****
431 REM *****
432 REM *****
433 REM *****
434 REM *****
435 REM *****
436 REM *****
437 REM *****
438 REM *****
439 REM *****
440 REM *****
441 REM *****
442 REM *****
443 REM *****
444 REM *****
445 REM *****
446 REM *****
447 REM *****
448 REM *****
449 REM *****
450 REM *****
451 REM *****
452 REM *****
453 REM *****
454 REM *****
455 REM *****
456 REM *****
457 REM *****
458 REM *****
459 REM *****
460 REM *****
461 REM *****
462 REM *****
463 REM *****
464 REM *****
465 REM *****
466 REM *****
467 REM *****
468 REM *****
469 REM *****
470 REM *****
471 REM *****
472 REM *****
473 REM *****
474 REM *****
475 REM *****
476 REM *****
477 REM *****
478 REM *****
479 REM *****
480 REM *****
481 REM *****
482 REM *****
483 REM *****
484 REM *****
485 REM *****
486 REM *****
487 REM *****
488 REM *****
489 REM *****
490 REM *****
491 REM *****
492 REM *****
493 REM *****
494 REM *****
495 REM *****
496 REM *****
497 REM *****
498 REM *****
499 REM *****
500 REM *****
501 REM *****
502 REM *****
503 REM *****
504 REM *****
505 REM *****
506 REM *****
507 REM *****
508 REM *****
509 REM *****
510 REM *****
511 REM *****
512 REM *****
513 REM *****
514 REM *****
515 REM *****
516 REM *****
517 REM *****
518 REM *****
519 REM *****
520 REM *****
521 REM *****
522 REM *****
523 REM *****
524 REM *****
525 REM *****
526 REM *****
527 REM *****
528 REM *****
529 REM *****
530 REM *****
531 REM *****
532 REM *****
533 REM *****
534 REM *****
535 REM *****
536 REM *****
537 REM *****
538 REM *****
539 REM *****
540 REM *****
541 REM *****
542 REM *****
543 REM *****
544 REM *****
545 REM *****
546 REM *****
547 REM *****
548 REM *****
549 REM *****
550 REM *****
551 REM *****
552 REM *****
553 REM *****
554 REM *****
555 REM *****
556 REM *****
557 REM *****
558 REM *****
559 REM *****
560 REM *****
561 REM *****
562 REM *****
563 REM *****
564 REM *****
565 REM *****
566 REM *****
567 REM *****
568 REM *****
569 REM *****
570 REM *****
571 REM *****
572 REM *****
573 REM *****
574 REM *****
575 REM *****
576 REM *****
577 REM *****
578 REM *****
579 REM *****
580 REM *****
581 REM *****
582 REM *****
583 REM *****
584 REM *****
585 REM *****
586 REM *****
587 REM *****
588 REM *****
589 REM *****
590 REM *****
591 REM *****
592 REM *****
593 REM *****
594 REM *****
595 REM *****
596 REM *****
597 REM *****
598 REM *****
599 REM *****
600 REM *****
601 REM *****
602 REM *****
603 REM *****
604 REM *****
605 REM *****
606 REM *****
607 REM *****
608 REM *****
609 REM *****
610 REM *****
611 REM *****
612 REM *****
613 REM *****
614 REM *****
615 REM *****
616 REM *****
617 REM *****
618 REM *****
619 REM *****
620 REM *****
621 REM *****
622 REM *****
623 REM *****
624 REM *****
625 REM *****
626 REM *****
627 REM *****
628 REM *****
629 REM *****
630 REM *****
631 REM *****
632 REM *****
633 REM *****
634 REM *****
635 REM *****
636 REM *****
637 REM *****
638 REM *****
639 REM *****
640 REM *****
641 REM *****
642 REM *****
643 REM *****
644 REM *****
645 REM *****
646 REM *****
647 REM *****
648 REM *****
649 REM *****
650 REM *****
651 REM *****
652 REM *****
653 REM *****
654 REM *****
655 REM *****
656 REM *****
657 REM *****
658 REM *****
659 REM *****
660 REM *****
661 REM *****
662 REM *****
663 REM *****
664 REM *****
665 REM *****
666 REM *****
667 REM *****
668 REM *****
669 REM *****
670 REM *****
671 REM *****
672 REM *****
673 REM *****
674 REM *****
675 REM *****
676 REM *****
677 REM *****
678 REM *****
679 REM *****
680 REM *****
681 REM *****
682 REM *****
683 REM *****
684 REM *****
685 REM *****
686 REM *****
687 REM *****
688 REM *****
689 REM *****
690 REM *****
691 REM *****
692 REM *****
693 REM *****
694 REM *****
695 REM *****
696 REM *****
697 REM *****
698 REM *****
699 REM *****
700 REM *****
701 REM *****
702 REM *****
703 REM *****
704 REM *****
705 REM *****
706 REM *****
707 REM *****
708 REM *****
709 REM *****
710 REM *****
711 REM *****
712 REM *****
713 REM *****
714 REM *****
715 REM *****
716 REM *****
717 REM *****
718 REM *****
719 REM *****
720 REM *****
721 REM *****
722 REM *****
723 REM *****
724 REM *****
725 REM *****
726 REM *****
727 REM *****
728 REM *****
729 REM *****
730 REM *****
731 REM *****
732 REM *****
733 REM *****
734 REM *****
735 REM *****
736 REM *****
737 REM *****
738 REM *****
739 REM *****
740 REM *****
741 REM *****
742 REM *****
743 REM *****
744 REM *****
745 REM *****
746 REM *****
747 REM *****
748 REM *****
749 REM *****
750 REM *****
751 REM *****
752 REM *****
753 REM *****
754 REM *****
755 REM *****
756 REM *****
757 REM *****
758 REM *****
759 REM *****
760 REM *****
761 REM *****
762 REM *****
763 REM *****
764 REM *****
765 REM *****
766 REM *****
767 REM *****
768 REM *****
769 REM *****
770 REM *****
771 REM *****
772 REM *****
773 REM *****
774 REM *****
775 REM *****
776 REM *****
777 REM *****
778 REM *****
779 REM *****
780 REM *****
781 REM *****
782 REM *****
783 REM *****
784 REM *****
785 REM *****
786 REM *****
787 REM *****
788 REM *****
789 REM *****
790 REM *****
791 REM *****
792 REM *****
793 REM *****
794 REM *****
795 REM *****
796 REM *****
797 REM *****
798 REM *****
799 REM *****
800 REM *****
801 REM *****
802 REM *****
803 REM *****
804 REM *****
805 REM *****
806 REM *****
807 REM *****
808 REM *****
809 REM *****
810 REM *****
811 REM *****
812 REM *****
813 REM *****
814 REM *****
815 REM *****
816 REM *****
817 REM *****
818 REM *****
819 REM *****
820 REM *****
821 REM *****
822 REM *****
823 REM *****
824 REM *****
825 REM *****
826 REM *****
827 REM *****
828 REM *****
829 REM *****
830 REM *****
831 REM *****
832 REM *****
833 REM *****
834 REM *****
835 REM *****
836 REM *****
837 REM *****
838 REM *****
839 REM *****
840 REM *****
841 REM *****
842 REM *****
843 REM *****
844 REM *****
845 REM *****
846 REM *****
847 REM *****
848 REM *****
849 REM *****
850 REM *****
851 REM *****
852 REM *****
853 REM *****
854 REM *****
855 REM *****
856 REM *****
857 REM *****
858 REM *****
859 REM *****
860 REM *****
861 REM *****
862 REM *****
863 REM *****
864 REM *****
865 REM *****
866 REM *****
867 REM *****
868 REM *****
869 REM *****
870 REM *****
871 REM *****
872 REM *****
873 REM *****
874 REM *****
875 REM *****
876 REM *****
877 REM *****
878 REM *****
879 REM *****
880 REM *****
881 REM *****
882 REM *****
883 REM *****
884 REM *****
885 REM *****
886 REM *****
887 REM *****
888 REM *****
889 REM *****
890 REM *****
891 REM *****
892 REM *****
893 REM *****
894 REM *****
895 REM *****
896 REM *****
897 REM *****
898 REM *****
899 REM *****
900 REM *****
901 REM *****
902 REM *****
903 REM *****
904 REM *****
905 REM *****

```

It's a winner

By Michael Fletcher



It's a midsummer night, you and your family are cruising the highway from L.A. to Denver when suddenly cars start screaming past.

What is this? The name of the game is The Great American Road Race, manufactured by Activision — and something different to the usual car racing game.

When the program is loaded you are presented with title screen showing a car blowing up dust and credits in the production of the program.

Then follow vital statistics of past road races. You pick your course — a map of the United States shows the four routes.

On the bottom of the screen is the dashboard of your car — a fuel gauge, rev counter, clock and speedometer.

To change gears you have three elements — clutch, gear stick, rev counter.

You have to ensure sufficient revs to change into higher gear, the signal being a high pitched car whine or the rev reading.

The clutch is depressed by pushing

the red action button and the gear stick moved by pushing the joystick forward.

Just be careful after changing gear to release gently the fire button before accelerating.

The hazards include snow — difficult, because in snow it becomes a lot easier to hit other cars. Hitting a car causes you to crash.

Other hazards are night driving, busy highways, oil and rain.

An obstacle is the inevitable traffic patrol car.

To get past you have to slow down to 55 m.p.h., or risk spending valuable time again on the side of the road.

An important element is fuel. At every 100 miles a fuel pump is displayed, but refuelling stops are your choice/risk.

Overall this race puts car games into a new dimension of reality. Graphics and sound enhance Atari's already superior gaming qualities.

The Great American Road Race is on a 32K disk, supplied by Activision.

```

7101 ? "VENUS:DIST. FROM SUN-108,200,000km:DIAMETER-12,100km:GRAVITY-.9: OF E'S:
DAY-243 L DAYS:YEAR-224.7 L DAYS"
7102 GOSUB 9000
7103 COLOR 0:PLOT 35,0:DRAWTO 35,60:PLOT 31,60:DRAWTO 35,60:PLOT 39,60:DRAWTO 35,60:POKE 764,255:GOTO 1045
7200 PLOT 30,0:DRAWTO 36,60:PLOT 34,60:DRAWTO 36,60:PLOT 42,60:DRAWTO 36,60
7201 ? "MARS:DIST. FROM SUN-149,600,000km:DIAMETER-12,750km:GRAVITY-1.1:DAY-23 HU
URS 36 MINUTES:YEAR-365 DAYS"
7202 GOSUB 9000
7203 COLOR 0:PLOT 30,0:DRAWTO 36,60:PLOT 34,60:DRAWTO 36,60:PLOT 42,60:DRAWTO 36,60:POKE 764,255:GOTO 1045
7204 PLOT 42,0:DRAWTO 42,60:PLOT 38,60:DRAWTO 42,60:PLOT 46,60:DRAWTO 42,60
7205 ? "JUPITER:DIST. FROM SUN-778,300,000km:DIAMETER-6,794km:GRAV.-2.5 OF E'S:DAY-
24 HOURS 55 MINS:YEAR-687 L DAYS"
7206 GOSUB 9000
7207 COLOR 0:PLOT 42,0:DRAWTO 42,60:PLOT 38,60:DRAWTO 42,60:PLOT 46,60:DRAWTO 42,60
7208 PLOT 71,0:DRAWTO 71,60:PLOT 67,60:DRAWTO 71,60:PLOT 75,60:DRAWTO 71,60
7209 ? "SATURN:DIST. FROM SUN-970,000,000km:DIAMETER-143,200km:GRAV.-2.3 OF E'S:DA
Y-9 HOURS 55 MINS:YEAR-11.06 L YEARS"
7210 GOSUB 9000
7211 COLOR 0:PLOT 71,0:DRAWTO 71,60:PLOT 67,60:DRAWTO 71,60:PLOT 75,60:DRAWTO 71,60:POKE 764,255:GOTO 1045
7212 PLOT 106,0:DRAWTO 106,60:PLOT 102,60:DRAWTO 106,60:PLOT 110,60:DRAWTO 106,60
7213 ? "URANUS:DIST. FROM SUN-2,870,000,000km:DIAMETER-51,000km:GRAV.-.9 OF E'S:
DAY-15.5 HOURS:YEAR-84 L YEARS"
7214 GOSUB 9000
7215 COLOR 0:PLOT 106,0:DRAWTO 106,60:PLOT 102,60:DRAWTO 106,60:PLOT 110,60:DRAWTO 106,60:POKE 764,255:GOTO 1045
7216 PLOT 183,0:DRAWTO 183,60:PLOT 179,60:DRAWTO 183,60:PLOT 187,60:DRAWTO 183,60
7217 ? "NEPTUNE:DIST. FROM SUN-4,497,000,000km:DIAMETER-49,500km:GRAV.-1.15 OF E'S:
DAY-16 HOURS 36 MINS:YEAR-163 L YEARS"
7218 GOSUB 9000
7219 COLOR 0:PLOT 183,0:DRAWTO 183,60:PLOT 179,60:DRAWTO 183,60:PLOT 187,60:DRAWTO 183,60:POKE 764,255:GOTO 1045
7220 PLOT 315,0:DRAWTO 315,60:PLOT 311,60:DRAWTO 315,60:PLOT 319,60:DRAWTO 315,60
7221 ? "PLUTO:DIST. FROM SUN-5,900,000,000km:DIAMETER-3,800km:GRAV.-.85 OF E'S:
DAY-6 L DAYS 9 HOURS:YEAR-243 L YEARS"
7222 GOSUB 9000
7223 COLOR 0:PLOT 315,0:DRAWTO 315,60:PLOT 311,60:DRAWTO 315,60:PLOT 319,60:DRAWTO 315,60:POKE 764,255
9000 POKE 764,255
9001 IF PEEK(764)=255 THEN 9005
9002 GOTO 9001
9005 ? "":RETURN

```



QUME



Quite simply, more for less with exact VT 220 emulation.

Once again Qume comes up with more for less. The Qume QVT-202 offers exact VT220 emulation — but More Features! Superior Ergonomics! Lower Price!

The ANSI terminal is true DEC VT220 emulation, including a 100% compatible keyboard layout. It offers far better emulation, has more features, and much higher quality for the price than other VT220 emulating terminals.

The QVT-202 features superior ergonomics. The durable HI-RESPONSE Capacitive Keyboard has superb touch and feel, and a 14" non-glare tilt/swivel screen.

QVT terminals have proven their ability to deliver 25,000 hours without a single repair, more than double the 10,000 hour industry standard.

No other terminals company offers Qume's strength in service and support through a network of service centres. And because Qume is part of ITT, Qume will be here in the years to come.

Qume[®]
A Subsidiary of **ITT**

STC DATA PRODUCTS (NEW ZEALAND) LIMITED
AUCKLAND PH 500-019, WELLINGTON PH 857-985
P O Box 26-064 Auckland, P O Box 40-140 Wellington

The best ideas are the ideas that help people. **ITT**

Jet is some spin-off

by Richard Gorham

Several interesting software products have been launched in New Zealand recently.

We will look at several in the next few issues.

Firstly, we'll give "Jet" a spin. It's the latest flight simulation from US software wizard Bruce Artwick, renowned for his previous work of art — the peerless Microsoft Flight Simulator.

SubLOGIC, Bruce Artwick's US company that specialises in high performance graphics hardware and software for the IBM PC, has recently released a High Speed Graphics System capable of drawing 100 million pixels per second.

At a retail price of US\$ 2,990 this is claimed to rival dedicated graphics systems costing around US\$ 40,000.

As a spin-off from this development, new techniques in graphics programming have been developed for the PC and are first seen in SubLOGIC's latest flight simulation program, the aptly named "JET".

Artwick's previous Flight Simulator (marketed by Microsoft and thus otherwise known as MFS) set a high standard for following simulation programs to achieve. The program provided a highly authentic real-time simulation of a single-engined Cessna light plane.

The only minor criticisms of the program have been the slow speed of graphics updates and lack of a choice of faster planes (real-time is OK if you're a serious flight buff — but 140 knots can get a bit tedious after a while).

JET, on the other hand, provides a choice of two supersonic jet fighters for free flight, dog-fight, or ground attack modes of flying.

The program runs on all IBM PC's (including AT and JR, and thus probably JX), requiring 128K and either an IBM compatible colour adaptor, or a Hercules mono-graphics card. IBM's enhanced graphics adaptor — EGA is also catered for.

Choice

The "pilot" has the option of F-16 Fighting Falcon ground based, or F-18 Hornet carrier based jets. Each has the capability of flying at more than twice the speed of sound.

Skill levels from 0-9 can be selected. Control is provided for undercarriage, radar, thrust, air-brakes, attitude display, weapon selection, weapon fire, 5-direction views out of plane (can be zoomed up to 8x normal), target selection, and auto-ranging display.

Control of the plane is by cursor-keys or joystick, if available.

These planes are both "fly-by-wire" machines in real life. That is, they have computers between the joystick and control surfaces to provide the pilot with a more predictable response.

Given that the F-16 has a thrust capability greater than its weight, and is thus truly ballistic, this is just as well! They would otherwise be non-flyable.

The result in real life, and in the simulation, is that all the pilot has to do is point the plane in the desired direction and the computer will do all the donkey work (unlike Cessnas and the MFS, where pilots had to really "fly" the plane).

H.U.D.

Instrumentation is in the form of a Heads-Up-Display (HUD) which is superimposed on the view out of the canopy.

Speed in Mach's, percentage thrust (including after-burner if in use), frame loading G force, altimeter, radar display, attitude, and range to target can all be displayed simultaneously.

Selection of free flight allows the "pilot" to practise take-off, flying manoeuvres, and landings without being attacked.

The enemy fly MIG 21 or MIG 23 jets.

Presumably the absence of nationality markings on all planes is intended to allow a certain cope for interpretation as to who is fighting what. Many nations around the world have access to the types of jets used in the simulation.

Dog-fight mode involves take-off from ground base or carrier, depending on plane selected, and attack and counter-attack with enemy aircraft using air-to-air missiles or cannon.

Luckless novices hit by the enemy's missiles can eject from the plane if they are quick enough.

After leaving the cockpit by this rather undecorous means, the survivor will be treated to the sight of their jet disappearing in a streak of flame.

They will then float gently to the ground, and be rewarded with a new plane (up to three planes per game).

Ground-strike mode gives "pilots" a number of ground or marine targets to attack with air-to-ground missiles or smart-bombs, and opposition coming in the form of ground-to-air missiles.

Quality of the graphics presentation is excellent, with realistic line-drawings of enemy planes, missiles, the ships. The speed of update is probably twice as fast

as the MFS even on the standard PC.

AT speed

I also ran the program on an AT, and can report that the speed is not far short of most arcade games. This difference in speed spoils one silly, and dropping back to the PC's speed is dramatic proof of the difference between machines.

One of the strong features of the program is the option to view the plane from outside (at a fixed ground position) during flight — thus flying by remote-control.

This is a facility that I always wished for in MFS.

Watching take-off from the carrier's control tower certainly puts a different perspective on the whole event.

Another interesting point is the optional input of a variety of different scenery disks for use with the program.

It would appear that SubLOGIC have released several of these for use with MFS (all of places in the continental US), although I don't think any have surfaced in NZ yet.

However, scenery from the MFS disk itself can also be used, and I duly managed to load the New York scenery with the program and successfully flew between the World Trade Towers at Mach 2.2!

Bugs

On the negative side, I did find that the program seemed to have a bug or two at high altitude — the controls appear to reverse themselves at times (seemingly NOT due to "pilot" error!).

Overseas reviews of the program by experienced jet pilots have questioned the authenticity of both the ground taxiing and the supersonic simulation too.

However, the program is aimed more at the recreational market than at authentic flight simulation devotees — and will no doubt be a big seller in this area despite its rather hefty NZ\$145 price tag.

The program's real strength lies in its ability to provide a coherent and challenging simulation for the "pilot" through its excellent graphics programming.

SubLOGIC will be hard pressed to surpass this one next Christmas, my only hope is that it's a full space shuttle simulation (complete with space walk, please).

Until then SubLOGIC's "JET" should be a highly popular contender for the title of top PC game of all time.

Next month's review:

In a much more serious vein, next month's review is of a database manager package called "Reflex" (priced at only NZ\$350).

Businesses at the crossroads

The race to computerise is on, but where is the starting line?

A business manager, whether he be a sole trader or controlling an operation of substantial size, will at some stage face the question: Do I really need a computer; if so where do I start?

In the last two years the traffic at these crossroads has dramatically increased.

And there business managers have been befuddled by a confusing mass of directions from those who purport to know the computing path they should be on.

The business managers are at a disadvantage, because most have not travelled this route before.

And even after a fair reconnaissance of the computing options ahead, often they are confronted still by what seems to be a conspiracy of secrecy about the right way to establish computer systems.

What was needed was something like the AA (Automobile Association) to put travellers of this road on the right track — a group without vested interests in particular routes being chosen, except in ensuring that the various routes are faithfully charted and signposted.

In the world of computer options, one of the major accountancies has decided to fulfill this neutral, advisory role by establishing MicroLab as a computer consultancy which has no vested interests in whatever computer systems are ultimately chosen by those seeking directions.

Its consultants sell advice rather than hardware, or software, and claim to be objective and impartial when discussing the computing needs of any business.

Supercalc 3 — a better spreadsheet?

We've just got the latest upgrade from Sorcim/IUS, Supercalc 3 Release 2. For those of you who use Supercalc and even those that use Lotus, look out for Release 2 — it is a giant leap forward from previous versions.

We've been Supercalc users ever since the early days of CP/M — in fact we got our first taste of it on the tiny 5-inch screen of an Osborne.

At the time it seemed miraculous to have adjustable column widths and text that wasn't limited to cell widths — features that we had cursed in the original Visicalc on an Apple.

Since those days (only 3 years ago!) spreadsheets have dramatically improved, and Supercalc has been enhanced with many new features.

Supercalc 3 only runs on the IBM or compatibles, but includes graphics and data base management, just as Lotus does. But it wasn't as quick or easy to

use as Lotus until Release 2.

With this new version Sorcim/IUS have added 8087 support, 9999 rows, and sparse matrix memory management — which means you can have much more information in a spreadsheet before you reach your RAM limitations.

Another bonus included is "sideways" — a utility that lets you rotate a wide report 90 degrees for printing on continuous paper.

What's less obvious until you use this Supercalc version are the improvements to the user interface: improved help, redesigned screen (in colour) and, at last, quick use of the page up, page down, and end keys...all looking suspiciously like Lotus.

So if you're an existing Supercalc user, here's a viable upgrade.

Or, if you're looking for a top class spreadsheet, take a close look at Supercalc.

Its graphics are better and easier to use than Lotus (you don't need another disk), there's a much wider range of numeric format options, and it's cheaper — only \$985. New Zealand agents are Arcorn-Pacific.

But hang on, there's a new version of Lotus just released...

Sybiz Plus... a first glance

We have just had Sybiz Plus installed on one of our MicroLab computers. For those of you who know Sybiz, and there are many of you, the Plus version offers some significant enhancements, particularly in the general ledger area.

Do not assume however that Plus has all existing Release 5F features plus more, as Sybiz themselves have said that some 5F features are in the process of being included in Plus.

Before you make any decision to upgrade your software, ensure you are not losing any essential features already existing in your current system.

Our first impressions of Plus were favourable — the same screen layouts and approach but with extra options.

If Sybiz can create the stability with Plus as they have with version 5F then the business community will have a useful product.

Some of the features in Plus are:

- New view windows to enquire on or search for any account within any ledger at any time; creating added flexibility for the single-screen user.
- New calculator window offering the basic four calculating functions with the added advantage of directly loading the calculated result into Sybiz Plus.
- The general ledger is upgraded to include the ability to post into different accounting months, to allow entry of

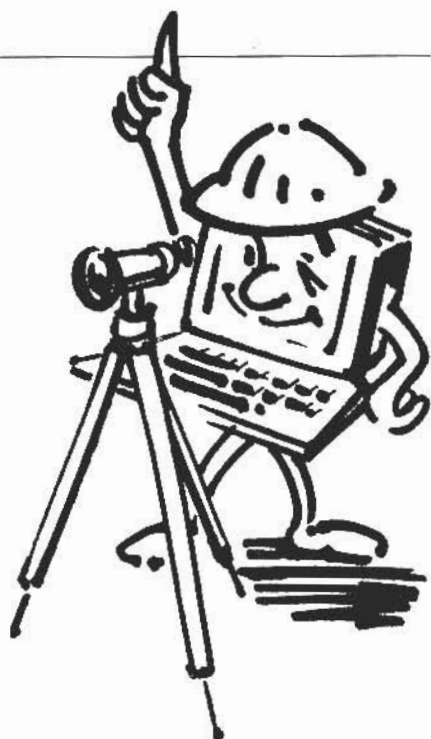

In this regular column we look at micro computers at work: at the software required for work-a-day tasks, and at the hardware employed to interface with spreadsheets, databases, project planners, accounting modules, communications facilities...

The research reports are from Phil Ashton, Brent Hill and Rob Clarke, who are d.p. consultants at MicroLab, a "neutral" consultancy established by the accountancy Kendon KMG, in Auckland.

the full year's budget month by month, to permit standing journals and more informative reports.

Just a point worth noting here, and it wasn't obvious in our demonstration system: once the year end roll-over has been actioned there should be some control to prevent posting into prior years' months (ie last account year months).

- Open Item reporting on debtors statements has been tidied up and the statement stationery and layout improved. The posting of cash against open item invoices has also been streamlined.
- Invoicing has been enhanced to include a third selling price level (trade), customer/product discount percentages have been introduced on a limited basis and invoice printing can now be delayed from time of data entry so that all are printed in one batch. A significant development.

Note: We have compared Plus with version 5F from Sybiz although we are aware an upgrade to 5F is now available in the form of 5G. We have not yet seen 5G to comment on it.

'Perfect' but for some flaws

by Peter Biggs

The Perfect Software series consists of a number of modules including a word processing package (Perfect Writer), a data base (Perfect Filer) and a spreadsheet (Perfect Calc). Other modules available are a Communications (Perfect Link) and a Graphics package. They are marketed by Thorn-EMI.

The Version I series became popular for the Apple and Commodore micros and two of these have since been upgraded, in 1984, and are called Version II. Only Perfect Writer and Perfect Filer are reviewed here, along with a glimpse at Perfect Calc.

There are two packaged versions — one from the UK (available from Dick Smith Electronics Ltd) and one from the USA (available from Thorn-EMI: Software Sciences Ltd). Perfect Writer II and Filer II from the UK are the packages reviewed here.

The packages are boxed with an attractive black, hard cover loose-leaf book containing the documentation and the discs.

Three discs are included in each package and none are copy protected.

This means that I could have made back up copies and installed them readily on a hard disc in the office.

Each disc comes with a tutorial and 'extras'.

Looking at the disc contents, it seems they have included as much as possible to aid the usefulness of their products — a feature some software houses could well emulate.

A Function Key template is provided with each program.

Both programs require at least 192K and two disc drives.

Each manual is about 400 pages long and are impressively readable and clear. Thorough and concise, they are also well written for first-time users.

I have an IBM PC compatible, a colour monitor and a hard disc with an Epson-code printer. Installation was easy and over in about 10 minutes, which included reading the documentation.

Perfect philosophy

Every program series has its own internal, hopefully consistent, philosophical approach to the user interface. Some make it difficult but many now try to make programs as user-friendly as possible.

In this case, Writer and Filer are both accessible from a common menu. This could be important in an office situation.

From this menu I could Write/Revise, Print a Document, Spelling Check, Calculate a Datasheet, Telecommunicate, File records, Document Utilities or Return to Operating System.

Two of these required Perfect Link and Calc.

The Document Utilities were very use-

ful as they took the place of DOS commands to manipulate files and disc drives. Again, a nice touch and user-friendly.

Menu-driven

The programs are all menu-driven rather than command-driven.

In every case, menus are obtained by pressing the ESC(APE) key and selected from there. To select the function needed either the cursor keys can be used or the first letter of the function typed.

This method applies to all the menus throughout the Perfect Series. Each menu has a HELP screen invoked with '?'.

The most distant function was four menu-levels 'deep', which meant choosing from four menus to obtain the required function. However, this was infrequent and two menu-levels deep was enough for most common uses.

I found this approach excellent for starting up and quickly using the programs. I had staff use Filer and they appreciated the ease of using these menus because it gave them confidence in their ability to manage the program.

A Mouse can be used to 'pull-down' the menus but as I don't have a mouse I couldn't test its efficiency. I suspect reaching for mouse would be distracting but it could be fun.

Because this series is 'modular' I will talk about each program separately and then look at the overall effect of the two packages.

Perfect Writer

Perfect Writer comes with a Spelling Checker (of unknown number of words) and a Thesaurus of 50,000 words. There is also provision to create my own dictionary of words commonly encountered in my particular situation.

The 10 function keys are dedicated to some of the more common functions such as transposing and marking text.

I photocopied the Menu Tree from the back of the manual and just used that unless I really needed more. This was

adequate for a long time.

I prefer to write with white on a blue background because it is less tiring so I tried colouring the screen.

A page can be 'painted' via menus but the colour disappears when the page is cleared. It seems a small point but I wonder why they bothered.

I gave up on the colour and settled for white on black — the unalterable default on this program. It would be no problem using a monochrome screen.

This is a WYSIWYG (What You See Is What You Get) word processor. Everything done to a page appears on the screen. With a bit of experimenting I very soon explored the main functions of the program.

I found all the features I would expect in a good word processor.

The 'cut and paste' option is fast. Page breaks can be inserted when required and the page justified on the screen.

Headers and Footers are readily set up as are page numbers for left and right hand pages (even and odd numbers).

When stuck for a word, I invoked the Thesaurus and inserted the chosen word, inserted directly into the text. This is a useful feature for writers.

I found it easy to work with, although the use of menus all the time to access functions was a little annoying after a while. It was either that or learning a set of commands.

I also could not find a way of going directly to a particular page of text without laboriously paging through the intervening pages.

This is a common fault of word processors that severely limit their usefulness for book work.

Document design

It is in document design that the program really stands out.

With care and patience I could set up the format of a form letter and quickly use this to write specific letters.

Many standard form letters are included on the discs. For example, I set up a "Thank you for your... I will... Enclosed is... I look forward to... Yours..." type standard letter and could quickly fill in the appropriate spaces.

A number of standard letters are included on disc.

All this and more is achieved using a command structure.

This structure is very powerful and with it I could readily produce a book.

I could set up Titles, Subtitles, Headings, Numbered Headings, Appendices,

(Continued on page 69)

D I A B L O



... NOW THERE'S SERVICE TO MATCH.

Now you can confidently expect a standard of service to match the excellence of the world's foremost daisywheel printers.

MITSUI COMPUTER SYSTEMS LTD

MITSUI COMPUTER SYSTEMS LTD, 15-19 WIGAN STREET, WELLINGTON. PO BOX 9447, COURTENAY PLACE. TEL. 845-819 TELEX MITSUI NZ3555.
PRINCES STREET, AUCKLAND. PO. BOX 4128. TEL. 395-686, TELEX MITSUI NZ2328.

(Continued from page 67)

Index, Footnotes, Chapter Headings and many more specific design features.

There are also typeface commands such as bold, italic, roman, superscript, and underline. This alone would make it useful to publishers both large and small.

Some problems

I did find some problems. When editing a large document I needed to reconfigure a larger temporary workfile on the disc.

I only discovered this when I got an undocumented error message. Also, when using the Thesaurus a number of times, the program came up with incomprehensible (and of course undocumented) error messages and I was unable to go further.

I finally got out of this but by then had corrupted the text itself. This appeared to come about because the program marks the text on the disc file.

A small point about word processors (and other programs): when I need to look at the list of documents I have saved on disc, I don't want to see all the program files at the same time.

I also need the files sorted alphabetically to save me searching through large numbers of files.

This is especially true of W P because in no time at all anyone will create a large number of letters and documents.

What I liked:

- It is user-friendly and a WYSIWYG (What You See Is What You Get) word processor.
- It has some exceptionally powerful features.
- The Spelling Checker and Thesaurus.
- The ability to mailmerge and print labels from Filer.

What I didn't like:

- The poor implementation of colour.
- No horizontal margin on the screen.
- The menus. After a while they are a mixed blessing.

Summing up:

A powerful, user-friendly word processing program.

Being menu-driven is excellent for first time or occasional users but could annoy really serious typists.

Using information from Perfect Filer to mailmerge letters and print labels is also a useful feature.

At \$595 it's good value.

Evaluating the performance of word processing packages is difficult because they are very individual.

I would say that MS Word is less powerful though more elegant (and more expensive), PFS Write is more straightforward (although far less powerful) and Wordstar is more difficult to learn than Perfect Writer II.

If you are writing, this one is worth looking at.

Perfect Filer

Perfect Filer can be properly configured for colour so this pleased me to begin with; then invoking the program gave me the first menu.

From here I could Add more records, Sort, Search, Edit, Print records, Set up another file or use the files for mailmerging or printing labels.

The program is again menu-driven but this time it seems to be more convenient and appropriate. I think this is because I am not manipulating text, and using the menus seems safer and more error-proof than commands.

The program uses the files direct from the disc which means that the maximum file length is the extent of a disc.

However if a file became too large, the sorting, searching and editing functions would slow down considerably.

I would think that a useful file length would be no more than around 2000 records and if I needed more than this I would choose a more powerful database. This practical limit is satisfactory at this level.

True to form, I ignored both the tutorial and the documentation and started straight in.

I found the menu structure prompted me at every point in the process and I knew the documentation would be there to support me if I became lost. I didn't.

Friendly

The record length is fixed by what can fit into one screen. At most, 100 fields are allowed but in practice this crowds the screen entirely.

I set up a record structure with name, address details and a further 10 fields of information.

My staff, completely unused to computers, then entered some client data. With menus, the process was very easy indeed and they were taught in one session. After a few data entry sessions they were confident using it. They know that the menus are available to guide them.

I now use it for a client list and it behaves well. It is easy to use and I rarely consult the manual.

This program was immediately able to be used effectively with little learning, which is to its credit.

An interesting feature of Filer is the number of pre-programmed macros available to quickly set up a screen for data entry and recovery on a file. These are available on a utility disc and I can make up my own.

With Writer, I am able to mailmerge information with a form letter and print

address labels quickly and conveniently.

Fatal flaw

The fatal flaw in this program is its inability to be able to add or perform any arithmetic operation on numeric fields.

Occasionally I would like to total a field labelled 'Books Purchased'.

I can't, and so this flaw seriously affects the overall use of the program as a database.

The only way this is possible is by transferring data to Perfect Calc (available for another \$500).

This could be a significant consideration when choosing a database for your own use.

This is the only problem with it. So far it has been well-behaved, genuinely user-friendly and functional.

What I liked:

Everything. It had an ease of use that impressed me and my staff.

What I didn't like:

Its unforgivable inability to at least add up a given field throughout the file.

Summing up:

A good, friendly data base. It has limits on the number of fields and the useful number of files but this is usual for this level of database.

If you simply need a customer list for mailmerging and address labels, then this database is very good value at \$495.

However, beware of its major defect.

(Continued on page 76)



UNIVERSITY BOOK SHOP

Specialists in
COMPUTER BOOKS

Over 1000 titles
in stock

PHONE OR WRITE VISA BANKCARD

STUDENT UNION BUILDING
34 PRINCES ST AND 19 HIGH ST
AUCKLAND 1
TELEPHONE 771 869

COMMODORE

64

FROM

TAB

Commodore 64 Programming: A Hands-On Approach to Basic \$34.50

Here's easy-to-follow, professional-quality instructions in BASIC programming that provides short programmes to fully familiarize you with BASIC.

Commodore 64 Assembly Language Arcade Game Programming \$50.95

Unlock an exciting new dimension of your Commodore 64's graphic capabilities that's not possible in BASIC. Create amazingly sophisticated arcade-type games for hours of pleasure.

1001 Things to do with Your Commodore 64 \$29.95

A brand new, revised edition of this all-time best-seller. More ideas and programs than you ever thought possible.

Serious Programming for the Commodore 64 \$34.50

Here's your guide to systematic programming that shows you how to avoid the usual trial and error methods. Designed for advanced programmers this is an essential tool for transforming your Commodore 64 into a serious and productive business machine.



REED METHUEN

Do-it-yourself BASIC

by Joe Colquitt

In this series of articles, I'll try to explain the workings of a computer and how you can use existing ROM routines to write your own BASIC.

If you're new to computing, you may not understand the method, but will still be able to use it.

There are many utilities that use re-defined keywords, such as Paintbox, Plotter, Simon's BASIC, disk wedges etc. Many have the same principles, but different characteristics.

Some don't list properly, some have error routines, or are awkward to type in because of unergonomic keyword spellings, eg @PLOT is a lot easier to type repeatedly than !PLOT.

When we come to writing the new additional BASIC routines, they will have to be in machine code, just like the keyword routines already in ROM.

If you've followed this ML column, you should be able to at least have a go at your own routines.

I'll be presenting a selection of routines to choose from, and making the system generally user definable.

In fact, just about any function can be assigned a keyword.

The keyword spellings I'll leave to you. I'd also like to get some ideas from you about what sort of routines you'd like to see.

At the moment, I've general ideas about keywords for sprites, sound, bit-mapping, screen editing, printer and disk commands.

To keep it brief, the main routine is given this month, with explanations and further keyword ideas in future issues.

The structure is quite simple if you look at it systematically.

The DATA statements are a fair indication of the layout.

What the new o/s does is to check if a token has a value of 204-254.

If it has, the new keyword is executed. If not, control is passed back to the normal BASIC system.

- 1) C008-C0FF new words table
- 2) C100-C1FF routine address table
- 3) C200-C2FF error message table
- 4) C300-C4IF operating system (o/s)
- 5) C420- new routines

To end Part One, below is the BASIC loader for the o/s and seven new words: LOC, BDR, BCK, TEXT, CLS, PAUSE and PAIR.

All seven are simple ML routines.

The '76' in line 100 is ASCII for 'L', the start of the keywords table.

You can change the words, as long as they are in the same order, and have 128 added to the last letter.

For instance, LOC as a keyword in the table is 76 79 195, not 76 79 67.

When you have activated the new o/s, the seven keywords are immediately available for use, on their own or with usual BASIC.

If you later load a program containing them (without the o/s) they won't work, and will not list properly.

Load the o/s to LIST or RUN.

If you run Program 1 before entering any of Program 2, you'll save yourself a lot of typing.

Erase lines 10-60 of Program 1 after the data lines have been compiled.

LOC(x,y) LOCate cursor at column,row and PRINT

```

Variable : o/s / #.
BDR(x) is to change the BDR colour.
BCK(x) is to change the BCK colour.
TEXT(x) is to change the foreground (character) colour.
CLS clears the screen.
PAUSE-- delay .xx/60 seconds.
PAIR(x) this function is the equivalent of !PEEK(x)+256*PEEK(x+1), eg *PAIR(42) 2049

```

Program 1

```

10 L=100
20 PRINTCHR(147);L;"DATA 0,0,0,0,0,0,0,0"
30 PRINT"L"=L;"100000"
40 PRINTCHR(18);IFL(47)THENPOKE100,3
50 POKE81,18;POKE82,13;POKE83,13
60END

```

Program 2

```

10 I=100;M=48100
20 READO(0);IFL(0)=1 THENBYE48200;NEW
25 IFL(78;M(0,1);M(78;M(48
30 M=VAL(M(0,1));IFL(47)THENPOKE1,M
35 BU=M(1);IFL(100)000
40 CK=VAL(RIGHT$(M(0,3))
50 IFCK(0)THENPRINT"ERROR";SU,M;END
60 000000
100 DATA 10, 100, 195, 203, 195, 237, 195, 76, 79, 101543
105 DATA 185, 88, 88, 218, 88, 87, 203, 87, 76, 211, 102772
110 DATA 65, 73, 210, 88, 85, 85, 83, 137, 84, 103784
115 DATA 89, 81, 81, 0, 0, 0, 0, 0, 0, 0, 0, 0
120 DATA 0, 0, 0, 0, 0, 21, 186, 64, 186, 104650
225 DATA 76, 186, 88, 186, 87, 186, 128, 196, 168, 186, 106180
235 DATA 8, 73, 78, 98, 80, 78, 73, 68, 32, 108731
240 DATA 77, 78, 76, 78, 85, 218, 87, 78, 78, 85, 107634
245 DATA 7, 88, 18, 88, 78, 81, 8, 8, 0, 108812
455 DATA 8, 8, 8, 184, 18, 184, 88, 184, 108850
455 DATA 6, 184, 0, 0, 0, 0, 0, 0, 0, 108818
470 DATA 0, 10, 178, 188, 182, 194, 133, 34, 188, 110279
480 DATA 193, 194, 133, 25, 76, 71, 164, 0, 162, 7, 111114
485 DATA 108, 4, 3, 157, 187, 8, 188, 0, 192, 187, 1012374
490 DATA 3, 202, 18, 241, 96, 38, 124, 105, 182, 113419
495 DATA 188, 4, 136, 15, 188, 8, 2, 133, 8, 114882
500 DATA 18, 24, 248, 78, 32, 15, 56, 233, 98, 102512
505 DATA 144, 34, 281, 81, 176, 38, 132, 113, 162, 76, 1161040
470 DATA 0, 10, 178, 188, 182, 194, 133, 34, 188, 110279
480 DATA 193, 194, 133, 25, 76, 71, 164, 0, 162, 7, 111114
485 DATA 108, 4, 3, 157, 187, 8, 188, 0, 192, 187, 1012374
490 DATA 3, 202, 18, 241, 96, 38, 124, 105, 182, 113419
495 DATA 188, 4, 136, 15, 188, 8, 2, 133, 8, 114882
500 DATA 18, 24, 248, 78, 32, 15, 56, 233, 98, 102512
505 DATA 144, 34, 281, 81, 176, 38, 132, 113, 162, 76, 1161040
510 DATA 132, 11, 168, 255, 134, 122, 282, 288, 232, 183, 117077
515 DATA 2, 256, 248, 8, 182, 248, 245, 78, 1, 128, 119198
520 DATA 88, 48, 5, 11, 164, 113, 232, 288, 153, 131, 102033
525 DATA 1, 185, 251, 1, 248, 54, 56, 233, 58, 248, 111886
530 DATA 188, 173, 288, 8, 133, 15, 56, 233, 98, 102512
535 DATA 288, 178, 133, 8, 188, 8, 2, 248, 233, 137, 1024281
540 DATA 848, 218, 288, 153, 251, 1, 232, 282, 248, 106804
545 DATA 188, 182, 238, 11, 288, 185, 7, 192, 16, 238, 102742
550 DATA 185, 8, 182, 288, 188, 188, 0, 2, 18, 188, 102832
555 DATA 133, 253, 1, 188, 253, 133, 122, 98, 16, 42, 102884
560 DATA 81, 255, 248, 38, 38, 15, 48, 34, 28, 101, 103110
565 DATA 144, 38, 38, 233, 883, 178, 132, 73, 188, 255, 102110
570 DATA 282, 248, 8, 888, 185, 8, 182, 18, 258, 48, 1033515
575 DATA 88, 288, 195, 8, 182, 48, 0, 32, 71, 171, 103875
580 DATA 288, 245, 78, 243, 188, 76, 238, 188, 76, 28, 103855
585 DATA 187, 32, 115, 8, 281, 284, 144, 21, 32, 216, 1037788
590 DATA 195, 76, 174, 187, 233, 284, 18, 188, 185, 1, 1039141
595 DATA 83, 78, 185, 8, 183, 78, 78, 125, 8, 32, 1040738
600 DATA 121, 8, 76, 231, 187, 188, 9, 133, 12, 28, 1041821
610 DATA 15, 8, 281, 255, 248, 38, 281, 288, 144, 28, 1044247
615 DATA 288, 233, 288, 18, 78, 32, 115, 8, 32, 241, 1043448
618 DATA 174, 184, 188, 185, 8, 183, 133, 85, 172, 8, 1044878
620 DATA 193, 139, 88, 32, 84, 8, 78, 141, 173, 32, 1045828
625 DATA 121, 8, 78, 141, 174, 8, 38, 285, 188, 188, 1046535
630 DATA 88, 81, 881, 48, 178, 15, 188, 224, 28, 178, 1047825
635 DATA 12, 24, 32, 248, 255, 32, 883, 174, 78, 181, 1049185
640 DATA 178, 188, 1, 44, 188, 2, 78, 248, 184, 32, 105282
645 DATA 188, 173, 32, 247, 183, 185, 28, 141, 32, 288, 101541
650 DATA 88, 32, 138, 173, 32, 247, 183, 185, 28, 141, 1052788
655 DATA 22, 288, 98, 288, 5, 188, 147, 32, 288, 84, 1054188
660 DATA 88, 185, 81, 72, 188, 88, 72, 32, 247, 183, 1055182
665 DATA 188, 177, 88, 133, 88, 888, 177, 28, 133, 1056381
670 DATA 88, 184, 133, 28, 184, 133, 21, 188, 144, 56, 1057878
675 DATA 32, 73, 188, 98, 32, 138, 173, 32, 247, 183, 1058478
680 DATA 178, 182, 8, 248, 8, 136, 185, 182, 197, 182, 1059983
685 DATA 248, 282, 288, 248, 284, 8, 248, 4, 282, 78, 1061582
690 DATA 141, 138, 98, 0, 8, 38, 138, 173, 32, 247, 1062647
695 DATA 183, 28, 8, 288, 31, 133, 98, 192, 16, 175, 1063885
700 DATA 83, 152, 182, 218, 134, 98, 162, 3, 188, 831, 1065832
705 DATA 145, 38, 138, 288, 281, 145, 95, 192, 98, 282, 1068182
710 DATA 16, 244, 141, 134, 2, 36, 163, 2, 76, 248, 1067338
715 DATA 184, 108, 184
720 DATA -1

```

'I need a robot'

Dear Editor,

I have a question that will interest many computer hobbyists.

I own a Commodore 64, and would like the computer to load a program (on disk or tape) as soon as it is booted up. This would be very useful in conjunction with a time switch. It could turn the computer on in the morning, load a program (eg MENU), then play a morning tune or show the day's timetable or something, without having to leave it on all night!

I can think of two ways to do this. Either construct a mechanical robot which physically types LOAD"MENU",8 <ret> — waits a while — RUN <ret>. This would take a lot of building (and therefore time, effort, and money).

Another alternative would be to program an EPROM and insert it like a cartridge into the back of the computer. Like a game cartridge, it could be activated on power-up, and automatically load & run the program.

I know very little about both methods.

Can you help?

Marcus McLaren,
Wellington

I agree that a robot is overkill in this instance.

Apart from the time to build a dedicated robot, it needs to be programmed as well, and unless you had another use for it, that time would be better spent programming an EPROM.

The second idea is quite feasible and readily accomplished. A 2K EPROM like the 2716 would be enough, but they are about \$40.

The process can be split into several operations, which will alternate between C64 ROM and the cartridge:—

a) the ROM routine at \$FCE2 checks for a cartridge as soon as the machine is switched on. If one is found, it jumps straight into the cartridge, and does not do any initialisation of the C64. Therefore, provision has to be made for the initialisation to be done.

b) perform the LOAD.

c) RUN the program.

d) disable the cartridge. This will give you 8K (\$8000-\$A000) of RAM back.

OK, the first thing needed is a 'cartridge header'. This is a sequence of bytes that identifies an inserted cartridge:

\$8000 .byte 09

\$8001 .byte 80 = cold start (RESET) vector

\$8002 .byte 09

\$8003 .byte 80 = warm start (RESTORE) vector

\$8004 .byte C3 = C+#\$80

\$8005 .byte C2 = B+#\$80

\$8006 .byte CD = M+#\$80

\$8007 .byte 38 = 8

\$8008 .byte 30 = 0



When the \$FCE2 routine finds a cartridge, it does the indirect JMP(\$8000), ie JMP to the address held at \$8000.

What you need there is to make it go back into the C64 to initialise the computer, and when it has finished that, return to the cartridge to LOAD.

To do this, have a copy program at the beginning of the cartridge so that BASIC and KERNAL ROMs are put into the shadow RAM under them, and then switch the ROMs off.

Now you have a soft copy of the operating system, which allows you to change the relevant vector affecting continuation after initialisation.

So the code in the EPROM is as below.

I haven't tried this in an EPROM, but it works OK having the code as software loaded from disk, using:

```
10 C=C+1:IFC=1THEN-
LOAD"CODE",8,1
20 SYS64738:REM $FCE2
```

A small program called "MENU" loaded and ran successfully.

If you look at p265 of the User Guide, you'll see the memory configuration needed.

Control of the EPROM's enable line via a transistor would allow you to use a signal from the User Port to switch it in/out, or you could try taking EPROM low by a pull-down resistor and a manual switch.

I would be interested to hear from anyone who has successfully accomplished this form of loading. If you have only a disk drive, this is about the only way you could load on power-up.

Loading from tape is a lot easier. Holding down the Commodore/Run-Stop key and pressing PLAY will load/run from tape.

The ROM routine at \$E5E7 can't tell the difference between the Commodore

key and Shift for the purposes of load/run, and will execute properly.

Because the Commodore key is depressed, the PAUSE at \$E4E0 which waits for Commodore, Space or CTRL key will not occur.

The disadvantages are that the pinch roller is subject to pressure all the time the unit is unattended and any load errors will halt the procedure.

Using this method, however, you could load from disk. Have this program loaded from tape:

```
10 PRINTCHR$(147)"LOAD"CHR$(34)"progname"CHR$(34)",8:"
20 POKE631,19:POKE632,131:
POKE198,2
```

When this runs, line 20 does some dynamic keyboarding, putting a HOME and a Shift/Run-Stop into the keyboard buffer.

After the disk program has loaded and run, the keyboard is inoperative, because of the non-release of the Run-Stop key. Dynamic key techniques will still work. Prog follows:

Joe Colquitt,
C64 columnist

```

$0000 00 00 00 00 00 00 00 00
$0008 30
$0009 LDY#00E 'copy routine
$000B TYA '
$000C STA$FA '
$000E LDA#A00 '
$0010 STA$FB '
$0012 LDA($FA)Y '
$0014 STA($FA),Y '
$0016 INY '
$0017 BNE#0012 '
$0019 INC#FF '
$001B LDA#FB '
$001D BNE#0012 '
$001F LDA#035 'ROMs off
$0021 STA$D1 'also store off value
$0023 STA#F0DE 'in I/O KERNAL routine
$0026 JSR#E544 'clear screen
$0029 LD#00FF 'perform initialisation
$002B STX#0016 '
$002E JSR#F0A3 '
$0031 JSR#F050 '
$0034 JSR#F015 '
$0037 JSR#FF5B '
$003A CLI '
$003B LDA#4C 'change this JMP in ROM so
$003D STA#A4B0 'that after system prints
$0040 LDA#052 ' "COMMODORE...BYTES FREE"
$0042 STA#A4B1 'it jumps back into the
$0045 LDA#000 'cartridge instead of
$0047 STA#A4B2 'printing 'READY.'
$004A LDA#000 'set 'direct' mode
$004C STA#A47C '
$004F JMP#E294 'other initialisations
$0052 LD#0000 'clear screen and print
$0054 LDA#000C 'LOAD"MENU",8
$0057 JMP#FFA2 '
$005A INY '
$005D CPY#00E '
$0060 BNE#0054 '
$006F LD#0013 'home' into v/b queue
$0071 STA#0277 '
$0074 LDA#000 '
$0076 STA#0278 'return
$0079 STA#0273 'return
$0082 LDA#052 '
$0085 STA#027A 'R
$0088 LDA#075 '
$0091 STA#027E 'shift U
$0094 LDA#000 '
$0097 STA#027C 'return
$009A LDA#005 'tell v/b buffer
$009D STA#0C 'K expresses waiting
$00A0 LDA#E7 'ROMs back in
$00A3 STA#01 '
$00A6 JMP#A4B3 'execute keypresses
$00A9 'data for print
$00B2 03 11 4C 6F 22 4D 45 4E
$00B5 05 22 2C 3B 00 00 00
$00B8 'C 00E is the program name.

```

The BITS & BYTES Computer Book Club

Usher in '86 with MSX

PEEKs & POKEs for the Spectravideo

Deane Whitmore

Written for the beginner to semi-advanced user, with the aim of further improving programming skills and knowledge of the Spectravideo SV-318 and SV-328. Covers BASIC, the text screen, graphic screens, delves into a few curiosities and includes three programs.

TME Our price \$15.65.

The Complete MSX Programmer's Guide

Toshiyuki Sato, Paul Mapstone & Isabella Muriel

Claims to be the definitive handbook for the MSX standard computer. Set out in four parts: a comprehensive, self-paced guide which takes the mystery out of learning to program; advanced programming techniques to sharpen the experienced programmer's skills, with information on sound and graphics facilities; detailed explanations of BASIC and machine language and programming guide to the operating system.

Melbourne House Our price \$75.95

Getting More From MSX — With Spectravideo & All MSX Computers

Brian Boyde-Shaw

Deals with editing and debugging of programs, then moves on to how to write programs for education or entertainment, writing text, graphics, sprites and sound. Each new idea is presented as a problem to be solved. The program which solves the problem is explained in detail but you can write your own program for comparison.

Sigma Our price \$28.45

Starting With The MSX

Tony Marriott

Written especially for the first-time user, explaining some of the "computer jargon" and introducing the MSX keyboard to the user. Step-by-step guide to elementary Microsoft BASIC — includes plenty of examples. Finishes with some games programs and graphics demonstrations.

Kuma Our price \$18.95

MSX Games Book

Andrew Lacy

Easily-entered listings for games to test reflexes, nerve, logic, strategy and intelligence — educational, simulation and adventure games. Games make full use of MSX features, including its sprite capabilities and sound. Screen shots preview each program, program structures outlined and key variables given to allow modification.

Melbourne House Our price \$37.95



Behind the Screens of the MSX

Mike Shaw

Takes an in-depth look at the MSX computer's powerful graphics screen displays, revealing many secrets and unveiling a mine of information. As well as providing the beginner with an insight into what's happening behind the MSX screens, it also provides reference information for the experienced programmer.

Kuma Our price \$28.45

MSX Exposed

Joe Pritchard

Comprehensive guide and encyclopaedia of solutions. Begins with BASIC programming and works through to machine language. Step-by-step format concentrates on providing understanding on how your MSX works. Each feature and program statement carefully explained with the aid of demonstration programs, tables of vital memory locations and system variables.

Melbourne House Our price \$37.95

Starting Machine Code on the MSX Microcomputer

G.P. Ridley

Shows how Z80 instructions are used and demonstrates these fundamental routines in a straightforward way. Explains and demonstrates accessing of machine code routines from BASIC to use of an assembler, movement of sprites and playing music in machine code.

Kuma Our price \$28.45

Fundamental BASIC on the Spectravideo

John Palmgren

Works through basic programming on the SV-318 and SV-328. Abundance of program examples give a wide experience of the most important and fundamental BASIC instructions.

forlagsgruppen Our price \$33.20

Graphics, Sound, Sprites on the Spectravideo

John Palmgren

Deals with graphics, colour, sprite and sound, and the disk drive, software and some peripherals available for the SV-318 and SV-328. A computer and preferably a tape recorder will get you through the first four chapters. You need disk drives, software and peripherals later on.

forlagsgruppen Our price \$33.20



SAVE \$1.00 by buying any ONE of these books
 SAVE \$2.50 by buying any TWO of these books
 SAVE \$4.50 by buying any THREE of these books
 SAVE \$8.00 by buying any FOUR of these books
 SAVE \$12.50 by buying any FIVE of these books
 SAVE \$18.00 by buying any SIX of these books

Our new selection

The Greatest Games: The 93 Best Computer Games of All Time

Dan Gutman & Shay Addams

In-depth reviews cover 18 games categories . . . from maze and mind games to classic arcade games and graphic adventures. You see how each game is played, scored and how you win. And you are given critiques of almost every game element.

COMPUTE Our price \$24.00. Save \$1.95

Speed Script: The Word Processor for Atari Computers

Charles Brannan

Concentrates on SpeedScript 3.0, providing a complete program listing; detailed documentation showing how to use commands and capabilities; The Machine Language Editor; MLX, and entry program; and the source code.

COMPUTE Our price \$24.00. Save \$1.95

COMPUTE's VIC-20 Collection

Seventy articles and programs make up a pot-pourri of tutorials, utilities, applications and games. All programs ready to type in and use — and there's a program to check your typing. Many beginner-level programs.

COMPUTE Our price \$30.45. Save \$2.50.

Games & Graphics Programming on the Amstrad Computers CPC 464, 664 & 6128

Steve Colwill

Assumes some knowledge of BASIC and written for those wanting to become more familiar with these computers. Introduces Amstrad's graphics capabilities and demonstrates how to use them to produce animated games and static graphics displays. Aims to help in design of long programs by looking at program structure. Program listings illustrate ideas discussed and a longer graphics game is gradually built up during the book.

Micro Press Our price \$36.95. Save \$3.00

BASIC Programming on the Amstrad Computers CPC 464, 664 & 6128

Wynford James

Covers BASIC programming on all three machines, taking you from the first principles through the basic precepts. Concludes with chapters on more specialised topics such as use of sound, and how to create files and read from them. Each chapter contains example programs and exercises.

Micro Press Our price \$32.30. Save \$2.65

Structured Programming on the Amstrad Computers CPC 464, 664 & 6128

Stephen Raven

Works through every element of program creation. Book features planning by the use of Top Down diagrams. Includes sections on: introducing the three computers; confidence through familiarity; principles of BASIC; little blocks to structured programs; handling text — the key to information storage.

Micro Press Our price \$36.95. Save \$3.00

Computer Fun Andrew Lysley & Roy Howarth

Simple, attractively presented introduction to the BBC Model B and Acorn Electron. Works step by step from first tagging of the keyboard to writing programs, playing with sound and colour, and making music. Plenty of fun projects, too.

Beaver Our price \$7.35. Save 60 cents

Machine Code Routines for Your Commodore 64

Andrew Bennett

Dozens of ready-made machine code routines for you to use in your own programs. Includes routines to move sprites on the screen, plot points on high resolution screens, play notes, help with programming and so on. Programmer can pick and choose routines most useful for a particular program. Each routine is fully explained and suggestions made for its use.

Virgin Our price \$18.45. Save \$1.50

Out of the Inner Circle: A Hacker's Guide to Computer Security

Bill Landreth

An insider goes public. A reformed "cracker" tells of the experiences and stories that were part of life as a 16-year-old hacker. Includes details of the more illustrious capers of the "inner circle" and along with the story of ultimate detection.

Penguin Our price \$27.75. Save \$2.25

Make and Program Your Own Robots for the Sinclair Spectrum

William Clark

Superbly illustrated guide to building models and simple programs to make your own robots perform. You don't need electrical or computer skills, and once you've mastered what's in the book, you can go on to develop your own original robots.

Beaver Our price \$10.50. Save 75 cents

Graphics With Microcomputers

Adrian Oldknow

Source book of programming, techniques, algorithms, ready-to-run programs and ideas for using computers' high resolution facility. Covers two and three-dimensional displays, graphs, user-defined characters, computer-aided design and animation. Describes underlying theory in simple terms and uses a utility program to show how to use it.

Nelson Our price \$28.65. Save \$2.30

IBM

IBM PC Programming

Richard Heskell & Glenn A. Jackson

Hands-on step-by-step approach for beginners and advanced programmers. Uses actual photographs taken from the computer screen in graphic examples to develop many fundamental programming concepts. Includes information on string variables and functions, IBM PC DOS; numerical variables and arithmetic; expressions; sound effects; medium resolution graphics; loops and subroutines; bar graphs; animated graphics.

Prentice-Hall Our price \$27.10. Save \$2.20

The IBM Connection

James W. Coffron

From the author of the popular Apple Connection, VIC-20 Connection and Z80 Applications, this book shows how easy it is to use your computer with common household devices. Explains techniques for setting up your IBM to control a home security system, home temperature and control system, voice synthesizer to make your computer talk, as well as other home appliances.

Sybox Our price \$55.45. Save \$4.50

Data File Programming on your IBM PC

Alan Simpson

Presents the techniques for writing BASIC programs for mailing list systems, grade books, library referencing system, graphic displays. Covers adding files, searching, sorting, editing and printing formatted reports.

Sybox Our price \$55.45. Save \$4.50

Your IBM Made Easy

Jonathan Sachs

Covers the fundamentals and details major features of the system, including coverage of DOS 2.0 and the PC XT. Step-by-step operating instructions, and a guide to resources — what you need to know about dealers, software, services and accessories. Reference guide to operations and troubleshooting for common problems.

Osborne/McGraw-Hill Our price \$29.55. Save \$2.40

Computer Graphics for the IBM Personal

Computer Donald Hearn & M. Pauline Baker

Discusses basic concepts and techniques of graphics and explores IBM PC's capabilities for these applications. Examines methods for creating two and three-dimensional pictures and graphs, and shows how to manipulate and animate displays. Also analyses make-up of PC and its graphic features.

Prentice-Hall Our price \$41.70. Save \$3.40

Your IBM PC Made Easy (includes IBM PC (DOS 2.0) and PC XT)

Jonathan Sachs

Covers the fundamentals and details the major features. Step-by-step operating instructions and a guide to resources telling you what you need to know about dealers, hardware, software, services and accessories. There's also a reference guide for operations and troubleshooting common problems.

McGraw-Hill Our price \$29.55. Save \$2.40

Animation, Games and Sound for the IBM PC

Tony Fabbri

Learn by having fun through brief discussions and programs at first, and ready-to-use examples to help you create new games and practical explanations. You learn programming skills in the process.

Prentice-Hall Our price \$54.10. Save \$4.40

Software Construction Set for the IBM PC & PC Jr

Eric Anderson

Complete package of software tools to help in designing programs. Contains techniques, advice and individual routines to help you build custom-made programs. References for information storage and retrieval, data searches, sorts, window building, using disk files, display charts and graphs.

Hayden Our price \$51.75. Save \$4.20

WordStar on the IBM PC

Richard Curtis

Complete guidebook written in clearly understood style. Assumes no prior knowledge of WordStar or the IBM-PC. Includes all enhancements the IBM-PC brings to WordStar along with add-ons such as MailMerge, SpellStar, StarIndex and CorrectStar.

McGraw-Hill Our price \$30.50. Save \$2.45

Handbook for Your IBM PC (includes XT version)

Louis E. Frenzel & Louis E. Frenzel, Jr.

Experienced users will find it a handy reference, with a concise summary of key operational information and as a source book of information about non-IBM accessories. Beginners will find it step-by-guide to using the computer and a source for "what to do and how to do it".

Sams Our price \$35.15. save \$2.85

Here Come the Clones: The Complete Guide to IBM PC Compatible Computers.

Melody Newrock

Explains which compatibles run what and which are hardware compatible, where the differences in design are critical, how the clones compare in overall performance, why some are and some are not real bargains, and where their hidden costs lie.

Osborne/McGraw-Hill Our price \$48.95. Save \$4.00

Atari

Assembly Language Programming for the Atari Computers

Mark Chasin

Routines follow the rules established for assembly language programmers and will work with any Atari computer. Examples given in both assembly language and, where possible, BASIC incorporating assembly language routines to perform tasks in BASIC.

Osborne/McGraw-Hill Our price \$41.60. Save \$3.35

How to Excel on Your Atari 600XL & 800XL

Timothy O. Knight

Chapters on programming, graphics, sound and music in straightforward terms. All key terms defined, and many accompanied by illustrations. Suggests many uses for business and fun.

Osborne/McGraw-Hill Our price \$25.85. Save \$1.90

BBC

The BBC Micro Gamemaster

Kay Ewbank, Mike James & S.M. Gee

Shows you how to develop your own games as you learn the techniques of the professional games programmers. You also pick up the skill of solving programming problems as they arise. Programs are structured so that each procedure, or module, performs a distinct task allowing variations on the "core" program to be written by substituting new modules. Also advice on how to customise your programs.

Granada Our price \$20.30. Save \$1.65

Cracking the Code of the BBC Micro

Benni Notarianni

Practical guide to machine code programming introduces you to the 6502 hardware and instruction set, then teaches you to combine the separate elements of machine code into the fast code of commercial programs. You learn creation, manipulation and the animation techniques for arcade graphics, there is a set of arithmetic routines for calculation within machine code programs, and appendices on the instruction set, BASIC 1 differences and fixes, and OSWORD calls.

Pan Our price \$24.95. save \$2.00

Exploring Music With the BBC Micro & Electron

Kevin Jones

Explores creative ways of using the computers to make music. Shows how to generate sounds, and to combine sound characteristics and rhythms. Covers wide range of styles — pop, folk, classical and modern. Examines many musical ideas and techniques

Pitman Our price \$36.00. Save \$2.95

Getting the Most From Your BBC Micro

Clive Williamson

Introduction intended to complement the User Guide supplied with the machine. Contains many hints and tips on programming and general use. Explores many possible uses and the computer's potential for expansion to suit individual needs. Some features and accessories, undocumented in the User Guide, are investigated, with specific advice on connecting printers, TV monitors and disk drives.

Penguin Our price \$13.80. Save \$1.15

Business

Multiplan Home & Office Companion

Elna Tymes & Peter Antoniak

Collection of models covering a broad Spectrum of business and personal applications, personal finance, household management Ready-to-use model described and accompanied by the listing needed to create the model and sample data with your own. As you become familiar with Multiplan, the modelling techniques help you to create customised models.

Osborne/McGraw-Hill Our price \$36.95. Save \$3.00

Lotus 1-2-3 Simplified

David Bolcan

Designed for all levels, it starts with installing and using Lotus 1-2-3, then moves through designing and using spreadsheets; formatting spreadsheets and making them aesthetically pleasing; generating printouts; working with oversized spreadsheets; graphics functions, data management; advanced spreadsheet applications and programming with macros. Attractive presentation includes many diagrams and graphs.

TAB: Our price \$31.70. Save \$2.55

Guide to using Lotus 1-2-3

Edward M. Baras

Detailed comprehensive guide to help you make full sense of Lotus 1-2-3's integration of spreadsheet, database and graphic functions. Includes step-by-step instruction on implementing practical application models for financial forecasting consolidating business statements, simulating dynamic processes, electronic forms management. Equally useful to beginners and experienced users.

Osborne/McGraw-Hill Our price \$38.80. Save \$3.15

Business Program Portfolio for your Apple II; An Integrated Office System

George H. Hildebrand

Collection of 61 BASIC programs covering such office tasks as interest calculation, financial analysis, depreciation, property management and real estate, cash receipts and disbursements, job cost, payroll. All programs documented for implementation and modification. There is also a guide to printing out business forms, creating a menu system, and securing business records with password programs.

Hayden Our price \$51.75. Save \$4.20

On-Line Computing for Small Businesses - Silver's Wall

Maurice A. Silver,

John Jeacocke & Ray Welland

Sets out to provide managers of small businesses with a clear, concise but non-technical instruction in the use of on-line computing based on the practical experience of the authors. No prior knowledge of computing assumed and only essential technical definitions are included.

Pitman Our price \$9.70. Save 70 cents

The ABCs of 1-2-3

Chris Gilbert & Laurie Williams

Hands-on approach using detailed step-by-step instructions. Lessons involve tackling projects such as building a worksheet, displaying the worksheet as a graph, building a database, simplifying several operations using macros, performing calculations and printing graphs and reports. Remains a handy reference once you are familiar with 1-2-3.

Sybox Our price \$37.85. Save \$3.05

Taking care of Business with your Commodore 64

David P. Dautenhahn

More than 100 brief BASIC and financial programs, each documented with a short explanation of what the computer will do and a BASIC listing. A real-life scenario follows, with a sample run and more instructions on how to combine two or more applications. Programs include: interest, depreciation, retailing, real estate, loan analysis, savings, lease analysis, time value for money, stocks and bonds analysis, sinking fund analysis, forecasting inventory needs, payroll, insurance, metric conversion.

Hayden Our price \$35.60. Save \$2.90

1-2-3 Run: 41 ready-to-use Lotus 1-2-3 Models

Robert & Lauren Flast

Collection of models that run on Lotus 1-2-3. Each model presented with a step-by-step description, complete listing, an illustration with sample data (you simply replace this with your own), and where applicable, instructions to produce bar and line charts. Designed to simply work, the models include applications for sales, accounting, real estate and the classroom.

Osborne/McGraw-Hill Our price \$38.80. Save \$3.15

Database for Fun and Profit

Nigel Freestone

For users wanting to do their own programming. Provides straight forward introduction to data processing, with explanations of routines in BASIC. Examples of system designs for home and business, which can combine and

expand. Systems for names and addresses, catalogue index; diary; stock control; bank account/budgeting; debtors list/sale/purchase ledger; payroll.

Granada Our price \$18.45. Save \$1.50

Electron

Getting the Most From Your Acorn Electron

Clive Williamson

Comprehensive introduction to the Electron, exploring its potential and possibilities to suit each owner's needs. Intended to complement the user guide, and contains many tips on programming, software and the general use of the computer. Some features and accessories not documented in the user guide are investigated.

Penguin Our price \$14.75. Save \$1.20

The Electron Gamemaster

Kay Ewbank, Mike James & S.M. Gee

Programs structured so that each procedure, or module, performs a distinct task, allowing variations on the "core" program to be substituted. You also learn how to customise your own programs, improving your programming skills along the way.

Granada Our price \$20.30. Save \$1.65

Adventure Games for the Electron

A.J. Bradbury

Numerous examples and ready-to-run program modules in a book which lets you in on the secrets of professional games programming. Takes you through the whole process of writing an adventure, with a chapter on the type of instructions you are most likely to need. All programs in MODE 6 unless otherwise stated.

Granada Our price \$25.85. Save \$2.10

Apple

Getting Started With ProDos

B.M. Peake & D. Rorke

Aimed at Apple II and IIe users, this is needed for someone familiar with the existing Apple DOS 3.3 systems. Comprehensive guide to ProDos, with exercises for practice. Reference section goes over commands and comments on their use, and there is a discussion on the advantages and disadvantages of the system. A list for further references is included.

Bluewater Press Our price \$6.45. Save 50 cents

Applesoft BASIC: A Teach-Yourself Introduction

B.M. Peake

Second edition revised to cover the Apple II Plus and IIe. A manual for New Zealanders to learn BASIC with the Apple, instead of picking information from two or three sources includes model answers. Enquiries for class sets welcome.

McIndoe Our price \$12.90. Save \$1.05

Fun, Games & Graphics for the Apple II, IIe & IIc.

Paul Garrison

Collection of more than 75 ready-to-run programs which you can use, study, modify, combine and experiment with. Complete listings written in standard Applesoft BASIC and CP M-Supported BASIC-80, and explanations. More than 20 financial and record keeping programs, and a wealth of graphics and education programs, a word processing organ and some small-scale database programs.

TAB Our price \$39.75. Save \$3.20

Ken Uston's Illustrated Guide to the Apple IIe

No-nonsense illustrations which allow the reader to master any application without reading the whole book. Self defined chapters deal with buying a computer, which Apple IIe components to buy, how to create a database, word process and perform spreadsheet calculations, how to tap into electronic information services, how to do fundamental BASIC programming, video games.

Prentice-Hall Our price \$35.95. Save \$2.95

Applied Apple Graphics

Pip Forer

Step-by-step introduction to graphics and their applications using BASIC. Suitable for Apple II, IIe and II-Plus. Covers hardware and software enhancements as solutions to graphic problems, in particular, reviewing the software utilities that can make BASIC programming pointless in some cases. Special disk, with 30 programs and 24 other files, is needed to understand many parts of the book.

Prentice-hall Our price \$66.75 (includes disk) Save \$5.40

The Apple House

John Blankenship

Explains how to compose your Apple to control your house security, lights, heat, telephone etc. This system allows the house to accept verbal commands and respond with its own voice. Shows how to build some items from scratch, and how to use some of the

equipment you already own.

Prentice-Hall Our price \$41.50. Save \$3.35

Commodore 64

Cracking the Code on the Commodore 64

John P. Gibbons

Introduction to 6510 instruction set and how to combine the elements of machine code into commercial-style speed. Full machine code monitor with 14 commands gives you the tools to interface with the 64's architecture. Learn good programming practice and trade tricks while using the sprite, sound and hi-res graphics, and get to grips with the interrupt handling for multiple sprites and smooth screen scrolls.

Pan Our price \$24.95. Save \$2.00

Getting the Most From Your Commodore 64

Simon Potter

Uses diagrams, colour photographs, programs and examples to introduce you to the machine. Moves from starting through writing programs to graphics and sound, printers, disks, and extras and troubleshooting.

Penguin Our price \$12.90. Save \$1.05

First Steps in Machine Code on Your C64

Ross Symons

Clear concise explanation of machine code - introduction to the disassembler and its use; instructions for the 6510 chip with the aid of a demonstration program; discussion of the kernel operating system and its applications such as printing, input/output devices and scanning the keyboard. Two complete machine code games show you how to create your own high speed, animated arcade-like games.

Corgi Our price \$12.00. Save 95 cents

Data handling on the Commodore 64 Made easy

James Gatenby

Data processing - sorting raw facts to produce useful information - can be just as rewarding as playing games. Explains how to use the Commodore 64 to process information for the home and small business. Uses straightforward examples to demonstrate storage of large quantities of data, attractive and readable on-screen display, and searching and print-outs.

Granada Our price \$20.30. Save \$1.65

Commodore 64: Basic Programs in Minutes

Stanley R. Trost

Collection of versatile, ready-to-enter programs for more than 65 home and business tasks on the Commodore 64. Programs for home finances, business calculations, real estate, data analysis record keeping and education. No knowledge of BASIC programming needed to use programs which can be entered and ready to run in less than 10 minutes.

Sybox Our price \$37.30. Save \$3.05

The Commodore 64 Experience

Mike Dean Klein

The many and varied uses of a home computer - programs for the home (recipes, shopping, phone books, kitchen metrics, budgeting); education programs (maths, geography, spelling, languages, graphics); entertainment programs, business programs (appointments, cash flow, interest, cheque books, inventory); utility programs (sprite creation, character design, memory loader, saver and clear, disk menu ideas). All programs can be modified.

Reston Our price \$31.80. Save \$2.60

The BASIC Explorer for the Commodore 64

Lee Berman & Ken Leonard

Combination of suspense novel and instructional text, it teaches introductory programming in BASIC. Elements of Commodore 64 BASIC and the thought processes that go into designing a computer program to solve a problem are introduced through the adventures of three modern-day explorers.

Osborne/McGraw-Hill Our price \$29.95. Save \$2.40

Commodore 64 Machine Language Tutorial

Paul Blair

Gets to grips with the intricacies of machine language programming, helping to overcome the demanding exacting and sometimes exasperating requirements. But master it and tasks such as sorting, searching and some graphics become much quicker. Judicious use of machine language also allows you to use larger and more complex programs. Demonstration program provided, with examples of short machine language routines.

Holt-Saunders Our price: Book & disk \$53.20. Save \$4.30 Book & cassette \$50.85. Save \$4.10

Language/programming

Structured Programs in BASIC Peter Bishop

Opens with a discussion of program structure and design. The rest of the book comprises example programs, with the complete program design process (from initial specification to final listing) carried out. Excellent source of programming techniques, algorithms, program modules, ready-to-run programs and ideas.

Nelson Our price \$25.65. Save \$2.10

MS-DOS User's Guide

Paul Hoffman & Tamara Nicoloff

Sets out to familiarise you with MS-DOS in all versions — IBM PC-DOS, and Versions 1.0, 1.1, 1.25, 2.0 and 2.11. Covers each computer running MS-DOS, gives the versions it runs and lists any improvements the manufacturer has made to the system. Complete information on software that runs under MS-DOS and products available to enhance the system.

Osborne/McGraw-Hill Our Price \$41.61. Save \$3.35

The MBASIC Handbook

Walter A. Ettlil & Gregory Solberg

Concise, graduated tutorial to help you build programming skills for use in business, education and personal applications. Covers MBASIC tools; describes statements, functions, commands and sequential and random access files; debugging and documenting programs. Includes five fully documented business programs which can be customised.

Osborne/McGraw-Hill Our price \$40.75. Save \$3.30

The Second Book of Machine Language

Richard Mansfield

Written for programming with Commodore 64, VIC-20, Atari Apple and PET/CBM computers, this book contains the powerful LADS machine language assembler. As well as being a sophisticated program, the book is a tutorial on how large, complex machine language programs can be constructed out of manageable subprograms. Extensive documentation provided.

Compute Our price \$36.95. Save \$3.00

The CP/M-86 User's Guide Jonathan Sachs

Comprehensive guide covering everything from Concurrent DOS CP/M-86 and Concurrent CP/M-86 to MP/M-86. Thorough explanation of commands, menu systems and files, then coverage of more advanced features such as DR Talk, DR EDIX or DR/Net. Advice on troubleshooting, full index and bibliography, and three machine-specific appendices on the IBM PC and XT, DEC Rainbow and CompuPro.

Osborne/McGraw-Hill Our price \$41.60. Save \$3.35

Adventures With Your Computer

L. Rade & R.D. Nelson

Easily followed activities include 16 chapters of adventure followed by 16 commentaries, providing solutions and guidance on how to program these solutions in BASIC. Avoids getting machine-specific or getting involved in dialects of BASIC. Programs usually given in a flow-diagram form, using minimal BASIC.

Penguin Our price \$9.20. Save 75 cents

Games

Arcade Games for Your VIC-20 Brett Hale

A 15-year-old whizz kid from Victoria, Australia has put together a collection of 20 arcade games for the unexpanded VIC-20. All programs listed twice — once for a straightforward keyboard play, and once for use with a joystick. All games extensively play tested. Selection includes Galaxy Robbers, Yackman, Sub Attack, Fantasy, Pinball, Indi 2000, Leaper and Bullet Heads.

Corgi Our price \$10.10. Save 95 cents

More Arcade Games for Your Commodore 64

Brett Hale

Collection of Arcade games by Australian whizz kid, 15-year-old Brett Hale. Games are in BASIC and can be modified to your wants. And they are listed twice — for keyboard and joystick use. Includes Speedy Boulders, Encircle, Yackman, and Barrel Jumper.

Corgi Our price \$10.15. Save 80 cents

Arcade Games for Your Commodore

Brett Hale

Fifteen-year-old Victorian whizz kid, Brett Hale has put together a collection of 12 extensively play-tested arcade games which are in BASIC and can be modified. Each is listed twice — for keyboard and joystick. Includes Tick, City Terror, Bricklayer and Surface Lander.

Corgi Our price \$10.15. Save 80 cents

Virgin Computer Games Series

Edited by Tim Hartnell

Each book contains a selection of more than 20 games which allow you to hone programming skills as well as have plenty of fun. Contains brief dictionary of computer terms, bibliography and hints on how to improve and extend some of the programs.

Commodore 64 edition \$11.05. save 90 cents Spectrum, ZX 81, TRS-80, VIC 20, Oric Dragon, Atari, BBC editions \$8.30. Save 75 cents Atari 600XL edition \$14.75. Save \$1.20

Tim Hartnell's Giant Book of Computer Games

More than 40 games compatible with Microsoft BASIC able to run on most micros, including BBC, VIC 20, Oric, Apple II and Ie, Commodore 64, Dragon 32, Tandy Color, IBM PC, Laser, TRS-80, PET, MZ80K and Spectrum. Range covers board, dice, space, brain and adventure games, simulations, artificial intelligence, and some just for fun.

Collins Our price \$13.80. Save \$1.15

40 Educational Games for the VIC-20

Vince Apps

Programs designed to help younger family members handle the VIC-20 and increase their general knowledge. Uses variety of games aids such as the beat clock, stop the handman, race the buzzer. Subjects include geography, languages, mathematics and science. Hints included to show how programs can be changed as skills improve.

Granada Our price \$20.30. Save \$1.65

Fantastic Games (Commodore 64 & VIC-20 editions)

Introduction provides instructions on running the games and the book ends with a section on how games are made. In between are Speedboat, Logger, Haze Maze, Getaway, Sub Attack and Snail's Trails.

Wingard-Hayes Our price \$7.95. Save 70 cents

Space Adventures (Commodore 64 & VIC-20 editions)

Introduction provides instructions on running the games and the book ends with a section on how games are made. In between are Moonshuttle, Meteor Shower, Protector, Alien Attack, Red Alert and Invasion — with a couple of sections explaining data and read statements.

Wingard-Hayes Our price \$7.95. Save 70 cents

Computer's Second Book of Commodore 64 Games

Sixteen new worlds to explore... from photographing the Loch Ness monster to running a presidential campaign...to test your strategy, skill and knowledge. All ready to type in and play. Also articles on writing text adventure games and designing video games, and special-purpose programs to guarantee error-free program entry.

Compute Our price \$35.60. Save \$2.90

Tim Hartnell's Giant Book of Spectrum Games

More than 80 programs covering just about every sort of game imaginable — arcade action, mind benders, chance and skill, adventure, space, board and card, fun, simulations. And there are utility and demonstration programs, games to convert notes on error trapping and a glossary.

Collins Our price \$13.85. Save \$1.10

Spectrum

Cracking the Code on the Sinclair ZX Spectrum

John Wilson

Practical machine code programming guide allowing the user to harness the full power of the Spectrum's hardware and escape the confines of BASIC. You are introduced to Z80 instruction set and learn to combine the various elements of machine code in commercial-like programs. Annotated example programs allow you to enter and use fast screen handling routines and sorts in your own programs, debug them with the trace facility, and run them with the on-screen clock. Covers ROM routines, interrupt handling and programming principals.

Pan Our price \$24.95. Save \$2.00

Adventures for Your ZX Spectrum

Clive Gifford

Six ready-to-run adventure games — Crash! Pearl Diver, The Ring of Power, The Seven Keys of Tarkus, School's Out and Everyday Adventure — plus advice on writing your own adventures on a glossary and bibliography.

Virgin Our price \$13.85. Save \$1.10

An Expert Guide to Spectrum Mike James

Practical introduction to the Spectrum's advanced hardware and software features. Aimed at the user seeking a deeper understanding of the machine and its capabilities. Starts with an inside view of the micro, then moves to a connoisseur's guide to ZX BASIC and an introduction to the machine operating system. Covers ZX video tape system, RS232 interface, microdrive and advanced programming techniques. Complete program listings and projects for further exploration.

Granada Our price \$23.10. Save 1.85

The Sinclair User Book of Games and Programs for the Spectrum

Sixty games and programs from the Spectrum magazine, Sinclair User; protect your castle from invading soldiers in Siege; test your three dimensional sense Labyrinth; improve your geography in Mapwork, face Mr Spec Trum on Wimbledon's centre court, run your own cricket test at Lords, jump a clear round in Olympia, play noughts and crosses against the computer, sink a submarine in Depth Charge, tackle a crash typing course in Touch Type.

Penguin Our price \$12.90. save \$1.05

Practical Spectrum Machine Code Programming

Steve Webb

Designed for programmers who want to write faster and better programs than they can in BASIC. Assumes you have no knowledge of machine code and works through the details to the point where you are linking routines and using routines with BASIC programs. Questions throughout to test progress.

Virgin Our price \$18.05. Save \$1.45

The Spectrum Add-On Guide

Allan Scott

Non-technical language used to explain what various peripherals do, how they work and how you can use them in programs... games, programming, business word processing or whatever. Detailed program listings for "best buy" in each section, and a complete adventure game that can use up to seven add-ons, including two network Spectrums.

Granada Our price \$20.35. Save \$1.60

Spectravideo

Games For Your Spectravideo

Damon Pillinger & Danny Olesh

More than 25 programs including Minefield, Road Race, Star Strike, Towers of Doom and High Fighter. Plus a series of graphic demonstrations and a chapter on making effective use of the Spectravideo's sound.

Virgin Our price \$12.90. Save \$1.05

Keyboarding

Keyboarding for Information Processing

Robert Hanson

Enables a person to develop basic touch keyboarding skill in a minimum time. The person who completes the book will be able to key in alphabetic, numeric and symbol information, input numbers on a separate 10-key pad; keyboard information quickly and accurately; understand some of the basic vocabulary used in keyboarding. Can be used for classroom or individual, self-instruction.

Osborne/McGraw-Hill Our price \$14.75. Save \$1.20

Quick Keyboarding

Vonnie Alexander

Sub-titled "Component Keyboarding in 8 hours", this book by New Zealander Vonnie Alexander has a unique method for teach-yourself competent keyboarding. A wall chart of finger positions is included.

Methuen Our price \$7.35. Save 60 cents

General

Graphics Compendiums — editions for Spectrum & Commodore 64

David Durang

Useful graphics designs and programs, including large library of pre-defined graphics characters, easy-to-use programs for designing and loading of your own graphics, special sections on graphic effects and animation techniques. Plus a selection of graphics games.

Pitman Our price \$18.45. Save \$1.50

Computer Bits and Pieces

Geoff Simons

This compendium of curiosities is an informative, amusing and entertaining — and somewhat disturbing — account of the wide-ranging activities of computers...their uses in science and research, creativity, transport, industry, offices and administration, medicine and health, monitoring the environment, education and training, games and entertainment, the home, and the future.

Penguin Our price \$11.95. Save \$1.00

Software review

(Continued from page 69)



Perfect Calc

I have glanced at Perfect Calc but have had no chance to investigate it further.

It is again menu-driven, but the screen display is not up to the professional standard of Lotus 1-2-3 or Multiplan.

I presume it works but I have been spoiled by better software.

If it was needed to use with the database it would be adequate but otherwise I would look for a more professional implementation.

Overall

Perfect Software Inc (USA) have done a good job at producing modules which can stand alone yet can integrate where needed — yet it seems each module has a significant flaw.

For me it is the need for proper colour implementation and a menu override in Writer.

And for Filer to be able to at least sum numeric fields.

The extent to which these are important depends on the task required of them.

They are both excellent value for money if these defects do not affect your needs.

Software summary

	Perfect Writer II	Perfect Filer II
Ease of Use	4	5
Getting Started	5	5
Manual	5	5
Memory needed (min)	192K	192K
Copy Protected	No	No
Tutorial on Disc	Yes	Yes
Max file size (approx)	30 pp	disc capacity
Useful file size	15 pp	2000 records
Each record	—	100 fields max.
Value for Money	5	5
Cost	\$595	\$495

Available from Dick Smith Electronics Ltd. UK version reviewed.

Classifieds

System 80 Computer for sale. 48K memory. Blue label model. Plenty of software, including utilities, games and word proc., host of documentation, \$300. Richard Still, 3 Hinton Rd, Taradale. Ph. 449-258

Epson HX-20 with expansion unit, micro cassette drive and the monitor display interface with few programmes and books for immediate sale. \$1300.00 or o.n.o. Please write to: Sarath Gunatunga, Medical Centre, Opunake. Phone 8738 during office hours only. Genuine reason for sale. Had very little use.

Vic 20, 7 yr old wants Penpal, anywhere in N.Z. any age. Richard Hay, 8 Suffolk Street, Ashburton.

Apple compatible, 80-col, Z-80 card, double disk drive, monitor, 70 disks, \$2200 or \$3200 with printer, negotiable. Phone (070) 796-029.

PANASONIC JR100 SOFTWARE for sale. High standard. Send SAE to: A. Somerville, 72 Aberdeen Rd, Castor Bay, Auckland 9.

7 programs for the 16K ZX81 on 1 cassette! only \$5. Send to: S. Atkinson, 36 Atawhai Drive, Nelson.

ProGames 65 Winston Street, Wellington 4, New Zealand. Phone (04) 792-666

are pleased to announce

ProGolf

- ★ a great new game, written on a KayPro, for a Kaypro
- ★ for 1 to 6 players, of all ages (even try it in the office in the lunch hour!)
- ★ a subtle blend of skill and randomness, just like the real thing
- ★ choice of four 18-hole courses, ranging from moderately easy to diabolical!
- ★ infinite variety of wind conditions and green lies
- ★ educational too — excellent practice in mastering compass directions and vector addition
- ★ source code provided so that you can design your own holes. Full instructions given

Only \$24.95, including postage!
Payment with order please.
State model Kaypro.

Advertisers index

Amstrad/Grandstand	2,3,32
Ashby Computer Centre	62
AWA	38
BOS Software	9
C J Battley	12
Commodore Computer	24,26
Compumedia (Maxell)	14,77
Computer Game Rentals	58
Computer Games Club	30,47
Computers for people	22,49
Control	36
Concord Communications	53
Dick Smith	28
EC Gough	50
Ganet Software	52
Genesis systems	5
Hi Tech Micro	80
Home Mail	12
ITT	64
James Electronics	22,46
Kane Agencies	59
Micro Software Hire Club	51
Micro Style	56
Mitsui	68
ML Systems	8
Office Electronics	25
Otakou Software	58
Pacific Software	34
Progeni	48
PC 86	10,11
Pitmans	27
Philips NZ	F. Cover
Racal Milgo	4
Reed Methuen	70
Remarkable Enterprises	6
S.D. Mandeno	55
Silkwood Furniture	16
Supatech	57
University Book Club	69
Verbatim	18
Warburton Franki	78



Maxell of Japan.

The 3½" microdisk that gives Macintosh™ more to chew on and helps the HP® Touchscreen PC tap your deepest memories.

Whether you're in search of primeval wisdom, or polishing up financial projections, Maxell makes a microdisk that sets new standards of excellence. In fact there's a Maxell disk for virtually every computer made. Maxell floppys are industry leaders in error-free performance. Each comes with a 10 year guarantee. And each microdisk is perfectly compatible with your 3½" drive.

maxell®

A NEW STANDARD OF EXCELLENCE

From your computer dealer or contact

COMPUMEDIA SYSTEMS LTD

Auckland: P.O. Box 3273, Tel. (09) 444-6085, Tlx 60835
Wellington: P.O. Box 11091, Tel. (04) 851-548, Tlx 31415

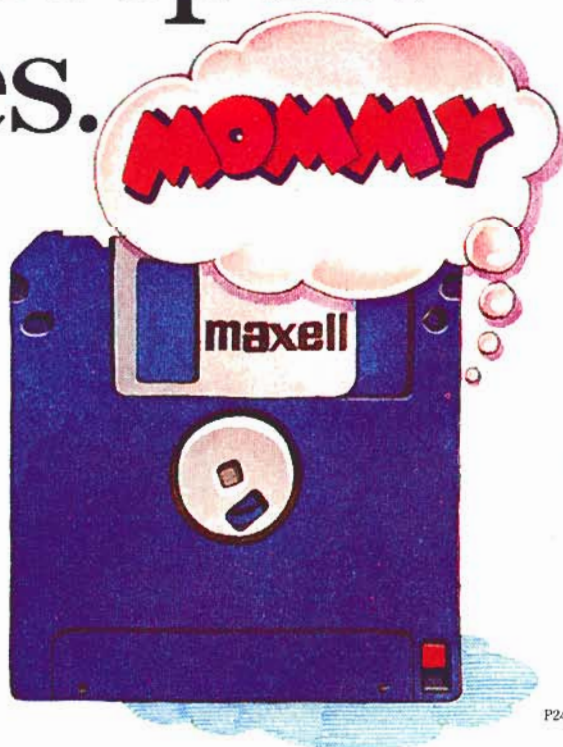

Macintosh is a trademark licensed to Apple Computer Inc.

RITEMAN F+

FRONT-LOADING
DOT MATRIX PRINTER

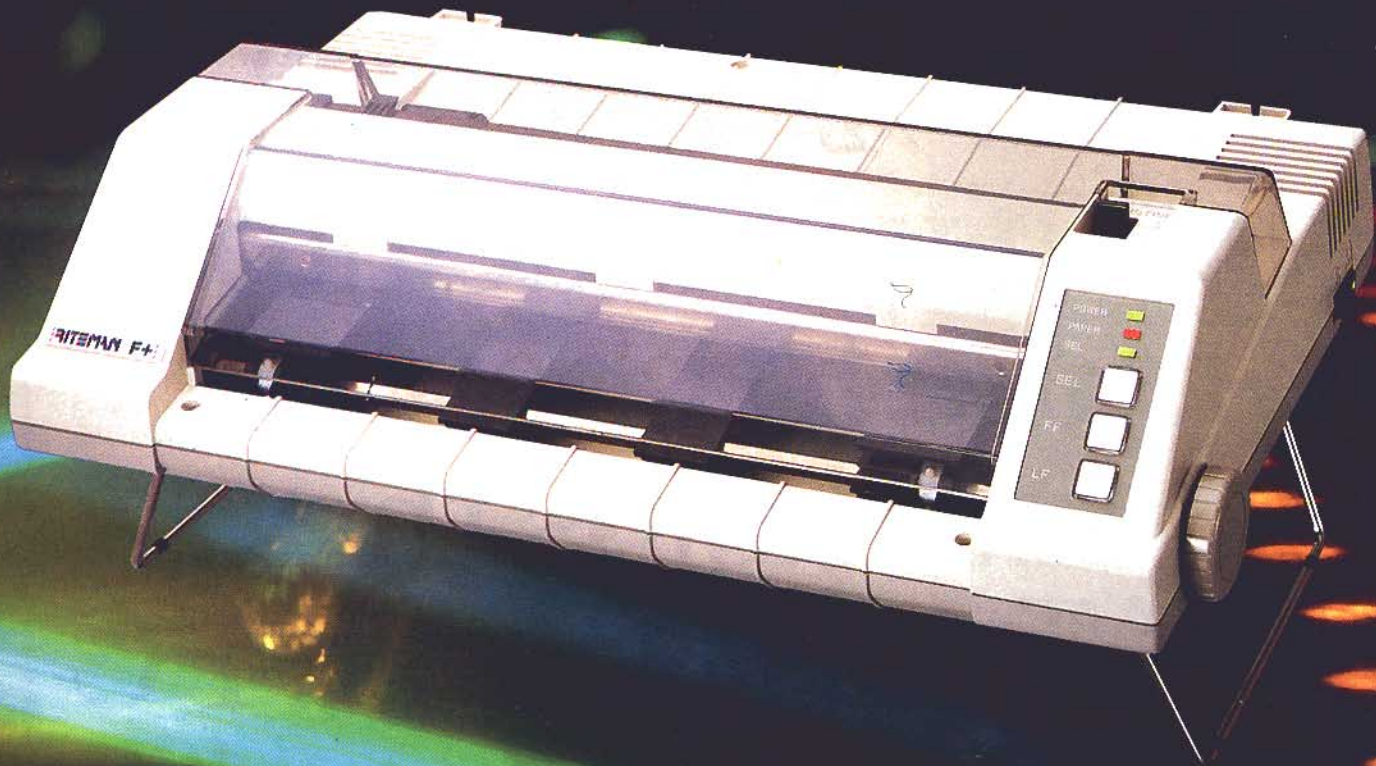

RITEMAN F+ FEATURES:

- Epson Compatibility
- Adjustable tractor feed standard
- Friction Feed standard
- Full-size 10" carriage
- 2K or 8K memory
- 256 programmable characters (with 8K RAM)
- 96 character mode, 32 block graphic characters, 9 languages
- 105 character-per second print speed
- Near letter quality (NLQ) printing
- IBM character fonts optional
- Serial interface optional (parallel standard)
- Built in printer stand
- Straight through paper path ideal for post cards and LABEL PRINTING
- 12 MONTHS WARRANTY

ALSO AVAILABLE:

RITEMAN C+

FRONT-LOADING PRINTER
FOR COMMODORE COMPUTERS

Available from preferred dealers throughout New Zealand. Contact the Riteman master agent for the name of your nearest retailer.

Warburton Franki

A division of ANI N.Z. Limited

Private Bag, Takapuna

TLX: NZ60893

TEL: (09) 444 2645

(04) 693 016



For your best
resolution
choose
TAXAN

“PC” PERIPHERALS

Leaders in setting ergonomic standards

COLOUR MONITORS (Supervision IV + KIF 3800)	9 x 7 PIXEL 0.31mm SLIT SIZE
MONOCHROME MONITORS (KX 1212/1213 + KIF 3700)	9 x 7 PIXEL
DOT MATRIX PRINTERS (incl. near letter quality)	11 x 9 PIXEL (NLQ 23 x 18) (DEC LA-50 OPTION)
XY PLOTTERS (6 colours)	0.025mm Addressable Resolution HP7475 PORT

MONITORS ARE HIGH CONTRAST — LOW GLARE, COMPLYING WITH AUSTRALIAN INFORMATION INDUSTRY ASSOCIATION'S GUIDELINES. PRINTERS ARE HIGH-SPEED, CAPABLE OF PRINTING THE FULL IBM FONT AS WELL AS PROGRAMMABLE FOR UP TO 240 DOTS PER INCH GRAPHICS.

	KX 1212	S/VIS III	S/VIS* IV	Printer	Plotter
AWA CORONA	●	●	●	●	●
CASIO FP-4000	●	●	●	●	●
COMMODORE	●	●	●	●	●
COMPAQ PORTABLE	●	●	●	●	●
EPSON QX-11, QX-16	●	●		●	●
ERICSSON PC	●	●	●	●	●
IBM PC/XT/AT	●	●	●	●	●
ITT (STC)X-TRA,X-TRA XP	●	●	●	●	●
OLIVETTI M24/21**	●	●	●	●	●
OSBORNE 2100	●	●	●	●	●
PRESIDENT PC/AT	●	●	●	●	●
SHARP PC — 5000	●	●		●	●
SPERRY PC	●	●	●	●	●
WANG PROFESSIONAL	●	●	●	●	●
ALL OTHER IBM PC COMPATIBLES AND MANY OTHER FINE P.C.s	●	●	●	●	●

* HIGH RESOLUTIONS KIF 3800 GRAPHICS BOARD (or equivalent) REQUIRED

** KIF 3800 NOT REQUIRED

AUTHORISED NEW ZEALAND DISTRIBUTORS



DEALER INQUIRIES WELCOME.

SKELLERUP SYSTEMS LTD

A division of Skellerup Industries Ltd

The above mentioned trade names
are Trade Marks of the various owners.

P.O. Box 19648 CHRISTCHURCH Telephone: 810-460
P.O. Box 7135 AUCKLAND Telephone: 594-687

Super 5

**Japanese technology and quality
at its best.**

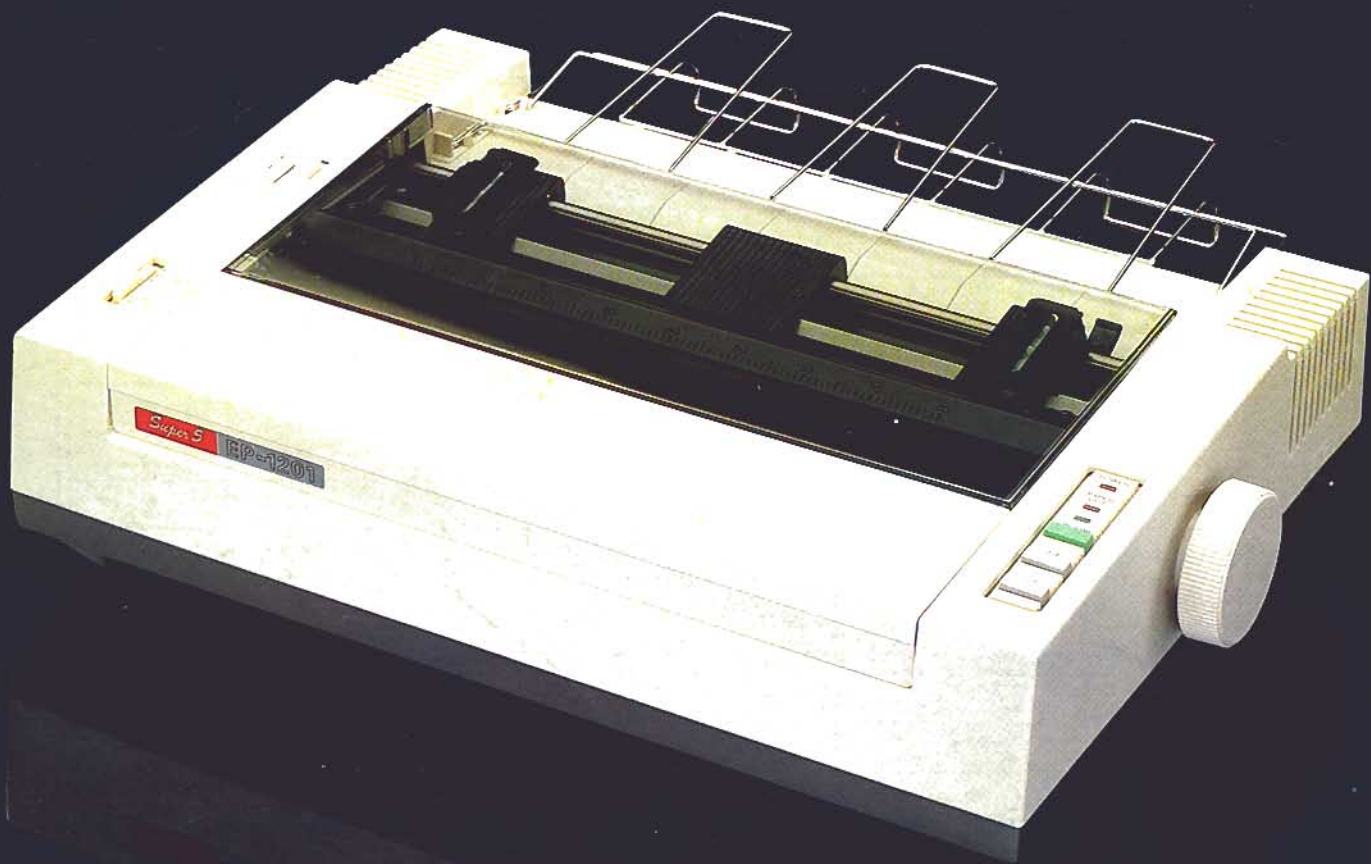

**Made in Japan by
EI-EN Enterprise Company.**

Available from all leading computer stores.