

Program  
Special!! Inside

WALAND'S PERSONAL COMPUTER MAGAZINE

# BITS & BYTES

September 1984: \$1.50

**An introduction to the new software wave  
— integrated and window packages**

- plus*
- Lotus 1, 2, 3 reviewed
- Macintosh software
- Wordprocessing for the IBM PC
- NEC Pinwriter Super 5 printers

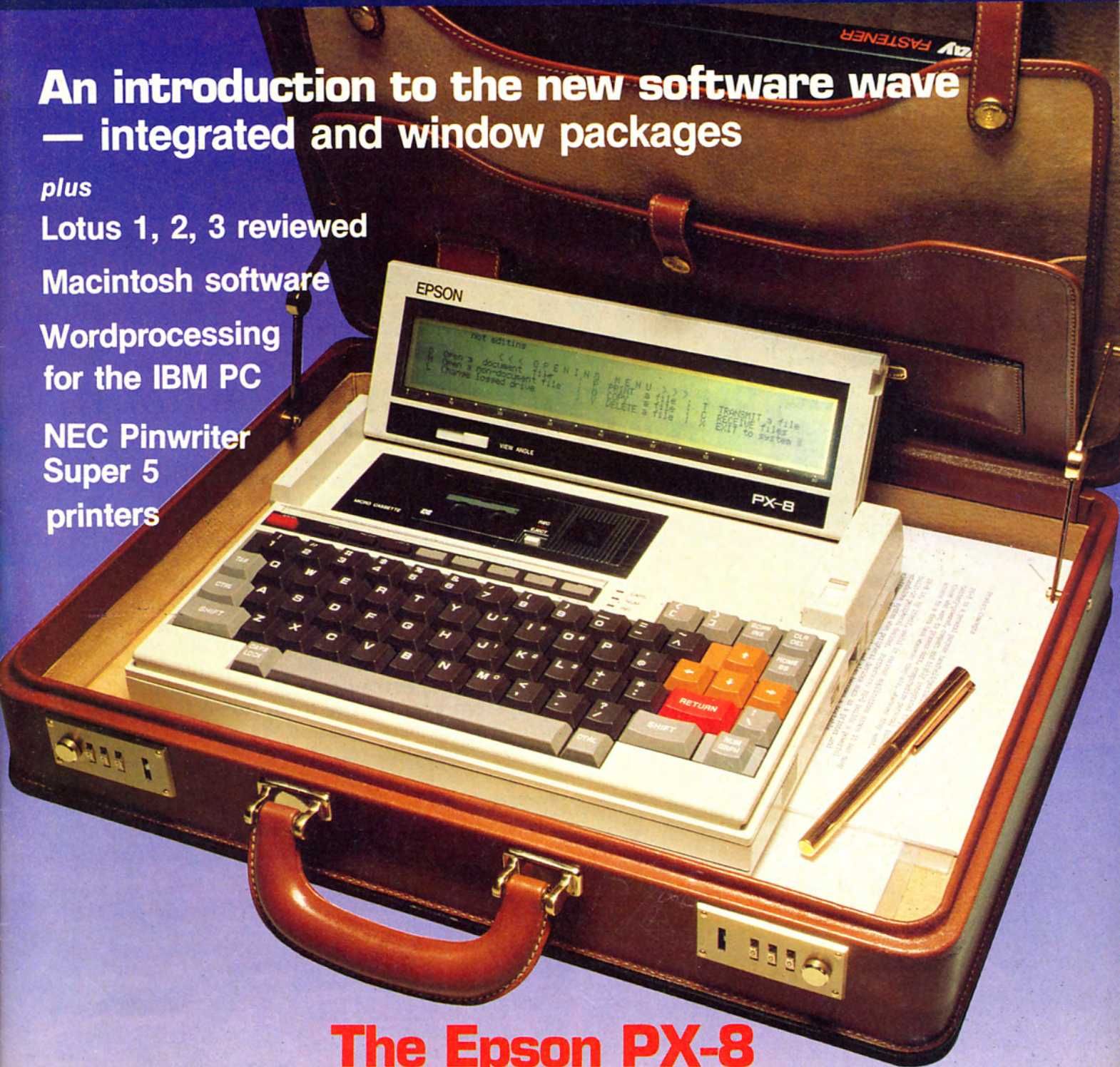

## The Epson PX-8

**Personal computer power when and where you want it.**

# SPECTRAVIDEO

## PERSONAL ★★★ COMPUTERS

COMPLETE PERSONAL COMPUTER SYSTEM



### WHAT IT WILL DO FOR YOU LATER IS AS IMPORTANT AS WHAT IT WILL DO FOR YOU NOW!

To the delight of prospective computer buyers, and to the dismay of our competition, we introduce the SpectraVideo – the most advanced most powerful personal computer system available today. Never before has a new computer been supported by so many state-of-the-art peripherals, all riding on the crest of the latest technology. And, most importantly, your SpectraVideo is very software orientated – with built in Microsoft Basic and CP/M compatibility you can take advantage of thousands of programs, as well as SpectraVideos own great selection of top

quality software. The comprehensive manual takes you step by step from Introduction to Basic to serious programming, so even if you're a beginner you'll be putting your SpectraVideo to good use from the moment you unpack it. The SV318 starts with 32K RAM, expandable to 144K, and includes among its many features a built-in joystick. The SV328 is twice as powerful, offering an amazing 80K of RAM, a full sized keyboard and numeric keypad. **SpectraVideo – 'the computer system you'll grow into, not out of.'**

Recommended Retail prices

SV318 – \$695  
SV328 – \$995

SV318 SV328



**AUTHORISED SPECTRAVIDEO DEALERS THROUGHOUT NEW ZEALAND  
CONTACT COMPUTER DISTRIBUTORS LTD BOX 31-355 MILFORD AUCKLAND. PH (09)495-809  
FOR THE NAME OF THE SPECTRAVIDEO DEALER NEAREST YOU.**

# BITS & BYTES

September, 1984 Vol. 2, No. 12

## FEATURES

### Integrated packages

John Vargo introduces us to integrated software . . . packages which combine two or more applications such as word processing, electronic spreadsheets and graphics, into a unified product. Auckland computer consultant Paul Smith describes Lotus 1-2-3 as "a giant step in spreadsheets". He explains why.

12-16

### Business

Philip Verstraaten continues his look at business software for the Commodore 64.

45

Dennis Lowe gets into the business of speeding up the sort with dBASE II.

18

### Hardware review

The Epson PX-8 is the latest development in the move towards a truly portable computer. Peter Ensor measures how far it has gone.

19

### Printer reviews

Speed and high quality printing has impressed Shayne Doyle about the NEC Pinwriter P1. He tells why.

22

The Super 5-CP80 — an Epson clone or a printer in its own right? Neil Clayton offers some answers.

24

### Education

As schools build up their computer resources, so there is a growing demand for teachers of computer education. Brother Bosco Camden, a teacher himself, has worked up a study guide for teachers.

30

### Program special

Another collection of the best programs from our readers.

33

### Beginners

Learning to program — why should we?; who should?; what should we learn?; which language?; how to go about it? Gordon Findlay answers these questions.

48

### People

A group of physically handicapped children in Wellington is moving into the computer age with the help of Wellington Polytechnic staff. Pat Churchill reports.

28

## COLUMNS

New this month:		Word processing on the 64	52
Macintosh	58	Commodore: BASIC pointers	53
IBM	59	Sega: The sound generator	69
Apple: Joy all round	57	Spectravideo: Fun with sprites	68
Atari: Thrills of the race	60	Spectrum: Four games reviewed	64
BBC: Defence of indirection operators	61	A printer and a Quantal response	66
Commodore 64: Win your own gold medals	50	TRS80/System 80: Some news and answers	70
		VZ200: Cutting the margin	63

## REGULARS

Advertisers index	76	Glossary	75
Book Club	37	Micro moments	2
Book reviews	71	Micro news	4, 6, 8, 10, 76
Classified Advts	76	User groups	74

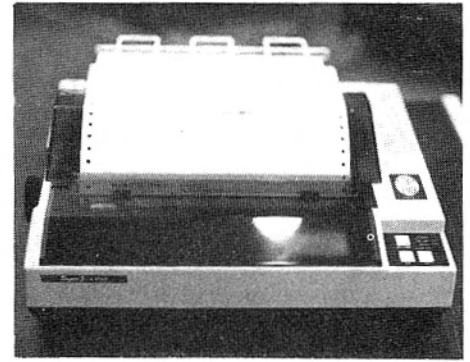

Super 5-CP80 . . . . . 24

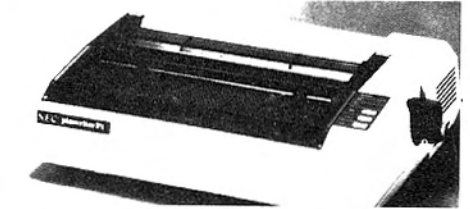

NEC Pinwriter P1 . . . . . 22



Program special . . . . . 33



The Epson PX-8 . . . . . 19

**BITS & BYTES** is published monthly, except January, by Bits & Bytes, Ltd.

Head Office: First Floor, Dominion Building, 91 Cathedral Square, P.O. Box 827, Christchurch, Telephone 66-566.

Auckland Office: Daytone House, 53 Davis Cresc., P.O. Box 9870, Newmarket.

Telephone 549-028 (advertising and editorial inquiries only).

### Advertising

Co-ordinator - Paul Crooks, telephone 66-566, Christchurch.

Representatives -

**Auckland:** Paul O'Donoghue, telephone 549-028 (w), 699-050 (h), P.O. Box 9870, Newmarket.

**Wellington:** Marc Heymann, telephone 844-985. P.O. Box 27-205.

### Editorial

Editor - Neill Birss, P.O. Box 827, Christchurch.

Programs editor: Gary Parker.

Representatives -

**Auckland:**

Gaie Ellis, telephone 549-028, P.O. Box 9870, Newmarket.

**Wellington:**

Pat Churchill, 5 Lucknow Terrace, Khandallah, telephone 797-193 (h).  
Shayne Doyle, 18 Holdsworth Avenue, Upper Hutt, telephone 280-333 ext. 892 (w). 278-545 (h).

### Merchandise

Book club and software manager: Dion Crooks.

### Subscription

**Subscription rate:** \$12 a year (11 issues) adults and \$10 a year for school pupils, subscriptions being from the issue of *Bits & Bytes* after the subscription is received.

**Overseas subscriptions:**

Surface mail - \$23 a year.

Airmail - Australia and South Pacific, \$45 a year; North America and Asia, \$72 a year; Europe, South America, the Middle East, \$94 a year.

**Subscription addresses:** When sending in subscriptions please include postal zones for the cities. If your label is incorrectly addressed please send it to us with the correction marked.

### Distribution

**Inquiries:** Bookshops - Gordon and Gotch, Ltd.

Computer stores - direct to the publishers.

### Disclaimers

**Opinions:** The views of reviewers and other contributors are not necessarily shared by the publishers.

**Copyright:** All articles and programs printed in this magazine are copyright. They should not be sold or passed on to non-subscribers in any form: printed, or in tape or disk format.

**Liability:** Although material used in *Bits & Bytes* is checked for accuracy, no liability can be assumed for any losses due to the use of any material in this magazine.

### Production

**Production Manager:** Dion Crooks.

**Assistants:** Roger Browning, Graeme Patterson.

**Cover and graphics:** Sally Williams.

**Typesetting:** Focal Point.

**Printed:** in Dunedin by Allied Press.

# New Zealand Microcomputer Industry Comes of Age!

New Zealand's first dedicated personal computer exhibition and microcomputer industry awards will be held in Auckland from May 8-12 next year.

In response to industry calls for a exhibition which is a representative showcase for New Zealand, the exhibition is being organised by The Communication Company, a marketing company specialising in the high technology field, in association with *Bits & Bytes*, New Zealand's personal computer magazine.

PC 85 will be held at the Overseas Terminal over three days with all the major New Zealand microcomputer companies expected to participate in a programme that will provide a focus on industry issues as well as present an ideal opportunity for product launches and a display of established products.

Leading figures in the industry from overseas and from within New Zealand will participate in seminars during the first day of the exhibition, examining trends in software and hardware development and focussing on market trends, sales tax and industry incentives.

These seminars are being designed to draw attention to the maturing audiences of a calibre that provides meaningful contact for participants in the exhibition.

An official dinner on the evening of the first day of the exhibition will mark the presentation of awards for excellence in New Zealand developed and produced software.

Awards will be made in a number of different categories including business, farming, education and recreation with an overall award for the software package that tops the judging criteria. *Bits & Bytes* will present trophies to the award winners and sponsorship is currently being negotiated.

*Bits & Bytes* will also be involved in the organising of the already established Wellington and Christchurch Computer Shows in 1985, giving microcomputer companies and the public the opportunity to attend specialised microcomputer exhibitions in the three main centres.

## MICRO NEWS

### Govt. cuts duty

The Australian government has moved to reduce the price of computers to both industry and consumers.

Computers imported into Australia from the United Kingdom, United States and Europe are now subject to two per cent duty compared with the previous five per cent, and the duty on monitors from those areas has dropped from 24 to 15 per cent.

Hardware imported from developing countries (including New

Zealand) will be duty free (previously, it was subject to 10 per cent duty). Monitors from those countries will be subject to 5 per cent duty, not 10 per cent as before.

Computer software imported on media is now duty free in Australia, and duties on recording media will be standardised at 20 per cent, with duties on most recording media being phased down to that level over two years.

## MICRO MOMENTS

BY MATT KILLIP



SOME MIGHT CALL ME PROMISCUOUS.  
All I've got to say to that is ###@!!!

It's jealousy.  
There aren't many printers around that can  
team up with a wide variety of personal computers.  
There's every chance that your computer and  
I would make a very handsome couple.  
I prefer to call my behaviour compatible rather  
than indiscriminate.

Of course, my excellent performance attracts  
a lot of people. My printout capacity of 80  
columns for standard letter sized sheets  
outshines most printers.  
But then who am I to brag?

I've got to admit though, my best feature  
is my size...I'll go anywhere with you.  
(I'm also loyal).

Measuring about the size of a standard letter sheet  
and being extra light means I can fit in your  
briefcase. I'm also battery powered...perfect  
for personal computers like hand held and home  
computers.  
I'm also very quiet.

So, that's me!  
Well, some of me. I'm not one of these "tell all  
on the first advertisement" types.  
Ask your dealer for the real nitty gritty on me

the Brother.

brother HR-5



# Give your computer a little brother.

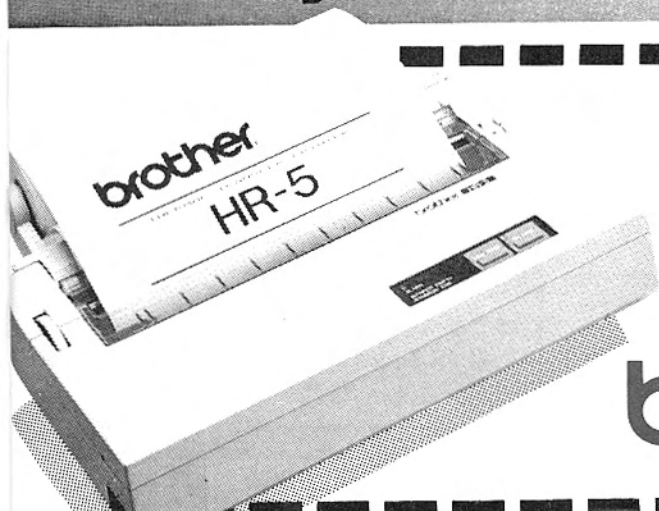

Please send me more information about the Brother HR-5.  
Post to: Freepost 213 (no stamp required)  
Brother Distributors Limited, Office Equipment Division,  
P.O. Box 2066, CHRISTCHURCH.

NAME \_\_\_\_\_  
ADDRESS \_\_\_\_\_  
PHONE \_\_\_\_\_

**brother**

*"With Brother you've got a friend"*

854-446

## Year goes off with a Wang

Wang Computers Ltd (New Zealand) has exceeded its expectations for the 1983-84 financial year with revenues in excess of \$21 million.

Adrian Foster, director and general manager in New Zealand, said the company increased its revenue by 63 per cent on the previous year – and that in a year when the economy had been difficult to trade in.

He is confident Wang will assume the number three position as an international supplier of technology here by next June.

During the year, Wang plans to extend its dealer network and product range in the personal computer field. Planning includes a decision to seriously seek out third party support for servicing as the number of dealers increases.

Mr Foster said Wang is investing in extensive research and development to ensure the people/computer interface was truly realised as the company moved more heavily into the low end of the micro market with an emphasis on providing more common software for the Wang PC.

While maintaining a philosophy of "people before computers", Wang will be offering some innovative features to personal computer users, including image processing, a very low-end word processing product (takes over where typewriters leave off) and digital voice exchange systems.

## Packet switching available

The Postmaster General, Jonathan Hunt, announced last month that the Post Office began providing a full commercial packet switching service from August 15.

Several computer equipment suppliers have participated in an experimental packet switching service this year.

The first stage in implementing the new data communication service involves packet switching exchanges at Auckland, Wellington and Christchurch but customers anywhere in New Zealand can be connected to the network.

Charges will be "distance independent" so that the cost of using the service will be the same for

## Easier retrieval

Executives will soon be able to retrieve information by calling up their computers and asking questions with English-like instructions, says local Software International general manager, Derek Schneideman.

His company has entered into a long-term agreement with Software A G in the United States to co-develop and market a series of advanced mainframe query products.

Software International's president, Jeff Goodman, said he intended to give the industry its first glimpse of a sweeping new query product line that will permanently change the way users retrieve and report data. We believe our series of query products will revolutionise the state of data-retrieval and reporting software, which is currently at a syntax-driven dead end."

Software International will incorporate the query product into its entire line of packaged financial and human resources application during the next year.

all subscribers regardless of location.

An international packet switching service to Australia, Great Britain and the U.S.A. was also introduced on August 15, said Mr Hunt. This service would be extended to other countries.

He believes the new service will stimulate development of other new services such as electronic funds transfer and credit card verification services.

Packet switching is a process used in data communications networks whereby information is grouped in bits and sent in bursts (or packets) along the telephone lines. The packets are placed between the signals carrying ordinary telephone calls.

It is a more efficient way of transmitting data between computers over long distances, and the Post Office charges are considerably lower than the previous alternatives of making a toll call or hiring a dedicated line.

## Lisa software

An integrated software package for Lisa 2 computers combines seven diverse business functions.

The Lisa 7/7 – released at the recent US national computer conference – can integrate and

A strong influence on Software International's choice was Software A G's NATURAL, an interactive application-development language that requires dramatically less coding than is required by traditional languages such as COBOL.

According to Derek Schneideman, mainframe query products on Software International's drawing board will benefit from projected advances in the NATURAL language. "The products will provide enormous shortcuts for users who access and retrieve information using mainframe terminals."

The comprehensive software will enable users to create queries, modify existing queries and perform hundreds of other data-retrieval and reporting functions in a fraction of the time – and with a fraction of the training – required today to master the difficult task of computer code and syntax, Mr Schneideman said.

The first product should be ready for local demonstration shortly after its US demonstration later this year.

move data easily between tasks, allowing the user to manipulate and present data in various ways. It also combines high quality colour-printing, a built-in spelling corrector, more type graphs, fast spread-sheet calculation and the ability to figure job costs.

The Lisa 7/7 can perform project management, word processing, spread sheet, data communications, data base, business graphics and structured graphics.

We specialise in the conversion of overseas computer & video tape recorders to N.Z.T.V. channels. (Any quantity from individual units to large production runs.)

**HARRIS**  
*Electronics*

653 Manukau Rd. Epsom.  
P.O. Box 84-017 Logan Park.  
Phone (09) 658-416

# Essential Software for 64

## Superbase 64

Superbase 64 is a highly sophisticated yet easy to use information management system which has been specifically designed to allow you, regardless of your level of computer expertise, complete control over and easy access to any information you wish to store.

In technical terms, Superbase 64 is a database handler, a database simply being a collection of information you can work with. This information is usually arranged in the form of a number of files, similar to a filing cabinet. Superbase 64 allows you to easily manipulate the information in the database without the need for any programming at all. You can, using simple commands, search, select and sort your data and then have it displayed or printed out in almost any format you want — be it labels, printed pages, or index cards, just to name a few.

Superbase 64 also contains built-in database programming language which opens up even more possibilities to you. You can quickly create your own programs tailored specifically for your individual needs.

Superbase 64 leaves you free to concentrate on getting the most out of your information, without having to be a computer expert.

Some of Superbase 64's outstanding features are:

- You can design your own record layouts simply by drawing them on the screen.
- Add, delete or modify your information easily and quickly.
- Link to Easy Script, the powerful word-processor for the Commodore 64, for mailshots, high-quality letters, quotes, tables, etc.
- Use Superbase 64's built-in HELP screens, then add your own.
- Search your files using multiple and sophisticated criteria. For instance, you might want to search for all customers living in a particular state who have a credit limit between \$200 and \$1,000, except those whose names start with a 'B' or a 'C'.

- Display or print information as you want. For instance, in the above example, having selected those customers you may want to display just the name, town and credit limit.
- Link between files to access and transfer data.
- Sort your files into any order.
- Use Superbase 64 either via the menus or by entering English-like commands directly.
- Transfer information to other programs from your databases.
- Create your own reports using the built-in report generator, with automatic totalling and sub-totalling if so desired.
- Alter and add new fields to your record layouts without having to modify your existing data.

All these features plus many more combine to offer an incredibly high-powered solution to your information handling needs.

**\$258.00**

## Calc-Result

Calc-Result is Commodore's "electronic" spreadsheet" program for the Commodore 64 personal computer and the SX64 executive computer that makes it easy for you to plan ahead with facts and figures.

More than just another "spreadsheet" program; Calc-Result 64 has been especially written to take advantage of the features built-in to Commodore's 64-family of personal computers.

You can highlight or separate different groups of figures on the computer screen by designating different colours. Type in a wrong command and the screen pulsates a red warning colour and an audible alarm is sounded.

If your work involves financial management, planning or forecasting, then Calc-Result can turn your C64 into the most powerful decision-making tool at your disposal. Yet this versatile tool is equally suited to simpler jobs like managing a home budget.

Now it is easier than ever before to prepare error free spreadsheets and graphs that can be read at a glance and put you in command, and rather than just a "green screen" you can use all the colours built-in to your Commodore 64 computer to highlight and differentiate your important figures.

If you get stuck while setting up your charts or tables, you don't have to keep referring back to the instruction book since Calc-Result includes built-in "help" files of information you can bring up on your computer's screen.

**\$352.00**

## Easy Script

Easy Script is a powerful word processing package. It enables you to create, modify and print text quickly and easily. Easy Script can be used for writing letters, reports, memos, book manuscripts — in fact any kind of document. Text can be stored on diskette or cassette so that it may be printed or modified as required.

The advantages of word processors in terms of time and cost-saving are well known. These include:

- being able to view text before it is printed;
- the facility to create a document from standard paragraphs;
- the ability to produce personalised standard letters.

Easy Script provides all these features together with many more advanced facilities to do all of the following:

- set and adjust left and right margins;
- align text at the righthand side of the page (justification);
- enable information to be printed at the top and/or bottom of each page;
- number pages automatically;
- give horizontal, vertical and decimal tabulation;
- link text files together;
- provide an automatic word search and replace function;
- transfer and/or duplicate text;
- insert, delete, erase and merge text; and much more.

**\$121.50**

 **commodore**  
COMPUTER

**P.O. Box 33-847  
Takapuna, Auckland  
Telephone 497-081**

Please send me more information on these Commodore products.

Name \_\_\_\_\_  
Address \_\_\_\_\_  
\_\_\_\_\_

or contact your local dealer

## New line in educational courseware

Control Data recently launched a new company to manufacture and market a complete line of educational courseware for schools, businesses and the personal computer market in Australia and New Zealand.

The \$2.5 million Control Data Publishing will introduce the first integrated set of educational courseware on the market. This will run on a variety of personal computers, according to Alan Rodda, Control Data Australia's marketing manager for education.

These will include the Apple II+, Apple IIe, IBM PC, Atari 800, Texas Instruments 99/4A, Commodore 64, and Control Data 110. The BBC Acorn will be added to the list later in the year.

The products include offerings from Plato, Control Data's educational courseware system, as well as from some of the largest educational software manufacturers in the world — Minnesota Education Computing Consortium, Cosine, Thoughtware and Krell.



Macintosh



the  
Byte  
shop

P.O. Box 2191.  
1 Fort St, Auckland. Ph. 32-860

The company is also looking for locally written software and has set up a products review board to evaluate offerings.

Rodda expects the range of products to grow from the present 200 titles to more than 500 within two years with a significant portion locally written.

The courseware will be manufactured in Melbourne at CD's Moorabbin facility. Packages will contain one to eight disks plus a manual. There are school and retail prices for each package.

Subjects covered include mathematics, languages, computer literacy, human relationships, business education, art, music theory, health and home economics, science, social studies. Some are available immediately. Other titles will be added later in the year.

The New Zealand distributor is D.R. Britton, Ltd, P.O. Box 38-400. Petone.

## Training seminars

A series of seminars to help people understand the role computers can play in staff training is planned over the next four months.

The half-day seminars in Wellington, Auckland and Christchurch — to be run by Control Data NZ, Ltd, — are designed to introduce the concept of computer-based training programmes for a wide variety of business organisations.

The courses will be offered in Wellington on October 4 and November 8; Auckland on September 11, October 18 and November 12; and in Christchurch on September 18 and November 15.

## Piece of magic

Commodore has released Magic Desk 1 — a plug-in cartridge costing \$70 for the C64 and requiring no typed-in commands but using visual references for basic processing functions.

It presents a full colour animated office on the screen, complete with desk, filing cabinet, clock, typewriter and waste paper basket... and a hand with a pointing finger. It is this last graphic which works for the user; by pointing the hand at any of the symbols, the computer automatically selects that mode of operation.

The program apparently has other function components yet to be made available here. These include an index file, telephone listings, calculator function and a financial journal.

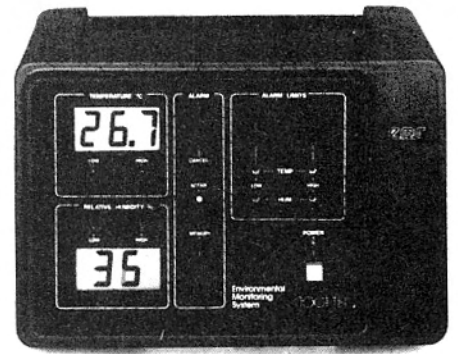

*The Environmental Monitoring System*

## Early warning

The Environmental Monitoring System (E.M.S.) — developed to act as an early warning system for failure or malfunction of computer room air conditioning plant — is now available in New Zealand through G.T.S. Engineering, Ltd (P.O. Box 9613, Newmarket, Auckland).

The electronic device senses the temperature and relative humidity and provides a large digital display of each condition.

If the sensed temperature or relative humidity falls outside the preset conditions, the alarm is given. The E.M.S. can also be supplied with a recording module, which produces strip charts of the temperature and relative humidity conditions, for future reference.



Macintosh

“4 colour logo”

**Sweat-shirt**

Available in Light Blue & White  
Please send Cheque or Money Order  
Stating size & colour

\$25 00 + \$1 50 Postage

**BURGESS SUPPLIES**  
11b Contessa Drive, Glenfield  
AUCKLAND 10



# Perfect Peripherals to expand your system from Dick Smith Electronics

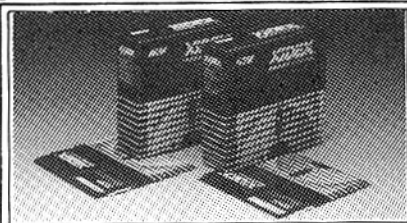

## Xidex Quality Diskettes

The new Xidex range of precision disks offer a level of quality and reliability previously unknown. Better disk substrate, finer particles in the coating, ultra-smooth polishing, tighter tolerances and an extra 18 critical tests ensure that all disks easily exceed the ANS 1 specs for 96 TPI high density recording.

Single sided, double density soft sector  
Cat X-3510 ..... \$6.50 each  
Box of 10 Single Sided, d/density soft sector  
Cat X-3512 ..... \$65.00  
Box of 10 Double Sided, d/density soft sector  
Cat X-3514 ..... \$85.00 box

Keep your drives clean and error free!

## Disk Head Cleaning Kit

One area often overlooked is your disk drives. For longer life and absolute reliability, they should be cleaned at least once a week. These handy items make head cleaning easy.

Cat X-3517 ..... **\$24<sup>95</sup>**

Replacement Disk Insert  
Cat X-3518 ..... \$6.95

Store your Disks in this quality

## Diskette Library

Even at our low prices, you should still treat your disks with care - especially if your company's financial records are on them! This disk library holds and protects up to 10 diskettes in their jackets, in an upright position for easy use. Can be closed for storage. A cheap investment.

Cat X-3515 ..... **\$9<sup>95</sup>**

Keep it on Cassette!

## Data Cassette Tape

Yes we're now stocking the famous 'Microcassette' computer verified cassette tape. Five minutes per side gives over 40K capacity per side.

Cat. X-3502

**\$4<sup>50</sup>**

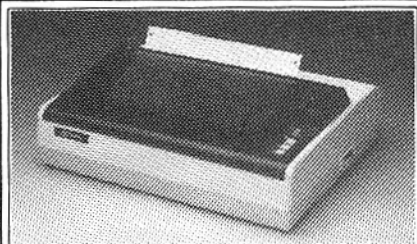

## BX-80 Dot Matrix Printer

The BX-80 offers high quality, speedy dot-matrix printing at a price for lower than comparable printers. Bi-directional, prints the full upper and lower case (with true descenders) ASCII, character set at 80 cps, with four character widths: 80 columns, 254mm wide either single sheet (friction feed) or fan-fold (sprocket feed). Prints bit-image graphics (640 dots/line), responds to ESC code sequences for software control. Standard Centronics type interface suits most popular computers.

Cat X-3268

**\$795<sup>00</sup>**

Ribbon cartridge for X-3268 printer  
Cat X-3269 ..... \$19.95

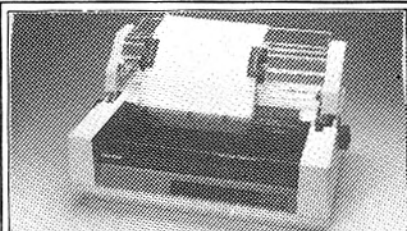

## Budget Daisywheel Printer

If you're using your computer for word processing, this daisywheel printer will give you top quality printing at a budget price. Prints at 18 cps. Offers a choice of 3 pitches (10/12/15 cpi) plus proportional. Takes standard 96-character print wheels and ribbon cartridges (Dialo/Qume compatible), paper up to 330mm wide. Very quiet too: only 58dBA. Standard Centronics-type interface suits most popular computers.

Cat X-3270

**\$1135**

Ribbon cartridge for X-3270 Printer  
Cat X-3271 ..... \$19.95  
Tractor feed attachment as shown above  
Cat X-3273 ..... \$195.00

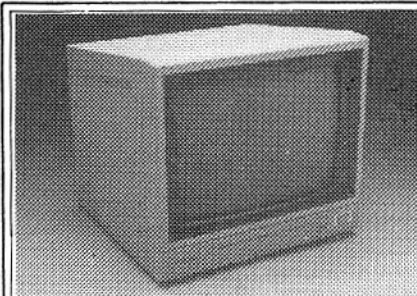

## High Resolution Green Monitor

Even with a colour computer, you may prefer to use a green screen monitor instead of a colour monitor - especially if you're using it for business. This high-resolution green monitor has a 30cm screen and 18 MHz band width, giving a bright, sharp display, even on 80-column text and hi-res graphics!

Cat X-1220

**\$449<sup>95</sup>**

# DICK SMITH ELECTRONICS

**Newmarket** 98 Carlton Gore Rd. Tel 504 409  
**Papatoetoe** 26 East Tamaki Rd. Tel 278 2355  
(Open till 8.30pm Thursday nights)  
**Avondale** 1795 Great North Rd. Tel 886 696  
**Hamilton** 450 Anglesea St. Tel 394 190  
**Christchurch** Cnr Victoria St & Bealey Ave. Tel 50405

Business Hours:  
Mon - Fri 9.00am - 5.30pm  
Sat Morn 9.00am - 12noon



**NOW OPEN**

Mail Orders

Dick Smith Electronics

Private Bag, Newmarket

Speedy Mail Order Service

Just phone Auckland 504 409, ask for mail orders, quote your Bankcard or Visa Card number and your order will receive prompt attention. (Collect calls NOT accepted).

Finance available to approved customers through AGC.

P & P Charges

ORDER VALUE	CHARGE
\$ 5.00 - \$ 9.00	\$ 1.00
\$ 10.00 - \$24.99	\$ 2.00
\$ 25.00 - \$49.99	\$ 3.00
\$ 50.00 - \$99.99	\$ 4.00
\$100.00 or more	\$ 5.50

These charges are for goods sent by post in New Zealand only - NOT airmail, overseas or road freight



NZ113/LL

## A mouse on HP

Hewlett-Packard has added two new low-priced machines to its HP 9000 Series 200 line.

The Model 217 engineering work station uses the MC 68010 high performance processor with memory management and 8 MHz clock. A mouse, offered for the first time by HP, is an option. The machine has a 14-inch green screen with 512 \* 390 resolution. The 512K of RAM is expandable to four megabytes using a new one-megabyte RAM board.

The Model 237 graphics work station uses the MC 68000 processor at 12.5MHz with memory management and cache system. Its 512K of RAM can be expanded to seven megabytes. There is a 17-inch, no-flicker monitor with a 1024 \* 768 bit-mapped display. The new mouse is standard.

The Series 200 line now consists of 14 work stations ranging from around \$10,000 to \$200,000 before tax. New HP software for the line includes two terminal emulators for the DEC VT100 and the TEX 4010, each including features of the HP 2622A terminal.

Another new package is the HP Techwriter which permits engineers and scientists to merge graphics and text in the same document.

### The new TcM

Delphi Industries, Ltd, the Auckland-based manufacturer of high technology equipment including the Poly I and Poly II machines, has developed a new microcomputer which could prove very popular with personal computer users.

The TcM, a fully configured single board micro, was initially developed for industrial control applications but its flexible design makes it highly suitable for the general micro market.

It has a standard CP/M operating system, Z80A processor with 4MHz clock and Z80A DMA controller for high speed memory to I/O or memory to memory transfers.

TcM has 128K of RAM and up to 32K EPROM with an on-board floppy disk interface which will accommodate up to four 8in or 5in single or double density, single or double sided drives in any mix. The expansion interface allows I/O and memory expansion; in addition to the standard Z80 signals, a number of additional signals have been added to ease I/O and memory expansion.

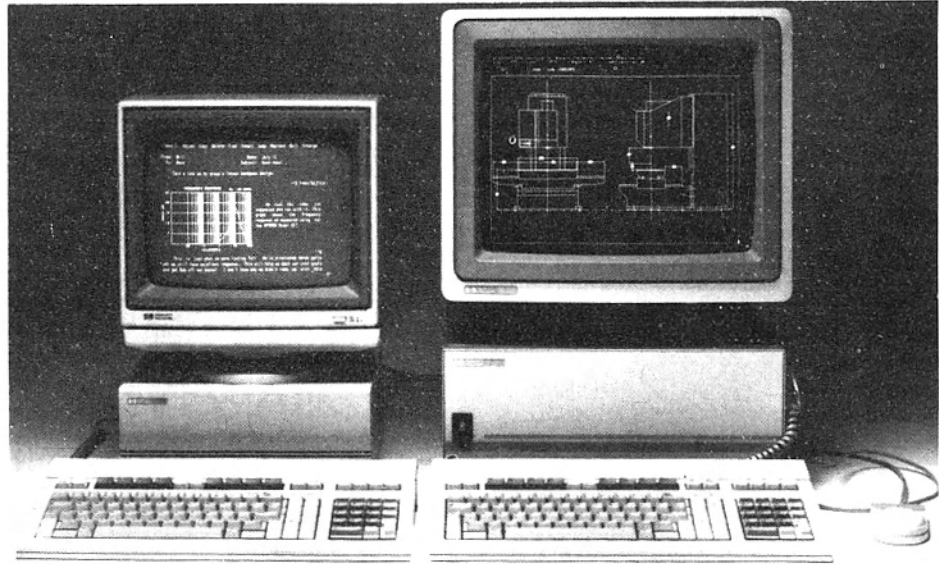

*New members of the HP9000 family of desktop engineering work stations . . . the model 217 (left) and the model 237 (with mouse).*

The board, for those who configure their own system, will retail at under \$1000, and a built-up system with two 5½in drives and a full range of industry standard ports, will sell for around \$3800.

### RAMs for Christmas

Two new CMOS static RAMs from Advanced Micro Devices are planned to be in production in December.

Organised as 4096 words by four bits, they will give a 45 nanosecond access time while drawing 80 milliamps when active. Both the standard Am9968 and the lower power Am99L68 have automatic power down when deselected. For battery-backed operation, the Am9968 draws 2 milliamps on standby and the Am99L68 50 microamps.

Future CMOS products from AMD are planned to include higher density static, dynamic, and nonvolatile memory circuits. Virtually all MOS devices now in design at AMD will be implemented in CMOS. Further information: G.T.S. Engineering Ltd, P.O. Box 9613, Newmarket, Auckland or P.O. Box 27-357, Wellington.

### A new portable

Computer Distributors, Ltd, has released the new Morrow portable which will retail at \$4495 (pre-devaluation). It offers a 5 x 9 inch amber screen displaying 80 columns by 24 lines, two 400K 5¼in floppy disk drives and five application software packages.

Hardware features of this 10kg machine include a Z80A micro-processor running at 4 MHz, 64K bytes of RAM, 4K bytes ROM, two

floppy disk drives, a standard parallel Centronics port and a RS232 serial port.

System software includes the CP/M operating system, Microsoft BASIC-80, Morrow Pilot and Morrow's menu system. Application software aimed at small businesses includes the New Word word processor, SuperCalc financial spreadsheet, Correct-It spelling checker and Personal Pearl database manager.

### HP and IBM!

The Businessworld group of companies will now sell and support Hewlett-Packard products as well as the full IBM range. The agreement was concluded recently with Hewlett-Packard (NZ) Ltd.

### Static control

3M has produced the First Touch static control computer pad — a 24in by 26in pad of a semi-conductive vinyl overlay and a highly-conductive scrim intermediate layer adhered to a non-skid, noise reducing foam backing. (The total thickness is a nominal 1/8in.)

The pad works by draining away static charge from personnel in less than 0.05 seconds. The operator need only touch the pad before activating the computer and then periodically retouch it.

The pad includes a 10ft grounding cord with a one megohm resistor inside its fastener to protect the operator from potential shock should an electrical fault occur. The pad can also be cut to fit with a sharp pair of scissors.

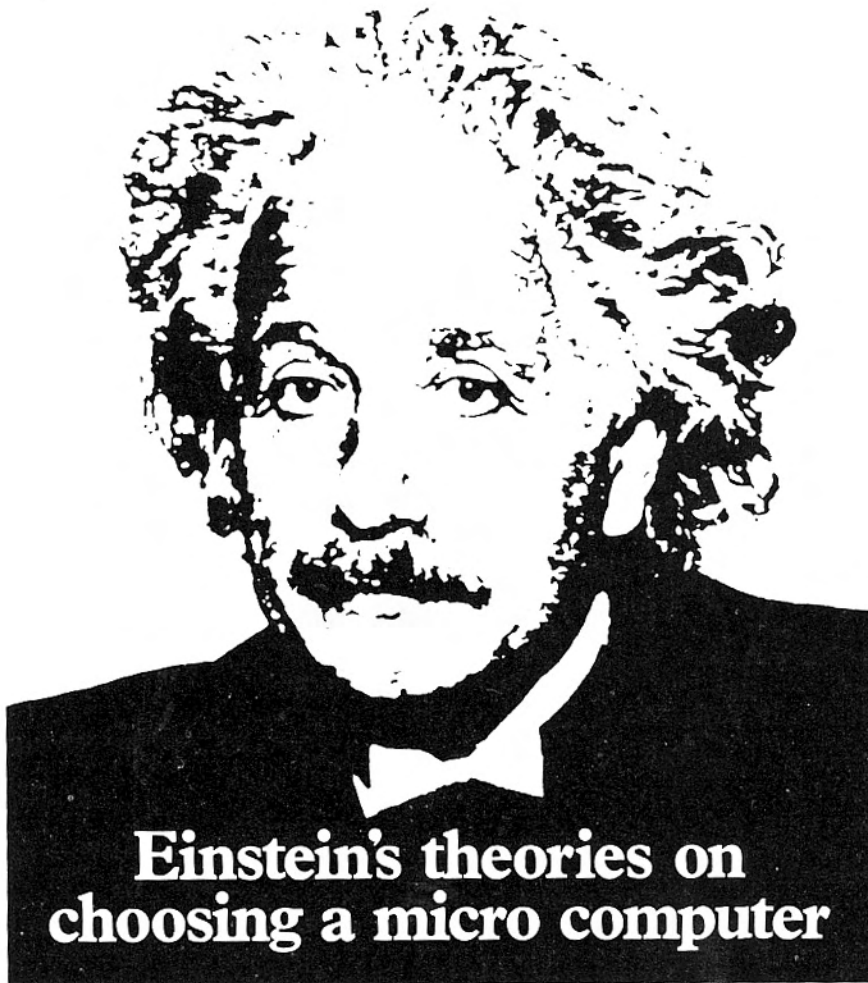

## Einstein's theories on choosing a micro computer

**C**hoosing a micro is a daunting task for the new-comer and with an ever increasing number of micros emerging on the New Zealand market. Even up-grading, say, from a ZX81 can be a risky and expensive exercise with the wrong decisions made. At Einstein Scientific Ltd, we believe it is important to look at the real facts and specifications, and check exactly what you get for your money before choosing your micro computer system.

### THE PIT-FALLS.

#### Don't buy a games machine.

Unless you want games and nothing else! With a games computer you are limited. Some computers, however, have the advantage of both games facility plus the whole world of computing to explore as your interest and skills develop. A real computer system will allow you to expand your knowledge of the high technology world, and help earn its keep with its added uses in the field of education, home, business use and communication.

#### Software.

Make sure the system you choose has a growing library of support software, to enable you to realise the full potential of your machine.

#### Check the quality of the product.

Low quality components and bad design will seriously affect the reliability of the end product, and lead to false economy. Watch out for unreliable edge connectors, corrosion and poor PCBs. Make sure that your supplier can provide an after sales service in case of product failure.

#### Don't let the add-ons add up.

A number of outlets are offering packages that seem to be good value at low cost. Unfortunately these offers have a hidden sting in as much as the essential accessories such as power supply, peripherals and

software often carry a very high cost premium. Make sure you get an 'all-up' price to enable you to start operating the system. Software for low cost hardware usually costs between \$50 and \$100 for a ROM cartridge.

### KEY POINTS TO LOOK FOR. Computer language.

It is too difficult to programme a computer in its binary language so high level languages are used, the most popular being BASIC. However, there are a number of basics, some being very different from the rest. A de facto standard in the computer industry is Microsoft BASIC. Learn this and you will be able to programme in the majority of computer basics, such an important point if the home computer is to be used to educate your children to face the technology of the future.

### Expansion.

As your interest and knowledge of computing grows you will need a computer system that will grow with you, able to accommodate printer, disk drive, joystick, communications modem and colour monitor as well as produce Hi-Fi sound effects.

### Software.

The computer you choose should have a growing selection of utility software to make the most of its capabilities. Remember, computing is here to stay. You can't learn to compute on a toy or a device that does not behave like a real computer.

### High resolution colour.

In general most home computers have a poor graphics resolution (or detail). Check on the vertical and horizontal resolution in graphic mode and multiply the two numbers together — if the result is less than 35,000, then the graphics can hardly be considered high resolution. Low resolution graphics displays, such as those used in games, tend to be "chunky" in appearance.

### Keyboard.

For accurate entry of programmes and data into a computer it is important that the keyboard has a good tactile feel and operation. A standard computer keyboard layout will familiarise the user with the vast majority of computers which are used in the world of business and professional applications, very important if the purpose of purchasing the computer is educational.

### RAM (Random Access Memory).

One of the most important features of a computer is the amount of RAM, or memory included. In general, the more powerful and exacting a computer program, the more RAM it requires. But take care, all computers are advertised quoting the total RAM used in the system. Computers use up a great deal of their own RAM for storing essential data, in particular supporting the graphics display and the CPU (central processing unit). If it is less than 32K, think again, is it enough?

In short look out for a computer which offers all the points above and you will be sure of getting good value for money.

177 Willis Street, WELLINGTON.  
154 Broadway Avenue, PALMERSTON NORTH  
115 King Street North, HASTINGS.  
Cnr. Egmont and King Street, NEW PLYMOUTH.  
Soon to open in Auckland, Hamilton and Tauranga

**Einstein**  
SCIENTIFIC LTD

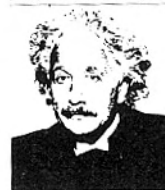

For a copy of this advertisement and request to join our mailing list please write to us at:  
P.O. Box 27188,  
Wellington.

The Computer World  
Made Simple.

## Eight go into one

The country's eight regional computer education societies have formed the New Zealand Computer Education Society — an umbrella organisation which will provide a national co-ordinating body for the regional societies.

A steering committee, consisting of representatives from the Auckland, Central and Canterbury societies — has been appointed.

The regional societies, which have sprung up over the last five years, focus on all aspects of educational computing.

This includes development, distribution, and design of educational software; elevation of educator awareness; dissemination of education-related information; and general promotion of computer use in education.

The new organisation will retain strong links with the New Zealand Computer Society which has taken a fostering role in its formation. The eight regional societies involved with its formation are: Northland, Auckland, Hawke's Bay, Waikato, Central Districts, Canterbury, Otago and Southland.

The national convener and spokesperson is Gerrit Bahlman, from Canterbury. Further information can be obtained from him at: 7 Gloucester St, Christchurch, 1.

## 256 per cent increase

PAXUS Information Services, a subsidiary of NZI, has announced a tax-paid profit of \$1,342,000 for the year ended March 31 — a 256 per cent increase on last year's \$527,000 profit.

The general manager, George Wheeler, says the figures reflect an "entrepreneurial management style" within the 10 autonomous information technology companies which make up the group.

Established in 1983, PAXUS has embarked on a vigorous development and company acquisition programme in New Zealand and Australia with five acquisitions during the year and a sixth since.

Mr Wheeler says the group has maintained a philosophy of preserving autonomy and entrepreneurial flair with each company in the group. The group's structure has been developed to ensure a high degree of flexibility to anticipate market demands, to communicate and

respond rapidly, and to maintain a singular sense of identity within the context of a supportive group environment.

## Down "Silicon Alley"

Computer Advances, Ltd, has established itself at new premises in Auckland's "Silicon Alley" (Great South Road) with the intent of putting a concerted effort into marketing and bringing to life the full range of products from Radio Shack.

The former manager of the Epson division of MDL, Keith Redit, is managing director of the company and has 20 years experience in computer related fields.

Enthusiastic about the prospects for Radio Shack in New Zealand, he and his fellow directors are going into the enterprise with the idea of providing a comprehensive service, including user seminars and user club facilities.

The company was established in 1982 as a vehicle for co-directors David Smith and Murray Grainger to pursue their hobby interests in computing. Their intention was to secure a dealership, write software for particular markets, and sell complete hardware and software systems to end users.

On learning that the New Zealand agency for Tandy Radio Shack computers had been relinquished, a relationship was established with the US company, resulting in Computer Advances' appointment as a dealer.

## The last Osborne 1

Sirius is about to receive its final shipment of the Osborne 1 following a re-organisation of Osborne in the USA after its bankruptcy file earlier this year. This machine goes out of production now and Osborne will be concentrating its efforts on the new Osborne III and the new Vixen portable.

However, the New Zealand distributor, Sirius, reports the Osborne I will continue to be sold and serviced for some time.

The new Vixen is a Z80 based 64K RAM portable with two 5¼in floppy disks, 380K bytes, a seven-inch screen with 80 columns by 24 lines and reverse video facility.

The Osborne III weighs 4kg and takes two 5¼in floppy drives with 360K bytes RAM. The operating system is MSDOS 2.1 and is bundled with a spreadsheet, word processing, appointments schedule and data communications package with optional IBM software available. It

will sell here for around \$6000 (one drive), \$7000 (two drives).

## Apple accessories

Two Auckland students, both Apple enthusiasts, have teamed up to supply cheap Apple accessories to New Zealand users.

Peter Bamberger, a NZCE student at the Auckland Technical Institute and Rob Clarke, a second-year commerce student at Auckland university, felt the equipment they were building for themselves to use on Apple could well be made available to other Apple users, at prices that would defeat the sales tax and duty-laden imported hardware.

"Our aim is to supply as many New Zealand Apple users as possible

## Zoo's who

Software International is putting its money where its logo is and giving the Wellington Zoo a pair of cheetahs. The company's symbol features one of these spotted cats.

"When we heard that one of the zoo's cheetahs had died we approached the Wellington City Council to see if we could donate another pair," said the general manager of SI's New Zealand and Pacific operations, Derek Schneideman.

A suitable cub was located at Whipsnade Zoo in Britain and will be brought to New Zealand in October. A mate will also be found and the zoo will start a breeding programme.

Operation Cheetah was announced at a function in Wellington recently.

with access to cheap equipment along with the best after sales service we can manage," Rob said. "This includes replacement, repair and updating hardware when we develop new modifications."

Along with this, they make joysticks to order — including left and right handed options and switches for versatility with more software, a service they consider may be unique here.

Main projects are aimed at developing devices they consider improve the Apple II+. They are currently making their own lower-case chips, speaker volume control devices, and a game I/O port expander for external use as well as writing protect over-ride for drives.



# OKI microline serial dot matrix printers.....

**OKI Serial Dot Matrix Printers can print almost anything**  
(with the possible exception of illuminated manuscripts)

OKI believe that Graphics Capability is no longer a luxury — it's an essential.

In the OKI range of printers, graphics capability is included in all models at no extra cost. Charts, graphs and displays are duplicated at lightning speed but still with the same exacting detail, care and attention that might have gone into an 11th century illuminated book.

The OKI reputation for High Performance and Versatility has made these printers one of the world's biggest sellers.

AWA are proud to be associated with OKI's versatile range of Serial Dot Matrix Printers — the greatest thing in printing in 900 years.

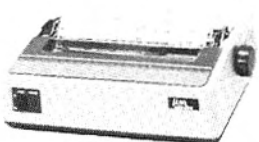

**Microline 80**  
80 cps  
Unidirectional  
80 Column  
132 columns condensed

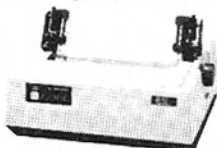

**Microline 92**  
160 cps  
Bidirectional  
80 Column  
Dual Interfaces

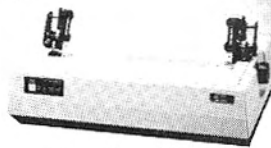

**Microline 93**  
160 cps  
Bidirectional  
136 Column



**OKI 2350**  
350 cps  
Bidirectional  
136 Column  
Two colour printing  
Wide Interface Availability



**OKI 2410**  
350 cps  
Bidirectional  
136 Column  
Two colour  
Technology Intensive.

## OKI

Guaranteed by:

**AWA New Zealand Limited**

For further information contact

AWA Data Systems Division:

**AUCKLAND**

P.O. Box 1363, Grey Lynn

Phone: 760-129

**WELLINGTON**

P.O. Box 50248, Porirua

Phone: 375-069

**CHRISTCHURCH**

P.O. Box 32054

Phone: 890-449

## INTEGRATED PACKAGES

# Integrated applications software: an introduction

By John J. Vargo

For many microcomputers, a wide range of applications software is now available: word processing, electronic spreadsheets, database management systems, graphics packages, and others. At first glance, all of these new software products allow your computer to be that much more useful to you. But with each new product, you also have new manuals, new procedures, new commands and new error messages to learn. Life is woefully short. . . too short to learn them all.

This is where integrated software comes in. Integrated software is a term that refers to software packages which "integrate" two or more applications such as word

processing, electronic spreadsheets and graphics, into a unified product. Examples of these products include: Context MBA, Lotus 1-2-3, and Knowledge-man.

In many cases, these integrated products will take two, three, four, or more independent applications and make a working family out of them. So instead of having to learn a new set of jargon, manuals, procedures, and menus for each application, you have just one set for the whole family.

Both the integrated application software and the new "window" environment for these integrated products are providing a path toward a greatly improved working interface between user and computer. It is an environment more natural to the user and will make the transition to computers easier for novices.

### Lowest level of integration

But simply having a related command and menu structure does not necessarily qualify a software product to be labelled "integrated". This is the lowest level of integration

which might be expected. In addition, the software may be able to exchange data and files directly between applications.

This ability to create a file of data in one application, such as a word processor, and have direct and easy access to the same data for inclusion or manipulation by another application, such as a spreadsheet, is one of the major benefits of these integrated products.

For example, you are using a word processor to create a report to management and want to include a condensed table of operating results previously created on a spreadsheet package. With non-integrated software, a space would be left on your word-processed report for the table you would like to include. Next, you print a copy of the report and a copy of the spreadsheet. Physically cutting and pasting the final report together completes the process.

On the other hand, with the integrated software, you would be able to electronically clip out a portion of the worksheet, "paste" it into the wordprocessor disk file and print out the whole report at once.

### Upgraded to 'windowing'

These integrated products are now being upgraded to run in a new operating environment offering a facility called "windowing". Windowing software products include Lisa from Apple, Visi-on from Visi-Corp and Symphony from Lotus Development Corp.

Such upgraded products provide an environment where not only can you have similar procedures and menus, and access common data files directly and easily, but you can access more than one of the applications at the same time, see the results on the screen of your computer, and exchange data between the applications on an ad hoc basis.

With the newer "windowing" software added, it is possible to view two or more applications simultaneously on your computer screen. You can then "cut and paste" the two (or more) sections of data together electronically on screen to produce the report as it will actually look when you are finished. What you see is what you get!

**If it's micro news in  
Auckland — phone  
Gaie Ellis 549-028**

**SPECIAL  
OFFER**

**FREE** Disc Holding Box (worth \$9.00)  
with every

**10 NASHUA High Quality DISCS**

Normal OUR

Description	Suggested Retail	Price per 10 with Sales Tax	Qty	Price Extn
5 1/4" Discettes Nashua MD1D (SSDD) number of sectors and bytes per sector is format dependant	<del>83.40</del>	49.96		
Nashua MD2D (DSDD) number of sectors and bytes per sector is format dependant	<del>705.00</del>	63.42		
Nashua MD2F (DSDD) number of sectors and bytes per sector is format dependant	<del>729.60</del>	81.48		
8" Discettes Nashua FD1D (SSDD) 26 soft sectors 128 bytes per sector	<del>714.00</del>	64.50		
Nashua FD2D (DSDD) 8 soft sectors 1024 bytes per sector	<del>726.00</del>	83.12		

PLEASE ASK FOR OUR SPECIAL PRICE ON 100 LOTS.

Packing & Postage

.95

TOTAL  
Cheque herewith

**CASH with Order PLEASE**

Please make your cheque out to :

Post to: **Microcomputer Specialists & Software Ltd**

61 Hobson St. P.O. Box 39-075

Auckland West. Ph 798-569

# C.ITOH TAKES CONTROL

**FACT: C.ITOH now distributes more  
printers each month than anyone  
else in the world.**

They have been New Zealand's largest selling business printer for the last four years – a fact confirmed by the Arthur Hoby Survey.

The reason for this success is that C.ITOH printers deliver the highest throughout performance in each class – a fact confirmed by thousands of satisfied users.

C.ITOH printers are supplied ex-stock, serviced and fully supported by CONTROL. 48 hour servicing turnaround from anywhere in the country via courier.

**CONTROL**

45 Normanby Road, Mt Eden, Auckland 3. P.O. Box 68-474,  
Auckland, N.Z. Telex NZ61102 "DATASYS" Phone 600-687

# INTEGRATED PACKAGES

## LOTUS 1-2-3

# A giant step in spread sheets

By Paul Smith

I first encountered Lotus 1-2-3 in late 1983 while involved in the development of a small costing/budgeting system. At that time, it was the topselling software package for micros in the USA. Its popularity has continued to the point that according to its New Zealand distributor (Imagineering Micro Distributors, Ltd, 1 Arawa St, Grafton, Auckland), it has enjoyed more than 60 (!) weeks as the top seller in the USA microcomputer software.

In this article, we'll attempt to understand why, examining such matters as product uses, costs, ease of use, technical issues and summarise the pros and cons of the package.

Before getting into the "meat", I want to acknowledge the assistance of Alan Thomson and Richard Gorham (systems analysts with the Auckland Farmers Freezing Co-op, Ltd.) in appraising Lotus 1-2-3, and AFFCO's help in allowing me to use its IBM PC for evaluation.

1-2-3 describes itself as an "electronic worksheet", and so it is. Wanting to know the implications of a five per cent increase in wages on your selling price of a particular product? With 1-2-3 (and the appropriate model set up, of course) you can quickly and readily find

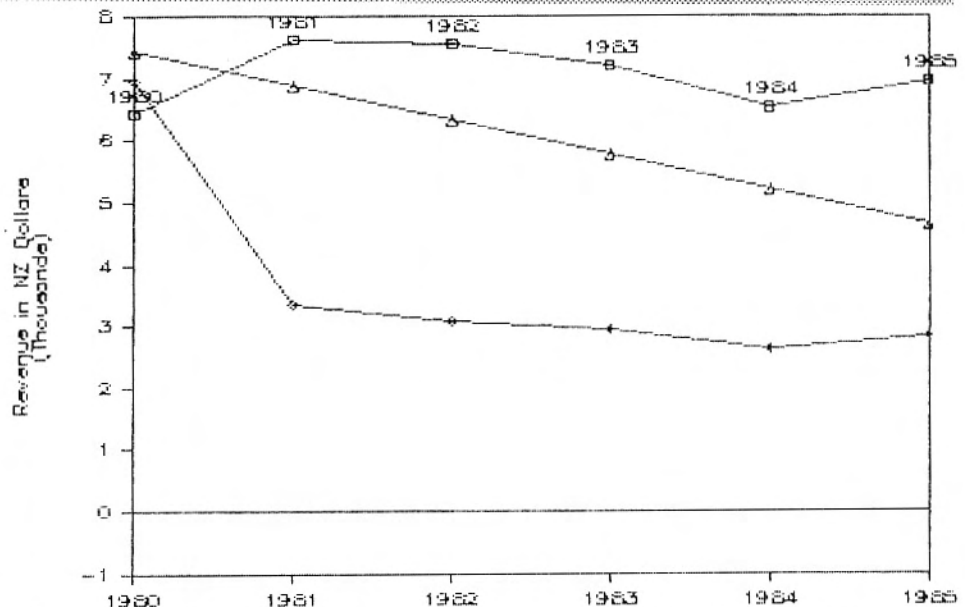

Output of graphs of a "dummy" model (to an Epson FX100 printer).

answers to "spreadsheet" type information. Interested in discovering the "break even" point for sales of product "X"? Again, given the appropriate model, 1-2-3 will quickly and readily provide the answer.

## Why all the fuss?

"OK, OK", you may be thinking, "but wasn't there a product called VisiCalc which handled this sort of thing? Why the big fuss over Lotus 1-2-3 when this sort of product has been around for several years?" Many theories have been offered, but I'll throw my own onto the pile:

1. The Lotus corporation made a significant step forward in the goal of "integrated software" — a package handling such day-to-day functions as word processing, spreadsheet calculations, graphing, data base management, report generation, communications etc so that data can be readily manipulated among these various processes using a set of similar commands.

While 1-2-3 primarily addresses the facilities for integrated spreadsheet and graphics (it also has provision for relatively simple file handling), it has combined and improved on earlier spreadsheet packages in this regard.

2. Given the degree of sophistication of this product — especially when compared with earlier spreadsheet packages — it provides many aids to help the user.

- Superior documentation. The manual is excellent and has three different types of indexes — by command grouping; by function; and the conventional alphabetical index.

- "Help" screens. More than 200 are provided — simply enter the "F1" function key and a narrative explanation is provided, along with the relevant page number in the manual for a more detailed explanation.

- "Tutorial" diskette. Various facilities of 1-2-3 are explored in an interactive fashion.

3. Massive amounts of money have reportedly been spent in promoting this package overseas.

```
A6: U /mAP1.AP40~J1~/mAP1.AP40~S1~/mAP1.AP40~AB1~
```

READY

A

```
1 (home)~/XMa102~
2 Amend
3 Amend data items for one or more Categories in a single week
4 (home)~/fccn\form1~WEEKNEW~(goto)F1~/wcs35~(goto)J1~/wcr~(goto)01~/wcs35
5 (goto)S1~/wcr~(goto)X1~/wcs35~(goto)AB1~/wcr~(goto)AG1~/wcs35~(home)~
6 /mAP1.AP40~J1~/mAP1.AP40~S1~/mAP1.AP40~AB1~
7 /XLHit ENTER then point to weeks datafile name~a99~(goto)B1~/fccn\all~{?
8 /xq~
```

An example of the Lotus 1-2-3 commands used to generate "keyboard macros".



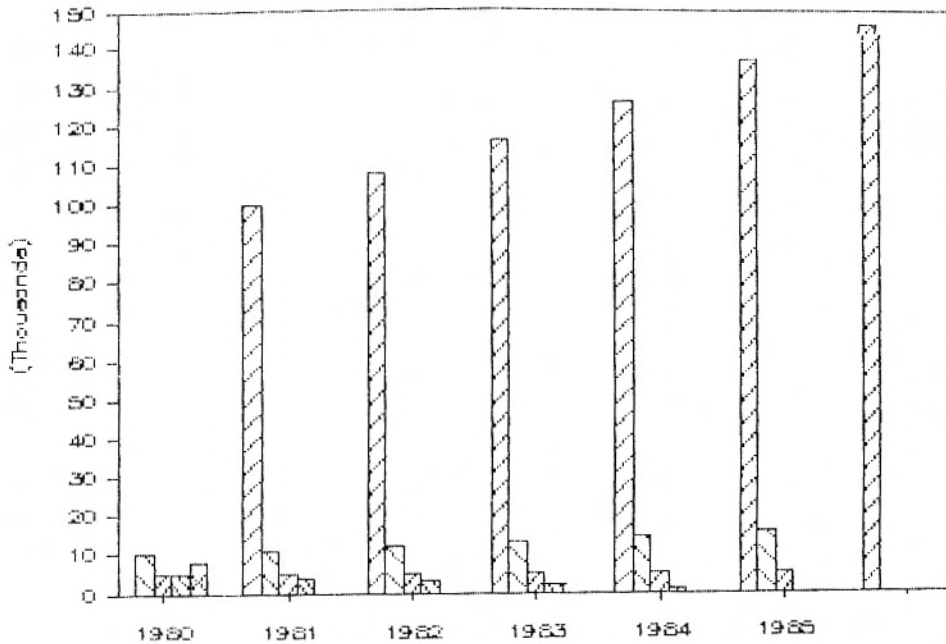

Product presentation and packaging have been carefully developed.

4. This was one of the first serious packages sold when the IBM PC was unveiled. So, for (at the time) the newly developing IBM PC 16-bit market, this represented "state-of-the-art" software. Lotus' timing in introducing the product cannot be faulted.

Without attempting to mention all Lotus' features (you'll have to read the 1-2-3 manual if you want that!), here are some of its more notable features:

## Menus

A "high level" menu is supported, giving the pertinent entry level command for a given process. What's especially nice is that for the function to be selected, a "sub level" menu is displayed below, describing the various processes available for the "high level" instruction.

## Cursors

While the conventional single-character type cursor is supported, especially nice is the inverted-video cursor for use within the spreadsheet. This can be used to avoid typing spreadsheet addresses when entering formulas, as well as for defining areas of the spreadsheet for manipulating, reporting, graphing, etc.

## Use of ESC key

Got yourself into a mess in terms of the current menu's offerings? Lost in an unfamiliar area of the various facilities offered by Lotus? No problem! Hit the "ESC" key and

1-2-3 will immediately return you to the previous menu level. This easy-to-remember, simple means of backtracking is something I appreciate, especially when I think back to some of the mini-computer systems I've examined in the past. Getting "locked" into a particular processing level by mistake isn't my cup of tea!

## Keyboard macros

This facility allows the storage of various keystroke sequences. So, if (say) to generate and print a graph required seven different key entries, it would be possible to reduce this to one keystroke with these keyboard macros.

## Graphing

Line, bar, pie, stacked bar and XY co-ordinate charts can be produced using data from the worksheet.

## Function keys

Lotus supplies a template for fitting over the "function key" portion of the PC. Frequently used commands, such as "Window", "Query", "Graph", etc., are provided.

## Importing/exporting files

While I didn't attempt this, the 1-2-3 manual indicates that standard ASCII text files can be accessed and/or output by Lotus. For example, VisiCalc on dBASE-II files can reportedly be accessed by Lotus (assuming, of course, your diskette format can be "read" by the computer you're using!!).

## The technical considerations

1-2-3 is reportedly available for the following computers: IBM PC and XT (3270 later this year); COMPAQ portable computer; Texas Instruments Professional Computer (reportedly responds to voice commands for this one!!); Zenith Z-100; Hyperion; DEC Rainbow 100; Wang Professional Computer; Victor 9000; HP150.

While the manual speaks of 1-2-3 running in 192K of memory, you'll want a minimum of 256K to really do anything. I'd recommend having at least 320K of memory for the IBM PC, as this allows around 128K of user area. Note that Lotus supports up to a 256 x 2048 size spreadsheet.

If you want you use 1-2-3's graphics capabilities (and I'd be surprised if you didn't), you'll need the Hercules graphics card installed. For output of graphs to printer, you'll need a printer with this sort of capability.

A pair of double-sided, double-density diskette drives is required as well, supporting 5.25in diskettes.

1-2-3 does support colour. If you do want this, obviously you'll need an RGB monitor!

The post-devaluation retail price of 1-2-3 is \$1050. I understand there is normally a three-month warranty for defects, in which case your diskette would be replaced free of charge. After the warranty period, a charge covering the cost of media transfer would be applicable.

Future upgrades could normally be purchased for \$75-150, but check with your dealer to be sure.

Imagineering (the New Zealand distributor) advised me that since early this year, sales of 1-2-3 for the IBM PC in New Zealand have been between 60 to 100 copies a month. There appears to be a substantial and growing "user base" out there.

## Outstanding spreadsheet

Lotus 1-2-3 is an outstanding spreadsheet program which has earned the ultimate compliment of spawning other products attempting to copy or better it in function, sophistication and ease of use.

The ability to produce graphics and generate simple queries for database reporting is useful and, at the time of its introduction, represented one of the earliest movements towards integrated software.

# INTEGRATED PACKAGES

It represents good value for money and, with such a large base of users and experienced computer consultants, help in getting the most from your purchase is most likely obtainable.

However, "perfect" software hasn't yet arrived, and I would offer the following criticisms, tempered by the fact that subsequent upgrades may have resolved these problems and/or my relative inexperience with the product may have resulted in erroneous conclusions. These criticisms are either from my own use of the product or from comments from other Lotus 1-2-3 users.

## Tutorial disk

- Use of some sort of prompt when new instructions are added to an existing screen of information would have been useful. On several occasions, I found myself re-reading text from a previous screen only to discover the new information requiring my attention was "tagged onto" the end of a three to four paragraph narrative. Some form of "blinking", reverse video, etc could have been used to highlight the new text.

- During a tutorial session, I was asked to move to a new address which was "northeast" from my current location. I was "forced" by the tutorial to go up first and then move to the right to reach this location, when an equally valid approach would have been to first move to the right and then upward. A first time computer user could have formed an incorrect impression of movement restrictions. Surely, a tutorial should simulate the "real

A1: (F2) 'AJT Ind.Corp.Ltd.@1984 CMD MENU

Expand Screen Full Report Totals Report New Data Original Quit  
 Expands matrix without printing the full report

	A	B	C	D	E	F	G	H
1	AJT Ind.C	1980@	1981'	1982	1983	1984	1985	
2	-----							
3	Potential	100000	108000	116640	125970	136050	146730	
4	Raw Mater	0.13	0.14	0.14	0.15	0.16	0.16	
5	Packing/U	0.07	0.07	0.08	0.08	0.08	0.09	
6	Labour/Un	0.10	0.11	0.12	0.13	0.14	0.15	
7	Distrib./	0.03	0.03	0.03	0.04	0.04	0.04	
8	Fixed Fac	10000	10900	11880	12950	14120	15390	
9	Other Fix	5000	5000	5000	5000	5000	5000	
10	Price/Uni	0.60	0.61	0.61	0.62	0.62	0.63	
11	Advertisi	5000	4000	3000	2000	1000	0	
12	Working C	30	29	28	27	26	25	
13	Capital I	8000	0	0	0	0	0	
14	Tax Rate%	52	52	55	55	55	55	
15	-----							
16	REVENUE	60000.00	65880.00	71150.40	78101.40	84351.00	92565.90	
17	WORKING C	4931.51	5234.30	5458.11	5777.36	6008.56	6340.13	
18	DEPRECIAT	560.00	560.00	560.00	560.00	560.00	560.00	
19	TOTAL VAR	33000.00	37800.00	43156.80	50388.00	57141.00	64649.20	
20	TOTAL FIX	20000.00	19900.00	19880.00	19950.00	20120.00	20390.00	

A dump of a screen containing a "dummy" model set up using Lotus 1-2-3. Note that a user menu has been generated using "Keyboard macro" — a very useful facility.

life" flexibility of the product and not impose a false constraint on someone trying to learn to use the product.

## Ease of use

Notwithstanding Lotus' publicity claims on ease of use, development of a model of any consequence will most likely require expert assistance from experienced computer personnel. I cannot see the average manager having the time or necessary computer concept training to satisfactorily implement this package. I'd allow five to 10 days as the "learning curve" for a computer person really coming to grips with all of Lotus' facilities — there's lots to learn as there's lots of sophistication in this package!

I see the package as one to be predominantly taken by an experienced computer person and, using the "keyboard macros" facility, turned into a relatively "user friendly" application. Fortunately, agents selling such software will most probably have the necessary expertise to get you going, and may even throw in a few hours of free support if you also bought the relevant hardware to run 1-2-3.

## Keyboard macros

As there is no indirect addressing, all cell addresses must be explicitly defined. Any insertion of a new parameter for your model, after these macros have been set up, means each affected cell address must be manually altered. Some sort of "global" change facility for the affected data area would be very nice.

## Diskette storage

Each Lotus file is output in ASCII. If diskette storage space were an

issue, the option to output in binary format would have been useful.

## Printing

A friend of mine informs me that Lotus has no facility for issuing a command to slew to a new page. If he has a spreadsheet matrix encompassing more than 66 lines, he must ensure he only issues a command for outputting the first 66 lines of his matrix, then the next 66, etc. I would hope this problem has been corrected in subsequent upgrades to Lotus, as it represents a real "nuisance value" problem.

In playing with Lotus for this review, we managed to get a blank screen once or twice when attempting to generate graphics. (It turns out we'd goofed and had no data for output in the selected matrix area of our own spreadsheet.) 1-2-3 should not permit a blank screen to result but rather display a message such as, "No data available for graph from this area of spreadsheet". Blank screens, with absolutely no message prompts, are unnerving. Pity the poor, first-time computer user.

By the time this article appears in *Bits & Bytes*, a "latest and greatest" product from Lotus should also be available. Symphony appears to build on the 1-2-3 software concepts while adding facilities for word processing, communications, and more advanced database facilities than provided by 1-2-3. My advice would be to check out this new offering closely before rushing out and buying 1-2-3. Then, you can decide which product best suits your business requirement.

Paul Smith is an Auckland-based computer consultant.



**ORIC-1**  
 64k = \$699

COMPARE THE FEATURES

- 64K • 60 Programs
- Full colour & sounds
- High res. graphics
- Centronics Interface
- Hard keys • Monthly mag.

FOR ORIC INFO PACK:  
 BARR BROS. COMPUTERS,  
 P.O. BOX 177, PAKAPURA,  
 AUCKLAND. PH 2989181.

# Computer based training



## The Fad or the Future??

Nearly everything new is treated with scepticism.

It's the same with computer based training. A lot of people have heard of it. But not many know very much about it.

So Control Data New Zealand, innovators in computer based training, are running seminars to explain what computer based training is, how it works and what it can offer you.

Seminars scheduled in —

### WELLINGTON

August 7, August 17, September 6, October 4, November 8

### AUCKLAND

August 14, September 11, October 18, November 12

### CHRISTCHURCH

September 18, November 15.

### PHONE:

WELLINGTON 739-505

AUCKLAND 770-844

We aim to dispel the fallacies and focus on the facts.

If you're a training manager or someone responsible for training in industry, commerce or government, our seminar is a great way to find out about computer based training. And what it can and can't do for you.

So fill in the coupon or call Control Data today for more information about our computer based training seminars.

Yes, I'm interested in Control Data's seminar on computer based training.

Name ..... Organisation .....

Address ..... Phone .....

Mail to Control Data New Zealand Ltd.  
Box 3301 Auckland or Box 3946 Wellington

# Speeding up the sort

By Dennis Lowe

Although dBASE II is capable of powerful data manipulation, its limitations can at times be frustrating. One common complaint is the slow speed of the SORT command, and the inability to sort on more than one field at a time.

The usual method of sorting a file on multiple fields is shown. First we create a new file called EXAMPLE and append seven records into it. Each record contains 4 fields, name and address, an account number and a sequence number. Sorting this is obviously rather trivial, but imagine a file of several hundred records sorting on several key fields — much more tedious!

The dBASE commands entered are shown underlined, while responses are shown boldfaced, in listing No. 1.

At this point we have generated a number of temporary files, one for each field sorted. For a large database this often means diskette shuffling and careful housekeeping to get rid of unwanted files. As well as being painfully slow!

Fortunately dBASEII has a very efficient INDEX command which can overcome these problems with SORT. To achieve a faster "sort" on multiple fields, simply create an INDEX over the required fields, then COPY the indexed file into a new file. (See listing No. 2).

The expression used to create the index is defined by concentrating all fields in the order of sort sequence desired. Numeric fields should be converted to character strings (with function STR) to avoid the difficulties caused by leading zero alignment.

In the example above, the last part of the index is created from the record number function (). This is not necessary in our example but is used to ensure that every record will have a unique index. If

. CREATE EXAMPLE

ENTER RECORD STRUCTURE AS FOLLOWS:

```
FIELD  NAME,TYPE,WIDTH,DECIMAL PLACES
001    NAME,C,10
002    ADDR,C,10
003    ACCT,N,4
004    SEQ,N,3
005    <RETURN>
```

.LIST ALL OFF

```
BILLY    HIGH ST      1234    1
BILLY    NEXT DOOR   1234    2
BILLY    DOWN TOWN   1234    3
BILLY    SOMEWHERE   3322    4
JIMMY    NEXT DOOR   3322    5
JIMMY    OUR PLACE   4321    6
JIMMY    HIGH ST     1234    7
```

.SORT ON SEQ TO EXSEQ

**SORT COMPLETE**

. USE EXSEQ

. SORT ON ACCT TO EXACCT

**SORT COMPLETE**

. USE EXACCT

. SORT ON ADDR TO EXADDR

**SORT COMPLETE**

. USE EXADDR

. SORT ON NAME TO EXNAME

**SORT COMPLETE**

. USE EXNAME

. LIST ALL OFF

```
BILLY    DOWN TOWN   1234    3
BILLY    HIGH ST     1234    1
BILLY    NEXT DOOR   1234    2
BILLY    SOMEWHERE   3322    4
JIMMY    HIGH ST     1234    7
JIMMY    NEXT DOOR   3322    5
JIMMY    OUR PLACE   4321    6
```

you are sure that no duplicate indices will result, then leave this out.

I haven't done any precise timing tests, but with 200 records sorted on three fields, the COPY from INDEXed file is about eight times faster than SORTing,

## Listing No. 1

even ignoring the file tidy up times. The saving becomes relatively greater as the sizes increase.

```
. USE EXAMPLE
. INDEX ON NAME+ADDR+STR(ACCT,4)+STR(SEQ,3)+STR(#,5) TO EXNDX
00007 RECORDS INDEXED
```

```
. COPY TO EXAMPLE2
00007 RECORDS COPIED
```

```
. USE EXAMPLE2
. LIST ALL OFF
```

```
BILLY    DOWN TOWN   1234    3
BILLY    HIGH ST     1234    1
BILLY    NEXT DOOR   1234    2
BILLY    SOMEWHERE   3322    4
JIMMY    HIGH ST     1234    7
JIMMY    NEXT DOOR   3322    5
JIMMY    OUR PLACE   4321    6
```

## Listing No. 2

## 40% prediction

Interactive Applications, Ltd, is predicting that sales of Microsoft BASIC and Multiplan, designed specifically for the Macintosh, could account for as much as 40 percent of the company's Microsoft revenue over the next 18 months.

Microsoft Multiplan has enhancements on other Multiplan versions, including an "undo" command which allows the last change to the spreadsheet to be reversed.

## HARDWARE REVIEW

### EPSON PX-8

Well on  
the way  
to being  
truly  
portable

By Peter Ensor

Epson has long been recognised for its design of printers. In addition, it has been producing computers such as the first portable, the HX-20. Now, Epson has taken another step forward by producing a new CP/M-based portable computer – the PX-8



The Epson PX-8

# dBASE II brings you into the modern age of database management.

dBASE II™ is a window into an entirely new way of managing your business world. It's a business productivity tool based on an advanced concept used on mainframe computers, that of the relational data base management system (DBMS). It's the most powerful information handling tool you can get for your microcomputer.

dBASE II turns your data into  
a corporate resource.

dBASE II gives you flexibility and freedom simply not found in any of the vertical, dedicated business programs available for your microcomputer.

ASHTON·TATE ■

Distributed by:



dBASE II™ is a registered trademark of Ashton-Tate  
©1983 Ashton-Tate

Contact your local dealer for more information or write to:  
Computer Store, Freeport 907, P.O. Box 31-261, Auckland 9.

## HARDWARE REVIEW

which is being promoted as a personal computer.

It is housed in a 297 x 216 x 48mm-high cream coloured plastic case weighing about 2.3kg – the same size and weight as two American *Byte* magazines. A carry handle on the front of the case unfortunately needs two hands to pull out before you can use it.

The light brown keyboard cover is removed to use the computer, revealing a 64-key QWERTY keyboard and nine extra special function keys. The RETURN and cursor keys are a distinctive red and orange colour respectively.

The cursor keys are placed in an inverted T pattern with the down arrow key where the home key normally is. The home key is between the up and right arrow keys.

The J,K,L and U,I,O keys are overlaid with numerals to form a numerical keyboard.

Opening up the display lid reveals a wide LCD display and micro-cassette drive and speaker. The LCD display is an 80-column by eight-line display which can be angled at any of the 13 clicked positions from fully closed to lying flat open. The screen can be scrolled through a total of 48 lines using the cursor keys.

The screen can be set in one of four modes which allow for split screen operation or as a graphics screen with a 480 x 64 resolution. There are nine international character sets which are switch or software selectable. None of the character sets uses descenders.

The LCD display is typically slow but the provision of a type-ahead buffer is a welcome feature. Since the computer is very portable, it can be used sitting on a knee. This meant the display was continually being adjusted and, coupled with low light levels and hence low contrast, made it hard to read.

### Computer asks for password

The microcassette drive uses the same size cassette as many dictaphones. The inbuilt speaker can be used to listen to these cassettes and by also using the word processing package, the computer can be used as a form of electronic notepad.

The cassette was slow in use but was a big advantage to be able to back up files. By using the automatic power off feature, the computer can be left to back itself up and then turn off when finished.

When the unit is turned on, the computer will first ask for a password if it has been enabled. The display then changes to show either a menu or what was showing when the computer was turned off.

The computer has a power-down state so that the user can return to exactly where he or she was before the computer was turned off, even if it was partway through an editing session.

The CP/M operating system is used, with a few extensions. All these extensions are accessible via the BIOS jump table and enable control to be made of, for example. The RS-232C serial port, the clock or the banked memory.

Use is made of RAM and ROM devices to emulate the disk drives. The 64K of main memory can be split up to contain up to 24K of RAM disk. This and the cassette are the only "disks" that be written to.

Other "disk" drives are the two user-insertable ROMs which behave like write protected disks. If more storage is required, another 120K of memory can be added by the addition of a slim case underneath the main unit.

If more permanent storage is required, floppy disk drives can also be added by using the high speed serial port. The computer contains a clock module supported by its own

battery backup. This clock can be used for simple time of day reporting in programs as well as an alarm clock or to run a program at a predefined time.

The unit is powered by NiCd batteries giving a maximum of 15 hours of use. When the batteries become flat, a "CHARGE BATTERY" banner is displayed for 20 seconds and the unit then powers down to use the clock backup batteries. The system may be continued on from where it left off when the charger is plugged in. Full recharging takes eight hours.

Other inputs into the unit are two analogue inputs to an analogue to digital converter and also a bar code reader.

### Software with the unit

Software supplied with the unit included adaptations of the WordStar wordprocessing program, a spreadsheet and Microsoft BASIC as well as some special programs for computer.

The first of these special programs makes the computer emulate a terminal. This goes hand in hand with another program called FILINK that transfers files between

## Microcomputer Summary

<b>Name:</b>	Epson PX-8
<b>Manufacturer:</b>	Epson Corporation.
<b>Microprocessor:</b>	Main CPU – Z80 lookalike; slave CPU – 6301; KB CPU – 7508.
<b>Clock speed:</b>	Main CPU – 2.45 MHz; slave CPU – 614 kHz; KB CPU – 200 kHz for keyboard (KB), 32 kHz for clock.
<b>RAM:</b>	Main memory 64K standard; slave 6K video and 128 bytes internal.
<b>ROM:</b>	32K operating system; 8-32K per capsule.
<b>Input/output:</b>	Bus interface, high speed serial, RS-232C, analogue input bar code reader, speaker output.
<b>Display:</b>	80 columns by 8 lines scrollable on 80 x 48 display memory.
<b>Language:</b>	Microsoft BASIC.
<b>Software:</b>	Portable WordStar, Portable Calc, Portable Scheduler.
<b>Graphics:</b>	480 x 64.
<b>Sound:</b>	4 1/2 octaves single voice.
<b>Cost:</b>	\$3400.
<b>Options:</b>	Larger RAM disk.
<b>Peripherals:</b>	60K RAM \$881.10; 120K RAM \$1244.22; twin floppy disk drives POA; acousitc coupler \$539.31; bar code reader POA; universal unit \$229.62.
<b>Other features:</b>	Compatible with all CP/M software.
<b>Reviewer's ratings (5 the highest):</b>	Documentation 5; ease of use 4; language 4; expansion 5; value for money 3; support 4.

(Review unit supplied by Microprocessor Developments Ltd).

## HARDWARE REVIEW

computers, allowing the last night's work to be loaded into another computer for further processing.

The WordStar package, which replaces the standard CP/M editor, is a welcome addition. The ability to write letters while travelling will be a major selling point of this computer. The Mailmerge and Spellstar options are not available because of memory restrictions but the WordStar contains its own file transfer program so that the files may be transferred to a larger machine for these functions.

Because of the small size of the screen, none of the menus are displayed. However, they may be requested by pressing the HELP key. The only major restrictions of this WordStar over a full version is that the help menu and the directory file listing are not available.

The Microsoft BASIC is very extensive with many additional commands to make use of the machine-specific facilities. A screen editor and random file access are also included in the BASIC. The SOUND command gave the inbuilt speaker a range of four and a half octaves.

One thing was surprising. Even though the BASIC is loaded off ROM, it is not much faster than if loaded off a floppy disk.

The spreadsheet is known as Portable Calc and, like the WordStar, has a limited range of commands. One of the commands is to blank the whole spreadsheet. The manual recommends to quit the spreadsheet and restart it.

### *A quirk & corruption*

Another annoying quirk of the spreadsheet is to disable the type-ahead buffer. This makes the system very slow to use when scrolling and, as it has no commands for setting up windows, this becomes annoying.

To top off Epsoms' embarrassment, the training manual leads the user through a sequence of commands that happens to corrupt some of the data in the cells. This corruption manifests itself as garbage in the cell, and the rest of the cells on that row are out of alignment with the border. At one stage, this corruption managed to lose the rest of the row starting at column B.

All these packages come in ROMs which are plugged into the back of

the unit and being CMOS, are susceptible to damage. The ROMs are mounted on a fragile carrier which does offer some protection but I am putting this fault down to a damaged ROM as it is very unlikely Epson would let this fault go unnoticed.

The remaining software package is Portable Scheduler, a memo style notepad. The screen is divided into half-hour divisions and notes may be placed against each of these periods.

The best part of this program is the display of the month's appointments on what look like staves of music. The computer fills in between each of these staves if that period is used, allowing the coming month to be planned very easily.

When the time equals one of these periods, a message is displayed on the screen as a reminder. This occurs even if the scheduler package is not resident in the computer.

Documentation provided for all the software and the computer is excellent. No manual is less than 15mm of useful information, and the presentation is good and easy to read.

This computer represents a major step towards the production of the truly portable computer. The large display and the supplied software combine to make a useful tool for the travelling user. The basic unit is restrictive but with the addition of the extra RAM unit, the system is likely to prove popular.

However, as far as value for money goes, there could be competition from the existing "luggables". But this system will win when either space or weight is a consideration.

### **New business micro**

Commodore Business Machines' new 8296-D microcomputer, specifically designed for business use has dual 5¼ in disk drive conveniently built into the porsche-designed cabinet containing the central processing unit (CPU).

Based on the 8096 micro-computer, it has 128K of memory on an 80-column display, and carries a full range of Commodore graphics and alpha-numeric set.

The dual disk drive has a capacity of 1.06 megabytes per drive and a maximum sequential file of 1.05 megabytes. The disk drive can access from track to track in five milliseconds. Up to 224 files can be stored on each disk.

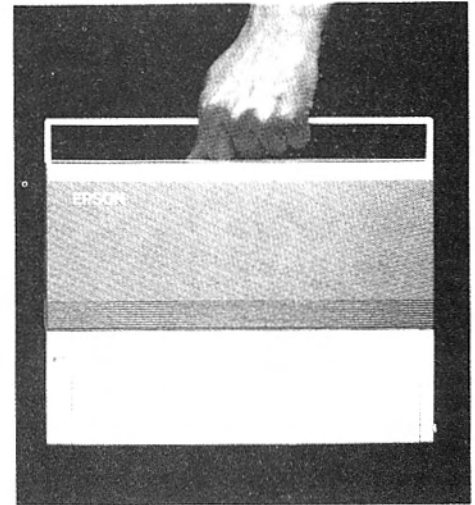

*The PX-8 — no larger and considerably lighter than a portable typewriter...*



*... Remove the protective panel to reveal the full-size keyboard...*



*... Flip up the large, legible display screen — and the PX-8 is ready to go to work.*

## PRINTER REVIEW

### NEC Pinwriter P1

# Speed and high quality printing

By Shayne Doyle

I first saw the NEC Pinwriter P1 about six months ago when an advance model was on demonstration. I was most impressed by the print quality then, and after using it for a week, I remain impressed. As can be seen from the print sample, standard pica-font, high-speed, draft mode is fairly similar to most other dot-matrix printers except it whizzes along at 180 characters per second. I did not actually time it, but objectively, it seems to be going very fast. Changing to pica font, high-density mode produces a dramatic improvement in character quality — almost up to typewriter standard, and still running at 90 cps.

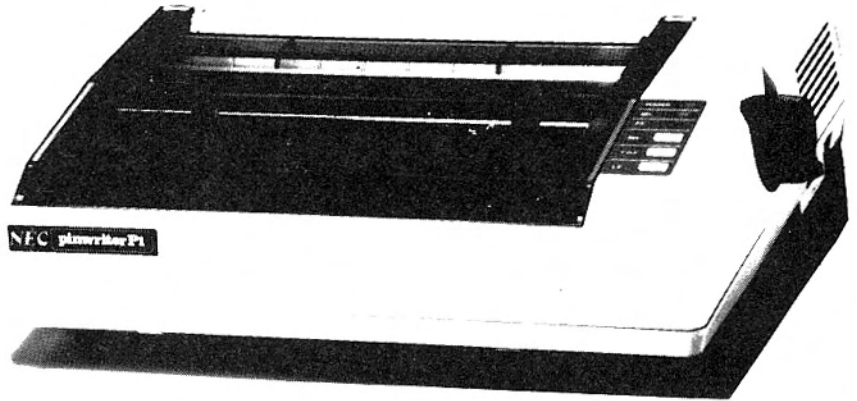

The NEC Pinwriter P1

A very compact unit, it is nevertheless well constructed and has a quality feel about it. The top aperture is covered with a tinted-perspex, acoustic cover with only minimum slots for paper feed which helps to keep noise to a minimum. The printer does not come with a "standard" interface, but when you buy one, it will be fitted with either a parallel or serial interface to suit your computer.

Standard paper feed is by friction platen, and while this is great for single sheet, I did find that fanfold

drifted to the right over the course of a long program listing. A tractor feed unit is available for \$114, and I consider this essential. A cut-sheet guide is also available for \$30. To the right are the usual controls and indicators — green power and select (on line) LEDs, red paper-out LED, select, form feed, and line feed switches. Line feed will advance paper one line and after a two second delay, go into continuous feed mode. The select switch does not stop the printer immediately, but stops it receiving data into its buffer.

The select function needs to be checked carefully with your computer, as this printer uses a full Centronics interface. As well as the Acknowledge signal on pin 10, it also uses Busy (pin 11) and Printer Select (pin 13). If your computer has a minimal Centronics interface as mine does the computer may not stop sending data when the printer is put offline. Either way, I found it annoying to have to wait for it to empty its buffer before printing stops. Connected to a computer with full interface (NEC APC), this is not a problem.

On the right side are ventilation grilles, behind which lurks a quiet fan to provide forced cooling. This keeps running for a few minutes after the printer stops. The paper feed knob on the right side is a dual control, incorporating a lever that operates the pressure bar. A good feature is the automatic sheet loading when the pressure bar release lever is returned to normal position. This greatly simplifies loading single sheets of paper.

The configuration DIP switches are sensibly located below the head carriage and are accessed by lifting the acoustic cover. Normally one would not need to alter these, but thankfully, more printer manufacturers are now placing them in an

#### NEC PINWRITER P1 PRINT SAMPLES

-----  
THE FOLLOWING GROUP IS PRINTED IN PICA HIGH SPEED

THESE TWO LINES ARE PRINTED IN STANDARD DRAFT MOD  
These two lines are printed in standard draft mod  
PRINTING NOW IN AUTOMATIC UNDERLINE MODE  
Printing now in automatic underline mode  
SWITCHING NOW TO CONDENSED STANDARD DRAFT MODE  
Switching now to condensed standard draft mode  
THESE TWO LINES ARE PRINTED IN EMPHASISED STANDAR  
These two lines are printed in emphasised standar  
PRINTING NOW IN EMPHASISED AUTOMATIC UNDERLINE MO  
Printing now in emphasised automatic underline mo  
SWITCHING NOW TO EMPHASISED CONDENSED STANDARD DRAFT MODE 1234567890  
Switching now to emphasised condensed standard draft mode 1234567890

THE FOLLOWING GROUP IS PRINTED IN PICA HIGH DENS I

THESE TWO LINES ARE PRINTED IN STANDARD DRAFT MOD  
These two lines are printed in standard draft mod  
PRINTING NOW IN AUTOMATIC UNDERLINE MODE  
Printing now in automatic underline mode

THE FOLLOWING GROUP IS PRINTED IN ELITE MODE

THESE TWO LINES ARE PRINTED IN STANDARD ELITE MODE 123456  
These two lines are printed in standard elite mode 123456  
PRINTING NOW IN AUTOMATIC UNDERLINE MODE  
Printing now in automatic underline mode



## PRINTER REVIEW

easily accessible location. This is important to a reviewer when trying the effects of such switches. Unscrewing one screw under the front edge enables the case to be quickly removed.

I particularly noticed that the mains socket has an in-built noise filter. This is a good touch as spurious mains spikes quite often affect a printer. My own printer is prone to performing a line feed if a switch-on transient comes along.

### STAGGERED ARRAY PRINT HEAD

The high print quality at high speed is due to the head format. This printer belongs to a small group of machines featuring a staggered array print-head. Instead of a single vertical array of nine pins, there are two sets, each offset vertically by a half dot. This arrangement also permits dual vertical graphics densities, eight or 16 dots per character position. The bit-image graphics features are no more difficult to master than any other printer: it takes only a half-hour or so to start producing high-resolution graphics if one is reasonably familiar with the principles involved.

The user manual is clear enough and is well detailed in the graphics area — usually a bit light in most printer manuals.

## Printer summary

<b>Name:</b>	NEC Pinwriter P1.
<b>Type:</b>	Dot matrix, bidirectional, logic seeking.
<b>Line format:</b>	80 characters per line at 10 cpi. 136 characters per line at 17 cpi.
<b>Character format:</b>	Pica high speed: 7 x 9 matrix Pica high density: 13 x 9 matrix Pica proportional spacing: 13 x 9 matrix Expanded characters: 14 x 9 matrix Condensed characters: 7 x 9 matrix
<b>Graphics format:</b>	80/120/240 dots per inch horizontally; 8 or 16 dots per vertical graphics line
<b>Character set:</b>	96 ASCII characters, full lower-case descenders, some block graphics and other graphics characters
<b>Printing speeds:</b>	180 cps in pica high speed draft mode, 108 cps in elite font; 154 cps in condensed 17 cpi mode; 90 cps in high density pica mode.
<b>Paper feed:</b>	Friction feed, 10in maximum paper width Original plus two copies.
<b>Ribbon:</b>	Fabric, endless loop cassette
<b>Print-head:</b>	High density, 18 pins arranged in 2 x 9 dot staggered arrays
<b>Interfaces:</b>	Supplied with either parallel or serial interface as needed.
<b>Buffer size:</b>	2K
<b>Dimensions:</b>	16in W x 13in D x 5in H; weight 16.5 lb
<b>Price:</b>	\$1854
<b>Options:</b>	Tractor feed unit \$114. Cut sheet guide \$30

Review model supplied by Wm. Scollay and Company, Ltd, Wellington.

Font and character options are pica high speed and pica high density (10 characters per inch), Elite font (12 cpi), compressed mode (17 cpi), proportional spacing mode, auto underlining, emphasised mode. Horizontal graphics densities are either 640 or 960 dots per 8in line. Left margin control and full vertical and horizontal tab facilities are provided. Italics are not available, and the machine is incapable of accenting a user-defined character set (character down-loading).

By the time this article appears, the P1 will have been updated by two new models — P2 and P3, the latter being a 15in carriage version. The new model has a 3.5K byte buffer, the optional tractor feed unit is bidirectional, and it comes with both interfaces now offered as quick-change, plug-in modules, each with its own configuration DIP switches on board. A range of cut sheet feeders is also available.

**Summary.** — This printer offers the best of both worlds, speed and quality. It produces the best letter quality I have yet seen on a dot matrix and at a good speed as well. I recommend this unit for your consideration if you are in the market for a printer for the office or home.

**Post your  
subscription  
today**

# PLATO



**Educational Courseware  
for Microcomputers now  
available from:**

**Auckland Area Dealer:**  
Computer World Ltd.  
Cnr Lorne & Victoria Sts,  
Auckland. Tel: 31-394

**Wellington Area Dealer:**  
Office Requisites  
(Microshop) Ltd.  
Cnr Waring Taylor &  
Featherston Sts,  
Wellington. Tel: 721-902

**Christchurch Area Dealer:**  
Computer Corp.  
78 Riccarton Rd,  
Christchurch. Tel: 488-300

**In All Other Areas:**  
Contact: D.R. Britton Ltd.  
3 Sydney St,  
P.O. Box 38400,  
Petone, Wellington.  
Tel: (04) 688-066  
Attention: Mark Britton

**Dealer and Public  
Enquiries Welcome.  
45 Apple and 15 IBM  
Titles in stock.**

**PLATO**

Changing How The World Learns

## PRINTER REVIEW

### SUPER 5-CP80

# An Epson clone?

By Neil Clayton

Like many micro-users, schools — especially the primary variety — often prefer the shallow end of the computing puddle before committing themselves too far. But before you know it, the addition of a printer to the system is up for consideration and the financial tide is lapping your chin.

So the announcement in February's *Bits & Bytes* of the Australian release of the EC-80 printer with a price tag of \$A250 was a straw to clutch at.

What we wanted at Queenstown School was a printer with better than average print quality — useable with an Apple IIe/Bank Street Writer combination — to extend our process writing program, especially for less able students. By this time, with another Apple on the way, we were in up to our eyeballs!

To the rescue came Business Services, Ltd, of Auckland, with something called a Super 5-CP80. It turned out to be the EC-80, alias Epson MX-80, in drag, made (you guessed it!) in Japan by C.T.I., Ltd, and with a price tag which, by mortgaging the school flagpole, we could just about afford at (predevaluation) \$595 retail, \$345 to school members of the Educational Trading Society. (The post-devaluation retail price is \$735.)

To cut a long, but breathless, story short we bought one sight unseen, played with it over the long Easter break and think we got out money's worth. Here's why.



A screen dump... inverse 640 dpl.

This Epson clone is a fairly conventional looking machine, built along the lines of a brick outhouse. But compared with, say, the Seikosha GP-250, in about the same price range, it has a lot more in the way of "useability".

The CP-80 accepts tractor or friction feed fan-fold paper, up to 254mm wide. Either feed is easily selected by a lever at the left of the platen. A plastic-coated wire paper guide clips on the back of the machine and stops most of the snarl-ups.

Single sheets can be used as in a conventional typewriter, a handy feature if using letterhead, but the "paper-out" sensor should be turned off first, otherwise the last few lines of text may be lost.

The sensor can be turned off with a short BASIC program put into the printer buffer before dumping the text. PRINT CHR\$(27);"8" does it nicely. PRINT CHR\$(27);"9" resets the sensor.

On or off-line to the computer is controlled with one of three keys on

the printer. In the off-line state, the other two are for linefeed and formfeed. Four keyboard display lights show power, on-line, ready and paper-out states.

### Good 'fill' between dots

Print quality is not in the "legal document" class, but the 7x8 in 8x9 dot matrix field and the square headed pins give a good "fill" between dots. Descenders really do, and the type is clean, very readable and altogether of a much higher quality than on many more expensive machines.

The ribbon comes in a plastic cartridge that slips nicely into the machine. It is easy to open to fix those inevitable and dreaded ribbon-glitches, in our case a faulty idler

### Change of tack

Checkpoint Computers has recently shifted emphasis in its product lines.

On the home computer front, it now sells Atari, Commodore and BBC, while at the top end of the market, it has gone over to 16-bit Sanyos.

Tony Pointon said his company has been surprised at the interest in the 16-bit machines — "we can't meet the demand."

Checkpoint's future plans include bringing in cheaper disk drives compatible with various systems in the home computer range. Mr Pointon said the average customer still had money problems when it came to buying disk drives.



**MICRO SOFTWARE HIRE CLUB**  
**OPEN WEEKDAYS & SATURDAY MORNINGS**  
**Commodore VIC20 & 64**  
**BBC — SPECTRUM — ZX81**  
**WRITE OR CALL**  
15A Porana Raod, Takapuna  
(P.O. Box 33-196) Auckland Ph 444-8063

# PRINTER REVIEW

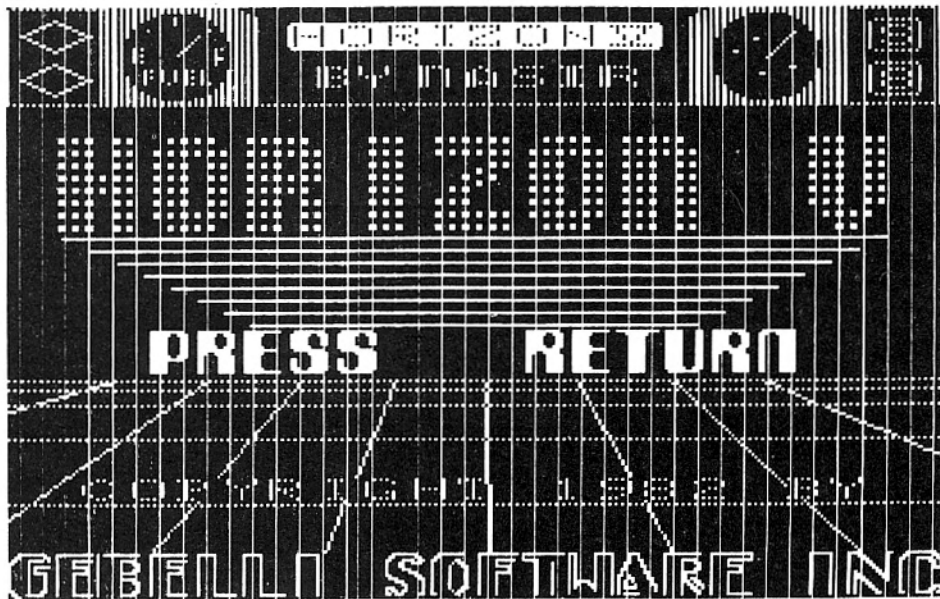

A screen dump... standard 1280 dpl.

wheel that slipped out of place.

Print speed is 80cps; the print head is bi-directional in normal text mode only. Line feed time is 200msecs for standard 4.23mm (1/6in) line spacing.

The character set extends to 228 ASCII characters, including normal and italic fonts for alpha-nums, symbols and a range of 32 semi-graphic characters.

A particularly wide range of print styles can be controlled from software, to include enlarged print (double width but, surprisingly, not double height), emphasised,

condensed, double printed, subscripts and superscripts, and underlined print.

These can be combined to give some 40 different print styles, and to mix print styles within a line of text.

Two alternatives are available for the zero symbol, 0 and 0, set by one of the DIP switches inside the printer, and factory set to print 0. If 0 is preferred, it means taking the printer case apart to reset the relevant switch.

(Thinks: perhaps some day an enlightened manufacturer will put the DIP switches in a get-atable

Print samples, Super 5-CP80 dot matrix printer

This is normal print at 80 cpl.

*This is normal italic print.*

This is EXPANDED text.

*THIS IS EXPANDED ITALIC.*

This is normal, underlined print.

This is condensed print at 142 cpl.

This is the full ASCII character set held in ROM in the printer and program addressable from the computer:

```
!"#$%&'()*+,-./0123456789:;<=>?@ABCDEFGHIJKLMNQRSTUvwxyz[\]^_`'abcdefghijklmnopqr
stuvwxyz{|}~@f" ' ` _ _ _ _ _ _ _ _ _ _ _ _ _ _ _ _ _ _ _ _ _ _ _ _ _ _ _ _ _ _ _ _ _ _
QRSTUVWXYZ[\]^_`'abcdefghijklmnopqrstuvwxyz(i)~0_ _ _ _ _ _ _ _ _ _ _ _ _ _ _ _ _ _ _ _ _
```

Print samples from the Super 5-CP80 printer

place, or put a removable cover over them. Sigh!

Print formatting includes horizontal tabulation, a variety of column widths from one to 142 characters depending on character size, line spacing in increments of 0.35mm (1/7in) or 0.118mm (1/216in), variable page length, and perforation skip-over, great for program listings.

Line length is normally 80 columns, but depending on character size can be varied — compressed characters is 142cpl, compressed double width 71 and double width 40cpl.

## Interfacing straightforward

Bit image graphics, single density at 640 dots per line and double density at 1280dpl, are controlled from software. But preparing the big-image data is not for the faint-hearted — the code tables in the manual take a bit of getting around.

High resolution graphics can be dumped from the screen but Apple IIe owners may find results unpredictable, to say the least, depending on which interface card is used. A CS-101P card from Computer Shop, Ltd, works fine provided it is switched correctly — which this time means climbing into the Apple to reset those damned DIP switches.

Interfacing is straightforward through a standard centronics parallel port and cable, with the plug at the printer end. Business Services has indicated it might soon be able to offer RS-232C serial interfacing as an optional extra for about \$20.

And so to the operating manual. If you're not into print, line or page formatting, it's fine. Some of the Jinglish in the first three sections covering general information, preparation for use, and operation is a bit quaint — "carefully lift front of printer and make it stands as the bottom of the case be vertically face to you and hold the unit by one of

## PRINTER REVIEW

your hand on the soft surface". But the control codes section and technical appendices are heady stuff!

Appendix B, control codes, needs a Rosetta stone to work out some of the "explanations". Take the format for turning on double width printing: [ESC]"W" N,N]1=]ON turns out to mean PRINT CHR\$(27);"W";CHR\$(1).

When we tackled Business Services about this, the reply was along the lines: "At only \$345 to you all-up chummy, there is no such thing as a free lunch." Point taken.

The CP80 is a rugged machine with enough features to keep a formatting freak very happy for the dollars spent. Print quality is well up to educational, small business and personal use and the graphics, in the right hands, can put many a higher priced machine to shame. It downloaded any software we could throw at it, with or without our own formatting programs in the buffer. We gave it 8.5 out of 10. That manual made the difference.

## Printer summary

<b>Name:</b>	Super 5-CP80 Type 1.
<b>Type:</b>	Serial impact dot matrix.
<b>Print speed:</b>	80cps, 640 dots/line/sec.
<b>Character set:</b>	228 ASCII characters; normal and italic fonts, symbols and semi-graphics.
<b>Print direction:</b>	Normal font is bidirectional, logic seeking; unidirectional in all other print and graphics modes.
<b>Line spacing:</b>	Normal is 4.23mm. (1/6in); programmable in increments of 0.35mm. (1/7in) and 0.118mm. (1/216in).
<b>Characters/line:</b>	40, 71, 80 and 142.
<b>Max. paper width:</b>	254mm. (10in).
<b>Paper feed:</b>	Tractor or friction.
<b>Copies:</b>	Top, plus three.
<b>Paper type:</b>	Fan fold or single sheet.
<b>Ribbon:</b>	Cartridge, black.
<b>Interface:</b>	36 pin centronics parallel; optional RS-232C serial possible available soon for about \$20.
<b>Data transfer:</b>	4000cps maximum.
<b>Dimensions:</b>	377mm. (W)x295mm. (D)x125mm. (H) incl. cover.
<b>Weight:</b>	5.3kg.
<b>Price:</b>	\$735 retail (post devaluation), discounts to schools through Educational Trading Society.

Distributed by Hitec Micro P.O. Box 1978, Auckland

Post your  
subscription  
today

## LETTERS

### Independent replies

Dear Sir,

I was disturbed to read an article in *Bits & Bytes* warning the buying public against purchasing cut-price computers from what we saw was being said, the independent importers.

We see that only one company fits into that category in NZ, that company being Manukau Computers.

Two points. Firstly, cut price. We maintain that retail margins are fair. We bought our prices down on mail order only, to stimulate that market and to offer an incentive for the public to buy that way. There will always be a place, obviously for retail outlets, for those who don't know the first thing about computers, those who want demonstrations, etc. There will always be those who will take up 1-2 hours of retailers' time and then

come to us to buy. We are not happy about that, and have always said so to first time buyers who ask where, because we don't demonstrate, is the nearest dealer they can go to, to have a look. We have never answered that, and have indeed made the point that wherever they go, they should buy, so as to fairly reward the retail dealer for his or her effort.

Secondly, servicing. This is the area into which we have put in a lot of time, money and effort. Not only do we provide a full and complete service back-up on our own machines we also service machines for other retailers around the country, as all the major organisations have, at the best of times a 2-6 week service turnaround. Our turnaround at the moment is 2-3 days. Indeed we have had machines come in the post mid morning and they have been put back in the post, fixed, by mid afternoon. Again one retailer sent us 2 ZX-81's and 2 Spectrums which arrived via courier yesterday at 4pm, they were back to the courier 11am today. We are also starting a fixed price servicing scheme for ZX-81's, unique to NZ. No matter what the fault, the fixed price repair will be \$38.00, returned post free anywhere. We have a full stock of Spectrum & ZX-81 parts. ZX Printer and other parts are only 10 days away and workshop manuals for the Spectrum, ZX Printer and Commodore are available for sale.

So it can be seen the buying public have nothing to fear or lose in dealing with Manukau Computers. They have, indeed, much to gain.

Yours faithfully,  
D.T. Ready  
Managing Director,  
Manukau Computers

### Mainframe deal

Lots of money is still being spent on mainframes. The Broadbank Corporation has just bought 90 ITT screens for its new central on-line system, which includes \$2 million worth of Hogan Systems software. The system goes live on October 1. The screens were sold by STC Data Products, a wholly owned subsidiary of the International Telephone and Telegraph Corporation of the United States, this firm employs more than 350,000 people, and its sales topped \$87 billion in the late 1970s.

# PUBLIC WARNING! PUBLIC WARNING!

**If your local computer dealers do not stock STAR printers, it's for one of two reasons:**

Either they don't know how good Star Printers are.

Or, they do not meet our dealer requirements.

*Our dealers must:*

- Have a stable financial background
- Know the products' capabilities, so that they may better meet your requirements.
- Know the importance of providing support and service to you the computer user.
- Have a commitment to the computer industry.

Before you buy, make sure you see a **star**  dealer.

They won't put you wrong.

Issued in the interests of the computer user by::

## GEMISIS SYSTEMS LTD

65 Huia Road, Otahuhu, Auckland 6, N.Z.  
P.O. Box 6255, Wellesley Street, Auckland 1, N.Z.  
Phone 27-67349. Telex 2814 (Rocket).

# Computer helps beat handicaps

By Pat Churchill

An ongoing association with Wellington Polytech personnel has led the physically handicapped students at Kimi Ora School into the computer age.

Initially, the Polytech helped make life simpler and more comfortable for the young students by designing special furniture for them.

Then, the Polytech's computer people wanted to get involved.

"If we can send someone to the moon, why can't we help a young girl who can't speak, or use her hands or feet, to communicate," asked Kimi Ora's principal, Miss Sylvia Spear.

Neil Scott, a professional engineer and head of Wellington Polytech's School of Physics, Electronics, Telecommunications and Electrical Engineering, accepted the challenge.

Miss Spear had a specific child in mind. Jackie had been able to do nothing at school. While some youngsters had managed to master a typewriter either laboriously with their hands or with a stick attached



Lee Rutene (left) and Jeremy Grey watch Togia Leni at the keyboard of one of Kimi Ora's Polys.

to headgear, such achievements were beyond Jackie's capabilities.

A computer offered one possibility. It could flash each letter of the alphabet in turn, and be stopped when it reached the letter the operator wanted.

"But this scanning is infuriating for children. They won't wait for the letters to come round," said Miss Spear.

Neil Scott suggested a Morse code approach. But it was found the handicapped children had difficulty pushing down a button for the right periods to enable differentiation between long and short signals. So Scott devised a wooden stick with three flat levers — one for short, one for long, and one to act as a return or enter key.

In Jackie's case, special controls

were required. A frame around her legs allows her to push her knees to one side or the other for a dot, a dash or enter.

When the Polytech team went to Kimi Ora with its original Poly computer, the Education Department gave a grant — "the remnants of the beer and tobacco money," said Miss Spear — for the system's development.

The department wanted to see what its money had been spent on. After having a look at the Kimi Ora set-up, it seconded Scott to develop a computer for use in secondary schools.

## Part of the furniture

The Kimi Ora project began about November 1981, with the school getting its first computer the next year. Now the two Polys — one pillarbox red, the other vibrant yellow — are very much part of the furniture for the school's 36 students.

The computers, while very good for a lot of the students, are an essential tool for four of these youngsters. They are a major teaching tool, a major form of communication.

The Polys offer different possibilities for various pupils. "They can be very good for children with perceptual difficulties," said Miss Spear. Such children might, for instance, draw a picture with the computer's help. This picture would then be broken down into squares so that the child could reassemble the jigsaw on screen.

While ordinary children can use blocks for counting, the child with

## 'Very exciting' response

The Wellington Crippled Children Society is using computers to provide an education and training tool for severely physically disabled young people.

The society has two Polys at its Johnsonville training unit which caters for teenagers and young adults.

Although the project is in its early stages, with the young folk still familiarising themselves with the computers, the response has been "very exciting", according to a spokesperson, Lauren Munro.

The 20 young folk from Wellington and the Hutt Valley attending the centre are learning computer skills.

"Some will make it in employment areas, while others will use computing as a leisure activity in

their homes," Mrs Munro said.

In addition, through the Accident Compensation Corporation, several young men attend the centre twice a week to use the computers. They are accident victims, quadraplegics with very little movement.

The computer scheme has been financed by Eagles golf tournaments, Mrs Munro said.

"Nationally, Crippled Children are looking at the whole education area," she said. Other branches also had computers and the Wellington branch was being kept informed of activities elsewhere in the country. A resource list was being compiled.

Wellington staff have attended a computer course at Wellington Polytechnic.

minimal motor skills cannot. But with the assistance of a computer, the handicapped youngster can note the number of blocks on a screen, tap a lever the correct number of times, then hit a return lever.

Again, the physically handicapped child may not be able to sort out flash cards to make up sentences. But with a computer and the aid of levers which direct a large cursor left or right under the jumbled up words of a sentence, the student can sort the words into the right order.

A screen may flash up a selection of options:

- The boy is sitting.
- The boy is walking.
- The boy is running.
- The boy is climbing.

A colourful picture of the boy is shown doing one of these activities. The pupil moves the cursor up or down with the help of the bump switch, and makes a selection.

Concepts of by, in, on and under can be checked as a child decides where a bird is in relation to a tree.

And students can be tested and scored on their achievements.

Miss Spear estimates something like a quarter of a million dollars worth of computing time has been donated for nothing by the team involved in the project.

Neill Scott has spent a lot of time at the school teaching the teachers to operate the computers.

"We have a team of computer people who invent things for us," said Miss Spear.

The computer scheme at Kimi Ora

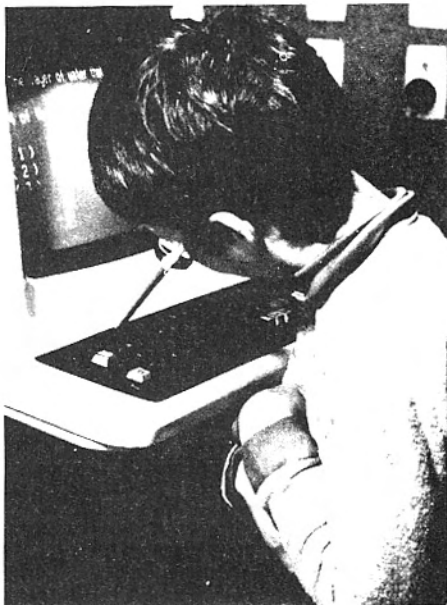

*Jeremy Grey operates the Poly by using a stick attached to the frame of his spectacles.*

is very much a developing thing with new programs being added regularly.

Some of the young pupils are taking a very close interest — one or two are having a go at programming themselves.

One man comes to the school regularly at lunchtime to do programming. "He usually has an admiring audience. Some of the little ones have pretty good brains," said Miss Spear.

While the Education Department gave money to help with computer scheme's development, the money has been made available from the International Year of the Disabled Person funds for a Poly computer for

each of the country's other five schools for cerebral palsied children — at Invercargill, Rotorua, Auckland, Christchurch and Dunedin.

The Technical Aids Trust, a charitable trust, was established in March 1983 to provide electronic and computer-based aids for disabled persons who would benefit from them.

Meantime, back at Kimi Ora, Jackie can now write a little story on the computer saying what she did during the weekend. And the other students are making tremendous progress, too.

"I'm convinced the venture is worth while," says Sylvia Spear.

# NASHUA

## DEAL DIRECT FROM NASHUA FOR HIGH QUALITY NASHUA DISCS

### QUALITY DISKS THAT PROTECT YOUR DATA

NASHUA's unique Quality Circle manufacturing process checks disks at each stage of production. So Users are guaranteed consistent reliability.

**BUY ONLY NASHUA**  
Don't accept look-a-likes or disks by any other name.

**NASHUA GUARANTEE DISKS FOR 5 YEARS**  
Problem disks replaced immediately.

**LOOK BULK BUY**  
**10% Discount**  
Try and match DS,DD 5 1/4" at **\$5.36**

**ORDER FORM**      10 QUALITY NASHUA DISKS with a FREE disk holding case

	Price \$	Qty	Total Price		Price \$	Qty	Total Price
SS SD 8in	6.78			SS SD 5 1/4in	5.22		
SS DD 8in	7.29			SS DD 5 1/4in	5.40		
DS DD 8in	8.45			DS DD 5 1/4in	5.96		
DS QD 5 1/4in	7.13			SS QD 5 1/4in	6.46		

10% Discount BULK CARTON 250DISKS      Type \_\_\_\_\_ Qty \_\_\_\_\_

Name \_\_\_\_\_ Address \_\_\_\_\_

Company \_\_\_\_\_

Signature \_\_\_\_\_

Send money plus \$1 postage and packaging.  
**DEALER INQUIRIES WELCOME**

# NASHUA

SEND TO NASHUA—P O Box 3941, WELLINGTON  
TELEPHONE 851.965

## A study guide for teachers

By Brother Bosco Camden

We have a growing demand for teachers of computer education courses, now that schools are building up their resources in this area. Much good work is being done in the teachers' colleges and universities, but there are many teachers, often experienced in some other field, who wish or need to add the computing string to their bow.

The plan below is a suggestion to such heroic souls about the content of appropriate computing knowledge. With obvious modifications to content and level, it could also form the basis of an extended pupil course.

The 10 main headings below could form a somewhat skeletal study plan, or lecture plan; ideally, the 30 sub-headings each deserve a full treatment. Naturally, an equal amount of time should be given to practical use of a computer.

No one book says it all, but a short list of references is appended as a guide.

### A. An overview

#### 1. "What is this thing?"

- Purpose: example of payroll management.
- Components related to input/processing/output.
- Hardware/software distinction.
- Operator capabilities.

#### 2. "Why are we interested in this computer?"

- The information explosion.
- Technological developments; computer revolution?
- Applications in business, industry, government, social

- services.
- Influence on society; organisation, dependence, culture.
- Influence on individual; careers, privacy, understanding.

#### 3. "What shall we do in school?"

- Office administration, professional administration (testing, organising).
- Subject instruction, drills, individual practice, simulations.
- Help for slow learner, remedial, handicapped.
- Specialised courses; computer science, word processing, business.
- Computer awareness.
- General learning skills; motivation, synthesis, self-improvement.

### B. From problem to program

#### 1. Communicating with a computer

- Language levels, ASCII code.
- Data, manipulation, presentation.
- Nature of a program, RAM.
- Interpreters and compilers.
- File management, file types.

#### 2. The underview

- Bits, bytes, gates, binary transmission
- Architecture; minis, networks, interfacing.
- RAM, ROM, disk, tape; speed/size/cost.
- Development of micro technology.
- Memory addressing.

#### 3. Input and output

- Data capture, validation.
- Punched cards, paper tape, keyboard, disk, OCR, bar codes.
- Printers and monitors and modems.
- Serial and parallel data transmission.
- Synthesis of speech.
- Digital/analogue signals, instrument interfacing.

### C. Software

#### 1. What is a program?

- Repetition, condition, sequence of action.
- Analysis of the task, structure

diagrams.

- Self-documentation, modularity, testing.
- Correctness, debugging, maintenance.
- User friendliness.

### 2. Computing languages

- Readability.
- Human thought patterns copied, language constructs.
- Historical perspective, authoring.
- Data structures and program structures.
- Operational convenience.
- Special-purpose languages.
- Programming costs, programming team.

### 3. Char lady at work

- File of characters from RAM to disk.
- Text, data, code files.
- The operating system in brief.
- System and programming utilities.
- File access methods.

### D. The education matrix

#### 1. The role of the school

- Response to new order, re-identify priorities.
- What is computer awareness, literacy?
- The electronic cottage.
- Role of computer as teacher, tool, responsive instrument.
- A new mode of learning, pupil power.
- Educational initiative or industrial dictation?

#### 2. Courses for tomorrow: Information Technology

- Changing employment patterns.
- A technocratic society; Third World response.
- Information is power, resource comparable to energy.
- Communications, the instant referendum.
- Robotics and automation.
- Governmental responsibilities.

#### 3. Computer games

- Play-way education and flight simulators.
- Valid learning features in game-playing.
- Account of researches.
- Criticism of violence.
- Analysis of a particular game.

### E. Which machine will suit?

#### 1. Motor-cycle or bus?

- Clarification of educational aims.
- Compatibility of hardware and software.
- Management of a computer laboratory.
- Phased introduction, expansion of facilities.
- Specifications of RAM, graphics quality, file access, etc.
- Let the buyer beware.

# HARRIS Electronics

- We specialise in the conversion of overseas computer & video tape recorders to NZTV channels. (Any quantities from individual units to large production runs.)
- Stockists of Commodore computers, hardware & software.
- Monitors repaired and aligned.
- We stock PAL and NTSC Monitors, also quality new and used TV's.

**653 Manukau Rd, Epsom. P.O. Box 84-017, Logan Park.  
Phone (09) 658-416**



# EDUCATION

## 2. The human interface

- (a) Ergonomic factors.
- (b) Critique of program quality.
- (c) Peripherals; joystick, light pen, wand, mouse, etc.
- (d) Computer errors, human errors.

## 3. Shall I buy one at all?

- (a) Retailers, consultants, and jargon.
- (b) Computer chaos or manual chaos?
- (c) Software availability.
- (d) Things will be better next month.
- (e) Quiz/checklist for buyer confidence.

## F. Some applications

### 1.

- (a) Videotex.
- (b) Help for the handicapped.
- (c) Computers in medicine.
- (d) Arms race model (Richardson).
- (e) Economic modelling.
- (f) Data processing, point-of-sale, inventory, etc.
- (g) Electronic spreadsheets, accounting procedures.
- (h) Process control.

### 2. The nature of simulation

- (a) Case study from some school topic.
- (b) Valid computer use in education.
- (c) Danger of false modelling.
- (d) Parameters, arbitrary and random.

## 3. Text processing

- (a) Composing, proof reading, editing.
- (b) Word processors in business, school course.
- (c) Creative writing by pupils.
- (d) Text compression, newspapers, library research.

## G. Computers and people

### 1. Artificial intelligence

- (a) Our thinking processes, basic computer operations.
- (b) Perception, relationships, judgment.
- (c) Research methods, languages.
- (d) Social dimension — Eliza.
- (e) Can computers think? Chess.
- (f) Biotechnology.

### 2. The future with microcomputers

- (a) International dependence on computers.
- (b) Information theory, technology, careers.
- (c) Information as resource; control, interpretation.
- (d) Daily life in the office, home, school.
- (e) Communications.

### 3. Social issues

- (a) Art or science — copyright or patent.
- (b) New medium, new law, new morality, new crime.
- (c) Security, software protection.
- (d) The cost of progress,

- employment, retraining, leisure.
- (e) State of the law, case studies.

## H. Beyond amateur status

### 1. Graphics and sound

- (a) Screen addressing, chunky graphics.
- (b) Resolution, pixels, bit-mapping.
- (c) Raster scan, colour production.
- (d) Programmable characters, sprites.
- (e) Sound synthesiser, use in programs.
- (f) Utilities, and control by software, or hardware.

### 2. Data representation

- (a) Visible levels — keys, dot matrix, digitisers.
- (b) Binary coding and arithmetic.
- (c) Data types; integer, real, Boolean, character, string.
- (d) Data structures; array, record, list, user-defined.
- (e) Language constructs to match.

### 3. The operating system

- (a) Management of resources — language, utilities, files.
- (b) Relative complexity of mainframe, mini, micro.
- (c) Spooling, processing speed.
- (d) Interactive and batched programs.
- (e) Timesharing, multiprocessing, distributed processing.
- (f) Memory management,

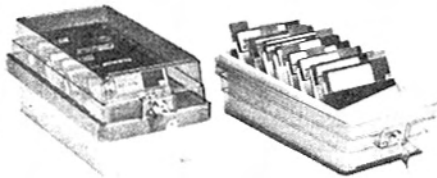

## Lockable Disk boxes

— hold 45 disks

ONLY \$75

## Low-cost peripherals!

Apple disk drives	\$700
MX 80 printer	\$700
Green monitor	\$220
Keyboards	\$150

*plus all Apple interface cards.*

# Check out... THE CHASTRONIC



## Apple compatible and CP/M too!

Compare the features:

- ★ Dual CPUs — 6502 and Z80A (for CP/M)
- ★ 64K of RAM — with further expansion possible
- ★ Integrated slim-line twin disk-drives (Quality TEAC brand)
- ★ Separate professional keyboard with numeric keypad
- ★ 26 function keys
- ★ 3 month guarantee

**All for only**

**\$2950**

For further information and comprehensive price list for our full range of computer hardware and software send to:

CHASTRONICS, P.O. BOX 22-062, CHRISTCHURCH  
(75 Peterborough Street)

NAME .....

ADDRESS .....

TELEPHONE .....

Or to order:

**Telephone (03) 797-318  
Now!**

We accept Visa/American Express

# EDUCATION

- interrupts, priorities.  
(g) Protection, directories, back-ups.
- I. Back to school matters
1. Don't re-invent the wheel
- (a) The French experiment of the 70's.  
(b) Other national experiments.  
(c) Plato, LOGO.  
(e) Professional educational software.
2. The school computer laboratory
- (a) The environment, and its control.  
(b) Safety, security, power supplies, storage.  
(c) Class management and time-tabling.  
(d) Resources and teaching aids.  
(e) Room design.
3. A computing language for education
- (a) Importance of pupils' first language.  
(b) Criteria of a good general-purpose language.  
(c) Compromises for cost, pupil ability, ease of learning.  
(d) Facilities for sound, graphics, operational ease.  
(e) Special claims of Pascal and LOGO.
- J. Design of software
1. An algorithm for success
- (a) Case study of task analysis; subject options in F7.  
(b) Progressive refinement, modularity, independence.  
(c) Structuring of data and function.  
(d) Qualities of a good algorithm.  
(e) Systems analysis.
2. Software techniques
- (a) Searching, comparison.  
(b) Sorting.  
(c) Random numbers.  
(d) Recursion.  
(e) Series evaluation for pi, etc.
3. Pupils as programmers?
- (a) Revise course objectives.  
(b) Programming as a discipline; mastery.  
(c) Natural language programming.
3. *Microman*  
Pask & Curran Century
4. *Computer Languages and Uses*  
Marshall Granada
5. *Sixty-minute Guide to Microcomputing*  
Hollerbach Prentice Hall
6. *Principles of Business Data Processing*  
Dock & Essick SRA
7. *Introduction to the Computer*  
Frates & Moldrup Prentice Hall
8. *Learning with LOGO*  
Watt McGraw Hill
9. *Intro to Computer Science Using Pascal*  
Glinert Prentice Hall
10. *Computer Science*  
Goldschlagler & Lister Prentice Hall
11. *Nine pamphlets re school usage*  
International Council for Computer Education
12. *Microcomputers in the classroom*  
Maddison Hodder & Stoughton

## Reference books for teachers

1. *Computer Literacy* (pupil text?)  
Horn & Poirot Stirling Swift
2. *Computer Consciousness* (pupils?)  
Covvey & McAlister Addison Wesley

Come in and meet the son  
of the BBC Micro — the

acorn  
**electron**

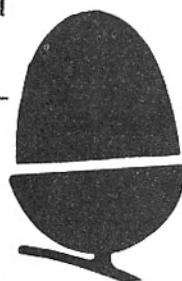

## THE NEW EDUCATION AND HOME COMPUTER

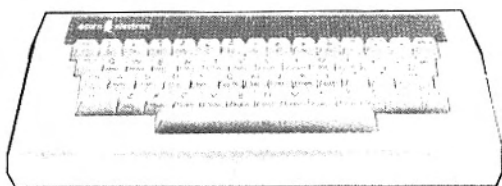

**ELECTRON \$877.00**  
\$90 Dep. (\$17.00 Weekly).

Electron, a handsome outstanding performer, has a total memory of 64K with the facility to store 32K (32000 characters).

It is versatile and can utilize your T.V. screen; most cassette tape recorders too can be linked directly into the system. With each unit there is a free introductory cassette which includes 19 programmes, a comprehensive user guide and a programming course in Basic.

There is a large and growing range of software programmes (cassette tapes) readily available and much of the original BBC software is also compatible.

Most people don't realize how much a computer can help them, so get curious, ask our people how Electron will promote your interest; they'll be glad to explain.

# Whitcoulls

More than a bookstore

We accept VISA: BANKCARD: AMERICAN EXPRESS: DINERS CLUB

# PROGRAMS

## ZX81

### Death Maze

By Craig Dowling

In Death Maze, for the 16K ZX81, you must collect bonus points by moving over dollar signs (worth 100 points) and question marks (worth a mystery bonus), until you amass 1000 points when a door will open, permitting entry into the second part of the maze. If you escape that, you will be asked if you want another game. But deadly black mists will make the game difficult to complete.

```

100 LET H1=0
101 GOSUB 700
102 CLS
103 CLAND
104 LET B=0
105 FOR D=0 TO 200
106 PRINT TAB(50);TAB(20);
107 NEXT D
108 PRINT AT 1,0;"
109 PRINT AT 5,0;"
110 PRINT AT 10,0;"
111 PRINT AT 15,0;"
112 PRINT AT 21,0;"
113
140 FOR C=1 TO 1
150 PRINT AT C,20;"
160 NEXT C
170 FOR D=11 TO 15
180 PRINT AT D,10;"
190 NEXT D
200 FOR E=5 TO 9
210 PRINT AT E,10;"
220 NEXT E
230 FOR F=17 TO 20

```

```

240 PRINT AT 20,9;"E"
250 FOR G=1 TO 5
260 PRINT AT RND*20,RND*50;"$"
270 NEXT G
280 FOR H=1 TO 5
290 PRINT AT RND*20,RND*50;"?"
300 NEXT H
310 LET X=INT (RND*30)+1
320 LET Y=INT (RND*20)+1
330 PRINT AT Y,X
340 IF PEEK (PEEK 16398+255*PEEK
K 16399)=170 THEN GOTO 500
350 IF PEEK (PEEK 16398+255*PEEK
K 16399)=10 THEN LET A=A+100
360 IF PEEK (PEEK 16398+255*PEEK
K 16399)=15 THEN LET A=A+INT (RN
D*2000)
370 IF PEEK (PEEK 16398+255*PEEK
K 16399)=170 THEN GOTO 300
380 PRINT "X+INT Y+(RND*.5)-(RN
D*.5),X+(RND*.5)-(RND*.5)" AN
D PEEK (PEEK 16398+255*PEEK 1639
9)(>21
390 LET A=A+10
400 PRINT AT 0,2;"SCORE: ";A
410 IF A>1000 THEN PRINT AT 10
,1;"
420 PRINT AT 0,12;"HI: ";HI;" :B
Y: ";N$
430 LET A$=INKEY$
440 IF A$<"5" OR A$="8" THEN GO
TO 480
450 PRINT AT Y,X;" "
460 LET X=X+(A$="8")-(A$="5")
470 LET Y=Y+(A$="6")-(A$="7")
480 GOTO 420
490 REM **INSTRUCTIONS**
500 PRINT "YOU MUST TRY TO COLL
ECT ALL THE '$' AND '?' BEF
ORE GOING TO THE EXIT 'E'."
510 PRINT
520 PRINT "BEWARE OF THE BLACK
MISTS WHICH WILL KILL YOU I
F YOU TOUCH IT...."
530 PRINT AT 18,10;"ENTER FIRST
NAME "
540 INPUT N$
550 RETURN
560 CLS
570 PRINT "YOU GOT ";A
580 IF A>HI THEN PRINT "HIGH SC
ORE"
590 IF A>HI THEN PRINT "FIRST N
AME PLEASE"
600 IF A>HI THEN INPUT N$
610 IF A>HI THEN LET HI=A
620 PRINT "ANOTHER GAME?"
630 IF INKEY$="" THEN GOTO 590
640 IF INKEY$="Y" THEN GOTO 5

```

## ZX81

### Conversion Programs

By Sean Collins

Here are three short imperial-to-metric conversion programs, which will fit into a 1K ZX81. The first converts inches to centimetres, the second feet to metres, and the third miles to kilometres.

```

5 REM COPYRIGHT BY SEAN COLLINS
10 PRINT "INPUT THE NUMBER OF
INCHES TO BE CHANGED."
20 INPUT A
30 LET B=2.5
40 LET C=A*B
50 PRINT C

5 REM COPYRIGHT BY SEAN COLLINS
10 PRINT "INPUT THE NUMBER OF
FEET TO BE CHANGED."
20 INPUT A
30 LET B=3.0
40 LET C=A*B
50 PRINT C

5 REM COPYRIGHT BY SEAN COLLINS
10 PRINT "INPUT THE NUMBER OF
MILES TO BE CHANGED."
20 INPUT A
30 LET B=1.609344
40 LET C=A*B
50 PRINT C

```

## ENHANCE YOUR P.C.'s POWER

with computer products from P.C. Power

We have access to more than 8000 U.S. software packages for business, education and recreation.

- SYMPHONY**  
(2 upgrades from 1-2-3)
- LOTUS 1-2-3**
- dBase III**
- BPI AIMS IMS**  
database manager
- CHART MASTER**  
plotting, charting and graphics

- SIGNMASTER**  
graph printing package
- SIDEWAYS**  
prints graphs and spreadsheets fully by printing across
- PROKEY**  
programs any key for any automatic routine

Also available: IRMA BOARDS — HERCULES GRAPHICS BOARDS — P.C. NET — MICRO BUFFERS — DISK DRIVES — JOY STICKS.

Enquire with P.C. Power **FIRST!!** for computer products.  
**DEALERS AND CORPORATE ENQUIRIES WELCOME**

## THIS MONTH'S SPECIAL P.C. TERMINAL PEDESTAL



This permits computer monitor adjustment to a tilt of 22 degrees and 360 degree swivel. This pedestal reduces operator fatigue substantially. Available for all monitors.

**PRICE: \$235**  
(Send \$235 plus \$5 shipping)  
7 Day Trial — Full Refund If Not Suitable.

Mail Order Form to: DEPT BB9, P.C. POWER LTD, 420 HIGH STREET, LOWER HUTT. Telephone (04) 693-050

**POWER LTD.**  
Personal Computer  
420 High St, Lower Hutt  
Phone (04) 693-050

Please send Terminal Pedestal at \$235 plus \$5 shipping.

My Monitor is: \_\_\_\_\_

Name \_\_\_\_\_  
Street \_\_\_\_\_ City \_\_\_\_\_  
Phone \_\_\_\_\_ My Computer brand is \_\_\_\_\_  
Cheque No. \_\_\_\_\_ Please charge my  Visa/Bankcard  
Signature \_\_\_\_\_ Expires \_\_\_\_\_

## SPECTRUM Cartesian Graphs

By Greg Locke

This program, for 16K or 48K Spectrums, will draw graphs of linear equations, parabolas, cubics, and hyperbolas.

Once RUN, the program asks which type of function you wish to graph, and then asks for each coefficient in turn. When these are entered, you are asked to input the step value, which determines how far apart the dots forming the graph will be. A value of 1 is generally acceptable.

To make entry of the user-defined graphics easier, it is suggested you begin by entering lines 9000 to 9195 first, and RUN this part of the program (which will set up the graphics), before you type in the rest of the program.

The REM lines do not need to be typed in, since they are not necessary for the functioning of the program.

```

10 REM Cartesian Graphs
15 REM menu
20 BORDER 4: PAPER 2: CLS: PR
INT PAPER 5, INK 1, AT 0,8, "Carte
sian Graphs"
30 PRINT INK 7, AT 5,5: "1 Linea
r": AT 6,5: "2 Parabola": AT 11,5:
"3 Cubic": AT 14,5: "4 Hyperbola": A
T 17,5: "5 Exit"
40 INPUT "enter the type of gr
aph: "; t
45 IF t=5 THEN INK 7: STOP
50 IF t>4 OR t<1 THEN GO TO 40
60 GO TO t*1000
9999 REM Lines: Graph
1000 PAPER 7: INK 1: CLS: PRINT
PAPER 5, AT 0,13: "LINEAR"
1010 PRINT AT 10,13: "y=ax+c"
1020 INPUT "enter m "; m$: INPUT
"enter c "; c$
1025 INPUT "enter step "; s$
1030 LET m=VAL m$: LET c=VAL c$
1040 PRINT AT 10,13: "
1050 GO SUB 5000
1060 FOR x=-60 TO 60 STEP s
1070 LET y=(m/S*x+c)/S
1080 IF y>60 OR y<-60 THEN GO TO
1100
1090 PLOT x+127,y+88
1100 NEXT x
1101 BEEP .05,0
1110 PRINT AT 19,1: "y="; m$; "x+";
c$
1120 GO SUB 6000
1130 IF p$="m" THEN GO TO 20
1140 IF p$="c" THEN GO TO 1000
1999 REM Parabola: Graph
2000 PAPER 7: INK 1: CLS: PRINT
PAPER 5, AT 0,12: "PARABOLA"
2010 PRINT AT 10,11: "y=ax^2+bx+c"
2020 INPUT "enter a "; a$: INPUT
"enter b "; b$: INPUT "enter c
"; c$
2030 LET a=VAL a$: LET b=VAL b$:
LET c=VAL c$
2040 INPUT "enter step "; s$
2045 PRINT AT 10,11: "
2045 GO SUB 5000
2050 FOR x=-60 TO 60 STEP s
2060 LET y=(a*x^2/5+b*x/5+c)/5
2070 IF y<-60 OR y>60 THEN GO TO
2100
2080 PLOT x+127,y+88
2100 NEXT x
2101 BEEP .05,0
2110 PRINT AT 20,1: "y="; a$, "x^2+"
b$: "x"; c$
2120 GO SUB 6000
2120 IF p$="c" THEN GO TO 2000
2130 IF p$="m" THEN GO TO 20
3000 REM Cubic
3010 PAPER 7: INK 1: CLS: PRINT
PAPER 5, AT 0,13: "CUBIC"

```

```

3020 PRINT AT 10,6: "y=(ax+b)/(cx+
d)"; a$, b$, c$, d$
3030 INPUT "enter a "; a$: INPUT
"enter b "; b$: INPUT "enter c
"; c$: INPUT "enter d "; d$: INP
UT "enter e "; e$: INPUT "enter
f "; f$
3035 INPUT "enter the step value
"; s$
3040 LET a=VAL a$: LET b=VAL b$:
LET c=VAL c$: LET d=VAL d$: LET
e=VAL e$: LET f=VAL f$
3050 PRINT AT 10,6: "
3060 GO SUB 5000
3070 FOR x=-60 TO 60 STEP s
3080 LET y=((b+ax/5)*(d+cx/5)*
(f+ex/5))/5
3090 IF y>60 OR y<-60 THEN GO TO
3110
3100 PLOT x+127,y+88
3110 NEXT x
3111 BEEP .05,0
3120 PRINT AT 20,1: "y="; a$, "x+"
b$: "x"; c$, "x"; d$, "x"; e$, "x+"
f$; "
3130 GO SUB 6000
3140 IF p$="c" THEN GO TO 3000
3150 IF p$="m" THEN GO TO 20
4000 REM Hyperbola
4010 PAPER 7: INK 1: CLS: PRINT
PAPER 5, AT 0,11: "HYPERBOLA"
4020 PRINT AT 10,15: "ax+b": AT 11
,12: "y=": AT 12,15: "cx+d"
4030 INPUT "enter a "; a$: INPUT
"enter b "; b$: INPUT "enter c
"; c$: INPUT "enter d "; d$
4040 LET a=VAL a$: LET b=VAL b$:
LET c=VAL c$: LET d=VAL d$
4050 INPUT "enter the step value
"; s$
4060 PRINT AT 10,15: "": AT
11,12: "
4070 GO SUB 5000
4075 LET ya=a/c: INK 2: IF ya<=1
0 AND ya>=10 THEN FOR i=57 TO 1
67 STEP 3: PLOT i,88+ya*i: NEXT
i
4076 LET xa=-d/c: IF xa<=10 AND
xa>=-10 THEN FOR i=27 TO 147 STE
P 3: PLOT 127+xa*i: NEXT i: IN
K 1
4080 INK 1
4090 FOR x=-60 TO 60 STEP s
4095 IF (c*x/5+d)=0 THEN GO TO 4
120
4096 LET y=((a*x/5+b)/(c*x/5+d))
4100 IF y>60 OR y<-60 THEN GO TO
4120
4110 PLOT x+127,y+88
4120 NEXT x
4121 BEEP .05,0
4125 LET u$=a$+"x"+b$
4126 LET v$=c$+"x"+d$
4128 LET u=(LEN u$ AND LEN u$)>LE
N v$)+(LEN u$ AND LEN u$)=LEN v$
4129 FOR i=4 TO 3+u$: PRINT AT 19
,i: "-": NEXT i
4130 PRINT AT 18,4: u$: AT 19,1: "y
=": AT 20,4: v$
4140 GO SUB 6000
4150 IF p$="c" THEN GO TO 4000
4160 IF p$="m" THEN GO TO 20
4998 STOP
4999 REM Draw the axis
5000 INK 3: PLOT 67,88: DRAW 120
0
5010 PLOT 127,27: DRAW 0,120
5019 REM Label the axis
5020 PRINT AT 11,23: "x": AT 3,16:
"y"
5030 PRINT AT 11,9: "0": AT 11,12:
"5": AT 11,19: "5": AT 11,22: "10"
5040 PRINT AT 4,16: "0": AT 7,16: "
5": AT 14,16: "5": AT 17,16: "10"
5100 FOR i=0 TO 100 STEP 5
5110 PLOT 128,i+38: PLOT 126,i+3
8
5120 NEXT i
5130 FOR i=0 TO 100 STEP 5
5140 PLOT 77+i,87: PLOT 77+i,89
5150 NEXT i
5200 INK 1: RETURN
6099 REM Printer routing
6000 INPUT "Printout, menu; c)
ontinue: "; p$
6005 IF p$="" THEN GO TO 6000
6005 LET p$=p$(1)
6010 IF p$<>"p" AND p$<>"m" AND
p$<>"c" THEN GO TO 6000
6020 IF p$(1)<>"p" THEN RETURN
6030 GOTO 6000
6040 GO TO 6000
6099 REM User defined graphics
9000 RESTORE
9001 FOR i=144 TO 153: FOR n=0 T
O 7
9010 READ row: POKE USR CHR$ i+n
: row
9020 NEXT n: NEXT i
9099 REM A = 10
9100 DATA 0,0, BIN 00010111, BIN 0
0010101, BIN 01010101, BIN 0001010
1, BIN 00010111, 0
9109 REM B = 5
9110 DATA 0,0, BIN 00001111, BIN 0
0001000, BIN 00101110, BIN 0000000
1, BIN 00001110, 0
9119 REM C = 10
9120 DATA 0,0, BIN 00010111, BIN 0
0010101, BIN 00010101, BIN 0001010
1, BIN 00010111, 0
9129 REM D = 5
9130 DATA 0,0, BIN 00011110, BIN 0
0010000, BIN 00011100, BIN 0000001
0, BIN 00011000, 0
9139 REM E = 2

```

```

9140 DATA BIN 01100000, BIN 00010
000, BIN 00100000, BIN 01110000, 0,
0,0,0
9149 REM F = 10
9150 DATA 0,0, BIN 10111000, BIN 1
0101000, BIN 10101000, BIN 1010100
0, BIN 10111000, 0
9159 REM G = 5
9160 DATA 0,0, BIN 11110000, BIN 1
03000000, BIN 11100000, BIN 0001000
0, BIN 11100000, 0
9169 REM H = 5
9170 DATA BIN 00001111, BIN 00001
000, BIN 01101110, BIN 00000001, B
IN 00001110, 0,0,0
9179 REM I = 5
9180 DATA 0,0,0, BIN 00011110, BIN
00010000, BIN 00011100, BIN 00000
010, BIN 00011100
9189 REM J = -
9190 DATA 0,0,0,0,255,0,0,0
9195 POKE 23609,30

```

Some examples of the graphs this program can produce.

LINEAR

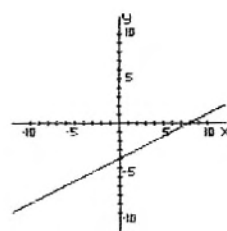

$$y = 1/2x + -4$$

PARABOLA

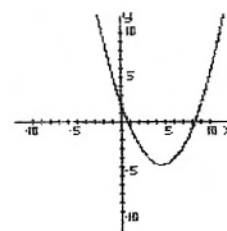

$$y = 1/3x^2 + -3x + 2$$

CUBIC

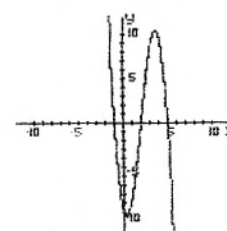

$$y = (-1x+5)(1x+1)(1x+-2)$$

HYPERBOLA

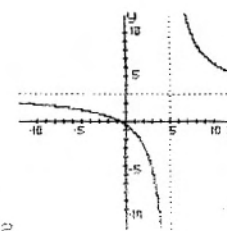

$$y = \frac{3x+2}{1x+-5}$$

# PROGRAMS

## ATARI

# Moire pattern

By T. Williamson

A Moire pattern is a multi-coloured display produced by light interference on a radiating pattern of closely-spaced black and white lines. This program, which works on any Atari computer, draws an excellent Moire pattern on the screen, and then runs through each hue of each colour, producing an impressive fading effect. To halt the program, press BREAK, as it continues indefinitely.

```

10 REM MOIRE PATTERNS
20 REM T. WILLIAMSON
30 GRAPHICS 8
40 COLOR 1:SETCOLOR 1,0,14:SETCOLOR 2,0,
  0
50 PLOT 160,100:DRAWTO X,Y
60 IF Y<=0 THEN Y=0:X=X+3
70 IF X>=319 THEN X=319:Y=Y+3
80 IF Y>=189 THEN Y=189:X=X-3
90 IF X<=0 THEN X=0:Y=Y-3
100 IF X=0 AND Y<=1 THEN GOTO 120
110 GOTO 50
120 FOR F=1 TO 15
130 SETCOLOR 2,G,F
140 FOR T=1 TO 25:NEXT T
150 NEXT F
160 G=G+1:GOTO 120
  
```

## TRS80/SYSTEM 80

# Dice

By P.D. Drew

This program displays two dice on the screen, and rolls them whenever the space bar is pressed. The program could be used to provide an unbiased dice-throws when the family plays board games, or it could be incorporated as a subroutine into a larger program.

Here is a description of the program's structure:

Lines 100-110 assign screen addresses to variables.

Lines 120-130 place the two dice on the screen.

Lines 140 puts dots on the dice.

Lines 150-180 'roll' the dice.

Lines 190-200 place a random number of dots on each dice.

Line 220 checks whether the SPACE BAR has been depressed.

Line 240 clears the dots from each dice.

Lines 260-490 are the subroutines for the dot patterns on each dice.

```

10 *****
20 *          =FC D I C E =
30 *          S: Paul David DREW
40 *          88 Caennanon Drive
50 *          Flaxmere, HASTINGS.
60 *          1s JULY 1984.
70 *****
80
90 CLS
100 B=15702:C=15706:D=15766:E=15768:F=15
170:G=15830:H=15834
110 B2=15722:C2=15726:D2=15786:E2=15788:
120 F2=15790:G2=15850:H2=15854
130 FOR X=340 TO 468 STEP 64:PRINT@X,STR
1ING#(X,191):NEXTX
140 FOR Y=360 TO 488 STEP 64:PRINT@Y,STR
1ING#(Y,191):NEXTY
150 GOSUB350:GOSUB490:GOTO210
160 FOR F=1 TO 2
170 FOR N=1 TO 19
180 NEXTN,R
190 L=RND(6):ONL6GOSUB270,310,350,390,430
,470
200 L2=RND(6):ONL2GOSUB290,330,370,410,4
50,490
210 PRINT@656,"HIT (SPACE BAR) TO ROLL T
HE DICE";
220 IF PEEK(14400)=128THEN230ELSE220
230 PRINT@658,STRING*(32,32):GOTO 150
240 / CLEAR DOTS
250 POKEB,191:POKEB2,191:POKEC,191:POKE
2,191:POKEE,191:POKEE2,191:POKEF,191:PO
KEF2,191:POKEH,191:POKEH2,191:RETURN
260 / DICE ONE - 1
270 POKEE,179:RETURN
280 / DICE TWO - 1
290 POKEE2,179:RETURN
300 / DICE ONE - 2
310 POKEC,143:POKEG,188:RETURN
320 / DICE TWO - 2
330 POKEC2,143:POKEG2,188:RETURN
340 / DICE ONE - 3
350 POKEC,143:POKEE,179:POKEG,188:RETURN
360 / DICE TWO - 3
370 POKEC2,143:POKEE2,179:POKEG2,188:RET
URN
380 / DICE ONE - 4
390 POKEB,143:POKEC,143:POKEG,188:POKEH,
188:RETURN
400 / DICE TWO - 4
410 POKEB2,143:POKEC2,143:POKEG2,188:POK
EH2,188:RETURN
420 / DICE ONE - 5
430 POKEB,143:POKEC,143:POKEE,179:POKEG,
188:POKEH,188:RETURN
440 / DICE TWO - 5
450 POKEB2,143:POKEC2,143:POKEE2,179:POK
EG2,188:POKEH2,188:RETURN
460 / DICE ONE - 6
470 POKEB,143:POKEC,143:POKEE,179:POKEF,
179:POKEG,188:POKEH,188:RETURN
480 / DICE TWO - 6
490 POKEB2,143:POKEC2,143:POKEE2,179:POK
EF2,179:POKEG2,188:POKEH2,188:RETURN
  
```

# 'it's a little cutie'

## LTR-1 LETTER QUALITY PRINTER

**FOR ONLY  
\$759**

### Features

- Elite 12 Font - 96 Characters
- 80 Characters per line
- Impact type printer
- Friction feed
- 12 Characters per second — printing speed
- Bi-directional printing
- Max paper width 215mm (A4 size)
- Paper thickness .02mm - 0.1mm
- Ink roller — no ribbons needed
- Centronics Parallel Interface
- Compact 298mm wide x 188mm long x 63mm high
- Weighs only 3kg



AUCKLAND: Computer Craft Ltd., 3049 Great North Rd. New Lynn. Southmark Electronics Ltd. IDAPS House, 171 Grafton Rd., K Road Video & Computer Co., 65 Pitt St. Newton. Goto Systems 1990, 313 Great South Rd. Papakura. Computer Warehouses, 10 O'Connell St. HAMILTON: Dollar Save Comput-a-centre, 83, Govt. Life Bldg. Ward St. ROTORUA: Brian Hamilton Ltd. 57 Eruera St. NEW PLYMOUTH: Taranaki Micro Electronics, 50 Lizard St. PALMERSTON NORTH: Viscount Electronics

Ltd., 306-308 Church St. FEILDING: David Brice Electronics Ltd., 47 Kimbolton Rd. MASTERTON: Masterton Computer Centre, 5 Perry St. WELLINGTON: The Computer Experience Ltd. C/- James Smith, Coastlands, Paraparaumu. The Computer Experience Ltd., C/- James Smith, Cuba St. CHRISTCHURCH: Reconn Enterprises Ltd., Wave House, 194 Gloucester St. Computer Centre Ltd., 149 Manchester St. DUNEDIN: Eclipse Radio & Computers Ltd., 134-136 Stuart St.

Distributed by Viscount Electronics  
Dealer Inquiries Welcome

# PROGRAMS

## APPLE

# Mastermind

By Murray Harding

This computer version of the Mastermind game is written in Applesoft on an Apple II+. The computer thinks of four numbers, which the player must try to guess, aided by clues provided by the computer. Full instructions are given in the program.

```
0 REM *****
1 REM * *
2 REM * MASTER-MIND *
3 REM * *
4 REM * WRITTEN BY *
5 REM * *
6 REM * M J HARDING *
7 REM * *
8 REM *****
9 REM
10 GOSUB 500: REM *RULES*
20 GOSUB 1000: REM *BOARD*
30 GOSUB 1100: REM *SPACES*
40 GOSUB 1200: REM *SET UP*
50 GOSUB 1300: REM *GET CODE*
60 FOR V = 4 TO 22 STEP 2
70 GOSUB 1400: REM **PLAY**
80 NEXT V
90 GOSUB 1800: GOTO 1640
100 END
500 HOME
510 PRINT TAB( 15); INVERSE : PRINT
"MASTER-MIND": NORMAL
520 PRINT : PRINT : PRINT "THE O
BJECT OF THE GAME IS FOR THE
PLAYER TO GUESS THE FOUR NUM
BERS THE COMPUTER HAS THOUGH
HT OF. EACH TIME YOU GUESS T
WO NUMBERS WILL BE DISPLAYED
, THE 1ST ONE TELLS YOU HOW
MANY ARE CORRECT AND IN"
530 PRINT "THE CORRECT PLACE, TH
E 2ND ONE TELLS YOUHOW MANY
ARE CORRECT BUT ARE NOT IN T
HE CORRECT PLACE. THE GAME I
S OVER WHEN YOU CORRECTLY GUE
SS THE NUMBERS OR WHEN YOU R
UN OUT OF GOES. THE NUMBERS
CAN BE FROM";
540 PRINT "1-4 TO 1-9 DEPENDING
ON WHICH LEVEL YOU HAVE CHOO
SEN."
550 VTAB 22: PRINT "SPACE-BAR WH
EN READY"; GET B$: RETURN
```

```
999 END
1000 HOME : INVERSE
1010 SP = 4
1020 FOR I = 1 TO 24: VTAB I: HTAB
1: PRINT SPC( 20): NEXT I
1030 VTAB 2: HTAB 1: PRINT "
MASTER-MIND "
1040 FOR I = 4 TO 22 STEP 2
1050 IF I = 22 THEN SP = 3
1060 VTAB I: HTAB J: PRINT SPC(
SP); I / 2 - 1
1070 NEXT I
1080 NORMAL
1090 RETURN
1100 NORMAL
1110 FOR I = 4 TO 22 STEP 2
1120 VTAB I: HTAB 10: PRINT SPC(
4)
1130 VTAB I: HTAB 17: PRINT " "
1140 VTAB I: HTAB 19: PRINT " "
1150 NEXT I
1160 NORMAL
1170 RETURN
1200 GOSUB 1800
1210 PRINT "WHAT LEVEL OF PLAY"
1220 INPUT "FROM 1 TO 6 ? "; A
1230 IF A > 6 OR A < 1 THEN FLASH
: GOTO 1220
1240 A = A + 3
1250 NORMAL : IF X = 2 THEN 1280
1260 PRINT : PRINT "TYPE IN YOUR
"
1270 PRINT : INPUT "NAME - "; A$
1280 CALL - 936
1290 RETURN
1300 FOR I = 1 TO 4
1310 R(I) = INT ( RND (1) * A) +
1
1320 IF I = 1 THEN NEXT I
1330 FOR J = 1 TO (I - 1)
1340 IF R(J) = R(I) THEN Z = 1
1350 NEXT J
1360 IF Z = 1 THEN Z = 0: GOTO 1
310
1370 NEXT I
1380 RETURN
1400 TEXT
1410 FOR H = 1 TO 4
1420 VTAB V: HTAB H + 9
1430 GET S$(H); S(H) = VAL (S$(H
)); PRINT S(H)
1440 NEXT H
1450 FOR I = 1 TO 4
1460 IF S(I) = R(I) THEN K = K +
1
1470 NEXT I
1480 FOR I = 1 TO 4
```

```
1490 FOR J = 1 TO 4
1500 IF J = I THEN 1520
1510 IF S(I) = R(J) THEN L = L +
1
1520 NEXT J
1530 NEXT I
1540 VTAB V: HTAB (H + 12): PRINT
K
1550 VTAB V: HTAB (H + 14): PRINT
L
1560 IF K = 4 THEN GOSUB 1800: GOTO
1600
1570 K = 0
1580 L = 0
1590 RETURN
1600 PRINT "CONGRATULATIONS"
1610 PRINT A$; ", YOU"
1620 PRINT "HAVE GOT IT ("R(1);R
(2);R(3);R(4);")"
1630 GOTO 1670
1640 PRINT "YOU LOSE"
1650 PRINT A$; ", THE"
1660 PRINT "NUMBER WAS "; R(1);R(
2);R(3);R(4)
1670 PRINT : PRINT "WOULD YOU LI
KE"
1680 INPUT "ANOTHER GAME "; B$
1690 IF LEFT$(B$,1) = "Y" THEN
TEXT : K = 0: L = 0: X = 2: GOTO
30
1700 TEXT : HOME : PRINT "BYE"; END
1800 POKE 32,21
1810 POKE 33,18
1820 POKE 34,0
1830 POKE 35,23
1840 CALL - 936
1850 RETURN
```

## Integrated disk/tape systems

Datamatic (P.O. Box 27-056, Wellington) is now offering Kennedy integrated disk/tape systems. Two versions — one providing 40 MBytes (4055) of disk storage and the other (8055) offering 80 MBytes — are available. Both systems incorporate 20 MByte quarter-inch cartridge tape backup drives.

The 19in cabinets also contain a 200 watt switching power supply providing 5V, 12V and 24V for the Winchester drive, cartridge transport and associated electronics.

According to a Datamatic spokesman, the new systems should reduce system design and integration time by up to six months.

# The BITS & BYTES Computer Book Club

## Books: they're great for your business

AND IT'S BETTER BUSINESS THE MORE YOU BUY

- Buy any ONE and save \$3 on normal price.
- Buy any TWO and save \$7 on combined price.
- Buy any THREE and save \$12 on combined price.
- Buy any FOUR and save \$18 on combined price.

**Professional's Guide to the TI Professional Computer**  
**Alvin D. Schneider**  
 Directed towards the small business person wanting to know if the business needs a computer, would a computer make the business more efficient and profitable, and which computer would be most suitable. Covers hardware, software, packaged software, data processing, printers, interfacing, modems, local area networks and support — while avoiding a mass of highly technical detail and terminology.  
 Sams  
 Normal price \$39.80

**COBOL on Microcomputers**  
**Alan D.T. Fryer**  
 An introduction to CIS COBOL and Level II COBOL compiler. Examines what COBOL does and why it is the most widely used business computer language. Guidance on how to use two popular COBOL compilers, how to write efficient COBOL programs, and how to use various accessory programs.  
 Sams  
 Normal price \$18.80

**Real World Unix**  
**John D. Halamka**  
 Explains the workings of the Unix operating system of filing, mailing, compiling reports, and many other business applications. Emphasis is on mini and microcomputers in the business environment, with specific instructions on using the Unix command structure for database management, word processing and electronic mail. Also looks at some computers and software based on Unix.  
 Sybex  
 Normal price \$36.95

**Graphics for the IBM PC**  
**Dan Illowsky & Michael Abrash**  
 Tutorial approach to graphics through extensive sample programs. Graphics are described and directions given for using them. Intended for the non-specialist and designed for business users wanting to produce charts, graphs and slides, or for home users wanting to learn graphics.  
 Sams  
 Normal price \$31.40

**Simply dBASE II**  
**Barbara S. Chirlain**  
 Straightforward guide to get you going with this database management program. Teaches you enough so that you can use the parts you need, and explains how dBASE II handles information, what the program does with the information to make it useful, and how to retrieve information. Lots of illustrations and four appendices, listing — dBASE II commands, functions, configuration parameters and glossary.  
 dilithium Press  
 Normal price \$22.95

**Advanced dBASE II User's Guide**  
**Adam B. Green**  
 Collection of tips, techniques and practical programs tested and refined over two years of seminars around the USA. Practical advice on: software tools; controlling program flow; macros, strings numbers, dates; relational data model; other data models; repairing damaged data files; debugging; writing an add-on; hacking; benchmarks.  
 Prentice-Hall  
 Normal price \$60.90

## Buy now!

**Doing Business With VisiCalc**  
**Stanley R. Trost**  
 Fifty business applications covering record keeping, finance, budgeting, sales, manufacturing, real estate and income tax. Appendices on VisiCalc convention and command summary, and the VisiCalc advanced version. Provides armoury to prepare and implement sophisticated spreadsheets.  
 Sybex  
 Normal price \$33.95

**On-Line Computing for Small Businesses — Silver's Wall**  
**Maurice A. Silver, John Jeacocke & Ray Welland**  
 Sets out to provide managers of small businesses with a clear, concise but non-technical instruction in the use of on-line computing based on the practical experience of the authors. No prior knowledge of computing assumed and only essential technical definitions are included.  
 Pitman  
 Normal price \$9.95

**Choosing Your First Computer System: A Guide for the Growing Business**  
**K. Ian Mitchell & Beven J. Clarke**  
 Written by New Zealanders to help the manager with no computer experience to describe whether the business needs a computer and if so, which one; what sort of computer services will be best, and how to manage selection and installation. Straightforward style helps remove the complexity from these problems.  
 Pitmans  
 Normal price \$6.95

## Spreadsheet Dilemma



**Spreadsheet Dilemma**  
**Peter H. & Phyllis Mackie**  
 A handbook to read before buying any spreadsheet program for the IBM PC, IBM PC XT or COMPAQ computer. Introduces concept of spreadsheets and their uses, and explains what they can do for your business. Compares five of the most popular spreadsheet programs Lotus 1-2-3, VisiCalc, SuperCalc3, Microsoft Multiplan, Context MBA, showing how they handle payrolls, budgets, parts inventories and expense accounts.  
 dilithium Press  
 Normal price \$22.50

**TI-99/4A Calc: A Complete Electronic Spreadsheet**  
**Gregory R. Schmalhofer**  
 Discusses how spreadsheets work and how to use them most effectively. Includes a complete 676-cell spreadsheet program which runs on any TI-99/4A with cassette recorder. Permits loading, editing and saving of individual spreadsheets and calculations can include numbers, formulas and cell referencing. Provides six spreadsheets already saved on cassette to help you.  
 Sams  
 Normal price \$20.60

**Selecting the Right Data Base Software for the IBM PC**  
**Kathleen McHugh & Veronica Corchado**

**Selecting the Right Word Processing for the IBM PC**  
 Two management consultants provide unbiased information evaluating what they rate the 10 best data base software/word processing packages. They list the advantages and disadvantages of each, and offer guidance in helping you decide which is the best for you.  
 Sybex  
 Normal Price Data Base Software \$14.95  
 Word processing \$15.50

**BASIC Business Subroutines for the Apple II & Ile**  
**Alan G. Porter & Martin G. Rezner**  
 Takes frequent business programming problems, works out how to solve them and gives the solutions in Applesoft BASIC. Solutions provided in subroutines (program modules) which are easy to transport between programs and easy to modify to your specific problem. Each solution builds on techniques previously explained, and all are brought together in a single program at the end.  
 Addison-Wesley  
 Normal price \$32.95

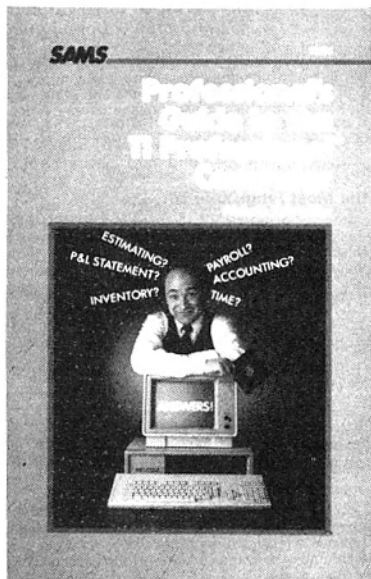

**Business**

**Databases for Fun and Profit** Nigel Freestone  
For users wanting to do their own programming. Provides straightforward introduction to data processing, with explanations of routines in BASIC. Examples of system designs for home and business use, which you can combine and expand. Systems for names and addresses, catalogue, index; diary; stock control; bank account; budgeting; debtors list; sale purchase ledger; payroll. Granada  
**Our price \$18.95. Save \$1 and earn 1 bonus point.**

**The Best Book of Lotus 1-2-3** Alan Simpson  
While the basics of 1-2-3 are fairly easy to grasp, it takes some time and practice to extract full advantage from this large and sophisticated program. This book easily followed with lots of graphs and illustrations — gives guidance in creating a worksheet; formatting and editing a worksheet; creating graphs; database management; macros; programming. Sams  
**Our price \$25.85. Save \$1.35 and earn 2 bonus points.**

**Database: A Primer** C. J. Date  
Dissects data and file management, focussing on how you can effectively use modern database systems and how to get the best from them. Thorough overview of databases, practical examples and exercises, discussion of widely used databases, the "how tos" of report writing, indexing and cataloguing; database design for protecting data. Addison-Wesley  
**Our price \$26.00. Save \$1.35 and earn 2 bonus points.**

**Basic Systems Analysis (2nd ed)** Barry S. Lee  
Sets out to give an overview of the knowledge and skills needed by a systems analyst. Assumes a basic understanding of computer technology, programming and data processing methods. Describes nature of data-processing systems, looks at the analyst's job and the development stages of new computer-based systems. Hutchinson  
**Our price \$21.15. Save \$1.10 and earn 2 bonus points.**

**Understanding dBase II** Alan Simpson  
Clear, concise text and eye-catching graphics help you master the basics, then guide you through programming techniques for useful applications such as mailing label systems, graphics, bookkeeping, printing and formatting reports. You also learn to interface dBASE II with other software systems to expand its capabilities. Sybex  
**Our price \$48.90. Save \$2.60 and earn 4 bonus points.**

**1,2,3, Go!** Julie E. Bingham  
Easy workout of the 1-2-3 program demonstrating the basics of the package, how to build a spreadsheet, how to create a graph, how to manage financial data collection, how to customise 1-2-3 to your business requirements. Well presented and plenty of examples. Addison-Wesley  
**Our price \$31.00. Save \$1.65 and earn 3 bonus points.**

**CP/M Database Management Systems** Carl Townsend  
Compares 12 database management systems for CP/M-based microcomputers, providing an overview with facts on installation, file creation, data retrieval, reporting and summary notes — along with the important advantages and disadvantages of each system. Part one introduces general database terms and concepts; part two examines the major CP/M database management systems. dilithium Press  
**Our price \$42.75. Save \$2.20 and earn 4 bonus points.**

**All About 1, 2, 3** Robert Schwarc & Alice Trembour  
Provides information for potential buyers of the 1, 2, 3 software package. Outlines its capabilities and a general guide to buying a managerial software package for a personal computer. Lots of examples of how it can be used. dilithium Press  
**Our price \$21.40. Save \$1.10 and earn 2 bonus points.**

**Simply VisiCalc** Barbara Chirlian  
Outlines basic concepts of VisiCalc and describes how it works. Sets out to bridge the gap between beginners and the formal VisiCalc documentation, teaching you enough so that you can start using it. Examples and illustrations, and demonstrations of tricks with labels, formulas, electronic rows and columns. dilithium Press  
**Our price \$21.80. Save \$1.15 and earn 2 bonus points.**

**Principles of Database Systems** Jeffrey D. Ullman  
The authoritative work on database systems from Stanford University's professor of computer science. Relates database ideas to concepts from programming languages, algorithms and data structures. Large section devoted to relations, their algebra and calculus, and the query languages designed with these concepts. Also examines recently developed protocols for guaranteeing consistency in databases. Computer Science Press  
**Our price \$45.35. Save \$2.40 and earn 4 bonus points.**

**Commodore 64**

**Basic Subroutines for Commodore Computers** Eddie Adams  
Easy-to-use manual which offers access to more than 300 BASIC subroutines — powerful building blocks you can combine and adapt to create programs for a wide range of business, educational and personal applications. Explanations for each subroutine with suggestions for modifying it to your needs. Each program is ready to run on any Commodore system. Wiley & Sons  
**Our price \$30.35. Save \$1.60 and earn 3 bonus points.**

**The club: how it works and what you get**

All you have to do to join the club is buy a book. Just pick out the books you want, fill in the coupon in the middle of the magazine, and post it in FREEPOST.

We offer savings on the cash price you pay for each book PLUS we give you bonus points. These are stored to your credit and may be used to save money on future purchases.

Please allow two or three weeks for orders to be processed and the book distributors to get the books to you.

**Bonus points**

Bonus points can now be cashed in to earn discounts of \$1 per point off books under \$20, \$1.50 per point off books between \$20 and \$39.99, and \$2 per point off books over \$40. Bonus points carried by the book you are buying cannot be used to reduce its price; and bonus points will not be credited on books discounted by the use of previous bonus points.

**How to Program the Commodore 64 — if you've never programmed a computer before** Robert Young  
After an introduction to the bits and pieces of the 64, you move to the process of learning to program on the keyboard. Concentrates on the key words and techniques to have you writing programs as quickly as possible, then allow you to refine the process at your leisure. Interface  
**Our price \$21.80. Save \$1.15 and earn 2 bonus points.**

**Basic Commodore 64 BASIC** James S. Coan  
An easy-to-read guide to computer operation and BASIC programming. Simple, direct approach involves mastering short programs, then adding a new command and watching as the program is created and illustrated. You then move on to another capability. Programs are divided into manageable segments, and special features and advanced programming techniques are explained. Hayden  
**Our price \$30.35. Save \$1.60 and earn 3 bonus points.**

**Blast Off With BASIC Games for Your Commodore 64** David D. Busch  
Twenty-five ready-to-run games designed for both fun and learning. You can enter and run programs without having to know the finer points of BASIC language — while at the same time, learning BASIC programming skills. Nine games are arcade-style, the others use graphics, sound and keyboard control. Brady  
**Our price \$27.70. Save \$1.45 and earn 2 bonus points.**

**How to Use The Commodore 64** Jerry & Deborah Willis  
Introduction to the computer and its basic components, explains what the components do and how they work together; step-by-step instructions on setting up and installation, shows how to load and save programs on diskette or cassettes, tells how to type in, use and modify programs, presents other sources of information. dilithium Press  
**Our price \$8.55. Save 40 cents and earn 1 bonus point.**

**IBM**

**Using Your IBM Personal Computer** Lon Poole  
After previous popular books on the Apple II, BASIC and the Atari, Lon Poole has now turned to the IBM PC. This comprehensive book is in two parts — for those who want to use only packaged programs; and for those who have never programmed a computer but want to learn BASIC programming. Also includes familiarity chapters with the hardware, sections of graphics and sound, and summaries of BASIC, PC DOS, error messages and characters, codes and keystrokes. Sams  
**Our price \$33.80. Save \$1.70 and earn 3 bonus points.**

**Executive VisiCalc for the IBM Personal Computer** Roger E. Clark  
Guides you to fulfilling specific business needs with examples for sales analysis, forecasting, bookkeeping, accounts receivable and so on. Tips for beginners, and discusses all command statements, logic functions to develop more complex and helpful models. Addison-Wesley  
**Our price \$26.00. Save \$1.35 and earn 2 bonus points.**

**PCjr Primer: A Guide to the IBM PCjr** Steve Stern & Greg Young  
Complete guide to the PCjr — its components, how to set it up, how to run it, what makes it different from the IBM PC. Discusses printers and peripherals, the infrared keyboard, the how and why of PCjr DOS, how to talk to other computers through the modem, and the three major pieces of software: Homeward, Home Budget Jr and Multiplan. Reston  
**Our price \$32.00. Save \$1.65 and earn 3 bonus points.**

**The IBM PC-DOS Handbook** Richard Allen King  
A complete guide intended to give you confidence to be creative with your computer's capabilities. Reveals features and functions inside PC-DOS, what you can do with them, and how they go together. Second half of book shows how to become adept at using PC-DOS's more advanced features. Sybex  
**Our price \$20.85. Save \$1.10 and earn 2 bonus points.**

**Useful BASIC Programs for the IBM PC** Stanley R. Trost  
A selection of tested programs for more than 65 home and business tasks. Home finances, business calculations, real estate, data analysis, record keeping and education are some of the fields covered. No knowledge of BASIC programming is needed to use these programs. Sybex  
**Our price \$18.95. Save \$1.00 and earn 1 bonus point.**

**The Best of IBM PC Software** Stanley R. Trost  
Selection of 50 commercially available programs for word processing, spreadsheets, database management, communications and utilities, languages and operating systems. Each review rates performance, ease of use, documentation and customer support, and provides information of use of the program. Sybex  
**Our price \$36.15. Save \$1.80 and earn 3 bonus points.**

**The IBM PC Connection** James W. Coffron  
From the author of the popular Apple Connection, VIC-20 Connection and Z80 Applications, this book shows how easy it is to use your computer with common household devices. Explains techniques for setting up your IBM to control a home security system, home temperature control system, voice synthesizer to make your computer talk, as well as other home appliances. Sybex  
**Our price \$28.45. Save \$1.50 and earn 2 bonus points.**

**PASCAL for the IBM Personal Computer** Ted G. Lewis  
Thorough guide to the two major versions of PASCAL available for the IBM PC. Written with both the experienced programmer (who will appreciate the comparison of the subtleties of both versions) and those new to PASCAL (who will find it a complete introduction) in mind. Addison-Wesley  
**Our price \$30.50. Save \$1.60 and earn 3 bonus points.**

**VIC**

**The VIC-20 Connection** James W. Coffron  
Shows how easily you can use the VIC along with household devices. Outlined techniques for using the computer to control a home security system, a home temperature system, a voice synthesizer to make the computer talk. The VIC is well suited for connecting to non-computer devices and this book provides many ideas and with the knowhow on what to do. Sybex  
**Our price \$17.05. Save 90 cents and earn 1 bonus point.**

**Getting Acquainted With Your VIC-20** Tim Hartnell  
Contains more than 60 games arranged to lead you, step by step, through most of the VIC's commands and statements. Each program is accompanied by an explanation and hints on how to get the best from it. Interface  
**Our price \$23.70. Save \$1.25 and earn 2 bonus points.**

**Getting the Most From Your VIC-20** Dennis Jarrett  
Carefully-designed introduction written and edited by professional journalists and writers. Uses diagrams, colour photographs, entertaining examples and informative appendices to take you through the elements of computing to mastery of your machine. Penguin  
**Our price \$13.25. Save 70 cents and earn 1 bonus point.**

**VIC 20 Programmer's Notebook** Earl R. Savage  
Collection of programming techniques, hints and kinks, tricks, subroutines and shortcuts. Equally useful for beginners and experienced VIC users. Sams  
**Our price \$29.85. Save \$1.55 and earn 2 bonus points.**

**Sixty Programs for the VIC 20/Commodore 64** Robert Erskine & Humphrey Waywyn  
Specially commissioned collection for each machine offering a mixture of games, graphics and utilities valuable for the games player and the more serious user. Short introduction explains how each program works. Pan  
**Our price \$20.85 each book. Save \$1.10 and earn 2 bonus points.**



# Begin at the beginning

These beginners guides really do start at the beginning. They assume you want to learn to use a computer for work or leisure, without becoming a theorist in computing. Each book assumes no prior knowledge, avoids jargon, uses photographs, diagrams and drawings extensively. Simple introduction to programming to inspire the user to further investigation of the machine's capabilities.



**SPECIAL  
SEPTEMBER  
OFFER!**  
**\$16.50 —  
SAVE \$5  
ON NORMAL  
PRICE**

- Apple II/IIe
- Atari 400/800
- Atari 600/800XL
- BBC
- Colour Genie
- Commodore 64
- Electron
- Oric 1
- TI99/4A
- VIC-20
- ZX81
- ZX Spectrum

## Our new selection

### Getting Started With ProDOS

**B.M. Peake & D. Rorke**

Aimed at Apple II and IIe users, this is intended for someone familiar with the existing Apple DOS 3.3 systems. Comprehensive guide to ProDOS, with exercises for practice. Reference section goes over commands and comments on their use, and there is a discussion of the advantages and disadvantages of the system. A list of further references is included.

Bluewater Press

**Our price \$6.65. Save 30 cents and earn 1 bonus point.**

### Fifty Pascal Programs

**Bruce H. Hunter**

Programs for beginners, business, finance, personal use, utilities, maths, machine-shop, electricity, mechanical engineering and games. Each has a commentary illustrating structured programming techniques and showing how to use them effectively. You can learn I/O techniques, transcendental and user-created functions, sequential and random file techniques, data type creation, and sort, searching and array manipulation.

Sybx

**Our price \$42.70. Save \$2.25 and earn 4 bonus points.**

### Interfacing Projects for the BBC Micro

**Bruce Smith**

Describes how to plug into the outside world and operate a variety of devices connected to and controlled by the BBC. Projects include burglar alarm, rain detector, light pen, EPROM programmer, X-Y plotter, joystick controller. Construction details provided, plus circuit diagrams, veroboard layouts and component lists. Tested and debugged programs to get projects running.

Addison-Wesley

**Our price \$27.50. Save \$1.45 and earn 2 bonus points.**

### Advanced Atari: BASIC Tutorial

**Robert A. Peck**

Uses practical examples to illustrate advanced programming techniques, concentrating on the use of Atari DOS and the commands necessary for efficient advanced programming. Helps develop a working knowledge of what makes up a database management program, and how to modify and apply these routines to your own programming needs. Numerous examples of debugged, self-documenting programs, including sort techniques, use of arrays, and graphics applications.

Sams

**Our price \$23.85. Save \$1.25 and earn 2 bonus points.**

### The Electron Book: BASIC, Sound & Graphics

**Jim McGregor & Alan Watt**

A guide from plugging in and switching on to the point where you can make full use of the Electron. Clear, simple description of BASIC and exploration of sound, graphics and animation.

Addison-Wesley

**Our price \$44.45. Save \$2.33 and earn 4 bonus points.**

### Programming the 6502

**Rodney Zaks**

Complete, self-contained text to learning programming, using the 6502. While it can be used by someone who has never programmed before, it should also be valuable to anyone using the 6502. For the novice, it teaches specific programming techniques and covers the elementary to intermediate techniques to start programming effectively.

Sybx

**Our price \$31.30. Save \$1.65 and earn 3 bonus points.**

### Commodore 64 BASIC Programs: 2nd ed

**Timothy Orr Knight & Darren LaBatt**

Thirty ready-to-run programs for education, games, graphics, personal, sound and utilities. Each program includes a sample run, an explanation by line numbers, a list of important variables, and suggested modifications.

Sams

**Our price \$19.85. Save \$1.05 and earn 1 bonus point.**

### Beginning Programming on the IBM PC

**Nancy Lee Olsen**

No previous programming experience needed to learn to program the IBM PC in BASIC through a no-nonsense approach. Designed for primary school children and their teachers, but suitable for any novice. Easy to follow with lots of concise explanations, and a glossary of more than 170 terms. Progress tests to check progress and understanding.

Sams

**Our price \$27.85. Save \$1.45 and earn 2 bonus points.**

### 32 Basic Programs for the Atari Computer

**Tom Rugg, Phil Feldmand & Timothy Barry**

Check-full of completely-tested, ready-to-run programs, including games, applications, education, graphics and mathematics. Each is fully documented with a complete source listing of the program, its purpose and how to use it. Advice on how to adapt programs through simple modifications.

dilithium Press

**Our price \$37.95. Save \$2.00 and earn 3 bonus points.**

### How to Use The VIC-20/Apple II & IIe

**Jerry & Deborah Willis**

Introduction to the computers and their basic components; explains what each component does and how they work together, instructions on getting the computers up and running; shows you how to load and save programs on diskette or standard audio cassettes; tells you how to type in, use and modify programs from books and magazines; reference of other information sources.

dilithium Press

**Our price \$12.35 each. Save 60 cents and earn 1 bonus point.**

### The World of PC-DOS

**Peter H. Mackie**

Explains the history and elements of DOS, teaches you how to load and start with computer with DOS, covers the DOS commands, how to respond to error messages and how to care for and protect diskettes and files. Brief introduction to programming and comparison of DOS versions and operating systems. Three appendices and a glossary.

dilithium Press

**Our price \$21.80. Save \$1.15 and earn 2 bonus points.**

### Introducing the Apple Macintosh

**Edward S. Connolly & Philip Lieberman**

Dissects the workings of the Macintosh and its features — how to make a desktop more efficient; how MacThinking improves productivity; what's behind the MacWindows; how to get the most from the mouse; using the MacTools; other available software; the 68000 microprocessor, small disk drives, communications with the Macintosh; how to make presentations.

Sams

**Our price \$25.85. Save \$1.35 and earn 2 bonus points.**

### Your First Basic Program: Editions for IBM PC, T199/4A, Apple IIe & IIplus, Atari

**Rodney Zaks**

The author of "Your First Basic Program" gets particular. Teaches the basic of BASIC. It doesn't matter whether you're eight or 88, if you want to learn how to program a computer, this book is aimed at you. No computer experience is needed. Written in Zaks' entertaining style and attractively produced with lighthearted but telling graphics.

Sybx

**Our price T199/4A & IBM PC \$22.75. Save \$1.20 and earn 2 bonus points.**

**Atari \$27.10. Save \$1.40 and earn 2 bonus points.**

**Apple IIe & IIplus \$27.50. Save \$1.45 and earn 2 bonus points.**

### Sixty Programs Editions for the VIC 20, Commodore 64, Electron

**Robert Erskine & Humphrey Waywyn**

Specialty commissioned collection for each machine offering a mixture of games, graphics and utilities valuable for the games player and the more serious user. Short introduction explains how each program works.

Pan

**Our price \$20.85 each book. Save \$1.10 and earn 2 bonus points.**

### Atari: Basic Programs in Minutes

**Stanley R. Trust**

Collection of versatile, ready-to-enter programs for more than 65 home and business tasks on the Atari. Programs for home finances, business calculations, real-estate, data analysis, record keeping and education. No knowledge of BASIC programming needed to use programs which can be entered and ready to run in less than 10 minutes.

Sybx

**Our price \$27.50. Save \$1.45 and earn 2 bonus points.**

## Language/programming

**Microsoft BASIC and its Files**  
**Jacques Boisgontier & Suzanne Ropiequet**  
 Handbook on programming techniques and a guide to data file programming. Reviews fundamentals of Microsoft BASIC programming language and provides more than 24 working programs as building blocks as you learn to design your own programs. Introduces data file programming principles and concepts, and discusses and compares random access and sequential files. Instruction on use of index files to access and sort file records. Lots of examples, programs and figures.  
 dlithium Press  
**Our price \$18.95. Save \$1.00 and earn 1 bonus point.**

**Structured Programs in BASIC**  
**Peter Bishop**  
 Opens with a discussion of program structure and design. The rest of the book comprises example programs, with the complete program design process (from initial specification to final listing) carried out. Excellent source of programming techniques, algorithms, program modules, ready-to-run programs and ideas.  
 Nelson  
**Our price \$26.35. Save \$1.40 and earn 2 bonus points.**

**LOGO: A guide to Learning Through Programming**  
**Peter Goodyear**  
 Introduces educational potential of programming in LOGO and guides you to programming and problem solving. Includes accounts of others' experiences with LOGO, a guide to further reading and suggested projects.  
 Heinemann/Horwood  
**Our price \$23.05. Save \$1.20 and earn 2 bonus points.**

**Introducing LOGO**  
**Boris Allan**  
 Explains philosophy behind LOGO and how it differs from many other computer languages. Shows how to program in LOGO, providing many examples and a detailed look at Turtle graphics and other applications. Guide to what LOGOs are available and what to look for when choosing.  
 Granada  
**Our price \$18.95. Save \$1.00 and earn 1 bonus point.**

**Understanding C**  
**Bruce H. Hunter**  
 Anyone with programming experience can use this book to learn the C language and familiarise themselves with the C environment and C systems in general. Information is especially geared to micros using CP/M and MS-DOS operating systems, and programs cover a wide cross-section of eight and 16-bit C compilers. Also covers data types and storage classes, memory management, UNIX-like utilities, C library functions, number crunching, and compares C compilers.  
 Sybex  
**Our price \$37.95. Save \$2.00 and earn 3 bonus points.**

**FORTH Fundamentals: Volume 1**  
**C. Kevin McCabe**  
 Devoted to explaining FORTH with a detailed examination of the language and its internal operations. Introduces fig-FORTH and FORTH-79 with full, non-technical descriptions of words and programming methods. Annotated listings of all fig-FORTH language model definitions. Numerical examples can be combined into more complex applications.  
 dlithium Press  
**Our price \$32.05. Save \$1.70 and earn 3 bonus points.**

**FORTH Fundamentals: Vol 2**  
**Kevin McCabe**  
 Language glossary companion to Volume 1. Dips into the variations between fig-FORTH and FORTH-79, and lists key core words. Organised by word name in ascending ASCII order. Name, applicable vocabularies, pronunciation and whether or not the word uses or changes the contents of its parameter stack. Shows colon definition for each word.  
 dlithium Press  
**Our price \$27.50. Save \$1.45 and earn 2 bonus points.**

**Exploring FORTH**  
**Owen Bishop**  
 Written especially for beginners, this practical introduction contains many examples for you to try and compare effects and results. Explains how to grasp the language and what you can achieve with it.  
 Granada  
**Our price \$23.70. Save \$1.25 and earn 2 bonus points.**

## Electron

**The Acorn Guide to the Electron**  
**Neil & Pat Cryer**  
 Comprehensive tour around the Electron, packed with outstanding diagrams and graphics. Discusses hardware, software, running programs on the Electron, making your own programs, Electron BASIC, getting data in and out of programs, graphics, colour, coloured shapes, programmed characters, animation, sound, assembly language.  
 Penguin  
**Our price \$13.25. Save 70 cents and earn 1 bonus point.**

**21 Games for Electron**  
**Mike James, S.M. Gee & Kay Ewbank**  
 The Electron has recently arrived in New Zealand. Now come 21 games with full colour and sound, specially written for the machine. Each game is listed in its entirety with a description of the object and details of how to play it. Typing tips to help you avoid difficulties in entering some programs. All games in BASIC.  
 Granada  
**Our price \$18.95. Save \$1.00 and earn 1 bonus point.**

**Games and other Programs for the Acorn Electron**  
 A mix of competitive action, dexterity, imagination, judgement and skill in a collection of 20 colourful programs. And "program rescue" programs are provided to help you put these games, colour graphics and sound programs on tape. One for arcade fanatics and those who prefer to develop thinking skills.  
 Penguin  
**Our price \$13.25. Save 70 cents and earn 1 bonus point.**

**The Electron Programmer**  
**S.M. Gee & Mike James**  
 Step-by-step guide from the first principles of BASIC to proficient programming, with special attention to the Electron's graphics and sound commands. Demonstrates the power and logic of Acorn BASIC, and introduces commands by showing why they are needed and how they are used. Example programs throughout demonstrate techniques and provide a starting point for your programming style.  
 Granada  
**Our price \$18.95. Save \$1.00 and earn 1 bonus point.**

**Advanced Programming Techniques for The Electron**  
**Jim McGregor & Alan Watt**  
 Gets into the programming principles and techniques behind arcade games and character animation, data structures and databases, text processing, board games and the beginnings of artificial intelligence. Emphasis is on applying these techniques in your own programs, with plenty of suggestions for refinements and developments of the material presented.  
 Addison-Wesley  
**Our price \$35.10. Save \$1.85 and earn 3 bonus points.**

## Games

**Tim Hartnell's Giant Book of Computer Games**  
 More than 40 games compatible with Microsoft BASIC able to run on most micros, including BBC, VIC 20, Oric, Apple II and IIe, Commodore 64, Dragon 32, Tandy Color, IBM PC, Laser, TRS 80, PET, MZ80K and Spectrum. Range covers board, dice, space, brain and adventure games, simulations, artificial intelligence, and some just for fun.  
 Collins  
**Our price \$14.20. Save 75 cents and earn 1 bonus point.**

**Tim Hartnell's Giant Book of Spectrum Games**  
 More than 80 programs covering just about every sort of game imaginable: arcade action, mind menders, chance and skill, adventure, space, board and card, fun, simulations. And there are utility and demonstration programs, games to convert notes on error trapping and a glossary.  
 Collins  
**Our price \$14.20. Save 75 cents and earn 1 bonus point.**

**40 Educational Games**  
**Vince Apps**  
 Editions for the Commodore 64 and the Electron. Developed with the help of educationalists and a professional programmer, programs have been designed to help younger family members handle the machine and increase their general knowledge. Subjects include languages, geography, mathematics and science. Hints show how program contents can be changed to suit the family as skills develop.  
 Granada  
**Our price \$18.95. Save \$1.00 and earn 1 bonus point.**

**Virgin Computer Games Series**  
**Edited by Tim Hartnell**  
 Each book contains a selection of more than 20 games which allow you to hone programming skills as well as have plenty of fun. Contains brief dictionary of computer terms, bibliography and hints on how to improve and extend some of the programs.  
**Commodore 64 edition \$11.35 Save 60 cents and earn 1 bonus point.**  
**Spectrum, ZX 81, TRS-80, VIC 20, Oric, Dragon, Atari, BBC editions \$8.45. Save 50 cents and earn 1 bonus point.**  
**Atari 600XL edition \$15.15. Save 80 cents and earn 1 bonus point.**

## Games for Apple, C64, VIC-20

Three classy collections of games for three computers. Thrill to adventures in imaginary environments; test your reflexes in arcade-like games; pit your brain against the computer in hard-to-win board games; have a lot of fun improving your programming at the same time.

**Editions for:**  
 • Apple Rohan Cook & Tim Hartnell  
 • Commodore 64 Robert Young & Paul Copeland  
 • Vic-20 Paul Copeland  
**Our price \$16.10 each. Save 85 cents and earn 1 bonus point.**

## General

**Getting Started on Your BBC, Atari, Spectrum, Oric, Commodore/VIC 20.**  
 Tim Hartnell has combined with other authors to produce this series designed to get first-time computer users into action with as few false starts and as much satisfaction and fulfilment as possible. Based around working examples, easy to read and use.  
 Futura  
**Our price \$8.95 per book. Save \$1.00 and earn 1 bonus point.**

## Pocket info

Instant answers can be at your hand with one of these Pitman pocket guides to:  
**PASCAL**  
**Wordstar**  
**IBM Displaywriter**  
**Word Processing**  
**Programming the BBC Micro**  
**Assembly Language for 6502**  
**Programming**  
**Our price \$7.95 Save \$1.**

**COBOL**  
**BASIC**

**The RS-232 Solution**  
**Joe Campbell**  
 Easy-to-follow guide to connecting your computer system to printers, modems, terminals, plotters or any other RS-232 peripheral. No expensive tools and only minimal electronic knowledge needed.  
 Sybex  
**Our price \$35.10. Save \$1.85 and earn 3 bonus points.**

**Fundamentals of Computing**  
**Neil A. Sheldon**  
 Intended to provide a grasp of fundamental principles by which digital computers work, concentrating on the concepts necessary for an understanding of all computer technology. Deals with how computers store and manipulate binary data; the facilities a computer system must have to store large quantities of data and communicate with users; the functions and organisation of processors and how they communicate with the rest of the hardware; and the software required to make a computer an efficient tool.  
 Hutchinson  
**Our price \$21.15. Save \$1.10 and earn 2 bonus points.**

**Computer Companion series**  
**Robert P. Haviland**  
 Editions for the Apple II and IIe, VIC-20 and Sinclair/Timex computers. Each provides a clear, concise reference to key words, functions, commands and statements, along with class designation, required form, conditions, results of use, and taken used for internal storage.  
 TAB  
**Our price \$23.25. Save \$1.25 and earn 2 bonus points.**

**The Business of Data Processing**  
**Roger Carter**  
 Guide for managers, small business people and students. Explains data processing systems and computer applications in business, with exercises for practical illustration. Examines control of data, systems analysis and design, buying and installing a computer.  
 Pan  
**Our price \$10.40. Save 55 cents and earn 1 bonus point.**

**Things To Do series**  
 Suggestions and ideas for games and entertainment; arts and crafts; teaching; home finance; record keeping; telecommunications; word processing; business and professional uses; programming; peripherals. Editions for Apple IIe, Atari, Commodore 64, Commodore 64/VIC20, IBM PC, Osborne, TI 99/4A and TRS80 Model 4.  
**Our price \$9.45. Save 50 cents and earn 1 bonus point.**

## Sinclair

**Using and Programming the Timex/Sinclair Computer**  
**Ken Knecht**  
 Complete education in Timex/Sinclair BASIC, using 75 short programming examples, including a full-length blackjack game. Covers basic programming, conditionals, random numbers, loops and subroutines, display control and graphics, strings, arrays, keywords, debugging, peripherals, and introduces you to machine language programming.  
 dlithium Press  
**Our price \$22.30. Save \$1.50 and earn 2 bonus points.**

**Control Things with your Timex/Sinclair**  
**Robert L. Swarts**  
 Concentrates on putting your Timex/Sinclair 1000 or 1500 to work timing events, producing tunes, measuring light, heat, weight etc, turning on lights and appliances by remote control, monitoring temperature, adding alarms and other sounds. Also shows how to add a real keyboard and/or joystick to your system.  
 dlithium Press  
**Our price \$15.15. Save 80 cents and earn 1 bonus point.**

## Spectrum

**Delving Deeper into Your ZX Spectrum**  
**Dilwyn Jones**  
 The step beyond introductory programming: screen tricks, escaping from INPUTs, screen scrolling, new character sets, block graphics, subroutines, user-defined graphics, speeding up programs, system variables, memory layout, all based round working examples.  
 Interface  
**Our price \$27.50. Save \$1.45 and earn 2 bonus points.**

**Spectrum Graphics and Sound**  
**Steve Money**  
 Covers techniques of drawing, producing graphics and using colour, and deals with animation, techniques for writing games programs and three-dimensional displays, how to produce sound effects and music. Many short program listings to try out what you have learnt.  
 Granada  
**Our price \$23.70. Save \$1.25 and earn 2 bonus points.**

# PROGRAMS

## APPLE

# Fourier analysis of standard waveforms

By C. Fawcett

This program is designed to demonstrate the way simple sinusoidal waves can be added to produce square, triangular, or sawtooth waveforms, and would form a useful teaching aid for a Physics Simple Harmonic Motion lesson.

Because of the lower case letters in the program, it will run best on an Apple IIe, although conversion for other Apples would involve simply entering all small letters as capitals.

```
JPR#0
JLIST

10 TEXT : HOME
20 PRINT "Fourier analysis of standard waveforms": PRINT "waveforms"
22 PI = 3.141592
30 PRINT : PRINT "Enter :-"
40 PRINT "1 - Square": PRINT "2 - Triangle": PRINT "3 - Sawtooth": PRINT "4 - to terminate": PRINT
50 INPUT "Enter Corresponding number ": IN
60 IF IN < 1 OR IN > 5 THEN GOTO 10
65 IF IN = 4 THEN STOP
70 SC = 40
80 PI = 3.141592
90 W = PI / 70
100 D = 1:N = 1:V = 139:XD = 139: S = 1
110 DIM Y(XD),R(XD)
120 HGR : HCOLOR=3
130 GOSUB 1000
140 FOR Q = 0 TO XD
150 C = SC * SIN (N * Q * W) / D * S
165 R(Q) = C:Y(Q) = Y(Q) + C
180 HPLOT TO Q,80 - C
200 NEXT
220 GOSUB 2000
230 HGR
240 GOSUB 1000
250 FOR Q = 0 TO XD
270 HPLOT TO Q,80 - Y(Q)
280 NEXT
290 GOSUB 3000
300 IF IN = 3 THEN N = N + 1: GOTO 320
310 N = N + 2
320 IF IN = 2 THEN D = N * N: GOTO 340
```

Subscribe today

```
330 D = N
340 IF IN > 1 THEN S = - S
350 GOTO 130
1000 HPLOT 0,80
1010 HPLOT TO 279,80
1020 HPLOT 0,80
1030 VTAB 23
1040 HOME
1050 VTAB 23
1060 PRINT "Harmonic number..":N
1070 PRINT "Amplitude.....":1 / D * 100: " % "
1080 RETURN
2000 FOR Q = 0 TO XD
2010 X = Q + V
2020 HPLOT TO X,80 - R(Q)
2030 NEXT
2040 HPLOT TO 279,80
2050 RETURN
3000 FOR Q = 0 TO XD
3010 X = Q + V
3020 HPLOT TO X,80 - Y(Q)
3030 NEXT
3035 HPLOT TO 279,80
3040 RETURN
```

## BBC

# Line Design

By John Kelleher

This program displays randomly selected designs of expanding and

contracting rectangles which continually change colour. The program begins in Teletext mode with a display of the BBC Micro Owl, and asks you to select the mode to be used. Once this is done, the display begins. As listed, the program works on a Model B. To run it on a Model A, change the MODEL in line 180 to MODE4.

```
10 MODE=
20 CLS
30 PRINTTAB(9,0)CHR#147" 9!1)9!1)1"CHR#148"0"
40PRINTTAB(9,9)CHR#147" 928_""&B1"CHR#148"zZ"
50PRINTTAB(9,10)CHR#147" ffg_e_e f"CHR#148"pp"
60PRINTTAB(9,11)CHR#147" 99991 1"CHR#148"n1"
70PRINTTAB(9,12)CHR#147" ""f f f f f"CHR#148"/.!"
80PRINTTAB(9,13)CHR#147" )9990 1"CHR#148"x10"
90PRINTTAB(9,14)CHR#147" b&b&g&f"CHR#148"_0"
100PRINTTAB(9,15)CHR#147" ! ! ! ! ! !"CHR#148" "" ""
110PRINTTAB(0,18)CHR#148CHR#157CHR#141CHR#131"PRESENTS....."
120PRINTTAB(0,19)CHR#148CHR#157CHR#141CHR#131"PRESENTS....."
130TIME=0:REPEATUNTILTIME=250
140CLS
141PRINTCHR#148CHR#157CHR#141CHR#131" LINE DESIGN"
142PRINTCHR#148CHR#157CHR#141CHR#131" LINE DESIGN"
150PRINTTAB(0,12)CHR#148CHR#157CHR#141CHR#131"mode 1 or 5 ?"
160PRINTTAB(0,13)CHR#148CHR#157CHR#141CHR#131"mode 1 or 5 ?"
170Z1=GCT#
180ZFZ1="1"THENMODE1ELSEMODE5
190VDU23;870219)0)0)
200VDU29;6402530)
210X=0)Y=0
220F=RND(50)D=RND(50)
230C=RND(3)
240PRINTA)
245CDBL3,C
250MOVEX,Y:DRAW-X,Y:DRAW-X,-Y
260DRAWX,-Y:DRAWX,Y
270X=X+P)Y=Y+0
280IFABS(X)>640THENP=-P)C=RND(3)
290IFABS(Y)>510THENQ=-Q)VDU19,RND(3),RND(7);0)
300UNTILTRUE=FALSE
```

## ZX Spectrum - BBC - Electron - C64

Trade supplies of software and hardware

*Including top of the charts software from the U.K.*

Be the first in your area to sell our popular range of items.

Retailers contact:

**Microware (NZ)**

**PO Box 6309, Wellington**



# PROGRAMS

```

1029 RETURN
1030 PLOT20,12,200
1035 PLOT21,12,201
1040 PLOT22,12,202
1045 PLOT23,12,200
1050 PLOT24,12,203
1055 PLOT25,12,204
1060 PLOT26,12,200
1065 PLOT27,12,205
1070 RETURN
1200 PRINT "OH NO!! YOU GOT IT WRONG !!!"
1205 FOR Y=1 TO 12
1210 PLOT22,Y,32
1213 PLOT25,Y,32
1214 SOUND14-Y:0
1215 NEXT Y
1220 T=T-1
1225 PRINT
1226 FOR D=1 TO 100
1227 NEXT D
1230 PRINT "NEVER MIND TRY AGAIN"
1240 RETURN
7000 FOR S=1 TO 2
7003 SOUND14:1
7005 SOUND16:1
7010 SOUND18:1
7015 SOUND19:1,11:5,7:5
7020 SOUND23:1
7025 SOUND19:1,2:1
7030 SOUND14:1
7035 SOUND16:1
7040 SOUND18:1
7045 SOUND19:1,11:5,7:5
7055 SOUND23:1
7057 NEXT S
7058 SOUND19:7,11:7,7:7
7060 RETURN
8000 CHAR 128,0000
8005 CHAR 129,0000000000000001C
8010 CHAR 136,0000000058207CFE
8015 CHAR 133,3E6D7F733E0C1E3F
8020 CHAR 137,DAFEE63C187E7E7E
8025 CHAR 130,0F0E0E04076FFFC
8030 CHAR 144,0000000000000001
8035 CHAR 131,3F2F4E9E3F3F7FFF
8040 CHAR 138,5A5A5A3C7EFFFFFFF
8045 CHAR 132,F0F0F0FCFCFBFBFB
8050 CHAR 152,000000E1F3FBFBFB
8055 CHAR 153,00007CFEFFFFFFF
8060 CHAR 154,000060F0FBFCFCFC
8065 CHAR 160,0107070F0F1F1F1F
8070 CHAR 168,0000000000000FFF
8075 CHAR 169,000000001F1FFFFF
8080 CHAR 176,FBFBFBFB7B7B7BBB
8085 CHAR 177,FFFFFFFFFFFFFFEFE
8090 CHAR 161,FE7E7E3FFFFFFF
8095 CHAR 162,9E9EFCFCFBFCFEFE
8100 CHAR 216,000000000000033F
8105 CHAR 184,1F3F3F3F7F7F7F7F
8110 CHAR 178,FEFEFEFEFEFEFEFE
8115 CHAR 179,FFFFFFFF7F7F7F3F
8120 CHAR 180,8DBDBDBEBDFDFDF
8125 CHAR 181,FEFEFE3DC3FFFF
8130 CHAR 185,FFFFFFFFFFFFFFEFE
8135 CHAR 186,FEFEFEFEFBFBFBFB
8140 CHAR 187,000000000808080
8145 CHAR 188,7F7F7F5F5F4F4F4F
8150 CHAR 189,FFFFFFFFFFFFFFEFE
8155 CHAR 182,FBFBFBFBDFDFCFEFE
8160 CHAR 183,FEFEFE7F7F7F3F4
8165 CHAR 208,FFFFFFFFDFBFBFB
8170 CHAR 190,FCFBFBF0F0F0F0F0
8175 CHAR 191,1F1F0F0F0F0F0707
8180 CHAR 192,8080C0C0C0C0C0C0
8185 CHAR 193,4743414141604000
8190 CHAR 209,E7F7F3DBD9DBDBFB
8195 CHAR 194,FFFFFFFFFCE00000
8200 CHAR 195,FFFFFFFF7F7F7F7F
8205 CHAR 196,F0F0F0F0F0F0F0F0
8210 CHAR 197,0703010100000000
8215 CHAR 198,C0C0E0E0F0783C1C
8220 CHAR 200,0000
8225 CHAR 201,FFFFFFFF7F0F0F
8230 CHAR 202,FBFCFCFCFEFE000
8235 CHAR 203,7F7F3F3F3F1F0F
8240 CHAR 204,FBFBFBFCFCFC0000
8245 CHAR 205,0800000000000000
8260 CHAR 96,00003C063E663E00
8265 CHAR 97,60607C6666667C00
8270 CHAR 98,00003C6660663C00
8275 CHAR 99,0606063E66663E00
8280 CHAR 100,00003C667E603C00
8285 CHAR 101,1C30307C30303000
8290 CHAR 102,00003E66663E063C
8295 CHAR 103,60607C6666666600
8300 CHAR 104,1800381818183C00
8305 CHAR 105,1800381818181870
8310 CHAR 106,6060666C786C6600
8315 CHAR 107,3818181818183C00
8320 CHAR 108,0000367E6B6B6363
8325 CHAR 109,00007C6666666600
8330 CHAR 110,00003C6666663C00
8335 CHAR 111,00007C66667C6060

```

```

8340 CHAR 112,00003E66663E0607
8345 CHAR 113,00006C7660606000
8350 CHAR 114,00003E603C067C00
8355 CHAR 115,30307C3030301C00
8360 CHAR 116,0000666666663E00
8365 CHAR 117,000066666666361800
8370 CHAR 118,00006366B6B7F3600
8375 CHAR 119,0000663C183C6600
8380 CHAR 120,00006666663E063C
8385 CHAR 121,00007EFC18307E00
8400 RETURN
9000 COLOR17,11,5
9005 COLOR18,8,5
9010 COLOR19,15,5
9015 COLOR20,15,5
9020 COLOR21,15,5
9025 COLOR22,15,7
9030 COLOR23,15,2
9035 COLOR24,15,4
9040 COLOR25,15,4
9045 COLOR26,15,13
9050 COLOR27,15,2
9055 COLOR28,4,5
9070 FOR C=13 TO 16
9075 COLOR C,16,2
9080 NEXT C
9085 FOR C=5 TO 8
9090 COLOR C,16,2
9095 NEXT C
9100 FOR C=9 TO 12
9105 COLOR C,11,2
9110 NEXT C
9150 RETURN

```

READY.

```

: REM "VIC WRITER"
5 REM BY AARON ENRIGHT*
10 INPUT "NAME":S#
20 INPUT "ADDRESS 1":V#
30 INPUT "ADDRESS 2":I#
40 INPUT "ADDRESS 3":O#
50 INPUT "DATE":G#
60 INPUT "YOUR REF":K#
70 INPUT "OUR REF":L#
80 OPEN L:4
210 DIM A$(30):A=1
220 PRINT "*****FUNCTION MODE*"
230 PRINT "001(1) GO TO LETTER"
240 PRINT "002(2) SEE LETTER"
250 PRINT "003(3) EDIT LETTER"
260 PRINT "004(4) PRINT LETTER"
270 PRINT "005(5) QUIT"
280 GET A$:IFA#="" THEN GOT0200
290 IFA#="1" THEN GOT0400
300 IFA#="2" THEN GOT0500
310 IFA#="3" THEN GOT0600
320 IFA#="4" THEN GOT0700
330 IFA#="5" THEN FOR F=1 TO 100:PRINT "VIC WRITER":NEXT F:END
340 GOT0200
400 PRINT "*****INPUT LINES OF LETTER WHEN FINISHED TYPE 001*":
410 PRINT "THE KEY '@' TO RETURN TO FUNCTION MODE.":FOR Z=1 TO 6000:NEXT Z:PRINT "0":
420 INPUT B#
425 IF B#="" THEN GOT0200
430 IF LEN(B#)>80 THEN PRINT "*****TOO LONG*****":GOT0420
435 IF LEN(B#)>80 THEN PRINT "*****TOO LONG*****":GOT0420
440 A$(A)=B#A=A+1:IFA=30 THEN PRINT "OK. THATS ENOUGH":FOR Z=1 TO 1000:NEXT Z:GOT0200
450 PRINT "O.K. NEXT LINE PLEASE":GOT0420
500 PRINT "0":FOR Z=1 TO A-1:PRINT "0"Z" "A$(Z)
510 GET T$:IF T#="" THEN S10
520 NEXT Z:GOT0200
600 PRINT "*****INPUT LINE TO EDIT*:INPUT Y:PRINT "PREVIOUS LINE WAS 001":PRINT A$(Y)
610 PRINT "*****NEW LINE IS*:INPUT B#
620 IF LEN(B#)>80 THEN PRINT "*****TOO LONG*****":GOT0610
630 A$(Y)=B#PRINT "O.K. ....":FOR Z=1 TO 500:NEXT Z:GOT0200
700 PRINT "1.CHR$(14):"MR. A.Z.NOBODY "CHR$(15)"
720 PRINT#1:."
730 PRINT#1:."
740 PRINT#1:."TELEPHONE:123456789012
750 PRINT#1:."
#
755 PRINT#1:PRINT#1:." YOUR REF:"K#
757 PRINT#1:." OUR REF: "L#
758 PRINT#1:PRINT#1:
780 PRINT#1:V#
790 PRINT#1:V#
800 PRINT#1:I#
807 PRINT#1:O#
910 PRINT#1:PRINT#1
920 FOR Z=1 TO A:PRINT#1:A$(Z):PRINT#1:NEXT Z:PRINT "O.K. ....":FOR Z=1 TO 500:NEXT Z:GOT0200
READY.

```

## VIC 20 VIC Writer

By Aaron Enright

This program for a VIC 20 of any memory size allows you to write letters and print them out on a 1525/1526 printer. Lines 700, 720, 730, and 740 should be changed to include your name and address. Once run, the program will ask you to enter the name and address of the person to whom you are writing, and then you can choose whether you want to begin a letter, view the letter, edit the letter, or print it on the printer.

When writing a letter, you will be asked to enter the lines one at a time. Each line must be no more than 80 characters in length. When the letter is completed, press @ to return to the menu. To end the program, press 5.

# PROGRAMS

## VIC 20

### Lineblaster

By Hugh Calveley & Roy Davies

Lineblaster is a visual co-ordination game. In a star-studded sky, numbers are hurtling towards you, and your only defence is to destroy them by pressing the correct number on the keyboard. The game has full on-screen instructions and excellent sound.

If you don't want to type the program in, copies are available from: Hugh Calveley, Tawa Road, R.D.1, Kumeu, Auckland. You must send a blank tape, \$2.50, and a 30c stamp.

## ATARI

### Saturn

By G. Glasgow

This program, which works on any Atari computer, draws a high-resolution picture of Saturn on the screen, and then gives a few facts about the planet.

Line 200 contains 17 spaces before the word 'Saturn'.

```
1 POKE 750,1
2 GRAPHICS 8:SETCOLOR 1,1,1:SETCOLOR 2,12,9:COLOR 1
3 GOTO 200
100 R=50:N=200:A=2*(25/7):INC=A/N
110 FOR I=0 TO A STEP INC
120 X=R*SIN(I):Y=INT(X*CX+CY+0.499)
130 Y=R*COS(I):Y=INT(Y*CY+CY+0.499)
140 SOUND 0,X,10,10:SOUND 1,Y,12,10
150 PLOT X,Y:NEXT I
160 RETURN
200 ? "          SATURN"
210 CX=160:CY=88
220 OX=1:OY=1
230 GOSUB 100
240 OX=3:OY=0.2
250 GOSUB 100
260 OX=3:OY=0.1
270 GOSUB 100
280 SOUND 0,0,0,0:SOUND 1,0,0,0
290 COLOR 0
300 FOR J=113 TO 206:PLOT J,83:PLOT J,78:NEXT J
310 ? "DAY=10.5 HOURS":? "YEAR =29.5 EARTH YEARS"
320 ? "DIAMETER=71,500 MILES"
330 GOTO 330
```

### Nibbles and bytes

When Software International held a cocktail party in Wellington recently, the guest list included a number of members of the Wellington City Council. One of them approached our Capital correspondent, and peered at the name tag on her jersey. "Bits and Bytes," he said, "Oh, you did the catering."

```
READY.
0 POKE36879,8:FORA=36874TO36877:POKEA,0:NEXTA:PRINT"J"CHR$(142):MEN=3
1 GOSUB1041:PRINT"J"
2 H=250:Z=38620:POKEZ+5,1:REM*COPYRIGHT HUGH CALVELEY & ROY DAVIES 1984
3 PRINT"J": FORB=1TO100:C=INT(RND(1)*22*23)+7680:POKEC,46:NEXTB:GOSUB4000
5 Q=7918:Q1=Q+1:Q2=Q+2
6 PRINT"*****"
7 PRINT"*****"
8 PRINT"*****"
10 A=INT(RND(1)*10)+48:IFA>56THEN10
11 A1=INT(RND(1)*10)+48:IFA1<56THEN11
12 A2=INT(RND(1)*10)+48:IFA2>56THEN12
15 POKE36879,8
16 PRINT"*****"
17 POKE38622,4:POKE38623,5:FORZ=38624TO38629:POKEZ,2:NEXTZ
19 POKE7903,66
20 POKE0,A
21 POKE0,1:A1:POKE02,A2
22 PRINT"TAB(6)"SCORE":SC
23 IFSO>HI THENHI=SC
24 PRINT"TAB(5)"HI-SCORE":HI
30 GETC#:C=VAL(C#)
35 POKE7902,C+48
40 IFC=A-48THENH=H-4:Q=7918:GOSUB1000:SC=SC+C:A=INT(RND(1)*10)+48:GOTO10
41 IFC=A1-48THENH=H-4:Q1=7919:GOSUB1000:SC=SC+C:A1=INT(RND(1)*10)+48:GOTO16
42 IFC=A2-48THENH=H-4:Q2=7920:GOSUB1000:SC=SC+C:A2=INT(RND(1)*10)+48:GOTO16
50 Q=Q-1:Q1=Q1-1:Q2=Q2-1
51 IQ=7903THEN80
61 IFQ1=7903THEN80
62 IFQ2=7903THEN80
66 POKE36878,2:FORV=241TO135STEP-15:POKE36876,0:POKE36877,V:NEXTV
69 FORY=1TOH:NEXTY
70 GOTO16
80 PRINT"***** !!!WASTED!!! " :FORR=1TO50:POKE36878,0:NEXTR
81 POKE36877,220
82 FORL=15TO0STEP-3:POKE36878,L:FORM=1TO300:NEXTM,L
83 GOSUB4000:MEN=MEN-1:IFMEN=0THENS000
85 GOTO2
90 H=H-4:GOTO2
1000 POKE36878,15
1010 FORI=215TO241STEP1
1020 POKE36876,I:NEXT
1030 POKE36878,0
1040 RETURN
1041 POKE36878,15:FORI=241TO215STEP-15:POKE36876,I:NEXT:POKE36878,0
1042 FORD=1TO4:POKE36878,15:FORM=180TO235STEP2:POKE36876,M:POKE36878,0:NEXTM
1043 NEXTD
1050 DATA9,14,19,20,18,21,3,20,9,15,14,19,40,25,47,14,41,63
1061 A=8144
1062 GOSUB2000
1063 DATA129,189,219,126,36,60,66,231
1064 DATA9,14,19,20,18,21,3,20,9,15,14,19,40,25,47,14,41,63
1065 FORG=1TO18
1070 READC
1075 POKEG+8142,C
1076 A=A+1
1077 POKE36878,15:POKE36876,195:POKE36876,225:FORM=1TO100:NEXTN:POKE36878,0
1080 NEXT G
1090 GETC#:IFC#=""THEN1090
1100 IFLLEFT(C#,1)=""THEN1130
1110 PRINT"J":GOTO2
1130 PRINT"J"
1140 PRINT"          "
1150 PRINTCHR$(14)
1160 PRINT"IN THIS GAME YOU HAVE TO BLAST THE ONCOMING NUMBERS BY TYPEING THE":
1170 PRINT"CORRESPONDING NUMBER ON THE KEYBOARD. WHEN THE NUMBERS TURN RED WAT
CH OUT!"
1186 PRINT"*****"
1187 PRINT"*****"
1190 PRINT:PRINT"*****"
1200 PRINT"*****"
1210 GETA#:IFA#=""THEN1210
1220 PRINTCHR$(142):PRINT"J":GOTO2
2000 PRINT:PRINT"*****"
2010 PRINT"*****"
2020 PRINT"*****"
2030 PRINT:PRINT"*****"
2040 PRINT"*****"
2050 PRINT"*****"
2060 RETURN
4000 PRINT"*****"SPC(7)"*****"MEN"ME"*****"
*****
4010 RETURN
5000 GOSUB4000:PRINT"*****"IGAME OVER!!"
5005 PRINT"*****PRESS'G'"
5010 GETA#:IFA#=""G"THEN MEN=3:SC=0:GOTO2
5020 GOTO5010
READY.
```

## BUSINESS

This is the third article in a series on business software for the Commodore-64. This month, another comprehensive business package, consisting of a number of separate modules is reviewed. The package has been written by James Electronics, Ltd, 328 Pollen St, P.O. Box 527, Thames.

# Choice galore

By Philip Verstraaten

The total system consists of modules for payroll, debtors, cashbook, general ledger, time and cost, and hire purchase, which may be purchased and used separately. They are sold on separate disks, each containing the programs and related data files. All parts of the programs are accessed through lists of options. This makes them easy to use. One of the options in each module is "SET PRINTER", which provides a choice of printers, including Commodore (except the 1526 and 1520) and Epson.

## Payroll

Implementing a computerised payroll system should always be performed very carefully. In some types of industry, timing of weekly payments is very important, which raises issues such as back-up, either manual or through the availability of a similar system. Therefore, I strongly recommend parallel running with your existing systems to monitor performance and to become familiar with the features of the package.

James' payroll module is comprehensive and provides a flexible tool with a large variety of options. The user may define up to 16 different banks and 50

"extra and deduction" codes for as many as 118 employees. An employee record holds details like department-number, last-week-of-pay, address, IRD-no., superannuation, rate amount, commencement and termination dates, taxcode, salary, rates, cash and banking requirements, rounding requirements and year-to-date totals.

Each employee may have a salary and/or up to three different hourly rates of pay, up to 12 extras and deductions, and a maximum of three separate banks per payslip.

As tax is calculated by the system, it must be adjusted by the supplier should there be any changes in legislation. This will cost \$45-\$60.

## General ledger

The general ledger module accommodates up to 250 separate accounts, each containing a code according to which it is stored. It is really a very simple debit and credit recording facility, where the transactions are entered either positive or negative. There is no facility to check whether the ledger is in balance or not, and no analysis features are available. An audit trail is provided by the automatic printing of transactions affecting the accounts.

The system remembers only the account totals, which makes these audit trials an absolute necessity. At the end of a period, the totals may be cleared and the ledger started again, unfortunately without any creation of financial statements.

Available listings are: codes and account-names; posted transactions (audit trail); totals per account for the batch; entries for each separate account. If the system is likely to run out of transaction entries (a maximum of 600), an early warning signal alerts you when only 50 more are available.

## Debtors ledger

The debtors' module, a facility to keep track of moneys outstanding from your credit customers, accommodates up to 500 accounts and a maximum of 3000 transactions. A file of these customers is maintained by additions, changes and deletions, with a facility to print customers according to an alpha-key or customer-number.

To update the balances, regular transaction runs may be performed by the user entering a transaction type like invoice, credit-note, receipt or journal, date, a numerical reference number and the amount. A very good feature is the facility to delete any earlier transactions so that they will not appear on the statements any more. At the end of a period, the balances may be aged and an aged trial balance and customer year-to-date totals printed.

## Time & cost

The time and cost module is very useful for professionals or any business that charges fees out to customers. If you are operating with a single disk drive, it will handle up to 320 clients and 50 staff members, and up to 1000 clients with a dual disk drive.

Besides the maintenance of client and staff files, the main options provided are for setting dates and ranges, transactions entry and listings. A range may be set to the upper and lower bounds for the range of client to be accessed or printed.

To create a transaction, a member's number is entered, making his name, rate and year-to-date total appear on the screen and printer. The required client number is then entered, its data loaded from disk and the client name displayed. Now the transaction units are entered, using up to two decimal points for fractions. The units are now multiplied

## Software for THE COMMODORE 64

### DEBTORS C64 — \$140

500 Customers - 3000 transactions per month - Customer lists - Aged trial balances - standard statement forms - monthly and annual aging - all on single disk - single program.

### PAYROLL C64 — \$350

200 Employees - mixed pay periods - 50 extra & deduction codes - full tax calculations - prints pay slips - dep analysis - IR12 printing - banking and cash breakdown - pay summary.

### CASH BOOK C64 \$180

150 payment codes - 50 deposit codes split cheque entry - Full analysis by code - Bank reconciliation showing uncashed cheques - Audit control of input - M.T.D. and Y.T.D. balances.

### GEN LEDGER C64 \$160

250 definable codes - Compiles trial balance - Entries referenced to page or journal number - Entries grouped by code - Month code balances - Year to date balances - Very quick.

### TIME & COST C64 \$299

320 Jobs - 47 Employees or Cost Stations - Full records by job and analysis by employee - 91 transactions per job - Analysis by date - Analysis by cost station - Job selective printing.

### HIRE PURCHASE C64 — \$299

100 contracts, up to 10 vendors - Analysis of overdue payments - Rebatable interest - Penalty interest calculated - Financial recording of all contracts - Single disk.

All programs compiled — Several printer types supported — Written in N.Z. — Fully supported and guaranteed.  
Contact your nearest Commodore 64 Dealer or

**James Electronics Ltd (Thames Computer Services)**

P.O. Box 527 THAMES  
PHONE (0843)86-893

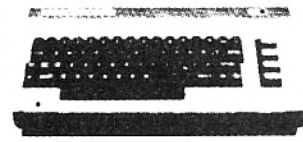

## BUSINESS

by the amount per unit and, after validation, added to a particular client's total.

A variety of reports is available with options for segmental reporting of f.e. transactions in date order.

### Cashbook

Many small businesses find it hard to keep track of their cash position and sometimes find themselves suddenly in unexpected overdrafts. For this purpose, a cash book module has been developed providing a facility to keep track of cash payments and deposits. The system may accommodate up to 150 payment codes, such as a variety of expenses and purchases, and up to 50 deposit codes, a number of different sales areas, for instance.

Transactions affecting the cashbook may be by cheque number or by a user defined alphabetical code, which makes the entries more meaningful and easier to understand. All payments and deposits may be split over several codes, dividing the amount of one cheque, for instance. A number of reports are provided, consisting mainly of payment, deposit and code entries with related totals.

A very useful feature is the option to perform a bank reconciliation. Any existing balances are adjusted by the transactions for deposits and payments. A total of 50 unpresented cheques may be entered to create a complete reconciliation, which is then printed out.

### Hire purchase

This module, developed for use by both finance companies and vendors, can hold up to 10 vendors, 8064 transactions and 100 contract records. It can process contracts falling under the Credit Contracts Act 1981, which imposed fairly strict conditions on presentation to the client and explanation of the true interest rate percentage.

The system maintains a vendor and a contract file, which is affected by transactions that are regularly entered. To add a new contract, you enter a number not currently used or enter 0 which will search for an available number.

In the case of a transaction, the contract number is entered and the computer loads the contract details, and calculates and prints the current balance owing, any chargeable penalty interest and the rebate on interest that can be credited, using rule 78 for today's date.

The five types of transactions are: receipt; rebate; journal + (debit correction); journal - (credit correction); and penalty interest.

This module provides a number of different reports which give information about free contract numbers, contract details, analysis (eg. current debt, last payment date, overdue amount), trial balance and the vendor instalments due. A number of different modes of listing are provided, and may be chosen through the listing option. Contracts may

be printed by groups or only selected ones.

### General remarks

All programs are guaranteed for 60 days from purchase, unless user-maltreatment of the media and failure to take adequate backup precautions have taken place. A licensing system for each program sold is used, requesting the purchaser to register the program within seven days. The vendor states clearly that he will not provide any support in case the purchaser fails to register.

Each package has included the very useful 1541 backup program - which should be used by each business client to secure the information on the disks.

The system is easy to use, with very clear screen layouts, and sufficient editing of the input. Although the input from the options is directly accepted without typing RETURN, any mistakes are easily recovered as the system works very quickly. The system is pleasant to use too because of an ABORT key which works well.

The documentation accompanying the packages is sufficient. One minor but really clumsy setup is that the documentation, together with the floppy disk, is packed in such a tight plastic bag I had to bend the already vulnerable floppy quite a bit to get it out.

### Prices

The difference in prices for the various

### Testing your disk drives

A new device from Dysan allows disk drive owners to test the performance of their drives more easily.

The digital diagnostic diskette (DDD) is a diagnostic tool for flexible diskette drives that doesn't require any disassembly or specially trained users (no more oscilloscopes!)

The DDD (cost \$150) is precisely recorded with intentionally misaligned information, which when read back, can determine the amount of alignment error.

Unfortunately, unless you are an IBM PC owner, you have to write your own software so diagnostic results can be reported on a screen or other appropriate device.

For IBM-PC owners a package called Interrogator is available which consists of menu-driven software that uses the DDD (total cost \$4500).

The other alternative is to purchase a PAT-1 alignment tester. This handheld device has a numeric keypad and LED screen that displays test results from the DDD in plain English. The price is not cheap, though, at \$2995.

All these products are available from Dysan's New Zealand agent, Solstat Industries (P.O. Box 13-183, Christchurch).

modules reflects the difference in sophistication.

Prices are: General ledger, \$160; cashbook, \$180; payroll, debtors, time & cost, hire purchase \$299.

In my view the \$299 is a little expensive, especially for the debtors' module. For this price, the client should at least get a few hours of implementation advice and guidance in system use.

*Philip Verstraeten is a Christchurch business computer consultant.*

Since this review was written, James Electronics has reduced the price of the debtors module to \$140 and released an entirely new payroll module.

The new payroll module increases the capacity to 200 employees and allows for several new features such as unit rates, pay summary and tax override features, plus a new pay slip format and full recovery procedures.

The new payroll module sells for \$350.

### A good month

Andas reports a successful month of Apple sales for July. The company's financial result is expected in the next couple of months. A new Olivetti machine is due out in October or November, an Andas spokesman said.

## Roland DG

### ROLAND XY PLOTTERS



- \* 8-Color & 1-Color models
- \* Both Parallel & Serial onboard
- \* Full A3 Size Plot
- \* Plot Accuracy 0.1mm
- \* Driven by AUTOCAD, SUPERCALC 3
- \* Easily Programmed by User

### HI-RES MONITORS

- \* RGB -Standard, IBM, Apple
- \* Greenscreens & Amberscreens
- \* Composite or IBM Inputs

This script was printed by a Roland Plotter

## ROLAND DG CORPORATION

Sole NZ Distributors:  
CONCORD COMMUNICATIONS LTD.,  
1 Ngaire Ave., Epsom.  
P.O. BOX 36-045, AUCKLAND.  
Phone 504-631.



**FREE!**  
Special Bonus  
worth over  
**\$750**

As a limited offer  
there's a  
**free Vic 20  
Home Computer**  
for the kids when  
you buy an SX-64 for  
yourself — C'mon Dad!

## Commodore SX-64 Executive. The portable, professional colour computer.



**\$3325**

**Includes valuable software:**

- **EASYSRIPT** (word processor)
- **EASYMAIL** (mailing lists & labels)
- **THE MANAGER**  
(information management system)
- **DISK BONUS PACK**

A full range of application software is available.  
Contact your specialist Commodore dealer

---

**commodore**  
COMPUTER  
Keeping up with you.

**FREE!**  
Special Bonus  
worth over  
**\$750**

As a limited offer  
there's a  
**free Vic 20  
Home Computer**  
for the kids when  
you buy an SX-64 for  
yourself — C'mon Dad!

## Commodore SX-64 Executive. The portable, professional colour computer.



**\$3325**

**Includes valuable software:**

- **EASYSRIPT** (word processor)
- **EASYMAIL** (mailing lists & labels)
- **THE MANAGER**  
(information management system)
- **DISK BONUS PACK**

A full range of application software is available.  
Contact your specialist Commodore dealer

---

**commodore**  
COMPUTER  
Keeping up with you.

## Learning to program — the why, who, what which & how

By Gordon Findlay

Home computers have already passed through three phases in their brief adolescence, each characterised by the sorts of things their owners have done with them.

The first phase was that of the builders. They either built a computer from scratch or a kit, or at least weren't averse to getting in with a soldering iron and using a junk teletype as a printer.

Next came the hackers. This has now become a pejorative term, relating to fools who break into communication and computer systems which don't belong to them. Until recently though, a hacker was a person who programmed — often in a way to get more out of a machine than could rightfully be expected, but always compulsively. These are the people we have to thank for much of the software we use now. They have written the books and magazine articles which we still use as sources, and as inspiration. A typical activity — using two years of spare time to find out how one version of BASIC worked.

Now we have the users. There are still, thank goodness, a lot of hobbyists who program, and program well. There are still just as many, or more, people willing to find

## Booting up

Each article in this series is a gentle introduction to some topic in the computing field. It is written for the beginner, so may appear very simple to the rest of you. If you find it too easy and not worth reading, congratulations — you are a beginner no more. Each issue will deal with a different topic, of general interest. Occasionally material may seem to repeat that which has already appeared in "Bits and Bytes". Remember, new readers are coming along all the time.

The title of the column comes from a computing term; "booting up" is whatever must be done to get a computer ready to run programs.

out how to make the machine do odd things. But I suspect, nay fear, most buyers now have little intention of programming.

What has caused this turnaround? There are several factors. One, is of course, the increasing amount of good software available to buy. The increasing amount of software which is locked up, either on disk or in a cartridge, discourages not only pirates, but also tinkering with and improving it. Manufacturers, possibly responding to the climate of opinion or possibly causing it, put more effort into tutorials and beginners guides than ever before (commendable) but leave out of the manuals much of the technical information they used to include, or like Apple, charge extra for the real manuals.

There is absolutely nothing wrong with using a computer as an appliance, but I suggest there are good reasons why everyone should learn at least a little about programming.

### WHY learn to program?

I am not suggesting everyone should, or can, become an expert programmer. But there are several reasons why everyone should work to gain a nodding acquaintance with simple programming.

First off, because it is fun. It may not seem so at first, but once you have, on your own, forced the computer to do exactly what you

told it to, the thrill is immense. The challenge is enormous; so are the rewards. Americans seem more ready to accept this sort of mental challenge than we do. Why?

Secondly, so you can, if you need to, modify other programs. I was once asked if I would modify a program which had been bought in the USA. Naturally, I agreed — the pay offered was good. But the only changes needed were in spelling of words and names of items — timber instead of lumber, aluminium instead aluminum, for example. The program user could have learnt to do that much!

The third reason is so that you can appreciate and criticise programs you meet. After writing a program, no matter how simple, you will understand what is involved in some of the complex, clever, packages you have bought. You will also be able to criticise, and reject programs which aren't good enough, or which make you the slave of the machine rather than the reverse.

The fourth reason: to sharpen your mental processes and help you sort out your ideas. You really do know something if you can program it!

### WHO should learn to program?

Basically, everyone.

School children — not to get a job, but so they really do understand what computers are like.

## Add Graphics Capability

*the Houston way*

to your home, school, business or laboratory

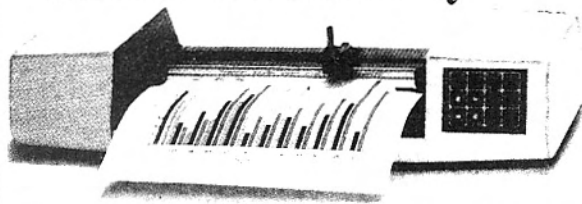

## houston DMP-40 or DMP 40-2 (2-pen)

Small capable single & 2-pen plotters using A3/A4 sized media. Perfect for home, school, or business use. Boasts 0.005" step size and robust firmware to generate high resolution complex drawings quickly and accurately. Easily transported to act as an output device for more than one computer. Low price belies its quality and capacity for generating superior graphics. Solid design and technology combine to provide extreme reliability under heavy use. I/O is RS-232C (others available). Prices from \$1894.

Extensive software listings for major computer brands are supplied.

For further information send to:

**S.D. MANDENO ELECTRONIC EQUIPMENT CO.**

10 WOODHALL ROAD, EPSOM, AK 3. PH 600-008. TELEGRAMS "NUCLEONIC"

Dealer appointments open

## BEGINNERS

Parents — so that they can keep up with their children, and even have some constructive fun with them.

Business people — not to write business software (there isn't time for that) but so that they can decide what software to buy, or have an idea of what their programmers are saying and why they are charging so much. Fewer bad programs would be around if bosses knew just enough to tell a programmer why the work wasn't good enough.

Everyone — to be little more independent.

### WHAT to program?

Every beginning programmer should have this motto written in large letters above the keyboard:

KISS: (Keep It Simple Stupid). Anything will do, provided it is simple. Usefulness is also worthwhile. Maybe your first programs won't be all that useful. Stick to things you know, or simple games. Perhaps a simple program can be used for some simple business task. Maybe you can keep a list of people to whom you send Christmas cards. What calculations have you done in the last month?

### WHICH programming language?

It is fashionable to knock BASIC. But for most people, BASIC is the only language they have available. This simplifies the choice immensely.

Of course, there are better languages, and decades of teaching schoolchildren has convinced me, against previous prejudice, that a language such as PASCAL might be better first. Certainly, BASIC has to be overcome eventually, but it is easier to learn good habits in

PASCAL than BASIC, and the effort of learning a second language is much less than the effort of learning the first.

### HOW do I go about it?

Programming is a bit like riding a bicycle. Once you learn, you will wonder what all the fuss was about. The main thing is to get down to the keyboard and get stuck in.

Several sources of help are available. Most important, a friend who knows a little more than you,

and can offer a suggestion when things go wrong. Join your nearest computer club — they are always willing to help. Many schools and computer shops run night classes — the school ones are almost always cheaper and often represent a bargain.

Read programs in magazines. Type some in, thinking as you type about the program instructions, and try to see why they are written as they are. Take a program written for a machine different to yours and convert it.

## OSBORNE holds prices at pre-devaluation levels!

The Company that introduced the concept of portability and bundled software passes the price benefit on to you!

### OSBORNE 1

CP/M 2.2  
WORDSTAR/MAILMERGE V2.26  
SUPERCALC V1.12  
MBASIC & CBASIC  
2 x 185K DISC DRIVES  
64K MAIN MEMORY  
1 x SERIAL PORT  
1 x PARALLEL PORT  
5" GREEN SCREEN

### EXECUTIVE 8

CP/M 3.0 PLUS  
WORDSTAR/MAILMERGE V3  
SUPERCALC & SUPERDATA  
INTERCHANGE  
MBASIC & CBASIC  
PERSONAL PEARL  
UCSD SYSTEM  
USER-DEFINABLE  
CHARACTER SETS  
2 x 185K DISC DRIVES  
128K MAIN MEMORY  
REAL TIME CLOCK  
PASSWORD PROTECTION  
2 x SERIAL PORTS  
1 x PARALLEL PORT  
7" AMBER SCREEN



These products are backed by the proven service and support of Sirius Systems Ltd. Talk to any Osborne user about how the Osborne has improved their productivity.

Contact us today and see how an Osborne portable personal business computer can be working for you!

New models coming soon — watch for announcements.

**Sirius**  
Systems

SIRIUS SYSTEMS LIMITED  
2 MANUKAU ROAD, EPSOM.  
P.O. BOX 9645 NEWMARKET.  
PHONE 504-895 (3 LINES).

### Spectrums for China

Sinclair Research has completed negotiations to sell an initial 600 48K ZX Spectrum computers to the computing and automation department of China's North East Technical College.

The computers will be used by the department's graduate researchers to learn BASIC programming skills.

Sinclair is also supplying an introductory library of ZX Spectrum software programs including the advanced microPROLOG and LOGO programming languages.

## Win your own gold medals

By Steven Darnold

As I write this review, the Olympics are in full swing, and I can hear the American crowds cheering on the television behind me. I suppose some Yankee athlete has just won another gold. Never mind, I've been winning plenty of gold medals of my own. I'm one of the stars at the Epyx Summer Games.

I'm pleased to see someone finally producing an Olympic simulation game for the Commodore 64. The Apple has had such a game for a long time, and it's about time we had one. Moreover, the Hyper Olympics arcade game is very popular just now, and it's good to be able to invite friends round to play a similar game on the computer.

Overall, the quality of Summer Games is excellent. Good use is made of graphics and sound, and the game is challenging and interesting. Epyx has enhanced the game considerably by including lots of little details. For example, at the beginning, each player chooses which country he represents, and subsequently each gold medal winner hears his country's national anthem while his flag is displayed. Moreover, if his performance sets a new world record, it is saved permanently to the disk. Such details give the game a satisfying richness.

The Summer Games title page lists seven different designers. Considering there are eight different events, it is my guess each person produced one or two events and they were then all linked together. If this was indeed the case, then the game holds together remarkably well. However, there are some weak spots.

The weakest part is unquestionably the two swimming events. They are not well integrated into the whole — they are loaded as separate programs from the main program and must reload the main program before they can evaluate the results and perform the medal ceremony. This produces a noticeable delay which does not occur in the other six events. And the two swimming events are nearly identical. The only difference is that one is a relay. This duplication is a tedious waste of time and detracts from the game.

I suspect that Epyx originally intended each of the eight events to be completely different. In fact, I wouldn't be surprised if an eighth designer had been lined up. However, Epyx was probably pressed for time and decided the most important thing was to get the game out before the

Olympics, and compromised.

So we get two rather similar running events, and two very similar swimming events. Fortunately, the running events are reasonably well done and don't noticeably detract from the game.

Two significant bugs are a further indication that Summer Games has been rushed to market. The graphics for the gymnastics event occasionally end up in the wrong mode and look very strange, and the little man in the diving event occasionally doesn't appear and everything locks up.

It's amazing Epyx should let the program go to market with these bugs. Even if the bugs show up only on our

PAL versions of the 64 and not on the American NTSC versions, Epyx really should have checked before releasing the game.

A bit more time could have made this a superb game. Nevertheless, even with its faults, it's still an outstanding program. The pole vault, gymnastics and skeet shooting are particularly good, and you get a realistic feel for what the athletes have to do. For example, I have discovered the vaulting horse is actually a very complicated event — not nearly as easy as those Romanian girls make it look.

You can have a lot of fun playing Summer Games on your own: however

## Volume can beat margin

Imagine what would happen if Michael Jackson's record company decided to sell his next album for \$100. A few keen people buy the record, they tape copies for their friends, the copies circulate, copies are made of the copies, and eventually everyone has Michael Jackson's latest. It's true that some of the copies are a bit fuzzy. It's also true that most people do not have the colourful album sleeve. Nevertheless, such things don't really matter when you're saving \$100.

By charging \$100, the record company makes copying worth while. For most people, it's too much trouble copying an entire album just to save \$10. However, when the price is \$100, there is a much bigger incentive to copy. As a result, the record company sells few albums, and pirate copies proliferate. In the end, the record company makes far less profit than had it sold the album for \$10.

This is the sort of thing happening in New Zealand with computer software. Many games for the Commodore 64 sell here for around \$100. That's a lot of money, particularly for adolescents. The result is that few copies of the games are sold, and there is a big incentive to copy them. In fact, because the prices are higher than overseas, New Zealand will probably experience more copying of commercial programs than most other countries.

Most expensive programs for the 64 are protected against copying in one way or another. However, what one person can do, another can undo. Persistent adolescents are quite capable of figuring out ways to circumvent protection schemes. Moreover, overseas magazines have numerous advertisements for utilities to copy protected programs. Several of these utilities are already in the country.

Some software producers try to stay one step ahead of the copiers by devising more and more sophisticated protection schemes. However, some people view new protection schemes as a delightful challenge, and it doesn't take long for new schemes to be broken.

Program protection does not stop the

hardcore copiers; often it serves only to inconvenience the legitimate user. For example, some protection schemes hammer the disk drive, which under certain circumstances can cause an older 1541 to go out of alignment. Furthermore, the protection may be linked to the inner workings of a 1541 drive and may stop the program functioning on IEEE and non-Commodore drives.

The worst problem, however, is that most protection schemes do not permit the user to make a backup copy. This is inexcusable. If you've got to pay \$100 for a program, you should get at least one back-up.

In my opinion, software producers are following the wrong strategy. Instead of wasting time and money developing protection schemes, they should lower their prices and aim for volume sales. If record companies can sell quality albums for \$10, there is no reason why software companies can't sell quality computer games at a similar price. After all, what's the difference between producing a music cassette and a game cassette? Royalties, duplication, packaging, and distribution are all pretty much the same. Why should a tape of Michael Jackson sell for \$10 and a tape of Jumpman sell for \$100?

Eventually, software prices should come down. In the not-too-distant future, we will probably see cassette games selling for around \$10 and disk games for \$20 or less. British software producers are already heading in this direction, but the Americans are still setting high prices for their games.

When you look at all the different brands of microcomputers on the market, you see several which imitate the Apple and several which imitate the IBM-PC. Have you ever wondered why there are none which imitate the Commodore 64? The answer is simple: the Commodore 64 sells at such a low price nobody sees any profit in copying it. Let's hope someday, we will be able to say the same about Commodore 64 software.

# COMMODORE 64

it is even better with a group. Up to eight people can play at the same time, and at the end, they are ranked according to how many medals they win. Such competition adds spice to the game and makes the running and swimming events more interesting.

## Zeppelin

Last month, when I was describing some Synapse games, I mentioned I had played a brief game of Zeppelin. At that time, the game appeared very attractive but I hadn't made enough progress to properly evaluate it. In the last few weeks, however, I have spent many hours on Zeppelin, and am convinced it is one of the best of the Synapse range. And that makes it a very good game indeed!

The sound and graphics are exceptionally good, the colours rich and well-defined, and the background intricately detailed. The animation is smooth, with some stunning graphical sequences, the sound effects well done, and the theme music particularly nice.

The game itself is fun to play. At first, it's quite interesting just to float around the cavern blasting everything in sight and looking at the beautiful graphics. Then, as you become more experienced, you discover how to turn off force fields and how to blast your way into new caverns.

At the lowest level, Zeppelin proceeds at a leisurely pace, and most beginners will be able to navigate around the first cavern without too many problems. The other caverns, however, become progressively more difficult, and there is plenty to challenge even the most hardened games fanatic.

## Zaxxon

Another Synapse game which has recently come into my possession is Zaxxon. It's a close copy of the arcade game very popular a year ago, but it's hard to see what all the fuss was about.

The graphics are very good, and there

are some nice 3-D effects. However, the game itself is rather one-dimensional. You simply fly along in one direction, blasting everything in front of you. Occasionally, there's a wall to fly over, but otherwise little to do. Zaxxon is somewhat similar to another Synapse game, Blue Max; however, Blue Max has more variety and is much more interesting.

If you liked the Zaxxon arcade game, you will probably like the Synapse version. Zaxxon is really the black sheep of the Synapse flock — it's the only one which is a copy of someone else's game. All other Synapse games are original creations.

## Two C64 languages

Commodore has two new languages for the C64, created to help children "learn faster"

LOGO, priced at \$110, allows experimentation with different ways of solving problems and accommodates easy program changes. It is a procedural language which lets the programmer break the program down into smaller, separate procedures and is designed for children to "teach the machine" to do what they want.

Like PILOT, it has been designed by a student of Jean Piaget, the child

psychologist. In the US, psychologists are claiming that students learn programming quickly and improve their speed in learning other subjects.

PILOT stands for programmed inquiry, learning or teaching, and sells for \$100. It has close similarities to LOGO and is designed to give teachers an easy way to generate computer-aided instruction courses.

It has a simple command structure and the ability to handle large amounts of text — as with multiple choice exam questions.

# USER FRIENDLY COMPUTER FURNITURE



## DATA CENTRE

THE DATA CENTRE is a compact unit designed specifically for storing serious P.C.s such as the IBM — WITH printer. Locks together, wheels anywhere, opens out providing an efficient all-purpose work station. Polished Silkwood Walnut finish.



Data Centre

## COMPUTER BUREAU

THE COMPUTER BUREAU is designed to compliment any home or office environment. Your computer can be tidily stored in a desk unit. Keyboard slides out providing work copy stand; cables and disks can be tidied away.



Ergonomic copy stand



Mobile work station



Mobile File Unit



Typical Work Station

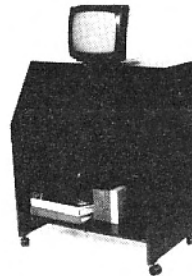

Computer Bureau

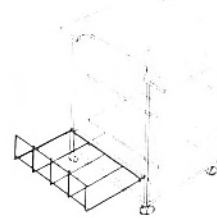

Printer mobile



Printer stand

YOU choose the units needed to make a station as complete as you want — knowing you can expand or change it around.

You will like the appearance — Polished Silkwood Walnut or blonde finish — and you will like the prices. Send for data sheets and retail outlets.

There are matching Silkwood bookcases, desks, cupboards and cabinets too.

\*Reg'd design pending

# SILKWOOD

Manufacturing Ltd

8 Tironui Road Papakura, Auckland. Phone 298 7089

## Word processing on the 64

By Steven Darnold

In last month's special feature on word processors, Gordon Findlay listed some of the advantages of word processing, and Jenny Phillips explained how her word processor trebled her productivity. There were also some details of the most popular word processing packages.

If you aren't already using a word processor on your 64, it's well worth considering. You don't even need a disk drive; you can assemble a very useful word processing system using only a datasette to store files. Of course, you will need a printer. There's little point processing your words if you can't print them out.

If you don't already have a printer, I suggest you look at the Gemini 10X. It costs less than Commodore's MPS 802, but is a much better printer. It has higher quality print, is faster, and can print up to 136 characters per line. It was reviewed last month in *Bits & Bytes*, and the reviewer liked it as much as I do.

Unfortunately, the Gemini printer cannot plug straight into the 64. You will

need some sort of interface. The Cardco G is probably the best, although the MW-302 and the Cardco B are cheaper. All are available in New Zealand. It is possible to get a cheap, software-driven interface, but in the long run, you are better off getting a hardware interface such as the Cardco.

Printer and interface will cost you slightly over \$1000. Then you will need a word processing program. Commodore's Easy Script is a good, solid program, but it really requires a disk drive. The program itself can use either tape or disk, but it is sold on disk and the disk protection keeps you from making a cassette copy.

Several other word processing programs for the 64 are detailed in last month's *Bits & Bytes*, but the best value for money is unquestionably SpeedScript. It appeared in the January

## Competition postponed

The winner of July's competition was D. Lowe, of Timaru, who has been sent a copy of Skramble (donated by Alpine Computing).

There is no competition this month, because Steven Darnold is moving house from Alexandra to Blenheim, and will be a wee bit busy over the next few weeks. Next month, however, we'll be back to normal with another competition.

issue of *COMPUTE!'s Gazette*, and is well worth typing in. An update was printed in the May issue, and further improvements have just been printed in the September issue. These improvements are particularly relevant to the Gemini 10X printer.

SpeedScript is written completely in machine language, and can be used with either tape or disk. Its huge text area can hold up to 9000 words. SpeedScript does not have as wide a range of formatting and editing commands as Easy Script, but it is more than adequate for many users. Moreover, *COMPUTE!'s Gazette* is giving SpeedScript ongoing support, and new features are likely to be added in coming issues.

It's worth noting that *COMPUTE!'s Gazette* occasionally prints programs of exceptionally high quality. SpeedScript is just one example. Another example is a program in the latest issue (September) which enables the 64 to display a full 80-column screen. Such programs alone are worth the price of a subscription. Now that the price of American computer magazines is climbing towards \$10 per issue, you have to pick and choose. Clearly, *COMPUTE!'s Gazette* is one of the few magazines to provide good value for money.

If it's micro news in Wellington — Phone Pat Churchill 797-193

# BÖWE Simply doing it better.

German precision-built Bowe cutters, bursters and decollators add the finishing touch to your computer printout stationery. Compact, easy to operate, reliable — Bowe, simply doing it better!

### Cutters

For a personalised, professional finish. Bowe cutters remove the margins, and cut the paper to any size perfectly. While the short set up time and easy to programme electronic controls make

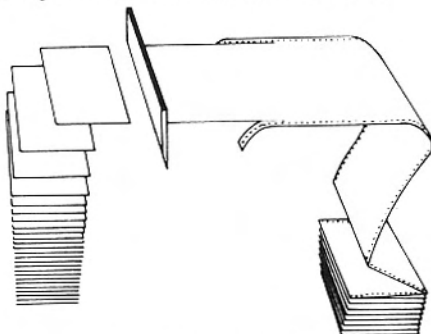

operation a snap. The compact quiet, electronic Bowe cutter — simply doing it better.

### Decollators

Messy carbons are automatically wound around a special roller for easy clean, disposal and up to four sheets can be decollated in one cycle. No mess, no

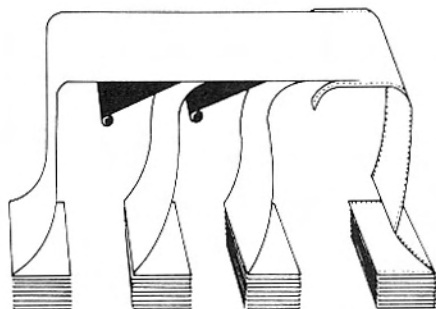

fuss Bowe decollators — simply doing it better.

### Bursters

No mountains of paper and no bulky

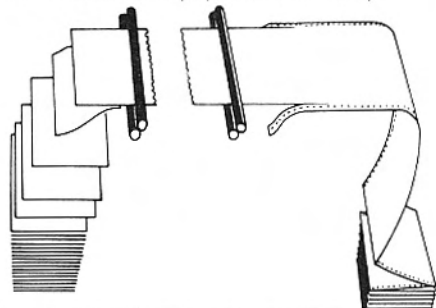

machinery — there's a Bowe burster for every requirement. Faster, simpler, quieter Bowe Bursters — simply doing it better.

Let us show you why 85% of Bowe users specify Bowe computer printout processors, again and again. Bring in your worst problem paper and we'll prove how Bowe is simply doing it better!

## Delairco ELECTRONICS LIMITED

P.O. Box 626 AUCKLAND Phone (09) 798 204  
P.O. Box 6629, T. A. W. WELLINGTON Phone (04) 651 864

Mail this coupon or telephone today.

- Please send me literature on Bowe computer printout processors.  
 Ask a Delairco consultant to contact me.

Name .....

Company .....

Address .....

Telephone .....

BGH 7460

# BASIC pointers

By Tony Graham

In previous articles, I have referred to "pointers". But what are pointers? Each pointer is an address in memory which "points" to a second address in memory. Your computer uses the pointers to keep track of its own operation so that it knows such things as how much memory is available and at which address the free memory is located, plus many other "housekeeping" functions.

The exact addresses of these pointers can be found in a memory map of your computer.

A memory map for the VIC can be found on page 50 of *VIC Revealed*, or page 20 of the *VIC-20 Programmers Reference Guide*, and for the C64 on page 310 of the *C64 Programmers Reference Guide*.

If you look through the memory map and in the column headed DECIMAL, you will find that memory locations 43 and 44 hold the "pointer to start of BASIC" with 55 and 56 holding the "pointer to end (or limit) of BASIC".

At the moment, we will look only at pointers between memory addresses 43 and 56, as these are the same for both the VIC and C64.

Switch on your computer and take note of how much free memory you have, now enter PRINT PEEK (56). If you add 1 to whatever number your computer has just PRINTed and POKE56 with that number, you will now have another 256 bytes of free memory. PRINT FRE(0) to prove this. The C64 will print a negative number, so you must add 65536 for a corrected answer.

There is a catch to this cheap memory expansion — the memory is non-existent. All we have done is tamper with the pointer to the end of memory to make the computer think it has more memory.

Creating non-existent memory is not very useful, but if we can make the computer think it has more memory, we can also make it think it has less. Try POKEing 56 with four less than your original PEEK(56). PRINT FRE(0) will now return 1024 (1K) bytes less than when your computer was first switched on.

After having paid good money for an extra RAM pack, why should we want to reduce our available memory? We are not really reducing memory, simply reserving it for a special reason such as a character set or machine language program. If we did not take this precaution, BASIC could over-write or move the contents of our now reserved memory.

Unfortunately, all pointers are held in two bytes of memory which the computer holds in hexadecimal form

(usually referred to as HEX) which means you or your computer need to do some calculations before POKEing the pointer locations.

You will have noticed changing the value held in memory location 56, i.e. PEEK 56, by one changes the free memory to 256 bytes. This is because we are changing the high byte of the "pointer to end of memory". If we change the value in location 55, by one, we will change the free memory by only one.

Location 55 is the low byte, the other half of the "pointer to end of memory." As your computer counts in HEX, the low byte of the pointer can count only up to 255. Higher values than 255 mean we must also increase the high byte.

Here is a program that will calculate from decimal the values which must be POKEd in the high and low bytes of pointers.

```
10 INPUT "DECIMAL ADDRESS", DA
20 HB=INT(DA/256)
30 LB=DA-(HB*256)
40 PRINT"HIGH BYTE =";HB
50 PRINT"LOW BYTE =";LB
```

To read the pointers in decimal, enter the following directly into the keyboard: PRINT PEEK(44)\*256+PEEK(43).

In this example, the answer will give the decimal address to the start of BASIC, as addresses 44 and 43 are the

pointers for that function.

If we wanted to find the end of a program, we would use addresses 46 and 45. The answer given would be the decimal address to the start of variables and the program would finish one byte less.

Note that the memory map shows pointer addresses are held in what is referred to as low byte/high byte order — the low byte we read directly comes first followed by the byte we need to multiply by 256. If we are PEEKing bytes, we can PEEK in the reverse order if we wish, but it is essential to multiply the correct byte by 256.

To get some idea of how BASIC positions its pointers, try this:

If your computer is switched on, switch it off for a few seconds then switch on again. This will give a fresh start. PEEK out all pointers from 43 to 56 and note their values.

Now load a program, but do not RUN. Again PEEK out the pointers from 43 to 56 and note any changes. RUN the program, then BREAK via the STOP key only. Again note any changes in pointers.

By now, you should be getting some idea of how to interpret a small section of a memory map and to follow the operation of the pointers. We will put this information to good use later.

## COMPARE OUR PRICES!

**PLUS BACKUP SERVICE AND GUARANTEE**

**OVERNIGHT DELIVERY N.Z. WIDE**

**PHONE OR SEND YOUR ORDER NOW!**

---

**YOUR CHOICE! \$895**

**COMMODORE C64**

**OR 1541 DISK DRIVE**

**CN2 DATASETTE ..... \$125**

---

<p style="margin: 0;"><b>Buy Spectrum</b></p> <p style="margin: 0;"><b>48K at \$599</b></p> <p style="margin: 0;">Get a Software 'Six Games Pack' Worth \$300</p>	<p style="margin: 0;"><b>THE</b></p> <p style="margin: 0;"><b>QL</b></p> <p style="margin: 0;"><b>IS</b></p> <p style="margin: 0;"><b>HERE</b></p>	<p style="margin: 0;"><b>COMMODORE</b></p> <p style="margin: 0;"><b>SX64 \$3333</b></p> <p style="margin: 0;">FREE 801 PRINTER</p> <p style="margin: 0;">COMMODORE PRINTER</p> <p style="margin: 0;">INTERFACES \$159 &amp; \$249</p> <p style="margin: 0;"><small>(Freely Available)</small></p>
---	--	---

---

- EASY FINANCE with 20% Deposit
- ALL CREDIT CARDS ACCEPTED (Except Sale Items)
- SEND CHEQUE, M.O., ETC., PLUS \$10 P & P
- PHONE OR WRITE - NOW! Mon-Sat. 10 a.m.-6 p.m.

**manukau** (N.Z.)  
**COMPUTERS** LTD.

**PHONE AK 656-002**

**P.O. Box 26-074 AUCKLAND 3**

**CORNER MANUKAU & PAH RDS - EPSOM**

# More on expansion options

By Peter Archer

In the July column, I outlined the more common hardware expansion options for your VIC. I will now detail some of the more exotic expansions.

The VIC-20 has several empty gaps in its "memory map". There is a large gap of 24K between where internal RAM finishes and where the BASIC ROM resides. When you fit an 8K RAM expander, you fill up the first 8K of this 24K gap; alternatively, a 16K expander will fill the first 16K of the 24K area.

Anything more than an extra 16K is probably not justified for the average VIC user (for one thing there is virtually zero software available to take advantage of any more than an extra 16K). There are, however, several options available.

Commodore does not make a RAM expansion any larger than 16K, but its 8K and 16K expansions can be configured in various ways, by using the switches inside the case, to fill up any of the three possible 8K blocks in the 24K memory gap (or also to fill the 8K gap in "higher" memory usually reserved for ROM cartridges).

But of course the VIC has only one memory expansion slot, so you can plug in only one cartridge at a time. But there are available so-called expansion "mother-boards" which multiply the

expansion slot by anything from (typically) three to six times.

Commodore used to make its own large expansion unit for the VIC. It contained its own power supply, so your cartridge did not draw power from the computer. This was a good idea, as the computer can supply only a limited amount of power to add-on cartridges, etc.

But there was one problem with Commodore's expansion unit — it was too expensive. Although it was withdrawn from sale in New Zealand some time ago, there may still be a few lurking among old stock, or on the second-hand market. If you could obtain

one for (say) under \$200, it would be worth having.

A more economical proposition is a simpler expansion board which makes the cartridges draw their power from the computer. There have been many different brands of these marketed in the USA, usually with three or maybe six slots. But none of these US boards has ever been mass-marketed in New Zealand. A couple of years ago, I brought one in from the USA (in kitset form) and it has given me very good service.

There is, however, one very well made three-slot expander marketed in New Zealand. This is made here for Commodore (NZ), Ltd, — and is

## Cartridge games aplenty

Many games cartridges are available for the VIC. Commodore has 38 on its price list, and many more are produced by independent software firms (mainly in the USA). In fact, I would say the VIC has the largest number of games cartridges available of any computer in New Zealand. These range in both quality and price. I will try to give an overview of the situation, and in future columns, will review some of them in more depth.

In the beginning (about three years ago), Commodore produced a limited range of games cartridges for the VIC. These included old favourites such as "Avenger" (really "Space Invaders"), "Super Lander", and "Draw Poker" and originally sold here for \$69.95, putting them a bit beyond many people's reach.

Commodore has progressively added more games cartridges to its library and reduced the prices. The list retail price fell first to \$59.95 and then recently to \$49.95. But I notice a large chain store is advertising some of the older cartridges as low as \$29.95. I suspect this may end up as the new retail price from all dealers. But I do not know if devaluation will effect this.

Incidentally, the same chain is advertising a "Recreation Pack" of six tape programs at a fairly low price. These programs are positively ancient — remnants from the very early days of the VIC. They are written mainly in BASIC, unlike almost all the more recent games which are written in machine-code. In fact, some of them are no better than public domain quality.

In the USA, there has recently been a bit of a glut of software for the VIC, with some programs advertised at large reductions. The firm, Creative Software, has always been known for its good quality Commodore games programs, but these were very scarce in New Zealand.

However, Viscount Electronics, of Palmerston North, recently imported a good range of VIC game cartridges, most of which have a New Zealand retail price of \$39.95. I will review several of these over the next month or two, but I must mention now the one I consider the best.

Every six months in the USA, a "Consumer Electronics Show" — a large

display of all manner of electronics products for the home — is held. It is a typical American extravaganza, accompanied by a lot of media hype.

At the show of just over one year ago, educational software for home computers was given very high billing. It is customary for awards to be made for various categories of product, and the award for "best educational software" (for any brand of computer) went to a VIC-20 cartridge program, by Creative Software, called "Pipes".

It has taken "Pipes" a year to reach New Zealand but I consider the wait well worth while. "Pipes" takes a simple everyday task and, with the aid of imaginative programming, turns it into an absorbing computer simulation. Your task is to connect houses to the water supply using the correct pieces of pipe. Sound simple?

To set a challenging task for a range of age groups and abilities, you can choose from one to five houses. You have a limited supply of money — with which you must buy suitable pieces of pipe from the "pipe store". But the store has only a limited number of each type of pipe. So occasionally, you have to improvise if the exact type of pipe you need is unavailable. The less money you spend in achieving your goal, the better your final score. And the feeling of achievement when you turn that valve and see the water rushing through the pipes with (you hope) no leaks is more constructive than that given by the typical "shoot-em-up" type game.

The technical quality of the programming in "Pipes" is very good, with good graphics and sound and easily used joystick control of the little plumber. The only small criticism I have is that young children might have difficulty turning on the water, and the map display sometimes gets in the way. But these points are very minor.

If only all of the so-called "educational" software I have seen was up to the same standard as "Pipes"! I will award "Pipes" a rating of nine out of 10. Over the next few months, I intend to review some more VIC educational software, so we shall see how some other offerings compare.

### COMPARE OUR PRICES!

PLUS BACKUP SERVICE AND GUARANTEE

OVERNIGHT DELIVERY N.Z. WIDE

PHONE OR SEND YOUR ORDER NOW!

TAKE YOUR CHOICE!

COMMODORE C64

1541 DISK DRIVE

FT5002 PRINTER

1701 COLOUR MONITOR

CN2 DATASETTE

COMMODORE SX64

\$985

\$125

\$2995

SPECTRUM 48K • \$599

INCLUDES POWER PACK

MICRODRIVE/INTERFACE 1 \$570

DK'TRONICS KEYBOARD \$235 LIGHT PEN \$135

KEMPSTON JOYSTICK & INTERFACE \$135

- SPECTRUM & COMMODORE PARTS & SERVICE
- ALL CREDIT CARDS ACCEPTED (Except Sale Items)
- SEND CHEQUE, M.O., ETC., PLUS \$10 P & P
- PHONE OR WRITE — NOW Mon. - Sat. 10am-6pm

**manukau** PH. AK 656-002  
COMPUTERS (N.Z.) LTD. CNR. MANUKAU RD. & PAH RD. EPSOM



distributed by the company to its dealers. It used to be priced at \$89.95, but has now been reduced to \$69.95 which I consider very good value.

There are also some more ambitious expanders marketed in the USA. Some of these combine RAM expansion and extra cartridge slots in the one unit. For the VIC owner wanting to expand to the ultimate, these appear to be the answer. I will briefly describe three:

The "Ramax", made by Apropos Technology, contains an extra 27K of RAM, plus two expansion slots. The latest price I know of was \$US124.95.

The "Select-a-RAM", by Advanced Processor Systems, gives a full 64K of extra RAM, plus two expansion slots, for \$US169. And there is even an offer to trade-in your old unwanted 3K, 8K or 16K expander. The "Golden RAM", by Voice World, contains an extra 24K of RAM, plus four expansion slots, for \$US149.

I do not know of any dealer or distributor importing any of these for sale in New Zealand.

I have also seen advertised overseas many different versions of 64K RAM expansion for the VIC. My advice on these would be no. The VIC cannot address any more than a maximum of an extra 35.5K (and only 24K of this can be used for BASIC). Any more has to be handled by some "paging" type of bank switching which, in my opinion, is of very limited use on a VIC: in fact, it would have only a novelty interest.

Coming closer to home. The prices I listed for Commodore's memory expanders in the July column are now out of date. Prices were reduced from July 1 to: 3K, \$59.95; 8K, \$89.95; 16K, \$129.95; Super Expander, \$69.95.

The reason for these reductions was a decrease in the sales tax rate. But this was *pre-devaluation*, and as I write this, it is not clear whether prices will have to rise again.

## Commonsense tape tips

By Peter Archer

In a previous column (July), I covered some of the tape loading problems that puzzle beginners. The Commodore datasette unit is usually an extremely reliable unit, as long as a few commonsense precautions are taken. The following tips also apply to most other brands of computer tape units, and I make no claim to originality; but so many people fall down on these elementary points they are well worth repeating again and again.

Keep your heads clean. A dirty tape head cannot work efficiently. If you use your datasette every day, clean its tape heads fortnightly. The approved method is with a "cotton bud" dipped in isopropyl alcohol (rectified spirits). Plain (not coloured) methylated spirits will do, but rectified spirits is best. Buy a small bottle from your local pharmacy.

Unplug your datasette from the computer. Open the lid, and press the "play" button. Clean both the erase (plastic) and the record/play-back (metal) head with a cotton bud dampened (not dripping wet) with rectified spirits. There should be no noticeable dirt on the bud when you have finished. If there is, the head must have been extremely dirty.

An occasional clean of the "pin roller" (the round black rubber roller at the right) is also advisable to remove any build-up of oxide deposit. Do not be alarmed if this leaves the bud very dirty (especially the first time you clean it) — as the rubber roller always sheds some black substance.

Once you have clean heads, do not spoil them again by using sub-standard blank tapes of the type sold very cheaply by chain stores. Some of these are very poor quality, and may shed their oxide coating quickly onto your clean heads.

This also accelerates head wear, and poor quality tapes make unreliable recordings. Surely your programs are worth recording on good quality tape.

It is difficult to give specific advice about tape brands, as there are so many on the market. But if a tape is much cheaper than most other brands, suspect its quality unless proved otherwise.

As the tape passes the record/play head, the head acquires a small permanent magnetic charge. This should occasionally be removed by "demagnetising" the head. Your local computer or hi-fi dealer should be able to do this for you at a very modest fee (or for free). Again, the frequency required depends on usage rate. But for the average hobbyist, I would suggest every few months.

Now your heads are clean and demagnetized. But — you are still having trouble loading tapes, especially pre-recorded ones. Maybe your record/play head is out of alignment.

Sad to say, not all Commodore datasettes leave the factory with their record/play head in perfect alignment. And sadly, not all dealers are fully aware of this. So if your datasette is still giving you lots of trouble even with clean and demagnetized heads, take it back to your dealer and request that the head alignment be checked.

This is a five-minute job for someone with the correct equipment and knowledge. If your dealer says it needs sending back to the distributor for checking, ask (tactfully) if he will lend you a spare while it is away. If anyone finds it impossible to get a datasette head alignment checked, feel free to write to me (c/- Bits & Bytes or at P.O. Box 860, Nelson) for advice.

## BUY NOW AT PRE-DEVALUATION PRICES!!

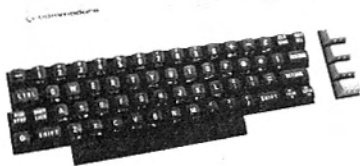

SX64	— \$2995
Commodore 64	— \$895 (\$200 Deposit)
BBC	— \$1930 (\$400 Deposit)
Electron	— \$795 (\$200 Deposit)
Spectrum	— (16K \$399) (48K \$599 — Dep \$150)
Vic 20	— \$399 (\$100 Deposit)



**Patrick Dunphy (Manager)**  
— Patrick has 15 years practical computer experience and can help you with the selection and choice of computing to suit the home user or small business.  
— Patrick offers you personal service before and after the purchase of your computer.

*Auckland's largest selection of programs, books, games, programming courses, paper, all accessories, cassettes, cartridges, etc.*

*Business systems also available. Mail orders and all credit cards accepted. Hire purchase available.*

## SUPATECH ELECTRONICS

430 MT. EDEN ROAD, MT. EDEN

P.O. BOX 2600 AUCKLAND

TELEPHONE 605-216

# SAVE \$100 ON A 48K SPECTRUM!

Don't sell your 16K Spectrum – upgrade it to 48K with the Softshop upgrade kit. No soldering – the chips just plug into sockets already there in the 16K version. No special tools – just two screwdrivers and your own two hands. No experience needed, either – kit comes with very full instructions, including a diagram showing exactly where each chip has to go. Only

**\$93.79**

**WHANGAREI:** Coutts the Chemist, Bank St. **AUCKLAND CITY:** Softshop, 421 Queen St (just below K Rd). **AUCKLAND CITY:** K Road Computers, 65 Pitt St. **HENDERSON:** Rathgar Road Bookshop, 126 Rathgar Rd. **HIGHLAND PARK:** Highland Park Bookshop, 503 Pakuranga Hwy. **MAIRANGI BAY:** Noble's Stationery, 358 Beach Rd. **MANUREWA:** Steven's Stationery, 180 Great South Rd. **PANMURE:** The Spot, 142 Queen's Rd. **ST HELIERS:** Daniel's Bookshop, 28 St Heliers Bay Rd. **HAMILTON:** Dollar Save Comput-a-Centre, Ward St. **MORRINSVILLE:** Echlin's, Thames St. **WAIHI:** Computoid Centre (div of Spectrum), Lower Seddon St. **TAURANGA:** Devon Mall Books & Stationery, 11 Devon Mall. **GISBORNE:** Eastwood's Bookstore, Gladstone Rd. **TAUMARUNUI:** Robertsons Shopping Plaza, Hakiha St. **NEW PLYMOUTH:** Thomas Avery & Sons, 79 Devon St. **NAPIER:** Marsden's Book Co Ltd, Emerson St. **WANGANUI:** Poynters Bookshops, 65 and 67 Victoria Ave. **PALMERSTON NORTH:** Ruahine Bookshop, 246 Ruahine St. **WELLINGTON:** Cardville, 84 Main Rd, Johnsonville. **PICTON:** Ward's Book & Stationery Centre, 28 High St. **CHRISTCHURCH:** Bishopdale Book & Toy World, Bishopdale. **CHRISTCHURCH:** Merivale Bookshop, Merivale Mall, 189 Papanui Rd. **DUNEDIN:** Hyndman's Bookshop, 17 George St. **CROMWELL:** Cromwell Newsagency, Melmore Tce.

## PROGRAMMERS WANTED – TOP ROYALTIES

NZ's fastest growing chain of software outlets – 25 now, soon to be 50 – needs more good games for Sinclair, Commodore and Sega micros, also interesting learning programs for pre-schoolers. If you have a good idea, we have the resources – help, advice and good royalties – to back it. Please contact Softshop Wholesale Ltd, Box 6457, Auckland, or drop in to 421 Queen Street for a chat.

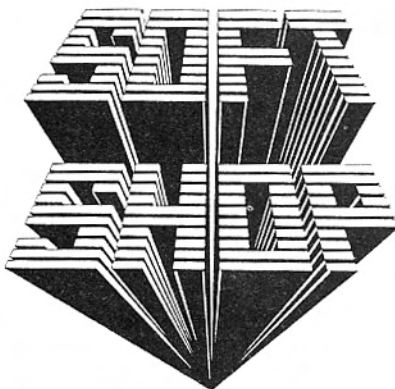

## FARMING

# System for farmers

Hewlett-Packard and Yates have joined forces to produce a system to help farmers manage land, labour, capital and other information.

Farmfax, launched in Wellington in early August, will be marketed by Yates.

Written in conjunction with New Zealand farmers for local conditions, it has individual information packages to meet the specific needs of the livestock farmer, horticulturist, dairy, deer, cropping and bloodstock farmers, and other special areas.

Farmfax will run on Hewlett-Packard's HP 150. It can be personalised to suit an individual farmer's requirements, and updated as and when necessary.

The system handles all basic accounting requirements including cashflow analysis, variance reports, operating budgets, stock reconciliation and profit and loss accounts. It also features a diary facility, break-even analysis, sensitivity analysis, automatic budgeting plus a full range of reports comparing actual results with budgets.

An individual information package, such as that tailored for horticulture, features block details, expenses, income analysis, packing and so forth. It also produces reports showing orchard, crop, block and variety analyses and other required special orchard reports.

Yates intends to establish backup to the individual farmer – Farmfax information systems in the form of regional information pools or database containing information relating to the various types of farming. Farmers can dial up these databases and feed in their own statistical information, providing an industry-wide information.

## Peripheral agent

Thorn EMI Measurement & Appliances NZ, Ltd, (P.O. Box 19125, Avondale, Auckland) has been appointed the New Zealand agent for computer peripherals manufactured by the UK parent company's Datatech subsidiary. The range includes what is claimed to be the world's 'smallest standard half inch compact "streamer" for disk drive to tape data transfer.

The New Zealand company also distributes (on a non-exclusive basis) printers and Winchester-type disk drives manufactured by Fujitsu, of Japan.

# Joy all round

By Alex and Fred Wong

I watch captivated, as Fred puts the joystick, one of three products from the Auckland firm, B.C. Micro, through its paces by playing an arduous game of Lode Runner. At some point over level 60, I tore my eyes from his screen and focussed on a blank page...

The joystick comes in a custom brown cardboard box. It is connected to the Apple II's games I/O port by a four-foot length of cable which leads into a black plastic case that sits sturdily on the table on grippy rubber feet.

Mounted on the rather crudely cut aluminium plate top (affixed to the case by four screws that just encourage tampering) on the left hand side are buttons 0 and 1. On the right hand side is the non self-centring, contoured aluminium joystick that fits snugly in the hand.

The joystick operation is good, its smooth and solid travel allowing steady, fast control, although when swivelled around at its extremity it has a tendency to scrape against the case top.

The buttons are positive, emitting a little click when depressed fully, and sensitive enough for extended use without excessive fatigue. However, they are arranged unconventionally; button 0 is at the top away from the operator, and Fred was so perplexed by this he rewired them to place button 1 at the top before using it's extensively (though B.C. Micro will redress personal preferences).

While there are some rough edges and some possible improvements, it is none the less a good solid joystick that should give many hours of smooth, reliable use.

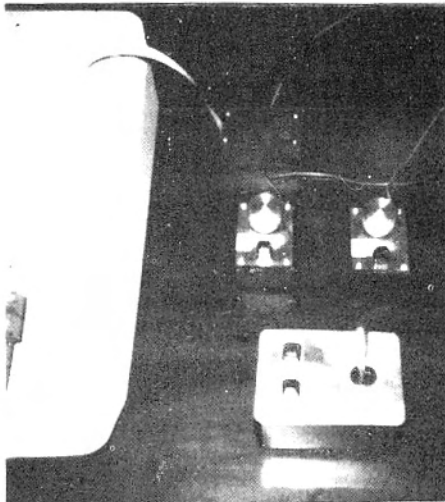

The joysticks

## Two at once

The games I/O expander (into which the joystick is plugged) allows two joysticks to be operated at once, and up to three joysticks or paddles to be connected to the Apple externally.

Its two-foot cable plugs into the games I/O port and slips out the back or side of the Apple to terminate at the other end in a black plastic box on top of which there are three similar ports. A toggle switch on the side of the box determines which one of the first two ports is active as the third 'expander' port is always active.

We tried this by plugging a joystick into port 1 and another into the 'expander' port and playing that excellent basketball game, Julius Irving and Larry Bird go one-on-one. Both joysticks worked perfectly, and I won!

Overall, the quality and operation is excellent, although it is not obviously necessary if no more than one device is to be connected.

In port 2 of the expander, we have the last of B.C. Micro's product line, a pair of

paddles. Although the cables are somewhat stringy, the top plates of the paddles are countersunk into the plastic cases, giving them a rather 'professional' look. On the top is a large sculptured aluminium knob and just below that, nearer the user, a bright red button.

They work well. The knobs are very smooth to turn with a good float and steady rotation. The buttons on each of them are very conveniently placed and only the slightly tacky labels detract from their appearance and operation. They are very presentable and since they often serve a different function from a joystick, can be extremely useful.

Even though this equipment is fairly basic in presentation, its operation is highly satisfactory. And at \$40 for the games I/O expander and \$35 each for the joystick and paddles, (\$2 more for the IIE versions), they represent excellent value for money.

The documentation is not the best at the moment but B.C. Micro has assured us that in line with its policy of continued improvement, this is being rewritten. Further enquiry should be made to B.C. Micro, 251 Titirangi Rd, Auckland.

And Fred is passing level 78 and still going...



**BENNETTS** COMPUTER BOOKS

Visit or write to us for N.Z.'s largest range of books covering:

- BBC MICRO & ELECTRON
- ATARI (400, 600 & 800 XL)
- APPLE (II, IIE & Macintosh)
- ZX SPECTRUM/81
- COMMODORE 64 & VIC 20
- TI 99/4A

100's of titles on:—

- BASIC, PASCAL & CP/M
- Other high level languages
- Word Processing & Database
- UNIX

Hardware, Accessories and Software for:

- BBC Micro & Atari Series

Ask for our complimentary Catalogue

Mail Orders/Credit Cards Welcome

**BENNETTS BOOKSHOP**

P.O. Box 138 Palmerston North  
Phone: 83-009/61-809

# New software unveiled

Apple is introducing a new version of Apple Writer II word processing software and demonstrating five new programs for the Macintosh and Lisa personal computers. All were unveiled at the 1984 national computer conference in Las Vegas, USA.

The Apple Writer II word processing software — designed for the latest Apple II personal business computers is an enhanced version of Apple Writer IIE. Enhancements include horizontal scrolling, and the ability to see page and line count in a document before printing takes place.

It also has a built-in-terminal mode, linking one computer to another and giving users access to information services.

In addition, more than 80 software

programs for the Macintosh and Lisa were demonstrated at the conference.

These included Apple MacTerminal, a data communications software package; MacDraw, a graphics program producing graphics and reports; MacProject, a tool for scheduling and tracking projects; Macintosh Pascal, an interpretive, interactive programming environment; and Lisa 7/7, a software package integrating seven business functions into one unit.

All Macintosh software will work on a Lisa, running under MacWorks, the Macintosh operating system for the Lisa 2 family.

Lisa 7/7, MacTerminal and Macintosh Pascal were due for US release last month with MacDraw and MacProject scheduled for this month.

# Macintosh software — at last

by John MacGibbon

As a small business computer, Apple's new Macintosh offers considerable potential at a comparatively low price. However, until quite recently, "potential" was the best one could say about the machine because for so long, it was available with only two programs.

Only one of these programs, the relatively limited word processor MacWrite, was of much practical

benefit. MacPaint, the other program, drew great pictures, but scarcely addressed the pressing needs of small businesses.

Macintosh was launched in the USA with loads of hoopla and promises of a soon-to-arrive flood of independent software. But months went by before any such material appeared. An initial sales boom in the USA tapered off, and by mid-1984, demand had slowed to the stage where dealers were offering Macintosh at discount prices.

Press coverage, typically ecstatic in early days, took on a more critical tone, with some respected publications such as the *Wall Street Journal* churlishly describing the fabled mouse as more a sales gimmick than a practical feature.

No such sales problem appears to exist in New Zealand where dealers are reportedly selling all the Macintosh stock they can lay hands on. The long delay in the general release of the Macintosh in New Zealand no doubt also delayed any outbreak of market cynicism.

In fact, whether by good judgment or good luck, the timing here seems to have been just right because the promised software is finally arriving. (Prospective buyers should heed the standard industry maxim that new software always turns up later than promised.)

## New release in N.Z.

Of interest to many small businesses will be the expected release this month of the IAL suite of programs by the Auckland firm, Interactive Applications Ltd.

The initial release includes three packages: accounts receivable, general ledger and inventory control, each priced at \$595. Users will also have to buy Microsoft BASIC (\$380) to run the software.

The IAL series, the first Macintosh

program to cater directly for New Zealand conditions, is to some extent inspired by the company's successful CHARTER series. However, IAL's managing director, Phil Norman, stresses that the Macintosh packages are essentially new products, aimed at users with simpler requirements.

IAL has made exclusive use of interface routines contained in the Macintosh's ROM. These have allowed pull-down menus, and use of icons to display action choices for selection by either the mouse or keyboard.

Next to word processing, spreadsheets are the most popular small business microcomputer application, and the July release of Microsoft's Macintosh version of Multiplan would have improved the machine's saleability in New Zealand.

The recommended retail price, \$490, is considerably lower than the price for Apple II and MS-DOS versions. The Mac program offers standard Multiplan features, plus enhancements including a facility to reverse the last change to the spreadsheet, faster recalculation, pull-down menus and use of the mouse.

Other Microsoft products for the Macintosh expected before long include Word, a word processor with more features than MacWrite: File, a database; and Chart, for business graphics. Expected retail prices are respectively \$490, \$490 and \$310.

The Auckland wholesale house, Imagineering, has a large number of Macintosh programs either already released or expected within the next few weeks. As well as a variety of business programs, they include the first Macintosh game programs to appear in New Zealand.

Business programs include the well-established PFS File and PFS Report which will retail for \$285 each, or bundled together, \$442. Other database releases will include Mainstreet Filer (\$503) and Helix (\$790).

The much praised idea/outline wordprocessor, Think Tank, is nearly here, and is expected to cost \$292. A Mac version of the popular home accounting program, Dollars and Sense, will cost \$244.

A trifle on the expensive side (it had better be good!) is Professional Music Composer — yours for \$986.

Adventure game addicts who traded their old-fashioned micros in on a Macintosh can now re-enter mysterious worlds via a release of the Infocom company's products: Zorks 1,2 and 3; Deadline and Witness. Prices vary from \$91 for Zork 1 and Witness, to \$134 for Deadline.

Other brain-teasing games include Transylvania, Legacy, Zyphus and Pensate and Run for Your Money. Most will cost about \$95.

At least two Macintosh tutorial programs should be available — MacCoach and Macintosh Complete.

Judging by reports from the USA, we are only seeing the beginning of a large, influx of sophisticated Macintosh



**ORIC-1**  
64k = \$699

COMPARE THE FEATURES

- 64K • 60 Programs
- Full colour & sounds
- High res. graphics
- Centronics Interface
- Hard keys • Monthly mag.

FOR ORIC INFO PACK:  
BARR BROS. COMPUTERS,  
P.O. BOX 177, PAPAKURA,  
AUCKLAND. PH 2989181.

## Teach Yourself

Lotus 1-2-3  
WordStar  
Multiplan  
dBASE II  
MBASIC

and more than 40 others ...

WITH A.T.I.

TRAINING PROGRAMS

(Available for most popular computers).

Become productive with your new computer and software in the quickest, easiest and most direct manner—A.T.I. Computer Based Training programs. Price \$155.

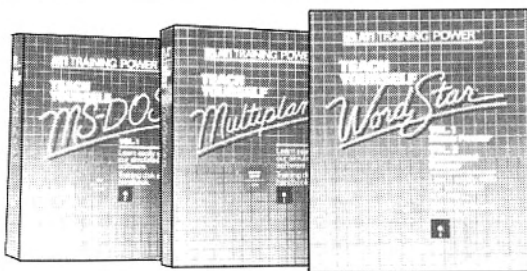

**NOW AVAILABLE FROM YOUR COMPUTER DEALER**

Enquiries and mail orders from:

**TOTAL computer services**

Authorised N.Z. Distributor.

P.O. BOX 1509, DUNEDIN, PHONE (024) 773-944

## MACINTOSH

programs now on, or near, release.

They include Mac versions of many of the big names in microcomputer software, including Ashton Tate's Friday and dBase II. Peachtree programs are also being worked up for Macintosh.

Many new programs were demonstrated in July when Apple staged a software spectacular at the National Computer Conference in Las Vegas. Apple Inc. and 65 independent developers showed more than 80 new software packages for Macintosh and Lisa. Apple claimed that 250 separate companies were now developing Macintosh software and peripheral products.

Major demonstrations of some programs were given on a special three-metre tall mock-up of Macintosh. Products given big Mac treatment included many of the programs already referred to, plus:

Millionaire, a stock market simulation game; FileVision, a graphic database; Market Manager, a stock portfolio program; Spreadsheet Link, a utility that enables users to cut and paste from remote computers into Multiplan documents; MacForth; and Straight Talk and MacTerminal, both communications packages.

A more comprehensive communications package demonstrated at Las Vegas was Habadex, a desktop management system that includes telephone dialing, a data base and appointment calendar.

Possibly most commercially significant of these products, considering its enormous success in the IBM PC and MS-DOS market, was Lotus Macintosh. This was a special version of the Lotus 1-2-3 integrated spreadsheet, information management, graphics, word-processing and communications program (see article this edition of *Bits & Bytes*).

Fifty-five other independent hardware and software developers touted Macintosh products at separate locations during the conference. In addition, Apple itself demonstrated four new programs: MacTerminal, a data communications package; MacDraw, a structured graphics program for generating presentation graphics and reports; Macintosh Pascal; and MacProject.

As well as these packages, a number of software houses demonstrated print utilities for the Macintosh. Assimilation Process had a new program that enabled MacWrite and Multiplan files to be printed on daisywheel printers.

Several other developers, including Apple itself, had packages to enable existing Macintosh files to be printed out on a variety of letter-quality printers.

Apple Inc should be decidedly chuffed about all this software support. There is every sign Macintosh is entering the snowballing software stage that ensured the success of earlier microcomputer giants like the Apple II and the IBM PC.

## IBM

*Richard McLean, a Wellington software consultant, looks at word processing for the IBM PC. This article elaborates on the IBM PC section of the word processing feature of the August edition of Bits & Bytes.*

# The IBM PC and word processing

Word processing led the way for computers into the general office environment during the 1970s. The market leaders, Wang, IBM and CPT, used hardware and software designed specifically ("dedicated") for productivity in word processing to sell successfully into all types of offices.

Buying dedicated word processors was clearly justified in productivity terms, where the competition was typewriters. Entering text is up to 30 per cent faster on a word processor, editing text several hundred per cent faster, and applications like mailmerge (easy on a word processor) were previously almost impossible. No one typed thousands of the same letter on a typewriter.

Many companies were buying word processing, so microcomputer software and hardware vendors quickly introduced word processing into the product ranges, hoping for success in selling into the large word processing market.

Early leaders were packages like WordStar. Designed for eight-bit micros, they were simple and not very friendly.

In the last couple of years things have changed:

The word processing market has grown steadily; buyers have a wider choice of dedicated word processing; prices have fallen; micros have advanced in power and speed; and sophisticated word processing programs are available on PCs.

In this article, we review several of our choices of top word processing programs, which we class as:

- Programs with unique design.
- Look-alikes of dedicated word processors.

### Unique designs

WordStar was the early leader, the largest seller, and is available on most CP/M or MSDOS computers. It includes an optional spelling checker, but compared with newer competition, its lack of sophistication is not reflected in ease of use. Not our favourite.

**NOW AVAILABLE**

## BUSINESS SOFTWARE

### FOR

## MACINTOSH & IBM PC

**HELIX** — the most advanced database ever, introduces new standards in ease of use.

**IO BASE** — rated best database by PC Magazine, includes a bridge to interface to 100 popular spreadsheets, word processors, etc.

**DAVINCI** — Architectural, Files for Macpaint, Interior, Exterior, Landscaping.

**INTEWORD** — Powerful word processor includes Mailmerge.

*Only a few of the powerful programs for the IBM PC and MAC that we support — Send \$2 for a catalogue — or contact us for the name of your nearest dealer.*



**The Software Shop Ltd**

P.O. Box 1057  
Auckland, New Zealand

Telephone:  
(09) 444-5077

## IBM

Spellbinder is another older generation program, but has progressed well over time. The MSDOS version is fast and quite sophisticated with good use of single key stroke functions, and a powerful macro to simplify complex jobs. Changing printer types is flexible and easy and reminds us of expensive dedicated word processors. Includes 50,000 word dictionary. The manual is a bit complex but overall, we like it.

Leading Edge is the name of an IBM compatible PC manufacturer also producing a word processing program. At first glance, I was impressed. The documentation rates 10 out of 10, with excellent indexed colour manuals and helpful quick-reference guide. The word processing features are comprehensive and our reviewer, was impressed.

Microsoft Word is the most different program we reviewed. It makes the best use of "mouse" technology we've seen outside Apple Macintosh. The mouse option does speed up word processing once you become familiar with it. In our first review, we twice ended up with our mouse behind the computer and our nose against the screen! Clever use of windows including editing of three documents at once, enhancing the futuristic concepts in Word. Word processing features are good, but not quite complete in one or two areas and the mouse option, including extra software, adds about \$600 to the price.

### IBM PC and compatible owners and users

Bits and Bytes would like to hear from any owners or users of IBM PC or compatible computers interested in new IBM PC column.

We are looking for articles on:

1. Original programs and utilities.
2. Hardware modifications.
3. Reviews of software.
5. Any other hints or information helpful to IBM PC and compatible owners.

Please write giving details of experience with the IBM PC or compatible, how regularly you could contribute articles and any ideas you may have to:

The Editor, Bits & Bytes  
Box 827, CHRISTCHURCH

## Look-alikes

Multimate is a very successful new program which appears very similar in all aspects to the Wang OIS word processor. New Zealand computer dealers like Multimate's ease of use and powerful word processing features, and it sells well. We felt its menu-driven operation takes a little of the productivity away, although Wang ranks in the top three with the same style on its dedicated word processors.

Displaywrite. The new boy/girl in PC word processing comes from the industry giant, IBM. Available only on its PC and PC XT, this program takes the features of the pen-ultimate level of software from its Displaywriter dedicated word processor and migrates them down to the lower cost PC. Includes 100,000 word dictionary. The software price is low, but the printer requirements a little expensive (at least \$4000). We felt the first edition of the manual needs an upgrade. Over all, another top quality package.

## Summary

All the packages we reviewed were high quality software. The documentation varies, with Leading Edge truly leading by a country mile.

In ease of use, we again rated Leading Edge highly, with Wordstar probably the hardest for typists to use.

Looking ahead at the likely success in the office automation market, the big guns of IBM must have a head start with Displaywrite on their PC and to a smaller degree, Multimate's Wang look-alike could ride on the success of the Wang dedicated word processor.

As a result of our research, we can make a few definite statements:  
Easiest to use — Leading Edge  
Most features — Spellbinder  
Newest technology — Microsoft Word  
Most mainstream — Displaywrite  
Most preferred by dealers — Multimate

(Richard McLean is a consultant with Power Systems, Ltd, of Wellington).

## ATARI

# Thrills of the race

By Michael Fletcher

Pole Position is one of the many new Atari cartridges distributed by Monaco Industries throughout New Zealand. Most of these cartridges are transformations of existing, original arcade games which have been brilliantly programmed to live up to the Atari promise of giving the closest arcade transformation possible for Atari computers.

Pole Position fulfils that promise very well; although not an arcade replica, it is still very enjoyable. It is also very educational — especially if you are learning to drive and want to practise a few techniques before you hit the roads.

As you might have gathered, Pole Position is essentially an arcade driving game (this version was adapted from the arcade game, also made by Atari). The home computer version pits you, in a formula one racing car, against other formula one cars, a time limit and many signposts scattered around the track.

One thing missing in the home version is the advertisements plastered on to the track and verge billboards. These won't affect the game play but do affect the realism.

Nevertheless, Pole Position is an outstanding piece of software. Its graphics surpass even the Atari Soft Commodore version, and the game is just as exciting as in the arcade — minus the 40 cents of course.

## Graphics make the game

The scene is the familiar Fujiama grand prix track in Japan, a setting stunningly portrayed in the back graphics, notably shown as the great Fujiama mountain summits, and the trees surrounding the track. The background graphics move consistently throughout the game, adding to the inertia effect of travelling



# FLOPPY DISK OFFER!

Suitable for all 5.25 inch drives. Guaranteed for 5 years.

Less than 10 disks	Description	Price	Qty	Total Cost
	SSDD	\$5.50		
	DSDD	\$7.40		

10 or more disks	Price	Qty	Total Cost
	\$4.95		
	\$6.58		

(Special quotes on 50 disks or more — Send details on number and type required.)

Add \$1 for postage and packing and send to: Dept BB9, P.C. Power, 420 High Street, Lower Hutt. Telephone (04) 693-050.

Name \_\_\_\_\_

My cheque for \$ \_\_\_\_\_ is enclosed. Please charge my  Visa

Address \_\_\_\_\_

\_\_\_\_\_

City \_\_\_\_\_ Phone \_\_\_\_\_

Signature \_\_\_\_\_ Expires \_\_\_\_\_

## ATARI

around a Japanese race track at 250km/hr.

The object is to navigate your formula one race car around a choice of four different tracks. The first part of the game is dedicated to qualifying on the eight-car grid for the real race. Qualifying involves racing around the track once in an attempt to beat the other drivers and qualify for the race.

Phase two is the actual race, a sort of always-win situation — you always win the race, the real challenge is surviving the race and the time limit for each lap. This is easier said than done; it is very easy to crash and crashing takes up valuable time. When you run out of time for a lap, your car grinds to a stop and the game ends.

The graphics are what really makes Pole Position a thrill to play. The movement for the cars and the track are superbly programmed to make racing around the Fujiama speedway seem almost a real experience. The speed of the graphics is incredible.

The choice of four different tracks also gives the novice player the chance to select the degree of difficulty — one of three race tracks and a practice lap with no other cars to compete against.

Pole Position is available now on a cartridge at all Atari dealers in New Zealand at \$79.95.

Next month, we will discuss a new letter quality printer and review a new Atari game, Jungle Hunt.

# New Zealand Educational Software for the BBC Micro

Barson Computers introduces a new range of educational software for the BBC. These programs have been designed in New Zealand specifically for New Zealand schools and are available only from Whitcoulls Education Branches.

**MUSIC.** Provides computer assisted testing and development for a class of up to 50 users. Difficulty levels from 1 to 99 — from primary school to university. \$110.

**LANGUAGES.** French and German vocabulary and social customs. Designed specifically for the New Zealand School Certificate syllabus. No close teacher supervision required. \$49.95

**GEOGRAPHY.** Two programs — Kiwiquiz, a fun way to test students knowledge of their own country and Regional Patterns of Unemployment, a study in changing patterns of regional development. \$49.95

**SCIENCE.** A series of programmes aimed at School Certificate level and beyond, covering Atoms, Isotopes and the Periodic Table and Ions and Ionic Compounds. \$49.95

**TIMETABLE SUITE.** A comprehensive and fully integrated suite of programs that will produce a complete school timetable. In addition, the program will print lists of students by form, sex, race, year, group etc., generate an examination timetable and automatically check the course fit for each individual student. \$250.

## The BBC Microcomputer System

**BARSON**  
computers

Distributed by BARSON COMPUTERS LTD,  
New Zealand's leading independent computer company.  
1 Ngaire Avenue, Epsom, Auckland. Phone 504-631

## BBC

# In defence of indirection operators

By Pip Forer

This month, we have a quick pep talk on behalf of a little loved group of commands which can actually have some very valuable applications. In any nomination for "least readable pages in the BBC User Guide", a strong contender must surely be pages 409-413, the indirection operators. Even the OSBYTE calls or the section on assembler may attract more interest from the first-time reader. Is this obscurity justified?

The indirection operators are a group of commands from BASIC which allow you to directly look at memory or to send values to particular memory locations. In the User Guide, the first paragraph

mentions their relationship to commands in other computers — PEEKs (look at a memory location) and POKEs (send something to a memory location).

Although certain machines are almost PEEK and POKE driven, it is generally held that PEEKs and POKEs are a bad thing. In any case, if you want to manipulate memory directly, the fashionably acceptable way to do it is to use assembler. Caught between a bad press and machine code programmers, the commands often get overlooked by the quite legitimate body of new programmers who want to work in BASIC. Given their power, this is regrettable.

The three indirection operators consist of the query(?), the pling(!), and the dollar(\$), and can be used as a sort of trio of super flexible PEEKs and POKEs.

With the query, typical BASICs allow the following statements:

```
POKE 16210,N or  
N=PEEK 16210
```

These, respectively, transfer the value of N (which must be between 0 and 255, the range of an 8-bit byte) to location 16210 in memory or take the value in 16210 and place it in N. On the BBC, a single command, the ?, works in place of both PEEK and POKE, its meaning depending on what side of an = sign it finds itself. The equivalent statements to those above would be:

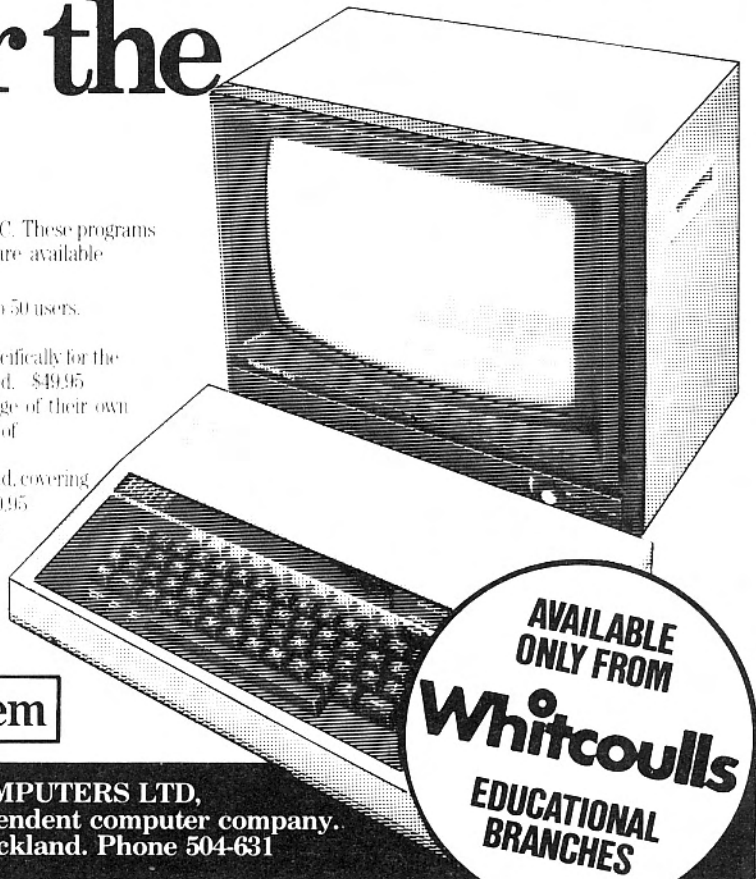

216210 = N and  
N = 216210

The additional operators allow the same operations to be performed on a numeric "word" of four consecutive bytes (!) or on a string of any desired length (\$). Thus:

\$address = "banker"

would place the six characters of the string, "banker", plus a carriage return, into memory starting at the memory location denoted by the value in the variable "address". The same string can be withdrawn into variable E\$ by using:  
E\$ = \$address

As a final touch, both pling and query can be used with two variables specifying location. For instance, X = start+offset would get the value from location (start + offset) and place in variable N.

All of which is to largely paraphrase the User Guide and invite the comment, so what? The hint to "so what?" being answerable is given by the promise of the guide's last comment on the matter: "The tools are provided to enable you to manipulate general tree structures and lists very easily in BASIC". Enigmatic,

but the clue to the value of these commands.

## Sophisticated Monopoly

An extended example might help. Suppose you were creating a geographic simulation, a sophisticated variant of Monopoly, where different players represented different economic figures - a banker, a trader, a farmer. Suppose each player had particular information which needed recording, such as player's status, name, assets value, debts and perhaps a series of code numbers for the property each player controlled.

In such a case, each player might be represented by two string variables (for name and status), two quite large numbers for wealth and several small numbers relating to coded items (27 might mean a sheep farm, 167 a savings bank etc). The simulation would need to keep track of changes in these values, all of which form a very ordered data structure. It becomes even more ordered if you know that all names are of a certain length only (say 15 characters), and any numeric values may be limited in range (assets might lie between \$-1 million and \$+1 million for instance, and the list might have only 255 item codes).

In simple BASIC, you might choose to handle these through a series of arrays. At its crudest but most transparent and workable, each item might be stored in an array (names in Names\$( ), status in type\$( ) and so on). To know the name of player 5 you would look at Names\$(5) and for his wealth in Asset(5).

However, the whole set of data could be saved directly into memory using indirection operators. Starting at a suitable memory location, each player could consist of 2x20 character strings (including carriage returns), two four-byte numbers and (as an example) space for 20 single byte numbers for the list of possessions. This would mean 68 bytes for the first person and the next could start at byte 69. For 10 players, you would use 680 bytes. Getting the name

of the fifth player now would use  
Name\$=\$\$(start+4\*68)  
where start is the first address of your data table.

On the face of it, this seems messy compared with stored arrays. However, there are some advantages to compensate for the lack of immediacy in your program listings. One is memory use. A single byte can hold an integer number between 0 and 255 and with a constrained list, this may be a wide enough range. An integer variable uses four bytes, a real number more than twice that. For all but large numbers, bytes or groups of bytes offer memory saving. This can be important.

A second advantage is ease in saving data. A known data structure in your memory can be easily saved and retrieved using \*SAVE or \*LOAD, each of which works directly with areas of memory. This is neater and much faster than saving array elements to a standard file.

Furthermore, such a data structure can be reloaded anywhere in memory and accessed by the same routines, provided the different start address is corrected for. It becomes quite easy to flip and flop values in and out of memory from disks.

The area of memory containing your values can be easily loaded back into other programs that also seek to use it and combined with other structures more easily than handling them through standard BASIC variables. The values can also be left in the machine while chaining in new programs - a useful way of passing information speedily between programs. The one warning is that, of course, the area in which you keep your data needs to be protected by being aware of the memory demands of your screens and programs and using such options as HIMEM and LOMEM.

That's why indirection operators are worth looking at. If you are short of memory and like fast-moving disk loads, they offer a lot in complex simulations. I'm told the same techniques are very useful in designing adventure quests too!

Next month, back to hardware. A review of perhaps the best hardware add-on I have seen for the Beeb - the 128K RAMDISK/Sideways RAM card produced by Solidtech.



**ORIC-1**  
64k = \$699

**COMPARE THE FEATURES**

- 64K • 60 Programs
- Full colour & sounds
- High res. graphics
- Centronics Interface
- Hard keys • Monthly mag.

**FOR ORIC INFO PACK:**  
BARR BROS. COMPUTERS,  
P.O. BOX 177, PAPAURA,  
AUCKLAND. PH 2989181.

## New Zealand's BBC computer specialists!!

We also sell Torch, Hewlett Packard (HP150) and Sega computers

**TOWER**  
COMPUTING (N.Z.) LTD

P.O. Box 25-091, Christchurch, Ph (03) 61-275

Return to TOWER COMPUTING (NZ) LTD

P.O. BOX 25-091 CHRISTCHURCH

I am interested in the following.

- The G.S.L. Winchester System
- 10 M.B. Hard Disc
- 20 M.B. up to 200 M.B. Hard Disc
- The Tower Slim Line Disk Drives
- Your full range of BBC Micros, Peripherals and Software
- Torch Computers & Co Processors
- Hewlett Packard Computers
- Sega Computers

or phone Campbell Egen (03) 61-275

Name: \_\_\_\_\_

Position: \_\_\_\_\_

Company/School: \_\_\_\_\_

Address: \_\_\_\_\_

Phone: \_\_\_\_\_

send me by return full technical information.



# Cutting the margin

By L. Clarke & A.R. Hill

These hints may help you shorten a line which is marginally too long to type into the 64 character input buffer (ie, exceeds two lines on the screen).

The word, "PRINT" may be entered as a question mark (?) saving four character spaces. The word, "REM" or ":REM", may be replaced by an apostrophe ('), saving either two or three character spaces.

The computer will convert the (?) to the token for "PRINT" when it is stored in the memory, so that when the line is listed, it will appear as "PRINT". If the line then exceeds 64 characters on the screen, it will "wrap around" onto the next line, but will still function normally. Of course, the on screen editor uses the input buffer, and any attempt to edit a

line exceeding 64 characters will result in the loss of all text after the 64th character displayed on the screen!

The following functions must be POKEd into an existing line in a BASIC program.

**Example 1:**

If the first line of a program is used (eg, line number 1), then the first memory location past the line number is 31469. This does not change regardless of the number of digits in the line number because all line numbers are stored in memory as a two byte code.

**Example 2:**

If you want use any of the following functions in the middle of a program — just type up to the place where you wish to insert the function, place a dummy character in that position, and press [RETURN].

Immediately (with no line number) type in the following  
 PRINT PEEK(30969) + 256 \* PEEK(30970) - 4.

This will give you the memory location of the last character you typed into the last program line (in this case the dummy character). Memorise this number (write it down!) then finish typing in the BASIC line, continuing immediately after the dummy character.

When you have finished typing in the line, LIST it and check it is correct,

because once you have POKEd the function code into the memory location in which your dummy character is stored, you will not be able to edit that line!

You may now POKE the function code into the memorised location which holds the dummy character. If the memory address should exceed 32767, it is first necessary to subtract 65536 to reduce it to an integer for the POKE command to work.

It is assumed you have made no changes (insertions or deletions) to the program before the dummy character, because these would have changed its memory location.

## Election graphics

The explicit graphics used on the television in the run-up to the recent general election, particularly in Eye Witness News, were produced on the Poly. Staff of the Auckland office of Progeni were contracted to work with producers and directors — with very little time between receiving data and completing the task, according to an item in the Polytalk newsletter.

Function No	How to Use	Description
RANDOM	134 1# POKE31469,134	Makes RND( ) statement more random.
DEFINT	153 1#A,B POKE31469,153	Defines all variable starting with "A" or "B" as being integers.
DEFSNG	154 1#C,D POKE31469,154	Defines all variables starting with "C" or "D" as being single precision (6/7 digit floating).
DEFDBL	155 1#E,F POKE31469,155	Defines all variables starting with "E" or "F" as being double precision (16/17 digit floating).
ON	161 1# POKE31469,161	Used with ON GOTO, ON GOSUB or ON ERROR (see below).
ERROR	158 1#* POKE31469,161 POKE31470,158	Used as "ON ERROR GOTO line no".
RESUME	159 1# 1#100 1#100 NEXT POKE31469,159	After error, return to error point. After error, GOTO 100. After error, return to the line after the one producing the error.
DELETE	182 1#150-300 POKE31469,182	Deletes lines 150 to 300 inclusive. Both lines 150 & 300 must exist.
AUTO	183 1# POKE31479, 183:RUN	Automatically prints line numbers starting at 10, increment of 10.
AUTO	183 1#500, 20 POKE31469, 183:RUN  POKE30945,175	Automatically prints line numbers starting at 500, increment of 20. AUTO will print any existing lines found. If the AUTO function was halted with [BREAK], it will now continue from that point.
VARPTR	192 1#(X) POKE31469,192	Used to locate the memory address of a variable.
STRING\$	196 1PRINT#(12,45) POKE31470,196	Will print 12 asterisks "*" (maximum length of string = 256 characters).
MEM	200 1PRINT# POKE31470,200	Tells the amount of unused memory left.
FRE	218 1PRINT#(A) POKE31470,218	Tells the number of unused bytes left in memory.
FRE	218 1PRINT#(A\$) POKE31470,218	Tells the number of unused bytes left in the reserved string space.
CINT	239 1#Z POKE31469,239	Removes all digits after the decimal point.
CSNG	240 1#Z POKE31469,240	Converts numeric variable from double to single precision.
CDBL	241 1#Z POKE31469,241	Converts numeric variable from single to double precision.
FIX	242 1A=#(N) POKE31471,242	Removes all digits to the right of the decimal point. Doesn't round down negative numbers.
ERL	194 1PRINT# POKE31470,194	Returns the line number from which program branched to error routine.
ERR	195 1PRINT# POKE31470,195	Returns a value related to the type of error which last occurred.

These functions may be performed either with or without a line number.  
 For TRON (Trace ON) just POKE 31003,175  
 For TROFF (Trace OFF) just POKE 31003,0  
 The audible "beep" produced when a key is pressed can be controlled.  
 For BEEP ON just POKE 30779,32  
 For BEEP OFF just POKE 30779,0

## Good pool

As time goes on, it seems fewer and fewer quality games are becoming available for the 16K ZX Spectrum. So it is nice to be able to review a well presented game for the unexpanded machine.

The implementation of pool with which you are presented is a little different from the usual. For a start, there are just six balls (plus the cue ball), distinguished only by the fact each has a number which determines its score.

Each player gets three turns at potting balls. However, these turns do not alternate as in real pool; instead, each turn comprises three shots and the score credited is the number of any ball potted multiplied by 10.

The direction of your shot is controlled by a small cross-hair. This is surprisingly easy to master and you will soon be producing fantastic shots.

Pool represents good value for money at \$24.95 and is supplied on tape for the 16K ZX Spectrum.

## Sport database

This program is a companion to Clubfile and indeed, shows much of the

### **BBC Owners!** **VIEW PRINTER DRIVERS**

For Brother Daisywheel typewriters and printers

- Many features
- Suite of programs on 80 track disk only \$50 (cassette also available)

Order from your local BBC dealer or in case of difficulty from:-

**B. Newman**  
PO. Box 482, Kaitaia

## Steven Cragg reviews four games for the 16K and 48K ZX Spectrum.

same professionalism in layout and general program design. The program is basically a database for sports clubs so that any team can keep results for the whole of that league and then the program calculates the league table. The program is very flexible, allowing any number of points for a win or draw, and up to 20 entrants. Almost any sport should find a use for this.

The program itself contains all the instructions with the traditional home of such directions, the cassette inlay, concerned only with loading instructions and restart instructions (to allow restart without loss of data if the program is accidentally stopped).

The only fault I found was the way in which a bye is entered. If you reply to the prompt, "How many teams have a bye this round?" with 0 when in fact, a team does have a bye, the team you do not enter in the fixture list gets credited with a 0-0 draw. This is a nasty fault as I could find no way of eliminating the draw which runs the league table.

In all, this is a good piece of software well worth \$19.95. Supplied on tape, it runs on the 48K ZX Spectrum and is available from: Sportsdata, P.O. Box 383, Wellington.

## Filing system

Clubfile, is as its name suggests, a computer filing system for sports clubs. The program allows you to keep a complete history of your club or team, as well as keeping data such as names of players and coaches. A nice feature is the way in which you can chart the club's past record in both league and knockout competition by means of a bar chart.

The program is menu driven and although written in BASIC, is fast and very professionally written. It is extremely easy to enter data and edit

anything wrong or out-of-date. As the program is written in BASIC, pressing the break key halts execution of the program.

In keeping with the generally high level of this product, the instructions (which are confined to the cassette inlay) tell you how to restart the program without losing all your data.

Overall, this program represents excellent value for \$19.95 and is available on tape for the 48K ZX Spectrum from: Sportsdata, P.O. Box 383, Wellington.

## Unaddictive bears

After seeing it advertised in overseas magazines, I was looking forward to reviewing Bear Bovver. However, when I came to play my first game, I was horribly disappointed. This has to be one of the worst games I have seen for a long while.

It involves running around a building site collecting batteries for your electric car while pursued by the "Bovver Bears". This, in itself, is no worse than other games of this ilk.

However, there are three main problems — the Bovver Bears are too big and you need large amounts of space between you and them to evade capture; the graphics when you are climbing the ladders are horrible and at certain places, you disappear completely (not very good when trying to decide how close the Bovver Bears are to you); getting off the ladders has to be judged absolutely perfectly otherwise you stop on the ladder and this is sure to be fatal. This makes for a very boring game which is totally unaddictive.

Bear Bovver is supplied on cassette for the 48K ZX Spectrum and I consider that it is poor value at \$24.95.

**Buy books  
this month**

**"UNBEATEN 1 YEAR — 1 MONTH — 1 DAY GUARANTEE — Instant Replacement"**

*Computer Plus can help you choose the right computer. We have the experience to advise, and the top brands; Spectrum, Atari, Tele Video to choose from. We also stock printers, paper and disks for Home and Business machines. Come in and see us soon!*

103 Riccarton Rd  
Christchurch

**COMPUTER  
PLUS**

Phone 488-519  
P.O. Box 8100

**HIGH QUALITY**

# BINDERS!

for BITS & BYTES

**\$14.95 EACH**

We now have available binders to hold your copies of BITS & BYTES. We have opted for the same type of binder used last year (pictured) as these provide high quality protection in an attractive finish.

These will be available in two styles.

STYLE 1: With the words "BITS & BYTES, VOL 2, September 1983–August 1984".

(For those who have a complete volume.)

STYLE 2: With the words "BITS & BYTES" only.  
(For recent subscribers or those with a mixture of volumes)

Each Binder holds 11 magazines

**Order now as stocks will be limited!!**  
**Please use the book club order form in the centre of the magazine and be sure to note which style of wording you require.**

**Cost: \$14.95 per binder**

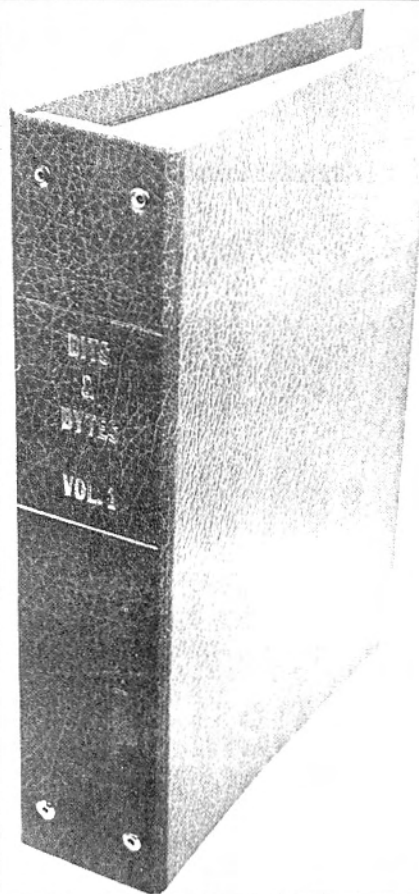

**Order any 10 back issues for only \$10**  
(individual copies \$1.50 each)

— all back issues contain hints and programs for popular brands, a host of microcomputer information and the following major articles!

Nov Issue 3	Review of BBC computer and Microprofessor 1, start of series on selecting a micro for a small business, feature on microcomputers for accountants.	August Issue 11	Reviews of Sord M5, Franklin Ace, Mannesmann printer, Calcstar. Word-processing feature. Start of Commodore 64 column.	March Vol 2 No 6	Reviews of Macintosh, HP150, Z100, daisy wheel printers. Program special.
Feb Issue 5	Hand-held computer feature, review of Sirius 1 and Epson HX-20, start of farming and education columns.	September Vol. 2 No.1	Reviews of V2200, Colour Genie, Multiplan. Communications feature.	April Vol 2 No 7	Communications feature. Reviews of the Electron, DEC Rainbow, Pencil II, Amust.
June Issue 9	Guide to farm software, reviews of Olivetti M20, Dick Smith Wizzard, Visicalc.	October Vol. 2 No.2	Reviews of NEC APC, Epson QX-10, Casio FP 1000 and JR 100. 16 Bit feature.	May Vol 2 No 8	Colour plotters. Reviews of Sanyo 16 bit, Apricot, Televideo portable, Casio lap computer and Sharp MZ-700.
July Issue 10	Reviews of Spectrum, BMC 800, Supercalc, Compute Mate printer. Start of Microbee column.	November Vol. 2 No.3	Reviews of Casio PB 100, Proteus, Cromemco C-10.	June Vol 2 No 9	Printers on the market. Reviews of Dick Smith Challenger, Sord lap computer, Atari 600 and 800 XL.
		Feb Vol 2 No 5	Summary of all computers \$5-10,000 in N.Z. Reviews of Sega, TI99, Franklin Ace 1200 and Epson FX-80 printer.	July Vol 2 No 10	Reviews of Dick Smith CAT, NEC and Tandy lap computers, Financial spreadsheets.

PLEASE NOTE! Any issue not listed here is out of stock and other stocks are limited

**ORDER FORM is on the card in the centre of the magazine**

(or send us a note stating which copies you require together with your payment)

# HARDWARE PERIPHERALS SOFTWARE

*Great range available for  
home computers*

## BBC

## ELECTRON

## CBM 64

## ZX SPECTRUM

### ALL ON DISPLAY IN OUR SHOP

*Come and see us at the  
top of Pitt Street for the  
best personal services  
and backup in town.*

**BANKCARD - VISA - CASH PRICES**

# K'R.D

# COMPUTER

# Co

65 PITT St., AUCKLAND  
Ph. 399-655

## SPECTRUM

# A tidy, compact little printer

By Gary Parker

The new Brother HR-5 printer, at the low price of \$599, may have caught the eye of Spectrum owners thinking of adding a printer to their computer. I was able to try one of these compact little units for a weekend.

## QL: bugs & enthusiasm

The specifications of the new Sinclair QL computer are creating quite a stir: 128K of memory (expandable to 640K), a 32-bit central processor, and built-in microdrives for £399.

The latest information I have suggests the QL is, however, still not bug-free. Sinclair ran out of ROM when writing the control routines, and had to add extra ROM which protrudes in a bulge out of the rear of the computer. The ROM routines have some serious bugs: the computer can be "crashed" so that it locks up (just like a faulty machine code program in RAM).

And despite the fast 32-bit central processor, the Sinclair SUPERBASIC is slow (although structure-wise it is said to be better than BBC BASIC). The QL

## Wheelie hard to beat

Wheelie, by Microsphere, is in the British top 30 at the moment, and is one of the best Spectrum games available. You control a motorcyclist who must find his way through a subterranean maze which scrolls sideways across the screen, avoiding gargantuan hedgehogs and ice patches, jumping over double-decker buses, and, of course, finding fuel.

I've never reached the end of the maze, but I'm told that if you do, a ghost rider awakens and races you back to the cave entrance, when you begin a new maze fraught with even more perils.

Wheelie has some of the most realistic motion I've seen in a computer game. If you jump over a bus too fast, you'll fall off the back of the bike. If you go too slowly, the bike will nose-dive and you'll fly over the handlebars. The game seems slightly too difficult to me, but a younger member of the family loves it.

The HR-5 is a small, neat-looking printer, measuring only 30cm by 17cm by 7cm. It comes in Centronics and RS232 versions. Spectrum owners with Interface One require no further interface, and can plug the printer directly into it. Most printer interfaces for the Spectrum are serial, so if you buy one of these, you will require the Centronics version of the HR-5.

This printer has most of the features of more expensive printers. I won't detail these here but will concentrate on the differences between this printer and others.

The HR-5 is battery powered, although a 6V transformer may be connected. The manual states that smooth finish paper (such as photocopy paper) is required. The roll of paper supplied with the printer is very smooth, and gives a good print.

I tried ordinary printer paper, and the result was poor. So the ability of the HR-5 to print on ordinary letterhead paper and the like is limited.

microdrives are about twice as slow as those of the Spectrum — obviously unacceptable for a machine aimed at taking over the small business market.

There are many things to get enthusiastic about in the QL: the massive memory (with one computer manufacturer describing 8K as massive, how do you describe 128K); the 68008 central processor (a machine code programmer's dream); the built-in microdrives, joystick interfaces, RS232 interface, and hard disk interface; the structured BASIC; the high-resolution screen display; the full-size keyboard; the multi-tasking facility (controlled by a separate eight-bit processor); and the free programs. But unless the ROM routines are improved, the QL will not realise this potential.

Wheelie is for the 48K Spectrum, costs \$24.95, and is available from Whitcoulls or directly from Software Supplies, P.O. Box 865, Christchurch. A Wheelie cassette will be awarded to the winner of this month's contest. All you have to do is display the words "Bits & Bytes" on the screen in the style of lettering seen on the cover of this magazine. The lettering doesn't necessarily have to be as large as on the cover, just as long as it looks like it.

Send your entries, preferably on cassette so that I don't have to type in all that character data, to:

Gary Parker  
(Wheelie Contest)  
P.O. Box 4063  
Christchurch.

Cassettes will be returned only if you include a stamped, self-addressed envelope. Entries close on September 25.

*Exceptionally  
easy to feed*

It is exceptionally easy to feed paper into the HR-5. There is no tractor feed, but the friction feed works well, allowing normal sheet paper to be used. The ribbon (contained in a cassette) is the plastic-film type, and can be used only once. It produces very black, sharp print, but the dots are discrete and produce rather "spotty" characters.

The HR-5 can also print on thermal paper (not the silver stuff that Sinclair uses but paper that looks like ordinary white paper) and a ribbon cassette is not required. Printing is slow — only 30 characters per second (compared with about 100cps for other small printers, albeit for several hundred dollars more) — although this should not worry the home user unduly.

The character set is standard ASCII, with eight extra international character sets. So if you ever want the symbol for a Finnish Markka, you need only flip a DIP switch! All the usual character styles are present — such as enlarged, reduced, and emphasised (which improves the print quality enormously, but slows the speed to 15cps) — except that subscripts are as large as normal writing, simply being raised or lowered on the line, and italics seem to be absent.

There are also graphic and Japanese characters. The number of columns is easy to set, which is important if you want to print 32-column program listings.

I use a Kempston Centronics interface which did not work properly with the HR-5. The unusually slow receiving rate of the printer seemed to cause the interface software to outrun it, so that every second character or so was missed. This is due to the interface software which could be modified to slow it down by a machine code programmer. I was not willing to undertake this task just for a weekend.

I tried the printer on a friend's Spectrum which has an Interface One (RS232) port, with an interface to convert that to Centronics, and it worked perfectly. This means the RS232 version of the HR-5 should work with Interface One. But if you have a Centronics interface, it would pay to check that the Centronics version of the HR-5 is compatible with your interface software.

Overall, the Brother HR-5 is a very good printer, with most of the features of more expensive machines. However, check on prices, since other printers are occasionally on special at prices approaching the HR-5.

(Printer supplied by Computer World, Christchurch.)

*Awkward to  
type in*

While on the subject of printers, have you noticed that printer listings for the

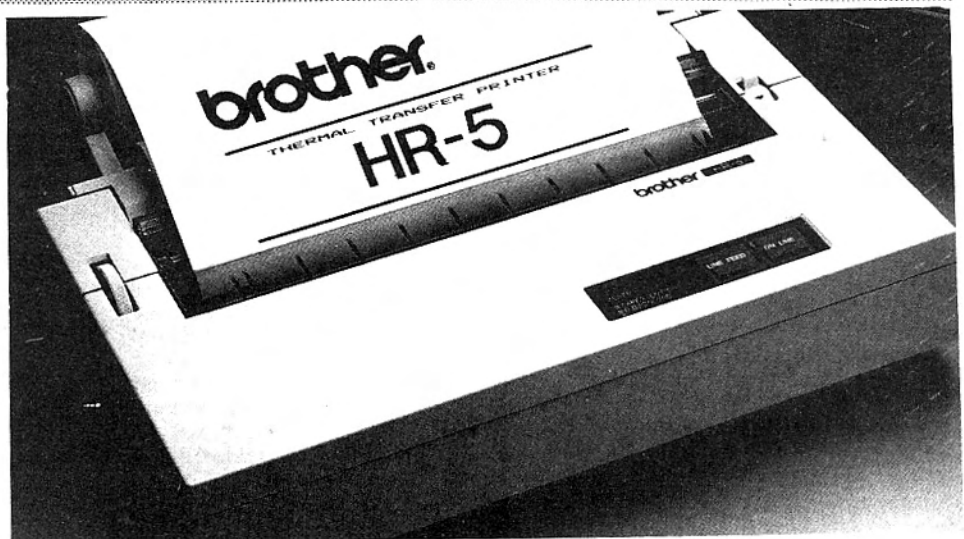

*The Brother HR-5 printer*

Spectrum which contain user-defined characters are awkward to type in, since extra comments are required to indicate which graphic is which letter?

A good way to avoid this problem is to use the CHR\$ function: instead of PRINTing the character itself, PRINT its code number preceded by CHR\$. For example, instead of:

PRINT "a"  
where "a" is the user-defined character

"a", use:  
PRINT CHR\$ 144

The user-defined characters "a" to "u" have codes 144 to 164, as listed on page 138 of the Spectrum manual, so any user-defined character can be PRINTed in this way. This will avoid the confusion of having a listing full of little Pacmen which nobody knows how to enter — a special point to consider when sending a program to *Bits & Bytes* for publication.

LIMITED OFFER!

## SMITH CORONA

### Daisywheel printers

Normal retail

~~\$1299~~

Now reduced to clear

**\$799**

**SPECIFICATIONS**

Print Speed: 12 CPS

Character Set: 128 ASCII, 93 printable

Character Spacing (pitch): 10 CPI or 12 CPI

Printing: Unidirectional

Paper Width: 13" (33cm) maximum

Writing Line: 10.5" (26.7cm)

- 105 character line in 10 pitch
- 126 character line in 12 pitch

Line Spacing: 6 lines per inch (4 or 3 lines per inch manually selectable)

Paper Feed: Friction — single sheet or forms. Tractor option

Page Length: 11" or DIN A4

Paper Thickness: 0.22" maximum

Impression Control: Operator selectable 5 level

Interface: Serial and Parallel included

Parallel: Centronics compatible 7 bit ASCII data, 3 control lines (Data Strobe, Busy, Acknowledge)

**Serial:** EIA RS232C-DTR; EXT/ACK; X-ON/X-OFF; Baud Rate (50-19,200), Parity, Character Bit Length, and Busy Polarity, are DIP switch selectable by operator.

**CASH with Order PLEASE Be quick! 12 only!**

Please make your cheque out to:

**Microcomputer Specialists & Software Ltd**

Post to: 61 Hobson Street, P.O. Box 39-075, Auckland West. Phone 798-569.

# Sprites: a lot of fun

By Barbara Bridger

A lot of the enjoyment of using a Spectravideo 318 home computer comes from creating and moving "sprites" — programmer defined shapes.

Sprites can be formed only when using either the high (1) or low (2) resolution graphics screen. There is a choice of two sizes of sprite for each screen: size 0 and 1 with screen 2; size 2 and 3 with screen 1. Sprites for screen 2 may be only an 8 x 8 pixel array while sprites for screen 1 can be built up from a 16 x 16 or an 8 x 8 pixel array.

After deciding whether the sprite is to be an 8 x 8 or a 16 x 16, the next stage in designing one is to decide which of the pixels in the array are to be on and which are to be off. For example, for an 8 x 8 sprite in the shape of the letter L, you could have:

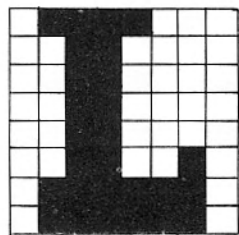

The pattern of blank and filled-in squares may then be translated into data statements of the form  
DATA 01111000

```
DATA 00110000
DATA 00110000
etc where 1s represent filled-in squares
and 0s represent blank squares. The
sprite may then be formed using the
following loop in your program (line
numbers are omitted).
```

```
S$ = ""
FOR I = 1 TO 8
READ A$
S$ = S$ + CHR$(VAL("&B"+A$))
NEXT I
SPRITE$(1) = S$
```

The sprite is put on to the screen with the statement  
PUT SPRITE 2,(100,120),6,1  
Here the 2 is plane 2 and there can be only one sprite on each plane; 100 is the column and 120 the row position of the sprite; 6 is the colour and 1 the sprite number.

When forming a 16 x 16 sprite, the 16 data statements for the left-hand side must be entered first, followed by the data statements for the right-hand side. The loop must then read in from 32 data statements.

Typing in all the necessary 0s and 1s can become rather laborious, particularly for 16 x 16 sprites. But this step can be shortened by converting the binary pattern of blank and filled in squares to decimal numbers, one number for each row of eight squares. For the L sprite, this would give the data statement.

```
DATA 120,48,48,48,48,50,126,126
The sprite is then formed with the
statements
```

```
S$ = ""
FOR I = 1 TO 8
READ A
S$ = S$ + CHR$(A)
NEXT I
SPRITE$(1) = S$
```

and put on to the screen as before.

One sprite can be put on to the screen at a number of different positions and with different colours if desired. The following program illustrates this process of forming sprites and uses them in a simple shooting game:

```
10 CLEAR 1000
20 COLOR 15,1,3
30 SCREEN 1,2
40 FOR I= 2 TO 15STEP3
50 LOCATE 100,90
60 PRINT "SHANE'S SPRITES"
70 COLOR I
80 FOR J= 1 TO 100:NEXT J
90 NEXT I
100 CLS
110 DIM X(5),Y(5),C(5),B$(19
2]
120 G3=0:G9=0
130 X(1)=20:X(2)=60:X(3)=100
:X(4)=140:X(5)= 90
140 Y(1)=20:Y(2)=60:Y(3)=100
:Y(4)=140
150 C(1)=11:C(2)=12:C(3)=8:C
(4)=13
160 FORJ=1TO6
170 A$=""
180 FORI=1TO32
190 READ A
200 A$=A$+CHR$(A)
210 NEXT I
220 SPRITE$(J)=A$
230 IF J=1 THEN B1$=A$
```

```
240 IF J=2 THEN B2$=A$
250 IF J=3 THEN B3$=A$
260 IF J=4 THEN B4$=A$
270 IF J=5 THEN B5$=A$
280 NEXTJ
290 B$=B1$+B2$+B3$+B4$+B5$
300 DATA 0,0,0,3,4,4,4,127
310 DATA 156,162,162,162,92,
63,0,0
320 DATA 0,0,0,194,62,62,34,
254
330 DATA 57,69,69,69,58,252,
0,0
340 DATA 1,1,3,70,172,164,18
8,160
350 DATA 184,164,162,227,7,1
5,0,0
360 DATA 0,0,128,196,106,74,
122,10
370 DATA 58,74,138,142,192,2
24,0,0
380 DATA 0,0,1,1,2,4,4,4
390 DATA 68,92,120,120,248,2
48,252,3
400 DATA 0,0,128,128,64,32,3
2,32
410 DATA 34,58,30,30,31,31,6
3,192
420 DATA 0,1,29,59,123,123,1
25,8
430 DATA 60,1,1,0,1,1,3,0
440 DATA 254,255,255,255,255
,255,255,254
450 DATA 140,206,206,132,140
,206,222,0
460 DATA 0,0,0,15,63,7,1,7
470 DATA 8,16,96,224,49,10,6
,1
480 DATA 30,37,37,165,189,16
1,33,255
490 DATA 1,1,1,1,155,103,102
,152
500 DATA 0,0,0,0,0,0,0,1
510 DATA 3,1,0,0,0,0,0,0
520 DATA 0,0,0,0,0,0,0,128
530 DATA 192,128,0,0,0,0,0,0
540 PUT SPRITE 5,(240,90),1,
5
550 RN=RND(-TIME)
560 C=0:G=0:SB=0
570 FOR J= 1 TO 40
580 STRIG(2)ON
590 FOR I=1 TO 4
600 R(I) =INT(RND(1)*10):NEX
T I
610 FOR K=1 TO 20
620 FOR I= 1 TO 4
630 IF R(I) < 5 THEN X(I) =X
(I) + (2*I) ELSE X(I) =X(I)
-(2*I)
640 IF X(I) >190 THEN X(I)=
-20
650 IF X(I)<-20 THEN X(I)=19
0
660 PUT SPRITE I,(Y(I),X(I))
,C(I),I
670 ON STRIG GOSUB 780
680 STRIG(0)ON
690 D=STICK(0)
700 IF D=1 OR D=2 OR D=8 THE
N X(5)=X(5)-3
710 IF D=6 OR D=4 OR D=5 THE
N X(5)=X(5)+3
720 PUT SPRITE 5,(225,X(5)),
7,5
730 NEXT I:G3=G3+1:NEXT K
740 LINE(190,173)-(225,192),
4,BF
```

## COMPUTER GAMES FOR HIRE

Games available for weekly hire for the following computers:

- \* ATARI 400/800 \* APPLE
- \* TRS 80/SYSTEM 80
- \* COM 64 \* VIC 20 \* BBC

Send for catalogue and membership details to:

COMPUTER GAME RENTALS  
P.O. BOX 30947, LOWER HUTT.

Name .....

Address .....

Type of Computer .....

```

750 LOCATE 195,182:PRINT 800
-63
760 NEXT J
770 GOTO 980
780 STRIG(0)OFF: SOUND6, 21: SO
UND7, 21: PLAY"s6m9000v818a"
790 SPRITE ON
800 SB=0
810 FOR K= 210 TO - 20 STEP
-2
820 PUT SPRITE 6, (K, X(5)-5),
6, 6
830 ON SPRITE GOSUB 880
840 IF SB=1 THEN GOTO 860
850 NEXT K
860 SPRITE OFF:PUT SPRITE 6,
(-10, 290), 6, 6
870 RETURN
880 SPRITE OFF: SOUND6, 15: SOU
ND7, 21: PLAY"s6v9m200018aa"
890 IF K>15 AND K<40 THEN X(
1)=192:PUT SPRITE 1, (-15, 290
), 2, 1:G1=80
900 IF K>50 AND K<75 THEN X(
2)=192:PUT SPRITE 2, (-15, 290
), 2, 2:G1=60
910 IF K>90 AND K<115 THEN X
(3)=192:PUT SPRITE 3, (-15, 29
0), 8, 3:G1=40
920 IF K>140 AND K<155 THEN
X(4)=192:PUT SPRITE 4, (-15, 2
90), 1, 4:G1=20
930 LINE (190, 0)-(220, 20), 4,
BF
940 C=C+1:G=G+G1:LOCATE 192,
7:PRINT G
950 IF C=20THEN GOTO 980
960 SB=1
970 RETURN
980 SCREEN 1, 3:LOCATE 100, 10
0:PRINT"GAME OVER"
990 G9= 800-63
1000 LOCATE 50, 130:PRINT"YOU
SCORED ";G9;" TIME POINTS"
1010 LOCATE 60, 145:PRINT" A
ND ";G;" HIT POINTS"
1020 LOCATE 64, 160:PRINT"TOT
AL ";G+G9;" POINTS"
1030 FOR J= 1 TO 5
1040 SPRITE$(J)=MID$(B$, ((J-
1)*32)+1, 32)
1050 PUT SPRITE J, (J*40, 40),
J, J
1060 NEXT J
1070 FOR J= 2 TO 15
1080 FOR K= 1 TO 5
1090 CL =J+K
1100 IF CL>15 THEN CL=CL-14
1110 PUT SPRITE 1, (K*40, 40),
CL, K
1120 FOR N= 1 TO 300:NEXT N
1130 NEXT K
1140 FOR I= 1 TO 500:NEXT I
1150 NEXT J
1160 CLS
1170 END

```

Use the joystick to control the up and down movement of the rightmost tank and the space bar to fire.

(Any reader interested in programming sprites using decimal numbers instead of strings of 0s and 1s but not wanting the effort of binary to decimal conversion could send a s.a.e. and \$1 postal note to "Binary to Decimal", 11 Mawson St, Lower Hutt to receive a copy of the 255 possible combinations of 0s and 1s with their decimal equivalents).

## The sound generator

By Brian Gibbs

The SC3000 uses a SN76489 IC as its sound generator. This IC has three sound channels and one noise generator. The three sound channels are completely independent of each other and so it is possible to play two or three tunes simultaneously.

The Sega manual is somewhat confusing in its explanation of the SOUND command, especially when it mentions such phenomena as "silences noise".

The manual refers to six sound channels (0-5). The first channel (0) actually turns off all three sound channels plus the noise generator. No other values are required, and so the valid command to achieve "silences noise" is SOUND 0.

SOUND 0 is the only command that does not require three values. When any of the other channels are used, the SOUND statement must follow the format SOUND C,F,V where C = Channel, F = Frequency and V = Volume.

Channels, 1, 2, and 3 refer directly to sound channels 1, 2, and 3. Each of these channels can generate tones simultaneously from a frequency of 110 Hz up to 3520 Hz. The frequency table is on page 136 of the Sega manual. The sound volume of each channel can also be controlled independently. The valid values are from 0-15 where 0 is off, 1 is minimum volume and 15 is maximum volume.

For example:  
SOUND 1, 110, 15 produces a 110 Hz tone at maximum volume on channel 1.  
SOUND 2, 1000, 8 produces a 1000 Hz tone at medium volume on channel 2.  
SOUND 3, 3520, 1 produces a 3520 Hz tone at minimum volume on channel 3.

Note it is possible to turn any of the three channels off independently by using 0 as the volume figure.

Channel 4 is the noise generator set to produce white noise. The frequency of the white noise can be set to either one of three predetermined values by entering the figures 0, 1, or 2, or can be set to the same value as the frequency previously assigned to Channel 3 by entering the value 3.

The volume values are again 0-15 where 0 is off, 1 minimum and 2 maximum volume. The three predetermined figures mentioned are set by the computer and can be calculated by dividing the clock speed of the Sega SC3000 (3.57 Mhz) by the figures 512, 1024 and 2048 respectively.

Channel 5 is the noise generator set to periodic noise. The frequency and volume is set in exactly the same manner as for channel 4.

## Change of outlook

Andrew Tearle, who opened the first retail byte shop in Auckland in 1982, has joined Barson Computers (NZ), Ltd, as product manager. He is responsible for the Apricot range of microcomputers and systems, and Sirius microcomputers. The company also handles Acorn, BBC and Electron microcomputers.

## LAZY WRITER — Word-processing software for TRS-80/System 80 users!

Word processing means you enter text from your keyboard, make changes to it on the screen, store it on disk, and print it out whenever you want. To use Lazy Writer, you need 32K of memory, at least one disk drive, and a printer. You use Lazy Writer with a Disk Operating System (DOS), either TRSDOS or any of the popular DOS's sold for use with a TRS-80.

Lazy Writer is probably the easiest word processor to use of any on the market. Our users and reviewers have consistently mentioned how easy this programme is to learn. Lazy Writer has two modes of operation: Text Entry and Editing. Once you have entered and edited your text, a simple command loads the printer module and you're ready for hard copy.

Lazy Writer® Mod I and III — \$295.00

For further information send \$4.50 for a copy of our latest 90 page Catalogue — or



**Molymex Ltd**

P.O. Box 60-152  
Titirangi  
Auckland  
New Zealand

Phone orders only:  
ring 817-4372 collect  
All other enquiries:  
ring 836-9873

Dealer Enquiries Welcome

Bankcard/Visa accepted

# Here is the news — & the answers

By Gordon Findlay

Some news this month, and the answers to some questions received over the last few weeks. I have sent the answers to the questioners, but they might be of general interest.

News first. You'll have seen last month's review of the Tandy 2000, an MS-DOS business machine priced well beyond hobby level, of course! Plans are well developed at the time of writing for importing the Tandy Radio Shack Model 4 and 4P as well. This will be major news for the TRS80 fraternity. The Model 4 is the successor to the Model 3; the 4P is a portable (like the Osborne computer) version.

The Model 4 will run just like a Model 3. However, in Model 4 mode, it has significant improvements. Memory may be expanded to 128K (it usually is), the display becomes 24 lines of 80 characters, and both parallel and serial interfaces are built in.

Most interesting of all, the Model 4 will run under the CP/M Plus operating system. Now CP/M isn't a great operating system by any means, and it is very dated compared with many newer DOSes. But, and it's a big but, there is a lot of software out there for CP/M machines.

## Personnel package

A flexible software package, tailored to suit personnel consultants, has been developed by Bob Chambers, of Rakon Computers Ltd.

The multi-user system can be run on any machine that runs BOS software.

Classifications for files are user definable; and data can be interrogated under several different headings.

This allows swift elimination and sorting when purusing files. The package should adapt well to other industries where cross reference and requirement "pairings" are important.

Further information: Rakon Computer Ltd, Private Bag, Newmarket. Phone 600-421.

The model 4P differs only in the size of the screen, and use of slim-line drives. As seems usual for Tandy, yet another version of TRSDOS is being distributed with these computers, and the usual thing has happened — reviewers have rubished it! By the time you get one though, the problems will have been sorted out.

The Model 4 is good news to those of us with Model 1s or similar. It proves there is still some life in the Model 1/3 line. Let's hope the Model 4 won't be astronomically expensive in New Zealand, and will be a big enough success to be around for a while. Only time will tell.

## Questions & answers

Now some questions. The first is about loading tape games on to disk. A reader has a game which starts automatically and has had trouble getting it loaded to disk. Funnily enough, I have a similar problem with two games myself. Games which auto-start often contain code which loads into separate parts of memory. Many load graphics characters directly on to the screen, its memory too.

Most tape to disk utilities don't like this sort of thing. The NEWDOS utility, LMOFFSET, complains about "bad main memory" which gives a bit of a fright. Others complain "data not contiguous." Either way, there isn't a lot to do about it. I can tell you the problem, but haven't yet got a solution. Has anyone managed to solve this one? Send me the info, and I'll past it on through *Bits and Bytes*.

Another letter asks why there are so many different DOSes available for the TRS80. The answer is twofold. Firstly, the original operating system, TRSDOS, was pretty unsophisticated, and in places rather clumsy. It certainly didn't fully exploit the capabilities of the machine. Secondly, so many TRS80s were sold that many programmers and companies saw them as a source of profit! The various operating systems all expand on the common core of TRSDOS, adding commands, expanding others and correcting bugs. Adding a disk also allows extension of the BASIC language, and the extensions differ in extent and usefulness. It is important to choose a DOS you can handle — most of the manuals are pretty awful.

The third letter is from a programmer who has become interested in assembly code (machine code) programming. He wonders which assembler he should use. The Tandy and Apparat assemblers are minimal versions — they do the job, with few frills. Microsoft publishes EDTASM-PLUS, in both disk and tape versions. This is very good, with a built-in debugger and many other advantages.

But if you have disk, the most powerful assembler — and the only one I bother with any more — is Macro-80. This is immensely powerful and

consequently is also immensely complex and difficult to learn at first. However, the results are worth it. Not the least advantage is the ability to use any word processor to build the source code. This is much more convenient than using a line editor such as the others offer. There are other powerful systems available too.

If you have questions, send them in. I don't always have the answer, but if I do, I reply individually, and will publish the more interesting questions later.

## LATEST BOOKS FOR THE APPLE COMPUTER

### APPLE BASIC FOR BUSINESS 2nd Edition by Parker/Stewart

Totally practical guide to learning BASIC on the Apple II series, including keyboard sessions on VisiCalc.

Reston Pub. \$39.90

### ASSEMBLY COOKBOOK FOR THE APPLE II/IIe by Don Lancaster

This cookbook is for those who want to build their machine language programming skills.

Howard W. Sams Pub. \$50.50

### INTRODUCING THE APPLE IIc by Philip Lieberman

In this book, you will be introduced to the remarkable features built into this miracle machine.

Howard W. Sams Pub. \$41.30

### INTERMEDIATE APPLE by Bill Parker

Perfect for the BASIC programmer who is ready to move on.

Reston Pub. \$37.40

### PICTURE PERFECT — Programming in Applesoft BASIC by Mason/Payne/Black

Teaches you to program through the use of computer graphics. Approach works because it is simple.

Reston Pub. \$37.40

### YOUR APPLE II NEEDS YOU by Frank Wattenberg

This book includes 30 programming projects, some are serious; some are fun, all are stimulating.

Prentice-Hall Pub. \$39.90

Order through your local Booksellers,  
Computer Shop or Bits & Bytes.  
Wholesale terms available to Trade Outlets.

DISTRIBUTED BY WHITEHALL BOOKS LTD,  
P.O. BOX 38-694, PETONE.

Send for information: Catalogues

Name .....

Address .....



## BOOKS

### Electronics experience needed

"The VIC-20 Connection" by James W. Coffron. Sybex, 273pp, \$17.95. Reviewed by Steven Darnold.

The VIC is capable of doing many things. It can make a picture on a T.V. screen; it can sense which way a joystick is pushed; it can stop and start a cassette motor. Experienced programmers take these things for granted. However, the VIC is also able to do much, much more. It can talk; it can measure the air temperature; it can sense when a

window is open. To do these things all the VIC needs is a few bits of hardware.

This book explains how to build those bits of hardware and how to write programs to utilise them. It gives full details on constructing a speech synthesizer, an analog-to-digital converter for measuring temperature, and a burglar alarm system. However, more importantly, the book teaches the reader the general principles for connecting all sorts of control devices to the VIC.

The book claims to be suitable even for those without electronics experience. However, this is not realistic. It has many schematic diagrams and it uses electronics terminology. Moreover, although there is an introductory section for beginners, it makes heavy use of a plug-in cartridge called the creative microprocessor systems I/O board. A beginner without such a board will probably get nowhere.

VIC owners with some electronics experience will probably find this book very worthwhile. It is reasonably priced and it opens up the VIC to numerous electronics projects.

### Eleven out of ten

"Clean Slate Word Processing for the TRS-80", by Henry Melton. Sams 382pp, \$34.10. Reviewed by Gordon Findlay.

This is an unusual, but in some ways interesting book. It consists of three parts, each building on the earlier ones.

The first part is the manual for a word processing program called "Clean Slate", written by the author to run on TRS-80 Model 1 and 3 computers, under a variety of operating systems. It is an unusual word processing system in its insistence on storing text on disk progressively (every time a page is full in fact), and maintenance of the numerous files generated on disk places a substantial demand on the program, and probably the operator too. The frequent use of the disk as a buffer must also produce some delays at times.

This apart, as a word processor, Clean Slate has just about every feature one could want — and more! Some of its capabilities are unique in word processors on micros.

However, I haven't used Clean

## COMPUTER BOOKS

### for EVERYBODY

#### COLLEGE STUDENTS PERSONAL COMPUTER HANDBOOK:

Whatever your career plans, this book will give you computer know-how to serve you well.

- \* Streamline paper writing
  - \* Make study time effective
  - \* Take better notes
  - \* Facilitate research & much more.
- Sybex \$44.95

#### FIFTY PASCAL PROGRAMS:

Whatever your computer-related profession — business, accounting, engineering, drafting, designing — you'll find it easy to apply these techniques. — Sybex \$44.95

#### VIC-20 FOR KIDS OF ALL AGES:

29 exciting programming steps to using Vic-20 as learning tool at home and in classroom — learn sound BASIC programming techniques. — Wiley \$26.95

#### EASY PROGRAMMING FOR ORIC-1:

Uncover the secrets of the Oric-1. Find out about: sound, colour and graphics, debugging, strings, Peek & Poke.

— Shiva \$23.95

#### PRESENTING THE MACINTOSH:

Introduces you to a new generation of personal computers. Find out if you need to be a part of it. Ideal handbook to read before you buy any computer.

— Dilithium \$17.95

AVAILABLE FROM YOUR BOOKSELLER:

Or if you have difficulty, contact:-

**AUSTRALIA & NEW ZEALAND BOOK COMPANY,  
PRIVATE BAG, TAKAPUNA,  
AUCKLAND 9.**

Please send me your free newsletter.

Please supply \_\_\_\_\_

Add \$1.50 Postage & Packing

FROM: \_\_\_\_\_

## UNIVERSITY BOOK SHOP

Specialists in  
COMPUTER BOOKS

Over 1000 titles  
in stock

PHONE OR WRITE VISA BANKCARD

STUDENT UNION BUILDING  
34 PRINCES ST AND 34 KITCHENER ST  
AUCKLAND 1  
TELEPHONE 771 869

## THE SOURCE for Computer Books

We deal with hundreds of publishers world-wide, ensuring that even if the computer book you require is not in our extensive stock at present, we can get it for you. Further to Go, More to See

*the University Bookshop*

University Drive, ILAM.  
ph 488579. Private Bag,  
Christchurch

## BOOKS

Slate. I haven't got it on disk, although it is supposed to be available.

The book has other purposes. The second part is a discussion of the design of word processors, particularly to run on the TRS-80. This discussion is interesting, albeit repetitive. Melton places great emphasis on the requirements for user customisation, communication by modem, and the need to make it difficult to lose text accidentally.

In fact, under almost any circumstance short of total power failure, it is impossible to completely lose text typed into Clean Slate. Even if power does fail, at most one page can be lost. Recovery procedures from all manner of accidents are specified.

But the third part of the book is the most important. It consists of the commented source code for the program itself, along with detailed explanatory notes. I found this fascinating, as it forms virtually a textbook on advanced machine code techniques. Want to know how to interface to a variety of DOSes? It's in here. Want to write an interrupt driven keyboard encoder? So is that. The entire program is table driven,

enabling the user to customise the program to individual requirements.

The code reflects this of course. The customisation section modifies these tables, and a lot of digging is needed to determine what some of the table entries do. There are lots of examples of all sorts of things which make this part of the book a goldmine for the advanced programmer. But those whose machine code experience is limited will find most of the 250 or so pages

in this part very obscure. The code is in 16 modules, which could be assembled and linked, but probably few would do so. If you did, you would end up with a 23K machine code word processor, and sore typing fingers!

As a word processor? Well, maybe. As a general book about word processing? There are much better. As an example of how to design a program, and how to write it? Eleven out of ten!

## A lot in a small space

*Illustrating Computers Without much Jargon* by Colin Day & Donald Alcock. Pan. 104pp. \$6.60. Reviewed by E.J. Brown.

The title is not well chosen but this small book manages to cram quite a lot between its covers. After a little bit of interesting history, it describes how computers work.

We learn about machine language programming and get a very brief look at higher languages. We are told about the hardware and various peripherals (attached devices) used by computers.

Operating systems come up in turn, as do the many and various uses to which computers may be put. Even the social implications of computers are touched upon. The whole book is profusely illustrated with cartoon-type sketches which help make the point.

For someone just becoming interested in computers or micro-computing, this book should be very informative. There is practically no high-sounding "computerese" and based on present-day prices, it rates as fair value.

## Pitman

Handy pocket-sized guides, specially designed for quick, easy access and to stand upright for use beside a terminal

**NEW!** Pocketguide titles arriving

**INTRODUCTION TO OPERATING SYSTEMS**

**CP/M  
MS-DOS  
UNIX**

AVAILABLE IN NEW ZEALAND  
NOVEMBER-DECEMBER

**\$9.95**

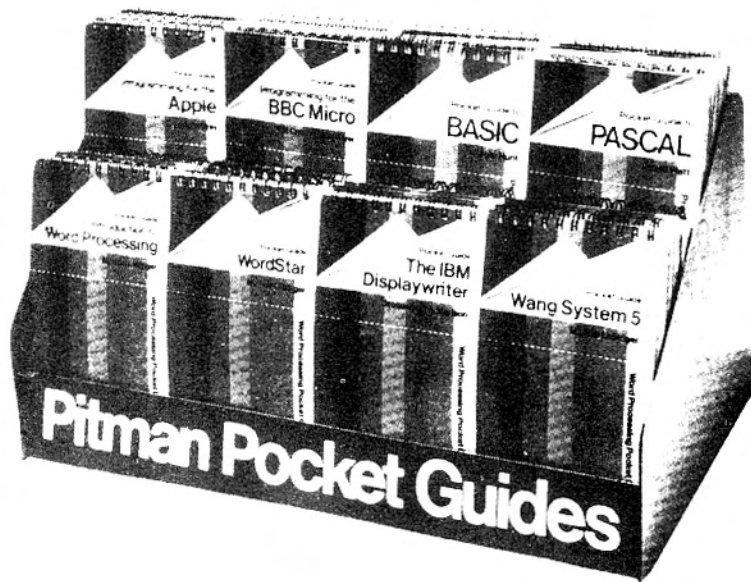

AVAILABLE FROM ALL GOOD BOOKSELLERS  
AND BITS & BYTES BOOK CLUB.

Further information:

**PITMAN PUBLISHING NEW ZEALAND  
PO Box 38.688  
PETONE**

# COMPUTASHOP.

For all products from Dick Smith Electronics including:

**CHALLENGER, CAT, AND VZ200** COMPUTERS AND ACCESSORIES

We offer a friendly, unbeatable back-up service

CALL OR WRITE TO:

**KANE AGENCIES LTD** 304A HARDY ST.  
Ph (054) 84-066  
P.O. BOX 710 NELSON

OPEN FROM 9am to 9pm WEEKDAYS, and 9am to 5pm SAT.

All orders despatched promptly, freight free!

Subscribe to:

## The Electric Apple

New Zealand's only monthly magazine devoted entirely to the Apple and Apple compatible Computers. Gain access to International Apple Core disks, and Apple Technical notes. \$30/12 issue subscription.

Contact Noel Bridgeman  
P.O. Box 3105 New Plymouth

## WANT HIGH QUALITY SOUND FOR YOUR SINCLAIR SPECTRUM?

AN EASY-TO-FIT UNIT  
GIVES AMPLIFIED SOUND  
THRU' YOUR T.V.

ONLY **\$39.95**

( \$2.50 P.&P.)



P.O. Box 102,  
WAITARA

# RAYTRONICS

## SHAMAN systems

"The High Priests of Software"

For user-friendly software tailored to your needs and your computer. Whether off-the-shelf or custom-built, contact us for a no-obligation quote. All programs fully supported and maintained.  
Phone (03) 792-822 or write to PO Box 2670 Christchurch.

## COMMERCIAL SOFTWARE for MICRO-COMPUTERS

Software division of the Micro-Bus New Zealand Ltd

Software consultants

P.O. Box 2489, Auckland. Phone (09) 486-452 (24 Hour answerphone)

**Our name is our business**

## ATARI Keyboards

*At last!*

A professional, full stroke keyboard for your Atari 400.

Increase your typing speed!

Can be permanently fitted in 4 minutes!

Order your in-home B. keyboard — for only **\$159.00**

Delivered by writing to:-

"ATARI KEYBOARDS",  
P.O. BOX 2240, TAURANGA SOUTH,  
TAURANGA. PHONE (075) 25-558.

## COMMODORE 64 BUSINESS SOFTWARE

### HIRE PURCHASE

100 Contracts - calculates rebatable & penalty interest.  
Single disk. **\$299**

### PAYROLL

200 employees - mixed pay periods - full tax calculations - banking & cash breakdown. **\$350**

### TIME & COST

320 jobs - 47 employees or cost stations. Job selective printing. **\$299**

Write for details to James Electronics, Box 527, Thames, Ph 86-893 or contact your nearest Commodore 64 dealer.

## COMMODORE 64 BUSINESS SOFTWARE

### DEBTOR'S LEDGER

500 customers - 3000 transactions per month. **\$140**

### CASH BOOK

150 payment codes - 50 deposit codes - full analysis by code. Bank reconciliation. **\$180**

### GENERAL LEDGER

250 definable codes. Compiles trial balance. **\$160**

Write for details to James Electronics, Box 527, Thames, Ph 86-893 or contact your nearest Commodore 64 dealer.

# USER GROUPS

- BBC MICROCOMPUTER USERS' GROUP OF NZ.** Local meetings - Auckland: 2nd Wednesday of month at VHF Clubrooms, Hazel Ave, Mt Roskill. Ph. Dave Fielder, 770-630, ext 518 (h). Wellington - Meets last Thursday of each month in staffroom, first floor, Correspondence School, Portland Cres, Thorndon. Local contact, Anton, 286-289. Hamilton - Waikato Tech B-block staffroom; last Wednesday of the month 5 p.m. Local contacts Peter (Ham) 393-990 or Alison (Morrinsville) 6695. Hawke's Bay - Hastings and Napier alternate months. Local contacts: Kendall (Napier) 435-624, Bob (Taradale) 446-955; Mitch (Hastings) 778-235. Christchurch - fortnightly, Tuesdays, 7 pm, Hagley High School. Local contact Michael, 582-267.
- SHARP PC1500 USER GROUP** - Contact: Allan Thomas, P.O. Box 155, Napier, Newsletter.
- KERIKERI APPLE USER GROUP:** Contact S. Shearman (chairman), Fairway Drive, Kerikeri, or I. Harris, C/- Post Office, Kerikeri.
- WHANGAREI COMPUTER GROUP:** Tom Allan, 3 Maunu Rd, Whangarei. Phone 83-063 (w). Meets every second Wednesday of the month at Northland Community College.
- N.Z. MICROCOMPUTER CLUB.** PO Box 6210, Auckland. A meeting is held on the first Wednesday of each month at the OSNZ Hall, 107 Hillsborough Rd, Mt Roskill, from 7.30 pm. Visitors are also welcome at Micro Workshop 10am - 5pm, at the same hall on the Saturday following the above meeting.
- The following user groups are part of, or affiliated with, the N.Z. Micro Club. Meetings start at 7.30pm at the OSNZ Hall. Those shown "..." are held at the VHF Clubrooms, Hazel Ave, Mt Roskill.
- APPLE USER GROUP:** Ross Bryon, ph 761-670 (h). Meetings: 3rd Tuesday.
- BBC USER GROUP:** Dave Fielder, ph 770-630, Ext 518 (w). Meetings: 2nd Wednesday.
- BUSINESS USER GROUP:** Cathy Arrow, phone 491-012. Meetings: 4th Tuesday \* even months, visits on odd months.
- CP/M USER GROUP:** Kerry Koppert, 2/870 Dominion Rd, Balmoral. Phone 695-355 (h). Meetings: 1st Wednesday 9pm.
- IBM PC USER GROUP:** Terry Bourden, ph 452-639 (h) 778-910 (w). Meetings: 3rd Thursday.
- MSX SPECTRAVIDEO COMPUTER CLUB:** P.O. Box 22-620, Otahuhu. Meetings: third Wednesday of month. \* Contact: Bill Ferguson (secretary), ph 276-1966 ext 803 (w).
- NZ COMMODORE USER GROUP (AK) INC:** John Walker, ph 8339-589 (h). PO Box 5223, Auckland. Meetings: 3rd Wednesday, Remuera Primary School Hall, Dromorne Rd, Remuera.
- NZ OSBORNE USER GROUP (NZOG):** Brian Jones, ph 659-738 (h). Meetings: 1st Thursday, 20 Kingley St, Grey Lynn.
- POCKET COMPUTER USER GROUP:** Peter Taylor, 14 Gollan Rd, Mt Wellington 6, phone 576-618 (h).
- SINCLAIR USERS GROUP:** Doug Farmer, phone 567-589 (h). Meetings: 4th Wednesday.
- SORCERER USER GROUP (NZ):** Selwyn Arrow, ph 491-012 (h). Meets at Micro Workshop.
- SORD USER GROUP:** Graeme Hall, 5 Brouder Pl, Manurewa, ph 266-8133 (h).
- Ti 99.4A USER GROUP:** Ray Tucker, ph 568-155 (h).
- TOMORROW USERS GROUP:** Chris Cotton, Phone 789-153. Meetings: 3rd Thursday, 7.30pm, 20 Kingley Street, Grey Lynn.
- WIZZARD USER GROUP:** Richard McFadgen, 11 Hilling St, Titirangi, ph 8178-219 (h).
- 1802 USER GROUP:** Brian Conquer, ph 695-669 (h).
- 2650 USER GROUP:** Trevor Sheffield, phone 676-591 (h).
- 68XX (X) USER GROUP:** John Kucernak, ph 606-935 (h).
- The above contacts can usually be found at N.Z. Microcomputer Club meetings and micro workshops, or via P.O. Box 6210, Auckland.
- Other Auckland-based groups:
- ACES (Auckland Computer Education Society):** C/- Director, Computer Centre, Secondary Teachers' College, Private Bag, Symonds Street, Auckland. Meetings, third Thursday of month, at the College.
- ATARI MICROCOMPUTER USER GROUP:** Ian Mason, 25 Manutara Ave, Forrest Hill, ph 467-347 (h). Meets 2nd Tuesday, Western Suburbs Radio Club, Gt North Rd, New Lynn.
- BBC Club:** See entry at head of this list.
- COLOUR GENIE USER GROUP.** (Auckland): Secretary: Mrs Nola Huggins, Ph 655-7518, P.O. Box 27-387, Auckland 4. Meets every fourth Monday, All Saints Church Hall, Ponsonby Rd, Auckland.
- EPSON HX20 USERS' GROUP:** Contact: C.W. Nighy, 231 Khyber Pass Road, Auckland. (Ansaphone, 774-268).
- HP41C USERS' GROUP (Auckland):** C/- Calculator Centre, P.O. Box 6044, Auckland: Grant Buchanan, 790-328 (w). Meets third Wednesday, 7pm, at Centre computers, Great South Rd, Epsom.
- NZ TRS-80 MICROCOMPUTER CLUB:** Olaf Skarsholt, 203A Godley Rd., Titirangi. Phone 817-8698 (h). Meets first Tuesday OSNZ Hall, 107 Hillsborough Rd, Mt Roskill.
- OSI/BBC USERS' GROUP (Aki):** Secretary: Ken Harley, 77 Boundary Road, Auckland. Meets third Tuesday, VHF Clubrooms, Hazel Ave, Mt Roskill.
- SYMPOOL (N.Z. SYM user group):** John Robertson, PO Box 580, Manurewa, ph 2675-188 (h).
- A.Z.T.E.C.:** Brian Mayo, Church Street, Katikati. Phone 490-326. Members use all micros.
- BAY MICROCOMPUTER CLUB (Tauranga):** G.L. McKenzie, Secretary, Snodgrass Road, Tauranga. Phone: 25-569.
- BAY OF PLENTY TAURANGA COMMODORE USERS GROUP:** Contacts - phone 62-083, 65-311, and 83-610. Meets first and third Monday of month, 7 p.m.
- BEACH COMPUTING CLUB (Waihi):** Jamie Clarke, Box 132, Waihi (Ph: 45-364 Waihi Beach).
- THE ATARI CONNECTION:** Contact: Paul Cormack, 29 McDiarmid Cres, Huntly. Ph (h) 88-695.
- HAMILTON SUPER 80 USERS:** Bruce White, (h) 436-878.
- WAIKATO COMMODORE USERS' GROUP:** Secretary, Mrs Eileen Woodhouse, 32 Kenny Crescent, Hamilton.
- WAIKATO COMPUTERS IN EDUCATION SOCIETY:** Secretary, Geoff Franks, Fraser High School, 72 Elliott Road, Hamilton. Phone (h) 81-050.
- WAIKATO SPECTRUM USERS' GROUP:** Secretary: Roger, Loveless, 18 Heath St, Hamilton. Phone 492-080. Meetings: First Tuesday of the month.
- MORRINSVILLE COMPUTER SOCIETY:** Contact: Alison Stonyer, 49 Coronation Road, Morrinsville. Phone 6695 (h). Meets 1st and 3rd Wednesdays.
- WAIHI COMPUTER ENTHUSIASTS:** Contact: G.C. Jenkins, 10 Smith St, Waihi (h) WAH 8478. Workshops every Tuesday. Meetings last Tuesday of month.
- GLOWWORM COMPUTER ENTHUSIASTS:** Meets every second Sunday of the month in the Otorohanga District Council's board room. Contacts: president, Colin Wilkins, Oto 8331; vice-president, Hugh Button, Oto 7228; secretary, Laurence Bevan, Oto 7066.
- GISBORNE MICROPROCESSOR USERS' GROUP:** Stuart Mullett-Merrick, P.O. Box 486, Gisborne. Phone 88-828.
- ROTORUA COMPUTER CLUB:** Contact: Ken Blackman, 6 Urquhart Place, Rotorua. Third Tuesday of each month at 7pm, Waiariki Community College, Rotorua.
- ELECTRIC APPLE USERS' GROUP:** Noel Bridgeman, P.O. Box 3105, Fitzroy, New Plymouth, Phone 80-216.
- TARANAKI MICRO COMPUTER SOCIETY:** P.O. Box 7003, Bell Block, New Plymouth: Mr K. Smith, Phone 8556, Waitara.
- SOUTH TARANAKI MICROCOMPUTER SOCIETY:** Contacts: Apple, Jim Callaghan, 86-667 Hawera; Commodore, Allen Goodhue, 86-194 Hawera; S80, TRS80, John Roberts-Thomson, 84-495 Hawera; Sega, Dave Beale, 85-108 Hawera; Spectrum, Guy Oakley, 8060 Mania. Sub groups meet on the third Wednesday of the month. The whole society meets periodically in the Hawera High School computer room. Written inquiries to Allen Goodhue, 21 Princes Street, Hawera.
- HAWKE'S BAY MICROCOMPUTER USERS' GROUP:** Bob Brady, Pirimai Pharmacy, Pirimai Plaza, Napier. Phone 439-016.
- HAWKE'S BAY COMMODORE USER GROUP:** Contacts: Mike Phillips, 401 Lascelles Street, Hastings (president); Mark Hodgson, 1108 Oliphant Road, Hastings (secretary). Meetings: first Tuesday of month at H.B. Community College.
- WANGANUI COMMODORE 64 USER GROUP:** Contact - P. Northway, 7 Broadhead Avenue, Wanganui. Meets first and third Wednesdays of month at Wanganui Community College.
- HBCEs (Hawke's Bay Computers in Education Society):** Contact - Grant Barnett, 89 King Street, Taradale, Napier. Ph: 446-992.
- MOTOROLA USER GROUP:** Harry Wiggins, (ZL2BFR), P.O. Box 1718, Palmerston North. Phone (063) 82-527 (h).
- MANAWATU MICROCOMPUTER CLUB:** Contact: Richard Anger, 64-108 (W) or 63-808 (H). Meets twice a month at PDC Social Club rooms.
- HOROWHENUA MICROCOMPUTER CLUB:** Meets on second and fourth Thursday of month. President, Wally Withell, P.O. Box 405, Levin; secretary, Dennis Cole, 28 Edinburgh Street, Levin. Ph (069) 83-904.
- WAIRARAPA MICROCOMPUTER USERS' GROUP:** Geoffrey Petersen, 27 Cornwall St, Masterton, (Ph) 87-439.
- CENTRAL DISTRICTS COMPUTERS IN EDUCATION SOCIETY:** Rory Butler, 4 John Street, Levin (069) 84-466 or Margaret Morgan, 18 Standen Street, Karori, Wellington. (041) 767-167.
- UPPER HUTT COMPUTER CLUB:** Shane Doyle, 18 Holdsworth Avenue, Upper Hutt. Phone 278-545. An all-machine club.
- BBC USER GROUP:** Users of other machines welcome too. See entry head of list.
- MICROBEE USERS' CLUB:** P.O. Box 871, Wellington, 2nd Sunday of month.
- NEC COMPUTER USERS' GROUP:** C/- P.O. Box 3820, Wellington.
- N.Z. SINCLAIR USERS' GROUP:** P.E. McCarrroll, 11 Miro Street, Lower Hutt.
- NZ SUPER 80 USERS' GROUP:** C/- Peanut Computers, 5 Dundee Pl., Chartwell, Wellington 4. Phone 791-172.
- OHIO USERS' GROUP:** Wellington. Secretary/Treasurer: R.N. Hislop, 65B Awatete Street, Porirua.
- POLY USERS GROUP:** Wellington: Contact - Christine Greenbank, Computer Studies, Wellington Teachers' College, Private Bag, Karori, Wellington.
- ATARI USERS' GROUP:** Wellington: Eddie Nickless. Phone 731-024 (w), P.O. Box 16011. Meetings: first Wednesday of month.
- WELLINGTON COMMODORE USERS' GROUP:** P.O. Box 2828, Wellington. Contacts: Peter March (h) 886-701, Robert Keegan (h) 789-157.
- WELLINGTON MICROCOMPUTING SOCIETY INC.:** P.O. Box 1581, Wellington, or Bill Parkin (h) 725-086.
- Meetings are held in the Fellowship Room, St Johns Church, 176 Willis Street, on the 2nd Tuesday each month at 7.30pm.
- SEGA OWNERS CLUB:** Lower Hutt. Meets 1st Monday each month. Contact: Murray Trickett. (w) 724-356, (h) 662-747.
- WELLINGTON SPECTRAVIDEO USER GROUP:** Contact - Don Stanley, ph 896-379. C/- Box 7057 Wellington or C/- Epidemiology Unit, Wellington Hospital. Meets on one Monday a month at Staff Common Room (Level D), Wellington Clinical School, Mein Street, Newtown.
- WELLINGTON SYSTEM 80 USERS' GROUP:** Contact: W.G. (Bill) Lapsley, day 286-175; evenings, 268-939; or Andrew Vincent 780-371 (evenings).
- HUTT VALLEY COMMODORE USER GROUP:** Contact - Ken Alexander, C/- 16 Enfield St, Wainuiomata or phone Wainuiomata 645-830. Meetings, first and third Mondays of month at St. Bernard's College, from 7.30 pm.
- NELSON COMMODORE USERS' GROUP:** Peter Archer, P.O. Box 860, Nelson. Phone (054) 79-362 (h).
- NELSON HOME COMPUTER CLUB:** Contact: Mike Jenkins, Box 571. Ph 87-930. Meets, 7 p.m., first and third Tuesdays of the month at Nelson Intermediate.
- BLENHHEIM COMPUTER CLUB:** Club night second Wednesday of month. Ivan Meynell, Secretary, P.O. Box 668. Phone (h) 85-207 or (w) 87-834.
- MARLBOROUGH COMMODORE USERS GROUP:** Secretary, Robin Vercoe, 42 Rogers Street, Blenheim. Meetings: Second Thursday of month, 7.30 p.m., IHC rooms.
- HOKITIKA COMPUTER USERS GROUP:** Contact - Adrian Mehrtens, 185 Sewell Street. Ph: 943.
- CANTERBURY COMPUTER EDUCATION SOCIETY:** Contact - Graeme Sauer (secretary), P.O. Box 31-065, Ilam, Christchurch 4.
- CHRISTCHURCH ATARI USERS GROUP:** Contact Ron van Lindt, 10 Silverdale Place, Christchurch 6. Ph 891-374.
- CHRISTCHURCH TRS-80 COLOUR USER GROUP:** Meetings: last Wednesday of month. Contact: Dennis Rogers, 21 Frankleigh Street, Christchurch 2. Phone 34-731.
- CHRISTCHURCH '80 USERS' GROUP:** Brendan Thompson. Phone (h) 370-381. P.O. 4118, Christchurch.
- OSI USERS' GROUP (CH):** Barry Long, 377 Barrington St., Spreydon, Christchurch. Phone 384-560 (h).
- SINCLAIR USERS' GROUP CANTERBURY, INC:** Contact: Gary Parker (president), Phone 894-820, P.O. Box 4063. Meets 7.30 p.m. last Monday of month at Ilam Research Centre, 27 Creyke Road.
- CHRISTCHURCH COMMODORE USERS GROUP:** John Kramer, 885-533 and John Sparrow. Phone 896-099.
- CHRISTCHURCH BBC USERS' GROUP:** Contact: Michael Hopkins (h) 582-267 or Rodney Derham (h) 893-215.
- PANASONIC (JB-3000) USERS' GROUP:** Contact: Prof B.J. Clarke, Dept of Accountancy, University of Canterbury, Private Bag, Christchurch, 1.
- CHRISTCHURCH COLOUR GENIE USERS' GROUP:** Meets 2nd Wednesday, 7.00p.m., Abacus Shop, Shades Arcade. Secretary, Robert Wilson, 17 Warlington Street, Christchurch, 7. Ph: 881-456.
- CHRISTCHURCH SORD MS USERS GROUP:** Meets first Thursday of month, 7pm. Ph: 792-771 for details.
- DICK SMITH WIZZARD COMPUTER CLUB:** Christchurch: Contact - Tony Dodd, 34 Mayfield Ave. Ph: 557-327.
- CHRISTCHURCH VZ-200 USERS GROUP:** Contacts - Ian Birse (523-915).
- ASHBURTON COMPUTER SOCIETY:** Mr. J. Clark, 52 Brucefield Avenue.
- SOUTH CANTERBURY COMPUTER GROUP:** Caters for all machines from ZX81 to IBM34. Geoff McCaughan: Phone Timaru 84-200 or P.O. Box 73.
- NORTH OTAGO COMPUTER CLUB:** Contact: Peter George, P.O. Box 281, Oamaru. Phone 29-106 (h) 70-646 (h).
- LEADING EDGE HOME COMPUTER CLUB:** Elaine Orr, Leading Edge Computers. P.O. Box 2260, Dunedin. Phone 55-268 (w).
- DUNEDIN COMMODORE USER GROUP:** Contact: Mrs S.I. Downes, C/- The Micro Shop, P.O. Box 5518, Dunedin. (w) 740-469. Meetings: second Monday of month, 7pm-9pm.
- DUNEDIN SORD USERS' GROUP:** Terry Shand. Phone (024) 771-295 (w), 881-432 (h).
- CENTRAL CITY COMPUTER INTEREST GROUP:** Contact: Terry Stevens, Box 5260, Dunedin. Phone 882-603. Meetings every second Tuesday.
- OTAGO COMPUTER EDUCATION SOCIETY:** Jim Ferguson, Arthur Street School, 26 Arthur Street, Dunedin. Ph. 776-524.
- ATARI USERS GROUP:** Dunedin: Contact - Harvey Kong Tin. Phone 741-509. Meets every second Thursday, cater for 400.600.800.
- SOUTHLAND COMMODORE USER GROUP:** (VIC 20 and 64s). Address: C/- Office Equipment Southland, Box 1079, Invercargill.
- SOUTHLAND COMPUTER EDUCATION SOCIETY:** Secretary, Bob Evans, Southland Boys' High School, Herbert Street, Invercargill. Ph (h), 73-050 or ZL4XL.
- N.Z. SOFTWARE EXCHANGE ASSOCIATION:** Non-profit group for exchange of software written by programmer members. Contact: Ian Thain, Box 333, Tokoroa.

**Note:** Clubs would appreciate a stamped self-addressed envelope with any written inquiry to them.

# GLOSSARY

- Acoustic coupler:** Connects the RS232 part of a microcomputer to a telephone handpiece.
- Algorithm:** A list of instructions for carrying out some process step by step.
- Applications program:** A program written to carry out a specific job, for example an accounting or word processing program.
- Array:** A data type found in high level languages, which is stored in a contiguous block of memory. Accessed by the array name and an index making it easier to process groups of data in many situations.
- ASCII:** American Standard Code for Information Interchange. An 8-bit code.
- BASIC:** Beginners' All-purpose Symbolic Instruction Code. The most widely used, and easiest to learn, high level programming language for microcomputers.
- Baud:** Speed of transferring data, measured in bits per second.
- Bidirectional:** A printer that prints when moving left as well as when moving right.
- Binary:** The system of counting in 1's and 0's used by all digital computers. The 1's and 0's are represented in the computer by electrical pulses, either on or off.
- Bit:** Binary digit. Each bit represents a character in a binary number, that is either a 1 or 0. The number 2 equals 10 in binary and is two bits.
- BASIC:** Beginners' All-purpose Symbolic Instruction Code. The most widely used, and easiest to learn, high level programming language for microcomputers.
- Baud:** Speed of transferring data, measured in bits per second.
- Binary:** The system of counting in 1's and 0's used by all digital computers. The 1's and 0's are represented in the computer by electrical pulses, either on or off.
- Bit:** Binary digit. Each bit represents a character in a binary number, that is either a 1 or 0. The number 2 equals 10 in binary and is two bits.
- Block graphics:** Chunky graphics, built up in small blocks rather than fine points.
- Boot:** To load the operating system into the computer from a disk or tape. Usually one of the first steps in preparing the computer for use. Short for bootstrap.
- Buffer:** An area of memory used for temporary storage while transferring data to or from a peripheral such as a printer or a disk drive.
- Bug:** An error in a program.
- Bus:** Also called a trunk or highway - a path on which several parts of a computer system may be connected so that signals can be passed between them.
- Byte:** Eight bits. A letter or number is usually represented in a computer by a series of eight bits called a byte and the computer handles these as one unit or "word".
- CAL:** Computer Aided Learning CAL programs are written to take different actions on different student answers.
- Card:** In hardware, a circuit board.
- CCIT:** An abbreviation for International Telegraph and Telephone Consulting Committee. A standard maker.
- Chip:** An integrated circuit on a single crystal of semiconductor, far smaller than fingernail size.
- CMOS:** Transistor technology - when a pair of transistors of opposite type are used together. Means low power use.
- Computer language:** Any group of letters, numbers, symbols and punctuation marks that enable a user to instruct or communicate with a computer.
- Courseware:** Name for computer programs used in teaching applications.
- cpi:** Means character per inch. A common way of describing character density, i.e., how close together characters are in printers.
- CP/M:** An operating system for Z80 based machines. It is by far the most widely used DOS for Z80 based machines and there is an extremely large software base for it. See also disk operating systems.
- cps:** Characters per second. A common way of describing speed in printers.
- Cursor:** A mark on a video that indicates where the next character will be shown, or where a change can next be made.
- Daisywheel printer:** A printer in which the letters are formed by impact of a letter on a disk rotated until the required character is in position. Daisywheel printing is close to traditional typing in appearance.
- Data:** Any information used by the computer either I/O or internal information. All internal information is represented in binary.
- DC:** Direct coupling (telecomputing); or direct current.
- Disk:** A flat, circular magnetic surface on which the computer can store and retrieve data and programs. A flexible or floppy disk is a single 8 inch or 5 1/4 inch disk of flexible plastic enclosed in an envelope. A hard disk is an assembly of several disks of hard plastic material, mounted one above another on the same spindle. The hard disk holds up to hundreds of millions of bytes - while floppy disks typically hold between 140,000 and three million bytes.
- Disk drive:** The mechanical device which rotates the disk and positions the read/write head so information can be retrieved or sent to the disk by the computer.
- Diskette:** Another name for a 5 1/4 inch floppy disk.
- Disk operating system:** A set of programs that operate and control one or more disk drives. See CP/M for one example. Other examples are TRSDOS (on TRS 80) and DOS 3.3 (for Apples).
- DOS:** See disk operating system.
- Dot matrix:** A type of print head, made up of a matrix of pins, e.g. 8x8. When a character is to be printed the appropriate pins push out and strike the ribbon to paper forming the character.
- Dot graphics:** These graphics are individual screen pixels. Used by either turning on or off one pixel.
- Double-density:** Floppy drives that store twice the standard amount of data in the same space.
- Dump:** Popular term for sending data from a computer to a mass storage device such as disks or tape.
- EPROM:** Erasable, user-programmable, read-only memory.
- Execute:** A command that tells a computer to carry out a user's instructions or program.
- File:** A continuous collection of characters (or bytes) that the user considers a unit (for example on accounts receivable file), stored on a tape or disk for later use.
- Floppies:** Thin plastic disks with a magnetic coating used for storing information. Called floppies because they are flexible.
- FORTH:** A compact language. The programmer extends the language as he programs.
- Friction feed:** A type of paper-feeding system for printers: normal paper in a continuous sheet is gripped between two friction rollers as on a typewriter.
- Hardware:** The computer itself and peripheral machines for storing, reading in and printing out information.
- Hex:** Abbreviation for hexadecimal notation, a base-16 numbering system convenient to use with computers.
- High-level language:** Any English-like language, such as BASIC, that provides easier use for untrained programmers.
- IEEE:** A standardisation based on the Institute of Electrical and Electronics Engineers.
- Ink-jet printer:** These printers form images by spraying droplets of ink on to paper. Each droplet is electrically charged and is deflected into the required position by magnetic plates.
- Input:** Any kind of information that one enters into a computer.
- Interactive:** Refers to the "conversation" or communication between a computer and the operator.
- Interface:** Any hardware/software system that links a microcomputer and any other device.
- I/O "Input/output":**
- Inverse video:** When the background is coloured; e.g. on a black and white screen white becomes background and characters are written in black.
- Justified:** Printing is justified when the lines are flush on the left and right sides.
- K:** The number 1024. Commonly refers to 1024 bytes. Main exception is capacity of individual chips, where K means 1024 bits.
- Kilobyte (or K):** Represents 1024 bytes. For example 5K is 5120 bytes (5 x 1024).
- LCD:** Liquid-crystal display.
- Line feed:** A control code character found in the ASCII character set. Its normal purpose is to move the cursor down one line (on screen) or move paper up one line (on printer). Does not return the cursor to the left-hand margin.
- Lower case:** Non-capital alphabetical letters.
- Machine language:** The binary code language that a computer can directly "understand".
- Mainframe:** The very large computers that banks and other large businesses use are called mainframes. Also in microcomputers the term is sometimes used to describe the core of the machine, i.e. the CPU plus memory.
- Mass storage:** A place in which large amounts of information are stored, such as a cassette tape or floppy disk.
- Megabyte (or Mb):** Represents a million bytes.
- Memory:** The part of the microcomputer that stores information and instructions. Each piece of information or instruction has a unique location assigned to it within a memory.
- Memory capacity:** Amount of available storage space, in Kbytes.
- Menu:** List of options within a program that allows the operator to choose which part to interact with (see Interactive). The options are displayed on a screen and the operator chooses one.
- Microcomputer:** A small computer based on a microprocessor.
- Microprocessor:** The central processing unit or "intelligent" part of a microcomputer. It is contained on a single chip of silicon and controls all the functions and calculations.
- Minicomputer:** Originally a computer that went with a single equipment cabinet. Now a computer between a microcomputer and a mainframe. Note that the boundaries between mini's and the classes on either side of it are unclear.
- Modem:** Modulator-demodulator. An instrument that connects a microcomputer to a telephone and allows it to communicate with another computer over the telephone lines.
- Mother board:** A large circuit board that has other boards attached to it.
- Network:** An interconnected group of computers or terminals linked together for specific communications.
- Output:** The information a computer displays, prints or transmits after it has processed the input. See input and I/O.
- Parallel interface:** A type of communications interface used mostly for printers. It sends a whole character of data down eight (commonly) lines, one bit down each line. The most common type of parallel interface for printers is the Centronics interface.
- Pascal:** A high-level language that may eventually rival BASIC in popularity. It incorporates the form of structured programmes.
- PEEK:** A command that examines a specific memory location and gives the operator the value there.
- Peripherals:** All external input or output devices: printer, terminal, drives etc.
- Pinfeed:** (also called sprocket feed). A method of paper feed in printers using sprockets.
- Pixel:** Picture element. The point on a screen in graphics.
- Plotter:** An output device for translating information from a computer into pictorial or graphical form on paper or a similar medium.
- POKE:** A command that inserts a value into a specific memory location.
- Program:** A set or collection of instructions written in a particular programming language that causes a computer to carry out or execute a given operation.
- RAM:** Random access memory is the very fast memory inside your computer. The access time for any piece is the same. Your program and run-time data are usually stored in RAM.
- REM statement:** A remark statement in BASIC. It serves as a memo to programmers, and plays no part in the running program.
- Resolution:** A measure of the number of points (pixels) on a computer screen.
- ROM:** Read only memory. Any memory in which information or instructions have been permanently fixed.
- Serial interface:** A type of communications interface used for a wide variety of purposes (printers, terminals, telephone correction etc.). It uses a minimum of two wires, and sends the data one bit at a time down one wire. The most common type of serial interface is RS232C.
- Sheet feed:** A type of paper feeding system normally used for high-quality document printers. A special device picks up a sheet of paper and feeds it into friction rollers.
- Software:** Any programs used to operate a computer.
- SP:** Second processor.
- Sprocket feed:** See pin feed.
- System:** A collection of hardware and software where the whole is greater than the sum of the parts.
- Tractor feed:** A type of paper feeding system for printers. Special computer paper with holes along both sides is fed by the tractors gripping these holes.
- Word:** A group of bits that are processed together by the computer. Most microcomputers use eight or 16 bit words.
- WP:** Word processor.

# MICRO NEWS

## Symphony release

Due for release in New Zealand this month is Symphony, an expanded and updated version of the popular integrated package Lotus 1-2-3 (reviewed in this issue).

While Lotus 1-2-3 combines a spreadsheet, a database and graphics in the one package, Symphony also includes a word processor communications functions.

Symphony also allows "windowing", i.e. each of the functions can be displayed on the screen in different windows and information swapped between them. For example, figures from the spreadsheet can be inserted into a letter on the wordprocessor.

For further details on integrated and window packages, see our general introduction to them this month. A full review on Symphony itself will appear in the near future.

The price for all this is \$1662 for Symphony or, if you are an existing Lotus 1-2-3 owner, an exchange programme is available which allows you to swap your Lotus 1-2-3 for Symphony at a cost of \$500.

## New Sharp software

Good news for Sharp MZ721 home computer users — a whole new range of software is being released on the New Zealand market. The new additions bring the locally available software range from 60 up to 220 packages. Biggest improvement in supplies is in the

games range followed by business programs. There are also new educational games and home budget programs available.

## Poly Pascal

A new enhanced version of PASCAL for the Poly is due for release soon. It will be supplied free to purchasers of the original version.

The new version includes random files, 32 digit integer and hex numbers (previously 16), an UPSHIFT function to convert lower case characters or strings, reporting of source code line numbers with run time errors, and improved speed of running object code.

## IDAPS in Computerland

IDAPS, a member of the PAXUS Information Services group developed by New Zealand Insurance during the past year, has acquired the microcomputer company, Computerland.

Computerland was established in 1979 as a retailer of electronic components and then extended into computers.

IDAPS' general manager, Garry Hawks, says the acquisition was a logical link in the extension of the company's IBM-based information processing services.

IDAPS has assumed management of Computerland and will be responsible for marketing, sales, software support, consulting, user education and administration.

Southmark Electronics, Ltd, the importing and wholesaling company purchased with Computerland, will continue to operate as an independent identity.

## Buy books this month

### Advertiser Index

ANZ Books	71
Auckland University Bookshop	71
Autocrat Sanyo	46
AWA	11
Barr Bros	16, 58, 62
Barsons	61
P.M. Bendall	73
Bennett's Bookshop	57
D.R. Britton	23
Brother Distributors	3
R.B. Burgess	6
Byte Shop	6
Canterbury University Bookshop	71
Chastronics	31
Commodore	5, 47
Computer Game Rentals	68
Computer Plus	64
Computer Store	19
Control Data	17
Control Microcomputers	13
Delairco Electronics	52
Dick Smith	7
Einstein Scientific	9
Electric Apple	73
Genesis Systems	27
Harris Electronics	4, 30
James Electronics	45, 73
K Rd	66
Kane Agencies	73
S.D. Mandeno	48
Manukau Computers	53, 54
Micro Software Hire	24
Microbus	73
Microcomputer Specialists	12, 67
Microware	41
Molymerx	69
Nashua	29
B. Newman	64
P.C. Power	33, 60
Pitmans	72
Raytronics	73
Shaman Systems	73
Silkwood Manufacturing	51
Sirius Systems	49
Soft Shop	56
Software Shop	59
Supatech Electronics	55
Total Computer Services	58
Tower Computing	62
Viscount Electronics	35
Whitehall Books	70
Whitcoulls	32

## CLASSIFIEDS

**BBC Starship-Command.** I will swap for Planetoid, Meteors, Arcadians or Philosopher's Quest. Phone Auckland 276-5965, after 4.00pm.

**SPECTRUM: Full PASCAL on 48K Cheap!** Details: M. Ottaway, 8/12 Rautangi Rd, Mt Eden. AK3 (600-502).

**FOR SALE:** Commodore VIC-20. Excellent condition. Datasheet books. Software on tape, cartridges. Programmer's Ref. Guide. Offers? M.J. Meacheam, Ph: 7174, Putaruru.

**FOR SALE:** ZX81, 16K RAM auto cassette control, internal power supply all enclosed in large case. Printer and paper, fullsize keyboard, cassette player (new), leads and manual plus large selection of mags. \$400.00. Mr P.R. Boyce, 135 Dobson St., Ashburton. Ph: 83-664.

**8 INCH DISKS** for sale. Memorex SSSD. \$80 for box of ten. Slightly used. Also 8 inch Shugart 901 disk drive with circuit diagram. Needs small repair in write circuit, \$200. B. Hoyt, 33 Worksop Rd., Masterton. Ph: 89-695.

**BBC and TRS-80/System 80 software.** Bring your hardware to life. Contact SHAMAN Systems, PO Box 2670, Christchurch. Ph. 792-822.

**FOR SALE:** System-80 Computer with software \$400 o.n.o. Phone 1775, Temuka or Write to: S. McNeilly, Levels Plain Road, 4 RD, Timaru.

**FOR SALE:** Super 80 48K and ROM Basic, Printer and S100 interface, EI graphix Kit 4, manuals. \$400 or offers. **PRINTER:** Seikosha CP 100 10 mth old \$450 or offer. Phone (062) 24-222 Hawera or Write: I. Wards, R.D.2, Patea.

**WANTED:** Software for using direct-connect modem interfaced to Apple IIe by RS232. Write to Alistair Stevens, 69 Russell St., Dunedin.

**APPLE COMPATIBLE** Microprocessor 64K, full size keyboard, joystick, self-test tape, game tape, full documentation, hardly used \$500. Phone Paraparaumu 71-466 5pm - 7pm collect.

**MICROPROFESSOR II** users interested in a users group please contact R.D. Keen, Box 1709, Auckland 1.

**MOTOROLA 6809 USER** wants to progress from Trainer Board to 6809 Based PC. Any advice on what to buy or build would be welcome. Blair Brocklehurst, Box 47, Napier.

# SOMETIMES, YOUR COMPUTER KNOWS BEST!

## Monthly Check List

- \* Check supply of higher quality diskettes
- \* Look after my disk drive with DISK DRIVE ANALYZER
- \* Use head cleaning disks regularly
- \* Store my diskettes safely.....  
purchase new Disk Minder

COMMAND:

° Call **COMPUDATA**

Auckland - Kate Thompson (09) 444-6085

Wellington - Judith Ward (04) 851-548°

Talk to your dealer,  
or contact

**COMPUDATA  
MEDIA  
SYSTEMS LTD,**

New Zealand's No. 1  
trade supplier of  
Computer Care Products.

P.O. Box 3273, Auckland  
P.O. Box 11-091, Wellington

# Four Reasons Why The Dysan Difference is Worth Paying For

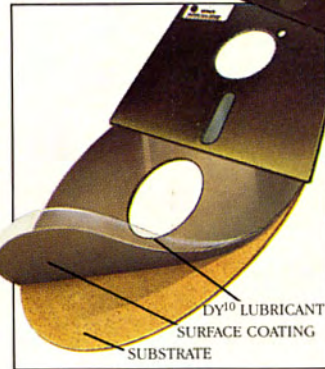
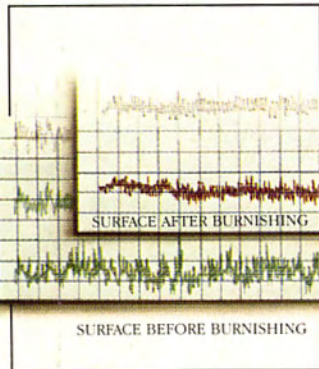

## 1. 100% Surface Tested

Only Dysan provides fully usable diskette surfaces that are truly 100% error-free across the entire face of the diskette. An exclusive on-and-between the track testing procedure guarantees error-free performance regardless of temperature and humidity distortions or slight head misalignments.

## 2. Advanced Burnishing Techniques

Dysan's advanced polishing methods create a smoother, more uniform diskette surface. This results in better signal quality on each track, less wear on drive heads and reliable access to data after millions of head passes.

## 3. DY<sup>10</sup>™ Lubricant

Dysan's proprietary DY<sup>10</sup> lubricant complements the advanced burnishing process. Both maximize error-free performance while minimizing headwear. Optimal signal presence is maintained between the head and diskette surface during millions of write/read interfaces.

DY<sup>10</sup> is a trademark of Dysan Corporation

## 4. Auto-Load Certification

Dysan's unique quality control methods reflect technological leadership in designing, producing and testing precision magnetic media. Each diskette is unerringly certified by Dysan-built, automated and microprocessor controlled certifiers. Your system and data base will benefit from Dysan's diskette reliability and unsurpassed quality.

The world's No. 1 media ex stock from selected dealers or call . . .

### \* solstat industries limited

32 Sheffield Crescent, Burnside, Christchurch, 5.  
P.O. Box 13-183, Armagh, Christchurch, 1.  
Phones (03) 588-202, (03) 582-459. Telex NZ4774.

### \* solstat data systems limited

5 Parity Place, Glenfield, Auckland, 10.  
P.O. Box 34-388, Birkenhead, Auckland, 10.  
Phones (09) 484-194, (09) 419-0882. Telex NZ21424.

**dy** **Dysan**  
CORPORATION

New Zealand Distributor

**solstat**®

Dealer enquiries welcome

Eventually you will be using Dysan — contact your local dealer now