



BELL LABORATORIES RECORD

Volume one

DECEMBER, 1925

Number four

OUR HISTORICAL MUSEUM

By PAUL B. FINDLEY

ON the title page of an encyclopedia published in 1798 appears a line of Latin, whose translation might well be the motto for our Museum:

“Let the Untaught Learn and the
Skillful Love to Remember”

For in the historical collection on the eleventh floor of our building are arranged specimens which trace the history of the communication art from Morse's telegraph tape recorder of 1843 down to the latest type of audiphone. Here newcomers to our ranks get a perspective of the physical history of the telephone; here our engineers may come for a quick picture of the “prior art”; here gather veterans to renew their memories of olden days.

The historical collection had its inception in an idea of General Carty. On January 29, 1912, he wrote to George K. Thompson of American Telephone and Telegraph:

The instrument which Professor Bell used at the opening of the New York-Chicago line is in the office of Mr. Bangs in this building where I saw it this morning. It occurred to me that this instrument should be carefully preserved with

the rest of our valuable historical apparatus. I spoke to Mr. Kingsbury and Mr. Bangs about it and they agreed that it would be best to transfer this instrument to our collection at the Western Electric Company. Won't you please make proper arrangements with Mr. Bangs and see that this instrument is suitably taken care of.

There should be some scheme of definite responsibility for the care of these instruments. I think there is such a scheme, but I would be glad if you would outline it in memorandum form so that we may have it understood generally.

Mr. Thompson arranged with James L. McQuarrie, then assistant chief engineer, that the material should be cared for at West Street. It will be recalled by the old-timers that our building was at that time (and until the completion of 195 Broadway in 1916) the headquarters building for the entire Western Electric Company. The exhibit room on the twelfth floor contained primarily a display of telephone and electrical supplies, and the historical apparatus was housed in locked cases along one side, the key being held by Charles S. Voorhees, now General Purchasing Agent of Western Union Telegraph Company. An article in the *NEWS* for December

of the diaphragm. Opening and closing the circuit was the only way known to control an electric current for signalling purposes. It was a conception of Bell's, drawn from an oscillogram of speech made on smoked glass which opened the door for his later discovery. That oscillogram, dated and signed by Bell, is in the Museum, with a note by the young man's mentor, Dr. Clarence J. Blake, that it was made with the drum and bones of a human ear as vibrator. After studying the wavy trace left in the smoked surface Bell said, "If I could make the current in a wire vary like that I could transmit speech." Looking at the replica of the harmonic-telegraph receiver, one can imagine the eager experimenter, his ear close

to the vibrating spring armature, suddenly hear a "ping" as Watson plucked a similar armature at the other end of the line and realize that somehow the characteristic sound had been turned into electric currents. Following Bell's directions, Watson overnight added a diaphragm of parchment, supporting the magnet system by a sort of gallows frame, and the first telephone was born. On a replica of this instrument is a plate which says that it was used by Dr. Bell to repeat across the Trans-continental Line the familiar phrase, "Mr. Watson, come here; I want you!" Nearby is a small coil of bell wire whose elaborate mounting suggests that it has a value far above the market price of copper wire; it is a

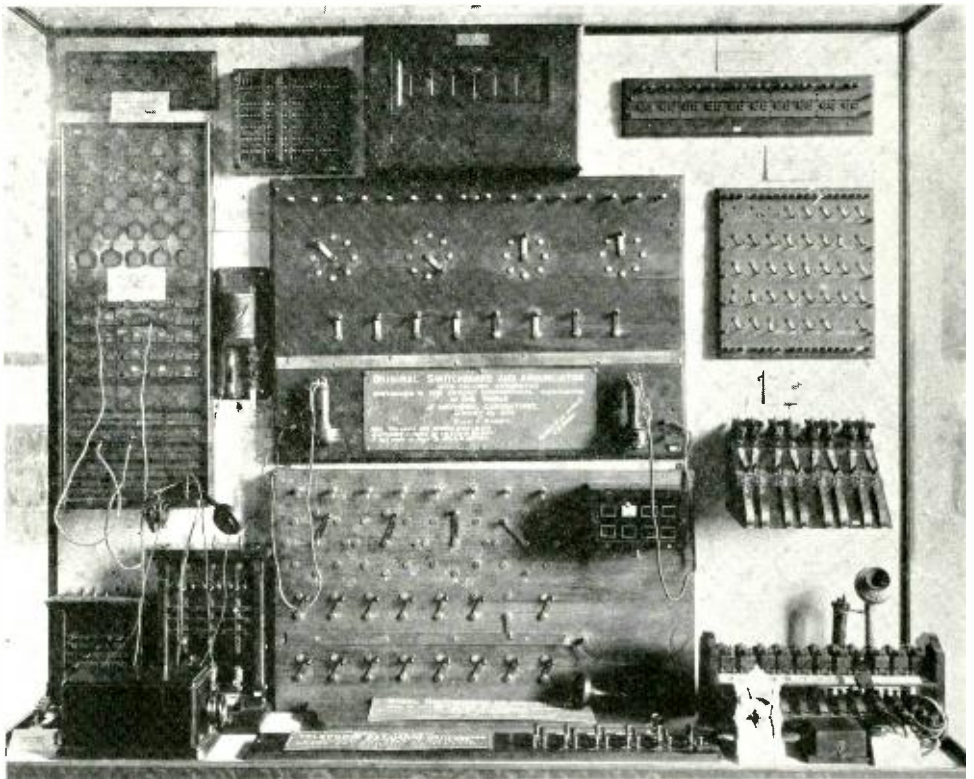

Early telephone switchboards: upper center, one installed at Meriden in 1878; at its left, one of the "universal" boards made by the Western Electric Manufacturing Company. This board used the "jack knife" switch.

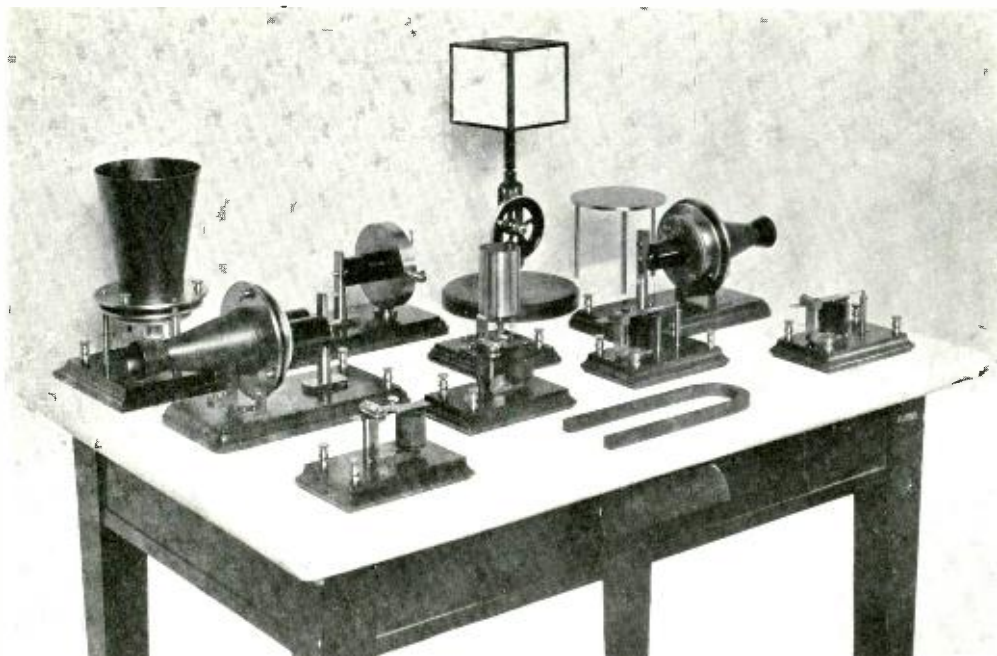

Replicas of the apparatus exhibited by Bell at the Centennial Exposition in 1876

piece of the wire over which that phrase was first transmitted, and is indeed the only thing used in that experiment which still remains.

Soon apparatus began to be made up in some quantity, and we see actual specimens of the first commercial telephone, of the "Watson thumper" (an addition of a small hammer whose noise, transmitted over the line, might call the subscriber), of the "butter-stamp" wood-end hand telephone, of complete subscriber's sets. We see certain basic ideas taking form: the magneto bell; provision of an additional hand telephone to be used as a transmitter; to cut out the bell, a switch arranged so that the receiver could not be hung up without throwing the switch back to normal; soon the hook-switch itself. The carbon transmitter appears, first enclosed in a separate box. Then comes the shop assembly on a back-board of all the scattered apparatus

with their local wiring. To please short subscribers as well as tall, the transmitter was later mounted on a movable arm, and we arrive at a set which most of us have at least seen in use.

About this time the desk stand appeared. Naturally its general appearance varied but little with the years. Early models were quite ornate; others had weighted bases and a bulge in the stem as if to give a better grip on them as weapons; the switch-contacts were on the outside for a while, then they and the wiring disappeared within the protecting column.

Development of transmitters and receivers is shown by a complete series of every type which has been standard in the Bell System. Progress here is represented by improvements in details, better materials, greater efficiency, lower maintenance costs, more economical manufacturing methods.



Plugs and jacks: top, the Scribner jack-knife; center, its successors, to which the modern type (bottom) bear a strong family resemblance

In its earliest days the telephone was grafted upon existing wire plants, particularly of district telegraph and burglar alarm systems. It was soon found that quick switching was a necessity to good service, and the first strictly telephone boards were built according to the ideas of the local managers. One of these boards, built in Meriden in 1878 for Ellis B. Baker, is in the Museum; it uses arm-switches travelling over circles of contacts. Soon after the advent of Mr. Vail, at his instance, the parent company advocated standardization. The first standard boards used pins connecting vertical and horizontal bars. So rapidly did exchanges grow that the limit of this method was soon reached and cords were introduced. To cut off the central office signal, Charles E. Scribner invented the "jack knife" switch. This took up too much space, and the next device,

known as the Warner jack, had contact springs perpendicular to the face of the board. Since its appearance in 1881, the names of many inventors have been attached to modifications of the jack, but its essential appearance remains unaltered. The receiver-click busy-test appeared at the same time, and remains in use until the present day.

Like the switchboard, the relay showed at first a strong resemblance to its telegraphic ancestor. It was not until much later that circuits had become sufficiently complicated to require any general use of relays. With the need, improved forms were soon developed with contacts enclosed as protection against dust, and with shields against cross-talk.

As the telephone frontier was pushed farther and farther West and South, the demand for something to reinforce the feeble voice currents

became more and more insistent. Finally a mechanical repeater was perfected by Herbert E. Shreeve to a point where it was used in commercial service. This repeater had the form of a receiver which drove, instead of a diaphragm, the front electrode of a transmitter button. One specimen shows it arranged for wall mounting, and another, the "cartridge type" with socket mounting so it could be quickly changed. This mounting, invented by Mr. Shreeve, is the parent of the present standard vacuum tube base. Vacuum tubes, or more properly, thermionic devices, have an entire case to themselves. Here we see models and some originals of Edison's discoveries, Fleming's two-element valve, De Forest's introduction of the grid, and many mechanical variations of the three-element amplifier tube. Some of these are British, French and German war-time models. Tubes de-

veloped in our Laboratories for the Bell System are shown, from the "peanut" to the huge 100,000 watt water-cooled tube. A smaller tube of the latter type is sectioned to show its internal construction. One who appreciates the technique of glass-blowing gets a real thrill out of the delicate structure of the cathode ray oscillograph.

On October 18, 1892, the New York-Chicago line was opened and a group of prominent men gathered around Dr. Bell as he talked over the circuit. The "long distance telephone" which he used stands in the Museum; it is a well-made desk at the back of which under a glass cover are the lightning arrester, ringer, generator, and coil. The old veteran is still workable; its bell rings out bravely at a turn of the crank. Another epoch was marked when on January 25, 1915, the Transcontinental Line was opened and

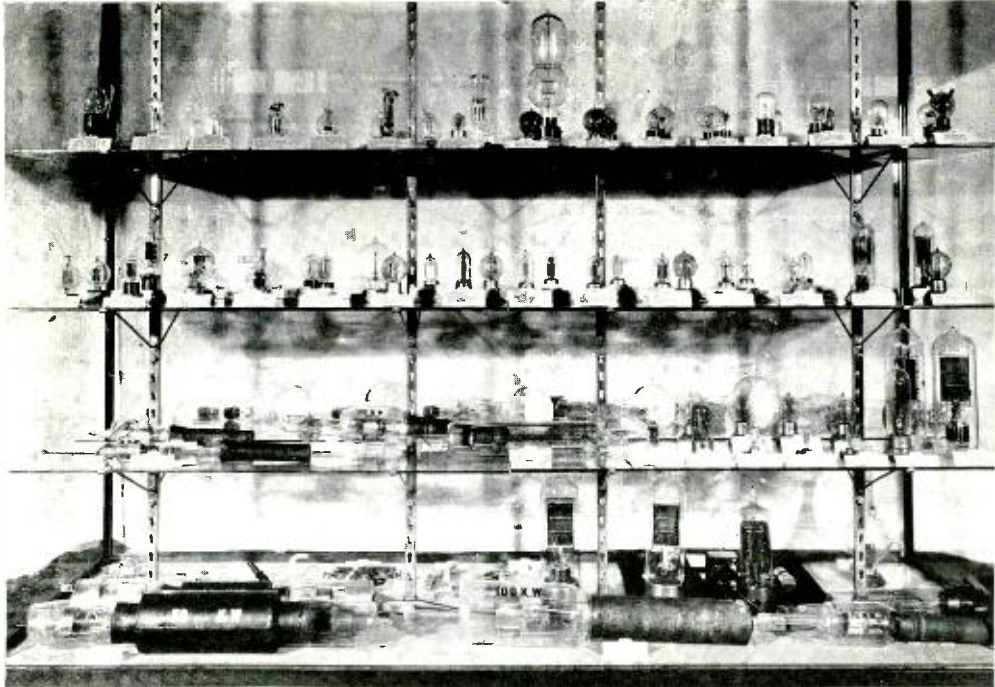

This case of vacuum tubes traces the art from Edison's discovery to the present day.

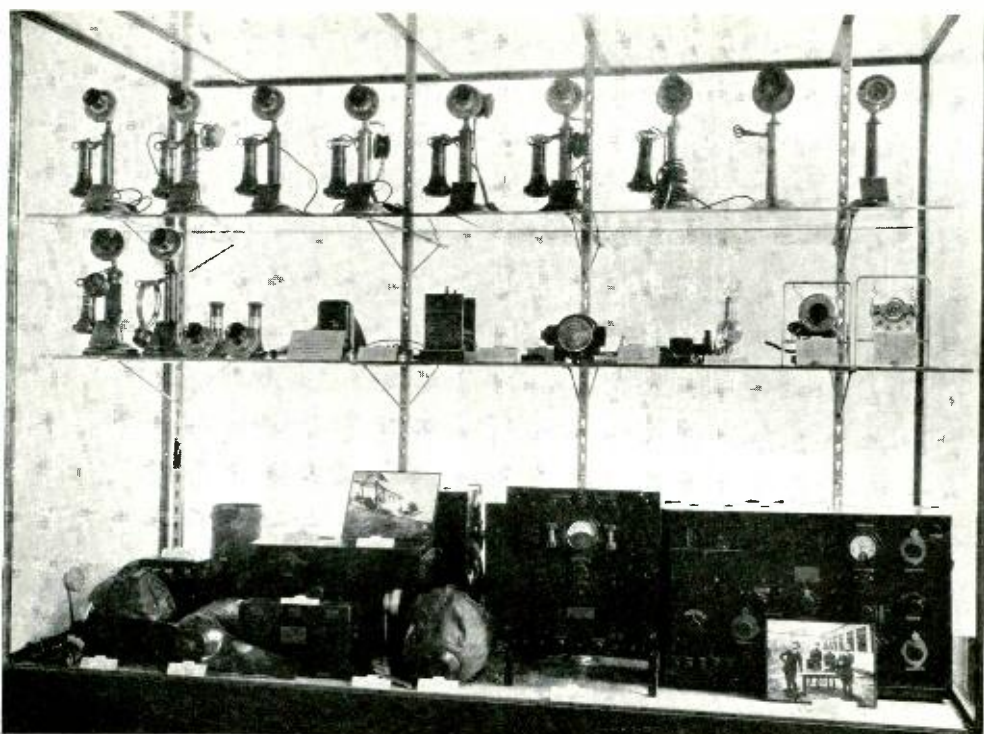

Telephones used on historic occasions occupy the shelves; below are specimens of our airplane radio telephone equipment. The photograph at the right shows Mr. Craft and Mr. Slaughter at a demonstration

there. Mr. Richards believes that museums should be useful particularly when they are supported by an industry. Education is of course the function of a museum, and the activities of this museum have taken many forms. Some 3,300 photographs of a great variety of subjects have been made and prints are constantly being supplied to Bell System people and others. Of particular interest to public service commissions have been sequences of pictures tracing the development of transmitters and receivers, as a bird's eye view of the changes which have been made to improve and extend telephone service. Such a sequence of transmitters is shown on a previous page.

Most of the Museum's specimens are unique, and proper care requires that they be kept inside our building.

The demand from the Associated Companies for material for historical displays was at first met by lending the few duplicates. Finally two travelling collections were made up of "dummy" models of the more important forms of subscribers' sets. These collections, routed by the Information Department of the American Telephone and Telegraph Company, are kept constantly in use in the field. By making up dummies largely of wood, much expensive shop work was saved, to say nothing of shipping expenses.

Fifty years of amazing progress are symbolized in our Historical Museum. But more wonderful progress promises for the next fifty years. And its symbol is the loyal and unified endeavor of all Bell System members, and their ideals of research and service.

MULTIPLEX TRANSMISSION BY CARRIER CURRENTS

By J. WARREN HORTON

ATTENTION has often been called to the magnitude and complexity of that portion of the telephone plant with which the average telephone user has no contact. On one hand there is the subscriber's desk-set, and on the other central-office switchboards, telephone cables, cross-country pole lines, and all the enormous transmission network which makes it possible for any one of the 15,000,000 subscribers' stations in the United States to be connected with any other one. The subscriber's station constitutes only about three percent of the total telephone equipment necessary for furnishing communication facilities.

Although it is undoubtedly true that the majority of us are more familiar with the telephone instruments on our desks than with the means by which they are connected to the instruments of those with whom we converse, we all have seen some of the open-wire telephelines and aerial cables which connect the cities and towns.

Over these telephone lines it is customary to say that speech is transmitted or that pictures may be transmitted. This is, however, entirely incorrect. The only thing which is ever transmitted in any electrical com-

munication system is an electric current. Certain characteristics, determined by the particular message or signal to be carried, are imparted to this current by the sending apparatus. By virtue of these characteristics the message, whether in the form of a spoken word, the music of an instrument, or the light and shade of a photograph may be reproduced by suitable receiving apparatus.

During the last twenty-five years a great deal of attention has been given to the study of these currents and, as a result of the increased knowledge of their characteristics, methods for their transmission have been vastly improved. In this work it has been found that the frequency of an electric current is one of its most important characteristics. Now the idea of "frequency" is very closely related to the idea of "pitch" with which we are

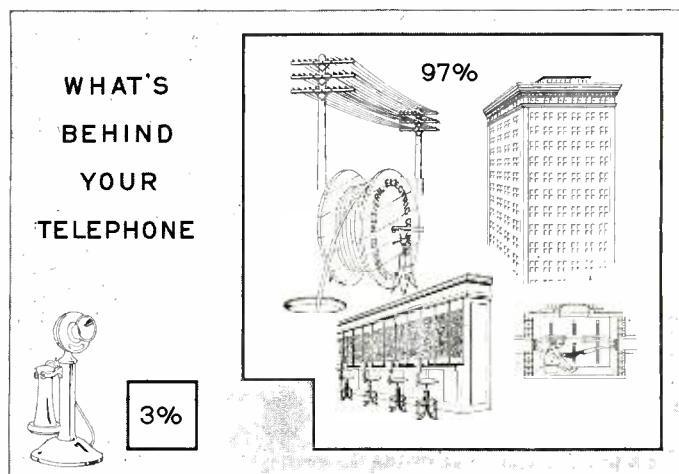

Diagram showing the relative investment in subscribers' apparatus and the equipment necessary to its functioning

exceed the requirements of a single speech-message. By moving different messages to different and not overlapping parts of the available frequency range multiplex carrier-current operation becomes possible. For each message which is to be so displaced from its usual low-frequency position a modulator is required. In order to connect several modulators to a single line at the transmitting end and at the receiving end to separate the currents associated with a given message from those associated with other messages, it is necessary to use band-pass filters. Low-pass and high-pass filters were described in the article on the artificial line in the October issue of the *RECORD*. A band-pass filter is one which combines certain elements and effects of these two filters. It readily transmits currents having frequencies within a certain specified range but restricts transmission above and below this range. A suitable band-pass filter, therefore, will permit the passage of all the necessary component waves of a given message.

DIRECTIONAL GROUPING

The arrangement of filters and

modulating circuits for a three-channel carrier system is shown in Figure 3. This illustrates the so-called "directional-grouping" scheme in which currents transmitting signals from east to west are all assigned to one continuous portion of the frequency range and currents transmitting signals from west to east to another portion. Currents sent out by any of the modulators shown at the left pass through their respective band-filters and through filter A. Filter B, however, prevents them from entering the receiving circuits at the same terminal. Similarly filter A prevents currents received from the other end of the line from entering the sending apparatus. Filter B, however, permits them to reach the receiving apparatus without undue loss. Were it not for these grouping filters electrical energy might flow continuously through the closed loops existing at either terminal and produce the familiar "singing" effect.

TELEGRAPH CHANNELS

In the case of some of the longer toll lines, where the investment in line warrants the added expense of

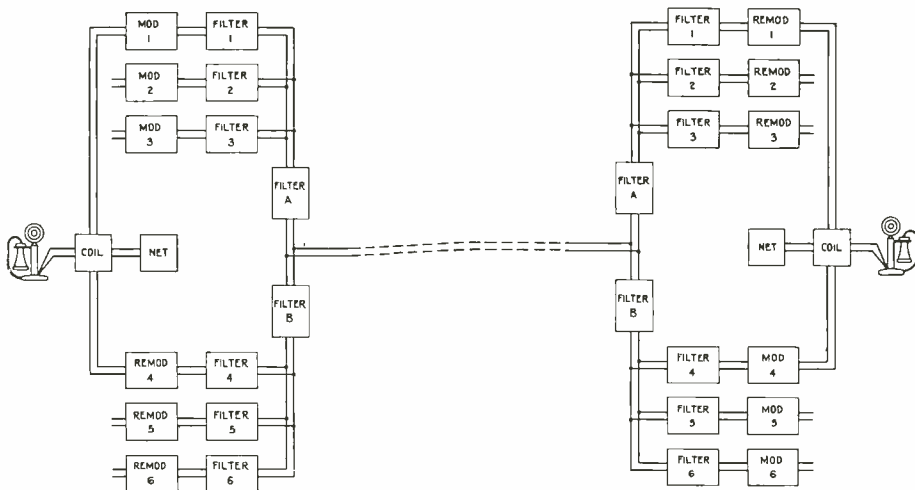

Fig. 3: Arrangement of filters and modulating circuits for a three-channel carrier system, illustrating the "directional grouping" scheme

apparatus, the circuits and equipment are arranged to provide both additional telegraph and telephone facilities. Since the range of frequen-

played in the circuits of Figure 3. Provision in circuits for separating the various groups of channels must also be made at each repeater station

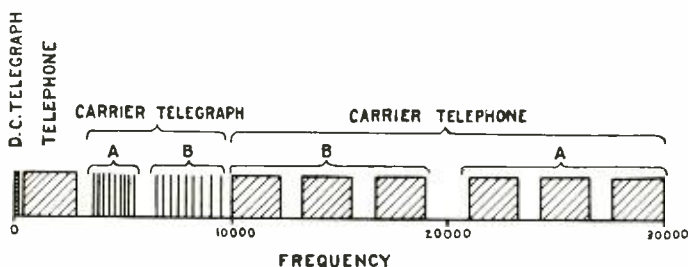

Fig. 4: Location of the various telephone and telegraph channels on the frequency scale

cies required for a telegraph message is very much smaller than for a speech message, in fact about one-twenty-fifth as large, a number of telegraph channels may be provided without encroaching on the frequency range of the speech channels. Figure 4 shows the location of the channels upon the frequency scale. The complete arrangement of the filter circuits which is required to combine and separate these various channels makes quite a complex circuit diagram—too complicated for the purposes of this article, but the principles involved are the same as those em-

ployed in the circuits of Figure 3. Provision in circuits for separating the various groups of channels must also be made at each repeater station

in order that each frequency group may be suitably amplified. As a result of the extensive application of carrier systems to the Bell telephone plant it is very probable, when you talk over a long toll connection, that the exclusive communication channel which you use for two-way conversation occupies a part of the frequency range of the line which years ago would not have been utilized. The electric signal-wave carrying your message has been switched about on the frequency scale to some unoccupied location and transmitted simultaneously with several other signal-waves.





CARRIER-CURRENT TELEPHONE SYSTEMS

By BURTON W. KENDALL

This article by an engineer concerned with carrier-current developments throughout their history, first in research and later in designing systems, describes some of the important steps in carrier-current telephony

TO "make two ears of corn, or two blades of grass, to grow upon a spot of ground where only one grew before," is a common formula of achievement. Translated into the language of telephony, it may be said that to make several messages travel over a path that had formerly been open to but one, greatly increases the usefulness of that path. The simultaneous transmission of telephone and telegraph messages over one circuit, and the phantoming of telephone lines so that two pairs of wires are made to carry a third conversation, are early examples of increased use of the wires of our Bell System. Our present example is the use of carrier currents to convey additional messages along a single circuit.

The history of telephony tells us that Alexander Graham Bell's early experiments were concerned with an attempt to develop a method for sending several telegraph messages over a single telegraph wire by using different frequencies for the different messages—much as broadcasting stations now send many messages over a single ether, if there be an ether, by using different frequencies. Since the time of Bell's most important invention, many investigators have been attracted to the problem of increasing the number of telephone messages transmitted over a single circuit, by using currents of different frequencies and separating them at the terminals.*

The development of the vacuum tube made available an instrument for the practical solution of this problem by furnishing in convenient form means for generating carrier currents, for controlling them in accordance with the message to be transmitted, for amplifying them, and for recovering from them the original message. When methods had been developed for performing these functions satisfactorily by means of the vacuum tube, an experimental carrier system, providing two conversations over a single circuit, was set up in the laboratory by R. A. Heising in 1914. The satisfactory results obtained and investigations by engineers of the American Telephone and Telegraph Company showed that multiplex telephony by carrier currents was a reasonable possibility, and a further study leading towards a field trial was undertaken. For determining the characteristics of open wire lines at carrier frequencies (i.e., from 5,000 to 50,000 cycles), measuring apparatus, including oscillators to furnish measuring current, instruments to receive and measure small alternating currents, and a bridge for measuring impedances at high frequencies, was developed. In the design and production of this testing apparatus C. R. Englund and E. O. Scriven were

*The more important of these suggestions and inventions were described in a definitive paper on "Carrier Current Telephony and Telegraphy," by E. H. Colpitts and O. B. Blackwell, in the 1921 *Transactions of the American Institute of Electrical Engineers*.

concerned. It was used extensively in the field by the engineers of the American Telephone and Telegraph Company in measuring the attenuation and impedance of telephone lines and the crosstalk between adjacent circuits at carrier frequencies. The results gave a knowledge of the character of the lines to be used and information which enabled engineers to work out transposition methods for minimizing crosstalk at high frequencies between adjacent pairs of wires.

Autumn of 1915 saw work begun on a carrier telephone system which should later be transferred to the telephone plant for trial. Since either of the two side-bands produced in modulating a high-frequency carrier-current by a telephone message contains all that is necessary for reproduction of the message, provided the carrier frequency is locally available, the system was planned to use the frequency range economically by transmitting only the lower side-band. The elimination of the carrier frequency itself was by the method of J. R. Carson. A modulator consisting of two vacuum tubes arranged in a differential circuit balanced out the carrier but not the side-bands. Each upper side-band was suppressed by a band-filter which also separated this channel from the other channels on the line.

It was necessary that the carrier currents supplied at the two ends of the line have very closely the same frequencies. To insure this, a method was devised by which all of the carrier currents could be derived from the output of a single oscillator, generating a current of 5,000 cycles for transmission over the circuit as a control frequency. At each end of the line, this control current was fed into vacuum-tube circuits arranged to produce harmonics (e.g., 10,000, 15,000, etc.), which were then selected and used independently as carriers.

This telephone system operated in both directions on the same frequencies. Both parts of a single conversation, were, therefore, lower side-bands produced by the modulation of the same carrier frequency. This required balancing at high frequencies the impedance of the line by an artificial line or network, in the same way as the impedances of the lines leading to a two-way voice repeater are balanced.

This system was originally assembled in the Laboratories and extensive tests were made. Early in 1917, it was shipped to Maumee, near Toledo, Ohio, where circuits leading to South Bend, Indiana, had been specially transposed for high-frequency transmission. Figure 1 shows part of the installation which comprised in all



Figure 1—Some experimental apparatus as used in Maumee tests in 1917

developed. The contribution of the Systems Development group to this project, started under N. H. Slaughter's direction, has been continued, since he was lured back into radio, under C. W. Green's direction, by R. W. Chesnut, R. E. Coram, W. B. Nottingham (now doing graduate work at Princeton), and others.

The frequency control by a single oscillator, a feature of type "A" systems, has been made unnecessary in the transmission of speech by further developments in oscillator circuits which have made them more stable under variations of power supply and temperature. With these oscillators, new filter-systems, and the elimination of the unmodulated carrier, it is not necessary to maintain a harmonic relation between the carriers as in the earlier systems. The carrier frequencies which are used were determined with the American Telephone and Telegraph engineers, by considering thoroughly all the factors which would enter into the annual charges

of the system. Among these were maintenance, the cost of transpositions, of apparatus and of the filters as affected by band widths and separations. The operation of this system with other systems on adjacent wires and the provision of two types of system with such distributions of frequencies as to lessen the interference between them were also considered in this allocation of carrier frequencies in the Type "C" system. The engineers of R. V. L. Hartley's group, particularly J. W. Horton, M. B. Long, W. P. Mason, E. Peterson, and D. M. Terry, made important contributions to the solution of this and other fundamental problems.

In previous systems, band-filters had been designed for uniformly high attenuation outside the transmitted band. In preparing the final requirements for Type "C" filters, use was made of a study by W. B. Nottingham in which he determined, from consideration of the possible forms and sources of inter-channel interference,

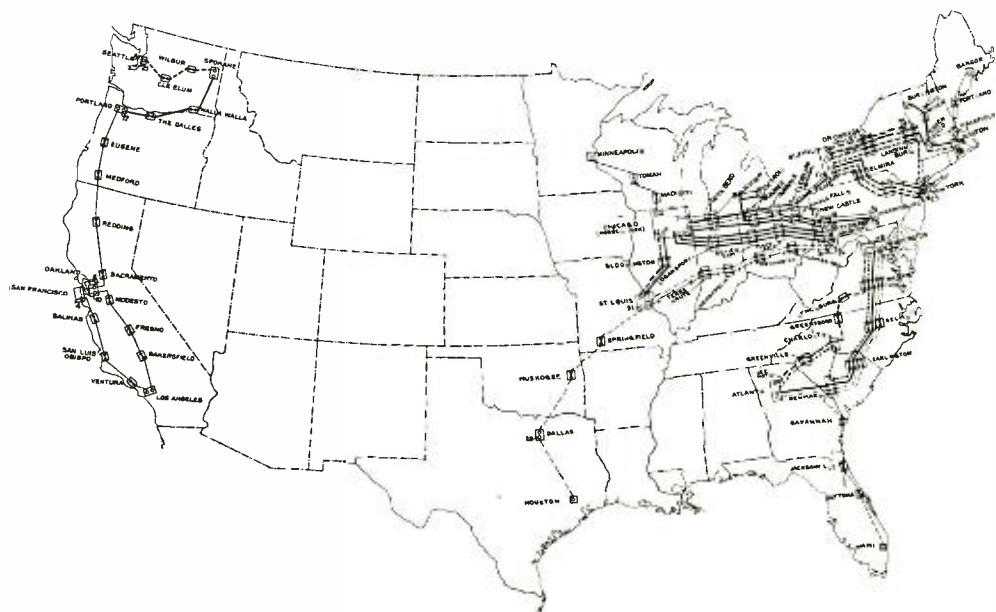

Figure 4—Routes and locations of carrier telephone systems, present and proposed

just what attenuation the filters of the system should introduce at definite frequencies. Intensive studies of filter structures in which W. L. Casper, T. E. Shea, K. S. Johnson and R. H. Mills were particularly active, led to the production of much better and much cheaper filters for this system.

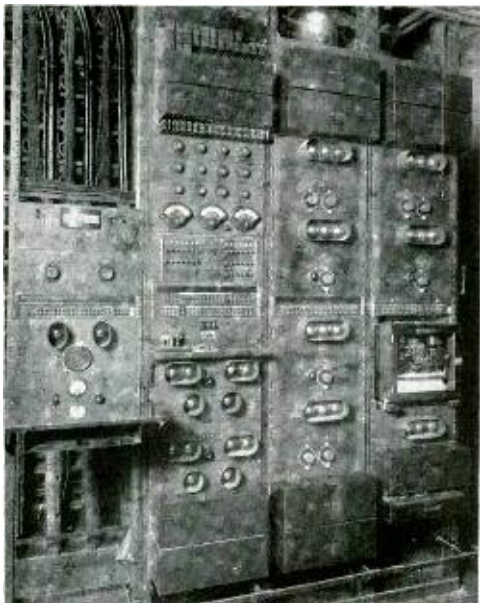

Figure 5—Eastern terminal of Pittsburgh-St. Louis Type "C" carrier system.

The first Type "C" equipment, made in our Model Shop, was installed for trial between Pittsburgh and St. Louis in 1924. It provides channels for three additional conversations, has given satisfactory service, and three similar systems have since been manufactured at Hawthorne.

In most carrier systems repeaters are required at intermediate stations. At a repeater the currents travelling in opposite directions are separated, in the type "A" system by balancing transformers and networks, but the directional grouping of frequencies in the later systems permits the use of filters for this separation. All the

messages in either direction are amplified in a two-stage push-pull amplifier circuit of six tubes. The earlier repeaters were made as complete units. Later the filters, amplifiers, and battery supply and testing equipment were separated and arranged for relay rack mounting as shown in Figure 6. Amplifier units essentially the same as those in the carrier repeater are used in the terminals of the type "C" system, each handling all the messages in one direction.

Such in part are the writer's remembrances of the development of

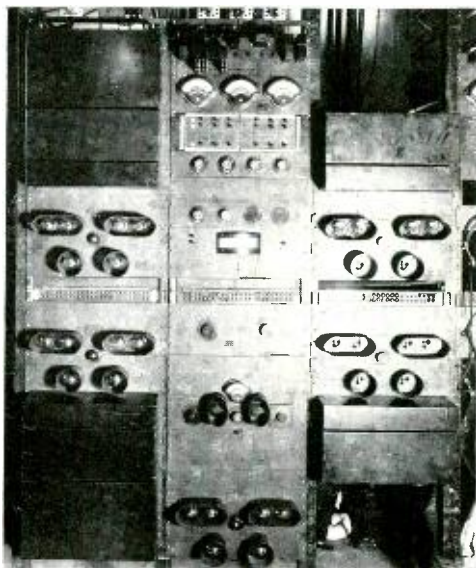

Figure 6—Typical repeater installation

carrier-current systems for multiplex telephony. Other applications of carrier methods would make an interesting story. This brief account has necessarily been incomplete and has been concerned primarily with contributions in our own Laboratories. A complete history of this important Bell System advance would fill several issues of the *RECORD* and require much searching of the files and of other memories.

FOR BETTER RADIO RECEPTION

The new 548 type loud speaking telephone is a big brother to the familiar "cone"

A NEW loud speaking telephone has taken its place among Western Electric acoustic products. This is the 548 type, similar to the 540 in principle but considerably larger, being thirty-six instead of eighteen inches in diameter. It is available in two models: the 548-AW, in which the projector is mounted on a wooden pedestal giving an overall height of forty-nine inches; and the 548-CW, which is equipped with a bracket for wall mounting.

Due to its large diaphragm the new speaker reproduces extremely low tones such as the pedal stops of the pipe-organ and the hollow growl of the contrabass with remarkable fidelity. These low tones, fundamental to the harmonic scheme of any orchestral composition, are conspicuously absent from the music delivered by most loud speakers.

In spite of its larger size, the 548 type speaker operates on the same power as the 540 type, and gives

about the same volume of sound. The same electro-magnetic unit is used in both types. With a high quality receiving set having one stage of audio frequency amplification, a 6025-B amplifier, and a 548 speaker, as satisfactory results may be obtained as are possible in the present stage of development of the radio art.

Occasionally suggestions appear in radio publications as to how our cone-type speakers may be improved. All of these ideas have been tried out in our laboratories,

and have been found to give no improvement, as far as measurements and the opinions of a large number of listeners can show. Tastes differ in the quality of reproduced speech and music, and while an occasional listener may prefer to emphasize or suppress certain frequency-ranges, the opinion of the public at large has been found to coincide quite well with the standards and trained judgment of our engineers.

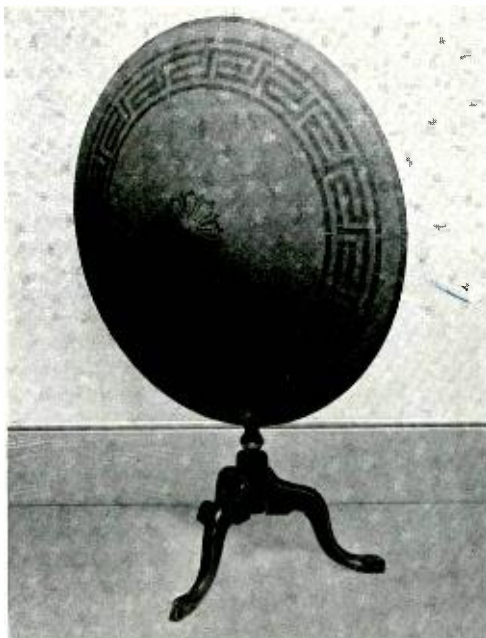

The 548-AW Loud Speaker



*Our Building Has a Bath:
To match the pristine freshness of the addition, the older part was cleaned—
the brickwork chemically, the stone by sandblasting*

ARE YOU A GOING CONCERN?

An editorial reprinted from the Western Electric News

TWO men were lunching together. They had been roommates in school; they had always liked each other; and they had always talked to each other frankly and in confidence.

"It has been some years since I have seen you, Bill," one said to the other. "You look mighty prosperous."

"Tom," he answered, "I have been doing well. I made ten thousand dollars last year, and I'll make more this. I hope you are as successful."

Tom was very thoughtful for a moment and they smoked in silence.

"Yes," he said, "I suppose I have been just as successful. What would you be worth if you died tomorrow?"

For a moment Bill was taken aback.

"Why the crepe, old boy?" he finally asked. "I never felt better in my life. I must be good for twenty years more. I don't suppose any man in middle life is worth much dead. I guess I'd leave a few thousand dollars. Perhaps, not a thousand after my bills were paid. Just enough to bury me, I guess. Depressing thought."

"Not necessarily depressing," answered Tom, and there was (more credit to him) nothing patronizing in his tone. "Men who do not prepare

for the future are usually merely thoughtless. They often earn more than the ones who look ahead. Now, I have never in my life earned more

than \$3,600 a year and yet, were I to die tomorrow, I should leave my family \$45,400, consisting of a house, free and clear, worth \$18,000; \$25,000 in life insurance, and securities worth \$2,400. You have enjoyed a fine income, Bill, but are you really a going concern? Will you do as well by your dependents as I?"

Bill looked at his friend and an expression not unlike amusement crossed his features.

"I shall not do as well by my dependents," he said, "but then, you see, I have no dependents."

Frankly, we hate to quote that last line, because it spoils our moral if there were going to be one. Or it at least brings up an argument about the absurdity of not making provision for old age. But this is a true story, and we must tell it as we heard it.

However, there is one striking thing in what Tom said; one thing well worth thinking about. "Are you a going concern?" he said. Well, what is a going concern? It is one, as we understand it, that on its working



capital earns a comfortable reserve for emergencies and at least six per cent. in interest. If we regard ourselves as business concerns, our annual earnings make up our working capital. How many of us have six per cent. of those earnings, and a reserve left over at the end of the year?

And yet, it is not an insurmount-

able problem. It is a matter, largely, of perspective. How many times have we heard men say that they found it easier to save when they were making less money. They could see then more plainly the necessity for systematic saving. With increased earning capacity is likely to come a feeling of false security.



OUR FOREIGN CORRESPONDENCE

LLOYD ESPENSCHIED (D. & R., L.A.T.&T.), who is in Paris acting as an unofficial observer at the International Telegraph Conference, recently wrote to John Mills a letter which is an interesting sequel to the article "Ten Years Ago" in the October *RECORD*. It will be remembered that Mr. Espenschied took an active part in the first transatlantic radio telephone demonstration, between Arlington and Paris, in 1915. His letter in part:

Paris, Oct. 17, 1925.

I have just received the first copy I have seen of the Bell Laboratories Record (Vol. 1, No. 2).

Clyde Snook's article on the Electrical Stethoscope gave me such a heart throb that I kept right on reading and did not stop until the last page was reached.

The article on the 1915 radio telephone tests was of particular interest because just the other day I visited the Eiffel Tower Station where Shreeve and Curtis did the receiving. I asked to see the very room in which that early vacuum tube radio telephone receiving set was employed and in which the voice of America was first reproduced in Europe—and found it to be now full of big vacuum tubes, for transmitting. Among the several trans-

mitting sets is the one employed for broadcasting; so that now the human voice passes through that room every day, but unfortunately not to as far as America.

And Gen. Ferri is in the picture here now as he was in 1915. I had the pleasure of calling upon him a few days ago and presenting him with a tele-photograph of *himself!* It was a reproduction which Shreeve had caused to have made over the New York-Chicago tele-photograph system. The original photo the General had given to Shreeve in Paris some years ago. The completion of this photographic cycle seemed to me to symbolize the decade of international friendship involved and synchronized nicely with the article "Ten Years Ago".

The Conference which I am attending (as an observer) is particularly interesting to the American because of the international complexity which it portrays, a picture which we do not get at home. One is impressed by the difficulty which attends the "getting-together" of the telegraph administration of the various governments, and by the extent to which political boundaries and governmental considerations, as distinguished from purely engineering considerations and economic boundaries, govern the decisions of the conference. Obviously the administering of international communications is a large question still young in its development, and one which requires for its healthy and free working out that the governmental hand be laid not too heavily upon it.



PRESSURE TESTING OF SUBMARINE CABLES

By VICTOR E. LEGG

ALTHOUGH the basement of our building is popularly supposed to be a labyrinth in which it is very easy to lose oneself, it really contains several interesting things besides those essential to the support of the rest of the Laboratories. Among these is the



R. A. Chegwidden measures the constants of permalloy cable with an impedance bridge

apparatus for testing submarine cable cores, located in Section G, comprising a bewildering network of heavy pipe, a powerful pump and hydraulic accumulator, a cold water circulating system, and a sensitive inductance bridge with its associated equipment.

The need for such pressure testing of submarine cable cores is of quite recent origin, arising in the course of our development of permalloy-loaded cable. The permalloy tape (or wire) is wrapped helically around the copper conductor to increase its inductance, and serves a purpose somewhat similar to the familiar loading coils on land

telephone lines. But soon after the invention of permalloy, it was found that the magnetic properties of the metal are quite sensitive to mechanical stresses, and it was necessary to find if such stresses would be present under deep sea conditions. Would the customary methods of cable manufacture be satisfactory when used with the sensitive permalloy, or what changes should be made? To answer these questions, sample cables had to be made and tested under deep sea conditions.

The most important deep sea condition is the great pressure, since everything at the bottom of the ocean is supporting the pressure of all the water above it. Recalling the weight of a cubic foot of water, it turns out that the pressure one statute mile down in the ocean is somewhat more than a long ton per square inch! A single square foot of the sea bottom only one mile down supports a weight of water greater than a couple of heavily loaded freight cars! What such pressures might do to permalloy-

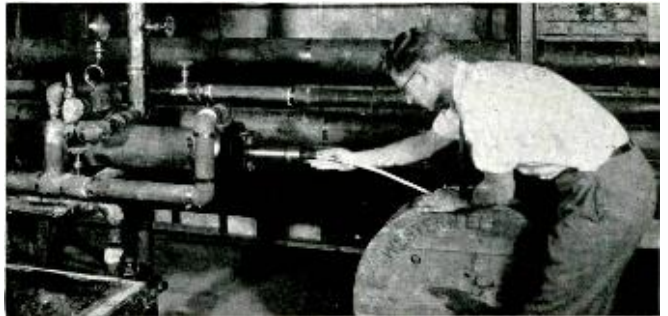

J. A. Robinson inserts the permalloy cable core into a high-pressure testing pipe

loaded cable was a question which had to be answered.

Specially designed test pipes were installed for tests of cores about twenty feet long, and one pipe fifty feet long was provided. Pressures up to 6,000 pounds per square inch are customary, and it is possible to use 10,000 pounds in one of the pipes, so that we can reproduce conditions more than four miles under the ocean. A very powerful pump is necessary, and for the storage of water under such pressures an hydraulic accumulator was installed. This is essentially a cylinder containing a vertical piston of one square inch sectional area. The upper end of the piston can be loaded with iron weights, up to 10,000 pounds, so that the water pressure within the cylinder, and in the test pipe connected to it, must be the same number of pounds per square inch.

Besides the enormous pressures, at sea bottom there is another condition, much less generally known. The water down there is very cold, being around thirty-nine degrees Fahrenheit. The reason for this is simple enough when it is remembered that sea water is denser at this temperature than at higher temperatures, thus leaving the

sea bottom at a constant low temperature. To reproduce this condition of the ocean it was necessary to put water jackets around the heavy hydraulic pipes in which the cores are tested and circulate through them

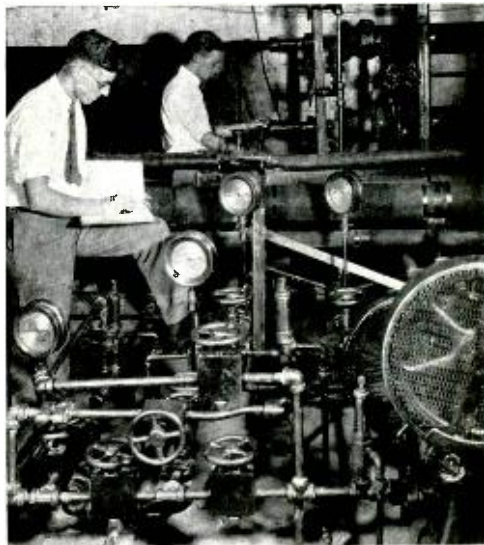

The pumps in the foreground create a pressure on the test samples equal to that of three miles of sea water. Pictured are Messrs. Robinson and Odell

water cooled by passing through a tank filled with cracked ice.

The first test conductors were made following as nearly as possible the standard cable practice of the time. The annealed, permalloy wrapped, copper conductors were coated with a sticky resinous material known as Chatterton's compound, just sufficient to cover the surface, before insulating with gutta-percha. In such form, the conductor is known as cable core, and many important tests are made at this stage in the manufacturing process. Inductance measurements showed that no serious mechanical stresses had been encountered during covering, so the samples were inserted in the pressure pipes, and the stuffing boxes were tightened down, prepara-

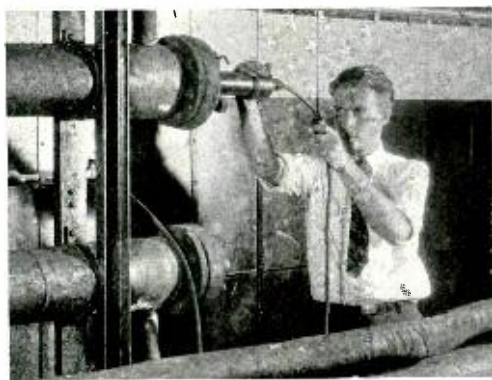

L. T. Odell attaches the test leads to the core of a permalloy-loaded cable, emerging from a high pressure testing pipe

tory to applying the pressure. No serious effects were observed up to this point. But when the pump was started, and the pressure was allowed to increase slowly just as if the cable were sinking into the sea, the inductance of the samples began to decrease, and had fallen to only one quarter of the desired amount before one mile depth had been reached. Evidently the old type of cable construction would not serve with the sensitive permalloy loading.

The next test was to determine if the permalloy loading was really affected by the sea water pressure, or if it was because the pressure was applied to the outside of the gutta-percha only. An uncovered loaded conductor was tested under pressure. Here the water could penetrate under the permalloy loading, and the full sea pressure was applied equally to both sides of the tapes. The inductance was not noticeably affected up to the highest pressures, which showed that if the permalloy floated in a

liquid medium, it would not be injured by deep sea pressure.

A solution of the problem was finally found, by the development and proper application of a compound whose quality is that it remains quite fluid at low temperatures. After the permalloy tape is applied and heat treated, the whole conductor is vacuum impregnated and coated with this compound, before the application of the gutta-percha insulation. Now, as the cable is subjected to increasing pressure, the gutta-percha compresses as in the earliest tests, but it is supported by the semi-fluid compound, which conveys the pressure effect to both sides of the permalloy loading, thus leaving it unstressed.

A great deal of work had to be done before arriving at a satisfactory compound, but this and other difficulties were overcome. The first cable of this type is now in satisfactory operation, and is transmitting three or four times as many messages per hour as any of the old-type cables.

1886—1925

It is with great regret that we record the death, on Monday, November 16, of our associate

Harold William Nichols
engineer and scientist

who has been connected with the work of the Laboratories since 1914, and was in charge of its research work in radio telephony.



A LIBRARY OF HEART THROBS

*A Report of Cooperative Developments by Doctors
Cabot and Gamble, the Columbia Phonograph
Company, and Bell Telephone Laboratories*

IN the *RECORD* for October, H. Clyde Snook told the story of cooperation in development of our electrical stethoscope. Developed on telephone principles and employing the vacuum-tube amplifier and electrical filters, the stethoscope will be of assistance to the medical profession in two ways: the vacuum-tube amplifier will compensate for any ordinary loss in acuity of hearing on the part of the examining physician; the filter will effect the separation from the complex ensemble of heart sounds of the faint and characteristic sounds which the physician desires to hear and analyze.

In its multiple form the electrical stethoscope facilitates researches and the teaching of auscultation to medical students, because it permits a large number of people simultaneously to hear the sound from the heart of a patient. No longer is it necessary for a physician, demonstrating before a clinic, to attempt to describe in words the sort of sound which his students are to expect to hear with their individual stethoscopes and the particular component of that sound which they are to interpret as a certain symptom.

The electrical stethoscope makes available to the medical profession an accurate and amplified reproduction of the sound of the human heart. A doctor can be assured of hearing the separate characteristic sounds of a patient's heart, but until there is available the new development here

described, he must rely upon his auditory memory for the comparison of the sounds under different pathologic conditions. Suppose he re-examines a patient whom he has diagnosed a year before. Is the patient's condition improved or not? The physician must remember the original sound or be able to reconstruct it in his mind through the aid of verbal notes descriptive of the sound, which he made at the time of the first examination. It is extremely difficult to compare sounds in this way, as every telephone man who has taken an interest in "quality" recognizes. In fact, the telephone method is to arrange that the sounds which are to be compared may be heard alternately for short intervals over and over again, thus reducing the length of auditory memory required and permitting many repetitions of the test.

A still more difficult condition in the recognition of sounds confronts the doctor when he examines a patient whom he suspects of having one of the rarer heart conditions of which he may never himself have observed a case, being familiar with it only through the reading of published reports. And here is where the new development promises the greatest assistance. Not only will it bring to this examining doctor an accurate record of the heart sound of this peculiar case, but first as a medical student and later as a practitioner or specialist it will have permitted him

to have studied this sound over and over again. All this may be accomplished by the use of high-quality phonograph records.

Within our Bell Laboratories the development of a new technique for phonographs was described in part in the November *RECORD*. New and improved methods of recording sound were involved as well as the production of an acoustic system which permits the more complete reproduction of sound. The development of electromagnetic methods of recording went hand in hand with that of reproducing. In fact, the wider pitch-range of reproduction which was described in the article referred to above, would have been of small value if the records which were being reproduced had not been cut with corresponding faithfulness in range of pitch and intensities of component sounds. Our

electrical method of recording for phonograph purposes which was developed by Joseph P. Maxfield, Henry C. Harrison, Stanley S. A. Watkins and their associates has been made available through the Western Electric Company to both the Columbia Phonograph Company and the Victor Talking Machine Company. Phonograph records of heart sounds transmitted by the electrical stethoscope and cut by this new method promise to be the solution of these difficulties of heart specialists and therefore of immense value to society.

Other possibilities of phonograph records appear somewhat dimly in the future, for heart sounds of a patient may be recorded and preserved. The records, also, may be shipped over long distances for purposes of consultation with specialists.

The immediate value of this new



Dr. Richard Cabot of Harvard University makes a diagnostic record of a heart sound

technique comes in the training of new doctors in the medical profession and in the development of a reference library of heart and chest sounds which will be of aid to the practitioner as well as to the student. In this task, of wonderful value to the profession and to humanity, Dr. Richard Cabot, assisted by Dr. C. J. Gamble, is at present engaged in co-operation with the Columbia Phonograph Company, which is making the records, and our engineers, especially Halsey A. Frederick and David G. Blattner, who are assisting as transmission experts.

The first records were made on October 31 at the recording laboratories of the Columbia Phonograph Company, where the picture which accompanies this article was taken. Dr. Cabot is there shown making a diagnostic record of a heart sound. The electrical stethoscope appears in the background, and in the left foreground is our familiar Western Electric microphone which is used for so many purposes in radio broadcasting, public address systems, phonograph recording, and the like.

As a celebrated diagnostician, Dr. Cabot is the author of a book on physical diagnosis most widely used by the medical profession and already in its eighth edition. It contains a chapter on "Auscultation" in which,

since this phonograph development had not yet been accomplished, Dr. Cabot was obliged in describing a heart sound to resort to a system of sound representation employing narrow and broad lines made at various angles to symbolize typical sounds. Today with high-quality phonograph records it would be entirely possible for Dr. Cabot, if he so desired, to illustrate an edition of his book by records containing the actual sound and the diagnoses of these sounds told in his own voice. Such records would be produced under the conditions of the picture. Through the microphone Dr. Cabot's comments are transmitted to the electrical recording mechanism and the phonograph wax, and through the electrical stethoscope there are transmitted the heart sounds which he describes.

A wonderful advance in preventive medicine is predicted by these developments and this co-operation. It is an advance which will long reflect to the credit of Dr. Cabot and the Columbia Phonograph Company. But that is not all, for as Mr. Snook observed while present at the first recording: "the world needs records not only of its masters in song and oratory but also of the voices of its great scientists. Among these is the voice of Dr. Richard Cabot, physicist and diagnostician, of Harvard University."





HIS FIRST JOB

The first work assignments in the Bell system of one of the men who is responsible for the present direction of our investigations and developments

A PATENT attorney's business is to protect other peoples' inventions, not his own; but our general patent attorney, John G. Roberts,

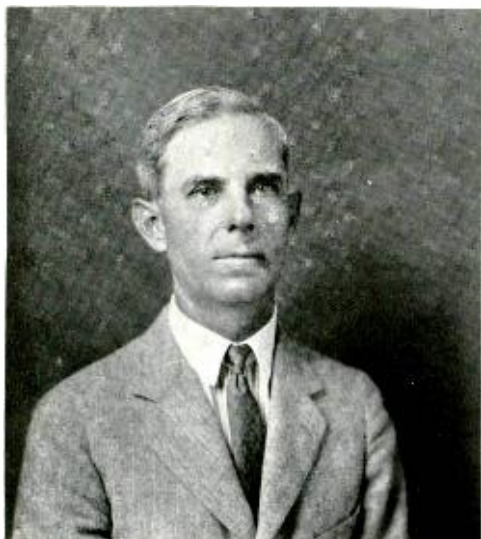

John G. Roberts

was an electrical engineer and an inventor in his own right before he became a man of law.

The Western Electric Company first came into Mr. Roberts' life as a prospective purchaser of some of his early inventions. This was in 1902, eight years after his graduation from Purdue—eight years filled with experience in electrical work varying from winding armatures to installing telephone exchanges. At that particular time he was in the throes of designing a synchronizer that would really synchronize, to be used in a "Telescripser" or picture transmis-

sion system invented by a German.

"While in the midst of my troubles with the Telescripser, I went to Chicago in an endeavor to sell some of my inventions to the Western Electric. They did not purchase my patents, but later on I received a letter from Mr. Frank R. McBerty asking me to come to Chicago for an interview. Mr. McBerty asked me what I knew about patents. I answered that I had read about two hundred relating to telephony, many of which were for inventions of Mr. Charles F. Scribner, Mr. James L. McQuarrie, and himself. On this showing I was taken on in January, 1902, as assistant to Edwin H. Smythe at Clinton Street, Chicago."

Until 1908 Mr Roberts remained at Clinton Street, acting as telephone expert and patent solicitor. Meanwhile he found time to attend the night course at John Marshall Law School, from which he graduated.

It was in 1908 that the General Departments of the Western—including the Patent—were removed to New York. Mr. Roberts preferred to stay in Chicago. So he and the Western separated temporarily. In the latter part of 1909, however, he was persuaded by DeWitt C. Tanner, general patent attorney of the Western to come East. He has had charge of patent work at West Street as assistant general patent attorney of the Western Electric Company and now as our general patent attorney.

LABORATORIES PERSONNEL CHANGES

HARRY E. YOUNG has been transferred from the Laboratories to the Western Electric Company, to become Telephone Sales Engineer. He will have charge of the Telephone Sales Department's relations with the American Telephone and Telegraph Company and with non-associate manufacturers of goods distributed by Western Electric; handle the publication of the apparatus card catalog and of telephone sales bulletins; and act as an engineering advisor in the Department's activities.

Mr. Young entered the Western Electric Engineering Department as a student in 1914, immediately after his graduation from Brooklyn Poly-



Harry E. Young

technic Institute. After completing the student course he started in the physical laboratory under the supervision of Daniel D. Miller, and from

there he was transferred to William T. Booth's radio development group. Shortly after the War ended, Mr. Young assumed charge of the branch



Charles W. Lowe

of the Order Service Department engaged in clearing up the Engineering Department's contracts with the Government. When this work was completed, the group undertook the supervision of similar contractual relations with the American Telephone and other associate companies; and from this grew the Commercial Service Department of which Mr. Young, as Commercial Service Manager, was the head at the time of his transfer to the Western.

Charles W. Lowe takes Mr. Young's place in the Commercial Department. Mr. Lowe is a University of Wisconsin man of the class of 1909, and like his predecessor, he served his apprenticeship in the Western Electric stu-

dent course, in his case at Hawthorne. In 1910 he was transferred to the Engineering Department, where for eight years he was engaged in apparatus design. When the decision was made to establish a separate department to prepare and issue manufacturing specifications, the organization and supervision were assigned to Mr. Lowe. He has been in charge of this work continuously since that time, and for the last two years has also been responsible for apparatus drafting and for the widely used Apparatus Card Catalog and departmental files and service.

Roy R. Ireland is Mr. Lowe's successor as head of the Apparatus Development Service Department. From

the University of Minnesota, where he received a B.S. degree in 1901 and an E.E. in 1903, Mr. Ireland came to the Western Electric plant at Hawthorne and started

as a student. After obtaining considerable shop experience he was transferred to the Engineering, then to the Merchandise Departments. In 1909 he was transferred to New York, and here he has been engaged in apparatus design, cost study, and apparatus service work. For several years previous to the present trans-

fer he has been responsible for the card catalogue and the departmental files and service. This position has now been filled by William A. Bischoff, who formerly reported to Mr. Ireland.



Roy R. Ireland

Sergius P. Grace, H. Clyde Snook, David G. Blattner, and Clarence H. Amadon recently visited the Southern Bell Telephone Company who are arranging for an investigation of teredos. The teredo is a marine boring worm which is annually responsible for enormous losses of property due to its attacks on bridge and dock timbers in Southern Coastal waters. The officials of the Southern Bell Telephone Company are planning to place at the disposal of the State Highway Department of Georgia and its bridge engineer, S. B. Slack, the apparatus and technique which has been developed in our Laboratories for detecting and amplifying feeble sounds. The equipment which will be used is essentially that of the electrical stethoscope. An investigation of the teredo has been carried on by the State of Georgia and it is expected that our apparatus will facilitate the investigation next year. Further assistance to the State will be through F. B. Saunders, Outside Plant Engineer of Southern Bell



A NEW PRIVATE EXCHANGE FOR THE LABORATORIES

A new No. 604 P. B. X. board has been ordered from Hawthorne, to be ready for service next April

THERE is an old saying to the effect that a cobbler is seldom well shod; but like most epigrams, this is only half true. Telephone service at the Laboratories is a case in point. The West Street private branch exchange board has not been neglected in the rush to design telephone systems and apparatus for others; and to make service in the building even better, a new thirty-three position switchboard has been ordered from Hawthorne, to be ready for use next April. Negotiations which led to the order for the new board started about two years ago; with the construction of the new Section H, need for increased telephone service has become urgent.

Telephonically speaking, the order calls for thirty-three sections of standard No. 604-C private branch exchange switchboard equipped for sixteen hundred lines; two one-panel end sections and one cable-turning section. Communication with the outside world will be carried on through one hundred trunks to the Chelsea office and sixty tie lines giving direct service to the P.B.X. boards of other Bell companies in and around New York. Tie lines will connect us with the offices of the Western Electric Company at 195 Broadway, Kearny, Pershing Square, Thirty-sixth Street, and 395 Hudson Street; with the general offices of the American Telephone and Telegraph Company; and with the New York Telephone Company's offices at 15 Dey Street and 104 Broad Street.

Although it is of the standard 604 type, our board will include a number of additional features such as interposition call circuits, and audible ringing. Its ultimate capacity will be fifty positions and 2800 lines. One of the positions will be for the use of telephone dictation.

The board will be in Section A of the tenth floor, in the space now occupied by Rooms 1002, 1003, and 1004, and the south corridor. A new hallway will be cut through just south of the present one. As the new power room will occupy some of the space now used by the old board, power will be supplied by the old power apparatus until the old board has been cleared away and new power apparatus installed. Hawthorne is working overtime and shipments are being made by express so that the installers may be able to start work January 11.

THE OLD EXCHANGE

For many years the West Street private exchange was a testing laboratory for machine switching apparatus as well as a service installation. The original manual board was taken out about 1910, and a 600 line semi-mechanical system set up, of the rotary type now widely used in Europe. This rotary type board was very different in principle from anything developed up to that time. It involved among other features a non-decimal instead of a decimal pulsing system, which permitted the use of

200 point rather than 100 point switches. The board was not really a P.B.X., but a miniature central office. When it had been operated long enough to demonstrate that the principles involved were correct, and might safely be applied to large commercial offices, it was removed and the present manual board installed.

That old rotary installation at West

Street has an important place in telephone history. There the principles which underlie the great panel central offices of today were first put to a practical test; for although the present panel system uses 500 instead of 200 point switches, and although panel apparatus bears little resemblance to rotary, the circuit principles of the two systems are similar.



Professor Michael Pupin of Columbia University visits the Laboratories. Professor Pupin examines a new permalloy relay shown him by William Fondiller, one of the professor's former students, with Burton W. Kendall, another former student and assistant.



ELECTION OF CLUB OFFICERS FOR 1926

*Early this month an election will be held,
to choose the president, vice-presidents,
and three advisers for the coming year*

At a meeting held on October 29, as provided by the constitution, the Nominating Committee, BURTON W. KENDALL, DAVID D. HAGGERTY, JOHN M. WILSON, ALBERT GOEBEL and ELLSWORTH PATERSON, selected the following candidates:

For President

ALBERT F. GILSON
WILLIAM WILSON



For First Vice-President

DANIEL R. McCORMACK
WILLIAM A. BISCHOFF



For Second Vice-President

MISS LEAH E. SMITH
MISS MARION G. MASON



Board of Advisers—Two Year Term

Apparatus Design

GRANVILLE MATTHEWS
LESTER B. FAMES

Shops

JAMES G. MOTLEY
CHARLES A. GRANT

Patent-Inspection

GEORGE H. HEYDT
THOMAS C. RICE

Ballots will be mailed to all Club members on Saturday, December 5, and must be placed in the Suggestion Boxes not later than Wednesday, December 9. No employee of the Bell Telephone Laboratories, Incorporated, who is not a member of the Club will receive a ballot. Membership application forms may be had

from Department representatives, or by calling at Rooms 108 or 322.

Applications for membership received after December 5 will not entitle new members to vote in the current elections. Non-members should file applications at once to insure themselves the right to cast a vote for their candidates.

THE CANDIDATES

Electioneering has been progressing since early November. Campaign committees have been organized for all of the candidates, and these and volunteer workers have been vying with each other in heralding the merits of their respective standard bearers. Campaign statements of the

Research Department, concerned with special research, including vacuum tube research and the supervision of the Experimental Tube Shop. He joined the company in June, 1914.

William A. Bischoff and Daniel R. McCormack are the contenders for the office of First Vice-President. Mr.



Albert F. Gilson



William Wilson

various committees appear elsewhere in this issue. In addition to those, and by way of introduction, the *RECORD* presents the following facts concerning the various candidates, whose photographs are likewise published:

Albert F. Gilson and William Wilson are the rivals for the Club presidency for the year 1926. Mr. Gilson is the head of the Design Division of the Apparatus Development Department. His service with the company dates from July, 1906, although there was a break from March, 1908 to November, 1909. Mr. Wilson is in the

Bischoff has been with the company since February, 1920. He is a member of the Apparatus Development Department, in which he was recently placed in charge of the files, card catalogs and miscellaneous departmental services. Mr. McCormack, in his capacity as office manager, is a member of the Commercial Department. He has been connected with the Company since December, 1919.

Miss Leah E. Smith and Miss Marion G. Mason are the feminine representatives in the list of candidates. They are contending for the

office of Second Vice-President. Miss Smith, as the supervisor of the group of Engineering Assistants, represents the Systems Development Department. Miss Mason is in charge of the transcription work of the Patent Department.



William A. Bischoff

Miss Smith has been with the Company since 1918, and Miss Mason since 1916.

The remaining candidates are for departmental representatives on the Board of Advisers. The

constitution of the Club provides for one representative for each of the six major divisions into which our organization has been divided in order to provide for approximately equal numerical representation. The term for this office is two years, three Advisers being elected annually. Only the members of the divisions affected are permitted to vote for these candidates. Their names will not appear on the ballots furnished to Club members who belong to other departments.

Apparatus Development, Shops and Plant, and Patent-Inspection are the groups which elect new representatives on the Board for 1926.

Lester B. Eames and Granville Matthews are the candidates from the Apparatus Development Department. Mr. Eames, who rejoined the Com-



Miss Marion G. Mason

pany in July, 1919, after a previous connection of over two years, is in charge of orders and order service for his Department. Mr. Matthews is in charge of the Department's Instrument Bureau and Laboratory Service.

He has been a member of the organization since 1909.

Charles A. Grant or James G. Motley will be elected as the representative of the Plant-Shop group. Mr. Grant is in charge of shop

orders and service. He has been with the company since July, 1905. Mr. Motley, a member of the organization since July, 1914, is Assistant Plant Manager.

The Patent Department and Inspection Engineering each present a candidate to represent their combined membership. George H. Heydt, the standard bearer of the Patent Department, has been with the Com-



Miss Leah E. Smith



Daniel R. McCormack

pany since August, 1915. Thomas C. Rice, in charge of the Complaint Bureau of the Inspection Engineering Department, has been connected with the Com-

pany since the early part of 1916.

The Nominating Committee of the Club concerns itself only with the individual offices when it selects the various candidates to place before the membership, and does not attempt

to arrange tickets. However, the contenders for the different offices may form alliances among themselves if they so desire. In the present election only the Wilson-McCormack forces have allied themselves for a joint campaign.



Granville Matthews



Lester B. Eames

elected annually so that the entire membership of the Board may not be new each year. The elected advisers appoint five additional for terms of one year.

The current election is the third in the history of the Club, which was founded during the autumn of 1923. Its constitution provides that an election shall be held annually in December so that the new officers may assume their duties in January.



Charles A. Grant

The president and the two vice-presidents are elected by the full Club membership to serve for a term of one year. The constitution directs that no officer except the secretary-treasurer shall hold the same office for more than two years in succession. The secretary-treasurer is appointed by the Company with no stated tenure of office. Six members of the Board of Governors are elected for two-year terms, three being

Harry E. Young, who was recently transferred to the Western Electric Company, was the Club's first president. Emil C. Mueller and Miss Marion G. Gilmartin were the first and second vice-presidents in 1924. The officers who retire this year are Burton W. Kendall, president, and William A. Bollinger and Miss Marion G. Gilmartin, first and second vice-presidents. David G. Haggerty has been the secretary-treasurer since the organization of the Club.



James G. Motley

The above facts, concerning the regulations governing the election of officers are published for the information of new members of our Company, particularly new Club members. Any member who desires a copy of the constitution may secure one at the office of the secretary.

The secretary-treasurer shall hold the same office for more than two years in succession. The secretary-treasurer is appointed by the Company with no stated tenure of office. Six members of the Board of Governors are elected for two-year terms, three being



George H. Heydt



Thomas C. Rice



STATEMENTS OF CAMPAIGN COMMITTEES

ALBERT F. GILSON

The formation of the Bell Laboratories Club has had a greater effect upon our work-day lives than any other one happening since the introduction of the Employees Benefit Plan. This effect is subtle, yet the benefits of the club are none the less real.

As is often the case in social organizations the brunt of the work is apt to filter down from the leaders to a few willing spirits, who generally are the same individuals year after year, and they carry on to the best of their abilities and enlightenments.

When such a condition becomes evident, it has been found by experience that brand new ideas executed under a new leadership which will attract to itself a new corps of supporters and workers will tend to revitalize interest in the organization.

To those of us who have been associated with Al Gilson, his ability as a leader is an outstanding characteristic. His is the happy faculty of securing the whole-hearted co-operation of those with whom he works and of directing their efforts in an efficient manner.

In the interest of furthering a greater club, guaranteeing to it the support of the active membership in a business-like and efficient administration, favoring no special group but rather serving the whole through better organization and closer co-operation, Albert F. Gilson was instantly indorsed for President by 500 active members of the club who place their confidence in one who has also been a member since its inception.

Gilson Campaign Committee.

WILLIAM WILSON

“BILL FILLS THE BILL”

This slogan aptly expresses the reason why we feel that Bill Wilson should be elected to the office of President of the Bell Laboratories Club.

He is a hard worker.

He is a live wire.

He favors all sports.

He is progressive.

He appreciates that the women's interests are entitled to the same consideration as the men's.

A better candidate couldn't be found.

RADIO TUBE CLUB

395 HUDSON STREET

November 13, 1925

MR. G. B. HAMM,
Chairman of Wilson-McCormack
Campaign Committee.

The officers and members of the Radio Tube Club, composed of members of the Tube Shop, are very glad to have as a candidate for President of the Bell Laboratories Club Mr. W. Wilson.

The Radio Tube Club indorses Mr. Wilson as their candidate because it was through his efforts that they became members of the Bell Laboratories Club and were able to share in the Club's activities. He was always an enthusiastic supporter of all social activities undertaken by us.

(Signed) C. B. SMITH

Chairman of Radio Tube Club

'NUF SAID

Go ahead

DON'T WAIT

VOTE STRAIGHT

You still have time

December 5 to December 9.

*Wilson-McCormack Campaign
Committee*

WILLIAM A. BISCHOFF

Affable - Benign - Capable - Democratic - Energetic - Forceful - Guiding - Helpful - Industrious - Judicious - Kindly - Lively - Masterful - Noble - Original - Progressive - Qualified - Reliable - Sincere - Thoughtful - Untiring - Valuable - Willing - Experienced - Youthful - Zealous - W. A. BISCHOFF

Two years is a long, long time and the men that drafted the constitution for our Club must have realized it when they set two years as the limit for a continuous term in office. Mac was elected to the board of Governors of the Club for 1924 and appointed for 1925. Are we going to drive this willing servant, who cannot say NO?

Dan *has been* the man for two years, why not let Bill Bischoff take up the baton and go on with the race? A change usually improves the health of an organization. Elect Bischoff and give Mac his well earned retirement.

Bischoff Campaign Committee

MARION G. MASON

Presenting Marion G. Mason of the Patent Department, popular, capable and singularly well adapted candidate for 2nd Vice-President.

As a departmental supervisor, Miss Mason has demonstrated a high quality of leadership and ability to cooperate with others for the success of the mutual undertaking. Her outstanding characteristics are getting quality work done cheerfully and promptly. Miss Mason, entirely aside from her skill in handling the day-to-day business, is well known as an organizer of happy times for others. These attributes are essentials to the only feminine officer of your Club.

Mason Campaign Committee.

DANIEL R. McCORMACK

Daniel R. McCormack, candidate for the office of 1st Vice President of the Bell Laboratories Club is a man well fitted to the job. He has both the ability and experience necessary to serve in this office.

For two years he has served on the Advisory Board of the Club and has been one of its hardest workers.

He has a very likeable personality, always has a smile and is never too busy to listen if you wish to see him.

As chairman of the Entertainment Committee he has managed six large parties for the Club. He is also the man who put across the idea of one dollar dances for club members.

Vote for Dan McCormack and place in office a man who will always have the interest of the Club at heart and who can be depended upon.

McCormack Campaign Committee.

LEAH F. SMITH

Don't forget to cast your ballot for Miss L. E. Smith, supervisor of the Engineering Assistants of Department 332-C located in Room 7-A, and help elect her to the office of Vice-President of Bell Laboratories Club.

This young lady, who has been in our happy midst for seven years or so, stands upon her record as they say on the political stump. She is indorsed by all who know her and is proclaimed to be a conscientious worker, a wonderful little organizer and one all-around athlete and good sport.

Again, if you want a radiant spirit of alertness, ability, pep and conscientiousness to do duty in that office, don't forget to run your pen or pencil over the right spot on your ballot and do your stuff. 'Nuff said!

Smith Campaign Committee.

CLUB NOTES

David D. Haggerty, Secretary

HORSEBACK RIDING

Since it was started by the Club in the spring of 1924, horseback riding has proven very popular—so much so, in fact, that Marion Gilmartin, in charge, has consistently received more applications for lessons than can be accommodated.

Since the middle of September Arthur D. Soper has conducted seven consecutive rides, including one on October 28th, when the ground was covered with snow, and another one on a very rainy Saturday when six sturdy and philosophical members decided that one doesn't get any wetter on a horse than in the bleachers at a football game.

These rides over the trails of Van Cortlandt Park and Westchester County have been taken by the experienced riders. A group of beginners has been riding each Saturday also, but they have remained in the corral for the most part, with an occasional trip outside for variety. Twelve new riders joined this group this fall.

Through the courtesy of the colonel of the 105th Field Artillery, the Club has had the use of some of that Regiment's horses on Saturday afternoons. But the demand has increased to such an extent that the Club has had to find additional mounts. Therefore, it has signed a contract with the Unity Riding Academy of Brooklyn whereby Club Members may use the horses for \$1.25 per hour. There is no additional charge for instruction. Tickets, which are good at any time

the Academy is open, including Saturdays, Sundays and holidays, may be obtained from Miss Gilmartin.

The Field Artillery has again made winter plans for us and on days that are too unpleasant for outdoor riding we may have the use of the Armory as during the last two winters. Although the Armory does not afford



Marion G. Gilmartin

outdoor scenery, the riding ring covers nearly a city block and gives plenty of space for action. Furthermore, it has the decided advantage of permitting better instruction.

WOMEN'S BASKETBALL

In the notes concerning the Women's Basketball League in the last issue of the *RECORD*, it was stated that the games would be played in Washington Irving High School; but since then plans have been changed and all basketball games will be played at Friends Seminary, Stuyvesant Square, on Tuesday and Thursday evenings. The season's games started on Tuesday evening, November 10th.

All women members of the Club are cordially invited to participate in this activity. If any member, whose department has no team, desires to play, Miss Hence will be glad to place her with one of the teams now organized.

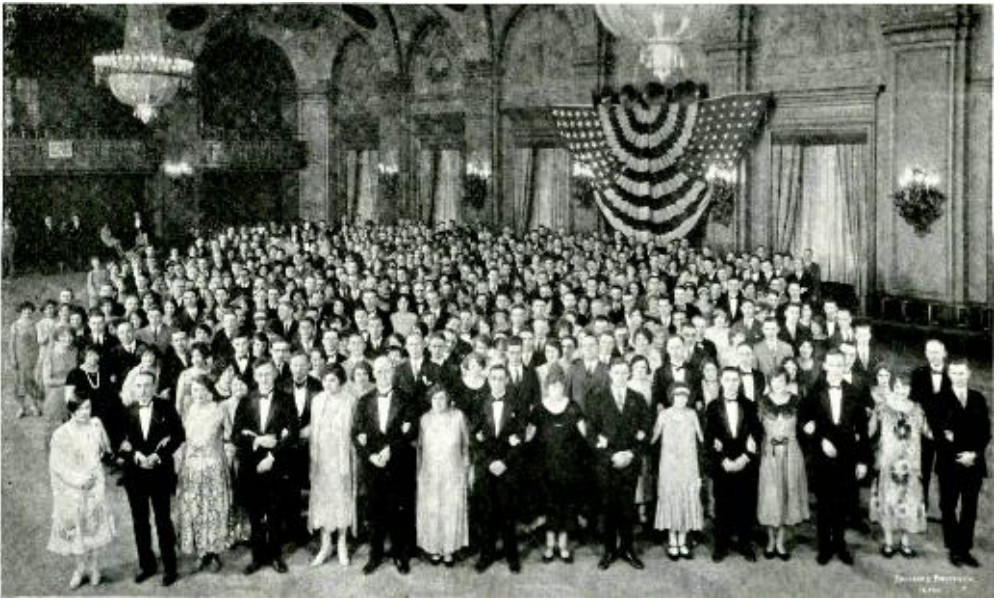

Dancers massed for flashlight photograph after Grand March

ENTERTAINMENT AND DANCE

The Fall Entertainment and Dance, given in the Grand Ballroom of the Hotel Pennsylvania, on the evening of November 9th, was pronounced by all of the seven hundred Club members and their guests who attended to be the most successful dance that has been given by the Club.

The weather was ideal and the crowd arrived early. By 9:30 over six hundred people were present and enjoying the music of Herbert Hood's orchestra. At 10:30 the Glee Club of thirty male voices, directed by F. M. Costello, presented three selections which were enthusiastically received.

The Grand March was led by Mr. and Mrs. Kendall who were followed by Mr. and Mrs. Gilson and Mr. and Mrs. William Wilson.

After the photograph was taken and a few dances there was a short intermission while the male quartette sang.

Applause brought several encore numbers and then the dancing was resumed. The dancing continued until 1:30. "Home Sweet Home" found about two hundred couples on the floor who left reluctantly.

SWIMMING FOR MEN AND WOMEN

One of the finest pools in the Metropolitan District is in the Shelton Hotel, 49th Street and Lexington Avenue, and the Club has secured special privileges for its members who wish to swim there.

The Hotel charge for the use of the pool is \$1.50 for either afternoon or evening session but if tickets are purchased through the Club Secretary, Room 108, the price is \$1.00. The pool is open until 11 P.M. on week days and until 9 P.M. on Sundays. If a large party wishes to be accommodated, reservations should be made in advance. The Hotel is always prepared to handle small parties.

BOWLING

On Friday evening, November 6th, the Bowling League completed the first round of seven of its twenty-eight nights, and Chairman Bostater finds



*Herbert L. Bostater
Bowling Manager*

himself with more regulars than can be accommodated. Each week one hundred and twenty men journey over to Brooklyn and give some very rough treatment to Recreation's wood. This holds good for all classes, as the weekly averages show a decided improvement on the part of all the men.

MEN'S BASKETBALL

The first game of the season will be played on Thursday evening, December 8th, at five thirty P.M., in Labor Temple, Fourteenth Street and Second Avenue, between the teams representing Toll Circuit and Apparatus Design groups. The second game of that evening will be between the Research and Equipment teams.

League games will be played every Tuesday and Friday evening until the season closes in early April. Spectators are always welcomed.

CARD PARTIES

The Card Club is now having meetings every Monday night in Room 427.

The players usually have dinner in the restaurant and start the play at six o'clock. Arthur Zitzman, in charge of the parties, can always make up another table at the last moment if unexpected contestants appear. New

players are always welcome and no formal arrangements need be made.

GYMNASIUM CLASSES FOR WOMEN

Gymnasium classes for the women of the Bell Laboratories Club are held at Houston House every Thursday evening. These classes, under the direction of Miss Janet Johnson, cover the same physical training instruction as is given in the Y. W. C. A. classes. The Club has purchased all the equipment necessary and volley ball teams are being organized. The attendance, the interest shown and the pleasure and benefit derived, have proven to the committee in charge that these classes are successful.

THE RADIO TUBE CLUB CHRISTMAS PARTY

On Thursday afternoon, December 24, the Radio Tube Club will hold their second annual Christmas party in the Recreation Room at Hudson Street.

Six acts of vaudeville will be presented by the club members and this entertainment will be followed by dancing and refreshments. The young actors and actresses of the Tube Shop are now rehearsing twice a week under the direction of Miss Lena Sproat.



Christmas Party Chorus: Misses Gertrude Wraight, Lena Sproat, Ethel Halleck, Margaret Thomson, Sadie Smith, Grace Parsons, and Mabel Sproat.



IN THE MONTH'S NEWS

O. B. BLACKWELL, H. S. Osborne and J. R. Carson (D.&R., A.T.&T.) sailed for Europe on the *Majestic*, October 24th, to attend a meeting in Paris on November 26th, at which the "unit of transmission" for telephone measurements is to be discussed. This meeting is under the direction of a sub-committee of "The International Consulting Committee on Long Distance Telephony." This international committee is supported by all of the principal European states, and its purpose is to make studies and recommendations looking towards the extension of long distance telephone service in Europe. While America, of course, has no direct connection with this work, the American Telephone and Telegraph Company has been invited to send representatives to attend the meeting and to discuss the subject from the viewpoint of the Bell System.

SERGIUS P. GRACE and Harvey Fletcher of our Laboratories attended the Annual Convention of the American Academy of Otolaryngology which was held at the Hotel Sherman, Chicago, during the week of October 21. The Western Electric Company displayed a complete exhibit of our audiometers at the convention.

REPRESENTATIVES of the Bell System have been visiting the colleges to which last year it donated electrical-communication measuring apparatus. In this connection, John Mills visited Wisconsin and Maurice B. Long visited Purdue, University of Missouri, University of Nebraska, University of Illinois and Washington University. George B. Thomas has

visited the Massachusetts Institute of Technology, Harvard and Hopkins.

On October 29th Mr. Long gave a talk before Bell telephone people in St. Louis. He brought out that in the past electrical theory was developed by considering mechanical analogues, but at present many of the advances are being made by considering mechanical problems from the electrical circuit viewpoint. He illustrated his talk by the new orthophonic Victrola. A hundred and fifty people were present and about fifty more listened in the hallway unable to get in the room.

The Laboratories were represented at the Personnel Conference in Washington during the week of October 19th by George B. Thomas, Personnel Director. Representatives of all the Associated Companies were present.

THURSDAY evening, October 29, the Edward J. Hall Chapter No. 25, Telephone Pioneers of America, met at 195 Broadway. About one hundred Pioneers were present. Dinner was served in the cafeteria and music for the occasion was furnished by the Long Lines Glee Club. The delegates who had attended the general annual meeting in Washington, D. C., told about that convention. Paul B. Findley then gave an illustrated talk on some recent developments of Bell Telephone Laboratories.

HERBERT F. IVES, on October 24, presented a paper on transmission of pictures before the Brooklyn Institute of Arts and Sciences. At the annual convention of the American Optical Society at Ithaca, New York, October 29-30, Dr. Ives also presented papers.

The First Anniversary of Bell Telephone Laboratories

ONE year ago Bell Telephone Laboratories joined the Bell System family as one of its corporate members. It was a day noteworthy in the history of industrial research.

In a great technical industry, whose success and progress are of vital concern to the welfare of our Nation, the laboratory phases of research and development had grown vast and intricate. The incorporation of the Laboratories signalized the realization that these activities had out-grown the habiliments of a mere department and could best be performed by a corporate unit analogous to the other corporate units which present day conditions make necessary.

This step, which was so radically in advance of existing practices, may naturally have raised doubts in some minds as to its feasibility. In our minds, however, there was never a doubt, for we knew the solidity of the foundation upon which the new structure was to be reared. The Laboratories were to be an association of specially trained men and women working together as a complete modern business organization, whose primary object was research and development directed to the improvement of a public service. To us this meant but another step forward in the logical development of an organization whose strength and virility were grounded deep in the character of its men and women, in their high ideals of truth, honesty, and fair dealing, and in their realization that individually each profits most by what collectively profits most to all, and finally in the special training and fitness of the group for the work to be done.

The results of the past year have justified our expectations.

In looking at the tasks which Bell Telephone Laboratories will be asked to do in 1926, as its part in improving the art and service of communication, we have every reason to view the future with confidence. The problems will be varied, important, and difficult, but we can approach them with full knowledge that our tools are better than ever before and with a courage born of the remembrance of our past accomplishments.

We congratulate our fellow workers in Bell Telephone Laboratories on the opportunities which the future presents and wish them individually and collectively a Happy and Prosperous New Year.

*Frank B. Jewett
Edward B. Craft*

Original Morse Telegraph Instrument

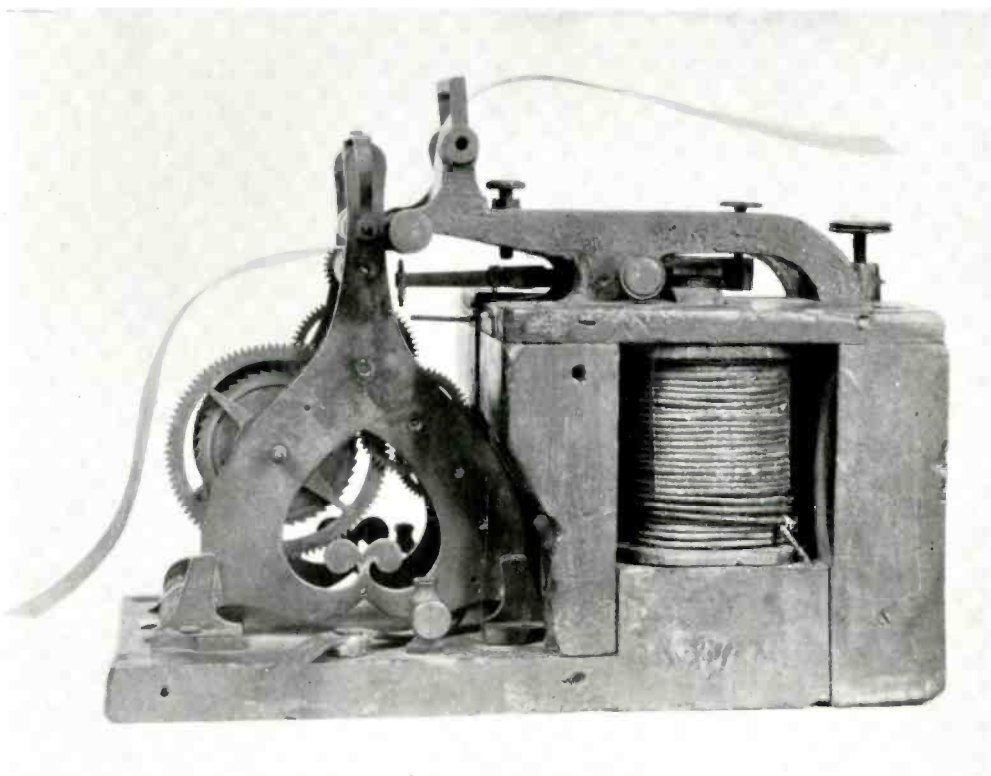

This original Morse telegraph paper tape receiver was presented to George F. Bulen of Palo Alto, California, by Samuel F. B. Morse, grandson of Professor Morse, the inventor of the telegraph. It was made for Professor Morse about 1843 and is a crude model of the one later used by him on May 24, 1844 in transmitting his notable message from Baltimore to Washington.

This instrument was identified by Mr. E. P. Warner of the Western Electric Company before Mr. John Rowley, Director of the Oakland California Public Museum, as the one on which his father, J. C. Warner assisted Professor Morse.

J. C. Warner was one of the first instrument makers employed by Gray and Barton, predecessors of the Western Electric Company, and with the change in organization, Mr. Warner became an employee of the Western Electric Company. This Morse instrument is now in the Historical Museum of Bell Telephone Laboratories.