



BELL LABORATORIES

RECORD

Volume one

OCTOBER, 1925

Number two

HEARTS OR WHAT MEN LIVE BY

The Story of the Electrical Stethoscope

By H. CLYDE SNOOK

WHAT do men live by? The celebrated physician, Dr. Richard Cabot of Harvard, says that men, and women too for that matter, live by "work and play," and "love and worship." Dr. Cabot's fascinating book, "What Men Live By," tells many interesting incidents in the lives of people whom he has studied, that show how a proper balance of these factors are necessary in our lives. As a diagnostician whose authority is justly recognized throughout the medical world, Dr. Cabot for many years has made a physiological study of the human heart. With his stethoscope he has listened to the sounds of so many human hearts, that not only has he made the diagnoses that were needed for his patients, but also many discoveries in the science of cardiology.

Dr. Cabot's interest in the study of hearts caused him several years ago to request our Laboratories to aid him in developing the science of auscultation, that is, the art of listening to the sounds of the human body.

The information we have obtained from the study of quality in telephone

transmission, and certain adaptations of our vacuum amplifiers, have enabled us to aid Dr. Cabot and his assistant, Dr. J. C. Gamble (now located at the University of Pennsylvania) to realize their ambition to possess an electrical stethoscope.

This result was facilitated by the earlier and contemporaneous research work of Dr. H. B. Williams, Professor of Physiology at Columbia University, who as early as 1911 co-operated with us in fundamental studies of heart sounds. The work of Dr. Williams was most helpful and continued almost unceasingly during the period from 1911 up to the present time.

A distinctly co-operative research and development it was, with Doctors Williams, Cabot, and Gamble, that resulted last year in our presentation to the American Medical Association at Chicago of the now well-known "multiple electrical stethoscope." This first appearance of the "electrical stethoscope" before the medical public was made by demonstrating with it the heart sounds of patients to over



Dr. J. S. Waterman with Miss Lawrence tries out the portable electrical stethoscope while C. C. Graves observes

600 doctors simultaneously while they were gathered together in the convention's auditorium. Since then, about a dozen of our most prominent medical colleges in this country have adopted it for the teaching of auscultation to their medical students. Also, it is gratifying to know that it is being received with favor in the medical circles of Europe.

During this last month the "Portable Electrical Stethoscope" made its bow to the medical public, and like its big brother just noted, it has met with great favor. The fundamental studies in hearing that have been inspired by our own Dr. Harvey Fletcher, have shown that after one reaches the age of about forty, his ability to recognize faint sounds tends on the average to decrease somewhat. It is on this account that the physician who has passed through his training period at college and has acquired experience in practice, is likely to find, by the time his judgment as a diagnostician has ripened to a real measure of ability, that his hearing is decreasing in its

acuteness, so that when he listens to the heart and chest sounds through his stethoscope he no longer can hear the sounds he should.

The electrical stethoscope not only overcomes this loss in hearing that is a handicap to the experienced physician, but also enables him more readily to hear and distinguish the faint sounds he has learned to recognize. This greater facility in hearing and recognizing these different kinds of sounds that mean so

much in medical diagnosis is in part due to the greater intensity to which these faint sounds may be elevated by the vacuum tube amplifier, and is in part accomplished by an adaption of our electrical filters whereby only those characteristic sounds to which the physician wishes to listen are permitted to come through the apparatus to his ears. By this means the heavy throb of the heart may be almost, if not entirely, filtered out from the complex ensemble of sounds, and leave standing out alone those faint and characteristic sounds which tell to the physician so much about the exact condition of his patient.

Our multiple electrical stethoscope, aiding research in the medical colleges, promises to do its share in helping the physicians to ease human burdens for those who now do not see the way. And in the near future our new portable electrical stethoscope also, accompanying many a doctor hurrying to a distant bedside, may there do its part.

TEN YEARS AGO

Many of the foundations were being laid for today's developments. This month the RECORD presents the story of the first trans-oceanic radio telephone talks

“WHAT was happening ten years ago?”

“The outstanding event, in my mind, is the Arlington-Paris radio telephone demonstration,” said Herbert E. Shreeve, assistant to President Jewett. “The feat, with its accompanying transmission to Darien, San Francisco, and Honolulu, was one of the biggest in the Bell System’s history. Remember that our engineers had been working with the vacuum tube only a short time; that its development had culminated in the opening of the Transcontinental line only nine months earlier. Remember also that the biggest tube in existence could deliver only 15 watts, and you may well marvel at the boldness of John J. Carty and Frank B. Jewett in attempting the feat.”

“And at the pluck and skill with which E. H. Colpitts and the Bell research engineers tackled the problem,” we added mentally, and then asked Mr. Shreeve to tell readers of the *RECORD* some reminiscences of those great days.

Work on the vacuum tube for radio had progressed step by step with its development for wire telephony, said Mr. Shreeve. Preliminary experiments from Montauk Point to Wilmington, Delaware, and to St. Simon’s Island, Georgia, were so successful that an attempt to reach across the ocean was begun. In the summer of 1915, use of the Arlington antenna was secured through the courtesy of the Navy, and

engineers from West Street set to work erecting and equipping a transmitting station there. Among these men were H. D. Arnold, Raymond A. Heising, John Mills, H. W. Everitt, and Benjamin B. Webb. Such were the power output limitations of the tubes of that day that the group which fed the antenna had as many as 550 tubes in parallel.

In August 1915, R. H. Wilson and naval officers at Darien received and understood voice transmission from Arlington. In September, receiving apparatus operated by Dr. Arnold and

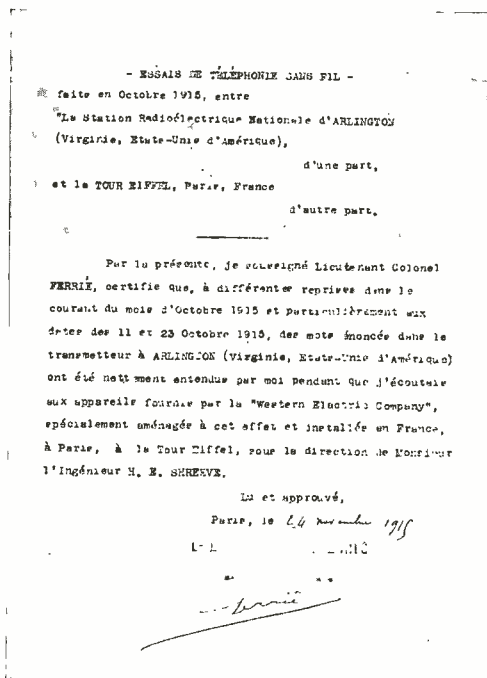

A letter from General Ferrié, hitherto unpublished, certifying to the reception from Arlington



Lloyd Espenschied

R. V. L. Hartley at Mare Island, California, was used to establish connections between Mr. Vail and other Bell System officials at New York, and Mr. Carty and others at San Francisco. The conversation proceeded by wire to Washington,

thence by radio across the continent, and back by the transcontinental line. Listening at another radio receiver in San Diego, William Wilson also heard

much of Arlington's transmission. Next day Lloyd Espenschied reported from his post in Honolulu that he had also heard talk over a distance of 4,500 miles.

Meanwhile, Mr. Shreeve and A. M. Curtis had gone to Paris. Here through the courtesy of Lieut. Col., now General, Ferrié they were allowed to use the antenna of the Eiffel tower for a short time each night. Difficulties in their path



Austen M. Curtis



These men helped put it over: William Wilson, Raymond Heising, Ralph V. L. Hartley, John Mills, H. W. Everitt; Benjamin B. Webb, holding the transmitter into which he talked at Arlington, Herbert E. Shreeve holding a loud-speaker used at Paris, H. D. Arnold and Richard H. Wilson

were not alone technical: they had to deal with busy officials, concerned above everything else with their country's struggle, some of them convinced that these experiments were futile. The fact that our engineers were permitted to use the antenna at all is a tribute to the interest in scientific development of the French Signal Service. Reminiscing of those days, Mr. Shreeve said, "We were exceptionally careful to show no curiosity in the operations of the station as a French military post. To reach our operating room we had to pass through a long room full of apparatus and machinery, but never did we even turn our heads as we walked."

Their tests were hampered by delays in communicating over congested cables with Arlington and by excessive interference from other European stations. Early in October fragments of

speeches were heard, and between October 12 and 23 a number of demonstrations were made, some of them with loud speakers, culminating in one before representatives of the French Signal Service. On this and other occasions, voices of his associates were clearly recognized by Mr. Shreeve.

On account of the war, experiments were then laid aside while our engineers bent every energy to military problems. In 1922 the problem of transatlantic radiotelephony was again taken up using the R. C. A. station at Rocky Point, L. I., for transmission and receiving apparatus set up in the plant of the Western Electric Company, Ltd., near London. The success of these later tests was due not only to progress in apparatus and circuits, but in considerable degree to lessons learned by our pioneers in 1915.



IN THE PUBLIC EYE

LYMAN F. MOREHOUSE, equipment development engineer, (A. T. & T.), in addition to his duties as vice president of the A. I. E. F. for the New York district, has been appointed chairman of the Publication Committee and a member of six other committees, including the important one of finance.

Bell Telephone Laboratories is represented on Institute committees by Frank B. Jewett, Edward B. Craft and Sergius P. Grace. Lauren S. O'Roark continues a member of the Committee on Membership.

One of the features of the Tuberculosis Day program of the Medical Society of the State of New York was a demonstration of the electrical

stethoscope by the Scientific Equipment Division of the Western Electric Company. The demonstration was made by Henry S. Kuhlmann, who was formerly a member of our organization.

FREDERICK G. BUHRENDORF, ROBERT W. DEMONTE, JOHN A. BATTLE, ANDREW A. GANDOLFI, LUDWIG E. HERBORN, RAYMOND G. MULLEE, and HENRY WALTHER, of our Laboratories, have this year received Bachelor of Science degrees from Cooper Union. Mr. Buhrendorf and Mr. DeMonte were graduated in Mechanical, the others in Electrical Engineering. All except Mr. Buhrendorf were students in the night courses.



THE SPINAL CORD OF A NATION

A STRIKING analogy in which the telephone cable is likened to the spinal cord of a nation has been advanced by R. M. Allen of the Apparatus Design Department, who devotes many of his leisure hours to the microscope and the camera.

This analogy is effectively demonstrated when a photograph of the cross-section of a telephone cable is compared with a photomicrograph of a transverse section of a human spinal cord. While the nerves are not placed as symmetrically as are the wires in a cable, they are about as closely spaced and each nerve is enclosed in an insulating sheath, or medulla, in the same manner that the telephone wires are insulated with paper.

The similarity may be carried further than mere physical resemblance when we consider the respective functions of the spinal cord and the telephone cable. The spinal cord of an individual is the conduit of the main nerves which go out from the brain and over which intelligence may be flashed to any part of the body. Scattered along the spinal cord there are a number of

aggregations of nerve cells called ganglia. The nerves which control the ordinary actions of the physical members go out from these ganglia. In similar manner the long-distance cables of the modern telephone plant connect physically the widespread members and communities of the social and economic structure of the nation. These cables connect the

various local offices which serve the body politic in the same way that the ganglia serve the human body. Each community handles its own business through its local office, just as the ganglia take care of "messages" originating in certain parts of the body, and dispose of them by appropriate muscular action, without involving the brain at all.

Mr. Allen, to whom we are in-

debted for this interesting analogy and for the photomicrograph of the spinal cord, is a leading spirit in the New York Microscopical Society. His photomicrographic equipment is probably the most complete of any amateur in the country. The section of the telephone cable was made in our photomicrographic laboratory by Francis F. Lucas.

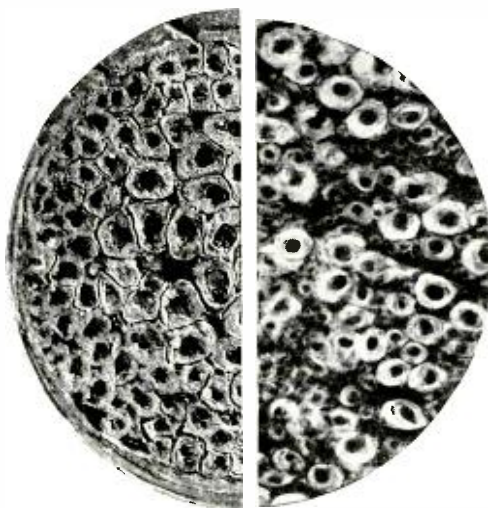

*Trunk Lines:
At left, segment of a quadded 10-13-16 gauge telephone cable, actual size; at right, a section of the human spinal cord, magnified 200 diameters*



ANALYSING THE MOTION OF MECHANICAL DEVICES

Spark and motion-picture photography have their place in this field, but for the engineering study of machine switching equipment certain methods developed in our Laboratories have their advantages

HOW to study the motions of moving parts is a problem that confronts all who are interested in the development of mechanical devices. The problem of studying rapid motions became of considerable importance in our Bell Laboratories when the design of machine switching apparatus was attacked.

For the analysis of rather slow motions the ordinary moving picture camera has proven fairly successful, but for more rapid motions probably the first fairly successful method was to take a succession of photographs on the same photographic plate, the illumination being obtained from an electric spark. The timing of sparks can be predetermined. Measurements of the motion that has occurred during the time interval between the successive sparks can be made directly on the plate. This scheme, however, has some inherent difficulties. The photographic plate must be in a plane parallel to that of the motion, or the angles that the plane of the motion makes with that of the plate must be known, in order that the true distances can be computed. Photographic emulsions, as is known, shrink a little under development; and such shrinkage, although very slight, may be sufficient to cause considerable error if the motions involved are small. With small motions also difficulty arises when one tries to make measurements on photographic plates because the precision of

the measurements becomes increasingly less as the distances involved grow smaller. Probably the most difficult technique enters in the proper placement of the camera and in adequate illumination by the electric spark. The problems in which this scheme has probably proven most successful have been those of the motion of bullets.

With the development of the so-called "slow-motion" motion pictures the moving picture camera has been brought into use for rapid motion study. The greatest number of pictures per second that can be satisfactorily taken with available standard apparatus is about two hundred and fifty. There have been several attempts to build a camera which would take a very large number of pictures per second. The Krupp Ernemann Company in Germany developed one which was more or less successful but very expensive to build and difficult to operate satisfactorily.

It will be remembered that in an ordinary moving picture camera the film is stationary during the time that the exposure is being made and is moved forward the distance of one frame between successive exposures. The speed at which this discontinuous motion can be operated has practical limits. To exceed that limit a camera with some method of continuously moving the film must be resorted to. The special extra-high-speed camera of Krupp Ernemann utilizes a con-

tinuously moving film and brings the images into focus at the proper place and time by moving mirrors.

Again, as with the spark method, one gets into certain difficulties. Placing of the camera, determining of the relative position of the plane of motion with respect to the plane of the film, and securing proper illumination, are not easily accomplished.

The motion picture method also has the disadvantage of the size of its picture, which is only three-quarter

must be measured it is generally recognized to be unsatisfactory.

An ingenious electrical device for analyzing the motion of the various parts of automatic telephone equipment was developed in our Laboratories by F. J. Schlink. A contacting slider on a high resistance rheostat is connected mechanically to the moving part. The two ends of this resistance are connected to a source of constant voltage. The voltage drop between the slider and one end of the resistance

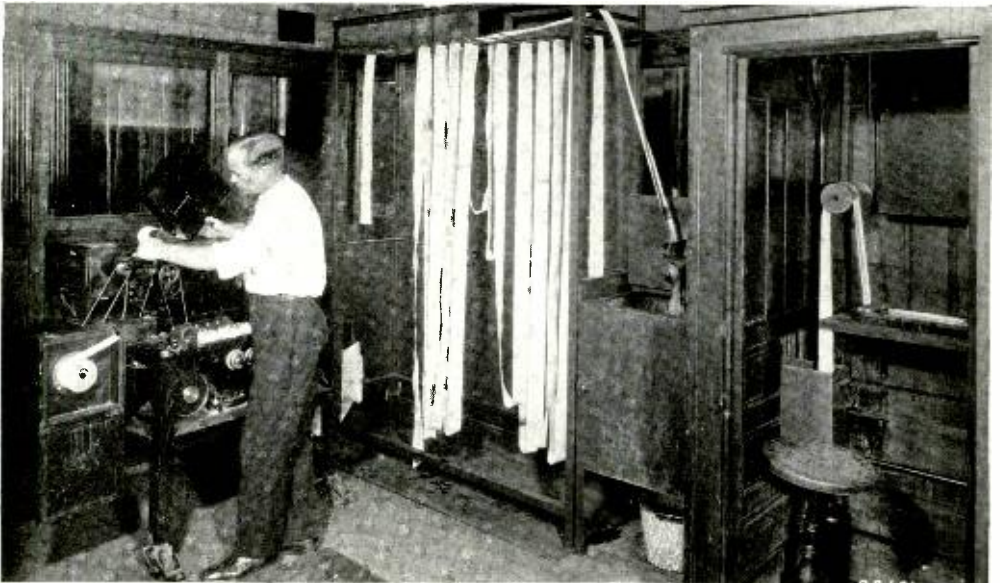

Vincent Bohman threads the sensitive paper through the oscillograph; behind him, the continuous photo-finishing apparatus

inch by one inch. This makes an accurate study of very small motions very difficult since the shift in the position of the moving body on successive pictures or frames of the motion picture film is so small that it cannot be accurately measured. Film shrinkage also adds difficulties. For the qualitative study of moderately rapid motions the modern day "slow motion" camera is quite successful but for studies in which actual distances

unit is then directly proportional to the position of the slider.

By connecting the slider and one end of the resistance unit to the vibratory element of an ordinary oscillograph, one can record the motion of the slider. The oscillograph is so adjusted that the movement of the beam of light is directly proportioned to the voltage applied to its vibrator. The record produced on the film is then a faithful reproduction of the

motion of the slider; and therefore, of the motion of the apparatus to which the slider is connected.

Standard laboratory oscillographs, such as that of the General Electric Company, have a normal film capacity of twelve inches which may be increased to about fifty-six inches by using an attachment for longer film. But for the study of successive rapid motions even this length of film is altogether too small.

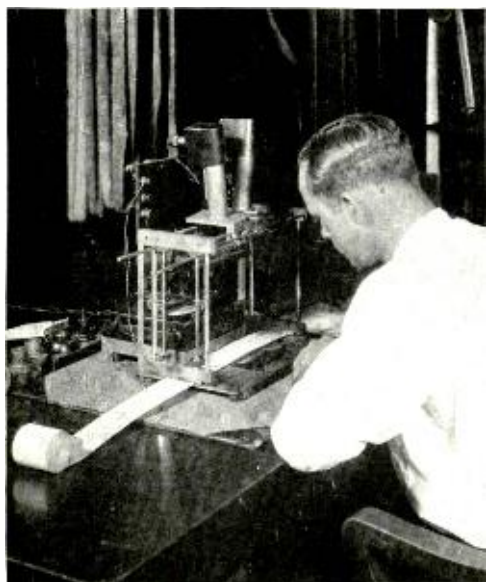

The measuring instrument in operation

A new recording mechanism, utilizing rapid bromide paper in lengths up to eight hundred feet instead of ordinary photographic film was therefore developed in our laboratories by Ira E. Cole. The paper is reeled from an upper to a lower drum by an electric motor. This winding mechanism is provided with a so-called motion-picture takeup so as to keep constant the tension on the paper ribbon. A tuning fork controls a stroboscopic wheel which interrupts the beam of light and thus establishes time coordinates, which appear as lines

across the paper strip. For most work coordinate lines every one hundredth of a second have proved satisfactory. The speed of travel of the paper is so adjusted that these lines fall about one-half inch apart. A special developing gear, operating in a dark room (which was conveniently formed from an old telephone booth) develops, fixes, and washes long strips of the exposed bromide paper. With this setup thousands of feet of oscillograph records can be made per day. In the laboratory, circuits are arranged so that connections can be made to this time recording equipment from any part of the room.

Once the photographic record of a motion has been made, the next problem is to measure the significant distances. A pair of ordinary dividers and a steel scale were used at first but this method was far too slow. In some of the studies that were made, and are being made daily, thousands of cycles of the same operation must be measured in order to determine accurately the performance of a piece of apparatus. The precision of these measurements is dependent upon the personal equation of the observer and this was found to vary throughout a working day. This change of precision of measurements introduced an undesirable factor of uncertainty.

To meet this need Frank H. Hibbard, in whose laboratory analyses of moving mechanisms are made, developed a simple instrument for rapidly measuring oscillograph records. An accompanying picture shows the measurement of a time record. The device for measurement utilizes a rheostat as shown in the accompanying line drawing. Resting on the paper tape is a light spring pointer which serves as an index. The two vertical tubes shown in the picture contain lamps

and project crosshair lines onto the tape.

To measure the distance between a point and a time line the following procedure is carried out:

The tape is slid along under guides until a time-coordinate line is in coincidence with the index pointer. The right-hand crosshair projector is then moved by a rack and pinion until the projected crosshair is on the next coordinate line. The left-hand crosshair projector is then moved until its crosshair coincides with that of the right-hand projector. The adjusting rheostat is then set so that the meter reads 100 scale divisions. The position of the left-hand projector is then readjusted so that its crosshair is in coincidence with the point to be measured. The fractional part of the total distance between the index point and the right-hand crosshair at which the left-hand crosshair is located is then read directly on the millivolt-

From this circuit diagram it then appears that when point "S" is in coincidence with point "F" the millivoltmeter will read zero. The rheostat has a constant resistance per unit of length. As the slider "S" is moved from point "E" to point "F," therefore, the millivoltmeter readings will be directly proportional to the distance between points "E" and "F." With this device a laboratory assistant can operate throughout a working day with surprisingly constant precision. It has been further found that one operator with this device can make as many measurements in the course of a day as six individuals equipped with draftsman's dividers and measuring scales.



WITH SLIDES AND FILM

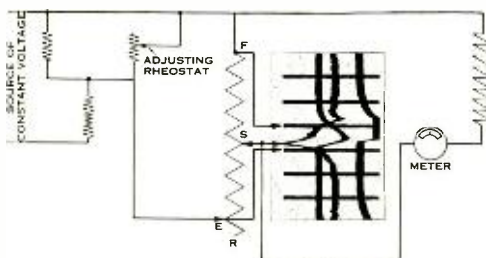

meter located at the back of the instrument.

The theory of the operation of this device is most clearly understood by referring to the schematic line diagram. The resistance marked "R" on the schematic diagram represents the slide wire rheostat. Point "F" corresponds to the position of the index pointer. Point "E" represents the slider connected to the right-hand projector. Point "S" represents the slider connected to the left-hand crosshair projector.

HERBERT E. IVES addressed the American Photo Engravers Association in convention at the Hotel Commodore on the development of the telephonic transmission of pictures.

The Engineering Society of Western Massachusetts at Springfield was addressed by Paul B. Findley on September sixteenth in an illustrated lecture on the work of Bell Telephone Laboratories.

HARVEY FLETCHER during August delivered, at the University of Michigan, a series of five lectures on the physical aspects and measurement of speech and hearing.

THORNTON C. FRY delivered an address on "Mathematics in Industry" at the summer meeting of the Mathematical Association of America, held at Cornell University.



THE ARTIFICIAL LINE

By PAUL C. HOERNEL

*The story of a device, not widely known
but of increasing importance throughout the
entire history of electrical communication*

IN THE latter part of the year 1832, Samuel F. B. Morse, an American artist, while on a voyage from France to the United States, conceived the idea of the electro-magnetic telegraph. It was over ten years later, during 1843 and 1844, that the first experimental line between Washington and Baltimore was constructed. The following year, 1845, telegraph lines began to be built over other routes. As telegraph traffic between centers increased, the number of wires connecting these centers increased; for a single wire was only capable of conveying one message at a time.

ATTEMPTS AT MULTIPLEXING

The possibility of making use of a single wire for the simultaneous transmission of two or more communications seems to have first suggested itself to Moses G. Farmer of Boston about 1852. He proposed to employ two rapidly revolving synchronous commutators, one at each end of the line, which would serve to bring it successively into connection with two or more sets of telegraphic apparatus. The current at the several terminal stations, although apparently continuous, would actually be composed of rapidly recurring synchronous pulsations. The difficulty, at that time, of maintaining synchronism between corresponding instruments restricted the commercialization of this means of multiplexing, though in later years

we find the general idea applied with great practical advantage.

In 1853 Dr. Wilhelm Gintl, Director of the Austrian State Telegraphs, devised a scheme of multiple transmission which, modified in 1854 by Carl Frischen, an inspector of telegraphs in Hanover, directed the labors of both European and American inventors into a new and more fruitful field. Essentially the same schemes were patented in England and Germany about the same time. The inventions of Gintl and Frischen provided for the simultaneous transmission of messages in opposite directions—a scheme known as “duplexing.”

BALANCING TELEGRAPH CIRCUITS

The condition to be fulfilled practically in carrying out this method of telegraphy is that the receiving instrument at the home station shall remain entirely unaffected by the movements of the transmitting key at that station, while at the same time it shall remain free to respond to the currents transmitted by the key at the distant station. An accompanying diagram shows the connection of the apparatus at a terminal station. The resistance “X” is adjusted so as to make it equal to that of the line plus that of the distant terminal apparatus. Upon the depression of the key, the outgoing current will divide at the mid-point “O” of the relay, one-half entering

the line and the other half passing through the resistance "X" to ground. The currents, therefore, which trav-

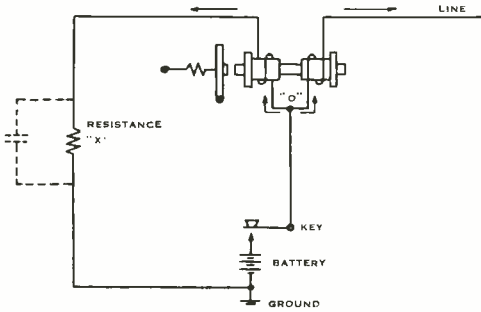

Terminal Connections for Elementary Duplex System

erse the relay windings, are equal but opposite in direction and hence produce no effect upon the relay armature. An incoming current from the distant station, however, will traverse the windings so as to make the relay respond.

The balancing resistance, "X", was termed an "artificial line," since the current entering the real line was approximately equal to that which traversed the resistance "X". Thus in its embryo form, the artificial line consisted of a single "lumped" unit of pure resistance.

As the length of the lines over which transmission occurs is increased, a property of the electrical conductor or transmission line comes into play whereby a momentary unbalance exists and the outgoing currents flowing in the relay circuit do not neutralize each other in their effect upon the relay but cause it to operate, with the result of troublesome false signals. This property of the transmission line is known as its electrostatic capacity, for the line has the characteristics of a condenser. When a condenser is connected to a battery, a momentary current flows until the condenser is

charged to the potential (i.e., the voltage) of the battery. The magnitude of the momentary current depends upon the voltage of the battery and upon the capacity of the condenser. There is a similar action in the case of a long transmission line. The instant a battery is connected to the line a momentary surge of current occurs and charges the line. A corresponding momentary surge of current, however, does not flow into the resistance "X", because it has none of the characteristics of a condenser. To compensate for this current surge and for the consequent unbalance of the opposing actions of the currents in the windings of the relay, a condenser is added to the resistance. The result is an artificial line consisting of a "lumped resistance" and a "lumped capacity."

This was first done by J. B. Stearns in this country and by C. S. Varley in England, about 1862. It was found that if, instead of using one condenser to simulate the capacity between the

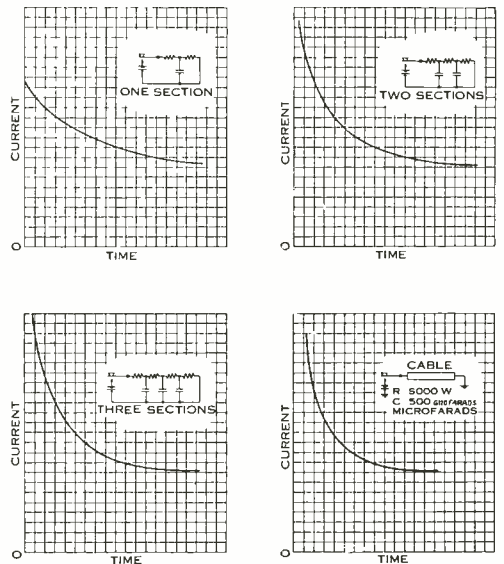

Comparison of entering current for artificial lines and cables

real line and the ground, several condensers of smaller capacity were inserted at intervals along the artificial line resistance, the degree of balance obtained was far superior.

The capacity effect is greater per mile of line for cable circuits than it is for open wire circuits. The effect and its neutralization at the relay is most easily shown, therefore, for a cable. An accompanying diagram shows the nature of the currents entering a cable, and artificial lines of one, two, and three sections, respectively. As the number of sections is increased, the nature of the current entering the artificial line approaches that of the cable or real line. This phenomenon is illustrated in the successive graphs.

DISTRIBUTING THE CAPACITY

Reasoning backward from this phenomenon there appears—what is more usually derived by direct but somewhat mathematical reasoning—the fact that a cable or transmission line considered from the standpoint of direct current telegraph operation is in effect a large number of small condensers all in parallel and separated from each other by resistances. Of the current which starts out along a transmission line, some must go to charge the first of these small condensers. The remaining current, then traversing the intervening resistance, is available to charge the next of the condensers; and so on, with the result that if these condensers are either very large or very numerous only a small fraction of the outgoing current reaches the distant terminal of the line.

In the case of cables constructed for long-distance submarine signalling, the electrostatic capacity is quite large. Without using batteries of such

high voltage as to incur danger of breaking down the cable insulation, it was very difficult to get enough current at the distant end to actuate an ordinary relay. Specially sensitive recording devices known as “syphon” recorders were therefore used. But the more sensitive the recording device the more readily will it respond to slight unbalances between the current entering the line and that entering the artificial line. Extreme care must be taken to make the artificial line as nearly as possible an exact electrical counterpart of the real line. This is accomplished by distributing the resistance and the capacity of the artificial line more nearly as they occur in the real line.

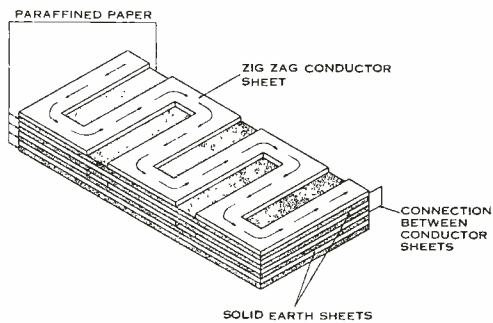

Muirhead type of artificial cable

This scheme was first suggested in 1875 by A. Muirhead. A sketch shows Muirhead’s artificial cable with distributed rather than lumped resistances and capacities. Each unit length of his artificial line consists essentially of a condenser formed by two plates, one of which is cut in the form of a grid. The current entering one end of the grid traverses its entire length to reach the other end, meeting as it does so the resistance of the successive parts of the grid. Every element of length of the path traversed by the current, however, is in capacitative relation to the opposing

plate which is connected to ground; and so the outgoing current is called upon to charge the succession of small condensers which are formed between each part of the grid and the other plate. This type of artificial line simulates very closely the effect of the distributed resistance and electrostatic capacity of a real line.

The function of an artificial line in duplex circuits is that of balancing; and a condition of balance is said to be established when the current entering the artificial line is identical with that entering the real line. The property which in the case of a line determines the nature of an entering current is its "impedance." Hence for equality of currents in duplexing, it is simply necessary to make the impedance of the artificial line equal to the impedance of the real line.*

APPLICATION TO TELEPHONY

A demand for artificial lines simulating real lines not only as to impedance but also as to transmission characteristics arose after the advent of the telephone in 1875. Like many new inventions the telephone was first received with some misgivings; but as its possibilities were more generally realized, the demand arose for service over longer and longer routes, and with this came a corresponding stimulation of the development of transmission technique. The impracticability of always associating equipment under study for development with an actual long line became apparent, and steps were taken in the direction of the development of an artificial line

**If wherever in a duplex circuit the impedance of an actual line is balanced by the impedance of some network of electrical conductors, the function of the balancing impedance is that of an artificial line, although this function may be obscured under the name of "balancing network". In the communication art there are many illustrations, e. g. anti-side-tone subsets, of duplex circuits in which impedances are thus balanced.*

which would conveniently enable engineers in a laboratory to study the performance of a line with experimentally associated equipment. To do this on a real line would involve the coordinate efforts of observers at different points, and be uneconomical both of time and money.

ARTIFICIAL TRANSMISSION LINE

For such artificial lines, concern is given not only to the nature of the current entering the line but also to the nature of the current leaving the structure. These artificial lines must, of necessity, have two pairs of terminals: namely, input and output pairs. When an artificial line of this type is connected to terminal apparatus, such as a transmitter at one end and a receiver at the other, the voltage, current, and power at the terminals should be respectively the same as the voltage, current, and power on the real line, when connected to the same terminal apparatus.

For speech transmission the superiority of a metallic return circuit over a ground return system was early recognized by John J. Carty. With this improvement the distance over which telephony was practicable made an enormous increase, and with the increased distance over which speech was possible there came into prominence another characteristic of transmission lines which had had small effect for short lines. To incorporate this characteristic into artificial lines for telephonic use was the suggestion, about 1892, of Theodore Spencer of the Bell System. In the construction of an artificial line to simulate General Carty's metallic-return open-wire circuits he suggested that consideration be given to the inductance.

Sending a current through an electrical conductor is analogous to setting

a mechanical body in motion. If a force is applied to a body to set it into motion the inertia of the body resists the action of the force. On the other hand, after the force has acted, even if it be removed, the body will continue to move, moving with decreasing velocity until its energy is dissipated. Somewhat similarly, when a battery is connected to a transmission line, there is established around the wires a magnetic field which effectively offers an inertia to the flow of current through the wires.

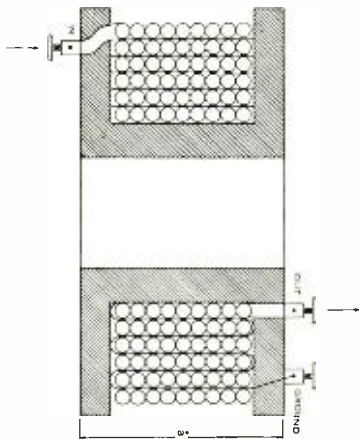

Section of One Coil of Pupin Line Containing Distributed Resistance, Inductance and Capacitance

And momentarily after the battery is discontinued, the current though gradually decreasing persists in the line. This inertia-like characteristic of a conductor is known as its inductance. For a cable, the inductance is very small and often neglected, but in the case of an open-wire line, the inductance is appreciable.

An artificial line containing distributed resistance, inductance and capacity was first constructed by Michael I. Pupin about 1899. The accompanying pictures indicate its construction. A layer of wire is wound on a small

spool and a sheet of tin foil is wrapped over it; and each succeeding layer is similarly wrapped. The tin foil layers are connected in series and then grounded. Care is taken that when the coil is complete, it has the same capacity, resistance and inductance as some length (for example, ten miles) of a telephone line.

The length of such a coil may be about three inches and yet it may be capable of storing up as much electrical energy as can ten miles of open-wire telephone line. Through such a coil an electrical wave will advance this three inches in the same time as it would take it to pass over ten miles of open-wire line. The electrical wave is projected through the coil in the same way as over the telephone line except that it covers a smaller distance in each instant of time; that is, has a smaller velocity and hence a shorter wave length. Such conductors slow down the rectilinear velocity of a wave and for this reason are sometimes referred to as "slow-speed conductors."

PRESENT DESIGNS

While the artificial lines as constructed by Muirhead and Pupin more nearly represent the actual condition of the distribution of the electrical constants of the cable or line they are to simulate, their construction is not always economical. In practice a sufficient degree of simulation can usually be obtained by using a number of small sections employing lumped constants.

An accompanying diagram shows a section of lumped artificial line which simulates the "standard cable" in terms of which telephone engineers for years expressed the transmission efficiency of telephone circuits and apparatus. Standard cable has a

resistance of 88 ohms, a capacity* of 0.054 microfarad per loop mile, and negligible inductance. Each condenser and its associated resistances constitute a network, which from similarity to the letter "T" is termed a "T" network. Each "T" network has the resistance and capacity of a definite length of cable. The total resistance in its series arms is equal to the total resistance, and its shunt capacity is equal to the total capacity of this length of cable.

The discrepancies introduced by the use of an artificial structure with lumped constants increase with the length of the circuit to be represented by it and with the frequency of the current which is to be transmitted. A

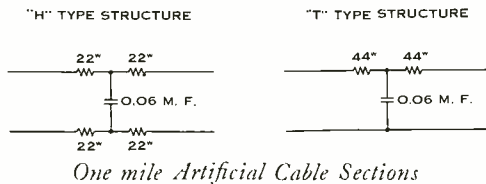

network correctly designed to simulate an actual line at voice frequencies may prove to be too lumpy a structure to represent the line at higher frequencies. In the artificial cables used in laboratories a two-mile section is usually the maximum employed to represent a No. 19 gauge cable. A three-mile artificial cable would therefore be obtained by combining two "T" networks, one representing a two-mile section and the other a one-mile section. In the case of open-wire line a twenty-mile length is usually the greatest which a "T" network should represent in cases where frequencies in the voice range are employed.

*Before the constants of "standard cable" were agreed upon a section of capacity 0.060 mf. was adopted in the Laboratories. Results obtained by using such a section are easily converted into results for standard cable.

It is usual to utilize an "H" type structure or network to represent the real line, in which case the total resistance of the series arms is made equal to the resistance of the real line, and the total capacity of the real line is shunted across the mid-points of the series-arm resistances. The "H" type network represents more nearly the metallic return-circuit used in telephony, although either the "T" or "H" type may be designed to give the same transmission characteristics.

So far in this description of the artificial lines only three of the electrical characteristics of a real line have been considered: namely, resistance, or ability to convert the electrical energy flowing through it into heat; inductance, or the inertia-like ability to store energy; and capacity, or the ability to store energy like a condenser. The fourth electrical property of a line, which is also a very important factor in determining the rate of decay of the current along the line, is its "leakage" or "leakance."

In any open-wire transmission line between two distant points a certain number of mechanical supports is necessary. The points of contact between the wires and these mechanical supports form between the wires leakage paths of high resistance. They are in effect minute loads placed regularly along the transmission line, each dissipating a small amount of energy in the form of heat. It is true that the amount of leakage, or shunt current, may be very small indeed for each support or pole, but in a transmission line of moderate length there may be thousands of poles and the magnitude of the shunting effect of these leakage paths becomes very appreciable. The insulation resistance of the supporting insulators, which determines the leakage of the line, is

greatly dependent upon whether the line is wet or dry; for if it is wet the insulation will be less and the leakage larger. In the modern telephone cable, the insulation resistance between wires is very high and is often assumed infinite in the construction of an artificial cable. This is not a correct assumption in the case of an open-wire line where the insulation resistance is relatively lower and

tance and the draining away of current by the capacity of the line, the current flowing along a transmission line rapidly decreases.

"Attenuation constant" is the factor which expresses the amount of such "decay of the current" along a line. Its dependence upon the shunt-distributed capacity and the series-distributed inductance results in a decrease of attenuation if the capacity

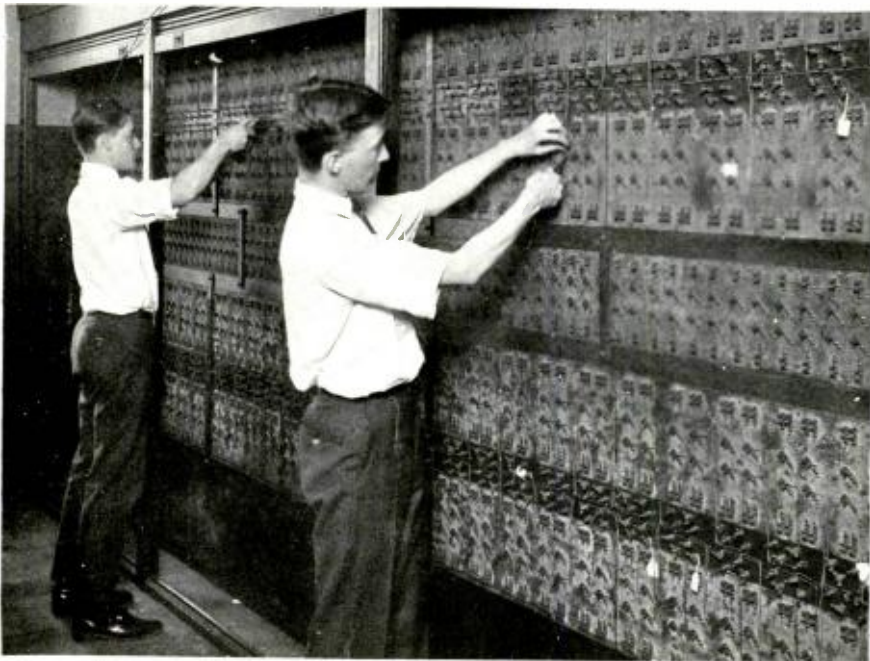

W. G. Breizogel and C. B. Northrup setting up an artificial line: by proper connections of the equipment a great variety of actual lines may be simulated

is greatly dependent upon weather conditions. When a leakage path is included in the T-network, a resistance corresponding to the insulation resistance of the particular section of line which the network represents is bridged across the shunt condenser.

Because of the effect of the resistance in dissipating the energy of the current and because of the loss of current by leakage, and particularly because of the inertia effect of induc-

is decreased or the inductance increased. To minimize the distributed capacity of an open-wire line would involve an impracticable change in size and spacing of the conductors. Resort, however, can be had to an increase in inductance. The idea originated with Oliver Heaviside who called attention in 1887 to the effects of inductance on the transmission of current impulses over a cable.

The inductive effect of a conductor

and the inductances shunt across from line to line. Such an imaginary line may easily be represented by an artificial line and the result is a filter which will not transmit frequencies below a definite cut-off frequency but will transmit all higher frequencies. This is an exactly opposite characteristic to that of the loaded line where

the inductances are in series and the capacities naturally shunt from line to line. Many of the amazing effects which today are being produced in wire and in radio communication are due in part to the use of these filters invented by George A. Campbell—artificial lines which represent lines impossible of physical construction.



A Tribute to Telephone Men

“The telegraph and telephone utility presents a truly remarkable contrast to all others (i.e., railroad, light, power and gas utilities). This utility is almost a complete monopoly, national in its scope. It has developed even faster than the electric light and power business, and stands head and shoulders above all other public utilities in the extent, in the cheapness, and in the standard of its service. The advance in this science has been almost incredible and it has come almost wholly from the research staffs and laboratories of the companies themselves. Even though deprived of the spur of necessity and fear which competition provides, few if any competitive industries have moved forward with greater energy and creative genius. One is tempted to say that no system could have been devised under which this industry would have made better progress, and yet the system is the same that has gone far to destroy the efficiency of our transportation business.

“There is no denying that the non-competitive conditions which have weakened the railroads and the gas companies and from which competition alone has rescued the electric companies have left the telephone companies unscathed. The thing is a modern miracle which I can only explain to myself by assuming that the men who conceived, created, and have developed the telephone were men of the rare auto-motive type whose driving power came from within, and who, therefore, did not need the external stimulation which competition alone can give, and for the lack of which the other public utility companies suffer.”

*Extract from “Competition is the Life of Trade” by Philip Cabot
Harvard Business Review, July, 1925*



HIS FIRST JOB

The first work assignment in the Bell System of one of the men who is responsible for the present direction of our investigations and developments

“MY first job in the Bell System gives a good example of the old way of introducing new employees and a contrast with today’s methods,” said Amos F. Dixon, Systems Development Engineer. “When Western Electric offered me a drafting job at Hawthorne in 1902, after my experience on heavy machinery, I questioned my fitness for the small details of the telephone, but they assured me I would soon learn. The method of instruction was certainly ‘trial and error.’ I was seated at a board, handed the drawing of a standard jack, and told to make a new drawing with some minor changes. No one took the trouble to tell me that square block lettering was one of many office standards which had to be followed exactly. An overheard comment ‘that lad can certainly do Gothic lettering’ was poor compensation to my feeling for having to do my first drawing all over again.”

His first real job, Mr. Dixon went on to say, was on the No. 7 coin collector. Having trigonometry at his command he was able to show that certain dimensions on the drawing of the very complicated coin chute were mutually impossible. As a result, he was given the job of finding out what the dimensions should be and of making a complete new drawing of the chute, to be used in making new patterns and tools. This drawing remained the standard for many years and Mr. Dixon’s first patent was for an improvement in coin collectors.



Amos F. Dixon

Two decades ago there were no student assistants’ or out-of-hours courses for men who wanted to know the why of what they were doing. When Mr. Dixon tried to find out the purpose of certain circuit elements, his supervisor advised him that none but engineers were supposed to know what even the condenser in a subscriber’s set was for. Meant in all kindness also was advice from an older draftsman, “My boy, you can study ’till your hair is gray and it will never get you anywhere.” A sufficient comment is that our Systems Engineer still persists in habits of study formed at that early day.

WHO PAYS OUR SALARIES?

A study of the flow of capital and services in the Bell System

EACH pay day finds certain funds transferred by check or currency from Bell Telephone Laboratories to us as individual employees. Where does this money come from? One might answer at once that it comes from the general public of telephone users; but the routes by which it reaches us and the services for which it pays are most significant.

In any business, it is usual to distinguish between money which is

received for the services which it renders. But the kind of work a company does, and the sort of services which it renders, depend upon what kind of business it is and with what purpose money was invested in it by its owners. To appreciate, therefore, when and how the Laboratories is paid for its services, one should trace the money which is invested in our building and equipment.

The capital invested in our Laboratories came from the large and rapidly

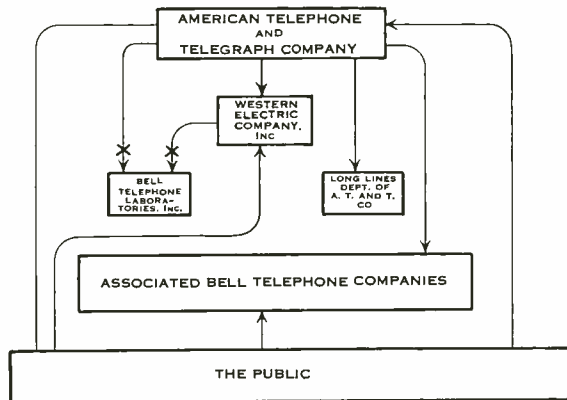

Main Lines of Investment Capital Flow in the Bell System.

x x *Joint Ownership and Responsibility for Operating Capital.*

invested in the business, that is capital, and money which comes in from day to day in return for manufactured goods or for services rendered, that is operating income. Any business which is to last must, of course, be so run that its capital does not suffer loss. Salaries and wages, raw material, maintenance, repairs, depreciation, the interest on money invested, and any profits must come from operating income.

Our salaries come from the operating income which the Laboratories re-

ceiving from the services which it renders. But the kind of work a company does, and the sort of services which it renders, depend upon what kind of business it is and with what purpose money was invested in it by its owners. To appreciate, therefore, when and how the Laboratories is paid for its services, one should trace the money which is invested in our building and equipment. The capital invested in our Laboratories came from the large and rapidly

investors in so far as we own stock in either of these two companies.

A large part of the money which has been invested in the Bell System is represented by stock in the American Telephone and Telegraph Company. This, the headquarters company of the system, reinvests the money which it receives from the sale of its stock, bonds, or notes, in the securities (stock, and bonds or notes) of the other companies of the System. It therefore owns large portions of the stock of the operating telephone com-

panies and must pay its own expenses and the dividends which it declares for its own stockholders.

The operating companies own and operate the telephone plants in their particular geographical territories and there give local and toll telephone service to their publics. For long distance service to connect subscribers in territories of different operating companies, there is what is in effect another operating company, the Long Lines Department of the American Telephone and Telegraph Company,

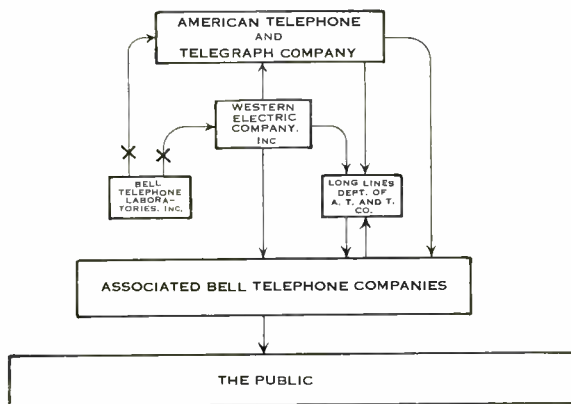

Main Lines of Flow of Services in the Bell System.

x x *Research and Development, and Engineering Services for the A. T. & T. Co.*

Research and Development; and Engineering and Manufacturing services for the W. E. Co.

panies of the Bell System, and almost the entire common stock of the Western Electric Company, Incorporated, which is the manufacturing and supply unit of the System. From these companies, in which the headquarters company owns stock, it receives dividends, when they are earned and declared, in the same way as do the other owners of their stock. And these dividends form part of the income of the American Telephone and Telegraph Company out of which

which was at one time a separate corporation.

The advantages which have accrued from this form of organization of the telephone industry, involving a headquarters company and a group of separate companies with individual duties or territories, have been well recognized by students of business organization and by conservative investors. The main components of the System are the headquarters organization, the manufacturing and supply

company, the research laboratories, the operating companies, and the Long Lines Department.

How these various units of the System receive their capital is indicated in the diagram of a preceding page. Dividends, and interest on bonds or loans, flow back along the lines which are followed by investment capital. The diagram serves also to indicate the source and route of the capital which is invested in our Bell Telephone Laboratories.

A particular advantage of the Bell System is its own organization of the lines of flow of services. Not only is the headquarters company the main source of investment capital and thus a financial bulwark for the support and development of the industry throughout our whole country, but it is the main source of the advances which have been, and are being, made in the telephone art. It is responsible for the research and development along technical lines which assures to the operating companies the most satisfactory and economical methods and equipment. Its engineering advice and assistance on all problems of operation is more responsible than perhaps the general public realizes for the high quality of equipment, methods, and service, of our American telephone system. The high standards which it establishes and maintains have made possible our universal telephone service over a nation-wide network of lines. As a part of its service to the associated operating companies the parent company has always supplied all transmitters and receivers. Among the various advantages of this procedure has been the fact that all operating companies alike have thus been equipped with standardized instruments, and a nation-wide uniformity has thus been secured.

The service of manufacturing telephone transmitters and receivers, as well as that of manufacturing other standardized telephone equipment, is one of the responsibilities of the Western Electric Company. The design and underlying laboratory investigations are the services of our Bell Laboratories. The accompanying diagram, showing flow of services, in the Bell System, therefore, indicates services on the part of the Laboratories for both the American Telephone and Telegraph Company and the Western Electric Company. The Laboratories carry out investigations for the American Company in accordance with its program of development and research and with its problems of operation and engineering which require laboratory investigation or design. For the Western Electric the Laboratories perform research and development services in the same general manner as for the American Company. In addition it performs for the Western Electric Company services peculiar to that company's requirements, and therefore known as "engineering and manufacturing services"; and also supplies designs of communication equipment and systems which are the approved apparatus embodiments of its investigations.

Such fundamentally are the services which the Laboratories give within the Bell System and for the expense of which it is reimbursed by the American Company or the Western Electric Company in accordance with the cost of its services. Payments, therefore, flow to the Laboratories from these two companies for value received in the form of services and a part of such funds in turn is issued individually to us as employees in proportion to our individual contributions to these services.



MODERN ECONOMIES REPLACE HISTORIC POWER PLANT

ON a Saturday afternoon in December, 1923, a group of "old-timers" stood in the engine room of our building and watched the last rites over the steam generating units. In the march of progress, a time had come when the four faithful engines had lived their life and they must retire in favor of central-station service. Nearly all the building's thirty-four hundred people had gone home, and when finally the time came and G. F. Morrison, power engineer, tripped the last circuit breaker, the plant load was at its lightest. Then "Old Ed" Secord, one of the original engine men and at that time* on our pension roll, closed the throttle and the last engine slowly came to a standstill. Thus ended twenty-five years of power supply without a single emergency shut-down.

CENTRAL STATION PROVES IN

Enough time has now passed to judge of the financial result of the change in our power supply. The decision to change followed a careful study by W. B. Sanford, S. H. Willard, and J. G. Motley. In this study account was taken of such items as salaries, supplies, repairs, depreciation, rent, house service, fuel, water, and supervision. After the figures had been compiled for the actual operations of 1924, the cost per kilowatt hour had shrunk from 6.97 cents in 1923 (11 months of plant operation, 1 month central station service) to 3.55 cents in 1924. These two figures are not a measure of the over-all economy of the change, be-

cause under the old regime the steam was used twice—first in the engines, then in the heating system. With the removal of the engines, the cost of generating the considerably smaller quantity of steam for the heating was increased by \$17,500. Deducting this sum from \$69,000, the annual saving in the cost of electricity, leaves \$51,500 net saving.

THE PLANT'S HISTORY

The story of our power plant is closely tied in with the Western Electric Company's early history. In 1897 the New York Shop was moved to the new building on Bethune Street, now sections B and C of the West Street building. When Sections A and D were projected, the original power plant was seen to be too small, and in the next three years (1898 to 1900) four new units replaced the old ones. The new units each consisted of a 510 HP Ball and Wood vertical compound engine connected to a 350 kw 110 volt Western Electric generator. (In those days, the Clinton Street Shop in Chicago manufactured a line of motors and generators.) There was also a 100 kw generator driven by a horizontal engine. Of the boilers, three Babcock & Wilcox and one Parker remain in service to provide steam for heating and industrial uses.

As the Shop's demands for power grew, the original plant needed reinforcement and a 1000 HP Allis Chalmers engine was added, direct-connected to a 650 kw Western Electric generator. This machine, affectionately known as "Big Liz," was in-

*Mr. Secord died some months after this event.

in entering the export field. Its first foreign sales were made in Australia in 1880, as the result of a trip there by F. R. Welles. During the following year Enos M. Barton and Charles E. Scribner did some missionary work in Europe, but with rather scant success—their only customer being a man who was operating a small exchange in Hungary. The first really important incursion into the foreign field was the establishment, in 1882, of a manufacturing plant in Antwerp, with branches in Holland, Switzerland, and Norway. Other plants followed in various parts of the world, and in 1918 the International Western Electric Company was organized to take over these various holdings and to handle export sales of goods manufactured in the United States. The total sales of the International and its associated companies for 1924 amounted to approximately \$43,800,000.

The International Telephone and Telegraph Corporation recently obtained franchises from the govern-

ments of Spain and Mexico to operate telephone systems, and is also interested in telephone development in several Latin-American countries and in the Cuban-American Telephone Company, which owns the Key West-Havana cables. The American Telephone and Telegraph Company is not financially interested in the International Telephone and Telegraph Corporation.

As an incident of the change of ownership, the personnel of the Engineering Department of the International Western Electric now at West Street will be transferred to quarters on Broad Street, adjacent to the headquarters of International Telephone. This group served to maintain contact between the foreign organizations and the Laboratories. It included James L. McQuarrie, chief engineer; Henry L. Hoffman (now in Japan), Ernest S. McLarn, and William G. Britten, specializing in apparatus, switchboards and machine switching; Henry P. Clausen, field work and fundamental plan studies; Francis A. Hubbard,



*Back row: Messrs. C. L. Howk, W. H. Capen, J. J. Wylie, Jr., V. Fredlund, W. G. Britten.
Front row: Messrs. L. E. Ackerman, F. A. Hubbard, H. P. Clausen*

Clarence L. Howk, Louis F. Ackerman, James J. Wyly, Jr., William H. Capen and Arthur A. Cameron on transmission; and Victor Fredlund, office manager. Telephone experience of these men totals up to nearly 250 years; six of them have twenty years or more of Bell System service to their credit. Their chief, Mr. McQuarrie, started with the New England Telephone and Telegraph Company in 1882. Twelve years later he entered Western Electric at Chicago, where with Mr. Scribner he had much to do with the development of the common

battery central office. For a considerable time he was Assistant Chief Engineer of the Western Electric Company. Mr. Hoffman was connected with various Associated Companies from 1888 until 1912, when he entered the Engineering Department, being transferred to International Western Electric in 1921. He is now in Japan on a mission to the Nippon Electric Company.

We part with regret from these our friends of many years; our wish for them is that their new associations may be as pleasant as ours have been with them.



OUR SERVICE EMBLEM

IN recognition of long service, it has been a custom of many years to present to each man and woman a gold emblem on the tenth anniversary of their entrance into the Bell System. On every fifth anniversary thereafter, a new emblem is presented, with added stars to indicate the length of service.

It is fitting that the emblem for us of the Laboratories should portray Bell's first telephone. This instrument was the embodiment of scientific study of hearing and electrical communication. Had it not been for Bell's knowledge, aided by Watson's mechanical skill, the telephone's birth might have been delayed.

Bell's corner in Charles William's workshop was the first of an unbroken series of laboratories culminating in our own. Here we have joined our hands and our brains in common attack on telephone problems. Through years of labor together there has



grown a comradeship of which the service emblem is a symbol.

The design of the emblem was suggested by Mr. Clifford and worked out by the Metallic Art Company of

this city from a replica of Bell's original model. Reproduced on this page is a button as it would be presented to a veteran of fifty years' service.

Between January 1 and September 30 of this year the following service honors have accrued: forty years, 1; thirty-five years, 3; thirty years, 5; twenty-five years, 11; twenty years, 29; fifteen years, 42; ten years, 31. In succeeding issues some account will be given of the careers of these men and women.

As soon as a supply is received from the manufacturer, an emblem with an appropriate number of stars will be presented to each member of the Laboratories of ten years' service or more.

of the organization. An intensive training course of two weeks duration is, therefore, arranged by Maurice B. Long, Educational Director, and his associates. This is intended to give each of these new members of the Laboratories a fairly comprehensive view of the activities of the Bell System with particular reference to the function and contribution of the Laboratories. He acquires thereby a broad perspective. In addition he makes a very considerable personal acquaintance, becomes familiar with our routines, and receives technical information which will be generally useful in his later work.

This year the survey for incoming graduates was conducted for three groups, one starting July sixth, another July twentieth, and the third, September fourteenth. A photograph was taken of each group and these photographs have now become part of BELL LABORATORIES RECORD.

The first day of the survey was devoted to a general introduction in which the men met alumni of their respective colleges at luncheon, were informed as to the geography of the vicinity, and obtained from a talk by George B. Thomas the outline and purpose of the survey. The remainder of the two weeks was spent in visits to the laboratories, listening to talks by department heads and specialists on technical matters, and in visits to the Longacre Office and the Long Lines offices in the Walker-Lispensard Building. The survey supplied information as to general matters of organization and routines through talks by M. B. Long, L. S. O'Roark, Kenneth B. Doherty, and John Mills. Preliminary technical information was given by a showing of moving pictures and talks by Paul C. Hoernel and F. C. Manderfeld.

Visits to laboratories and shops, and demonstrations of apparatus and



Top row: O. W. Main, Yale; R. L. Rockefeller, Brown; C. J. Calbick, Washington State; M. W. Baldwin, Jr., Cornell; W. M. Bishop, Miami University; C. W. Ramsden, University of Pennsylvania; A. W. Clement, University of Washington. Center row: C. A. Baker, University of Maine; L. W. Hodges, Columbia Law School; H. C. Cunningham, City College of New York; W. F. Kannenberg, University of Minnesota; R. T. Holcomb, Harvard; P. Hall, Harvard; C. V. Litton, Stanford; L. A. Morrison, University of Michigan; R. H. Freeman, University of Colorado; A. H. Lince, University of Michigan; G. H. Alexander, Pratt; O. A. Keefe, Massachusetts Institute. Bottom row: W. E. Wandell, Stevens; E. G. Shower, Johns Hopkins; J. E. Ruedy, Western Reserve; J. G. Nordahl, University of Washington; C. M. Blackburn, Chicago; F. E. Haworth, University of Oregon; A. R. Olpin, Brigham Young; A. J. Grossman, Rensselaer; W. S. Ross, Dartmouth; F. W. Webb, Greenville; W. E. Hinrichs, Haverford.

methods, together with talks by members of the technical staff, occupied the greater part of the two weeks. For this part of their program the introduction was a discussion of telephone terminology by Kenneth S. Johnson. Talks descriptive of our work were given by representatives of the several departments. Those who thus cooperated in introducing the new college men may be grouped by departments as follows:

For the Research Department, talks were given by R. V. L. Hartley, Robert C. Mathes, Harvey Fletcher, Joseph B. Kelly, Warren C. Jones, Charles R. Moore, Halsey A. Frederick, John C. Steinberg and Warren A. Marrison, who discussed problems of transmission, speech, hearing, articulation, and frequency measurements; and William Wilson, who talked on vacuum tubes and arranged the visit to the Vacuum Tube Laboratory.

For the Apparatus Development Department, talks were given by

William Fondiller and P. Norton on the work of the General Development Laboratory, and by William A. Evans, Charles W. Lowe, Frank H. Hibbard, Daniel D. Miller, and John R. Fry on problems of apparatus development; by William C. Redding and Frank B. Livingston on problems of cable development; and by Timothy E. Shea, Ralph H. Mills, and Louis A. Thomas on coils and filter development.

For the Systems Development Department, H. H. Lowry outlined the problems of equipment engineering, Burton W. Kendall, Charles W. Green, and Edgar D. Johnson discussed toll systems, carrier current, and repeaters. The problems of circuit development were introduced by William H. Matthies, and methods of operation of telephone systems by John V. Moran, U. S. Ford, and A. Kenner, who also supervised the visits to telephone offices.

Inspection Engineering was out-

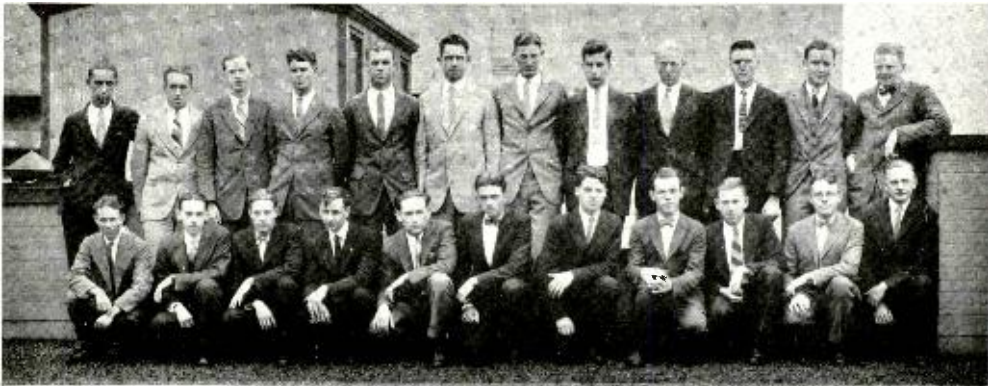

Top Row: H. R. Moore, University of Missouri; J. W. Brubaker, Union; W. B. Warren, University of California; P. W. Stroud, Pomona; J. C. Crouch, Mississippi A. & M.; A. B. Newell, Washington University; E. H. Bedell, University of Missouri; N. Botsford, Union; H. W. Newlund, Iowa State; W. R. Bennett, Oregon Agricultural; J. Dillon, Fordham; J. S. Zautzinger, Trinity; Bottom row: D. G. Angus, Cornell; H. T. Byck, New York University; W. P. Hilliker, Wooster; J. Kinzer, Stevens; E. A. Ewers, Rose Polytechnic; J. E. Greene, Penn State; R. K. McAlpine, Purdue; N. C. Norman, Indiana University; C. A. Boggs, California Institute; C. J. Brasfield, Princeton; H. K. Dunn, California Institute.



These college men have recently entered the D. & R. Department of the A. T. & T. Co., where they are pursuing an introductory survey course. Top Row: John W. Emling, University of Pennsylvania; Thomas A. McCann, Ohio State; Powell H. Humphries, Harvard; Doren Mitchell, Princeton; Kenneth G. Van Wynen, Cornell; Frank F. Shipley, Purdue; Richard P. Booth, M. I. T.; Frank A. Liebe, Stevens. Bottom Row: Walter D. Siddall, M.I.T.; Marcellus B. McDavitt, M.I.T.; Harvey N. Misenheimer, Coe College; Louis A. Dorff, Michigan; Alfred P. Jahn, Cornell.

lined in organization and responsibility by R. L. Jones. The Patent Department's functions were similarly discussed by Edgar W. Adams. Our Commercial Relations were explained by Harry E. Young.

A visit to the Model Shop was arranged by Adolph H. Sass, and a demonstration of a public address system by David G. Blattner. The various groups were marshalled from

laboratory to laboratory and their schedule maintained through the activities of Martin K. Kruger. A general view of the Laboratories was conducted by William C. Farnell and George F. Fowler.

Towards the end of each survey course the new men met Vice-President Craft in his office and heard from him, as man to man, of the ideals and policies which guide our work.



ADMITTED TO NEW YORK BAR

DURING the current year George H. Heydt, Walter C. Kissel, and Joel C. R. Palmer, all of our Patent Department, have been admitted to the bar of the State of New York.

Several other members of the Patent Department, including Edgar W. Adams, Harry A. Burgess, Guy M. Campbell, John A. Hall, Bennett H. Jackson, Irving MacDonald, Maurice R. McKenney, Guy T. Morris, John G. Roberts, James W. Schmied, and

Homer A. Whitehorn had previously, but since joining the Company, taken the bar examinations and been admitted to practice law in this State.

In addition to these men, a number are at present attending various law schools in and about the city of New York to prepare for the examinations. Some attend the night courses offered by New York University and the Brooklyn Law School; others the day course of the New York Law School.



OUR FAR-FLUNG OUTPOSTS

SEVERAL of our engineers engaged in toll developments have been in the field during the past few weeks. Ray S. Wilbur was in Seattle for two weeks in connection with the toll-dialing trial under way there. Joseph A. Krecek, Edward Vroom, and Herman A. Paulssen spent considerable time during the summer at Providence in testing a new type of repeater. John Meszar spent a week in Philadelphia and Atlantic City working on new toll switchboards in those two cities in advance of the heavy traffic which was expected for Labor Day. In Washington, John H. Bell co-operated with the local telephone people and M. C. Hall [D&R, AT&T], in testing an improved telegraph circuit between Washington and Atlanta.

William C. Redding, in an article entitled "All in One Day's Work" published in the *Western Electric News*, tells of the repair work under his supervision on the Los Angeles-Catalina cable.

From the Laboratories several men are now in England. Joseph P. Maxfield, with the assistance of Paul B. Flanders and Thomas G. Kinsley, is introducing to licensees of the Western Electric Company electrical methods of phonographic recording and reproduction. Mr. Maxfield plans a brief tour of European broadcasting stations and studios. Arthur A. Oswald is conducting tests on the high power radio station which is being constructed by the Western Electric Company, Ltd., at Rugby. After an absence of two months in England Oliver E. Buckley has now returned.

Lloyd Espenschied [D&R, AT&T] is in attendance at the International Telegraph Conference in Paris. The purpose of this conference, held by invitation of the French Government, is to consider the revision of the International Telegraph Convention first adopted in St. Petersburg in 1896 and last revised in 1908. This convention contains regulations in accordance with which a large part of the international telegraphic communication of the world is conducted. It has been the historic policy of the American Government not to adhere to this convention but when periodical meetings are held to send one or more representatives who act somewhat in the capacity of unofficial observers. At the Paris meeting, the same policy will be followed; several representatives of our Government will be present but will have no vote. Mr. Espenschied, with representatives of other American communication companies, is at Paris, but not in an official capacity.

William A. Knoop is stationed at Horta, on the island of Fayal in the Azores, conducting preliminary tests of terminal equipment used with the new permalloy-loaded Western Union cable. The trial equipment at Horta was installed during the latter part of 1924 under the direction of Allison A. Clokey, with the assistance of Mr. Knoop and Jesse F. Wentz. The distributors, channel equipment, and direction control apparatus for the trial installation were manufactured by the Model Shop. Similar equipment for the permanent installation is now under construction in the Shop.

BELL SYSTEM RESEARCHES

As Recorded In Articles Recently Published

LOADING TELEPHONE CABLE—The adoption of long loaded cable for toll use has given telephone engineers a whole new series of problems; for as advances have been made in the technique of long distance communication, it has been necessary constantly to study and often to modify radically the design of loading coils. In a paper¹ by William Fondiller some of these advances are outlined, especially the development of phantom loading apparatus. The Campbell-Shaw system, (the one in use by the Bell System), and the Olson-Pleijel and Fbeling systems are described and illustrated with diagrams. A number of tables show in an illuminating way the characteristics and applications of several of the more important types of loading coils used in the Bell System.

FREQUENCY CHARACTERISTICS OF HEART AND LUNG SOUNDS—The work of Richard H. Cabot, M.D., of Boston, in analyzing heart and lung sounds by means of the Western Electric electrical stethoscope, is recounted in this issue by Mr. Snook. A paper² giving in somewhat more detail the results of these experiments has been published by Dr. Cabot and Harold F. Dodge of our Laboratories. A large number of cases in the Massachusetts General and University of Pennsylvania Hospitals is analyzed, and tables are given showing the bands of frequencies within which lie the characteristic heart murmurs and breathing sounds.

SPEECH AND HEARING—A number of numerical constants useful in the study of speech and hearing are given by Harvey Fletcher.³ His paper does not record new researches but gathers together in convenient form a number of tables and diagrams which have appeared at various times in different publications.

CONTEMPORARY ADVANCES IN PHYSICS—THE ATOM MODEL—“Like railway time-tables, atom models should be inscribed ‘subject to change without notice.’” Karl K. Darrow gives this warning early in the first of three papers on the “Atom Model”⁴; and he proceeds to pile up the evidence which is principally used in designing the atom models of today. And the evidence which has been so used is extensive; extraordinarily so, considering how difficult it is to devise an atom model competent to account even for a few facts.

Dr. Darrow’s first paper is devoted chiefly to the “facts of observation” which the atom model known by the names of Rutherford and Bohr—the present favorite among physicists—is designed to interpret. A brief description of the model is included; a more detailed account is reserved for the following papers.

CHARACTERISTICS OF TELEPHONE RECEIVERS AT LOW POWER INPUTS—One of the most sensitive detectors of weak alternating currents, over voice frequencies, is the ordinary telephone receiver. An investigation carried on

¹*Electrical Communication, Vol. IV, No. 1, July, 1925.*

²*Journal of the American Medical Association, Vol. 84, No. 24, June 13, 1925.*

³*Bell System Technical Journal, Vol. IV, No. 3, July, 1925.*

⁴*Bell System Technical Journal, Vol. IV, No. 1, July, 1925.*

by the Western Electric Company in 1918 and 1919, the results of which were only recently published⁵ by A. S. Curtis, showed that such an instrument as the Western Electric No. 509 Receiver—the one commonly used in radio—would respond audibly to a current of the order of 10^{-9} amperes. This is a very feeble current indeed; so feeble that the extent of the motion which it causes is less than the distance from one side to the other of a single molecule of the diaphragm material. Impedance and vibratory characteristics of the receiver remain practically unchanged as the current is reduced until no sound can be heard.

INSTRUMENTS AND METHODS FOR TESTING AND MEASURING—An arrangement of tape-wound springs which effectively protects delicate instruments from jar is described by Alfred L. Johnsrud.⁶ This device was designed some years ago by Henry C. Harrison and Joseph P. Maxfield. Due to the weight (about 120 pounds) of the frame of the suspension system, and to the careful proportioning of its mass, it protects instruments from the tilting and twisting impulses sometimes necessary for their adjustment, as well as from building vibration.

A null-reading astatic magnetometer of novel design, suitable for measuring the magnetic properties of small amounts of materials in the form of fine wires or thin strips or of thin deposits on non-magnetic materials, is described by Richard M. Bozorth.⁷ The magnetometer consists essentially of a magnetizing coil, two balancing coils, and two suspended needles whose position is indicated by a mirror and scale.

A resistance potentiometer arrange-

ment for measuring at radio frequencies voltages down to about one-tenth micro-volt, is the subject of a paper⁸ by Axel G. Jensen. A vacuum tube generator, a 700 ohm thermocouple in connection with a microammeter, and a potentiometer are the important parts of the instrument. The potentiometer is compactly built (the resistance units being of No. 36 B. & S., or smaller, manganin wire D.S.C., non-inductively wound on a hard rubber toroid) in order to minimize capacity effects and for convenient use in the field.

ELECTRONIC PHYSICS—Three papers by John B. Johnson,⁹ Lester H. Germer,¹⁰ and Clinton Davisson,¹¹ have to do with certain characteristics of thermionic emission. Mr. Johnson studies the irregularities in the thermionic currents from filaments which result from the statistical nature of electronic emission. A formula stated by Schottky was carefully tested but was found to apply only at certain frequencies, the experimental results being often widely at variance with the results predicted by his formula, especially in low frequency circuits.

Mr. Germer's paper and that of Mr. Davisson have to do with the distribution of initial velocities among the electrons emitted from a tungsten filament. The experimental results show that electrons stream from a filament in much the same way that gas molecules escape through a small orifice—that is, with velocities depending upon the mass and temperature of the particles in the way predicted by the kinetic theory of gases.

MAGNETISM—Data obtained in a study of the effect of tension upon the magnetic behavior of a number of

⁸*Physical Review, 2d Ser., Vol. 26, No. 1, July, 1925.*

⁹*Physical Review, 2d Ser., Vol. 26, No. 1, July, 1925.*

¹⁰*Physical Review, 2d Ser., Vol. 25, No. 6, June, 1925.*

¹¹*Physical Review, 2d Ser., Vol. 25, No. 6, June, 1925.*

samples of permalloy containing various proportions of iron and nickel are set forth and analyzed in detail by Oliver E. Buckley and Louis W. McKeegan.¹² Conclusions as to the magnetostrictive behavior of the nickel-iron alloys are drawn from these data, and are further interpreted by Mr. McKeegan¹³ as a distinct contribution to the theory of ferromagnetism. He suggests that in every ferromagnetic material, the process of magnetization involves both intra-atomic and inter-atomic changes, the latter being evidenced by the phenomenon called magnetostriction. As nickel shortens and iron lengthens when magnetized, it seems reasonable to expect that when these two metals are properly alloyed, the two sorts of inter-atomic strain should to a large extent be compensatory, with the

¹²*Physical Review*, 2d Ser., Vol. 26, No. 2, August, 1925.

¹³*Physical Review*, 2d Ser., Vol. 26, No. 2, August, 1925.

result that the alloy will have high permeability and low hysteresis losses—which, of course, are the characteristics of permalloy.

TELEPHONE TRANSMISSION—A graphic representation of the impedance of networks containing resistances and two reactances, illustrated by numerical examples, is given¹⁴ by Charles W. Carter, Jr.¹⁵ A network consisting of any number of resistances combined in any way, is provided with three pairs of terminals, two of which are connected variable pure reactances formed of capacities and self and mutual inductances. The two reactances are not connected to each other by mutual reactance, but may be of any degree of complication within themselves. The problem investigated in this paper is the driving point impedance of such a network.

¹⁴*Bell System Tech. Journal*, Vol. II, No. 1, July, 1925.

¹⁵*Of the American Tel. & Tel. Co.*



WHEN THE ALARM RINGS

IN front of me on my desk is an odd little mechanism. Its backbone is a piece of black faced fibre a scant inch and three-quarters long by seven-sixteenths wide (I've just measured it). The ends are notched, one notch lengthways of the piece, the other sideways. The backbone around the notches is covered with tinned copper, which near one end rises to form a wide thin post and at the other holds a flat spring on the opposite or under side. Soldered to the post is the inner end of a brass coil spring, the free end of which carries a bit of white glass tube. Close to the glass tube a tiny wire is soldered to the spring. This

wire runs through a small oval hole in the fibre backbone, and holds the flat spring on the other side close to the fibre.

Of course this little mechanism is none other than the ubiquitous 35-type fuse. Wherever you go you find them protecting the exchange equipment. In manual offices, for example, each cord circuit has its 35-type fuse; while subscribers' circuits, ringing circuits, and most tone circuits are protected in small groups by these fuses.

There are two customary methods of locating them in central offices. Both of these depend on the fact that

it is usually economical to place the fuse near the first piece of apparatus occurring in the battery lead.

In local manual offices the fuses are mounted on a coil rack fuse panel located adjacent to the rack on which the cord and trunk coils are mounted. In toll offices they are placed on the toll or miscellaneous fuse panel as it is variously called. In some cases, however, the fuses are put in the



Like a sore thumb: the indicator of the No. 35 Fuse "sticks out" when the fuse is blown

switchboard section on position fuse panels. In machine switching installations the apparatus is mounted in groups of definite size concentrated in a small area. For this reason it becomes economical in these offices to provide a separate fuse panel for each frame or group of apparatus, with a miscellaneous fuse panel in addition.

The 35-type fuse itself has several sizes, ranging from 1/2 ampere to 5 amperes. The 1 1/3 ampere size is the most widely used variety. It is rated to blow in one and a half minutes when subjected to a current of 2 amperes. When a fuse blows, the tiny wire connecting the coil spring on top to the flat spring on the bottom is burned out, releasing both springs. The flat one on the bottom instantly

makes contact with an alarm bar or terminal on the panel. The spring is in the battery lead, while the alarm bar is connected to ground through a lamp and a relay which controls a bell circuit. Thus the blowing of the fuse lights a lamp and starts a bell ringing. At the same time the coil spring on the top of the fuse flies up, carrying the bit of glass tube (the bead, it is called) to a position parallel with the panel.

It is interesting to note that the patent on the 35-type fuse, applied for in 1904, was the first of a long series by Mr. Craft. The visual signal consisting of the spring and glass bead essentially constituted his contribution.

In order to distinguish the different sizes of fuse, three features are varied. The 1/2 ampere fuse has tinned copper terminals notched to take No. 10 screws, and a red bead. The standard 1 1/3 ampere size is the same except that the bead is white. The larger sizes which have been standardized by the American Telephone and Telegraph Company all have plain copper ends, and are notched for No. 6 screws. In general, every effort is made to keep current val-



*Good Blown
Two side views of the No. 35 Fuse*

ues to 1 1/3 ampere or less, and the 1 1/3 ampere fuse is by far the commonest type.





IN THE MONTH'S NEWS

SERGIUS P. GRACE has been elected vice-president of the New York Electrical Society. He is also a member of the Committee on Communication of the American Institute of Electrical Engineers.

THE PHOTOGRAPH of Edward B. Craft in the September issue of the *Record*, which aroused a great deal of favorable comment, was taken by Herbert Maude in our Photographic Department.

ACCORDING TO AN ARTICLE by C. B. Jolliffe, of the Bureau of Standards, W E A F is the only major broadcasting station which has consistently maintained its assigned frequency during the year in which the Department of Commerce has interested itself in broadcasting. Maintaining frequency exactly eliminates the whistling sound of the station itself, and facilitates the finding of desired stations on the dial.

RAYMOND L. WEGEL has been elected an honorary member of the American Otological Society in recognition of his contribution to the knowledge of the dynamics of the human ear.

DURING THE COURSE of experimental work with lead alloys, carried on by R. S. Dean, physical chemist, and his assistants at the Hawthorne Plant of the Western Electric Company, a heat-treated lead-antimony alloy was developed which is considerably harder than the ordinary product of its type. Starting with a mixture containing about two and one-half per cent antimony and slight traces of other metals, and having a breaking strength

of 4,000 pounds per square inch, there can be made by Mr. Dean's method of heat treatment, a product with a breaking strength of 11,000 pounds or more. The hardness is proportionally increased.

It is believed that this alloy, while probably not suitable for cable sheaths on account of its rigidity, may be useful for storage batteries, type metal and tank linings.

FRANCIS M. CRAFT, brother of Edward B. Craft and well known to many of our engineers, has been appointed chief engineer of the Southern Bell Telephone Company. Mr. Craft entered the Western Electric engineering department at Hawthorne in 1905, going into the associated company field in 1916.

SAMUEL F. BUTLER will attend the Twelfth Annual Meeting and the Fourth Meeting of the General Assembly of the Telephone Pioneers of America as our delegate from Edward J. Hall Chapter, No. 25. These meetings will be held in the Mayflower Hotel, Washington, D. C., October 16-17, 1925.

CLARENCE H. AMADON is a member of the Committee on Timber, American Society for Testing Materials, and Committee on Non-Pressure Treatment of Poles, American Wood Preservers' Association.

HARRY N. VAN DEUSEN is Chairman of the Committee on Molded Insulating Materials and also a member of the Committees on Slate, and Electrical Insulating Materials of the American Society for Testing Materials.

STORAGE "B" BATTERY TRUCK

HERE and there through our building one can see big "tea wagons" with row upon row of dry cells inclined in slots along the sides. The cells, though the best of their type, wear out too fast, giving but scant warning before their final collapse; their replacement is a time-wasting job; and most annoying of all, they take up badly needed floor space.

Some time ago in the Research Service group William A. Mueller investigated the feasibility of using storage cells, mounted compactly and neatly in a well-constructed truck. It took some time before the proper equipment could be secured; but it was secured, tested and approved. Now these trucks are available, and several are already in use in different laboratories.

The new storage "B" battery and its truck have various interesting features. The battery is made up of small storage cells with substantial terminals, covered to prevent leakage, and is designed throughout for long service. The truck is made in sizes for 120 and for 240 volts.

Each has a rugged wood base equipped with heavy duty casters, a steel frame, a control panel at one end, and an expanded metal guard over the top. Switches, keys, and meter are on the face of the control panel; the fuses, connection sockets, and other apparatus are on the back. The sockets are at the top, so that plug connectors can be inserted from outside the metal guard. When the fuses need replacing, a hinged door in the top of the guard permits access.

For 120 volts the truck has a single

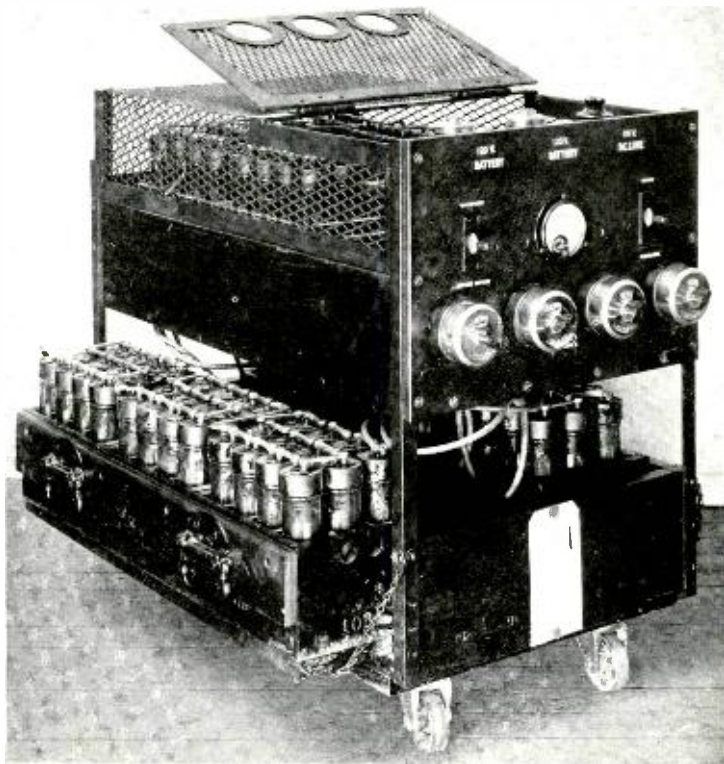

*TWICE THE VOLTAGE IN THE SAME SPACE
The New 240 Volt Storage "B" Battery Truck With Half of the Lower
Tier of the Battery Drawn Out for Inspection*

tier of batteries and is approximately the size of that for dry cells. However, the storage batteries have a much greater ampere-hour capacity and can supply two, and sometimes more, circuits of the type served by the old batteries.

The 240 volt equipment, in proportion to its voltage, is even more economical of space since both trucks have practically the same base. Its lower tier of cells is held in two trays. At the bottom of the truck low sides open out on hinges and are held horizontal by chains. Onto the shelf thus formed the tray slides out for inspection, repair, or replacement of cells. The upper tier is reached by removing the expanded metal guard, just as in the case of the 120 volt truck. The two tiers, of 120 volts each, are wired for charging either separately or in series, and proper switches are provided for that purpose.



PATENTS

DURING the month of August, twenty-one patents were granted to the following engineers of the American Telephone and Telegraph Company:

H. S. Osborne	J. Herman
H. Nyquist	J. F. Toomey *
E. Dietze	L. Espenschied
O. B. Blackwell	J. M. Fell
R. E. Pierce	D. K. Gannett
M. Kirkwood	P. Mertz
G. S. Vernam	H. A. Affel

**Now of the Bell Telephone Laboratories.*

Forty-three patents were issued to the Western Electric Company, of which thirty-seven were the results of inventions of the following engineers of our Laboratories:

J. O. Gargan	E. Vroom
W. L. Casper	E. L. Schwartz
J. S. Jammer	H. Phannenstiehl
P. H. Pierce	J. B. Speed
A. H. Falk	R. A. Heising
W. J. Shackleton	H. Fletcher
J. J. Gilbert	John Mills
H. M. Stoller	E. R. Morton
W. G. Houskeeper	A. A. Clokey
M. B. Long	F. A. Hubbard
P. C. Smith	H. W. Weinhart
S. B. Williams	E. H. Clark
C. L. Goodrum	L. H. Johnson
M. B. Kerr	H. D. MacPherson
J. W. Gooderham	J. F. Hearn
H. A. Frederick	A. Haddock
E. B. Craft	A. M. Curtis

Thirty-six applications were filed on inventions made by the following Bell Laboratories engineers:

S. E. Anderson	K. S. Johnson
W. M. Beaumont	W. C. Kiesel
A. F. Bennett	F. A. Kuntz
F. A. Bonomi	C. R. Moore
W. Bruce	H. W. O'Neill
C. A. Clarke	F. X. Rettenmeyer
A. S. Curtis	J. C. Schelleng
G. W. Elmen	O. A. Shann
C. B. Fowler	T. E. Shea
J. C. Gabriel	R. Stokely
E. V. Griggs	H. M. Stoller
R. A. Heising	A. L. Thuras
H. E. Ives	G. Thurston

When it is remembered that patents are but one expression of the scientific development work of our Bell System, and that this output is for one month of the vacation season, there is obtained a new picture of the productivity of the System. There is also evident the impracticability of presenting in magazine pages month by month any adequate description of such a large number of patentable novelties.

It is also true that important technical advances today usually involve so many interrelated inventions and developments that the separate description of individual inventions might give an imperfect idea as to the progress of our communication art.



CLUB NOTES

David D. Haggerty, Secretary

TELEPHONE SYSTEMS 13 —TUBE SHOP 7

By defeating the Tube Shop Team 13 to 7 at Friends Field, Saturday, September 12, the Telephone Systems



David D. Haggerty

Team carried off the baseball league championship of the Bell Laboratories Club for the second time in two years.

Decidedly closer than the score would seem to show, the game was without doubt the hardest fought contest of the entire season. Telephone Systems had not lost a game, while Tube Shop was charged with one defeat; winning this game would create a three cornered tie between Telephone Systems, Commercial, and Tube Shop; and would give each another chance to play for the Spalding Trophy.

Lew Drenkard's excellent pitching for Systems was ably backed up by his team-mates. They made 14 hits, of which one, a home run, was slammed out by Bill Trottere. The Tube Makers fought an uphill battle all the way and had a chance to win when they tied the score in the sixth inning. However, this advantage was lost when the Systems hitters put six runs

over the plate in the eighth inning. The score:

Tube Shop	0 0 0 0 2 2 2 0 1 — 7
Telephone Systems	0 1 0 4 1 0 1 6 x — 13

Batteries: Laucella and Keiper; Drenkard and Prichard.
Umpire: Bartheld.

The semi-windup of the 1924 baseball season came on August 27 with the defeat of Western Electric's "G H Q" team from 195 Broadway. It was the first defeat for that team of the current season and our players are to be congratulated for their splendid showing.

The game had been well advertised and about three hundred spectators



Bart Lays Down the Law: Captain Angelo Kontis (Tube Shop); Leslie P. Bartheld, Manager of Baseball; Captain Bill Trottere (Telephone Systems)

were present at Friends' Field, Brooklyn. Both teams were prepared for a hard struggle. G H Q scored their first and only run in the first half of the first inning. In our half of that inning Krumenaker knocked out a home run, scoring Trottere. This practically decided the game for thereafter the G H Q players were unable to solve Kuhlmann's delivery. In the fifth inning our team scored five runs from seven hits. The box score follows:

	R	H	E
G H Q.....	1	0	0
B L C.....	2	1	1

0 0 0 0 0—1 4 3
0 0 0 0 0—9 12 1

Batteries: Reid and Goodrich; Kuhlmann and Flynn.

Umpire: Jack Murray of A. G. Spalding & Company.

L. P. Bartheld has now lost that worried look. However, the cares of baseball manager still rest heavily on Bart's shoulders.

The Telephone Systems team played

two games outside the Club League, losing to the New York Police Department by 4 to 14, but winning from W E A F by 5 to 3.

League Standing September 12, 1925

	Won	Lost	Percent
Tel. System.....	5	0	1000
Commercial.....	4	1	800
Tube Shop.....	3	2	600
Research.....	2	3	400
Development.....	1	4	200
Patent-Inspection.....	0	5	000

EQUITATION

Horseback riding classes were resumed on September 19, to continue each Saturday. Until cold weather intervenes all classes will be held in Van Cortlandt Park. When cold weather makes outdoor riding inadvisable, classes will be in the armory of the 105th Field Artillery at 168th Street. The Club has secured the

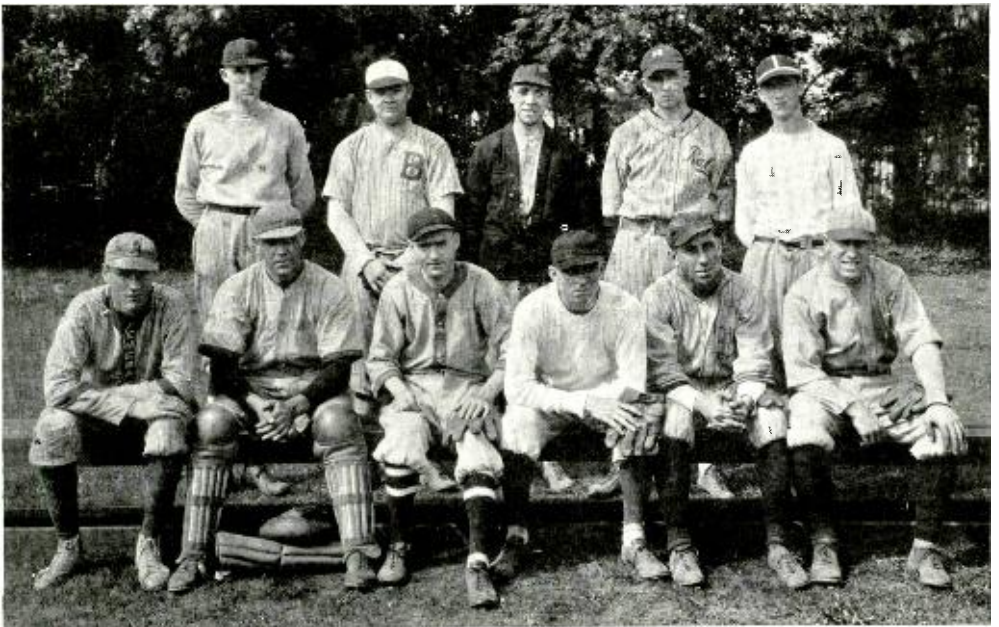

Victors by 13 to 7: Telephone Systems team. Standing: Harold Cahill, Pat Moran, Lew Drenkard Bill Trottere, Sid Brymer. Sitting: Jim Mallon, Ernie Pritchard, Mark Sloane, Whitey Baumfalk, Tommy Ingram, Cy Corwin

services of three competent instructors and our members are invited to participate in this delightful and beneficial sport.

For Club members who live in Brooklyn, arrangements have been completed with the Unity Riding Academy, Ocean Parkway, whereby members may obtain horses, without instruction on Sunday at a reduced fee.



Henry M. Yates, well-known Metropolitan sprinter and captain of the track team

Marion Gilmartin will gladly furnish information regarding riding classes.

TRACK AND FIELD

During the past two years the Club athletic teams have competed with other organization teams with great success, as is attested by the baseball, basketball, and bowling trophies in our trophy case. But there are no trophies for track and field events. This autumn we hope to organize a team which will represent our Club successfully in various industrial indoor meets.

Henry M. Yates, who has been chosen captain, has had an exceptionally successful track record, winning the "Melrose 300" at the Melrose Meet last winter.

All Club members who have had any experience on High School or other track teams are urged to come out for the team.

CARDS

Members who have attended any of the Club's auction bridge parties

will be interested to know that plans have been made to play, twice each month during the winter season, in our West Street building. A small fee will provide prizes for the three best scores at each party. Merwin N. Smalley will be glad to give further particulars.

PHYSICAL TRAINING FOR WOMEN

During the spring the Club embarked upon a venture which proved to be exceptionally popular. It organized a class for women in physical training and swimming. Discontinued during the summer, the work will be resumed in October under competent instructors. Girls who attended the spring classes feel that they derived great benefit as well as pleasure from the work; and they can be of great



Miss Janet Johnson, director of athletics for women

aid in increasing the roll call this season. There will be no charge for membership in either of the classes. All girls who expect to go out for basket-ball and track are particularly urged to take up this work.

The winter's activities will be announced from time to time through bulletin board notices and other information may be obtained from Ervin Hence or Janet Johnson.

THE GIRLS' SWIMMING MEET

A swimming and diving meet is planned for December, providing a

sufficient number of entries are received. Various water sports will be included in the list of events. Attractive prizes will be offered. Our women members have always excelled in the various sports in which they have competed and it is expected that this meet will bring out all of our expert swimmers.

All who are interested are requested to communicate with Miss Ervin Hence or Miss Janet Johnson. As soon as the minimum number of entries are received, the dates will be selected and the details published.

GIRLS' BASKETBALL

On Wednesday, October 14, a meeting will be held in the Rest Room to discuss basketball plans for the coming season. Two delegates from each group will be present.

In addition to the usual inter-department games, a series of games between teams made up from selected players are being planned. The practice period will be short for the latter groups. Prizes will be awarded for both series.

SEWING

The success of the sewing class of last season was such as to encourage its continuation this year. A new class is to begin in November with meetings twice a week in the eleventh floor Rest Room. Designing, cutting, fitting, and finishing will be under the supervision of an expert. There will be a charge of fifty cents per lesson. Club members who are interested should communicate with Miss Hence.

HIKING

Are you a lover of the out-doors and do you enjoy tramping in the country? If so, the Hiking Club will be

glad to welcome you as a member. Weekly hikes were resumed on September 19. With the assistance of an expert from a national walking club, an enjoyable autumn schedule has been planned. There will be a hike every week, sometimes on Saturday, occasionally on Sunday and on all Holidays, to points of interest in and about New York. Interested members should call Phyllis Barton or Nelson E. Sowers.

DANCING

Do you know that the Club is giving a dance at the Pennsylvania Hotel on Monday evening, November ninth? The Grand Ballroom of the Pennsylvania has been engaged and there will be dancing space for all. Music by Hood's orchestra, which furnished the music for several of our dances in the past. The Glee Club will present some special numbers and tables will be provided for those who desire to play bridge.

Tickets, as usual, will be \$1.10 and may be obtained from departmental representatives or the Club Secretary.



In Perfect Harmony: Conductor Zammataro and Director Costello agree on the phase relations in an orchestral passage

MUSIC CLUB

The Music Club includes the Glee Club, the Symphony Orchestra, and the Dance Orchestra. The Club has been under the direction of Frank Costello since the first of the year and a very successful season is anticipated. New members are welcome in the Music Club. Any who are interested should consult Director Costello, or the manager of either the Glee Club or Orchestras.

Reinhold Petersen, Manager of the Glee Club, has outlined a very interesting program for our songsters. The first rehearsal of this season was on September 21. Hereafter rehearsals will be Mondays at 5:10 P.M. At present the Club is rehearsing selections to be broadcast by W E A F sometime in October.

Both the Symphony and Dance Orchestras are under the able direction of Samuel J. Zammataro. They have had initial rehearsals and their season is well under way.

CHESS

The chess season opens this month. A strenuous program is in prospect. For two years Bell Laboratories Club has entered a team in the Commercial Chess League of New York and each year has won the league championship without losing a match. In so doing, it has gained two legs on the Potter

Trophy which will become our permanent possession if we win again this season. We have been told that we may expect to encounter stronger teams this year.

The telegraph match with Hawthorne is one of the most important games of the season. We won two years ago but Hawthorne defeated us last March by a small margin. So the cup is now in Hawthorne and our team is determined to bring it to West Street again.

All interested in chess are cordially invited to attend games and new players will be welcomed. Notices of games will be posted on the bulletin boards.

BOWLING

The Bowling League season opened September 25th at Recreation Alleys in Brooklyn. At 5:45 P. M. Herbert Bostater rang the bell, formally opening the season of twenty-eight weeks for twenty-four teams. The enthusiasm of this first night indicates that the 1925-26 season will be the best in Club annals.

Chairman Bostater is always looking for new bowlers. Arthur Dring and William A. Bollinger are on the Substitute Committee this season. All Club members interested in bowling either as part-time or regular bowlers are urged to notify them.



Spalding Baseball Trophy Won by Tel. Systems Team with a percentage of 1000

TUBE SHOP MEN HAVE ANNUAL OUTING

by O. J. Short,

Board of Advisors, Bell Laboratories Club

ON Saturday, August 29, the men of the Tube Shop enjoyed their second annual outing and clambake at Glenwood Landing, Long Island.

They left Houston Street at eleven that morning and arrived at Glenwood Landing, after a very enjoyable bus trip, at one o'clock, just in time for dinner. After dinner there was a baseball game between the married and single men, which was captured in the tenth inning by the married men who came from behind to tie the score in the ninth inning. The married men had the old punch in the closing innings while the single men could not do much with the pitching of P. Laucella who seemed to grow stronger as the game progressed.

After the game there were various athletic events, the most interesting of which were the tug of war between the Pump and Assembly Departments, and the fat men's race. In the tug of war the Pump Department had things all its own way and won

easily. Things were different in the fat man's race with three of the largest men in the Tube Shop, Schwerin, McNally, and Bosch. They made an exciting finish, McNally just nosing Schwerin out at the tape, with Bosch a close third.

The games over, the boys all tramped down to the dining room with the exception of Walter Bensburg, who ran. After supper there were songs, old and new, with our own talent doing their stuff. The feature of the evening was the singing of "Schnitzelbank" with Paul Schwerin conducting and William C. Just at the Piano.

BOX SCORE OF THE GAME

Married Men	1 3 0 0 0 2 0 0 3 4—13
Single Men	0 0 1 3 4 1 0 0 0 1—10
Batteries: Married Men—Laucella, Short and Leykam.	
Single Men—Thoesen, T. Smith; Doyle and Rupp.	



The Merry Men of the Tube Shop: Pumps, ovens and torches forgotten, they frolic on the shore of Hempstead Harbor